

# JASN

KIDNEY WEEK EDITION

Journal of the American  
Society of Nephrology

## Abstract Supplement





# KIDNEY WEEK **20 22**

## Abstract Supplement

### Abstract Publication

More than 3,000 abstracts are published in this supplement. Abstracts are arranged by the abstract type\*\*, then by presentation date\* for orals, and then by chronological publication number. Abstracts with a "PUB" number will not be presented at the ASN Annual Meeting.

\* TH = Thursday, FR = Friday, SA = Saturday

\*\* OR = Oral, PO = Poster, PUB = Publication Only

The presenting author's name is underlined.

### Abstract Author Index

The Author Index lists all abstract authors in alphabetical order. To locate an abstract, first reference the abstract type (OR, PO, or PUB) and then the presentation day for orals (TH, FR, or SA), and then the chronological publication number.

### Abstract Keyword Index

The Keyword Index lists major keywords from each abstract in alphabetical order. To locate an abstract, first reference the abstract type (OR, PO, or PUB) and then the presentation day for orals (TH, FR, or SA), and then the chronological publication number.

### Abstract Reference Format

To cite abstracts in this publication, please use the following format: Author Names: Abstract Title [Abstract]. *J Am Soc Nephrol* 33, 2022: Page(s).

### Abstract Disclaimer and Copyright

This abstract issue of JASN® contains proprietary information belonging to the American Society of Nephrology. It is published as a service for the personal, noncommercial, and informational use only of the kidney community. Any commercial use is strictly prohibited. ASN's program materials and publications facilitate scientific discourse for educational purposes. ASN accepts no responsibility for any products, presentations, opinions, statements, or positions expressed, and inclusion of such materials within Kidney Week and other ASN publications or online postings does not constitute endorsement by ASN.

### Abstract Experts

Abstract submissions were rigorously reviewed and graded by multiple experts. ASN thanks the abstract category chairs and reviewers for assistance with the abstract process. The ASN website lists all abstract experts.

### ASN General Information

#### Kidney Week Program and Presentations

The Kidney Week program, which can be found on the ASN website, includes:

- Plenary Sessions
- Basic/Clinical Science Sessions
- Clinical Practice Sessions
- Translational Sessions
- Special Sessions
- Educational Symposia
- Oral Abstract Sessions
- Poster Sessions

#### Disclosure Statement

ASN requires all individuals in a position to control content for Kidney Week to complete a disclosure form. Responses are listed on the ASN website.

#### Trademark

The American Society of Nephrology, ASN, Kidney Week, CJASN, JASN, Kidney360, nephSAP, and *ASN Kidney News* are registered trademarks of ASN.

#### Contact ASN

American Society of Nephrology  
1401 H Street, NW, Suite 900  
Washington, DC 20005  
Phone 202-640-4660  
email@asn-online.org  
www.asn-online.org

TH-OR01

**Clonal Hematopoiesis of Indeterminate Potential Is Associated With a Higher Risk of Incident AKI**

Caitlyn Vlasschaert,<sup>1</sup> Alexander Bick,<sup>2</sup> Michael J. Rauh,<sup>1</sup> Matthew B. Lanktree,<sup>3</sup> Morgan Grams,<sup>5</sup> Bruce M. Psaty,<sup>4</sup> Anna Kottgen,<sup>6</sup> Nora Franceschini,<sup>8</sup> Holly J. Kramer,<sup>7</sup> Bryan R. Kestenbaum,<sup>4</sup> Cassianne Robinson-Cohen,<sup>2</sup> TOPMed Kidney Working Group<sup>1</sup> *Queen's University, Kingston, ON, Canada;* <sup>2</sup>*Vanderbilt University Medical Center, Nashville, TN;* <sup>3</sup>*McMaster University, Hamilton, ON, Canada;* <sup>4</sup>*University of Washington, Seattle, WA;* <sup>5</sup>*Johns Hopkins University, Baltimore, MD;* <sup>6</sup>*Albert-Ludwigs-Universitat Freiburg, Freiburg im Breisgau, Germany;* <sup>7</sup>*Loyola University Chicago, Chicago, IL;* <sup>8</sup>*The University of North Carolina at Chapel Hill, Chapel Hill, NC.*

**Background:** Clonal hematopoiesis of indeterminate potential (CHIP) is a common, age-related process wherein an acquired driver mutation in a hematopoietic stem cell produces a resilient clonal leukocyte population with dysregulated inflammatory signaling. The presence of CHIP has been associated with the progression of chronic kidney disease. We tested whether CHIP is a novel risk factor for acute kidney injury (AKI) in two community-based cohorts.

**Methods:** We evaluated participants from the Atherosclerosis Risk in Community (ARIC; N = 10,570) and Cardiovascular Health Study (CHS; N = 2,792). We identified somatic DNA mutations in peripheral leukocytes that met established criteria for CHIP using whole exome and whole genome data. AKI events were previously ascertained in both cohorts based on hospitalization codes with additional validation by manual chart review in CHS. We used proportional hazards regression to test associations of CHIP with AKI after adjustment for relevant confounders.

**Results:** CHIP was identified in 7.6% of ARIC participants (median age: 58) and 14.5% of CHS participants (median age: 72). The incidence rate of AKI was higher among persons with CHIP in both cohorts: 12.6 vs. 10.4 events per 1000 person-years in ARIC and 6.6 vs. 4.4 events per 1000 person-years in CHS. In a fixed-effects meta-analysis adjusted for age, age<sup>2</sup>, sex, and baseline eGFR, the presence of CHIP was associated with an estimated 18% greater risk of AKI (HR 1.18, 95% CI: 1.02 – 1.37). The risk for AKI was greatest for mutations in driver genes other than DNMT3A (non-DNMT3A CHIP; HR 1.29, 95% CI: 1.07 – 1.55).

**Conclusions:** CHIP is associated with a greater risk of incident AKI in two large community-based cohorts. Non-DNMT3A CHIP mutations demonstrate the strongest associations with incident AKI. CHIP may therefore be a novel risk factor for AKI that could partially explain the strong age dependency of this condition. Future studies will elucidate which subtypes of CHIP pose the highest risk of kidney sequelae and in which scenarios emerging treatments for CHIP would be beneficial.

**Funding:** Other NIH Support - NHLBI Trans-Omics for Precision Medicine

TH-OR02

**Leveraging AKI Recovery Patterns Reveals a Genome-Wide Significant Variant Associated With a Higher Risk of Non-Resolving AKI**

Pavan K. Bhatraju,<sup>1</sup> Ian B. Stanaway,<sup>1</sup> Rajasree Menon,<sup>2</sup> Jennifer A. Schaub,<sup>2</sup> Matthias Kretzler,<sup>2</sup> Talat Alp Ikizler,<sup>3</sup> Edward D. Siew,<sup>3</sup> Vernon M. Chinchilli,<sup>4</sup> Amit X. Garg,<sup>5</sup> Steven G. Coca,<sup>6</sup> Alan S. Go,<sup>7</sup> James S. Kaufman,<sup>8</sup> Paul L. Kimmel,<sup>9</sup> Chirag R. Parikh,<sup>10</sup> Mark M. Wurfel,<sup>1</sup> Jonathan Himmelfarb.<sup>1</sup> <sup>1</sup>*University of Washington, Seattle, WA;* <sup>2</sup>*University of Michigan, Ann Arbor, MI;* <sup>3</sup>*Vanderbilt University, Nashville, TN;* <sup>4</sup>*The Pennsylvania State University, University Park, PA;* <sup>5</sup>*Western University, London, ON, Canada;* <sup>6</sup>*Mount Sinai Health System, New York, NY;* <sup>7</sup>*University of California San Francisco, San Francisco, CA;* <sup>8</sup>*New York University, New York, NY;* <sup>9</sup>*The George Washington University, Washington, DC;* <sup>10</sup>*Johns Hopkins University, Baltimore, MD.*

**Background:** Genetic studies have focused on associations between genetic variants and the risk for AKI compared to controls, but this framework may be limited because AKI is highly heterogeneous. We hypothesized that a GWAS for distinct AKI recovery patterns (resolving versus non-resolving AKI) would identify novel and robust genetic risks for AKI.

**Methods:** We included 2,271 patients with AKI previously enrolled in three different studies of hospitalized patients (ASSESS-AKI, iSPAAR and HMC Trauma). Resolving AKI was a ≥ 0.3 mg/dL or ≥ 25% decrease in serum creatinine within the first 72 hours after AKI onset (n=1524) and non-resolving AKI was the absence of resolving (n=747). Array-based genome-wide genotypes were obtained from each dataset and imputed with Haplotype Reference Consortium v 1.1. We pooled results from all three studies and used an additive genetic model adjusting for site, age, sex, and the first 10 principal components (significance was  $p < 5 \times 10^{-8}$ ).

**Results:** We identified one variant (rs263152, C>T, frequency 29%) on chromosome 6 that achieved genome-wide significance with the T allele associated with a greater risk of non-resolving AKI (OR=1.47, 95% CI: 1.28-1.68,  $p=4.28 \times 10^{-9}$ ) (Figure 1). rs263152 is intronic to LOC153910, a long non-coding RNA. In each cohort, the minor allele of rs263152 was consistently associated with a greater risk of non-resolving AKI. Query of the NephQTL database revealed that rs263152 is a cis eQTL for AIG1 (Androgen Induced Gene-1) in tubulointerstitial cells ( $p=0.007$ ). AIG1 has been implicated in albuminuria in the Framingham Heart Study.

**Conclusions:** Identification of genetic risks for AKI may be facilitated by a focus on less heterogeneous sub-phenotypes, such as non-resolving AKI. Our findings suggest that genetic variation that alters expression of AIG1 confers greater risk of non-resolving AKI.

**Funding:** NIDDK Support

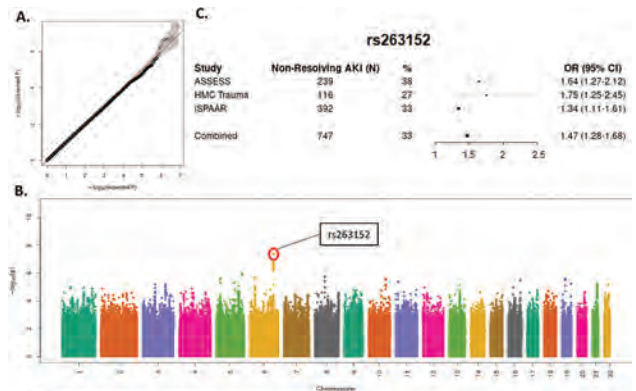

**Figure 1.** Genome wide significant variant is associated with non-resolving AKI compared to resolving AKI. A. Quantile-quantile plot showing overall adherence to expected p values. The genomic inflation factor based on a median chi-square was estimated at 0.997, indicating negligible variation in population structure between cases and controls. B. Manhattan plot demonstrates rs263152, an intronic SNP in chromosome 6, is significantly associated with a greater risk of non-resolving AKI (OR=1.47, 95% CI: 1.28-1.68,  $p=4.28 \times 10^{-9}$ ). C. Forest plot demonstrates a consistent direction of effect with the minor allele of rs263152 associated with a greater risk of non-resolving AKI in all three studies. The size of the boxes represents the sample size of each study.

TH-OR03

**Associations of Blood Mitochondrial DNA Copy Number With Risk of AKI After Cardiac Surgery**

Vasantha Jotwani,<sup>1</sup> Heather Thiessen Philbrook,<sup>2</sup> Ronit Katz,<sup>3</sup> Dan Arking,<sup>2</sup> Joachim H. Ix,<sup>4</sup> Gregory J. Tranah,<sup>8</sup> Sushrut S. Waikar,<sup>5</sup> Samir M. Parikh,<sup>7</sup> Mark J. Sarnak,<sup>6</sup> Michael Shlipak,<sup>1</sup> Chirag R. Parikh,<sup>2</sup> <sup>1</sup>*University of California San Francisco, San Francisco, CA;* <sup>2</sup>*Johns Hopkins University, Baltimore, MD;* <sup>3</sup>*University of Washington, Seattle, WA;* <sup>4</sup>*University of California San Diego, La Jolla, CA;* <sup>5</sup>*Boston University, Boston, MA;* <sup>6</sup>*Tufts University, Medford, MA;* <sup>7</sup>*The University of Texas Southwestern Medical Center, Dallas, TX;* <sup>8</sup>*California Pacific Medical Center, San Francisco, CA.*

**Background:** Mitochondria are necessary for recovery from ischemia-reperfusion injury due to their critical roles in oxidative phosphorylation. Mitochondrial DNA copy number (mtDNA-CN) is an indirect marker of mitochondrial abundance that has been used to quantify the number of mitochondrial genomes per cell. Prior epidemiologic studies have associated higher blood mtDNA-CN with reduced risks of chronic kidney disease and mortality, but to our knowledge no study has examined risk of acute kidney injury (AKI).

**Methods:** Among 628 adults undergoing cardiac surgery, mtDNA-CN was quantified in pre-operative blood buffy coat specimens using multiplexed SYBR Green-based qPCR. AKI was defined as >50% increase in serum creatinine or need for dialysis following surgery. Subclinical AKI was defined by the highest quintiles of urine interleukin-18 (IL-18), kidney injury molecule-1 (KIM-1), monocyte chemoattractant protein-1 (MCP-1), and chitinase-3-like-protein-1 (YKL-40) on the first post-operative day among those without clinical AKI. Multivariable logistic regression models were used to evaluate associations of mtDNA-CN with clinical and subclinical AKI.

**Results:** The mean age was 73±9 years and mean pre-operative eGFR was 72±18 ml/min/1.73m<sup>2</sup>. Each SD higher mtDNA-CN was associated with about a 38% lower risk of AKI (Table) in both unadjusted and multivariable adjusted models. There were no significant associations of mtDNA-CN with subclinical AKI, as defined by urinary levels of IL-18, KIM-1, MCP-1, or YKL-40.

**Conclusions:** Among adults undergoing cardiac surgery, higher pre-operative mtDNA-CN was associated with reduced risk of AKI but not with urinary biomarkers of tubular injury. mtDNA-CN may reflect kidney energetic reserve that promotes defense against acute ischemic stress.

**Funding:** NIDDK Support, Other NIH Support - NIA 2R01AG027002

**Table: Association of pre-operative mtDNA copy number with risk of AKI after cardiac surgery among TRIBE participants**

mtDNA-CN	AKI <sup>1</sup>	Odds Ratio (95% CI)	
		Unadjusted	Multivariable adjusted <sup>2</sup>
per SD higher <sup>3</sup> (N=628)	70 (11%)	0.64 (0.49, 0.84)	0.62 (0.47, 0.82)
T1 (N=209)	33 (16%)	1.0 (ref)	1.0 (ref)
T2 (N=210)	24 (11%)	0.69 (0.39, 1.21)	0.69 (0.38, 1.22)
T3 (N=209)	13 (6%)	0.35 (0.16, 0.69)	0.34 (0.17, 0.67)

Abbreviations: AKI, acute kidney injury; SD, standard deviation  
<sup>1</sup>AKI defined as >50% increase in serum creatinine or need for dialysis  
<sup>2</sup>Multivariable model adjusts for age, sex, pre-operative estimated glomerular filtration rate, diabetes mellitus, and heart failure  
<sup>3</sup>SD = 0.82

TH-OR04

**Oral Anticoagulant Therapy and Risk of Kidney Disease: A Nationwide Cohort Study**

Ane Emilie F. Vestergaard,<sup>1</sup> Simon K. Jensen,<sup>1</sup> Uffe Heide-Jørgensen,<sup>1</sup> Kasper Adelborg,<sup>1</sup> Henrik Birn,<sup>3,4</sup> Juan J. Carrero,<sup>2</sup> Christian F. Christiansen,<sup>1</sup> <sup>1</sup>Aarhus Universitet Klinisk Epidemiologisk Afdeling, Aarhus, Denmark; <sup>2</sup>Karolinska Institutet Institutionen för medicinsk epidemiologi och biostatistik, Stockholm, Sweden; <sup>3</sup>Aarhus Universitet Institut for Biomedicin, Aarhus, Denmark; <sup>4</sup>Aarhus Universitetshospital Nyremedicinsk Afdeling C, Aarhus, Denmark.

**Background:** Oral anticoagulant therapy may be associated with kidney complications. Emerging evidence from observational studies suggest lower risks associated with direct oral anticoagulants (DOACs) compared to vitamin K-antagonists (VKAs). However, these studies suffer from methodological limitations, which we aimed to address using the unique Danish setting of population-based medical databases.

**Methods:** We conducted a new user active comparator cohort study in patients who started oral anticoagulant drug use within three months after an incident atrial fibrillation diagnosis during 2012 to 2018. Using routinely collected creatinine measurements from laboratory databases, we followed patients in an intension-to-treat approach for acute kidney injury (AKI) and chronic kidney disease (CKD) progression. AKI was defined according to the KDIGO criteria; CKD progression was a composite of >30% decline in estimated glomerular filtration rate (eGFR) or kidney failure. Propensity-score weighting was used to balance baseline confounders; we reported weighted absolute risks using the Aalen-Johansen estimator and weighted hazard ratios (HRs) using Cox regression. Consistency was checked within prespecified subgroups.

**Results:** We included 33,670 persons with atrial fibrillation initiating oral anticoagulation with 77% in the DOAC cohort. The median age was 75 years, 48% were women, and 25% had a baseline eGFR <60 ml/min/1.73 m<sup>2</sup>. The median follow-up was 2.3 years. Absolute risks of kidney complications were high: During the first year of treatment the cumulative risk of AKI was 13.9% in the DOAC group and 15.5% in the VKA group; the 5-year risk of CKD progression was 14.0% in DOAC-users and 15.4% in VKA users. Compared to VKA initiation, DOAC treated patients had lower rates of both AKI and CKD progression with HRs of 0.85 (95% CI [0.81; 0.89]) and 0.84 (95% CI [0.78; 0.91]) respectively. Results were similar across subgroups of age, sex, baseline eGFR, and diabetes.

**Conclusions:** Kidney complications were common among atrial fibrillation patients initiating oral anticoagulant drugs. DOAC initiators had lower absolute risks and corresponding lower rates of AKI and CKD progression than initiators of VKAs.

**Funding:** Private Foundation Support, Government Support - Non-U.S.

TH-OR05

**Urine NGAL for AKI Screening Following Triggering of Baby NINJA (Nephrotoxic Injury Negated by Just-in-Time Action)**

Cara L. Slagle,<sup>1,2</sup> Trina S. Hemmelgarn,<sup>1,2</sup> Hailey W. Gavigan,<sup>3</sup> Kelli A. Krallman,<sup>1</sup> Stuart Goldstein,<sup>1,2</sup> <sup>1</sup>Cincinnati Children's Hospital Medical Center, Cincinnati, OH; <sup>2</sup>University of Cincinnati, Cincinnati, OH; <sup>3</sup>Levine Children's Hospital, Charlotte, NC.

**Background:** Nephrotoxic medication (NTM) exposure is a cause of neonatal Acute Kidney Injury (AKI). Baby NINJA (Nephrotoxic Injury Negated by Just-in-time Action) is a screening process aimed to reduce NTM exposure and AKI in the neonatal intensive care unit, but requires daily serum creatinine (sCr) screening. Urine neutrophil gelatinase-associated lipocalin (uNGAL) has been associated with AKI and offers a less invasive screening mechanism.

**Methods:** This single center study observed use of an alternative pathway for daily screening following patient triggering of Baby NINJA starting June 2021. Following triggering, providers were prompted daily for selection of sCr or uNGAL monitoring. If uNGAL was >150 ng/mL, screening was transitioned to daily sCr only. Screening compliance was tracked for quality metrics and calculated by daily sCr or uNGAL obtained divided by NTM exposure days plus 2 days. Process control methods determined trends from baseline. Statistical analysis included Mann-Whitney U Test.

**Results:** Daily screening compliance increased following implementation of the alternative pathway (*pre* 78% vs. *post* 84%, *p*= 0.006)(Figure 1). 37% of screening occurred by uNGAL with conversion to daily sCr in 21%(21/99) of new exposures. Rates of high NTM exposure per 1000 patient days decreased (8% to 5%, *p*=0.0002). AKI rates did not differ between *pre* and *post* implementation eras. Median uNGAL that triggered conversion was 263 ng/mL (IQR 195-825 ng/mL). Median birth gestational age of those that converted was 30 wks (IQR 25-35 wks). Following implementation, 7 subjects experienced a total of 16 days of AKI. 5 patients had AKI at the time of baby NINJA trigger and continued with daily sCr, while 2 patients uNGALs triggered conversion (859 & 2835 ng/mL). Of the 7 patients with AKI, 4 experienced death within 48 hours of trigger. Clinical uNGAL was obtained with sCr in subjects with AKI with a median uNGAL of 946 ng/mL (IQR 594-2724 ng/mL).

**Conclusions:** Urine NGAL offers a less invasive screening pathway for AKI from nephrotoxic medication exposure.

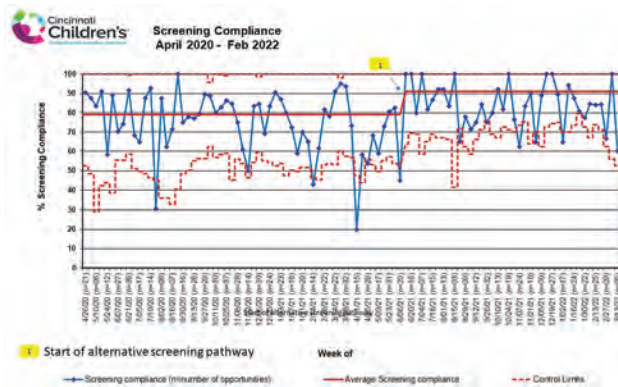

TH-OR06

**Development of a Machine Learning Algorithm to Predict Major Adverse Kidney Events (MAKE) After Hospitalization**

Jay L. Koyner,<sup>1</sup> Kyle Carey,<sup>1</sup> Matthew M. Churpek,<sup>2</sup> <sup>1</sup>University of Chicago Pritzker School of Medicine, Chicago, IL; <sup>2</sup>University of Wisconsin-Madison, Madison, WI.

**Background:** MAKE are common after inpatient stays and are associated with increased morbidity, mortality, and costs. We seek to develop a machine learning (ML) risk score to identify patients at high risk for MAKE following hospitalization.

**Methods:** All patients discharged alive following admission to the University of Chicago between November 2008 and June 2020 were eligible for inclusion, and patients with a history of dialysis and/or chronic kidney disease ((CKD) stage 4 or 5 based on ICD codes or admission creatinine (SCr) ≥3) prior to admission were excluded. An ML-gradient boosted algorithm was developed using demographics, inpatient vital signs, and laboratory results to identify patients at risk for MAKE within 90 of discharge (primary outcome). MAKE was defined as a composite of new CKD (defined by ICD codes for CKD4 or 5 or an SCr > 3.0 mg/dl), recurrent AKI (defined by KDIGO SCr criteria or ICD codes), ESRD / need for dialysis, or mortality. The algorithm was developed in 70% of the admissions and areas under the receiver operating characteristic curve (AUCs) were calculated for the MAKE composite endpoint and the individual components at day 90 and 365 in the held-out 30% test data.

**Results:** Of the 50,448 included patients, 9,931 (19.7%) developed a MAKE outcome within 90 days of discharge. The ML model provided an AUC(95%CI) of 0.74(0.73, 0.75) for the detection of MAKE90 in the test set. The model performed best at identifying those patients who developed post-hospitalization CKD at both 90 and 365 days (Table).

**Conclusions:** We developed and validated a post-hospital discharge ML risk algorithm to predict the future development of MAKE90. Our model can be used to identify the discharged patients most in need of follow-up with nephrology.

**Funding:** NIDDK Support

AUC for MAKE Outcomes

Outcome	Timing	AUC (95% CI)
Major Adverse Kidney Event	90 Days	0.74 (0.73, 0.75)
	365 Days	0.73 (0.72, 0.73)
CKD Progression	90 Days	0.94 (0.93, 0.95)
	365 Days	0.92 (0.91, 0.93)
Recurrent AKI	90 Days	0.74 (0.73, 0.74)
	365 Days	0.72 (0.72, 0.73)
Need for New Dialysis	90 Days	0.87 (0.83, 0.91)
	365 Days	0.85 (0.82, 0.87)
Death	90 Days	0.76 (0.74, 0.78)
	365 Days	0.75 (0.74, 0.76)

TH-OR07

**Machine Learning Models Uncover Subphenotypes of AKI With Unique Signatures That Associate With Differing Clinical Outcomes**

George Vasquez-Rios,<sup>1</sup> Wonsuk Oh,<sup>1</sup> Samuel Lee,<sup>1</sup> Pavan K. Bhatraju,<sup>2</sup> Sherry Mansour,<sup>3</sup> Dennis G. Moledina,<sup>3</sup> Edward D. Siew,<sup>4</sup> Amit X. Garg,<sup>5</sup> Vernon M. Chinchilli,<sup>6</sup> James S. Kaufman,<sup>7</sup> Chi-yuan Hsu,<sup>8</sup> Kathleen D. Liu,<sup>8</sup> Paul L. Kimmel,<sup>9</sup> Alan S. Go,<sup>8</sup> Mark M. Wurfel,<sup>2</sup> Jonathan Himmelfarb,<sup>2</sup> Chirag R. Parikh,<sup>10</sup> Steven G. Coca,<sup>1</sup> Girish N. Nadkarni.<sup>1</sup> <sup>1</sup>Icahn School of Medicine at Mount Sinai, New York, NY; <sup>2</sup>University of Washington, Seattle, WA; <sup>3</sup>Yale University, New Haven, CT; <sup>4</sup>Vanderbilt University, Nashville, TN; <sup>5</sup>Western University, London, ON, Canada; <sup>6</sup>The Pennsylvania State University, University Park, PA; <sup>7</sup>New York University, New York, NY; <sup>8</sup>University of California San Francisco, San Francisco, CA; <sup>9</sup>National Institutes of Health, Bethesda, MD; <sup>10</sup>Johns Hopkins University, Baltimore, MD.

**Background:** Acute kidney injury (AKI) is defined through serum creatinine and urine output metrics. However, these markers do not capture the complexity of AKI and do not fully inform on the future risk of kidney and clinical events.

**Methods:** We evaluated clinical and biomarker data from AKI patients during the acute hospitalization from ASSESS-AKI via three machine learning algorithms to uncover different AKI composites. We compared key characteristics within each subphenotype via classic statistics and then examined the time to event for kidney events (CKD incidence and progression), cardiovascular events, and death by subphenotype.

**Results:** We included 748 AKI patients. The mean age (±SD) was 64 (13) years, 67.9% were men, and the median follow-up was 4.8 years. Patients with AKI subphenotype 1 ('cardioresenal injury', N=181) were characterized by prevalent CVD (78%, P<0.001) and the highest levels of KIM-1, urinary IL-18, and Troponin T. Subphenotype 2 ('benign', N=250) was comprised of individuals with a low prevalence of comorbid conditions and high uromodulin levels, a marker of tubular repair. AKI subphenotype 3 ('cardioresenal inflammation, N=159) comprised patients with markedly high levels of pro-BNP, TNFRs and low kidney injury (KIM-1, NGAL). Finally, patients subphenotype 4 ('sepsis-AKI', N=158) had high rates of infections and dialysis-requiring AKI. These patients had the highest levels of vascular/kidney (YKL-40, MCP-1), and injury activity. AKI subphenotype 3 and 4 were independently associated with a higher risk of death: adjusted hazard ratios (aHR) of 2.9 (95% CI: 1.8 - 4.6, p<0.001) and 1.6 (1.01 - 2.6, p=0.04), respectively. Subphenotype 3 was also independently associated with triple the risk of CKD outcomes (aHR: 2.6, CI: 1.6 - 4.2) and CVD events (aHR: 2.6, CI: 1.6 - 4.1).

**Conclusions:** We discovered four novel and clinically meaningful AKI subphenotypes that inform on potential pathway abnormalities that associate with differing risks for long-term events. We found a new role for biomarkers when they are evaluated in an agnostic fashion, which can serve to advance precision medicine in AKI care.

**Funding:** NIDDK Support

TH-OR08

**Machine Learning for Development of a Real Time AKI Risk Prediction Model in ICU With External Validation and Federated Learning at Five Medical Centers: From Model Development to Clinical Application**

Chun-Te Huang, Taichung Veterans General Hospital, Taichung, Taiwan.

**Background:** Early prediction of AKI ahead of 24 to 48 hours window has now been proposed as a possible strategy to prevent or alleviate AKI by providing clinicians sufficient time for timely intervention. We aim to develop a parsimonious AKI prediction model and build a platform using federated learning for easy data transport and integration of the model between different hospitals.

**Methods:** All adult ICU admissions from 2015-2020 in Taichung Veterans General Hospital (TCVGH) were used as the derivation cohort. Adult ICU admissions from 2018-2020 in four other medical centers were used as external validation cohort. AKI labelling is based on 2012 KDIGO AKI definition. A parsimonious prediction model was selected by LASSO and deployed to the 2018-2020 external validation cohort at 4 other medical centers. A federated learning platform is built retrain and tune the AKI prediction model.

**Results:** A total of 16785 adult ICU admissions were included in the derivation cohort with median age of 68, 62% male, and 30.8% AKI incidence. Total of 60 predictors were included in the model. The machine learning algorithm for AKI prediction revealed XGBoost with better performance metrics in terms of sensitivity:0.795, specificity:0.866, AUROC:0.911, precision:0.726, and accuracy:0.844, and decision curve analysis. After applying LASSO for parsimonious prediction model for external validation at these 4 hospitals showed the prediction performance with AUROC ranging from 0.785 to 0.864. Federated learning using neuron network algorithm improved the prediction performance.

**Conclusions:** AKI is common in ICU with poor prognosis. Early prediction ahead of 24-48 hours may help clinicians for timely intervention to prevent it from happening. We demonstrate the concept of artificial intelligence as medical assistance to clinicians in a feasible way.

**Funding:** Government Support - Non-U.S.

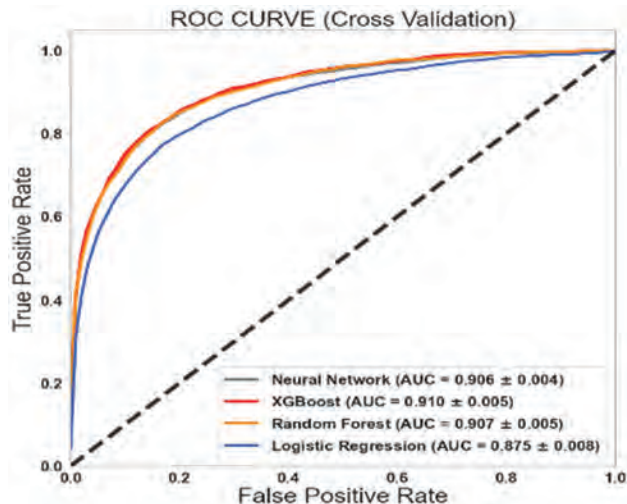

TH-OR09

**AKI Flagger: A Standardized AKI Definition Tool for Electronic Health Record (EHR) Research**

Abinet M. Aklilu, Ishan Saran, Francis P. Wilson. CTRA (Clinical and Translational Research Accelerator) Yale School of Medicine, New Haven, CT.

**Background:** EHR data is increasingly utilized in large studies investigating in-hospital AKI. Although such studies often attempt to use guideline criteria to diagnose AKI, there is often variability in the methodologies. We have hence developed the AKI Flagger-an open-source tool to help standardize the definition of AKI in large database studies.

**Methods:** The AKI Flagger tool employs three techniques to operationalize the definition of AKI using the KDIGO serum creatinine(SCr) criteria for AKI: Rolling Minimum Window(RMW, using 48hour and 7day windows), Historical Baseline Trumping(HBT, median SCr within 7-365days pre-AKI) and Baseline Creatinine Imputation(BCI, imputed from eGFR 75mL/min/1.73m<sup>2</sup>). The flagger was internally validated in a cohort of 40,106 adult inpatients at 6 hospitals. We determined the sensitivity and specificity of various AKI definitions in predicting stage 2 AKI, dialysis, and death.

**Results:** The incidence of AKI was higher using BCI(40.0%) compared to the HBT(31.1%) and RMW(26.1%) techniques. AKI was detected earlier with BCI(median 0.9d, IQR:0.0-5.7), followed by HBT(median 2.7d, IQR:0.0-8.1), and RMW(median 4.2d, IQR:1.6-10.3). AKI diagnosed using RMW was associated with the highest percentage of dialysis(3.2 vs 2.7 vs 2.1%) and mortality(8.0 vs 7.3 vs 6.2%), and the longest hospital stay(9.01 vs 8.31 vs 8.03 days) compared to HBT and BCI, respectively. BCI had the highest sensitivity(0.93) and lowest specificity(0.69) for AKI progression with an AUC of 0.81. RMW had the lowest sensitivity(0.87) and highest specificity(0.83) for predicting AKI progression with an AUC of 0.85.

**Conclusions:** The incidence of AKI and related outcomes vary according to the definition and timeframe used. The AKI Flagger can be a useful tool to promote consistent reporting and reproducibility in AKI research. It is available for use without permission in R and Python.

Performance of the AKI Flagger tool in predicting AKI outcomes

Technique	Sensitivity/Specificity		AUC
	AKI progression*		
BCI	0.93	0.67	0.81
HBT	0.89	0.77	0.83
RMW	0.87	0.83	0.85
Dialysis			
BCI	1.00	0.61	0.80
HBT	0.89	0.70	0.84
RMW	0.88	0.75	0.86

\* doubling of admission SCr

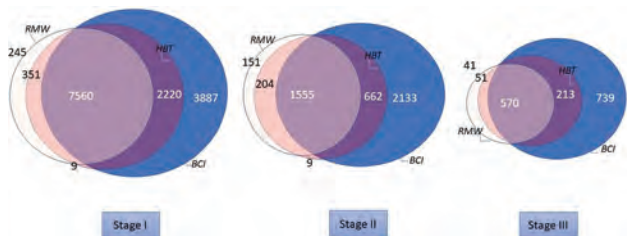

TH-OR10

Novel Urinary Proteins Differentiate Sub-Phenotypes in Patients With Sepsis-Induced AKI

Ian B. Stanaway, Matthew R. Thau, Leila R. Zelnick, Eric D. Morrell, Bryan R. Kestenbaum, Mark M. Wurfel, Pavan K. Bhattraju. *University of Washington School of Medicine, Seattle, WA.*

**Background:** Patients with sepsis-induced AKI can be classified into distinct sub-phenotypes (AKI-SP1 and AKI-SP2) using biomarkers of inflammation and endothelial dysfunction. These sub-phenotypes differ in clinical outcomes and treatment response, though biologic mechanisms underlying these sub-phenotypes remain unknown.

**Methods:** We prospectively enrolled 120 ICU patients with suspected infection (including COVID-19), both with AKI (n=62) and without (n=58), collecting matched blood and urine within 24 hours of ICU admission. We classified patients with AKI as AKI-SP1 (n=45) or AKI-SP2 (n=17) using three plasma biomarkers: angiopoietin-1, angiopoietin-2 and soluble tumor necrosis factor receptor 1. Using the SomaScan @ platform to measure 5,212 urinary proteins, we compared urinary proteins in patients with and without AKI and between patients with AKI-SP1 and AKI-SP2, adjusting for age, sex, BMI, and COVID infection using a false discovery rate (FDR) < 0.05.

**Results:** AKI-SP2 had higher risk for new dialysis (OR=12.2; 95% CI: 2.0-73.1; p=0.006) compared to AKI-SP1, adjusting for age, sex, BMI, and COVID infection. No urinary proteins were differentially expressed in patients with and without AKI (Figure 1A). In patients with AKI, 194 proteins were significantly higher in the urine in AKI-SP2, and 296 proteins were higher in AKI-SP1 (Figure 1B). Proteins involved in inflammation, chemoattraction of neutrophils and monocytes (CXCL1 and CCL14) and oxidative stress (SOD2) were associated with AKI-SP2, while proteins involved in collagen deposition (GP6), podocyte derived (SPOCK2), and mesenchymal cell proliferation (IL11RA) were associated with AKI-SP1.

**Conclusions:** In patients with sepsis-induced AKI, we identified 490 urinary proteins that differed significantly between two AKI sub-phenotypes. The alternative functions of these proteins suggest heterogeneity in the pathophysiology that drives AKI in sepsis and supports the value of AKI sub-phenotypes for the identification of novel pathways in AKI development.

**Funding:** NIDDK Support, Other U.S. Government Support

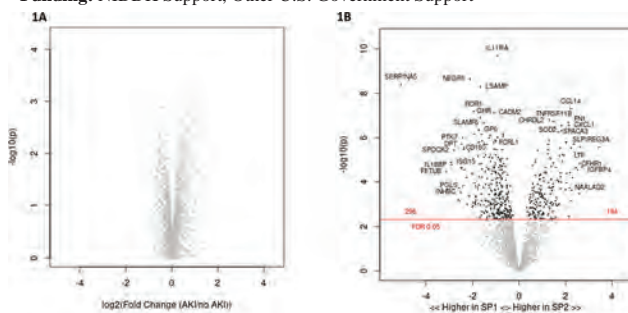

Figure 1. Comparison of urinary proteomic profile between patients with and without AKI and between patients with AKI-SP1 and AKI-SP2. Figure legend: (a) Volcano plot showing no proteins are differentially expressed between patients with and without AKI adjusted for age, sex, body mass index and COVID status. (b) Volcano plot showing that limiting the analysis to only patients with AKI demonstrates that 194 proteins were significantly more abundant in the urine in AKI-SP2, while 296 proteins were higher in AKI-SP1. Dotted line indicates a false discovery rate (FDR) 0.05 significant threshold. Urinary proteins to the right of 0 are higher in patients with AKI-SP2 and proteins to the left of 0 are higher in patients with AKI-SP1.

TH-OR11

Role of the Pre-Hemodialysis Lung Ultrasound for Dry-Weight Assessment and Intradialytic Hypotension Risk Prediction

Giulia Palazzini,<sup>1,2</sup> Gianmarco Lugli,<sup>1,3</sup> Iacopo Gianassi,<sup>2</sup> Egrina Dervishi,<sup>2</sup> Lino C. Cirami,<sup>2</sup> Marco Allinovi.<sup>2</sup> <sup>1</sup>Università degli Studi di Firenze, Firenze, Italy; <sup>2</sup>Azienda Ospedaliero Universitaria Careggi, Firenze, Italy; <sup>3</sup>Azienda Ospedaliero Universitaria Meyer, Firenze, Italy.

**Background:** Intradialytic hypotension (IDH) is a frequent complication of hemodialysis, occurring in about one-third of patients. The importance of IDH is given by its association with potential severe clinical outcomes. Nevertheless, IDH prediction and dry-weight determination may be difficult by using conventional parameters and techniques.

**Methods:** In this prospective observational study, 91 chronic hemodialytic patients underwent a multiparametric evaluation of fluid status, through lung ultrasound (LUS) with quantification of B-lines, physical examination, blood pressure, NT-proBNP and chest X-rays, immediately before and at the end of the dialysis session. The patients were divided into IDH or no-IDH group.

**Results:** A pre-dialysis B-line number ≥15 showed a high sensitivity in fluid overload diagnosis (90%), even higher than chest X-ray and physical examination. On the other hand, a pre-dialysis number of B-lines ≤8 was predictive of IDH episode with a sensibility of 61.7% and a specificity of 74.2% (ROC curve was 0.704). A single increase in B-lines number gave a 5.083 times higher odds to exhibit fluid overload and a 0.957 times higher odds to exhibit IDH, thus indicating that decreasing B-lines was associated with an increasing likelihood of IDH. At the multivariable analysis, NYHA class, blood-albumin low level, low pre-dialysis systolic BP and a low pre-dialysis B-line number resulted as independent risk factors for IDH.

**Conclusions:** LUS is a valuable and reliable method for evaluating fluid status in dialysis patients. B-lines quantification at the beginning of dialysis showed a high sensitivity in fluid overload diagnosis and IDH prediction. Thus, LUS can help individualized ultrafiltrate profile prescription through an integrated bedside approach.

NYHA Class	Multivariable Analysis		
	OR	95% CI	p
SBP before dialysis (mmHg)	2.149	0.998 - 4.627	0.051
SBP before dialysis (mmHg)	0.971	0.943 - 0.999	0.043
Hypalbuminemia (yes/no)	3.245	1.045 - 10.075	0.042
B-Lines before dialysis (n)	0.931	0.880 - 0.973	0.001

Multivariable analysis on different risk factors for predicting an intradialytic hypotension episode

TH-OR12

Application of Intradialytic Magnetic Resonance Imaging and Spectroscopy Demonstrates Hemodialysis-Related Acute Brain Injury

Dickson Y. Wong,<sup>1</sup> Udunna C. Anazodo,<sup>4,2</sup> Jean Théberge,<sup>4,2</sup> Madeleine T. Dacey,<sup>2</sup> Janice Gomes,<sup>5,3</sup> Jarrin D. Penny,<sup>2,3</sup> Michael J. Van Ginkel,<sup>1</sup> Stefan E. Poirier,<sup>2,4</sup> Christopher W. McIntyre.<sup>4,3</sup> <sup>1</sup>Western University Schulich School of Medicine & Dentistry, London, ON, Canada; <sup>2</sup>Western University Department of Medical Biophysics, London, ON, Canada; <sup>3</sup>London Health Sciences Centre London Kidney Clinical Research Unit, London, ON, Canada; <sup>4</sup>Lawson Health Research Institute, London, ON, Canada; <sup>5</sup>Western University Department of Pathology and Laboratory Medicine, London, ON, Canada.

**Background:** Hemodialysis (HD) provides lifesaving treatment for patients with end stage kidney disease. However, treatment related hemodynamic stress results in recurrent ischemic injury to vulnerable organs, such as the heart. Short term reduction in brain blood flow and long-term white matter (WM) changes have been reported. However, the basis of HD-induced brain injury is neither well recognized nor understood even though progressive cognitive impairment is common.

**Methods:** 21 patients (age: 63±13 years, male: 58.8%) were recruited. Study procedures included neurocognitive assessments, intradialytic anatomical magnetic resonance imaging (MRI), diffusion tensor imaging (DTI), and magnetic resonance spectroscopy (H-MRS). Data acquired before HD and during the last 60 minutes of HD (during peak hemodynamic stress) were analyzed to assess the acute impact of HD on the brain.

**Results:** HD resulted in the development of multiple regions of white matter (WM) intradialytic fractional anisotropy (FA) increase with associated mean diffusivity (MD) and radial diffusivity (RD) decreases (Fig. 1a), characteristic features of cytotoxic edema (with increase in global brain volumes, Fig. 1b). Decreases in H-MRS measured NAA and choline concentrations during HD were also observed (Fig. 2), indicative of regional ischemia. Severity of WM changes were associated with reduced cognitive function performance, particularly relating to executive functioning (Fig. 1c).

**Conclusions:** This study demonstrates, for the first time, that functionally significant intradialytic changes in brain tissue volume, diffusion metrics, and brain metabolite concentrations consistent with ischemic injury occurs. Preventing HD-induced brain injury requires urgent additional investigation to improve subjective tolerability of treatment and maintenance of independence and cognitive vitality for patients.

**Funding:** Private Foundation Support

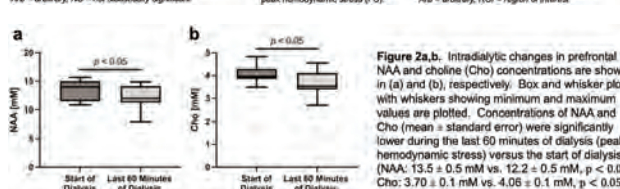
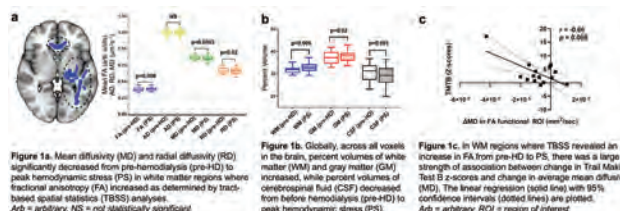

TH-OR13

**Intradialytic Exercise Is Associated With Lower Mortality Risk in Hemodialysis Patients**

Pedro M. Martins,<sup>1,2</sup> Diogo V. Leal,<sup>1</sup> Kenneth R. Wilund,<sup>3</sup> Manuel A. Ferreira,<sup>2,4</sup> Joao L. Viana.<sup>1</sup> <sup>1</sup>Research Center in Sports Sciences, Health Sciences and Human Development (CIDESD), University of Maia, Maia, Portugal; <sup>2</sup>Nephrocare Portugal SA, Lisboa, Portugal; <sup>3</sup>University of Illinois Urbana-Champaign Department of Kinesiology and Community Health, Champaign, IL; <sup>4</sup>Universidade Nova de Lisboa Comprehensive Health Research Centre, Lisboa, Portugal.

**Background:** HD patients have an increased mortality risk that may be minimized with physical activity (PA). Intradialytic exercise (IDE) is very convenient, potentially increasing adherence to PA and making use of otherwise sedentary time. However, it is not known whether this potential protective role of PA can be achieved through IDE. Thus, the aim of this study was to analyze the association of IDE with mortality in HD patients.

**Methods:** Multicenter prospective cohort study in adult HD patients eligible to IDE (3 times/week cycling and lower body resistance exercises using ankle weights) from 21 HD units in Portugal. After 1-year of IDE implementation, patients were followed for up to 3 years. Three groups were created based on IDE exposure (exercise minutes/week): no-exercise (patients who refused IDE); low-exercise (<87 min/week); high-exercise (≥87 min/week). Kaplan-Meier (unadjusted analysis) and cox proportional hazard models (adjusted for age, dialysis vintage, vascular access, comorbidity index, cardiovascular disease, lean tissue, overhydration and hospitalizations) were used with no-exercise group as reference. Further, sub-analysis restricted to IDE participants were performed with exposure as a continuous variable.

**Results:** 741 patients (no-exercise: 394; low-exercise: 174; high-exercise: 173) were followed for a median of 33.2 (IQR 11.5) months. Unadjusted mortality incidence was different between the three groups: (no-exercise: 21.6%; low-exercise: 19.0%; high-exercise: 6.4%; p<0.001). In adjusted analysis, the high-exercise group had a lower mortality risk than the no-exercise group (HR=0.38, 95% CI 0.20-0.75, p=0.005), whilst this was not observed in the low-exercise group (HR=1.18, 95% CI 0.77-1.79, p=0.453). Moreover, the mortality risk was reduced for each 50 min of exercise/week in unadjusted (HR=0.43, 95% CI 0.26-0.71, p=0.001) and adjusted analysis (HR=0.47, 95% CI 0.27-0.82, p=0.008).

**Conclusions:** Our data shows that IDE is associated with a reduction in mortality risk in HD patients, but considerable exercise volume is required. Therefore, patients achieving low-exercise doses may need out-of-clinic PA/exercise approaches to complement IDE.

**Funding:** Commercial Support - Fresenius Medical Care, NeproCare Portugal, Government Support - Non-U.S.

TH-OR14

**0.075% Capsaicin Lotion for the Treatment of Peripheral Neuropathy in ESRD Patients: A Multicenter Randomized Double-Blind Placebo-Controlled, Cross-Over Trial**

Parinada Kittidanairuk,<sup>1</sup> Narittaya Varothai,<sup>1</sup> Veerapatr Nimkietkajorn.<sup>2</sup> <sup>1</sup>Phramongkutklo Hospital, Bangkok, Thailand; <sup>2</sup>Buddhachinaraj Phitsanulok Hospital, Phitsanulok, Thailand.

**Background:** Neuropathic pain is one of the common symptom in chronic kidney disease (CKD) patients leads to problems in physical, mental and quality of life. Pain medications are also limited in CKD. This study aims to evaluate the effect of 0.075% capsaicin lotion in neuropathic pain, quality of life and side effect of End Stage Renal Disease (ESRD) patient required Renal Replacement Therapy (RRT).

**Methods:** We conducted a multicenter randomized, double-blinded, crossover, placebo controlled trial included 60 ESRD patients required RRT who had peripheral neuropathy in dialysis units in Bangkok and Phitsanulok province. The participants were randomized to received 0.075% capsaicin/placebo for 8 weeks, then crossing over to the other treatment for 8 weeks after a 2-weeks washout period. Primary outcome was the change in visual analog scale (VAS) score of pain severity. Secondary outcomes were changes in neuropathic pain scale, short-form McGill Pain questionnaire, quality of life in kidney disease using KDQOL-36 and adverse event.

**Results:** A total of 55 participants were enrolled, baseline VAS pain score was 6.05. After 8 weeks of capsaicin lotion, VAS score decrease 1.75 (p 0.615) after 8 weeks. Proportions of patients with pain score reductions of 50% significantly decreased in capsaicin group 23 (41%) and 14 (25.45%) in control group (p 0.022). From subgroup analysis, VAS in patients with severe pain score at start decreased significantly (p 0.021), compare to those with moderate pain score at start (p 1.000). KDQOL-36, the mean score in daily activity trend to decrease 0.25 in capsaicin group compare to 0.05 in control group (p 0.094). Capsaicin lotion was well tolerated with some local skin reactions.

**Conclusions:** In ESRD patients with peripheral neuropathy, 0.075% capsaicin lotion can significantly decrease pain score 50% and trend to improve daily activity aspect of quality of life in kidney disease.

**Funding:** Commercial Support - Bangkok Drug Company

TH-OR15

**Preferences for End-of-Life Care Among Dialysis Patients: A Discrete Choice Experiment**

Ania Filus, Katie T. Harmeyer, Steven M. Brunelli, Francesca Tentori. *Davita Clinical Research, Minneapolis, MN.*

**Background:** Given the high symptom and morbidity burden related to kidney failure, there is an urgent need to deliver care that aligns with patient wishes and priorities at each stage of their disease, including as they approach End of life (EoL). However, there is a knowledge gap of patients' specific preferences for their EoL care. We leveraged a discrete choice experiment approach to identify factors that are important to dialysis patients.

**Methods:** In August-September 2021, we deployed an online survey that assessed the importance of the three aspects of EoL care: degree of pain management (well vs. poorly controlled), frequency of hospitalizations (sometimes vs. often), and place of death (home vs. hospital). We utilized a block fraction factorial design with 2 blocks and 4 questions within each block (Figure 1). Patients were asked to choose between two alternative scenarios of EoL care for each question.

**Results:** Surveys were collected from 796 patients, including home dialysis (2.2%) and in-center (97.8%) dialysis patients. The median age was 54 years and 40% were female. The race composition was 37% White, 35% Black, 16% Hispanic, and 5% Asian. The majority of surveyed patients (70%) reported being on dialysis from 1 to 7 years and most rated their subjective health as average (49%) or better (33%) than other dialysis patients. Results from the discrete choice experiment indicate that patients were 3.7 times more likely to choose a scenario with well-managed pain over poor pain management. The frequency of hospital visits [OR 1.3 (95% CI 1.21-1.47)] at the EoL was the least important attribute of quality of care at the end of life (Table 1). Patients were 1.5 times more likely to choose dying at home vs the hospital.

**Conclusions:** The level of pain management was the most important attribute of quality of care at the end of life, over frequency of hospital visits and place of death.

	Coefficient	Odds Ratio	SE (Coefficient)	Statistical Significance
Well managed pain vs. not well managed pain	1.31	3.7	0.05	p<0.001
Occasional hospitalization vs. frequent hospitalization	0.29	1.3	0.05	p<0.001
Dying at home vs. dying in the hospital	0.40	1.5	0.05	p<0.001

Read carefully the description of two hypothetical options for care at the end of life. Which option (A or B) would you prefer? Select one choice.

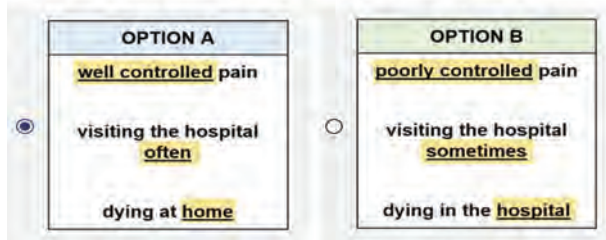

TH-OR16

**DIALIZE China: A Phase 3b Study to Reduce Pre-Dialysis Hyperkalemia With Sodium Zirconium Cyclosilicate in Chinese Subjects**

June Zhao,<sup>1</sup> Zhaohui Ni,<sup>2</sup> Renhua Lu,<sup>2</sup> Xudong Xu,<sup>3</sup> Xueyan Bian,<sup>4</sup> Zhou Zhihong,<sup>5</sup> Junwei Yang,<sup>6</sup> Qun Luo,<sup>7</sup> Chen M. Hua,<sup>8</sup> Chaosheng Chen,<sup>9</sup> Xiuli Sun,<sup>10</sup> Lei Yu,<sup>11</sup> Qiang He,<sup>12</sup> Hong Jiang,<sup>13</sup> Wei jie Yuan,<sup>14</sup> Yi Li,<sup>15</sup> Rong Zhou,<sup>16</sup> Wang Jianqin,<sup>17</sup> Xinzhou Zhang,<sup>18</sup> Li Zuo,<sup>19</sup> Haijiao Jin,<sup>2</sup> Xiangwen Meng,<sup>20</sup> Zhiren Chang.<sup>20</sup> For the DIALIZE China Study Group. <sup>1</sup>AstraZeneca, Wilmington, DE; <sup>2</sup>Ren Ji Hospital, Shanghai Jiao Tong University School of Medicine, Shanghai, China; <sup>3</sup>Central Hospital of Minhang District, Shanghai, China; <sup>4</sup>Ningbo First Hospital, Ningbo, China; <sup>5</sup>The Second Affiliated Hospital of Wenzhou Medical University, Wenzhou, China; <sup>6</sup>The Second Affiliated Hospital of Nanjing Medical University, Nanjing, China; <sup>7</sup>Ningbo Huamei Hospital, University of Chinese Academy of Sciences, Ningbo, China; <sup>8</sup>General Hospital of Ningxia Medical University, Yinchuan, China; <sup>9</sup>The First Affiliated Hospital of Wenzhou College, Wenzhou, China; <sup>10</sup>Baotou City Central Hospital, Baotou, China; <sup>11</sup>Inner Mongolia People's Hospital, Hohhot, China; <sup>12</sup>Zhejiang Traditional Chinese Medicine Hospital, Hangzhou, China; <sup>13</sup>People's Hospital of Xinjiang Uygur Autonomous Region, Xinjiang, China; <sup>14</sup>Shanghai General Hospital, Shanghai, China; <sup>15</sup>Dongguan People's Hospital, Dongguan, China; <sup>16</sup>Shanghai Yangpu District Central Hospital, Shanghai, China; <sup>17</sup>Lanzhou University Second Hospital, Lanzhou, China; <sup>18</sup>Shenzhen People's Hospital, Shenzhen, China; <sup>19</sup>Peking University People's Hospital, Beijing, China; <sup>20</sup>AstraZeneca, Shanghai, China.

**Background:** Sodium zirconium cyclosilicate (SZC) is an anti-hyperkalemia (HK) therapy (oral potassium binder) indicated in adults. DIALIZE China (NCT04217590) evaluated the safety and efficacy of SZC in individuals receiving hemodialysis (HD) in China.

**Methods:** DIALIZE China was a randomized, double-blind, placebo (PBO)-controlled, multicenter, phase 3b study of adults receiving HD 3-times weekly for kidney failure with pre-dialysis HK (serum potassium [sK<sup>+</sup>] >5.4 mmol/L after the long interdialytic interval [LIDI] and >5.0 mmol/L after 1 short interdialytic interval). Following a 1-week screening period, subjects were randomized 1:1 to SZC or PBO (5 g/day on non-dialysis days), titrated over 4 weeks up to 15 g/day as required to achieve normokalemia (NK; pre-dialysis sK<sup>+</sup> 3.5–5.5 mmol/L), prior to a 4-week evaluation and 2-week follow-up. The primary outcome was the proportion of responders (pre-dialysis sK<sup>+</sup> 4.0–5.0 mmol/L for ≥3 of 4 HD visits following the LIDI, without any rescue therapy during evaluation). Secondary outcomes included assessment of pre-dialysis sK<sup>+</sup> values; safety outcomes included adverse events (AEs).

**Results:** Overall, 134 adults from China were randomized to SZC or PBO (each n=67); mean (SD) age was 54.7 (11.3) years, 49% were male and mean weight was 60 kg. There was a significantly higher proportion of responders in the SZC arm (37.3%) vs PBO arm (10.4%) (estimated odds ratio [OR]: 5.10, 95% CI: 1.90–15.12, P<0.001). A greater proportion of subjects achieved NK on ≥3 of 4 LIDI visits during evaluation with SZC (73%) than with PBO (30%). The probability of all pre-dialysis sK<sup>+</sup> values being between ≥3.5 to ≤5.5 mmol/L was significantly higher with SZC vs PBO (estimated OR: 6.41, 95% CI: 2.71–15.12, P<0.001). AEs and serious AEs, respectively, occurred in 64% and 9% of subjects in the SZC arm, and 66% and 12% of subjects in the PBO arm, with no new safety concerns identified.

**Conclusions:** SZC is an effective and well-tolerated treatment for HK in Chinese individuals receiving HD.

**Funding:** Commercial Support - AstraZeneca

**TH-OR17**

**Effect of ESRD Treatment Choices (ETC) on Home Dialysis Utilization Among Incident Dialysis Patients**

**Kirsten L. Johansen,<sup>1,2</sup> Shuling Li,<sup>1</sup> David T. Gilbertson,<sup>1,2</sup> Eric D. Weinhandl,<sup>3,1</sup> Chuanyu Kou,<sup>1</sup> Christopher D. Knapp,<sup>1</sup> James B. Wetmore.<sup>1,2</sup>** <sup>1</sup>Hennepin Healthcare Research Institute, Minneapolis, MN; <sup>2</sup>University of Minnesota Medical School Twin Cities, Minneapolis, MN; <sup>3</sup>Satellite Healthcare, San Jose, CA.

**Background:** The Advancing American Kidney Health Executive Order set ambitious targets for home dialysis in the US. CMS introduced payment models to incentivize home dialysis, including ETC, which launched in January 2021. Although ETC applies only to Medicare fee-for-service (FFS) beneficiaries, it has the potential to change provider behavior for all patients. We examined changes in use of home dialysis among all incident dialysis patients in the US according to provider ETC assignment.

**Methods:** ESRD providers were randomly assigned to ETC participation at the Hospital Referral Region (HRR) level. Using USRDS data, we analyzed adult patients with incident ESRD who initiated dialysis from January 1, 2016 to March 31, 2022. We excluded patients dialyzing in a SNF or long-term care facility, prior transplant, or missing provider ZIP code. We examined the percentage of patients on home dialysis by ETC participation from first quarter (Q1) 2016 to Q1 2022 and used a changepoint method to assess whether there was a change in the differences between ETC and non-ETC markets during this period.

**Results:** In total, 766,055 patients were studied (31% ETC participants). Before the assignment of ETC markets in late Q3 2020, the proportion of patients started on home dialysis was increasing steadily but was slightly lower among patients in ETC markets than among those in non-ETC markets (Figure). A changepoint was found just prior to Q4 2020 (p=0.004 for before-after Q4 2020). After this time, home dialysis use increased among patients in ETC markets but not among those in non-ETC markets. After the launch of ETC, a higher percentage started home dialysis in ETC markets (15.4% vs. 14.5%).

**Conclusions:** The ETC payment model for Medicare FFS beneficiaries appears to have affected practice patterns for all incident dialysis patients. After its introduction, the proportion of patients starting home dialysis continued to increase in ETC markets and flattened in non-ETC markets.

**Funding:** NIDDK Support

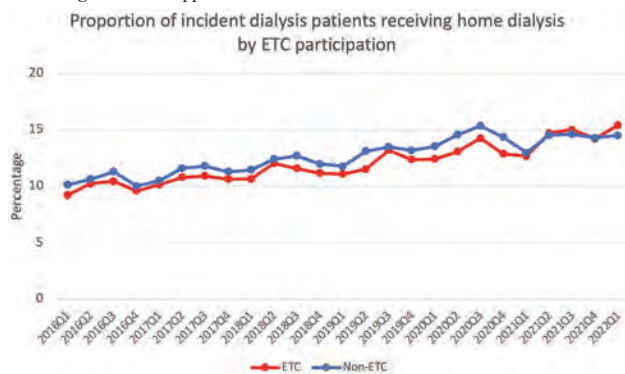

**TH-OR18**

**The Effects of Implementing a Home Dialysis Project ECHO**

**Christopher T. Chan,<sup>1</sup> Rajnish Mehrotra,<sup>2</sup> Matthew B. Rivara,<sup>2</sup> Danilo Concepcion,<sup>3</sup> Karen Crampton,<sup>4</sup> Renin Cassidy,<sup>6</sup> Nancy Pierce,<sup>7</sup> Katy G. Wilkens,<sup>6</sup> Stephanie Hutchinson,<sup>5</sup> Barbara Dommert-Breckler,<sup>5</sup> Jessica Joseph,<sup>8</sup> Elizabeth Montgomery.<sup>8</sup>** Home Dialysis Echo HUB group <sup>1</sup>University of Toronto, Toronto, ON, Canada; <sup>2</sup>University of Washington, Seattle, WA; <sup>3</sup>Providence St Joseph Health, Renton, WA; <sup>4</sup>University of Michigan, Ann Arbor, MI; <sup>5</sup>Comagine Health, Seattle, WA; <sup>6</sup>Northwest Kidney Centers, Seattle, WA; <sup>7</sup>ESRD Network 16, Seattle, WA; <sup>8</sup>National Kidney Foundation, New York, NY.

**Background:** Insufficient home dialysis education and mentorship are suggested barriers contributing to the under utilization of home therapies in the U.S. The National Kidney Foundation KDOQI Home Dialysis task force hypothesized that the use of a Project ECHO (Extension for Community Healthcare Outcome) program may enhance home dialysis uptake.

**Methods:** In partnership with Comagine Health, the NKF home dialysis ECHO project delivered 20 interprofessional education sessions virtually to 108 registrants from 19 dialysis centers derived from 2 ESRD network regions over 1 year. Our home dialysis curriculum has previously been published. Sessions were divided into case discussion and didactic teaching moderated by the home dialysis hub team. Using a mixed method before and after approach, we described the differences in home dialysis rate and knowledge utilization.

**Results:** 108 healthcare workers registered for our home dialysis ECHO project. The median number of participated sessions was 1.5 (range = 16). The registrants represented a diverse background (including: dietitian [n = 15], facility administrator [n = 20], nurse [n=36] and social worker [n=18]). Using exit questionnaires, the registrants consistently recommended ECHO sessions to their peers with the top sessions saturating amongst the themes of “establishing home dialysis culture”, “modality education” and “psychosocial adjustment”. At baseline, the participating centers’ median home dialysis rate was 9.28% (0.00 – 18.52%) [25–75%] which increased to 12.8% (0.00 – 24.6%) [Wilcoxon Signed Rank Test, p = 0.004] after the program.

**Conclusions:** We demonstrated that home dialysis ECHO project was a feasible strategy that was associated with a modest increase in home dialysis rates. A prospective examination of national adoption of such a strategy to physicians and dialysis clinic staff is warranted.

Home Dialysis Rate Before and After Virtual ECHO project

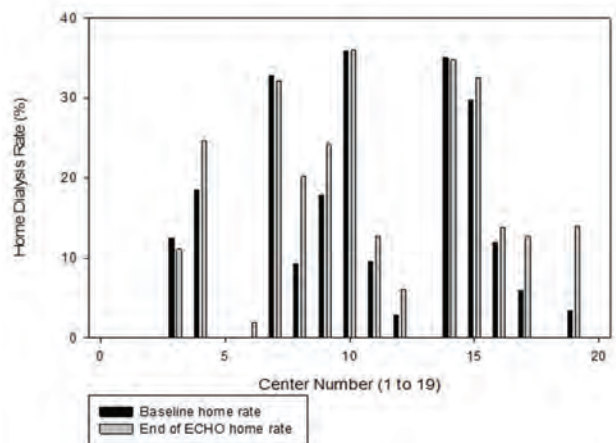

**TH-OR19**

**High-Flow Arteriovenous Fistula and Myocardial Fibrosis in Hemodialysis Patients With Non-Contrast Cardiac Magnetic Resonance Imaging**

**Jwa-kyung Kim,<sup>1</sup> Sung Jin Moon,<sup>2</sup> Sungmin Kim,<sup>1</sup> Dong Hee Lee,<sup>1</sup> Sung Gyun Kim.<sup>1</sup>** <sup>1</sup>Hallym University Sacred Heart Hospital, Anyang, Gyeonggi-do, Republic of Korea; <sup>2</sup>Catholic Kwandong University International Saint Mary’s Hospital, Incheon, Republic of Korea.

**Background:** Myocardial fibrosis is a critical part of maladaptive cardiac remodeling that leads to heart failure (HF). In patients with chronic kidney disease, diffuse myocardial fibrosis is a typical uremic cardiomyopathy characteristic unrelated to ischemic heart disease. The role of high-flow arteriovenous fistula (AVF) in myocardial fibrosis in hemodialysis (HD) patients is very likely under-recognized.

**Methods:** Markers of myocardial damage, galectin-3 and N-terminal pro B-type natriuretic peptide (NT-proBNP), were measured in 101 HD patients who underwent regular monitoring of intra-access Qa. AVF with Qa >2 L/min was considered a high-flow AVF. The degree of myocardial fibrosis according to intra-access Qa was assessed by native T1 relaxation times on cardiac MRI and serum galectin-3.



**Results:** Compared to HV, HD patients showed a significantly higher galectin-3 value and increased T1 relaxation time, suggesting increased myocardial fibrosis in uremic conditions. In HD patients, 20 (19.8%) had a  $Q_a > 2$  L/min, and they had significantly higher cardiac output, cardiac index, left ventricular mass, as well as increased T1 relaxation times than those with a  $Q_a \leq 2$  L/min. Also, galectin-3 value and NT-proBNP levels were much higher in these patients with a high  $Q_a$ , indicating a close relationship between increased  $Q_a$ , myocardial fibrosis, and increased risk of HF. Notably, the association between higher  $Q_a$  and myocardial fibrosis was independent of traditional risk factors as well as serum NT-proBNP and inflammatory marker, monocyte chemoattractant protein-1.

**Conclusions:** A supra-physiologically high  $Q_a$  can be related to increased myocardial fibrosis and remodeling in HD patients. Regular  $Q_a$  monitoring and early detection of myocardial fibrosis could be helpful for preventing further cardiac damage.

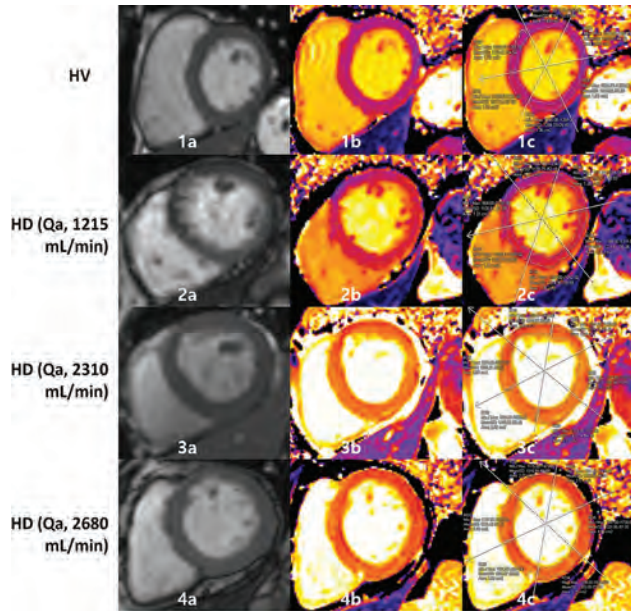

**TH-OR20**

**Biofunctionalized Vascular Access Graft Enhanced Patency and Endothelialization in a Pig Arteriovenous (AV) Model**

Prakash Parthiban Selvakumar,<sup>1</sup> Unimunkh Uriyanghai,<sup>2</sup> Richard D. Johnson,<sup>1</sup> Christine Wai,<sup>2</sup> Prabir Roy-Chaudhury,<sup>2</sup> Wei Tan.<sup>1</sup> <sup>1</sup>University of Colorado Boulder, Boulder, CO; <sup>2</sup>University of North Carolina System, Chapel, NC.

**Background:** Dialysis vascular access is currently both the “Lifeline” and the “Achilles heel” of dialysis vascular access. Dialysis access grafts suffer from clinical complications such as kinking, thrombosis, restenosis, and lack of rapid endothelialization. An anti-kinkable vascular access graft which promotes rapid endothelialization, thus restricting thrombosis and restenosis is a clinical necessity. Previously, we have successfully developed an acellular vascular graft which showed promising results in small animals. Here, we have reinforced the same graft to provide anti-kinking properties, and examined its effectiveness in a large animal model of AV stenosis.

**Methods:** 6 mm graft comprising poly-ε-caprolactone (PCL) and polyethylene glycol norbornene (PEG-NB) was coaxially electrospun with PCL as the core and PEG-NB as the sheath and conjugated with various biomolecules. Biodegradable polydioxane sutures were spirally wound for anti-kinkability. These grafts were implanted in a loop configuration between the femoral artery and vein of pigs. Computer tomography (CT; weeks 1 and 4) and Doppler ultrasound examination (a week for 4 weeks) was performed. The grafts were removed after 28d for histological examination.

**Results:** We observed no kinking of the grafts during the test period. The CT scan showed a patent lumen with continuous blood flow. Ultrasounds documented patency and an average volume flow of 756.3 ml/min (Fig. 1a-c). Histology revealed active cellular integration, ECM synthesis and the formation of a luminal endothelial layer (Fig. 1d).

**Conclusions:** Our electrospun grafts with precision engineered biomolecules, promoted rapid endothelialization and cellular integration with good flow, in an arteriovenous configuration. This approach will reduce the huge morbidity, mortality and economic cost currently associated with dialysis vascular access dysfunction.

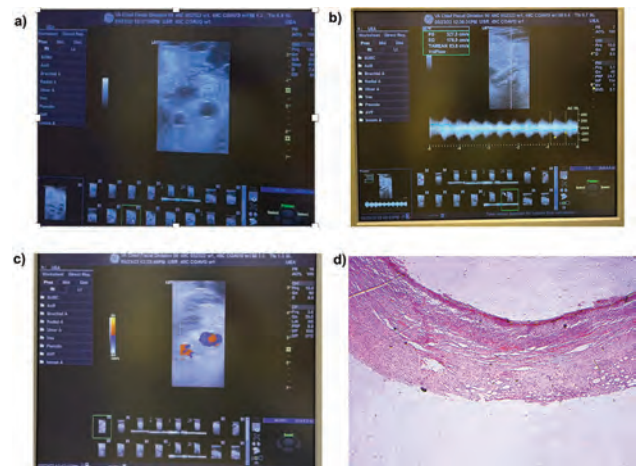

**TH-OR21**

**Hyperaldosteronism Screening Among a Large Diverse Resistant Hypertension Population Within an Integrated Healthcare System**

Victor D. Kim,<sup>1</sup> Jiaxiao Shi,<sup>2</sup> Jaejin An,<sup>2,3</sup> John J. Sim,<sup>1,3</sup> Kaiser Permanente Los Angeles Nephrology <sup>1</sup>Kaiser Permanente Los Angeles Medical Center, Los Angeles, CA; <sup>2</sup>KPSC Research and Evaluation, Pasadena, CA; <sup>3</sup>Kaiser Permanente Bernard J Tyson School of Medicine, Pasadena, CA.

**Background:** Hyperaldosteronism (HA) is one of the most common causes of resistant hypertension (RH), and screening for HA is recommended. HA is potentially treatable with more targeted therapy and interventions such as mineralocorticoid receptor antagonists (MRAs). We sought to determine the rate of screening for HA and use of MRAs among a large diverse RH population from an integrated health system.

**Methods:** A cross-sectional study was performed within Kaiser Permanente Southern California using electronic health records. We identified patients with RH between 7/1/2014 and 6/30/2015 using a criteria of systolic blood pressure >130 mm Hg on 3 or more antihypertensive medicines or requiring 4 or more medicines regardless of BP. We evaluated the rate of serological screening for HA among those with RH. Screening captured as closest date before or after 5 years of RH index date. Positive screen for HA was defined as aldosterone renin ratio  $\geq 20$  or aldosterone level  $\geq 15$  ng/dl. We evaluated patient demographic and clinical characteristics, and MRA use among RH and HA patients.

**Results:** Among 102,480 RH patients (Hispanic = 24.5%, black = 19.5%, white = 44.4%, Asian = 8.6%), a total of 2,824 (2.8%) patients were screened for HA and among them, 1,170 (41.4%) patients met criteria for HA. HA patients were more likely to be male, black, and had lower potassium levels (3.9 vs 4.1 mEq/L). MRA use was 6.5% among all RH, 14.7% among all screened, and 31.7% among patients with HA.

**Conclusions:** Among a large diverse RH population, we observed a low rate of screening for HA while the positivity rate was high among those screened. MRA use was low in the RH population but higher among HA patients. Understanding potential barriers to HA screening and empiric use of MRA among the RH population warrant further investigation.



TH-OR23

**Influence of Baseline Diastolic BP (DBP) on the Effects of BP Lowering on Cardiovascular (CV) Outcomes: A Meta-Analysis of NIH BP Trials**  
 Amara Sarwal,<sup>1</sup> Robert E. Boucher,<sup>1</sup> Sydney E. Hartsell,<sup>1</sup> Guo Wei,<sup>1</sup> Xiangyang Ye,<sup>1</sup> Jincheng Shen,<sup>1</sup> Glenn Chertow,<sup>2</sup> Paul K. Whelton,<sup>3</sup> Alfred K. Cheung,<sup>1</sup> Tom Greene,<sup>1</sup> Srinivasan Beddhu.<sup>1</sup> <sup>1</sup>University of Utah Health, Salt Lake City, UT; <sup>2</sup>Stanford University School of Medicine, Stanford, CA; <sup>3</sup>Tulane University School of Public Health and Tropical Medicine, New Orleans, LA.

**Background:** Lowering systolic BP (SBP) in persons with low DBP might affect tissue perfusion and thereby, increase risk for CV events.

**Methods:** We conducted a meta-analysis of 4 NIH BP trials that examined the effects of BP goals on CV outcomes; SPRINT, N = 9247, SBP goal < 120 vs. < 140), ACCORD BP standard glycemia arm (N = 2361, SBP goal < 120 vs. < 140), SPS3 (N= 3008, SBP goal < 130 vs. < 140) and AASK (N=1094, goal MAP < 92 mmHg vs. 102-107). We used DerSimonian-Laird random-effects models in Stata version 15.1 to conduct meta-analyses of the interaction between baseline DBP and the BP intervention on CV outcomes.

**Results:** Mean baseline DBP in SPRINT, ACCORD BP, SPS-3 and AASK were 78 ± 12, 76 ± 10, 78 ± 11, 96 ± 14 mmHg, respectively with evidence of heterogeneity. In the 15,710 participants included, there were 1614 CV events over 59,925 person-years of follow-up. Intensive BP control resulted in overall lower hazard of CV events, (HR 0.79, CI 0.72, 0.87) (Table). Lower baseline DBP was associated with increased risk of CV events in SPRINT and ACCORD BP but not in SPS3 and AASK with a non-significant association of lower DBP with CV events (HR 1.10, CI 0.97, 1.24) (Table). The interaction term of baseline DBP and the BP intervention on CV events was non-significant in each of the studies and pooled overall (Figure).

**Conclusions:** In this meta-analysis of large, multicenter NIH-funded trials, BP intervention was beneficial for improving CV outcomes, but there was no evidence that these beneficial effects were modified by baseline DBP.

**Funding:** NIDDK Support, Other NIH Support - NIA, Veterans Affairs Support

Effects of BP intervention on and the associations of baseline DBP with CV events

	Intensive vs Standard BP (HR, CI)	HR per 10 mmHg ↓ in baseline DBP (HR, CI)
SPRINT	0.76 (0.65, 0.88)	1.20 (1.12, 1.28)
ACCORD-BP	0.76 (0.62, 0.94)	1.24 (1.11, 1.37)
SPS3	0.86 (0.70, 1.06)	1.02 (0.92, 1.12)
AASK	0.90 (0.65, 1.24)	0.95 (0.85, 1.06)
Overall	0.79 (0.72, 0.87)	1.10 (0.97, 1.24)

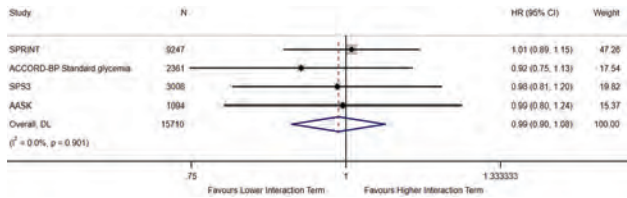

TH-OR24

**Sex Difference in Cardiovascular Risk in Non-CKD and CKD: NHANES 1999-2018**

Ester Oh,<sup>1</sup> Zhiying You,<sup>1</sup> Kristen L. Nowak,<sup>1</sup> Anna Jovanovich.<sup>1,2</sup> <sup>1</sup>University of Colorado - Anschutz Medical Campus, Aurora, CO; <sup>2</sup>VA Eastern Colorado Health Care System, Aurora, CO.

**Background:** In the general population, females (vs. males) have a lower risk for cardiovascular disease (CVD). However, little is known whether this sex-specific risk pattern of CVD translates to individuals with chronic kidney disease (CKD). The purpose of this study was to examine if there was a sex-specific risk of CVD in adults who participated in the National Health and Nutrition Examination Survey (NHANES), both with CKD and without CKD.

**Methods:** Multivariable logistic regression models were used to examine the odds ratio (OR) for 1) self-reported CVD, including myocardial infarction, stroke, angina pectoris, and congestive heart failure, in females vs. males in non-CKD (18-75 y and ≥55 y) and stage 3-4 CKD sub-groups (18-75 y) and 2) Atherosclerotic Cardiovascular Disease (ASCVD) risk score in non-CKD (18-75 y and ≥55 y) vs. CKD (18-75 y), separately for males and females.

**Results:** Adults with CKD (n=1,347; 52% F; 64±9 y; estimated glomerular filtration rate [eGFR] 47±10 ml/min/1.73m<sup>2</sup>) and without CKD (n=38,858; 51% F; 43±16 y; eGFR 102±18 ml/min/1.73m<sup>2</sup>) were included in the study. In order to better match the mean age between the non-CKD and CKD sub-groups, adults without CKD were further sub-grouped into those ≥55 y (n=11,117; 50% F; 64±5 y; eGFR 87±13 ml/min/1.73m<sup>2</sup>). Females had a lower fully adjusted odds for CVD than males in the 18-75 y and ≥55 y non-CKD (Fig. 1A). However, in adults 18-75 y with CKD, there was no sex difference in fully adjusted odds for CVD. As compared to females ≥55 y without CKD, females 18-75 y with CKD had a higher odds of intermediate-high vs. low-borderline ASCVD risk score in the fully adjusted model (Fig. 1B). No difference was observed in the OR of a higher ASCVD score between CKD males 18-75 y vs. non-CKD males ≥55 y.

**Conclusions:** Our findings suggest that CKD abolishes the cardiovascular protection observed in females without CKD. In addition, CKD may be a stronger risk factor for CVD in females than males.

**Funding:** NIDDK Support, Veterans Affairs Support

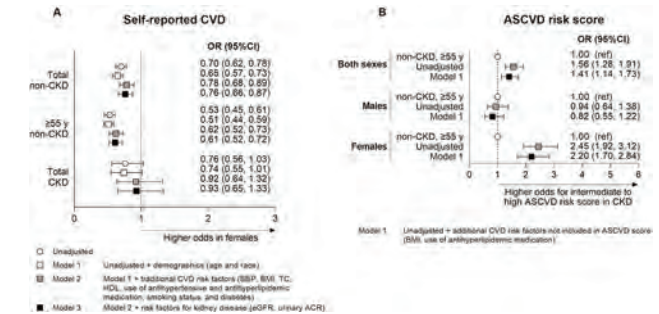

Sex difference in self-reported CVD in non-CKD and CKD (A) and ASCVD risk score in non-CKD vs. CKD by sex (B).

TH-OR25

**Associations of Impaired Kidney Function With Cerebral Small Vessel Disease and Cognitive Disorders: Findings From the Framingham Heart Study**

Dearbhla M. Kelly,<sup>1</sup> Adlin Pinheiro,<sup>3,2</sup> Christopher D. Anderson,<sup>4,5</sup> Hugo J. Aparicio,<sup>3,6</sup> Charles S. Decarli,<sup>7</sup> Shih-Jen Hwang,<sup>3</sup> A. Viswanathan,<sup>1</sup> Jose R. Romero.<sup>3,6</sup> <sup>1</sup>Massachusetts General Hospital, Boston, MA; <sup>2</sup>Boston University School of Public Health, Boston, MA; <sup>3</sup>Framingham Heart Study, Framingham, MA; <sup>4</sup>Brigham and Women's Hospital, Boston, MA; <sup>5</sup>Broad Institute, Cambridge, MA; <sup>6</sup>Boston University School of Medicine, Boston, MA; <sup>7</sup>University of California Davis School of Medicine, Sacramento, CA.

**Background:** CKD has been associated with cognitive dysfunction in epidemiological studies, but it is unclear if this association is independent of blood pressure (BP) and related to cerebral small vessel disease (CSVD). Using the Framingham Heart Study, a population-based longitudinal cohort study with detailed cognitive phenotyping and neuroimaging, we evaluated baseline kidney function in relation to subsequent BP measurements and CSVD, and to mild cognitive impairment (MCI) and dementia.

**Methods:** We included Framingham Offspring participants free of dementia, attending an examination during midlife for ascertainment of kidney function status, with brain MRI late in life, cognitive outcome data and available interim BP assessments. We related CKD (eGFR < 60 ml/min/1.73m<sup>2</sup>) and albuminuria (UACR ≥ 30 mg/g) to CSVD markers (enlarged perivascular spaces [ePVS] and covert brain infarcts [CBI]) using multivariate logistic regression, and to incident MCI or dementia using Cox proportional hazards regression. Models for CSVD markers adjusted for age, sex, mean pre-morbid systolic BP, and time interval between MRI date and exam 8. Models for incident MCI/dementia adjusted for age, sex, education, and mean pre-morbid systolic BP.

**Results:** Among 2738 participants (mean age 67.4 (SD=9.2), 187 (7%) had CKD and 251 (9%) albuminuria. Albuminuria was associated with both high burden of ePVS in mixed brain regions (adjusted OR=1.56 [1.06-2.31] p=0.026), particularly in the basal ganglia (adjusted OR=1.64 [1.13-2.38] p=0.010), and CBI (OR=1.65 [95% CI: 1.09-2.49] p=0.017). Albuminuria was also independently associated with incident MCI and dementia (adjusted HR=1.65 [1.23-2.23] p=0.001). CKD was not associated with CSVD markers but was associated with higher risk of incident dementia (adjusted HR=1.51 [1.01-2.27] p=0.046), mainly the vascular subtype (adjusted HR=2.39 [1.01-5.67] p=0.048).

**Conclusions:** Albuminuria was associated with both CSVD markers and cognitive disorders independent of pre-morbid BP, indicating that 1) hypertensive cerebral vascular injury (reflected on CSVD markers) may not be reflected by BP measurements alone, or 2) other shared pathobiology may exist between the kidney and the brain, for instance with mechanisms such as endothelial dysfunction.

TH-OR26

**Nutritional Status and Cardiorenal Syndrome: Associations of Protein-Energy Wasting and Abdominal Obesity With the Risk of Heart Failure in CKD**

Tejita Agarwal,<sup>1</sup> Sydney E. Hartsell,<sup>1,2</sup> Robert E. Boucher,<sup>1,2</sup> Farahnaz A. Moghaddam,<sup>1</sup> Stephen R. Sammons,<sup>1,2</sup> Amara Sarwal,<sup>1,2</sup> Adhish Agarwal,<sup>1,2</sup> Guo Wei,<sup>1,2</sup> Srinivasan Beddhu.<sup>1,2</sup> <sup>1</sup>The University of Utah School of Medicine, Salt Lake City, UT; <sup>2</sup>VA Salt Lake City Health Care System, Salt Lake City, UT.

**Background:** The term malnutrition is defined as faulty nutrition due to inadequate or unbalanced intake of nutrients or their impaired assimilation or utilization. In that context, both Protein-Energy Wasting (PEW) syndrome and abdominal obesity are two extremes of this disorder. We examined the hypothesis that both of these extremes are risk factors for heart failure (HF) in CKD and thus might play a role in cardiorenal syndrome.

**Methods:** We used data from the Chronic Renal Insufficiency Cohort Study (CRIC), a NIH-funded observational study of participants with CKD. We used a previously published, modified definition of PEW syndrome categories (low serum chemistry, low body mass and low muscle mass). Presence of at least one criteria (albumin < 3.5 g/dl or cholesterol < 100 mg/dl for serum chemistry, BMI < 23 kg/m<sup>2</sup> for body mass and sex specific < 25th percentile of 24-hour urinary creatinine for low muscle mass) within each

category was considered to meet the presence of that category. Abdominal obesity was defined by waist circumference. We used separate Cox regression models to relate baseline PEW and abdominal obesity with the time to subsequent adjudicated HF outcomes.

**Results:** 3745 CRIC participants were included. Mean baseline age was 58 ± 11 yrs and eGFR 44 ± 15 ml/min/1.73 m<sup>2</sup>. At baseline, 1094 patients (29.2%) met 1 PEW criterion, 320 (8.5%) met ≥ 2 criteria and 2486 (67%) had abdominal obesity. There were 630 HF events over 32,877 years of follow-up. As shown in table, adjusted for baseline demographics, smoking, alcohol use, income, comorbid conditions, BP levels, and eGFR, both PEW and abdominal obesity were associated with higher risk of HF events.

**Conclusions:** Abdominal obesity is much more common than PEW in CKD. Both abdominal obesity and PEW are risk factors for HF in CKD. The underlying mechanisms by which PEW might play a role in cardiorenal syndrome needs further study.

**Funding:** NIDDK Support, Other NIH Support - NHLBI, NIA, Veterans Affairs Support

HR (95% CI) for CHF

	Unadjusted	+Demographics, alcohol, smoking, income	+Comorbidities, BPs, eGFR
		Model 1	
0 PEW criterion	Reference	Reference	Reference
1 PEW criterion	2.14 (1.81, 2.52)	2.05 (1.74, 2.43)	1.77 (1.49, 2.09)
≥2 PEW criteria	1.99 (1.52, 2.61)	2.19 (1.67, 2.88)	1.57 (1.18, 2.08)
		Model 2	
Abdominal obesity	1.68 (1.40, 2.01)	1.66 (1.37, 2.00)	1.34 (1.11, 1.63)

TH-OR27

**Role of Human T Cells in Hypertension and Hypertensive Organ Damage**

Masudur Rahman, Johannes Stegbauer, Mina Yakoub, Denada Arifaj, Lydia Hering, Lars C. Rump. *Heinrich-Heine-Universität Dusseldorf, Dusseldorf, Germany.*

**Background:** Inflammation seems to influence hypertension and hypertensive organ damage. Animal studies suggest that adaptive immunity, in particular T cells contribute to the development hypertension. Due to the complex pathophysiological interactions *in vivo*, the impact of human T cells in the development of hypertension and hypertensive organ damage is still unknown.

**Methods:** To investigate the impact of human T cells in hypertension, we transferred T cells from treatment resistant hypertensive patients (TRH) and healthy controls (controls) into immunodeficient NOD.Cg-Prkdcscid H2-K1tm1Bpe H2-D1tm1Bpe Il2rgtm1Wjl/SzJ (NSG-(KbDb) null) mice to establish a humanized mouse model. Hypertension was induced by angiotensin (Ang)II (500ng/kg/min) infusion for 14 days.

**Results:** PBMCs from RHT or controls were transferred to NSG-(KbDb) null mice. After ensuring T cell engraftment, blood pressure (BP) was measured by radiotelemetry. At baseline, systolic BP did not differ, however, systolic BP in response to AngII was increased in NSG-(KbDb) null mice receiving PBMCs from TRH compared to controls (week 1: 133±6 vs. 162±3mmHg, p<0.01; week 2: 141±6 vs. 158±7mmHg, n=5-6, p<0.05). Moreover, endothelial-dependant vasorelaxation was significantly impaired in isolated perfused kidneys of NSG-(KbDb) null mice receiving PBMCs from TRH compared to controls. Proportions of effector memory CD4 and Th17 CD4 cells in the spleens and kidneys of NSG-(KbDb) null mice engrafted with PBMCs from TRH were significantly higher compare to controls. Furthermore, renal mRNA expression of TNFα derived from human T cells (p<0.05) and renal perivascular T cell infiltration were significantly higher in NSG-(KbDb) null mice engrafted with PBMCs from TRH compared to controls. Overnight incubation of aortic rings with human TNFα impaired endothelial-dependen vasorelaxation compared to untreated aortic rings (p<0.01). Finally, NSG-(KbDb) null mice engrafted with PBMC from TRH were treated with the TNFα inhibitor etanercept. TNFα inhibition attenuated the systolic BP response to AngII compared to untreated mice (132±1 vs. 160±2mmHg, n=6, p<0.01).

**Conclusions:** The present results suggest that pro-inflammatory cytokines released by T cells from patients with TRH directly influence the development of hypertension and therefore may have a pathophysiological relevance in the genesis of human hypertension.

TH-OR28

**HLA-DR/DQ Single Molecule Eplet Mismatch and Formation of De Novo Donor-Specific Anti-HLA Antibodies After Kidney Transplantation in Children**

Vaka K. Sigurjonsdottir,<sup>1,2</sup> Kim H. Piburn,<sup>2</sup> Paul C. Grimm.<sup>2</sup> <sup>1</sup>University of Miami School of Medicine, Miami, FL; <sup>2</sup>Stanford University School of Medicine, Stanford, CA.

**Background:** Eplet mismatches in HLA at the single-molecule level, have been identified as a prognostic biomarker for primary alloimmunity. Limited evidence exists on the optimal risk stratification cut-offs in racially diverse pediatric patients receiving kidney transplantation

**Methods:** Children transplanted from 1/1/2010-3/1/2018 at Stanford, with >12-month follow-up, were included. High-resolution HLA typing was performed using next-generation sequencing. Outcome: time to de novo donor specific antibody (dnDSA) formation. dnDSA were screened at the time of transplant, 1, 2, 3, 6, and 12 months following, at least annually thereafter, and as clinically indicated. ROC analysis at the DR and DQ loci was performed to determine risk categories based on total and single-molecule eplet mismatch thresholds. Survival analysis was performed by the Kaplan-Meier method using the log-rank test for significance

**Results:** A total of 233 patients were identified. Our preliminary results include high-resolution typing for 174. Of those, median age was 13 (IQR 9), 23.6% had living donor transplant and 48.3% were female. The Median follow-up time was 36.5 months (IQR 36). 46.0% formed Anti-HLA class II dnDSA. Patients with an eplet mismatch sum of HLA DR > 6 and/or DQ > 4 (n=161) had increased risk of HLA-DR/DQ dnDSA formation, p=0.006. Similarly, patients with single-molecule HLA-DR > 5 and/or DQ > 4 had an increased risk of HLA-DR/DQ dnDSA development. [Figure]

**Conclusions:** Single-molecule eplet mismatch and total eplet mismatch are associated with an increased risk of dnDSA formation. Assessing a patient's individual risk based on donor/recipient HLA-DR/DQ eplet mismatches may guide immunosuppression regimen in the post-transplant period and predict adverse outcomes.

**Funding:** Private Foundation Support

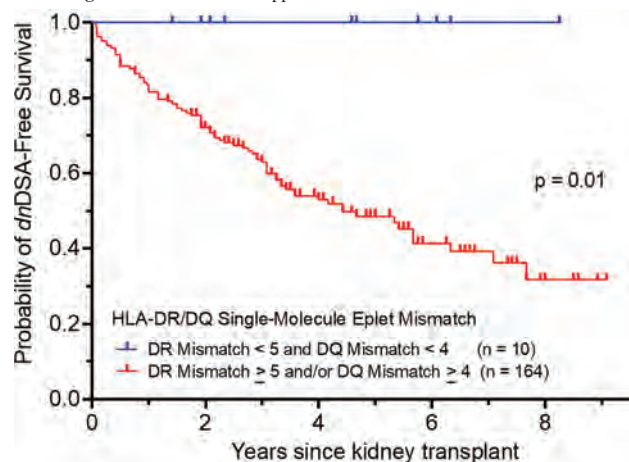

Figure Kaplan-Meier estimates of time to dnDSA formation according to single-molecule HLA-DR/DQ eplet mismatch

TH-OR29

**A Multi-Population Polygenic Risk Score for Pediatric Steroid Sensitive Nephrotic Syndrome Is Correlated With Disease Age at Onset**

China Nagano,<sup>1,2</sup> Alexandra Barry,<sup>1</sup> Michelle McNulty,<sup>1</sup> Matt G. Sampson.<sup>1</sup> NEPTUNE <sup>1</sup>Boston Children's Hospital, Boston, MA; <sup>2</sup>Kobe University Graduate School of Medicine, Kobe, Japan.

**Background:** Genome wide association studies (GWAS) have implicated thousands of single nucleotide polymorphisms (SNPs) in common complex diseases and traits. These SNPs can be combined to generate polygenic risk scores (PRS) that can be used for subsequent predictions and clinical association studies. There are no known PRSs of nephrotic syndrome (NS). In this study, we created a multi-population PRS of pediatric steroid sensitive nephrotic syndrome (SSNS) from the largest GWAS of this disease ever conducted and examined its relationship with clinical phenotypes in two independent cohorts.

**Methods:** The PRS for SSNS was constructed using PRS-CSx, which improves PRS prediction by integrating GWAS from multiple populations. We used GWAS summary statistics derived from European (361 cases and 4309 controls) and Asian (1364 cases and 7954 controls) datasets to generate population-specific PRSs. We used an independent European pediatric SSNS cohort (313 cases and 2508 controls) to identify the optimal parameters based on predictive performance. We then tested the association between SSNS PRS and multiple clinical covariates in the independent European cohort. We then assessed PRS associations in the more clinically heterogeneous Nephrotic Syndrome Study Network (NEPTUNE) cohort.

**Results:** 239 children with SSNS from the independent European cohort also had clinical information. There was a significant negative correlation between PRS and age of onset (P=0.002) adjusting for sex and genetic principal components. There were no significant differences in the PRS between sexes or relapse patterns. We then generated PRS for 353 patients with focal segmental glomerulosclerosis or minimal change disease from NEPTUNE. The PRS was associated with age of onset (P=7.90x10<sup>-10</sup>) after adjustment for genetic ancestry, sex, and histology. Increasing PRS was significantly associated with increased odds of being child- vs adult- onset (adult onset ≥ 19 yrs; P=7.21x10<sup>-8</sup>).

**Conclusions:** This is the first study to create a PRS of NS. We used it to assess the relationship between PRS and NS phenotypes in two independent cohorts. Results suggest that individuals with increased genetic risk of disease have earlier onset. Future studies are needed to replicate our results and examine its predictive power.

TH-OR30

**Prevalence and Persistence of CKD and Hypertension 36 Months Post-Cisplatin in Children**

Kelly McMahon,<sup>1</sup> Yajur Iyengar,<sup>2</sup> Asaf Lebel,<sup>3</sup> Vedran Cockovski,<sup>3</sup> Stella Q. Wang,<sup>3</sup> Michael Zappitelli,<sup>3</sup> ABLE Nephrotoxicity Group <sup>1</sup>Research Institute of the McGill University Health Centre, Montreal, QC, Canada; <sup>2</sup>University of Toronto Temerty Faculty of Medicine, Toronto, ON, Canada; <sup>3</sup>SickKids Research Institute, Toronto, ON, Canada.

**Background:** Long-term kidney outcomes in children treated with Cisplatin(CisP) are unclear. We 1) estimated low eGFR and elevated BP or hypertension(eBP-HT) prevalence 36 months(m) post- pediatric CisP therapy; 2) determined if a)AKI during CisP and b)3m and 12 m kidney and BP status were associated with 36m low eGFR and eBP-HT.

**Methods:** 12 Canadian-site 36m prospective cohort study of CisP-treated children. Exposures: a) AKI during CisP therapy (KDIGO serum creatinine criteria); b) 3m and 12m low eGFR (<90ml/min/1.73m<sup>2</sup>) and eBP-HT. 36m outcomes: a) low eGFR; eBP-HTN. Univariate tests and logistic regression (odds ratios [OR], 95% CI) were used to evaluate exposure-outcome associations.

**Results:** 101 participants (51.5% girls, median[IQR] age 4.4[2.4-9.2]) included. 36m post CisP: 16/85(18.8%) had low eGFR; 26/88(29.6%) had eBP-HT; 38/79 patients(48.1%) had low eGFR or eBP-HT. Table 1 shows characteristics by outcomes. AKI was associated with 36m composite low eGFR or eBP-HTN (AKI: 23/38[60.5%]; no AKI: 15/38[39.5%], p<0.05). Low eGFR at 3m and 12m post-CisP were associated with 36m low eGFR (OR[95% CI]: 17.5[1.7-183]; 16[1.5-167], respectively, Table 1). 12m eBP-HT was associated with 36m eBP-HT (OR [95% CI] 4[1.4-11.8], Table 1). 12m low eGFR or eBP-HT was associated with 36m low eGFR or eBP-HT (OR [95% CI] 3.0 [1.1-8.3]).

**Conclusions:** Low eGFR and high BP are common after CisP and persist from 3m and 12m to 36m. Clear post-CisP kidney health follow-up guidelines must be developed. AKI during therapy may portend worse long-term CisP kidney health.

Table 1. Characteristics by low eGFR and by eBP-HT status at 36 months post CisP therapy

	Low eGFR		eBP or HT	
	No [69 (81.2)]	Yes [16 (18.8)]	No [62 (70.4)]	Yes [26 (29.6)]
<b>Patient, cancer and AKI Characteristics</b>				
Female	32 (46.4)	11 (68.7)	31 (50.0)	13 (50.0)
Age at chemotherapy start	3.9 (2.3-8.2)	5.5 (2.7-13.4)	5.1 (2.9-9.8)	3.3 (2.1-6.8)
Caucasian	53 (76.8)	13 (81.3)	46 (74.2)	20 (76.9)
Baseline eGFR (mL/min/1.73m <sup>2</sup> )	143 (115-171) *	118.5 (91.8-144.5)	132.9 (109-157)	160 (135-177) *
Nephrotoxic medications <sup>a</sup>	8 (11.6)	1 (6.3)	5 (8.1)	2 (7.7)
<b>Cancer Type</b>				
Osteosarcoma	10 (14.5)	1 (6.3)	11 (17.7)	1 (3.9)
Germ cell tumor	8 (11.6)	3 (18.8)	7 (11.3)	2 (7.7)
Neuroblastoma	28 (40.6)	3 (18.8)	18 (29)	12 (46.2)
CNS Tumor	17 (24.6)	7 (43.8)	21 (33.9)	8 (30.8)
Hepatoblastoma	5 (7.3)	2 (12.5)	4 (6.5)	3 (11.5)
Other	1 (1.5)	0 (0)	1 (1.6)	0 (0)
Total cisplatin dose (mg/m <sup>2</sup> )	383 (254.1-410.5)	403.5 (300.1-498.8)	385.9 (273.6-465)	395.1 (266.4-409.6)
<b>Acute Kidney Injury Types: Any AKI and Severe (Stage 2 or worse) AKI</b>				
AKI during therapy	29 (42)	10 (62.5)	24 (38.7)	15 (57.7)
Severe AKI	8 (11.6)	3 (18.8)	7 (11.3)	5 (19.2)
<b>3 and 12 month low eGFR and presence of eBP or HT</b>				
Low eGFR at 3 months	1 (1.5)	3 (21.4)		
eBP or HT at 3 months			12 (22.6)	7 (31.8)
Low eGFR at 12 months	1 (1.5)	3 (20)		
eBP or HT at 12 months			10 (17.2)	10 (45.5)

\* p-value <0.05; \*\* p-value<0.01; # In the month prior to the 36 months' follow-up visit. Continuous variables expressed as median [interquartile range]; categorical variables expressed as numbers (proportion of total).

TH-OR31

**Rapid Correction of Hyponatremia Is Not Associated With Mortality or Neurological Morbidity in Children: The Correcting Hyponatremia in Children Study**

Madeleine Didsbury,<sup>1</sup> Emily See,<sup>1,2</sup> Daryl R. Cheng,<sup>1,3</sup> Joshua Y. Kausman,<sup>1,3</sup> Catherine Quinlan,<sup>1,3</sup> <sup>1</sup>The Royal Children's Hospital Melbourne, Parkville, VIC, Australia; <sup>2</sup>The Royal Melbourne Hospital, Parkville, VIC, Australia; <sup>3</sup>Murdoch Children's Research Institute, Parkville, VIC, Australia.

**Background:** In patients with hyponatremia current guidelines recommend reducing sodium by <0.5mmol/L per hour to avoid cerebral edema, however there are no large-scale studies in the pediatric population. This study aimed to examine the rate of correction of hyponatremia, neurological outcomes, and mortality in children.

**Methods:** A retrospective review was conducted using the electronic medical record at a quaternary pediatric hospital to capture all children with at least one sodium level of ≥150mmol/L from 2016-2019. Electroencephalogram results, neuroimaging and medical records were reviewed manually for seizures and cerebral edema. Correction rates over the first 24 hours and overall were calculated from the peak sodium and defined as rapid (>0.5mmol/L) or slow (<0.5mmol/L per hour). Binary, univariable and multivariable analyses were used to examine the association between the rate of correction and need for neurological investigation and death.

**Results:** There were 402 episodes of hyponatremia amongst 358 children over three years. 179 were community-acquired and 223 developed during admission. 28 patients (7%) died during admission. Compared to those with community-acquired hyponatremia, patients with hospital-acquired hyponatremia had higher mortality (10% vs 4%, p=0.02), more intensive care unit (ICU) admissions (63% vs 51%, p=0.01), and a longer length of stay (20.7 vs 7.2 days, p<0.001). Rapid correction occurred in 200 children and was not associated with increased mortality (OR 0.54, 95% CI 0.24 to 1.2, p=0.13) or neurological investigation (OR 0.89, 95% CI 0.55 to 1.46, p=0.65) compared to slow correction. Findings were consistent when examined with the correction rate as a continuous variable and by age subgroups. Both hospital and ICU length of stay were longer in children who received slow correction (median days in hospital 24.9 vs 15.9, p=0.009; median days in ICU 11.3 vs 8.5, p=0.03).

**Conclusions:** We did not find any evidence that rapid sodium correction was associated with neurological morbidity or mortality; however slow correction was associated with a longer length of stay. Further prospective studies are needed to confirm the safety and advantages of rapid correction in children.

TH-OR32

**Intradialytic Hypotension and Mortality in Children and Young Adults**

Xixi Zhao,<sup>1</sup> Tara I. Chang,<sup>1</sup> Wolfgang C. Winkelmayer,<sup>2</sup> Olivera Marseanic,<sup>1</sup> <sup>1</sup>Stanford University, Stanford, CA; <sup>2</sup>Baylor College of Medicine, Houston, TX.

**Background:** Intradialytic hypotension (IDH) is associated with mortality in adult patients requiring hemodialysis (HD), however large-scale pediatric studies are lacking. Moreover, there is no evidence-based consensus definition of IDH in the pediatric literature. We aimed to test whether a similar relationship between IDH and mortality existed in children and young adult patients, and if so, which IDH definition captured that association best.

**Methods:** We studied 1,581 patients (ages 1-21 years old) receiving HD at a large dialysis organization to investigate the associations of commonly used IDH definitions with mortality. IDH definitions were selected *a priori* based on a literature review (Table 1). Patients were classified as having IDH if they experienced IDH in at least 30% of HD treatments.

**Results:** IDH did not associate with mortality in any of the commonly used IDH definitions after adjusting for age, race, cause of end-stage kidney disease, predialysis systolic blood pressure (SBP), and ultrafiltration rate (Figure 1). Subgroup analysis by age (≤18 and 19-21 years old) and predialysis SBP (<120, 120-150, >150 mmHg) did not demonstrate an association with mortality either. We then examined the occurrence of IDH in <5%, 5-29%, 30-50%, and >50% of baseline treatments, and did not find a dose-response association of IDH with mortality.

**Conclusions:** IDH was not independently associated with mortality in children and young adults, contrary to the findings in adults. Future studies will examine the association of IDH with outcomes other than death, and mechanisms that may allow this population to better tolerate IDH.

IDH definitions

Term	Definition
5th percentile	70 + (2 × age)
50th percentile	90 + (2 × age)
>20 drop	(Predialysis SBP - nadir intradialytic SBP) > 20 mmHg
>30 drop	(Predialysis SBP - nadir intradialytic SBP) > 30 mmHg
SBP<90	Nadir intradialytic SBP<90 mmHg
SBP<100	Nadir intradialytic SBP<100 mmHg
>20 drop + SBP<90	(Predialysis SBP - nadir intradialytic SBP) > 20 mmHg and nadir intradialytic SBP<90 mmHg
>30 drop + SBP<90	(Predialysis SBP - nadir intradialytic SBP) > 30 mmHg and nadir intradialytic SBP<90 mmHg

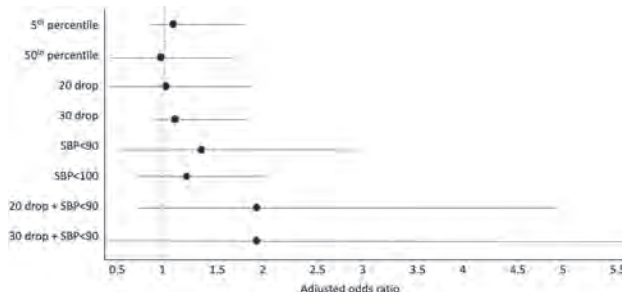

TH-OR33

**Urinary DKK3 Predicts Short-Term eGFR Decline and Nephroprotective Efficacy of Antihypertensive Therapy in Children With CKD: Findings From the 4C Study and ESCAPE Trial**

Franz S. Schaefer,<sup>1</sup> Thimoteus Speer,<sup>2</sup> Stefan J. Schunk,<sup>2</sup> Danilo Fliser.<sup>2</sup> 4C trial and ESCAPE study investigators <sup>1</sup>Ruprecht Karls Universität Heidelberg, Heidelberg, Germany; <sup>2</sup>Universitätsklinikum des Saarlandes und Medizinische Fakultät der Universität des Saarlandes, Homburg, Germany.

**Background:** Childhood-onset chronic kidney disease (CKD) is a progressive condition with major impact on life expectancy and quality. We evaluated the usefulness of the kidney tubular cell stress marker urinary Dickkopf-3 (uDKK3) in determining the short-term risk of CKD progression in children and identifying those who will benefit from specific nephroprotective interventions.

**Methods:** We assessed the association between uDKK3 and kidney endpoints, and its interaction with intensified blood pressure reduction in the randomized-controlled ESCAPE trial. Estimated glomerular filtration rate (eGFR) and uDKK3 were quantified in 659 children with CKD enrolled in the prospective multicenter ESCAPE and 4C studies at baseline and at 6-monthly follow-up visits, yielding 3,935 semi-annual evaluation blocks.

**Results:** In ESCAPE, the effect of intensified blood pressure control on the kidney survival endpoint and the need for kidney replacement therapy was limited to children with uDKK3 above the median, i.e. >1,689 pg/mg (HR 0.33, 95%CI:0.17-0.64; NNT 4.1 vs. 25.0 and HR 0.27, 95%CI:0.11-0.66; NNT 6.7 vs. 55.6). In 4C, inhibition of the renin-angiotensin-system resulted in lower uDKK3 levels (12,235 vs. 6,861 pg/mg, P=4.7\*10<sup>-6</sup>). In both cohorts, uDKK3 >1,689 pg/mg creatinine was associated with significantly greater 6-month eGFR decline (ESCAPE: -6.3%, 95%CI:-7.8—-4.9% vs. 0.2%, 95%CI:-1.1—1.6%, P=4.2x10<sup>-10</sup>; 4C: -6.5%, 95%CI:-13.4—0.4 vs. -1.7%, 95%CI:-8.6—5.2, P=2.4x10<sup>-10</sup>), independently of kidney diagnosis, eGFR, and albuminuria.

**Conclusions:** uDKK3 is associated with a greater short-term risk of declining kidney function and may allow a personalized medicine approach to pharmacological nephroprotection by identifying children who benefit from intensified blood pressure lowering.

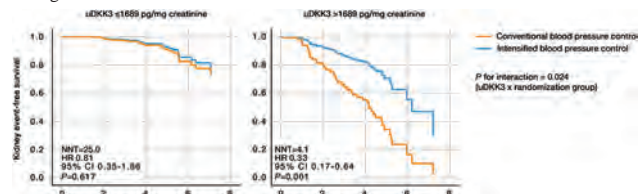

TH-OR34

**Nedosiran in Patients With Primary Hyperoxaluria 1: Interim Results From an Extension Trial (PHYOX3)**

John C. Lieske,<sup>1</sup> Gema Ariceta,<sup>2</sup> Michelle A. Baum,<sup>3</sup> Vladimir Belostotsky,<sup>4</sup> Andrea Cappoli,<sup>5</sup> Pierre Cochat,<sup>6</sup> Thomas A. Forbes,<sup>7</sup> Jaap Groothoff,<sup>8</sup> Shuzo Hamamoto,<sup>9</sup> Bernd Hoppe,<sup>10,11</sup> Andrew J. Mallett,<sup>12</sup> Armando Torres,<sup>13</sup> Hiroyuki Satoh,<sup>14</sup> Burkhard Toenshoff,<sup>15</sup> John Karafilidis,<sup>11</sup> Shabbir H. Mochhala.<sup>16</sup> <sup>1</sup>Mayo Clinic Minnesota, Rochester, MN; <sup>2</sup>Hospital Universitari Vall d'Hebron, Barcelona, Spain; <sup>3</sup>Boston Children's Hospital, Boston, MA; <sup>4</sup>McMaster Children's Hospital, Hamilton, ON, Canada; <sup>5</sup>Ospedale Pediatrico Bambino Gesù, Roma, Italy; <sup>6</sup>Hospices Civils de Lyon, Lyon, France; <sup>7</sup>The Royal Children's Hospital Melbourne, Parkville, VIC, Australia; <sup>8</sup>Amsterdam UMC Locatie AMC, Amsterdam, Netherlands; <sup>9</sup>Nagoya Shiritsu Daigaku, Nagoya, Japan; <sup>10</sup>Universitätsklinikum Bonn, Bonn, Germany; <sup>11</sup>Dicerna Pharmaceuticals, Inc. A wholly owned subsidiary of Novo Nordisk A/S, Lexington, MA; <sup>12</sup>Royal Brisbane and Women's Hospital, Herston, QLD, Australia; <sup>13</sup>Hospital Universitario de Canarias, La Laguna, Spain; <sup>14</sup>Tokyo Toritsu Shoni Sogo Iryo Center, Fuchu, Japan; <sup>15</sup>Ruprecht Karls Universität Heidelberg, Heidelberg, Germany; <sup>16</sup>Royal Free Hospital, London, United Kingdom.

**Background:** Primary hyperoxaluria (PH) is a family of genetic disorders leading to oxalate overproduction, causing calcium oxalate stones and kidney damage, which may result in kidney failure. Nedosiran—an investigational RNA interference (RNAi) therapy in development for treatment of PH—silences hepatic LDH expression encoded by the LDHA gene, which reduces oxalate production. In a 6-month (mo) placebo-controlled pivotal trial (PHYOX2), monthly nedosiran resulted in significantly lower urinary (Uox) and plasma oxalate in PH1 patients.

**Methods:** PHYOX3 (NCT04042402) is an open-label extension trial evaluating long-term safety and efficacy of monthly SC nedosiran in patients with genetically confirmed PH and eGFR ≥ 30 mL/min/1.73 m<sup>2</sup> who completed a previous nedosiran trial. This is a 9-mo analysis of PH1 patients from PHYOX2 nedosiran (NEDO|NEDO) and placebo (PLBO|NEDO) arms who rolled into PHYOX3.

**Results:** Both NEDO|NEDO and PLBO|NEDO groups showed substantial reduction in 24-hr Uox, regardless of baseline Uox entering PHYOX2 or PHYOX3 (Figure). The mean Uox reduction was 64.9% and 68.1% for NEDO|NEDO and 55.1% and 60.8% for PLBO|NEDO at the 6-mo and 9-mo visits, respectively. Among the NEDO|NEDO patients, 11 of 13 (85%) and 7 of 7 (100%) achieved normal or near-normal Uox (< 0.6 mmol/24-hr; < 1.3 x ULN) at the 6-mo and 9-mo visits, respectively. Most common drug-related AEs were administration site events; injection site reactions were observed in 3 patients. There were no drug-related SAEs or study discontinuations, or deaths.

**Conclusions:** Nedosiran administration to PH1 patients resulted in significant and persistent reduction of Uox and showed an acceptable safety profile. Analysis of long-term effects on kidney function is ongoing.

**Funding:** Commercial Support - Dicerna Pharmaceuticals, Inc. (A wholly owned subsidiary of Novo Nordisk A/S)

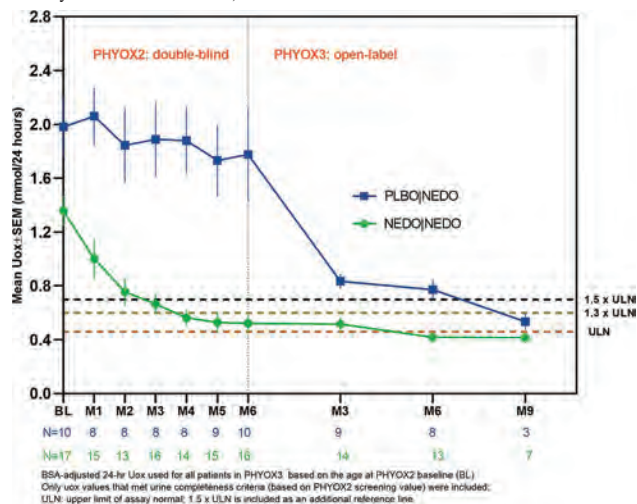

TH-OR35

**Ciliary ARL13B Is a Major Driver of Kidney Cystogenesis**

Robert E. Van Sciver,<sup>1</sup> Eduardo Gigante,<sup>2</sup> Tamara Casparly.<sup>1</sup> <sup>1</sup>Emory University, Atlanta, GA; <sup>2</sup>Georgia Institute of Technology, Atlanta, GA.

**Background:** Polycystic kidney disease (PKD) is intricately linked to the primary cilium. *PKD1* and *PKD2* encode for polycystin proteins which localize to cilia, and mutations in these genes are causative for PKD. Mouse models predict the presence of a cilia-dependent cyst activating (CDCA) pathway that functions in cilia to drive cystogenesis. Despite the central importance of this organelle to renal cystic diseases, the ciliary driver(s) of cyst pathogenesis remain unknown. Mouse models have implicated that the ciliary GTPase ARL13B may be a major regulator of the CDCA pathway.

**Methods:** To directly test ARL13B's role in the CDCA pathway, we engineered mice with an amino acid point mutation in ARL13B's cilia-localization motif so the mice express cilia-excluded ARL13B from the endogenous locus. The resulting protein retains all known ARL13B biochemical functions, is stably expressed and is undetectable in cilia. Combining this mouse model with the kidney-specific loss *Pkd1* allowed us to directly test ARL13B's ciliary role in kidney cystogenesis.

**Results:** At 18-weeks, control kidneys had a kidney weight to body weight ratio (KW:BW) of 1.41±0.05. In adult induction mouse models, loss of ciliary ARL13B did not lead to cysts with a KW:BW of 1.40±0.03, while loss of *Pkd1* led to severe cystic kidneys with KW:BW of 6.13±1.33. Loss of *Pkd1* and ciliary exclusion of ARL13B suppressed the cystic phenotype caused by loss of *Pkd1* alone with KW:BW of 2.13±0.16.

**Conclusions:** In adult induction models, loss of ciliary ARL13B suppresses the severe cystic kidney phenotype caused by loss of *Pkd1* alone. These results directly implicate ciliary ARL13B as a major regulator of the CDCA pathway. Our findings indicate that ARL13B plays a critical role within the cilium in regulating kidney cystogenesis, with ciliary ARL13B activating a pro-cystogenic pathway.

**Funding:** NIDDK Support, Other NIH Support - NIGMS

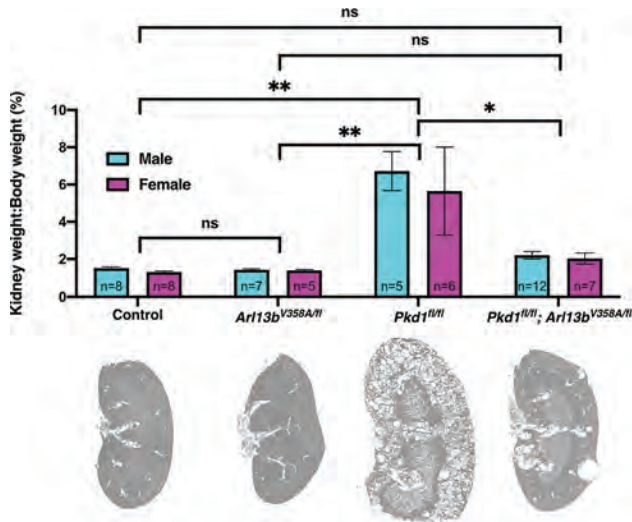

Ciliary exclusion of ARL13B suppresses the severe cystic phenotype caused by loss of *Pkd1*.

TH-OR36

Arginine Metabolism Has a Pivotal Role in Cystogenesis of Tuberos Sclerosis Complex (TSC) and Its Inhibition Alleviates TSC Cyst Overload

Morris Nechama, Athar Amleh, Iddo Z. Ben-Dov, Oded Volovelsky. Hadassah University Medical Center, Jerusalem, Israel.

**Background:** Kidney disease affects most patients with tuberous sclerosis complex disease (TSC) and is a leading cause of death in adulthood. Mutations in *Tsc1* or *Tsc2* in TSC induce mTOR activation, resulting in cell growth manifested by cystic kidney disease. However, the exact mechanisms leading to tubular cell damage and cyst formation remain poorly understood. Metabolic reprogramming is an essential mechanism by which cells rewire their activity to promote cell proliferation and growth. Here, we show that TSC kidneys exhibit major metabolic alterations, mainly the arginine biosynthesis pathway and that arginine pathway inhibition alleviates the TSC cyst overload.

**Methods:** Metabolites were extracted and analyzed from kidneys of vehicle or rapamycin-treated *Six2 Cre<sup>+/lox</sup> Tsc1<sup>-/-</sup>*, and control mice using liquid chromatography/in-line tandem mass spectrometry. Kidneys were also used for histology, RNA/protein extraction, and immunofluorescence.

**Results:** Metabolome analysis of whole kidneys and proximal tubular cells (PTCs) from TSC mice showed major perturbation in several metabolic pathways, mainly the arginine biosynthesis pathway. These trends were associated with an increase in urea cycle metabolites and the rate-limiting enzyme, argininosuccinate synthase 1 (ASS1), expression levels. High ASS1 level was specifically localized in cyst lining cells in the TSC kidney. Rapamycin treatment reversed the increase in ASS1 expression in *Tsc1* Knockout HK2 cell, emphasizing the contribution of the *Tsc1*-mTORC1 pathway to ASS1 expression. Finally, arginine depletion *in vivo* and *in vitro* reduced the mTOR signaling pathway, cell proliferation, and kidney cyst overload.

**Conclusions:** TSC kidneys exhibit significant perturbations in the arginine biosynthesis pathway. Based on our results, we suggest that dysregulated mTOR pathway in TSC PTCs induces the arginine biosynthesis pathway by overexpression of ASS1 to support the high arginine demand in PTCs. Arginine depletion ameliorates PTC signaling and cell proliferation which are significant contributors to cyst development in TSC. Our studies highlight potential targets for immediate translational and clinical implications.

TH-OR37

Abstract Withdrawn

TH-OR38

Transdermal Glomerular Filtration Rate Measurement: Clinical Results From a Pilot Multicenter Study Establishing Feasibility and Efficacy

Richard B. Dorshow, Martin Debreczeny, Jeng-Jong Shieh. MediBeacon Inc., Saint Louis, MO.

**Background:** Point-of-care measured (not estimated) glomerular filtration rate has been a goal of nephrologists for the last 30 years. To this end, a fluorescent GFR tracer agent, relmapirizin, has been rationally designed and 24 standard nonclinical assays as required by the FDA have been performed. Fluorescent detection instrumentation to acquire and process the emission signal from the agent through the skin has been developed. The pilot clinical study objectives were to: *Demonstrate relmapirizin is a*

*GFR agent in humans by comparison to iohexol, Establish that the GFR as measured by the transdermal fluorescence excretion rate matches the plasma GFR. This combination product was evaluated on 120 subjects covering three clinical sites.*

**Methods:** Subjects were enrolled with GFR values from normal to Stage 4 CKD values, and for all six skin colors on the Fitzpatrick Skin Scale (FSS). Relmapirizin and iohexol were administered IV in consecutive boluses, and blood samples were taken periodically over the subsequent 12 hours. Prior to agent dosing, the transdermal sensor was placed on the chest of each subject and fluorescent readings were initiated. Urine was collected post-dosing.

**Results:** The plasma-derived GFR measured from relmapirizin matched the plasma-derived GFR measured from iohexol. An algorithm was developed to convert the transdermal fluorescence measurement directly into an indexed GFR, applicable to the entire GFR range and for all skin colors (Figure 1). The % administered relmapirizin dose recovered in the urine matched that of iohexol. No serious nor significant adverse events were reported.

**Conclusions:** Clinically amenable point-of-care measured GFR has been demonstrated for subjects with a range of GFR values and for all skin colors, thus validating this methodology. Data and fits will be shown in this oral presentation.

**Funding:** Commercial Support - MediBeacon Inc.

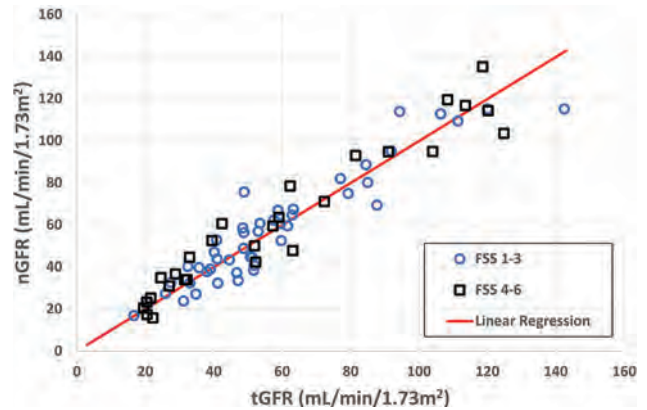

The transdermal GFR (tGFR) correlates to the indexed plasma GFR (nGFR).

TH-OR39

Evaluation of Renal Blood Flow Using <sup>64</sup>Cu-ATSM PET

Naoki Takahashi, Yudai Nishikawa, Sho Nishikawa, Yuki Shimamoto, Kazuhisa Nishimori, Sachiko Fukushima, Sayu Morita, Mamiko Kobayashi, Hideki Kimura, Kenji Kasuno, Masamichi Ikawa, Tetsuya Tujikawa, Hidehiko Okazawa, Masayuki Iwano. Fukui Daigaku Igakubu, Yoshida-gun, Japan.

**Background:** In patients with CKD, it is important to evaluate renal blood flow (RBF). RBF can be obtained by the clearance method, estimation from eGFR or measurement using nuclear medicine test, but all have their advantages and disadvantages. For this reason, a method to assess RBF with ASL-MRI has recently been investigated and has been shown to be reliable. Cu(II)-diacetyl-bis(4-methylthiosemicarbazone) (<sup>64</sup>Cu-ATSM) is a tracer developed for hypoxia imaging and has been reported to be able to quantify cerebral blood flow. Therefore, in this study, we performed ASL-MRI and PET imaging simultaneously and obtained the actual RBF values. Furthermore, we compared the estimated RBF (eRBF) obtained from clinical parameters with the measured RBF of both imaging methods and investigated the usefulness of PET for the evaluation of RBF.

**Methods:** The study consisted of 15 subjects, including 5 healthy subjects and 10 patients with various CKD. A single dose of 300-400 MBq <sup>64</sup>Cu-ATSM was administered, the abdomen was imaged for PET, and then ASL images were taken. Circular ROIs were placed on the upper to lower poles of the kidney cortex for PET/MRI imaging. To obtain an RBF, the mean of the 20 ROI values was calculated. eGFR was calculated from serum creatinine (sCr) and cystatin C (sCys), respectively, and eRBF was calculated using the eGFR, hematocrit and FF values. Furthermore, renal volume was calculated by integrating MRI and eRBF per 100 g of kidney weight was calculated.

**Results:** The RBF measured with MRI-ASL was positively correlated with eRBF by sCr (r=0.596, p<0.05) and sCys (r=0.669, p<0.01), respectively. The RBF measured with <sup>64</sup>Cu-ATSM was positively correlated with the RBF estimated by sCr (r=0.621, p<0.05) and sCys (r=0.591, p=0.02), respectively. The RBF measured with MRI-ASL was positively correlated with the RBF measured with <sup>64</sup>Cu-ATSM (r=0.714, p=0.003). The linear regression line had a slope close to 1 (0.88) and the intercept (14.1) also approximated the origin. The Bland-Altman analysis showed agreement with the RBF measured by ASL imaging and <sup>64</sup>Cu-ATSM imaging (Bias=-2.4, SD=24.9).

**Conclusions:** We report for the first time that <sup>64</sup>Cu-ATSM PET is useful for assessing RBF in healthy subjects and patients with various renal diseases, as well as ASL-MRI.

**Funding:** Government Support - Non-U.S.

## TH-OR40

## Targeted Isolation of Urine-Derived Renal Tubular Cells for Personalised Medicine

Chutong Zhong, Stephen B. Walsh, Keith Siew. *University College London, London, United Kingdom.*

**Background:** The kidney achieves homeostasis through the complex actions of the nephron; a heterogenous structure made up of 14+ segments. Rare monogenic tubular diseases are often characterised by impairment of specific tubular segments. Isolation and characterisation of patient-specific urine-derived renal tubular epithelial cells (uRTEC) from disease-relevant segments can assist diagnosis and treatment planning.

**Methods:** Urine samples collected from healthy volunteers and patients with genetic tubular disease were pelleted by centrifugation at 400 RCF for 10min at RT, and the cell pellet was washed with a 50:50 mixture of DMEM:F12 (supplemented with 10% FBS, 100U/ml penicillin, 100µg/ml streptomycin, 1X insulin-transferrin-selenium, 2.5µg/ml nicotinamide, 500µg/ml hydrocortisone). Targeted isolation and enrichment of segment-specific cells was performed using a magnetic beads conjugated to target-specific antibodies/lectins. Primary urine-derived cells were either fixed using 4% w/v formaldehyde-PBS for 15min at RT at 60% confluency, or lysed with TRI reagent at 90% confluency for RNA isolation. Cell types were validated by staining with fluorescently-tagged marker antibodies/lectins and qPCR of segment specific mRNAs.

**Results:** Primary urinary cells successfully cultured from patients' urine samples with different morphologies presented and can be maintained to the third passage. As can be seen in **Figure 1**, cells from several patients stained positively with *Dolichos Biflorus Agglutinin* indicating the presence of distal convoluted tubule cells. These was validated by confirmation of expression of NCC.

**Conclusions:** uRTEC can be routinely isolated from patient's urine, targeted for enrichment, and successfully subcultured for several passages. Future work, would aim to utilise these cells in 3D "Organ-on-a-Chip" systems, where we could potentially artificially reconstruct patient's tubules from primary urinary cells and conduct individualised pharmacological experiments to optimize treatments, thereby bringing true personalised medicine to nephrology.

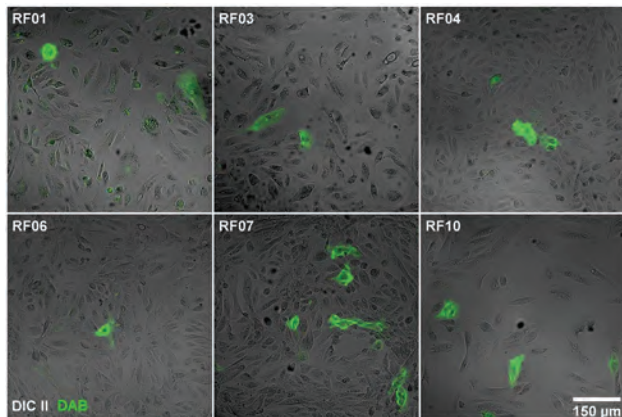

## TH-OR41

## CODEX Multiplex Imaging Uncovers Unique Cell Types, States, and Niches in Health and Disease

Daria Barwinska,<sup>1</sup> Angela R. Sabo,<sup>1</sup> Seth Winfree,<sup>2</sup> Connor J. Gulbranson,<sup>1</sup> Michael T. Eadon,<sup>1</sup> James C. Williams,<sup>1</sup> Tarek M. El-Achkar.<sup>1</sup> *KPMP<sup>1</sup> Indiana University School of Medicine, Indianapolis, IN; <sup>2</sup>University of Nebraska Medical Center, Omaha, NE.*

**Background:** Co-Detection by indEXing (CODEX) multiplex imaging is a new and powerful tool for imaging many protein markers on one tissue specimen. A challenge in applying this technology on human kidney tissue is to establish a robust analytical pipeline to analyze the resultant multidimensional large-scale data and compare multiple datasets.

**Methods:** We imaged human cortical tissue from healthy reference and renal disease (AKI, Lupus, CKD, IgA) specimens with 38 different antibodies, including epithelial, immune, and injury markers. Segmentation of nuclei and unsupervised analysis, classification and visualization were performed using a customized open-source software tool: Volumetric Tissue Exploration and Analysis (VTEA). Additional analysis to combine datasets in a single analytical space was performed using R and visualized in VTEA. We also performed cell centric neighborhood analysis to define spatially relevant cell niches.

**Results:** In healthy tissue, unsupervised clustering and classification of cell types not only identified the major structures in the renal cortex, but also unique subsets of both proximal tubules (PTs) and thick ascending limbs (TALs). PTs were consistently found to have a unique subset that was positive for THY1 (CD90), which is a marker of cell differentiation. PT and TALs cells also showed a subset that was positive for PROM1 (CD133), which is a marker associated with repair. Immune cell clusters were defined using various markers such as CD45, CD68, CD11C, CD206, CD20 and CD3. In kidney disease, we observed a marked alteration in the abundance and distribution of epithelial

and immune cell subtypes. Neighborhood analysis showed unique cell niches that were altered in disease. Specifically, cell niches enriched in THY1+ PTs were markedly diminished, whereas immune-rich niches expanded with disease.

**Conclusions:** We established a unique analytical pipeline for CODEX multiplexed imaging data that can be utilized to define various cell types in the human kidney in health and disease and compare between specimens. Our findings highlight unique cell niches and uncover alteration of specialized epithelial and immune cell types with disease, thereby identifying potential novel targets for therapy.

**Funding:** NIDDK Support

## TH-OR42

## Super-Resolution Microscopy in Clinical Specimens Using Conventional Widefield Microscopes

Dominik Kylies,<sup>1</sup> Marina Zimmermann,<sup>1</sup> Fabian Haas,<sup>1</sup> Malte B. Kuehl,<sup>1</sup> Jan Czogalla,<sup>1</sup> Oliver Kretz,<sup>1</sup> Nicola M. Tomas,<sup>1</sup> Thorsten Wiech,<sup>1</sup> Christoph Kuppe,<sup>2</sup> Rafael Kramann,<sup>2</sup> Milagros N. Wong,<sup>1</sup> Tobias B. Huber,<sup>1</sup> Victor G. Puelles.<sup>1</sup> *<sup>1</sup>Universitätsklinikum Hamburg-Eppendorf, Hamburg, Germany; <sup>2</sup>Rheinisch-Westfälische Technische Hochschule Aachen, Aachen, Germany.*

**Background:** Super-resolution microscopy (SRM) enables nanoscale molecular characterization of tissues, but the access to SRM systems is limited, hindering their applicability in the scientific and clinical pathology community. Expansion microscopy and computational image enhancement algorithms like "super-resolution radial fluctuations" (SRRF) are promising alternatives, but do not achieve sufficient resolution when combined with LED-based widefield microscopy (WFM). Here, we introduce expansion-enhanced super-resolution radial fluctuations (ExSRRF), enabling nanoscale molecular SRM in clinical pathology samples using WFM.

**Methods:** We performed immunofluorescence labeling of tissues, followed by hydropal embedding, tissue expansion and time-stacked image acquisition with WFM. Subsequent computational processing using the SRRF algorithm yielded super-resolved images. To define the resolution range, nanorulers (synthetic molecules containing two fluorescent dyes at precisely predefined distances) were expanded and imaged in a similar fashion to tissues. Automated image analysis of the slit diaphragm (SD) was performed using a multi-step process including region of interest- and ridge-detection, followed by SD-density and dilatation measurements using both, custom and open-source tools.

**Results:** In a set of nanorulers, ExSRRF displayed non-overlapping point-spread functions at distances between 120nm and 25nm, thus providing a resolution of at least 25nm. ExSRRF was applied across a broad range of formalin-fixed paraffin-embedded clinical and experimental tissues. In an experimental model of renal ischemia-reperfusion injury, ExSRRF resolved endoplasmic reticular dilatation. In human kidney biopsies, ExSRRF resolved normal foot processes (FP) and detected FP effacement as a diagnostic feature of minimal change disease (MCD). In a small case series, ExSRRF resolved the SD and provided quantitative changes and a morphological disease signature of MCD.

**Conclusions:** ExSRRF is a flexible, scalable, inexpensive, and robust method for the molecular characterization of experimental and clinical specimens and thus has the potential to bridge SRM and both clinical and experimental pathology, enabling universal access to molecular nanopathology.

## TH-OR43

## Analyzing Cell Type-Specific Dynamics of Metabolism in Kidney Repair

Ton J. Rabelink,<sup>1</sup> Gangqi Wang,<sup>1</sup> Bram Heijs,<sup>1</sup> Sarantos Kostidis,<sup>1</sup> Ahmed Mahfouz,<sup>1</sup> Rosalie Rietjens,<sup>1</sup> Roel Bijkerk,<sup>1</sup> Angela Koudijs,<sup>1</sup> Lois van der Pluijm,<sup>1</sup> Cathelijne W. Van den Berg,<sup>1</sup> Sébastien J. Dumas,<sup>2</sup> Peter Carmeliet,<sup>2</sup> Martin Giera,<sup>1</sup> Bernard van den Berg.<sup>1</sup> *<sup>1</sup>Leids Universitair Medisch Centrum, Leiden, Netherlands; <sup>2</sup>Vlaams Instituut voor Biotechnologie KU Leuven Center for Cancer Biology, Leuven, Belgium.*

**Background:** Conventional single-cell metabolomics approaches such as MALDI based mass spectrometry imaging (MALDI-MSI) generate biochemical snapshots, neglecting the inherent dynamic nature of metabolism. Here we describe a platform based on isotope tracing and MALDI-MSI that allows *in-situ* dynamic measurements of cell type-specific metabolism at single-cell resolution, and thus unravel cell metabolism within its tissue architecture.

**Methods:** We applied different <sup>13</sup>C-isotope-labeled nutrients on vibratome slices of fresh mouse kidney. MALDI-MSI at single-cell resolution (i.e. pixel size of 5 × 5 µm<sup>2</sup>) was then applied to detect metabolites and lipids from the harvested tissues. Following MALDI-MSI analysis, post-MSI-analyzed sections were stained and subsequently imaged using multiplexed immunofluorescence (IF) microscopy for cell-type identification.

**Results:** We show that this method can map cell type-specific dynamic changes in the central carbon metabolism, as well as the contribution of different nutrients to energy metabolism in a complex heterogenous tissue architecture such as the kidney. Combined with multiplexed immunofluorescence staining, we can detect metabolic changes and nutrient partitioning in targeted cell types as demonstrated in a bilateral renal ischemia/reperfusion injury (bIRI) model. At baseline, we identified a marked heterogeneity in respect to TCA metabolite consumption and glycolysis in the outer stripe outer medullary proximal tubular segments (PT-S3) when compared to the cortical PT-S1/S2 segments. After bIRI, PT cells that failed to repair remained in a hyperglycolytic state. Meanwhile, PT cells with an apparent normal phenotype in the recovery phase still display a striking difference in tricarboxylic acid (TCA) cycle substrate use when compared to those in sham kidneys. As TCA metabolites serve biosynthesis as well as gene regulation this may be of relevance to the homeostatic capacity of the kidney microenvironment.

Key: TH - Thursday; FR - Friday; SA - Saturday; OR - Oral; PO - Poster; PUB - Publication Only

Underline represents presenting author.

**Conclusions:** In sum, this method allows to achieve single-cell resolution *in situ* and hence interpret cell type-specific metabolic dynamics in the context of kidney structure and metabolism of neighboring cells.

**Funding:** Private Foundation Support

#### TH-OR44

### High Resolution Spatially Resolved Transcriptomic Atlas of Kidney Injury and Repair With Direct RNA Hybridization-Based In Situ Sequencing

Haojia Wu,<sup>1</sup> Eryn E. Dixon,<sup>1</sup> Juanru Guo,<sup>1</sup> Debashish Chitnis,<sup>2</sup> Anezka Niesnerova,<sup>2</sup> Hao Xu,<sup>2</sup> Morgane Rouault,<sup>2</sup> Benjamin D. Humphreys.<sup>1,3</sup> The Humphreys Lab <sup>1</sup>Division of Nephrology, Department of Medicine, Washington University in St. Louis, St Louis, MO; <sup>2</sup>10X Genomics, Pleasanton, CA; <sup>3</sup>Department of Developmental Biology, Washington University in St. Louis, St Louis, MO.

**Background:** Understanding how different kidney cell types contribute to acute kidney injury (AKI) requires knowledge of their spatial organization and connectivity, information that is lost in single cell techniques that rely on cell dissociation. Recent advances in spatial transcriptomic technologies enable visualization of multiplexed transcripts at cellular resolution.

**Methods:** We performed highly multiplexed direct RNA hybridization based in situ sequencing (dRNA-HybISS) (CARTANA, part of 10X Genomics) on the mouse kidneys from sham, 4h, 12h, 2d, and 6w after bilateral ischemia–reperfusion injury (IRI).

**Results:** We achieved sub-cellular transcript resolution and were able to map cell type specific markers precisely to their respective cell types (Fig 1). As expected, spatial expression of the injury marker *Havcr1* was confined to the PT-S3 segment at 4h, 12h and 2d, and was absent in sham and 6w. We segmented ~400,000 cells from all time points of IRI. Unsupervised clustering revealed 10 major kidney cell types including rare cell types such as podocytes and JGA cells. We were able to reconstruct glomerular cell type organization with podocyte, EC and JGA. We revealed dynamic changes in spatial distribution of immune cell subsets across IRI time course. For example, Cd14+ monocytes were increased in early time points of IRI whereas the Ptpcr+ macrophages accumulated only in later time point. Integration with snRNA-seq data increased resolution of our spatial map to 26 kidney cell types, including different PT injury states. We also compare these results to Visium analysis of the same time course, revealing that dRNA-HybISS provided much higher cell resolution including classification of individual rare cell types.

**Conclusions:** dRNA-HybISS enables in situ identification and spatial mapping of cell types in the kidney. When applying this technique to IRI, we reveal the dynamics of immune cell migration both in time and region during kidney injury and repair.

**Funding:** NIDDK Support

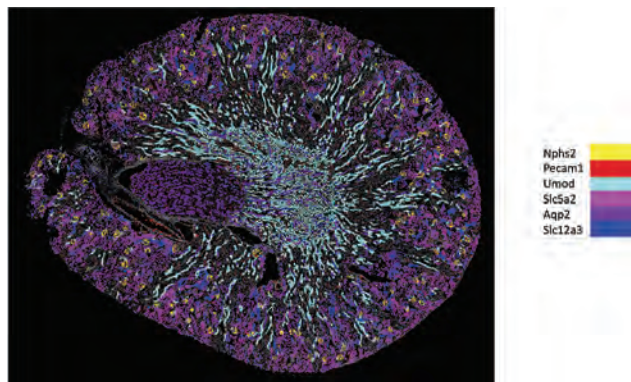

RNAi injections was done. The severity of renal injury (IRI and cisplatin) was monitored in control and KO littermates or in mice injected with control and PLSCR3 siRNA through measurement of BUN, serum creatinine, histological analysis, and biomarker analysis.

**Results:** In cell culture models of cisplatin nephrotoxicity, cell survival and mitochondrial protection provided by SS-31 is abrogated by PLSCR3 knockdown or knockout. *In vivo*, PLSCR3 gene ablation or knockdown in RTECs suppresses the protective effects of SS-31 in cisplatin and ischemia-reperfusion associated models of AKI (Fig.1). Using liposome-based assays, we also found that SS-31 activates PLSCR3 scramblase activity.

**Conclusions:** Our studies have discovered phospholipid scramblase 3 as the crucial mediator of the cell protective effects of SS-31. We propose that SS-31 activates PLSCR3 phospholipid scramblase activity resulting in mitochondrial protection under stress conditions associated with AKI.

**Funding:** NIDDK Support

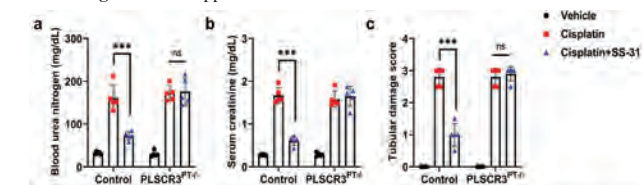

**Figure 1: Tubular PLSCR3 gene ablation abrogates the renal protective effects of SS-31 during cisplatin nephrotoxicity.** RTEC-specific PLSCR3 knockout mice were generated by crossing *Ggt1-Cre* mice with PLSCR3-floxed mice. 8–12-week-old littermate control and PLSCR3 conditional knockout male mice (indicated by PLSCR3<sup>fl/fl</sup>) were then challenged with cisplatin (50 mg/kg, single intraperitoneal injection) in the presence or absence of SS-31 (5 mg/kg, intraperitoneal, 2 hours before cisplatin) followed by examination of renal structure and function at 72 hours. (a-b) Blood urea nitrogen and serum creatinine analysis showed that tubular epithelial-specific PLSCR3 deficiency results in suppression of the renal protective effects of SS-31. (c) H&E staining and histological analysis of tubular damage confirmed that SS-31 mediated renal protection is abrogated in the PLSCR3 conditional knockout mice. One-way ANOVA followed by Tukey's multiple-comparison test was carried out (n=5 biologically independent samples), and statistical significance is indicated by \*p < 0.05, \*\*p < 0.01, \*\*\*p < 0.001.

#### TH-OR46

### Downregulation of Syndecan-1 and Alternative Complement in Renal Proximal Tubular Epithelial Cells by Crotamine/Sirna Complexes

Jacob van den Born,<sup>1</sup> Joana D. Campeiro,<sup>1</sup> Wendy Dam,<sup>1</sup> Miriani A. Hayashii,<sup>2</sup> <sup>1</sup>Universitair Medisch Centrum Groningen, Groningen, Netherlands; <sup>2</sup>Universidade Federal de Sao Paulo, Sao Paulo, Brazil.

**Background:** In proteinuria, syndecan-1, an epithelial heparan sulfate proteoglycan, serves as a docking platform for filtered urinary proprotein in the apical membranes of proximal tubular epithelial cells (PTEC) activating the complement system via alternative pathway. Targeting PTEC aiming to reduce syndecan-1 expression might be useful to slow down the alternative complement activation during proteinuria. Crotamine is a non-viral cell-penetrating peptide which after *ip* injection accumulates in PTEC via apical endocytosis. We now tested crotamine-siRNA complexes for *in vitro* and *in vivo* targeting of PTEC.

**Methods:** The complexes formed by crotamine and syndecan-1 siRNA were characterized by biophysical methods. After the *in vitro* transfection of HK2 cells with crotamine-siRNA complexes, the efficiency to downregulate the syndecan-1 expression, properdin binding, and subsequently, complement deposition was assessed by FACS and qRT-PCR. The targeted internalization into PTEC *in vivo* was evaluated by confocal microscopy of kidney sections from mice injected with fluorescently-labeled crotamine-siRNA complexes.

**Results:** We demonstrated that the efficient complex formation is time- and crotamine-siRNA ratio-dependent and that crotamine is able to protect siRNA against degradation by endonucleases. After 48 h, the transfection with the complex reduced ~50% of syndecan-1 expression at both mRNA and protein levels (both p<0.01) *in vitro*. Subsequently, properdin binding was also comparably reduced (p<0.001) and the alternative pathway activation declined ~60% (p<0.001). Moreover, *ip* injection of the fluorescently-labeled crotamine-siRNA complexes in mice showed siRNA presence in the cell membranes of proximal tubular cells, followed by internalization into these tubular cells.

**Conclusions:** We show for the first time the use of crotamine as a non-viral nanocarrier for PTEC-specific delivery of siRNA both *in vitro* and *in vivo*. Successful reduction of the expression of syndecan-1 was accompanied by down modulation of alternative complement activation by PTECs *in vitro*. We suggest crotamine as a prototypic next generation kidney-specific non-viral vector to modulate aberrant gene expression in kidney PTECs, for instance, in proteinuric renal diseases.

**Funding:** Government Support - Non-U.S.

#### TH-OR45

### Genome-Wide CRISPR Screen Reveals That Elamipretide (SS-31) Mediated PLSCR3 Activation Mitigates Mitochondrial Dysfunction During AKI

Josie A. Silvaroli,<sup>1</sup> Bijay Bisunke,<sup>2</sup> Ji Young Kim,<sup>1</sup> Navjot Singh P. Pabla,<sup>1</sup> Amandeep Bajwa,<sup>2</sup> <sup>1</sup>The Ohio State University, Columbus, OH; <sup>2</sup>The University of Tennessee Health Science Center College of Medicine, Memphis, TN.

**Background:** Mitochondrial dysfunction is a hallmark of several human disorders, including acute kidney injury (AKI). SS-31 a cell-permeable mitochondrial-targeted peptide restores healthy mitochondrial function and is currently undergoing clinical trials. SS-31 interacts with cardiolipin in the inner mitochondrial membrane; however, the pharmacological basis of its protective effects remains obscure. Importantly, the role of phospholipid scramblase 3 (PLSCR3), a mitochondrial cardiolipin binding protein, in SS-31 and renal biology is unknown.

**Methods:** We performed a genome-wide CRISPR screen in a nephrotoxic model of tubular epithelial cell-death with SS-31. The primary and secondary screens in BUMPT and HK-2 cells showed that PLSCR3 is essential for the protective effects of SS-31. Seahorse based analysis of mitochondrial function was also carried out in WT and PLSCR3 KO HK-2 cells. Conditional KO mice were generated by crossing PLSCR3-floxed with GGT1-Cre mice (Fig. 1). Next *in vivo* KO of PLSCR3 through hydrodynamic intravenous



## TH-OR47

**#AskRenal: Use of an Automated Twitter Account to Crowdsourcing Nephrology Queries**

Jade M. Teakell,<sup>1</sup> Alicja Rosolowska,<sup>2</sup> Swapnil Hiremath,<sup>3</sup> Matthew A. Sparks,<sup>4</sup> Edgar V. Lerma,<sup>5</sup> Joel M. Topf,<sup>6</sup> Nikhil A. Shah.<sup>7</sup> #NephJC <sup>1</sup>The University of Texas Health Science Center at Houston John P and Katherine G McGovern Medical School, Houston, TX; <sup>2</sup>Uniwersytet Medyczny w Białymstoku, Białystok, Poland; <sup>3</sup>University of Ottawa Faculty of Medicine, Ottawa, ON, Canada; <sup>4</sup>Duke University, Durham, NC; <sup>5</sup>University of Illinois Chicago, Chicago, IL; <sup>6</sup>Oakland University William Beaumont School of Medicine, Rochester, MI; <sup>7</sup>University of Alberta Faculty of Medicine & Dentistry, Edmonton, AB, Canada.

**Background:** Social media platforms are used in contemporary crowdsourcing, and Twitter is apt for reaching a large number of people with a common interest. Users, especially those with a small follower count may find it challenging to reach a large audience. #AskRenal was developed as a Twitter crowdsourcing tool to help users get answers to nephrology questions. We hypothesized that the #AskRenal hashtag could be used by anyone to receive helpful and timely responses to simple or complex nephrology questions posed on the social media platform.

**Methods:** A Twitter account @AskRenal, and an online Twitter bot that automatically retweeted any new tweets containing the hashtag #AskRenal were created. Using the Symplr Healthcare Hashtag tool, we extracted and analyzed public Twitter content containing the hashtag #AskRenal posted between Dec 2016 to Aug 2020. Tweets were excluded if they were duplicates, retweets, or if the tweet content was not the form of an original question. A group of 15 medical professionals reviewed #AskRenal tweets individually and a 10-question survey was completed for each one.

**Results:** During the study period, there were 17,704 tweets containing the hashtag #AskRenal and 3099 were included in the survey analysis. We found that 40% (1228/3099) of #AskRenal questions were posed by users with < 1000 followers and 9% (270/3099) were from students and trainees. The questions were spread across a wide range of nephrology topics. Over 75% (2386/3099) of the #AskRenal questions garnered a response, and answers came quickly with 69% (1644/2386) receiving a reply within 6 hours of posting. The reviewers found these responses to be helpful in answering the original questions 83% (1978/2386) of the time. The inclusion of hyperlinks and images in the reply was associated with a helpful answer ( $p < 0.001$ ) and a higher follower count was not significantly associated with the probability of obtaining a helpful answer.

**Conclusions:** We demonstrated that a targeted hashtag and a dedicated Twitter account that retweets the hashtag automatically can be used to garner timely and helpful responses by a wide range of individuals, irrespective of follower count, seeking answers to nephrology questions.

## TH-OR48

**Using Three-Dimensional Imaging and Single-Cell Transcriptomics to Interrogate Human Kidney Lymphatics in Transplant Rejection**

Daniyal J. Jafree,<sup>1,2</sup> Benjamin J. Stewart,<sup>4</sup> Maria K. Joannou,<sup>1</sup> Lauren G. Russell,<sup>1</sup> Gideon Pomeranz,<sup>1</sup> Peter Scambler,<sup>1</sup> Menna R. Clatworthy,<sup>4</sup> Reza Motallebzadeh,<sup>3</sup> David A. Long.<sup>1</sup> UCL ICH Kidney Development & Disease Group <sup>1</sup>UCL Great Ormond Street Institute of Child Health, London, United Kingdom; <sup>2</sup>UCL MB/PhD Programme, London, United Kingdom; <sup>3</sup>UCL Division of Surgery and Interventional Science, London, United Kingdom; <sup>4</sup>University of Cambridge, Cambridge, United Kingdom.

**Background:** Lymphatics participate in immune homeostasis and their dysfunction has been linked to autoimmunity and cancer. There is a need to enhance our understanding of the spatial and molecular features of lymphatics in human kidney health and transplant rejection.

**Methods:** Wholmount immunolabelling, tissue clearing and 3D microscopy were used to visualise lymphatics in non-transplanted donor kidney and allografts with chronic transplant rejection (CKTR). Furthermore, we integrated multiple human kidney single-cell RNA sequencing (scRNA-seq) datasets, including samples with distinct aetiologies of CKTR.

**Results:** In donor kidneys, lymphatics reside hierarchically within the cortex, form terminal branches along cortical nephron segments and possess a unique capillary phenotype, which is distinct from other organ lymphatics due to their low expression of LYVE1. In CKTR, lymphatics undergo expansion, lose structural hierarchy and infiltrate the medulla (Fig.1). Allograft lymphatics are predominantly donor-derived, express HLA-DR, and exhibit C4d immunoreactivity; indicative of targeting by anti-allograft antibodies. Additionally, kidney lymphatics are T cell-rich conduits which interconnect tertiary lymphoid structures. Using scRNA-seq, we identify putative crosstalk between lymphatics and T cells, featuring co-inhibitory immune checkpoints.

**Conclusions:** Utilising 3D imaging and scRNA-seq, we uncovered the spatial and molecular profile of human kidney lymphatics. We have revealed fundamentals of these vessels to inform future studies into renal biology, as well as identifying lymphatic phenomena and molecular candidates involved in CKTR.

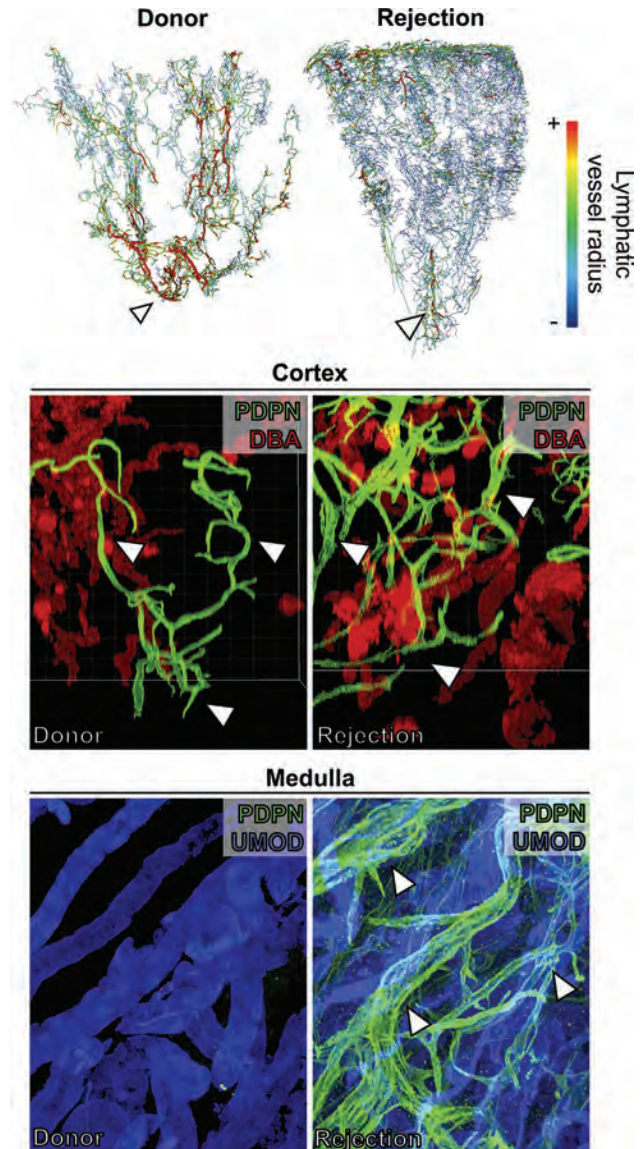

Fig.1. The lymphatic phenotype in transplant rejection

## TH-OR49

**Critical Role of CD74 in Immune Regulation and Allograft Tolerance**

Zhabiz Solhjoui,<sup>1</sup> Nour K. Younis,<sup>1</sup> Hengcheng Zhang,<sup>1</sup> John Y. Choi,<sup>1</sup> Anis J. Saad,<sup>1</sup> Christa A. Deban,<sup>1</sup> Ahmad Halawi,<sup>1</sup> Richard Bucala,<sup>2</sup> Jamil R. Azzi.<sup>1</sup> Brigham and Women's Hospital, Boston, MA; <sup>2</sup>Yale School of Medicine, New Haven, CT.

**Background:** While known as the receptor for Microphage Inhibitory Factor (MIF) and MHC class II chaperone, the role of CD74 remains elusive in alloimmunity. We identified enriched CD74 transcriptome in urinary exosome of kidney allograft rejection, thus we explored the role of CD74 in alloimmune response in a mice transplant model.

**Methods:** We generated universal and conditional CD74KO mice and used as recipients of murine heart allograft in a full HLA mismatch model. Graft survival assessed; with Immunophenotyping of allograft and proliferation and functional assays performed.

**Results:** We observed indefinite survival heart allografts in CD74KO recipients compared to WT (MST >100 vs 7 days,  $p=0.0008$ ); Treg depletion resulted in allograft rejection (Fig 1,2). At day 7 post-transplantation, 5 times increase in Tregs infiltrating allograft as compared to WT noted, similar pattern with smaller magnitude observed in draining lymph node. To our surprise, higher frequency of activated effector CD4 cells (CD44+) observed in allograft of CD74KO recipients. In-vitro, activated effector CD4 cells harvested from CD74KO mice revealed decreased proliferation compared to WT. In contrast, CD74KO Tregs showed higher proliferation and suppressive function in-vitro. Naive CD4 cells show minimal CD74 expression. CD74 expression significantly increased in Tregs upon stimulation at both protein and RNA level (up to 30 times), with minimal MIF expression. Effector CD4 cells show 8 times increase in MIF expression. MIF is involved in activation of CD4 cells and we are currently studying its role in suppression of Treg activity and function.

**Conclusions:** Our data identifies a differential role of CD74 on regulatory and effector T cells function towards stronger regulatory and defective effector function. This contrasting cell-type specific phenotype could be at least partly due to MIF dependent CD74 inhibitory signaling of Tregs.

**Funding:** NIDDK Support

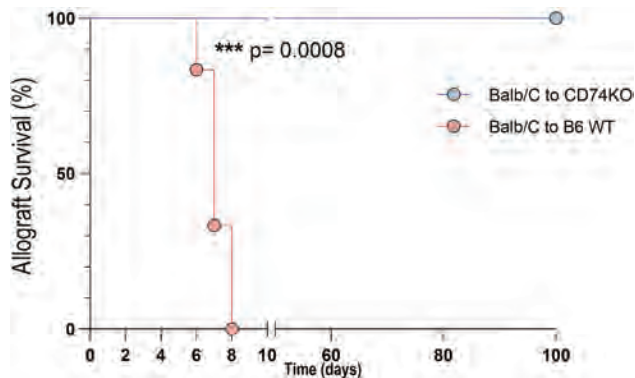

**TH-OR50**

**Single Nuclei RNA-Sequencing Identifies Distinct Immune Profiles in Interstitial Fibrosis and Tubular Atrophy Human Allografts Following 15 Months Post-Transplantation**

**Thomas Rousselle,<sup>1</sup> Jennifer M. McDaniels,<sup>1</sup> Amol C. Shetty,<sup>1</sup> Elissa Bardhi,<sup>1</sup> Cem Kuscu,<sup>2</sup> Canan Kuscu,<sup>2</sup> Manish Talwar,<sup>2</sup> Thangamani Muthukumar,<sup>3</sup> James D. Eason,<sup>2</sup> Daniel G. Maluf,<sup>1</sup> Valeria R. Mas.<sup>1</sup>** <sup>1</sup>University of Maryland Baltimore, Baltimore, MD; <sup>2</sup>The University of Tennessee Health Science Center College of Medicine, Memphis, TN; <sup>3</sup>Cornell University, Ithaca, NY.

**Background:** The cellular immune response associated with interstitial fibrosis and tubular atrophy (IFTA) following kidney transplantation is unclear. This study utilized snRNAseq to uncover the immune landscape between normal and IFTA human allografts after 15-months post-transplantation (PT). Immune profiling is validated using imaging mass cytometry (IMC).

**Methods:** snRNAseq was performed for normal (n=3) and IFTA (n=5) human kidney allografts. Differences in ECM production and immune cell distribution led to the division of two IFTA groups: low vs high ECM (L-ECM vs H-ECM). Ligand receptor analysis was performed using the LRD package in R and an interaction score was computed. IMC detected immune cells and spatial distribution. IMC images were processed in QuPath using Ir192 nuclei stain to detect cells. Antibody expression per cell was quantified by an artificial neural network and significant values (p<0.05) used to annotate cellular identity.

**Results:** snRNAseq revealed 12 distinct immune subclusters. Higher proportions of monocytes (MO1/MO2), dendritic, and mast cells were detected in L-ECM whereas B- and T-cells were more abundant in H-ECM. Congruent with snRNAseq results, B- and T-cells were largely detected in H-ECM. However, memory T-cells (CD3+CD4+CD45RO+) were more abundant in L-ECM than H-ECM. In addition, IMC revealed a distinct subpopulation of double negative T-cells (CD3+CD4-CD8-) that was not previously explored in snRNAseq. Significant proportions of macrophages (CD68+) were found to be increased in L- and H-ECM, indicating its key role in pathogenesis.

**Conclusions:** Defining the immune cell landscape will uncover novel immune to kidney cell interactions to target fibrogenesis and improve long-term outcomes.

**Funding:** NIDDK Support

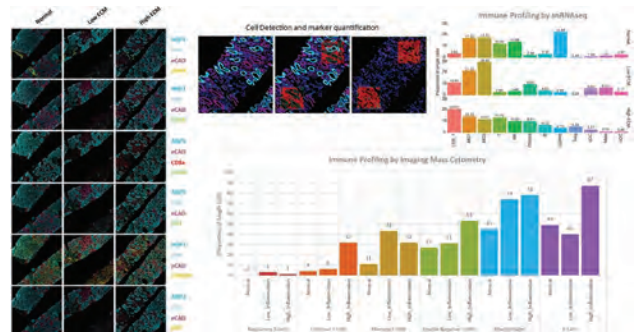

**TH-OR51**

**A Single-Nucleus RNA-Sequencing of Human Kidney Transplant Biopsies Identifies a Novel Role of Pericytes and Endothelium in Cellular Rejection**

**Ahmad Halawi,<sup>1</sup> Abdullah B. El Kurdi,<sup>2</sup> Katherine A. Vernon,<sup>3</sup> Zhabiz Solhjou,<sup>1</sup> John Y. Choi,<sup>1</sup> Anis J. Saad,<sup>1</sup> Nour K. Younis,<sup>1</sup> Christa A. Deban,<sup>1</sup> Pierre Khoueiry,<sup>2</sup> Anna Greka,<sup>4,5</sup> Jamil R. Azzi,<sup>5,1</sup>** <sup>1</sup>Brigham and Women's Hospital, Boston, MA; <sup>2</sup>American University of Beirut, Beirut, Lebanon; <sup>3</sup>Q32 BIO, Cambridge, MA; <sup>4</sup>Broad Institute, Cambridge, MA; <sup>5</sup>Harvard Medical School, Boston, MA.

**Background:** Immunosuppressive therapies in kidney transplantation were developed based on their effect on T-cell activation rather than alloimmunity mechanisms. Thus, understanding the role of different cells during rejection is essential to identifying directed therapies.

**Methods:** Single nucleus RNA sequencing was done on non-rejecting allograft, borderline, and T-cell mediated rejection (TCMR) samples. Data analysis was done using RStudio and Seurat. Pathway analysis was performed using Enrichr and Gene Sets Enrichment Analysis. Ligand-Receptor (LR) analysis was performed using SingleCellSignalR.

**Results:** Pathway analysis of T-cells in borderline and TCMR samples showed enrichment for allograft rejection and IFN-gamma response pathways, suggesting that our borderline sample reflects an early rejection. Hence, this allows for studying the early stages of cellular rejection. Pathway analysis of endothelial cells (ECs) of borderline and non-rejecting samples showed that focal adhesion and IFN-gamma pathways were significantly enriched compared to TCMR. Furthermore, LR analysis found that in borderline rejection, ECs increase NOTCH4 response to JAG1, among others. These interactions potentiate pericytes' ability to stabilize ECs and protect the allograft from lymphocyte invasion in the borderline rejection, but not in TCMR. Furthermore, ECs upregulate TLR4 in borderline rejection and not TCMR, which interacts with T-cells' HMGB1 suggesting a role for TLR4 in early rejection. To support our findings, we performed biopsy staining from borderline and TCMR and in vitro analysis of HUVEC exposed to IFN-gamma and T-cells.

**Conclusions:** ECs are involved in the early rejection process by upregulating IFN-gamma response, focal adhesion pathway, and TLR4 interacting with HMGB1 secreted by T-cells.

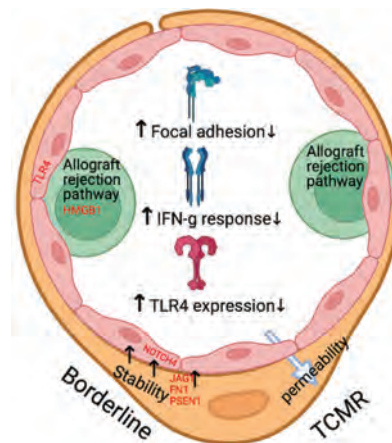

## TH-OR52

**IL-2/Anti-IL-2 Immune Complex Attenuates Cold Ischemia-Reperfusion Injury in Kidney Transplantation by Expanding Regulatory T Cells**

Ga Young Heo,<sup>1</sup> Joon Young Jang,<sup>1</sup> Tai yeon Koo,<sup>2</sup> Hee Byung Koh,<sup>1</sup> Hyo Jeong Kim,<sup>1</sup> Beom Seok Kim,<sup>1</sup> Jaeseok Yang,<sup>1</sup> <sup>1</sup>Yonsei University College of Medicine, Seodaemun-gu, Seoul, Republic of Korea; <sup>2</sup>Korea University Medical Center, Seoul, Republic of Korea.

**Background:** Renal cold ischemia-reperfusion injury (IRI) is an inevitable complication after kidney transplantation and a more severe inflammatory response than renal warm IRI. We investigated role of regulatory T cells (Tregs) in cold renal IRI and whether Treg-expanding IL-2/anti-IL-2 complex (IL-2C) can attenuate renal cold IRI.

**Methods:** We used a mouse cold IRI model based on kidney transplantation along with Foxp3-DTR mouse to deplete Tregs. We investigated impact of IL-2C on acute, subacute, and chronic phase of cold IRI as well as role of Tregs.

**Results:** Cold IRI induced more severe renal functional deterioration, renal tissue damage and fibrosis than warm IRI. Mortality after cold IRI increased as cold ischemic time became longer than 6hr. Adoptive transfer of Tregs successfully attenuated cold IRI. In parallel, administration of IL-2C, a Treg expander before cold IRI, attenuated acute renal functional deterioration, renal tissue injury and apoptosis, and suppressed renal infiltration of effector cells along with expression of pro-inflammatory cytokines. IL-2C also attenuated subacute renal injury and facilitated renal regeneration on day 7 after cold IRI. Furthermore, IL-2C suppressed chronic fibrosis and epithelial mesenchymal transition along with renal infiltration of SMA<sup>+</sup>F4/80<sup>+</sup>CD11b<sup>+</sup> profibrotic macrophages on day 28 after cold IRI. ROS injury was also attenuated by IL-2C, as expression levels of Nox2, 8-OHG, MDA, and nitrotyrosine were decreased with increased expression of SOD and GSH. On the other hand, depletion of Tregs using diphtheria toxin in the presence of IL-2C, abrogated the beneficial effects of IL-2C on cold IRI.

**Conclusions:** Tregs play protective roles in renal cold IRI. IL-2C attenuated acute injury, facilitated subacute recovery, and suppressed chronic fibrosis in renal cold IRI through expansion of renal Tregs, suggesting the therapeutic potential of IL-2C in kidney transplantation-associated cold IRI.

## TH-OR53

**Mobilizing MHC Class Ib-Restricted Regulatory CD8 T Cells (CD8 Treg) With a Peptide Agonist Promotes Allograft Tolerance in a Fully Mismatched Mouse Kidney Transplant Model**

John Y. Choi,<sup>1,2</sup> Hengcheng Zhang,<sup>1</sup> Anis J. Saad,<sup>1</sup> Zhabiz Solhjoui,<sup>1,2</sup> Christa A. Deban,<sup>1</sup> Hye-jung Kim,<sup>3,2</sup> Harvey Cantor,<sup>3,2</sup> Jamil R. Azzi.<sup>3,2</sup> <sup>1</sup>Brigham and Women's Hospital, Boston, MA; <sup>2</sup>Harvard Medical School, Boston, MA; <sup>3</sup>Dana-Farber Cancer Institute, Boston, MA.

**Background:** A subset of CD8 T cells that express TCR restricted to Qa-1 - a Class-Ib MHC molecule - plays a critical regulatory function. CD8 Tregs kill activated CD4 T cells, which significantly upregulate Qa-1 during allograft rejection. We previously showed that allograft recipients with dysfunctional CD8 Treg undergo severe antibody-mediated rejection. We have engineered a Qa-1-binding 9-mer peptide superagonist (FL9-SA) that strongly activates CD8 Treg. We hypothesized that vaccinating hosts with FL9-SA may mobilize CD8 Treg and promote allograft tolerance by suppressing alloreactive CD4 T cells in the kidney transplant model.

**Methods:** The kidney of BALB/c mice (H-2<sup>d</sup>) was recovered with a full-length ureter and transplanted into B6 hosts (H-2<sup>b</sup>). The ureter of the remaining native kidneys was then ligated to inhibit native kidney function. Transplanted B6 hosts were treated intraperitoneally FL9-SA, or PBS emulsified in Adjuvant, once a week, starting POD2. Rapamycin was provided to certain groups on POD 0-4.

**Results:** Hosts treated with FL9-SA showed prolonged allograft survival compared to the control group (40 days vs 20.5 days). We also observed the indefinite survival of the kidney allograft when FL9-SA is combined with an mTOR inhibitor compared to the mTOR inhibitor only (38.5 days). Mechanistic analysis showed a diminished germinal center response and suppressed DSA level in hosts treated with FL9-SA compared to the control group. The allograft retrieved from the FL9-SA treated group showed a significant reduction in C4d deposit and cellular infiltrate. The overall memory CD4 T cells between the two groups remained similar; however, CD4 T cells from hosts treated with FL9-SA showed less proliferative capacity when co-cultured with irradiated donor splenocytes.

**Conclusions:** Our study suggests that mobilizing CD8 Tregs with a tolerogenic peptide vaccine is a novel method to promote kidney allograft tolerance. CD8 Treg-specific superagonist showed a synergistic effect with an mTOR inhibitor. Finally, mobilized CD8 Treg specifically suppresses alloreactive CD4 T cells while sparing the rest of the memory CD4 T cells that may play important role in host defense against pathogens.

**Funding:** Other NIH Support - NIAID, Private Foundation Support

## TH-OR54

**Targeting the Archetypal Innate Immune Receptor Integrin CD11b Prolongs Kidney Allograft Survival in Nonhuman Primates (NHPs)**

Abbas Dehnadi,<sup>1,2</sup> Grace Lassiter,<sup>1</sup> Takayuki Hirose,<sup>1,2</sup> Tatsuo Kawai,<sup>1,2</sup> Anthony B. Cosimi,<sup>1,2</sup> M. Amin Arnaout.<sup>1,2</sup> <sup>1</sup>Massachusetts General Hospital, Boston, MA; <sup>2</sup>Harvard Medical School, Boston, MA.

**Background:** Peri-transplant IRI activates innate immunity leading to delayed graft function, inferior long-term transplant outcomes, and interferes with tolerance induction. mAb107 is a first-in-class orthosteric antagonist of CD11b that blocks on-target

conformational activation and proinflammatory outside-in signaling in an NHP model of IRI (*Nature Comm*, 2017). We have now evaluated the effect of mAb107 on allograft survival in NHPs receiving subtherapeutic tacrolimus (Tac) in our well-studied transplant model.

**Methods:** The donor's kidney from each of 8 NHPs was subjected to a 20-min WIT, followed by a 2-hour CIT before transplanting into each of 8 right nephrectomized MHC-mismatched recipients (half receiving IV mAb107 before allograft reperfusion and the other half receiving saline). The left native ureter was ligated on day 8 post-transplant (Tx). Recipients were followed by blood tests, transabdominal ultrasound, and Tac trough levels (adjusted to <10ng/ml, previously determined to result in acute rejection within 4-5 weeks in controls). Protocol biopsies were performed on days 8-10 and 30 post-Tx and all surviving animals were to be sacrificed on day 60 post-Tx.

**Results:** Following revascularization, immediate uniform reperfusion was observed only in mAb107-treated allografts, suggesting rapid termination of the maladaptive responses to ischemia. mAb107 induced significant prolongation of allograft survival in recipients (Fig. 1), with sustained vascular perfusion on day 20 post-Tx, reduced C4d staining, and ACR.

**Conclusions:** Suppressing the peri-transplant inflammatory response significantly prolonged NHP allograft survival, suggesting the potential of mAb107 in preventing/mitigating delayed graft function and enhancing tolerance.

**Funding:** NIDDK Support

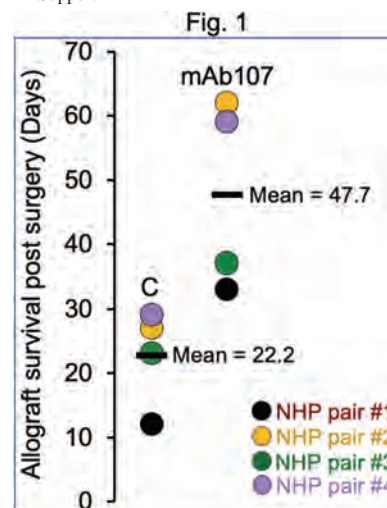

## TH-OR55

**Molecular and Cellular Mechanisms of Lipocalin-2-Mediated Renoprotection in Kidney Transplantation**

Anna M. Pfefferkorn,<sup>1</sup> Liang Zhao,<sup>2,3</sup> Minze Xu,<sup>3</sup> Angelika Kusch,<sup>4</sup> Raphaela Fritsche,<sup>5</sup> Cem Erdogan,<sup>3</sup> Hubert G. Schwelberger,<sup>7</sup> Felix Aigner,<sup>6</sup> Andreas Patzak,<sup>3</sup> Igor M. Sauer,<sup>1</sup> Muhammad Imtiaz Ashraf.<sup>1</sup> <sup>1</sup>Department of Surgery, Experimental Surgery, Charité – Universitätsmedizin, Berlin, Germany; <sup>2</sup>Department of Nephrology, the Children's Hospital, Zhejiang University School of Medicine, National Clinical Research Center for Child Health, Hangzhou, China; <sup>3</sup>Institute of Translational Physiology, Charité-Universitätsmedizin, Berlin, Germany; <sup>4</sup>Berlin Institute of Health at Charité – Universitätsmedizin, Berlin, Germany; <sup>5</sup>Berlin Institute of Health at Charité – Universitätsmedizin Berlin, Metabolomics Platform, Berlin, Germany; <sup>6</sup>Department of Surgery, Krankenhaus der Barmherzigen Brüder, Graz, Austria; <sup>7</sup>Department of Visceral, Transplant and Thoracic Surgery, Medical University Innsbruck, Innsbruck, Austria.

**Background:** While Lipocalin-2 (Lcn2) is an early marker of acute kidney injury, delayed graft function and acute rejection, our previous studies have outlined a protective effect of recombinant Lcn2:Siderophore:Fe (rLcn2) in a mouse kidney transplantation (KTx) model. The underlying mechanism of renoprotection has not yet been fully investigated, elucidating which forms the primary focus of this study.

**Methods:** Kidneys were transplanted from Balb/c to C57Bl/6 mice ( $\pm$ rLcn2, 250mg/kg). Phenotyping of the immune cells, isolated from graft, spleen, lymph nodes and blood was performed by flow cytometry at post-KTx day 3 and 7. For analyses of stress, inflammation and survival signaling in the mouse kidney multiplex signaling analysis was performed following syngeneic KTx (cold ischemia (CI): 5.5h, reperfusion (R): 24h  $\pm$ rLcn2, 250mg/kg) and in mouse primary proximal tubular epithelial cells, subjected to hypoxia/reoxygenation (H: 24h/ R: 30min, 6h, 12h, 24h  $\pm$ rLcn2, 1 $\mu$ g/ml). To determine the effect of rLcn2 on physiology of renal microvessels, dilatation function of BAY 58-2667 (soluble guanylyl cyclase activator) on angiotensin II-precontracted murine afferent arterioles (AA) was examined following H/R (H:30min/ R:10min) and syngeneic KTx (CI: 5.5h, R: 20h)  $\pm$ rLcn2, apo-rLcn2 and deferoxamine (DFO).

**Results:** Analysis of the leukocytes revealed no general immunosuppressive or regulatory effect of rLcn2. However, rLcn2 treatment curtailed intra graft accumulation of total and in particular of activated (NKG2D<sup>+</sup>) CD8<sup>+</sup> T cells. Degranulation capacity and frequency of interferon gamma<sup>+</sup> and perforin<sup>+</sup> CD8<sup>+</sup> T cells was significantly attenuated. No clear effect of rLcn2 was observed on candidate stress, inflammation and survival signaling molecules in the mouse kidney epithelia during H/R and KTx. Interestingly, rLcn2 not only circumvented H/R-induced loss in dilatation of isolated renal AA but also substantially improved CI-impaired vasodilatation. While Fe free apo-rLcn2 could not ameliorate loss of vasodilatation, DFO reversed the protective effect of rLcn2, validating the iron-dependent effect.

**Conclusions:** rLcn2 protects mouse renal allografts from CD8<sup>+</sup>T cell mediated alloimmune response and abates loss in dilatation of renal AA both *in vitro* (H/R) and *in vivo* (KTx).

**Funding:** Government Support - Non-U.S.

## TH-OR56

### Phascolarctobacterium-Producing Propionate and Acute Rejection Among Kidney Transplant Recipients

Hyunjeong Cho,<sup>1</sup> Ji Eun Kim,<sup>2</sup> Jangwook Lee,<sup>3</sup> Yong Chul Kim,<sup>4</sup> Ji In Park,<sup>5</sup> Jung Pyo Lee,<sup>6</sup> Dong Ki Kim,<sup>4</sup> Yon Su Kim,<sup>4</sup> Hajeong Lee,<sup>4</sup> <sup>1</sup>Chungbuk National University Hospital, Cheongju, Republic of Korea; <sup>2</sup>Korea University Guro Hospital, Seoul, Republic of Korea; <sup>3</sup>Dongguk University Ilsan Hospital, Goyang, Gyeonggi-do, Republic of Korea; <sup>4</sup>Seoul National University Hospital, Jongno-gu, Seoul, Republic of Korea; <sup>5</sup>Kangwon National University Hospital, Chuncheon, Kangwon, Republic of Korea; <sup>6</sup>Seoul National University Hospital, Biomedical Research Institute, Seoul, Republic of Korea.

**Background:** Acute rejection (AR) is associated with worse long-term allograft survival. Therefore, identifying and regulating the potential risk factors of AR is very important. Recent studies have shown that gut microbiota regulates host immune response, although the association between gut microbiota and AR in kidney transplant (KT) recipients is poorly understood. Here, we aimed to evaluate the gut microbiota and its metabolites could predict AR after kidney transplantation (KT).

**Methods:** We prospectively collected 98 KT recipients' stool samples at pretransplant (n=97), posttransplant 3 months (n=66), and 12 months (n=33). Metagenomic DNA from feces was sequenced using by Illumina MiSeq system. Stool metabolites were measured by a 1H nuclear magnetic resonance spectroscopy. We obtained various clinical factors including biopsy-proven AR within 1 year after KT.

**Results:** Within the 1<sup>st</sup> year of the transplantation, 33 (34%) patients developed AR. Bacterial richness (observed ASVs) and diversity of the microbial communities (Shannon diversity index) were lower in the AR group than in the non-rejection group ( $P_{FDR}=0.07$ ,  $P_{FDR}=0.02$ , Wilcoxon rank-sum test with FDR). In ALDEx2 analysis, at the genus level, the *Escherichia-Shigella* had significantly increased abundance in the AR group compared to that in the non-rejection group ( $P_{FDR} < 0.25$ ), while the *Phascolarctobacterium* was significantly decreased ( $P_{FDR} < 0.25$ ) in the AR group compared to in the non-rejection group. In ROC analysis, two bacteria adding clinical values significantly predict AR (AUC: 0.897). In LEFSe analysis based on the PICRUS2 results, we found 83 differentially abundant metaCyc pathways in the AR group than in the non-rejection group (LDA score  $> 2.0$  and  $P < 0.05$ ). In particular, pathways of homolactic fermentation and mixed acid fermentation were enriched in the AR group. And finally, fecal propionate, a key metabolite of short-chain fatty acid was 12% lower in the AR group than in the non-rejection group ( $p=0.05$ ).

**Conclusions:** In this study, we found that pre-transplant decreased relative abundance of *Phascolarctobacterium* was associated with AR after KT. In addition, its fecal propionic acid which was known to be produced by *Phascolarctobacterium* was decreased in the AR group.

## TH-OR57

### Cytomegalovirus-Responsive CD4 T Cells Exhibit a Stable, Cytotoxic Phenotype During the First Year After Solid Organ Transplant

Ayah Ahmad,<sup>1</sup> Lauren Higdon,<sup>2</sup> Jonathan S. Maltzman,<sup>2,3</sup> <sup>1</sup>Hunter College, New York, NY; <sup>2</sup>Stanford University, Stanford, CA; <sup>3</sup>VA Palo Alto Health Care System, Palo Alto, CA.

**Background:** Cytomegalovirus (CMV) can cause serious disease in humans after solid organ transplant. In healthy individuals, immune surveillance typically controls primary infection of CMV. However, the latent virus remains dormant with the potential to reactivate periodically, causing deleterious effects on immune-compromised individuals. The anti-viral immune response to CMV in transplant recipients is hindered by associated

immunosuppressive therapies. Antiviral CD4 T cells are an important component of viral control through production of inflammatory cytokines as well as lysis of infected cells. We sought to understand the homeostasis of this critical population in transplant recipients.

**Methods:** We characterized the phenotype and repertoire of protective CD4 T cells in six recipients of kidney or heart transplant within the first year after transplant. We analyzed peripheral blood samples from the recipients pre-, 3-, and 12-months post-transplant by both flow cytometry and targeted single cell sequencing. To analyze the phenotype of CMV-responsive CD4 T cells, we isolated CD4 T cells producing interferon gamma in response to CMV peptide stimulation and used targeted single cell RNA sequencing of T cells producing cytokine in response to CMV peptide stimulation to measure gene expression as well as T-cell receptors (TCR) to measure clonal expansion.

**Results:** By flow cytometry, we found that pre-transplant exposure to CMV was associated with elevated aging of CD4 T cells in comparison to recipients with no pre-transplant exposure. CD4 T cells maintained phenotypic stability over time. Our sequencing data also indicate that CMV-responsive CD4 T cells are largely anti-viral and cytotoxic, and phenotypically stable during the first year after transplant. We found that clonally expanded CMV-responsive CD4 T cells were primarily of an aged, cytotoxic phenotype as well.

**Conclusions:** Overall, these data indicate that in contrast to CD8 cells, transplantation and immunosuppression do not have a significant impact on CMV-responsive CD4 T cells within the first year post-transplant. Furthermore, the cytotoxic phenotype of the CD4 T cells suggests that these cells play an important role in control of CMV. Future studies are required to determine the impact of CMV-responsive CD4 T cells on control of CMV and post-transplant outcomes.

**Funding:** Other NIH Support - T32AI07290; K011K01DK123196; 1R25DK122957-01A1, Veterans Affairs Support

## FR-OR01

### The Effect of a Fermentable Dietary Fiber Inulin on a Rat Model of CKD-MBD

Neal X. Chen,<sup>1</sup> Kalisha O'Neill,<sup>1</sup> Shruthi Srinivasan,<sup>1</sup> Corinne E. Metzger,<sup>1</sup> Paul B. Fallen,<sup>1</sup> Annabel Biruete,<sup>1</sup> Pieter Evenepoel,<sup>2</sup> Matthew R. Allen,<sup>1</sup> Sharon M. Moe,<sup>1</sup> <sup>1</sup>Indiana University School of Medicine, Indianapolis, IN; <sup>2</sup>Nephrology and Renal Transplantation Research Group, Leuven, Belgium.

**Background:** Human studies have suggested that a diet rich in fermentable dietary fiber may prevent the progression of chronic kidney disease and its associated complications by altering gut microbiome and decreasing uremic toxins. The goal of this study is to investigate if the fermentable fiber inulin supplement will improve CKD-MBD.

**Methods:** We treated a naturally occurring model of CKD-MBD, the Cy/+ rat, with a casein-based diet supplemented with or without the fermentable fiber 10% inulin for 10 weeks, starting at 22 weeks (~CKD stage 3b) with euthanization at 32 wk (~15% of normal GFR). Normal littermates (NL) were used as control. Blood biochemistry, cardiovascular parameters and bone quantity and turnover were assessed.

**Results:** CKD rats had the expected elevations of blood creatinine, phosphorus, PTH, fibroblast growth factor 23 (FGF23) and oxidative stress marker 8-OHdG compared to NL. The CKD with inulin treatment compared to CKD without inulin had similar kidney function, but reduced levels of plasma phosphorus by 23% ( $p<0.001$ ), PTH by 65% ( $p<0.003$ ) and 8-OHdG by 22% ( $p<0.01$ ). CKD rats had elevated serum levels of uremic toxin indoxyl sulfate (IS) and p-cresyl sulfate (PS) and inulin treatment significantly decreased IS levels by 54% ( $p<0.001$ ) and PS levels by 80% ( $p<0.02$ ). Inulin treatment also improved cardiovascular parameters in CKD rats by reducing aorta calcification by 28%, heart calcification by 80% and left ventricular mass by 17%. In the skeleton, CKD rats had increased cortical porosity and reduced cortical thickness and area compared to NL and inulin treatment in CKD rats normalized these parameters ( $P<0.01$ ). Furthermore, inulin treatment decreased trabecular osteoclast surfaces by 37% in CKD rats. However, inulin treatment did not improve bone mechanics in CKD rats.

**Conclusions:** These results suggested that the fermentable dietary fiber inulin had a beneficial effect on CKD-MBD by reducing cardiovascular disease, cortical porosity, and osteoclasts although there was no effect on bone mechanics. These data suggest that changes in gut microbiota and/or uremic toxins may play a role in the severity of CKD-MBD and may justify a concerted effort to increase fermentable fiber in the diet of patients.

## FR-OR02

### Estrogen Protects Female Mice With CKD From Developing FGF23-Induced Left Ventricular Hypertrophy

Dominik Kentrup, Guillaume Courbon, Xueyan Wang, Bridget Hunt-Tobey, Valentin David, Aline Martin. Northwestern University Feinberg School of Medicine, Chicago, IL.

**Background:** Elevated levels of serum fibroblast growth factor 23 (FGF23) directly contribute to the development of left ventricular hypertrophy (LVH) and mortality in patients with chronic kidney disease (CKD). Although the risk of cardiovascular events and mortality is significantly higher in men than in women, the sex-specific differences in FGF23-induced LVH are unclear.

**Methods:** We studied age-matched C57BL/6J wild-type (WT) and Col4a3 knockout (CKD) male and female littermate mice with progressive CKD at 4, 8, 12, 16, and 20 weeks of age. We analyzed kidney and heart morphology and function and circulating markers of mineral metabolism in all mice. We performed RNAseq analyses on hearts isolated from 20 week-old mice. We assessed lifespan in a separate set of mice. In vitro, we isolated primary cardiomyocytes (NMCs) from mouse neonates separated by sex, and cultured them in presence of FGF23, estradiol (E2), both or none.

Key: TH - Thursday; FR - Friday; SA - Saturday; OR - Oral; PO - Poster; PUB - Publication Only

Underline represents presenting author.

**Results:** Compared to WT, CKD males showed elevated blood urea nitrogen (BUN) levels starting at 16 weeks of age indicating onset of CKD. Concomitant with CKD progression, serum levels of FGF23 also started to increase at 16 weeks. At 20 weeks, CKD males showed overt LVH and died at 22 weeks. In contrast, CKD females showed an earlier decline in kidney function and increase in FGF23 levels at 12 weeks of age. At all timepoints, CKD females displayed higher FGF23 levels than CKD males. However, CKD females did not develop LVH and lived until 24 weeks. Heart transcriptomics analyses showed that differentially regulated LVH-related genes were downstream targets of estrogen receptor 1. In culture, E2 alone slightly reduced the size of female NMCs, but had no effect on male cells. In contrast, FGF23 induced similar hypertrophic growth in male and female NMCs. E2 co-treatment partially reduced the dose-dependent FGF23 hypertrophic effects in male cells and fully prevented them in female cells.

**Conclusions:** CKD female mice do not develop LVH and live longer than CKD males, despite an earlier CKD onset and higher FGF23, indicating that the mechanisms leading to LVH in CKD are sex-dependent. This study shows that estradiol cancels the direct hypertrophic effects of FGF23 on female cardiomyocytes, suggesting the presence of common molecular targets of FGF23 and E2 signaling in the heart.

**Funding:** NIDDK Support

## FR-OR03

### Vitamin D Receptor Regulates Furin-Mediated FGF23 Cleavage

Petra Simic, Isinsu Bastepe, Wen Zhou, Birol Ay, Eugene P. Rhee, Murat Bastepe. *Massachusetts General Hospital, Boston, MA.*

**Background:** Fibroblast growth factor 23 (FGF23) is a bone-derived hormone that decreases serum phosphate. The full-length protein, intact FGF23 (iFGF23), is cleaved by furin protease at an Arg-XX-Arg site into inactive N-terminal (aa 25-179) and C-terminal (aa 180-251) fragments. Several studies have proposed a putative role of vitamin D in the regulation of furin in the context of infections. Therefore, we investigated the effect of vitamin D (1,25(OH)<sub>2</sub>D) and vitamin D receptor (VDR) on furin-mediated cleavage of FGF23.

**Methods:** In *Vdr* knock out (*Vdr*<sup>-/-</sup>) mice, we first quantitated the relative abundance of FGF23 and its fragments in circulation, utilizing ELISA assays that specifically detect only iFGF23, or a combination of iFGF23 and C-terminal cleavage fragments (cFGF23). We further evaluated gene expression and protein levels of furin in bone marrow and plasma and furin activity in plasma. We administered a furin inhibitor, decanoyl-RVKR-CMK, *i.p.* to test if furin mediates cleavage in *Vdr*<sup>-/-</sup> animals. Conversely, we administered recombinant furin protein to wild type mice to test if its effect on FGF23 cleavage can be blocked by 1,25(OH)<sub>2</sub>D administration. All experiments were repeated *in vitro* in the osteocyte-like Ocy454 cells in which *Vdr* was knocked out using CRISPR/Cas9.

**Results:** Mice lacking VDR had a 25-fold increase in FGF23 cleavage, judged by the cFGF23-to-iFGF23 ratio, and elevated furin gene expression, protein levels and activity compared to wild type (WT) littermates. Inhibition of furin activity by decanoyl-RVKR-CMK fully blocked increased FGF23 cleavage in *Vdr*<sup>-/-</sup> animals, and decreased cFGF23 to levels comparable to WT mice. This effect was recapitulated in a cell-autonomous manner in *Vdr* deficient Ocy454 cells. Moreover, 1,25(OH)<sub>2</sub>D injection increased total FGF23 without an increase in FGF23 cleavage, with cFGF23/iFGF23 ratio being comparable to vehicle injected animals. When administered with furin recombinant protein, 1,25(OH)<sub>2</sub>D fully blocked furin's effect on increased FGF23 cleavage.

**Conclusions:** In summary, 1,25(OH)<sub>2</sub>D and VDR suppress furin-induced FGF23 cleavage, providing a mechanism by which vitamin D signaling can augment biologically active FGF23 levels.

**Funding:** NIDDK Support

## FR-OR04

### Skeletal Muscle Is a Novel Source of FGF23 in Mouse Models of CKD and Skeletal Muscle Atrophy

Kylie Heitman, Isaac D. Campos, Christopher Yanucil, David G. Westbrook, Madison Thomas, Abul Fajol, Christian Faul. *The University of Alabama at Birmingham Department of Cell Developmental and Integrative Biology, Birmingham, AL.*

**Background:** Chronic Kidney Disease (CKD) affects various tissues and is associated with elevated serum levels of fibroblast growth factor 23 (FGF23) and phosphate (Pi). FGF23 is a hormone that is produced by the bone and targets the kidney to regulate Pi homeostasis. Since Pi is a potent inducer of FGF23 expression in bone, we studied whether Pi can induce FGF23 production in skeletal muscle (SM), and potentially contribute to atrophy. We analyzed SM on a functional, histological and molecular level in four models of hyperphosphatemia – two CKD models, *i.e.* mice with global deletion of collagen 4a3 and wildtype mice receiving an adenine-rich diet, as well as wildtype mice on a high Pi diet with normal kidney function, and *kltho* deficient mice. Finally, we determined the effect of a low Pi diet on SM in Col4a3<sup>-/-</sup> mice.

**Methods:** C2C12 myotubes were treated with 1-5 mM Pi for 24 hours, followed by qPCR expression analysis of FGF23 and atrophy genes. We studied Col4a3<sup>-/-</sup> mice receiving normal chow or a 0.2% phosphate diet at 10 weeks age; C57Bl/6 mice receiving an adenine-rich (0.2%) diet for 14 weeks or 3% phosphate diet for 6 months, and *kltho* deficient mice. We analyzed grip strength, hindlimb area by MRI, muscle mass, cross-sectional area of muscle fibers, and expression levels of atrogenes by qPCR and of FGF23 by qPCR, ELISA, and immunofluorescence microscopy

**Results:** Pi treatments increased the expression levels of atrogenes and FGF23 in C2C12 myotubes. In the four mouse models, grip strength was significantly reduced. In CKD and *kltho* deficient mice, muscle mass, cross-sectional area of myofibers was reduced, and the expression levels of atrogenes were elevated when compared to

respective controls. Furthermore, we detected elevations in the mRNA and protein levels of FGF23 in the hindlimb muscles of all models. Administration of a low Pi diet protected Col4a3<sup>-/-</sup> mice from developing SM atrophy.

**Conclusions:** Elevated Pi induces myotube atrophy and FGF23 expression *in vitro*. Mouse models with hyperphosphatemia develop SM atrophy and produce FGF23 in SM tissue in the presence and absence of CKD. Administration of a low Pi diet protects the SM in CKD mice. Future studies need to determine whether SM-derived FGF23 contributes to tissue injury or is protective against phosphate-induced damage.

**Funding:** NIDDK Support, Other NIH Support - Research reported in this publication was supported by the National Institute Of Dental & Craniofacial Research of the National Institutes of Health under Award Number T90DE022736 to K.H.

## FR-OR05

### Parathyroidectomy Decreases Muscle Expression of TGF-β1 and Improves Muscle Function

Eduardo J. Duque,<sup>1</sup> Shirley F. Crispilho,<sup>3</sup> Andre Kakinoki Teng,<sup>1</sup> Ivone B. Oliveira,<sup>1</sup> Luzia N. Furukawa,<sup>1</sup> Vanda Jorgetti,<sup>1</sup> Samuel K. Shinjo,<sup>1</sup> Carla M. Avesani,<sup>2</sup> Rosilene M. Elias,<sup>1,3</sup> Rosa M. Moyses.<sup>1</sup> *<sup>1</sup>Universidade de Sao Paulo Hospital das Clinicas, Sao Paulo, Brazil; <sup>2</sup>Karolinska Institutet, Stockholm, Sweden; <sup>3</sup>Universidade Nove de Julho, Sao Paulo, Brazil.*

**Background:** Secondary hyperparathyroidism (SHPT) is commonly associated with muscle dysfunction in patients with chronic kidney disease (CKD). PTH and TGF-β are known to operate together to exert their biological activities, and pathological TGF-β release from bones was shown to mediate muscle weakness. We sought to investigate the relationship between changes in mineral and bone metabolism (MBD) in patients with SHPT pre- and post-parathyroidectomy (PTX), and muscle expression of TGF-β, FNDC5 (the irisin precursor), and RANKL, which has been recently recognized as an inducer of sarcopenia.

**Methods:** We prospectively enrolled 29 patients on dialysis (39 ys, 62% female) referred for PTX. Muscle phenotyping involved histological analysis by immunohistochemistry and gene expression; body composition by DXA; functional and strength tests analysis by using Actigraph GT3X accelerometer, handgrip (HGS), supine (SP) and leg press (LP). Muscle biopsies were obtained from the vastus lateralis at baseline and 6 months after PTX, and from healthy controls. Biochemical parameters were also collected.

**Results:** MBD, DXA and physical evaluation parameters are shown in Table 1. TGF-β1 expression decreased (21 vs 7%, *p* < 0.01) and vitamin-D receptor increased (31 vs. 68 +cells/mm<sup>2</sup>, *p* < 0.01) after PTX. At baseline, muscle RANKL and FGF21 genes were upregulated (16-fold, *p* = 0.002; and 6-fold, *p* = 0.06, respectively), when compared to controls, with no effect of PTX. Conversely, FNDC5 was downregulated (3.2-fold, *p* = 0.034), and PTX led to its increase (2-fold, *p* < 0.01).

**Conclusions:** Patients with SHPT on dialysis submitted to PTX experienced a marked improvement in bone mass and muscular function, but not in muscle mass. Our findings suggest that muscle TGF-β1 and RANKL might play a role in CKD-associated sarcopenia. We also propose that SHPT impairs muscular strength through changes in Irisin and TGF-β synthesis, which were reverted by PTX.

**Funding:** Government Support - Non-U.S.

	Before PTX	After PTX
<b>MBD parameters</b>		
PTH, pg/mL	1,513 (1,354-1,959)	104 (36-281)*
Alkaline phosphatase, U/L	374 (218-739)	81 (65-123)*
Ca, mg/dL	9.7 (8.7-10.6)	8.6 (7.6-9)*
Phosphate, mg/dL	6.0 ± 1.6	4.8 ± 1.1*
25 vitamin D (ng/mL)	27 (18-36)	39 (28-48)*
<b>Physical evaluation</b>		
BMI (kg/m <sup>2</sup> )	25.8 ± 3.9	26.6 ± 4.2*
HGS, Kg	26.9 ± 11.1	31.0 ± 11.4*
LP, Kg	28.5 (7.5 - 36)	39.5 (29 - 64.7)*
SP, Kg	26.4 ± 12	30.6 ± 13*
Steps/day	4,408 (2,647-6,694)	6,742 (5,103-9,406)*
<b>DXA parameters</b>		
Bone mineral content, Kg	1.9 (1.6-2.3)	2.2 (2-2.6)*
Skeletal muscle index, Kg/m <sup>2</sup>	7 ± 1.1	7.2 ± 1
FAT mass, Kg	23.5 ± 9	26.2 ± 9*
* <i>p</i> < 0.01		

## FR-OR06

### Early Changes in Bone Turnover Markers Predict Bone Loss After Kidney Transplantation

Hanne S. Joergensen,<sup>1,2</sup> Patrick D'Haese,<sup>5</sup> Etienne Cavalier,<sup>3</sup> Pieter Evenepoel.<sup>1,4</sup> *<sup>1</sup>Katholieke Universiteit Leuven, Leuven, Belgium; <sup>2</sup>Aarhus Universitetshospital, Aarhus, Denmark; <sup>3</sup>Universite de Liege, Liege, Belgium; <sup>4</sup>Katholieke Universiteit Leuven Universitaire Ziekenhuizen Leuven Campus Gasthuisberg, Leuven, Belgium; <sup>5</sup>Universiteit Antwerpen, Antwerpen, Belgium.*

**Background:** Bone mineral density (BMD) changes are highly variable after kidney transplantation (TX) with subgroups of patients gaining or losing BMD in the first post-TX year. We investigated whether early changes in bone turnover markers (BTMs) could predict the BMD trajectory, which could enable targeted therapy.

**Methods:** BMD was measured at TX and 1 yr and parathyroid hormone (PTH) and BTMs at TX, 3 mo, and 1 yr (*n* = 230). Paired transiliac bone biopsies were available in a subset (*n* = 49).

Key: TH - Thursday; FR - Friday; SA - Saturday; OR - Oral; PO - Poster; PUB - Publication Only

Underline represents presenting author.

**Results:** Lumbar spine BMD loss at 1 yr was associated with higher PTH and BTMs at TX, with greater decreases in BTMs at 3 and 12 mo (Table). Trajectories of BTMs differed for patients gaining and losing BMD (Figure). By bone biopsy, patients with lumbar spine BMD gain vs loss had greater decreases in osteoid volume (-1.7 vs +2.2%, p=0.01) and surface (-9.09 vs +8.97uM, p=0.01). Changes in cortical porosity and thickness by micro-CT (n=19) were minimal and unrelated to changes in BMD.

**Conclusions:** Rapid mineralization of osteoid results in substantial BMD gain post-TX in a subset of patients. Changes in bone turnover markers during the first 3 mo can be used to predict the trajectory of BMD in the first post-TX yr.

Table

Biochemistry	Lumbar spine BMD loss (<2.5%) (n=78)	Lumbar spine BMD neutral (n=86)	Lumbar spine BMD gain (>2.5%) (n=66)	p
Bioactive parathyroid hormone (TX), xU/mL	2.78 (1.40; 4.49)	3.22 (2.01; 5.71)	4.83 (2.73; 8.69)	<0.001
Bone-specific alkaline phosphatase (TX), ug/L	17.4 (13.6; 23.8)	18.8 (14.8; 29.3)	30.8 (21.5; 49.5)	<0.001
Tartrate resistant acid phosphatase isoform 5b (TX), U/L	4.73 (3.17; 6.58)	5.03 (3.73; 7.25)	5.99 (3.94; 9.08)	0.01
Estimated glomerular filtration rate (12mo), mL/min/1.73m2	48.02 (36.37; 57.56)	46.00 (38.07; 54.90)	51.58 (43.91; 60.14)	0.03
Bioactive parathyroid hormone (12mo), xU/mL	1.17 (0.69; 2.11)	0.97 (0.64; 1.94)	1.01 (0.68; 1.79)	0.43
Bone-specific alkaline phosphatase (12mo), ug/L	20.6 (13.7; 29.2)	15.6 (11.3; 23.7)	13.8 (10.4; 21.2)	0.001
Tartrate resistant acid phosphatase isoform 5b (12mo), U/L	3.89 (2.93; 5.20)	3.96 (2.15; 4.14)	2.71 (1.78; 4.12)	<0.001
ΔBALP (3mo), %	-7.8 (-32.3; 35.6)	-23.4 (-47.6; 3.8)	-34.1 (-61.7; -1.7)	<0.001
ΔTRAP5b (3mo), %	-26.8 (-48.2; 0.3)	-44.5 (-58.6; -20.3)	-52.2 (-67.3; -32.4)	<0.001
ΔBALP (12mo), %	-1.1 (-25.8; 67.5)	-22.7 (-48.1; 18.8)	-51.5 (-70.8; -30.6)	<0.001
ΔTRAP5b (12mo), %	-13.1 (-41.6; 13.5)	-38.7 (-57.0; -17.1)	-54.9 (-67.6; -42.7)	<0.001

Median(IQR) with P by Kruskal-Wallis test

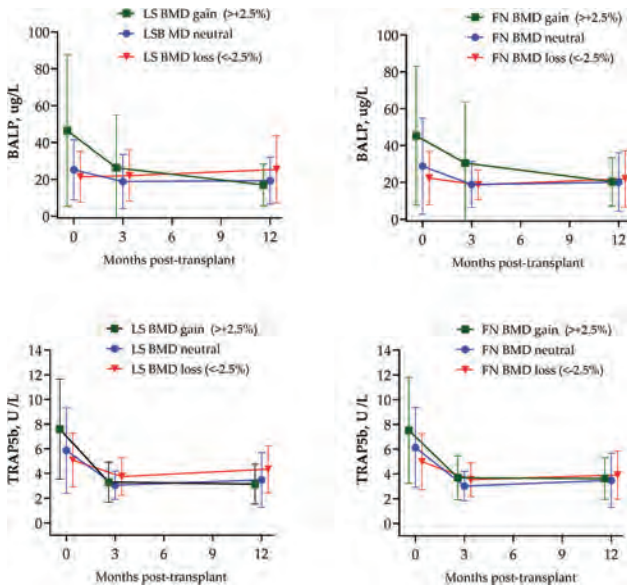

FR-OR07

**Hepatocyte Nuclear Factor 4 Alpha 2 Is a Novel Osteoblast Transcription Factor That Plays a Role in CKD-MBD**

Marta Martinez-Calle,<sup>1</sup> Guillaume Courbon,<sup>1</sup> Bridget Hunt-Tobey,<sup>1</sup> Jadeah J. Spindler,<sup>1</sup> Xueyan Wang,<sup>1</sup> Luciene dos Reis,<sup>2</sup> Carolina S. Martins,<sup>2</sup> Rosa M. Moyses,<sup>2</sup> Aline Martin,<sup>1</sup> Valentin David.<sup>1</sup> <sup>1</sup>Northwestern University Feinberg School of Medicine, Chicago, IL; <sup>2</sup>Hospital das Clinicas da Faculdade de Medicina de Botucatu, Botucatu, Brazil.

**Background:** Renal osteodystrophy (ROD) is a poorly understood disorder of bone metabolism that affects virtually all patients with chronic kidney disease (CKD), and is associated with adverse clinical outcomes including fractures, cardiovascular events and death. Using RNA (RNAseq) and Chromatin Immunoprecipitation (ChIPseq) sequencing approaches and complementary mouse models, we aimed to identify novel bone-derived factors that contribute to the onset and progression of ROD.

**Methods:** We first performed RNAseq in bone biopsies isolated from patients and mice with and without CKD and identified hepatocyte nuclear factor (HNF) 4 alpha as one of the top regulated genes with reduced expression in CKD. Next, we generated mice harboring a conditional deletion of *Hnf4a* in osteoblasts and osteocytes (*Hnf4a*<sup>oc-CKO</sup>) and studied their bone phenotype at 6 and 12 weeks of age. In parallel, we characterized the transcriptome and HNF4a cistrome of MC3T3 and osteoblast cultures lacking (*Hnf4a*<sup>CKO</sup>) or overexpressing *Hnf4a* (*Hnf4a*<sup>TS</sup>). Finally, we evaluated the impact of restoring osteoblastic *Hnf4a* expression in mice with CKD.

**Results:** Osteoblast deletion of *Hnf4a* resulted in impaired osteogenesis in cells and mice. *Hnf4a*<sup>oc-CKO</sup> mice showed reduced bone formation and increased bone resorption, resulting in a ~50% loss of trabecular bone volume at 12 weeks of age compared to

wild-type (WT) littermates. In addition, osteoblast cultures isolated from *Hnf4a*<sup>oc-CKO</sup> mice showed altered differentiation and mineralization compared to WT cells. In sharp contrast, *Hnf4a*<sup>TS</sup> cells showed increased expression of osteoblastic markers, such as *Runx2*, *Sp7* (Osterix) and *Bglap* (Osteocalcin), and ChIPseq analysis demonstrated that HNF4α is a master regulator of osteogenic genes. As a consequence, osteoblast specific overexpression of *Hnf4a* in mice with CKD delayed the onset of ROD and resulted in a 2-fold increase in trabecular bone volume and ~40% reduction of cortical porosity compared to CKD mice.

**Conclusions:** Our results establish the direct role of HNF4α in the regulation of osteogenesis, suggest that osseous HNF4α deficiency contributes to the pathogenesis of ROD and propose a novel mechanism to explain intrinsic bone defects in patients with CKD.

**Funding:** NIDDK Support

FR-OR08

**Encalret Normalized Mineral Homeostasis in Autosomal Dominant Hypocalcemia Type 1 (ADH1) in a Phase 2 Study**

Kelly Roszko,<sup>1</sup> Rachel Gafni,<sup>1</sup> Iris R. Hartley,<sup>1</sup> Edward F. Nemeth,<sup>2</sup> Karen A. Pozo,<sup>1</sup> Ed Lombardi,<sup>3</sup> Mary S. Roberts,<sup>3</sup> Scott H. Adler,<sup>3</sup> Michael Collins.<sup>1</sup> <sup>1</sup>National Institute of Dental and Craniofacial Research, Bethesda, MD; <sup>2</sup>MetisMedica, Toronto, ON, Canada; <sup>3</sup>Calcilytix Therapeutics, San Francisco, CA.

**Background:** Gain-of-function variants in the calcium-sensing receptor (CaSR) cause ADH1, a disorder of low PTH, hypocalcemia, hypercalciuria, & hyperphosphatemia. Therapy with calcium and active vitamin D worsens hypercalciuria and can lead to renal morbidity. Calcilytics (negative allosteric modulators of the CaSR) decrease the CaSR's sensitivity to extracellular calcium and correct biochemical abnormalities in rodent models. Encalret is an oral calcilytic under investigation as a potential treatment for ADH1.

**Methods:** Thirteen adults with ADH1 participated in a Phase 2b open-label dose-ranging study. Mean (range) therapy at screening was: calcium 2120mg/day (750-4800); calcitriol 0.7µg/day (0.2-2.0). These and thiazides were stopped before enalapril initiation. Periods 1 and 2 evaluated safety/tolerability and dose-finding. Period 3 (P3) was a 24-week (W24) outpatient period to optimize dosing and assess safety and efficacy. Encalret doses were individually titrated to normalize corrected blood calcium (cCa).

**Results:** P3W24 mean±SD encalret sulfate dose was 86±70mg BID (5-190 BID). Encalret was well-tolerated with no serious adverse events reported; there were no treatment or study discontinuations. Encalret resulted in dose-dependent increases in iPTH and normalization of mineral homeostasis (table):

**Conclusions:** This study represents a molecularly-targeted, precision medicine approach to ADH1 treatment. The consistent and sustained normalization of cCa and 24-hr UCa are clinically meaningful and support Phase 3 evaluation of the efficacy and safety of encalret as a potential treatment for ADH1.

**Funding:** Other NIH Support - This research was supported by the DIR, NIDCR, a part of the Intramural Research Program of the NIH, DHHS., Commercial Support - Calcilytix Therapeutics

Parameter	Baseline	P3W24
iPTH (nI 10-65 pg/mL)	6.3±7.8	31.3±20.8**
cCa (nI 8.4-10.2 mg/dL)	7.1±0.4	9.0±0.6**
24-hr UCa (nI <250-300 mg/d)	395±216	189±72*
Fractional Excretion of Ca	0.025±0.014	0.016±0.003*
Phos (nI 2.3-4.7 mg/dL)	4.5±1.1	3.5±0.6**
Tubular reabsorption of Phos (nI 85-95%)	91±5	86±5**
Mg (nI 1.6-2.6 mg/dL)	1.7±0.2	2.0±0.2**
Fractional Excretion of Mg	10.7±6.8	7.2±6.0**
24-hr Urine citrate (nI <250-1190 mg/d)	487±255	421±254
1,25 OH2-vitamin D (nI 20-70 pg/mL)	19.5±4.4	30.2±14.0*
eGFR mL/min/1.73 m2	84±25	83±23

Data presented are 24-hour mean±SD values from P3W24 compared to baseline. \*p<0.05 \*\* = p<0.01

FR-OR09

**A Spatially Anchored Transcriptomic Atlas of the Human Kidney Papilla Identifies Significant Immune Injury and Matrix Remodeling in Stone Disease Patients**

Angela R. Sabo,<sup>1</sup> Victor Hugo Canela,<sup>1</sup> William S. Bowen,<sup>1</sup> Ricardo Melo ferreira,<sup>1</sup> Daria Barwinska,<sup>1</sup> Seth Winfree,<sup>2</sup> Blue Lake,<sup>4</sup> Ying-Hua Cheng,<sup>1</sup> Kaice A. LaFavers,<sup>1</sup> Kun Zhang,<sup>4</sup> Fredric L. Coe,<sup>6</sup> Elaine M. Worcester,<sup>6</sup> Sanjay Jain,<sup>3</sup> Michael T. Eadon,<sup>1</sup> James C. Williams,<sup>1</sup> Tarek M. El-Achkar.<sup>1,5</sup> <sup>1</sup>KPMP <sup>1</sup>Indiana University School of Medicine, Indianapolis, IN; <sup>2</sup>University of Nebraska Medical Center, Omaha, NE; <sup>3</sup>Washington University in St Louis School of Medicine, St Louis, MO; <sup>4</sup>University of California San Diego Department of Bioengineering, San Diego, CA; <sup>5</sup>Richard L Roudebush VA Medical Center, Indianapolis, IN; <sup>6</sup>University of Chicago Department of Medicine, Chicago, IL.

**Background:** Kidney stone disease causes significant morbidity and health care utilization. The pathogenesis of this disease is incompletely understood. This is partly due to the poor characterization of the cellular and molecular makeup of the human papilla and its alteration with disease.

**Methods:** We utilized renal papillary biopsies obtained from calcium oxalate stone formers and non-stone formers. Specimens underwent single nuclear RNA sequencing (snRNAseq), spatial transcriptomics and/or high-resolution large-scale multiplexed 3D and Co-detection by indexing (CODEX) imaging. snRNAseq data from the Kidney Precision Medicine Project was used for comparison. A cohort including 58 patients and healthy volunteers was used for urine studies.

**Results:** We define and localize a complete landscape of papillary cells, which include surface epithelial cells, stromal and immune cells, unique subtypes of principal cells, and an undifferentiated epithelial cell type that was enriched in specimens from stone patients. Despite the focal nature of mineral deposition, we show that injury pathways such as immune activation, oxidative stress and matrix remodeling are globally upregulated across multiple cell types within the papilla of stone patients. We also characterize Randall's plaque as an active immune zone with inflammatory macrophages and T cells and demonstrate the presence of an immune lifespan around mineral deposition ranging from inflammation to fibrosis. Finally, we show that two matrix metalloproteinase, MMP7 and MMP9, are linked to active stone disease and mineralization within the papilla, and that their levels in the urine correlate with disease activity.

**Conclusions:** Our integrated multiomics approach reveals the complexity of the human kidney papilla and provides insights into the role of immune system activation and matrix remodeling in mineral deposition and stone disease. We also identify MMP7 and MMP9 as potential noninvasive markers of kidney stone disease course and activity.

**Funding:** NIDDK Support

## FR-OR10

### Crystalluria Impairs Macrophage Function During Kidney Stone Formation

Tanecia Mitchell, Emma Laurence, Parveen Kumar. *The University of Alabama at Birmingham School of Medicine, Birmingham, AL.*

**Background:** Approximately 10% of the United States population will form a kidney stone in their lifetime. Increased consumption of oxalate-rich meals is positively associated with urinary oxalate levels and stone formation. Macrophages are essential for removing crystals, which are the precursors to kidney stones, and rely on mitochondria and lysosomes to carry out their function. Interleukin-10 (IL-10) is an anti-inflammatory cytokine that regulates mitochondrial function in macrophages. The purpose of this study was to determine whether urinary nanocrystals reduce macrophage metabolism, signaling, and mitochondrial/lysosomal function. We hypothesize human urinary nanocrystals impair macrophage metabolism, IL-10 signaling, and mitochondrial quality control.

**Methods:** Ten adult healthy subjects and CaOx stone formers consumed controlled high oxalate diets for 4 days. Urine was collected 24 hours before and after the dietary regimen. Urinary nanocrystals were characterized using nanoparticle tracking analysis and subsequently exposed to macrophages (human and THP-1 monocyte-derived macrophages) with or without exogenous IL-10 (40 ng/ml) for 24 hours. Cell viability was measured using the MTT assay and metabolism was assessed using the Seahorse XF Analyzer. Mitochondrial and lysosomal gene expression and protein levels were determined using real-time quantitative reverse transcription-PCR, western blotting, or confocal microscopy. Mitochondrial reactive oxygen species (ROS) levels, mitochondrial membrane potential, and lysosomal activity were assessed using fluorescent-based plate reader assays.

**Results:** Our results show that high oxalate diets stimulate urinary nanocrystals and these crystals impair macrophage viability, metabolism, IL-10 and ROS signaling, mitochondrial and lysosomal gene expression and protein levels, and mitochondrial quality control. Further, we determined that exogenous IL-10 treatment prevented these outcomes.

**Conclusions:** These findings suggest that urinary nanocrystals impact macrophage function and this may reduce their ability to prevent kidney stone formation and growth. Future studies will determine mechanisms contributing to IL-10 signaling impairment in macrophages following oxalate exposure and test potential therapies to improve macrophage function during kidney stone formation.

**Funding:** NIDDK Support, Private Foundation Support

## FR-OR11

### Intracellular Magnesium Trafficking: A Novel Target to Prevent Ischemic Kidney Injury

William B. Reeves, Weiwei Wang, Kang Li, Serena J. Kim, Manigandan Venkatesan, Neelanjan Vishnu, Karthik Ramachandran, Muniswamy Madesh. *The University of Texas Health Science Center at San Antonio Joe R and Teresa Lozano Long School of Medicine, San Antonio, TX.*

**Background:** Mitochondrial dysfunction is a hallmark of AKI. We recently reported that intracellular lactate triggers the release of  $Mg^{2+}$  from endoplasmic reticulum with subsequent  $Mg^{2+}$  uptake by mitochondria via the mitochondrial  $Mg^{2+}$  channel Mrs2 (Daw et al Cell 2020). High mitochondrial  $Mg^{2+}$  uptake resulted in impaired mitochondrial function. Since lactate accumulation occurs in conditions of impaired oxidative phosphorylation, we explored the role of mitochondrial  $Mg^{2+}$  uptake in ischemic AKI.

**Methods:** We induced ischemic AKI via bilateral clamping of the renal pedicle for 26 minutes in male WT mice and in mice lacking Mrs2 (Mrs2 KO). Kidney function was assessed by measurement of blood urea nitrogen (BUN) and creatinine. Kidney histology was assessed by PAS staining and Ly6G staining for neutrophils.

**Results:** WT mice developed severe loss of renal function (24 hr BUN=99±16 mg/dl, Cr=1.13±.19 mg/dl, n=9), along with elevated KIMI and NGAL, histologic tubular injury and leukocyte infiltration. In contrast, Mrs2 KO mice had preserved renal function

(BUN=27±7 mg/dl, creatinine=0.48±0.09 mg/dl, n=9, P<0.01 vs WT) and less histologic damage and inflammation. Studies in bone marrow chimeric mice demonstrated that the presence or absence of parenchymal Mrs2, rather than hematopoietic Mrs2, accounted for these differences. CPACC, a novel inhibitor of Mrs2, administered 2 hours prior to ischemia largely prevented ischemic kidney injury (Cr: CPACC 0.35±0.06 mg/dl vs saline 1.47±0.30, P=0.006, n=5). To explore the potential role of lactate in mediating these effects, we administered oxamate, an inhibitor of LDH, which catalyzes the conversion of pyruvate to lactate, prior to ischemia. Mice which received oxamate, sustained significantly less renal dysfunction (BUN 34±5 mg/dl; Cr 0.37±.06 mg/dl), histologic injury and inflammation than saline treated mice (BUN 148±25 mg/dl, Cr 0.93±0.12 mg/dl, P=0.0001). Administration of oxamate 6 hours after ischemia had no protective effect.

**Conclusions:** These results support the view that lactate-triggered  $Mg^{2+}$  uptake into mitochondria is a critical mediator of ischemic AKI and that targeting this pathway may prevent ischemic kidney injury.

**Funding:** NIDDK Support

## FR-OR12

### Proximal Tubule Pannexin 1 Channel Regulates Cell Death and Inflammation During AKI

Nabin Poudel, Shuqiu Zheng, Nataliya Skrypnik, Eibhlin S. Goggins, Christopher B. Medina, Diane L. Rosin, Mark D. Okusa. *University of Virginia, Charlottesville, VA.*

**Background:** Pannexin 1 (Panx1) serves as a conduit for release of small metabolites during cellular stress and injury. Pharmacological inhibition or genetic deletion of *Panx1* in mice is protective against renal ischemia-reperfusion injury (IRI). We hypothesized that proximal tubule Panx1 mediated metabolite release exacerbates AKI by inducing proximal tubule cell death and by increasing inflammatory cell recruitment to the injured kidney.

**Methods:** We performed bilateral IRI or cisplatin-induced AKI (cis-AKI) in a transgenic mouse that overexpresses the human isoform of PANX1 globally (*PANX1<sup>tg</sup>*), specifically in proximal tubules (*PTEC<sup>Cre</sup>*), or endothelium (*EC<sup>Cre</sup>*) and evaluated extent of kidney injury. *PANX1* overexpressing proximal tubule epithelial cells (OX) were treated with cisplatin *in vitro* to assess cell death and mitochondrial damage. Flow cytometry was performed to measure leukocyte infiltration in the kidneys after cis-AKI.

**Results:** *PANX1<sup>tg</sup>* mice had significant rise in plasma creatinine and expression of kidney injury marker, *Ngal*, in the kidneys in both models of AKI compared to their littermate controls. *PTEC<sup>Cre</sup>* mice also had significantly higher injury compared to their littermates in both cis-AKI or IRI-AKI. *In vitro* studies showed that OX cells had higher cisplatin-induced cell death than wildtype (WT) cells. Furthermore, in a co-culture model in which both WT and OX cells were cultured together, OX cells had higher cisplatin-induced cell death. Conditioned media from cisplatin treated OX cells induced higher cell death compared to conditioned media from cisplatin treated WT cells. The higher cisplatin-induced cell death was associated with reduced mitochondrial function and increased mitochondrial ROS production. Assessment of mitochondria in kidneys showed a significant reduction in Drp1 levels in *PANX1<sup>tg</sup>* kidneys compared to WT controls. Cisplatin induced a higher infiltration of neutrophils, CD8-positive T cells, and CD11b-positive dendritic cells in the kidneys of *PTEC<sup>Cre</sup>* animals compared to WT.

**Conclusions:** We showed that PANX1 overexpression resulted in overt renal injury during AKI that is in part mediated by reduced mitochondrial function, increased cell death, and inflammation. Selective strategies to inhibit Panx1 could help prevent or treat AKI.

**Funding:** NIDDK Support, Private Foundation Support

## FR-OR13

### Proteomic Analysis Reveals Proteins Associated Exclusively With Urinary Muddy Brown Granular Casts

Michael G. Janech,<sup>1</sup> Elizabeth A. Fongheiser,<sup>1</sup> Noah F. Compton,<sup>1</sup> Alison Bland,<sup>1</sup> Benjamin A. Neely,<sup>3</sup> Vipin Varghese,<sup>2,4</sup> Juan Carlos Q. Velez,<sup>2,4</sup> Ochsner Nephrology <sup>1</sup>College of Charleston, Charleston, SC; <sup>2</sup>Ochsner Medical Center, New Orleans, LA; <sup>3</sup>National Institute of Standards and Technology Material Measurement Laboratory, Charleston, SC; <sup>4</sup>The University of Queensland Ochsner Clinical School - New Orleans, New Orleans, LA.

**Background:** The presence of "muddy" brown granular casts (MBGC) in the urinary sediment is pathognomonic for acute tubular injury (ATI), but the composition of MBGC remains understudied and no proteomic studies have been reported. Because MBGC are only visualized via manual inspection by microscopy, a diagnostic test to identify MBGC without microscopic inspection of the urine could be clinically useful. Unlike most acute kidney injury (AKI) biomarker discovery approaches, we hypothesized that MBGC-enriched urinary sediment (MBGC-sedi) contains unique proteins that could serve as biomarkers of ATI.

**Methods:** MBGC were enriched from 12 patients with AKI using a series of cell strainers (mesh size: 40 - 100µm). Enriched MBGC, matching urine supernatant samples, and urine sediments controls without MBGC (N=6) were proteolytically digested using S-traps and analyzed using tandem mass spectrometry. Proteins were identified by MASCOT and accepted at 1% false discovery. Identified proteins were quantified by weighted spectral count and ranked using exponentially modified protein abundance index (emPAI). ANOVA was utilized to filter proteins that were enriched in MBGC samples versus sediment lacking MBGC or urine supernatant.

**Results:** A total of 3367 proteins were identified across all MBGC samples (mean±SD = 1976±243 proteins/sample). The most abundant proteins in MBGC samples were Ig kappa constant region and retinol-binding protein 4. Although abundant, uromodulin had a mean rank of 15 across all MBGC samples. A total of 272 proteins were higher in MBGC compared to urine supernatant or control sediment without MBGC. Only one protein was exclusive to all MBGC samples, adrenodoxin, a small 19 kDa iron-binding mitochondrial protein known to be expressed in kidney tubules. A second protein, PDZ/LIM domain protein 1 was exclusive to 11 out of 12 MBGC samples and is involved in cytoskeletal stress fiber assembly in fibroblasts.

**Conclusions:** Mitochondrial adrenodoxin (ferrodoxin) and PDZ/LIM domain protein 1 may constitute a biomarker of MBGC presence and serve an alternative method to urine microscopy for identifying the presence of MBGC. We conclude that urinary adrenodoxin and PDZ/LIM domain protein 1 are potential target proteins for ATI diagnosis.

**Funding:** NIDDK Support

#### FR-OR14

##### **Ketone Body Metabolism in Renal Endothelium Triggers PPAR Signaling, Reduces Immune Cell Recruitment, and Preserves Kidney Function Upon Ischemia/Reperfusion Injury**

Mila Borri,<sup>1</sup> Sébastien J. Dumas,<sup>1</sup> Elda Meta,<sup>1</sup> Ann Bouché,<sup>1</sup> Pepijn Saraber,<sup>1</sup> Melissa García-Caballero,<sup>1,3</sup> Nuphar Veiga,<sup>1</sup> Joanna Kalucka,<sup>1,2</sup> Guy Eelen,<sup>1</sup> Peter Carmeliet.<sup>1,2</sup> <sup>1</sup>Vlaams Instituut voor Biotechnologie KU Leuven Center for Cancer Biology, Leuven, Belgium; <sup>2</sup>Aarhus Universitet, Aarhus, Denmark; <sup>3</sup>Universidad de Malaga, Malaga, Spain.

**Background:** Renal ischemia/reperfusion injury (IRI), a major cause of acute kidney injury (AKI), affects cellular energy state, induces oxidative stress and immune cell recruitment, ultimately impairing kidney function. Targeting renal endothelial cells (ECs) could prevent kidney dysfunction and improve the outcome for patients with IRI-related AKI. Ketone body supplementation protects against IRI. Renal ECs are directly exposed to circulating ketone bodies but their contribution to the protective effect and possible underlying mechanisms remain unknown.

**Methods:** *Oxct1*<sup>WT</sup> and *Oxct1*<sup>ΔCKO</sup> mice (lacking the rate-limiting enzyme of ketolysis in ECs) were fed a chow or ketogenic diet (KD) and exposed to sham surgery or bilateral clamping of renal pedicles. Kidney function (plasma markers) and injury (histology) were assessed 24h after reperfusion. Renal ECs were freshly isolated and submitted to bulk RNA-seq. Immune cell populations in kidneys were analyzed by flow cytometry. Gene expression was assessed in *Oxct1*-silenced HUVECs by qPCR.

**Results:** KD improved kidney function, decreased tubule injury and immune cell infiltration in kidneys of mice exposed to renal IRI. These effects were partly impaired in *Oxct1*<sup>ΔCKO</sup> mice, highlighting the role of EC ketolysis. Transcriptomics analysis of renal ECs upon IRI showed upregulation of immune activation genes and downregulation of metabolic genes involved in fatty acid, arachidonic acid, and glutathione metabolism, among others. KD partially reverted this gene signature in *Oxct1*<sup>WT</sup> ECs, but only to a limited extent in *Oxct1*<sup>ΔCKO</sup> ECs. Geneset enrichment analysis identified PPAR signaling as a potential hub downstream of ketolysis, since oppositely regulated by KD and *Oxct1* knockout. *Oxct1*-silenced HUVECs upregulated immune activation genes, suggesting an anti-inflammatory role of ketolysis in ECs.

**Conclusions:** EC ketolysis partly mediated the KD protective effect in a mouse model of renal IRI, by preventing renal EC activation, reducing immune cell recruitment, maintaining a metabolic homeostasis in ECs, and preventing kidney function impairment. Activation of the metabolic regulator PPAR in ECs appears to contribute to this protective mechanism in IRI.

**Funding:** Government Support - Non-U.S.

#### FR-OR15

##### **Kidney Injury Molecule-1 (KIM-1) Shapes the Kidney Immune Microenvironment via Lymphotoxin Beta Receptor (LTβR) Signaling**

Naoka Murakami, Shun Kawashima, Yutaro Mori, Samuel Mon-Wei Yu, Takaharu Ichimura, Joseph V. Bonventre. Brigham and Women's Hospital, Boston, MA.

**Background:** Tertiary lymphoid tissues (TLTs) are inducible ectopic lymphoid tissues which are found in chronic inflammatory conditions and in various pathologic kidney diseases. However, the mechanisms of TLT formation in kidney and its implication in acute kidney injury are poorly understood.

**Methods:** In an aristolochic acid (AA)-induced kidney injury mouse model, we analyzed the resultant immune microenvironment in KIM-1 wild type (WT) and KIM-1 mutant (delta mucin, functional knockout of KIM-1) animals. Gene expression was examined in kidneys harvested on day 14 after AA treatment (5 mg/kg, intraperitoneal injection, once). Primary mouse kidney tubular epithelial cells (TEC), derived from WT and KIM-1 mutant kidneys were treated with AA and assessed cytokine production. In addition, immune-related gene expression profiles were examined using human kidney biopsy samples.

**Results:** AA treatment induced more prominent TLTs in kidney interstitium in KIM-1 WT animals, associated with higher levels of lymphotoxin beta (LTβ) and its receptor (LTβR) expression in the kidneys when compared to results in KIM-1 mutant animals, suggesting that the expression of KIM-1 plays a role in lymphocyte trafficking. Gene expression of chemokine ligand/receptor pairs such as CXCL13/CXCR5, CCL21/CCR7, were also higher in KIM-1 WT compared to KIM-1<sup>delta-mucin</sup> mutants. Primary tubule epithelial cells (TECs) co-cultured with endothelial cells revealed that AA treatment in vitro induced higher CXCL13 and CCL21 secretion in cells derived from WT animals

as compared to TECs isolated from KIM-1<sup>Dmucin</sup> animals, and greater endothelial activation evident by increased PNA-d. Human kidney biopsy samples from patients with drug-induced AKI confirmed expression of LTβ, CXCL13 and CCL21, suggesting the relevance of these molecules in human AKI.

**Conclusions:** KIM-1 expression plays a crucial role on lymphocyte trafficking via inducing expression of LTβ/LTβR and chemokines in kidneys. Our data provide novel information to suggest epithelial-endothelial-immune crosstalk and may lead to identification of novel therapeutic targets.

**Funding:** NIDDK Support, Private Foundation Support

#### FR-OR16

##### **Kidney Resident Macrophages Alter MHC II Expression and Location in Response to Acute and Chronic Injury**

Elise Erman,<sup>1,2</sup> Kyle H. Moore,<sup>1,2</sup> Matthew D. Cheung,<sup>1,2</sup> Anupam Agarwal,<sup>2</sup> James F. George.<sup>1</sup> <sup>1</sup>The University of Alabama at Birmingham Department of Surgery, Birmingham, AL; <sup>2</sup>The University of Alabama at Birmingham Division of Nephrology, Birmingham, AL.

**Background:** Patients remain at increased risk for developing chronic kidney disease (CKD) after recovery from AKI. The cause of this increased risk is unknown and biomarkers for it are severely lacking. We have identified a subpopulation of kidney injury-associated macrophages (KIA) that appear after AKI and lack MHC II expression. We hypothesize that KIA cells are uniquely involved in the pathogenesis of injury and may be a key to an AKI to CKD transition.

**Methods:** C57BL/6J mice (n=6/grp) were subjected to a bilateral ischemia-reperfusion injury (AKI) or aristolochic acid treatment at doses of 2 mg/kg BW (CKD) or 3 mg/kg BW (severe CKD). KIA cells were localized within the tissue using Visium Spatial Transcriptomics and single-cell RNA sequencing (scRNAseq). The phenotype was validated by flow cytometry. Kidney function was determined using serum creatinine and glomerular filtration rate (GFR).

**Results:** Following AKI, KIA cells are detectable at 24 hours by flow cytometry and at 12 hours by scRNAseq. Spatial transcriptomics shows that KIA cells localize to the cortico-medullary region contiguous with the proximal tubule S3 segments. Differentially expressed genes include those associated with platelets and wound healing. As kidney function recovers, KIA cells decrease in number and return to quiescent levels by 14 days post-injury (p < 0.0001). In contrast, in the severe CKD model, KIA cells persist for up to six weeks, composing approximately 20% of the total kidney resident macrophage population (p = 0.0035). A less severe version of CKD results in fewer KIA cells but similar persistence, suggesting the appearance of KIA cells directly correlates with injury severity. Following a low dose of LPS, KIA cells represent up to 90% of the resident compartment without a significant increase in serum creatinine (p < 0.0001).

**Conclusions:** We conclude that KIA cells may locate at damage sites and may be involved in the AKI to CKD transition. Therefore, targeting KIA cells could potentially reduce CKD risk following AKI.

#### FR-OR17

##### **Tubular Epithelium-Specific Deletion of Megalin Aggravates Ischemia/Reperfusion Kidney Injury and Accelerates the Progression to CKD**

Qingtian Li,<sup>1</sup> Michael Holliday,<sup>1,2</sup> Jenny S. Pan,<sup>1,2</sup> David (Daud) Sheikh-Hamad,<sup>1,2</sup> <sup>1</sup>Baylor College of Medicine, Houston, TX; <sup>2</sup>Michael E DeBakey VA Medical Center, Houston, TX.

**Background:** Ischemic AKI may accelerate the progression to ESKD. We have shown stanniocalcin-1 (STC1) activates AMPK and promotes mitochondrial antioxidant defenses through upregulation of uncoupling protein 2 and SIRT3. Transgenic overexpression of STC1 confers resistance to ischemia/reperfusion (I/R) kidney injury. We have shown STC1 is shuttled by megalin from the cell surface to the mitochondria through retrograde-early endosomes-to-Golgi- and Rab32-mediated pathway; knockout of megalin in cultured cells impairs glycolysis and mitochondrial respiration. In the current experiments, we sought to determine kidney phenotype after I/R kidney injury in mice with tubular epithelium-specific deletion of megalin.

**Methods:** We generated mice (on C57B/6 background) with tubular epithelium-specific KO of megalin (Lrp2f/f;Pax8rtTA;LC1-Cre; referred to as tLrp2KO) and combined tubular epithelium-specific KO of megalin and overexpression of STC1 (Lrp2f/f;tetOhSTC1;Pax8rtTA;LC1-Cre; referred to as tLrp2KO;STC1O), upon treatment with Doxycycline. Eight -12 weeks old mice were subjected to 30 min ischemia (clamping both renal pedicles) followed by reperfusion. Mice were euthanized after 1, 3, 10 and 45 days, blood was collected for creatinine measurement, and kidneys were harvested for analyses.

**Results:** Compared with I/R in control mice, I/R in tLrp2KO mice was associated with more severe AKI (higher NGAL and serum creatinine), greater inflammation and fibrosis. Kidney injury was less severe in female mice; but, the injury was greater in female tLrp2KO mice. Kidney injury was not rescued in tLrp2KO;STC1O mice, consistent with megalin-dependent STC1-mediated renal protection from I/R. I/R in tLrp2KO mice was associated with exaggerated inflammatory response that persisted through day 45, diminished tubular epithelial cell proliferation, upregulation of TGF-β signaling and fibrosis, and accelerated CKD progression. CRISPR-Cas-mediated knockout of megalin in cultured proximal tubular epithelial cells (BUMPT) upregulates TGF-β signaling, induces cell cycle arrest, impairs mitogenesis and diminishes autophagosome clearance.

**Conclusions:** Tubular epithelium-specific deletion of megalin aggravates I/R kidney injury and accelerates the progression to CKD.

**Funding:** Veterans Affairs Support

Key: TH - Thursday; FR - Friday; SA - Saturday; OR - Oral; PO - Poster; PUB - Publication Only

Underline represents presenting author.



## FR-OR18

**The Role of the Circadian Clock System in the Transition From AKI to CKD**

Yina Fang, Ko Yoon Sook, Lee Hee Young, Sewon Oh, Young Eun Choi, Suk Min Chung, Sungyeon Kim, Sang-Kyung Jo, Myung-Gyu Kim. *Korea University Anam Hospital, Seoul, Republic of Korea.*

**Background:** Recent studies suggest that circadian rhythms are an important factor in maintaining healthy kidney functions; however, its role in acute kidney injury (AKI) remains unclear.

**Methods:** To investigate the role of tubule-specific clock gene disturbance in hypoxic tubular injury, we created human proximal tubule-specific *BMAL1* KO cells using CRISPR-Cas9 gene editing. In mice, we also determined whether time-restricted feeding (TRF), a dietary strategy to enhance circadian rhythm, can have beneficial effect on recovery of ischemia reperfusion injury (IRI) or its progression to chronic kidney disease (CKD).

**Results:** *BMAL1* loss in tubule cells resulted in the upregulation of cell cycle regulatory gene (p21) and inflammatory genes (TNF- $\alpha$  and CCL4) mRNA expression, suggesting that *BMAL1* is a critical regulator of these genes. Exposure to hypoxia for 48 h resulted in more increased expressions of p21 in *BMAL1* KO cells than in WT HK-2 cells, leading to higher expression of TGF- $\beta$ . In addition, loss of *BMAL1* led to significantly increased vimentin and decreased E-cadherin expression upon TGF- $\beta$  stimulation, suggesting an aggravated epithelial-mesenchymal transition upon *BMAL1* deletion. To clarify the role of clock system in AKI, we also tested whether TRF can have a beneficial effect during recovery phase after IRI. Despite limited access to food, TRF for 4 weeks after IRI had no effect on the total intake or weight of mice. However, we observed that TRF significantly improved renal function on day21 and reduced renal fibrosis on day28, which suggests that enhancing clock gene oscillations through restoring fasting/feeding cycle has a protective effect in the AKI to CKD transition.

**Conclusions:** We identified an important role of clock system in hypoxic tubular injury and the effects of treatment targeting circadian rhythm in AKI. Our results can provide a new perspective for developing novel therapeutic strategies for AKI.

## FR-OR19

**TIGIT Modulates Kidney T Cell Memory Phenotype and Metabolic Profile and Mediates Both Ischemic and Nephrotoxic AKI in Mice**

Sanjeev Noel, Kyungho Lee, Sepideh Gharaie, Johanna T. Kurzhagen, Lois J. Arend, Patrick Cahan, Hamid Rabb. *Johns Hopkins University, Baltimore, MD.*

**Background:** T cells play pathogenic and reparative roles in acute kidney injury (AKI) but mechanisms regulating their functions are poorly understood. We found upregulated expression of the novel immune checkpoint molecule T cell immunoreceptor with Ig and ITIM domains (TIGIT) on kidney CD4 T cells after ischemia reperfusion (IR) using RNA-Seq. We explored TIGIT effect on kidney T cells, AKI outcomes and mechanisms.

**Methods:** TIGIT effect on murine kidney T cells was assessed at baseline and after ischemic AKI by flow cytometry and single cell RNA sequencing (scRNA-Seq). B6 wild type (WT) and TIGIT knockout (KO) mice were studied during ischemic and cisplatin-induced AKI. TIGIT expression was assessed in AKI patients using the Kidney Precision Medicine Project (KPMP) scRNA-Seq dataset.

**Results:** Ischemic AKI in WT mice led to an increase in kidney CD4+TIGIT+ effector memory (EM; 79.4 $\pm$ 3.9 vs 65.4 $\pm$ 5.4%, p=0.05) and central memory (CM; 10.0 $\pm$ 2.3 vs 0.9 $\pm$ 0.1%, p=0.001) cells compared to CD4+TIGIT- cells. CD4+TIGIT+ T cells had increased mean fluorescent intensity (MFI) of CD44 and reduced MFI of CD62L at baseline and after IR injury. TIGIT KO mice had significantly reduced serum creatinine (SCR) after IR (24h Scr, 1.1 $\pm$ 0.2 vs 2.7 $\pm$ 0.1 mg/dL; p $\leq$ 0.001) and cisplatin (72h Scr, 0.8 $\pm$ 0.1 vs 1.4 $\pm$ 0.1 mg/dL; p=0.0002) injury compared to WT mice. TIGIT KO kidneys had significantly reduced necrotic tubules in outer medulla after IR (48.8 $\pm$ 4.7% vs 73.0 $\pm$ 1.5%; p=0.001) and cisplatin (11.5 $\pm$ 3.0% vs 31.3 $\pm$ 4.0%; p=0.008) injury than WT kidneys. scRNA-Seq analysis showed enrichment of inflammatory genes in Th1 and Th17 cells from WT kidney. Th1 and Th17 cells from TIGIT KO kidney had an enrichment of oxidative phosphorylation and mTORC1 signaling related genes. Human KPMP data demonstrated increased TIGIT expression in kidney T/NK cells of AKI patients compared to controls (p $\leq$ 0.0001).

**Conclusions:** TIGIT is a direct pathophysiologic mediator of both experimental ischemic and nephrotoxic AKI. Kidney CD4 TIGIT expression correlated with effector and central memory phenotype, and distinct inflammatory/metabolic transcriptional profiles. TIGIT expression also increased in kidney T cells from AKI patients. TIGIT is a promising novel therapeutic target for AKI, and also relevant due to increasing use of TIGIT blockade to treat cancer.

**Funding:** NIDDK Support

## FR-OR20

**Proximal Tubular Epithelial Cell States in KPMP Protocol Kidney Biopsies Are Linked to Short-Term AKI Patient Outcomes**

Jennifer A. Schaub,<sup>1</sup> Rajasree Menon,<sup>1</sup> Pavan K. Bhatraju,<sup>2</sup> Ricardo Melo ferreira,<sup>3</sup> Blue Lake,<sup>8</sup> Edgar A. Otto,<sup>1</sup> Rachel S. Sealfon,<sup>3</sup> Olga Troyanskaya,<sup>3</sup> Jeffrey B. Hodgins,<sup>1</sup> Laura Barisoni,<sup>4</sup> Michael T. Eadon,<sup>5</sup> Kun Zhang,<sup>8</sup> Angela M. Victoria Castro,<sup>6</sup> Francis P. Wilson,<sup>6</sup> Raghavan Murugan,<sup>7</sup> Matthew R. Rosengart,<sup>7</sup> Paul M. Palevsky,<sup>7</sup> Sanjay Jain,<sup>2</sup> Jonathan Himmelfarb,<sup>2</sup> Matthias Kretzler.<sup>1</sup> KPMP <sup>1</sup>University of Michigan Michigan Medicine, Ann Arbor, MI; <sup>2</sup>Washington University in St Louis, St Louis, MO; <sup>3</sup>Princeton University, Princeton, NJ; <sup>4</sup>Duke University School of Medicine, Durham, NC; <sup>5</sup>Indiana University, Bloomington, IN; <sup>6</sup>Yale School of Medicine, New Haven, CT; <sup>7</sup>University of Pittsburgh, Pittsburgh, PA; <sup>8</sup>University of California San Diego, La Jolla, CA.

**Background:** Acute Kidney Injury (AKI) is a heterogeneous syndrome making it challenging to identify biological underpinnings for poor outcomes. Linking sub-phenotypes, such as resolving and non-resolving AKI, with single cell RNA sequencing data may help identify relevant biologic signatures. As part of Kidney Precision Medicine Project (KPMP), we performed an integrated tissue level analysis from 19 participating AKI patients.

**Methods:** Clinical assessment of AKI resolution 72 hours post diagnosis was performed on the AKI patients, classified as 'resolving' versus 'non-resolving'. Resolving AKI was defined as "decrease in the concentration of sCr of 0.3 mg/dl or more or 25% or more from maximum in the first 72 hours after AKI diagnosis" (PMC7154800). Single cell and single nucleus analyses (sc/sn) (10x Chromium) and spatial transcriptomic data (visium) were performed on biopsy samples from AKI patients. Cell clusters were annotated using the integrated analysis of AKI sc/sn datasets per KPMP atlas (bioRxiv 2021.07.28.454201).

**Results:** 107,119 sc/sn post QC from the 19 AKI samples clustered to 71 cell types/states. A global differential expression analysis across all cell types/states between resolving (n=6) and non-resolving (n=13) samples resulted in 231 genes that were significantly differentially expressed (adj p value < 0.05). Majority of these genes were enriched in the degenerative (5,990 sc, 4,177 sn) and adaptive (6,134 sc, 13,237 sn) states of the proximal tubular epithelial cell; Immune-related processes were enriched for these genes. Ligand receptor analysis indicated multiple potential interactions between T cells and these two proximal tubular cell states. Moreover, we were able to identify a similar adaptive proximal cell state using spatial transcriptomic technology in resolving AKI kidney biopsy tissue.

**Conclusions:** Using integrated analysis of single cell expression data with a clinical assessment variable, we identified a molecular signature enriched in adaptive and degenerative cell states of proximal epithelial cells linked to short term outcomes in AKI.

**Funding:** NIDDK Support

## FR-OR21

**Air Pollution, Genetic Factors, and the Risk of Incident CKD: A Prospective Study of Polygenic Risk Score Analysis in the UK Biobank**

Boram Weon,<sup>1</sup> Jeonghwan Lee,<sup>2,1</sup> Jung Pyo Lee,<sup>2,1</sup> Chun Soo Lim.<sup>2,1</sup> <sup>1</sup>Seoul National University Boramae Medical Center, Seoul, Republic of Korea; <sup>2</sup>Seoul National University College of Medicine, Seoul, Republic of Korea.

**Background:** Both genetic and environmental factors contribute to chronic kidney disease (CKD), but the degree to which air pollution modifies the impact of genetic susceptibility on CKD remains unknown. We aimed to investigate the effects and their interaction of air pollution and genetic factors on incident CKD.

**Methods:** We analyzed data from 350,994 participants (53% women) without previous CKD at baseline in the UK Biobank. The concentrations of particulate matter (PM) (PM <2.5 mm in aerodynamic diameter [PM2.5], coarse PM between 2.5 mm and 10 mm in aerodynamic diameter [PMcoarse], and PM <10 mm in aerodynamic diameter [PM10]), nitrogen dioxide (NO2), and nitrogen oxides (NOx) were estimated by using land-use regression models, and the association between air pollutants and incident CKD was investigated by using a Cox proportional hazard model. Furthermore, we constructed a polygenic risk score and evaluated whether air pollutants modified the effect of genetic susceptibility on the development of CKD.

**Results:** The results showed significant associations between the risk of CKD and PM2.5 (hazard ratio [HR], 1.21; 95% confidence interval [CI], 1.06–1.37) and NOx (HR, 1.19; 95% CI, 1.05–1.35). There were additive interactions between air pollutants and the genetic risk in PM10 and PMcoarse. Compared with participants with high genetic risk score groups, those with high air pollution exposure and low genetic risk showed significantly increased hazards for incident CKD (PM2.5: HR, 1.21; 95% CI, 1.06–1.37; NOx: HR, 1.19; 95% CI, 1.05–1.35).

**Conclusions:** Long-term exposure to air pollution may increase the risk of CKD, especially in those with low genetic risk.

Fig.1. The effect of PM2.5 exposure on hazard ratio (HR) for CKD according to the polygenic risk score (PRS) tertiles (Restrictive Cubic Spline curves).

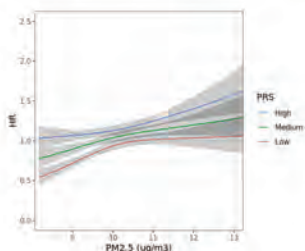
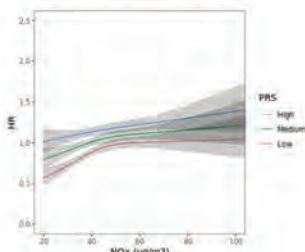

Fig.2. The effect of NOx exposure on hazard ratio (HR) for CKD according to the polygenic risk score (PRS) tertiles (Restrictive Cubic Spline curves).



FR-OR22

**Time-Dependent Risk Differences in Kidney Failure and Death Between Black and White Veterans Following Incident CKD**

Guofen Yan,<sup>1</sup> Robert Nee,<sup>2</sup> Julia J. Scialla,<sup>1</sup> Wei Yu,<sup>1</sup> Tom Greene,<sup>3</sup> Alfred K. Cheung,<sup>3,4</sup> Keith C. Norris.<sup>5</sup> <sup>1</sup>University of Virginia, Charlottesville, VA; <sup>2</sup>Walter Reed National Military Medical Center, Bethesda, MD; <sup>3</sup>University of Utah Health, Salt Lake City, UT; <sup>4</sup>VA Salt Lake City Health Care System, Salt Lake City, UT; <sup>5</sup>University of California Los Angeles, Los Angeles, CA.

**Background:** Recent research indicates that among US veterans with incident CKD defined using the new 2021 CKD-EPI creatinine equation, Black patients had 27-37% higher adjusted rates of kidney failure (KF) than White patients. We examined whether this higher rate persisted in the entire course of CKD or only within a certain time period following incident CKD.

**Methods:** The study included 180,881 non-Hispanic White and 32,187 non-Hispanic Black veterans, aged 18-90 years, with incident CKD from 2003-2008 in the US Veterans Health Administration, followed through 2018. Incident CKD was defined by the first time when two eGFR values >3 months apart were both <60 mL/min/1.73 m<sup>2</sup> using the 2021 CKD-EPI equation. We calculated cause-specific hazard ratios (HR) of KF, censoring on death, and HRs of death (including death after KF) for Blacks versus Whites in five consecutive 2-year intervals for a total of 10 years, adjusting for demographics, clinical factors, and comorbidities.

**Results:** At incident CKD, Black veterans were on average younger than White veterans (66 and 74 years, respectively) with similar mean eGFR (50-51 mL/min/1.73 m<sup>2</sup>). Over 10 years of follow-up, the adjusted risk of KF was 30% greater in Blacks than in Whites (Table), but this difference was more pronounced over the early years of CKD onset (e.g., 38% greater risk in years 0-2) than at later years (only 8% greater risk, p>0.05 in years 8-10). Despite the overall similar adjusted mortality risks after adjusting for major confounding of age along with other covariates, the difference evolved over time, with a greater adjusted risk of death for Blacks during the first 4 years of CKD onset, followed by a lower risk thereafter. These risk differences over time were consistent across subgroups such as those with and without specific comorbidities (e.g., hypertension, diabetes, or cardiovascular diseases).

**Conclusions:** Black individuals are particularly susceptible to adverse outcomes during the first several years of CKD onset, which demands a stronger urgency for close evaluation in the earlier years of CKD to improve outcomes.

**Funding:** NIDDK Support

Adjusted HRs (95% CIs) for Black versus White veterans in years after incident CKD

Outcome	The entire 10-year period	Years after CKD onset				
		0-2	2-4	4-6	6-8	8-10
Kidney failure	1.30 (1.24-1.37)	1.38 (1.26-1.52)	1.44 (1.31-1.57)	1.32 (1.20-1.45)	1.23 (1.11-1.36)	1.08 (0.96-1.21)
Death	1.01 (0.99-1.03)	1.27 (1.23-1.32)	1.07 (1.03-1.11)	0.95 (0.91-0.99)	0.94 (0.91-0.98)	0.83 (0.82-0.89)

FR-OR23

**Protein Carbamylation and the Risk of CKD Progression**

Sahir Kalim,<sup>1,2</sup> Sophia Zhao,<sup>3</sup> Mengyao Tang,<sup>1</sup> Eugene P. Rhee,<sup>1,2</sup> Andrew S. Allegretti,<sup>1,2</sup> Sagar U. Nigwekar,<sup>1,2</sup> James P. Lash,<sup>4</sup> <sup>1</sup>Massachusetts General Hospital, Boston, MA; <sup>2</sup>Harvard Medical School, Boston, MA; <sup>3</sup>Analytica Now, Brookline, MA; <sup>4</sup>University of Illinois Chicago, Chicago, IL.

**Background:** Protein carbamylation, a post-translational protein modification driven by urea, associates with mortality and adverse outcomes in ESKD, but less is known about its relationship to clinical outcomes in earlier stages of CKD.

**Methods:** In 3,111 patients with CKD stages 2 through 4 enrolled in the Chronic Renal Insufficiency Cohort study, we evaluated an established protein carbamylation marker (carbamyated albumin, C-Alb) as a risk factor for ESKD (primary); the composite ESKD or 50% decline in eGFR; and death.

**Results:** Participant demographics included mean [SD] age 59 [10.8] years; 1358 (43.7%) female; 1334 (42.9%) white. The mean [SD] eGFR at the time of C-Alb assessment was 41.8 [16.4] mL/min/1.73m<sup>2</sup> and the median [IQR] C-Alb value was 7.8 mmol/mol [5.8 - 10.7]. During an average of 7.9 [4.1] years of follow up, 981 (31.5%) individuals reached the outcome of ESKD, and 1175 (37.8%) individuals reached the composite endpoint of ESKD or a 50% decline in eGFR. In multivariable adjusted Cox models, on a continuous scale or in quartiles, higher C-Alb levels independently associated with a monotonically increasing risk of both ESKD and the composite endpoint. Compared with quartile 1 (C-Alb ≤ 5.80 mmol/mol) those in quartile 4 (C-Alb > 10.71 mmol/mol) had a greater risk for ESKD (adjusted hazard ratio [HR], 2.29; 95% confidence interval [CI] 1.75-2.99), as well as a greater risk for the composite endpoint (HR 2.01; CI 1.59-2.53). Moreover, the top C-Alb quartile had a 1.58 (95% CI, 1.25 - 2.01) times increased risk of death compared to the bottom quartile. The results remained significant across numerous sub-group analyses, when treating death as a competing event in CKD progression analyses, using different assessments of eGFR, and after adjustment for blood urea nitrogen levels. Measures of risk discrimination showed significant improvement when C-Alb was added to fully adjusted models.

**Conclusions:** These results reflect the largest study of carbamylation in humans to date. Higher levels of protein carbamylation as measured by circulating C-Alb levels were an independent risk factor for CKD progression, ESKD, and death in individuals with CKD stages 2 to 4. Future studies should evaluate whether therapeutic interventions to prevent or lower carbamylation can improve CKD outcomes.

**Funding:** NIDDK Support

FR-OR24

**Changes in CKD Prevalence in the United States Using the Age-Adapted CKD Classification System**

Maria Clarissa Tio,<sup>1</sup> Aliba Syed,<sup>2</sup> Elani Streja,<sup>2</sup> Rajesh Talluri,<sup>1</sup> Yoshitsugu Obi,<sup>1</sup> Tariq Shafi,<sup>1</sup> Kamyar Kalantar-Zadeh.<sup>2</sup> <sup>1</sup>University of Mississippi Medical Center, Jackson, MS; <sup>2</sup>University of California Irvine, Irvine, CA.

**Background:** Current eGFR criteria for diagnosing CKD (eGFR <60 mL/min/1.73m<sup>2</sup>) do not take an individual's age into consideration. An age-adapted CKD definition was recently proposed (JASN 2019). We determined the changes in CKD prevalence in the US, comparing the current KDIGO classification system (CKD-KDIGO) to an age-adapted CKD classification system (CKD-Age).

**Methods:** We analyzed data from the 2017-2020 National Health and Nutrition Examination Survey (NHANES; N=8,016). CKD-KDIGO was defined as having a CKD-EPI 2021 eGFR <60 mL/min/1.73m<sup>2</sup> or ACR ≥30 mg/g. CKD-Age was defined as proposed: eGFR <75 mL/min/1.73m<sup>2</sup> for ages 18 to <40 years, eGFR <60 mL/min/1.73m<sup>2</sup> for ages 40 to 65 years, eGFR <45 mL/min/1.73m<sup>2</sup> for ages >65 years, or ACR ≥30 mg/g. We used reclassification tables to determine changes in CKD prevalence.

**Results:** The US CKD population has a mean age of 60 years. Among the 31 million persons with CKD-KDIGO, 39.4% were 18 to <40 years old, 43.4% were 40-65 years, and 17.2% were >65 years. Median age is 71 years for CKD-KDIGO G3A, 76 years for G3B, 78 years for G4, and 63 years for G5. Using the CKD-Age classification, 5.2 million (16.7%) of those with CKD-KDIGO were reclassified to being CKD-free (Table 1). 1.2 million (0.6%) of those without CKD were reclassified to having CKD-Age and all of these individuals were 40-65 years old.

**Conclusions:** Age-based CKD classification may prevent overdiagnosis of CKD in older individuals and identify younger individuals with low eGFR at risk for kidney failure, allowing prioritization of care.

**Funding:** Other NIH Support - NIGMS

Table 1: Changes in CKD Prevalence Using the Current KDIGO Classification (CKD-KDIGO) vs. the Age-Adapted CKD Classification System (CKD-Age)

CKD-KDIGO	Not CKD	CKD-AGE		Total
		Not CKD	CKD	
	Not CKD	195.2 million (99.4%)	1.2 million (0.6%)	196.4 million (86.3%)
	CKD	5.2 million (16.7%)	26 million (83.3%)	31.1 million (13.7%)
	Total	200.4 million (88.1%)	27.1 million (11.9%)	

## FR-OR25

**Dipstick Urinalysis Protein and Specific Gravity Can Identify Patients With Early CKD Who Lack a Quantified Proteinuria Measurement**

Meredith C. McAdams, Michael M. Li, Pin Xu, Duwayne L. Willett, Susan Hedayati. *The University of Texas Southwestern Medical Center, Dallas, TX.*

**Background:** Urine albumin-to-creatinine ratio (UACR) >30 mg/g or protein-to-creatinine ratio (UPCR) >0.15 g/g are the gold standard cutoffs for diagnosing early stages of CKD for patients with preserved estimated glomerular filtration rates (eGFR) >60 mL/min, but these tests are not commonly obtained. Dipstick urinalysis protein (DSP) is a widely-available and routinely obtained test that provides a semi-qualitative measurement of albuminuria but is affected by urine specific gravity (SG).

**Methods:** We conducted an analysis using the EPIC electronic health records of 11,229 patients with a UPCR or UACR value obtained on the same day as a urinalysis. Prognostic utility of various DSP cutoffs (negative/trace, 30, 100, 300, and ≥500 mg/dL) were compared to clinically significant proteinuria (UACR >30 mg/g or UPCR >0.15 g/g). Predictive models for proteinuria were built using DSP, adjusted for SG and assessed with receiver operating characteristic (ROC) curves comparing areas under the curve (AUC). 10-fold cross-validation was performed.

**Results:** Of 11,229 included, 4073 (36%) had clinically significant proteinuria based on gold standard definitions. 54.0% were female, 27.5% had diabetes mellitus, 51.3% hypertension, and 11.9% cardiovascular disease. A DSP of 30 mg/dL had an odds ratio (OR) (95% CI) of 5.84 (5.22, 6.52) and 9.92 (8.73, 11.27), when adjusted for SG, to predict proteinuria. A DSP of 100 mg/dL had an OR of 44.63 (95% CI 36.11, 55.15) and 77.66 (95% CI 61.67, 97.80), when adjusted for SG. A DSP value ≥300 mg/dL had an OR of 278.37 (95% CI 115.00, 673.81) and 495.91 (95% CI 202.03, 1,217.26) in the SG adjusted model. Addition of SG to DSP improved the AUC to 0.824 (95% CI 0.815, 0.833) from 0.765 (95% CI, 0.756, 0.773) for DSP alone, P<.001. The final model including SG had a specificity of 93%, positive predictive value of 83%, negative predictive value of 80%, and positive and negative likelihood ratios of 9.52 and 0.43. Optimal predicted SG cutoffs to use for each DSP value were negative/trace=1.001; 30 mg/dL=1.024; 100 mg/dL=1.044; ≥300 mg/dL=1.063.

**Conclusions:** Combining DSP and SG from dipstick urinalysis can accurately determine clinically significant proteinuria to identify patients with early stages of CKD in clinical practice.

## FR-OR26

**Dapagliflozin Effect on Hospital Admissions in Patients With CKD: A Post Hoc Analysis of the DAPA-CKD Trial**

Meir Schechter,<sup>1,7</sup> Niels Jongs,<sup>1</sup> Glenn Chertow,<sup>2</sup> Ofri Mosenzon,<sup>7,11</sup> John McMurray,<sup>3</sup> Ricardo Correa-Rotter,<sup>4</sup> Peter Rossing,<sup>5</sup> Anna Maria Langkilde,<sup>6</sup> David Sjoström,<sup>6</sup> Robert D. Toto,<sup>8</sup> David C. Wheeler,<sup>9</sup> Hiddo J. L. Heerspink.<sup>10,11</sup>  
<sup>1</sup>Universitair Medisch Centrum Groningen, Groningen, Netherlands; <sup>2</sup>Stanford University School of Medicine, Stanford, CA; <sup>3</sup>University of Glasgow, Glasgow, United Kingdom; <sup>4</sup>National Medical Science and Nutrition Institute Salvador Zubiran, Mexico City, Mexico; <sup>5</sup>Steno Diabetes Center Copenhagen, Herlev, Denmark; <sup>6</sup>AstraZeneca, BioPharmaceuticals R&D, Gothenburg, Sweden; <sup>7</sup>Hadassah University Medical Center, Jerusalem, Israel; <sup>8</sup>UT Southwestern Medical Center, Department of Internal Medicine, Dallas, TX; <sup>9</sup>University College London Faculty of Medical Sciences, London, United Kingdom; <sup>10</sup>The George Institute for Global Health, Newtown, NSW, Australia; <sup>11</sup>Hebrew University of Jerusalem Faculty of Medicine, Jerusalem, Israel.

**Background:** The DAPA-CKD trial demonstrated that the sodium glucose co-transporter 2 inhibitor dapagliflozin improves kidney and cardiovascular outcomes in patients with chronic kidney disease (CKD) with or without type 2 diabetes (T2D). In a post-hoc analysis, we investigated the effect of dapagliflozin on all-cause hospital admissions (ACHA).

**Methods:** We randomized 4304 adults with estimated glomerular filtration rate (eGFR) 25–75 mL/min/1.73m<sup>2</sup> and urinary albumin-to-creatinine ratio (UACR) 200–5000 mg/g to either dapagliflozin 10mg or placebo once daily (1:1). Treatment effects on first and all (first and recurrent) ACHA were assessed in the whole population and in the prespecified eGFR (<45 or ≥45 mL/min/1.73m<sup>2</sup>) and UACR (≤1000 or >1000 mg/g) subgroups. We used the system organ class classification as reported by investigators to evaluate the effects of dapagliflozin on different causes of admission. Admissions were analyzed using Cox-proportional hazards regression models (first ACHA), the Lin-Wei-Ying-Yang method (all ACHA), and negative binomial models (all admissions related to specific causes).

**Results:** Over a median follow-up of 2.4 years, ACHA occurred in 566 (26.3%) patients in the dapagliflozin group and 658 (30.6%) in the placebo group. Compared to placebo, dapagliflozin reduced the risk of first ACHA (HR 0.84 [95%CI 0.75–0.94]; P<.001); number needed to treat over the study period of 23 [95%CI 14–63]) and all ACHA (RR 0.79 [95%CI 0.70–0.89]; P=0.002). The effect of treatment was consistent across the eGFR and UACR subgroups (P-interaction ≥0.215). Compared to placebo, dapagliflozin reduced the rate of admissions due to cardiac disorders (438 events; RR 0.67 [95% CI 0.53–0.86]), renal and urinary disorders (313 events; RR 0.61 [95% CI 0.46–0.79]), metabolism and nutrition disorders (134 events; RR 0.61 [95% CI 0.41–0.91]), and neoplasms (84 events; RR 0.62 [95% CI 0.39–0.96]; all P≤0.033).

**Conclusions:** Dapagliflozin reduced the risk of ACHA among patients with CKD, with or without T2D. These findings may have significant implications for quality of life in individual patients and the overall healthcare burden and expenditure attributed to CKD.

**Funding:** Commercial Support - AstraZeneca

## FR-OR27

**Notch Blockade Specifically in FSP-1-Positive Cells Ameliorates Renal Fibrosis by Attenuating Inflammation**

Jizhong Cheng,<sup>1</sup> Ming Liang,<sup>1,2</sup> Yongdong Wu,<sup>1</sup> Tae Hoon Lee,<sup>1</sup> William E. Mitch,<sup>1</sup> Luan D. Truong,<sup>3</sup> <sup>1</sup>Baylor College of Medicine, Houston, TX; <sup>2</sup>South China University of Technology, Guangzhou, China; <sup>3</sup>Houston Methodist, Houston, TX.

**Background:** The infiltration of inflammatory cells during kidney injury stimulates myofibroblast activation leading to kidney fibrosis. Fibroblast specific protein 1 (FSP-1) positive cells have been reported as myofibroblast and monocytes during tissue fibrosis. The function and regulation of the FSP-1<sup>+</sup> cells have not been well investigated.

**Methods:** In current study, the FSP-1<sup>+</sup> cells were characterized and the role of Notch signaling in activation of these cells was determined during kidney fibrosis.

**Results:** After creating unilateral ureteral obstruction (UUO), the FSP-1<sup>+</sup> cells were significantly accumulated in the tubulointerstitial area. Only few FSP-1<sup>+</sup> cells (< 5%) expressed markers of myofibroblasts, in contrast, most of the FSP-1<sup>+</sup> cells costained with inflammatory cell markers (CD45, F4/80). This observation was further confirmed obstructed kidneys in FSP-1 reporter mice (FSP-1-GFP). Most of GFP<sup>+</sup> cells (FSP-1<sup>+</sup> cells, > 90%) were positive for myeloid cell marker. Moreover, these GFP<sup>+</sup> cells were found in obstructed kidneys in WT mice that were transplanted with bone marrow from FSP-1-GFP reporter mice. These results indicate that FSP-1<sup>+</sup> cells represent a bone marrow-derived specific inflammatory cell population. Notably, the levels of Notch targets were increased in UUO, and activated Notch1 co-expressed with FSP-1 in cells in tubulointerstitium. *In vitro*, the isolated bone marrow FSP-1<sup>+</sup> cells were differentiated into functional type I and type II macrophage after treatment with LPS or IL-4, respectively. Inhibition of Notch signaling blocked activation and cytokine secretion of FSP-1<sup>+</sup> cells that were induced by LPS, but not by IL-4. In mice, specific KO of RBP-Jk in bone marrow FSP-1<sup>+</sup> cells suppressed UUO-induced ECM deposition, inflammatory cell accumulation, cytokine production, and interstitial fibrosis. Furthermore, inducible expression of dominant negative mastermind1, the co-activator of Notch signaling, in FSP-1<sup>+</sup> cells ameliorated myofibroblast activation and renal fibrosis in obstructed kidneys.

**Conclusions:** In conclusion, our study reveals that most of FSP-1<sup>+</sup> cells in obstructed kidneys are activated macrophage that are derived from bone marrow. Notch signaling activates the production of M1 cytokines in FSP-1<sup>+</sup> monocytes/macrophage, which is important for renal inflammation and fibrosis.

**Funding:** NIDDK Support

## FR-OR28

**Cyclin G1 Promotes Proximal Tubule Cell Maladaptive Dedifferentiation and Fibrosis in CKD**

Bertha C. Elias, Kensei Taguchi, Sho Sugahara, Craig R. Brooks. *Vanderbilt University Medical Center, Nashville, TN.*

**Background:** Acute Kidney Injury (AKI) frequently occurs in hospitalized patients and predisposes them to developing chronic kidney disease (CKD). This AKI-to-CKD transition promotes irreversible fibrosis, loss of kidney function, and ultimately organ failure. Though the exact molecular mechanisms that are involved in this process are unclear, we and others have shown that maladaptive repair of proximal tubule cells (PTC), G2-M cell cycle arrest, PTC dedifferentiation, upregulation of senescence markers, and secretion of profibrotic cytokines are features of the AKI-to-CKD transition. Here we directly test whether cyclin G1 promotes fibrosis through G2-M arrest of PTCs.

**Methods:** Male BL57B1/6 (WT) and cyclin G1 knockout (CG1KO) littermates age 8-12 weeks were subjected to 3 different kidney injury models: aristolochic acid nephropathy (AAN), repeat low-dose cisplatin, and unilateral ureter obstruction (UUO) models. Paclitaxel was used to induce G2/M arrest. The expression of cyclin G1, fibrotic markers, and dedifferentiation markers were measured by immunofluorescence, protein expression and/or mRNA levels.

**Results:** Kidney fibrosis, G2-M arrest and the expression of dedifferentiation markers were all reduced in CG1KO mice when compared to wild-types in all three injury models tested. Treatment with paclitaxel increased G2-M arrest in AAN injured CG1KO mice to similar levels to AAN + paclitaxel treated wild-type mice; however, wild-type mice showed significantly lower kidney function and increased kidney fibrosis compared to CG1KO mice following treatment. While deletion of cyclin G1 did not reduce the number of dedifferentiated cells in the acute phase of injury, the number of dedifferentiated cells in the chronic phase of injury were greatly reduced in all three models tested. Paclitaxel/G2-M arrest did not induce dedifferentiation in CG1KO mice. CG1KO primary PTCs were resistant to AAN and/or paclitaxel induced dedifferentiation and did not develop senescence markers or profibrotic cytokine secretion.

**Conclusions:** Cyclin G1 regulates G2-M arrest but G2-M arrest in the absence of dedifferentiation does not affect AKI-to-CKD transition. CG1 promotes maladaptive dedifferentiation possibly by activation of CDK5. Inhibition of CG1 and/or CDK5 may be a promising therapeutic strategy to prevent AKI to CKD transition.

**Funding:** NIDDK Support

## FR-OR29

**PRDM16 Protected Tubular Mitochondrial Function and Attenuated Renal Fibrosis by Upregulating PGC-1 $\alpha$** 

Qian Yuan, Ben Tang, Chun Zhang. *Union Hospital, Tongji Medical College, Huazhong University of Science and Technology, Wuhan, China.*

**Background:** The kidney is a high oxygen consumption organ with abundant mitochondria. However, in the kidney of chronic kidney disease (CKD) patients or animals, mitochondria in tubules were decreased and destroyed. Similarly, brown adipocytes with rich mitochondria converted into white adipocytes with rare mitochondria due to loss of PRDM16. Thus, we proposed that PRDM16 preserved tubular mitochondria and attenuated renal fibrosis.

**Methods:** Male C57BL/6J mice with 8 weeks were operated with unilateral ureteral obstruction (UUO) and unilateral ischemia-reperfusion (UIRI) surgery. Kidneys and blood were collected. Western Blot, qPCR, and immunohistochemical staining (IHC) were used to test the expression of PRDM16 in injured kidneys. Lentivirus was used to overexpress PRDM16 in HK2 cells, and UUO and UIRI models. RNA-seq, Western Blot, qPCR, IHC, ATP detecting, Oil-red staining, mito-tracker staining, Masson's staining, renal function detecting, and electron microscope were used to verify the renal protected role of PRDM16 in vivo and in vitro. Tubular-specific PRDM16 knockout mice were generated. PGC-1 $\alpha$  agonist ZLN-005, p-Smad3 inhibitor SIS3, DNA-pull down, ChIP, Co-IP, and luciferase assay were used to verify the mechanism of PRDM16.

**Results:** The results showed PRDM16 was largely expressed by tubular epithelial cells of healthy kidneys, but decreased greatly in injured kidneys. TGF- $\beta$  mediated the depression of PRDM16 in Smad3 dependent way. PRDM16 overexpression inhibited TGF- $\beta$  induced mitochondrial dysfunction and restored PGC-1 $\alpha$  levels in vitro. And PRDM16 attenuated renal fibrosis, and preserved mitochondrial function and PGC-1 $\alpha$  levels in UUO and UIRI models. However, the kidney injury was worse in PRDM16 tubular-specific knockout mice who suffered from UUO and UIRI surgery, and the effects can be attenuated by the PGC-1 $\alpha$  agonist, ZLN-005. Mechanistically, PRDM16 upregulated the expression of PGC-1 $\alpha$  by directly binding to the promoter of PGC-1 $\alpha$ .

**Conclusions:** PRDM16 was highly expressed by normal tubular epithelial cells but decreased greatly in injured kidneys. The downregulation of PRDM16 was mediated by TGF- $\beta$  in Smad3 dependent way. PRDM16 overexpression attenuated renal fibrosis and protected tubular mitochondrial function. Mechanistically, PRDM16 upregulated the expression of PGC-1 $\alpha$  by directly binding to the promoter of PGC-1 $\alpha$ .

**Funding:** Government Support - Non-U.S.

## FR-OR30

**Unbiased Human and Mouse Kidney Metabolomics Identifies the Key Role of NAD Metabolism in Kidney Disease Development**

Tomohito Doke, Katalin Susztak. *University of Pennsylvania Perelman School of Medicine, Philadelphia, PA.*

**Background:** The kidney is a highly metabolically active organ and plays a key role in organismal metabolism. Changes in human kidney metabolism have been analyzed in an unbiased manner.

**Methods:** Here we collected 50 human kidney samples from healthy and chronic kidney disease subjects. We obtained clinical information, and histological analysis, and performed untargeted metabolomics (900 metabolites) and gene expression studies by RNA sequencing. Metabolites data was analyzed using Metaboanalyst. Gene expression analysis and untargeted metabolomic studies have also been performed for the cisplatin-induced mouse kidney injury model. Wild type and RIG-I knock-out mice were injected with cisplatin. We used the primary culture of mouse kidney tubule cells. Human snATAC and in situ hybridization were employed for validation.

**Results:** Untargeted metabolomics identified 153 metabolites showing differences in human CKD kidneys and 687 in mice. Pathway enrichment analysis indicated NAD metabolism pathway was commonly enriched in both human and mice metabolomics data. Treating mice with NAD precursor NR (Nicotinamide riboside) and NMN (Nicotinamide mononucleotide) ameliorated cisplatin-induced kidney disease severity. Unbiased gene expression analysis showed significant normalization of genes associated with cytosolic RNA sensing, and immune and mitochondrial pathways. In vitro cell culture studies indicated NAD precursor treatment protected from mitochondrial depolarization, ROS release, cell death, and proinflammatory gene expression. Molecular analysis showed that cisplatin treatment led to the cytosolic leakage of mitochondrial RNA and activation of the cytosolic RNA sensor RIG-I. Kidney damage, (BUN level, structural changes) was lower in cisplatin-treated RIG-I KO mice compared to wild-type animals. Increased RIG-I expression in renal tubules was confirmed in human disease kidneys. Kidney NAD levels negatively correlated with RIG-I, Igf1, and Irf7 expression in human kidneys.

**Conclusions:** Unbiased metabolomics of human kidneys highlighted changes in NAD metabolism. NAD precursor treatment protected from mitochondrial damage and improved kidney function in mice by preventing the activation of the cytosolic nucleotide sensors.

**Funding:** NIDDK Support

## FR-OR31

**The Single-Cell Landscape of Kidney Immune Cells Reveals Transcriptional Heterogeneity in Late Diabetic Kidney Disease**

Jia Fu, Zeguo Sun, Weijia Zhang, Kyung Lee, John C. He. *Icahn School of Medicine at Mount Sinai, New York, NY.*

**Background:** Mounting evidence supports the involvement of renal inflammation is the key driver in diabetic kidney disease (DKD) pathogenesis and it contributes significantly to the progression of DKD. Many studies have demonstrated that macrophages are a major inflammatory cell type infiltrating the kidney in both patient and experimental animal models of DKD. Our preliminary data revealed relatively mild alteration in molecular and phenotype shift in macrophage subpopulation in early DKD, but the dynamic shift and transcriptional signature of these subpopulations in later stages of DKD remain largely unknown.

**Methods:** Fluorescence-activated cell sorting was used to isolate CD45+ cells from control and OVE26 diabetic mice at 28 weeks. To uncover the gene expression changes in specific immune cell subsets in late DKD, we employed single-cell RNA sequencing using the 10x Genomics platform. We generated single cell transcriptome profiles and performed comprehensive bioinformatics analysis and gene expression validation. Cell Ranger, R and Seurat, Macspectrum were used to make gene-cell matrices and for downstream analyses.

**Results:** Gene ontology enrichment analysis showed pronounced activation of immune pathways shared across MNPs in late DKD, whereas oxidative phosphorylation and cellular respiration were enriched in early DKD. Compared to early DKD, there's a significant accumulation of infiltrating macrophage (IM) in late DKD, particularly anti-inflammatory Ly6c<sup>low</sup> Ace<sup>hi</sup> IMs and a novel population M2-like macrophage, which highly expressed alternatively activated macrophage markers (*Retnla*, *Fcna*, *Cd163*). After injury, go terms show Ly6c<sup>low</sup> IM played more roles in tissue repair, regulation of cell matrix adhesion, and cellular response to laminar fluid shear stress upon injury. Interestingly, M2-like macrophages were well distinguished by expressing genes enriched in TGF- $\beta$  signaling, a key pathway that leads to renal fibrosis.

**Conclusions:** We revealed recruitment of alternatively activated macrophage and reparative macrophage phenotype Ly6c<sup>low</sup> Ace<sup>hi</sup> IMs in late DKD, suggesting the dynamic plasticity of macrophage functions in kidney during disease progression. This highlights the value of potential therapeutic target of immunotherapy as a means of preventing the progression of DKD are discussed.

**Funding:** NIDDK Support

## FR-OR32

**Human Kidney Multimodal Single Cell and Spatial Transcriptomics Atlas Identify Key Cell Types and Pathways for Diabetic Kidney Disease**

Amin Abedini,<sup>1</sup> Ziyuan Ma,<sup>1</sup> Julia Frederick,<sup>1</sup> Kishor B. Devalaraja-Narashimha,<sup>2</sup> Lori Morton,<sup>2</sup> Gurmanna Kalra,<sup>3</sup> Erding Hu,<sup>3</sup> Lea Sarov-Blat,<sup>3</sup> Carine Boustany,<sup>4</sup> Paolo Guarnieri,<sup>4</sup> John T. Liles,<sup>5</sup> Anil K. Karihaloo,<sup>6</sup> Hanying Yan,<sup>1</sup> Kyle P. Coleman,<sup>1</sup> Jian Hu,<sup>1</sup> Qihuang Zhang,<sup>1</sup> Matthew Palmer,<sup>1</sup> Mingyao Li,<sup>1</sup> Katalin Susztak.<sup>1</sup> *<sup>1</sup>University of Pennsylvania, Philadelphia, PA; <sup>2</sup>Cardiovascular, Renal and Fibrosis Research, Regeneron Pharmaceuticals Inc, Tarrytown, NY; <sup>3</sup>Research and Development, GSK, Collegeville, PA; <sup>4</sup>Department of Cardiometabolic Diseases Research, Boehringer Ingelheim Pharmaceuticals, Ridgefield, CT; <sup>5</sup>Department of Biology, Gilead Sciences, Foster City, CA; <sup>6</sup>Novo Nordisk Research Center Seattle, Inc, Seattle, WA.*

**Background:** Diabetic kidney disease (DKD) is responsible for more than half of all end stage renal disease in the US, yet disease driving cell types and pathways are poorly defined. Innovative single cell tools can define transcriptomics, gene regulation or even spatial gene expression at single cell resolution.

**Methods:** We generated single cell and single nuclear gene expression (scRNA-seq, snRNA-seq) and single nuclear assay of open chromatin (snATAC-seq) datasets for 66 (34 healthy and 32 CKD/DKD) samples capturing 0.5 million cells. Furthermore, we generated high-quality spatial gene expression datasets for healthy and DKD kidneys. The data was complemented with bulk RNA-seq, clinical and histological information available for 298 human kidney samples.

**Results:** Our high-quality kidney single cell atlas captured 40 main and more than 100 cell subtypes or cell states, including epithelial, endothelial, immune and stromal cells. Using a combination of snRNA and spatial transcriptomics analyses, we successfully mapped all cell types and states back to their spatial location in healthy and diseased kidneys. Our results highlighted the key role of proximal tubule, immune, and stromal cells in disease development. We identified different localization patterns of different cell types, including a novel interaction between stromal, immune cells and injured tubule cells in fibrosis. Our analyses defined a gene signature pattern for injury niches, which could also accurately classify a cohort of 298 tubule bulk RNA-seq into subsets based on eGFR and renal fibrosis.

**Conclusions:** Our comprehensive human kidney single cell and spatial atlas define new pathways and gene signatures for DKD, and a valuable resource for the community to identify potential new therapeutic targets, pathways and cell types in kidney diseases.

**Funding:** Commercial Support - GSK, Regeneron, Boehringer, Gilead, Novo Nordisk

## FR-OR33

**Multi-Omic Analysis Identifies a New Class of Proximal Tubular Cell With Metabolic Alterations in Diabetic Kidney Disease**

Hiroshi Maekawa, Yalu Zhou, Margaret E. Fain, Dorian Kaminski, Navdeep S. Chandell, Susan E. Quaggin. *Northwestern University Feinberg School of Medicine, Chicago, IL.*

**Background:** Therapeutic inhibition of the sodium glucose cotransporter 2 (SGLT2) protects the kidney although underlying mechanisms are incompletely known. We tested the hypothesis that cell-specific metabolic pathways activated by SGLT2 inhibition in diabetic kidney disease (DKD) underly benefits.

**Methods:** Kidneys from 10-week-old male SglT2 mutant (MT) and wildtype (WT) mice, fed with normal or high fat diet (HFD) for eight or eighteen weeks, were analyzed. Changes in body weight, food intake, insulin and glucose tolerance were determined. Single cell RNA sequence (scRNA seq) analysis was performed on libraries prepared from whole kidneys. Metabolomic analysis of renal cortex was conducted by Metabolon, Inc. Human proximal tubular cells (HK-2), were exposed to 50 mM of D-glucose with/without 1 $\mu$ M of Methionine Adenosyltransferase 2A inhibitor (MAT2Ai) and treated with SGLT2 siRNA or S-Adenosyl methionine (SAM) for 48hr.

**Results:** HFD-induced obesity was similar in both MT and WT while compensatory hyperphagia was observed in MT. Glucose intolerance occurred in mice fed HFD (WT>MT). Molecular and functional markers of kidney injury including KIM-1, number of apoptotic cells and albuminuria were higher in WT>MT. Analysis of scRNAseq data showed emergence of a new class of proximal tubular cells (New-PTC), predominantly found in HFD-fed WT. New-PTC showed increased expression of genes related to epithelial-mesenchymal transition (EMT), apoptosis and inflammation. Pathway enrichment analysis of metabolomic data uncovered differences in WT vs MT renal cortex; metabolites of methionine cycle including SAM were preferentially increased in HFD-fed MT. High glucose treatment of HK-2 recapitulated molecular changes observed in New-PTC of HFD-WT mice, including markers of EMT (elevated fibronectin, reduced E-cadherin) and inflammation (increased IL-6, IL-8, TNF) which could be inhibited by SGLT2 knock down or SAM supplementation, which enhances methionine metabolism. Conversely, an inhibitor of the methionine cycle, MAT2Ai, exacerbated EMT and inflammation.

**Conclusions:** Multi-omic analysis identified a New-PTC type and an association between methionine cycle pathway and renal-protection in a model of DKD. SGLT2 inhibition suppressed the emergence of this New-PTC, which can be replicated in vitro by modulation of methionine cycle.

**Funding:** NIDDK Support, Commercial Support - Takeda Science Foundation

## FR-OR34

**Combination of Transcriptional Signatures and 3D Images of Epithelial Nuclei in Kidney Biopsies Using a Deep-Learning Outlier Detection Model Uncovers Signatures of Injury in Diabetic Kidney Disease**

Seth Winfree,<sup>1</sup> Daria Barwinska,<sup>3</sup> Jun Zhuang,<sup>2</sup> Niloy Talukder,<sup>2</sup> Michael T. Eadon,<sup>3</sup> Pierre C. Dagher,<sup>3</sup> Mohammad A. Hasan,<sup>2</sup> Tarek M. El-Achkar.<sup>3</sup> Kidney Precision Medicine Project <sup>1</sup>University of Nebraska Medical Center College of Medicine, Omaha, NE; <sup>2</sup>Indiana University Purdue University Indianapolis, Indianapolis, IN; <sup>3</sup>Indiana University School of Medicine, Indianapolis, IN.

**Background:** Epithelial cell states in renal health and disease have become an area of intense research focus. By integrating multiomics and imaging from samples collected by large consortia (e.g. Kidney Precision Medicine Project) epithelial cell states of injury, maladaptive and adaptive repair, cycling and degeneration have been identified. Recently, we demonstrated the sufficiency of nuclei labeled with a common nuclear stain in classifying the epithelia of the nephron in the human renal cortex. To expand this approach and identify signatures of injury in diabetes, we implemented a deep learning model for outlier detection combining transcriptional profile of cell states with images of renal epithelial nuclei.

**Methods:** To identify injury classes of epithelia in imaging data we first trained a deep learning encoder with 3D images of nuclei of proximal tubule (PT) and thick ascending limb (TAL) generated by Volumetric Tissue Exploration and Analysis. In parallel, a side-information encoder was trained with transcriptional signatures of normal PT or TAL based on genes previously defined. Lastly, the two encoders were trained jointly to minimize the embedding distance between an image of a given label and its corresponding transcriptional signature for classification.

**Results:** Our outlier detection model was used to classify 3D nuclei of PT and TAL cells in biopsies from patients with diabetic kidney disease collected by the Kidney Precision Medicine Project. PT and TAL cells were either classified as normal or injured based on an outlier score. The putative injured PT and TAL were shown to positively correlate ( $p < 0.05$  by Pearson) with areas of injury by neighborhood analysis in the original image volumes.

**Conclusions:** Using a deep learning approach that integrates 3D images of nuclei and transcriptomics we identify a putative signature of injury in biopsies of patients with diabetic kidney disease. Our approach has implications for unbiased assessment of the landscape of cellular injury based only on the morphology and textures of nuclei, leading to a better characterization of the severity of disease and its prognosis.

**Funding:** NIDDK Support

## FR-OR35

**Identification of Early Diabetes-Induced Renal Changes Using Spatial Metabolomics**

Rosalie Rietjens,<sup>1</sup> Gangqi Wang,<sup>1</sup> Bram Heijts,<sup>2</sup> Bernard van den Berg,<sup>1</sup> Ton J. Rabelink.<sup>1</sup> <sup>1</sup>Leids Universitair Medisch Centrum Niercentrum, Leiden, Netherlands; <sup>2</sup>Leids Universitair Medisch Centrum Center for Proteomics and Metabolomics, Leiden, Netherlands.

**Background:** Diabetic nephropathy usually presents itself with irreversible kidney damage. Clearly, there is a need to better understand early renal cell type specific diabetes-induced changes before occurrence of overt renal histopathology. The metabolism is a very dynamic process which is expected to change upon diabetes, preceding morphological changes. Mass spectrometry imaging (MSI) offers a label-free method to study metabolism in the context of tissue histology, giving us the opportunity to investigate renal cell type specific metabolic changes.

**Methods:** Apolipoprotein E-knockout mice were treated with streptozotocin (STZ) and put on an enriched cholesterol diet to induce diabetes. After 12 weeks, both control (n=4) and diabetic (n=4) mice were sacrificed and kidneys were harvested for immunohistochemistry and MSI. Post-MSI immunofluorescent microscopy (IF)-assisted annotation was used to identify various renal cell types. Metabolome-driven segmentation and subsequent multivariate analysis allowed us to find cell type specific metabolic changes in the diabetic kidney.

**Results:** Two weeks after STZ induction, blood glucose levels of diabetic mice were significantly elevated compared to control. Besides small glomerular changes, we could not find further histological signs of diabetic tubular injury. Metabolome-driven spatial segmentation analysis of the MSI data revealed that in both groups different renal cell types could be distinguished based on their metabolic profile. Using IF-assisted cell type annotation, we found various metabolites and lipids being reduced in glomeruli of the diabetic kidney. Furthermore, we found considerable changes in the metabolic profile of the proximal tubular cells in the S3 segment (PT-S3). Using a multivariate ROC analysis, we established metabolites and lipids that could distinguish PT-S3 between healthy and diabetic kidneys. Membrane lipid metabolism and protein homeostasis in these PT-S3 cells already appeared to be affected by diabetes, before showing signs of histological changes.

**Conclusions:** Using a spatial metabolomics approach, we were able to identify renal cell type specific diabetes-induced early changes in the diabetic kidney compared to the healthy control. Already finding such changes in molecular phenotype would allow to assess therapeutics for treatment before irreversible damage occurs in the kidney.

## FR-OR36

**Multi-Omics Integration Links Angiotensin-Tie Signaling Pathway Activation With Diabetic Kidney Disease Progression**

Viji Nair,<sup>1</sup> Jiahao Liu,<sup>3</sup> Yiyang Zhao,<sup>4</sup> Dongyuan Chang,<sup>4</sup> Christine P. Limonte,<sup>2</sup> Nisha Bansal,<sup>2</sup> Ian H. de Boer,<sup>2</sup> Min Chen,<sup>4</sup> Markus Bitzer,<sup>1</sup> Matthias Kretzler,<sup>1</sup> Wenjun Ju.<sup>1</sup> KPMP <sup>1</sup>University of Michigan Michigan Medicine, Ann Arbor, MI; <sup>2</sup>University of Washington, Seattle, WA; <sup>3</sup>Central South University, Changsha, China; <sup>4</sup>Peking University First Hospital, Beijing, China.

**Background:** Identification of prognostic biomarkers and pathways reflective of underlying molecular mechanisms are critical for effective management of diabetes and chronic kidney disease. Our study aims to establish this link by integrating circulating biomarker and kidney transcriptomic profiles with disease progression

**Methods:** A marker panel of circulating proteins measured in SOMASCAN platform predicting composite outcome of ESRD or 40% baseline GFR reduction from the C-PROBE cohort was identified using a machine learning method. Validations were performed in Cardiovascular Health Study, CHS (N=3183) and a Chinese Cohort Study of Chronic Kidney Disease participants with DKD (N=210). An Angiotensin/Tie (ANG-TIE) pathway score was generated using expression of ANG-TIE signaling mediators using transcriptomic data. Cell specific regulation of the pathway and receptors were evaluated using single cell RNAseq profiles of DKD participants from the Kidney Precision Medicine Project.

**Results:** The three-plasma marker panel (ANGPT2, CLEC4M, EGFR) significantly improved prediction of composite outcome in discovery (N=58) and validation group (N=68) over the clinical parameters, LR test  $p=0.003$  and  $0.0004$ , respectively. Plasma ANGPT2 remained significant in CHS (HR=1.50, 1.18:1.92) and Chinese cohort (HR=2.07, 1.39:3.09) with higher levels associated with increased risk of progression after adjusting for confounding factors including age, gender, race, diabetic history, GFR, and ACR. The glomerular ANG-TIE pathway activation scores were elevated in progressors/advanced DKD in C-PROBE ( $p=0.02$ ) and in an external cohort ( $p<0.01$ ). This was further supported by higher Tyrosine-Protein Kinase Receptor TEK level in glomeruli and higher ANG-TIE activation scores in endothelial cells in DKD by scRNASeq data. ANG-TIE pathway activation also showed positive correlation with plasma ANGPT2 levels ( $r=0.43$ ,  $P=0.01$ ).

**Conclusions:** Our work suggests that activation of ANG-TIE signaling in the kidneys underlies the association of plasma ANGPT2 with disease progression, thereby providing potential targets to prevent DKD progression.

**Funding:** NIDDK Support, Other NIH Support - a grant from the University of Michigan Health System and Peking University Health Sciences Center Joint Institute for Translational and Clinical Research.

FR-OR37

**A Prospective Study of Urinary Complement Proteins in Early Diabetic Kidney Disease in Type 1 Diabetes**

Zaipul I Md Dom,<sup>1,2</sup> Salina Moon,<sup>1</sup> Sara D. Pickett,<sup>1</sup> Andrzej Galecki,<sup>3</sup> Michael Mauer,<sup>4</sup> Alessandro Doria,<sup>1,2</sup> Monika A. Niewczas,<sup>1,2</sup> *Joslin Diabetes Center, Boston, MA; <sup>2</sup>Harvard Medical School, Boston, MA; <sup>3</sup>University of Michigan, Ann Arbor, MI; <sup>4</sup>University of Minnesota Twin Cities, Minneapolis, MN.*

**Background:** We identified robust urinary Complement-enriched proteomics profiles that were associated with 10-year ESKD risk in a prospective Joslin Kidney Study cohort with overt diabetic kidney disease (DKD). The role of the Complement pathway in early stages of the disease process remains unknown. This study evaluated the associations of Complement proteins and early DKD in T1D.

**Methods:** This prospective study included 207 participants followed for 3 years from the Preventing Early Renal Function Loss (PERL) study with T1D and baseline albuminuria (AER  $\geq 20$   $\mu\text{g}/\text{min}$ ) and CKD stages 1-3 (median AER: 127  $\mu\text{g}/\text{min}$ ; mean eGFR: 74  $\text{mL}/\text{min}/1.73\text{m}^2$ ). Two dozen Complement proteins were measured in baseline spot urines using low-multiplex immunoassays. The kidney outcomes of interest included binary eGFR decline  $\geq 3$  (43% of subjects) or 5 (23%)  $\text{mL}/\text{min}/1.73\text{m}^2/\text{year}$ , and a continuous eGFR slope. Model accuracy was evaluated with biostatistical and machine learning approaches.

**Results:** In the univariable logistic models, more than a dozen Complement proteins were associated with eGFR decline. Odds of developing eGFR decline per one tertile increase in the distribution of CFP the top Complement protein was: OR (95%CI): 2.5 (1.8, 3.6);  $p < 10^{-6}$ . The proteins represented all major components of the Complement pathway. Most of the proteins remained significant after adjustment for select clinical covariates. Albuminuria substantially impacted the Complement associations (changes in beta estimates: from 23-40%). The effect size in the principal component (PCA)-based model was larger in comparison with other models using individual proteins (Fig.1).

**Conclusions:** Our study of subjects with T1D and mild to moderate DKD demonstrated that Complement proteins are associated with kidney function decline over a 3-year period. These new findings suggest that the Complement pathway may play a role at earlier stages of disease process than previously assumed.

**Funding:** Other NIH Support - NIH R01 DK123459, Private Foundation Support

3-year Kidney Outcome		
	OR (95%CI)	P
C2	2.17 (1.53, 3.08)	$<10^{-4}$
C5a	2.37 (1.66, 3.39)	$<10^{-5}$
CFP	2.53 (1.76, 3.64)	$<10^{-6}$
C7	2.21 (1.55, 3.13)	$<10^{-5}$
PCA	2.57 (1.79, 3.70)	$<10^{-6}$

FR-OR38

**Endogenous Retroviruses Contribute to Kidney Fibrosis Development by Triggering the Innate Immune Response**

Poonam Dhillon, Kelly A. Mulholland, Hailong Hu, Xin Sheng, Jihwan Park, Amin Abedini, Allison Vassalotti, Hongbo Liu, Junnan Wu, Katalin Susztak. *Susztak Lab University of Pennsylvania, Philadelphia, PA.*

**Background:** Inflammation is a common feature of diabetic kidney disease (DKD); however, underlying mechanisms triggering inflammation remain poorly understood. Endogenous retroviruses (ERVs) are transposable elements (TEs) that were fixed in the genome by cumulative exogenous retroviral infection over millions of years. ERVs constitute 10% of the human and mouse genome. ERVs are dynamically silenced in the genome by cytosine methylation or other repressive epigenetic modifications. The aim of this study was to characterize ERV expression and to understand its role in kidney disease development.

**Methods:** We performed RNA-seq and genome-wide methylation analysis on 485 human kidney samples and mouse kidney fibrosis models induced by folic acid injection (FAN) or unilateral ureteral obstruction (UUO) and quantified TEs using RepeatMasker and full-length ERVs by HERVQuant. Mouse models with kidney tubule-specific deletion of DNA methyltransferase 1 (DNMT1) and nucleotide sensors (STING and RIG-I) were generated. For *in-vitro* experiments, primary cultures of mouse kidney tubule cells were analyzed.

**Results:** Our analysis identified 1925 TEs and 74 ERVs levels that were increased and correlated with kidney disease severity in patients. We detected increased expression of 560 TEs in UUO and 130 TEs in FAN mice kidneys. The strong correlation between ERVs and cytosolic demethylation suggested that epigenetic derepression likely contributes

to increased TE/ERV levels in diseased kidneys. Kidney-specific genetic deletion or pharmacological inhibition of DNMT1 resulted in increased TE/ERV levels leading to renal inflammation and fibrosis. The ectopic expression of ERV in cultured kidney tubule cells triggered the activation of cytosolic nucleotide sensors such as RIG-I, MDA5, and STING and the expression of IFN-stimulated genes (ISGs). TE/ERV expression in human and mice kidney tissue samples correlated with RIG-I/STING pathway gene expression and with kidney immune cell fractions. Genetic deletion of RIG-I or STING or treatment mice with reverse transcriptase inhibitor ameliorated kidney fibroinflammation.

**Conclusions:** Epigenetic derepression mediated increased ERV levels contribute to the sterile inflammation in DKD by activating the cytosolic nucleotide sensing pathways (RIG-I/STING).

**Funding:** NIDDK Support

FR-OR39

**A Phase 2b Randomized Controlled Trial of Selonsertib in Moderate to Severe Diabetic Kidney Disease (MOSAIC)**

Vlado Perkovic,<sup>1</sup> Katherine R. Tuttle,<sup>2</sup> Pablo E. Pergola,<sup>3</sup> Kenneth W. Mahaffey,<sup>8</sup> Uptal D. Patel,<sup>4</sup> Julie H. Ishida,<sup>4</sup> Fang Chen,<sup>4</sup> Gerald Crans,<sup>4</sup> Robert Kustra,<sup>4</sup> Mona Trivedi,<sup>4</sup> Hidde J. L. Heerspink,<sup>5</sup> Peter Rossing,<sup>6</sup> Naoki Kashihara,<sup>7</sup> Glenn Chertow.<sup>8</sup> *<sup>1</sup>University of New South Wales, Sydney, NSW, Australia; <sup>2</sup>University of Washington and Providence Health Care, Spokane, WA; <sup>3</sup>Renal Associates PA, San Antonio, TX; <sup>4</sup>Gilead Sciences Inc, Foster City, CA; <sup>5</sup>University Medical Center, University of Groningen, Groningen, Netherlands; <sup>6</sup>Kobenhavns Universitet, Kobenhavn, Denmark; <sup>7</sup>Kawasaki Ika Daigaku, Kurashiki, Japan; <sup>8</sup>Stanford Center for Clinical Research, Stanford University, Stanford, CA.*

**Background:** Selonsertib (SEL) is an apoptosis signal-regulating kinase 1 inhibitor that reduces inflammation, fibrosis, and apoptosis. The MOSAIC study evaluated whether SEL could slow decline in kidney function in patients with diabetic kidney disease (DKD).

**Methods:** We conducted a Phase 2b study in adults with type 2 diabetes mellitus and eGFR 20- $<60$   $\text{mL}/\text{min}/1.73\text{m}^2$  with UACR 150-5000  $\text{mg}/\text{g}$  on an ACEi or ARB. To account for the acute decrease in eGFR<sub>cr</sub> associated with SEL initiation, following placebo (PBO), all patients entered a 4-week SEL run-in period to establish treatment-specific baseline eGFRs (Fig 1). Patients were randomized 1:1 to SEL 18 mg or PBO once daily for  $\geq 48$  weeks. The primary efficacy endpoint was eGFR<sub>cr</sub> slope from treatment-specific baselines to Week 84, evaluated at a 2-sided significance level of 0.30. Kidney clinical events (KCE; eGFR<sub>cr</sub>  $\geq 40\%$  decline from pre-run-in baseline, kidney failure, or death due to kidney disease) and adverse events (AEs) were evaluated.

**Results:** Overall, 310 patients were randomized (SEL n=154, PBO n=156; 68% male, 52% white, mean age 65 years, 18% SGLT-2i use at randomization, and mean baseline eGFR<sub>cr</sub> 35.0  $\text{mL}/\text{min}/1.73\text{m}^2$ ). The mean difference in eGFR<sub>cr</sub> slope at Week 84 between arms was 1.20  $\text{mL}/\text{min}/1.73\text{m}^2/\text{year}$  (95% CI, -0.41, 2.81;  $p=0.14$ ) (Fig 2). KCEs occurred in 17% (26/154) of the SEL arm and 12% (19/156) in PBO (difference, 5%; 95% CI, -6%, 16%;  $p=0.19$ ). The most common AE was acute kidney injury (AKI) (SEL, 11.0/100 patient-years [PY]; PBO, 5.9/100 PY).

**Conclusions:** The study met the primary efficacy endpoint, suggesting that SEL may slow kidney function decline in diabetic kidney disease, although a potential safety concern for AKI was identified.

**Funding:** Commercial Support - Gilead Sciences

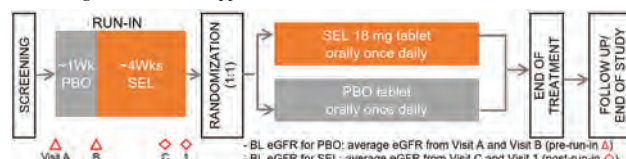

Fig. 1. Study design

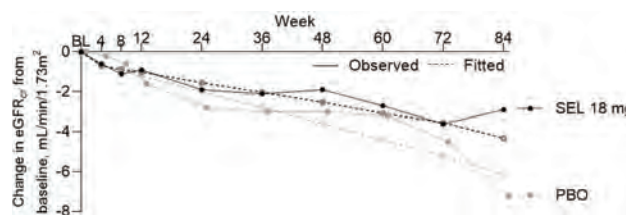

Fig 2. Change in eGFR<sub>cr</sub> from treatment-specific baselines through Week 84

## FR-OR40

### Safety and Preliminary Efficacy Results of a Novel Mesenchymal Stromal Cell Therapy in Diabetic Kidney Disease: The Multicenter, Randomized, Placebo-Controlled, Phase-1b/2a NEPHSTROM Clinical Trial

Matthew D. Griffin,<sup>1</sup> Giuseppe Remuzzi,<sup>2</sup> Paul Cockwell,<sup>3,4</sup> Alexander P. Maxwell,<sup>9</sup> Norberto Perico,<sup>2</sup> Piero L. Ruggenenti,<sup>5,2</sup> Martino Inrona,<sup>5</sup> Andrew A. Finnerty,<sup>6</sup> Jon Smythe,<sup>10</sup> Willem E. Fibbe,<sup>7</sup> Stephen J. Elliman,<sup>8</sup> Timothy O'Brien.<sup>1</sup> The NEPHSTROM Trial Consortium <sup>1</sup>Regenerative Medicine Institute (REMEDI), School of Medicine, NUI, Galway, Ireland; <sup>2</sup>Istituto di Ricerche Farmacologiche Mario Negri IRCCS, Bergamo, Italy; <sup>3</sup>University Hospitals Birmingham NHS Foundation Trust, Birmingham, United Kingdom; <sup>4</sup>Queen Elizabeth Hospital Birmingham, Birmingham, United Kingdom; <sup>5</sup>Aziende Socio Sanitarie Territoriale Papa Giovanni XXIII, Bergamo, Italy; <sup>6</sup>National University of Ireland Galway (NUIG), Galway, Ireland; <sup>7</sup>Leiden University Medical Center, Leiden, Netherlands; <sup>8</sup>Orbsen Therapeutics Ltd, Galway, Ireland; <sup>9</sup>Queen's University Belfast Centre for Public Health, Belfast, United Kingdom; <sup>10</sup>National Head of Cellular and Molecular Therapies, Oxford, United Kingdom.

**Background:** Mesenchymal stromal cells (MSC), by targeting individual or combined effects of renoprotective processes, are candidates for treatment of diabetic kidney disease (DKD).

**Methods:** NEPHSTROM is a randomized, placebo-controlled, double blind, dose-escalation phase 1b/2a clinical trial of next-generation bone marrow-derived, antibody-purified allo-CD362<sup>+</sup> MSC (ORBCEL-M) in adults with type 2 diabetes, DKD and eGFR 25-55 ml/min/1.73 m<sup>2</sup> with evidence of or risk of progressive eGFR decline. We report the experience with the first dose cohort, consisting of 16 subjects [single i.v. infusion of ORBCEL-M 80x10<sup>6</sup> cell (n=12, group A) or placebo (n=4, group B)], enrolled at 3 sites in Italy, Ireland and UK, and followed-up for 18 months.

**Results:** All randomized patients were negative for anti-HLA antibodies at study entry. Mean baseline measured GFR (mGFR, iohexol clearance) and estimated GFR (eGFR, CKD-EPI equation) were comparable between the two groups. The trial intervention was well tolerated and safe (primary outcome), with one quickly-resolved infusion reaction (in the placebo group) and no subsequent SAEs ascribed to trial product. Two patients in group A died of cell product unrelated causes between 12 and 18 months. Serial serum assays for anti-HLA antibodies indicated low-level allo-immune sensitization in a patient from month 3. The median annual rate of renal function decline by mGFR (secondary outcome) was numerically lower in group A than group B; by eGFR this was statistically significant (Table). Blood pressure, glycemic and lipid profiles and spot morning urinary albumin creatinine ratio were comparable in the two groups during the 18 month follow-up.

**Conclusions:** In summary, for subjects enrolled into the first (low-dose) cohort of the NEPHSTROM trial, the safety and tolerability of ORBCEL-M was established. Over 18 months rate of decline of eGFR was less for recipients of cells compared to placebo.

	ORBCEL-M	Placebo	P value <sup>a</sup>
mGFR (ml/min/1.73m <sup>2</sup> per year)	-3.8 [-5.7, -2.1]	-7.5 [-13.9, +1.0]	0.467
eGFR - CKD-EPI (ml/min/1.73m <sup>2</sup> per year)	-2.6 [-4.2, -0.3]	-8.7 [-11.4, -4.6]	0.034

Values are median [IQR]. \*Wilcoxon rank sum ORBCEL-M vs Placebo

## FR-OR41

### The Impact of Microgravity on Kidney Function During Spaceflight

Keith Siew, Stephen B. Walsh. University College London, London, United Kingdom.

**Background:** The impact of microgravity (MG) on deep space travellers has mainly focused on cardiovascular, musculoskeletal, neurological and ocular health. However, MG exposed astronauts have an unusually high rate of kidney stone formation which poses a mission critical risk. In fact, over 30 incidents have been reported and previous missions have almost been aborted due renal stone formation

**Methods:** To investigate this, we studied kidneys and biofluids from mice aboard the Rodent Research-10 (RR-10) Mission that launched with SpaceX-21 to the International Space Station and spent ~30 days in MG. These were compared to ground controls (n=10 per all groups) and underwent spatial transcriptomics and miRNA analysis, quantitative proteomics/phosphoproteomics, urine/plasma electrolyte analysis and 3D imaging of immunostained optically cleared tissues for histomorphometry.

**Results:** Thus far, our network analysis of the data supports evidence of mitochondrial damage, extracellular matrix dysfunction and decreased lomerular filtration rate. Interestingly, there are also marked dysregulation in gene products relating to lipid metabolism, SLC membrane transporter superfamily and phosphorylation status.

**Conclusions:** Our data suggest that there are detrimental changes in the abundance and activity of key transporters/channels that either directly or indirectly regulate calcium homeostasis, and that these may be primary changes in the kidney that drive renal stone formation on the backdrop of milieu of increased renal stone risk factors (e.g. bone resorption, dehydration, enhance crystal formation in MG).

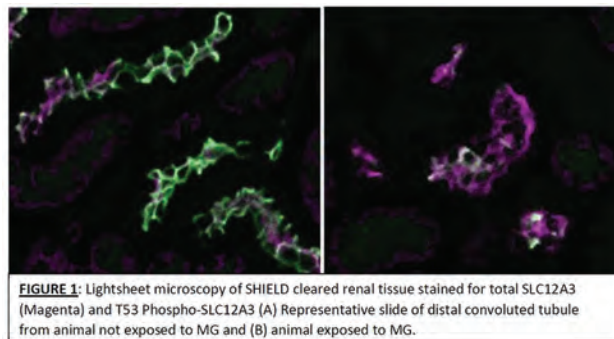

**FIGURE 1:** Lightsheet microscopy of SHIELD cleared renal tissue stained for total SLC12A3 (Magenta) and T53 Phospho-SLC12A3 (A) Representative slide of distal convoluted tubule from animal not exposed to MG and (B) animal exposed to MG.

## FR-OR42

### Dietary Anion Controls Potassium Excretion: It's More Than a Poorly Absorbable Anion Effect

Lama Al-Qusairi,<sup>1</sup> Rick Grimm,<sup>1</sup> Ava M. Zapf,<sup>1</sup> Seyedmohammadebrahim Tahaei,<sup>1</sup> Delaney C. Abood,<sup>2</sup> Susan M. Wall,<sup>2</sup> Paul A. Welling.<sup>1</sup> <sup>1</sup>Johns Hopkins Medicine, Baltimore, MD; <sup>2</sup>Emory University, Atlanta, GA.

**Background:** Aldosterone-dependent and -independent mechanisms are known to orchestrate potassium excretion in the distal nephron (DN). In the latter, potassium secretion, mediated by ROMK and BK channels, is dependent on lumen-negative transepithelial potential established by ENaC. Poorly absorbable anions, including HCO<sub>3</sub><sup>-</sup>, are thought to increase K<sup>+</sup> secretion by hyperpolarizing the membrane potential, but accumulating data indicate luminal anions may also directly influence the expression of the potassium secretory machinery.

**Methods:** Here we characterize the anion effect in wild-type mice randomized to control, or high KCl or high KHCO<sub>3</sub> diets, and explore mechanisms in knockout mice, lacking aldosterone synthase (AS-KO) or the chloride-bicarbonate exchanger, pendrin (Pds-KO).

**Results:** Consumption of the high KHCO<sub>3</sub> diet increased urinary potassium K<sup>+</sup> excretion and the trans-tubular K<sup>+</sup> gradient (TTKG) significantly more than high KCl diet. Although both diets increased ENaC expression and proteolytic activation and increased ROMK protein abundance and apical membrane expression in the early connecting tubule (CNT), the responses were significantly more pronounced with consumption of the high KHCO<sub>3</sub> diet, despite elevating aldosterone to similar levels. Compared to the more restricted response in the early CNT with the high KCl diet, the high KHCO<sub>3</sub> diet increased apical membrane ROMK along the entire CNT. In addition, the high KHCO<sub>3</sub> diet uniquely increased the abundance of the BK potassium channel b4 subunit, which stabilizes BKA channel membrane localization. Studies in AS-KO mice revealed the stimulatory effects of high KHCO<sub>3</sub> diet on ROMK are not dependent on aldosterone. The KHCO<sub>3</sub> diet also uniquely upregulated the Cl<sup>-</sup>/HCO<sub>3</sub><sup>-</sup> exchanger, pendrin, and studies in pendrin KO mice revealed that pendrin deletion blunted the increase in the TTKG specific to the KHCO<sub>3</sub> condition.

**Conclusions:** In summary, bicarbonate stimulates potassium excretion beyond a non-absorbable anion effect, increasing ENaC cleavage, and apical membrane expression of ROMK and pendrin. The latter plays a significant role in K<sup>+</sup> secretion by providing the luminal HCO<sub>3</sub><sup>-</sup>. The response provides an adaptive mechanism to prevent hyperkalemia and alkalosis while consuming alkaline-ash rich diets.

**Funding:** NIDDK Support

## FR-OR43

### Wearable Device for Continuous, Non-Invasive Monitoring of Serum Potassium in Hemodialysis Patients

Forrest Miller, Alio, San Francisco, CA.

**Background:** Maintenance of healthy serum potassium levels is critical for the approximately 500,000 patients undergoing dialysis in the United States. Hypo- and hyperkalemia are serious conditions that can result in extreme adverse outcomes including sudden cardiac death. The SmartPatch system (SP) offers a wearable, remote monitoring system for serum potassium.

**Methods:** This study evaluated the ability of the SP system to identify hemodialysis patients with hypo- or hyperkalemia. Hemodialysis patients (n=96) with a functional arteriovenous fistula were prospectively enrolled in an IRB-approved study. During one dialysis session per month for four months, a wearable SP was applied over the fistula by a nurse or the patient, neither with prior experience placing the device. Venous blood samples were tested before and after dialysis to measure serum potassium (K<sup>+</sup>) levels. SP data was remotely collected throughout dialysis and analyzed for hematocrit (Hct) and K<sup>+</sup>. A classification model was trained and tested, using nested cross-validation, to classify data points according to potassium level. Hypokalemia was defined as K<sup>+</sup> < 3.5 mEq/L and hyperkalemia was defined as K<sup>+</sup> > 5.2 mEq/L.

**Results:** A combined set of 1229 data recordings were collected and used in this analysis, and all parameter tuning and performance evaluation was performed using nested k-fold cross validation. Reference serum potassium values ranged from 2.5 to 6.4 mEq/L. The median value was 4.2 mEq/L. Reference Hct values ranged from 18 to 48 percentage points. The median value was 34 percentage points. The SP dyskalemia algorithm identified dyskalemia—defined as either hypokalemia (K<sup>+</sup> < 3.5 mEq/L) or

hyperkalemia ( $K^+ > 5.2$  mEq/L)—with a total weighted recall of 86%. The precision—also known as the positive predictive value—of the model was 86%, indicating that the model achieved both high sensitivity and a low rate of false positives.

**Conclusions:** The results of this study demonstrate a novel proof-of-concept for a noninvasive PPG-based assessment of  $K^+$  status in hemodialysis patients using the Alio system. Future studies will include patients who present with hypokalemia at the start of dialysis, as the safety benefit from at-home surveillance is likely greatest for these patients, compared to those who only present with post-dialysis hypokalemia, as was the case in this study.

**Funding:** Commercial Support - Alio, Inc. San Francisco, CA

#### FR-OR44

##### KCC3a, a Pathway for Potassium Loss in Alkalemia

Mohammed Z. Ferdaus, Andrew S. Terker, Rainelli Koumangoye, Eric J. Delpire. *Vanderbilt University Medical Center, Nashville, TN.*

**Background:** Loss-of-function mutations in the human potassium chloride cotransporter-3 (KCC3) cause a hereditary motor sensory neuropathy associated with agenesis of the corpus callosum. While recapitulating the neuropathy, KCC3 knockout (KCC3-KO) mice also exhibit high blood pressure. This phenotype is believed to have neurogenic and/or vascular origins. The role of KCC3 in the kidney is poorly understood. KCC3 is encoded by two major isoforms originating from alternative promoters: KCC3a and KCC3b, with KCC3b being the predominant transcript in kidney. Although the transporter has previously been localized to the proximal tubule, the localization and function of renal KCC3a isoform is unknown.

**Methods:** Using KCC3-KO mice, we validated a KCC3a-specific polyclonal antibody for both immunofluorescence and immunoblotting studies. Wild-type mice were subjected to dietary manipulation, water restriction, or 7 days of diuretic administration. Immunofluorescence was used to study protein localization and Western blotting was used for quantification.

**Results:** We observed intense KCC3a signal restricted to cortical intercalated cells. No overlap was detected between KCC3a and sodium chloride cotransporter (NCC), a distal convoluted tubule (DCT) marker; or between KCC3a and ENaC or calbindin, which are both principal cell markers. KCC3a signal was observed in cells expressing the apical V-ATPase and pendrin, establishing a unique expression pattern characteristic of intercalated cells of type B or type non-A/non-B. We further show that treatment of wild-type mice with hydrochlorothiazide, amiloride, or fed a  $K^+$  deficient diet up-regulated KCC3a levels, suggesting that volume depletion increases KCC3a abundance. This hypothesis was confirmed by showing higher abundance of KCC3a protein after 23-hrs water restriction or after placing the mice on a low salt diet. More importantly, abundance of the  $Cl^-/HCO_3^-$  exchanger, pendrin, which is known to secrete bicarbonate in alkalotic conditions, was significantly diminished in KCC3 knockout mice. In addition, KCC3a abundance increased significantly alongside pendrin abundance in bicarbonate-treated alkalotic mice, providing a credible mechanism for  $K^+$  loss in metabolic alkalosis.

**Conclusions:** We showed that KCC3a is expressed in pendrin-expressing intercalated cells and propose a possible mechanism for  $K^+$  loss in metabolic alkalemia.

**Funding:** NIDDK Support, Private Foundation Support

#### FR-OR45

##### Complications and Treatment of Hypercalciuria in Familial Hypercalcaemic Hypertension (FHHT)

Viola D'Ambrosio, Keith Siew, Stephen B. Walsh. *University College London, London, United Kingdom.*

**Background:** Hypertension is frequently associated with hypercalciuria<sup>1,2</sup>, nephrolithiasis<sup>3</sup> and low bone mineral density<sup>4</sup>. Familial Hypercalcaemic Hypertension (FHHT) causes hypercalciuria<sup>5</sup>, although complications of this are not reported.

**Methods:** We examined a cohort of 9 patients with genetically confirmed FHHT. Biochemical, radiological, and clinical data was obtained in patients before and after thiazide treatment. All patients gave informed consent. The study had ethics committee approval (REC 05/Q0508/6). Data were compared using paired t tests or Wilcoxon paired rank tests.

**Results:** 5 of the 9 patients were female (median age 41.7 years). The genetic diagnosis was confirmed in all patients, 5 patients had variants in KLHL3, 3 patients had variants of WNK4, and one had a variant of WNK1. Pre-treatment potassium was high (median 5.6 IQR 5.2-6.2 mmol/L). Pre-treatment calcium was in the normal range (2.34 IQR 2.29-2.38 mmol/L). There was significant hypercalciuria with a raised urinary calcium/creatinine ratio (0.69 IQR 0.41-1.13). However, PTH (4 IQR 3.95-4.35 pmol/L), phosphate (1.15 IQR 1.25mmol/L) and alkaline phosphatase (57 IQR 45-84 mmol/L) were all in the normal range. Thiazide treatment significantly reduced hypercalciuria (calcium/creatinine ratio 0.15 IQR 0.05-0.29  $p=0.04$ ) as well as the serum potassium (3.9 IQR 3.5-4.4 mmol/L  $p=0.0167$ ). Patients also developed complications of hypercalciuria. 3 patients had kidney stones demonstrated on cross-sectional imaging. One of these patients (male, 30 years old) had DXA criteria for osteoporosis (T score Femoral neck -1.5, lumbar spine -2.4).

**Conclusions:** This is the first case series to demonstrate complications of hypercalciuria (i.e. kidney stones) in patients with FHHT. We demonstrate that thiazide treatment normalises urinary calcium excretion. Thiazide treatment may have clinical utility in FHHT even if hypertension or hyperkalaemia are not problematic in order to avoid the complications of hypercalciuria.

#### FR-OR46

##### Insulin Receptor Substrate 4 (IRS4) Contributes to Hypomagnesemia by Mediating the Insulin Effect on the Renal Magnesium Channel TRPM6

Matthias T. Wolf,<sup>1</sup> Jing Zhang,<sup>1</sup> Sudha Neeam,<sup>1</sup> Anuja Bhatta,<sup>1</sup> Femke Latta,<sup>2</sup> Joost Hoenderop,<sup>2</sup> Michel G. Baum,<sup>1</sup> Sung wan An.<sup>1</sup> *<sup>1</sup>The University of Texas Southwestern Medical Center, Dallas, TX; <sup>2</sup>Radboud Universiteit, Nijmegen, Netherlands.*

**Background:** The kidney is the key regulator of magnesium ( $Mg^{2+}$ ) homeostasis in the human body. In the distal convoluted tubule (DCT), the apical epithelial  $Mg^{2+}$  channel TRPM6, determines how much  $Mg^{2+}$  is excreted. To better understand the regulation of human renal  $Mg^{2+}$  absorption we screened for novel TRPM6 interaction partners. We identified insulin receptor substrate 4 (IRS4) as a new TRPM6 modifier mediating the insulin effect on TRPM6.

**Methods:** After a TRPM6-GST pull-down assay we pursued liquid chromatography/tandem mass spectrometry (LC/MS MS) sequencing and confirmed the TRPM6-IRS4 protein interaction by co-immunoprecipitation. For tubular *Irs4* gene expression we performed microdissection of wild-type (WT) C57BL/6 mouse tubules. Gene expression of *Irs4* and magnesiotropic genes (in kidneys of WT and *Irs4* knockout (*Irs4*<sup>-/-</sup>) mice) was studied with qRT-PCR. 24 h urinary  $Mg^{2+}$  excretion and serum  $Mg^{2+}$  levels were tested in *Irs4*<sup>-/-</sup> and WT mice using metabolic cages. Glucose tolerance tests were performed. The IRS4 effect on TRPM6 was examined with whole-cell patch-clamp studies.

**Results:** With LC/MS MS sequencing, we found IRS4 enriched with TRPM6-GST but not with GST control. We confirmed physical interaction between IRS4 and TRPM6 by co-immunoprecipitation. Micro-dissecting mouse tubules, we detected IRS4 mRNA expression mostly in the DCT and to a lower degree in the proximal tubule and thick ascending limb. Given the overall low abundance of IRS4 mRNA along the tubule, we investigated the phenotype of *Irs4*<sup>-/-</sup> mice. The *Irs4*<sup>-/-</sup> mice displayed significantly higher urinary  $Mg^{2+}$  losses at 3, 6, and 12 months and lower blood  $Mg^{2+}$  levels at 6 and 12 months than WT mice. Claudin-16, claudin-19, and Hnf1b mRNA and Claudin-16 and Trpm6 protein expression was significantly higher in kidneys of 3 month old *Irs4*<sup>-/-</sup> mice consistent with a compensatory mechanism to conserve  $Mg^{2+}$  in the body. Applying whole-cell patch clamp recording we confirmed the stimulatory role of insulin on TRPM6 and showed that IRS4 targets the two TRPM6 phosphorylation sites T1391 and S1583 to enhance TRPM6 current density. Glucose tolerance was mildly abnormal in 6 month old *Irs4*<sup>-/-</sup> mice.

**Conclusions:** We show that IRS4 mediates insulin signaling towards TRPM6 by phosphorylating the TRPM6 residues T1391 and S1583.

**Funding:** Other U.S. Government Support

#### FR-OR47

##### Salt-Sensitive Blood Pressure Response in CKD Is Not Volume Mediated

Jetta J. Oppelaar, Emma H. van Schijndel, Bert-Jan Van den born, Rik H. Olde Engberink, Liffert Vogt. *Amsterdam UMC Locatie AMC, Amsterdam, Netherlands.*

**Background:** Chronic kidney disease (CKD) patients are advised to limit salt intake, because of blood pressure (BP) and albuminuria lowering effects. The salt-sensitive BP response in CKD is classically attributed to the renal incapacity to excrete sodium ( $Na^+$ ) resulting in fluid overload. In non-kidney patients BP sensitivity to salt has been shown to be fluid independent and might be linked to vasodysfunction. We aimed to investigate which factor contributes to BP sensitivity to salt in CKD.

**Methods:** We performed a randomized cross-over study in CKD patients (stage 2a-3, proteinuria  $>500$  mg/d) and healthy controls (HC). All subjects followed both an 8-day low sodium diet (LSD,  $<50$ mmol/d) and high sodium diet (HSD,  $>200$ mmol/d). After each diet, assessment of the hemodynamic profile included 24-hour BP measurements (Mobil-O-Graph) and cardiac output (using Nexfin™), by which SVR was calculated accordingly. Body fluid volume was assessed with multi-frequency body impedance spectroscopy (Fresenius).

**Results:** We included 13 HC (median age 27 yrs) and 6 CKD patients (median age 49 yrs, proteinuria 1.2 (SD 1.1) grams/day). After HSD, patients with CKD showed a mean daytime systolic BP increase (LSD vs HSD (118.2 (SD 10.6) mmHg vs. 130.8 (SD 7.8) mmHg,  $p=0.04$ ) while systolic BP in HC did not increase. After HSD, we observed a comparable extracellular fluid (ECV) expansion in CKD and HC subjects (Fig 1A), but no effect on cardiac output (Fig 1B). Delta SVR showed a distinct response in CKD and HC (respectively, 67.6 (SD 313.3) vs -67.5 (SD 106.6) dyn/s/cm<sup>5</sup>,  $p=0.07$ ). The difference in BP response was not accompanied by differences in urinary  $Na^+$  excretion after HSD (259 mmol/day vs 247 mmol/day,  $p=0.73$ ).

**Conclusions:** Salt sensitivity in CKD is characterized by systolic BP increase. In these patients, this BP increase may not be explained by increased volume expansion due to the renal incapacity to excrete  $Na^+$ . However, in CKD the salt sensitive BP response might coincide with incapacity for vasodilation.



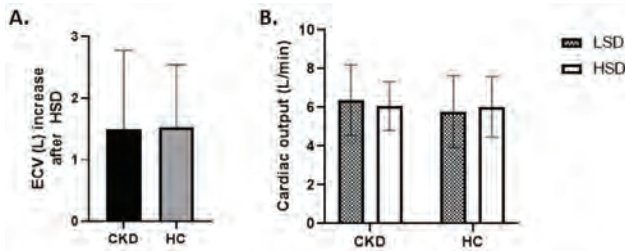

**Figure 1 A.**  $\text{Na}^+$  induced effects on extracellular fluid volume (ECV) were equal in CKD and HC (1.7 vs 1.5,  $p=0.74$ ). **B.** Cardiac output was not affected by  $\text{Na}^+$  in CKD (6.1 vs 6.4,  $p=0.70$ ) and HC (5.8 vs 6.0,  $p=0.62$ )

#### FR-OR48

**In Vivo and In Vitro Effects of Hypoxia on NKCC2: Role of MAGE-D2**  
 Kamel Laghmani,<sup>1,2</sup> Dalal Bakhos Al Douaihy,<sup>2</sup> Thibaut Charlemagne,<sup>1,2</sup> Stefan Rudloff,<sup>3</sup> Elie Seayfan,<sup>4</sup> Sylvie Demaretz,<sup>1,2</sup> Uyen Huynh-do,<sup>3</sup> Martin Kömhoff.<sup>4</sup> <sup>1</sup>Inserm, CNRS-ERL8228, Sorbonne Université, Paris, France; <sup>2</sup>Centre de Recherche des Cordeliers, Paris, France; <sup>3</sup>Universität Bern, Bern, Switzerland; <sup>4</sup>Philipps-Universität Marburg Fachbereich Medizin, Marburg, Germany.

**Background:** We previously reported that MAGE-D2 mutations cause a severe but a transient form of antenatal Bartter syndrome (tBS) associated with impaired expression of the sodium-chloride cotransporters NKCC2 and NCC. However, the transient nature of the disease remained unclear. In this regard, hypoxia was of particular interest because we considered it as the major difference between the antenatal symptomatic stage of MAGE-D2 related tBS and the post-natal asymptomatic stage. Consequently, the aim of the present study was to investigate the effect of chronic hypoxia induced *in vivo* and *in vitro*, on NKCC2 biogenesis and explore the potential role of MAGE-D2 in this process.

**Methods:** To model chronic fetal hypoxia, timed-mated pregnant mice were exposed to 10% oxygen from E14.5 to E18.5 as previously described (Rudloff et al, Nat Commun 2021; 12:549). NKCC2 subcellular distribution was assessed using immunohistochemistry. *In vitro* hypoxia was induced, in HEK cells transiently or stably transfected with NKCC2, physically (1%  $\text{O}_2$ ) or chemically using cobalt chloride for 16-24 hours. NKCC2 stability was assessed by cycloheximide chase assay.

**Results:** Chronic fetal hypoxia induced ER stress conditions as illustrated by the increase in the expression of GRP78/BIP. Importantly, this was associated with a reduction of NKCC2 surface expression in hypoxic fetal kidneys as judged by enhanced ER retention and colocalization with the ER marker BIP. Physically or chemically induced cellular hypoxia in HEK cells, marked by the stabilization of HIF-1 alpha, was correlated also with an elevation of this ER stress marker. Under these hypoxic conditions, total NKCC2 protein expression was significantly decreased. Moreover, cycloheximide chase assay revealed that in cells submitted to cellular hypoxia, NKCC2 stability and maturation are decreased. Interestingly, the detrimental effect of hypoxia on NKCC2 maturation was more profound in MAGE-D2 depleted cells.

**Conclusions:** Our data indicate that cellular hypoxia induces ER stress and impairs NKCC2 maturation and cell surface expression. Most importantly, our findings strongly suggest that MAGE-D2 protects NKCC2 against ER associated degradation induced by ER stress under cellular hypoxia, which could explain, at least in part, the transient nature of BS in carriers of MAGE-D2 mutations.

**Funding:** Government Support - Non-U.S.

#### FR-OR49

##### One Size Does Not Fit All: Real World Data on the Safety of Bolus Hypertonic Saline for Symptomatic Hyponatremia

Anissa Pelouto, Adrienne A. Zandbergen, Ewout J. Hoorn. Department of Internal Medicine, Erasmus Medical Center, Rotterdam, Netherlands.

**Background:** Symptomatic hyponatremia is a medical emergency that warrants prompt correction. The European and American guidelines recommend rapid bolus-wise infusion of hypertonic saline with fixed volumes of 150 and 100ml regardless of body weight. However, this approach may lead to overcorrection, which may be harmful in patients with “acute on chronic” or chronic hyponatremia with symptoms. Here, our aim was to assess the safety of the current “one size fits all” approach in clinical practice. We hypothesized that lower BMI results in more overcorrection.

**Methods:** We retrospectively assessed biochemical and clinical outcomes in patients treated with fixed bolus hypertonic saline (150 or 100ml) for hyponatremia at Erasmus Medical Center between July 2017 and July 2021. The cut-off for low BMI was  $21 \text{ kg/m}^2$ , based on the lowest quartile of the cohort. Primary outcome was overcorrection, defined as an increase in plasma sodium ( $\text{pNa}$ )  $>10 \text{ mmol/L/24 hours}$ ,  $>18 \text{ mmol/L/48 hours}$ , or need for  $\text{pNa}$  lowering (use of hypotonic fluids and/or desmopressin). We performed multivariable logistic regression analyses to identify predictors for the primary outcome, adjusting for known risk factors including baseline  $\text{pNa}$  level, volume depletion and hypokalemia.

**Results:** A total of 183 patients were included for analysis (median age 63, IQR 55-7; 44% males, median baseline  $\text{pNa}$  120 mmol/l, IQR 116-122). Overcorrection occurred in 20% of patients. The overcorrection rate was significantly higher in patients with low BMI compared to patients without low BMI (37% versus 14%,  $P<0.001$ ). In addition, BMI was independently associated with overcorrection both when analyzed continuously (aOR 0.86, 95%CI 0.76-0.96) and when categorized as low BMI (aOR 4.24, 95%CI 1.67-10.80). Furthermore, we confirm that lower baseline  $\text{pNa}$  (aOR 0.87, 95%CI 0.80-0.94), volume depletion (aOR 5.81, 95%CI 2.11-16.00) and hypokalemia (aOR 5.62, 95%CI 1.89-16.91) are independent risk factors of overcorrection.

**Conclusions:** We show that the current “one size fits all” approach – bolus infusion of hypertonic saline with fixed volumes – exposes patients with low BMI to a significantly higher risk of overcorrection. Therefore, we recommend volume adjustments in patients with low BMI. Future prospective studies should test whether a weight-based approach is indeed safer.

#### FR-OR50

##### Thiazides Induce Glucose Intolerance Through Inhibition of Mitochondrial Carbonic Anhydrase 5b in $\beta$ -Cells

Patrycja Kucharczyk,<sup>1,2</sup> Giuseppe Albano,<sup>1,2</sup> Daniel G. Fuster.<sup>1,2</sup> <sup>1</sup>Inselspital Universitätsspital Bern Universitätsklinik für Nephrologie und Hypertonie, Bern, Switzerland; <sup>2</sup>Department for BioMedical Research (DBMR), University of Bern, Bern, Switzerland.

**Background:** Thiazide and thiazide-like diuretics (thiazides) have been the cornerstone for the treatment of arterial hypertension and pharmacologic recurrence prevention of kidney stones for more than 50 years. Hence, not surprisingly, thiazides belong to the most widely prescribed drugs worldwide. Since their introduction into clinical medicine, thiazides are known to be associated with glucose intolerance and new onset diabetes, but the molecular mechanisms remain elusive. The aim of this study was to decipher the molecular basis of thiazide-induced glucose intolerance.

**Methods:** We employed wild-type and genetically modified mice, primary pancreatic  $\beta$ -cells and murine MIN6 cells to study the impact of thiazides on systemic glucose homeostasis, insulin sensitivity and insulin secretion.

**Results:** In mice, hydrochlorothiazide induced a pathological glucose tolerance, characterized by reduced first phase insulin secretion but normal insulin sensitivity. *In vitro*, thiazides inhibited glucose- and sulfonylurea-stimulated insulin secretion in islets and the murine  $\beta$ -cell line Min6 at pharmacologically relevant concentrations. Inhibition of insulin secretion by thiazides was  $\text{CO}_2/\text{HCO}_3^-$ -dependent, not additive to unselective carbonic anhydrase (CA) inhibition with acetazolamide and independent of extracellular potassium. In contrast, insulin secretion was unaltered in islets of mice lacking the known molecular thiazide targets NCC (SLC12A3) or NDCBE (SLC4A8). CA expression profiling with subsequent knock-down of individual CA isoforms suggested mitochondrial CA5b as molecular target. In support of these findings, thiazides significantly attenuated Krebs cycle anaplerosis through reduction of mitochondrial oxalacetate synthesis. CA5b KO mice were resistant to thiazide-induced glucose intolerance, and insulin secretion of islets isolated from CA5b KO mice was unaffected by thiazides.

**Conclusions:** Our study reveals attenuated insulin secretion due to inhibition of the mitochondrial CA5b isoform in  $\beta$ -cells as molecular mechanism of thiazide-induced glucose intolerance.

**Funding:** Government Support - Non-U.S.

#### FR-OR51

##### The Predictive and Prognostic Value of Antigen-Specific Memory B Cell Levels in PLA2R-Associated Primary Membranous Nephropathy

Quansheng Zhu,<sup>1</sup> Meryl A. Waldman,<sup>2</sup> Richard Zhu,<sup>1</sup> Hong Tang.<sup>1</sup> <sup>1</sup>ImmunoWork, Monrovia, CA; <sup>2</sup>National Institute of Diabetes and Digestive and Kidney Diseases, Bethesda, MD.

**Background:** B lymphocytes play a critical role in developing autoimmunity in patients through antigen-presentation, cytokine release, and antibody production. Antigen stimulation of the cognate memory B cells triggers their rapid differentiation into plasma cells, producing massive amounts of pathogenic antibodies in a short period. In idiopathic nephrotic syndrome, rheumatoid arthritis, systemic lupus erythematosus, and IgG4-related disease, an early recovery of memory B cells in patients post-Rituximab therapy is the only reliable parameter that strongly predicts disease relapse. The phospholipase A2 receptor (PLA2R) is the dominant autoantigen in primary membranous nephropathy (PMN), associated with ~80% of clinical cases. Considering that memory B cells are a heterogeneous pool of antigen-experienced B cells, we developed a sensitive and reliable method to detect and quantify the PLA2R antigen-specific memory B cells (PLA2R-MB) in patients diagnosed with PLA2R-associated PMN.

**Methods:** The PLA2R antigen was expressed in the HEK 293 cells and affinity purified. The purified antigens were then conjugated to a fluorochrome. Peripheral blood mononuclear cells (PBMCs) from biopsy-proven PMN patients and healthy volunteers were isolated using the BD Vacutainer® CPT™ mononuclear cell preparation tubes, stained with the PLA2R fluorescent probe, anti-CD19, and anti-CD27 monoclonal antibodies, and subsequently analyzed by the flow cytometry.

**Results:** The PBMCs isolated from healthy volunteers or patients with non-PLA2R-associated PMN had little PLA2R fluorescent probe staining in the memory B cell repertoire, less than 2%, whereas the PBMCs isolated from patients with PLA2R-associated PMN had up to 70% of positive staining that correlated to the disease status. Importantly, patients with early signs of relapse, while possessing undetectable

anti-PLA2R antibodies, showed at least a one-fold increase in the PLA2R-MB level. Moreover, patients with partial remission showed a sustained high level of PLA2R-MBs, which fluctuated with the immunosuppressive therapy.

**Conclusions:** Our data indicate that the PLA2R antigen-specific memory B cell levels in patients have a substantial value in serving as a new biomarker to assess the patient response to immunosuppressive therapies for treatment adjustment and predict the pre-clinical signs of PMN relapse.

**Funding:** NIDDK Support, Commercial Support - ImmunoWork LLC

## FR-OR52

### APOL1 Promotes Endothelial Cell Activation Beyond the Glomerulus

Miguel Carracedo,<sup>1</sup> Elke Ericson,<sup>1</sup> Rasmus Ågren,<sup>1</sup> Anna Forslöw,<sup>1</sup> Katja Madeyski-Bengtson,<sup>1</sup> Rebecca B. Riddle,<sup>2</sup> Jonas Christoffersson,<sup>1</sup> Hernán González-King Garibotti,<sup>1</sup> Bojana Lazovic,<sup>1</sup> Peter J. Greasley,<sup>1</sup> Mark Lal.<sup>1</sup> *AstraZeneca PLC, Gothenburg, Sweden; <sup>2</sup>University of Cambridge, Cambridge, United Kingdom.*

**Background:** Apolipoprotein-L1 (APOL1) high-risk genotypes are associated with increased risk of chronic kidney disease (CKD) in people of African ancestry. APOL1 is endogenously expressed in the kidney by podocytes, and endothelial cells (ECs). Interestingly, despite the abundant APOL1 expression in the endothelium little attention has been given to this cell type. Given the importance of ECs in the development and progression of CKD we hypothesized that APOL1 high-risk genotypes may promote EC activation and dysfunction.

**Methods:** To test our hypothesis we performed bioinformatic analysis of publicly available transcriptomics datasets from human and transgenic mice. *In vitro*, we expressed APOL1 in ECs derived from genetically modified induced pluripotent stem cells (iPSCs) as well as in transfected primary glomerular ECs.

**Results:** In this study, we show the high expression of endogenous APOL1 and its inducibility in various vascular beds of the kidney. Utilizing two datasets of glomeruli from patients with nephrotic syndrome and focal segmental glomerulosclerosis, we identified an increase in intercellular adhesion molecule-1 (ICAM-1) expression and an enrichment in leukocyte migration pathways in patients carrying APOL1 high-risk genotypes. This signature of EC activation was confirmed by analyzing publicly available RNA-seq data from podocyte-specific APOL1 transgenic mice, which presented a 4.9 and 2.8-fold increase in VCAM-1 and ICAM-1, respectively. In both ECs derived from genetically modified iPSCs and primary human glomerular ECs we show that APOL1 expression induced EC activation in a non-phlogistic manner. Specifically, APOL1 overexpression promoted changes in adhesion molecules, endothelial junctional proteins, inflammatory receptors, and intracellular complexity leading to an increase in monocyte attachment.

**Conclusions:** Overall, our data support the involvement of APOL1 as an inducer of EC activation and dysfunction, both *in vivo* and *in vitro*, in multiple vascular beds with effects beyond the glomerular vasculature.

**Funding:** Commercial Support - Astra Zeneca

## FR-OR53

### Identification of Glomerular and Plasma APOM as Novel Biomarkers in Glomerular Disease

Yelena Drexler,<sup>1</sup> Makoto Kurano,<sup>3</sup> Judith T. Molina David,<sup>1</sup> Tali Elfassy,<sup>1</sup> Ruijuan Ma,<sup>1</sup> Christina Christoffersen,<sup>4</sup> Yutaka Yatomi,<sup>3</sup> Laura H. Mariani,<sup>2</sup> Gabriel Contreras,<sup>1</sup> Sandra M. Merscher,<sup>1</sup> Alessia Fornoni.<sup>1</sup> *<sup>1</sup>University of Miami School of Medicine, Miami, FL; <sup>2</sup>University of Michigan Michigan Medicine, Ann Arbor, MI; <sup>3</sup>Tokyo Daigaku Daigakuin Igakuei Kenkyuka Igakubu Seirigaku, Bunkyo-ku, Japan; <sup>4</sup>Rigshospitalet, Kobenhavn, Denmark.*

**Background:** Lipid-induced kidney injury is a highly relevant pathway in experimental models of glomerular disease (GD). Apolipoprotein M (APOM) has a crucial role in the mobilization of cellular cholesterol and modulation of the bioactive sphingolipid sphingosine-1-phosphate (S1P). APOM expression is decreased in glomeruli of patients with focal segmental glomerulosclerosis. We hypothesized that GD represents a state of glomerular APOM deficiency and that altered APOM expression and plasma APOM correlate with clinical outcomes.

**Methods:** GD patients from the NEPTUNE study with proteinuria >1 g/g and available microarray gene expression data were included in the analysis (n=84). Glomerular mRNA expression levels of APOM, sphingosine kinase 1 (SPHK1), and S1P receptors 1-5 (S1P1-5) were obtained from microdissected kidney tissue in GD patients and living kidney donor controls (n=6). From baseline samples, plasma APOM (pAPOM) was measured by ELISA and log<sub>2</sub>-transformed. Plasma S1P (pS1P) and other bioactive lipids were measured by LC-MS/MS. We used Welch's t-test to compare gene expression in GD and controls. We used correlation analyses to determine associations between glomerular APOM expression with pAPOM levels. We used linear regression to determine whether glomerular APOM, pAPOM, pS1P, and bioactive lipids were associated with baseline eGFR. Using Cox models, we determined whether glomerular APOM and pAPOM were associated with time to complete remission (CR).

**Results:** In GD patients compared to controls, APOM expression was reduced (P<0.01) and SPHK1 and S1P1-5 expression was increased (P<0.05), suggesting modulation of APOM/S1P signaling. APOM expression was positively correlated with pAPOM levels (R<sup>2</sup>=0.12, P<0.01). Every unit decrease in APOM expression and pAPOM was associated with a 10.17 (95% CI, 4.35–16.00) and 14.95 (95% CI, 5.29–24.61) lower eGFR, respectively (P<0.01). pS1P was not associated with eGFR. From Cox models adjusted for age, sex, and race, pAPOM was a significant predictor of CR (HR 1.85; 95% CI, 1.06–3.23).

**Conclusions:** Plasma APOM is a non-invasive biomarker of glomerular APOM deficiency and is strongly associated with clinical outcomes in GD. We also found evidence supporting APOM/S1P pathway modulation, warranting further study.

**Funding:** Other NIH Support - The project is supported by Grant Number KL2TR002737, Miami Clinical and Translational Science Institute, from the National Center for Advancing Translational Sciences and the National Institute on Minority Health and Health Disparities.

## FR-OR54

### Urinary CD4+ T Cell Quantification Identifies ANCA Patients at Risk for Subsequent Renal Flares: Results of the Prospective, Multicenter Pre-Flared Study

Luka Prskalo,<sup>1</sup> Christopher Skopnik,<sup>1</sup> Janis Sonnemann,<sup>1</sup> Emil Grothgar,<sup>1</sup> Jan Klocke,<sup>1</sup> Udo Schneider,<sup>1</sup> Alan D. Salama,<sup>2</sup> Markus Bieringer,<sup>3</sup> Adrian Schreiber,<sup>1</sup> Philipp Enghard.<sup>1</sup> *<sup>1</sup>Charite Universitätsmedizin Berlin, Berlin, Germany; <sup>2</sup>University College London Medical School, London, United Kingdom; <sup>3</sup>Helios Kliniken GmbH, Berlin, Germany.*

**Background:** Patients with ANCA-associated vasculitis (AAV) are at risk for recurrent renal flares. Presently, there are no reliable biomarkers for flare prediction. Urinary CD4+ T cells have previously been reported to distinguish active renal involvement in AAV from AAV in stable remission, but it is currently unknown if they may predict future flares in quiescent disease.

**Methods:** We prospectively collected urine samples from 112 AAV patients in remission (BVAS=0) at three AAV clinics in two hospitals (NCT04428398). 10 patients met the exclusion criteria; 102 patient samples were analyzed. Renal flares were defined as an increase in BVAS >0 and at least one element of the renal BVAS or alternatively as new initiation of induction treatment. Using flow cytometry, urinary CD4+ and CD8+ T cell subsets were quantified. The primary end point was the prediction of renal relapse after six months using the initial CD4+ count.

**Results:** Of the 102 analyzed patients 10 developed a renal flare, 2 developed a non-renal flare and 90 remained in stable remission. The number of urinary CD4+ T cells predicted renal flares with a Receiver-Operator Characteristic (ROC) area under the curve (AUC) of 0.88. Urinary CD4+ T cells outperformed traditional biomarkers such as ANCA titers, hematuria, and proteinuria in renal flare prediction. Applying a cut-off of 490 CD4+ T cells per 100ml urine yielded a sensitivity of 60% and specificity of 97.8% in identifying patients with future renal flares. A combination of urinary CD4+ T cells (>50/100ml) and PR3 ANCA levels (>40IU/ml) increased the predictive value to the sensitivity of 100% and specificity of 92%. Furthermore, in the complete patient cohort (n=102), the number of urinary CD4+ T cells correlated with loss of GFR (p<0.01) and increase in proteinuria (p<0.05) in the subsequent 6 months.

**Conclusions:** Urinary CD4+ T cell numbers identify AAV patients at risk for renal flares. Combining urinary CD4+ T cell numbers with ANCA levels may further improve flare prediction.

## FR-OR55

### Explainability of a Deep Learning Based Classification Model for ANCA-Associated Glomerulonephritis

Maria Wester Trejo,<sup>1</sup> Maryam Sadeghi,<sup>2</sup> Shivam Singh,<sup>2</sup> Andreas Kronbichler,<sup>3</sup> Vladimir Tesar,<sup>4</sup> Xavier Puéchal,<sup>5</sup> Georg Goebel,<sup>2</sup> Ingeborg M. Bajema.<sup>1</sup> *<sup>1</sup>Leiden University Medical Center, Department of Pathology, Leiden, Netherlands; <sup>2</sup>Medical University of Innsbruck, Department of Medical Statistics, Informatics and Health Economics, Innsbruck, Austria; <sup>3</sup>University of Cambridge, Department of Medicine, Cambridge, United Kingdom; <sup>4</sup>Charles University and General University Hospital, Department of Nephrology, Prague, Czechia; <sup>5</sup>Hôpital Cochin, Department of Internal Medicine, Paris, France.*

**Background:** The histopathological classification for ANCA-associated glomerulonephritis (ANCA-GN) is a well-established tool to reflect the variety of patterns and severity of lesions that can occur in renal biopsies of patients with ANCA-associated vasculitis. As with many fields, medicine saw a rapid emergence of Artificial Intelligence (AI) and Deep Learning (DL) approaches. In the field of digital pathology, AI can now serve as decision-support for pathologists, with the potential for gains in productivity and time-saving. It was demonstrated previously that AI can aid in identifying histopathological classes of renal diseases, e.g. of diabetic nephropathy. Although these models reach high prediction accuracies, their black box structure makes them very non-transparent. The disadvantage is that the networks' decisions are not easily interpretable by humans and it is not clear what information in the input data underlies their decisions. This necessitates the use of Explainable AI (XAI), so that decisions made by AI models become accessible for validation by a human expert.

**Methods:** Renal biopsy slides of 80 patients with ANCA-GN from 3 European centers, who underwent a diagnostic renal biopsy between 1991 and 2011, were included. On the scanned slides glomeruli were labelled as 'normal', 'sclerotic', 'crescentic' or 'abnormal - other'. We developed a DL-based computational pipeline, which detects and classifies the glomeruli. We investigated the explainability of our model, using XAI techniques to shed light on the decision-making criteria of our trained DL classifier, using saliency maps. These maps were analyzed by pathologists to compare the decision-making criteria of humans and the DL model.

**Results:** Our DL model shows a prediction accuracy of 93% for classifying glomeruli. The saliency maps from our trained DL models help us to better understand the decision-making criteria of the DL black box.

Key: TH - Thursday; FR - Friday; SA - Saturday; OR - Oral; PO - Poster; PUB - Publication Only

Underline represents presenting author.

**Conclusions:** AI and DL play an increasingly important role in (nephro) pathology. To ultimately enable safe implementation of these models in clinical practice, validation of their decisions is needed. To achieve this, we used XAI techniques, which showed great potential for illuminating the decision-making criteria of the DL black box.

## FR-OR56

### Sparsentan Improves Glomerular Endothelial and Podocyte Functions and Augments Protective Tissue Repair in a Mouse Model of Focal Segmental Glomerulosclerosis (FSGS)

Georgina Gyarmati,<sup>1</sup> Sachin K. Deepak,<sup>1</sup> Urvi Nikhil Shroff,<sup>1</sup> Audrey Izuhara,<sup>1</sup> Radko Komers,<sup>2</sup> Patricia W. Bedard,<sup>2</sup> Janos Peti-Peterdi.<sup>1</sup> <sup>1</sup>University of Southern California Keck School of Medicine, Los Angeles, CA; <sup>2</sup>Travere Therapeutics Inc, San Diego, CA.

**Background:** Emerging evidence indicates strong nephroprotection by dual antagonism of the endothelin (ET) type A (ETAR) and angiotensin (AngII) type 1 (AT1R) receptors with sparsentan (SP). Previously, we reported antiproteinuric and protective hemodynamic effects of SP in both FSGS and normal mouse kidneys and differences between SP and AT1R inhibition alone. This study investigated the glomerular cell and molecular mechanisms of SP's protective effects in experimental FSGS.

**Methods:** Multiphoton microscopy (MPM) of the kidney in vivo was combined with urinalysis and histology. Glomerular endothelial surface layer (glycocalyx) thickness (FITC-WGA labeling), podocyte mitochondrial metabolism (MitoTracker-Red intensity), and endothelial and renin lineage single-cell fate-tracking using Confetti mice were measured in 6 months-old FSGS mice (TRPC6 overexpression) received either no drug, losartan (Los; 10 mg/kg/day), or SP (120 mg/kg/day) in custom rodent chow for 6 weeks.

**Results:** The heterogeneous segmental increase in glomerular endothelial glycocalyx observed in FSGS mice was fully restored by SP compared to the intermediate effects of Los. Similarly, MPM found clear elevation of mitochondrial membrane potential indicating oxidative stress in podocytes in FSGS, which was attenuated by both Los and SP. Moreover, compared to Los, SP resulted in a more robust increase in the number of Confetti+ cells of both renin and endothelial lineages, clones, and individual cells/clone in both the glomeruli and tubules of FSGS mice indicating active tissue remodeling in response to SP.

**Conclusions:** MPM imaging directly visualized the pleiotropic protective effects of SP in the intact living kidney of FSGS mice including restoration of glomerular endothelial surface layer and podocyte metabolic functions and enhanced endogenous tissue repair, in addition to the previously identified hemodynamic improvements. Compared to Los, SP was more effective in the long-term preservation of kidney structure and function and in augmenting endogenous tissue repair in experimental FSGS, which further underscores the importance of ET component in the nephroprotective actions of SP.

**Funding:** Commercial Support - Travere Therapeutics

## FR-OR57

### Long-Term Efficacy and Safety of Sparsentan in FSGS: 240-Week Analysis of the DUET Open-Label Extension (OLE)

Tarak Srivastava,<sup>1</sup> Vladimir Tesar,<sup>2</sup> Kirk N. Campbell,<sup>3</sup> Michelle N. Rheault,<sup>4</sup> Radko Komers,<sup>5</sup> Edward Murphy,<sup>5</sup> Howard Trachtman,<sup>6</sup> Loreto Gesualdo,<sup>7</sup> <sup>1</sup>Children's Mercy Hospitals and Clinics, Kansas City, MO; <sup>2</sup>Charles University, General University Hospital, Prague, Czechia; <sup>3</sup>Ichan School of Medicine at Mount Sinai, New York, NY; <sup>4</sup>University of Minnesota Medical School Twin Cities, Minneapolis, MN; <sup>5</sup>Travere Therapeutics Inc, San Diego, CA; <sup>6</sup>University of Michigan, Ann Arbor, MI; <sup>7</sup>University of Bari Aldo Moro, Bari, Italy.

**Background:** Sparsentan (SPAR) is a novel, orally active, single molecule Dual Endothelin Angiotensin Receptor Antagonist (DEARA) being investigated for focal segmental glomerulosclerosis (FSGS) and immunoglobulin A nephropathy. In the 8-week double-blind period of the phase 2 DUET trial in patients with FSGS (excluding secondary FSGS), SPAR (200, 400, and 800 mg/day) resulted in greater proteinuria reduction vs irbesartan 300 mg/day. The 240-week analysis of the DUET OLE reports the on-treatment long-term efficacy and safety of SPAR.

**Methods:** Patients (n=108 who received ≥1 SPAR dose) were examined from first SPAR dose (double-blind or OLE) through 240 weeks (4.6 years). Urinary protein/creatinine ratio (UP/C), eGFR, and blood pressure (BP) were assessed every ~12 weeks. Treatment-emergent adverse events (TEAEs) and treatment-related TEAEs were summarized as cases per 100 patient-years.

**Results:** At OLE data cutoff (February 5, 2021), 45/108 patients (41.7%) had ongoing SPAR treatment. Total patient years with SPAR were 366. Median years to treatment discontinuation was 3.9. At Week 240 vs baseline, median (IQR) UP/C was 0.80 g/g (0.33, 2.55; n=41) vs 2.7 g/g (1.5, 4.2; n=107) and eGFR was 57.8 mL/min/1.73m<sup>2</sup> (34.3, 71.4; n=45) vs 69.4 mL/min/1.73m<sup>2</sup> (44.1, 92.0; n=108). Systolic/diastolic BP (mean±SD) was 122.9±15.0/76.1±9.6 mmHg (n=47) vs 129.0±12.4/81.6±8.8 mmHg (n=108). Table shows the most common TEAEs and the cases considered treatment-related.

**Conclusions:** Sustained proteinuria reduction was observed over 240 weeks in patients who continued SPAR in the OLE. No new or unexpected TEAEs vs the double-blind period were observed with long-term SPAR treatment.

**Funding:** Commercial Support - Travere Therapeutics, Inc., San Diego, CA

Table. Incidence of the Most Common TEAEs and TR-TEAEs by Cases Per 100 Patient-Years (PY)

Preferred Term	TEAE ≥7 cases/100 PY	TR-TEAE cases/100 PY
Headache	11.74	3.82
Edema peripheral	11.19	2.46
URTI	10.64	0
Hyperkalemia	10.37	9.28
Hypotension	9.28	7.92
Nausea	8.46	3.55
Hypertension	7.64	0.55
Vomiting	7.64	2.46
Diarrhea	7.10	1.09

PY, patient years; TR-TEAE, treatment-related treatment emergent adverse events; URTI, upper respiratory tract infection.

## FR-OR58

### Efficacy and Safety of Voclosporin Over 3 Years in Patients With Severe Lupus Nephritis

Hanni Menn-Josephy,<sup>1</sup> Matt Truman,<sup>2</sup> Mary Palmen,<sup>2</sup> Henry Leher.<sup>2</sup> <sup>1</sup>Boston University School of Medicine, Boston, MA; <sup>2</sup>Aurinia Pharmaceuticals Inc, Victoria, BC, Canada.

**Background:** The AURORA 1 study demonstrated that addition of voclosporin, a novel calcineurin inhibitor, to mycophenolate mofetil (MMF) and low-dose steroids significantly increased rates of complete renal response (CRR) at 52 weeks in patients with lupus nephritis, with efficacy maintained for an additional 24 months in those who continued treatment in the AURORA 2 study. Here we report on a post hoc analysis evaluating voclosporin use in patients with severe lupus nephritis using pooled data from the AURORA 1 and AURORA 2 studies.

**Methods:** Patients who completed AURORA 1 were eligible to enter AURORA 2 to continue the same blinded therapy of voclosporin or placebo; all patients received MMF and low-dose steroids. In this post hoc analysis, the definition of severe lupus nephritis included patients with Class III or IV (± Class V) disease with active lesions and urine protein creatinine ratio (UPCR) ≥3 mg/mg at AURORA 1 baseline. CRR was defined as UPCR ≤0.5 mg/mg with stable renal function, use of low-dose steroids, and no use of rescue medication and was assessed over the three-year treatment period of AURORA 1 and AURORA 2.

**Results:** Of the 116 patients in the voclosporin arm and 100 patients in the control arm who continued treatment in AURORA 2, 47 and 37 patients in each arm, respectively, had severe disease. Mean (SD) UPCR at pre-treatment AURORA 1 baseline was 6.02 (2.29) mg/mg in the voclosporin arm and 6.08 (2.46) mg/mg in the control arm. Rates of CRR in the voclosporin and control arms were 46.8% and 21.6%, respectively, at one year (OR 4.41, 95% CI 1.47, 13.26; p=0.008), 57.4% and 35.1% at two years (OR 3.08, 95% CI 1.17, 8.10; p=0.022), and 53.2% and 35.1% at three years (OR 2.92, 95% CI 1.07, 7.94; p=0.036). The rates of serious adverse events were similar in the voclosporin (21.3%) and control (27.0%) arms, with one death occurring in a control-treated patient.

**Conclusions:** In patients with severe lupus nephritis, adding voclosporin to MMF and low-dose steroids results in significantly higher CRR rates and a similar safety profile to that of control. This is clinically meaningful given that patients with severe disease are at higher risk of worse long-term outcomes and development of end stage kidney disease.

**Funding:** Commercial Support - Aurinia Pharmaceuticals Inc.

## FR-OR59

### Effect of Iptacopan on Proteinuria and Complement Biomarkers Over Time in IgA Nephropathy

Brad H. Rovin,<sup>1</sup> Jonathan Barratt,<sup>2,3</sup> Hong Zhang,<sup>4</sup> Dana Rizk,<sup>5</sup> Naoki Kashihara,<sup>6</sup> Bart D. Maes,<sup>7</sup> Hernan Trimarchi,<sup>8</sup> Ben Sprangers,<sup>9</sup> Matthias Meier,<sup>10</sup> Dmitriy Kollins,<sup>10</sup> Annabel R. Magirr,<sup>10</sup> Guido Junge,<sup>11</sup> Vlado Perkovic.<sup>12</sup> <sup>1</sup>The Ohio State University Wexner Medical Center, Columbus, OH; <sup>2</sup>University Hospitals of Leicester NHS Trust, Leicester, United Kingdom; <sup>3</sup>University of Leicester Department of Cardiovascular Sciences, Leicester, United Kingdom; <sup>4</sup>Peking University First Hospital Department of Nephrology Renal Division, Beijing, China; <sup>5</sup>The University of Alabama at Birmingham School of Medicine, Birmingham, AL; <sup>6</sup>Kawasaki Ika Daigaku Jinzo Koketsuatsu Naikagaku Kyoshitsu, Kurashiki, Japan; <sup>7</sup>AZ Delta vzw, Roeselare, Belgium; <sup>8</sup>Hospital Britanico de Buenos Aires, Buenos Aires, Argentina; <sup>9</sup>Katholieke Universiteit Leuven Universitaire Ziekenhuizen Leuven Campus Gasthuisberg, Leuven, Belgium; <sup>10</sup>Novartis Pharma AG, Basel, Switzerland; <sup>11</sup>Novartis Institutes for BioMedical Research Basel Department of Translational Medicine, Basel, Switzerland; <sup>12</sup>University of New South Wales, Sydney, NSW, Australia.

**Background:** The alternative complement pathway (AP) plays a key role in the pathogenesis of IgA nephropathy (IgAN). Iptacopan (LNP023) is an oral, first in class, highly-potent, selective inhibitor of factor B (FB). In a Phase 2 study, iptacopan treatment led to a dose dependent reduction in proteinuria and inhibition of AP in patients with IgAN.

**Methods:** This parallel-group adaptive design Phase 2 study (NCT03373461) randomized biopsy-confirmed IgAN patients to one of the four iptacopan doses (10, 50, 100, or 200 mg bid) or placebo for either a 3-month (m) (Part 1; N=46) or 6-m (Part 2; N=66) treatment period. In this analysis, we report changes in proteinuria (ratio to baseline

in UPCR), and biomarkers of complement activity (plasma Bb, FB, properdin, C3 and C4, and serum Wieslab activity) with iptacopan 200 mg bid (n=26) vs placebo (n=25) at 3 m (pooled part 1 and 2 data) and 6 m (part 2).

**Results:** UPCR fell by 31% (80% CI: 23%, 39%) and 41% (31%, 49%) from baseline to 3- and 6-m (post-hoc analysis of part 1 and 2) in the iptacopan arm vs 12% (0%, 20%) and 2% (-20%, 23%) in the placebo arm (Figure 1A). Iptacopan selectively inhibited AP as demonstrated by changes in Wieslab activity, Bb, FB, properdin levels (Figure 1B) and small increases in C3; C4 levels remained largely unchanged indicating that iptacopan does not inhibit classical/lectin pathway (Figure 1B).

**Conclusions:** In accordance with its mechanism of action, iptacopan 200 mg bid attenuates activation of AP and results in clinically meaningful reductions in proteinuria in patients with IgAN.

**Funding:** Commercial Support - Novartis Pharma AG

Figure 1A: Effect of iptacopan on proteinuria reduction

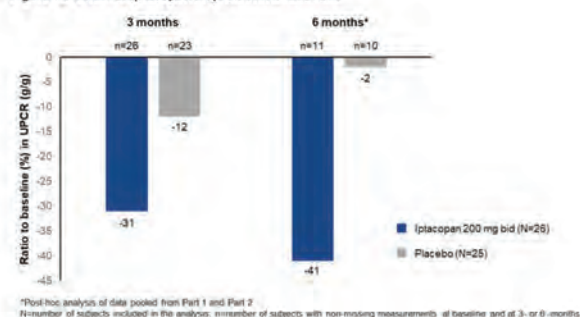
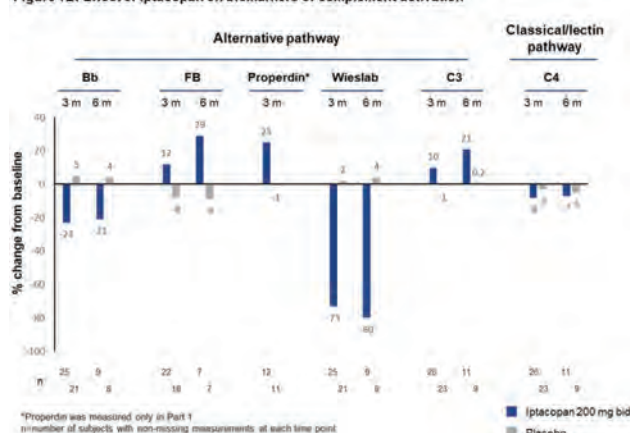

Figure 1B: Effect of iptacopan on biomarkers of complement activation



Effect of iptacopan on proteinuria and complement biomarkers

FR-OR60

A Multi-Omics Approach to IgA Nephropathy Characterization in the NURTuRE Cohort Enables Precision-Based Treatment Approaches

N. E. Olson,<sup>1</sup> Jennifer H. Cox,<sup>1</sup> I-Ju Lo,<sup>2</sup> Seamus Ragan,<sup>1</sup> Niklas Michel,<sup>2</sup> Johannes Pospiech,<sup>2</sup> Michaela Bayerlová,<sup>2</sup> Simone Romoli,<sup>1</sup> Taher Sathaliya,<sup>1</sup> Tobias Bohnenpoll,<sup>2</sup> Nikolas Stroth,<sup>2</sup> Olivier Radresa,<sup>2</sup> Andrew J. King,<sup>1</sup> Uwe Andag.<sup>2</sup> <sup>1</sup>Chinook Therapeutics Inc, Seattle, WA; <sup>2</sup>Evotec International GmbH, Göttingen, Germany.

**Background:** IgA nephropathy (IgAN) is the most commonly reported primary glomerulonephritis, yet risk stratification and prediction of treatment response remain a challenge. Systems biology approaches integrating multiple data types have the potential to identify patient subsets that could benefit from precise treatment approaches. Here we describe a multi-omics analysis of the NURTuRE IgAN patient cohort to generate an integrated understanding of disease pathogenesis and patient stratification.

**Methods:** Data collected from 205 patients with IgAN in the NURTuRE cohort included clinical characteristics, MEST-C scores for glomerular and tubular injury, serum proteomics using the Olink Explore panel of 3072 analytes and blood and kidney transcriptomes (Table). Relationships between serum proteins, kidney function, kidney and blood gene expression and histopathology were determined using Spearman correlation, ANOVA and Kruskal-Wallis tests.

**Results:** Serum protein levels of TNFSRF1A, B2M, LCN2, APRIL and TNFRSF17 were inversely correlated with eGFR. Analysis by MEST-C score identified proteins significantly associated with the tubular atrophy/interstitial fibrosis (T) score, including LCN2 and B2M, which are increased in patients with T1 or T2. Analysis of kidney biopsy gene expression by MEST-C score showed that scores for an inflammatory response gene signature were significantly higher in kidney biopsies from patients with T1 or T2.

**Conclusions:** A multi-omics approach to the characterization of IgAN in the NURTuRE cohort was performed, integrating clinical, histological, transcriptomic and serum proteomic data to gain deeper insights into patient stratification and disease

Key: TH - Thursday; FR - Friday; SA - Saturday; OR - Oral; PO - Poster; PUB - Publication Only  
Underline represents presenting author.

biology. These learnings will be applied to clinical studies evaluating atrasentan, an endothelin receptor A antagonist, and BION-1301, an anti-APRIL antibody, for the treatment of IgAN.

**Funding:** Commercial Support - Chinook Therapeutics, Inc; Evotec International GmbH

Data availability			
Data type	Source	n	%
Clinical data	UK Renal Registry	205	
Immunoglobulin isotypes (Gd-IgA1, IgA, IgG, IgM)	Serum	70	
Histopathology report (MESTC)	Biopsy	86	
RNA-Seq	Biopsy	59	
RNA-Seq	Blood	179	
SNP array	Blood	200	
Whole Exome Sequencing	Blood	198	
Targeted proteomics (3072 analytes)	Serum	71	

Percent of Patients

SA-OR01

Long-Term Renal Outcomes of COVID-19-Associated Nephropathy (COVAN)

Gabriel A. Giannini,<sup>1</sup> Tiffany Caza,<sup>1</sup> Rebecca May,<sup>1</sup> Muner Mohamed,<sup>2</sup> Clarissa A. Cassol,<sup>1</sup> Shree G. Sharma,<sup>1</sup> Christopher P. Larsen,<sup>1</sup> Juan Carlos Q. Velez,<sup>3</sup> <sup>1</sup>Arkana Laboratories, Little Rock, AR; <sup>2</sup>Stamford Hospital, Stamford, CT; <sup>3</sup>Ochsner Health Network LLC, New Orleans, LA.

**Background:** COVID-19-associated nephropathy (COVAN) is a type of collapsing glomerulopathy that leads to acute kidney injury (AKI) and overt proteinuria in individuals with apolipoprotein L1 (APOL1) polymorphism infected with SARS-CoV-2. Although the severity of the acute presentation of COVAN is well described, the long-term renal prognosis has not been clearly established.

**Methods:** We retrospectively identified native kidney biopsies from patients with diagnosis of COVAN discharged alive between January 2020 and March 2021. Time of biopsy pathological and clinical data were collected. We performed APOL1 genotyping for G1/G2 risk alleles. We examined the rate of end-stage kidney disease (ESKD), de novo or progressive chronic kidney disease (CKD) and death. Factors associated with those outcomes were assessed by logistic regression.

**Results:** A total of 43 patients with COVAN with median follow-up at 244 days were included. Mean age was 53 ± 12 years (range 30-78), 49% women, and 85% were of African descent. High-risk APOL1 genotypes were found in 86%. Most presented with AKI (91%) and nephrotic-range proteinuria (81%). Sixteen patients required dialysis at presentation (AKI-RRT), 8 of which reached ESKD and dialysis dependence at follow-up. Additionally, 6 patients without AKI-RRT developed ESKD and required dialysis at follow-up. Forty patients (93%) either developed de novo CKD or progressed to advanced stage of CKD [mean serum creatinine (sCr) 3.1 ± 1.9 mg/dL]. Overall, 35% reached the combined endpoint of ESKD, progressive CKD or death. Predictive factors of ESKD included older age (59.1 ± 13.9 vs. 50.4 ± 10.7 years, p=0.03), increased sCr at time of biopsy (9.4 ± 3.2 vs. 6.0 ± 4.9, p=0.03), increased glomerular obsolescence (52.8 ± 21.3 vs. 25.0 ± 23.2%, p=0.0005), and IFTA [moderate-severe vs. mild, OR 9.8 (CI: 1.1-85.2), p=0.03]. AKI-RRT, sex, proteinuria at the time of biopsy, and absence vs. presence of an APOL1 high-risk genotype were not predictive of ESKD.

**Conclusions:** COVAN is associated with ominous long-term renal sequelae. Serum creatinine at time of biopsy, patient age, glomerular obsolescence, and IFTA are associated with greater risk of ESKD.

SA-OR02

Renal Pathology of Fatal Cases of COVID-19: A Study of 94 Autopsies

Arian Pourmehdi Lahiji, Rachele A. Gietzen, David D. Walker, Judith Aronson, Marjan Afrouzian. The University of Texas Medical Branch at Galveston, Galveston, TX.

**Background:** Acute kidney injury (AKI) is a serious complication of infection with SARS-CoV-2 and it associated with high mortality. Post-mortem examination of kidney & lung of these patients allows a logistical assessment of the glomerular & vascular events. This is one of the largest North American autopsy series with details on renal lesions correlated with lung microthrombi.

**Methods:** From April 2020 to July 2021, a total of 94 autopsy cases were examined: 82 COVID-19 cases examined prospectively, & 12 control cases with similar comorbidities, retrospectively from the pre-COVID-19 era. Demographics, clinical presentation, cause of death, laboratory results were collected & pathologic findings, focusing on the following pathological lesions were studied: 1- collapsing glomerulopathy (CG), 2- evidence of thrombotic microangiopathy (TMA), i.e., presence of any glomerular microthrombi +/- thrombi in arteries/arterioles & acute tubular injury & necrosis (ATI-ATN); 3- topography

of the lesions in cortex; 4- presence of pulmonary microthrombi. Beside routine stains used in renal pathology, Martius-scarlet-blue (MSB) stain and immunohistochemistry for fibrin were performed on 54 cases to detect microthrombi.

**Results:** In the COVID-19 group composed of 82 cases, CG was observed in 40 (49%) cases, of whom only 14 (35%) were of African descent; TMA in 32 (39%); combined CG + TMA in 16 (19%) & ATI-ATN in 29 (35%). In the control group composed of 12 cases, TMA was observed in 3 (25%), ATI-ATN in 6 (50%) and no CG was found. Lung microthrombi examined in 35 cases were found in 19 cases (54%), 14 (40%) cases having TMA in the kidney. Statistical analysis of Variance showed a p-value of 0.0847, reflecting trending correlation between presence of TMA and CG.

**Conclusions:** TMA, CG, and ATI-ATN were the main renal pathologic findings in our study. Wedge-shaped areas of cortical scarring suggesting a vascular pattern were observed. Co-occurrence of TMA & CG was observed in half of the cases, suggesting an association between TMA & CG. Only a percentage of cases with CG were of African descent suggesting a second pathogenesis (other than podocyte injury related to APOL-1) for CG: In patients of non-African descent, TMA may be the pathogenesis behind the development of CG.

### SA-OR03

#### Incidence and Clinical Course of Gross Hematuria Following COVID-19 Vaccination Among Patients With IgA Nephropathy

Hitomi Kimura, Hiroko Beppu, Tomoko Kawanishi, Hina Ogawa, Ayumi Ishiwatari, Minami Toda, Yuiko Kamei, Toshie Ogawa, Yasutomo Abe, Mariko Endo, Sachiko Wakai. *Okubo Byoin, Shinjuku-ku, Japan.*

**Background:** IgA nephropathy (IgAN) flares with gross hematuria after COVID-19 vaccination have been recently reported as adverse events of immunization, but no study to date has examined the incidence and clinical course of IgAN patients with gross hematuria following vaccination.

**Methods:** A single-center retrospective observational study included 301 patients with biopsy-proven IgAN and followed-up for more than 6 months with therapeutic intervention and received at least one dose of COVID-19 vaccination. We examined from medical records the incidence of gross hematuria following vaccination and also evaluated the clinical course of eGFR, spot urine protein/Cr ratio (UPCR), urinary erythrocyte count (URBC) /hpf among IgAN patients with gross hematuria following COVID-19 vaccination.

**Results:** We identified 7 (3.0 %) patients with gross hematuria following COVID-19 vaccination. 6 patients were female. The median age was 42 (range, 33 to 48). Median time to develop gross hematuria after vaccination was 1 (range, 0 to 4) day and gross hematuria resolved within 3 (range, 1 to 7) days. 6 patients presented gross hematuria after the second dose. Mean baseline eGFR and UPCR before vaccination were 73.7 (IQR, 61.3 to 86.0) ml/min/1.73m<sup>2</sup> and 0.23 (range, 0.01 to 0.70) g/g Cr, respectively, and median grade of hematuria was URBC 10-19/hpf. With mean follow up of 238.7 (range, 184 to 282) days after the onset of gross hematuria, 4 patients were introduced steroid therapy. Within one month after the onset of gross hematuria, mean eGFR decreased -13 (range, -29.2 to -5.2) % and UPCR increased +0.70 (range, +0.02 to + 2.59) g/gCr from baseline, and median grade of hematuria increased to URBC 50-99/hpf as compared to baseline. At 6 months, mean eGFR and UPCR improved to 73.9 (IQR, 60.2 to 88.0) ml/min/1.73m<sup>2</sup> and 0.30 (range, 0.06 to 0.74) g/g Cr, respectively, and median grade of hematuria decreased to URBC 5-9/hpf.

**Conclusions:** Our study revealed the incidence of gross hematuria following vaccination in IgAN patients and also suggested that eGFR, proteinuria and hematuria may transiently worsen but improve almost to baseline with appropriate therapeutic intervention or careful follow-up.

### SA-OR04

#### Urinary Transcriptomics Identified Inflammatory Signals Associated With COVID-19-Related AKI

Sean Eddy,<sup>1</sup> Rajasree Menon,<sup>1</sup> Edgar A. Otto,<sup>1</sup> Jennifer A. Schaub,<sup>1</sup> Chrysta C. Lienczewski,<sup>1</sup> Yuan O. Zhu,<sup>2</sup> Anita Boyapati,<sup>2</sup> Kishor B. Devalaraja-Narashimha,<sup>2</sup> Nikhil Singh,<sup>2</sup> Gabor Halasz,<sup>2</sup> Lori Morton,<sup>2</sup> Abhijit S. Naik,<sup>1</sup> Matthias Kretzler.<sup>1</sup> *<sup>1</sup>University of Michigan, Ann Arbor, MI; <sup>2</sup>Regeneron Pharmaceuticals Inc, Tarrytown, NY.*

**Background:** SARS-CoV-2, associated with COVID-19, can include dysfunction in many organs including the kidney. Early in the pandemic, a high incidence of acute kidney injury (AKI), with an associated increase in mortality, was observed, particularly in those with severe respiratory failure. Given the effect on the kidney and limited availability of biopsied tissue, we designed a non-invasive protocol to isolate and sequence renal cells from the urine of patients with COVID-19 to identify the cellular and molecular mechanisms of COVID-19-related AKI, and the impact of immunomodulatory treatment.

**Methods:** Three groups of hospitalized patients, AKI with and without COVID-19 and COVID-19 without AKI, were recruited at Michigan Medicine (N=48). We documented >90 clinical parameters, including serum creatinine trends, treatment exposure to IL-6 inhibitors, and patient outcomes. Urine samples near peak AKI were collected and immediately processed for single cell RNA sequencing (scRNAseq); profiles were generated on the 10x Genomics platform and clustered using Seurat. Differentially expressed gene profiles were generated in a cell type selective manner.

**Results:** Urine scRNAseq profiles from 44,440 cells clustered into 5 major cell-types, based on cell marker assignment. Renal cells comprised 12% of the recovered cells. Comparing renal cells from COVID-19-related AKI group to either of the two other groups identified 129 up-regulated and 89 down-regulated genes in common (q<0.05).

The COVID-19-related AKI renal cell profile was consistent with activation of one or more inflammatory cytokines including IFN- $\gamma$ , IL-6, and IL-1 $\beta$ . Conversely, patients exposed to IL-6 inhibitors had a reduced expression of inflammatory marker genes.

**Conclusions:** This study demonstrates the successful isolation and generation of cell type transcriptional profiles of renal cells in the urine of patients with COVID-19, with or without AKI, and non-COVID-19 AKI. Expression profiles in renal cells were consistent with intra-renal inflammatory activation in COVID-19-related AKI. Association of profiles with renal function and patient outcomes may identify predictive markers of COVID-19-related AKI and potential targets for therapeutic modulation.

**Funding:** Commercial Support - Regeneron Pharmaceuticals, Private Foundation Support

### SA-OR05

#### Single Nucleus RNA-Sequencing in Diagnostic Biopsy Cores of COVID-AKI Patients Reveals Robust Modelling, Injury, and Profibrotic Markers

Reetika R. Ghag,<sup>1</sup> Madhurima Kaushal,<sup>1</sup> James C. Williams,<sup>2</sup> Lois J. Arend,<sup>3</sup> Avi Z. Rosenberg,<sup>3</sup> Tarek M. El-Achkar,<sup>2</sup> Chirag R. Parikh,<sup>3</sup> Sanjay Jain.<sup>1</sup> *<sup>1</sup>Washington University in St Louis, St Louis, MO; <sup>2</sup>Indiana University School of Medicine, Indianapolis, IN; <sup>3</sup>Johns Hopkins University, Baltimore, MD.*

**Background:** Renal (acute kidney injury, AKI) involvement in COVID-19 patients is associated with high mortality and morbidity. Critically ill COVID-19 patients are at twice the risk of in hospital mortality compared to nonCOVID AKI patients. The cell types that succumb to direct or indirect damage and the associated abnormal biological responses are unclear. New generation single cell technologies have the potential to provide insights into physiological states and molecular mechanisms in COVID-AKI. One of the key limitations is that biopsies are not routinely performed and the risks of procuring an additional research core is indeterminate making it difficult to get direct insights into the landscape of COVID-AKI disease in the kidney at genome wide and cellular scale.

**Methods:** We developed an innovative method that used remnant kidney biopsy tissue from OCT-embedded frozen diagnostic pathology biopsy core and generated single nucleus transcriptome (snRNAseq) of COVID-AKI from as little as 1 mm<sup>2</sup> of tissue. Comparative analysis of snRNAseq of 4 COVID-AKI and 4 control cortical biopsies was done in conjunction with urine transcriptomics to find overlapping genes in these two datasets representing COVID-AKI-enriched genes and the corresponding cell types in the kidney.

**Results:** snRNAseq of COVID-AKI remnant or control frozen kidney biopsies (15659 and 15604 nuclei passing QC, respectively) identified all major and minor cell types. Differential expression analysis of COVID-AKI biopsies showed pathways enriched in viral response, kidney regeneration, WNT signaling, cancer, kidney development and cytokines in several nephron epithelial cells including kidney injury markers and fibrosis indicating robust remodelling in various cell types. Ten genes were also detected in urine cells of COVID-AKI patients as potential biomarkers. Two of these genes, LRP1B and PDE3A, have been recently implicated in driving fibrosis in COVID-AKI model systems.

**Conclusions:** snRNAseq is feasible on leftover kidney biopsy tissue using minimum amount of sample and enabled identification of altered kidney cell types and states with several novel genes associated with tissue injury, remodelling and fibrosis.

**Funding:** Other NIH Support - Common Fund (NHLBI)

### SA-OR06

#### Kidney Disease and COVID-19 Outcomes in the Temporal Analysis of Pandemic Waves

Ning Shang, Krzysztof Kiryluk. *Columbia University, New York, NY.*

**Background:** COVID-19 continues to spread worldwide with considerable morbidity and mortality. CKD is among the most prevalent diseases related to COVID-19 mortality. AKI is a common COVID-19 complication. Distinct pandemic waves were observed as a function of specific COVID-19 variants, public health policies and vaccination status. Studies reported changing patient characteristics and outcomes by different waves. However, changes in the effect of clinical risk factors as a function of each wave have not been well studied. Here, we examine the temporal effects of pre-existing CKD (also KDIGO A and G stages) on COVID-19 outcomes by waves.

**Methods:** We used estimated effective reproduction numbers with US data to define distinct waves. We designed a COVID-19 algorithm based on WHO guidelines, N3C COVID-19 V2.2 and local data characteristics as having  $\geq 1$  positive SARS-CoV-2 RT-PCR or antibody test, or  $\geq 3$  diagnosis or problem codes if no relevant tests. Comorbidities and outcomes were captured electronically using published algorithms. We used logistic regression and survival analysis to identify predictors of COVID-19 outcomes for each wave.

**Results:** Five national waves were identified and mapped to 4 distinct NYC waves observed at Columbia University Medical Center (CUMC). We identified 64246 COVID-19 cases at CUMC, 8% were severe, 18% were hospitalized. The risk of severe COVID-19 was associated with pre-existing CKD, heart disease, diabetes and hypertension in most waves; and lung disease, obesity and cancer in at least one wave. AKI occurred in 49% of severe cases and 35% of hospitalized ones. The risk of AKI was associated with heart failure, obesity, diabetes and cancer in most waves; and CKD, CAD, hypertension and stroke in one or two waves. The risk of AKI was not associated with pre-existing lung disease. A and G stages independently predicted severe COVID-19 and COVID-19 related AKI across all waves. Pre-existing albuminuria significantly predicted COVID-19 mortality independent of G-stage, diabetes, obesity, hypertension, cancer or cardiovascular disease throughout the entire pandemic.

**Conclusions:** Pre-existing kidney disease was among the strongest and most consistent clinical predictors of poor COVID-19 outcomes regardless of the pandemic wave. Even in the pandemic late phase, patients with decreased kidney function or albuminuria were at a higher risk of severe COVID-19, AKI and death.

**Funding:** NIDDK Support

**SA-OR07**

**COVID-19 Pandemic Effect on Mortality of Hemodialysis Patients**

**Yan Zhang,<sup>1</sup> Luca Neri,<sup>2</sup> Paola Carioni,<sup>2</sup> Otto Arkossy,<sup>1</sup> Manuela Stauss-Grabo,<sup>1</sup> Frank M. Laukhuf,<sup>1</sup> Len A. Usvyat,<sup>3</sup> Stefano Stuard,<sup>1</sup> Anke Winter,<sup>1</sup> <sup>1</sup>Fresenius Medical Care Deutschland GmbH, Bad Homburg, Germany; <sup>2</sup>Fresenius Medical Care Italia SpA, Palazzo Pignano, Italy; <sup>3</sup>Fresenius Medical Care North America, Waltham, MA.**

**Background:** COVID-19 was associated with significant excess mortality among dialysis patients. We aimed to assess mortality risk of patients with confirmed COVID-19 infection (COVID-19+) versus other hemodialysis (HD) patients, and its relation to COVID-19 pandemic in general population (GP).

**Methods:** We included 63,216 HD patients treated in 2019-2020 at NephroCare centers of 23 countries from European Clinical Database (EuCliD®). Mortality risk per calendar month in 2020 was estimated separately for COVID-19+ and other HD patients using Cox regression models, with COVID-19 status as a time-varying covariate and patients per month in 2019 as reference. The correlation between monthly mortality risk and numbers of COVID-19 cases and deaths in GP were evaluated.

**Results:** Monthly treated patients were 42,000-43,000 (Fig1). In line with two waves of pandemic in GP, two fluctuations of mortality risk were observed for both COVID-19+ and other HD patients (Fig1). Mortality risk of COVID-19+ patients persisted at much higher levels across 2020, with adjusted hazard ratios (HR)>6.5, whereas mortality risk of other HD patients elevated slightly (HRs<1.5) and mainly during the pandemic peak period (Fig1). Correlation of mortality risk with pandemic in GP were higher for other HD patients (spearman correlation coefficients [ρ] of HRs with the numbers of COVID-19 cases/deaths in GP, 0.77/0.44) than for COVID-19+ HD patients (ρ, -0.10/0.42).

**Conclusions:** COVID-19 pandemic had direct and indirect impact on mortality of HD patients. Potential reasons of increased mortality in patients without confirmed COVID-19 diagnosis could be understesting or healthcare system capacity constraints. Quantifying the magnitude of pandemics on patients with/without confirmed disease may benefit dialysis clinics to manage patients during critical events.

**Funding:** Commercial Support - Fresenius Medical Care

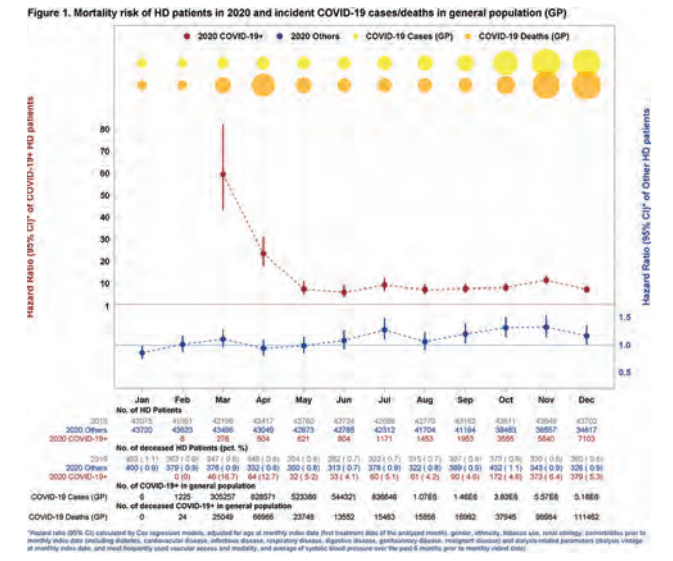

**SA-OR08**

**Vaccine Effectiveness of One, Two, or Three Doses of SARS-CoV-2 mRNA Vaccines in Maintenance Dialysis Patients**

**Harold J. Manley,<sup>1</sup> Nien Chen Li,<sup>1</sup> Antonia Harford,<sup>1</sup> Jill M. Frament,<sup>1</sup> Margaret Mcnamara,<sup>1</sup> Gideon N. Aweh,<sup>1</sup> Karen M. Majchrzak,<sup>1</sup> Dana Miskulin,<sup>2</sup> Daniel E. Weiner,<sup>2</sup> Caroline M. Hsu,<sup>2</sup> Doug Johnson,<sup>1</sup> Eduardo K. Lacson.<sup>1,2</sup> <sup>1</sup>Dialysis Clinic Inc, Nashville, TN; <sup>2</sup>Tufts Medical Center, Boston, MA.**

**Background:** Preventing COVID-19 infection or its consequences through SARS-CoV-2 vaccination in maintenance dialysis patients, a high risk population, is imperative. We determined relative vaccine effectiveness (VE) of 1, 2, or 3 doses of an mRNA vaccine in preventing SARS-CoV-2 infection, hospitalization, and death.

**Methods:** All adult maintenance dialysis patients at Dialysis Clinic, Inc. offered an mRNA vaccine between 12/15/20 and 2/28/22 were included, with follow up time through 3/31/22. Using a multivariable logistic regression model, we calculated adjusted odds ratios (OR) for COVID-19 infection and associated hospitalization and death

within 30 days during pre-Delta (12/15/20-6/19/21), Delta (6/20-12/18/21) and Omicron (12/19/21-2/28/22) periods. VE was calculated as (1-adjusted OR) x 100%. Patients were censored at infection, death, or transplantation.

**Results:** The 17,309 maintenance dialysis patients included had mean age of 63±15 years, 58% male, 35% Black, 47% White, 87% HD and mean vintage 42±55 months. Across all three COVID-19 variant periods, VE increased with each successive mRNA dose received, improving protection against infection, hospitalization and death (Table). VE was highest among patients vaccinated with homologous mRNA-1273 regimens.

**Conclusions:** Two or more SARS-CoV-2 mRNA vaccine doses exhibited VE protecting against COVID-19 related associated hospitalization and death in maintenance dialysis patients irrespective of variant era. At least 3 doses maximizes protection and may be necessary due to uremia-related mild to moderate immunodeficiency.

**SARS-CoV-2 mRNA vaccine effectiveness**

Period	# mRNA doses	# Patients	Vaccine Effectiveness, % (95% Confidence Interval)		
			Infection	Hospitalization	Death
Pre-Delta	Unvaccinated	3,651	Ref	Ref	Ref
	One dose	544	NR	NR	78 (39, 92)
	Two doses	9,441	59 (52, 65)	70 (61, 77)	99 (97, 100)
Delta Dominant	Unvaccinated	2,572	Ref	Ref	Ref
	One dose	384	NR	NR	NR
	Two doses	4,816	24 (12, 33)	44 (29, 56)	64 (47, 76)
Omicron Dominant	Unvaccinated	2,415	Ref	Ref	Ref
	One dose	390	NR	NR	NR
	Two doses	3,771	NR	40 (18, 55)	64 (34, 81)

Ref = reference group; NR = not reported as effect and/or confidence interval crosses zero

**SA-OR09**

**Clinical Efficacy of the Fourth Dose of the BNT162b2 Vaccine in Chronic Dialysis Patients**

**Moshe Shashar,<sup>1</sup> Ayelet Grupper,<sup>3,4</sup> Tzipi Hornik-Lurie,<sup>2,3</sup> Sydney Benchetrit,<sup>2,3</sup> Yael Einbinder,<sup>2,3</sup> Naomi Nacasch,<sup>2,3</sup> Keren Cohen - Hagai,<sup>2,3</sup> <sup>1</sup>Laniado Hospital, Netanya, Israel; <sup>2</sup>Meir Medical Center, Kfar Saba, Israel; <sup>3</sup>Tel Aviv University, Tel Aviv, Israel; <sup>4</sup>Tel Aviv Sourasky Medical Center, Tel Aviv, Israel.**

**Background:** Following the emergence of the Omicron B.1.1.529 variant of SARS-CoV-2, Israel began on January 2, 2022, to administer a fourth dose of the BNT162b2 vaccine to people 60 years and older and to at-risk populations. Chronic dialysis patients were among the first to receive the fourth dose. Given the scarcity of evidence regarding the efficacy or necessity of a fourth dose, we assessed the clinical efficacy regarding infectivity and all-cause mortality of the fourth dose of the BNT162b2 vaccine among chronic dialysis patients.

**Methods:** This study was conducted using the electronic database of Clalit HMO in Israel. Chronic dialysis patients receiving hemodialysis and peritoneal dialysis during the COVID-19 pandemic were included. The control group was matched in a 4 to 1 ratio to the dialysis group. The study included the pre-vaccination and post-vaccination periods.

**Results:** Included in this analysis were 14,230 patients of whom 2,846 were chronic dialysis patients with a mean age of 66.2±14.3 (range 18-97) years and 62.5% (1,779) were males. Mortality among unvaccinated chronic dialysis patients who tested positive for COVID-19 was 18.4%, as compared to 10.8% among similar patients who did not test positive for COVID-19 during the same period (OR 1.9, 95%CI 1.3-2.7; p<0.001). A total of 1,908 chronic dialysis patients had information available regarding vaccine status and were alive when vaccinations began in December 2020. Among them, 159 (8.3%) were unvaccinated, 113 (5.9%) were vaccinated with 1 dose, 270 (14.2%) with 2 doses, 703 (36.8%) with 3 doses, 663 (34.7%) with 4 doses. During 2022, which was dominated by the Omicron variant, 34.7% of chronic dialysis patients vaccinated with 3-doses were infected with SARS-CoV2 vs. 24.3% of 4-dose patients. Odds ratio for SARS-CoV2 infection after fourth dose was 0.6, (95%CI 0.5-0.8; p<0.001). Odds ratio for all-cause mortality in chronic dialysis patients who received 4 vs. 3 doses was 0.6 (0.4-0.9, 6.3% vs. 10.1%; p<0.001).

**Conclusions:** As seen in the general population, and previous vaccine boosters, the fourth dose of the BNT162b2 vaccine reduced COVID-19 infections, as well as mortality among chronic dialysis patients. Additional studies are needed to establish the exact dose and schedule of the COVID-19 vaccine in patients treated with chronic maintenance dialysis.

**SA-OR10**

**BOOST KIDNEY: A Randomized Controlled Trial of Third Dose BNT162b2 vs. mRNA-1273 COVID-19 Vaccination in CKD and Dialysis Patients**

**Kevin Yau,<sup>1</sup> Christopher T. Chan,<sup>1</sup> Kento T. Abe,<sup>2</sup> Matthew J. Oliver,<sup>1</sup> Adeera Levin,<sup>3</sup> Anne-Claude Gingras,<sup>2</sup> Michelle A. Hladunewich.<sup>1</sup> <sup>1</sup>University of Toronto Temerty Faculty of Medicine, Toronto, ON, Canada; <sup>2</sup>Lunenfeld-Tanenbaum Research Institute, Toronto, ON, Canada; <sup>3</sup>BC Provincial Renal Agency, Vancouver, BC, Canada.**

**Background:** Due to waning humoral immunity, a third COVID-19 vaccine dose is recommended but there is a lack of evidence regarding whether there is benefit to homologous versus heterologous mRNA vaccination.

**Methods:** This was a multi-centre parallel group randomized controlled trial in Toronto, Ontario from September 30, 2021 to May 13, 2022 which enrolled participants with stage 3B-5 chronic kidney disease with prior homologous mRNA two dose vaccination. Overall 273 participants were randomized 1:1 to either 30µg BNT162b2 (n=137) or 100 µg mRNA-1273 (n=136) third dose stratified by initial vaccine type. Neutralizing antibodies against the B.1.1.529 (Omicron) variant of concern as well as binding SARS-CoV-2 IgG antibodies to the spike protein, receptor binding domain, and nucleocapsid protein were measured.

**Results:** Participants had a median age of 67 years, 94% were on dialysis, 3% had prior COVID-19, and 59% had received BNT162b2 for initial two dose vaccination. Prior to the third vaccine dose, detectable Omicron neutralizing antibodies were present in 2% with BNT162b2 and 54% with mRNA-1273 two dose vaccination. At 1 month post third dose, among those with baseline BNT162b2, Omicron-specific neutralizing antibodies were detectable in 84% with third dose BNT162b2 in comparison to 83% with third dose mRNA-1273 (p=0.70). In those with baseline mRNA-1273, 100% receiving third dose mRNA-1273 had Omicron-specific neutralizing antibodies in comparison to 96% with third dose BNT162b2 (p=0.75). During the study period, 9.3% of participants (n=25) contracted COVID-19 and two died from COVID-19 with no difference in infection based on vaccine type (p=0.26).

**Conclusions:** In this randomized controlled trial of third dose COVID-19 vaccination, both homologous and heterologous vaccination elicited robust SARS-CoV-2 neutralizing antibody response.

**Funding:** Commercial Support - Oreopoulos/Baxter Home Dialysis Grant from the University of Toronto Division of Nephrology, Government Support - Non-U.S.

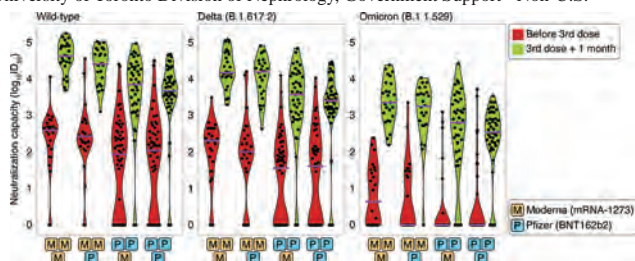

Viral neutralization against wild-type, Delta, and Omicron variants of concern prior to third dose and 1 month following third dose BNT162b2 or mRNA-1273 vaccination.

## SA-OR11

### Genome-Wide Association Studies of a Composite Renal Phenotype Reveal Pleiotropic Effects and a Novel Locus

Moumita Barua,<sup>1</sup> Sarah A. Gagliano Taliun,<sup>2</sup> Andrew Paterson.<sup>3</sup> <sup>1</sup>Toronto General Hospital, Toronto, ON, Canada; <sup>2</sup>Universite de Montreal, Montreal, QC, Canada; <sup>3</sup>The Hospital for Sick Children, Toronto, ON, Canada.

**Background:** Our previous genome-wide association study (GWAS) of hematuria using ICD codes in the UK Biobank identified 6 loci, some of which overlap with loci for albuminuria suggesting pleiotropy. Hematuria cases had higher systolic blood pressure, higher urine albumin:creatinine (uACR) ratios and lower eGFR compared to controls, supporting enrichment for hematuria due to glomerular pathologies. Although most GWAS analyze one trait at a time, many clinical syndromes are defined by combinations of outcomes. Therefore, generating a combined phenotype may improve power to detect loci influencing multiple traits.

**Methods:** The composite outcome of hematuria and albuminuria was chosen to enrich for glomerular disease. We performed a case-control GWAS in the white British subset of the UK Biobank. Cases had both hematuria defined by ICD codes and albuminuria defined as uACR >3 mg/mmol. Controls did not have either an ICD code for hematuria nor an uACR >3 mg/mmol.

**Results:** 2,429 cases and 343,509 controls were included. eGFR was significantly lower in cases (F: 88.6±16.5 mL/min/1.72m<sup>2</sup>, M: 82.2±20.1 mL/min/1.72m<sup>2</sup> by CKD EPI) compared to controls (F: 90.6±13.1 mL/min/1.72m<sup>2</sup>, M: 90.6±12.6 mL/min/1.72m<sup>2</sup>) in both sexes. Variants at 4 loci met genome-wide significance (p<5x10<sup>-8</sup>) with the following nearest genes: *COL4A4-COL4A3*, *TRIM27*, *ETV1* and *CUBN*. *TRIM27* is part of the extended *MHC* locus. Our previous GWAS of hematuria reported *COL4A3-COL4A3* variants and *HLA-B\*0801* within *MHC*, but the latter is not in linkage disequilibrium (LD) with the *TRIM27* variant. Additional loci are identified for the composite outcome including *CUBN* (previously associated with albuminuria) and a novel signal at chromosome 7 (*ETV1*, (nearest gene), rs146676616, p=1.3x10<sup>-8</sup>, alternate allele (G) frequency in cases versus controls: 1.77% versus 0.91%, OR=2.61, 95% CI=1.87-3.63).

**Conclusions:** GWAS for the composite outcome of hematuria and albuminuria identifies 4 loci. Three were not identified in our previous GWAS of hematuria enriched for glomerular causes. These include variants with closest genes *TRIM27*, within the extended *MHC* locus but not in LD with *HLA-B\*0801* reported previously, *CUBN* and a novel signal at chromosome 7. Analysis of composite phenotypes has the potential to identify novel loci which have pleiotropic effects.

**Funding:** Government Support - Non-U.S.

## SA-OR12

### Gene Surgery: A Potential CRISPR/Cas-Based Treatment Option for Nephropathic Cystinosis In Vitro

Elena Sendino Garvía,<sup>1</sup> Mert Öktem,<sup>1</sup> Rosalinde Masereeuw,<sup>1</sup> Patrick T. Harrison,<sup>2</sup> Enrico Mastrobattista,<sup>1</sup> Manoe J. Janssen.<sup>1</sup> Pharmacology Group <sup>1</sup>Universiteit Utrecht Utrechts Instituut voor Farmaceutische Wetenschappen, Utrecht, Netherlands; <sup>2</sup>University College Cork, Cork, Ireland.

**Background:** Nephropathic cystinosis is a rare monogenetic kidney disease caused by mutations in the *CTNS* gene, which encodes for the lysosomal cystine transporter, cystinosin. Mutations in the *CTNS* gene lead to the loss of the cystinosin transporter, resulting in intralysosomal cystine accumulation. There is no curative treatment for cystinosis to date, therefore, we aim to develop a novel gene repair strategy for the most predominant 57 kb deletion of *CTNS* using CRISPR-Cas9 technology, which allows for the delivery of a *CTNS* repair template into a specific location in the genome.

**Methods:** For this study, we used two conditionally immortalized proximal tubule epithelial cells (ciPTEC): a cystinotic patient-derived and a *CTNS*<sup>-/-</sup> knock-out. For the delivery of the repair complex, we used a novel non-viral peptide-mediated delivery system. The repair construct for *CTNS* (3.2 kb) contains the *CTNS* promoter and the first 10 exons of the *CTNS* gene, as well as a fluorescent reporter gene (*mCherry*). Additionally, a second repair construct was designed (1.7 Kb), excluding the *mCherry* gene, to study a more therapeutic-like construct.

**Results:** After transfection of the repair construct, the large and small repair templates achieved 5% and 20% insertion efficiency (N=3), respectively, indicating that the cells had successfully inserted the repair template into their DNA. Further analysis of individual clonal cells showed restoration of lysosomal cystine levels in 60% of the clones transfected with the big template (3.2 Kb), showing cystine values between 1-2nmol/mg protein (N=12; p<0.001). Strikingly, more than 70% of the clones transfected with the therapeutic-like template (1.7 kb), which were blind sorted, show cystine values between 0.5-2nmol/mg protein (N=15; p<0.001) thus, indicating that in most of the cells the repair template was inserted, consequently restoring the *CTNS* function.

**Conclusions:** In conclusion, these data show that the *CTNS* repair template can be precisely inserted into the genome, leading to the translation of a functional cystinosin transporter, which consequently restores the lysosomal cystine accumulation. Eventually, this gene repair system may offer a potential curative therapy for cystinosis, as well as a system for the *in vitro* restoration of several other genes involved in monogenic diseases.

**Funding:** Government Support - Non-U.S.

## SA-OR13

### Channel Function of Polycystin-2 in Endoplasmic Reticulum Protects Against Polycystic Kidney Disease

Biswajit Pathy, Jian Xie, Rumping Wang, Fang Lin, Chou-Long Huang, Huang Lab University of Iowa Carver College of Medicine, Iowa City, IA.

**Background:** Autosomal dominant polycystic kidney disease (ADPKD) is among the most common monogenic inherited disease in humans leading to end-stage renal disease. Mutations in PKD2 gene that encodes PC2 protein are responsible for ~15% of the ADPKD cases. The prevailing view is that altered Ca<sup>2+</sup> influx by mutated PC2 in the primary cilia is the cause for ADPKD pathogenesis. Yet, most of PC2 is localized to endoplasmic reticulum (ER) and more permeable to K<sup>+</sup> than Ca<sup>2+</sup>. In the cilia-centric view, ER-localized PC2 mainly facilitates ciliary targeting of PC1-PC2 complexes.

**Methods:** The trimeric intracellular channel-B (TricB), aka TMEM38B, is an ER resident K<sup>+</sup> channel that mediates K<sup>+</sup>-Ca<sup>2+</sup> counterion exchange for inositol trisphosphate-mediated Ca<sup>2+</sup> release. Using TricB as experimental tool, we explored the function of ER-localized PC2 and its role in ADPKD pathogenesis by using cultured cells, zebrafish, and mouse models.

**Results:** ATP-induced ER Ca<sup>2+</sup> release was defective in PC2-null renal epithelial cells, which was reversed by exogenous expression of TricB. Likewise, exogenous PC2 reversed ER Ca<sup>2+</sup> release defect in TricB-null HEK293 cells. Microinjection of wildtype but not non-functional TricB mRNA into PC2-morphant zebrafish embryos ameliorated pronephric cysts. Similarly, ER targeting of ROMK K<sup>+</sup> channel normally expresses on the plasma membrane suppressed the cystic phenotypes. R6G mutant of PC2 that fails to localize to cilia was still capable of reversing ER Ca<sup>2+</sup> release defect in PC2-null cultured cells and PC2-deficient zebrafish phenotypes. Transgenic expression of TricB reversed cystic phenotypes in conditional Pkd2-inactivated mice. TricB deletion enhanced cystogenesis in Pkd2-heterozygous kidneys.

**Conclusions:** ER-localized PC2 plays an important role in the pathogenesis of ADPKD. It acts as a K<sup>+</sup> channel to facilitate K<sup>+</sup>-Ca<sup>2+</sup> counterion exchange for inositol trisphosphate-mediated Ca<sup>2+</sup> release. The results challenge the current cilia-centric dogma providing insights for understanding ADPKD pathogenesis and proof-of-principle for pharmacotherapy by TricB activators.

**Funding:** NIDDK Support

## SA-OR14

**Downregulation of O-GlcNAc Reduces Ciliary Length and Attenuates Renal Cystic Disease in PKD Mice**

Matthew A. Kavanaugh,<sup>1,2</sup> Wei Wang,<sup>1,2</sup> Henry Wang,<sup>1,2</sup> Brittany M. Hufft-Martinez,<sup>1,2</sup> Chad Slawson,<sup>2,3</sup> Stephen C. Parnell,<sup>2,3</sup> Darren P. Wallace,<sup>2,4</sup> Pamela V. Tran,<sup>1,2</sup> <sup>1</sup>University of Kansas Medical Center Department of Anatomy and Cell Biology, Kansas City, KS; <sup>2</sup>The Jared Grantham Kidney Institute, Kansas City, KS; <sup>3</sup>University of Kansas Medical Center Department of Biochemistry and Molecular Biology, Kansas City, KS; <sup>4</sup>University of Kansas Medical Center Department of Physiology, Kansas City, KS.

**Background:** Renal cysts occur in both ciliopathies and mitochondrial diseases, and primary cilia and cellular metabolism are important modifiers of autosomal dominant polycystic kidney disease (ADPKD). The nutrient sensor, O-linked N-acetylglucosamine (O-GlcNAc), regulates mitochondrial function as well as ciliary homeostasis. Thus, we hypothesized that O-GlcNAc signaling is misregulated in ADPKD and contributes to renal cystogenesis.

**Methods:** Immunostaining and Western blot analysis were performed to examine O-GlcNAc levels in mouse and human ADPKD tissues. Using the HoxB7-Cre in mice, *Pkd1* was deleted in collecting ducts, alone and together with O-GlcNAc transferase (*Ogt*), which transfers O-GlcNAc onto protein substrates. Mouse kidneys were analyzed on postnatal days 14 and 21. ADPKD patient cells were treated with pharmacological inhibitors of OGT and ciliogenesis, and effects on cilia lengths and *in vitro* cyst formation were examined. Co-immunoprecipitation in mouse renal tissue was performed to determine endogenous targets of OGT.

**Results:** O-GlcNAc levels were elevated in mouse and human ADPKD renal cyst-lining cells compared to normal tissues. *Ogt* deletion in juvenile *Pkd1* conditional knock-out mice reduced ciliary length, renal cystogenesis and kidney weight/body weight, improved kidney function, and increased survival of the mice. Similarly, OGT inhibition in cultured ADPKD patient renal epithelial cells shortened primary cilia and reduced *in vitro* cyst formation. Additionally, combined treatment of ADPKD cells with OGT and ciliogenesis inhibitors reduced cyst formation to a greater extent than treatment with either inhibitor alone. Co-immunoprecipitation data revealed that OGT interacts with intraflagellar transport protein IFT81, which is important for cilia synthesis and maintenance.

**Conclusions:** O-GlcNAc is elevated in ADPKD kidneys, and its downregulation reduces ciliary length and renal cystogenesis. OGT binds to IFT81, which may present a novel mechanism of ciliary length control. We propose that O-GlcNAc links the metabolic and ciliary defects in ADPKD and may present new avenues for designing therapeutic strategies.

**Funding:** Other U.S. Government Support

## SA-OR15

**The Methionine-Mettl3-RNA Methylation Axis Is Essential for Nephrogenesis**

Harini Ramalingam, Jesus A. Alvarez, Elyse D. Grilli, Thomas J. Carroll, Vishal Patel. *The University of Texas Southwestern Medical Center Department of Internal Medicine, Dallas, TX.*

**Background:** RNAs undergo dynamic chemical changes, which can impact their processing, stability, or translational efficiency, a phenomenon termed 'epitranscriptomics'. N6-methyladenosine (m<sup>6</sup>A) is the most abundant eukaryotic RNA chemical modification. Mettl3, an mRNA methyltransferase, mediates the m<sup>6</sup>A reaction by transferring an activated methyl group from S-adenosyl methionine (SAM) to adenosine. A major contributor of renal failure is low 'nephron endowment', which chiefly occurs due to defects in the self-renewal or the differentiation of the nephron progenitors (NPs). Here, we studied whether the methionine-RNA methylation pathway plays a role in the renewal and differentiation of NPs.

**Methods:** We examined Mettl3 expression in the NP lineage of developing kidneys. We generated mice to conditionally ablate or overexpress Mettl3 in the NP lineage. We used a Mettl3-specific inhibitor or activator to pharmacologically modulate the m<sup>6</sup>A pathway in *ex vivo* kidney cultures and isolated primary NP cultures. We also tested whether methionine and SAM impact NP fate.

**Results:** We find that the Mettl3-m<sup>6</sup>A pathway expression is higher in differentiated NPs compared to renewing NPs. Six2/cre-mediated Mettl3 deletion blocks NP differentiation leading to the accumulation of renewing NPs and a markedly lower nephron count. In contrast, deleting Mettl3 subsequent to NP differentiation, using Wnt4/cre, has no impact on kidney development. Conversely, Six2/cre-mediated Mettl3 overexpression results in precocious and ectopic differentiation leading to the premature depletion of renewing NPs. Similarly, acute pharmacological Mettl3 inhibition or methionine depletion blocks NP differentiation whereas acute Mettl3 activation or higher SAM availability has an opposite effect in cultures. Moreover, methionine/SAM promotes Mettl3 expression in NPs, and regulates NP fate through Mettl3. Finally, subthreshold activity of the Mettl3-m<sup>6</sup>A pathway appears to induce both NP renewal and differentiation leading to enhanced nephrogenesis in *ex vivo* kidney cultures and in kidney organoids.

**Conclusions:** Our work uncovers RNA methylation as a novel stem cell pathway in metanephros development and links methionine utilization to m<sup>6</sup>A chemical modification in NP fate commitment.

**Funding:** NIDDK Support

## SA-OR16

**Estrogen Signaling Is an Essential Regulator of Nephron Segmentation**

Hannah M. Wesselman, Rebecca A. Wingert. *University of Notre Dame, Notre Dame, IN.*

**Background:** Despite many significant advances in understanding nephron segment patterning, numerous questions remain about the underlying genes and signaling pathways that orchestrate cell fate and regulate differentiation. In an effort to identify novel regulators of nephron segmentation, our lab conducted a high throughput drug screen using a bioactive chemical library and developing zebrafish, which are a conserved vertebrate model and particularly conducive to large-scale screening approaches. 17 $\beta$ -Estradiol (E2), which is the dominant form of estrogen in vertebrates, was a particularly interesting hit from this screen. While E2 has been extensively studied in the context of gonad development, the mechanism of E2 action in nephron development and segmentation remains poorly understood.

**Methods:** We evaluated the effects of E2 on segmentation using high throughput chemical screens and analyzed segmentation phenotypes using whole mount *in situ* hybridization (WISH). Knockdown of estrogen receptors was achieved via morpholino injection and CRISPR-Cas9 mutagenesis. Changes in cell dynamics (e.g. cell death and proliferation) were also analyzed via immunofluorescence.

**Results:** Exogenous estrogen treatments revealed changes in distal segment composition. Interestingly, xenoestrogens ethinylestradiol and genistein yielded the same changes in distal segments. Upon treatment with an Esr2 antagonist, PHTPP, we observed the opposite phenotypes. Similarly, genetic knockdown of Esr2 analogs revealed phenotypes consistent with that of PHTPP treatment. Inhibition of E2 signaling also resulted in decreased expression of essential distal transcription factors.

**Conclusions:** Taken together, these data suggest that estrogenic compounds are essential for distal segment fate during nephrogenesis, and add to our understanding of hormone function during kidney organogenesis. Considering the presence of sex differences observed in kidney morphology and renal disease, exploring the influence of sex hormones in the kidney is of utmost importance.

## SA-OR17

**Human Ureteric Bud Organoids Derived From Pluripotent Stem Cells Recapitulate Embryonic Development and Differentiate Into Collecting Duct Cell Types With Functional Ion Transport**

Kyle McCracken,<sup>1,2</sup> Ankit B. Patel,<sup>2</sup> Joseph V. Bonventre,<sup>2</sup> <sup>1</sup>Boston Children's Hospital, Boston, MA; <sup>2</sup>Brigham and Women's Hospital, Boston, MA.

**Background:** The ability to derive functional ureteric and collecting duct epithelia from human pluripotent stem cells (hPSCs) will be an essential component of kidney regenerative medicine. Here we describe highly efficient methods to guide the differentiation of ureteric bud (UB) organoids and derive functional collecting duct (CD) cells from these organoids.

**Methods:** Directed differentiation of hPSCs was performed using sequential growth factor manipulations to recapitulate normal developmental stages including pronephric intermediate mesoderm (IM), nephric duct (ND), and UB. At day 3 IM cells were aggregated into spheroids, which at day 7 were then embedded into a 3D matrix to support branching morphogenesis. Cells from the organoids were functionally interrogated using 2D transwell culture and Ussing chambers.

**Results:** hPSCs were induced into PAX2/GATA3<sup>+</sup> pronephric IM progenitor cells at 90% efficiency, which then generated spheroids that underwent spontaneous organization and adopted a molecular phenotype consistent with the ND. In 3D culture, the spheres developed into UB organoids that exhibited branching morphogenesis and spatial organization comparable to the fetal UB. At later stages the UB organoids differentiated into CD organoids, which contained >95% CD cell types as estimated by scRNA-seq. Cells isolated from the organoids generated robust ENaC-mediated vectorial Na<sup>+</sup> transport that was further induced by stimulation with mineralocorticoid signaling. We also showed that ectopic FOX11 induced formation of intercalated cells (ICs), which in 2D exhibited V-type ATPase-mediated H<sup>+</sup> secretion that produced a transepithelial pH gradient.

**Conclusions:** These methods result in efficient and consistent differentiation of UB organoids, making them accessible to the kidney research community. The organoids exhibit developmental properties including branching morphogenesis, which will enable their use in catalyzing novel regenerative medicine approaches. The derivation of both functional principal cells and ICs that exhibit Na<sup>+</sup> and H<sup>+</sup> transport, respectively, is the first demonstration of renal cells derived from hPSCs with advanced ion transport and electrophysiologic properties and presents an unprecedented model for interrogating CD physiology and disease.

**Funding:** NIDDK Support, Private Foundation Support

## SA-OR18

**ASH2L Is Essential for the Ureteric Bud Lineage Development**

Ziyi Zhao,<sup>1</sup> Fujun Lin,<sup>1,2</sup> Gengru Jiang,<sup>1,2</sup> <sup>1</sup>Xin Hua Hospital of Shanghai Jiao Tong University School of Medicine, Shanghai, China; <sup>2</sup>Centre for Rare Disease, Shanghai, China.

**Background:** Ureteric bud (UB) induction/branching morphogenesis are the fundamental processes during kidney development, of which GDNF-RET/GFRA1 signaling pathway occupies a central place. Histone modifications have a crucial role in kidney development by placing active/silencing histone marks at different gene regions to fine-tune genes expression. Given that ASH2L, a core subunit in KMT2 enzymes which



mediate H3K4 methylation, is widely expressed in UB derivatives, we examined the role of ASH2L in UB lineage morphogenesis during mouse kidney development.

**Methods:** We inactivated *Ash2l* expression in the UB lineage using the Cre/loxP system by crossing transgenic Hoxb7creEGFP mice to *Ash2l<sup>fl/fl</sup>* mice and analyzed the phenotype of the *Ash2l* mutants and their littermate controls. Kidney histology and UB branching morphogenesis were studied in *Ash2l* mutants. E16.5 metanephroi were digested and the UB lineage cells were sorted by FACS and processed for RNA-seq or CUT&Tag-seq. Differentially expressed genes were validated by RT-qPCR and RNA-scope.

**Results:** Conditional inactivation of *Ash2l* in the UB lineage results in malformed kidneys at birth. The budding/branching events of the UB is severely delayed both *in vivo* and *in vitro*. Molecularly, inactivation of *Ash2l* leads to downregulated expression of GDNF-RET/GFRA1 signaling pathway components via repression of H3K4 tri-methylation on promoter regions, resulting in eventually UB cell cycle arrest.

**Conclusions:** Our study uncovers the novel role of ASH2L during the UB lineage development and H3K4 methylation as the upstream epigenetic regulator of GDNF-RET/GFRA1 signaling pathway. Our study also offers new insights into the role of active histone marks in the molecular pathogenesis of CAKUT.

**Funding:** Government Support - Non-U.S.

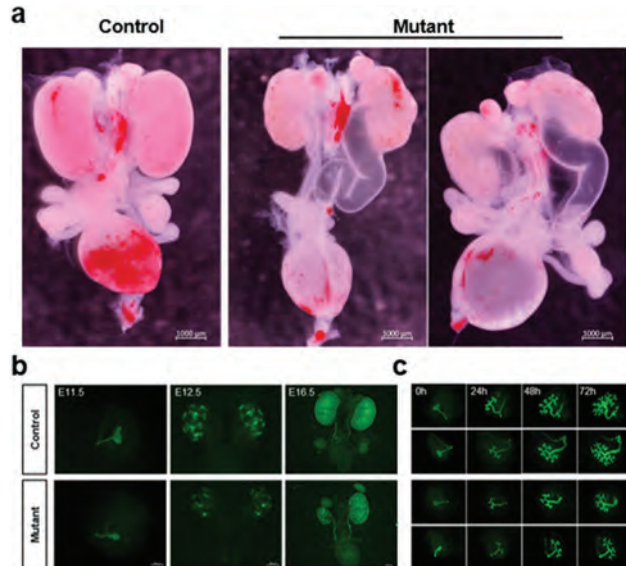

The mutants show malformed kidneys at birth (a). The budding/branching events of the UB is severely delayed both *in vivo* (b) and *in vitro* (c).

## SA-OR19

### Establishing the Spatiotemporal Organization and Function of Renal Nerves Throughout Nephrogenesis

Pierre-Emmanuel N'Guetta, Lori L. O'Brien. O'Brien Lab The University of North Carolina at Chapel Hill Department of Cell Biology and Physiology, Chapel Hill, NC.

**Background:** Essential kidney functions are regulated by intrinsic cellular mechanisms including signaling through renal nerves. Despite their significance to renal physiology, we still lack a fundamental understanding of the establishment, organization, and function of kidney innervation during organogenesis. Our goal is to spatially and temporally map renal sensory and sympathetic innervation throughout development to identify cellular targets and elucidate functional crosstalk.

**Methods:** To assess the process of kidney innervation across development, we generated 3D anatomical maps of renal nerves using light-sheet fluorescent microscopy and confocal microscopy.

**Results:** Our analyses show that renal innervation initiates at E13.5 as these nerves track closely with the smooth muscle-coated arterial tree. We find that sensory and sympathetic nerves innervate the kidney concomitantly, and that innervation continues via branching events as axons track with the developing vasculature. After the establishment of the renal neurovascular main branches, we observed subsequent interstitial branching by E17.5 as renal nerves grow until axonal projections reach their targets. Further, we uncovered that renal nerves synapse with the vasculature as early as E16.5, suggesting the establishment of functional crosstalk. We also observed synapses near glomeruli and tubules by E18.5. To assess functional roles for nerves during kidney development, we genetically ablated neurons innervating the kidney utilizing a *TrkA* knockout mouse. Postnatal *TrkA* knockout kidneys had a significant reduction in renal innervation and presented with reduced glomerular number and dilated proximal tubules, suggesting renal nerves mediate proper nephrogenesis and/or early function.

**Conclusions:** Taken together our findings provide novel insights into the establishment of renal innervation and the role renal nerves play during development. Future efforts will aim to conditionally delete sensory or sympathetic renal nerves independently and investigate the developmental and functional phenotypes.

**Funding:** NIDDK Support

## SA-OR20

### Deciphering the Origins of Kidney Lymphatics

Daniyal J. Jafree,<sup>1,2</sup> Christopher Rowan,<sup>3</sup> Maria K. Joannou,<sup>1</sup> Lauren G. Russell,<sup>1</sup> Julie A Siegenthaler,<sup>4</sup> Adrian S. Woolf,<sup>5</sup> Norman D. Rosenblum,<sup>3</sup> Peter Scambler,<sup>1</sup> David A. Long.<sup>1</sup> UCL ICH Kidney Development and Disease <sup>1</sup>UCL Great Ormond Street Institute of Child Health, London, United Kingdom; <sup>2</sup>UCL MB/PhD Programme, London, United Kingdom; <sup>3</sup>SickKids Research Institute, Toronto, ON, Canada; <sup>4</sup>University of Colorado, Denver, CO; <sup>5</sup>The University of Manchester Faculty of Biology Medicine and Health, Manchester, United Kingdom.

**Background:** Lymphatics clear excess tissue fluid, cells and macromolecules from organs, and are emerging as players in kidney diseases and transplant rejection. Lymphatics were thought to solely originate by sprouting from veins. More recently, we showed that kidney lymphatics can arise using a distinct cellular mechanism featuring the formation of lymphatic 'clusters', akin to a *de novo* vasculogenic process. In this study, we designed experiments to decipher where kidney lymphatics come from.

**Methods:** To identify kidney lymphatics origins, we utilised Cre recombinase-dependent expression of tdTomato for lineage tracing in mouse embryos. We used the following Cre lines to determine the contribution of different cell lineages to lymphatics: (i) *Tie2-Cre* for endothelial precursors; (ii) *Osr1-CreER<sup>TR</sup>* for posterior intermediate mesoderm and (iii) *Six2-Cre*, *Tbx18-CreER<sup>TR</sup>* and *Foxd1-Cre* for nephron epithelial, ureteral mesenchyme and renal stroma, respectively. Intact, lineage traced kidneys were subject to wholemount immunolabelling for tdTomato and the lymphatic markers, PROX1 and PDPN, before tissue clearing and confocal microscopy. From the resulting high-resolution 3D images, we quantitatively assessed contributions from each origin to kidney lymphatics.

**Results:** We found 85% of kidney lymphatics to derive from endothelial precursors, as assessed by labelling *Tie2<sup>+</sup>* cells and their progeny. Conversely, 15% of kidney lymphatics arose from an *Osr1<sup>+</sup>* cell lineage, whereas lymphatics in the heart, skin and lung did not originate from *Osr1<sup>+</sup>* progenitors. We found that kidney lymphatics did not originate from *Six2<sup>+</sup>* cells, or from *Tbx18<sup>+</sup>* ureteral mesenchyme, both which derive from *Osr1<sup>+</sup>* cells. However, we provide evidence that the *Foxd1<sup>+</sup>* renal stroma is a source of progenitor cells giving rise to kidney lymphatics. No single lineage was exclusive for lymphatic clusters.

**Conclusions:** Our study emphasises the early colonisation of the mammalian kidney by lymphatics. It also points to an unexpected variety of lineages giving rise to kidney lymphatics, including a novel non-endothelial origin specific to the kidney. These insights challenge the paradigm that lymphatics from different origins form through distinct cellular mechanisms. Further, they critically inform future studies of the roles of lymphatics in kidney development and disease.

## SA-OR21

### Tenascin-C Promotes Migration and Proliferation of Parietal Epithelial Cells and Participates in the Pathogenesis of FSGS

Ke Sun, Chuanming Hao. Fudan University, Shanghai, China.

**Background:** The parietal epithelial cells (PECs) have been suggested to play an important role in FSGS. Our previous study shows that extracellular matrix Tenascin-C (TNC) is expressed in the PECs. The present study examined the role of TNC expressing PECs and TNC in the pathogenesis of FSGS.

**Methods:** Experimental FSGS was induced on 8-week-old male BalbC mice by i.v. of 10.5 mg/kg body weight of adriamycin. A TNC promoter driven tamoxifen inducible CreER2-IRES-EGFP knock-in mouse line (BalbC) was generated to examine the role of TNC in FSGS. TNC-CreER-tdTomato mice were used for a TNC reporter and cell lineage tracing experiment.

**Results:** TNC reporter mice showed that TNC was selectively expressed in the PECs. The TNC expression was induced in the kidney of adriamycin-induced FSGS as shown by immunoblot. Immunohistochemistry revealed that the expression of TNC was localized to the sclerotic area in the glomeruli and in the adhesion between the glomerular tuft and Bowman's capsule of sclerotic lesions. Importantly the expression of TNC in the PECs was also observed in human kidney by *in situ* hybridization. To examine the role of TNC expressing parietal epithelial cells in sclerosis lesion in FSGS, we did a cell lineage tracing study. Following adriamycin injection, the daughter cells of the TNC expressing PEC lineage appeared in glomerular tufts, suggesting the migration and invasion of the PECs into the glomerular tufts. To further examine the role of TNC in the sclerotic damage in FSGS, we generated TNC knockout mice. BUN was significantly increased in mice following adriamycin treatment ((6.71±0.73) vs(18.38±2.93) mmol/l, p<0.01). TNC deletion significantly attenuated the elevation of BUN ((15.42±2.09) mmol/l, p<0.05). TNC deletion also significantly attenuated the proteinuria following adriamycin treatment (p<0.05). Cell culture studies showed that TNC promoted PEC proliferation and migration. EGFR/ERK cascade and integrin β1 signaling mediated the effect of TNC on PEC.

**Conclusions:** TNC plays an important role in promoting the migration of parietal epithelial cells into the sclerotic area of the glomeruli and participates in the pathogenesis of FSGS.

## SA-OR22

**Cell-Specific Role of STAT3 Signaling in Podocytes vs. Parietal Epithelial Cells in Proliferative Glomerulopathy**

Yogesh Gowthaman,<sup>1</sup> Yiqing Guo,<sup>1</sup> Jesse A. Pace,<sup>1</sup> Robert Bronstein,<sup>1</sup> John C. He,<sup>2</sup> David J. Salant,<sup>3</sup> Sandeep K. Mallipattu.<sup>1,4</sup> <sup>1</sup>Stony Brook Medicine, Stony Brook, NY; <sup>2</sup>Icahn School of Medicine at Mount Sinai, New York, NY; <sup>3</sup>Boston University School of Medicine, Boston, MA; <sup>4</sup>Northport VA Medical Center, Northport, NY.

**Background:** Podocyte-specific loss of an essential zinc finger transcription factor Krüppel-like factor 4 (KLF4) triggers the activation of STAT3 in both podocytes and neighboring parietal epithelial cells (PECs), leading to podocyte loss, PEC activation and proliferation, and eventual FSGS. STAT3 is also activated in podocytes and PECs post-nephrotoxic serum (NTS) treatment, a model of proliferative glomerulopathy. Podocyte-specific loss of *Stat3* preserves podocyte markers and attenuates PEC activation post-NTS treatment. However, the role of *Stat3* in PECs has not previously been studied. The aim of this study is to investigate the cell-context-dependent role of STAT3 in inducing podocyte loss, but contributing to PEC activation and proliferation.

**Methods:** *Podocin-Cre Klf4<sup>fl/fl</sup>;Stat3<sup>fl/fl</sup>* (*Klf4/Stat3-PODKO*) mice were generated to test whether the loss of *Stat3* prevents podocyte loss and subsequent PEC activation and FSGS in *Klf4-PODKO* mice, a model of proliferative glomerulopathy. Inducible and conditional loss of *Stat3* was achieved in PECs by generating *PEC-rtTA;TRE-Cre;Stat3<sup>fl/fl</sup>* (*Stat3-PECKO*) after 2 weeks of doxycycline (DOX) treatment. *Stat3-PECKO* and wild-type mice were treated with nephrotoxic serum (NTS). STAT3-specific inhibitor, S31-201, (control-DMSO) was administered in mice after NTS treatment to assess the effects of simultaneous pharmacological inhibition of STAT3 activation in podocytes and PECs.

**Results:** *Klf4/Stat3-PODKO* mice showed improved albuminuria, %FSGS lesion, preservation of podocyte markers (WT1 and synaptopodin) with a reduction in glomerular CD44 expression, indicating improvement in PEC activation as compared to *Klf4-PODKO* mice. *Stat3-PECKO* exhibited less PEC activation and proliferation, albuminuria, crescent formation, and FSGS compared to wild-type mice after NTS treatment. S31-201 attenuated albuminuria, loss of podocyte markers (WT1, synaptopodin, podocin, and podocalyxin), PEC activation and proliferation (CD44), and FSGS lesions compared to DMSO post-NTS treatment.

**Conclusions:** STAT3 activation in podocytes induces podocyte loss, but in PECs contributes to PEC activation and proliferation in proliferative glomerulopathy.

**Funding:** NIDDK Support, Veterans Affairs Support

## SA-OR23

**Continuous Non-Mutagenic DNA Damage in Podocytes Activates Pathogenic Memory T Cells Through Altered DNA Methylation**

Ran Nakamichi, Kaori Hayashi, Akihito Hishikawa, Hiroshi Itoh. *Keio Gijuku Daigaku Igakubu Daigakuin Igaku Kenkyuka Naikagaku Kyoshitsu, Shinjuku-ku, Japan.*

**Background:** We have previously reported the association of KAT5-mediated DNA damage repair with altered DNA methylation in podocytes (Cell Rep 2019). Recent epigenome-wide studies suggested the association of altered DNA methylation in blood cells with kidney function. However, the mechanism and pathological significance has remained to be adequately elucidated.

**Methods:** To investigate the significance of DNA double-strand breaks (DSBs) in podocytes, we generated podocyte-specific I-PpoI-expressing mice. I-PpoI is a homing endonuclease which causes non-mutagenic DSBs.

**Results:** I-PpoI-mice developed nephrotic syndrome at 6 weeks of age and died because of renal failure around 24 weeks of age following rapid deterioration of renal function. Single-cell RNA seq analysis using renal cortex revealed a marked expansion of immune cells, especially CD8+ T cells exhibited a KLRG1low IL-7Rhigh memory precursor effector cell phenotype, with high expression of NKG2D receptors in I-PpoI-mice. The expression of murine NKG2D ligands, which are upregulated by DNA damage, increased in I-PpoI-mice podocytes. Upregulation of human NKG2D ligands in glomeruli was also observed in patients with various kidney diseases. NKG2D blocking prevented exacerbation of albuminuria and attenuated glomerulosclerosis and fibrosis in I-PpoI mice. Me-DIP seq analysis using peripheral blood cells revealed hypermethylated regions in I-PpoI mice, were enriched in binding sites for a transcription factor STAT1. I-PpoI-mice showed a significant increase in CD44high memory phenotype cells of peripheral CD8+ T cell populations, which was similar phenotype of STAT1 knockout mice. The chimeric WT mice with bone marrow (BM) cells of I-PpoI-mice exhibited an increase in albuminuria temporarily, whereas the chimeric I-PpoI-mice with BM cells of WT mice prevented renal fibrosis and renal death.

**Conclusions:** Continuous non-mutagenic DSBs in podocytes altered methylation of blood cells, including CD8+ T cells, leading sustained changes in immune microenvironment of the kidney and also BM. These results suggest the altered immune microenvironment in the kidney may be a therapeutic target preventing exacerbating glomerulosclerosis and renal fibrosis following podocyte DNA damage in CKD.

## SA-OR24

 **$\gamma$  Isoform of Phosphoinositide 3 Kinase Plays a Critical Role in Propagation of Podocyte Injury in a Genetic Podocytopathy**

Xiaoyan Liang,<sup>1,2</sup> Vidhi Dalal,<sup>1,2</sup> Tomoko Hayashida.<sup>1,2</sup> <sup>1</sup>Ann and Robert H Lurie Children's Hospital of Chicago, Chicago, IL; <sup>2</sup>Northwestern University Feinberg School of Medicine, Chicago, IL.

**Background:** Injury to podocytes is a hallmark of primary glomerular diseases. We previously showed that pharmacological inhibition of  $\gamma$  isoform of phosphoinositide 3 kinase (PIK3CG) abrogates podocyte injury in a mouse model of chemically induced podocytopathy. Here, we show that genetic ablation of PIK3CG prevents podocyte injury in a mouse model of genetic glomerular disease.

**Methods:** NPHS2 deletion was induced by podocyte-specific inducible Cre (NPHS2-rtTA, Tet-o-Cre) in NPHS2f/f, PIK3CG<sup>-/-</sup> mice or their wild type littermates PIK3CG<sup>+/+</sup> by doxycycline starting at 4 weeks of age for 2 weeks. Kidney, urine and serum samples were harvested 2 and 4 weeks after the completion of Cre induction. Urine albumin and creatinine levels were measured by ELISA. Podocytes were isolated by flow sorting with anti-NPHS1 antibody and subjected to RNA sequencing. Specificity for the effect of PIK3CG deletion in podocytes was validated with inducible PIK3CG knockout mice (PIK3CG cKO-podo) treated with intravenous administration of Adriamycin, a chemically-induced model of podocytopathy.

**Results:** Proteinuria became apparent after 2 weeks and peaked at 4 weeks after the completion of doxycycline administration in NPHS2f/f; NPHS2-rtTA Tet-o-Cre; PIK3CG<sup>+/+</sup> mice. In contrast, NPHS2f/f; NPHS2-rtTA Tet-o-Cre; PIK3CG<sup>-/-</sup> mice, proteinuria was minimal at 2 weeks and significantly less compared to PIK3CG<sup>+/+</sup> mice at 4 weeks after Cre recombinase activation. Electron microscope evaluation confirmed that foot processes were preserved in the PIK3CG<sup>-/-</sup> mice. While PIK3CG is also expressed in leukocytes, PIK3CG cKO-podo mice showed significantly less proteinuria in response to Adriamycin compared to their wild-type littermates, suggesting that the protective effect of PIK3CG deletion is specific to podocytes. RNA sequencing is being performed with RNAs isolated from podocytes of NPHS2f/f, NPHS2-rtTA Tet-o-Cre, PIK3CG<sup>-/-</sup> or <sup>+/+</sup> mice with and without disease induction.

**Conclusions:** Together, our data suggest that PIK3CG mediates podocyte injury and could be a novel therapeutic target for children with genetic mutation causing steroid resistant nephrotic syndrome. However, previous studies found that systemic inhibition of PIK3CG increases severe infection due to suppression of its activity in leukocytes. Genes we find by RNA sequencing in this study could be an alternative target.

**Funding:** NIDDK Support

## SA-OR25

**A Possible Role of Anti-Nephrin Autoantibody in Endocytosis of Nephrin in Patients With Post-Transplant Focal Segmental Glomerulosclerosis Recurrence and Minimal Change Disease**

Yoko Shirai,<sup>1</sup> Kenichiro Miura,<sup>1</sup> Shoichiro Kanda,<sup>2</sup> Kiyonobu Ishizuka,<sup>1</sup> Taro Ando,<sup>1</sup> Misako Nakamura,<sup>1</sup> Ryo Nakatani,<sup>1</sup> Aya Kato,<sup>1</sup> Makoto Eguchi,<sup>1</sup> Kazuho Honda,<sup>3</sup> Yutaka Yamaguchi,<sup>4</sup> Motoshi Hattori.<sup>1</sup> <sup>1</sup>Department of Pediatric Nephrology, Tokyo Women's Medical University, Tokyo, Japan; <sup>2</sup>Department of Pediatrics, Tokyo University, Tokyo, Japan; <sup>3</sup>Department of Anatomy, Showa University School of Medicine, Tokyo, Japan; <sup>4</sup>Yamaguchi Pathology Laboratory, Chiba, Japan.

**Background:** Recently, we have found that in a case with post-transplant focal segmental glomerulosclerosis recurrence (rFSGS), circulating nephrin autoantibody was present in the patient's serum and altered localization of nephrin, which merged with IgG, was observed in the kidney tissue specimens of postperfusion (1 h) (Hattori, et al. Am J Transplant 2022). To investigate the mechanism of altered localizations of nephrin in rFSGS, we examined whether phosphorylation of nephrin and endocytosis are involved in very early phases of rFSGS using immunofluorescence study.

**Methods:** 1h biopsy specimens obtained from four patients with rFSGS and native kidney biopsy specimens obtained from four patients with minimal change disease (MCD) relapse were analyzed. Double immunostaining of nephrin or phosphorylated nephrin (p-nephrin) (tyr1176) and IgG were performed using structured illumination microscopy. In addition, double immunostaining of nephrin and ShcA, an adapter protein of p-nephrin, or cholera enterotoxin subunit B (CTxB), a marker of raft-mediated endocytosis (RME), were performed using confocal microscope.

**Results:** Punctate IgG depositions were co-localized with nephrin and p-nephrin (tyr1176) in all patients with rFSGS and three of four patients with MCD relapse. In these seven cases with rFSGS and MCD whose specimens showed punctate IgG deposition co-localizing with nephrin, altered localization of nephrin was observed and the expressions of ShcA were upregulated co-localizing with nephrin. CTxB was colocalized with nephrin in all rFSGS patients, while almost no expression was observed in MCD patients.

**Conclusions:** Anti-nephrin autoantibodies and phosphorylation of nephrin which is associated with ShcA might be involved in the pathogenesis of very early phases of rFSGS and partly contribute to relapse in a subset of MCD patients. Notably, Our study may also suggest that CTxB relating RME altered localizations of nephrin in rFSGS, but not in MCD.

## SA-OR26

**Podocyte-Specific Loss of Klf4 Induces the Formation of Extracellular Matrix Extensions**

Nina Cintron Pregosin, Robert Bronstein, Sandeep K. Mallipattu. *Stony Brook Medicine, Stony Brook, NY.*

**Background:** Podocyte loss is characteristic of multiple glomerular diseases, including focal segmental glomerulosclerosis (FSGS) and rapidly progressive glomerulonephritis (RPGN). In these diseases, podocyte loss triggers the activation and proliferation of neighboring parietal epithelial cells (PECs), leading to crescent formation in the Bowman's space and eventual glomerular injury. We previously identified potential key ligand-receptor interactions between injured podocytes that trigger the activation and proliferation of quiescent PECs in the setting of podocyte-specific knockdown of the pro-differentiation transcription factor, Krüppel-like factor 4 (KLF4). Recent evidence also suggests that injured podocytes might be capable of physically interacting with neighboring cells by extending their extracellular matrices to form bridges between cells. These physical extensions are unique from foot processes and filopodia of podocytes, yet their function is not known.

**Methods:** We investigated bridge formation in two models of proliferative glomerulopathy: mice with podocyte podocyte-specific loss of Klf4 (*Klf4<sup>ΔPod</sup>*) and dual reporter (RFP labeling podocytes, eGFP labeling PECs) mice treated with nephrotic serum (NTS). Immunohistochemistry, immunofluorescence staining, and electron microscopy was used to identify extracellular matrix extensions in glomeruli. Single nucleus (sn)RNA-seq was performed on both injury models.

**Results:** Periodic-acid schiff staining and electron microscopy revealed de novo bridges in mice with podocyte-specific loss of *Klf4* and in mice treated with NTS. Staining NTS-treated dual reporter mice for CD44, a marker of activated PECs, revealed both RFP+ and CD44+ extensions. We also observed colocalization of RFP and CD44, suggesting that both podocytes and PECs are capable of forming bridges. Enrichment analysis of differentially expressed genes between wild type and *Klf4<sup>ΔPod</sup>* mice and IgG and NTS treatment showed common upregulated pathways including focal adhesion (ACTN1, ITGA6, BIRC3), axon guidance (ROCK2, MYL12A, MYL21B), and actin cytoskeleton regulation (ACTN1, FGFR2, MYH9, MSN) in the podocyte and PEC clusters.

**Conclusions:** This is the first study to demonstrate that glomerular bridges in proliferative glomerulopathy originate from both injured podocytes and activated PECs.

**Funding:** NIDDK Support, Other NIH Support - NIH T32

## SA-OR27

**RCAN1 I162T Variant Disrupts Calcineurin Regulation and Reduces Viability in Patient-Derived Podocytes**

Kinsie Huggins,<sup>1,4</sup> Somenath Datta,<sup>3,4</sup> Karen Soldano,<sup>3,4</sup> Daniel P. Silas,<sup>3,4</sup> Elhussein A. Elhassan,<sup>2</sup> Megan Chryst-Stangl,<sup>3,4</sup> Guanghong Wu,<sup>3,4</sup> Opeyemi A. Olabisi,<sup>3,4</sup> Peter J. Conlon,<sup>2</sup> Rasheed A. Gbadegesin,<sup>3,4</sup> Brandon M. Lane.<sup>3,4</sup> <sup>1</sup>Duke University, Durham, NC; <sup>2</sup>Beaumont Hospital, Dublin, Ireland; <sup>3</sup>Duke University School of Medicine, Durham, NC; <sup>4</sup>Duke Molecular Physiology Institute, Durham, NC.

**Background:** We have previously shown that deleterious mutations in RCAN1 are a cause of familial FSGS. One of these mutations, I162T resulted in dysregulated calcineurin (CN) activity and reduced viability in HEK293 cells overexpressing the variant compared to WT expressing cells. Deficits in I162T cell viability was rescued by treatment with calcineurin inhibitors as well as inhibitors of GSK-3β. Knockdown of RCAN1 also produced similar disruptions in podocyte viability in conditionally immortalized human podocytes. However the phenotype of podocytes derived from patients with RCAN1 I162T mutation is unknown.

**Methods:** Using PBMCs collected from a patient carrying the RCAN1 I162T mutation as well as an unaffected family member, we generated induced pluripotent stem cells (iPSCs). After differentiating iPSCs into podocytes, the cells were examined for changes in CN regulation and viability.

**Results:** Differentiated podocytes from both affected and unaffected individuals displayed podocyte specific markers including Neph1, WT1 and Synaptopodin as confirmed by both RT-PCR and immunofluorescence. Automated live-cell imaging over 72 hours using a fluorescent reporter of caspase 3 activity revealed an increase in serum starvation induced apoptosis in the podocytes carrying the mutant I162T compared to podocytes from the control unaffected family member (p<0.0001).

**Conclusions:** We have now confirmed that the RCAN1 I162T allele causes decreased podocyte viability due to defects in calcineurin regulation using cells derived from affected family. These patient iPSC derived podocytes set the stage for a better understanding of RCAN1-mediated regulation of CN activity and evaluation of therapeutic alternatives to calcineurin inhibitors in the treatment of FSGS.

**Funding:** NIDDK Support

## SA-OR28

**C3a/C3aR1 Signaling as a Crucial Pathogenic Mechanism in Membranous Nephropathy**

Stefano Da Sacco,<sup>1</sup> Qi Zhang,<sup>1</sup> Sofia Bin,<sup>2</sup> Astgik Petrosyan,<sup>1</sup> Luis F. Sanchez Russo,<sup>2</sup> Valentina Villani,<sup>1</sup> Micaela Gentile,<sup>2</sup> Roger E. De Filippo,<sup>1</sup> Kevin V. Lemley,<sup>1</sup> Laura Perin,<sup>1</sup> Paolo Cravedi.<sup>2</sup> <sup>1</sup>Children's Hospital of Los Angeles, Los Angeles, CA; <sup>2</sup>Icahn School of Medicine at Mount Sinai, New York, NY.

**Background:** Primary membranous nephropathy (MN) is a leading cause of nephrotic syndrome in adults worldwide caused by the deposition of anti-podocyte-antibodies in the glomerular subepithelial space. While complement deposition is thought to play a crucial pathogenic role, the exact effector mechanism of complement in MN is unclear due to the lack of in vitro and in vivo systems that can faithfully recapitulate human disease. We have developed a novel glomerulus-on-a-chip system (GOAC) using human primary podocytes and glomerular endothelial cells (GEC) and assessed functional response to human MN serum, role of membrane-attack-complex (MAC) formation and C3a/C3aR1 signaling in MN pathogenesis.

**Methods:** GOACs were exposed to anti-PLA2R+ sera from MN patients; sera from healthy individuals were used as control. Functional response was assessed by albumin permeability assay to evaluate permselectivity. Role of PLA2R1, IgGs, complement, MAC and C3a/C3aR1 signaling pathway were assessed by immunofluorescence, western blotting and functional analysis while mechanisms of action were explored by PCR arrays, proteomics and immunostaining. Results were confirmed in vitro using podocytes on which C3aR1 was silenced and in vivo using THSD7A induced MN in balb/c mice.

**Results:** Following exposure to sera from MN patients, we confirmed IgG deposition, complement activation and MAC formation accompanied by albumin leakage. PLA2R silencing on podocytes, IgG neutralization as well as complement inactivation successfully prevented injury while leakage still occurred following MAC inhibition. GOAC supplemented with C3aR1 antagonists as well as GOAC using podocytes in which C3aR1 was silenced were able to counteract glomerular filtration damage and prevent albumin leakage and lessen oxidative stress in podocytes. Efficacy of C3aR1 antagonists in preventing proteinuria was confirmed in vivo, substantiating our findings.

**Conclusions:** We have successfully developed a glomerulus-on-a-chip system that closely mimics the GFB structure and provides a powerful tool for studying renal regenerative and disease mechanisms in proteinuric diseases. Using a combination of in vitro and in vivo models, we showed that C3a/C3aR signaling plays a dominant role in complement-mediated MN pathogenesis.

**Funding:** NIDDK Support, Private Foundation Support

## SA-OR29

**Targeting the Integrated Stress Response Pathway in T Cells Ameliorates Crescentic Glomerulonephritis in Mice**

Nariaki Asada, Pauline Ginsberg, Anna Kaffke, Anett Peters, Hans-Joachim Paust, Christian F. Krebs, Hans-willi Mittrücker, Ulf Panzer. *Universitätsklinikum Hamburg-Eppendorf, Hamburg, Germany.*

**Background:** CD4<sup>+</sup> T cells play a central role in immunity by producing cytokines. After infection, some T cells remain in organs and become tissue-resident memory T (Trm) cells, which contribute to efficient host defense by immediate production of cytokines. Recently, it was demonstrated that Trm cells are also associated with autoimmune disease development and relapse. Therefore, tight regulation of cytokine production by Trm cells is of great importance to achieve efficient host defense without excessive inflammation. However, the underlying mechanisms of cytokine production by Trm cells are not well characterized.

**Methods:** Human and murine T cells in the kidney were analyzed by single cell RNA sequencing (scRNAseq), polysome profiling, RT-PCR, flow-cytometry, immunocytochemistry, and mRNA FISH. Mouse models for *Staphylococcus aureus* infection and crescentic glomerulonephritis were used to induce and study Trm cells *in vivo*.

**Results:** scRNAseq analysis of T cells from human healthy kidney revealed that Trm cells express high mRNA levels of proinflammatory cytokines such as *IL17A*, *INFG*, and *CSF2*. However, flow-cytometry, tissue signature analysis, and polysome profiling showed that Trm cells do not translate cytokine mRNA into protein without re-stimulation. Mechanistically, we demonstrated that the phosphorylation of eIF2a, a key feature of the integrated stress response (ISR) activation, results in recruitment of cytokine mRNA into stress granules, which are organelles crucial for regulating mRNA translation during ISR. Re-stimulation of Trm cells resulted in eIF2a dephosphorylation, leading to rapid translation of cytokine mRNA into protein. Moreover, we found that blocking eIF2a phosphatase by Raphin1 efficiently suppresses eIF2a dephosphorylation and cytokine production from Trm cells. *In vivo* administration of Raphin1 improved crescent formation and albuminuria in immune-mediated kidney injury in mice.

**Conclusions:** CD4<sup>+</sup> Trm cells express high level cytokine mRNA but regulate translation through ISR under homeostatic conditions. Targeting ISR by Raphin1 suppresses cytokine production from activated Trm cells and autoimmune kidney disease progression in mice. Our study identifies a novel mechanism of how ISR regulates rapid cytokine production of poised Trm cells in health and disease.

**Funding:** Government Support - Non-U.S.

## SA-OR30

## Abstract Withdrawn

## SA-OR31

**Linked by Love: Relatability and Cultural Appropriateness of an Edutainment Series About CKD in an African American Family**

LaShara A. Davis,<sup>1</sup> Nicole D. Mendez,<sup>2</sup> Susanne B. Nicholas,<sup>3</sup> Amy D. Waterman.<sup>1</sup> <sup>1</sup>Houston Methodist Hospital, Houston, TX; <sup>2</sup>Mendez National Institute of Transplantation Foundation, Los Angeles, CA; <sup>3</sup>Ronald Reagan UCLA Medical Center, Los Angeles, CA.

**Background:** African Americans (AA) are 3.1 times more likely than Whites to have chronic kidney disease (CKD) and progress to kidney failure, but less likely to receive living donor kidney transplants (LDKTs), in part, due to poorer transplant knowledge and motivation to learn more. We examined whether the scripts for the CKD edutainment series, *Linked by Love*, were engaging and culturally sensitive to the AA community and determine recommendations for improvement.

**Methods:** We recruited AA patients to watch a script read of one of six scripts and provide feedback on the cultural sensitivity of and their engagement with the storyline prior to filming. We conducted 13 focus groups (FG) with 2-6 participants (Median: 4) per group. Participants also provided recommendations about how to make the series more authentic to the experiences of CKD patients and families. FGs were transcribed verbatim and thematically coded for reactions to the scripts and recommendations for improvements. Themes were generated using inductive and deductive coding.

**Results:** FG participants (N=32) reported that the series was authentic (55.3%), engaging (42.1%), and enjoyable (42.1%) in a response to a brief survey on engagement. Themes emerged around the lack of awareness of common causes of CKD and limited depictions of AA health stories on television. Script elements depicting the main character as a superwoman and health secrecy within AA families were seen as culturally sensitive and caused curiosity about improving kidney health. Most stated that they would share the series with others. After viewing the series, several participants shared that they now planned to check their creatinine levels. Suggested improvements included earlier distinction of CKD symptoms, more family involvement in the evaluation process, and discussion of nutrition as a factor in health and illness.

**Conclusions:** Fictionalized stories about CKD and transplant challenges in AA families are well received by AA audiences when they include realistic family portrayals, depictions of strong female characters, and highlight AA family secrecy around health and illness. Edutainment is a promising technique to connect with and educate AA families. Further research is needed to assess whether this strategy can improve CKD knowledge, prevention, and behaviors.

**Funding:** Private Foundation Support

## SA-OR32

**A Randomized Controlled Pilot Study of a Patient Decision Aid About Conservative Kidney Management**

Susan P. Wong, Taryn Oestreich, David K. Prince, Bridgett A. Chandler, J. Randall Curtis. *University of Washington Department of Medicine, Seattle, WA.*

**Background:** Conservative kidney management (CKM) is an important treatment option for patients who do not wish to receive maintenance dialysis. However, most patient decision aids do not present information on this treatment approach.

**Methods:** We conducted a randomized controlled pilot study (NCT04919941) to assess the feasibility and acceptability of a new decision aid about CKM with patients aged  $\geq 75$  years with stage 4 or 5 CKD and family members between August 2020-December 2021. After completing an initial study visit (T1), participants were randomized to receive the aid or to usual care. Acceptability was assessed based on attrition rates in each study arm between (T1) and 3-month follow-up (T3). Our primary outcome measure and measure of feasibility was the proportion who discussed CKM with a healthcare provider at T3. We also explored changes in patients' decisional uncertainty (Decision Conflict Scale [DCS] scores) about treatment options for their CKD (dialysis, CKM, or unsure) at T3.

**Results:** We randomized 92 patients of which 86 patients (55.8% male; age 82 $\pm$ 6 years; 82.6% White) completed T1—42 in the usual care arm and 44 in the intervention arm—and 56 family members of which 53 (18.9% male; age 71 $\pm$ 11 years; 86.8% White) completed T1—20 in usual care arm and 33 in the intervention arm. Attrition rates were low in the usual care and intervention groups for patients (21% vs. 21%,  $p=1.0$ ) and family members (10% vs. 18%,  $p=0.46$ ). The intervention was associated with greater discussion of CKM with a healthcare provider for patients (26.4% vs. 3.0%,  $p=0.007$ ) and family members (26.9% vs. 0%,  $p=0.02$ ). Patients who were unsure about which treatment option they preferred decreased by 20.0% in the intervention group and by 12.1% in the control group ( $p=0.27$ ). Patients' decisional uncertainty about their options also decreased for the intervention (DCS -15.7 $\pm$ 21.2) and control (DCS -9.1 $\pm$ 20.6) groups ( $p=0.06$ ).

**Conclusions:** Our decision aid on CKM was feasible, acceptable, and promoted discussion of this treatment option with healthcare providers. The aid may show promise as a useful adjunct to currently available educational tools on treatments for advanced CKD.

**Funding:** Private Foundation Support

## SA-OR33

**Impact of Race/Ethnicity and Age on Hospitalization Outcomes in Advanced CKD Patients Treated With Conservative Management vs. Dialysis**

Connie Rhee,<sup>1</sup> Amy S. You,<sup>1</sup> Yoko Narasaki,<sup>1</sup> Dana B. Mukamel,<sup>1</sup> Susan T. Crowley,<sup>2</sup> Ji Hoon Yoon,<sup>1</sup> Csaba P. Kovacs,<sup>3</sup> Danh V. Nguyen,<sup>1</sup> Kamyar Kalantar-Zadeh.<sup>1</sup> <sup>1</sup>University of California Irvine, Irvine, CA; <sup>2</sup>Yale University, New Haven, CT; <sup>3</sup>The University of Tennessee Health Science Center, Memphis, TN.

**Background:** Given evidence that dialysis results in greater healthcare utilization and morbidity among certain subgroups, there is rising interest in conservative management (CM) as an alternative patient-centered treatment strategy for advanced CKD. Little is known about the comparative effectiveness of CM vs. dialysis on hospitalization outcomes across different races/ethnicities.

**Methods:** We compared hospitalization rates in advanced CKD patients treated with CM vs. dialysis over 1/07-6/20 from the Optum Labs Data Warehouse, which contains de-identified administrative claims, including medical and pharmacy claims and enrollment records for commercial and Medicare Advantage enrollees as well as EHR data. Patients were categorized according to receipt of CM, defined as those who did not receive dialysis within 2-yr of the index eGFR (1<sup>st</sup> eGFR $<25$ ), vs. receipt of dialysis parsed as late vs. early dialysis transition (eGFRs  $<15$  vs.  $\geq 15$  at dialysis initiation). We used Poisson regression to compare raw and model-based hospitalization rates in CM vs. dialysis patients across race/ethnicity and age.

**Results:** Among 309,188 advanced CKD patients who met eligibility, 55% of patients had  $\geq 1$  hospitalization(s) within 2-yr of the index eGFR; the most common causes of hospitalization in both the CM and dialysis groups were CHF, respiratory, or HTN-related (Fig A). In Non-Hispanic (NH) White, NH Black, and Hispanic patients, late and early dialysis had higher hospitalization rates than CM, in which early dialysis demonstrated the highest rates across all age groups (Fig B). Among Asian patients, whereas late and early dialysis also had higher hospitalization rates than CM, late dialysis had higher model-based rates than early dialysis, particular in older age groups.

**Conclusions:** We observed differential relationships between CM vs. dialysis on hospitalization rates across race/ethnicity and age. Further research is needed to determine which patients are optimal candidates for CM vs. dialysis using a personalized approach.

**Funding:** NIDDK Support

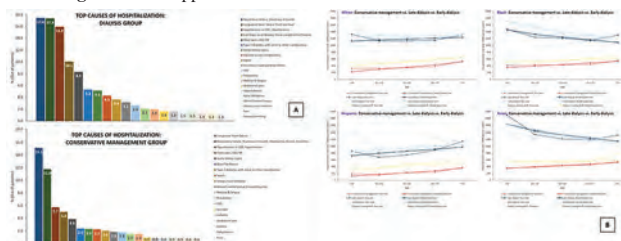

## SA-OR34

**Prevalence of CKD Among Asian Adults in the United States, 2011-2018**

Sophie E. Claudel, Insa M. Schmidt, Sushrut S. Waikar, Ashish Verma. *Boston Medical Center, Boston, MA.*

**Background:** Chronic kidney disease (CKD) is a leading risk factor for cardiovascular disease (CVD). Asian adults in the United States (US) have high rates of CVD. We hypothesized that Asian adults have a higher burden of CKD and associated conditions than White individuals, and risk may vary across Asian ethnicities.

**Methods:** Using cross-sectional data from NHANES 2011-2018 (N=21,566), we calculated weighted, age-adjusted prevalence of CKD and associated conditions (hypertension (HTN), diabetes (DM), obesity, metabolic acidosis, albuminuria, CVD) among non-Hispanic adults. CKD was defined as an estimated GFR $<60$ ml/min per 1.73m<sup>2</sup> or albuminuria  $\geq 30$ mg/g. Using the National Health Interview Survey (NHIS; N=14,194), we explored heterogeneity in self-reported prevalence across Asian ethnicities.

**Results:** The NHANES population was 37% White, 23% Black, 13% Asian, and 28% other race, with a mean age of 48 years. Overall CKD prevalence was 12.7% (95%CI 12.1, 13.4). Asians had a 1.5- and 1.3-fold higher prevalence of CKD compared to White and Black participants, respectively. Among Asians, the prevalence of HTN and obesity increased over time ( $p$ -trend=0.001 for both) and remained significantly greater than among White and Black participants throughout the study period. In the NHIS, there was higher prevalence of HTN and obesity among Filipino participants and lower prevalence of HTN, DM, and obesity among Chinese participants.

**Conclusions:** Analysis of nationally representative data from the US demonstrates a disproportionately high prevalence of CKD and associated conditions among Asian adults, with prevalence rates for some conditions exceeding those of Black and White participants.

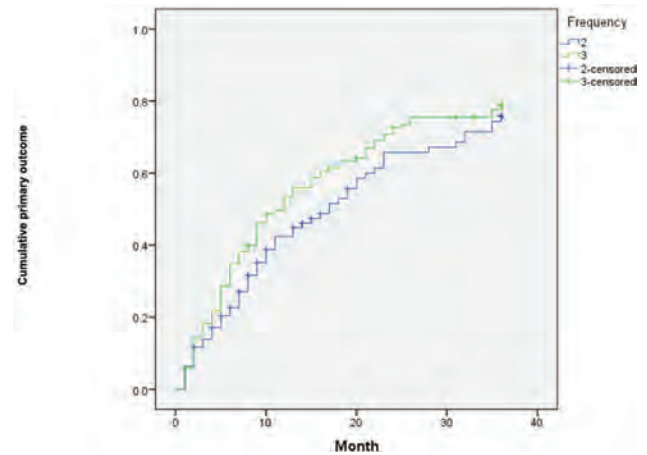
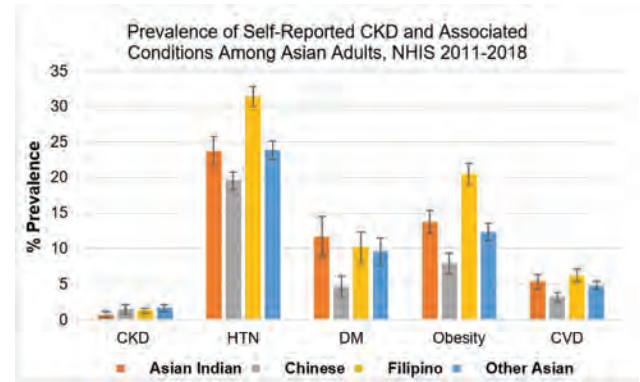
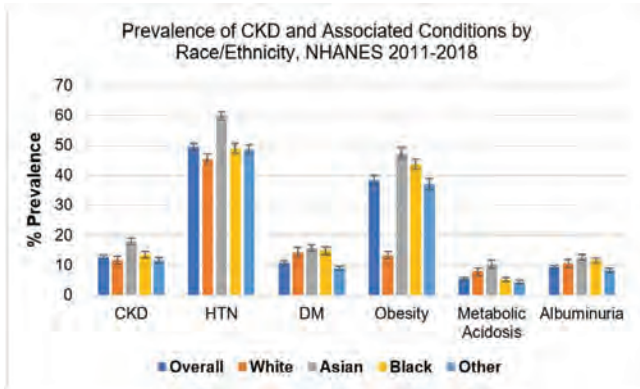

Kaplan-Meier showing the cumulative primary outcome

SA-OR35

**Comparison of Clinical Outcomes Between Twice- vs. Thrice-Weekly Hemodialysis in Thai Elderly Patients: A Single-Center Study**

Prapa Pattarornpisut,<sup>1</sup> Kittiphon Khruewang,<sup>1</sup> Darunee Buddeewong,<sup>1</sup> Inthira Srichaichana,<sup>1</sup> Kanyapa Srila,<sup>1</sup> Picha Yincharoen,<sup>1</sup> Tanyarat Teerapornletratt,<sup>1</sup> Kriang Tungsanga.<sup>1,2</sup> <sup>1</sup>Bhumirajanagarindra Kidney Institute Hospital, Bangkok, Thailand; <sup>2</sup>King Chulalongkorn Memorial Hospital, Bangkok, Thailand.

**Background:** Hemodialysis (HD) in the elderly is a complex process, given the physiologic changes and comorbidities. Although studies, which included patients aged  $\geq 18$ , suggested twice-weekly HD (BWD) may not be inferior to thrice-weekly HD (TWD), there are scarce studies in the elderly.

**Methods:** We conducted a single-center, prospective cohort study to observe whether BWD and TWD would result in different outcomes in the elderly. All end-stage kidney disease patients, aged  $\geq 65$ , who had received HD for  $>3$  months at our center, were enrolled. Those who had received kidney transplantation, peritoneal dialysis or refused to give informed consent were excluded. Patients were allocated into 2 groups: BWD and TWD. The decision about HD frequency was shared between treating nephrologists and a patient. The primary outcome was the composite endpoint of all-cause mortality, cardiovascular (CVS) events, and hospitalization from any cause over 36 months.

**Results:** 210 patients were enrolled: 94 in the BWD group and 116 in the TWD group. The overall mean age was 77.4 ( $\pm 7.8$ ) years old, 38% aged over 80. Comparing with the TWD group, the BWD group had shorter dialysis vintage (692 IQR 332, 1207 vs 1324 IQR 884, 1790 days,  $p < 0.001$ ) and a higher proportion of cases with  $K_{tV} \geq 2$  mL/min (36.7% vs 6%,  $p < 0.001$ ). There was no difference in the proportion of cases who reached the primary outcome between the 2 groups [62 (66%) vs 88 (76%) cases, long-rank  $p = 0.25$ ]. There was also no difference in each component of the primary outcome.

**Conclusions:** In summary, over 36 months, elderly patients on BWD did not differ from those on TWD with respect to a composite endpoint of all-cause mortality, CVS events and hospitalization from any cause. This study provides information on outcomes exclusively in the elderly on HD and suggests TWD might not be necessary for this age group. Nevertheless, a RCT is needed to confirm this finding.

**Funding:** Private Foundation Support

SA-OR36

**Effects of Dapagliflozin on Anemia in Patients With CKD With or Without Type 2 Diabetes: A Pre-Specified Analysis of the DAPA-CKD Trial**

Hiddo J. L Heerspink,<sup>1,2</sup> Akihiko Koshino,<sup>1,3</sup> Meir Schechter,<sup>1,4</sup> Priya Vart,<sup>1</sup> Niels Jongs,<sup>1</sup> Glenn Chertow,<sup>5</sup> Robert D. Toto,<sup>6</sup> Peter Rossing,<sup>7,8</sup> Ricardo Correa-Rotter,<sup>9</sup> John McMurray,<sup>10</sup> Anna Maria Langkilde,<sup>11</sup> David C. Wheeler.<sup>12</sup> <sup>1</sup>Universiteit Groningen Faculteit Medische Wetenschappen, Groningen, Netherlands; <sup>2</sup>The George Institute for Global Health, Newtown, NSW, Australia; <sup>3</sup>Kanazawa Daigaku Daigakuin Iyaku Hokengaku Sogo Kenkyuka Iyaku Hoken Gakuiki Igakurui, Kanazawa, Japan; <sup>4</sup>Hadassah University Medical Center, Jerusalem, Israel; <sup>5</sup>Stanford Medicine, Stanford, CA; <sup>6</sup>UT Southwestern Medical Center, Department of Internal Medicine, Dallas, TX; <sup>7</sup>Steno Diabetes Center Copenhagen, Herlev, Denmark; <sup>8</sup>Kobenhavns Universitet Sundhedsvidenskabelige Fakultet, Kobenhavn, Denmark; <sup>9</sup>National Medical Science and Nutrition Institute Salvador Zubiran, Mexico City, Mexico; <sup>10</sup>University of Glasgow Institute of Cardiovascular and Medical Sciences, Glasgow, United Kingdom; <sup>11</sup>AstraZeneca, BioPharmaceuticals R&D, Gothenburg, Sweden; <sup>12</sup>University College London Faculty of Medical Sciences, London, United Kingdom.

**Background:** Anemia is a common complication of chronic kidney disease (CKD) and is associated with worse outcomes. The sodium-glucose cotransporter 2 inhibitor dapagliflozin increased erythropoietin and hematocrit (Hct) and corrected anemia in patients with heart failure. We examined the effect of dapagliflozin in preventing and correcting anemia in patients with CKD with or without type 2 diabetes (T2D).

**Methods:** The DAPA-CKD study randomized patients with eGFR 25-75 mL/min/1.73m<sup>2</sup> and UACR 200-5000 mg/g to dapagliflozin 10mg or placebo. Hct was measured at baseline, 14 days, 2 and 4 months, and every 4 months thereafter. Anemia was defined as Hct levels  $< 39\%$  in males or  $< 36\%$  in females. Investigators' reporting was used to define anemia-related adverse events. The effect of dapagliflozin on Hct was assessed using mixed effect model for repeated measures. Treatment effect in preventing and reversing anemia was assessed by Cox proportional hazard regression models.

**Results:** Of patients with Hct levels at baseline (N=4292 [99.7%]; mean Hct 38.9%), 1549 (36.1%) had anemia. Patients with anemia had lower mean eGFR (40 vs 45 mL/min/1.73m<sup>2</sup>) and higher median UACR (1124 vs 877 mg/g) compared to those without anemia. Over 2.4 years' median follow-up, dapagliflozin increased absolute Hct levels vs placebo by 2.3% (95%CI 2.1-2.5;  $p < 0.001$ ). In patients without anemia at baseline, 134 (9.7%) developed anemia with dapagliflozin vs 228 (17.0%) with placebo (HR 0.53; 95%CI 0.43-0.66;  $p < 0.001$ ). Dapagliflozin reduced the risk of anemia-related adverse events compared to placebo (HR 0.46; 95%CI 0.23-0.95;  $p = 0.04$ ). In patients with anemia at baseline, anemia was corrected in 343 patients (47.5%) receiving dapagliflozin and 192 (24.8%) receiving placebo (HR 2.27; 95%CI 1.90-2.71;  $p < 0.001$ ). The effects of dapagliflozin in preventing and correcting anemia were consistent in patients with and without T2D ( $p$  interaction  $\geq 0.83$ ).

**Conclusions:** The effects of dapagliflozin on Hct may support its role in prevention and treatment of anemia in patients with CKD with or without T2D.

**Funding:** Commercial Support - AstraZeneca

SA-OR37

**Time-Dependent Covariate Analysis of Hemoglobin Values on Risk of Major Adverse Cardiovascular Events in the ASCEND Trials**

Gregorio T. Obrador,<sup>1</sup> Kirsten L. Johansen,<sup>2</sup> Sushrut S. Waikar,<sup>3</sup> Vivekanand Jha,<sup>4</sup> Ricardo Correa-Rotter,<sup>5</sup> Lucia Del Vecchio,<sup>6</sup> Aleix Cases,<sup>7</sup> Michele Robertson,<sup>8</sup> Stephen Mallett,<sup>9</sup> Christine K. Bailey,<sup>10</sup> Alexander R. Cobitz,<sup>10</sup> Ajay K. Singh.<sup>11</sup> <sup>1</sup>Universidad Panamericana School of Medicine, Mexico City, Mexico; <sup>2</sup>Hennepin Healthcare, Minneapolis, MN; <sup>3</sup>Boston University School of Medicine and Boston Medical Center, Boston, MA; <sup>4</sup>George Institute for Global Health, New Delhi, India; <sup>5</sup>Instituto Nacional de Ciencias Médicas y Nutrición Salvador Zubirán, Mexico City, Mexico; <sup>6</sup>Azienda Socio Sanitaria Territoriale Lariana, Como, Italy; <sup>7</sup>Universitat de Barcelona, Barcelona, Spain; <sup>8</sup>Robertson Centre for Biostatistics, University of Glasgow, Glasgow, United Kingdom; <sup>9</sup>R&D, GSK, Brentford, United Kingdom; <sup>10</sup>R&D, GSK, Collegeville, PA; <sup>11</sup>Brigham and Women's Hospital and Harvard Medical School, Boston, MA.

**Background:** The evidence supporting an association between rapid changes in hemoglobin (Hb) and cardiovascular (CV) outcomes is limited. We performed a time-dependent covariate analysis in patients with chronic kidney disease on dialysis (ASCEND-D, NCT02879305) or not on dialysis (ASCEND-ND, NCT02876835) treated with daprodustat or erythropoiesis-stimulating agent (ESA).

**Methods:** ASCEND-D and ASCEND-ND were event-driven CV outcomes trials, enrolling 2694 and 3872 patients, respectively. Major adverse CV events (MACE) were a composite of death from any cause, non-fatal myocardial infarction, and non-fatal stroke. In this post-hoc analysis, two Hb-related time-dependent covariates were constructed based on 12-weekly intervals for each patient: most recent 4-week Hb change (>1, ≥0 to ≤1, ≥-1 to <0, <-1g/dL) and most recent Hb level (low <10, medium 10 to 11.5, high >11.5 g/dL). Associations between time-varying Hb and change in Hb and risk of adjudicated first MACE were explored using a piecewise exponential model adjusted for baseline and other covariates (Figure). Odds ratios and 95% confidence intervals are reported.

**Results:** Results were consistent between daprodustat and ESA treatment arms in ASCEND-D and ASCEND-ND. A most recent 4-week Hb change >1g/dL and most recent 4-week Hb change <-1g/dL vs an Hb change ≥0 to ≤1g/dL, and low Hb vs medium Hb, were associated with higher MACE risk (Figure). No increased risk was seen with Hb changes ≥-1 to <0g/dL or with high Hb.

**Conclusions:** Our data suggest that rapid Hb changes and low absolute Hb values may be associated with higher MACE risk in patients treated with daprodustat or ESA. Additional analyses are needed to delineate these associations further.

**Funding:** Commercial Support - This study was funded by GSK.

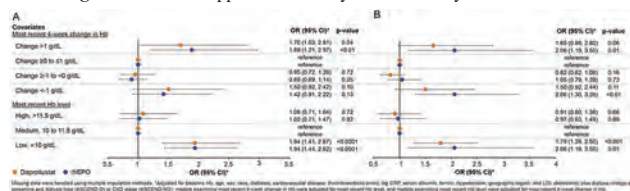

**Figure.** Hb-related time-dependent covariate analyses for ASCEND-D (A) and ASCEND-ND (B)

SA-OR38

**Change in Albuminuria and GFR Slope as Joint Surrogate End Points for Kidney Failure: Implications for Phase 2 Trials**

Tom Greene,<sup>1</sup> Lesley A. Inker,<sup>2</sup> Hiddo J. L. Heerspink,<sup>3</sup> Hocine Tighiouart,<sup>4</sup> Willem H. Collier,<sup>1</sup> Benjamin Haaland.<sup>1</sup> Chronic Kidney Disease-Epidemiology Collaboration <sup>1</sup>University of Utah Health, Salt Lake City, UT; <sup>2</sup>Tufts Medical Center, Boston, MA; <sup>3</sup>Universitair Medisch Centrum Groningen, Groningen, Netherlands; <sup>4</sup>Tufts Clinical and Translational Science Institute, Boston, MA.

**Background:** Change in urinary albumin:creatinine ratio (UACR) and GFR slope are individually used as surrogate endpoints in clinical trials of CKD progression. We developed a strategy that combined both endpoints to improve prediction of drug effects on clinical outcomes.

**Methods:** We used data from 43 randomized controlled trials of CKD progression and fitted trial-level Bayesian meta-regression models to characterize the joint relationship between the treatment effects on the clinical endpoint (sustained doubling of serum creatinine, GFR < 15 ml/min per 1.73m<sup>2</sup>, or end-stage kidney disease) and those on UACR change and chronic GFR slope. We applied the results of the meta-regression to the design of a phase 2 trial to assess design implications (sample size, follow-up time) for using UACR change and GFR slope individually or in combination. For each design we calculated the positive predicted value (PPV) for inferring clinical benefit based on observed treatment effects on UACR and GFR slope.

**Results:** The median R<sup>2</sup> of the model was 0.926. The PPV of both surrogates on the clinical endpoint was almost exclusively determined by estimated treatment effects on UACR when the sample size was small (~60 patients per arm) and follow-up short (~1 year; fig1A), with the importance of GFR slope increasing when the sample size and

follow-up increased (fig1B/C). At large sample sizes (>600 per group) or long follow-up (≥ 2 year), clinical benefit was solely determined by GFR slope (fig1D).

**Conclusions:** In phase 2 clinical trials with sample sizes of 100 to 200 patients per arm or follow-up times ranging between 1 and 2 years combining the information from treatment effects on UACR change and GFR slope improved prediction of treatment effects on clinical endpoints.

**Funding:** Private Foundation Support

**Design A: 60 per group, 1.25 years of follow-up, quarterly GFRs**

Est. effect on chronic slope ml/min/1.73m <sup>2</sup> /yr	Estimated Treatment Effect on UACR (GMR)							
	1.00	0.95	0.90	0.85	0.80	0.75	0.70	0.65
0	0.569	0.633	0.697	0.762	0.819	0.869	0.908	0.938
0.2	0.582	0.647	0.712	0.769	0.829	0.872	0.914	0.942
0.4	0.593	0.661	0.721	0.785	0.837	0.884	0.921	0.946
0.6	0.610	0.671	0.736	0.792	0.848	0.889	0.926	0.950
0.8	0.621	0.686	0.746	0.808	0.855	0.899	0.931	0.955
1	0.638	0.696	0.759	0.814	0.863	0.905	0.937	0.957

**Design B: 120 patients per group, 1.25 years of follow-up, quarterly eGFRs**

Est. effect on chronic slope ml/min/1.73m <sup>2</sup> /yr	Estimated Treatment Effect on UACR (GMR)							
	1.00	0.95	0.90	0.85	0.80	0.75	0.70	0.65
0	0.568	0.632	0.702	0.763	0.82	0.868	0.907	0.935
0.2	0.598	0.659	0.727	0.787	0.84	0.884	0.920	0.944
0.4	0.618	0.683	0.748	0.805	0.857	0.900	0.930	0.951
0.6	0.644	0.708	0.772	0.826	0.876	0.911	0.941	0.957
0.8	0.671	0.733	0.791	0.842	0.888	0.921	0.948	0.962
1	0.696	0.752	0.808	0.862	0.899	0.932	0.955	0.970

**Design C: 240 patients per group, 2 years of follow-up, quarterly eGFRs**

Est. effect on chronic slope ml/min/1.73m <sup>2</sup> /yr	Estimated Treatment Effect on UACR (GMR)							
	1.00	0.95	0.90	0.85	0.80	0.75	0.70	0.65
0	0.579	0.628	0.673	0.718	0.766	0.805	0.839	0.862
0.2	0.660	0.708	0.756	0.793	0.831	0.862	0.888	0.909
0.4	0.741	0.779	0.822	0.857	0.887	0.909	0.928	0.939
0.6	0.804	0.844	0.873	0.905	0.926	0.942	0.955	0.962
0.8	0.860	0.890	0.916	0.938	0.955	0.965	0.973	0.978
1	0.899	0.925	0.946	0.960	0.973	0.981	0.986	0.988

**Design D: 600 per group, 2 years of follow-up, quarterly GFRs**

Est. effect on chronic slope ml/min/1.73m <sup>2</sup> /yr	Estimated Treatment Effect on UACR (GMR)							
	1.00	0.95	0.90	0.85	0.80	0.75	0.70	0.65
0	0.579	0.614	0.645	0.673	0.704	0.732	0.745	0.761
0.2	0.720	0.752	0.780	0.809	0.827	0.845	0.857	0.862
0.4	0.830	0.858	0.879	0.897	0.914	0.921	0.927	0.929
0.6	0.906	0.925	0.940	0.954	0.962	0.967	0.968	0.970
0.8	0.950	0.953	0.973	0.981	0.984	0.986	0.987	0.987
1	0.974	0.982	0.988	0.992	0.994	0.995	0.995	0.995

PPV from observed treatment effects on ACR and GFR Slope in phase 2 studies to infer clinical benefit defined as HR < 1. Light gray: PPV>0.8; dark gray: PPV>0.9. The relationship between joint treatment effects on UACR change and GFR slope with treatment effects on clinical endpoint showed a posterior median meta-regression coefficient of -0.429 (2.5% - 97.5% P: 0.660 to -0.192) for the treatment effect on the GFR slope and -0.113 (-0.839 to 0.631) for that on log UACR.

SA-OR39

**Effect of a Nutritional Supplement of Probiotics and/or Prebiotics vs. Placebo on Nutritional Status in Automated Peritoneal Dialysis (APD) Patients**

Fabiola Martin del Campo,<sup>1</sup> Alfonso M. Cueto-Manzano,<sup>1</sup> Carmen Sanchez-Ramirez,<sup>3</sup> Natali Vega,<sup>4</sup> Marcela Peña Rodríguez,<sup>2</sup> Laura Cortes-Sanabria,<sup>1</sup> Enrique Rojas-Campos,<sup>1</sup> Mariana Villasana Ballesteros.<sup>1</sup> Unidad de Investigación Médica en Enfermedades Renales 'Hospital de Especialidades del Centro Medico Nacional de Occidente IMSS, Guadalajara, Mexico; <sup>2</sup>Universidad de Guadalajara Departamento de Biología Molecular y Genómica, Guadalajara, Mexico; <sup>3</sup>Universidad de Colima Facultad de Medicina, Colima, Mexico; <sup>4</sup>Departamento de Microbiología y Patología, Universidad de Guadalajara, Guadalajara, Mexico.

**Background:** Prebiotics and probiotics may improve nutritional status in dialysis patients by decreasing inflammation and intestinal production of uremic toxins; however, no study has been performed comparing these interventions altogether and separately. Aim: to evaluate the effect of a supplement of probiotics and/or prebiotics vs placebo on nutritional status in APD.

**Methods:** Randomized, triple blinded, controlled, clinical trial in 64 clinically stable APD patients, assigned to: Probiotic (2x10<sup>8</sup> CFU probiotics+placebo); Prebiotic (20g inulin+placebo); Symbiotic (2x10<sup>8</sup> CFU probiotics+20g inulin); or Placebo (placebo+placebo) during 3 months. Nutritional status determined by subjective global assessment (SGA). Intestinal microbiota was evaluated with 16S rRNA gene sequencing.

**Results:** Nutritional status results shown in Figure. Prebiotic group increased SGA score (5.1±1.1 vs 5.9±0.7, p=0.02), dietary intake of energy (1121±373 vs 1508±637, p=0.02) and marginally fiber (17±7 vs 24±12, p=0.08); Probiotic marginally increase SGA (5.6±1.0 vs 6.1±0.7, p=0.06); no statistical differences were observed in Symbiotic and Placebo groups. At the end of the study, Prebiotic significantly increased relative abundance of Blautia, Ruminococcaceae and Faecalibacterium prausnitzii bacteria and decreased Clostridiales; compared to placebo, Prebiotic showed higher predominance of Succinivibrio, Aeromonadales, Bifidobacterium, Bifidobacteriales and SMB53 at final evaluation. Adherence to treatment was >90% in all groups during the study; main adverse effects were mild gastrointestinal symptoms (not significantly different between groups).

**Conclusions:** Prebiotic improve nutritional status and intestinal microbiota in APD patients; this could be an easy and inexpensive intervention for this patients.

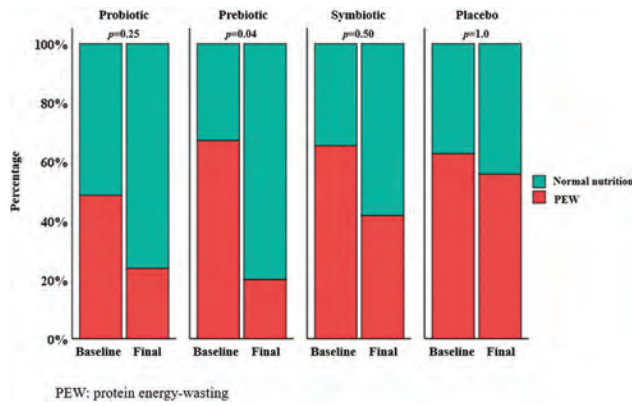

SA-OR40

**Obesity Weight Loss Phenotypes in CKD: Data From the Chronic Renal Insufficiency Cohort Study (CRIC)**

Meera N. Harhay,<sup>1,2</sup> Lucy Robinson,<sup>2</sup> Yuna Kim,<sup>2</sup> Brandy-Joe Milliron.<sup>3</sup>  
<sup>1</sup>Drexel University College of Medicine, Philadelphia, PA; <sup>2</sup>Drexel University Dornsife School of Public Health, Philadelphia, PA; <sup>3</sup>Drexel University College of Nursing and Health Professions, Philadelphia, PA.

**Background:** Although adults with chronic kidney disease (CKD) and obesity are often advised to lose weight, weight loss may also signal a decrease in physiologic reserve and higher mortality risk. The aim of this study was to identify features of high-risk weight loss among individuals with obesity and CKD.

**Methods:** We identified CRIC participants with a BMI of  $\geq 30$  kg/m<sup>2</sup> at baseline. We estimated a multivariate latent class model to identify distinct trajectories of change from baseline BMI, mean arterial pressure (MAP), and % fat free mass (FFM) using nonlinear trends over time for each variable and subject-level random effects. We fit a Cox model for death using estimated latent classes and adjusted for race/ethnicity, sex, and baseline age, BMI, %FFM, MAP, diabetes, and estimated glomerular filtration rate (eGFR).

**Results:** Among 2,909 CRIC participants (median baseline BMI 35.5 (IQR 32.4-39.9) kg/m<sup>2</sup>), median follow-up time was 6.4 years, median age was 61 (interquartile range [IQR] 54-67) years, 53% were male, 37% were non-Hispanic White, and 82% were trying to lose weight. Median BMI was 35.5 (IQR 32.4-39.9) kg/m<sup>2</sup>. We observed six distinct latent classes in the study cohort, defined by similar patterns of changes over time in BMI, MAP, and %FFM (Figure). Latent classes were independently and significantly associated with mortality risk (p=0.009); class 6 had the lowest unadjusted mortality. Relative to class 6, those in class 1 were younger (58 vs 62 years) more likely to be female (65% vs 46%), have diabetes (70% vs 57%), have higher initial BMI (42 vs 35 kg/m<sup>2</sup>) and MAP (88 vs 85 mm Hg), and lower eGFR (36.9 vs 47.3 ml/min/1.73m<sup>2</sup>) and %FFM (56 vs 62%) at baseline. After multivariable adjustment, class 1 was associated with a nearly 2-fold higher death risk relative to class 6 (adjusted Hazard Ratio 1.9, 95% Confidence Interval 1.18-2.41, p=0.004).

**Conclusions:** Among individuals with CKD and obesity, the pattern characterized by steep initial BMI loss, increase in %FFM, and stable MAP was associated with the highest risk of death.

**Funding:** NIDDK Support

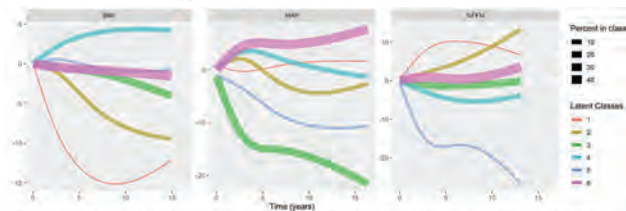

Figure. Figure depicts six class-specific mean predicted trajectories of changes in body mass index (BMI), mean arterial pressure (MAP), and % fat free mass (FFM) from baseline among 2,909 CRIC participants with obesity at baseline. Line thickness corresponds to the % of the cohort in each class.

SA-OR41

**Utilization of SARS-CoV-2 (COVID-19)-Positive Donor Kidneys**

Warren T. McKinney,<sup>1,2</sup> David P. Schladt,<sup>3</sup> Ajay K. Israni.<sup>1,2</sup> <sup>1</sup>Hennepin Healthcare Research Institute, Minneapolis, MN; <sup>2</sup>Scientific Registry of Transplant Recipients, Minneapolis, MN; <sup>3</sup>Chronic Disease Research Group, Minneapolis, MN.

**Background:** The Organ Procurement and Transplantation Network requires documentation of SARS-CoV-2 (COVID) testing status for each potential donor and lower respiratory specimen testing with nucleic acid tests for all donor lungs. In the absence of guidelines for the use of COVID-positive donor kidneys, we sought to examine the clinical characteristics of COVID-positive donors and trends in the utilization of COVID-positive donor kidneys.

**Methods:** This study used Scientific Registry of Transplant Recipients data and included all deceased donors (n=24,940) and recipients (n= 29,478) from June 1, 2020, through April 2, 2022. Variation in donor and recipient characteristics were considered significant at P<.05.

**Results:** 1,310 (5.35%) of donors during the observation period had a positive test for COVID-19 with 1,731 (67.70%) kidneys transplanted, 108 (4.22%) not recovered, and 714 (27.92%) recovered but not transplanted. COVID-positive donors differed from COVID-negative or untested donors in terms of race, ethnicity, cause of death, and donation after circulatory death status (all P < .05). 813 recipients (2.76%) received COVID-positive deceased donor kidneys. Recipients of COVID-positive donor kidneys were more likely to be White, not have received a previous transplant, and had greater cold ischemic times (all P < .05). The number of transplants with COVID-positive donors peaked in early 2022 (Figure 1). Adjusted hazard ratios for all-cause graft failure with COVID-positive donors and death were 0.89 (95% CI, 0.62-1.28) and 0.87 (95% CI, 0.52-1.46), respectively.

**Conclusions:** Transplant with COVID-positive donor kidneys increased during the study period and is not associated with increased risks for recipients. However, high discard rates for COVID-positive donors and greater cold ischemic times may suggest that such donor kidneys remain difficult to place. Patient- and transplant program-level interventions targeting decision support and risk aversion may be necessary to reduce discard rates for COVID-positive donor kidneys.

**Funding:** Other NIH Support - This material is based in part upon work supported by the Agency for Healthcare Research and Quality (AHRQ) and the Patient-Centered Outcomes Research Institute (PCORI) grant K12HS026379 (W.T.M.).

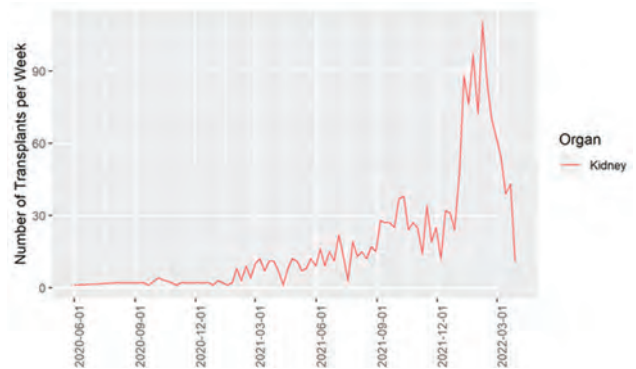

COVID Positive Transplants by Week

SA-OR42

**Viro-Immunological Monitoring as a Predictor for Complicative Events in the First Year After Kidney Transplantation: The VIRENO Study**

Patrick Affeldt,<sup>1</sup> Katharina Burkert,<sup>1</sup> Georg Dieplinger,<sup>6</sup> Christopher Holzmann-Littig,<sup>2</sup> Katharina Tuschen,<sup>3,4</sup> Martin Kann,<sup>1</sup> Franziska Grundmann,<sup>1</sup> Vanessa A. Ditt,<sup>8</sup> Benjamin Wilde,<sup>5</sup> Lutz Renders,<sup>2</sup> Dirk L. Stippel,<sup>6</sup> Christine E. Kurschat,<sup>1</sup> Veronica Di Cristanziano,<sup>7</sup> Roman-Ulrich Mueller.<sup>1</sup>  
 VIRENO Team <sup>1</sup>Department II of Internal Medicine and Center for Molecular Medicine Cologne, Faculty of Medicine and University Hospital Cologne, University of Cologne, Cologne, Germany; <sup>2</sup>Department of Nephrology, Klinikum rechts der Isar, Faculty of Medicine, Technical University Munich, Munich, Germany; <sup>3</sup>Medical Clinic III - Nephrology and Dialysis, St. Vincenz Hospital Paderborn, Paderborn, Germany; <sup>4</sup>Department of Medicine I - Nephrology, Transplantation & Medical Intensive Care, University Witten/Herdecke, Medical Center Cologne-Merheim, Cologne, Germany; <sup>5</sup>Department of Nephrology, University Hospital Essen, University Duisburg-Essen, Essen, Germany; <sup>6</sup>Department of General, Visceral, Cancer and Transplant Surgery, Faculty of Medicine, University Hospital Cologne, University of Cologne, Cologne, Germany; <sup>7</sup>Institute of Virology, Faculty of Medicine and University Hospital of Cologne, University of Cologne, Cologne, Germany; <sup>8</sup>Institute for Clinical Transfusion Medicine, Transplant Center Cologne, Merheim Medical Center, Cologne General Hospital, Cologne, Germany.

**Background:** VIRENO is an interdisciplinary, multicenter study aiming at identifying immunological parameters that predict major infectious and immunological adverse events after kidney transplantation (KTX).

**Methods:** Viro-immunological monitoring of the cohort was performed pre-KTX, 3 weeks and 6 months post-KTX. To address humoral immunity, anti-polyomavirus BK (BKPyV) and anti-cytomegalovirus (CMV) IgG were assessed in living donor and recipients. Cellular immunity to CMV was investigated by QuantiFERON-CMV (Qiagen) and T-SPOT®CMV by Oxford Immunotec. In addition, Torque Teno Virus (TTV) viremia was surveyed in all recipients. Clinical parameters were recorded for 12 months after transplantation focusing on infection- and rejection-related endpoints. As part of a first ad hoc evaluation, forward selection (Wald) binary logistic regression was used to determine the variables most suitable for predicting major events after transplantation.

**Results:** In total, 196 patients were followed up for one year after transplantation. Concerning the two primary endpoints, there were 113 infectious events (CMV n= 52, EBV n= 17, BKPyV n= 40, infection with hospitalization n= 59) and 34 immunological events (rejection n= 30, de novo DSA n= 8). A binary logistic regression model was suitable for predicting infectious complications with high sensitivity (87,1%) but low specificity (50,8%). Concerning prediction of immunological events after transplantation, a binary logistic regression model revealed a high sensitivity (91,7 %) and specificity (93,5%)(Table 1).

**Conclusions:** First results indicate that viro-immunological monitoring is a promising tool to predict infectious and immunological complications after kidney transplantation.

Binary logistic regression models for immunological and infectious events in the first year after kidney Transplantation (KTx)

	Accuracy (%)	Sensitivity (%)	Specificity (%)	clinical parameters included	baseline viro-immunological monitoring included	3 weeks post Tx Viro-immunological monitoring included
Infectious events	71,9	86,9	49,1	Age <sup>1</sup> , Donor Sex <sup>2</sup> , preemptive Donation <sup>3</sup> , non immunological kidney disease <sup>4</sup> , deceased kidney donation.	TTV (plasma), TTV per MHCs/Cells, Baseline <sup>5</sup> , BKPyV IgG.	TTV (plasma and blood), TTV (urine), BKPyV IgG.
Immunological events	93,1	91,7	93,5	genetic kidney disease	ELISPOT IE1 <sup>6</sup> , Donor BKPyV IgG.	ELISPOT positive control, CMV Quantiferon PBMC <sup>7</sup> , ELISPOT IE1 <sup>8</sup> .

Table 1: logistic regression models of infectious and immunological events: unless otherwise stated, all values are receptor values, \*p < 0,1

**SA-OR43**

**A Randomized Phase 2 Study of MAU868 vs. Placebo to Treat BK Viremia in Kidney Transplant Recipients**

Stanley C. Jordan,<sup>1</sup> Ajit Limaye,<sup>2</sup> Bernard V. Fischbach,<sup>3</sup> Puneet Sood,<sup>4</sup> Suzon Collette,<sup>5</sup> Leanne Gasink,<sup>6</sup> Amy Patick,<sup>7</sup> Marshall W. Fordyce,<sup>9</sup> Celia J. Lin,<sup>9</sup> Daniel C. Brennan,<sup>8</sup> <sup>1</sup>Cedars-Sinai Medical Center, Los Angeles, CA; <sup>2</sup>University of Washington, Seattle, WA; <sup>3</sup>Dallas Nephrology Associates, Dallas, TX; <sup>4</sup>UPMC, Pittsburgh, PA; <sup>5</sup>Hopital Maisonneuve-Rosemont, Montreal, QC, Canada; <sup>6</sup>LBG Consulting, San Diego, CA; <sup>7</sup>Amplix Pharmaceuticals Inc, San Diego, CA; <sup>8</sup>Johns Hopkins University, Baltimore, MD; <sup>9</sup>Vera Therapeutics, Brisbane, CA.

**Background:** Reactivation of BK virus (BKV) infection can cause significant kidney disease in immunocompromised patients. BKV nephropathy is a leading cause of allograft loss in kidney transplant recipients. There are currently no effective or BKV-specific therapies. MAU868 is a novel monoclonal human IgG1 that binds to the BKV major capsid protein with potent *in vitro* neutralizing activity against the 4 major BKV genotypes.

**Methods:** This is a Phase 2, randomized, placebo-controlled, double-blind study in patients (pts) who received a kidney transplant within one year. Pts had BK viremia; either  $\geq 10^4$  copies/ml within 10 days of randomization or  $\geq 10^3$  copies/ml in 2 consecutive samples 1-3 wks apart with most recent value measured within 10 days of randomization. Pts were randomized (2:1) to MAU868 or placebo intravenously (IV) every 28 days for 12 wks, with 24 wks follow-up. This analysis reports efficacy results at 16 and 36 wks for 2 cohorts: Cohort 1: MAU868 1350 mg IV X4 doses, and Cohort 2: MAU868 6750 mg IV followed by 1350 mg IV X3 doses. The primary endpoint was safety; BKV viral load (VL) response to treatment was assessed as secondary endpoints and post-hoc analyses.

**Results:** 20 pts received MAU868 and 8 pts received placebo; all completed 12 wks of treatment and 24 wks of follow-up. Baseline characteristics were comparable between groups. Median baseline VL was 16,700 log<sub>10</sub> BKV DNA copies/ml (range 1,200-1,800,000). MAU868 was well tolerated, with a comparable frequency of adverse events and serious adverse events between groups through wk 36. There were 2 deaths in the MAU868 group due to COVID-19 infection deemed unrelated to study drug. The antiviral effect was greater in the MAU868 group than in the placebo group at wk 16 and sustained through wk 36 (Table).

**Conclusions:** MAU868 was well tolerated and demonstrated clinically meaningful BK antiviral activity in kidney transplant recipients with BK viremia. These results support the further development of MAU868 as a therapy for BK viremia.

**Funding:** Commercial Support - Amplix Pharmaceuticals/Vera Therapeutics

	Week 16		Week 36	
	MAU868 (N=20)	Placebo (N=8)	MAU868 (N=20)	Placebo (N=8)
Patients VL decreased by $\geq 1$ log <sub>10</sub> BKV DNA copies/ml vs baseline	8 (40%)	1 (12%)	15 (75%)	4 (50%)
Patients with VL < lower limit of detection (LOD)	3 (15%)	0	6 (30%)	0
Patients with VL < 10 <sup>4</sup> log <sub>10</sub> BKV DNA copies/ml	13 (65%)	3 (38%)	15 (75%)	5 (63%)
BKV VL reduction - median log <sub>10</sub> BKV DNA copies/ml (Interquartile range (IQR))	-0.97(-2.6, 0.8)	-0.38 (-2.3, 0.5)	-1.31 (-3.3, 0.6)	-0.85 (-2.3, 1.3)
Change in estimated glomerular filtration rate (eGFR) - median ml/min/1.73m <sup>2</sup> (Min,Max)	-4.5 (-28.0,13.0)	-6.0 (-11,2.0)	-0.5 (-51.0,25.0)	-5.5 (-27,12)

Antiviral Effect and Effect on Kidney Function of MAU868 vs Placebo

**SA-OR44**

**Spatial mRNA Analysis of Human Allograft Endothelium Shows Distinct Structure-Specific Endothelial Transcripts in Chronic Antibody-Mediated Rejection**

Ira Doressa Anne L. How,<sup>1</sup> Kristen Tomaszewski,<sup>2</sup> Andrea Rios,<sup>1</sup> Samantha M. Morales,<sup>1</sup> Prajan Divakar,<sup>3</sup> Rex N. Smith,<sup>1</sup> Robert B. Colvin,<sup>1</sup> Ivy A. Rosales,<sup>1</sup> <sup>1</sup>Massachusetts General Hospital, Boston, MA; <sup>2</sup>Cleveland Clinic, Cleveland, OH; <sup>3</sup>NanoString Technologies Inc, Seattle, WA.

**Background:** Bulk tissue mRNA analysis has shown the importance of endothelium-associated transcripts, but structure-specific transcript differences remain unexplored. We used the NanoString GeoMx Digital Spatial Profiler (DSP) to spatially analyze transcripts in glomerular (Ge) and peritubular capillary (PTCe) endothelium in human renal allografts with and without T cell-mediated (TCMR) and chronic antibody-mediated (CAMR) rejection.

**Methods:** Five micron-thick formalin-fixed paraffin-embedded (FFPE) sections from 12 CAMR, 13 TCMR, 15 no rejection (NER), and 9 native (control) biopsies were hybridized with an 84-gene Immune Pathways and 10-gene custom panel attached to photocleavable oligonucleotide tags, and incubated with fluorophore-labeled antibodies (DNA, CD10, CD45, CD31). Using GeoMx DSP, Ge and PTCe areas of interest (AOIs, n=210) were segmented by CD31 expression. Oligonucleotide tags from AOIs were quantified using the NanoString nCounter MAX instrument. Data analysis was done using GeoMx DSP software.

**Results:** In controls, *VEGFA*, *KDR* and *EHD3* are enriched in Ge while *PLVAP* is enriched in PTCe. Ge in CAMR with transplant glomerulopathy (TG) shows enrichment of *CD59* (p=0.00005), *PECAM1* (p=0.0005), *COL4A1* (p=0.007), *CD74* (p=0.006), *HLA-DQ* (p=0.02), *CCND1* (p=0.005) and *CXCL9* (p=0.03), while *LAG3* (p=0.00005), *EHD3* (p=0.003) and *VEGFA* (p=0.02) are decreased when compared to TCMR (Figure 1), indicating loss of *VEGFA*, endothelial dedifferentiation, and GBM remodelling with ectopic *COL4A1*. PTCe in CAMR showed IFNG-associated PTCe injury with increased *IFNGR1* (p=0.001), *PRFI* (p=0.005), *ICAM1* (p=0.04), *CD59* (p=0.02) and decreased *PLVAP* (p=0.001), *STAT1* (p=0.05) and *ITGB2* (p=0.005) are enriched in TCMR PTCe.

**Conclusions:** Spatial mRNA analysis identified distinct endothelial transcript expression that are potentially relevant to pathogenesis and therapeutic targets.

**Funding:** Other NIH Support - NIH training grant (5T32AI007529) for Dr. Tomaszewski

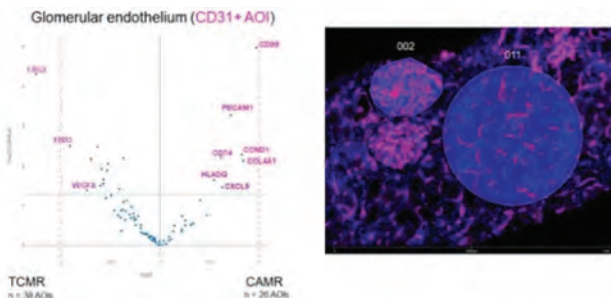

**SA-OR45**

**Acute Tubular Injury and Necrosis Do Not Lead to Meaningful Elevations in Donor-Derived Cell-Free DNA (dd-cfDNA)**

Sridhar Reddy Allam,<sup>1</sup> Alexander C. Wiseman,<sup>2</sup> Matthew Cooper,<sup>3</sup> Dhiren Kumar,<sup>4</sup> Nikhil Agrawal,<sup>5</sup> Thin Thin Maw,<sup>6</sup> <sup>1</sup>Medical City Fort Worth, Fort Worth, TX; <sup>2</sup>Centura Health, Englewood, CO; <sup>3</sup>MedStar Georgetown University Hospital, Washington, DC; <sup>4</sup>Virginia Commonwealth University, Richmond, VA; <sup>5</sup>CareDx Inc, Brisbane, CA; <sup>6</sup>University of Southern California, Los Angeles, CA.

**Background:** Associations between non-rejection histologic diagnoses and dd-cfDNA have not been extensively characterized. We explored these associations in kidney transplant recipients in the Kidney allograft Outcomes AlloSure Registry (KOAR, NCT03326076).

**Methods:** For-cause and surveillance biopsies with no rejection or other abnormalities (NR) or acute tubular injury/necrosis (ATI/ATN), and paired dd-cfDNA were included. The incidence of a composite outcome (eGFR decline > 25%, rejection, and de novo DSA detection) at 12 months after biopsy was also assessed.

**Results:** 166 biopsies (141 patients) with NR and 70 biopsies (64 patients) with ATI/ATN were included; compared to patients with ATI/ATN, patients with NR had lower KDPI (49% vs 64%, p<0.05) and shorter cold ischemia time (13 vs 18 hours, p<0.01). ATI/ATN biopsies were more likely to be for-cause (91.4% vs 59.6%, p<0.001), earlier post-transplant (83.0 vs 116.5 days, p<0.001), and occur at lower eGFRs (43 vs 32 mL/min, p<0.001) [Table 1]. There was no significant difference in median dd-cfDNA between NR (0.23%, IQR: 0.11 - 0.53) and ATI/ATN (0.21%, IQR: 0.13 - 0.55) biopsies (p = 0.993). When patients were stratified by dd-cfDNA at the time of their first biopsy (< 0.5% vs  $\geq$  0.5%), there was a non-significant trend towards a higher incidence of the 12-month clinical composite among those with dd-cfDNA  $\geq$  0.5% (27.5% vs 12.9%, p=0.53), with eGFR decline being most common (78.5% of events).



**Conclusions:** Our findings suggest that acute tubular injury/necrosis is not associated with substantial elevations in dd-cfDNA. The use of dd-cfDNA to identify patients with non-actionable histologic findings may allow more nuanced clinical decision-making and reduce the number of unnecessary biopsies.

**Funding:** Commercial Support - CareDx

Biopsies				
Variable	Total	ATI/ATN	No Rejection	p value
Number of Biopsies	236	70	166	
Timing (days post-transplant)	236	70	166	< 0.001
Median (IQR)	105.0 (71.0-197.25)	83.0 (57.0-118.25)	116.5 (76.75-207.5)	
eGFR at biopsy (mL/min)	236	70	166	<0.001
		32 (24.9-44.0)	43 (28.5-61.1)	
Indication for Biopsy	236	70	166	< 0.001
For-Cause Biopsy (%)	163 (69.1%)	64 (91.4%)	99 (59.6%)	
Surveillance Biopsy (%)	73 (30.9%)	6 (8.6%)	67 (40.4%)	
Patients				
Variable	Total	ATI/ATN	No Rejection	p value
Number of Patients	205	64	141	
Age (years)	205	64	141	0.5874
Median (IQR)	57.0 (45.0-65.0)	57.0 (47.75-64.25)	56.0(44.0-66.0)	
Induction IS	205	64	141	0.0825
Alemtuzumab	35 (17.1%)	17 (26.6%)	18 (12.8%)	
ATG	136 (66.3%)	37 (57.8%)	99 (70.2%)	
Basiliximab	20 (9.8%)	7 (10.9%)	13 (9.2%)	
Others	14 (6.8%)	3 (4.7%)	11 (7.8%)	
Donor Type	205	64	141	0.0608
Living Donor (%)	44 (21.5%)	13 (20.3%)	31 (22.0%)	
KDPI	152	49	103	0.0126
Median (IQR)	56.0 (32.0-75.0)	64.0 (49.0-82.0)	49.0(28.0-70.5)	
Cold Ischemia Time (hours)	181	62	119	0.0057
Median (IQR)	14.0 (7.0-20.0)	18.0 (9.5-22.0)	13.0 (6.5-18.0)	

SA-OR46

**Validation of a Urinary Exosome mRNA Signature for the Diagnosis of Human Kidney Transplant Rejection**

Rania El Fekih,<sup>1</sup> Brian C. Haynes,<sup>5</sup> Areej saud Alghamdi,<sup>2</sup> John Y. Choi,<sup>1</sup> James Hurley,<sup>4</sup> Helmut G. Rennke,<sup>1</sup> Astrid Weins,<sup>1</sup> Christa A. Deban,<sup>1</sup> Anis J. Saad,<sup>1</sup> Ahmad Halawi,<sup>1</sup> Nour K. Younis,<sup>1</sup> Zhabiz Solhjou,<sup>1</sup> Camila Macedo,<sup>3</sup> Johan Skog,<sup>4</sup> Jamil R. Azzi,<sup>1</sup> Transplant Research Center, Brigham and Women's Hospital <sup>1</sup>Brigham and Women's Hospital, Boston, MA; <sup>2</sup>Boston Children's Hospital, Boston, MA; <sup>3</sup>UPMC, Pittsburgh, PA; <sup>4</sup>Exosome Diagnostics, Waltham, MA; <sup>5</sup>Bio-Techne, Austin, TX.

**Background:** Traditional biomarkers currently used to monitor kidney allograft rejection are late markers of injury, and lack sensitivity and specificity. Biopsies are invasive and costly. Urinary exosomes are nanoscale extracellular vesicles. They are released from kidney cells, and contain a payload of proteins and nucleic acids that reflect the physiology of the parent cells. Their potential to serve as a liquid biopsy and biomarker for post-transplant rejection has recently been investigated.

**Methods:** We collected 411 urine samples from 366 patients undergoing for cause or management transplant kidney biopsy. Using a clinically validated platform for exosome isolation and analysis, a transcript of 17 gene targets, previously determined by us to be associated with kidney rejection, were pre-amplified and evaluated by RT-qPCR. Machine learning was applied to the training cohort data to determine an optimal algorithm for detecting kidney rejection.

**Results:** The prevalence of any-cause rejection among the for-cause and the management biopsy group were 36.3% and 22.2%, respectively. In the for-cause biopsy group, we identified a linear SVM classifier of 3 mRNA features (*IL32*, *B2M*, and *CXCL11*) that distinguishes any-cause rejection from no rejection, achieving an AUC of 0.731, with a sensitivity and an NPV of 93%. This shows the potential to save 43% of unnecessary biopsies. In the management-biopsy group, we identified a classifier that distinguishes any-cause rejection from no rejection, achieving an AUC of 0.781, with a sensitivity of 93% and an NPV of 97%. We are further evaluating the role of significant underlying inflammation determined by biopsy, such as moderate to significant lymphocytic infiltration, interstitial nephritis (BKV nephritis or AIN), glomerulopathy or immune complex deposition, in the classification of samples that are rejection negative by biopsy.

**Conclusions:** mRNA signatures derived from urinary exosomes represent a powerful and non-invasive tool to assess kidney allograft rejection, detect early renal allograft rejection and support clinicians in therapeutic decisions. This signature holds strong potential for diagnostic use, to be further demonstrated in a prospective clinical setting.

**Funding:** Other NIH Support - T32 Ruth L. Kirschstein Institutional National Research Service Award, Commercial Support - ExosomeDx, a Biotechne brand

SA-OR47

**Five-Year Follow-Up of a Phase 1 Trial of Donor-Derived Modified Immune Cell Infusion in Kidney Transplantation**

Matthias Schaefer,<sup>1</sup> Christian Morath,<sup>1</sup> Lei Wang,<sup>1</sup> Christian Kleist,<sup>1</sup> Gerhard Opelz,<sup>1</sup> Thuong H. Tran,<sup>1</sup> Sabine Scherer,<sup>1</sup> Caner Süsal,<sup>1</sup> Eman H. Ibrahim,<sup>1</sup> Mostafa G. Aly,<sup>1</sup> Cristian M. Alvarez,<sup>1</sup> Angela Hückelhoeven-Krauss,<sup>1</sup> David Czock,<sup>1</sup> Arianeb Mehrabi,<sup>1</sup> Constantin Schwab,<sup>1</sup> Ruediger Waldherr,<sup>1</sup> Paul Schnitzler,<sup>1</sup> Uta Merle,<sup>1</sup> Georg Bohmig,<sup>2</sup> Jochen Reiser,<sup>3</sup> Martin G. Zeier,<sup>1</sup> Michael Schmitt,<sup>1</sup> Peter Terness,<sup>1</sup> Anita Schmitt,<sup>1</sup> Volker Daniel,<sup>1</sup> TOL-1 Study group at Nierenzentrum Heidelberg <sup>1</sup>Ruprecht Karls Universität Heidelberg, Heidelberg, Germany; <sup>2</sup>Medizinische Universität Wien Universitätsklinik für Innere Medizin III, Wien, Austria; <sup>3</sup>Rush University Rush Medical College, Chicago, IL.

**Background:** The administration of modified immune cells (MIC) prior to kidney transplantation led to specific immunosuppression against the allogeneic donor and a significant increase in regulatory B lymphocytes (Breg) (Morath et al., J Clin Invest 2020). We now wanted to investigate how this approach affects the clinical course of treated patients.

**Methods:** Clinical results of ten patients from a phase I clinical trial who had received MIC infusions before kidney transplantation were compared to results of 15 matched standard-risk recipients. Follow-up was until year five after surgery.

**Results:** The 10 MIC patients had an excellent clinical course with stable kidney graft function and showed no donor-specific human leukocyte antigen antibodies (DSA) or acute rejections during follow-up. In contrast, 1 of 15 controls died and 5 of 15 controls developed DSA (log rank  $P = 0.046$ ) (Figure 1 A, B). While the number of patients with a non-opportunistic infection did not differ significantly between groups ( $P = 0.36$ ), opportunistic infections were reported more frequently in controls (log rank  $P = 0.033$ ) (Figure 1 C). Compared to controls, MIC patients were found to have a trend towards a higher COVID-19 anti-S1 IgG index after vaccination with a median of 53 vs. 2 ( $P = 0.16$ ). Importantly, the four MIC patients who had received the highest MIC cell dose 7 days before surgery and were on low immunosuppression during follow-up, continued to show absent anti-donor T lymphocyte reactivity in vitro and high CD19<sup>+</sup>CD24<sup>hi</sup>CD38<sup>hi</sup> transitional Breg as well as CD19<sup>+</sup>CD24<sup>hi</sup>CD27<sup>+</sup> memory Breg.

**Conclusions:** MIC infusions together with reduced conventional immunosuppression were associated with lower de novo DSA development and lower rates of opportunistic infections. In the future, MIC infusions could contribute to graft protection while reducing the side effects of immunosuppressive therapy.

**Funding:** Commercial Support - TolerogenixX GmbH, Government Support - Non-U.S.

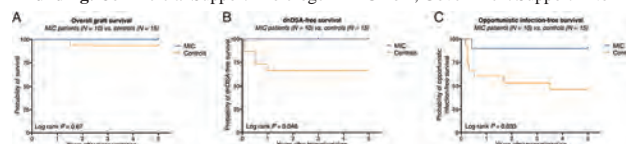

SA-OR48

**A Regimen of Nonmyeloablative Conditioning and CD8+/TCR- Facilitating Cells Tips the Balance Towards Immune Downregulation and Away From Cytopathic Activity in Kidney Allograft Recipients**

John R. Lee,<sup>1</sup> Joseph Leventhal,<sup>2</sup> Carol Y. Li,<sup>1</sup> Suzanne Ildstad,<sup>3</sup> Manikkam Suthanthiran.<sup>1</sup> <sup>1</sup>Weill Cornell Medicine, New York, NY; <sup>2</sup>Northwestern University Feinberg School of Medicine, Chicago, IL; <sup>3</sup>Talaris Therapeutics, Inc., Louisville, KY.

**Background:** We tested the hypothesis that tolerance induced with a regimen of nonmyeloablative conditioning and CD8+/TCR- facilitating cells (FCR001) is associated with immune down regulation and away from cytopathic activity.

**Methods:** Blinded to clinical status and biopsy diagnosis, the Laboratory quantified urinary cell mRNA levels in 28 urines from 14 FCR001-tolerant patients with durable chimerism and off immunosuppression per protocol(FCR DC off IS); 23 urines from 12 FCR001-tolerant patients with DC and on immunosuppression per protocol(FCR DC on IS); 43 biopsy-matched urines from 34 kidney allograft recipients from the Clinical Trials in Organ Transplantation-04(CTOT-04) study and TCMR biopsies (TCMR Cohort); and 161 biopsy-matched urines from 124 recipients from CTOT-04 study with No Rejection biopsies (NR Cohort).

**Results:** In accord with negative immune regulation in tolerant patients, urinary cell mRNA levels of CTLA-4 were significantly higher in the FCR DC off or on IS than the TCMR cohort or the NR Cohort ( $P < 0.05$ , Wilcoxon rank sum test, Table 1). In accord with lack of cytopathic activity in tolerant patients, levels of Granzyme B and Perforin were significantly lower or no different in the FCR DC off or on IS compared to the NR cohort (Table 1). Levels of additional mRNAs in the FCR DC on or off IS were significantly lower than the TCMR Cohort and mostly similar to that in the NR Cohort (Table 1).

**Conclusions:** Tolerance induced with a nonmyeloablative conditioning regimen and CD8+/TCR- facilitating cells is characterized by tipping of the balance towards immune down regulation and away from cytopathic activity.

Table 1

Gene	FCR Durable off IS Median Copies	FCR Durable on IS Median Copies	No Rejection Group Median Copies	TCMR Group Median Copies	FCR Durable off IS vs. No Rejection P Value	FCR Durable off IS vs. TCMR P value	FCR Durable on IS vs. No Rejection P value	FCR Durable on IS vs. TCMR P value	TCMR vs. No Rejection P Value
CTLA4	439	575	13	135	6 x 10 <sup>-15</sup>	0.005	4 x 10 <sup>-4</sup>	2 x 10 <sup>-12</sup>	
CD3	1239	1782	360	8826	0.06	5 x 10 <sup>-5</sup>	0.002	7 x 10 <sup>-11</sup>	
Granzyme B	106	207	337	3304	0.008	3 x 10 <sup>-9</sup>	0.47	4 x 10 <sup>-6</sup>	
Perforin	92	277	223	4119	0.25	2 x 10 <sup>-8</sup>	0.48	1 x 10 <sup>-5</sup>	
IFN $\gamma$	153	266	75	1445	0.17	1 x 10 <sup>-5</sup>	0.03	1 x 10 <sup>-10</sup>	
FoxP3	13	13	13	73	0.33	0.007	0.20	2 x 10 <sup>-5</sup>	
TGF $\beta$ 1	2182	3045	4589	15142	0.01	4 x 10 <sup>-7</sup>	0.68	2 x 10 <sup>-4</sup>	
ISS mRNA	4 x 10 <sup>98</sup>	6 x 10 <sup>98</sup>	7 x 10 <sup>98</sup>	2 x 10 <sup>99</sup>	0.08	4 x 10 <sup>-5</sup>	0.41	0.003	
CTLA4/Granzyme B Ratio	5.62	1.56	0.04	0.03	7 x 10 <sup>-15</sup>	6 x 10 <sup>-16</sup>	3 x 10 <sup>-12</sup>	3 x 10 <sup>-10</sup>	

SA-OR49

Clinical Performance Validation of Tuteva Biomarker

**Oriol Bestard**,<sup>1</sup> Joshua J. Augustine,<sup>2</sup> Lorenzo G. Gallon,<sup>3</sup> Mohammed Javed Ansari,<sup>4</sup> Gaetano La Manna,<sup>5</sup> Milagros D. Samaniego-Picota,<sup>6</sup> Roslyn B. Mannon,<sup>7</sup> <sup>1</sup>Hospital Universitari Vall d'Hebron, Barcelona, Spain; <sup>2</sup>Cleveland Clinic, Cleveland, OH; <sup>3</sup>Northwestern University, Evanston, IL; <sup>4</sup>Northwestern Memorial HealthCare Corp, Chicago, IL; <sup>5</sup>Universita degli Studi di Bologna, Bologna, Italy; <sup>6</sup>Henry Ford Health System, Detroit, MI; <sup>7</sup>University of Nebraska System, Lincoln, NE.

**Background:** Identification of kidney allograft rejection relies mainly on monitoring methods such as proteinuria and serum creatinine. These measures may lead to assessment by biopsy. Biomarkers which correlate to or predict the presence of acute rejection are needed to support clinical management in a sensitive and less invasive manner. As a priority, biomarkers require validation in a prospective study that is reflective of the complex transplant population and for which correlation to a gold reference standard is measured. Herein we report on the validation of the Tuteva test for predictive risk of the presence of clinical / sub-clinical acute rejection in a global clinical trial.

**Methods:** Tuteva is a blood-RNA expression next-generation sequencing assay which interrogates the gene expression profile (GEP) of kidney transplant recipients using a signature derived in an independent cohort of transplant patients. By applying machine learning algorithm (MLA) to a discrete gene set, the assay generates a risk score interpreted by an MLA derived cut-off to predict a patients' risk of the presence of acute rejection. The test is performed and analytically validated in a CLIA laboratory. All GEP Tuteva results were calculated in a blinded manner. The clinical study was conducted at 13 centers in the USA, Spain, Italy, France and Australia from which 151 unique kidney transplant participants were included. Each patient had blood collected at the time of surveillance or indication biopsy. All biopsies were evaluated by central pathology in blinded manner based on current BANFF criteria; borderline rejections were included in the analysis, and biopsy findings served as the outcome of ABMR, TCMR, or mixed as case definition. The event rate was 30%.

**Results:** Tuteva results were reported as a continuous risk score from 1-100 with a cutpoint at 50 for separating high from low risk. This cutpoint resulted in 26% of patients in high-risk group, of which 60% showed evidence of rejection on biopsy; of the 74% of patients in the low-risk group, 80% had negative biopsy for rejection. Seven biopsies were positive for BK; 6/7 (86%) were low risk in Tuteva.

**Conclusions:** Tuteva represents an advancement in biomarker transplant biology to better inform medical management of all kidney transplant patients in a more personalized and predictive manner.

**Funding:** Commercial Support - Verici Dx Inc

SA-OR50

Immune Cell Transcriptome in Living-Donor Kidney Transplant Patients Tolerized With Allogeneic Hematopoietic Stem Cell Transplantation Therapy

**Jennifer M. McDaniel**,<sup>1</sup> Amol C. Shetty,<sup>1</sup> Thomas Rousselle,<sup>1</sup> Joseph Leventhal,<sup>2</sup> Suzanne Ildstad,<sup>3</sup> Valeria R. Mas,<sup>1</sup> <sup>1</sup>University of Maryland Baltimore, Baltimore, MD; <sup>2</sup>Northwestern University Feinberg School of Medicine, Chicago, IL; <sup>3</sup>Talaris Therapeutics Inc, Louisville, KY.

**Background:** Long-term outcomes in living donor kidney transplant (LDKT) patients are suboptimal due to lifelong chronic immunosuppression complications. FREEDOM-1 is a randomized, controlled, open-label Phase 3 study of FCR001 in adult LDKT patients. The mechanisms underlying immune tolerance after HSCT are poorly understood. This study deciphered the immune landscape associated with tolerance at single cell resolution.

**Methods:** Peripheral blood mononuclear cells (PBMCs) from 4 LDKT patients (3 in the FCR001 group and 1 with standard of care (SOC) immunosuppression) were studied at 4 timepoints (T0-, T1-, T3-, and T6-month(s)). Cross-sectional and longitudinal evaluations were done. Analysis was done using CellRanger software and visualized with UMAP. DEGs (FDR $\leq$ 0.05) identified enriched GO terms and pathways.

**Results:** Unsupervised PBMCs clustering (>100,000 cells) identified 17 unique cell clusters, including monocytes, natural killer (NK) and T cell subclusters (Fig 1A). At T6, FCR was characterized by decreased NK1, T helper, and T memory cells, while CD14+

monocytes, NK2, and T proliferating cell clusters were increased compared to SOC. A mixed immune cluster was increased in FCR (Fig 1B) and characterized by PD-L1 checkpoint and T cell receptor signaling pathways. There was a higher proportion of cells in S phase from FCR, indicating early alterations in transcriptional activity (Fig 1C). High heterogeneity in NK clusters was observed; NK1 was reduced in FCR (Fig 1D). DEGs showed that NK1 cells were less transcriptionally active in FCR at T6 (Fig 1E).

**Conclusions:** This study represents the first longitudinal evaluation of PBMCs from LDKT patients underlying mechanisms of tolerance at single cell resolution. Unique patterns of immune cell types, cell states, and transcriptional activity were identified with NK cell subclusters playing a critical role.

**Funding:** Commercial Support - Talaris Therapeutics

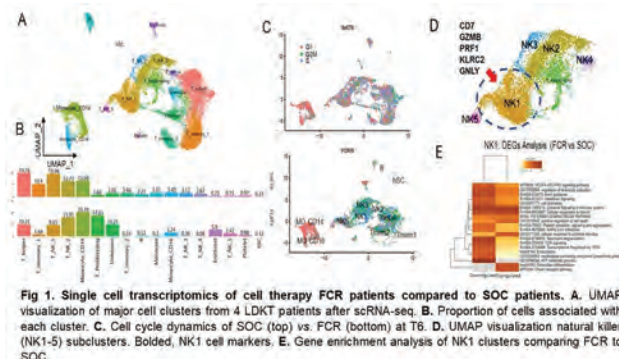

**Fig 1.** Single cell transcriptomics of cell therapy FCR patients compared to SOC patients. A. UMAP visualization of major cell clusters from 4 LDKT patients after scRNA-seq. B. Proportion of cells associated with each cluster. C. Cell cycle dynamics of SOC (top) vs. FCR (bottom) at T6. D. UMAP visualization natural killer (NK1-5) subclusters. Bolded, NK1 cell markers. E. Gene enrichment analysis of NK1 clusters comparing FCR to SOC.

TH-PO001

Quality Improvement in CKD Management in a Resident Primary Care Clinic

**Nicole Wyatt**, Phillip Madonia. Brookwood Baptist Health, Birmingham, AL.

**Background:** Primary care physicians (PCPs) are in a unique position to identify and manage CKD early in the disease process, preventing disease progression. Given the recent increased emphasis on providing resources and education for PCPs, we identified a need to implement an educational protocol to train internal medicine residents on the diagnosis and management of CKD in the primary care clinic. We present preliminary data evaluating the impact of this educational training.

**Methods:** A retrospective electronic medical record (EMR) search included all patients in the resident clinic diagnosed with CKD stage 3 from June 2019 to October 2021. Each chart was evaluated for urinary albumin creatinine (ACR), blood pressure and glycemic control, therapy with ACEi/ARB and SGLT2i, and referral status to nephrology. Then, an educational presentation and informational handout was given to the residents. A repeat EMR search was made 6 months post-education to re-evaluate the above parameters.

**Results:** Pre-intervention data showed 71 clinic patients diagnosed with CKD3. Blood pressure was controlled in 31% and glucose controlled in 66% with HbA1c ordered (n=59). ACR was ordered at least once in 50.7% and annually in 15.5%. Of those without contraindications (n=65), 84.6% had ACEi/ARB therapy. SGLT2i therapy had been initiated in 2.8%. Referrals to nephrology were made in 42.3%. Review performed 6 months post-intervention revealed 45 patients with CKD3, including those that returned or were newly diagnosed. Blood pressure was controlled in 48.9% and glucose controlled in 67.6% with HbA1c ordered (n=34). Annual ACR had been ordered in 60%, ACEi/ARB therapy was ordered in 78.9% without contraindications (n=38), and SGLT2is were prescribed to 20.9%. Referrals were made in 46.7%. One-year post-intervention data is still being collected.

**Conclusions:** Preliminary results at 6-months post educational training show a promising trend in improvement in the management of CKD stage 3 patients in the resident clinic population. Importantly, there has been an increase in annual ACR orders and SGLT2 inhibitor initiation. We expect this trend to continue with our 12-month interval data collection. Given the importance of PCPs in the identification and management of CKD patients, as well as an overall shift to value-based care, it is integral to improve graduate medical education on this topic.

TH-PO002

A CKD Awareness Campaign and mHealth Education to Improve Knowledge and Quality of Life Among CKD Patients in Bangladesh: A Randomized Controlled Trial

**Mohammad H. Sarker**. International Centre for Diarrhoeal Disease Research Bangladesh, Dhaka, Bangladesh.

**Background:** Chronic kidney disease (CKD) is linked to major health consequences and a poor quality of life. Despite the fact that CKD is becoming more prevalent, public knowledge of the disease remains low. We aimed to evaluate the outcome of a health education intervention designed to enhance knowledge, health-related quality of life (QOL), and healthy lifestyle among CKD adults.

**Methods:** This was a parallel-group (1:1) randomized controlled trial in Bangladesh that compared two groups of CKD patients. Adults individual with CKD (stages 1-3) were enrolled in November 2020 and randomly assigned to intervention or control group. The intervention group received health education through a CKD awareness campaign and

mHealth technologies, whereas the control group received usual care, and was observed for six months. Primary Outcome was improved scores on the CKD knowledge questionnaire and secondary outcomes were improved QOL and changes in the level of blood pressure (BP), BMI, fasting blood sugar (FBS), cholesterol, triglyceride and serum uric acid.

**Results:** We enrolled 126 patients (control, n=63, intervention, n=63) in the study and performed intention to treat analysis. The analyses included repeated measures ANOVA and results were observed to be significantly different in case of within-group ( $P<.001$ ), between groups ( $P<.001$ ) and interaction of group  $\times$  time factor ( $P<.001$ ) in terms of knowledge score. Diastolic BP and BMI showed significant differences arising from within groups ( $P<.001$ ,  $P=.01$  respectively) and in interaction of group  $\times$  time factor ( $P=.001$ ,  $P=.02$  respectively); hip circumferences showed significant difference arising from within groups ( $P=.03$  respectively) and between groups ( $P=.02$ ). Moreover, systolic BP and waist circumference showed significant differences within groups ( $P<.001$ ,  $P=.003$  respectively). Regarding laboratory findings, from baseline to six months, the mean ( $\pm$ SD) FBS decreased by  $0.51 \pm 3.77$ mg/dl in the intervention group and by  $0.10 \pm 1.44$  g/dl in the control group ( $P=.03$ ).

**Conclusions:** The health education strategy, which included a campaign and mHealth, showed promise for enhancing CKD knowledge and controlling their FBS and BP among CKD patients. The combined health education initiatives give evidence for scaling them up in Bangladesh and possibly other low- and middle-income countries.

**Funding:** Other NIH Support - Grants-in-Aid for Scientific Research Program (KAKENHI)

### TH-PO003

#### Advancing Treatments for CKD: Trends and Opportunities

Andrew M. Bevan,<sup>1</sup> Davide Garrisi,<sup>2</sup> Carmichael Angeles,<sup>2</sup> <sup>1</sup>Evidera, a business of PPD, part of Thermo Fisher Scientific, London, United Kingdom; <sup>2</sup>PPD, part of Thermo Fisher Scientific, Morrisville, NC.

**Background:** Several factors, including high unmet need, ongoing evolution of endpoints and faster approval tracks make nephrology an interesting development opportunity, which has contributed to a renewed interest in clinical development. We undertook an analysis of metadata from Clinicaltrials.gov (CT.gov) to characterize trends over the last 20 years and what this may tell us about the future trajectory for treatment development.

**Methods:** CT.gov was searched for studies of drugs or biologicals containing the terms "Chronic Renal Failure", "Chronic Renal Disease", "Chronic Kidney Disease" or "Chronic Renal Insufficiency" posted from 01-Jan-2002 and 31-Dec-2021. 1038 records were returned and 194 were excluded due the study intervention being either behavioral, procedural, diagnostic, dietary supplement or "other". 844 studies in the analysis were divided into 2 time periods: P1 - 2002 to 2011, and P2 - 2012 to 2021, and analyzed by study phase, population type, type of intervention and funding.

**Results:** There was a 54% increase studies in P2 vs P1 with the most marked increase in early phase studies, which increased by 132%. Most studies were in adults (P1 88%, P2 91%). The number of industry funded studies increased by 32% in P2 vs P1; however, the increase was a more marked in non-industry funded studies, which doubled. In terms of intervention type, there was a 19-fold increase in the number of studies investigating biological interventions in P2 (39) vs P1 (2). Hemoglobin (Hb) was the most frequently assessed primary endpoint in industry sponsored studies, increasing by 55% in P2 vs P1.

**Conclusions:** Our data provides evidence of increased clinical research activity in CKD in the last 10 years and more focus on biologicals that are best designed to precisely target complex biological pathways in disease pathophysiology. Targeted therapies have the potential to transform the treatment of CKD in children, where the level of unmet medical need is high. However, our results did not reveal an increase in research activity in pediatrics. The marked growth in studies investigating the effect of therapies on Hb reflects the surge in interest in the study of CKD-anemia. The marked rise in non-industry funded studies may indicate a growth in basic science that may translate into further increases in industry sponsored research in the future.

**Funding:** Commercial Support - PPD, Part of ThermoFisher Scientific

### TH-PO004

#### Online Patient Education on Polycystic Kidney Disease Prompts Real Life Changes

Amy Larkin, Steven Smith. Medscape LLC, New York, NY.

**Background:** We sought to measure the impact of online education for patients on knowledge and confidence as well as on prompting change in daily life.

**Methods:** The educational activity was available online, and comprised of text and integrated visuals as well as a patient video. Demographic questions were asked prior to starting the education. A knowledge question was asked both before and after the activity to assess learning gains, as well as intent to change and confidence questions at the end. Absolute improvements were calculated for pre/post questions. The activity launched December 8, 2021, and preliminary data collected through April 26, 2022.

**Results:** To date, 19,600 learners have participated in the patient/caregiver activity, "Polycystic Kidney Disease: What Do You Need to Know?" Completers of all questions (included in outcomes analysis): 4,765 Demographics: 70% female; 67% white, non-Hispanic; 63% over the age of 54; 19% have polycystic kidney disease, 13% are caregivers or family of someone with polycystic kidney disease, 69% were interested in learning more about polycystic kidney disease Knowledge Changes: 12% increase in learners who recognized that sticking to your PKD treatment is important even if you're feeling ok (55% pre, 67% post) Intent-to-act: 74% plan to talk to their HCP about ways to manage their PKD Confidence: 78% reported being confident in talking to my doctor or healthcare provider about PKD and what it means for me

**Conclusions:** The metrics and outcomes gathered in this assessment are a strong indicator that these patient-focused online educational activities improved knowledge and confidence and prompted intent to act by patients related to polycystic kidney disease.

### TH-PO005

#### Nephrologists as Internal Medicine Residency Program Directors: Trends From a National Survey

Patricia F. Kao,<sup>1</sup> Michael Kisielewski,<sup>2</sup> <sup>1</sup>Washington University in St Louis School of Medicine, St Louis, MO; <sup>2</sup>Alliance for Academic Internal Medicine, Alexandria, VA.

**Background:** Internal medicine (IM) resident interest in nephrology careers peaked in 2008, declined in subsequent years, and has remained low over the last decade. Studies cite a lack of nephrology role models and lack of exposure to nephrology as contributing factors (Beck, 2020). IM program directors (PDs) are important stakeholders and role models who influence nephrology exposure and education during residency training. The number of nephrologists in IM residency leadership roles is currently unknown. The objective of this study was to quantify the number of IM residency PDs who are nephrologists, and to explore historical trends.

**Methods:** The Association of Program Directors in Internal Medicine (APDIM) Annual Survey queries IM PDs from ACGME-accredited ("Continued" or "Initial" status) about their sub-specialty training. The 2021 Annual Survey included PDs from 439 APDIM member programs, representing 80.4% of the 546 accredited U.S./U.S. territory-based IM training programs. To assess historical trends, we performed a multivariate regression and a multivariate test of means with survey data collected using a similar methodology from 2008 to 2021.

**Results:** Of the 267/439 (61.0%) PDs who completed the 2021 Annual Survey, only 10/267 (3.7%) reported specializing in nephrology. From 2008 to 2021, the modal percentage of IM PDs who reported being nephrologists occurred in 2008 (6.0%; 16/268), reaching a nadir in 2020 (1.5%; 4/260). The reported percentage of IM PDs who are nephrologists decreased from 2008 to 2021 ( $p<0.01$ ). (Figure 1)

**Conclusions:** The percentage of IM residency PDs who are nephrologists is low and has declined over the past 14 years. This may represent a missed opportunity for nephrologists to serve as role models to medicine residents and to advocate for more exposure to nephrology during residency training. Attracting more trainees to the field of nephrology may require encouraging more nephrologists to pursue key stakeholder leadership roles in residency education.



Percentage of IM Residency Program Directors Who Are Nephrologists: 2008 to 2021

### TH-PO006

#### Impact of a Simulation Dialysis Access Ultrasound Tutorial for Nephrology Fellows

Alexander S. Hawkins,<sup>1</sup> Sarah F. Sanghavi,<sup>1</sup> Ryan Wong,<sup>1,2</sup> <sup>1</sup>University of Washington, Seattle, WA; <sup>2</sup>Banner University Medical Center South, Tucson, AZ.

**Background:** Bedside ultrasound imaging has grown in importance across a variety of specialties, but few Nephrology programs have any formal ultrasound teaching. We developed a tutorial for dialysis access ultrasound assessment using a simulation model, and evaluated the tutorial with a knowledge assessment and a survey on clinical ultrasound use.

**Methods:** We randomly assigned three first year Nephrology fellows to receive a hands-on ultrasound tutorial along with a didactic lecture about dialysis access, with two fellows receiving the didactic only. The tutorial presented several cases with simulation fistulas which could be physically examined with a mock ultrasound probe. Participants were prompted to measure a variety of parameters in evaluating the fistula and calculate blood flow. Cases included outflow stenosis, evaluation of fistula maturity, and pseudoaneurysm. The tutorial was led by a second year fellow. Six months later we sent a knowledge assessment (validated by several Nephrology faculty members), and a survey, which included qualitative measures of each fellow's practical experience with ultrasound, and confidence with vascular access issues.

**Results:** The survey had a 100% response rate. Fellows who completed the tutorial scored an average of 6 of 7 points on the knowledge assessment, while those who did not scored an average of 3.5/7 points. The tutorial group rated their conceptual exposure to dialysis access ultrasound at 43.3/100 points (100 being highest exposure), compared with 29.5 points in the non-tutorial group. When asked about confidence in speaking with Radiology or Vascular Surgery about dialysis access issues on a 5-point scale, the tutorial

group had an average response of 3 (Neutral), versus 2 (Slightly less confident) in the other group. In both groups, clinical use of ultrasound for dialysis access issues was low, with lack of time on rounds and lack of experience with ultrasound being selected as the main barriers.

**Conclusions:** Our hands-on simulation improved knowledge and confidence in assessing dialysis access issues among first year Nephrology fellows when compared with a didactic lecture alone. Barriers to clinical use of ultrasound for dialysis access issues include lack of time and experience. Though limited by small sample size, these results encourage further study and formal implementation into the curriculum.

**TH-PO007**

**Conducting an Ultrasound Guided Kidney Biopsy Workshop in Leon, Nicaragua**

Sreedhar A. Mandayam,<sup>1</sup> Biruh Workeneh,<sup>1</sup> Alexei V. Mikhailov,<sup>2</sup> Michael H. Carstens,<sup>2</sup> <sup>1</sup>The University of Texas MD Anderson Cancer Center, Houston, TX; <sup>2</sup>Wake Forest Baptist Medical Center, Winston-Salem, NC.

**Background:** Investigations into the etiology of CKDu are hampered by very limited renal pathology specimens from patients due to multiple constraints like lack of training of nephrologists in bedside ultrasound guided renal biopsy, lack of renal pathologists. We describe our experience on conducting an Ultrasound Guided Renal Biopsy Workshop at the Hospital Escuela Oscar Danilo Rosales Argüello, Leon, Nicaragua

**Methods:** Nephrologists at Hospital Escuela Oscar Danilo Rosales Argüello, Leon and Hospital Espana Chinandega, participated. Patients provided informed consent. Local and Ministry of Health, Nicaragua (MINSa) IRB approval was obtained. 2 nephrologists from MD Anderson Cancer Center with experience performing ultrasound guided renal biopsies conducted the workshop. Phillips Lumify Ultrasound Transducers, Samsung S 6 tablets used scanning and CIVCO brackets used to act as needle guides. Scout scan to ensure 2 kidneys of normal size, lower pole of the kidney identified, depth of cortex measured, CIVCO bracket-needle guide system used to direct the angle of needle placement and depth of needle

**Results:** All biopsies were conducted in the operating room at the hospital. Conscious sedation provided in addition to local anesthesia. CBC and BMP measured 24 hours prior to biopsy. 18 kidney biopsies were performed over 2 days. Initial 2 biopsies performed by faculty and the remaining 16 biopsies by the local doctors with the guidance from the faculty. 3 subjects were not biopsied (kidney size less than 8 cm and 1 uncontrolled HTN). 3 cores were obtained on all the 18 subjects. All cores deemed adequate by bedside cytopathologist. Post biopsy ultrasound scans performed on all 18 subjects showed no significant post biopsy bleeding. All patients had labs drawn at 24 hours and evaluation by nephrologist as safety follow up. None of the 18 subjects had clinically significant bleeding and no complications were noted at 24 hours post biopsy. All attendees affirmed a significant increase in comfort level about performing ultrasound guided renal biopsies and multiple renal biopsies have been performed independently subsequently

**Conclusions:** Ultrasound guided percutaneous renal biopsy can be performed safely in resource limited settings in Leon Nicaragua and the training workshop has significantly increased the ability of local nephrologists to perform renal biopsies

**TH-PO008**

**Impact of Structured Kidney Transplant Patient Education Program on Kidney Transplant Referrals and Pre-Transplant Work-up Within the Northern California Veterans Affairs Health Care System**

Michael Joshua G. Morales, Monique L. Parker, Melissa Marston, Inderpreet S. Sekhon, Pratik B. Shah. VA Northern California Health Care System, Mather, CA.

**Background:** Kidney transplantation (KT) is the treatment of choice in patients with end-stage renal disease (ESRD). VA medical centers completing kidney transplant education and pre-transplant work-up submits referral using a standardized electronic process (TRACER) to one of the nine VA kidney transplant centers in the US. The VA Northern California Health Care System (VANCHCS) has been offering KT referral to ESRD patients from its two sites (Sacramento Valley and East Bay). Patient education and timely completion of pre-transplant work-up were noted as barriers in timely referral to KT and potential dropouts in the evaluation process.

**Methods:** Structured KT patient education program was started in VANCHCS in 2020 to address barriers in the pre-transplant work-up. The program involved creation of education clinic, KT education written material and videos, patient engagement, and tracking of pre-transplant work-up and addressing delays in real time. The program was run by nephrology RN at the two sites.

**Results:** *Kidney Transplant Referrals* The annual KT referrals were tallied between the two sites from 2019 to 2021. In 2021, the Sacramento Valley referral numbers are 21 which is a 320% increase compared to 2019 and 133.33% increase compared to 2020. The East Bay's 2021 referrals totaled to 9 which is 125% increase compared to 2019 and 200% increase compared to 2020. *Pre-transplant work-up time* The Sacramento Valley median pre-transplant work-up completion time decreased from 228 to 108. The East Bay median pre-transplant work-up completion time decreased from 248 days to 116 days.

**Conclusions:** Structured kidney transplant education program and tracking resulted in improvement in kidney transplant referral within Northern California VA Health Care System.

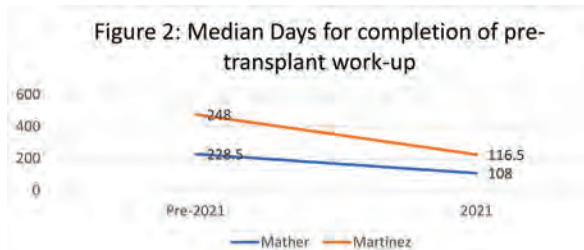
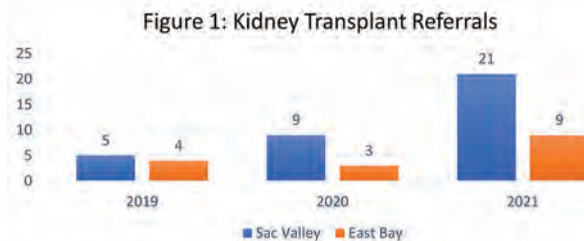

**TH-PO009**

**Qualitative Assessment of a 3-Dimensional (3D) Virtual Reality (VR) Educational Tool**

Georges Nakhoul, Jonathan J. Taliercio, Bryce Montane, Susana Arrigain, Jesse D. Schold, Joseph V. Nally, Richard M. Wardrop, John F. O'Toole, S. Beth Bierer, John R. Sedor, Ali Mehdi. Cleveland Clinic, Cleveland, OH.

**Background:** Leveraging technological advances in learning platforms has led to creative innovations in the development of interactive tools. Using funding from the ASN, we developed a 3D VR renal physiology course, on which we present a qualitative analysis.

**Methods:** Internal medicine PGY1 residents were randomly assigned into 2 groups: a VR group (exposed to the VR session) and a traditional group (received a printed script of the VR learning course). The VR session consisted of a 3D review of the mechanism of action of diuretics. Within a week of being exposed to the VR vs. traditional material, both groups underwent a 2-hour seminar on diuretics. The VR group was asked to rate their VR experience. Assessment of the VR platform was performed using a Redcap-based survey consisting of a 4-point Likert scale, and focused on the following parameters: interface, clarity, educational value, engagement, likability, and dissemination. Residents randomized to the VR group were also asked to participate in a focus group. Sessions were recorded and transcribed verbatim. Data was analyzed through the content analysis approach by 2 independent reviewers who met to compare coding and reach consensus on emerging themes.

**Results:** 42 residents assigned to VR session attended the seminar and completed the platform assessment. Overall, > 90% of the residents rated the platform positively in all parameters (Table 1A). Two focus groups met for one hour. Several recurring themes emerged in our analysis and were classified as presented in Table 1B. Follow the QR code to see a YouTube video of the 3D application.

**Conclusions:** The feedback of the VR course was overwhelmingly positive and was perceived to be a helpful educational adjunct. Educational institutions should consider supporting the development of interactive educational tools to enhance learner experience.

Survey question	N	Agree or Strongly Agree N (%)
The response time of the program is adequate	41	40(97.6)
I was absorbed in the activity of the simulation	42	42(100.0)
The delivered material was clear	42	40(95.2)
The Oculus Quest made it easy to understand the learning objectives	42	40(95.2)
The Oculus Quest is a useful learning aid	42	40(95.2)
Oculus Quest enhanced my understanding of nephrology concepts during this activity	42	40(95.2)
I found the Oculus Quest enjoyable to use while learning	42	41(97.6)
I preferred using the Oculus Quest to the standard teaching method	42	35(83.3)
I would like the Oculus Quest to be utilized for more topics in nephrology	42	41(97.6)
I would like the simulation to be applied for topics other than nephrology	42	40(95.2)

Table 1A. Survey evaluating the VR platform

POSITIVE THEMES	NEGATIVE THEMES
Recall: memory Anchor	Lack of immediate clinical relevance
Attention span: great hook	More interaction: somewhat passive experience despite interactive format
Interaction: engaging and powerful	Organization: integrate the VR and lesson
Spaciality: improves understanding of structures	Technical / logistical challenges: motion sickness, lag, teleportation-feature
Enjoyable: cool / fun / graphically appealing	
Great supplemental resource	

Table 1B. Focus group themes. Note that the QR code will link you to a YouTube video displaying the content of the animation.



Print X like

TH-PO010

Assessment of a 3-Dimensional (3D) Virtual Reality (VR) Educational Tool

Georges Nakhoul, Ali Mehdi, Alejandro Duran Crane, Jesse D. Schold, Susana Arrigain, Richard M. Wardrop, Joseph V. Nally, S. Beth Bierer, John R. Sedor, John F. O'Toole, Jonathan J. Taliercio. Cleveland Clinic, Cleveland, OH.

**Background:** Improving student engagement with information technology has led to the proliferation of innovative teaching tools. Using funding provided by the ASN, we developed a 3D VR kidney physiology course. Our goal was to objectively assess its efficacy as a teaching tool on knowledge gain.

**Methods:** Internal medicine PGY1 residents were randomly assigned into 2 groups: a VR group (exposed to the VR session) and a traditional group (received a printed script of the VR learning course). The VR session consisted of a 3D review of water and electrolyte transport and of the mechanism of action of diuretics. Within a week of being exposed to the VR vs. traditional material, both groups underwent a 2-hour seminar on diuretics. Knowledge acquisition and retention were assessed with a test administered immediately after the seminar and again within 6-12 weeks. The 40-question test was issued using the platform RedCap. Tests were anonymous and it was not possible to link results from both test administrations. We used t-tests to compare the number of correct answers and the percent correct between the VR and traditional groups. Initial and follow-up tests were evaluated separately.

**Results:** Of the 133 PGY1 residents scheduled and randomized to participate, 71 completed the courses and initial testing (41 VR group vs. 30 traditional group). 53.5% of participants were males. Average age was 27.2±2.0. Results of the initial test showed higher scores among VR vs. traditional group (77.6% correct vs. 70.7%, Table 1). 36 PGY1s participated in the follow-up testing (23 VR group vs. 13 traditional group). Results of the follow-up test showed no significant difference in test results (Table 1). Follow the QR code to see a video of our application.

**Conclusions:** The 3D VR platform is a useful supplemental educational tool with improved short-term resident learning. To understand the long-term impact on transfer of learning, a larger student cohort with longer-term follow-up is needed.

Table 1. Test results by group participation

	Overall (N=71)	VR (N=41)	Traditional (N=30)	t-test p-value
<b>Initial Test Score Results</b>				
Score out of 40 questions, Mean ± SD	29.9±4.9	31.0±4.1	28.3±5.6	0.018
Percent correct, Mean ± SD	74.7±12.4	77.6±10.3	70.7±13.9	0.018
<b>Follow up Test Score Results</b>				
Score out of 40 questions, Mean ± SD	26.1±4.7	26.0±4.9	26.2±4.4	0.95
Percent correct, Mean ± SD	65.2±11.7	65.1±12.3	65.4±11.0	0.95

Note: Follow the QR code to see a YouTube video of our 3D application.



TH-PO011

Utilizing Virtual Reality Tools in Dialysis Modality Education

Sijie Zheng,<sup>1</sup> Ritchie M. Nabong-Salem,<sup>1</sup> Neelam M. Bhalla,<sup>1</sup> Lierisa D. Villafior,<sup>1</sup> Thomas G. Eppenberger,<sup>2</sup> George Lai.<sup>1</sup> <sup>1</sup>The Permanente Medical Groups, Oakland, CA; <sup>2</sup>Kaiser Permanente, Oakland, CA.

**Background:** In US, only 12% of ESRD patients utilize PD as his/her RRT modality. Part of the reason is lack of effective education tool. Kaiser Permanente Northern California is an integrated health care system providing health care to 4.6 million members in greater San Francisco Bay area. We piloted a proof-of-concept study to test if utilizing virtual reality can improve patient dialysis modality education.

**Methods:** Nephrologists, PD nurses and technology-centered team from KPNC met regularly in 2019 to find out the gaps in dialysis modality educations. After several meetings and reviewing the current educational material, we decided to produce a 360 immersive video with 3 separate segments using a GoPro Camera. Google cardboard is used as the VR tool. We then tested on 9 patients during their patient education section.

**Results:** Three segments showing nursing home visit, patient performing PD at home and patient sleeping during PD were produced. They can be assessed on YouTube: <https://www.youtube.com/watch?v=BayBNoZbNbA>. We tested this VR tool for 9 patients. This number was limited due to in person trainings being curtailed during the COVID-19 pandemic. Most patients felt that the first-person nature of the video (without VR) helped because the content was so helpful. However, there were some challenges: some patient became confused due to too much movement needed, not able to focus. Overall, patients appreciated the content but felt the 360 VR was not needed. They hoped if the video could be steadied, they would have a better experience. Table one listed the demographics and feedbacks.

**Conclusions:** VR is a viable option for better patient education if it can be improved with better ease of use. Further studies with improved technology and larger numbers of patients are warranted to improve patient dialysis modality education.

Feedback from Patients

Patient Number	Age	Gender	Comments
#1	59	Female	easy but does not serve the purpose, got irritated trying to find focus, make it more user friendly
#2	63	Male	Good content, will be better if steady video
#3	51	Male	Just okay, more on listening, content is good
#4	62	Male	too much movement needed, somewhat helped by listening. Got dizzy w/ movement.
#5	58	Female	Confused, poor quality, regular video is sufficient.
#6	46	Male	got lost when started to move, content is good, better to just watch steady
#7	60	Male	tried to engage, like the loudness of the conversation, cannot get the full effect, hard to focus
#8	72	Female	it is okay, no comment w/ the video
#9	63	Female	initially got dizzy, went well afterwards, requested steady video

TH-PO012

Case-Based Online Education Significantly Improved Nephrologists' Knowledge and Confidence in Managing CKD-aP

Elaine Bell,<sup>1</sup> Joy Marko,<sup>2</sup> James Burton.<sup>3</sup> <sup>1</sup>Medscape Education Global, London, United Kingdom; <sup>2</sup>Medscape LLC, New York, NY; <sup>3</sup>Dept of Cardiovascular Sciences, University of Leicester, Leicester, United Kingdom.

**Background:** Chronic kidney disease-associated pruritus (CKD-aP) is a common and distressing condition that affects ≥60% of people undergoing haemodialysis, with 20-40% reporting moderate-to-severe pruritus. Intense itching can lead to poor sleep quality, depression, reduced quality of life, increased risk of infection, and an increased risk of death. However, there are limited options for controlling CKD-aP, making it a challenging condition to manage effectively.

**Methods:** Nephrologists participated in an online case-based activity entitled 'Patient Case Challenges in CKD-aP' (launched 17 May 2021, data collection by 17 Sept. 2021). Educational effect was assessed using a repeated-pair design, pre-/post-assessment. A paired samples t-test was conducted for significance testing on overall average number of correct responses and for confidence rating. Cohen's d estimated the effect size of the education on number of correct responses (<.20 modest, .20-.49 small, .59-.79 moderate, ≥.80 large). A series of McNemar's tests were conducted at the question level (5% significance level, P <.05).

**Results:** Nephrologists (n=107) significantly improved their knowledge regarding diagnosis & severity assessment of CKD-aP (55% correct answer at baseline, 97% post-assessment), novel therapies for CKD-aP (59% correct answer at baseline, 95% post-assessment), and optimizing outcomes for people with CKD-aP (60% correct answer at baseline, 97% post-assessment) (all P <.001) 64% of nephrologists reported improved confidence in understanding treatment options for CKD-aP 98% of nephrologists reported that the education would improve their performance, leading to better patient outcomes

**Conclusions:** These results highlight the benefits of case-based education in helping nephrologists understand how to better manage CKD-aP. Further education would be beneficial to support nephrologists to translate knowledge of novel treatment strategies into clinical practice in order to optimize outcomes.

**Funding:** Commercial Support - Supported by an independent educational grant from Vifor Pharma

TH-PO013

A Curriculum of Online Education Significantly Improved Nephrologists' Knowledge and Confidence in Managing CKD-aP

Elaine Bell,<sup>1</sup> Joy Marko,<sup>2</sup> James Burton.<sup>3</sup> <sup>1</sup>Medscape Education Global, London, United Kingdom; <sup>2</sup>Medscape LLC, New York, NY; <sup>3</sup>Dept of Cardiovascular Sciences, University of Leicester, Leicester, United Kingdom.

**Background:** Chronic kidney disease-associated pruritus (CKD-aP) is a common and distressing condition that affects ≥60% of people undergoing hemodialysis. Intense itching is associated with poor quality of life and an increased risk of death. However, there are limited options for controlling CKD-aP, making it a challenging condition to manage effectively.

**Methods:** A curriculum of 6 activities was developed on CKD-aP, including a panel discussion, video lecture and interactive case-based education. Data were collected 2020 to 2021 with n numbers ranging from 56 to 178 completing pre- and post-activity questions. For each activity, educational effect was assessed with a repeated-pairs pre-/post-assessment; 3 multiple-choice, knowledge questions and 1 self-efficacy, 5-point Likert scale confidence question were analyzed. Data were subsequently combined and analyzed by theme to provide a summative overview of the effect of the education across the combined activities. A McNemar's test was conducted to assess statistical significance of changes from pre- to post-assessment.

**Results:** Nephrologists demonstrated a statistically significant improvement in knowledge or competence across 6 of the 7 learning themes (pathogenesis of itch; impact of itch; diagnosis & severity assessment; mode of action of difelikefalin; treatment/clinical data; all P <.0001) There was a numerical improvement in knowledge regarding the prevalence of CKD-aP The relative improvements in % of correct responses for each learning theme ranged from 10%-121% Pre-education, 19% of nephrologists felt confident or very confident in managing people with CKD-aP, but this rose to 48% post-education

**Conclusions:** These results highlight the benefits of a curriculum of education in helping nephrologists understand how to better manage pruritus associated with CKD. However, the results suggest that nephrologists would benefit from further education on the prevalence and impact of CKD-aP and to support them in translating knowledge of novel treatment strategies into clinical practice in order to optimize outcomes.

**Funding:** Commercial Support - Supported by an independent educational grant from Vifor Pharma

#### TH-PO014

##### Nephrology Program Director Protected Time for Program Administration: A National Survey

Christina M. Yuan,<sup>1</sup> Brian Y. Young,<sup>3</sup> Maura A. Watson,<sup>1</sup> Amy N. Sussman.<sup>2</sup>  
<sup>1</sup>Walter Reed National Military Medical Center, Bethesda, MD; <sup>2</sup>Banner University Medical Center Tucson, Tucson, AZ; <sup>3</sup>University of California Davis Health System, Sacramento, CA.

**Background:** In July 2019, the Accreditation Council for Graduate Medical Education (ACGME) reduced protected time for training program administration from 20 to 10-20 hours/week for nephrology program directors (PDs). No minimum time was specified for core faculty, where it had been 10 hours/week. In July 2022, it will be reduced to 8 hours/week for the majority of PDs. Program administration is defined as "non-clinical teaching and administration".

**Methods:** Anonymous survey of all US adult nephrology PDs, administered from 3/31-4/30/2022, regarding protected time received for program administration, how much they think necessary, and division of their professional time overall. The 20-question, anonymous, on-line survey link was delivered by email to 151 PDs (ACGME Public List of Nephrology Specialty Programs 2021-22).

**Results:** Response rate was 66% (99/151). Geographic distribution and approved clinical fellow positions were similar to the entire population. Median approved clinical fellow positions was 6 (IQR 4,8); 59% had <7 approved positions. Median protected time was 10 hours/week (IQR 5,10), but only 8 hours/week (IQR 5,10) for those with <7 positions. Overall, PDs estimated they required a median 12 hours/week (IQR 10,16) protected time to effectively administer their programs, as did those with <7 approved positions (12 hours/week (IQR 10,15)). PDs reported core clinical faculty receive a median 2 hours/week (IQR 0,5); 39% of PDs reported 0 hours. Of PDs devoting <10 hours/week to program administration (median 8 hours/week (IQR 4,10) protected time), 62% provided >20 hours of direct patient care.

**Conclusions:** Approximately half of US nephrology programs are not in compliance with the ACGME-stipulated 10 hour/week minimum protected time for PDs. The majority estimate at least 12 hours/week are needed to effectively educate fellows and manage their programs. In view of our results and historically low board examination pass rates, the ACGME should track effects and reassess the 2022 decrease in PD protected time, as it does not align with PD-reported needs for education and administration. Disclaimer: The views expressed in this abstract are those of the authors and do not necessarily reflect the official policy the Department of Defense or the U.S. government.

#### TH-PO015

##### Educational Efficacy of Mobile Platform in Improving Patient Understanding of Kidney Disease

Jamie E. Cronin,<sup>1</sup> Chang Hwei Chen,<sup>2</sup> Ernesto Salcedo.<sup>1</sup> <sup>1</sup>University of Colorado Denver School of Medicine, Aurora, CO; <sup>2</sup>University of Colorado Health, Aurora, CO.

**Background:** Chronic kidney disease (CKD) is a leading cause of mortality internationally and has very low rates of treatment compliance. Preventing disease progression and minimizing complications is essential in CKD management. Patients' active participation in their treatment plan is critical. However, participation may be limited due to the complex nature of the disease and lack of understanding. Educational intervention of any kind has been demonstrated to improve both patient and clinically reported outcomes. We aimed to evaluate the efficacy of a free, concise mobile application in educating CKD patients and in promoting participation in decision-making for their treatment.

**Methods:** The app has eleven sections covering all aspects of chronic kidney disease. Built in pre- and post-surveys utilize a Likert-type psychometric scale where patients indicate their level of agreement with the statement. The same eleven questions are presented in each survey and are designed to determine the efficacy of the app in educating participants on the urinary system, causes of CKD, stages, lifestyle management, comorbidities, complications, and various treatment methods. Participants first interact with the pre-survey, proceed through the modules, then complete the post-survey. The individual questions are compared between the pre- and post-surveys and a single-tail T-test is used to analyze significance (p-value less than or equal 0.05).

**Results:** Participant recruitment (goal of N =50) and data collection is still ongoing and will conclude by 7/1/2022. Preliminary data has found the app to be significantly effective in helping patients understand the causes of kidney disease ( $P < 0.05$ ), lab values ( $P < 0.05$ ), disease management ( $P < 0.05$ ), and in contributing to patient confidence in discussing their options with a provider ( $P < 0.05$ ).

**Conclusions:** Providing a free, easily accessible, concise application on chronic kidney disease significantly improves health literacy in CKD patients and helps them feel more confident in the decision-making process of their treatment plan.

#### TH-PO016

##### Virtual NephroTalk: Teaching Communication Skills During the COVID-19 Pandemic

Alexandra E. Bursic, Amar D. Bansal, Jane O. Schell. *University of Pittsburgh Department of Medicine, Pittsburgh, PA.*

**Background:** Nephrologists engage in advance care planning with their patients less often than other specialists caring for patients with similarly life-limiting illnesses, and many patients with kidney disease receive invasive care that may not be consistent with their wishes. The UPMC NephroTalk curriculum has previously been shown to increase both self-rated preparedness and objective performance of essential communication skills to help prepare nephrology fellows to discuss goals of care with patients and families. The COVID-19 pandemic has necessitated innovation in teaching communication skills. We adapted the NephroTalk curriculum to provide the opportunity to acquire and practice communication skills while learning remotely.

**Methods:** Nephrology fellows from 4 ACGME-accredited nephrology programs, as well as other renal healthcare professionals participated in a three-day virtual course with synchronous and asynchronous components including 1) self-paced modules explaining and demonstrating communication skills; 2) small group drills to promote deliberate practice of core skills led by experienced facilitators; and 3) small group practice with simulated patients incorporating peer and facilitator feedback. Surveys measured participants' self-perceived communication preparedness pre- and post-curriculum and satisfaction with the program.

**Results:** Twenty-two healthcare professionals participated in the virtual NephroTalk curriculum over two years. Prior to the course, most learners described feeling "not prepared" or "somewhat prepared" on a 5-point Likert scale to perform 12 key communication skills including discussing prognosis, eliciting patient values, discussing conservative kidney management, and recommending a treatment plan. After completing the program, 100% of participants reported feeling "prepared" or "very prepared" to perform all 12 communication skills. Respondents expressed a high degree of satisfaction with the course overall.

**Conclusions:** The COVID-19 pandemic has resulted in a shift toward virtual learning within medical education. Nephrology fellows and clinicians participating in the virtual NephroTalk curriculum expressed high levels of satisfaction and preparedness to utilize the skills demonstrated in the course. Future research should evaluate the impact of virtual communication skills training on sustained skill maintenance over time and patient outcomes.

#### TH-PO017

##### Tweeting a Path to Communication Success: What Nephrology Training Programs Are Sharing on Twitter

Laura J. Maursetter,<sup>1</sup> Hector M. Madariaga,<sup>2</sup> Tejas Desai.<sup>3</sup> <sup>1</sup>University of Wisconsin-Madison, Madison, WI; <sup>2</sup>Lahey Hospital and Medical Center, Burlington, MA; <sup>3</sup>Vifor Pharma Ltd, Glatfbrugg, Switzerland.

**Background:** Twitter is an important tool for communication by nephrology training programs. Using Twitter impacts recruitment and programs increasingly rely on this platform to reach a generation of learners who are connected on social media. Effective use of Twitter takes time and dedication and little is known about the patterns of its use. In this study, we collected tweets from US nephrology training programs to provide information on patterns and subjects of Twitter use.

**Methods:** Over a period of 40 months, we collected tweets from nephrology training programs known to have Twitter accounts. We manually reviewed a small corpus of tweets to establish the 5 most common themes. Subsequently, we developed a code book that provided a taxonomy system for the tweets. Excel was programmed to read each tweet and categorize into any of the 5 themes. Tweets could be classified into more than one domain to capture the richness of the tweet.

**Results:** We analyzed 33,112 tweets from 78 of the 149 domestic adult nephrology training programs between 8/2018 and 12/2021. The range of Twitter activity was 2 to 2,265 tweets per program and 4 programs authored 25% of the tweets. Only 42% of tweets contained original content; 58% were retweets. Our thematic analysis categorized each tweet into any combination of the 5 themes: Advocacy/DEI (12%), Work-Life Balance (2%), Professional Development (22%), Promotion (self or program) (45%), and/or Medical Knowledge (42%). Programs interacted with AJKDOnline, ASNKidney, CJASN, ASNKidney360, and KidneyMed the most often.

**Conclusions:** Twitter is an increasingly common communication tool used by US nephrology training programs. We analyzed a large numbers of tweets from over 50% of programs with active accounts. The most frequent themes were Medical Knowledge and Promotion. Even though using Twitter can take a significant amount of time and might be challenging, more than half of the activity comes from retweets which can provide a reprieve to busy clinicians. Our next step is to determine if Twitter activity and/or specific themes have made a difference in match outcomes.

#### TH-PO018

##### Early Recognition of CKD in Primary Care Setting

Alexandra M. Johnston, Mary Lynn Sealey, Lauren Mathos, Mrudula Gadani. *Allegheny Health Network, Pittsburgh, PA.*

**Background:** Chronic kidney disease (CKD) affects 37 million people in the US but 10% are aware they have CKD. Recognizing CKD early in the disease has shown to improve outcomes while failure to do so can lead to increased morbidity and mortality. In the 2020-2021 academic year, there were 28,569 Internal Medicine Residents in the US and this group is of critical importance in identifying patients with CKD.

**Methods:** We aimed to identify and increase screening of CKD in patients in our residency clinic by implementing a small group case-based didactic on recognizing and screening for CKD along with management once diagnosed. We also conducted a pre/post-test to determine the effectiveness of the didactic. Residents were encouraged to utilize a smartphrase created in EPIC to identify patients with risk factors that should be routinely screened for CKD. Baseline data of patients with a diagnosis of CKD was collected and again at 6 months.

**Results:** Ninety five residents participated in didactics with an average pre-test of 2.9/8(36.2%) which improved to 5.7/8(70.7%) post-test. At baseline, a total of 235 patients had a diagnosis of CKD out of 3900 patients (6.0%). 6 months after didactic and implementation of SmartPhrase, a total of 286 out of 4050 patients had a diagnosis of CKD (7.1%). There was an overall increase in patients screened and diagnosed with CKD. Most notable change was in patients over age 65 years and black patients with an increase from 16.7% (149/892) to 19.7% (187/949) and 9.7% (139/1433) to 11.4% (163/1435) respectively.

**Conclusions:** Kirkpatrick evaluation model was utilized to assess our CKD focused small group case-based didactic and QI intervention. Learning was evaluated with pre/post-test showing an increase in scores by 34%. In addition, behavioral change was noted by utilization of SmartPhrase and subsequently resulted in an increase in identification of patients with CKD with largest increase in patients over age 65 years and black patients. Use of a similar hybrid intervention in Internal Medicine Training programs may be beneficial to increase CKD recognition across the country. Future measurement of treatment parameters including blood pressure control and medication use are planned.

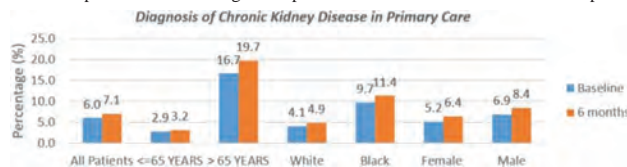

**TH-PO019**

**Love and Breakup Letters to an Online Nephrology Learning Tool**

Samira S. Farouk,<sup>1</sup> Layla Fattah,<sup>1</sup> Matthew A. Sparks,<sup>2</sup> David C. Thomas,<sup>1</sup>  
<sup>1</sup>Icahn School of Medicine at Mount Sinai, New York, NY; <sup>2</sup>Duke University School of Medicine, Durham, NC.

**Background:** NephSIM is a free, open access medical education (FOAMed) tool that aims to teach nephrology to a wide group of learners. It is not known how learners feel about FOAMed as they progress through their training from medical school to fellowship. Love & Breakup Letter Methodology (LBM), while relatively new in medical education, is a technique that has been used extensively in user experience technology-based research. LBM asks participants to creatively write a “love” or “breakup” letter to a product under study to capture their thoughts & emotions when engaging with it. We hypothesized that LBM would allow us to understand reactions towards NephSIM among distinct groups of trainees.

**Methods:** Three 90-min. virtual, recorded focus groups (FG) were conducted with 2nd year medical students (MS), internal medicine residents (IMR), & nephrology fellows (NF). Participants were asked to review selected portions of NephSIM prior to the FG. At the start of the FG, they composed & read their love/breakup letter. Semi-structured FG discussions were led by facilitator-driven questions & peer comments (Fig.1). After FG transcription, analysis was conducted using Braun & Clarke’s 6-step thematic analysis.

**Results:** Inductive thematic analysis revealed reactions varied by trainee experience & perceived situated learning needs. Differences were identified between groups in terms of learning motivation, perceived application, required effort, & resulting benefit to practice. All 8 MS wrote love letters that highlighted the benefits of NephSIM in developing problem solving, critical thinking, & clinical reasoning skills. In contrast, reactions from 7 IMR & 5 NF were mixed: 6/12 & 6/12 wrote love & breakup letters, respectively. IMR were interested in brevity & speed of learning, preferring algorithms & succinct learning to meet their practice-based learning needs. Nephrology fellows’ learning needs were driven by a desire to prepare for the nephrology board examination & review uncommonly seen cases.

**Conclusions:** LBM provided a valuable methodology through which to identify trainee reactions to a FOAMed tool & highlighted the challenges of meeting learning needs of a continuum of trainees with a single learning platform.



Figure 1. Love & breakup letter methodology to explore trainee attitudes towards NephSIM (FG: Focus group)

**TH-PO020**

**Assessing the Value of “A Family Journey” Community Program for Supporting Pursuit of Preemptive Living Kidney Transplantation**

Bethany Cruz, Ahmed O. Gaber, Joseph D. Sharp, Vernell Bosie, Julie Corkrean, Edward A. Graviss, Duc T. Nguyen, Alexis Bobu, Amy D. Waterman. *Houston Methodist Hospital, Houston, TX.*

**Background:** Outreach to patients not yet in kidney failure and their support network may result in more preemptive living donor transplants (PLDT). We examined characteristics of kidney patients who participated in an education program, “A Family Journey,” and its impact on PLDT.

**Methods:** Kidney patients not yet on dialysis were invited to attend “A Family Journey,” a 1.5-hour education program at the onset of transplant evaluation. Educational topics discussed included the advantages of having a living donor kidney transplant and PLDT, training on how to seek donors, and available financial resources. Using EMR data and living donor pre-screening portals, we tracked demographic data, the number of living donor inquiries, and PLDT- actions taken by patients attending and not attending the class.

**Results:** Between 2019-2022, 11 in-person and 25 virtual sessions occurred. Of the 466 patients referred to “A Family Journey” class, 333 (71%) attended the class, with those attending being more likely to be White (39.6% vs. 36.8%, p=0.71), African American (26.4% vs. 22.5%, p=0.74), have commercial insurance (62.7% vs. 41.3%, p=0.003), and have incomes over \$75,000 (24.9% vs. 18.0%, p=0.006) (Table). Compared to others, attendees were more likely to finish evaluation (81% vs. 65%, p<0.001), have a living donor inquiry (52% vs. 32%, p<0.001), and receive a PLDT (14% vs. 0.07%, p<0.001).

**Conclusions:** This PDKT-focused community education class was well attended with patients having more living donor inquiries and PLDTs compared to those who didn’t attend. Further randomized controlled trials needed to determine how best to reach disparate communities with less access to PLDT.

	Referrals N=466	Attendees n=333 (71%)	Non-attendees n=133 (29%)
<b>Demographics</b>			
Median age (years)	58	58	58
Gender			
Male*	61%	59%	89%
Ethnicity			
White*	181 (39%)	132 (40%)	49 (37%)
African American*	118 (25%)	88 (26%)	30 (23%)
Hispanic	107 (23%)	75 (23%)	32 (24%)
Asian	50 (11%)	34 (10%)	16 (12%)
Other	10 ( 2%)	4 ( 1%)	6 ( 5%)
Foreign Language			
Non-English	37 (8%)	21 (6%)	16 (12%)
Insurance Type			
Medicare	202 (43%)	124 (37%)	78 (59%)
Commercial Insurance*	264 (57%)	209 (63%)	55 (41%)
Educational Status			
HS/CED or Less*	120 (26%)	91 (27%)	29 (22%)
Some College*	155 (32%)	123 (37%)	32 (24%)
Associates/Bachelors	63 (14%)	41 (12%)	22 (17%)
Professional	78 (17%)	53 (16%)	25 (19%)
Unknown	50 (11%)	25 (8%)	25 (19%)
Income Level			
Less than \$29,999	69 (15%)	51 (15%)	18 (14%)
\$30,000-\$49,000*	44 (9%)	37 (11%)	7 (5%)
\$50,000-\$74,999*	44 (9%)	37 (11%)	7 (5%)
More than \$75,000*	107 (23%)	83 (25%)	24 (18%)
Unknown	202 (43%)	125 (38%)	77 (58%)
<b>Program Outcomes</b>			
Began Evaluation*		323 (97%)	106 (80%)
Finished Evaluation*		270 (81%)	86 (65%)
Approved recipient*		250 (75%)	73 (55%)
LD Inquiries*		173 (52%)	43 (32%)
LD Candidates*		100 (30%)	23 (17%)
LDKT*		63 (19%)	1 (7%)
PLDT*		46 (14%)	1 (7%)

TH-PO021

**National Survey: Point-of-Care Ultrasound Use Among Nephrology Program Directors, Fellows, and Graduates**

David L. Cook,<sup>1</sup> Christina M. Yuan,<sup>1</sup> Robert Nee,<sup>1,3</sup> Samir S. Patel,<sup>2</sup> Scott D. Cohen,<sup>2</sup> Dustin J. Little.<sup>1</sup> *Walter Reed National Military Medical Center, Bethesda, MD; <sup>2</sup>Washington DC VA Medical Center, Washington, DC; <sup>3</sup>Uniformed Services University of the Health Sciences, Bethesda, MD.*

**Background:** Nephrologists have been slow to adopt Point-of-Care Ultrasound (POCUS). We surveyed all US nephrology program directors (PDs), their fellows, and our program graduates regarding nephrology-specific POCUS training and use.

**Methods:** Anonymous, online survey of US nephrology PDs and their fellows (academic year 2021-2022), and 90 graduates (1986-2021) of the Walter Reed nephrology program (POCUS curriculum began 2019). We inquired about current/planned POCUS training, training type, and barriers to training and use.

**Results:** PD response rate (n=151) was 46%. 361 fellows were forwarded the survey link; 33% responded. Of 89 graduates, 62% responded. 51% of programs offered POCUS training, most commonly via bedside training in non-POCUS oriented rotations (71%), didactic lectures (68%), and simulation (43%). 46% of current fellows reported fellowship POCUS training; but approximately half reported not being sufficiently trained or not being confident in kidney (56%), bladder (50%), and IVC assessment (46%). Common barriers to training cited by PDs were: not enough trained faculty (78%), PDs themselves not being sufficiently trained (55%), and equipment expense (51%). 63% of PDs and 56% of fellows reported <10% of faculty were POCUS-trained. 64% of fellows reported too little training. 72% of PDs agreed that POCUS should be part of the curriculum. Among our graduates, 15% perform POCUS in clinical practice, but 50% of those with <5 years of practice experience do so. 77% of graduates agreed that POCUS should be part of the curriculum. The majority of fellows (59%) and graduates (61%) preferred hands-on POCUS training over didactic lectures or simulation.

**Conclusions:** The majority of fellows, PDs, and fellowship graduates surveyed agree that POCUS should be incorporated into the nephrology curriculum. The majority did not feel sufficiently trained to confidently perform POCUS, and the greatest barrier to training was lack of sufficiently trained faculty. This highlights the need to “train the trainers” before POCUS can be fully integrated into the curriculum and commonly used in nephrology practice. *Disclaimer: The views expressed in this abstract are those of the authors and do not necessarily reflect the official policy the Department of Defense or the U.S. government.*

TH-PO022

**Comparison of Outcomes in Prospective and Retrospective Studies of Biomarker for AKI Risk**

Ashley La, Samantha Gunning, Jay L. Koyner. *The University of Chicago Medicine, Chicago, IL.*

**Background:** Novel urinary biomarkers, including Tissue Injury Metallo-protease-2 and Insulin-like Growth Factor Binding Protein 7 ([TIMP-2]\*[IGFBP7] or T2\*17), have been developed to predict patients at risk for developing severe AKI. While T2\*17 has been approved as an AKI risk stratification tool, “real world” data on its clinical utility in preventing AKI is minimal.

**Methods:** We conducted a single-center quality improvement study of University of Chicago ICU patients at risk for severe (KDIGO stage 2 or 3) AKI by comparing patients previously enrolled in retrospective clinical trials of T2\*17 in which clinical teams were not aware of biomarker values (n=59) with a prospective cohort of at-risk and stage 1 AKI patients. In the prospective cohort (n=105), ICU providers were given the biomarker values with KDIGO-based care guidelines based on biomarker values. We analyzed the patients’ charts for data on the use of these guidelines and clinical outcomes.

**Results:** More patients in the prospective cohort had stage 1 AKI at the time of biomarker measurement (66(63.5%) vs 10(17.0%), p < 0.001). The peak change in serum creatinine (SCr, mean(SD)) within 7 days of ICU admission was lower in the prospective study compared to the retrospective studies among the entire cohort (0.27(0.78) vs 0.93(1.50), p < 0.001) as well as only in those at higher risk for AKI (T2\*17 >0.3) (0.34(0.87) vs 1.02(1.41), p = 0.004). AUC(SE) for T2\*17 as a predictor of severe AKI in 48 hours was 0.644(0.40), p=0.057, in the prospective cohort and 0.720(0.66), p=0.077, in the retrospective cohort.

**Conclusions:** The use of T2\*17 coupled with practice guidelines is associated with a smaller increase in SCr in ICU patients at high risk for AKI despite more baseline AKI. Given these findings, the impact of T2\*17 reporting on clinical care warrants continued investigation.

Outcomes of ICU patients with urinary [TIMP-2]\*[IGFBP7] >0.3 by study cohort

	Prospective (n = 78)	Retrospective (n = 37)	p-value
Nephrology consults	22 (28.2%)	2 (5.4%)	0.006
Net intake/output (mL) (SD)	-1044 (8190)	-1343 (8403)	0.85
Incidence of nephrotoxin exposure (SD)	4.99 (4.14)	4.32 (3.54)	0.44
Peak change in SCr in 7 days (mg/dL) (SD)	0.34 (0.87)	1.02 (1.41)	0.004
Inpatient mortality	8 (10.3%)	9 (24.3%)	0.09
Inpatient dialysis	8 (10.3%)	3 (8.1%)	>0.99

TH-PO023

**Impact of Practice Guidelines in Critically Ill Patients at Risk for AKI**

Ashley La, Samantha Gunning, Jay L. Koyner. *The University of Chicago Medicine, Chicago, IL.*

**Background:** Novel urinary biomarkers, including Tissue Injury Metallo-protease-2 and Insulin-like Growth Factor Binding Protein 7 ([TIMP-2]\*[IGFBP7] or T2\*17), have been developed to predict which ICU patients are at risk for severe AKI (stage 2/3). While T2\*17 has been validated as a risk stratification tool, data on its “real-world” impact on patient care outside of clinical trials is lacking.

**Methods:** We conducted a single-center prospective quality improvement study of ICU patients at risk for AKI or with KDIGO serum creatinine (SCr) stage 1 AKI at the University of Chicago. T2\*17 measurements were made via the hospital lab at the discretion of the ICU team. ICU providers were given KDIGO AKI-guideline-based practice recommendations based on T2\*17 results. The use of these guidelines and clinical outcomes were compared amongst patients with T2\*17 of <0.3, 0.3-2, and >2.

**Results:** Of 105 ICU patients included in our analysis, 66(63%) had stage 1 AKI at time of biomarker measurement. A higher proportion of patients with T2\*17 >2 had stage 1 AKI compared with T2\*17 ≤2 (25(78.1%) vs 41(56.9%), p = 0.038). There was no significant difference in peak change in SCr (mean(SD)) within 7 days of biomarker measurement between T2\*17 >2 (0.48(1.09)) and T2\*17 ≤2 (0.17(0.58)) (p = 0.24). There was also no difference in proportions of patients who progressed to severe AKI in 7 days (10(31.3%) vs 14(19.2%), p = 0.5). Across the entire cohort, AUC(SE) for T2\*17 as a predictor of severe AKI in 48 hours was 0.65(0.11), p=0.06.

**Conclusions:** Despite having higher T2\*17 levels and more stage 1 AKI, those ICU patients with values >2 did not progress to have significantly more stage 2 or 3 AKI. When used in conjunction with guideline-based care, T2\*17 can improve the outcomes of ICU patients.

Outcomes of ICU Patients by Urinary [TIMP-2]\*[IGFBP7]

	[TIMP-2]*[IGFBP7] ≤2 (n = 73)	[TIMP-2]*[IGFBP7] >2 (n = 32)	p-value
Nephrology consults	12 (16.4%)	13 (40.6%)	0.01
Pharmacy consults	34 (46.6%)	17 (53.1%)	0.67
Net intake/output (mL) (SD)	-2776 (6224)	1033 (10590)	0.07
Incidence of nephrotoxin exposure (SD)	5.53 (4.9)	4.19 (3.0)	0.25
Peak change in SCr in 7 days (mg/dL) (SD)	0.17 (0.58)	0.48 (1.09)	0.24
Inpatient mortality	4 (5.5%)	5 (15.6%)	0.13
Inpatient dialysis	4 (5.5%)	5 (15.6%)	0.13

TH-PO024

**Urinary DcR2/Cr Is Associated With Adverse Outcomes in Patients With AKI**

Xiangling Yi, Jia Chen, Yani He. *Army Medical University, Chongqing, China.*

**Background:** Acute kidney injury (AKI) is now considered a major public health problem affecting millions of people worldwide, and AKI is a significant risk of chronic kidney disease and end-stage renal disease. However, there is currently a lack of biomarkers for the prognosis of AKI. Decoy receptor 2 (DcR2), a senescent marker, is expressed exclusively in senescent tubular epithelia and urinary DcR2 (uDcR2) is associated with renal fibrosis in CKD. The aim of study is to investigate the relationship of uDcR2 with kidney injury and renal prognosis in patients with AKI.

**Methods:** 130 biopsy-proven AKI patients were included from our hospital from January 2018 to February 2022. A composite renal endpoint included creatinine more than 50% higher than the baseline or ESRD after 90 days. All patients were divided into positive endpoints (n=63) and negative endpoints (n=64). The clinical characteristics were collected, and the pathological injury was scored. uDcR2 levels were measured using enzyme-linked immunosorbent assay and normalized to urinary cre (uDcR2/Cr). The correlation of uDcR2/Cr levels with renal function and renal pathological scores were analyzed. The logistic regression analysis was used to investigate the association of uDcR2/Cr with endpoints. The association of uDcR2/Cr with the composite renal endpoint using Kaplan-Meier curves were calculated.

**Results:** The level of uDcR2/Cr was positively correlated with cystatin C, and negatively correlated with estimated glomerular filtration rate (eGFR). And uDcR2/Cr was positively associated with renal pathological scores, including acute and chronic kidney injury. The risk factors for endpoint positive were uDcR2/Cr, pathological scores, male, and CKD history. Compared with endpoint-negative group, the uDcR2/Cr level of endpoint-positive patients was significantly higher. Among the patients with uDcR2/Cr < 433ng/g, the percentage of endpoint-negative AKI patients was the higher. And patients with uDcR2/Cr > 433ng/g are more likely to reach the renal end point.

**Conclusions:** Urinary DcR2/Cr is closely associated to kidney injury and renal prognosis of AKI, suggesting that uDcR2/Cr could serve as a novel biomarker for predicting adverse outcomes in patients with AKI.

**Funding:** Other U.S. Government Support



TH-PO025

Urinary Uromodulin Level Reflects Tubular Recovery in Patients With AKI

Takatsugu Iwashita,<sup>1</sup> Izumi Nagayama,<sup>1</sup> Kazutoshi Ono,<sup>2</sup> Daisuke Nagata,<sup>2</sup> Hajime Hasegawa,<sup>1</sup> Akito Maeshima.<sup>1</sup> <sup>1</sup>Department of Nephrology and Hypertension, Saitama Medical Center, Saitama Medical University, Kawagoe, Japan; <sup>2</sup>Division of Nephrology, Department of Internal Medicine, Jichi Medical University, Shimotsuke, Japan.

**Background:** Uromodulin is the most abundant protein excreted in the urine under physiological conditions. It is exclusively produced by the thick ascending limb of Henle and secreted into the urine via proteolytic cleavage. Uromodulin plays an important role in preventing urinary tract infections and kidney stones. However, it remains unknown whether urinary uromodulin level is correlated with the severity and prognosis of acute kidney injury (AKI). In this study, we investigated whether urinary uromodulin is useful as a biomarker for AKI.

**Methods:** AKI patients (n=91) who were treated at Jichi Medical University (December 2018 to January 2020) and Saitama Medical Center Saitama Medical University (December 2020 to September 2021) were enrolled. Written consent was obtained from all patients. Serum and urinary uromodulin were measured by ELISA. Correlations of urinary uromodulin level and various clinical parameters were analyzed. This study was approved by the Ethics Committee on Human Research of our institutions (Approval number A18-081, A18-089, No.2472).

**Results:** Urinary uromodulin level was significantly decreased in AKI patients, compared to that in healthy control (974.9 ± 792.3 vs. 2251.0 ± 942.6 ng/mL, p<0.001). Urinary uromodulin was not correlated with urine protein level, NAG, alpha1-microglobulin, L-FABP, and kidney injury molecule-1. No significant correlation between serum and urinary uromodulin was observed, suggesting that urinary uromodulin is derived from kidney but not from blood. In patient with drug-induced AKI, urinary uromodulin level returned to normal level consistent with improvement of renal function (463.5 to 1974.6 ng/mL). No recovery of urinary uromodulin was observed in AKI patients who required renal replacement therapy and progressed to end stage renal disease. In case of kidney transplantation recipient, urinary uromodulin was undetectable at 1 day after transplantation, but was markedly increased thereafter (day 42, 558.3 ng/mL).

**Conclusions:** Urinary uromodulin reflects the quantity of normally functioning renal tubules and may be useful for monitoring the recovery of damaged renal tubules in AKI.

TH-PO026

Urinary Biomarkers and Kidney Injury in the VA NEPHRON-D Trial

Elizabeth Kiernan,<sup>1</sup> David G. Hu,<sup>1</sup> Heather Thiessen Philbrook,<sup>1</sup> Joachim H. Ix,<sup>2</sup> Steven G. Coca,<sup>3</sup> Michael Shlipak,<sup>4</sup> Dennis G. Moledina,<sup>5</sup> Joseph V. Bonventre,<sup>7</sup> Linda F. Fried,<sup>6</sup> Chirag R. Parikh.<sup>1</sup> <sup>1</sup>Johns Hopkins Medicine, Baltimore, MD; <sup>2</sup>University of California San Diego, La Jolla, CA; <sup>3</sup>Icahn School of Medicine at Mount Sinai, New York, NY; <sup>4</sup>University of California San Francisco School of Medicine, San Francisco, CA; <sup>5</sup>Yale School of Medicine, New Haven, CT; <sup>6</sup>UPMC, Pittsburgh, PA; <sup>7</sup>Brigham and Women's Hospital, Boston, MA.

**Background:** Clinical trials evaluating interventions that modify systemic or intraglomerular pressure lead to elevations in serum creatinine, which may or may not reflect true kidney injury. Urine biomarkers could help phenotype injury patterns in these trial participants.

**Methods:** A subset of participants in the VA NEPHRON-D trial had urinary biomarkers including Albumin: Creatinine ratio (ACR), YKL-40, KIM-1, MCP-1 and EGF measured at baseline and at 12-months. Urinary biomarkers were compared between treatment groups (combination vs monotherapy) and by Acute Kidney Injury (AKI) status. Biomarker results from NEPHRON-D were included in a meta-analysis with other large CKD trials (ACCORD and SPRINT) to assess global trends.

**Results:** In 703 participants, with 2.2 years of follow-up, the incidence of AKI was higher (20.7%) in the combination therapy group as compared to the monotherapy group (12.7%) (RR 1.64 (1.2, 2.3)). Urine biomarkers at 12 months were either the same [MCP-1 -3% (-13%, 9%), KIM-1 -10% (-20%, 1%)] or lower [Albuminuria, -24% (-37%, -8%), YKL-40 -44% (-58%, -25%), EGF -7% (-12, -1%)] in the combination arm compared to monotherapy arm. Meta-analysis demonstrated reduction in albuminuria across 3 trials (pooled estimate -29% 95% CI (-36%, -22%)). No trial showed higher biomarkers in the intervention arm which induced rise in serum creatinine.

**Conclusions:** Treatment with combination ACE-i/ARB therapy was associated with a favorable decrease in urinary biomarkers, suggesting improved tubular health, despite higher risk of serum creatinine defined-AKI. This supports use of kidney injury biomarkers in phenotyping of renal injury.

**Funding:** NIDDK Support, Other NIH Support - NIH grants R01HL085757, UH3DK114866, U01DK106962 and R01DK093770 and P30DK079310, Veterans Affairs Support

Ratio of Intervention to Standard of Care Arm (%)

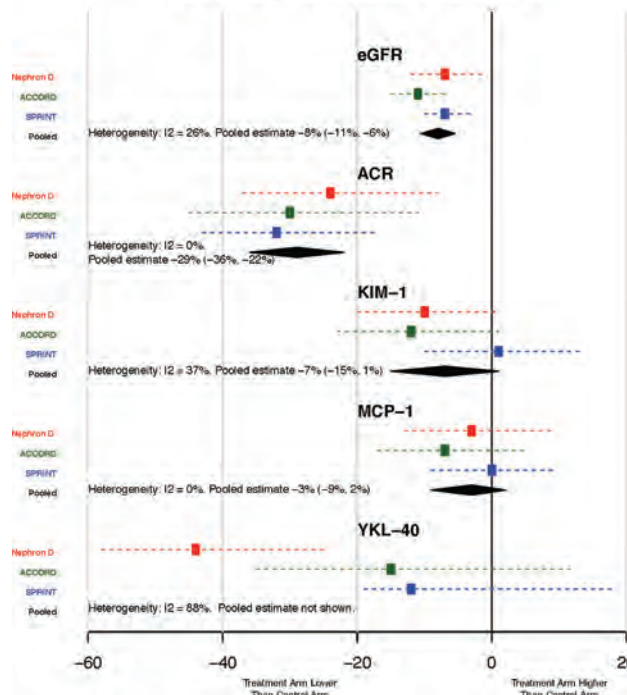

eGFR and Urinary Biomarkers Associated with Interventions in 3 Large Clinical Trials

TH-PO027

Prognostic Value of Urinary Liver-Type Fatty Acid-Binding Protein (uL-FABP) for Major Adverse Kidney Outcomes Among Critically Ill Adult Septic Patients

Carlo Antonio Boado, Jeanne B. Bayaca, Armin N. Masbang. *St. Luke's Medical Center, Quezon City, Philippines.*

**Background:** Urinary L-FABP is predominantly located in the proximal tubule and is excreted into the tubular lumen bound to toxic peroxisomal products which accumulate during tubular injury. uL-FABP is detected by a urine test for the early diagnosis of AKI however, its evidence for prognostication remains unclear. This study aimed to determine the utility of uL-FABP to predict the development of major adverse kidney outcomes: critical AKI, initiation of kidney replacement therapy (KRT), and AKI-related mortality over 30 days among critically ill septic patients in an academic medical center.

**Methods:** Urinary L-FABP was tested among critically ill septic patients upon arrival at the emergency department. Patients were then classified according to the uL-FABP test. Patients were then followed up for 30-day major adverse kidney outcomes which include - critical AKI, initiation of KRT, and AKI-related mortality. We also analyzed independent clinical variables that increase the risk for adverse kidney outcomes.

**Results:** A total of 118 septic patients were included in the study. AKI was diagnosed among 87.2% of the subjects. Patients positive for uL-FABP (48) had severe organ dysfunction and the proportion of those with critical AKI (85.42% vs. 40.00%, p=0.001), KRT initiation (75.00% vs. 20.00%, p=0.001) and mortality (72.92% vs. 21.43%, p=0.001) were all significantly higher among those who tested positive for the uL-FABP test. Cox proportional-hazard regression analyses showed that uL-FABP was able to predict major adverse kidney outcomes among septic patients - critical AKI (HR 3.26 (2-5.3) p=0.0001, KRT initiation (HR 3.13 (3.29-11.43) p=0.0001 and AKI-related mortality (HR 3.13 (3.29-11.43) p=0.0001 over 30 days of observation. Independent variables such as diabetes and chronic kidney disease and dipstick proteinuria correlated were associated with increased risk for adverse kidney outcomes.

**Conclusions:** Urinary L-FABP test is a readily available biomarker for prognostication as it was able to predict 30-day major adverse kidney outcomes among critically ill septic patients. Independent variables like diabetes and chronic kidney disease and an increasing level of proteinuria from the dipstick test are correlated with increased risk for major adverse kidney outcomes.

TH-PO028

Changes in Urinary Epidermal Growth Factor and CKD Progression: The ASSESS-AKI Study

Steven Menez,<sup>1</sup> Heather Thiessen Philbrook,<sup>1</sup> David G. Hu,<sup>1</sup> Wassim Obeid,<sup>1</sup> Pavan K. Bhatraju,<sup>7</sup> Talat Alp Ikizler,<sup>2</sup> Edward D. Siew,<sup>2</sup> Amit X. Garg,<sup>3</sup> Vernon M. Chinchilli,<sup>9</sup> Alan S. Go,<sup>4</sup> Kathleen D. Liu,<sup>5</sup> James S. Kaufman,<sup>10</sup> Paul L. Kimmel,<sup>6</sup> Jonathan Himmelfarb,<sup>7</sup> Steven G. Coca,<sup>8</sup> Chirag R. Parikh,<sup>1</sup> ASSESS-AKI Consortium <sup>1</sup>Johns Hopkins University School of Medicine, Baltimore, MD; <sup>2</sup>Vanderbilt University Medical Center, Nashville, TN; <sup>3</sup>Western University, London, ON, Canada; <sup>4</sup>Kaiser Permanente Northern California, Oakland, CA; <sup>5</sup>University of California San Francisco School of Medicine, San Francisco, CA; <sup>6</sup>National Institute of Diabetes and Digestive and Kidney Diseases, Bethesda, MD; <sup>7</sup>University of Washington School of Medicine, Seattle, WA; <sup>8</sup>Icahn School of Medicine at Mount Sinai, New York, NY; <sup>9</sup>Penn State College of Medicine, Hershey, PA; <sup>10</sup>NYU Langone Health, New York, NY.

**Background:** Acute kidney injury (AKI) and chronic kidney disease (CKD) are interconnected syndromes with AKI recognized as a clear risk factor for CKD incidence or progression. However, biomarkers of repair and epithelial cell integrity of the distal tubule, such as urinary epidermal growth factor (uEGF), may help better inform this risk, given the limitations of serum creatinine (sCr) in the setting of AKI.

**Methods:** We enrolled 1,538 hospitalized patients prospectively in the multi-center Assessment, Serial Evaluation, and Subsequent Sequelae of Acute Kidney Injury (ASSESS-AKI) Study. We measured uEGF from samples collected during hospitalization and at 3 months post-discharge. The primary outcome was a composite of major adverse kidney events (MAKE) consisting of CKD incidence, progression, or development of end-stage kidney disease.

**Results:** 299 (20%) patients developed the primary outcome at a median of 4.3 years follow-up. In fully adjusted models, each 1-standard deviation increase in uEGF from hospitalization to 3 months was associated with a significantly decreased risk of the composite outcome (aHR 0.71; 95% CI: 0.54-0.94; **Table 1**). Patients in tertile 3 (increase in uEGF) had a significantly lower risk of MAKE (aHR 0.53; 95% CI: 0.36-0.78) compared to those in tertile 2, which included patients who had no improvement in uEGF. Similar results were seen in stratified analysis by AKI status at the time of hospitalization, suggesting subclinical disease in patients without AKI.

**Conclusions:** Urinary EGF is a marker of healthy repair after kidney injury, and increases in uEGF from hospitalization to discharge are associated with a decreased risk of MAKE in patients both with and without AKI.

**Funding:** NIDDK Support

Table 1. Association of the difference in uEGF from hospitalization to follow-up with MAKE

AKI	uEGF Difference	Range (ng/mL)	Event rate*	Model 1	Model 2	Model 3
Overall (n=1531)	per 1-SD	-32.4 - 49.4	47.4 (42.3-53.1)	0.94 (0.93-1.07)	0.69 (0.52-0.91)	0.71 (0.54-0.94)
	T1 (n=510)	-32.4 - -0.6	39.7 (32.3-48.8)	0.54 (0.40-0.73)	1.26 (0.93-1.69)	1.29 (0.87-1.92)
	T2 (n=511)	-0.6 - 1.7	70.5 (59.5-83.6)	1.00 (reference)	1.00 (reference)	1.00 (reference)
	T3 (n=510)	1.7 - 49.4	35.5 (28.2-44.4)	0.45 (0.33-0.61)	0.56 (0.39-0.81)	0.53 (0.36-0.78)
AKI (n=765)	per 1-SD	-21.1 - 32.4	73.2 (63.9-84.0)	0.84 (0.71-0.99)	0.74 (0.54-1.01)	0.75 (0.54-1.03)
	T1 (n=207)	-21.1 - -0.6	71.1 (55.1-91.5)	0.62 (0.43-0.88)	1.44 (0.87-2.40)	1.33 (0.76-2.32)
	T2 (n=300)	-0.6 - 1.7	99.7 (81.9-121)	1.00 (reference)	1.00 (reference)	1.00 (reference)
	T3 (n=258)	1.7 - 32.4	46.0 (36.0-63.6)	0.40 (0.27-0.58)	0.55 (0.33-0.91)	0.49 (0.28-0.86)
No AKI (n=766)	per 1-SD	-32.4 - 49.4	26.5 (21.6-32.5)	1.06 (0.90-1.25)	0.74 (0.52-1.05)	0.78 (0.54-1.14)
	T1 (n=303)	-32.4 - -0.6	21.6 (15.2-30.6)	0.46 (0.26-0.77)	1.31 (0.65-2.61)	1.36 (0.61-3.01)
	T2 (n=203)	-0.6 - 1.6	36.6 (25.0-52.1)	1.00 (reference)	1.00 (reference)	1.00 (reference)
	T3 (n=260)	1.7 - 49.4	24.9 (17.3-35.9)	0.54 (0.32-0.91)	0.47 (0.25-0.91)	0.46 (0.18-0.85)

Values are HR (95% CI)  
 Model 1: Unadjusted  
 Model 2: Adjusted for urine creatinine and albumin at 3 months after discharge (V3), urine EGF during hospitalization (V0), eGFR difference (V3M - V0), BMI at V3M, gender, ethnicity, race, smoking status, diabetes, and sepsis  
 Model 3: Further adjusted for urinary biomarkers at 3 months after discharge: NGAL, IL-18, KIM-1, MCP-1, UMGG, YKL-40  
 \* per 1,000 person-years, mean (95% CI)  
 † Ranges are not standardized

TH-PO029

Serum Myo-Inositol Oxygenase Levels at Hospital Discharge Predict Progression to CKD in Community-Acquired AKI

Ashok K. Yadav,<sup>1</sup> Jaskiran Kaur,<sup>1</sup> Kajal Kamboj,<sup>1</sup> Prabhjot K. Johal,<sup>1</sup> Monica Kundu,<sup>2</sup> Arpita Ghosh,<sup>2</sup> Jasmine Sethi,<sup>1</sup> Vivek Kumar,<sup>1</sup> Vivekanand Jha,<sup>2</sup> <sup>1</sup>Post Graduate Institute of Medical Education and Research, Chandigarh, India; <sup>2</sup>The George Institute for Global Health India, New Delhi, India.

**Background:** Acute kidney injury (AKI) increases the risk of morbidity, mortality, and progression to chronic kidney disease (CKD). There are few data on the risk of CKD following community-acquired AKI (CA-AKI) and its predictors from developing countries. We evaluated the association of a panel of serum and urine biomarkers at the time of hospital discharge with 4-month renal outcome in CA-AKI.

**Methods:** Patients of either sex, aged between 18-70 years, with no underlying CKD, and with CA-AKI were recruited at the time of discharge from hospital. Levels of serum and urine biomarkers were analyzed and association between these markers and development of CKD, defined as eGFR <60 ml/min/1.73 m<sup>2</sup> or dialysis dependence at 4 month after discharge, were analyzed using multivariate logistic regression analysis and penalized least absolute shrinkage and selection operator logistic regression.

**Results:** Out of a total 126 patients followed up for 4 months, 25 developed CKD. Those who developed CKD were older (p=0.008). Adjusted logistic regression showed that each 10% increase in standardized serum myo-inositol oxygenase (MIOX) level increased the odds of progression to CKD by 13.5%. With 10% increase in standardized urine Neutrophil gelatinase-associated lipocalin (NGAL), serum creatinine and urine protein creatinine ratio (uPCR), increase in the odds of progression to CKD was 10.5%, 9.6% and 8%, respectively. Multivariable logistic model including serum MIOX, discharge serum creatinine and discharge uPCR, was able to predict the progression of CKD (Figure 1).

**Conclusions:** High level serum MIOX levels at the time of discharge from hospital are associated with progression to CKD in patients with CA-AKI.

**Funding:** Government Support - Non-U.S.

Figure 1: Receiver operating characteristic curves (ROC) for the multivariate model and its individual constituents. AUC: area under the curve.

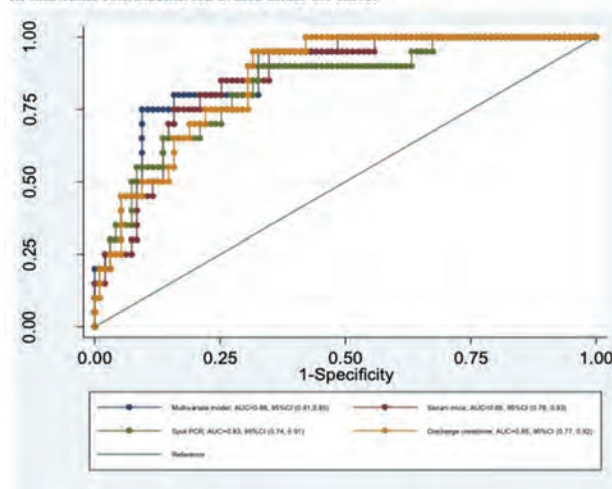

TH-PO030

Insights Into Urinary Renin in AKI

Alexander H. Flannery,<sup>1</sup> Victor M. Ortiz-Soriano,<sup>2</sup> Prasad Devarajan,<sup>3</sup> Javier A. Neyra,<sup>4</sup> <sup>1</sup>University of Kentucky College of Pharmacy, Lexington, KY; <sup>2</sup>University of Kentucky College of Medicine, Lexington, KY; <sup>3</sup>Cincinnati Children's Hospital Medical Center, Cincinnati, OH; <sup>4</sup>The University of Alabama at Birmingham School of Medicine, Birmingham, AL.

**Background:** An activated intra-renal renin-angiotensin system (RAS), reflected by urinary markers including renin, is hypothesized to contribute to and serve as a biomarker of AKI. However, methodologic limitations with urinary renin immunoassay have been noted, including whether the standard is prorenin and not renin. Furthermore, it is unknown if urine renin is elevated simply due to elevations in plasma concentrations. Using a validated direct renin assay with a low cross-reactivity for prorenin, we sought to evaluate concurrent concentrations of urinary and serum renin in patients with and without AKI.

**Methods:** Biospecimens for this study were obtained from a previous cohort study investigating serum renin in critically ill patients. We identified 19 patients with AKI (KDIGO stage 2 or higher) due to sepsis and 19 matched control patients (i.e. critical illness without AKI). The biospecimens under study were obtained within the first 3 days of intensive care unit admission. Urine and serum renin were measured in duplicate with a renin (active) ELISA and normalized to urine creatinine (Cr).

**Results:** Patients were well-matched with demographics, although AKI patients were more critically ill. Urine renin and urine renin normalized to Cr were significantly (p<0.001 for both) higher in AKI patients versus controls (Fig. 1A-B). Serum renin was higher in AKI patients than controls (p=0.014). Urine renin: serum and urine renin (normalized to urine Cr): serum renin ratios were numerically higher in AKI patients versus controls (Fig. 1C-D): p=0.300 and 0.226, respectively. Scatterplots (Fig. 1E-F) support the concept of a differential relationship of urine to serum renin in AKI and that an elevated serum renin is not a requirement for elevated urinary renin.

**Conclusions:** Urine renin is higher in AKI patients vs. controls, is not solely explained by high circulatory concentrations, and may represent a biomarker of intra-renal RAS activation in AKI.

**Funding:** NIDDK Support

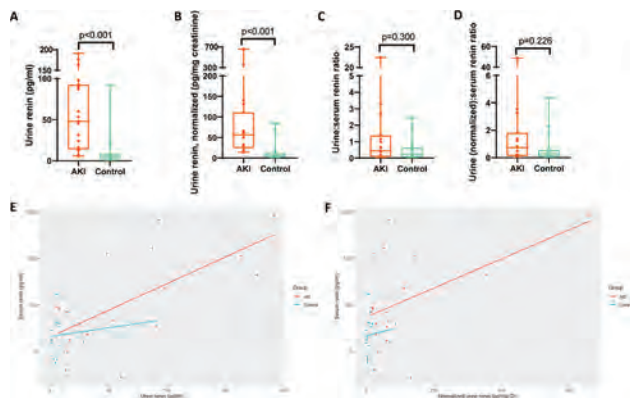

Fig. 1. Urine Renin in AKI vs. Controls

TH-PO031

**Galectin-3 and EGF Are the Only Cardiorenal Biomarkers to Predict AKI Progression in the Setting of Acute Heart Failure**

Stephen Duff,<sup>1</sup> Nicholas Wettersten,<sup>2</sup> Yu Horiuchi,<sup>3</sup> Sagar Raturi,<sup>1</sup> Ruairi Irwin,<sup>1</sup> Patrick T. Murray.<sup>1</sup> The AKINESIS Investigators <sup>1</sup>University College Dublin College of Health Sciences, Dublin, Ireland; <sup>2</sup>VA San Diego Healthcare System, San Diego, CA; <sup>3</sup>Shakai Fukushi Hojin Mitsui Kinen Byoin, Chiyoda-ku, Japan.

**Background:** Acute Kidney Injury (AKI) is common in hospitalized patients and is associated with high morbidity and mortality. Acute Kidney Injury Neutrophil gelatinase-associated lipocalin Evaluation of Symptomatic heart failure Study (AKINESIS) was a prospective, international, multicentre cohort which enrolled 927 patients presenting with acute heart failure (AHF). We hypothesised that novel urinary and plasma cardiorenal biomarkers would predict progression of AKI and associated outcomes in the setting of AHF.

**Methods:** The primary analysis assessed if biomarkers measured at the time of developing Stage 1 or 2 AKI within 72 hours of admission predicted progression to a higher AKI Stage, RRT or death within 30 days. Twenty-four novel urinary and plasma biomarkers were analysed using commercially available ELISAs and the architect platform.

**Results:** In total, 175 patients had Stage 1–2 AKI within 72 hours of hospital admission and were included in the study. Of the 24 biomarkers studied, plasma Galectin-3 and EGF improved prediction of AKI progression. None of the other biomarkers were associated with the outcome.

**Conclusions:** AKI progression in AHF occurred in the absence of tubular damage as assessed by a panel of urinary plasma biomarkers, consistent with the functional mechanism of AKI in AHF. Systemic inflammatory and fibrotic processes may contribute to progression.

**Funding:** Government Support - Non-U.S.

Predictor	n	Brier		R <sup>2</sup>		LR χ <sup>2</sup>		LR P-Value <sup>a</sup>
		Pre-test	Post-test	Pre-test	Post-test	Pre-test	Post-test	
Urea	175	0.14	0.14	0.06	0.06	6.38	6.44	0.797
Serum Creatinine	175	0.15	0.14	0.04	0.06	4.23	6.44	0.137
Galectin-3	175	0.14	0.12	0.06	0.22	6.44	24.89	<0.001
EGF	139	0.12	0.11	0.10	0.20	7.80	16.48	0.013
Uromodulin	139	0.12	0.12	0.10	0.13	7.80	10.49	0.101
ACR	129	0.12	0.11	0.08	0.15	5.80	11.79	0.112
Troponin I	175	0.14	0.14	0.06	0.08	6.44	8.72	0.131
TIMP-2	139	0.12	0.12	0.10	0.12	7.80	9.74	0.164
IGFBP-7	139	0.12	0.12	0.10	0.12	7.80	9.49	0.194
IGFBP-1	139	0.12	0.12	0.10	0.11	7.80	9.38	0.209
uCreatinine	174	0.14	0.14	0.06	0.07	6.65	7.79	0.286
KIM-1	139	0.12	0.12	0.10	0.10	7.80	8.58	0.377
MCP-1	139	0.12	0.12	0.10	0.10	7.80	8.48	0.411
YKL-40	139	0.12	0.12	0.10	0.10	7.80	8.44	0.423
FENa	129	0.12	0.12	0.08	0.08	5.80	6.33	0.469
TIMP-2*IGFBP-7	139	0.12	0.12	0.10	0.10	7.80	8.30	0.481
A1M	139	0.12	0.12	0.10	0.10	7.80	8.12	0.57
CCL-14	139	0.12	0.12	0.10	0.10	7.80	8.02	0.638
pNGAL	175	0.14	0.14	0.06	0.06	6.44	6.59	0.7
uNGAL	174	0.14	0.14	0.06	0.06	6.65	6.73	0.777
CRP	127	0.13	0.13	0.04	0.04	3.12	3.20	0.782
LFABP-1	139	0.12	0.12	0.10	0.10	7.80	7.84	0.842
BNP	175	0.14	0.14	0.06	0.06	6.44	6.46	0.907
FEUrea	129	0.12	0.12	0.08	0.08	5.80	5.81	0.942
Cystatin C	127	0.13	0.13	0.04	0.04	3.12	3.12	0.963
AGT	139	0.12	0.12	0.10	0.10	7.80	7.80	0.984

<sup>a</sup>Likelihood Ratio χ<sup>2</sup> test

TH-PO032

**Urine TIMP-2\*IGFBP7 Compared With Traditional Parameters for Predicting Hemodialysis Termination in AKI: A Prospective Observational Study**

Teeraporn Suttayamook, Pongsathorn Gojaseni. Bhumibol Adulyadej Hospital, Bangkok, Thailand.

**Background:** Currently, there is no official guideline or protocol for when to stop intermittent kidney replacement therapy (IKRT) in acute kidney injury (AKI). The decision to stop IKRT was based on clinical perspectives and nephrologists' experiences. The urinary cell cycle arrest biomarkers tissue inhibitor of metalloproteinase-2 (TIMP2) and insulin-like growth factor binding protein-7 (IGFBP7) have good performance in risk prediction of AKI and there is some evidence for predicting renal recovery. Thus, this study aimed to explore the association between successful IKRT discontinuation and urinary TIMP2\*IGFBP7, compared with other traditional parameters.

**Methods:** We prospectively enrolled medical and surgical patients who were diagnosed with AKI based on KDIGO 2012 criteria and required IKRT at Bhumibol Adulyadej Hospital, Bangkok, Thailand from July 2021 to January 2022. TIMP2\*IGFBP7 and other clinical parameters were collected before each IKRT which potential to be the last session. The primary outcome was successful IKRT discontinuation for 14 days.

**Results:** Seventeen patients (age 68.35 ± 17.60) with thirty-nine AKI sessions were enrolled in the study. Of 39 IKRT sessions, 8 (20.51%) were able to terminate from IKRT for 14 days. We have found a non-significant association between urinary TIMP2\*IGFBP7 and successful IKRT discontinuation with an area under the receiver operating characteristic curve (AUC) 0.55 [95% confidential interval (CI) 0.32-0.77, P=0.66]. On the other hand, 24-hour pre-IKRT urine volume showed the fair performance to predict an ability for successful IKRT discontinuation with an AUC of 0.76 [95% CI 0.56-0.96, P=0.023] with optimal cut point >1,478 ml/day (Youden's index 0.49).

**Conclusions:** We have found no association between pre-IKRT urine TIMP2\*IGFBP7 and successful IKRT discontinuation at 14 days, while 24 hours pre-IKRT urine output showed a fair predictive performance. Thus, clinical perspectives still play an important role in deciding to stop IKRT.

**Funding:** Government Support - Non-U.S.

## TH-PO033

**Urine Mass Spectrometry Can Distinguish Prerenal and Intrarenal AKI**  
Reece B. Mitchell, Luke T. James, Christian Herzog, Joseph H. Holthoff, John M. Arthur. *University of Arkansas for Medical Sciences, Little Rock, AR.*

**Background:** Postrenal causes of acute kidney injury (AKI) are often determined by imaging, but differentiation of prerenal (PR) from intrinsic renal (IR) can be challenging. A point of care method for differentiating these two entities would be useful. Mass spectrometry (MS) can visualize small molecules in urine. We utilized a portable, single quadrupole mass spectrometer with a simple ionization interface to measure small molecules in urine. The interface allows for direct analysis of samples without the need for time-consuming preparation. The goal was to distinguish PR and IR AKI by urine analyte profiles.

**Methods:** Inpatients with AKI were eligible for enrollment. COVID-19 patients were excluded. Informed consent was obtained under an approved UAMS IRB protocol. Patients were categorized as either PR (n=15) or IR (n=19) AKI etiology using the diagnosis by the on-service nephrology attending. Two microliter aliquots of urine were dispensed onto a stainless steel probe without prior processing and analyzed by MS with an Advion Expression CMS Mass Spectrometer. Peaks were recorded within the 20 to 500 m/z range. MS spectra were processed and binned in 1 m/z increments for peak clustering using MATLAB. The frequency of binned peaks in the PR AKI group were compared to the IR group and marked as a PR peak of interest if the difference in peak occurrence was eight or more. IR peaks of interest were identified similarly.

**Results:** Fifteen peaks met our initial criteria for difference in frequency between intrinsic and prerenal cases. From the fifteen, two were PR peaks and thirteen were IR peaks of interest. Mann-Whitney-U testing identified two peaks of significant variation between the PR and IR population: a PR peak with a m/z of 233 (p=0.0027) and an IR peak with a m/z of 372 (p=0.0027).

**Conclusions:** Point of care MS has the potential to rapidly differentiate PR from IR and potentially to further phenotype causes of AKI. Based on previous studies, the peaks we identified are likely small molecule metabolites. Additional sampling will enable the use of machine learning algorithms to classify the kidney disease that is present. Further correlation of the different analytes in prerenal and intrarenal AKIs is needed, however this study shows the potential utility of mass spectrometry to rapidly phenotype AKI in the clinical setting.

## TH-PO034

**Initiation of Terlipressin at Lower Serum Creatinine Levels Is Associated With Avoidance of Dialysis in Patients With Hepatorenal Syndrome Type 1**  
Juan Carlos Q. Velez,<sup>1</sup> Ira Kurtz,<sup>2,3</sup> John M. Vierling,<sup>4</sup> Stevan A. Gonzalez,<sup>5</sup> Khurram Jamil.<sup>6</sup> *<sup>1</sup>Ochsner Health Network LLC, New Orleans, LA; <sup>2</sup>University of California Los Angeles David Geffen School of Medicine, Los Angeles, CA; <sup>3</sup>UCLA Brain Research Institution, Los Angeles, CA; <sup>4</sup>Baylor College of Medicine, Houston, TX; <sup>5</sup>Baylor Scott & White Health, Fort Worth, TX; <sup>6</sup>Mallinckrodt LLC, Clinton, NJ.*

**Background:** Results from 3 North American, randomized, placebo (PBO)-controlled trials (RCTs [OT-0401, REVERSE, and CONFIRM]) demonstrated that terlipressin (TERLI) effectively reversed acute kidney injury (AKI) due to hepatorenal syndrome type 1 (HRS-1), and reduced the cumulative need for renal replacement therapy (RRT). However, factors associated with avoidance of RRT have not been formally examined.

**Methods:** A pooled analysis of the 3 RCTs in patients with HRS-1 (OT-0401, REVERSE, and CONFIRM) was conducted to compare the efficacy of TERLI + albumin vs. PBO + albumin. Logistic regression analysis was used to evaluate baseline characteristics associated with avoidance of RRT by Day 90. Numerical values were used as continuous variables. Patients who died without undergoing RRT were excluded to eliminate death as a potential confounder.

**Results:** In the pooled cohort, the following factors were significantly associated with a lower odds of avoidance of RRT by Day 90: a higher serum creatinine (SCr) level at study entry ([n=412], odds ratio [OR], 0.55; 95% CI: 0.44–0.68; P<.001) and higher scores for liver disease severity (Child Pugh score [n=393]; OR, 0.89; 95% CI: 0.80–0.99, P=.037; and MELD score [n=361]; OR, 0.96; 95% CI: 0.93–0.99; P=.010). Randomization to TERLI (n=412) was significantly associated with a greater odds of avoidance of RRT (OR, 1.57; 95% CI: 1.06–2.33; P=.025). In contrast, age, male sex, race, alcoholic hepatitis, baseline mean arterial pressure (MAP), serum sodium, serum albumin, total bilirubin, INR, prior albumin use, presence of precipitating factors for HRS, or prior use of midodrine/octreotide were not associated with avoidance of RRT. Among TERLI-treated patients, a higher SCr level (n=241; P<.001) and MELD score (n=213; P=.01) were significantly associated with a lower odds of avoidance of RRT. Among PBO-treated patients (n=171), a higher SCr level (P<.001) and lower MAP (P=.008) were associated with a lower odds of avoidance of RRT.

**Conclusions:** TERLI treatment at a lower SCr level and MELD score was associated with a greater probability of avoiding RRT by Day 90 in patients with HRS-1. Thus, initiation of TERLI in patients with a lower SCr may reduce the need for RRT in patients with AKI due to HRS-1.

**Funding:** Commercial Support - Mallinckrodt Pharmaceuticals

## TH-PO035

**Impact of Terlipressin on Serum Sodium Levels in Patients With Hepatorenal Syndrome (HRS): The North American Experience**  
Shehzad N. Merwat,<sup>1</sup> Aftab Karim,<sup>3</sup> Muhammad W. Khattak,<sup>4</sup> Muhammad A. Mujtaba,<sup>1</sup> Zunaira Zafar,<sup>5</sup> Khurram Jamil.<sup>2</sup> *<sup>1</sup>The University of Texas Medical Branch at Galveston Development Office, Galveston, TX; <sup>2</sup>Mallinckrodt Pharmaceuticals, Clinton, NJ; <sup>3</sup>Texas Health Presbyterian Hospital Dallas, Dallas, TX; <sup>4</sup>University of Illinois Chicago College of Medicine, Peoria, IL; <sup>5</sup>St. Mary Medical Center, Langhorne, PA.*

**Background:** Hyponatremia is an electrolyte abnormality commonly observed in patients (pts) with advanced cirrhosis and is associated with a poor prognosis. HRS—a rapid kidney failure—occurs in pts with decompensated cirrhosis and ascites. In some pts with HRS, terlipressin (Terli) treatment successfully reversed HRS and improved renal function. However, hyponatremia has been previously reported as a common adverse event associated with Terli administration.

**Methods:** Data from the 3 largest (N=608), prospective, randomized, placebo-controlled, clinical studies in HRS (OT-0401, REVERSE, and CONFIRM) were pooled in a database and assessed in a subgroup analysis. Pts with HRS were randomly assigned to receive Terli or placebo (Pbo), both plus albumin. Overall and treatment-response-dependent changes in serum sodium levels were evaluated from baseline to end of treatment (EOT). Response (ie, HRS reversal) was defined as at least 1 serum creatinine (SCr) value of  $\leq 1.5$  mg/dL while on treatment. EOT was defined as the last date/time of treatment + 24 hours.

**Results:** Baseline characteristics were similar across treatment groups and were characteristic of advanced liver disease: in the Terli and Pbo groups, mean MELD (SD) scores were 33.0 (6.4) and 33.1 (5.9) and mean (SD) serum sodium levels were almost identical: 132.5 (6.1) mmol/L and 132.7 (6.0) mmol/L, respectively. By EOT, serum sodium levels increased significantly more in the Terli group vs the Pbo group, in general, and in all clinical response categories defined by changes in SCr (P $\leq$ .001; **Table**).

**Conclusions:** This subgroup analysis utilized the largest prospective database to evaluate the effects of Terli vs Pbo on serum sodium concentrations. In contrast to previous observations, by EOT, hyponatremia in pts with HRS improved to a significantly greater degree when treated with Terli vs Pbo. The improvement in serum sodium was greater in subjects who had a complete response vs a partial response.

**Funding:** Commercial Support - Mallinckrodt Pharmaceuticals

Group		Change in serum sodium level (mmol/L)		P-value
		Terli (n=338)	Pbo (n=246)	
All	Mean (SD)	4.3 (5.7)	2.0 (5.3)	<.001
Complete response <sup>a</sup>	n	116	42	
	Mean (SD)	6.0 (6.7)	2.9 (4.8)	<.001
Partial response <sup>b</sup>	n	43	67	
	Mean (SD)	3.9 (4.9)	1.0 (6.8)	.001
No response <sup>c</sup>	n	213	108	
	Mean (SD)	5.0 (6.2)	2.3 (4.7)	<.001

<sup>a</sup>Complete response: HRS reversal; <sup>b</sup>Partial response:  $\geq 30\%$  improvement in SCr but not HRS reversal; <sup>c</sup>No response: no change or worsening of SCr.

**Table.** Change in serum sodium concentrations from baseline to EOT, pooled intent-to-treat population.

## TH-PO036

**Impact of Fluid Overload on Patients Receiving Continuous Dialysis for AKI**

Samantha Gunning, Jay L. Koyner. *University of Chicago Division of the Biological Sciences, Chicago, IL.*

**Background:** Fluid overload at the time of dialysis initiation for acute kidney injury (AKI) has been associated with dialysis dependence and mortality. This observation supports the view that there is a survival benefit associated with large fluid removal with dialysis (e.g. >10% of body weight); however, this has not been fully explored in the literature.

**Methods:** We conducted a single-center retrospective cohort study among adult patients admitted to the intensive care unit (ICU) at University of Chicago Medical Center with AKI treated with continuous veno-venous hemodialysis (CVVHD) from April 1, 2016 to March 31, 2020. We collected patient demographics, severity of illness, daily fluid balance in the 72 hours prior to and 7 days subsequent to CVVHD initiation, and ICU outcomes (duration of mechanical ventilation, length of stay, dialysis dependence, and mortality). Percent fluid overload was defined as total documented inputs minus outputs divided by weight on ICU admission.

**Results:** Cohort size was 1382 patients who were 42% female, 58% black, with an average age of 60 years. Average SOFA score was 8.5 at the time of ICU admission. In the 72 hours prior to CVVHD there was no association between percent fluid overload and 30-day mortality. In the 72 hours and 7 days after CVVHD start, there was a linear association between percent fluid overload and 30-day mortality with the lowest 30-day mortality among patients achieving greater than -10% fluid overload and highest among patient achieving greater than 10% fluid overload [Table].

**Conclusions:** Percent fluid overload at 72 hours and 7 days after starting CVVHD is associated with 30-day mortality. Those achieving the most substantial fluid removal had the highest 30 day survival.

**Funding:** Commercial Support - Fresenius Medical Care

Percent Fluid Overload at 72 hours prior to CVVHD, 72 hours after CVVHD, and 7 days after CVVHD

% Fluid Overload	72H Pre (%)	30-Day Mortality (%)	72H Post (%)	30-Day Mortality (%)	7D Post (%)	30-Day Mortality (%)
>=10%	3 (0.27)	1 (33.3)	25 (1.9)	4 (16.0)*	138 (10.6)	36 (26.1)*
-5% to <10%	21 (1.9)	11 (52.4)	125 (9.6)	40 (32.0)*	180 (13.8)	53 (29.4)*
0% to <5%	274 (24.7)	125 (45.6)	380 (29.1)	149 (39.2)	277 (21.2)	115 (41.5)
0% to 5%	576 (52.0)	284 (49.3)	433 (33.2)	233 (53.8)	332 (25.4)	190 (57.2)
5% to 10%	159 (14.4)	80 (50.3)	179 (13.7)	103 (57.5)*	180 (13.8)	112 (62.2)*
> 10%	75 (6.8)	40 (53.3)	163 (12.5)	108 (66.3)*	198 (15.2)	131 (66.2)*

\*p<0.005 when comparing mortality rate to those with <5% to 5% fluid overload (using Chi-Square Test)

#p<0.05 when comparing mortality rate to those with <5% to 5% fluid overload (using Chi-Square Test)

TH-PO037

**Impact of Hepatorenal Syndrome (HRS) Reversal on the Need for Renal Replacement Therapy (RRT): Analysis From 3 Phase 3 Terlipressin Studies**  
 Muhammad A. Mujtaba,<sup>1</sup> Ann Kathleen N. Gamilla-Crudo,<sup>1</sup> Shehzad N. Mervat,<sup>1</sup> Michael Kueht,<sup>1</sup> Aftab Karim,<sup>3</sup> Muhammad W. Khattak,<sup>3</sup> Zunaira Zafar,<sup>4</sup> Khurram Jamil.<sup>2</sup> <sup>1</sup>The University of Texas Medical Branch at Galveston Development Office, Galveston, TX; <sup>2</sup>Mallinckrodt LLC, Clinton, NJ; <sup>3</sup>University of Illinois Chicago College of Medicine, Chicago, IL; <sup>4</sup>St. Mary Medical Center, Langhorne, PA.

**Background:** HRS is a progressive but potentially reversible kidney failure in patients (pts) with advanced cirrhosis. RRT is offered if pts fail pharmacotherapy; however, it is an invasive and costly intervention associated with increased morbidity in some pts. Terlipressin (Terli) is the standard-of-care treatment for pts with HRS based on the current US and European guidelines.

**Methods:** Data from 3 Phase 3, placebo (Pbo)-controlled clinical studies (OUT-0401, REVERSE, and CONFIRM) were pooled (N=608) for subgroup analyses. Associations between HRS reversal—defined as at least 1 serum creatinine (SCr) value of ≤1.5 mg/dL while on treatment—and the need for RRT, overall and per treatment, were examined up to 90 days.

**Results:** By Day 90, 209 pts had received RRT (Terli, n=111; Pbo, n=98). Baseline characteristics were similar between treatment groups and typical of pts with advanced cirrhosis: mean (SD) MELD scores were 33.6 (6.4) and 33.2 (6.0) in the Terli and Pbo groups, respectively. Overall, HRS reversal was associated with a reduced need for RRT (Table). In pts who achieved HRS reversal, RRT incidence was similar between treatment groups. Yet, among nonresponders (ie, no HRS reversal), there was still a lower incidence of RRT in pts treated with Terli vs Pbo (Table). Mean (SD) changes in SCr from baseline to end of treatment among nonresponders were 0.1 (1.3) mg/dL in the Terli group vs 0.6 (1.4) in the Pbo group; P<.001.

**Conclusions:** This analysis evaluated the largest database of pts with HRS treated with Terli. Improved renal function resulted in a decreased need for RRT. Even among nonresponders, changes in renal function were significantly better in the Terli group vs the Pbo group and, therefore, Terli reduced the need for RRT in these pts vs Pbo.

**Funding:** Commercial Support - Mallinckrodt Pharmaceuticals

RRT, n/N (%)	Overall (N=608)		HRS Reversal (n=159)		No HRS Reversal (n=449)	
	HRS Reversal	No HRS Reversal	Terli	Pbo	Terli	Pbo
by Day 30	9/130 (6.9)	117/254 (46.1)	6/92 (6.5)	3/38 (7.9)	50/126 (39.7)	67/128 (52.3)
by Day 60	9/119 (7.6)	107/217 (49.3)	6/85 (7.1)	3/34 (8.8)	46/108 (42.6)	61/109 (56.0)
by Day 90	11/114 (9.6)	101/201 (50.2)	7/82 (8.5)	4/32 (12.5)	45/100 (45.0)	56/101 (55.4)

Table. Incidence of RRT through Day 90 for patients alive at landmark time points

TH-PO038

**Porto-Pulmonary Hypertension and Decongestion in Norepinephrine-Treated Hepatorenal Syndrome Type 1**

Terrance J. Wickman,<sup>1</sup> Adil Yousef,<sup>1</sup> Muner Mohamed,<sup>1</sup> Juan Carlos Q. Velez.<sup>1,2</sup> Ochsner Nephrology <sup>1</sup>Ochsner Medical Center, New Orleans, LA; <sup>2</sup>The University of Queensland Ochsner Clinical School, Brisbane, QLD, Australia.

**Background:** Porto-pulmonary hypertension (PoPHTN) is a complication of cirrhosis that can lead to venous congestion. Contrary to traditional dogma, we previously reported that in patients with acute kidney injury (AKI) due to hepatorenal syndrome type 1 (HRS-1), addition of IV furosemide (FURO) to vasoconstrictor therapy with norepinephrine (NE) results in enhanced diuresis without worsening the course of AKI. We aimed to examine the relationship between PoPHTN and AKI course and response to FURO in NE-treated HRS-1.

**Methods:** We searched records of patients with HRS-1 treated with NE as a vasoconstrictor who during the course of AKI underwent echocardiography with an estimate of pulmonary artery systolic pressure (PASP) over a 3-year period. PoPHTN was defined as echo-based PASP > 35 mmHg and absence of reduced left ventricular ejection fraction (rLVEF) or left ventricular diastolic dysfunction (LVDD). Outcomes examined were association of PoPHTN with need for dialysis (AKI-RRT) and influence of PoPHTN on the correlation between NE-induced MAP rise and FURO-enhanced diuresis.

**Results:** Among 39 patients with HRS-1 treated with NE, 26 had echo-based PASP, 9 (35%) had PoPHTN (5 confirmed by right heart catheterization); 4 had reduced right ventricular systolic function, 1 rLVEF and 1 LVDD. Five of 9 (55%) of those with PoPHTN reached AKI-RRT compared to 4 of 17 (24%) without PoPHTN (p=0.11). Of the 26 patients, 19 received FURO [median 160 (80-240) mg q 12 (8-24) hrs] for decongestion. Urine output (UOP) response correlated with NE-induced MAP rise (r=0.62, p=0.004). The correlation between UOP and MAP rise among those with PoPHTN (n=9, median PASP 45, r=0.84, p=0.009) was stronger than that observed in those without PoPHTN (n=10, median PASP 27, r=0.53, p=0.09). Furthermore, PoPHTN with concomitant estimated central venous pressure (CVP) 8-15 mmHg (n=4) was associated with greater UOP response to MAP rise compared to absence of PoPHTN with CVP 3 mmHg (n=4) (252 vs 101 ml/mmHg, p=0.0008).

**Conclusions:** PoPHTN may be present in 1/3 of patients with HRS-1 and it is associated with greater dependence of the UOP response to FURO to the NE-induced MAP rise. Presence of PoPHTN should be assessed to guide decongestive strategies in the management of AKI due to HRS-1.

TH-PO039

**Multi-Center Study to Assess the Safety of a Selective Cytopheretic Device (SCD) for Treatment of Immunomodulatory Dysregulation due to AKI in Children ≥10 and ≤20 kg: Report From the First 4 Patients**

Kelli A. Krallman,<sup>1</sup> Xavier French,<sup>1</sup> H. David Humes,<sup>2</sup> David J. Askenazi,<sup>3</sup> Lenar T. Yessayan,<sup>2</sup> Michaela Collins,<sup>1</sup> Jessica Potts,<sup>3</sup> Stuart Goldstein.<sup>1</sup> <sup>1</sup>Cincinnati Children's Hospital Medical Center, Cincinnati, OH; <sup>2</sup>University of Michigan Medical School, Ann Arbor, MI; <sup>3</sup>Benjamin Russell Hospital for Children, Birmingham, AL.

**Background:** Acute kidney injury (AKI) that requires continuous kidney replacement therapy (CKRT) is a highly lethal condition in critically ill patients. Despite improvements in acute care and dialysis therapies, the mortality rate from the past four decades has not improved. In a previous single treatment arm study of children on CKRT treated with SCD > 20 kg, 12/16 subjects survived to ICU discharge, all of whom were dialysis independent by day 60. We now report outcomes in findings the first 4 treated patients < 20 kg.

**Methods:** 4 center US study of SCD in children that weigh between ≥10 and ≤20kg, have a clinical diagnosis of AKI requiring CKRT and at least one non-renal organ failure. With these subjects the SCD was integrated post CKRT membrane, changed daily, and circuit ionized calcium (iCa) maintained <0.4 mmol/L. Subjects received SCD treatment for up to 10 days or CKRT discontinuation, whichever came first.

**Results:** 5 patients (2F/3M) have been enrolled since 07/2021. Four patients (Age 1.6 - 10.4 years. PRISM-2 Score range = 14-27) received SCD therapy. Three of these patients received SCD on a PRISMAFLEX™ one on a PRISMAX™ machine. Circuit iCa has been maintained at <0.4 mmol/L during 81% of therapy. Three of the four patients demonstrated renal recovery after SCD therapy, coming off all forms of KRT within 5 days post SCD therapy. Of the patients that have reached day 60, both were dialysis independent. The fourth patient died after SCD therapy had ended but before ICU discharge. An additional patient was enrolled but did not continue with SCD because their iCa was not in range due to citrate intolerance. No SCD-related serious adverse events have been reported.

**Conclusions:** Our initial findings suggest that SCD is safe in critically ill pediatric patients weighing between 10-20kg.

**Funding:** Private Foundation Support

Patient Information

Patient Number	Age (yrs)	Weight (Kg)	Diagnosis	Final Outcome
1	1.9	14.1	Shock and pancytopenia	Alive with renal recovery
2	1.7	12	Necrotizing pneumonia	Deceased
3	10.4	16.5	Status epilepticus	Alive with renal recovery
4	3.5	14.3	Bowel perforation and septic shock	Ongoing but off KRT

TH-PO040

**Delay in Renal Replacement Therapy Initiation in Critically Ill Patients With AKI: A Secondary Analysis of the STARRT-AKI Trial**

Rachel Jeong,<sup>1,2</sup> Andrea K. Harvey,<sup>3</sup> Brian Kirkham,<sup>4</sup> Sean M. Bagshaw,<sup>5</sup> Ron Wald.<sup>6,7</sup> The STARRT-AKI Investigators <sup>1</sup>Department of Critical Care Medicine, University of Calgary, Calgary, AB, Canada; <sup>2</sup>Division of Nephrology, University of Calgary, Calgary, AB, Canada; <sup>3</sup>Department of Medicine, University of Toronto, Toronto, ON, Canada; <sup>4</sup>Applied Health Research Centre, St. Michael's Hospital, Toronto, ON, Canada; <sup>5</sup>Department of Critical Care Medicine, University of Alberta, Edmonton, AB, Canada; <sup>6</sup>Division of Nephrology, St. Michael's Hospital and the University of Toronto, Toronto, AB, Canada; <sup>7</sup>Li Ka Shing Knowledge Institute of St. Michael's Hospital, Toronto, AB, Canada.

**Background:** The STARRT-AKI trial demonstrated that earlier initiation of renal-replacement therapy (RRT) does not lead to improved outcomes as compared to a strategy of watchful waiting until a conventional indication arises. However, in patients with persistent acute kidney injury (AKI), the safety of prolonged delay in RRT initiation is unclear. We hypothesized that protracted delays in RRT initiation would be associated with excess mortality. Our objective was to determine the association between relative delay to RRT initiation and outcomes among patients randomized to the standard-strategy in STARRT-AKI.

**Methods:** We conducted a post-hoc secondary analysis of the standard-strategy group in STARrrt-AKI. The exposure was time from randomization to RRT initiation, in quartiles. The primary outcome was all-cause mortality at 90 days after randomization. The association between time to RRT initiation and the outcomes were described as adjusted odds ratios (aOR) or adjusted mean differences (aMD), as appropriate.

**Results:** There were 1462 patients in the standard-strategy group, of whom 903 (62%) received RRT. Median time (IQR) to RRT initiation was 12.1 (8.3-13.8), 24.5 (21.8-26.5), 46.8 (35.2-52.1), and 96.1 (76.7-139.2) hours across quartiles 1 through 4, respectively. Compared to patients in quartile 1, longer delay to RRT initiation was associated with lower 90-day mortality in quartiles 3 and 4 (aOR [95% CI] 0.52 [0.35-0.77] and 0.63 [0.42-0.94], respectively). There were no significant differences in RRT dependence, number of RRT-free or hospitalization-free days at 90 days. Patients in quartile 4 had longer durations of ICU and hospital stay (aMD [95% CI] 8.26 [5.77-10.74] and 12.42 [7.59-17.25] days, respectively), relative to quartile 1.

**Conclusions:** Among patients with persistent AKI, delay in RRT initiation was not associated with excess mortality, however, was associated with longer durations of ICU and hospital stay.

**Funding:** Government Support - Non-U.S.

## TH-PO041

### Endotoxin Removal Therapy With Polymyxin B Immobilized Fiber Column as a Flowchart Protocol Strategy for Endotoxic Shock

Silvia De Rosa,<sup>1,2</sup> Anna Lorenzin,<sup>1,2</sup> Massimo de Cal,<sup>1,2</sup> Marta Proglgio,<sup>1</sup> Nicola Marchionna,<sup>1</sup> Claudio Ronco,<sup>2,1</sup> Monica Zanella.<sup>1,2</sup> <sup>1</sup>*Ospedale San Bortolo di Vicenza, Vicenza, Italy;* <sup>2</sup>*International Renal Research Institute of Vicenza, Vicenza, Italy.*

**Background:** Endotoxin-induced sepsis is a leading cause of ICU mortality. From 1994 to present, Polymyxin B-hemoperfusion (PMX-HP) is available as an adjuvant therapeutic option. PMX-HP is also an immunomodulatory blood purification. The aim of this study was to evaluate the role of diagnostic-therapeutic flowchart for the use of endotoxin neutralization by Polymyxin B Hemoperfusion.

**Methods:** We conducted a prospective, observational web-based database analysis (EUPHAS2 registry), single centre basis, of critically ill patients admitted to the ICU between January 2016 until to May 2021 who were affected by endotoxic shock caused by proved or suspected infection related to Gram negative bacteria and received PMX-HP as per clinical indication of the attending physician. Patients were divided based on the use of diagnostic-therapeutic flowchart in two groups: Pre-Flowchart (Pre-F) and Post-Flowchart (Post-F).

**Results:** 61 patients were treated with PMX-HP out of 531 who received diagnosis of septic shock. The most common source of infection was secondary peritonitis (36.0%) followed by community acquired pneumonia (29.0%). We identified gram negative bacteria in most of the microbiological culture (N=59, 51%), followed by gram positive bacteria in (N=31, 27%), fungi (N=11, 9%) and no growth (N=15, 13%). In both groups, SOFA score progressively improved over the next 120h following PMX-HP and it was associated with endotoxin activity levels (EA) decrease. Particularly, in the Post-F Group EA decreased from 0.71 [0.64-0.80] at T0 to 0.56 [0.45-0.66] at T120. Particularly, in Post-F group a lower 28-day mortality [21%], ICU [29%] and lower 90-day mortality [29%] compared to Pre-F group [30%] were observed.

**Conclusions:** In critically ill patients with endotoxic shock, PMX-HP was associated with organ function recovery, hemodynamic improvement and contemporary EA level reduction.

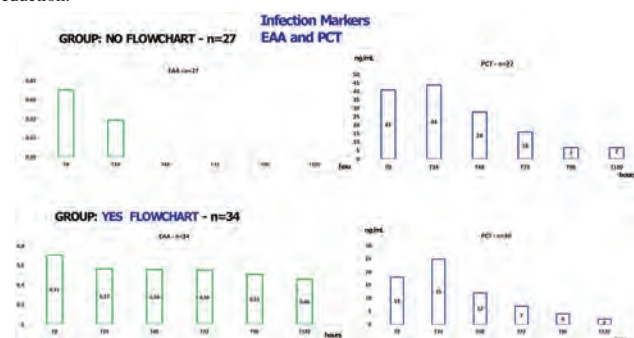

Trend of EAA and PCT in Pre-F and Post-F groups.

## TH-PO042

### Safety and Clinical Efficacy of Plasma-Saving Membrane-Based Therapeutic Plasma Exchange (mTPE) in the Critically Ill Patients Undergoing Continuous Renal Replacement Therapy

Jae Sung Ahn, *Asan Medical Center, Songpa-gu, Seoul, Republic of Korea.*

**Background:** The mTPE eliminating endotoxin, cytokine and abnormal antibody could be beneficial. To minimize adverse reaction caused by fresh frozen plasma (FFP) and bleeding risk, we used 5-20% albumin, crystalloid fluid and 8 units of FFP as replacement solution. We investigated bleeding event, the changes of platelet count, prothrombin time (PT), activated partial thromboplastin time (aPTT) and 28-Day mortality rate as primary outcome.

**Methods:** In this retrospective study, 118 mTPE sessions were performed in 60 patients (age 59.6±14.4 years, M:F=34:26) undergoing CRRT and receiving antibiotics and vasopressors for severe sepsis/shock (n=43), inflammatory disease (n=12) and others (n=5). Our subjects were divided into four groups according to the SOFA score: I (0-9, predicted mortality rate <10%), II (10-12, 10-30%), III (13-14, 40-60%), and IV (15-24, > 75%). mTPE was repeated with the interval of 24-48 hours up to 10 times, if needed.

**Results:** There was no significant difference in SOFA scores, mean arterial pressure, vasopressor index score and PT. The hemoglobin (8.8±2.0 vs. 8.4±2.0 g/dL, p=0.021) and platelet count (96K±101K vs. 80K±86K /mm<sup>3</sup>, p=0.001) were significantly decreased after 1st mTPE. aPTT was significantly increased from 62.7±38.6 to 74.5±41.2 seconds (p=0.037). The similar changes persisted after 2nd mTPE. However, there was no bleeding event within 24 hours from the end of mTPE sessions. The 28-Day mortality rates were 22.2%, 12.5%, 0% and 67.6% in the 4 groups, respectively. Analyzing survival according to the number of mTPE application, 14 patients survived among 29 who received only one time of mTPE and 4 among 20, two times of mTPE. Only 2 patients survived among 11 who received three time or more of mTPE.

**Conclusions:** Despite aPTT prolongation and decreased hemoglobin and platelet count, no bleeding events and lower-than-expected mortality suggest that mTPE could be safe and beneficial in these patients.

## TH-PO043

### Reduction of Intra-Operative Nephrotoxic Antimicrobial Exposure Can Improve Renal Recovery in Patients Undergoing Heart Transplantation

Syed M. Quadri, Ashley Golbus, Blaithin A. McMahon, *Medical University of South Carolina, Charleston, SC.*

**Background:** Acute Kidney Injury (AKI) is very common complication after orthotopic heart transplant (OHT) with reported incidence of approximately 40-70%. Antibiotics, particularly Piperacillin-tazobactam and vancomycin (VPT) combination has been associated with 3-fold increased hazard ratio for AKI. We hypothesized that reducing the exposure of intra-operative nephrotoxic antimicrobial medication exposure may result in lower rates of AKI after OHT.

**Methods:** Single-center, prospective, non-randomized, open-label observation study was performed at Medical University of South Carolina (MUSC) between 04/2015 to 04/2021. We introduced an intra-operative protocol change from VPT to cefepime and vancomycin (VC) use. 48 patients undergoing adult OHT received intra-operative VPT between 04/2015-05/2019, labelled as pre-intervention arm. 72 patients undergoing OHT between 05/2019-04/2021 received intra-operative VC, labelled as post-intervention arm. AKI was defined as per KDIGO 2012 criteria. Renal recovery was defined as 25% improvement in serum creatinine within 7 days of surgery without kidney replacement therapy (KRT) or KRT cessation in those requiring KRT. Major adverse kidney events (MAKE) were assessed at hospital discharge and 12-months. A p-value of less than 0.05 was considered significant.

**Results:** Rates of all stages of KDIGO AKI and rates of RRT remained the same after the intervention. The rates of renal recovery prior to hospital discharge improved 3.8-fold in the post-intervention group (79.3% vs 44.4%, P<0.05). All patients who required KRT in pre-intervention group did not recover at one-week post-OHT (0% vs 31.25%, P < 0.05). MAKE were less in post-intervention group at hospital discharge (p<0.05). 27% of blood cultures were positive in pre-interventional arm compared to 22% in post-interventional arm (p=0.66). There was no positive enterococcal blood culture in post-interventional arm.

**Conclusions:** Our results suggest that high doses of VPT combination lead to poor AKI recovery rates and significant MAKE at hospital discharge in OHT patients as compared to VC. Though this results in loss of enterococcal coverage, none of the patients grew enterococcal species in blood cultures. The mechanism by which the combination VPT contributes to poor renal recovery requires further research.

## TH-PO044

### Efficacy of Regional Citrate vs. Heparin Anticoagulation in Patients With AKI Requiring Continuous Renal Replacement Therapy: A Randomized Study

Anil Bhalla, Gaurav M. Bhandari, Vaibhav Tiwari, Vinant Bhargava, Anurag Gupta, Manish Malik, Ashwani Gupta, Devinder S. Rana, *Sir Ganga Ram Hospital, New Delhi, India.*

**Background:** For the functioning of any Renal replacement treatment (RRT) and adequate hemoperfusion, it needs anticoagulation to prevent the extracorporeal circuit from clotting. Although heparin is cheap and easy monitoring can be done, bleeding risks are high. Regional citrate anticoagulation (RCA) acts only in the extracorporeal circuit and thus appears safe.

**Methods:** A RCT was conducted in the Intensive Care Unit of this hospital. AKI patients requiring CRRT were randomized into 2 groups based on anticoagulation used. Group 1 - RCA as anticoagulation while group 2 was the heparin group. A total of 52 patients were taken, equally divided into two groups. Efficacy and safety parameters were analyzed in both groups. **Outcome measures:** Filter lifespan, effective delivered RRT dose, number of bleeding episodes, hypocalcemia, citrate toxicity (ratio of total calcium to ionized calcium), and metabolic complications.

**Results:** Demographic data were comparable amongst both the groups. Sepsis was the most common cause of hospital admission in both groups (38.5% vs 50%). Oliguria was the most common indication for CRRT (53.8% in the RCA group and 61.5% in the heparin group). Mean filter lifespan in the RCA group was 45.11 hours while in the heparin group was 26.11 hours and it was clinically significant (P <0.001). The mean effective delivered RRT dose was higher in the RCA group (26 ml/kg/hour) compared to

Key: TH - Thursday; FR - Friday; SA - Saturday; OR - Oral; PO - Poster; PUB - Publication Only

Underline represents presenting author.

the heparin group (24.23 ml/kg/hour) and was clinically significant ( $P < 0.001$ ). Bleeding was higher in the heparin group than RCA group (42.3% vs 11.5%) and it was clinically significant ( $P = 0.027$ ). 4 patients (15.4%) experienced hypocalcemia in the RCA group but were corrected with calcium and decreasing RCA dose. Zero cases of citrate toxicity were seen and only two patients (7.7%) were found to have metabolic alkalosis which was also corrected by reducing the RCA dose and stopping bicarbonate infusion if going on.

**Conclusions:** In critically ill patients with AKI on CRRT, regional citrate anticoagulation, when compared to systemic heparin, is safe and more effective than heparin. Heparin was associated with significant bleeding complications and increased heparin-induced thrombocytopenia episodes.

**TH-PO045**

**Urea Reduction in AKI and Mortality**

Jonathan Chavez,<sup>1,2</sup> Guillermo Navarro Blackaller,<sup>2</sup> Pablo Maggiani,<sup>1</sup> José David G. Barajas,<sup>1,2</sup> Miguel Ángel P. Venegas,<sup>1,2</sup> Ramon Medina,<sup>1,2</sup> María de la Luz Alcantar Vallin,<sup>1,2</sup> Alexa N. Oseguera Gonzalez,<sup>1,2</sup> César Murguía Soto,<sup>1,2</sup> Karina Renoirte,<sup>1,2</sup> Guillermo Garcia-Garcia.<sup>1</sup> <sup>1</sup>Universidad de Guadalajara, Guadalajara, Mexico; <sup>2</sup>Hospital Civil de Guadalajara, Guadalajara, Mexico.

**Background:** Urea is a toxin present in AKI. It is reasonable to think that its decrease could be associated with better clinical evolution. We explore the association between urea reduction and mortality in patients with AKI

**Methods:** In this prospective cohort in AKI patients. We create 4 groups of urea reduction (UrR) by their percentage decrease magnitude: 0, 1-25, 26-50 and >50. The objectives was to assess the association of UrR and mortality within 10 days of admission; find the characteristics of patients with UrR >50% and identify which KRT modality (hemodialysis, peritoneal dialysis and conservative) achieved this goal

**Results:** A total of 651 AKI patients were included. AKI stage 3 was present in 58.5%, sepsis in 45.9%, the mean urea value was 154 mg/dL, kidney replacement therapy (KRT) started in 32.4%, and 18.9% died. 50% did not reduce urea (UrR 0%). A trend to decrease risk of dead was observed with the magnitude of UrR. The best survival (94.3%) was observed in those with UrR >50%, and worst (72.1%) in those with UrR 0%. After adjusting for confounders, 10-day hospital mortality was higher in groups that did not achieve a UrR of at least 25% with an OR of 1.20. Subgroups of patients who achieved UrR >50% were those with uremic and obstructive nephropathy.

**Conclusions:** In our prospective cohort 50% with AKI did not reduce urea, and this was associated with an increased risk of death. Achieving UrR of at least 25% decreased the risk, and a greater magnitude of UrR with any treatment was associated with better survival.

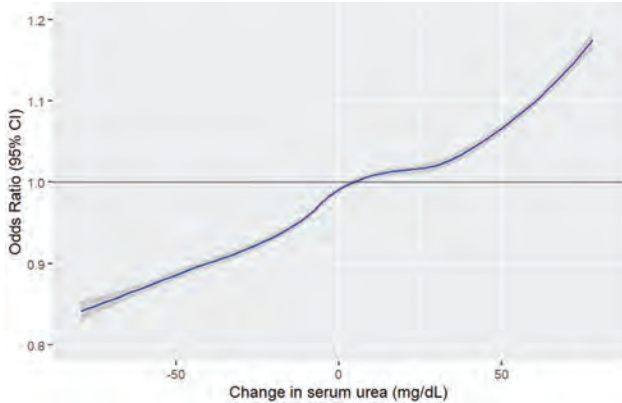

Urea reduction in AKI and mortality risk

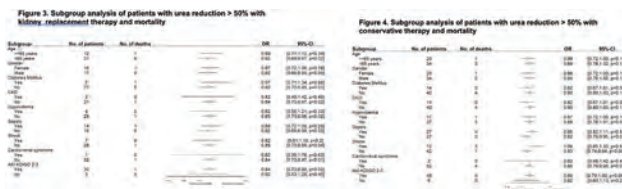

Subgroup analysis of patients with urea reduction >50% with kidney replacement therapy, conservative management and mortality

**TH-PO046**

**Serum Potassium Trajectory During AKI and Mortality**

Jonathan Chavez,<sup>1,2</sup> Guillermo Navarro Blackaller,<sup>2,1</sup> Pablo Maggiani,<sup>1</sup> Bladimir Diaz Villavicencio,<sup>1,2</sup> Ana E. Oliva,<sup>1,2</sup> Frida Margarita de la Vega Méndez,<sup>1,2</sup> Guillermo Garcia-Garcia,<sup>1</sup> Clementina Elizabeth Calderon Garcia,<sup>1,2</sup> Manuel L. Prieto Magallanes,<sup>1,2</sup> Alejandro Martínez Gallardo González,<sup>1,2</sup> Alexia Romero,<sup>1,2</sup> <sup>1</sup>Universidad de Guadalajara, Guadalajara, Mexico; <sup>2</sup>Hospital Civil de Guadalajara, Guadalajara, Mexico.

**Background:** The association between potassium (sK) trajectory and mortality or the need for kidney replacement therapy (KRT) during acute kidney injury (AKI) has not been explored

**Methods:** In this prospective cohort study, AKI patients were divided in 8 groups based on sK (mEq/L) trajectories, (1) normoK, sK between 3.5-5.5; (2) corrected hyperK, sK > 5.5 to normoK; (3) corrected hypoK, sK < 3.5 to normoK; (4) fluctuating potassium, sK increased / decreased in and out of normoK; (5) uncorrected hyperK, sK < 3.5; (6) normoK to hypoK, sK normal and decreased to hypoK; (7) normoK to hyperK, (8) uncorrected hyperK, sK > 5.5. We assessed the association of sK trajectories with mortality and the need for KRT

**Results:** In 311 AKI patients. AKI 3 was present in 63.9%. KRT started in 36%, and 21.2% died. After adjusting for confounders, 10-day hospital mortality was higher in group 7 and 8 (OR, 1.37 and 1.63  $p < 0.05$ , respectively), and KRT initiation was higher in group 8 (OR 1.40  $p < 0.05$ ) compared with group 1. Mortality in different subgroups of patients did not change the primary results

**Conclusions:** In our prospective cohort, most patients with AKI had dyskalemia. NormoK to hyperK and Uncorrected hyperK were associated with death, while only uncorrected hyperK was correlated with the need for KRT

Potassium trajectories	Model 1 <sup>a</sup>		Model 2 <sup>b</sup>	
	OR (95% CI)	P value	OR (95% CI)	P value
NormoK	1 (reference)	-	1 (reference)	-
Corrected hyperK	0.92(0.78-1.07)	0.30	0.97(0.83-1.13)	0.71
Corrected hypoK	0.94(0.77-1.14)	0.54	0.91(0.75-1.10)	0.36
Fluctuating K	0.99(0.89-1.09)	0.85	0.92(0.83-1.02)	0.15
Uncorrected hypoK	1.03(0.77-1.38)	0.79	1.03(0.77-1.36)	0.83
NormoK to hypoK	1.06(0.83-1.36)	0.62	1.01(0.79-1.28)	0.93
NormoK to hyperK	1.34(1.06-1.70)	0.01*	1.37(1.09-1.72)	0.006*
Uncorrected hyperK	1.71(1.42-2.06)	<0.001*	1.63(1.35-1.97)	<0.001*

<sup>a</sup> Model 1: unadjusted

<sup>b</sup> Model 2: adjusted for age, sex, gender, diabetes mellitus, hypertension, smoking, hypothyroidism, chronic kidney disease, cerebrovascular disease, ischemic cardiopathy, sepsis, hypovolemia, cardiorenal syndrome, nephrotoxic, shock, AKI Stage, and RRT

The association between sK+ trajectories and 10-days mortality

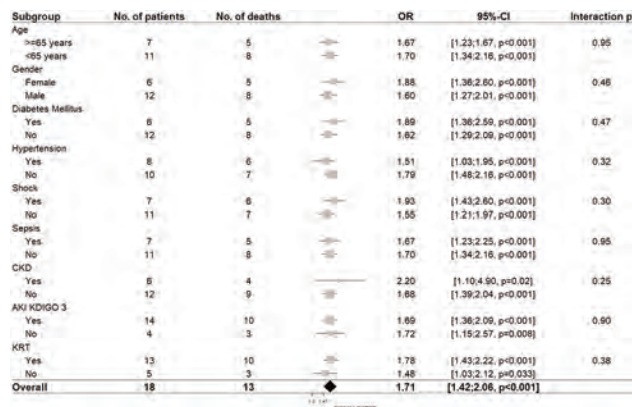

OR of unadjusted 10-days mortality in different subgroups of patients with uncorrected hyperK

**TH-PO047**

**Serum Sodium Trajectory During AKI and Mortality Risk**

Jonathan Chavez,<sup>1,2</sup> Guillermo Navarro Blackaller,<sup>1,2</sup> Edgar J. Carmona,<sup>1,2</sup> Manuel Arizaga Napoles,<sup>1,2</sup> Karla Hernandez Morales,<sup>1,2</sup> Guillermo Garcia-Garcia,<sup>1</sup> Alejandro Martínez Gallardo González,<sup>1,2</sup> Marcela Plascencia Cruz,<sup>1,2</sup> Fidel Ramos Avellaneda.<sup>2,1</sup> <sup>1</sup>Universidad de Guadalajara, Guadalajara, Mexico; <sup>2</sup>Hospital Civil de Guadalajara, Guadalajara, Mexico.

**Background:** The association between serum sodium (sNa) level and mortality or the need for kidney replacement therapy (KRT) during acute kidney injury has not been explored

**Methods:** In this prospective cohort, we enrolled AKI patients and divided them into 5 groups based on the sNa level trajectories up to 10 days, 1) stable Na (135-145), 2) fluctuating Na levels (increased/decreased in and out of normonatremia), 3) uncorrected hyponatremia, 4) corrected hyponatremia, and 5) uncorrected hypernatremia. We assessed the association of sNa trajectories with mortality and the need for KRT

**Results:** A total of 288 patients were included. AKI3 was present in 50.4%. KRT started in 25% patients, and 15.6% died. After adjusting for confounders, 10-day hospital mortality was higher in group 5 (HR 3.12, p = 0.03), and KRT initiation was higher in group 3 (HR, 2.44;p = 0.03) compared with group 1

**Conclusions:** In our cohort, most patients with AKI had alterations in sNa. Uncorrected hypernatremia was associated with death, and uncorrected hyponatremia was correlated with the need for KRT

HRs unadjusted for 10-day mortality in different patient subgroups with uncorrected hypernatremia and KRT initiation HRs unadjusted need for KRT initiation in different subgroups of patients with uncorrected hyponatremia

Trajectory of Sodium	Mortality [Total(events)]	Model 1 <sup>a</sup>		Model 2 <sup>b</sup>	
		HR (95% CI)	P-Value	HR (95% CI)	P-Value
Stable normonatremia	54 (8)	1 (reference)	-	1 (reference)	-
Fluctuating sodium	114 (15)	0.84 (0.35 to 1.99)	0.70	0.60 (0.24 to 1.51)	0.28
Uncorrected hyponatremia	58 (9)	1.05 (0.40 to 2.73)	0.91	0.52 (0.18 to 1.48)	0.22
Corrected hyponatremia	40 (5)	0.78 (0.25 to 2.38)	0.66	0.51 (0.15 to 1.64)	0.26
Uncorrected hypernatremia	22 (8)	2.88 (1.08 to 7.69)	0.03	3.12 (1.05 to 9.24)	0.03

HR, hazard ratio.

<sup>a</sup>Model 1: unadjusted

<sup>b</sup>Model 2: adjusted for age, sex, gender, diabetes mellitus, hypertension, smoking, hypothyroidism, chronic kidney disease, ischemic cardiopathy, sepsis, hypovolemia, cardiorenal syndrome, nephrotoxic, AKI Stage, kidney replacement therapy, and baseline sodium.

The association between sNa trajectories and 10-day mortality

**TH-PO048**

**Temporal and External Validation of the Prediction Model for Successful Discontinuation of Continuous Renal Replacement Therapy**

Minsuk Seo, Sehun Lee, Sung Bin Yoon, Junseok Jeon, Jung eun Lee, Wooesong Huh, Yoon-Goo Kim, Hye Ryoung Jang. *Samsung Medical Center, Sungkyunkwan University School of Medicine, Seoul, Republic of Korea.*

**Background:** Continuous renal replacement therapy (CRRT) is widely used as a preferred modality of renal replacement therapy (RRT) in critically ill patients with acute kidney injury (AKI). However, there is no consensus criterion for discontinuing CRRT. We evaluated the usefulness of the prediction model developed in our previous study through one temporal cohort and four external cohorts.

**Methods:** A total of 1517 critically ill patients with AKI who underwent CRRT from 2018 to 2020 in five medical centers were included in the validation. Patients who underwent CRRT for more than 2 days and survived for 7 or more days after CRRT discontinuation were selected. Successful discontinuation of CRRT was defined as not restarting RRT for 7 days after CRRT discontinuation. The prediction model was composed of four variables: urine output ( $\geq 300$  mL/day, score 4) on the day before discontinuation and blood urea nitrogen (BUN  $< 35$  mg/dL, score 2), serum potassium ( $< 4.1$  mmol/L, score 1), and mean arterial blood pressure (50-78 mmHg, score 1) on the discontinuation day.

**Results:** The prediction model showed area under the curve of the receiver-operating characteristic (AUC-ROC) curve 0.74 (95% CI 0.71-0.76) in pooled analysis of all cohorts. Overall differences between observed and predicted incidence rates were 3.0% (17.7% observed and 16.9% predicted probability), 3.6% (35.2% and 34.8%), and 2.0% (69.3% and 70.3%) in the low- (0-2 points), intermediate- (3-5 points), and high-score (6-8 points) groups, respectively. In an analysis of each cohort, four cohorts including one temporal cohort showed similar good discriminatory power (AUC-ROC 0.770, 0.731, 0.735, and 0.725, respectively), while one cohort showed poor discriminatory power (AUC-ROC 0.556).

**Conclusions:** Our prediction model for successful discontinuation of CRRT in critically ill patients showed good performance in one temporal and three external cohorts, with poor performance in one external cohort. Our results support the need of an appropriate protocol for the discontinuation of CRRT.

**TH-PO049**

**A Comparison Among Adult Patients Receiving Extracorporeal Membrane Oxygenation With and Without Continuous Renal Replacement Therapy at an Integrated Healthcare System**

Waleed Zafar, Evan Gajkowski, Kaushal V. Solanki, Alex R. Chang, Maria Bermudez. *Geisinger Health, Danville, PA.*

**Background:** Extracorporeal Membrane Oxygenation (ECMO) is being increasingly used among critically ill patients some of whom have multiple organ failure and need concurrent use of continuous renal replacement therapy (CRRT). Limited data are available regarding outcomes among such patients.

**Methods:** We report retrospective data on patients who were treated with ECMO with or without CRRT over a period of 36 months (Jan 2019 – Mar 2022) at hospitals within a single integrated healthcare system in Pennsylvania. Patients with end stage renal disease were not eligible to receive ECMO within this system.

**Results:** 166 patients were treated with ECMO of whom 50 (30.1%) received CRRT during the course of their treatment. Mean age of patients on ECMO was 52.1 years (interquartile range 43-64), 68.1% were male; and 23.5% had Covid-19. Reasons for ECMO included cardiac arrest (43%), post cardiac surgery (18%), acute respiratory distress syndrome (38%) and transcatheter aortic valve placement (2%). Patients received either Venousarterial (VA) ECMO (45.8% patients; mean age 60.0) and its variant extracorporeal cardiopulmonary resuscitation (eCPR) (9.6%; mean age 50.9) or Venovenous (VV) ECMO (44.6%; mean age 44.4). A comparison among patients who needed CRRT versus those who did not is provided in figure 1. 38% patients who received CRRT survived to discharge compared to 62.9% who did not receive CRRT (p=0.003)

**Conclusions:** Nearly 1 in 3 patients treated with ECMO needed CRRT at some point during their care. Patients who needed CRRT on ECMO were significantly less likely to survive to discharge. Nephrology service was involved in the care of ECMO patients from the beginning in some cases. However, there remains a need for early multi-disciplinary care for critically ill patients requiring ECMO therapy.

Table 1: Characteristics and outcomes among all patient on ECMO who were also on CRRT versus those who never received CRRT

	Received CRRT along with ECMO (50 patients)	Did not need CRRT while on ECMO (116 patients)
Male, n (%)	39 (78.0)	74 (63.8)
Age, years mean (minimum; maximum)	55.0 (20; 82)	50.9 (18; 82)
Age above 65 years, n (%)	16 (32.0)	24 (20.7)
Type of ECMO, n (%)		
VA	33 (66)	43 (37.1)
eCPR	6 (12)	10 (8.6)
VV	11 (22)	63 (54.3)
Covid-19 positive, n (%)	5 (10)	34 (29.3)
Time on ECMO, days; mean (95% confidence interval)	8.27 (6.57 – 9.97)	9.36 (7.47 – 11.25)
Survived ECMO, n (%)	30 (60.0)	80 (69.0)
Survived to discharge, n (%)	19 (38.0)	73 (62.9)
Alive at the time of data extraction	17 (34.0)	70 (60.3)

CRRT: Continuous renal replacement therapy; ECMO: Extra corporeal membrane oxygenation; VV: Venovenous; VA: Venousarterial; eCPR (extracorporeal cardiopulmonary resuscitation) a version of VA ECMO.

**TH-PO050**

**Point of Care Creatinine for Community-Acquired AKI in Africa: Study Design**

Dimitrios J. Poulikakos,<sup>1</sup> Ibi Erekosima,<sup>1</sup> Prelador E. Fakrogha,<sup>2</sup> David M. Lewis,<sup>1</sup> Agiriye Agba M. Harry,<sup>3</sup> Pedro C. Emem-Chioma,<sup>2</sup> <sup>1</sup>Northern Care Alliance NHS Foundation Trust, Salford, United Kingdom; <sup>2</sup>University of Port Harcourt, Choba, Nigeria; <sup>3</sup>Rivers State of Nigeria Government, Port Harcourt, Nigeria.

**Background:** Community acquired Acute kidney injury (AKI) is associated with adverse outcomes in low and middle-income countries due to delayed diagnosis and lack of universal health care coverage. Supported by the International Society of Nephrology, in a collaborative project between a UK renal centre and a renal centre and the primary care health board in Port Harcourt Nigeria, we evaluated point of care creatinine (POC Cr) technology using capillary samples (<https://doi.org/10.1016/j.ekir.2022.03.022>).



This phase of the project is designed to evaluate the use of POC Cr in conjunction with a minimum bundle of AKI care in a large primary care health centre in Nigeria that does not provide renal function tests.

**Methods:** Attendances data for March 2022 were obtained from the Ozuoba Comprehensive Health Centre in Nigeria. A 2 stage, modified delphi process, will be used to reach consensus amongst primary and secondary care clinicians on clinical algorithm and minimum AKI bundle. We plan to screen with POC Cr 500 patients at risk (Figure 1) with the aim to detect > 100 AKI cases.

**Results:** Out of 4148 recorded patient attendances, (20.3% medical, 18.8% obstetrics and 60.8% paediatrics), 464 (11.1%) were acute requiring short admission and 19 patients were referred to the hospital. The first stage of the consensus process concluded that the minimum AKI bundle will include renal function testing, urine dipstick, IV fluids and/or antibiotics for 48 hours if required. The second stage will be performed at a workshop in Port Harcourt in 2022.

**Conclusions:** This study will assess the cost-effectiveness and clinical impact on outcomes of POC Cr as a triage screening tool in acute presentations in this low-resource primary setting in conjunction with a minimum care bundle.

**Funding:** Commercial Support - NOVA biomedical

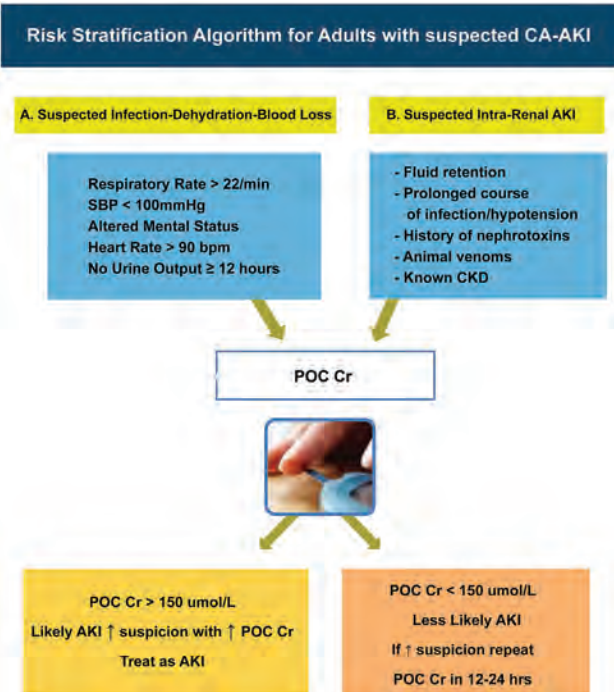

TH-PO051

Multidisciplinary Care Improves Follow-Up for AKI Survivors

Heather P. May, Diana J. Schreier, Joseph Herges, Kianoush Kashani, Andrea G. Kattah, Rozalina G. McCoy, Brenda K. Anderson, Laurie A. Meade, Angeliki G. Tinaglia, Kristin C. Mara, Andrew D. Rule, Erin F. Barreto. The ACT Study Group *Mayo Clinic Minnesota, Rochester, MN.*

**Background:** Innovative models are needed to address significant gaps in kidney care follow-up for AKI survivors.

**Methods:** The AKI in Care Transitions (ACT) pilot included adults with stage 3 AKI, discharged to home without dialysis. ACT included pre-discharge education and care coordination and post-discharge follow-up in primary care with a clinician and pharmacist within 14 days (Figure 1). ACT was implemented in phases (Usual Care, Education, ACT) for group comparisons. The primary outcome was feasibility, measured by the proportion of participants who received the phase-appropriate intervention components. Secondary outcomes at 14 and 30 days were compared across groups using the Fisher's exact or Kruskal-Wallis tests.

**Results:** 46 of 110 (42%) eligible adults were enrolled (Table 1). Education was completed in 18/18 and 14/15 participants in the Education and ACT groups, respectively. The cumulative incidence of provider and laboratory follow-up at 14 and 30 days was significantly different across groups [14 days: Usual care 0%, Education 11%, ACT 73% (p<0.01); 30 days: 0%, 22%, and 73% (p<0.01)].

**Conclusions:** Multidisciplinary post-AKI care improved timely laboratory and provider follow-up in the primary care setting. This was driven by compliance with best-practice recommendations for urine protein evaluation, a key indicator of prognosis and therapeutic needs.

**Funding:** NIDDK Support, Other NIH Support - National Institute of Allergy and Infectious Diseases (K23 AI143882, PI: E.F.B.), the Agency for Healthcare Research and Quality (HS028060-01, PI: E.F.B.), Private Foundation Support

Table 1. Select Participant Data, Outcomes

	Usual Care (N=13)	Education (N=18)	ACT (N=15)	P-Value
Characteristics				
Chronic kidney disease	6 (46)	11 (61)	6 (40)	—
Dialysis during hospitalization	0	4 (22)	2 (15)	—
Dismissal w/eFR (ml/min/1.73m <sup>2</sup> )	40 (16, 58)	29 (19, 54)	31 (16, 58)	—
Process, Clinical Outcomes				
30-day serum creatinine	11 (85)	14 (78)	14 (93)	0.52
30-day urine protein	2 (15)	5 (28)	13 (87)	<0.0001
Days to first urine protein	35 (28, 78)	20 (7, 52)	5.5 (2, 9)	0.001
30-day primary care follow-up	12 (92)	11 (61)	12 (80)	0.12
30-day nephrology follow-up	1 (8)	3 (17)	5 (33)	0.22
30-day readmission	3 (23)	8 (44)	2 (13)	0.13

N(%); median(IQR)

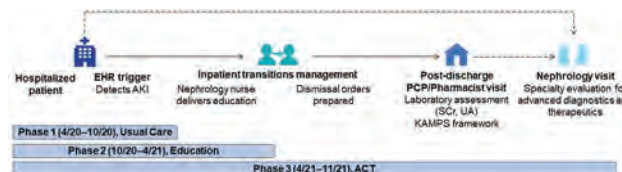

Figure 1. Study Design

TH-PO052

Improving Patient-Centered Care in Pediatric AKI

Anna E. Williams, Rasheed A. Gbadegesin, Clarissa J. Diamantidis. *Duke University School of Medicine, Durham, NC.*

**Background:** Acute kidney injury (AKI) is the sudden loss of kidney function and is a common complication of pediatric hospitalizations, affecting approximately 5-10% of all children admitted to the hospital. Despite a persistent risk of adverse outcomes following hospital discharge, providers infrequently provide education to patients or families on how best to manage AKI once they return home. We sought to identify providers' perceived challenges to pediatric AKI care in order to inform optimal patient-centered AKI care strategies.

**Methods:** Physician stakeholders experienced with pediatric AKI were recruited from a single academic center in Durham, North Carolina in June and July 2020 to participate in semi-structured interviews via phone. Interviews assessed perceived barriers and facilitators to post-AKI care for pediatric survivors. The interview guide was developed by the study team using adult learning theory and included open-ended questions. All interviews were recorded and transcribed prior to analysis by the study team for theme identification.

**Results:** Ten physician interviews—4 of outpatient pediatricians and 6 of pediatric nephrologists—were conducted in summer 2020. Providers relayed several themes related to post-AKI care: patient awareness of AKI diagnosis is low, family concerns (e.g. child's prognosis, underlying cause of AKI) often arise during AKI discussions, gaps exist in non-subspecialists AKI knowledge, pediatricians rely on subspecialists for co-management of AKI, and pediatric nephrologists readily offer AKI education. Of these themes, low AKI diagnosis awareness and provider knowledge gaps were considered barriers to optimal post-AKI care. Participants also expressed that these barriers were particularly evident when reflecting on AKI care in the neonatal intensive care unit (NICU).

**Conclusions:** Both pediatric nephrologists and general pediatricians identified patient lack of awareness of diagnosis as a barrier to optimal post-AKI care. Patient-centered educational tools promoting AKI awareness and self-management may improve long-term outcomes for pediatric AKI survivors.

**Funding:** Other NIH Support - NHLBI R38HL143612

TH-PO053

Four-Year Report on Renal Outcomes Following Elective Withdrawal of Long-Term RAAS Blockade in a Cohort of Patients With Otherwise Inexplicable New-Onset and Progressive AKI

Macaulay A. Onuigbo.<sup>1,2</sup> <sup>1</sup>University of Vermont College of Medicine, Burlington, VT; <sup>2</sup>University of Vermont Medical Center, Burlington, VT.

**Background:** RAAS blockade is renoprotective for both diabetic and non-diabetic CKD. There have been discordant reports on renal and cardiovascular outcomes following RAAS blockade discontinuation in advanced CKD. To the contrary, a few prospective cohort studies have demonstrated reversal of otherwise inexplicable AKI in patients after discontinuation of RAAS blockade. This is a 4-year report of such a cohort.

**Methods:** Prospective Cohort Analysis, enrolled between February 2018 – May 2021. Kidney function was monitored after elective withdrawal of long-term RAAS blockade in CKD patients presenting with new-onset otherwise inexplicable progressive AKI as defined by a >25% increase in baseline serum creatinine.

**Results:** By February 2022, 12 patients had died, and 8 patients were on hemodialysis for ESRD. The remaining 51 patients, with a baseline serum creatinine of 1.30 ± 0.42 (0.66 - 2.70) mg/dL, have been followed up for 706 (40-1478) days. Peak serum creatinine at study entry was 2.17 ± 1.06 (1.1 – 8.3) mg/dL, n=51, P<0.0001, t=6.4872, df=135. Serum creatinine, 48 months later, was 1.58 ± 0.54 (0.84 – 3.3) mg/dL, n=50, p<0.0001, t=5.1805, df=119. Death in 7 of 8 (87.5%) patients were from non-renal causes; most deaths occurred despite improved kidney function.

**Conclusions:** Our results support the elective withdrawal of long-term RAAS blockade in CKD patients with new-onset progressive yet otherwise inexplicable AKI. Significant sustainable renal salvage is common - Such self-selected patients generally exhibit clearly improved renal outcomes without increased mortality. (Figure). This is testament to the syndrome of late onset renal failure from angiotensin blockade (LORFAB) which we first described in 2005 from the Mayo Clinic Health System in Northwestern Wisconsin.

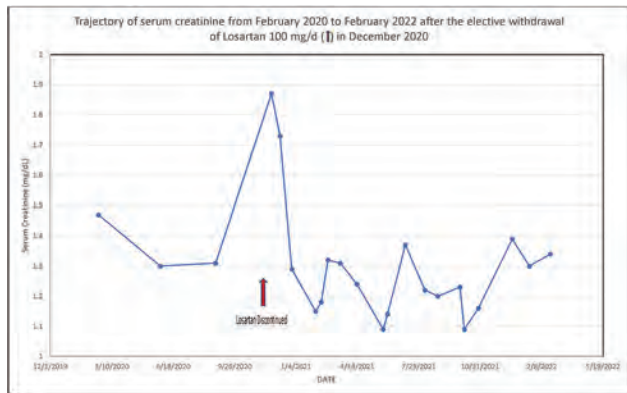

Serum creatinine trajectory from February 2020 - February 2022 after the elective withdrawal of Losartan 100 mg/d in December 2020

TH-PO054

**Patterns of Healthcare Resource Utilization and Goals of Care Discussions in Patients With Cirrhosis and AKI**

Romela Petrosyan,<sup>1</sup> Paul Endres,<sup>1,2</sup> Nneka Ufere,<sup>3</sup> Shelsea A. St. Hillien,<sup>1</sup> Scott Krinsky,<sup>1</sup> Sahir Kalim,<sup>1</sup> Sagar U. Nigwekar,<sup>1</sup> Andrew S. Allegretti,<sup>1</sup> <sup>1</sup>Massachusetts General Hospital Division of Nephrology, Boston, MA; <sup>2</sup>Thomas Jefferson University Sidney Kimmel Medical College, Philadelphia, PA; <sup>3</sup>Massachusetts General Hospital, Liver Center and Gastrointestinal Division, Boston, MA.

**Background:** Patients with cirrhosis and acute kidney injury (AKI) are critically ill and have high health care resource utilization (HCRU) during hospitalizations. The timing and impact of goals of care discussions on code status changes and rates of HCRU are not well described.

**Methods:** Medical records of 221 patients who previously enrolled in a prospective cohort study of patients hospitalized with AKI and cirrhosis at the Massachusetts General Hospital were reviewed. Documentation and timing of goals of care discussions were analyzed as predictors of high HCRU, defined as a composite outcome of either intubation, initiation of renal replacement therapy, or admission to the ICU.

**Results:** Median MELD score was 26 [IQR 19, 33]. 63/221 (29%) patients were listed for liver transplant and 41/221 (18.5%) patients later received liver transplant. 90-day mortality was 61%. 51% patients had at least one high HCRU episode. For all patients, code status on admission was 91% full code, 7% do not resuscitate, 0% comfort measures. By discharge, this changed to 68% full code, 14% do not resuscitate, 18% comfort measures (p <0.001). 28% patients underwent goals of care discussions, with change in code status at a median of 16 [9,22] days into their admission. However, only 18% of these discussions were prior to a high HCRU episode. Being listed for liver transplant was not associated with whether goals of care discussions occurred (23% listed vs. 31% non-listed, p = 0.24) but was associated with higher HCRU (69% vs. 43%; p <0.001).

**Conclusions:** Goals of care discussions occurred late into the hospital course, generally after an episode of high HCRU. Efforts to engage in these discussions earlier in a hospital stay, may decrease HCRU in this critically ill population and provide more goal-concordant care.

TH-PO055

**Urinary Sediment Microscopy as a Diagnostic Tool in Patients With End-Stage Liver Disease With AKI**

Vipin Varghese,<sup>1,2</sup> Mohammad T. Sultan,<sup>1</sup> Dustin Chalmers,<sup>3</sup> Paula A. Cacioppo,<sup>1</sup> Durin Y. Uddin,<sup>1</sup> Juan Carlos Q. Velez,<sup>3,2</sup> Ochsner Nephrology <sup>1</sup>Department of Internal Medicine, Ochsner Clinic Foundation, New Orleans, LA; <sup>2</sup>The University of Queensland Ochsner Clinical School, New Orleans, LA; <sup>3</sup>Department of Nephrology, Ochsner Clinic Foundation, New Orleans, LA.

**Background:** Microscopic examination of the urinary sediment (MicrExUrSed) is a useful diagnostic tool in acute kidney injury (AKI). MicrExUrSed findings in patients with end-stage liver disease (ESLD) with AKI have not been well characterized. Hepatorenal syndrome type 1 (HRS-1), a type of AKI in ESLD, is difficult to diagnose despite the International Club of Ascites (ICA) criteria. Thus, we hypothesized that MicrExUrSed findings in ESLD differ from those in the absence of ESLD, and that they may aid in diagnosis of AKI, specifically to distinguish HRS-1 from acute tubular injury (ATI).

**Methods:** MicrExUrSed was performed in patients with AKI stage ≥ 2 with or without ESLD over a 3-year period. Data were collected prospectively. The percentage of low power fields (LPF) containing hyaline casts (HC), waxy casts (WxC), renal tubular epithelial cell casts (RTECC), granular casts (GC), and muddy brown granular casts (MBGC) was assessed. HRS-1 was defined by the ICA criteria and urine Na (uNa) <20 mEq/L. The presence of GC was used to determine the diagnosis of ATI.

**Results:** Distribution of casts by percentage of LPF containing casts differed between the ESLD (n=185) and non-ESLD (n=421) groups. HC, RTECC, and GC were identified more often in ESLD compared to non-ESLD [42 vs 7% (p<0.0001); 30 vs 9% (p<0.0001) and 54 vs 26% (p<0.0001) for HC, RTECC and GC, respectively]. No difference in frequency of WxC (22 vs 19%, p=0.39) or MBGC (21 vs 24%, p=0.42) was found. In the ESLD group, total bilirubin level was significantly higher for those with RTECC [24.9 vs. 9.4 mg/dL (p<0.0001)] suggesting potential pathogenesis of bile cast tubulopathy. A diagnosis of HRS-1 (based on ICA + uNa) was assigned to 51/185 (27%) of patients with ESLD and AKI. Among them, 27/51 (53%) were converted to ATI based on the presence of GC.

**Conclusions:** MicrExUrSed can aid in the diagnosis of AKI in ESLD by identifying those with evidence of ATI, i.e., not consistent with HRS-1. Additionally, the spectrum of MicrExUrSed findings in patients with ESLD differs from that of patients without ESLD. Higher frequency of HC in ESLD may reflect more frequent tubular stasis consistent with their disease state. More studies are needed to examine the clinical implications of RTECC seen in those with higher total bilirubin.

TH-PO056

**Bile Cast Nephropathy-Retrospective Cohort of Hyperbilirubinemia Associated Nephropathy**

Nabil Abu Amer, Orit Erman, Lesya Kukuy, Margarita Kunin, Sharon Mini-Goldberger, Pazit Beckerman. *Chaim Sheba Medical Center, Rmat Gan, Israel.*

**Background:** Bile cast nephropathy (BCN) represents kidney dysfunction in the setting of severe hyperbilirubinemia. The proposed pathogenesis includes direct bile toxicity and obstructive tubular cast formation. BCN remains controversial despite typical findings on kidney pathology. The aim of this study is clinical characterization and risk factor identification of hyperbilirubinemia associated nephropathy.

**Methods:** A retrospective cohort study of patients admitted to surgery departments between January 2007 and January 2020 with total bilirubin above 10 mg/dL. Hyperbilirubinemia associated acute kidney injury (AKI) were identified, after carefully excluding all other etiologies of AKI. Data collected included demographic parameters, medical background, etiology of hyperbilirubinemia, lab tests, vital signs and nephrotoxic agents given during the hospitalization period.

**Results:** A total of 1,181 patients with serum bilirubin above 10 mg/dl were enrolled. 672 patients with other known kidney insults were excluded. The remaining 509 patients had a mean maximal bilirubin of 14.7 mg/d (SD±5.8). Of which, eighty-eight patients (17%) developed AKI, defined as bile cast nephropathy. They were mostly female (78%) and had a lower baseline estimated glomerular filtration rate compared to patients with hyperbilirubinemia who did not develop AKI (66 mL/min per 1.73 m<sup>2</sup> (IQR 60.8-99.7) and 81 mL/min per 1.73 m<sup>2</sup> (IQR 48.7- 80.4), respectively). Most of the patients (63%) had AKI stage 1 and there was no linear correlation between bilirubin level and AKI event. Renal recovery occurred after a decrease in serum bilirubin to a nadir of 4.19 mg/dl (IQR 1.4-6.8).

**Conclusions:** The diagnosis of bile cast nephropathy should be considered in patients with hyperbilirubinemia who develop AKI. In most cases AKI is mild and resolves following a decrease in bilirubin levels. This finding suggests that reduction in bilirubin levels may be beneficial among patients who develop AKI, even when no definitive treatment of hyperbilirubinemia is available.

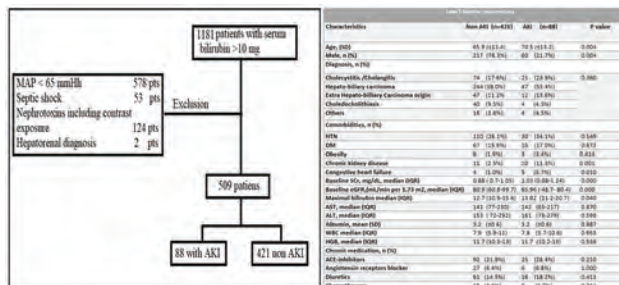

TH-PO057

**Pre-Hospitalization Characteristics Confound AKI Associations With Cardiovascular Outcomes: Findings From the CRIC Study**

Ian McCoy,<sup>1</sup> Jesse Y. Hsu,<sup>10</sup> Xiaoming Zhang,<sup>10</sup> Clarissa J. Diamantidis,<sup>5</sup> Jonathan J. Taliercio,<sup>6</sup> Alan S. Go,<sup>7</sup> Kathleen D. Liu,<sup>1</sup> Paul E. Drawz,<sup>11</sup> Anand Srivastava,<sup>4</sup> Edward J. Horwitz,<sup>8</sup> Jiang He,<sup>9</sup> Jing Chen,<sup>9</sup> James P. Lash,<sup>2</sup> Matthew R. Weir,<sup>3</sup> Chi-yuan Hsu.<sup>1,7</sup> <sup>1</sup>University of California San Francisco, San Francisco, CA; <sup>2</sup>University of Illinois Chicago College of Medicine, Chicago, IL; <sup>3</sup>University of Maryland School of Medicine, Baltimore, MD; <sup>4</sup>Northwestern University Feinberg School of Medicine, Chicago, IL; <sup>5</sup>Duke University School of Medicine, Durham, NC; <sup>6</sup>Cleveland Clinic, Cleveland, OH; <sup>7</sup>Kaiser Permanente, Oakland, CA; <sup>8</sup>Case Western Reserve University, Cleveland, OH; <sup>9</sup>Tulane University, New Orleans, LA; <sup>10</sup>University of Pennsylvania, Philadelphia, PA; <sup>11</sup>Regents of the University of Minnesota, Minneapolis, MN.

**Background:** AKI during hospitalization has been associated with increased risks of cardiovascular events, but these associations may be confounded by differences in pre-hospitalization characteristics, including the pre-hospitalization rate of kidney function decline and pre-hospitalization proteinuria level.

**Methods:** Among 1,630 participants hospitalized in 2013-2019 in the Chronic Renal Insufficiency Cohort (CRIC) study who survived until the next post-hospitalization study visit, we examined associations between AKI and subsequent cardiovascular outcomes: time to first heart failure hospitalization and time to first atherosclerotic event (ASCVD: encompassing myocardial infarction, ischemic stroke, or peripheral arterial disease). AKI-outcome associations (adjusted for demographics, BMI, diabetes mellitus, coronary artery disease, heart failure, smoking status, dyslipidemia, family history of coronary disease) were assessed using cause-specific hazard models before and after adjusting for pre-hospitalization variables (eGFR, eGFR slope, proteinuria, blood pressure, and antihypertensive use).

**Results:** As compared to patients who did not experience AKI (n=1317), patients who experienced AKI during their hospitalizations (n=313) had not only worse kidney function pre-hospitalization (eGFR 44 vs 50 ml/min/1.73m<sup>2</sup>) but also faster chronic loss of kidney function pre-hospitalization (eGFR slope -0.68 vs -0.43 ml/min/1.73m<sup>2</sup>/yr), and more proteinuria pre-hospitalization (UPCR 0.24 vs 0.15 g/g); they also had higher pre-hospitalization systolic blood pressure (130 vs 127 mmHg) despite more antihypertensive medications (p<0.001 for all comparisons). AKI associations with heart failure and ASCVD were attenuated and lost significance after adjustment for pre-AKI variables.

**Conclusions:** Pre-hospitalization variables including eGFR slope and proteinuria confound associations between AKI and cardiovascular outcomes.

**Funding:** NIDDK Support

Adjusted hazard ratios (95% confidence intervals) of AKI for cardiovascular outcomes

Model	Heart Failure (HF)	ASCVD (MI, Stroke, PAD)
AKI (adjusted as per methods section)	1.51 (1.13-2.03)	1.44 (1.03-2.02)
AKI (additionally adjusted for pre-hospitalization variables)	1.30 (0.97-1.75)	1.27 (0.90-1.80)

MI: myocardial infarction; PAD: peripheral arterial disease

TH-PO058

**Actionable Forecasting of Kidney Function and Serum Potassium in Hospitalized Adults**

Carl P. Walther, Jamie Philp, Sankar D. Navaneethan. *Baylor College of Medicine, Houston, TX.*

**Background:** Derangements in kidney function and electrolytes are common in hospitalizations. Preemptive risk identification for these derangements could enable intervention. We developed forecasting models to inform risk identification using deep learning.

**Methods:** We obtained data for all adults hospitalized at an academic hospital 1/1/20-1/20/22. We divided hospitalizations into training (70%), validation (15%), and test (15%) sets. From each hospitalization, multiple input/target pairs were created, from which all prior information was used to predict each subsequent day's creatinine and potassium. For initial modeling, 12 laboratory tests were used. Long short term memory (LSTM) layers were used, and multiple architectures and hyperparameters were assessed with training/validation data. The best performing model was evaluated using test data. Results were compared to naïve baseline predictions (last value carry forward and linear regression).

**Results:** A total of 219,087 input/target pairs were available. The final model used 4 LSTM layers (64 nodes each), followed by 4 densely connected layers (32 nodes each), a linear layer, and dropout regularization. On test data, the mean absolute error for creatinine was 0.24 mg/dl and for potassium was 0.29 mEq/L. Both outperformed naïve baseline predictions. Interrogation of modeling results in individual hospitalizations from the test set revealed possible patterns that the model learned in forecasting values.

**Conclusions:** A deep learning model outperformed baseline predictions in forecasting creatinine and potassium levels in hospitalized adults. Next steps will incorporate additional predictive variables and translate the predicted levels to risk estimates for clinically actionable derangements.

**Funding:** NIDDK Support

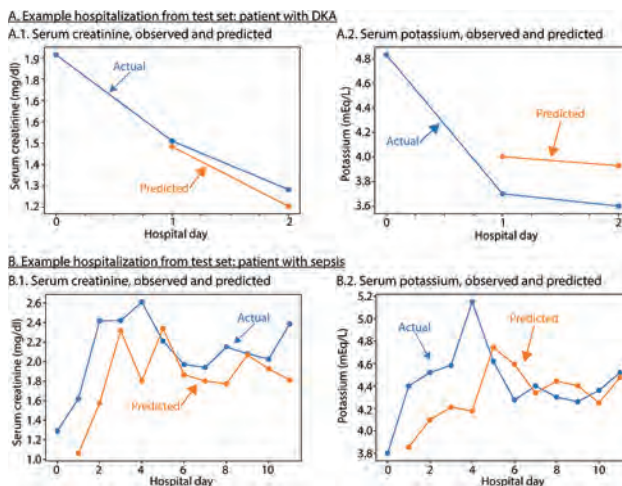

Forecasting models to applied to two examples from test set. Predicted values for each day (starting the day after admission) were calculated using all available lab values from all prior days.

TH-PO059

**Association of Mild-to-Moderate AKI With Decline in eGFRcys vs. eGFRcr Among Individuals With CKD: The CRIC Study**

Anthony N. Muir,<sup>1</sup> Jesse Y. Hsu,<sup>2</sup> Xiaoming Zhang,<sup>2</sup> Jonathan J. Taliercio,<sup>3</sup> James H. Sondheimer,<sup>4</sup> Ana C. Ricardo,<sup>5</sup> Ian McCoy,<sup>1</sup> Kathleen D. Liu,<sup>1</sup> James P. Lash,<sup>5</sup> Edward J. Horwitz,<sup>6</sup> Jiang He,<sup>7</sup> Alan S. Go,<sup>8</sup> Barry I. Freedman,<sup>9</sup> Paul E. Drawz,<sup>10</sup> Jing Chen,<sup>7</sup> Lawrence J. Appel,<sup>11</sup> Chi-yuan Hsu.<sup>1</sup> <sup>1</sup>University of California San Francisco, San Francisco, CA; <sup>2</sup>University of Pennsylvania, Philadelphia, PA; <sup>3</sup>Cleveland Clinic, Cleveland, OH; <sup>4</sup>Wayne State University, Detroit, MI; <sup>5</sup>University of Illinois Chicago, Chicago, IL; <sup>6</sup>Case Western Reserve University, Cleveland, OH; <sup>7</sup>Tulane University, New Orleans, LA; <sup>8</sup>Kaiser Permanente, Oakland, CA; <sup>9</sup>Wake Forest University School of Medicine, Winston-Salem, NC; <sup>10</sup>Regents of the University of Minnesota, Minneapolis, MN; <sup>11</sup>Johns Hopkins University, Baltimore, MD.

**Background:** We reported that after accounting for key potential confounders such as pre-AKI proteinuria and pre-AKI eGFR slope, mild-moderate AKI was not independently associated with an absolute decline in eGFR creatinine (eGFRcr) after AKI. However, analyses based on eGFRcys may underestimate CKD progression due to loss of muscle mass and reduced creatinine generation after hospitalized AKI. Therefore, we examined the decline in cystatin C based eGFR (eGFRcys) after hospitalized AKI.

**Methods:** In the prospective Chronic Renal Insufficiency Cohort (CRIC), we used multivariable mixed effects models to quantify the independent association between an episode of hospitalized mild-to-moderate AKI with change in absolute eGFR value and change in eGFR slope before vs. after an episode of hospitalized AKI, using eGFRcys (CKD-EPI 2012) and eGFRcr (CKD-EPI 2021).

**Results:** We included a total of 3,150 participants with mean age of 65 years. Mean baseline eGFRcys and eGFRcr were 51 mL/min/1.73m<sup>2</sup> and 52 mL/min/1.73m<sup>2</sup>, respectively. We observed 612 episodes of AKI among 433 CRIC study participants during a median follow-up of 3.9 years. As shown in the table an episode of AKI at 1.9 years was significantly associated with eGFRcys absolute drop (-2.2 mL/min/1.73 m<sup>2</sup>, p=0.02), but not eGFRcr (-0.8 mL/min/1.73 m<sup>2</sup>, p=0.09). There was no detectable change in eGFRcys nor eGFRcr slopes from before to after AKI (see table).

**Conclusions:** Mild-moderate AKI was associated with a modest drop in absolute eGFR after AKI, but only when using cystatin C as the filtration marker. Our findings suggest that cystatin C should be considered as part of routine post-AKI follow-up to evaluate risk for CKD progression after an episode of AKI.

**Funding:** NIDDK Support

	Change in eGFR value after each AKI (95% CI)	p-value	Difference in eGFR slopes, before and after each AKI episode (per year) (95% CI)	p-value
eGFRcys	-2.2 (-3.9, -0.4)	0.02	0.2 (-0.8, 1.1)	0.74
eGFRcr	-0.8 (-1.7, 0.1)	0.09	0.2 (-0.2, 0.7)	0.35

Linear mixed effect models adjusted for clinical center and demographic characteristics (age, sex, and race), time-updated diabetes mellitus, heart failure, systolic blood pressure, receipt of ACEi and ARBs, and proteinuria

## TH-PO060

**Comparison of Diagnostic Criteria for AKI in Critically Ill Children: A Multicenter Cohort Study**

Yuxian Kuai, Hui Huang, Yanhong Li. *Children's Hospital of Soochow University, Suzhou, China.*

**Background:** Substantial interstudy heterogeneity exists in defining acute kidney injury (AKI) and baseline serum creatinine (SCr). This study assessed AKI incidence and its association with pediatric intensive care unit (PICU) mortality under different AKI and baseline SCr definitions to determine the preferable approach for diagnosing pediatric AKI.

**Methods:** This multicenter prospective cohort study was conducted in the PICUs of four tertiary hospitals in China. AKI was defined and staged according to the definitions of the KDIGO, modified KDIGO (SCr increase should reach a concentration of at least 0.5 mg/dL when the KDIGO criterion with SCr is applied to define AKI), and the pROCK (pediatric reference change value optimized for AKI: SCr rise  $\geq 0.2$  mg/dL and  $\geq 1.3$  times the baseline SCr within 7 days). The baseline SCr was calculated based on the Schwartz formula or estimated as the upper normative value (NormsMax), admission SCr (AdmSCr) and modified AdmSCr. The impacts of different AKI definitions and baseline SCr estimation methods on AKI incidence, severity distribution and AKI outcome were evaluated.

**Results:** Different AKI definitions and baseline SCr estimates led to differences in AKI incidence, from 6.8% to 25.7%; patients with AKI across all definitions had higher PICU mortality ranged from 19.0% to 35.4%. A higher AKI incidence (25.7%) but lower mortality (19.0%) was observed based on the Schwartz according to the KDIGO, which however was overcome by modified KDIGO (AKI incidence: 16.3%, PICU mortality: 26.1%). For the modified KDIGO, the consistencies of AKI stages between different baseline SCr estimation methods were all strong with the concordance rates  $>90.0\%$  and weighted kappa values  $>0.8$ , and PICU mortality increased pursuant to staging based on the Schwartz. For the pROCK, PICU mortality did not increase pursuant to staging and AKI stage 3 was not associated with mortality after adjustment for confounders.

**Conclusions:** The AKI incidence and staging vary depending on the definition and baseline SCr estimation method used. The KDIGO definition is sensitive, identifying a great number of mild AKI. The modified KDIGO based on the Schwartz method is more strongly associated with related mortality and may be the preferable approach for the diagnosis of pediatric AKI, which shows promise for improving clinicians' ability to diagnose AKI in children.

## TH-PO061

**Relationship Between the Rate of Fluid Resuscitation and AKI**

Swetha Reddy, Kianoush Kashani. *Mayo Foundation for Medical Education and Research, Rochester, MN.*

**Background:** Septic shock is the leading cause of acute kidney injury (AKI) in critically ill patients. While fluid resuscitation has become the cornerstone of early septic shock management, the association between fluid resuscitation rates and kidney outcomes remains unclear. This investigation examines the relationship between fluid resuscitation rate and AKI resolution.

**Methods:** We retrospectively studied adult ( $\geq 18$  years) patients with AKI and septic shock, defined based on sepsis III definition, from January 1, 2006, through May 31, 2018, in the medical intensive care unit (MICU) of Mayo Clinic Rochester. The fluid resuscitation time was defined as the time required to infuse the initial fluid bolus of 30 ml/kg, based on the recommendations of the surviving sepsis campaign. The cohort was divided into three groups based on the average fluid resuscitation time ( $<1$ hr, 1.1-2hr,  $>3$ hr) and the corresponding fluid rate  $\geq 0.5$ , 0.25-0.49, and  $<0.17$  ml/kg/min, respectively. The primary outcome was the recovery of AKI on day 7.

**Results:** 597 patients met eligibility criteria and were included in the analysis. The AKI recovery was significantly different among the groups ( $P=0.006$ ). Patients in groups 1 and 2 who received fluid resuscitation faster had a higher rate of AKI recovery (53% and 50%) when compared with group 3 (37.8%).

**Conclusions:** In septic shock patients with AKI, an initial fluid resuscitation rate of 0.25-0.50 ml/kg/min (i.e., completion of the initial 30 ml/kg IV fluid resuscitation within the first two hours) is associated with higher AKI recovery compared with slower infusion rates.

Figure: AKI recovery with different initial fluid resuscitation rates

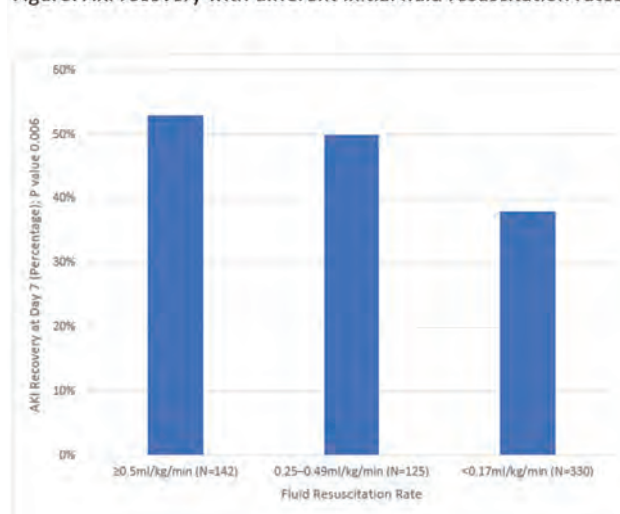

## TH-PO062

**Systolic Blood Pressure and Mortality Among Veterans Following AKI**

Benjamin R. Griffin, Masaaki Yamada, Meenakshi Sambharia, Melissa L. Swee, Heather Reisinger, Diana I. Jalal. *The University of Iowa Hospitals and Clinics, Iowa City, IA; \*Veterans Health Administration Center for Access & Delivery Research and Evaluation, Iowa City, IA.*

**Background:** Acute kidney injury (AKI) complicates 20-25% of hospitalizations and is associated with increased long-term mortality. Recommended target blood pressures (BP) have been reduced in the last 5 years, but whether lower targets should be applied in the post-AKI population is unknown. We evaluated the impact of different systolic BP (SBP) categories on mortality among post-AKI Veterans.

**Methods:** In this retrospective cohort analysis, we included all adult VA patients admitted from 2013 to 2018 with in-hospital AKI who were discharged alive and had at least 1 blood pressure within 30 days of discharge. SBP was assessed for up to 2 years after discharge and categorized as 100-120, 120-130, and  $>130$  mmHg (SBP  $<100$  mmHg were excluded). The primary outcome was 2-year mortality. We used Cox Proportional Hazards regression to adjust for baseline age, race, sex, chronic lung disease, unexplained weight loss, dementia, congestive heart failure (CHF), hematocrit, blood urea nitrogen, bilirubin, and albumin, while allowing SBP to vary over the follow-up period. Because angiotensin-converting enzyme inhibitors (ACEI) and angiotensin receptor blockers (ARB) are associated with decreased mortality, we stratified the analysis based on whether the patient was on an ACEI/ARB within 90 days of discharge.

**Results:** A total of 97,376 patients met inclusion criteria, of which 25,600 (26%) died within 2 years of discharge. The cohort had high rates of hypertension (85%), CHF (28%), and diabetes mellitus (19%). Within 30 days of discharge, 32%, 25%, and 43% had SBP  $<120$ , 120-130, or  $>130$ , respectively. Compared to follow-up months with SBP  $>130$  mmHg, SBP 120-130 and  $<120$  mmHg had adjusted hazard ratios (HR) for mortality of 0.870 (95% CI 0.865-0.876) and 0.968 (95% CI 0.964-0.971), respectively. Within 90 days, 41,147 (42%) were treated with ACEI/ARB, and these patients had 20.6% 2-year mortality compared to 30.5% in those not treated with ACEI/ARB (unadjusted OR 0.59 (95% CI 0.57-0.61)). When stratified for ACEI/ARB use, HRs for SBP 100-120 and 120-130, relative to SBP  $>130$  were similar to the full cohort.

**Conclusions:** In a post-AKI cohort, SBP of 120-130 mmHg was associated with a lower HR for 2-year mortality than 100-120 mmHg, and both were superior to  $>130$  mmHg. This association was independent of the use of ACEI/ARB.

## TH-PO063

**Mortality and AKI Severity in Cirrhosis: Model for End-Stage Liver Disease Score and Bilirubin Predictive, HRS-1 as AKI Etiology Not Predictive**

Mohammad T. Sultan, Vipin Varghese, Dustin Chalmers, Paula A. Cacioppo, Juan Carlos Q. Velez. *Ochsner Nephrology Ochsner Medical Center, New Orleans, LA.*

**Background:** End-stage liver disease (ESLD) carries high morbidity and mortality, particularly among those who develop acute kidney injury (AKI). There is conflicting data regarding factors associated with poor outcomes, including studies examining etiology of AKI [hepatorenal syndrome type 1 (HRS-1) vs acute tubular injury (ATI)] as factor. Moreover, prognostic value of findings from microscopic examination of urinary sediment (MicroExUrSed) in patients with ESLD with AKI has not been examined. We hypothesized that illness severity factors (rather than type of injury) are associated with worse outcomes in this patient population.

**Methods:** We established prospective data collection in patients with ESLD with AKI stage  $\geq 2$  (AKIN) over 3-years. Demographic and clinical data including Model for End-stage Liver Disease (MELD) score were collected. Each patient completed

MicroExUrSed. Presence of hyaline casts (HC), waxy casts (WxC), renal tubular epithelial cell casts (RTECC), granular casts (GC), and muddy brown granular casts (MBGC) were recorded. All parameters were assessed for the relative risk (RR) of reaching a composite endpoint (CP) of death/hospice at discharge or need for renal replacement therapy (RRT). Analysis was repeated for RRT alone as secondary endpoint.

**Results:** We included 185 patients [37% women, 75% white, 16% black, median age 57 (25-87)]. Higher MELD score was associated with greater RR of reaching the CP, RR 1.24 (1.04-1.50), p=0.01. Total bilirubin level was also associated with greater RR of reaching the CP, RR 1.23 (1.01-1.50), p=0.03. Neither age, sex nor race were predictive. HRS-1 was not associated with higher mortality compared to ATI (1.09, p=0.36). Neither HC, WxC, RTECC, GC nor MBGC were independently associated with higher risk for the CP. Regarding RRT as sole endpoint, only total bilirubin level trended towards an increased risk, RR 1.37 (0.98-1.91), p=0.06.

**Conclusions:** Higher MELD score and total bilirubin levels were associated with greater risk for poor clinical outcomes in patients with ESKD with AKI, whereas HRS-1 as the etiology of AKI did not confer greater risk of mortality or need for RRT compared to ATI. Altogether, these data suggest that in ESKD, severity of illness is the main driver for ominous outcomes rather than the type of AKI.

**TH-PO064**

**Persistent AKI Risk Index to Predict Risk of Persistent AKI in Critically Ill Adult Patients: A Validation Cohort Study**

Blessa Marie H. Pelayo, Maria Kristina Alolod. *St. Luke's Medical Center - Quezon City, Quezon City, Philippines.*

**Background:** The persistent AKI risk index(PARI) scoring tool is designed as a simple calculator using changes in serum creatinine and only three clinical risk factors such as hyperbilirubinemia, sepsis, ventilation or use of inotropic support. It is an effective bedside tool to exclude low risk patients and detect high risk patients to develop persistent AKI. This risk assessment tool can provide real-time clinical decision to prevent persistent AKI and help clinicians decide on aggressive management such as kidney replacement therapy. The PARI has not been externally validated to detect the potential population of patients at high risk for persistent AKI.

**Methods:** A total of 2560 critically ill adult patients age ≥19 years were screened for the study from 2015 to 2019 at the critical care units of St. Luke's Medical Center – Quezon City. The mean age of participants were 63.8 years and 59.3% of which were male. Primary outcome is to predict risk of developing persistent AKI using PARI were score of 8 is considered positive. Secondary outcomes includes risk for kidney replacement therapy(KRT), mortality and length of hospital stay. Discrimination using logistic regression C testing and calibration using Hosmer & Lemeshow test were used to evaluate the predictive ability of the scoring system.

**Results:** A total of 386 patients were eligible after exclusion evaluation. The PARI was statistically significant in predicting risk of persistent AKI and need for KRT with an OR of 15.13 (CI 9.1 to 25.0), p value 0.0001 and OR 11.35 (CI 6.7 to 19.2), p value 0.0001, respectively and provides acceptable discrimination with C statistics of 0.79 and 0.70. Patients with positive PARI score showed HR of 3.94 (CI 2.6 to 6.1), p value 0.0001 for mortality with acceptable performance in discriminating patients risk for mortality. No statistical significance in length of hospital stay, p value 0.83. The calibration study showed p values of <0.05 indicating poor goodness to fit for all outcomes.

**Conclusions:** PARI is a convenient and cost-effective bedside tool that can be used to predict persistent AKI with an impact in management of critically ill adult patients. This will provide as an add on tool to biomarkers for early intervention and goal-directed therapies for better prognosis.

**TH-PO065**

**Risk of Ventricular Tachycardia and Its Outcomes in Patients Undergoing Continuous Renal Replacement Therapy due to AKI**

Seong Geun Kim, Donghwan Yun, Jinwoo Lee, Min woo Kang, Dong Ki Kim, Kook-Hwan Oh, Kwon Wook Joo, Yon Su Kim, Seung Seok Han. *Seoul National University College of Medicine, Seoul, Republic of Korea.*

**Background:** Despite the best efforts to treat critically ill patients requiring continuous renal replacement therapy (CRRT) due to acute kidney injury, their mortality risk remains high. This worse condition may be attributable to complications of CRRT, such as arrhythmias. Here, we addressed the occurrence of ventricular tachycardia (VT) and its relationship with patient outcomes after starting CRRT due to acute kidney injury

**Methods:** A total of 2,397 patients who started CRRT due to severe acute kidney injury were retrospectively enrolled from 2010 to 2020 at Seoul National University Hospital, Korea. The occurrence of VT was evaluated from starting to weaning from CRRT. The odds ratios (ORs) of mortality outcomes were measured using logistic regression models after adjustment for multiple variables.

**Results:** VT occurred in 150 (6.3%) patients after starting CRRT. Among them, 95 cases were defined as sustained VT (i.e., lasting ≥ 30 sec), and the other 55 cases were defined as nonsustained VT (i.e., lasting < 30 sec). The occurrence of sustained VT was associated with a higher mortality rate than nonoccurrence (OR, 1.99 [1.17–3.37] for 7-day mortality; OR, 2.04 [1.23–3.39] for 30-day mortality; and OR, 4.06 [2.04–8.08] for 90-day mortality). The mortality rates did not differ between patients with nonsustained VT and nonoccurrence. The use of ≥ 3 vasopressors and certain trends of blood laboratory findings such as acidosis and hyperkalemia were associated with the subsequent risk of sustained VT for patients on CRRT.

**Conclusions:** Sustained VT occurrence after starting CRRT is associated with patient mortality. The monitoring of electrolytes and acid-base status during CRRT is essential because of its relationship with the risk of VT.

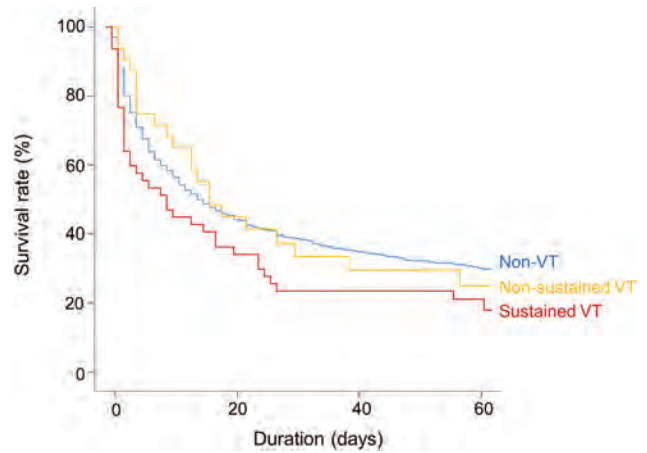

**TH-PO066**

**Hyperlactatemia Is a Predictor of Mortality in Patients Undergoing Continuous Renal Replacement Therapy for AKI**

Seong Geun Kim, Jinwoo Lee, Min woo Kang, Dong Ki Kim, Kook-Hwan Oh, Kwon Wook Joo, Yon Su Kim, Seung Seok Han. *Seoul National University College of Medicine, Seoul, Republic of Korea.*

**Background:** Hyperlactatemia occurs frequently in critically ill patients, and this pathologic condition leads to worse outcomes in several disease subsets. Herein, we addressed whether hyperlactatemia is associated with the risk of mortality in patients undergoing continuous renal replacement therapy (CRRT) due to AKI.

**Methods:** A total of 1,661 patients who underwent CRRT for severe AKI were retrospectively reviewed between 2010 and 2020. The patients were categorized according to their serum lactate levels, such as high (≥ 7.6 mmol/l), moderate (2.1–7.5 mmol/l) and low (≤2 mmol/l), at the time of CRRT initiation. The hazard ratios (HRs) for in-hospital mortality were calculated with adjustment of multiple variables. The increase in the area under the receiver operating characteristic curve (AUROC) for the mortality risk was evaluated after adding serum lactate levels to the Sequential Organ Failure Assessment (SOFA) and the Acute Physiology and Chronic Health Evaluation (APACHE) II score-based models.

**Results:** The moderate and high lactate groups had a higher risk of mortality than the low lactate group, with HRs of 1.64 (1.22–2.20) and 4.18 (2.99–5.85), respectively. The lactate-enhanced models had higher AUROCs than the models without lactates (0.764 vs. 0.702 for SOFA score; 0.737 vs. 0.678 for APACHE II score).

**Conclusions:** Hyperlactatemia is associated with mortality outcomes in patients undergoing CRRT for AKI. Serum lactate levels may need to be monitored in this patient subset.

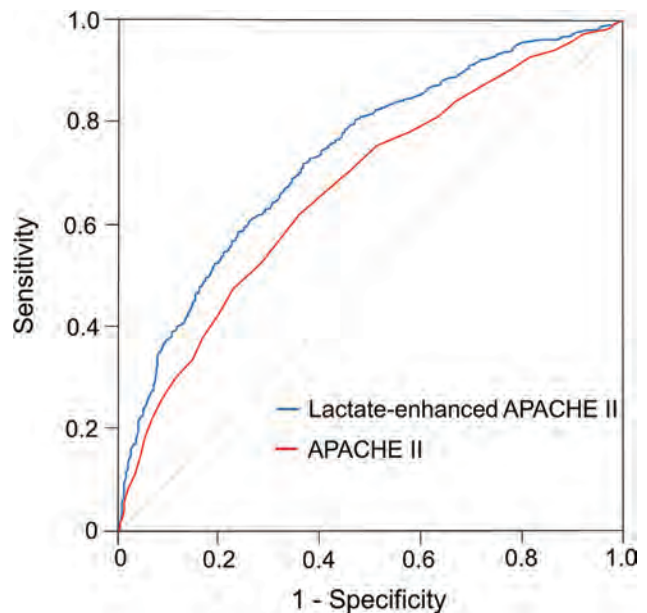

## TH-PO067

### U-Shaped Association Between Platelet-to-Lymphocyte Ratio and In-Hospital Mortality in Critically Ill Patients With AKI Requiring Continuous Renal Replacement Therapy

Hee Won Noh, Soojee Jeon, Hee-Yeon Jung, Ji-Young Choi, Sun-Hee Park, Chan-Duck Kim, Yong-Lim Kim, Jeong-Hoon Lim, Jang-Hee Cho. *Kyungpook National University, Daegu, Republic of Korea.*

**Background:** The platelet-to-lymphocyte ratio (PLR) is a marker of inflammation and predictor of mortality in a variety of diseases. However, the effectiveness of PLR as a predictor of mortality in patients with severe acute kidney injury (AKI) is uncertain. We evaluated the association between PLR and mortality in critically ill patients with severe AKI who underwent continuous renal replacement therapy (CRRT).

**Methods:** This is a retrospective observational cohort study, and a total of 1044 patients with AKI who underwent CRRT in Kyungpook National University Hospital from 2017 to 2021 were analyzed. The study subjects were divided into quintiles according to the PLR at CRRT initiation. A Cox proportional hazards model was used to investigate the association between PLR and mortality.

**Results:** PLR was associated with in-hospital mortality in a non-linear manner, showing a higher mortality rate at both ends of the PLR. The Kaplan–Meier curve analysis revealed the highest mortality rates with the first and fifth quintiles, while the lowest mortality rate occurred with the third quintile. Compared with the third quintile (the lowest mortality rate group), the first (adjusted hazard ratio [aHR] = 1.94, 95% confidence interval [CI] = 1.44–2.62,  $P < 0.001$ ) and fifth (aHR = 1.60, 95% CI = 1.18–2.18,  $P = 0.002$ ) quintiles of PLR had significantly higher in-hospital mortality. The first and fifth quintiles showed a consistently increased risk of 30-day and 90-day mortality compared with the third quintile. In the subgroup analysis, lower and higher PLRs were predictors of in-hospital mortality in patients with older age, female sex, hypertension, diabetes, and higher Sequential Organ Failure Assessment score.

**Conclusions:** Both the lower and higher PLRs were independent predictors of in-hospital mortality in critically ill patients with AKI who underwent CRRT. Thus, the PLR may be a useful and easily accessible prognostic indicator for patients with severe AKI.

**Funding:** Government Support - Non-U.S.

## TH-PO068

### AKI Among Patients With Multi-Drug Resistant Infection: A Study From Jordan

Ashraf O. Oweis,<sup>1</sup> Sameeha A. Alshelleh,<sup>2</sup> *Jordan University of Science and Technology Faculty of Medicine, Irbid, Jordan;* <sup>2</sup>*The University of Jordan, Amman, Jordan.*

**Background:** Acute kidney injury (AKI) is a well-known complication for hospitalized patients especially in the intensive care unit. Sepsis and various infections play major role in increasing the incidence of AKI. In our study we are evaluating the risk for Multidrug resistant (MDR) infections and its effect on incidence of AKI, hospitalization, need for dialysis and mortality.

**Methods:** In a retrospective study design, data was collected from all adult patients with a positive multi-drug resistant culture who were admitted to King Abdullah University Hospital (KAUH). Records of 436 patients who were admitted to general floors or the intensive care units (ICU) between January 2017 – December 2018 with at least one year follow up and had infection with positive multidrug resistant cultures were reviewed

**Results:** The mean age for the patients was 57.3 years (SD± 23.1) and 58.5% were males. The most common source of positive culture was sputum culture 50%, followed by wound culture 22.2%. The incidence of AKI was 59.2% and most cases were in stage 3 AKI (41%). The most isolated microorganism was *Acinetobacter baumannii* 76.8% followed by *Pseudomonas aeruginosa* 14.9% (picture 2). On multivariate analysis, age (OR 1.1, 95% CI 1.1–1.2,  $P=0.001$ ), HTN (OR 1.8, 95% CI 1.0–3.3,  $P=0.02$ ), DM (OR 1.1, 95% CI 0.6–1.9,  $P=0.69$ ) and the use of foley catheter on chronic bases (OR 4.3, 95% CI 2.6–6.8,  $P<0.0001$ ) were a strong predictors of AKI. Among patients with AKI; 74.4% died in comparison to 44.4% ( $p<0.001$ ).

**Conclusions:** In patients with MDR incidence for AKI, hospitalization, and mortality is high. Early detection and addressing of the problem may decrease bad outcomes, health education for decreasing antibiotic abuse is needed to decrease MDR.

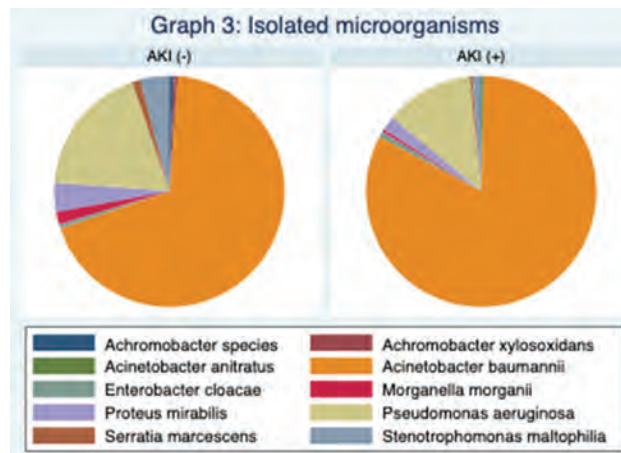

## TH-PO069

### Assessment of the Nature of AKI Post Adult Orthotopic Heart Transplantation: A Single Tertiary Referral Center Experience

Ashley Golbus,<sup>1</sup> Syed M. Quadri,<sup>2</sup> Blaiithin A. McMahon,<sup>2</sup> *<sup>1</sup>Medical University of South Carolina College of Medicine, Charleston, SC;* *<sup>2</sup>Medical University of South Carolina Department of Medicine, Charleston, SC.*

**Background:** AKI is common following adult orthotopic heart transplantation (OHT) with rates ranging from 40.3% to 72.3%. AKI worsens 12-month survival with a subset of patients requiring kidney replacement therapy (KRT), developing ESRD, worsening CKD, or death. The purpose of our study was to assess the nature of AKI occurring post-adult OHT at the Medical University of South Carolina and to serve as a metric of how to best improve renal outcomes in this cohort of patients.

**Methods:** We analyzed AKI rates and renal outcomes in a cohort of 120 adult patients undergoing OHT at MUSC from 04/2015 to 04/2021. We investigated AKI incidence, severity, and timing; the effect of hemodilution on AKI I criteria; and KRT indication and initiation in a sub-cohort of AKI patients who required KRT (AKI-D patients). We investigated major adverse kidney events (MAKE) outcomes at 12-months post-OHT. We identified several risk factors for AKI and AKI-D and performed a univariate logistic regression analysis of risk factors.

**Results:** 90% of patients met AKI criteria within 7 days post-OHT; 10% had no AKI, 48.3% had stage I AKI, 15.8% stage II, and 25.8% stage III. 31% of AKI stage I patients met criteria due to hemodilution. AKI criteria diagnosis was on median day 1 post-OHT. Median initiation of KRT was POD2 for the predominant indication of volume overload. Of AKI-D patients, MAKE criteria was assessed at 12 months post-OHT and showed 74.2% (n=23) of patients had doubling SCr, 16.2% (n=5) were ESRD, and 19.4% (n=6) died. Significant risk factors for AKI included CPB time (OR: 1.007, 95% CI: 1.001–1.013;  $P=0.015$ ), VIS score (OR: 1.041, 95% CI: 1.011–1.072;  $P=0.007$ ), preoperative SCr (OR: 5.61, 95% CI: 2.397–13.133;  $P<0.001$ ), primary graft dysfunction (OR: 8.546, 95% CI: 2.705–26.994;  $P<0.001$ ), and RV failure (OR: 5.548, 95% CI: 2.263–12.606;  $P<0.001$ ).

**Conclusions:** AKI is a common finding post-OHT, however the majority of the AKI in this cohort of patients was AKI stage I. We identified that any AKI was associated with poor renal outcomes such as MAKE-12 months. Timing of all stages of AKI suggests etiologies such as RV failure and graft dysfunction as major risk factors for AKI.

## TH-PO070

### Seeing Is Believing: Imaging Tests in Acute Renal Failure and Acute-on-Chronic Kidney Disease and Their Influence on Outcomes

Maria Isabel Acosta-Ochoa, Armando Coca, Arturo Lorenzo, Alicia Mendiluce. *Hospital Clinico Universitario de Valladolid, Valladolid, Spain.*

**Background:** Imaging techniques allow the diagnosis of abnormalities of renal structure; patients with structural abnormalities have CKD if persist  $>3$  months. We evaluated if an abnormal imaging test influenced outcomes in patients with acute renal failure (ARF) or Acute on Chronic Kidney Disease (AoCKD).

**Methods:** Retrospective study of in-patients with AKI. We excluded individuals without image tests. We divided the cohort in normal and abnormal imaging, and in acute renal failure (ARF basal GFR  $>60$ ) and Acute on Chronic Kidney Disease (AoCKD basal GFR  $<59$ ). We compared clinical features, and tested the incidence of need for HD and in-hospital mortality.

**Results:** We included 616 individuals. Patients with AoCKD in both groups were older and had higher Charlson's Index (ChI); they were hospitalized less frequently in ICU, and more frequently in medical wards compared to ARF individuals. Besides comorbidities, AKI severity and hard renal and clinical outcomes showed no statistically significant differences between groups; except for higher hospital stay in the AoCKD group with normal imaging tests.

**Conclusions:** We found that an abnormal imaging test does not confer worse prognosis in ARF neither AoCKD. It is noteworthy that 52% of patients didn't have an image test during hospitalization. Although individuals with AoCKD are older and

have higher ChI, the hard outcomes rates were not affected by an abnormal imaging test. Future studies with more accurate techniques that measure and evaluate kidney volume, in combination with functional imaging and/or elastography could shed light over ARF and AoCKD diagnosis and prognosis.

	Abnormal Image			Normal Image		
	ARF (98)	AoCKD (220)	P Value	ARF (171)	AoCKD (127)	P Value
<b>A. Feature</b>						
Age	73 ± 10	75 ± 12	0.22	66 ± 15	72 ± 13	<0.001
Female Sex	23 (24)	58 (26)	0.68	57 (33)	39 (31)	0.70
HT	78 (80)	197 (90)	0.02	125 (73)	117 (92)	0.02
DM	15 (15)	86 (39)	<0.001	47 (28)	62 (49)	<0.001
CAD	16 (16)	61 (28)	0.03	24 (14)	39 (31)	0.001
AHF	20 (20)	81 (37)	0.004	40 (23)	54 (43)	0.001
Itus	15 (15)	39 (18)	0.63	25 (15)	19 (15)	1.00
Medical Service	45 (46)	147 (67)	0.001	132 (77)	93 (73)	0.50
Charlson's Index	4.0 ± 2.7	5.0 ± 2.4	0.001	3.4 ± 2.4	4.7 ± 2.4	0.001
ICU	19 (19)	25 (11)	0.08	49 (29)	20 (16)	0.01
<b>KDIGO Stage</b>						
1	18 (18)	62 (28)	0.70	18 (18)	62 (28)	0.70
2	19 (19)	17 (8)	0.004	19 (19)	17 (8)	0.004
3	61 (62)	141 (64)	0.80	61 (62)	141 (64)	0.80
<b>B. Results</b>						
Hospital Stay	18 ± 16	15 ± 12	0.08	19 ± 17	21 ± 18	<0.001
Need for HD	12 (12)	35 (16)	0.49	34 (20)	25 (20)	1.00
HD Dependence	4 (4)	20 (9)	0.17	2 (1)	6 (5)	0.08
Mortality	19 (19)	53 (24)	0.39	42 (25)	30 (24)	0.89

TH-PO071

**Risk Factors for Post-Contrast AKI in Patients Administered Both Iodine- and Gadolinium-Based Contrast Media on the Same Visit to the Emergency Department**

Suyeon Han,<sup>1</sup> Hojoon Ko,<sup>1</sup> Moo Jun Kim,<sup>1</sup> Eu Jin Lee,<sup>1</sup> Jae wan Jeon,<sup>3</sup> Youngrok Ham,<sup>2,1</sup> Dae Eun Choi,<sup>2,1</sup> Kiryang Na,<sup>2,1</sup> Kang Wook Lee.<sup>2,1</sup>  
<sup>1</sup>Chungnam National University Hospital, Daejeon, Republic of Korea; <sup>2</sup>Chungnam National University, Daejeon, Republic of Korea; <sup>3</sup>Chungnam National University Sejong Hospital, Sejong, Republic of Korea.

**Background:** This study aimed to investigate the incidence of post-contrast acute kidney injury (PC-AKI) and its risk factor in patients administered iodine-based contrast media (ICM) alone and mixed use of ICM and gadolinium-based contrast media.

**Methods:** This retrospective study analyzed the data from 2016 to 2021. Patients who had end-stage of renal disease or missing data for estimating renal function were excluded. The primary outcome was the development of PC-AKI, i.e., an increase in creatinine of ≥25% or 0.5 mg/dL over the baseline or reduction in eGFR of ≥25% within 72 h. We compared the primary outcomes between the ICM alone and Mixed groups using a propensity score matching (PSM) analysis, and its risk factors were assessed from multivariable logistic regression.

**Results:** Of the 29,635 patients administered ICM, 6,318 were included. There were 139 patients who mixedly administered ICM and GBCA. Mixed group showed significant higher rate of development of PC-AKI compared with ICM alone group in total cohort (adjusted OR, 3.09 [95% CI, 2.09 – 4.58]) and PSM cohort (adjusted OR, 2.38 [95% CI, 1.25 – 4.55]). On multivariate analysis to investigate risk factors in Mixed group, osmolality (adjusted aOR, 1.05 [95% CI, 1.01–1.10]) and eGFR (adjusted OR, 0.931; 95% CI, 0.883–0.983) were associated with PC-AKI.

**Conclusions:** Mixed administration of ICM and GBCA on same day at ED visit may be a risk factor for PC-AKI compared with single administration of ICM alone. Osmolality and eGFR may be independently associated with PC-AKI after mixed administration of ICM and GBCA

**Funding:** Government Support - Non-U.S.

TH-PO072

**Evaluation of Nephrotoxicity of Liposomal Amphotericin in Three Administration Regimens for the Treatment of Disseminated Histoplasmosis in AIDS Patients**

Marilia Rodovalho Guimaraes,<sup>1</sup> Renata B. Soares,<sup>3</sup> Talita R. Sanches,<sup>1</sup> Cássia S. Godoy,<sup>3</sup> Diego R. Falci,<sup>4</sup> Alessandro C. Pasqualotto,<sup>2</sup> Lucia Andrade.<sup>1</sup>  
<sup>1</sup>University of São Paulo School of Medicine, Sao Paulo, Brazil; <sup>2</sup>Universidade Federal de Ciências da Saude de Porto Alegre Faculdade de Medicina, Porto Alegre, Brazil; <sup>3</sup>Pontificia Universidade Catolica de Goias, Goiania, Brazil; <sup>4</sup>Pontificia Universidade Catolica do Rio Grande do Sul, Porto Alegre, Brazil.

**Background:** HIV infection is now endemic, and disseminated histoplasmosis (DH) is an AIDS-defining disease. One common treatment for DH is liposomal amphotericin B (LAmB), the main side effect of which is nephrotoxicity.

**Methods:** The main objective of this study was to compare different L-AmB regimens, in terms of their nephrotoxicity, in patients with HIV/AIDS undergoing induction therapy for the treatment of DH. We conducted a prospective exploratory cohort study, nested within a prospective, multicenter, open phase II experimental study, to analyze the nephrotoxicity of induction therapies for DH in HIV/AIDS, followed by oral therapy with itraconazole. Patients were randomized into 3 arms of LAmB administration: 10 mg/kg, single dose (arm 1); 10 mg/kg on day 1, followed by 5 mg/kg on day 3 (arm 2); and 3 mg/kg for 14 days (arm 3). Before and after treatment, we measured levels of cystatin C (cys-C) and fractional excretion of sodium, as well as fractional excretions of potassium and magnesium (FENa, FEK and FEMg, respectively). Means, standard deviations and odds ratios were calculated.

**Results:** We selected 90 hospitalized patients, each of whom were randomly assigned to one of the three arms (n = 30/arm). There were no statistical differences among the arms regarding patient sex, age, CD4 count or viral load (VL). The mean age was 42 years, and 80% of the patients were men. Of the 90 patients evaluated, 18 (20%) died during hospitalization. The mean VL was 776,243 copies/mm<sup>3</sup>, and the mean CD4 count was 89±120 cells/mm<sup>3</sup>. Tubular toxicity was greatest in arm 3, FENa and FEMg being increased in 100% of the patients, whereas FEK was increased in 66%. The values of cys-C were higher than were the creatinine values and correlated more strongly with tubular dysfunction (p<0.001). In arm 1, the increases in FENa and FEMg presented an OR of 12.1 for AKI over a 7-day interval.

**Conclusions:** The 14-day LAmB infusion regimen proved to be more toxic to the renal tubule than did the two other regimens evaluated. Tubular dysfunction with increased FENa and FEMg appears to correlate well with AKI, and cys-C appears to more sensitive than creatinine for predicting AKI.

**Funding:** Government Support - Non-U.S.

TH-PO073

**Precipitous AKI due to Vancomycin: Risk Factors and Clinical Outcomes**

Danielle N. Aliano,<sup>1</sup> Swetha Rani Kanduri,<sup>1,2</sup> Ardem Elmayan,<sup>1</sup> Juan Carlos Q. Velez.<sup>1,2</sup> Ochsner Nephrology <sup>1</sup>Ochsner Medical Center, New Orleans, LA; <sup>2</sup>The University of Queensland Ochsner Clinical School - New Orleans, New Orleans, LA.

**Background:** A distinct form of AKI due to vancomycin (VA-AKI) characterized by a steep rise in serum creatinine (sCr) has been described, known as vancomycin-associated precipitous-AKI (VA-pAKI). However, its incidence, risk factors and associated outcomes are unknown.

**Methods:** We searched records of hospitalized adults ≥18 yrs who received ≥ 2 consecutive doses of IV vancomycin (2012-2021). We defined AKI by KDIGO. VA-pAKI was defined as AKI with a rise in sCr ≥1.6 mg/dL within 24 +/- 2 hrs. To eliminate confounders, we excluded those with pre-existing CKD stages 3-5, ESKD, kidney transplant, shock requiring vasopressors, rhabdomyolysis, and those with concomitant exposure to trimethoprim (blocks creatinine secretion) or to a nephrotoxin (eg, NSAIDs, aminoglycosides, etc.). We compared variables among 3 groups: no AKI, control non-precipitous VA-AKI (VA-npAKI) and VA-pAKI by ANOVA or chi square, as appropriate.

**Results:** A total of 36,768 patients were included. Among them, 2,428 had AKI (7%), 403 (17%) of them stage 3 AKI. Of those, 129 had VA-pAKI (overall incidence 0.4%, 5% of VA-AKI, 30% of stage 3 VA-AKI), averaging 1 VA-pAKI case per month. Median peak rise in sCr for the VA-pAKI cases was 2.0 (1.6-3.5) mg/dL/day. Median age were 58, 60 and 46 yrs for no AKI, VA-npAKI and VA-pAKI, respectively (p<0.0001). No difference in sex or race were found. Median body weight were 177, 192 and 216 lbs. for no AKI, VA-npAKI and VA-pAKI, respectively (p<0.0001). Median cumulative dose were 3.7, 4.2 and 4.8 g for no AKI, VA-npAKI and VA-pAKI, respectively (p<0.0001). Median vancomycin level were 13, 19 and 25 mcg/mL for no AKI, VA-npAKI and VA-pAKI, respectively (p<0.0001). Regarding outcomes, 2% of VA-npAKI needed dialysis compared to 12% of the VA-pAKI group (p<0.0001). Median length of hospital stay (LOS) were 8, 12 and 14 days for no AKI, VA-npAKI and VA-pAKI, respectively (p<0.0001).

**Conclusions:** VA-pAKI is a distinct subtype of VA-AKI associated with younger age, greater body weight, greater cumulative dose of vancomycin and higher vancomycin level. Furthermore, VA-pAKI is associated with prolonged LOS and greater need for dialysis. Mechanistic studies are required to better understand this clinical entity.

TH-PO074

**AKI May Be Underdiagnosed in Children Receiving High-Dose Methotrexate**

Brenda Mendoza Flores, Amanda J. Clark, Marie Christelle Saade, Samir M. Parikh. The University of Texas Southwestern Medical Center, Dallas, TX.

**Background:** High-dose methotrexate (HDMTX) is a nephrotoxic therapy given to children with cancer. It is known that every episode of acute kidney injury (AKI) increases the risk of developing chronic kidney disease, making it particularly impactful for children. Current protocols for reducing AKI incidence with HDMTX include hyperhydration, urine monitoring, and serial serum creatinine measurements. It is not well known how hydration affects creatinine interpretation or AKI diagnosis during HDMTX therapy.

**Methods:** All children admitted to a children's hospital receiving HDMTX as part of routine care in a six month period were enrolled under an IRB approved protocol. Clinical and demographic data were collected from patients' charts. For each patient, serum creatinine at admission was recorded along with the hyperhydration creatinine nadir. The nadir was determined as the point in which serial urinalyses showed a specific gravity < 1.010 but before HDMTX was given. AKI was defined as a 50% increase above admission creatinine or hydration nadir creatinine based on KDIGO criteria. Data were analyzed using Chi-square and paired t-tests.

**Results:** In total, 58 admissions for HDMTX were studied representing 19 children aged 2-19. The hydrated nadir creatinine was 15.8% ± 12.6 lower than admission creatinine (Fig 1A, p < 0.0001). Based on admission creatinine, 3.45% of HDMTX admissions resulted in AKI. After reclassification using the hydrated nadir, AKI incidence rose to 13.8% (Fig 1B-C, p=0.004).

**Conclusions:** These data highlight the difficulties in using serum creatinine as a marker for renal function, especially in children where modest changes in creatinine imply significant changes in estimated function. Serum creatinine fluctuates with fluid

Key: TH - Thursday; FR - Friday; SA - Saturday; OR - Oral; PO - Poster; PUB - Publication Only

Underline represents presenting author.

status; fluid augmentation with chemotherapy accentuates this limitation. Our data show that children receiving HDMTX may be underdiagnosed with AKI. This could prevent renal protective medication adjustments and limit access to renal-specific follow-up. These data highlight the ongoing need for more sensitive, specific, and timely markers of renal function, specifically in children.

**Funding:** Other NIH Support - K12-HD000850, R01 DK095072, R01 AG027002, Private Foundation Support

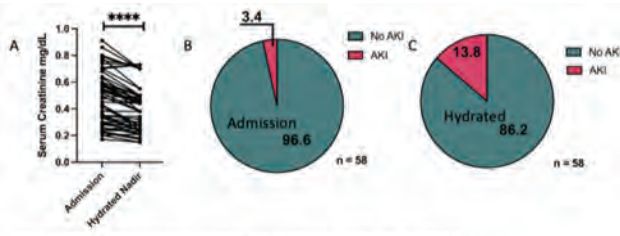

Figure 1. Creatinine levels for admission and hydrated state (A). Admission and hydrated AKI incidence (B-C).

TH-PO075

**AKI and Acute Kidney Disease After Radical Cystectomy for Muscle Invasive Bladder Cancer: A Hidden Uro-Nephrological Affair**

Francesco Trevisani,<sup>1,3</sup> Alessandra Cinque,<sup>3</sup> Matteo Floris,<sup>2</sup> Mattia Longoni,<sup>1</sup> Roberto Minnei,<sup>2</sup> Camilla Maria Ester Bonzi,<sup>1</sup> Maria Rita Rota,<sup>1</sup> Andrea Salonia,<sup>1</sup> Alberto Briganti,<sup>1</sup> Francesco Montorsi,<sup>1</sup> Marco Moschini,<sup>1</sup> <sup>1</sup>IRCCS Ospedale San Raffaele, Milano, Italy; <sup>2</sup>Azienda Ospedaliera Brotzu, Cagliari, Italy; <sup>3</sup>Biorek s.r.l., Milano, Italy.

**Background:** Radical cystectomy (RC) represents the first line surgical treatment for muscle-invasive bladder cancer (MIBC). RC is a complex surgical procedure characterized by significant morbidity and mortality. The incidence of significant complications following RC is a well-recognized issue however still paucity of data exists regarding postoperative renal function. Aim of the study was to evaluate the incidence of acute kidney injury (AKI) and Acute kidney disease (AKD) after RC, evaluating the impact of surgery and comorbidities.

**Methods:** In this study, we collected a consecutive cohort of 280 patients who underwent RC for MIBC in a single tertiary institution. All clinical variables and comorbidities were reported pre and after surgery. Serum creatinine with subsequently eGFR using CKD-EPI formula were collected at baseline pre-operative and in the acute setting at 24h, 48, 72h, 6 days for the AKI onset, and after 9,12,15,18,21,24,27,30,45, 60, 75, 90 days for the AKD establishment. Fisher's exact test; Wilcoxon rank sum test; Pearson's Chi-squared test were used for the statistical analysis.

**Results:** Clinical data are present in table 1. Surprisingly, the 51.4% of patients experience AKI and 37.5% of pts AKD. The unique risk factor using univariate analysis was the presence of hypertension at baseline. The surgical techniques did not have any influence. 23.6% of patients experience both AKI and AKD, while 13.9% of patients experience AKD, but not AKI.

**Conclusions:** AKI and AKD are very frequent side effects in the RC for MIBC and require the nephrological counseling immediately after the surgery to monitor the onset of AKI and AKD. Hypertension represents the main risk factor.

Characteristic	N	Overall %	no AKI %	yes AKI %	p-value
Stage CKD-epi pre	280				0.2
Stage 1	1	0.4%	0%	0.4%	
Stage 2	122	43.6%	38.5%	43.6%	
Stage 3a	38	13.6%	10.7%	13.6%	
Stage 3b	112	40.0%	38.5%	40.0%	
Stage 4	9	3.2%	7.1%	3.2%	
Stage 5	18	6.4%	14.3%	6.4%	
Age	280	68.6 (24)	69.6 (24)	67.6 (24)	0.3
Sex	280	0.9	0.9	0.9	
I	22	7.9%	11.4%	7.9%	0.9
M	258	92.1%	88.6%	92.1%	
Type of surgery	280	0.9	0.9	0.9	
Open	209	74.6%	72.7%	74.6%	
Robotics	71	25.4%	27.3%	25.4%	
Neoadjuvant Chemotherapy	280	0.2	0.2	0.2	
Yes	236	84.3%	81.8%	84.3%	
No	44	15.7%	18.2%	15.7%	
Neoadjuvant Radiotherapy	280	0.6	0.6	0.6	
Yes	277	99.0%	98.9%	99.0%	
No	3	1.1%	1.1%	1.1%	
BMI	278	25.0 (9.3)	25.0 (9.3)	25.0 (9.3)	0.5
Obesity	278	0.5	0.5	0.5	
0	237	85.3%	81.8%	85.3%	
1	41	14.7%	18.2%	14.7%	
Type 1 diabetes	280	0.7	0.7	0.7	
0	275	98.2%	98.9%	98.2%	
1	5	1.8%	1.1%	1.8%	
Type 2 diabetes	280	0.3	0.3	0.3	
0	245	87.5%	87.5%	87.5%	
1	35	12.5%	12.5%	12.5%	
Hypertension	280	0.003	0.003	0.003	
0	107	38.2%	35.3%	38.2%	
1	173	61.8%	64.7%	61.8%	
Ischemic heart disease	280	0.008	0.008	0.008	
0	232	83.2%	81.8%	83.2%	
1	48	16.8%	18.2%	16.8%	

\*Fisher's exact test; Wilcoxon rank sum test; Pearson's Chi-squared test

TH-PO076

**Pregnancy Associated AKI: An 8-Year Study From South India**

Devidas S. Bantewad, Manjusha Yadla. Gandhi Hospital, Secunderabad, India.

**Background:** Pregnancy-related acute kidney injury (PRAKI) is a major cause of maternal and fetal morbidity and mortality in developing countries. With improvement in antenatal and postnatal care, the incidence of PRAKI in India has steadily declined from 22% in 1960s to 9% in 1980s, and further down to 3-7% in 2000s.

**Methods:** Aim : To study the clinical characteristics and outcomes of patients with PRAKI Design : Prospective observational study Setting : Tertiary Care Government Hospital in Telangana Period of study : Jan 2014 to May 2022 Methodology : Data collected prospectively from All admitted pregnant and postpartum patients who developed a PRAKI. Inclusion criteria : All pregnant and postpartum patients who developed a PRAKI. Exclusion criteria : 1. Evidence of renal disease prior to pregnancy 2. Elevated serum creatinine prior to gestation

**Results:** A total of 311 patients satisfied inclusion criteria. Pregnancy related Acute Kidney Injury was 0.32% of total pregnancies in our institute. The Institutional incidence of pregnancy related Acute Kidney Injury in context of all cases of AKI was 5.88%, out of which dialysis requiring PRAKI incidence was 4.22% at our institute.

**Conclusions:** 1. Incidence of pregnancy related Acute kidney injury in context of overall AKI was 5.88% 2. Most common cause of PRAKI in our study was preeclampsia (43.4%) 3. Sepsis and multisystem involvement was in 74.27 and 21.86% patients respectively. 4. In our institute Maternal mortality was 21.54% and fetal mortality was 47.58%. 5. Total patients receiving RRT was 223 (71.70%) while 88 (28.29%) patients was managed conservatively.

Baseline characteristics		
Parity	Number of patients	Percentage
Primigravida	162	52.09
Multigravida	149	47.90
1st trimester	3	0.96
2nd trimester	18	5.78
3rd trimester & puerperium	290	93.24
Thrombocytopenia	157	50.48
Mode of delivery		
Mode of delivery	Number of patients	Percentage
Vaginal delivery	140	45.01
LSCS	162	52.09
Lab and basic parameters		
Parameter	Mean + SD	
Age	24.9 + 4.1	
Hemoglobin	9.19 + 1.82	
TLC	15.05 + 5.6	
Platelets	1.40 + 1.1	
Blood urea	60.68 + 39.9	
Serum creatinine	3.56 + 1.99	
Bilirubin	3.0 + 4.6	
Albumin	3.35 + 0.89	

RESULTS TABLES

Etiology of AKI		
Parameter	Number of patients	Percentage
Preeclampsia	135	43.40
Sepsis	96	30.86
APH/PPH	62	19.93
Unknown	18	5.78
RRT		
Type	Number of patients	Percentage
HD	195	62.70
PD	23	7.39
HD + PD	5	1.60
Total patients receiving RRT	223	71.70
Conservative	88	28.29
Renal biopsy		
Biopsy result	Number of patients	
Severe ATN	3	
Cortical necrosis	9	
Outcomes		
Deaths	Number of patients	Percentage
Maternal deaths	67	21.54
Fetal deaths	148	47.58

RESULTS TABLES

TH-PO077

**AKI in Critically Ill Patients Presenting With Gastrointestinal Hemorrhage**

Mythri Anil Kumar,<sup>1</sup> Dheera Grover,<sup>1</sup> Niala Moallem,<sup>1</sup> Tara McLaughlin,<sup>2</sup> Raj Parikh,<sup>2</sup> <sup>1</sup>UConn Health, Farmington, CT; <sup>2</sup>Hartford Hospital, Hartford, CT.

**Background:** Acute gastrointestinal bleeding (GIB) is associated with a high mortality and morbidity rate. Acute kidney injury (AKI) in critically ill patients admitted with GIB as their primary diagnosis is scarcely studied. We aimed to determine the incidence, risk factors and significance of acute kidney injury (AKI) in this cohort.



**Methods:** This was a single center retrospective study of patients admitted to the IU and ICU from the ED with GIB as their primary diagnosis from March 1, 2015 to March 1, 2021. Baseline characteristics, laboratory values and therapeutic interventions performed were extracted. AKI was defined according to the KDIGO criteria. Groups with and without AKI were compared. Chi square test was and Wilcoxon rank sum test were performed for categorical and continuous variables respectively.

**Results:** Among 300 patients, 46.3% developed an AKI. Diabetes mellitus (DM), heart failure (HF), atrial fibrillation (Afib), chronic kidney disease (CKD) were more frequently present in GIB patients who developed AKI. Mean arterial pressure (MAP) and heart rate (HR) at admission were lower in the AKI group [75 (interquartile range (IQR) 67,88) vs 80 (IQR 71,93) and 82 (IQR 72,100) vs 92 (IQR 76.5,108) respectively]. Vasopressor use and mechanical ventilation rates were higher in the AKI group. 14.7% of the GIB patients who developed AKI were transitioned to comfort care only (CMO) compared to 4.9% patients without AKI. While 90-day readmission rate with GIB and 30-day mortality rate were not significantly different between the groups, both the hospital and ICU/IU LOS were longer in patients with AKI [6 (IQR 4,10.25) vs 5 (IQR 3,7); p value <0.001 and 3.5 (IQR 2,5) vs 3 (IQR 2,4); p value 0.015 respectively].

**Conclusions:** In critically ill GIB patients, comorbid conditions such as DM, HF, Afib, CKD are risk factors for the development of AKI. They tended to present with a lower MAP, lower HR and higher lactic acid (LA). Risk stratification scores including Glasgow-Blatchford Bleeding Score (GBS) and AIMS 65 were worse. These patients were sicker and had higher vasopressor and mechanical ventilation needs. Consequently, they had longer hospital and ICU/IU LOS and were more likely to be made CMO. The development of AKI in critically ill GIB patients is associated with greater morbidity.

**TH-PO078**

**A Retrospective Analysis of Fluid Balance in Patients With AKI and Respiratory Failure due to COVID-19**

Pranav Sharma, Amar M. Bhagat, Chioma Madu, Jonathan Lebowitz, Lilian Saro-Nunez, Steve I. Khalil. *Robert Wood Johnson University Hospital, New Brunswick, NJ.*

**Background:** The optimal amount of hydration for patients with severe COVID-19 infection and AKI is unknown. This study aims to investigate the impact of fluid management strategy and outcomes in patients with AKI and respiratory failure due to COVID-19.

**Methods:** Data was gathered from a retrospective chart review of patients with hypoxia due to COVID-19 infection and stage 2 or greater AKI. Primary outcome was the difference in net fluid balance between patients who were successfully weaned to lower levels of oxygen support and discharged compared to those who died or remained ventilator dependent.

**Results:** Of 58 cases, 41 died, 3 remained ventilator-dependent, and 14 were discharged without supplemental oxygen. The groups differed in net fluid balance (-10,065 cc vs +7,980 cc, p<0.001) and daily fluid balance (-367 vs. 515 cc/day, p<0.001) with a substantially lower mean fluid balance in patients who survived with minimal requirement for supplemental oxygen. Patients who maintained a positive fluid balance were significantly more likely to become ventilator dependent or die (OR: 40.7, 95% CI: 5.3 - 312.9). A fluid restrictive strategy did not reduce the likelihood of recovery from AKI or increase the need for renal replacement therapy.

**Conclusions:** In our cohort, patients with COVID-19 and AKI who survived with minimal or no oxygen requirements tended to have negative fluid balance in contrast to those who died or remained ventilator-dependent. A fluid restrictive strategy with judicious volume removal using diuretics or dialysis may lead to improved outcomes in COVID-19 patients with AKI.

**TH-PO079**

**A Tertiary Care Centre Experience of COVID-19-Associated AKI During the First and Second Waves of the Pandemic**

Maitrayee Kumaresan,<sup>1,2</sup> Phanidhar Mogga,<sup>2</sup> Georgi Abraham,<sup>2</sup> Urjitha Rajagopalan.<sup>2</sup> *<sup>1</sup>University Hospital Lewisham, London, United Kingdom; <sup>2</sup>MGM Healthcare, Chennai, India.*

**Background:** There is a scarcity of information on the incidence and outcomes of acute kidney injury in COVID-19 patients in India. Therefore, we analysed the correlation of AKI risk factors and compared the outcomes of the first and second COVID-19 waves in a tertiary care centre.

**Methods:** •Single centre retrospective analysis •Patients who tested positive for COVID-19 between July 2020 and May 2021, with serum creatinine levels measured on admission (n= 1260). •AKI was defined according to the KDIGO clinical practice guidelines. •Multivariate binomial logistic regression yielded odds ratios for risk variables of AKI. •Age-adjusted odds ratios(OR) were used to compare COVID-19 outcomes between the first and second waves.

**Results: Baseline characteristics:** •Median Age= 56 (IQR 47-66) •Population with diabetes-55.2% •Population with hypertension-42.11% **All AKI** (n=86) •Stage 1 (n=57) •Stage 2 (n=20) •Stage 3 (n=9) **Risk factors for AKI:** •Diabetes OR 1.9 (1.2 - 3.1) •Hypertension OR 3.2 (2.0 - 5.2) •C-reactive protein ≥ 10 mg/dl, OR 3.6 (1.6 - 8.0). •D-dimer ≥ 250 pg/ml, OR 4.2 (2.5 - 6.8). •Need for ventilation OR 3.06 (1.8 - 4.9) **Comparison of COVID -19 outcomes:** Compared to the first wave, the second wave cohort had lower risk for: •Acute kidney injury (adj OR: 0.4; CI: 0.2-0.7) •Mortality (adj OR: 0.2; CI: 0.09-0.7) •Invasive mechanical ventilation (adj OR: 0.2; CI: 0.06 - 0.8) •Length of ICU stay > 5days (adj OR: 0.4; CI: 0.2 - 0.7)

**Conclusions:** In our retrospective study, AKI prevalence was 6.8%, and the mortality rate of 2.9%. Our analysis shows that the second wave of COVID -19 exhibits improved clinical outcomes compared to the first wave

Demographics	First wave		Second wave		P-value
	Mean	Standard deviation	Mean	Standard deviation	
Age in years, mean ± SD	56.86	14.05	54.44	14.48	0.0031
Gender	N	%	N	%	0.1960
Male, n (%)	487	38.70%	314	24.90%	
Female, n (%)	262	20.80%	197	15.60%	
Comorbidities	N	%	N	%	
Hypertension	325	25.80%	206	16.30%	0.2770
Diabetes	391	31.00%	304	24.10%	0.0110
Chronic lung disease	36	2.90%	29	2.30%	0.4940
Hypothyroidism	84	6.70%	58	4.60%	0.9410
Coronary artery disease	64	5.10%	38	3.00%	0.4790
Heart failure	12	1.00%	3	0.20%	0.1030
Ischemic Heart disease	10	0.80%	15	1.20%	0.0450
Dyslipidemia	24	1.90%	29	2.30%	0.0320

Table 1: Characteristics of individuals with COVID-19 infection during the first and second waves of the pandemic.

Clinical outcomes	First wave (n = 745)	Second wave (n = 517)	'Second wave vs. First wave					
	Absolute risk n (%)	Absolute risk n (%)	Risk difference	95% CI	Age adjusted odds ratio	95% CI		
Total number of patients requiring invasive mechanical ventilation	20	6	-0.0150	-0.0546	0.0245	0.2346	0.0072	0.8191
Total number of patients requiring ventilators	352	222	-0.0370	-0.0765	0.0025	0.7848	0.5701	1.0302
Length of ICU stays > 3 days	90	44	-0.0424	-0.0819	-0.0029	0.4406	0.2677	0.7430
Respiratory failure	65	59	0.0283	-0.0112	0.0679	0.8477	0.5217	1.3775
Sepsis	24	4	-0.0243	-0.0638	0.0153	-0.1303	0.0297	0.5709
Acute Kidney Injury (AKI)	56	30	-0.0163	-0.0558	0.0233	0.4267	0.2328	0.7823
Length of Hospital Stay > 3 days	428	465	0.0586	0.0291	-0.1082	2.2569	1.3669	3.7263
Death (fatal event)	27	0	-0.0185	-0.0381	0.0210	0.2328	0.0003	0.7070

Table 2: Clinical outcomes of individuals with COVID-19 during the first and second wave of the pandemic.

**TH-PO080**

**Urine Proteomic Analysis Identifies Interferon Gamma Downstream Chemokine CXCL-9 as a Biomarker for Diagnosis of Acute Interstitial Nephritis**

Dennis G. Moledina,<sup>1</sup> Wassim Obeid,<sup>3</sup> Meghan E. Sise,<sup>2</sup> Ivy A. Rosales,<sup>2</sup> Rex N. Smith,<sup>2</sup> Robert B. Colvin,<sup>2</sup> Michael B. Kuperman,<sup>4</sup> Michael Kashgarian,<sup>1</sup> Gilbert W. Moeckel,<sup>1</sup> Francis P. Wilson,<sup>1</sup> Chirag R. Parikh.<sup>3</sup> *<sup>1</sup>Yale School of Medicine, New Haven, CT; <sup>2</sup>Massachusetts General Hospital, Boston, MA; <sup>3</sup>Johns Hopkins University, Baltimore, MD; <sup>4</sup>Arkana Laboratories, Little Rock, AR.*

**Background:** Targeted analyses have identified TNF-a and IL-9 as diagnostic biomarkers of AIN. However, unbiased analysis may reveal more accurate biomarkers for AIN diagnosis.

**Methods:** In a prospectively enrolled cohort of participants who underwent a kidney biopsy for evaluation of acute kidney disease with adjudicated histological diagnosis, we performed urine proteomics via Olink assay. We validated proteomics findings by developing a sandwich immunoassay in urine, and by examining gene expression in kidney tissue using Nanostring.

**Results:** We observed that 32 (17%) of 184 proteins were significantly different between AIN cases (n=31) and non-AIN controls (n=57). Of these differentially expressed proteins, CXCL-9 had the highest strength of association (Figure). Pathway analysis showed that activation of interferon-γ, the key upstream regulator of CXCL9, explained observed changes in the urine proteome. Using a sandwich immunoassay, we showed that CXCL-9 was 6-fold higher in AIN cases (n=32) than non-AIN controls (n=186). Participants in the top quartile of CXCL-9 had higher odds of AIN than those in the bottom quartile after controlling for a diagnostic model for AIN (adj. OR, 5.9 (95% CI, 1.8, 20)) with an AUC of 0.82 (0.74, 0.89). Finally, CXCL-9 expression was higher in kidney tissue from patients with drug-induced AIN as compared to those with diabetes, acute tubular injury, or healthy kidney donors.

**Conclusions:** Using urine proteomics, we identified CXCL-9 as a novel biomarker for AIN diagnosis. We validated the association of CXCL-9 using immunoassay and kidney tissue expression data.

**Funding:** NIDDK Support

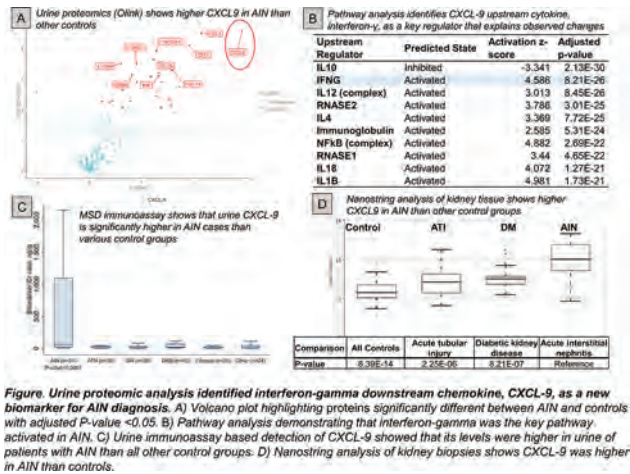

TH-PO081

Olfactomedin 4 as a Loop of Henle-Specific AKI Biomarker That Predicts Furosemide Response

Denise C. Hasson,<sup>1</sup> Kelli A. Krallman,<sup>1</sup> Bin Zhang,<sup>1</sup> Katherine A. Vandenheuvell,<sup>1</sup> Shina Menon,<sup>2</sup> Kristalynn M. Kempton,<sup>1</sup> Prasad Devarajan,<sup>1</sup> Stuart Goldstein,<sup>1</sup> Matthew N. Alder,<sup>1</sup> <sup>1</sup>Cincinnati Children's Hospital Medical Center, Cincinnati, OH; <sup>2</sup>Seattle Children's Hospital, Seattle, WA.

**Background:** Acute kidney injury (AKI) is associated with bad outcomes. Olfactomedin 4 (OLFM4) is a glycoprotein expressed in neutrophils and stressed epithelial cells. In septic animals, OLFM4 expression localized to the loop of Henle (LOH). OLFM4 null septic murine pups had higher renal cell apoptosis and plasma creatinine. We hypothesized urine OLFM4 (uOLFM4) will increase in patients with AKI, and if localized to the LOH in humans, predict furosemide response.

**Methods:** A retrospective study used urine samples based on AKI and sepsis status from day 1 of intensive care unit (ICU) admission from a single center repository. A prospective validation study used convenience urine from ICU patients (pts). uOLFM4 was tested with a custom bead based Luminex immunoassay. Demographic, lab data (NGAL), were collected from the medical record. AKI was defined by KDIGO stage 2-3 (severe) creatinine criteria. Immunofluorescence on biopsies from pts with kidney injury was performed with antibodies for uromodulin, OLFM4. Furosemide response was >3 mL/kg/hr of urine made in 4 hrs after 1mL/kg IV furosemide given for clinical need. Mann Whitney U, Kruskal Wallis tests were performed, and linear mixed modeling accounted for lack of independence.

**Results:** Pts with severe AKI had higher uOLFM4 (retrospective, n=36, p=0.04; prospective, n=178, p=0.007). Although uOLFM4 and urine NGAL correlated (r 0.40, p<0.0001), some pts had high uOLFM4 and low NGAL and vice-versa. On biopsy, OLFM4 signal colocalized with uromodulin, suggesting OLFM4 localizes to human LOH. uOLFM4 was higher in pts who were unresponsive to furosemide (p=0.04), AUC 0.75 (95% CI, 0.60-0.90); NGAL was not.

**Conclusions:** Severe AKI is associated with increased uOLFM4. OLFM4 colocalized to human LOH; higher uOLFM4 associated with furosemide resistance. OLFM4 may be a novel LOH-specific AKI biomarker that warrants further testing to determine whether it may enhance identification of pts likely to benefit from early kidney replacement therapy.

**Funding:** Other NIH Support - NIGMS

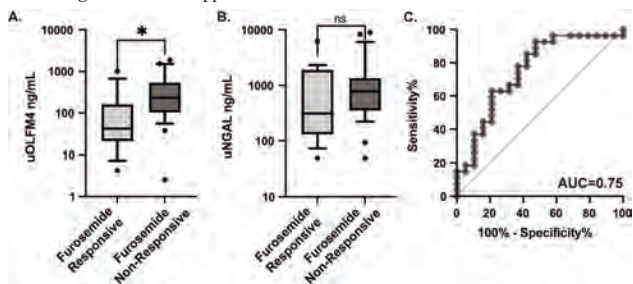

TH-PO082

Carcinoid Tumor Causing Cardiorenal Syndrome

Zachary A. Hansen, Adrian J. Baudy. Tulane University, New Orleans, LA.

**Introduction:** Carcinoid tumors are a rare condition that most commonly occurs in the gastrointestinal tract and presents as flushing, diarrhea, and hypotension. Occasionally, it can develop into carcinoid heart disease causing heart failure. This places patients at risk of developing cardiorenal syndrome (CRS) where dysfunction in the heart causes dysfunction in the kidney. CRS has traditionally been attributed to decreased renal perfusion from left heart failure (LHF) but there is now evidence that venous

congestion from right heart failure (RHF) is a major cause and has been termed congestive nephropathy. Here, we describe a previously unreported case of carcinoid heart disease causing right sided cardiorenal syndrome.

**Case Description:** 70 year old male with heart failure (EF 60-65%), tricuspid regurgitation, carcinoid tumor with liver and mesenteric metastases presented with worsening upper and lower extremity edema, abdominal swelling and dyspnea for 1 week. On exam, he was hypotensive and hypoxic with Jugular venous distention, ascites and +3 lower extremity edema. Labs showed creatinine of 3.4 and BUN 144, from a baseline of 1.4 and 40 respectively. Chest x-ray showed bilateral pleural effusions. He was admitted to the ICU and diagnosed with CRS. He was treated with Milrinone, dobutamine and furosemide and initially had good urine output but it decreased over the next two days. Intrarenal venous doppler showed discontinuous waveforms consistent with congestive nephropathy. Diuretics were increased to a maximum daily dose of 320mg furosemide, 10mg metolazone and 500mg acetazolamide as well as norepinephrine, dobutamine and milrinone with minimal improvement in urine output. He was started on CRRT for volume removal, but his clinical condition deteriorated, and he died a few days later.

**Discussion:** To our knowledge, this is the first reported case of right heart failure causing cardiorenal syndrome as a direct result of carcinoid heart disease. Carcinoid tumors are an uncommon neuroendocrine disorder that rarely affects the heart. Cardiorenal syndrome is a familiar condition but is typically attributed to left rather than right heart failure. This case demonstrates a previously unreported combination of cardiorenal syndrome due to right heart failure caused by carcinoid heart disease. It also emphasizes the difficulty in management and the need for further studies regarding congestive nephropathy from right heart failure.

TH-PO083

AKI in Patients With SARS-CoV-2 Is Significantly Associated With Mitochondrial Dysfunction and ER Stress

Pushkala Jayaraman,<sup>1</sup> Ishan Paranjpe,<sup>1</sup> George Vasquez-Rios,<sup>1,2</sup> Sergio Dellepiane,<sup>1,2</sup> Girish N. Nadkarni.<sup>1,2</sup> Augmented Intelligence in Medicine at Mount Sinai Group (AIMS group at D3M, MSSM) <sup>1</sup>Cahn School of Medicine at Mount Sinai, New York, NY; <sup>2</sup>Department of Medicine, Mount Sinai, New York, NY.

**Background:** AKI is a common complication of COVID-19. The peripheral blood molecular signatures are unknown and could unveil potential therapeutic targets.

**Methods:** We enrolled a prospective patient cohort of 283 patients with COVID-19 (Mar 24-Aug 26, 2020), with blood samples from Mount Sinai Biobank. We determined AKI severity using KDIGO criteria on admission parameters. 31 patients with severe AKI (AKI 2-3) were defined as cases. We then performed bulk peripheral RNA sequencing and fit a multivariate linear regression model adjusting for key covariates. We also performed cell-type deconvolution following to adjust for neutrophils, and whole blood cells. We considered a significant p-value (0.05) after Bonferroni correction and then used ingenuity pathway analysis (IPA) to analyze differentially expressed genes.

**Results:** Patients who developed AKI were significantly older (67 vs. 60 yrs.) and had a greater prevalence of type 2 diabetes (37% vs 20%), and chronic kidney disease (20% vs 4%) vs. controls. Of the 18539 genes in the analysis, 1597 were upregulated and 1267 were downregulated after Bonferroni correction. Top canonical pathways (Fig 1) showed significantly downregulated genes including EIF2, eIF4, and p70S6K via activation of ATF6, a marker of ER stress. Potential mechanisms displayed by our analyses include upregulation of the NF-KB inhibitor and IL6 pathways. Genes involved in oxidative Phosphorylation and mitochondrial dysfunction were heavily downregulated and there was upregulation of markers of kidney cell necrosis. In contrast, upregulated genes CRK and TIMP2 have been previously implicated in kidney injury and progression. Downregulated mTOR pathway is responsible for the activation of the ER stress response via the eIF2/4 complex which is also supported by our finding of upregulated NRF2-transcriptional pathway.

**Conclusions:** Transcriptomic analysis of AKI in COVID-19 revealed evidence of mitochondrial dysfunction driven by ER stress and immune-mediated pathways. Addressing these pathways could aid development of targeted therapies.

**Funding:** NIDDK Support

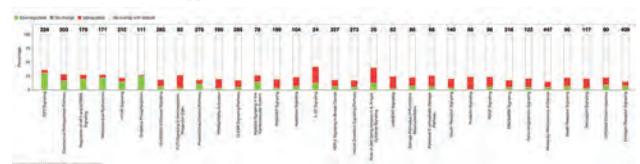

TH-PO084

Potential Regulator of KIM-1 Mediated Autophagy

Yilong Li,<sup>1</sup> Elena Tutunea-Fatan,<sup>1,2</sup> Lakshman Gunaratnam.<sup>1,2</sup> <sup>1</sup>Western University, London, ON, Canada; <sup>2</sup>Lawson Health Research Institute, London, ON, Canada.

**Background:** Kidney injury molecule 1 (KIM-1) is a phosphatidylserine receptor expressed on injured proximal tubule epithelial cells (PTECs) during acute kidney injury (AKI). KIM-1 mediates the phagocytic clearance of apoptotic cells by PTECs and targets the engulfed apoptotic corpses to autophagosomes by triggering autophagy. However, the detailed signaling mechanisms are poorly understood. This study aims to uncover KIM-1-interacting proteins that regulate autophagy in PTECs.

**Methods:** KIM-1 immunoprecipitates from human PTECs (HK-2), which endogenously express KIM-1, stimulated with apoptotic cells were separated using SDS-PAGE. The bands of putative KIM-1 interacting proteins were visualized using Coomassie blue staining and analyzed using liquid chromatography with tandem mass spectrometry. Proteins were identified using PEAKS DB proteomics software, which uses *de novo* sequencing assisted database searching. Protein-protein interactions were confirmed using western blot analysis.

**Results:** The immunoprecipitation of KIM-1 was confirmed by both western blot and mass spectrometry analyses, in which KIM-1 was only present in the anti-KIM-1 group and absent in the IgG control. We identified the phosphoinositide-3-kinase regulatory subunit 4 (PIK3R4) with a PEAKS peptide score of 99.1 (minimum threshold at 26.7) and a sequence coverage of 6%. Western blot analysis showed that PIK3R4 co-immunoprecipitated with KIM-1 in both apoptotic cells-stimulated and unstimulated HK-2 cells.

**Conclusions:** PIK3R4 interacts with KIM-1 constitutively in PTECs. It has previously been implicated in the regulation of autophagy including autophagosome formation and endocytic trafficking but not in PTECs. Further investigation will elucidate whether PIK3R4 is required for KIM-1 mediated autophagy.

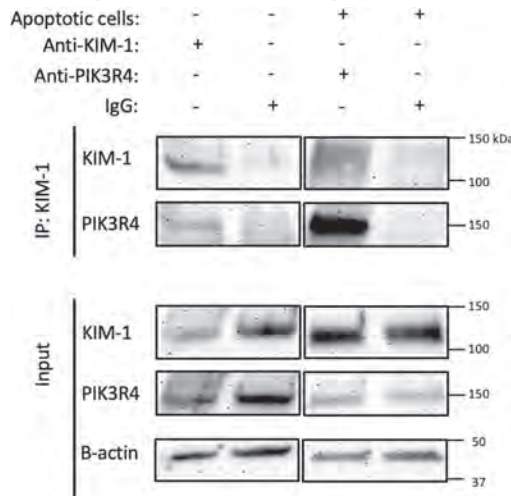

**Figure 1.** Co-immunoprecipitation of KIM-1 and PIK3R4 from HK-2 cells.

**TH-PO085**

**Prerenal Azotemia Triggers the Hepatic Acute Response in a Novel, Clinically Defined Murine Model**

Kayo Okamura, Sizhao Lu, Zhibin He, John R. Montford, Mary C. Weiser-Evans, Sarah Faubel. *University of Colorado, Denver, CO.*

**Background:** Prerenal azotemia (PRA) is uncommonly studied in murine models and is thought to be systemically inert. We developed a novel murine model of PRA that met the current clinical definition in humans: Decreased GFR that returns to baseline with restoration of hemodynamics. Since plasma IL-6 is elevated during AKI, in part due to reduced GFR and is the major mediator of the hepatic acute phase response, we hypothesized that PRA would result in elevated plasma levels of IL-6 and hepatic production of acute phase proteins.

**Methods:** Mice: C57Bl/6J. Interventions: 4 mg of furosemide IP (PRA) or vehicle (Veh) at time 0 hours and 3 hours in wild type (WT) and *IL-6*<sup>-/-</sup> mice; at 6 hours, resuscitation was started with 1 mL IP saline x 4 over 36 hours. Measurements: transdermal measured glomerular filtration rate (tGFR) at baseline, 6 and 48 hours; all other measurements at 6 hours that included: plasma IL-6, NGAL, CXCL1, and haptoglobin, and hepatic tissue RNaseq.

**Results:** tGFR was 30% of normal at 6 hours and returned to baseline at 48 hours. At 6 hours, plasma IL-6 was significantly increased, renal and liver histology were normal, renal and liver lactate were normal, and renal KIM-1 IF was normal. By RNaseq, 587 differentially regulated genes were significantly changed in the liver in WT PRA versus WT Veh; 327 genes were significantly upregulated and 260 were significantly suppressed; the acute phase response was the most significantly upregulated pathway. 25% of upregulated genes in the liver were reduced in *IL-6*<sup>-/-</sup> PRA, and the acute phase response was the most significantly downregulated pathway. Hepatic gene expression and protein levels were determined for 3 of the significantly upregulated genes: NGAL, CXCL1, and haptoglobin; gene expression and plasma protein levels were all increased in WT PRA versus WT Veh and were all reduced in *IL-6*<sup>-/-</sup> PRA versus WT PRA.

**Conclusions:** These data demonstrate previously unknown systemic effects of PRA, demonstrating that significant consequences may occur with the sudden loss of GFR in the absence of tubular injury. Since it is widely thought that the systemic consequences of AKI are predominantly associated with tubular injury, these data change the paradigm by which the consequences of PRA should be considered.

**TH-PO086**

**Mechanisms of Difference in AKI-CKD Transition due to Acute Cardiorenal Syndrome and Ischemia-Reperfusion Injury**

Yoshio Funahashi,<sup>1,2</sup> Jessica F. Hebert,<sup>1,2</sup> Adam C. Munhall,<sup>1,2</sup> Megan N. Nickerson,<sup>1,2</sup> Michael Hutchens.<sup>1,2</sup> <sup>1</sup>Oregon Health & Science University, Portland, OR; <sup>2</sup>Portland VA Medical Center, Portland, OR.

**Background:** Cardiorenal syndrome type 1 (CRS1) is acute kidney injury (AKI) due to acute heart failure. Heart-specific cardiac LIM protein (CSRP3) is released into the plasma after cardiac arrest and is differentially endocytosed in the proximal tubule depending on megalin. We hypothesized that the phenotype of AKI-CKD transition differs between cardiac arrest and cardiopulmonary resuscitation (CA/CPR) and kidney-only ischemia due to renal uptake of heart-specific CSRP3.

**Methods:** 8 to 12 weeks old C57BL/6J male mice and inducible proximal tubule-specific megalin knockout (iMegKO) mice (with littermate controls) were subjected to 8-minute CA/CPR or bilateral renal pedicle occlusion (IRI) with multiple durations. Glomerular filtration rate (GFR) and other outcomes were measured 24h and 49 days later.

**Results:** 24h GFR was equivalent between 27-minute IRI and 8-minute CA/CPR. 8-minute IRI, the same ischemia duration as CA/CPR, resulted in higher 24h GFR than CA/CPR. 49 days after surgery, CA/CPR induced GFR was lower, and blood urea nitrogen (BUN) and cystatin-C (Cys-C) were higher than 8min IRI, suggesting milder chronic injury from 8min IRI. GFR, BUN and Cys-C were not different between CA/CPR and 27min IRI although survival. IRI induced late albuminuria and proteinuria, but CA/CPR did not. Cardiac CSRP3 was elevated after CA/CPR but not after IRI. Injection of recombinant CSRP3 after 8min IRI reduced the GFR 49 days following injection compared with 8min IRI. CA/CPR-exposed iMegKO mice demonstrated increased GFR compared to controls identical to that of 8min IRI compared with 8min CA/CPR. Inducible, cardiac-specific CSRP3 knockout (iCSRP3 KO) mice exhibited cre-recombinase expression and floxed *Csrp3* genotype.

**Conclusions:** Cardiorenal AKI and focal ischemia (IRI)-induced AKI demonstrated different phenotypes in AKI-CKD transition, with different degrees of chronic filtration loss and albuminuria. CSRP3 may mediate this different phenotype. iCSRP3 KO mice are expected to delineate this important mechanism.

**Funding:** Veterans Affairs Support

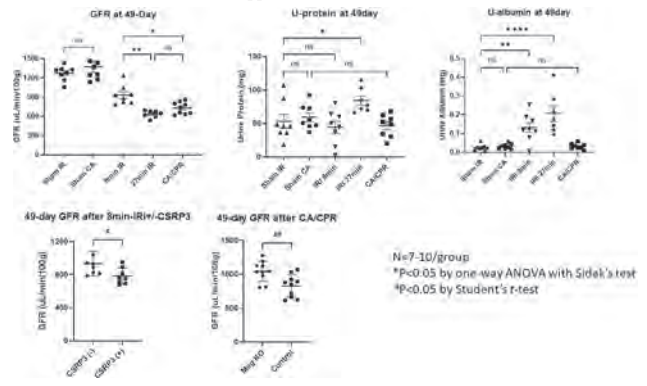

**TH-PO087**

**Casual Association of Oxidative Stress With Cardiorenal Syndrome in Pulmonary Hypertension: An Experimental Investigation and Its Clinical Implications**

Firoozeh Farahmand. *Saint Louis University, Saint Louis, MO.*

**Background:** AKI due to pulmonary hypertension (PH) has been associated with an increase in mortality. Studies have shown 36% of the patients with AKI and PH died in the hospital compared with 5% in the PH group who did not develop AKI and retrospective study of hospitalized patients and PH registries shows AKI and CKD in 4%-50% of patients and renal insufficiency associates with poor prognosis. However, there is hardly any data available regarding pathogenesis of complex interplay of kidney, lung and the heart. To investigate experimental model of PH without left ventricular failure is essential to develop novel therapeutic targets.

**Methods:** In a chemically induced experimental model of PH with right ventricle (RV) dysfunction and AKI in rats we investigated whether antioxidant has cardiorenal protective effect & would this treatment modify oxidative stress in kidney & heart. Rats were divided into 3 groups ; control, CRS and CRS+ Antioxidant Prob (treated 1 wk pre & 1 wk post chemical injection). Rats were assessed with serial doppler echo for 3 wk to monitor PH via Pulmonary Artery Acceleration (PAAT), ejection fraction (EF) & RV hypertrophy (RVH). At 3 wk heart & kidney tissue and plasma were used to analyze antioxidant enzymes; superoxide dismutase (SOD) and glutathione peroxidase (GSHPx), as well as lipid peroxidation to assess oxidative stress. After sacrificing animals, hearts and kidneys were removed for histopathology. To assess congestion, pieces of tissue from the lung, kidney and the RV were removed to obtain the wet/dry weight ratio.

**Results:** In 3 wk, CRS group showed signs of progressive respiratory distress & doppler Echo demonstrated decrease in PAAT an indication of pulmonary hypertension, increase RVSP & normal EF. Oxidative stress in kidney and the RV was associated with decrease in antioxidant enzyme activities of SOD and GSHPx. Light and electron

microscopy of the Kidney showed ATN. Wet/dry weight showed mild congestion in the lung but not in the kidney and the heart. In CRS+ antioxidant PROB these changes were not observed.

**Conclusions:** Cardiorenal protective effect of antioxidant and absence of renal congestion- a potential contributor in CRS- suggest a cause-effect relationship between oxidative stress and CRS in PH. Targeting oxidative stress may lead to novel therapeutic strategies to improve outcome.

#### TH-PO088

##### Diabetes and Obesity Increase the Severity of Ischemia-Reperfusion Induced AKI in ZSF1 Rats

Li-Jun Ma,<sup>1</sup> Fuyong Du,<sup>1</sup> Kamal Albarazani,<sup>1</sup> Jianying Liu,<sup>1</sup> Qiu Li,<sup>1</sup> Lili Guo,<sup>1</sup> Jenson Qi,<sup>1</sup> George Ho,<sup>1</sup> Rong Meng,<sup>1</sup> Tao Chen,<sup>2</sup> Raul Camacho,<sup>1</sup> Andrea R. Nawrocki.<sup>1</sup> <sup>1</sup>Cardiovascular, Metabolism, and Retina at The Janssen Pharmaceutical Companies of Johnson & Johnson, Spring House, PA; <sup>2</sup>Preclinical Sciences and Translational Safety at Janssen, Johnson & Johnson, Spring House, PA.

**Background:** Acute kidney injury (AKI) is a multifactorial disease with various etiologies including cardiac surgery and sepsis. Preclinical AKI is typically induced in young and healthy rodents and the predictive value of preclinical AKI models for drug discovery is unclear. Obese, diabetic ZSF1 rats display multiple preexisting metabolic complications including kidney dysfunction. We show that obese, diabetic ZSF1 rats are more susceptible to ischemia reperfusion injury (IRI) induced-renal function decline and tubular injury compared to lean, non-diabetic ZSF1 rats.

**Methods:** AKI was induced in male, obese, diabetic ZSF1 (CRL) or age-matched, lean ZSF1 rats at age of 17-18 weeks by unilateral IRI with uninephrectomy (Unx) and followed for 1 or 7 days. Renal function was assessed by transcutaneous glomerular filtration rate (tGFR, FITC-labeled sinistrin, Medibeacon) and plasma creatinine (LC/MS). Urinary Nephrocheck, gene expression and kidney histology were assessed.

**Results:** 24 hrs post IRI surgery, glomerular filtration rate (tGFR) was dramatically decreased in both obese ZSF1 Unx/IRI and lean ZSF1 Unx/IRI groups compared to controls. Further, IRI in obese ZSF1 rats caused significantly greater renal function decline indicated by plasma creatinine, and more severe tubular necrosis. Tubular injury marker genes (Kim1, NGAL) were upregulated in kidney, while mitochondrial genes (mdufa2, uqcrs1, ATP5g1, PPARgc1) and tubular integrity marker genes (AQP1, rGT1) were downregulated to a greater extent in obese vs lean ZSF1 IRI kidneys. Urinary Nephrocheck levels were higher in obese vs lean ZSF1 rat IRI. The decline in kidney function persisted in obese ZSF1 IRI rats but recovered in lean ZSF1 IRI rats from day 3 to 7. Overall, we observed 25% mortality in obese ZSF1 rats with Unx/IRI while the moderate AKI was reversed in lean rats after IRI surgery without progression to kidney failure.

**Conclusions:** Our data indicate that obese and diabetic ZSF1 rats with underlying metabolic disease and albuminuria exhibit severe renal function decline after a single, moderate ischemic episode relative to non-diabetic, lean counterparts. Our data suggest that typically used rodent IRI models for AKI do not represent the full spectrum of the human disease.

**Funding:** Commercial Support - Johnson & Johnson

#### TH-PO089

##### Blue Kidney With Repaired Valve

Kanza Haq, Alana Dasgupta, S.M. Bagnasco, Samir C. Gautam. Johns Hopkins University, Baltimore, MD.

**Introduction:** Renal hemosiderosis has been reported in diseases characterized by chronic intravascular hemolysis but it is a relatively rare finding following cardiac valve repair

**Case Description:** 70-year-old male with a history of CKD stage IIIA2 presented for evaluation of worsening renal function. Pertinent past medical history includes hypertension and mitral valve annuloplasty performed 20 years prior. Serum creatinine had gradually increased from 1.6 mg/dL to 2.3 mg/dL. Urinalysis was consistently notable for hemoglobin pigment with intermittent microscopic hematuria. Serological workup was negative. Laboratory studies were also notable for anemia (hemoglobin 10.7 g/dL), elevated reticulocyte count (4.9%), elevated LDH (1174 U/L), and low haptoglobin (< 3mg/dL). Echocardiogram showed moderate to severe mitral valve regurgitation. Percutaneous renal biopsy revealed proximal tubule epithelial cells containing brown, granular pigment within the cytoplasm (Fig 1), which stains blue with the Prussian blue iron stain (Fig 2). He was ultimately referred to cardiac surgery for consideration of mitral valve replacement.

**Discussion:** Intravascular hemolysis is a well-recognized complication after prosthetic cardiac valve replacement or repair. Recurrent, or residual valvular regurgitation can cause serious mechanical hemolysis as regurgitant flow creates high shear stress that results in fragmentation of red blood cells. The chemically active iron in hemosiderin can cause tubular damage through various mechanisms.

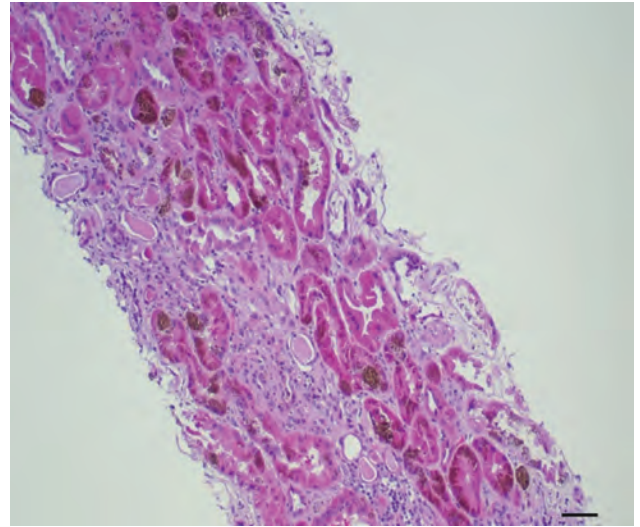

Figure 1

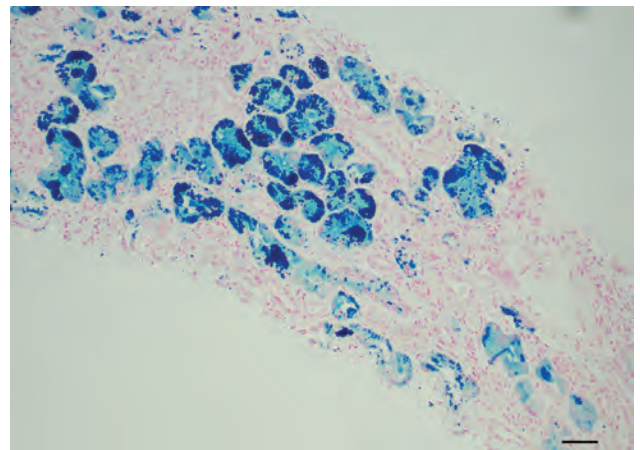

Figure 2

#### TH-PO090

##### Double-Stranded DNA-Induced AIM2 Pyroptosis Limits Excessive Inflammation During Rhabdomyolysis-Induced AKI

Chintogtokh Baatarjav, Takanori Komada, Masafumi Takahashi. Jichi Ika Daigaku, Shimotsuke, Japan.

**Background:** Rhabdomyolysis-induced acute kidney injury (RIAKI) is a severe complication of rhabdomyolysis, reportedly in part via double-stranded DNA (dsDNA) released from necrotic muscle. A dsDNA-sensor absent in melanoma 2 (AIM2) engages inflammasome activation, leading to maturation of IL-1 $\beta$  and gasdermin D (GSDMD)-dependent pro-inflammatory cell death called pyroptosis. The role of AIM2-mediated pyroptosis during RIAKI remains unknown.

**Methods:** C57BL/6J-background wild type (WT) and Aim2-knockout (Aim2-KO) mice underwent intramuscular glycerol injection to induce RIAKI. Isolated kidney macrophages and bone marrow-derived macrophages were subjected to dsDNA-induced pyroptosis assays in vitro.

**Results:** A specific endonuclease for dsDNA, DNase-I, effectively ameliorated tubular injury and inflammation during RIAKI, corroborating that dsDNA is a critical danger molecule of RIAKI. TUNEL staining and immunoblotting for GSDMD in RIAKI kidneys demonstrated massive macrophage pyroptosis in WT, and Aim2-KO diminished this response. While pyroptosis was suppressed, Aim2-KO kidneys displayed abnormally more macrophage accumulation than WT. Aim2-KO promoted RIAKI by TANK-binding kinase 1 (TBK1)-NF- $\kappa$ B signalling and recruited more CD206<sup>+</sup>CXCR3<sup>+</sup> macrophages, resulting in excessive kidney inflammation, fibrosis, and sustained kidney dysfunction. In vitro study, dsDNA induced swift pyroptotic cell death in kidney macrophages without releasing IL-1 $\beta$ . Aim2-KO macrophages were devoid of pyroptosis in response to dsDNA. These surviving Aim2-KO macrophages alternatively developed STING-TBK1-IRF3/NF- $\kappa$ B activation, and secreted IFN $\beta$  and TNF $\alpha$ . Conditioned medium of dsDNA-treated Aim2-KO macrophages, not WT macrophages, upregulated pro-inflammatory genes on macrophages and kidney tubular epithelial cells. These results indicate pro-inflammatory functions of Aim2-deficient macrophages escaped from pyroptosis.

**Conclusions:** Aim2 deficiency worsens inflammation and fibrosis of RIAKI despite reduced macrophage pyroptosis. Macrophage survivors lacking Aim2 potentiate

inflammation on surrounding cells. dsDNA-induced, AIM2-dependent macrophage pyroptosis potentially provides a resolution of inflammation and determines the healing process of RIAKI.

**Funding:** Government Support - Non-U.S.

**TH-PO091**

**Magnetic Resonance Imaging (MRI) Contrast Agent Safety: Speciating Intracellular Gadolinium-Rich Nanoparticles in Human and Rodent Kidneys**

Brent Wagner,<sup>1,2</sup> G. P. Escobar,<sup>1,2</sup> Joshua Deaguero,<sup>1,2</sup> Karol Dokladny,<sup>1,2</sup> Tamara A. Howard,<sup>1</sup> James H. Degan,<sup>5,2</sup> John D. Watt,<sup>3,4</sup> Adrian Brearley,<sup>6</sup> Kidney Institute of New Mexico <sup>1</sup>University of New Mexico Health Sciences Center, Albuquerque, NM; <sup>2</sup>New Mexico VA Health Care System, Albuquerque, NM; <sup>3</sup>Center for Integrated Nanotechnologies, Albuquerque, NM; <sup>4</sup>Los Alamos National Laboratory, Los Alamos, NM; <sup>5</sup>University of New Mexico Department of Mathematics and Statistics, Albuquerque, NM; <sup>6</sup>University of New Mexico Department of Earth & Planetary Sciences, Albuquerque, NM.

**Background:** The leitmotifs of MRI contrast agent-induced complications are kidney injury, symptoms associated with gadolinium (Gd) exposure (SAGE), Gd encephalopathy, and 'nephrogenic' systemic fibrosis. Despite evidence that Gd is retained intracellularly, disinherited patients flock to unproven therapies (e.g. chelation).

**Methods:** Patient kidneys ( $n = 5/5$  contrast-exposed and naïve) were obtained from the University of New Mexico Health Sciences Center Human Tissue Repository. Inductively-coupled plasma mass spectroscopy was performed with a NexION 300D (PerkinElmer). Energy-dispersive x-ray spectroscopy was performed using a JEOL NEOARM 200 kV aberration correction scanning transmission electron microscope (human).

**Results:** Gd mineralized into nanoparticles throughout the renal cortex, particularly intralysosomal in the proximal tubular epithelia. By multivariable linear regression, gadolinium was positively correlated with phosphorus (P), oxygen (O), and magnesium (P < 0.001). Gd as a function of P and O was the optimal model based on Akaike information criterion (AIC) reduction.

**Conclusions:** Gd mineralizes intracellularly in kidneys. This has ramifications for all MRI contrast agents and purported SAGE therapies such as chelation.

**Funding:** NIDDK Support, Other NIH Support - UL1TR001449, Veterans Affairs Support, Other U.S. Government Support, Private Foundation Support

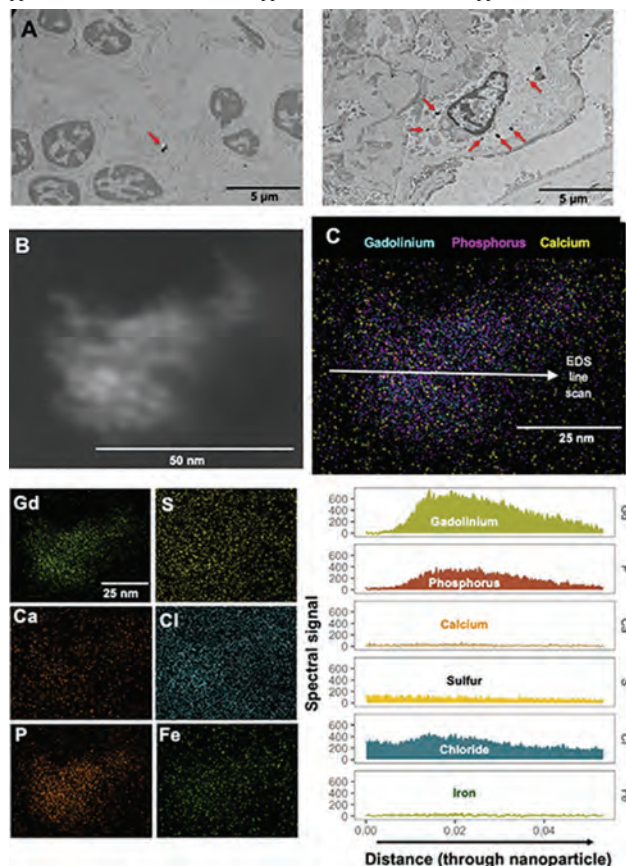

**Speciation of a gadolinium-rich nanoparticle in human kidney.** A. Intracellular electron-dense material in kidney, including a glomerular podocyte (right). B. (Top) High magnification image of an electron density in patient tissue shown in A. (Bottom) 2-dimensional (2D) EDS spectral map for gadolinium (Gd), sulfur (S), calcium (Ca), chlorine (Cl), phosphorus (P), and iron (Fe). C. Energy-dispersive x-ray spectroscopic (EDS) line scan through the electron density in B (top).

**TH-PO092**

**Detecting the Metabolism of Gadolinium-Based Contrast Agents Using Electron Paramagnetic Resonance (EPR) Spectroscopy**

Brent Wagner,<sup>1,2</sup> Emily Hong,<sup>2,4</sup> Jing Yang,<sup>3</sup> Karol Dokladny,<sup>2,1</sup> Joshua Deaguero,<sup>2,1</sup> G. P. Escobar,<sup>2,1</sup> Kidney Institute of New Mexico <sup>1</sup>New Mexico VA Health Care System, Albuquerque, NM; <sup>2</sup>Kidney Institute of New Mexico, Albuquerque, NM; <sup>3</sup>University of New Mexico Department of Chemistry and Chemical Biology, Albuquerque, NM; <sup>4</sup>University of New Mexico School of Medicine, Albuquerque, NM.

**Background:** Magnetic resonance imaging (MRI) contrast agents cause kidney injury, symptoms associated with gadolinium (Gd) exposure (SAGE), and 'nephrogenic' systemic fibrosis. Contrast agents are multidentate complexes designed to chelate Gd to 1) reduce free ion toxicity and 2) enhance renal elimination. Whether liberation of Gd from these complexes is a mechanistic step of disease has yet to be proven.

**Methods:** Mice were administered MRI contrast agent as per routine in our laboratory. Room temperature solution EPR spectroscopy was performed using a Bruker EMX spectrometer with associated Bruker magnetic control electronics and microwave bridges. The microwave frequency was ~9.4 GHz, field attenuation 20-25 dB, modulation amplitudes 6 - 10G,  $3.17 \times 10^5$  gain, and up to 16 scans.

**Results:** The  $g$  values for Dotarem (macrocyclic) and Omniscan (open-chained) were  $1.9791 \pm 0.0025$  (mean, S.D.) and  $1.9374 \pm 0.0040$ , respectively. The  $g$  values for Omniscan and Dotarem did not change significantly regardless of freezing/thawing. Concentrated HCl altered the EPR spectra of gadolinium-based contrast agent regardless of class. The EPR spectra remained unchanged in mouse urine days after last administration.

**Conclusions:** The healthcare system largely disinherits individuals with gadolinium-induced complications, many of whom seek off-label therapies such as metal chelation. The affinities of proprietary chelates for gadolinium will not govern equilibrium (chelate-bound metal) as gadolinium precipitates into insoluble minerals according to Le Chatelier's principle. These discoveries provide the foundation for developing rational therapies and improving the safety of magnetic resonance imaging contrast agents.

**Funding:** NIDDK Support, Other NIH Support - UL1TR001449, Veterans Affairs Support, Other U.S. Government Support, Clinical Revenue Support

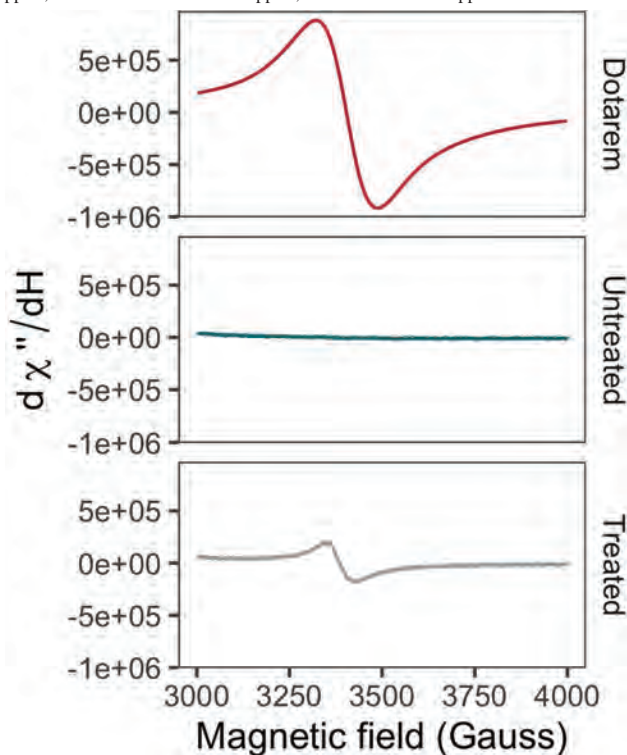

EPR spectra of Dotarem and urine from a single gadolinium-treated mouse.

**TH-PO093**

**Cold Storage-Mediated Global (Phospho)Proteome Changes Following Kidney Transplantation**

Nirmala Parajuli, Parajuli Research Team *University of Arkansas for Medical Sciences, Little Rock, AR.*

**Background:** Extended cold storage (CS) of deceased donor kidney is associated with poor long-term outcome following transplantation. Previously, we showed impaired protein homeostasis and graft dysfunction following 18-hr CS combined with transplantation. However, the precise mechanisms responsible for this CS-mediated renal

graft damage are largely unknown. We hypothesize that CS contributes to covalent post-translational modification of renal proteins leading to impaired protein homeostasis after transplantation.

**Methods:** Isolated donor rat kidneys were cold-stored for 0- or 18-hr followed by transplantation to recipient rats. Kidney transplant homogenates were digested and the resulting peptides were labeled using a tandem mass tag 10-plex isobaric label reagent set and enriched using phosphopeptide enrichment kits. Both enriched and un-enriched isobaric labeled peptides were employed for mass spectrometric analysis. Differential expression and enrichment analyses were performed on (phospho) proteomics data individually followed by integrative analysis.

**Results:** Quantitative proteomics data revealed that 18-hr CS plus transplantation (CS+transplant) resulted in the significant dysregulation of 378 or 256 renal proteins (Log<sub>2</sub> FC = 1, Adjusted p value = 0.05) when compared to sham or autotransplantation (ATx; transplant with 0-hr CS), respectively. Gene set enrichment analysis of renal proteomes showed activation of 12 pathways (e.g., complement and coagulation) and suppression of 15 pathways (e.g., glutathione) in the CS+transplant group when compared to sham or ATx groups. Differential abundance analysis with phosphoproteomics data showed that 232 or 143 proteins were differentially phosphorylated in the CS+transplant group when compared to the sham or ATx group, respectively. Integrated analysis of differentially regulated global proteomes (N=378 or N=256) and phosphoproteomes (N=232 or N=143) identified only 8 or 2 renal proteins that were differentially phosphorylated when comparing CS+transplant with the sham or ATx groups, respectively.

**Conclusions:** These data suggest, for the first time, that CS contributes to altered renal (phospho) proteomes, which may lead to disrupted protein homeostasis and graft dysfunction. New studies designed to target the affected renal phosphoproteomes during CS may have promising therapeutic implications for prolonging outcome after renal transplantation.

**Funding:** NIDDK Support, Private Foundation Support

### TH-PO094

#### Gut Microbiota Derived D-Alanine Ameliorates Kidney Damage via Protection of Mitochondria in Murine AKI

Yasunori Iwata, Yusuke Nakade, Takashi Wada. *Kanazawa Daigaku, Kanazawa, Japan.*

**Background:** We have previously reported that the gut microbiota produces various D-amino acids including D-Serine (Ser) and D-Alanine (Ala) in a murine acute kidney injury (AKI) model. D-Ser showed the renoprotective effect on ischemia-reperfusion (I/R) induced kidney injury. Here, we further explored the pathophysiological role of D-Ala in AKI.

**Methods:** We analyzed transcripts of the N-methyl-D-aspartate (NMDA) receptor, a receptor for d-Ala, in tubular epithelial cells (TECs). The therapeutic effect of D-Ala was then assessed in vivo and in vitro. Finally, the plasma level of d-Ala was evaluated in patients with AKI.

**Results:** The *Grim* genes encoding NMDA receptor subtypes were expressed in TECs. D-Ala protected TECs from hypoxia-related cell injury and induced proliferation after hypoxia. D-Ala inhibits reactive oxygen species (ROS) production and improves mitochondrial membrane potential, through NMDA receptor signaling. The ratio of D-Ala to L-Ala was increased in feces, plasma, and urine after the induction of I/R. Moreover, Enterobacteriaceae produce D-Ala. Oral administration of D-Ala ameliorated kidney injury after the induction of I/R in mice. Deficiency of NMDA subunit NR1 in tubular cells worsened kidney damage in AKI. In addition, the plasma level of d-Ala was increased and reflected the level of renal function in patients with AKI.

**Conclusions:** D-Ala ameliorates I/R-induced kidney injury via protection of mitochondria. The plasma level of d-Ala reflects the estimated glomerular filtration rate in patients with AKI. D-Ala could be a promising therapeutic target and potential biomarker for AKI.

### TH-PO095

#### Dietary Modification of Fat and Protein Composition and Its Effects on the Repair of Ischemic AKI

Junseok Jeon,<sup>1</sup> Yunsoo Lee,<sup>1</sup> Minsuk Seo,<sup>1</sup> Kyungho Lee,<sup>2</sup> Jung eun Lee,<sup>1</sup> Wooseong Huh,<sup>1</sup> Yoon-Goo Kim,<sup>1</sup> Hye Ryoun Jang,<sup>1</sup> <sup>1</sup>Samsung Medical Center, Sungkyunkwan University School of Medicine, Seoul, Republic of Korea; <sup>2</sup>Johns Hopkins University School of Medicine, Baltimore, MD.

**Background:** The effects of dietary composition on the repair after ischemic acute kidney injury (AKI) are not well established. The effects of dietary modification of fat and protein composition on intrarenal immunologic microclimate and the repair of tubular damage after ischemic AKI were investigated using murine ischemic AKI and human kidney-2 (HK-2) cell hypoxia model.

**Methods:** Three different diet regimens were provided to mice (9-week-old male C57BL/6) from day 3 after bilateral or unilateral ischemia-reperfusion injury (BIRI or UIRI) operation: control diet, high-fat with high-protein (HF+HP) diet, and low-fat with low protein (LF+LP) diet. HK-2 cells were treated with additional lipid or amino acid after hypoxic insult.

**Results:** Body weight was greater and total cholesterol concentration was higher in the HF+HP group, and body weight was lesser and blood pressure and BUN were lower in the LF+LP group compared to the control diet group, while there was no difference in plasma creatinine between groups. In the expression of intrarenal cytokines/chemokines, RANTES was increased in the HF+HP group, and IFN- $\gamma$ , IL-4, IL-10, IL-6, TNF- $\alpha$  were increased and VEGF was decreased in the LF+LP group than in the control group after BIRI. IFN- $\gamma$ , IL-4, and IL-6 were decreased in the HF+HP group and IL-6 was increased

in the LF+LP group than in the control group after UIRI. The fibrosis of postischemic kidney was more extensive in the LF+LP group compared to the control group after UIRI, while comparable between groups after BIRI. In HK-2 cell hypoxia model, addition of amino acid suppressed, but addition of lipid promoted proliferation of HK-2 cells after hypoxic insult.

**Conclusions:** Excessive restriction of protein and fat during the healing phase of ischemic AKI can be detrimental. Further studies are needed to clarify the optimal dietary compositions and the individual effects of protein and lipid during the recovery of ischemic AKI.

**Funding:** Government Support - Non-U.S.

### TH-PO096

#### Expression of Urine Cytokines in Patients With Severe Pneumonia by SARS-CoV-2

Gustavo A. Casas-Aparicio. Departamento de Investigación en Enfermedades Infecciosas Instituto Nacional de Enfermedades Respiratorias, Ciudad de Mexico, Mexico.

**Background:** Cytokines are involved in the pathogenesis of AKI. The aim of this study was to investigate the urine cytokine profile in patients with severe Pneumonia by SARS-CoV-2 and AKI.

**Methods:** This prospective, longitudinal cohort study was conducted at the National Institute of Respiratory Diseases. We included individuals with Severe pneumonia caused by SARS-CoV-2, >18 years of age; without chronic kidney disease (CKD). AKI was defined as creatinine elevation >0.3 mg/dL in 48 hours or level of TIMP2xIGFBP7 >0.3 ng/ml. Urine samples were collected in critical areas and frozen at -80, urinary concentrations of TIMP-2 and IGFBP7, NGAL and a panel of 27 cytokines were analyzed. **Statistical Analysis:** We first explored whether cytokine patterns between AKI and NO-AKI groups using the Mann-Whitney test, because of a high level of correlation between our panel of urine cytokines and kidney damage biomarkers we performed Principal Component Analysis (PCA). Statistical significance was set at p<0.05.

**Results:** We included 51 patients, 30 were male (58.8%); the median age was 53 years (IQR, 40-61); 14 had hypertension (27.5%); 16 had diabetes (31.4%); and 21 were obese 41.2%. Significant characteristics as well as serum biochemical laboratories, urine kidney stress biomarkers and cytokines are shown in Table 1. We used Principal Component Analysis to built dimensions associated to AKI outcome. After adjustment by Age and Sex, Dimension 2 composed by IL-5, IP 10 (CXCL10), IGFBP7, MIG (CXCL9) was associated with AKI [aHR 95% CI 19.84 (1.00-399) p= 0.050] as well as Dimension 3 composed by N-GAL, RANTES, IL 8, INF-gamma [aHR 95% CI 21.52 (1.91-242) p=0.013].

**Conclusions:** In our study, some cytokines and biomarkers of kidney damage, such as IGFBP7 and N-Gal, were involved in the development of AKI.

**Funding:** Government Support - Non-U.S.

#### Baseline Characteristics of the study population

Characteristic	AKI (25)	NO-AKI (26)	p Value
Age, years	55 (40.5-61.5)	51 (40-55)	0.123
Male (%)	19 (63)	11 (37)	0.148
PaO <sub>2</sub> /FIO <sub>2</sub>	141 (108-187)	138 (101-162)	0.062
Hypertension	12 (86)	2 (14)	0.007
SOF-A score	-4 (3-7)	3 (2-6)	0.015
CPK	224 (79-739)	60 (35-291)	0.025
Procalcitonin	0.62 (0.35-1.26)	0.14 (0.08-0.34)	0.001
N-GAL	54.7 (36.4-117.4)	32.4 (14-40)	0.002
EGF	4581 (1846-4581)	4581 (4581-5545)	0.003
RANTES	13 (2-19)	2 (2-11)	0.031

### TH-PO097

#### IL33 Mediates Cardiomyopathy After AKI by Directly Signaling to Myocytes

Nans Florens, Allen J. York, Jeffery D. Molkenin. Heart Institute - Molecular Cardiovascular Biology Cincinnati Children's Hospital Medical Center, Cincinnati, OH.

**Background:** Acute kidney injury (AKI) is a major cardiovascular risk factor. However, few direct molecular mechanisms have been identified that show how AKI leads to cardiac disease. The aims of this project are to assess the role of IL33 in cardiac damage after AKI.

**Methods:** AKI was induced in mice by ischemia-reperfusion injury of both kidneys by 30 min of reversible artery occlusion in WT, IL33 null and mice in which the IL33-receptor was deleted in cardiomyocytes. We also generated AAV9 carrying the IL33 cDNA (AAV-IL33) or an empty vector (AAV-EV) under a CMV promoter and injected 10<sup>12</sup> viral particles intrathoracically in 6 to 9 days-old pups. Mice containing an insertion of a MerCreMer cDNA driven by the alpha-MHC ( $\alpha$ MHC<sup>CMV</sup>, cardiomyocyte specific) promoter were crossed with a Il1r1-loxP(f)-targeted mouse (Il1r1<sup>fl/fl</sup>, IL33-receptor) and recombination was obtained by intraperitoneal tamoxifen injections. Echocardiography was performed at 28 days after AKI surgery. Hearts were analyzed for fibrosis, cardiomyocyte area measurement, capillary content and myocardial ischemia with 2-nitroimidazole (EF5).

**Results:** AKI induced cardiac dysfunction after 28 days, measured with echocardiography (mean ejection fraction (EF): 58 in shams and 46% with AKI, p<0.05). We observed increased fibrosis area in hearts from WT mice after AKI compared to Sham (2.3 vs 4.5% area, p<0.05) and increased cardiomyocyte surface areas indicative

Key: TH - Thursday; FR - Friday; SA - Saturday; OR - Oral; PO - Poster; PUB - Publication Only

Underline represents presenting author.

of hypertrophy (333 vs 597  $\mu\text{m}^2$ ,  $p < 0.05$ ). Compared to Sham, WT AKI mice exhibited a capillary rarefaction (CD31 staining) along with increased myocardial EF5 staining, suggesting ongoing ischemia. However, cardiac function and architecture were preserved after 28 days of AKI in IL33 null mice. Moreover, WT mice injected with AAV9-IL33 showed impaired cardiac function compared to AAV9-EV injected ones after 8 weeks (EF 58 vs 42%,  $p < 0.05$ ). After AKI, targeted deletion of the IL33-receptor gene in cardiomyocytes ( $\alpha\text{MHC}^{\text{MCM}}$  IL1r1<sup>fl/fl</sup> mice), preserved cardiac function and architecture with no significant increase in fibrosis, hypertrophy and no significant capillary rarefaction compared to Sham-operated mice ( $\alpha\text{MHC}^{\text{MCM}}$  only mice).

**Conclusions:** Secreted during AKI, IL33 has a direct toxic effect on the heart. Our observations are in contrast to some previous reports in the literature where IL33 was suggested to function as a cardioprotective factor.

**TH-PO098**

**Warm Ischemia Time During Pediatric Kidney Transplant Does Not Correlate With Urine AKI Biomarkers**

Kyle Merrill,<sup>1</sup> Cassie L. Kirby,<sup>1</sup> Lakhmir S. Chawla,<sup>3</sup> David K. Hooper,<sup>1,2</sup> Stuart Goldstein,<sup>1,2</sup> *Cincinnati Children's Hospital Medical Center, Cincinnati, OH;* <sup>2</sup>*University of Cincinnati, Cincinnati, OH;* <sup>3</sup>*VA San Diego Healthcare System, San Diego, CA.*

**Background:** Ischemia-reperfusion injury (IRI) is a mechanism of acute kidney injury (AKI). Like cardiopulmonary bypass, kidney transplantation is a form of controlled IRI resulting in acute tubular necrosis and possibly delayed graft function (DGF). Therefore, we sought to investigate kidney transplantation in pediatric patients as a clinical model of AKI, focusing on warm ischemia time (WIT) and novel AKI urine biomarkers.

**Methods:** Prospective study of patients aged 3 months to 26 years who received a kidney transplant from 7/2020 and 11/2021. Urine was collected daily for 7 days post-transplant. Biomarkers tested were neutrophil gelatinase-associated lipocalin (NGAL), kidney injury molecule 1 (KIM-1), interleukin 18 (IL-18), and hepcidin. DGF was defined as receiving kidney replacement therapy within 7 days post-transplant. Wilcoxon rank sum test was used to compare cohorts. Linear regression was used to compare biomarker concentrations to WIT on post-operative days 0-2. The optimal cutoff for NGAL to predict lack of DGF was determined using negative predictive value (NPV) and a Youden's index.

**Results:** 4/30 patients developed DGF with a longer WIT of 55 minutes (IQR 52-57) vs. 38 minutes (IQR 32-45). Thus, we compared biomarker concentrations in patients with WIT <45 vs.  $\geq 45$  minutes. NGAL, KIM-1 and Hepcidin did not differ between cohorts. IL-18 was higher on day 1 in the  $\geq 45$ -minute WIT cohort. A positive linear relationship was noted between WIT and NGAL on day 2 and a negative relationship with hepcidin on day 0. The optimal Youden's index was 0.6 for an NGAL cutoff of 150 ng/mL on either day 0 or 1 post-transplant with a NPV of 95.7% (95% CI 80-99%).

**Conclusions:** We found no consistent correlation between WIT and biomarkers suggesting that AKI may be more complex than simply IRI. NGAL <150 ng/mL on post-operative day 0 or 1 correlated to a high NPV for development of DGF.

	Warm Time < 45 minutes N=19	Warm Time > 45 minutes N=11	p value	Linear Regression		
				Estimate (95% CI)	p value	R <sup>2</sup>
<b>NGAL (ng/mL)</b>						
POD 0*	92.9 (26.8 - 283)	300 (93.7 - 430)	0.18	19.63 (-46.4 - 85.7)	0.547	0.014
POD 1*	37.8 (22.7 - 96.6)	58.5 (31.1 - 258)	0.41	31.65 (-2.2 - 65.5)	0.0657	0.12
POD 2*	35.7 (17.2 - 109)	135 (51.8 - 214)	0.085	33.9 (1.5 - 66.4)	<b>0.0411</b>	0.14
<b>KIM-1 (ng/mL)</b>						
POD 0*	0.84 (0.26 - 2.0)	0.52 (0.26 - 1.0)	0.40	-0.02 (-0.11 - 0.07)	0.65	0.008
POD 1*	3.1 (0.9 - 8.1)	3.9 (2.4 - 9.0)	0.28	0.10 (-0.04 - 0.25)	0.17	0.07
POD 2*	2.66 (0.75 - 5.3)	3.5 (2.0 - 8.2)	0.29	0.09 (-0.05 - 0.23)	0.21	0.055
<b>IL-18 (pg/mL)</b>						
POD 0*	15.6 (15.6 - 72.1)	15.6 (15.6 - 34.1)	0.70	-0.93 (-2.8 - 0.92)	0.31	0.038
POD 1*	15.6 (15.6 - 20.1)	34 (24.5 - 79.2)	<b>0.016</b>	-0.52 (-7.7 - 6.7)	0.89	0.0008
POD 2*	15.6 (15.6 - 20.3)	20.5 (15.6 - 35.8)	0.13	0.72 (-0.26 - 1.7)	0.15	0.07
<b>Hepcidin (ng/mL)</b>						
POD 0*	457 (302 - 553)	249 (51.4 - 453)	0.07	-9.8 (-18.7 - -0.85)	<b>0.033</b>	0.16
POD 1*	241 (50.9 - 427)	130 (104 - 243)	0.87	-0.6 (-10.6 - 9.35)	0.90	0.0006
POD 2*	164 (56.6 - 282)	141 (108 - 259)	0.73	4.99 (-4.46 - 14.4)	0.29	0.04

\*Median(IQR)

**TH-PO099**

**Distant Organ Effects of Renal Injury**

Katherine J. Kelly,<sup>1,2</sup> Jesus H. Dominguez,<sup>1</sup> *1Indiana University School of Medicine, Indianapolis, IN;* *2Richard L Roudebush VA Medical Center, Indianapolis, IN.*

**Background:** Acute kidney injury (AKI) results in immense human and economic cost. The cause of death in AKI is often not kidney failure per se. An enlarging body of data supports the systemic harmful effects of AKI. Understanding the linkage of renal injury with distant organ effects is critical in evaluating potential therapies and preventing/reducing morbidity and mortality.

**Methods:** We employed a well characterized model of renal ischemia/reperfusion injury to examine the effect on distant organs (heart, dura, small intestine, mesentery, liver and spleen) both short term (48 h) and longer term (10 wk) after renal injury. We have previously shown the beneficial effect of renal exosomes, given after renal failure is established, on the kidney. In the present work, we examine the effect of this potential therapy systemically. Controls included sham surgery, unilateral ischemia and nephrectomy (48 hours only).

**Results:** We found leukocyte infiltration following renal ischemia in the heart, dura, small intestine, mesentery, liver and spleen, 2-5 fold the levels following nephrectomy. Tumor necrosis factor alpha was significantly increased in heart, lung and spleen 48 hours after renal ischemia, 2-90 fold. In the heart, significantly altered transcripts included inflammatory (C3, C4), fibrotic (collagen 1, 5, TIMP), angiogenic (VEGF), oxidant (superoxide dismutase, catalase) and apoptosis (bak, bcl2) related, examples in table. Although renal exosomes were not found in large numbers in remote organs, leukocyte infiltration was significantly decreased in these organs in the exosome-treated postischemia group. In longer term studies, we found increased heart and liver weights (1.7 and 1.2 fold increased vs sham surgery, respectively,  $p < 0.03$ ), which was ameliorated (1.2 and 1.0 fold,  $p < 0.04$ ) after treatment with renal exosomes. More importantly, longer term mortality in the post-renal ischemia group (50%) was eliminated (0%) in the exosome treated group,  $p < 0.04$ .

**Conclusions:** Significant remote organ alterations after found after renal ischemia and these can be improved with exosome treatment after renal failure is established.

**Funding:** Other NIH Support - NIAID, Veterans Affairs Support

CARDIAC TRANSCRIPTS (fold change renal ischemia vs sham, examples)

C4	1.75
TIMP	0.65
SOD	0.63
VEGF	0.75
bcl2	1.22

**TH-PO100**

**Complement-Mediated Hemolytic Uremic Syndrome Presenting With Nephrotic Range Proteinuria**

Aditi Singh, Stephen N. Simeone, Duha A. Jweeha, Mamta Shah. *UConn Health, Farmington, CT.*

**Introduction:** Complement-mediated hemolytic uremic syndrome (CM-HUS) has a varied clinical presentation and diagnosis remains one of exclusion. We present a case of thrombotic microangiopathy (TMA) secondary to CM-HUS presenting with hematuria and nephrotic range proteinuria without underlying glomerulonephritis (GN).

**Case Description:** A 45-year-old male presented with a three-day history of dark brown urine. Work-up revealed acute kidney injury (AKI) with a serum creatinine of 1.6 mg/dL from a baseline of 0.9 mg/dL, hemoglobin of 10.1 g/dL and a platelet count of 19,000 platelets/ $\mu\text{L}$ . Haptoglobin was <8 mg/dL and peripheral blood smear showed 7 schistocytes per high-power field. Urinalysis depicted large hemoglobin with 10-15 red blood cells and 24-hour urine protein collection had nephrotic range proteinuria at 3 grams. Given suspicion for thrombotic thrombocytopenic purpura, plasma exchange (PEX) was initiated however this was discontinued after ADAMTS13 was found to be 63%. Despite improvement in his hemoglobin and platelet counts, proteinuria persisted and extensive evaluation for an autoimmune, infectious or hematologic etiology was negative. Renal biopsy findings were consistent with glomerular TMA (Figure 1) without evidence of underlying GN or IgA nephropathy. High dose steroids were administered with resolution of his AKI and proteinuria. Genetic testing demonstrated heterozygosity for CD46 and PLG variants of CM-HUS.

**Discussion:** TMA with proteinuria is associated with comorbid GN or systemic vascular diseases such as systemic lupus erythematosus. This case of CM-HUS is unique in its presentation of proteinuria without associated GN. There are few such reported cases of CM-HUS in children and they describe a resolution of proteinuria following PEX and eculizumab treatment. The mechanism of proteinuria in CM-HUS is poorly defined however endothelial injury or podocytopathy could be suspected.

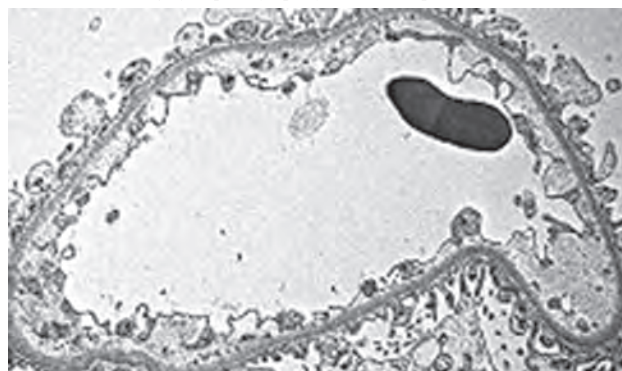

Capillary loop with endothelial cell lift off of glomerular basement membrane with fluffy amorphous deposit in subendothelium

TH-PO101

**Kidney-Protective Vagus Nerve Stimulation Modulates Splenic Immune Populations and Reduces IFN $\gamma$  Production in Response to Toll-like Receptor Agonists**

William Nash,<sup>1</sup> Shinji Tanaka,<sup>2</sup> Mark D. Okusa.<sup>1</sup> <sup>1</sup>University of Virginia School of Medicine, Charlottesville, VA; <sup>2</sup>University of Tokyo Graduate School of Medicine, Bunkyo City, Japan.

**Background:** Vagus nerve stimulation (VNS) prior to injury is able to reduce inflammation and protect mice from acute kidney injury (AKI). This protection requires an intact spleen since splenectomy prior to VNS and AKI removes the protection. Since the immune system and spleen are closely intertwined, we sought to identify alterations in splenic immune cells post-VNS to gain insight into the potential anti-inflammatory and kidney-protective effects of VNS.

**Methods:** Mice underwent VNS or sham surgery. The vagus nerve was exposed at the neck and electrodes placed on it. Electrical pulses were delivered for 10 minutes, sham mice did not receive pulses. After 48 hours, spleens were processed into single cell suspensions. An aliquot was assessed via flow cytometry to quantify immune cell populations. The rest was used to seed 96-well plates for ex vivo stimulation. 7.5x10<sup>5</sup> cells were plated per well and incubated with agonists for toll-like receptors (TLR). Each well received either vehicle control or an agonist to TLR3, 4, or 9. After 20-24 hours, media from each well was collected for cytokine concentration analysis via 32-plex Luminex assay.

**Results:** Spleens from VNS-treated mice weighed less (sham avg=0.064±0.01 g; VNS avg=0.046±0.01 g) and exhibited reduced abundance of most splenic immune cell populations. The most significantly impacted were T cells (p=0.007), B cells (p=0.01), NK cells (p=0.01), dendritic cells (p=0.01), and basophils (p=0.02). Monocytes and eosinophils also showed trends toward lower numbers, but NKT cells, macrophages, and neutrophils exhibited no reduction. Ex vivo cytokine production was also depressed. The profile of cytokines affected varied depending on TLR agonist, but a subset exhibited common regulation across multiple TLR-stimulation conditions (IFN $\gamma$ , CCL2, CXCL9, VEGF, CCL3, CXCL10, GM-CSF, CCL4, IL-10, and IL-9). In particular, IFN $\gamma$  production was decreased in all conditions tested.

**Conclusions:** VNS modulates immune cell abundance and suppresses cytokine production profiles in response to TLR agonists, which may contribute to establishing an anti-inflammatory state. Our results indicate VNS can dynamically control the inflammatory capacity of immune cells and the apparent ubiquitous impact on IFN $\gamma$  provides a good candidate for further mechanistic investigation into the kidney-protective effects of VNS.

**Funding:** NIDDK Support

TH-PO102

**Cytokines and Urinary Biomarkers Predict Adverse Renal Impacts of Propranolol in Biliary Cirrhotic Rats**

Chiao-Lin Chuang,<sup>1,2</sup> Hui-Chun Huang.<sup>1,2</sup> <sup>1</sup>Taipei Veterans General Hospital, Taipei, Taiwan; <sup>2</sup>National Yang Ming Chiao Tung University School of Medicine, Taipei, Taiwan.

**Background:** Non-selective beta-blockers (NSBBs) are the mainstay of treatment for variceal bleeding in cirrhotic patients. However, the advantage of NSBBs must be weighed against the potential risk of acute kidney injury (AKI).

**Methods:** Secondary biliary cirrhosis was induced by common bile duct ligation (CBDL). We used propranolol-treated CBDL rats to delineate the thorough hemodynamics, urinary biomarkers, and inflammatory cytokines.

**Results:** Propranolol treatment led to significant decreases in mean arterial pressure (MAP), portal pressure (PP), and renal blood flow (RBF) in CBDL rats (p < 0.05). Both MAP and PP significantly correlated with RBF, while RBF inversely correlated with urinary liver-type fatty acid-binding protein (L-FABP) and the combination of tissue inhibitor of metalloproteinase-2 and insulin-like growth factor binding protein-7 ([TIMP-2]x[IGFBP7]) levels in propranolol-treated CBDL rats (p < 0.05). Propranolol-treated CBDL rats with severe hypotension (MAP < 65 mmHg) showed higher IL-1 $\beta$ , but lower IL-6 levels than those with MAP  $\geq$  65 mmHg (p < 0.05).

**Conclusions:** NSBBs treatment in cirrhosis may need to be individualized accompanied by careful monitoring of blood pressure and inflammatory condition. Urinary L-FABP and [TIMP-2]x[IGFBP7] serve as promising candidates for detecting renal hypoperfusion following NSBBs. The changes in serum IL-1 $\beta$  and IL-6 over time might allow physicians to predict the possibility of NSBBs-induced AKI in cirrhosis.

Hemodynamic and biochemistry data of CBDL rats

	Control (n = 10)	Propranolol + MAP $\geq$ 65 mmHg (n = 13)	Propranolol + MAP < 65 mmHg (n = 6)
Portal pressure (mmHg)	13.1±0.5	11.5±0.9	6.3±0.5 <sup>a,b</sup>
Renal blood flow (ml/min/100 g)	2.4±0.2	1.9±0.2	0.8±0.1 <sup>a,b</sup>
Serum creatinine (mg/dl)	0.55±0.05	0.49±0.03	0.52±0.05
Urinary L-FABP (ng/ml)	0.7±0.1	0.7±0.1	2.7±0.7 <sup>a,b</sup>
Urinary [TIMP-2]x[IGFBP7] (ng/ml) <sup>2</sup>	0.05±0.01	0.09±0.02	0.47±0.12 <sup>a,b</sup>

Data expressed as mean  $\pm$  SEM. aP < 0.05 vs. control, bP < 0.05 vs. MAP  $\geq$  65 mmHg following propranolol

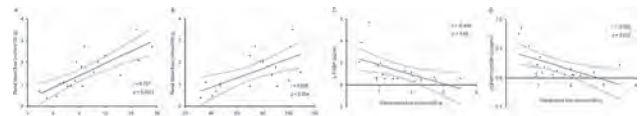

Correlation between RBF with PP(A), MAP(B), and urinary biomarkers(C&D) in propranolol-treated CBDL rats.

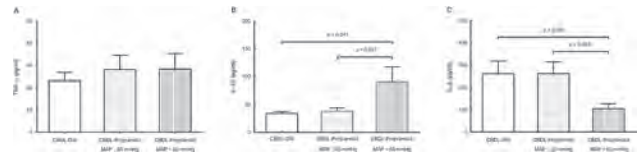

Serum inflammatory markers in propranolol-treated CBDL rats.

TH-PO103

**Cancer-Derived Extracellular Vesicles Worsen Sepsis-Induced AKI**

Takayuki Tsuji, Naoko Tsuji, Yoshitaka Naito, Naoki Hayase, Xuzhen Hu, Peter S. Yuen, Robert A. Star. National Institutes of Health, Bethesda, MD.

**Background:** Patients with hematological malignancies are at high risk for acute kidney injury (AKI). We established a mouse xenograft model of acute myeloid leukemia (AML)-associated sepsis AKI. We found that AML worsened sepsis AKI (ASN 2020). However, it is not known what leukemia-associated factors contribute to the deterioration of AKI. It has been reported that cancer-derived extracellular vesicles (EVs) have various effects on host immune cells and hematopoiesis. We hypothesized that AML cell-derived EVs worsen sepsis AKI.

**Methods:** AML cells (Human Leukemia HL60 cells) were incubated in serum free medium for 48 h to obtain AML cell-derived EVs. Large and small EVs were isolated by a differential centrifugation procedure (14K x g and 200K x g) and quantitated by Zetaview. To examine the effect of EVs on sepsis-induced AKI, cecal ligation and puncture (CLP) was performed to induce sepsis in male CD-1 mice (n=8-10 per group), and EVs or PBS were injected intravenously at the time of CLP surgery. Multiple organ damage, splenic apoptosis and mouse systemic cytokines were evaluated at 24 h after CLP or sham surgery.

**Results:** EVs obtained from 14K x g pellet (EVs(14K)) intensified sepsis-induced organ damage including AKI. BUN, LDH, AST and ALT were significantly higher in EVs(14K)+CLP than both EVs(200K)+CLP and PBS+CLP. EVs(14K)+CLP, EVs(200K)+CLP, PBS+CLP. BUN; 127.0±13.8, 59.4±33.3, 67.0±43.6 mg/dl, LDH; 4,007±1,378, 2,221±1,040, 3,111±714 U/l, AST; 817±268, 487±147, 514±137 U/l p<0.05). Kidney histological damage and splenic apoptosis were significantly worse in EVs(14K)+CLP compared to either EVs(200K)+CLP or PBS+CLP. Systemic cytokines at 24 h after CLP were significantly higher in EVs(14K)+CLP than either EVs(200K)+CLP or PBS+CLP (TNF $\alpha$ ; 628±220, 149±107, 281±195 pg/ml, IL-6; 119±61, 41±29, 56±59 ng/ml, IL-10; 4,810±1,494, 1,470±913, 2,607±805 pg/ml, p<0.05).

**Conclusions:** We found that AML cell-derived EVs obtained from 14K x g pellet, but not 200K x g pellet worsened sepsis AKI. Therefore, the impact of leukemia can be largely recapitulated by administration of EVs. Further study is needed to determine what components within EVs are responsible for this worsening of sepsis AKI. Additionally, mechanistic insights may inform how to therapeutically target these EVs during septic episodes in leukemia patients.

**Funding:** NIDDK Support

TH-PO104

**Acute Oxalate Nephropathy due to Transthyretin (ATTR) Amyloidosis Causing Autonomic Neuropathy and Enteric Hyperoxaluria**

Phoenix Xu,<sup>1</sup> Jennine Michaud,<sup>2</sup> Harshad Chaudhari,<sup>1</sup> Smita Mahendrakar,<sup>1</sup> Anjella Manoharan,<sup>1</sup> Michael Yudd.<sup>2</sup> <sup>1</sup>Rutgers New Jersey Medical School, Newark, NJ; <sup>2</sup>VA New Jersey Health Care System, East Orange, NJ.

**Introduction:** Acute oxalate nephropathy (AON) is an uncommon renal biopsy finding. There are 3 pathophysiologic mechanisms leading to AON: genetic mutations causing excessive hepatic production (primary hyperoxaluria, PH); increased bowel absorption of oxalate in malabsorptive states (enteric hyperoxaluria, EH); intake of food or substances that are metabolized to excessive oxalate (e.g., starfruit, ethylene glycol).

**Case Description:** 86 year-old non-diabetic man was admitted with severe acute kidney injury requiring dialysis. Serum creatinine was 0.9 mg/dl 3 months earlier. He had a history of congestive heart failure with reduced ejection fraction and atrial fibrillation. He described a distinct change in bowel habits over the last 6 months, going from regularity to new onset of alternating weekly loose bowel movements and constipation, and weight loss of 60 lbs. Ten years earlier he was diagnosed with peripheral neuropathy when he developed numbness and tingling in hands and feet. Most of his food came from Meals on Wheels. He denied drinking antifreeze, or eating foods with high oxalate content. He weighed 145 lbs and had a BMI of 19.7 kg/m<sup>2</sup>. He appeared weak and cachectic. He had vibratory loss in glove/stocking pattern and somatosensory loss in stocking pattern. Pertinent findings: - Renal biopsy: diffuse tubular oxalate deposits. Congo red (-). - Cardiac: pyrophosphate scan highly suspicious for ATTR amyloid. - Fat pad biopsy: Congo red (+); on mass spectrometry ATTR was most likely wild type. - Gastrointestinal (GI): chronic non-specific inflammation on upper and lower endoscopy, congo red (-). Negative fecal fat. - Genetic testing: negative for both PH and hereditary ATTR.

Key: TH - Thursday; FR - Friday; SA - Saturday; OR - Oral; PO - Poster; PUB - Publication Only

Underline represents presenting author.



**Discussion:** EH appeared to be the cause of AON. PH was ruled out by genetic testing, and ingestions appeared very unlikely. The patient was cachectic with marked weight loss, and clearly had a change in his bowel habits. This along with urinary frequency and lightheadedness on standing, suggested the presence of an autonomic neuropathy. The GI work-up ruled out a classic malabsorptive state. ATTR amyloid typically involves the heart and can cause severe peripheral and autonomic neuropathies. We suspect that severe GI autonomic dysfunction lead to marked weight loss and altered absorption, causing EH and subsequently AON.

**TH-PO105**

**suPAR Inflames Kidneys With T Cells and Aggravates Septic AKI**

**Christian Nussbag,<sup>1,5</sup> David C. Wei,<sup>5</sup> Eunsil Hahm,<sup>5</sup> Salim Hayek,<sup>2</sup> Jing Li,<sup>5</sup> Florian Kälble,<sup>1</sup> Claudius Speer,<sup>1</sup> Jesper Eugen-Olsen,<sup>3</sup> Ellen Krautkrämer,<sup>1</sup> Martin G. Zeier,<sup>1</sup> Christian Morath,<sup>1</sup> Thorsten Brenner,<sup>4</sup> Jochen Reiser.<sup>5</sup>**  
<sup>1</sup>Ruprecht Karls Universität Heidelberg, Heidelberg, Germany; <sup>2</sup>University of Michigan, Ann Arbor, MI; <sup>3</sup>Copenhagen University Hospital Hvidovre, Hvidovre, Denmark; <sup>4</sup>Universitätsklinikum Essen, Essen, Germany; <sup>5</sup>Rush University Medical Center, Chicago, IL.

**Background:** The soluble urokinase plasminogen activator receptor (suPAR) is an immune-derived glycoprotein implicated in the pathogenesis of acute kidney injury (AKI). Sepsis is a strong inducer of plasma suPAR levels and a known contributor to the development of AKI. We hypothesized that suPAR is involved in the pathophysiology of sepsis-related AKI.

**Methods:** We used a polymicrobial model of sepsis (Cecal Slurry [CS] vs. Glycerol [GLY]) in wild-type (WT), uPAR knockout (KO, suPAR deficient), and transgenic suPAR-overexpressing (OE) mice. We compared measures of kidney function, tissue damage, and tissue inflammation in septic and untreated mice. Kidney tissue inflammation was quantified by kidney flow cytometry, immunohistostaining, and kidney luminex assay.

**Results:** Kidneys from untreated OE mice expressed high levels of interleukin-16 (IL-16) and C-C motif chemokine ligand 3 (CCL3); both involved in cell-mediated kidney injury and potent chemo-attractants for T and NK cells. Consistent with this expression pattern, we found significantly increased numbers of kidney T and NK cells in untreated OE mice, equaling numbers observed in septic WT mice. Further, high plasma suPAR aggravated sepsis-induced ultrastructural kidney damage, cellular apoptosis and kidney function impairment after 24h of sepsis. In contrast, KO mice showed a strong protective effect against AKI. Kaplan-Meier analysis revealed a survival benefit of KO over OE mice (87% vs. 50%, p=0.033). The composition of kidney immune cells in sepsis was strongly influenced by varying suPAR plasma levels. Especially, numbers of kidney T cells were strongly linked to the extent of systemic suPAR elevation and kidney function impairment, with significant higher numbers in septic OE mice compared to septic WT and KO mice.

**Conclusions:** suPAR inflames the kidney with T cells potentially via local upregulation of IL-16 and CCL3. "SuPAR inflamed" kidneys react with increased kidney injury in sepsis which can potentially be improved by relecting suPAR. These findings hold great potential for new therapeutic strategies.

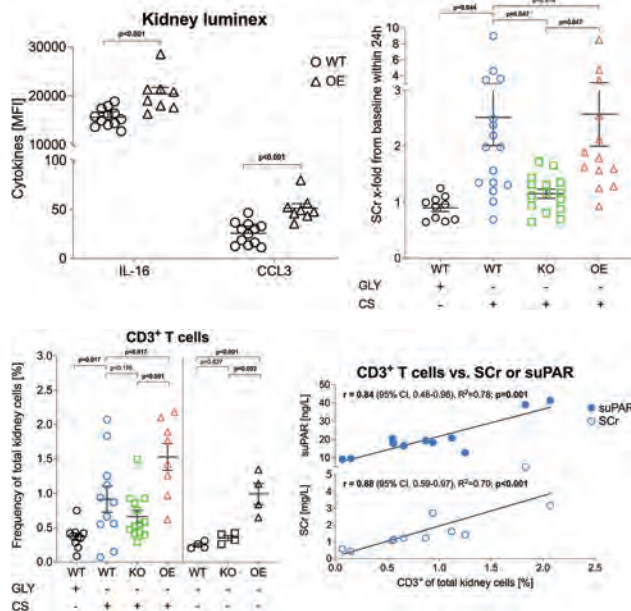

**TH-PO106**

**Calciophylaxis in a Patient With Tumor Lysis Syndrome due to T-Cell Lymphoma**

**Mahmoud Ali,<sup>1</sup> Mariela Navarro Torres,<sup>2</sup> Molly Fisher.<sup>2</sup>** <sup>1</sup>Saint Barnabas Hospital, Bronx, NY; <sup>2</sup>Montefiore Medical Center, Bronx, NY.

**Introduction:** Calciophylaxis is characterized by skin ischemia and necrosis and is most often observed in end-stage kidney disease (ESKD) or transplant patients. Non-ESKD associated calciophylaxis is uncommon but has been reported in patients with primary hyperparathyroidism, alcoholic liver cirrhosis, connective tissue disease and malignancy. We report an unusual presentation of calciophylaxis in the context of severe acute kidney injury (AKI) with tumor lysis syndrome (TLS) from T-cell lymphoma.

**Case Description:** A 46-year-old man with history of colon cancer treated with right hemicolectomy and chemotherapy and untreated T-cell lymphoma presented with respiratory distress. Laboratory results revealed a serum creatinine of 21.8 mg/dL compared to a baseline of 1.1 mg/dL seven months prior, potassium of 6.5 mEq/L, bicarbonate of <10 mEq/L, phosphorus of 15mg/dL, calcium of 7.6 mg/dL, uric acid of 8.9 mg/dL, lactate dehydrogenase of 542 U/L and severe pancytopenia. Spontaneous TLS in the setting of untreated lymphoma was suspected as the cause of his AKI. He was admitted to the intensive care unit and underwent emergent hemodialysis. Two days after admission, he was found to have a firm and tender lesion on the right medial thigh described as an ecchymosis with surrounding ulceration. A CT was negative for necrotizing fasciitis and the skin lesion was treated as a soft tissue infection. However, the lesion progressed, developing eschar. A punch skin biopsy was performed which confirmed a diagnosis of calciophylaxis. Intact parathyroid hormone was 228 pg/mL. Treatment included sodium thiosulfate, phosphorus control and hemodialysis. He was initiated on chemotherapy for his lymphoma and unfortunately, remained dialysis dependent.

**Discussion:** Malignancy is a known risk factor for calciophylaxis but to our knowledge, this is only the second reported case of calciophylaxis in the setting of TLS. We hypothesize that our patient's late presentation of TLS with fulminant AKI and severe metabolic derangements led to vascular calcium chelation and deposition. This case highlights the importance of calcium and phosphorus control in patients with TLS and risk factors for calciophylaxis.

**TH-PO107**

**Role of Kynurenine/Tryptophan Ratio in Kidney-Lung Cross-Talk in Two Porcine Trauma-Induced Multi-Organ Injury Models**

**Pragya Singh,<sup>1</sup> Daniel Montemayor,<sup>1</sup> Annapurna Pamreddy,<sup>1</sup> Viktor Drel,<sup>1,2</sup> Hongping Ye,<sup>1</sup> Anthony J. Franzone,<sup>1</sup> Yanyi Zang,<sup>3</sup> Teryn R. Roberts,<sup>3</sup> Kevin K. Chung,<sup>4</sup> Andriy Batchinsky,<sup>3,4</sup> Kumar Sharma.<sup>1,2</sup>** <sup>1</sup>The University of Texas Health Science Center at San Antonio, San Antonio, TX; <sup>2</sup>South Texas Veterans Health Care System, San Antonio, TX; <sup>3</sup>Autonomous Reanimation and Evacuation Research Program, San Antonio, TX; <sup>4</sup>Uniformed Services University of the Health Sciences, Bethesda, MD.

**Background:** Multiple Organ Failure (MOF), often precipitated by Acute Respiratory Distress Syndrome (ARDS) brought on by trauma-induced injury, is a significant cause of death in military and civilian life. In ARDS, Acute Kidney Injury (AKI) is the most common organ failure, affecting nearly half of all patients and having twice the mortality rate than those with ARDS alone. Thus, understanding the molecular differences between survivors and non-survivors can significantly reduce the mortality burden.

**Methods:** A 24-hour unilateral pulmonary contusion porcine model (pneumectomy) of trauma-induced MOF model (n=17) and separate 48-hour polytrauma injury of bilateral pulmonary contusion, traumatic brain injury, and hemorrhage (polytrauma) MOF model (n=26) was developed at Dr. Batchinsky's AREVA laboratory. Serum was assayed at baseline and 3h or 6h post-trauma for amino acid metabolites using the Zip-Chip platform for mass spectrometry. The IDO1 enzyme activity assay kit (ab235936) was used to measure IDO1 enzyme activity in the tissue.

**Results:** In the pneumectomy model, 10 survived and 7 died and in the polytrauma group, 13 survived and 13 died. In the pneumectomy model, there was a significant increase in the serum kynurenine/tryptophan (KYN/TRP) ratio in the non-survivors 3h post-injury. A similar pattern was found in the validation group, which showed a significant increase in the KYN/TRP ratio at 6h post-trauma in non-survivors from the polytrauma model. There was a significant increase in IDO1 enzyme activity in non-survivor kidney tissues and no changes in the lungs in the pneumectomy model.

**Conclusions:** In two separate ARDS multi-organ injury trauma porcine models, an increase in the KYN/TRP ratio post-trauma identified the pigs that suffered early mortality. The increase in kidney IDO1 activity could contribute to the reduction in serum tryptophan and increase in kynurenine in the non-survivors. As a result, focusing on therapeutics targeting the kynurenine pathway to reduce the incidence and severity of MOF is warranted.

**Funding:** Other U.S. Government Support

TH-PO108

Acute Interstitial Nephritis Secondary to Brentuximab

Nour Hammad, Meghan Kapp, Arash Rashidi. University Hospitals, Cleveland, OH.

**Introduction:** Emerging of new treatments such as immune checkpoint inhibitors and targeted therapies have changed treatment of cancer patients. All these new treatments can cause different side effects, including renal complications. Brentuximab vedotin is a CD30-directed antibody drug conjugate, which is used to treat relapsed or refractory Hodgkin lymphoma and systemic anaplastic large cell lymphoma. Here we present a case of acute interstitial nephritis (AIN) in a 65 years old woman with T-cell lymphoma on Brentuximab vedotin (trade name: Adcetris) therapy.

**Case Description:** A 64 year-old female was diagnosed initially with cutaneous T-cell Lymphoma with subsequent metastasis to the liver despite multiple therapies. She was started on Brentuximab vedotin. She had normal kidney function at baseline and after two doses of Brentuximab vedotin her kidney function started declining with peak serum creatinine at 3.75 mg/dl. Urinalysis showed 1+ proteinuria, WBC 4, and RBC 4. A renal biopsy was performed and showed diffuse acute interstitial nephritis (Image 1, PAS, 200x). Subsequently, Brentuximab was discontinued and the patient was started on oral steroid taper with improving kidney function back to baseline creatinine of 1 mg/dl.

**Discussion:** To the best of our knowledge this is the second case of TIN following Brentuximab vedotin. Karyomegalic interstitial nephritis (KIN) was previously described as a potential side effect with Brentuximab. KIN is characterized by enlarged hyperchromatic tubular epithelial cell nuclei which was not seen in our patient's renal biopsy. The timing of AKI has coincided after the second cycle of Brentuximab in our patient making it the major contributor for the AIN. High suspicion for AIN is important as early recognition and treatment have better prognosis. The key prognosticating factor for renal recovery is the extend of renal fibrosis.

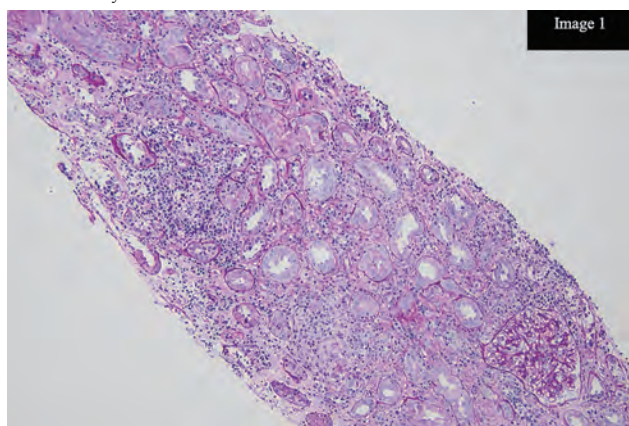

A renal biopsy showing interstitial edema, inflammatory infiltrate comprised of lymphocytes, occasional eosinophils, and rare neutrophils, and tubulitis.

TH-PO109

Adipose-Derived Mesenchymal Stem Cells Cultured in Serum-Free Medium Attenuate Acute Contrast-Induced Nephropathy by Exerting Anti-Apoptotic Effects

Mitsuki Kadono, Naoki Ishiuchi, Ayumu Nakashima, Kensuke Sasaki, Takao Masaki. Hiroshima Daigaku Byoin, Hiroshima, Japan.

**Background:** Contrast-induced nephropathy (CIN) is a major clinical problem associated with acute kidney injury during hospitalization, however therapeutic methods for CIN have made little progress. We previously showed that culturing mesenchymal stem cells (MSCs) in serum-free medium enhanced their anti-inflammatory effects. In this study, we investigated the therapeutic effects of human adipose-derived MSCs cultured in serum-free medium (SF-MSCs) on a mouse model of CIN.

**Methods:** C57BL/6 mice (8 weeks of age) underwent right nephrectomy. One week later, the left renal artery was clamped for 30 min to cause ischemia-reperfusion injury, and mice were injected with iohexol using a retro-orbital injection method. The bodies of mice were shielded using a lead plate, except for the left kidney, which received 10 Gy of X-ray irradiation. MSCs cultured in Dulbecco's Modified Eagle Medium containing 10% fetal bovine serum (S-MSCs) or SF-MSCs were then injected through the tail vein. We also investigated the ability of conditioned medium from S-MSCs or SF-MSCs to suppress apoptosis of X-ray-irradiated HEK293 cells.

**Results:** Serum creatinine and blood urea nitrogen levels were remarkably increased in CIN mice injected with phosphate-buffered saline (control), but suppressed in CIN mice injected with SF-MSCs compared with S-MSCs. Similarly, cleaved caspase 3 protein levels and numbers of TUNEL-positive cells were increased in CIN mice, but suppressed in CIN mice injected with SF-MSCs compared with S-MSCs. In addition, protein levels of  $\gamma$ H2AX, a marker of chromosomal damage, were upregulated in CIN mice, but reduced by S-MSCs

treatment and further reduced by SF-MSCs. In vitro experiments showed that the increase in cleaved caspase 3 protein level induced by radiation of HEK293 cells was more strongly suppressed by conditioned medium from SF-MSCs compared with that from S-MSCs.

**Conclusions:** Adipose-derived SF-MSCs attenuate CIN by exerting anti-apoptotic effects, indicating that SF-MSCs may be a potential therapy for CIN.

TH-PO110

Non-Pharmacological Interventions in Chronic Non-Communicable Diseases: The Impact of Moderate Physical Exercise in Rats

Maria de Fatima F. Vattimo,<sup>1,2</sup> Eloiza O. Silva,<sup>1,2</sup> Sara Ventura,<sup>1,2</sup> Brenner K. Oliveira,<sup>3,1</sup> Carla d. Victoria.<sup>1,2</sup> Research Group on Experimental Acute Kidney Injury <sup>1</sup>Universidade de Sao Paulo, Sao Paulo, Brazil; <sup>2</sup>School of Nursing, Sao Paulo, Brazil; <sup>3</sup>Universidade Federal do Amazonas, Manaus, Brazil.

**Background:** Chronic non-communicable diseases (NCDs) are the most relevant cause of premature deaths and morbidities. The goal of the World Health Organization is to reduce NCDs by 25% by 2025. Among the complications of NCDs, chronic kidney disease (CKD) and acute kidney injury (AKI) stand out. The physical exercise (E) is a non-pharmacological intervention that suppress the morbidity of CKD and DM. This study aims to evaluate the effect of the moderate aerobic exercise in DM and CKD rats submitted to the nephrotoxicity of the iodinated contrast.

**Methods:** Wistar rats were divided in groups: SHAM; CKD (nephrectomized animals, 5/6 renal mass); CKD+E (CKD submitted to swimming training, 60 min, 5 days, 4 weeks); aCKD (CKD received meglumine sodium ioxithalamate, contrast medium, 6 mL/kg, iv; once); aCKD+E (aCKD trained as described); Citrate (streptozotocin-STZ vehicle, 0.4 mL; ip; once); Citrate+E (Citrate trained as described); DM (STZ, 60 mg/kg, iv, once); DM+E (DM subjected to E as described); aDM+E (aDM trained as described). Renal function (inulin clearance, serum creatinine and microalbuminuria), hemodynamics (renal vascular flow and resistance) and oxidative profile (urinary peroxides, TBARS, nitric oxide and thiols) were evaluated.

**Results:** [Figure 1] [Figure 2].

**Conclusions:** Exercise was confirmed as a non-pharmacological therapy by reducing the progression of CKD and the diabetic kidney disease aggravated by the use of contrast, demonstrating improvement in renal function, renal hemodynamics and oxidative stress.

**Funding:** Government Support - Non-U.S.

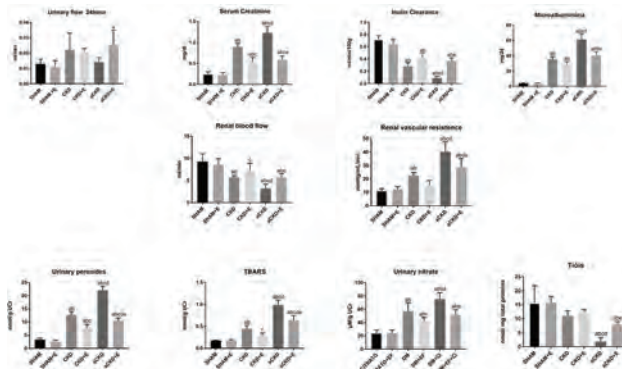

[Figure 1] CKD group: renal fuction, hemodynamics and oxidative stress

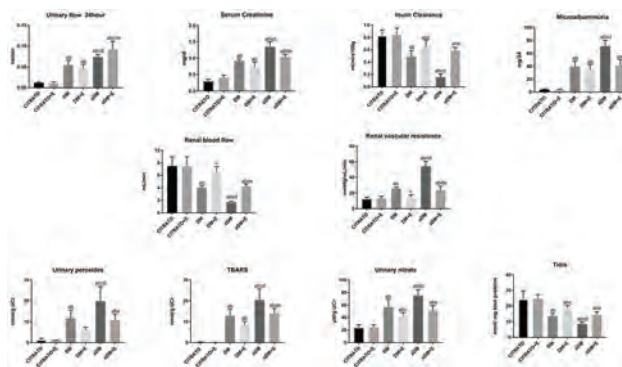

[Figure 1] DM group: renal fuction, hemodynamics and oxidative stress

## TH-PO111

**Normal Renal Function in a Patient With Elevated Serum Creatinine**

Janelle Muuse, Alexander Pennekamp, John Hergenrother. *Christ Hospital, Cincinnati, OH.*

**Introduction:** Creatinine is an imperfect marker to estimate GFR, and awareness of situations where it will not accurately reflect kidney function is crucial. Creatinine is affected not only by states that increase or decrease its production (i.e. rhabdomyolysis, sarcopenia) but also by factors that affect its reabsorption in the tubule (or within the body).

**Case Description:** A 65 year old male with a history significant for prostate cancer was admitted to the hospital for abdominal pain and distention four days after undergoing a radical prostatectomy. Initial pertinent labs included a serum creatinine of 1.5mg/dL (baseline 1.0 mg/dL) and an eGFR of 47 (CKD-EPI 2009). He had a JP drain in place with large amounts of serosanguinous fluid. Imaging revealed postoperative ileus. On subsequent days, his creatinine continued to rise and was refractory to intravenous fluids. The patient became increasingly distended to the extent that abdominal compartment syndrome was a concern. A decompressing colonoscopy failed to relieve the patient's symptoms. Lasix and albumin were given and caused his JP drain output to increase significantly. The abdominal fluid was found to have a creatinine of 9.7, signifying a possible urine leak. By day 3, his serum creatinine rose to 4.10. Urinalysis was bland. A cystogram was then performed and demonstrated a moderate vesicourethral anastomotic leak. Due to the patient's large urine output and lack of other markers of renal dysfunction such as fluid overload and electrolyte abnormalities, it was determined that both his ileus and elevated creatinine were caused by uroperitoneum. This was later confirmed by a cystatin c level. His urine leak was treated conservatively and his serum creatinine returned to normal in the following days.

**Discussion:** This was an unusual case of uroperitoneum post prostatectomy, as urine leaks most commonly present in the retroperitoneum. Creatinine absorbed into the peritoneum caused an elevated serum creatinine due to reabsorption of creatinine from the peritoneal space back into the blood. The utility of measuring cystatin c is highlighted here—his eGFR using cystatin c was found to be 52 (compared to 14 using the creatinine equation)—showing a much more accurate indicator of renal function. Identifying pseudo-acute renal failure was imperative in this case to avoid unnecessary interventions such as dialysis.

## TH-PO112

**Cilastatin in the Prevention and Treatment of Rhabdomyolysis-Induced Acute Renal Failure**

Maria Angeles Gonzalez-Nicolas Gonzalez,<sup>1</sup> Blanca Humanes Sanchez,<sup>1</sup> Alberto Lazaro Fernandez.<sup>2,1</sup> <sup>1</sup>Instituto de Investigacion Sanitaria Gregorio Maranon, Madrid, Spain; <sup>2</sup>Universidad Complutense de Madrid, Madrid, Spain.

**Background:** Rhabdomyolysis (RM) is a clinical and biochemical syndrome characterized by skeletal muscle rupture and massive release of cellular components including myoglobin (MG). MG directly damages the kidneys by activation of apoptotic, oxidative and inflammatory pathways in addition to tubular obstruction due to precipitation causing acute renal failure (ARF), one of its most serious complications. In fact, 50% of patients with RM will develop ARF with mortality rate can reach to 60%. Cilastatin, a renal dehydropeptidase-I inhibitor, has demonstrated its usefulness in the protection of ARF induced by nephrotoxic drugs due to interference with lipid rafts. Here, we evaluate the utility of cilastatin as a protector against RM-induced ARF.

**Methods:** RM was induced in Wistar rats by administering in the hind legs with 50% glycerol (or vehicle to the control group). Cilastatin (150 mg/kg) or its vehicle, was administered immediately and every 24 hours after RM induction. Renal damage was assessed 48h after glycerol/vehicle administration by measuring serum creatinine, blood urea nitrogen (BUN), glomerular filtration rate (GFR), renal damage biomarker KIM-1, renal tissue morphology and iron accumulation, as well as apoptotic, oxidative and inflammatory parameters such as caspase 3, CD68, 4-HNE and TGFβ among others.

**Results:** RM increased serum creatinine, BUN and decreased GFR compared to the control group. These renal effects were confirmed by an increase in the KIM-1 and the presence of severe morphological changes. Iron accumulation in tubular cells was observed, as well as a statistically significant increase in apoptotic, inflammatory and oxidative biomarkers. Cilastatin treatment completely prevented renal dysfunction and restored significantly all other parameters to levels found in the control groups. It also reduced many of the histological symptoms of renal damage.

**Conclusions:** Our findings support the potential use of cilastatin as a useful drug in the prevention and treatment of RM, ameliorating RM-induced ARF. Therefore, cilastatin may be a very beneficial therapeutic strategy in clinical practice for patients with some type of trauma or susceptible to renal damage due to RM.

## TH-PO113

**The NADPH Oxidase (NOX2) Is Required to Control Urinary Tract Infections**

Juan de Dios Ruiz-Rosado, Israel Cotzomi Ortega, Rachel Han, Gregory Ballash, Yuriko I. Sanchez-Zamora, Hanna H. Cortado, Birong Li, Brian Becknell. *Nationwide Children's Hospital, Columbus, OH.*

**Background:** Urinary tract infections (UTIs) account for 7 million office visits and \$1.6 billion dollars in health care spending annually in the United States. Uropathogenic *Escherichia coli* (UPEC) is the primary etiological pathogen causing over 80% of UTI. Currently, there is a critical need for innovative and effective strategies to treat UTI. The NADPH oxidase complex 2 (NOX2) is one of the major sources of reactive oxygen species (ROS) in immune phagocytes and has a central role in the antimicrobial response against many bacterial and fungal infections, but its role during UTIs remains unknown. In this study, we elucidated the role of NOX2 during experimental UTI.

**Methods:** Female wild-type (WT) C57BL/6 mice, NOX2 knockout (NOX2 KO) mice, and WT mice treated with a NOX2 inhibitor (GSK) were transurethraly infected with UPEC (CFT073 strain). NOX2 protein expression was analyzed by Western blotting. Cellular sources of NOX2 were identified by immunofluorescence. The bacterial burden (UPEC) in the urinary tract was measured by enumerating colony forming units (CFU). Histopathological analysis of the infected bladder was conducted using the Hopkins score. Bone marrow Neutrophils from uninfected WT, NOX2 KO mice or peripheral blood neutrophils from healthy human donors were infected with UPEC *in vitro*. Neutrophil ROS production was determined using the Amplex Red kit.

**Results:** Knockdown or pharmaceutical inhibition of NOX2 in mice led to an increased bacterial burden in the bladder and kidney during UPEC-induced UTI. The increased susceptibility in infected NOX2 KO mice was associated with augmented bladder pathology, characterized by mucosal lesions and lamina propria edema, compared to infected WT mice. NOX2 expression significantly correlated with bacterial burden in the bladder from infected WT mice. Immunofluorescence microscopy localized NOX2 primarily in infiltrating neutrophils in the infected urinary tract. NOX2 KO neutrophils exhibited impaired extracellular ROS production and increased intracellular bacteria compared to WT neutrophils following UPEC infection *in vitro*. Similar effects occurred in primary human neutrophils following chemical inhibition of NOX2 *in vitro*.

**Conclusions:** NOX2-derived ROS serves a critical antimicrobial role during experimental UTI.

**Funding:** NIDDK Support

## TH-PO114

**Sjogren Syndrome Manifesting as Thrombotic Microangiopathy and Cryoglobulinemic Vasculitis**

Reshma J. Kariyil, Kanza Haq, Alana Dasgupta, S.M. Bagnasco, Samir C. Gautam. *Johns Hopkins University School of Medicine, Baltimore, MD.*

**Introduction:** Cryoglobulinemic vasculitis is an immune complex mediated small vessel vasculitis with significant morbidity and mortality. Renal manifestations are generally MPGN pattern but less commonly membranoproliferative glomerulopathy and intraglomerular thrombi.

**Case Description:** We present the case of a 49-year-old Palestinian female with history of SLE on hydroxychloroquine, hypertension, and chronic kidney disease with prior biopsy proven chronic thrombotic microangiopathy. She presented with dyspnea on exertion, lower extremity purpuric rash and edema, and new left foot weakness and numbness. Laboratory testing showed severe acute kidney injury, proteinuria as well as predominantly low C4 hypocomplementemia, positive ANA, RF, and anti-Ro52 and Ro62 antibodies. Renal biopsy showed rare glomeruli with thickened capillary walls and PAS-positive intracapillary coagula. Similar coagula were seen to fill the lumens of several small arteries (Fig 1, PAS 400x). These coagula stained brightly for IgM, IgG, C3, kappa, and lambda on immunofluorescence. On electron microscopy, rare cellular interpositioning with scattered paramesangial and intracapillary electron dense deposits were seen (Fig 2). These deposits were comprised of haphazardly arranged tubulocylinders with an average diameter of 27 nm. Additional laboratory testing revealed circulating type II cryoglobulin with high cryocrit > 40%. She was eventually diagnosed with cryoglobulinemic vasculitis and TMA from Sjogren's syndrome. She was given steroids, rituximab, and ultimately required dialysis.

**Discussion:** Cryoglobulinemic vasculitis with renal involvement is most commonly seen with hepatitis C infection. Among renal manifestations, membranoproliferative pattern is common. Though our patient had fibrinoid necrosis of small arteries, glomerular thrombi were not present. Although association with Sjogren's syndrome is rare, it is associated with higher risk of lymphoma and high systemic disease activity.

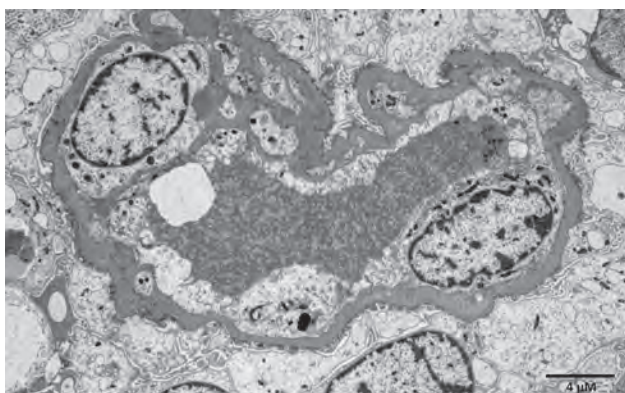
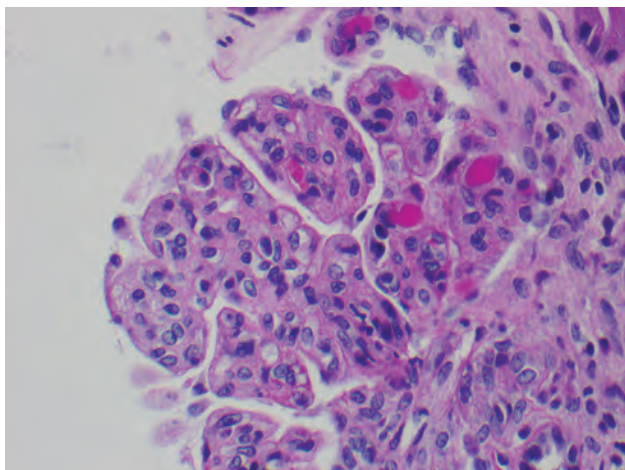

#### TH-PO115

##### Renal Dysfunction in Bartonella Endocarditis With ANCA Positive Titers: A Management Dilemma

Tharika S. Rajmohan,<sup>1</sup> Harsha Sai Sreemantula,<sup>1</sup> O'Neil P. Chaudhry,<sup>1</sup> Muhammad O. Hanif,<sup>1</sup> Charles P. McClure.<sup>2</sup> <sup>1</sup>Mercy Fitzgerald Hospital, Darby, PA; <sup>2</sup>Hospital of the University of Pennsylvania, Philadelphia, PA.

**Introduction:** Bartonella endocarditis is the common cause of culture-negative endocarditis. Renal dysfunction is common in infective endocarditis with immune complex mediated Glomerulonephritis (GN). Here we discuss a case of acute kidney injury in Bartonella endocarditis with elevated anti neutrophil cytoplasmic antibodies (ANCA) which makes the management complex.

**Case Description:** 60-year-old homeless male with history of recurrent upper gastrointestinal (GI) bleeds from arteriovenous malformation, anemia of chronic disease, ischemic cardiomyopathy (ejection fraction of 45%) with defibrillator placement, mitral regurgitation, hypertension, chronic hepatitis B treated, pulmonary embolism not on any anticoagulation due to GI bleed, polysubstance abuse from cocaine and alcohol, presented with complaints of malaise, fatigue and shortness of breath on exertion. Physical examination was remarkable for pale conjunctiva, and holosystolic murmur heard at the apex. Vitals were unremarkable. Labs were remarkable for hemoglobin of 6.9 mg/dL, platelet count of 30,000 and creatinine (Cr) of 6.10 mg/dL (baseline creatinine of 1 mg/dL, 3 months ago). Urinalysis was suggestive of significant proteinuria of >300 mg/dl, Blood +ve with RBC and a normal renal scan. Renal panel showed low complements with positive ANCA titers with proteinase 3 (PR3) along with positive Rheumatoid Factor. Echocardiogram showed vegetation with Bartonella serology positive. Renal Biopsy was placed on hold due to thrombocytopenia and antibiotics was started (Doxycycline and Rifampin). He required hemodialysis due to worsening acidosis and significant uremia and later died due to disseminated intravascular coagulation and septic shock.

**Discussion:** Presence of ANCA positive titers in a culture negative Bartonella endocarditis renal dysfunction is an interesting and challenging at the same time as ANCA vasculitis traditionally is Pauci immune on immunofluorescence with normal complements. Renal dysfunction with hypocomplementemia in an immune complex glomerulonephritis (GN) and positive ANCA titers creates confusion as management can be challenging with antibiotics as the mainstay for the treatment of endocarditis, while immunosuppression is for ANCA vasculitis. Few case reports have been reported where renal biopsy plays a major role in terms of management.

#### TH-PO116

##### Mathematical Representation of Drug Induced Crystal Nephropathy Using a Quantitative Systems Toxicology Approach

Shailendra Tallapaka,<sup>1</sup> Pallavi Bhargava,<sup>1</sup> Bhabuk Koirala,<sup>2</sup> Jeffrey L. Woodhead,<sup>1</sup> <sup>1</sup>Simulations Plus Inc, Research Triangle Park, NC; <sup>2</sup>Janssen Research and Development LLC, Springhouse, PA.

**Background:** Drugs may cause crystal nephropathy by precipitating within kidney tubules or inducing the precipitation of endogenous compounds. A mechanistic mathematical model of drug induced crystal nephropathy was developed within the context of RENAsym® to help de-risk drug development programs by predicting the potential of a drug to cause crystal nephropathy. RENAsym is a quantitative systems toxicology model of acute kidney injury that includes representation of proximal tubule cells, drug-induced cell death, and resultant biomarker responses. The crystal nephropathy model comprises of formation, aggregation, distribution and elimination of crystals within the kidney and the subsequent toxic effects on kidney function.

**Methods:** The crystal nephropathy model was developed using ethylene glycol (EG)-induced calcium oxalate (CaOx) crystal formation as an exemplar due to the amount of literature data available to inform model parameterization. The model is designed to use the physicochemical properties of a drug in combination with tubular drug concentrations to predict crystal formation. A PBPK model representing EG and its metabolites glycolic acid, glyoxalic acid, and oxalic acid was constructed using GastroPlus 9.8 to inform oxalate concentrations in the kidney tubule. Precipitation of CaOx, crystal disposition, crystal uptake by tubular cells, cell death due to crystal induced oxidative stress, and crystal clearance was then parameterized using published data in mouse and rats.

**Results:** The kidney tubule concentrations predicted by the PBPK model are well above the solubility limit and therefore result in crystal formation at all simulated doses. The RENAsym crystal nephropathy submodel has been parameterized to induce mild PTC injury when EG is administered at a 0.75% (w/v) in drinking water to rats. Simulations did not predict a serum creatinine increase greater than 1.5X baseline, which aligns with the data as the simulated protocol is not expected to have an appreciable effect on creatinine clearance.

**Conclusions:** The crystal nephropathy model in RENAsym does a reasonable job of representing EG-induced CaOx crystal formation and its nephrotoxic effects. The model shows promise in its ability to predict kidney injury due to other compounds that can precipitate in the kidney tubule, such as indinavir.

**Funding:** NIDDK Support

#### TH-PO117

##### Multi-Omics Conjoint Analysis Identified pglyrp1 as a Potential Biomarker and Target for Sepsis-Induced AKI

Ruilian You, Lubin Xu, Jiatong Xu, Yixin Ma, Jianfeng Lin, Huadong Zhu, Limeng Chen. Peking Union Medical College Hospital, Dongcheng-qu, China.

**Background:** Sepsis-induced acute kidney injury (SI-AKI) is a frequent complication of critical patients leading to high morbidity and mortality without a satisfactory prognosis. Further studies are needed to unveil the SI-AKI mechanisms for detecting new biomarkers and treatment targets.

**Methods:** We conducted the genome-wide Mendelian randomization (MR-PheWAS) using the 2116 instruments for 1699 proteins from the open protein quantitative trait loci (pQTLs) data published by the Jie Zheng et al. and the genome-wide association studies (GWAS) of the acute kidney failure including 456348 European. Adjusted  $P < 3 \times 10^{-5}$  was considered significant and  $P < 0.05$  was considered suggestive of an association. We selected the expression profile GSE125276 from the Gene Expression Omnibus (GEO) database to analyze the differentially expressed genes (DEGs) of the SI-AKI. Animal model of SI-AKI was established with lipopolysaccharides (LPS). Common gene identified based on the genome and the transcriptome was validated by the quantitative real-time PCR (qRT-PCR) and western blot.

**Results:** A total of 61 proteins were considered suggestive of an association by the MR-PheWAS, including 34 protective genes and 27 risk proteins. The 316 DEGs were identified from the GSE125276. Csf2rb, pglyrp1, and slurp1 were common genes of the multi-omics analysis. Pglyrp1 was included in the top hub module extracted from the molecular complex detection (MCODE). The RNA and protein expression levels of the pglyrp1 are all significantly elevated in the nephron tissue of the SI-AKI mice compared to control group.

**Conclusions:** Our study first combined the MR-PheWAS method using genome data and expression data in SI-AKI, validated that pglyrp1 upregulated as a potential causal risk molecular of the SI-AKI.

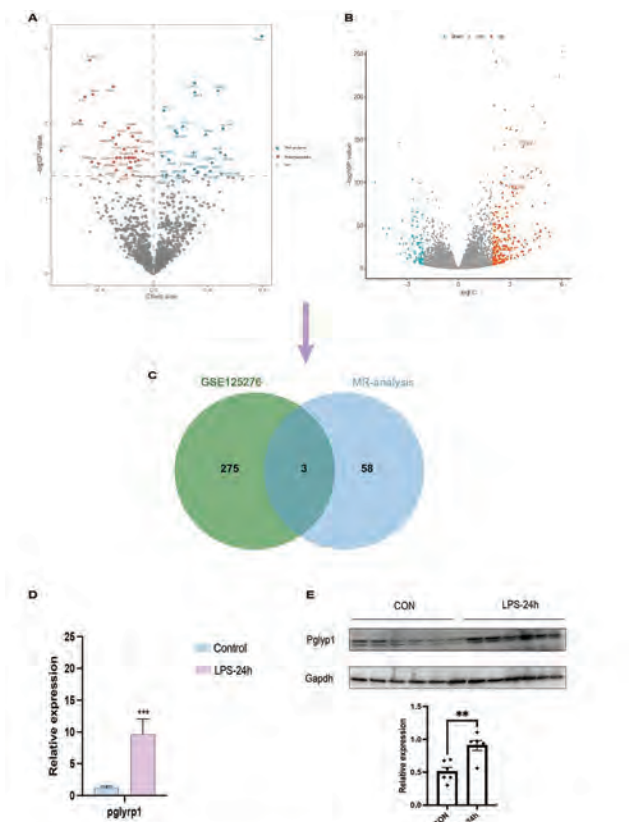

**Figure 1. Multi-omics conjoint analysis identified *pglyrp1* as a potential biomarker and target for Sepsis induced Acute Kidney Injury (SI-AKI).** A: Volcano plot of the effect size from MR analysis of 1669 proteins with risk of AKI. B: Volcano plot showed significant DEGs in GSE125276. C: Venn diagram presents the two analysis methods' common genes/proteins. D: The mRNA expression of the *pglyrp1* in kidney of SI-AKI and control groups. E: Western blot analysis of the protein *pglyrp1* in SI-AKI and control groups.

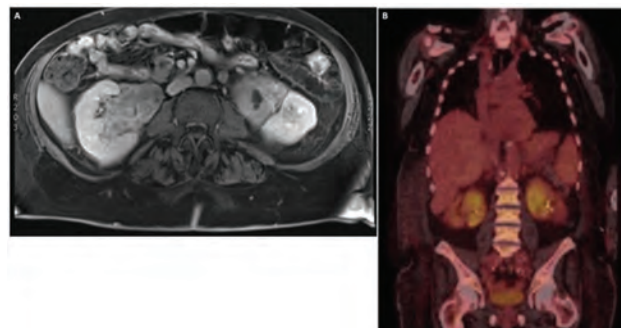

A. MRI with contrast showing bilateral peripelvic masses.

B. PET-CT.

**TH-PO119**

**Anti-GBM Glomerular Basement Membrane Disease Sans Kidney Involvement**

Olesya Ilkun, Josephine Abraham. University of Utah Health, Salt Lake City, UT.

**Introduction:** Anti-GBM (anti-glomerular basement membrane) is an autoimmune disease involving glomerular and pulmonary capillaries diagnosed in 1 patient per million per year. Predominant lung involvement can be seen in 6% of patients most of which still demonstrate microscopic hematuria and biopsy with typical linear IgG immunofluorescence (99%).

**Case Description:** We report a case of a 57-year-old man who presented with several weeks of dyspnea and myalgia, and was found to have acute kidney injury and multifocal tree-in-bud groundglass opacities throughout both lungs (Figure 1). His serum creatinine was elevated to 4.5 mg/dL from baseline of 0.8 mg/dL three months earlier but no proteinuria or hematuria. COVID19 was negative. Bronchoscopy showed blood throughout the tracheobronchial tree. Anti-GBM was elevated at 80 AU/mL. CRP was elevated at 17 mg/dL. Further work-up for other infectious or autoimmune causes was unremarkable. Kidney biopsy showed acute tubular necrosis (ATN), mixed interstitial inflammatory infiltrate, and one isolated fibrous cellular crescent. Immunofluorescence was negative. Due to the concern for progression of untreated anti-GBM disease, the patient was given high dose steroids, plasma exchange, and oral cyclophosphamide. His anti-GBM titer decreased to an undetectable level. Creatinine improved to 2.33 mg/dL.

**Discussion:** This case brings to light a rare variant of anti-GBM with no detectable kidney involvement and presents a therapeutic dilemma. Two independent pathologists reviewed kidney biopsy and felt that crescent was a non-specific result of prior glomerular injury or pauci-immune focal glomerulonephritis. ANCA serologies were negative, and there were no other systemic manifestations. ATN was attributed to poor intake and Naproxen use. The patient received a typical anti-GBM treatment but more data are needed to support this approach in mild cases.



**TH-PO118**

**Bilateral Hydronephrosis due to Rosai-Dorfman Disease**

Olesya Ilkun,<sup>1,2</sup> Rama Kethineni,<sup>1,2</sup> Monique E. Cho,<sup>1,2</sup> Josephine Abraham.<sup>1,2</sup> Utah <sup>1</sup>University of Utah Health Hospitals and Clinics, Salt Lake City, UT; <sup>2</sup>VA Salt Lake City Health Care System, Salt Lake City, UT.

**Introduction:** Rosai-Dorfman Disease (RDD) is a rare histiocytic proliferative disorder, with approximately 100 cases diagnosed each year in the United States. Typically it presents as nodal and cutaneous disease, but kidneys can be affected in 4% of cases.

**Case Description:** We present a case of a 78-year-old man who was admitted with osteomyelitis and acute kidney injury. His serum creatinine was elevated to 2.62 mg/dL from baseline of 0.67 mg/dL ten weeks earlier. Retroperitoneal ultrasound showed bilateral hydronephrosis. Further imaging showed obstruction at the level of ureteropelvic junction due to bilateral masses: left 7.0 x 6.1 cm and right 5.7 x 5.2 cm, that were solely enhancing on PET-CT (Figure 1). Biopsy of the right parapelvic mass showed atypical histiocytic and paraplasmic infiltrate consistent with Rosai-Dorfman Disease. Bone culture showed Enterobacter cloacae and patient was started on antibiotics. ANA was detected at 1:320 but C3, C4, and dsDNA were normal and there were no other manifestations to indicate lupus or lupus nephritis. Work-up for other infectious or autoimmune secondary causes was negative. Treatment strategies of this heterogeneous disease vary from surgical resection or debulking, corticosteroids to chemotherapy or radiotherapy. Given ongoing osteomyelitis and further indolent course of his RDD, this patient was managed conservatively with bilateral ureteral stents, and his creatinine improved to 1.4 mg/dL.

**Discussion:** This is a very rare case of Rosai-Dorfman Disease isolated to bilateral kidneys. Ongoing infection hindered use immunosuppression in this patient. This case brings to light a rare disorder and underscores the importance of renal imaging when evaluating acute kidney injury.

## TH-PO120

### Newly Diagnosed Sickle Cell Disease Complicated by AKI With Bone Marrow Necrosis and Fat Embolism Syndrome Successfully Treated With Plasma Exchange

Jun Li,<sup>1,2</sup> Michel Terzibachi,<sup>1,2</sup> Deep Sharma,<sup>1,2</sup> Jyotsana Thakkar,<sup>1,2</sup> Laurene Tuidier,<sup>3</sup> Molly Fisher.<sup>1,2</sup> <sup>1</sup>Albert Einstein College of Medicine, Bronx, NY; <sup>2</sup>Montefiore Medical Center, Bronx, NY; <sup>3</sup>United Health Service Medical Center, Johnson City, NY.

**Introduction:** Bone marrow necrosis with fat embolism syndrome (FES) is a devastating complication of sickle cell disease (SCD) that is associated with high mortality. We report an unusual case of an elderly female who presented with severe acute kidney injury (AKI) and features suggestive of thrombotic microangiopathy (TMA) who was found to have hemoglobin SC disease (HbSC) with FES, which was successfully treated with plasma exchange.

**Case Description:** A 76-year-old African American female with diabetes, hypertension, rheumatoid arthritis presented with altered mental status, hypoxic respiratory failure and septic shock due to pneumonia requiring intubation and vasopressors. Upon admission, she was found to have an elevated serum creatinine of 3.6mg/dl as well as severe anemia (hemoglobin 6.7 g/dL), thrombocytopenia (platelet count 66 k/ $\mu$ L) and elevated transaminases. Additional workup revealed a lactate dehydrogenase of 2553 U/L, haptoglobin <10mg/dl, ADAMTS 13 activity 0.52 IU/mL. Peripheral smear revealed schistocytes, sickle cells and findings of bone marrow necrosis. She was also found to have bilateral femoral head avascular necrosis on CT. Hemoglobin electrophoresis was performed and showed elevated hemoglobin S and hemoglobin C, consistent with HbSC disease. The patient received emergent exchange transfusion for FES in the context of sickle cell crisis. She subsequently received plasma exchange for 5 days and supportive hemodialysis. After treatment, her mental status improved as well as her hematologic parameters and kidney function leading to discontinuation of hemodialysis.

**Discussion:** Bone marrow necrosis with FES is a rare complication of SCD that can mimic TMA. Interestingly, this syndrome is most often described in HbSC disease, a mild variant of SCD. The present case highlights the importance of not overlooking this diagnosis in patients with SCD who present with TMA-like features and AKI and also shows that plasma exchange is an effective therapeutic strategy.

## TH-PO121

### High Oxygen Exposure Activates the Renal Endothelin System and Induces Extracellular Matrix Deposition

Abigail Kraus, Sara Biswal, Carmen De Miguel. *University of Alabama at Birmingham, Birmingham, AL.*

**Background:** High oxygen supplementation is abundantly used in the clinical setting. Despite increasing evidence of excessive O<sub>2</sub> increasing mortality and morbidity in ICU patients, the exact molecular mechanisms involved remain obscure. Of note, acute kidney injury and acute lung injury often occur in tandem in critical care and are both associated with elevated levels of endothelin-1 (ET-1) and ET<sub>A</sub> receptor overactivation. However, if the ET-1 system plays a role in kidney injury during exposure to elevated O<sub>2</sub> levels remains unknown. These studies aimed to define the role of the ET-1 system in hyperoxia-induced kidney damage.

**Methods:** Male and female adult C57Bl/6N mice were exposed to room air (RA) or hyperoxia (HA, >95% O<sub>2</sub>) for 72 hours. Kidneys were collected for assessment of extracellular matrix deposition (ECM) via Picosirius staining as well as mRNA expression of ET-1, and ET<sub>A</sub> and ET<sub>B</sub> receptors and ECM deposition markers in different kidney regions.

**Results:** Kidneys from mice exposed to high O<sub>2</sub> expressed significantly greater ET-1 levels compared to room air littermates. In response to HA, the outer and inner medulla showed a 2.3- and 5-fold upregulation of ET-1 mRNA expression, respectively (RA vs. HA, outer medulla: 1±0.23 vs. 2.3±0.35, p=0.02, n=6-8/group; inner medulla: 1±0.19 vs. 5.2±0.71, p=0.001), but no difference was observed in cortex (p=0.37). No differences in renal expression of ET<sub>A</sub> or ET<sub>B</sub> receptors were detected with HA. The HA-induced changes in the ET-1 system were accompanied by prominent ECM deposition in all areas of the kidney when visualized under bright-field and polarized light microscopy. Further, the inner medulla revealed a 4.5 fold increase in collagen IV gene expression when exposed to HA (1±0.40 vs. 4.01±1.00, p=0.02). No sex differences in the effects of HA on the kidney ET-1 system were detected.

**Conclusions:** In conclusion, high O<sub>2</sub> exposure induces ECM deposition in the kidney and upregulates the ET-1 system, specifically in the renal medulla. Our findings strongly suggest that high O<sub>2</sub> supplementation results in ET-1-mediated kidney injury. A better understanding of the renal ET-1 system response in high O<sub>2</sub> states will help designing better pharmaceutical or O<sub>2</sub> management interventions to limit the detrimental effects of high O<sub>2</sub> supplementation and improve patient care.

**Funding:** Other NIH Support - NIH K01HL145324 to CDM, Private Foundation Support

## TH-PO122

### Hydralazine-Induced ANCA Vasculitis: The Fault in Our Drugs

Neha Siddiqui, Jay G. Shastri, Lorraine Alcantara, Areej Lalani, Anum S. Khan, Ram Sinha. *AtlantiCare Regional Medical Center, Atlantic City, NJ.*

**Introduction:** Hydralazine is a vasodilator used in the management of high blood pressure. It is not a first-line agent and is usually given to patients who can not tolerate ACE/ARB or as an additional therapy in patients who have residual hypertension. Hydralazine

is known to cause a drug-induced lupus-like syndrome but rarely, Hydralazine can cause antineutrophil cytoplasmic antibody-associated (ANCA) vasculitis, it commonly presents as multi-organ related vasculitis with skin and pulmonary-renal manifestations. In this case study, we present a rare case of renal limited hydralazine induced ANCA vasculitis.

**Case Description:** An 89-year-old female presented to the emergency department due to acutely worsening kidney function in outpatient labs. Urine analysis was positive for hematuria and proteinuria. Ultrasound of the kidneys showed no signs of obstruction. Creatinine continued to rise despite the discontinuation of ACE inhibitors. The patient was positive for p-ANCA/MPO, ANA, and double-stranded DNA antibodies. C3 level was normal and C4 was at the low end of normal. The patient was recently started on hydralazine 100mg TID eleven months before presentation. She denied joint discomfort, visible hematuria, rashes, hemoptysis, shortness of breath, or signs of purpura. She received pulse dose steroids and hydralazine was discontinued. Creatinine responded to discontinuation of hydralazine supporting the diagnosis of hydralazine-associated vasculitis. The patient refused to undergo a biopsy hence immunosuppressive therapy could not be initiated.

**Discussion:** Hydralazine-induced ANCA vasculitis has an incidence of 5.4% in patients receiving 100mg/day of hydralazine and 10.4% in patients receiving 200mg/day for more than 3 years. It mostly presents with multi-organ system disease, there are only four reported cases of hydralazine induced vasculitis limited to the kidney. In a large study comprising 80 cases of hydralazine associated ANCA-GN, 98% of the subjects were P-ANCA/MPO positive and 39% had dual positivity with P-ANCA and C-ANCA. There are few reported cases of asymptomatic, renal limited, hydralazine induced ANCA vasculitis which makes it challenging to diagnose and, therefore, can be easily missed. Increasing awareness amongst the health care workers can lead to timely diagnosis and prompt initiation of treatment resulting in a better outcome.

## TH-PO123

### Cefoxitin-Induced Pseudo-AKI

Jeanette M. Atencio, J. Pedro Teixeira, Sara Combs. *University of New Mexico Health Sciences Center, Albuquerque, NM.*

**Introduction:** Drug toxicity is a common cause of hospital-acquired acute kidney injury (AKI), but drug-induced pseudo-AKI is rare. We present a case of pseudo-AKI from cefoxitin.

**Case Description:** A 57-year-old man with opiate use disorder was transferred for a *Mycobacterium abscessus* prosthetic left hip infection. He had previously been treated for >1 month with amikacin, cefoxitin, and tigecycline with normal serum creatinine (Cr) throughout. On admission to our hospital, blood urea nitrogen (BUN) was 20 mg/dL and Cr was 0.87 mg/dL, he was continued on the same antibiotics. On hospital day (HD) 8, when Cr was 0.94 and BUN was 20, the cefoxitin was switched from 3 times daily dosing to a continuous infusion. On HD 10 his Cr jumped to 10.1 with BUN 17. When redrawn 2h later, Cr was 15.0 and BUN was 16. Nephrology was consulted and cefoxitin was stopped. Renal ultrasound and urinalysis were normal. Infectious disease suspected lab interference from cefoxitin and recommended redrawing labs from a site away from the site of cefoxitin infusion. On HD 11 his Cr returned to 0.86 and cefoxitin was resumed. Cystatin C drawn the afternoon of HD 10 eventually resulted at 0.9 mg/dL.

**Discussion:** Most labs measure serum Cr using the kinetic alkaline picrate (Jaffe) method, which can rarely be subject to interference from other chromogens, leading to spurious elevation. Compounds known to interfere include cefoxitin, flucytosine, dexamethasone, acetacetate (in DKA), and bilirubin (when extremely elevated). When diagnosing pseudo-AKI, the timing of drug administration and lab draw and the venipuncture site relative to the drug infusion site are important factors. Additional clues include non-physiologic rise in Cr and lack of change in other markers of renal function. With intermittently dosed cefoxitin, pseudo-AKI can be confirmed with a lab redraw after cefoxitin is eliminated (i.e., after 2-4h in normal kidney function, 6-8h in mild-to-moderate renal failure, and variable interval in severe renal failure). Though rare, this case illustrates the importance of considering pseudo-AKI in the differential diagnosis of unexplained AKI.

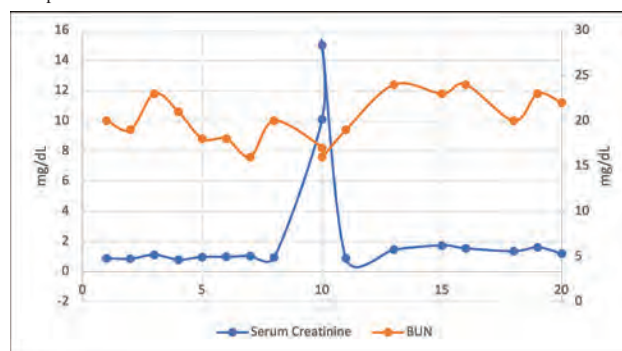

## TH-PO124

**Postpartum Complement Mediated Thrombotic Microangiopathy: A Case Report**

Christian Anderson, Iiro Honkanen, Sarat C. Kuppachi. *The University of Iowa Hospitals and Clinics, Iowa City, IA.*

**Introduction:** Complement mediated thrombotic microangiopathy (TMA) can be associated with a high risk of progression to ESRD if it is unrecognized early in its course. Frequently, a trigger in a genetically susceptible individual initiates aberrant activity of the complement cascade causing microangiopathic hemolytic anemia. Herein, we present the case of a 26-year-old who presented with TMA at the time of her delivery and subsequently found to have a mutation in the Wilms' tumor 1 (WT1) gene.

**Case Description:** A 26-year-old nulliparous woman was admitted to the hospital on post-partum day (PPD) 1. Delivery was complicated by profuse bleeding requiring transfusion of RBCs, platelets, and FFP. She was referred to the Nephrology service on PPD2 with anuria, acute kidney injury (AKI) with a creatinine of 3.6 mg/dL, thrombocytopenia (nadir 14,000), hemolytic anemia, and low complement levels. Urinalysis showed hematuria, protein creatinine ratio of 1.55, and muddy brown casts. Given progression of her kidney injury despite plasmapheresis and a normal ADAMTS-13 level, she was started on eculizumab 900 mg every 14 days with improvement in her platelet count. She required three hemodialysis treatments for volume overload, before her kidney function eventually normalized. Her eculizumab was then discontinued. Genetic testing revealed a heterozygous mutation in WT1 variant NM\_024426.6:c.662-6C>A, which is a variant of unknown significance.

**Discussion:** Pregnancy is a well-established trigger for TMA which must be included in the differential diagnosis of peri- and post-partum patients with AKI. Once TMA is identified, it is important to pursue genetic testing to better understand the genetic variants implicated in the disease. This has implications for treatment, prognosis, and further research. To the best of our knowledge there is only one reported case of WT1 mutation presenting as complement mediated hemolytic syndrome. WT1 encoded proteins are necessary to regulate cell growth and maintain normal function of renal podocytes and the glomerular filtration barrier. We hypothesize that reduced WT1 expression, leading to podocytopeny could be one of the pathogenic factors contributing to the occurrence of TMA. Based on this experience, and successful treatment with eculizumab, we want to raise awareness to the to the possibility of WT1 mutations triggering TMA in susceptible patients.

## TH-PO125

**A Case of Streptococcal Toxic Shock Syndrome With Acute Renal Failure**

Renuka Tolani, *Palmetto General Hospital, Hialeah, FL.*

**Introduction:** Elderly patients with skin lesions and risk factors such as diabetes, can develop streptococcal toxic shock syndrome (STSS) with multiorgan involvement. Certain patients present with acute kidney injury (AKI), and later progress to renal failure requiring renal replacement therapy.

**Case Description:** Patient is an 86 year old male with past medical history of CKD stage 3b and diabetes (on Ozempic and insulin) who presents to the ED for weakness, chills, and fever after injuring his right arm on a car door the week prior. Physical exam was significant for tenderness and diffuse bullae, with sharp margin of erythema and desquamation in the right upper extremity. Patient was in septic shock with increasing lactic acidosis. Multiple pressors, IV fluids, and broad spectrum antibiotics were administered. Patient became tachypneic and required intubation. Initial labs were significant for leukocytosis of 15 with left shift, bicarb 20, anion gap 13, lactic acid 5.9, and creatinine 2.6 with GFR 23. ABG on 3 L NC showed metabolic acidosis with pH 7.131, pCO<sub>2</sub> 25, bicarb 8, paO<sub>2</sub> 98. Repeat labs showed bicarb level dropped from 20 to 9, with anion gap of 22 and lactic acid 17. Ph decreased to 7.057. Cr was 1.6 and GFR was 41 on labs the year prior, AKI on CKD stage 3b. Transaminitis more than 2 times the upper limit of normal also developed. Glucose was 200 without ketones or glucose noted in urine. A foley catheter was placed. Urgent exploratory surgery and biopsy were done. The patient grew strep pyogenes in both blood and wound cultures. Pathology report showed extensive coagulative necrosis with cocci like bacteria, without evidence of necrotizing fasciitis. Despite administration of bicarb drip and pushes, the patient's acidosis did not improve. The patient had less than 500 ccs of urine production in 24 hours, and there was an increase of potassium to 6.3 from 4.6. The creatinine also increased to 4.3 from 2.6. Decision was made to begin Continuous Renal Replacement Therapy (CRRT). Urinalysis was negative for leukocyte esterase or nitrite, but showed WBC > 50 and RBC > 20. His family was offered the choice of right upper extremity amputation, but opted for comfort care.

**Discussion:** Clinicians should recognize the life-threatening process involved in STSS. Hypotension and toxin-induced hemolysis with myoglobinuria and hemoglobinuria, may contribute to acute renal failure and ATN for which CRRT plays a major role.

## TH-PO126

**Kidneys, Windows to the Liver: A Case of Autoimmune Hepatitis With Lupus Nephritis**

Leanne Brown, Aditi Singh. *UConn Health, Farmington, CT.*

**Introduction:** Systemic lupus erythematosus (SLE) is an autoimmune disease with a wide range of systemic manifestations. However, primary involvement of the liver is rare and is not part of the diagnostic criterion. We present a case of biopsy proven primary biliary cholangitis (PBC), later diagnosed as lupus nephritis with suspected autoimmune hepatitis (AIH) given remission with immunosuppressive therapy.

**Case Description:** An Asian-American 51 year-old male presented to the hospital with worsening lower extremity edema. Laboratory investigations revealed normal renal function, persistently elevated liver enzymes and equivocal antimitochondrial antibody (AMA) titers. PBC was diagnosed two years prior to presentation with liver biopsy demonstrating interface hepatitis with chronic inflammatory infiltrates and bile duct injury. He was started on ursodiol without significant improvement in his liver dysfunction. He subsequently developed an acute kidney injury (AKI) and was found to have both hematuria and proteinuria. Further work up demonstrated positive antinuclear antibodies in high titers and positive double stranded DNA antibodies with renal biopsy consistent with Class IV Lupus nephritis. He was induced with pulse dose steroids followed by maintenance with cyclophosphamide with later transitioned to mycophenolate mofetil. He achieved clinical and serological remission with improvement in his renal function and complete resolution of liver dysfunction on immunosuppressive regimen for SLE.

**Discussion:** Although the liver is not a major target for damage in SLE, clinical and biochemical evidence of liver dysfunction is common. This can pose great diagnostic challenges given a considerable degree of overlap in the presentation of lupus hepatitis, AIH and PBC. In our case a diagnosis of AIH was made after lupus nephritis was detected on renal biopsy and its response to immunosuppressive therapy. A high degree of clinical suspicion is required, especially in patients of Asian descent where AIH is more prevalent.

## TH-PO127

**A Case of AKI due to Oxalate Toxicity Following an Over-the-Counter 3-Day Cleanse**

Louis Damian, Shilpa Sannapaneni, Christopher Hebert, Akinwande A. Akinfolarin. *Baylor Scott & White Health, Dallas, TX.*

**Introduction:** Oxalate toxicity is a rare but serious disorder that can result in crystal induced Acute Kidney Injury. Calcium oxalate deposition in the kidney can be caused by excessive intake of oxalate in food, fat malabsorption following Roux-en-Y gastric bypass causing increased enteric absorption of oxalate, and primary hyperoxaluria due to hepatic enzyme defects. With the increasing use of "juice cleanses", it is important to recognize the potential risk of excessive ingestion of oxalates in juices made from these over the counter products included in "juicing" protocols.

**Case Description:** A 46-year-old male with past medical history significant for chronic alcohol abuse complicated by alcoholic liver disease was admitted to our hospital with worsening jaundice, fatigue, dyspnea at rest, and generalized weakness. He had noticed a reduction in his urine output but had no hematuria or skin rash. He had no significant medication history but on further questioning reported taking the over-the-counter "Renew-Life 3-Day liver cleanse" approximately one week before onset of symptoms. **This cleanse contained extracts from Rhubarb and Cape aloe.** Laboratory findings from his renal panel were significant for a Creatinine of 13.66 mg/dL (his baseline was 0.8), sodium 123 meq/L, potassium 5.6 meq/L. His Liver panel revealed a total bilirubin 36.0 mg/dL, alkaline phosphatase 437 U/L, AST 70 U/L, ALT 60 U/L, INR 1.8. Serum osmolality was 318 mosm/kg (calculated osmolality 301 mosm/kg). Ethylene glycol was absent on serum toxic alcohol screen. **Serum oxalate level was 9.0 mg.** His clinical course was complicated by anuria and electrolyte derangements. His clinical condition deteriorated with acute respiratory failure and therapy with renal replacement was initiated. He has remained anuric and dialysis dependent.

**Discussion:** Over the counter "cleanse" products may have high oxalate content and predispose to crystal induced kidney injury. This may be more so in patients with concurrent liver disease who can develop fulminant liver failure. A high index of suspicion is required in patients presenting with anuric renal failure after a "cleanse", in order to provide appropriate and timely renal therapy. More advocacy should be paid to warning kidney patients of the potential risk of "cleanses".

## TH-PO128

**Renal Limited Sarcoidosis Presenting as Granulomatous Interstitial Nephritis**

Shilpa Sannapaneni, Louis Damian, Wesley Hiser, Akinwande A. Akinfolarin. *Baylor University Medical Center at Dallas, Dallas, TX.*

**Introduction:** Sarcoidosis is a multisystem disorder which primarily involves the lung. Although, renal involvement can be seen in up to 35-50% of sarcoidosis patients, renal limited sarcoidosis without any extra renal manifestations is extremely rare. Here we present a unique case of renal limited sarcoidosis presenting with granulomatous interstitial nephritis (GIN).

**Case Description:** A 69-year-old female with a past medical history of type 2 diabetes, hypothyroidism, chronic obstructive pulmonary disease, chronic kidney disease with baseline creatinine of 1.1 mg/dL was referred to Nephrology with generalized weakness, nausea, vomiting. She had no skin rash, lymphadenopathy, hematuria, no recent history of systemic infections, or antibiotic use. Home medications included sitagliptin, levothyroxine, vitamin D and calcium supplements which were all started two years prior to referral. On presentation, her vital signs were normal and physical examination was unremarkable. Laboratory studies revealed Creatinine 4.77 mg/dL, Calcium 15 mg/dL, Vitamin D 82 ng/ml; 1, 25 dihydroxy vitamin D 114 pg/ml, Parathyroid hormone (PTH) 16.9 pg/mL, PTH related peptide 18 pg/ml, Angiotensin converting enzyme level: 74 U/L, urine protein creatinine ratio: 0.3 mg/mg. Extensive infectious work-up was negative. Renal ultrasonography was unremarkable. A kidney biopsy was performed which was significant for acute interstitial nephritis, small granulomas with multinucleated giant cells concerning for granulomatous interstitial nephritis. Computed tomography scan of chest and abdomen showed no evidence of extra renal sarcoidosis. She was started on steroids and her creatinine trended down to 2.4 mg/dL at the time of discharge.

**Discussion:** Renal manifestations of sarcoid include nephrolithiasis, GIN, nephrocalcinosis, non-granulomatous interstitial nephritis and glomerular disease. GIN can be also seen with medications, infections, crystal deposition, paraproteinemias and vasculitis. GIN is a rare pathological diagnosis which may be seen in about 0.5-0.9% of native kidney biopsies and about 6% biopsies with interstitial nephritis. It is extremely rare to find GIN in sarcoidosis without extra renal involvement. A review of literature revealed about 100 cases of renal sarcoid associated GIN but majority had extra renal manifestations. The mainstay of therapy for sarcoidosis with GIN is steroids.

#### TH-PO129

##### **If in Doubt, Biopsy: Unexpected Renal Pathology Proves Critical to Patient Management in Two Interesting Cases**

Michelle Madden,<sup>1</sup> Mairead Hamill,<sup>1</sup> Blathnaid O'Connell,<sup>1</sup> Robert W. Casey,<sup>1</sup> Brendan Doyle,<sup>2</sup> Catherine M. Brown,<sup>1</sup> Sean F. Leavey.<sup>1</sup> <sup>1</sup>University Hospital Waterford, Waterford, Ireland; <sup>2</sup>Beaumont Hospital, Dublin, Ireland.

**Introduction:** We describe two patients who presented with an unexplained elevation in serum creatinine, inconclusive urinalysis and an unexpected rate of eGFR decline leading to kidney biopsy.

**Case Description:** A seventy year-old man presented with several days of severe nausea, vomiting and diarrhoea. Creatinine was 8.92mg/dL, eGFR 6ml/min, a decline from a normal estimate when last checked one year prior. With intravenous fluids, creatinine fell to 4.03mg/dL but failed to improve further. Urinalysis was bland and urine ACR 3 mg/mmol. Kidney biopsy showed oxalate crystal deposition in the tubules and secondary acute tubular injury. The patient subsequently reported commencing a daily supplement of 550mg Vitamin C, more than five times the recommended allowance, eighteen months previously. Supplementation was discontinued and dietary counselling provided; twenty-four hour urine collection two weeks later showed a normal oxalate excretion of 27 mg/24 hour. Kidney function improved to stable stage 4, most recent creatinine 2.38mg/dL, nineteen months post biopsy. An eighty year-old lady was referred by her GP for an eGFR that had fallen from >60 to 33ml/min. Serum creatinine at referral was noted to be 1.45mg/dL, compared to 1.1mg/dL twelve months prior and 0.68mg/dL eighteen months prior. She had no microalbuminuria or hematuria. She was on apixaban for paroxysmal atrial fibrillation. New medications introduced eighteen months prior were pantoprazole and amiodarone. Obstruction and myeloma were ruled out and pantoprazole ceased, but creatinine rose further to 1.72mg/dL over three months and kidney biopsy was arranged. The biopsy revealed acute tubular injury with vacuolization of cells. This pattern of drug-induced injury is associated with amiodarone-related phospholipidosis and toxicity in the literature. Amiodarone was discontinued. The patient's serum creatinine improved and is 1.43mg/dL, eGFR 35ml/min, eighteen months later.

**Discussion:** In each of these cases, an unexpected kidney biopsy result critically and favourably altered management. Had these patients been left untreated, there was a significant likelihood of progression to end-stage kidney disease. Whether amiodarone may be an under-appreciated nephrotoxin deserves further research.

#### TH-PO130

##### **Contrast Nephropathy: Associated or Induced?**

Ramandeep Kaur,<sup>1</sup> Clay A. Block,<sup>1,2</sup> Jason R. Pettus.<sup>1,2</sup> <sup>1</sup>Dartmouth-Hitchcock Medical Center, Lebanon, NH; <sup>2</sup>Dartmouth College Geisel School of Medicine, Hanover, NH.

**Introduction:** Acute Kidney Injury (AKI) secondary to radiographic contrast exposure has been challenged in recent years. Contrast Associated Nephropathy (CAN) often occurs in the presence of other risk factors for AKI. We report a case in which AKI developed following radiocontrast exposure but also in the presence of other risk factors for AKI. A kidney biopsy established the diagnosis.

**Case Description:** A 64-year-old woman presented with acute confusion and falls suspicious for CNS vasculitis. She was admitted and treated with pulse methylprednisolone and intravenous vancomycin, ampicillin, ceftriaxone, acyclovir and omeprazole while performing studies for infection and autoimmunity. The creatinine rose from 0.6 mg/dL on day 1 to 2.3 mg/dL on day 3. The urine protein - creatinine ratio was 0.55 g/g. UPEP, SPEP, serum free light chains, and immunological studies including C-ANCA, P-ANCA, MPO Ab, ANA, PR3 Ab, C3 and C4 complements, Cryoglobulins, anti-ds DNA, anti-CCP antibodies were negative. A kidney biopsy was done. It demonstrated severe, diffuse tubular isometric vacuolization compatible with osmotic nephrosis. There was no evidence of acyclovir toxicity, AIN, or conventional ATN. With supportive care, the renal function normalized by day 6.

**Discussion:** Radiocontrast is commonly used in hospitalized patients and has a strong potential for nephrotoxicity. CAN is considered when the patient receives a radiocontrast either intravenously or intra-arterially with a subsequent elevation of serum creatinine of either 0.5 mg/dL or 25% increase above the baseline over the next 24-72 hours. In AKI following radiocontrast exposure and competing explanations, kidney biopsy may point to a specific diagnosis.

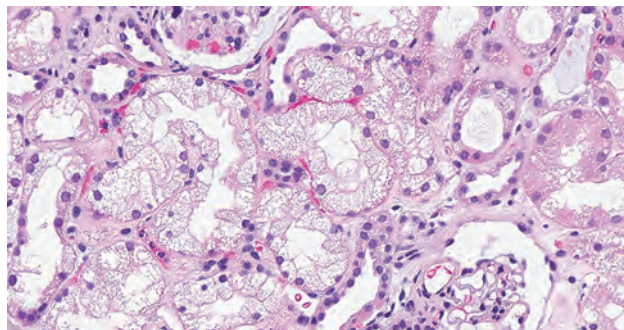

H&E, 40 X

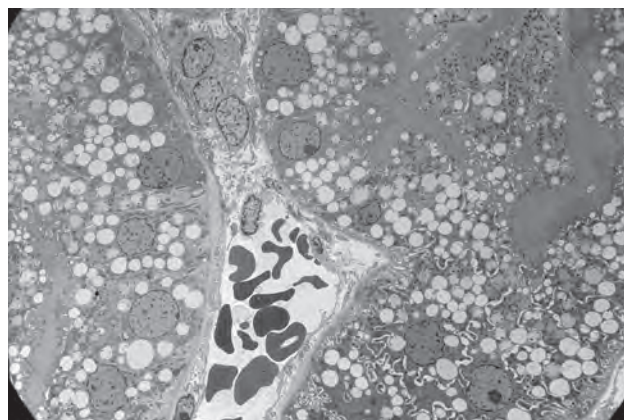

Transmission EM

#### TH-PO131

##### **Lamotrigine Causing Drug-Induced Acute Interstitial Nephritis With Granulomas**

Mal P. Homan, Brian J. Holahan, Breanna S. Goldner, Margaret Duffy. *Lehigh Valley Health Network, Allentown, PA.*

**Introduction:** Lamotrigine is used for its antiepileptic and mood stabilization properties. Serious complications can include Steven-Johnson Syndrome or aseptic meningitis. A lesser-known adverse reaction from lamotrigine is acute interstitial nephritis (AIN) with granulomas.

**Case Description:** A 25-year-old man presented to the emergency department with fever, bilateral flank pain, and decreased urination. Medical history was remarkable for bipolar II disorder for which lamotrigine was started a few months prior. Upon arrival, his oral temperature was 100.6°F with otherwise unremarkable vitals. Serum creatinine was 2.0 mg/dL (baseline 0.8-0.9 mg/dL) and there were 10% eosinophils on labs. Urine microscopy revealed 11-20 WBC/hpf, 6-10 RBC/hpf, 1+ bacteria, and >10 hyaline casts; urine protein-creatinine ratio was 2.4 g/g. Imaging revealed bilateral renal enlargement, loss of cortical medullary differentiation, and perinephric stranding suspicious for pyelonephritis. He was initiated on antibiotics and admitted. The creatinine progressively worsened up to 9.56 mg/dL with oliguria and hemodialysis was started. He also developed a diffuse maculopapular rash. Infectious work up was negative, and he was given pulse dose steroids for possible drug-related eosinophilic systemic symptoms (DRESS) or AIN. A kidney biopsy revealed severe interstitial nephritis with granulomatous features in a vasculocentric distribution. The lamotrigine was discontinued, and his renal function and diffuse rash subsequently improved. After discharge, he had full renal recovery after a four-week taper of oral prednisone.

**Discussion:** We describe a rare and severe case of acute granulomatous interstitial nephritis attributed to lamotrigine. AIN can occur days to several months after initiation of an offending agent. Non-renal manifestations such as fever, rash, or eosinophilia can also develop. Although AIN is typically associated with medications such as non-steroidal anti-inflammatory drugs, proton-pump inhibitors, or antibiotics, lamotrigine-related AIN has been reported.<sup>1,3</sup> Interstitial nephritis with granulomas on biopsy should prompt a thorough review of a patient's medications, as this pattern of injury is usually due to a drug-related AIN.<sup>4</sup> In patients with new-onset renal failure in the setting of lamotrigine use, AIN should be considered so that early and appropriate intervention can be initiated.



## TH-PO132

**An Unusual Complication of IgG4-Related Interstitial Nephritis as Resistant Hypertension**

Hubert Wang,<sup>1</sup> Monica P. Revelo Penafiel,<sup>2</sup> Sobia N. Khan.<sup>1</sup> <sup>1</sup>Stony Brook University Renaissance School of Medicine, Stony Brook, NY; <sup>2</sup>University of Utah Health, Salt Lake City, UT.

**Introduction:** IgG4-related disease is immune-mediated, can affect multiple organ systems, and is characterized by tissue biopsy with dense lymphoplasmacytic infiltrate, high numbers of IgG4-positive plasma cells, and varying degrees of tissue fibrosis in a storiform pattern. We present a unique case of resistant hypertension (HTN) as a prominent manifestation in IgG4-related interstitial nephritis.

**Case Description:** A 64-year-old male with history of HTN and livedoid vasculopathy presented for acute kidney injury with no prior kidney disease. He finished 10 days of Bactrim DS 2 weeks before admission. Home medications included bisoprolol-HCTZ 5mg-6.25mg daily. BP 187/94. Labs: Na 129 mmol/L, K 3.2 mmol/L, BUN 41 mg/dL, SCr 3.2 mg/dL. Urinalysis showed + protein. ANA positive, C3/C4 normal, and SPEP/UPEP with Kappa chain elevation and M-spike. Immunofixation showed IgG Kappa monoclonal antibody. Bone marrow biopsy showed 10-15% CD138 positive plasma cells, diagnosed with smoldering multiple myeloma. Renal ultrasound unremarkable. Renal biopsy consistent with acute interstitial nephritis and mild interstitial fibrosis and tubular atrophy. He was treated with prednisone. HTN controlled on amlodipine, labetalol, and hydralazine. Electrolyte abnormalities prevented diuretic use. He developed AKI on CKD 8 months later. Repeat renal biopsy showed mixed interstitial inflammatory infiltrate with IgG4-positive plasma cells and obliterative arteriopathy consistent with IgG4-mediated interstitial nephritis. He was treated with prednisone taper and rituximab. He presented for hypertensive emergency 2 months later, treated with nicardipine infusion, oral minoxidil added, but complicated by bilateral pleural effusions. Secondary HTN workup negative. Final HTN regimen: clonidine patch 0.6 mg weekly, oral clonidine 0.2 mg in AM and 0.3 mg at noon and PM, hydralazine 100 mg TID, imdur 30 mg BID, labetalol 800 mg TID, nifedipine 60 mg BID, and aldactone 12.5 mg daily.

**Discussion:** The prominent characteristic of our patient's IgG4-related interstitial nephritis was resistant hypertension. He had negative renal artery duplex, unremarkable abdominal MRI, and plasma renin activity and serum aldosterone concentration inadequate to conclude on hyperaldosteronism. No prior case report describes resistant HTN as a prominent manifestation in IgG4-related interstitial nephritis.

## TH-PO133

**Stage 3 AKI, Rhabdomyolysis, and Hyponatremia Developing Within 48 Hours of Transurethral Resection of Bladder Tumor (TURBT)**

Harshil Fichadiya,<sup>1</sup> Poorva P. Bhide,<sup>1</sup> Hardik Fichadiya,<sup>2</sup> Raghu Tiperneni,<sup>1</sup> Farah Heis,<sup>1</sup> Ahmad S. Al-Alwan.<sup>1</sup> <sup>1</sup>Monmouth Medical Center, Long Branch, NJ; <sup>2</sup>Trinitas Regional Medical Center, Elizabeth, NJ.

**Introduction:** 1/3 AKI associated with urologic procedures are seen following elective procedures while 2/3 are seen in patients admitted from the emergency department with the need of a urological intervention. Among elective procedures nephrectomy is the most common etiology of AKI, while sepsis and urinary obstruction are major culprits of AKI for patients requiring emergent urological intervention. TURBT is rarely associated with AKI with most reported cases from pre-renal and post-renal etiology.

**Case Description:** 62 year old male developed sudden onset renal failure with 8 fold rise in serum creatine within 48 hour of TURBT procedure that was complicated by extra-peritoneal rupture of bladder. Euvolemic moderate hyponatremia and mild rhabdomyolysis were seen. His bladder injury was managed conservatively with foley catheter and regular monitoring of urine output. His serum creatinine urine output started to improve on post op day 5 and hyponatremia improved with fluid restriction.

**Discussion:** The following mechanisms lead to development of AKI in our patient: 1) Extraperitoneal rupture of bladder causing leak and systemic absorption of irrigating fluid from systemic veins-> free fluid excess in plasma-> hyponatremia-> muscle swelling and rupture-> rhabdomyolysis-> ATN 2) Reflux of heme and saline from the bladder to renal tubules via the renal collecting system-> toxic damage to renal tubules ->ATN 3) Hemodynamic changes during TURBT procedure cause decreased renal blood flow->pre-renal injury and tubular damage->AKI We recommend restricting the use of irrigating fluid, avoiding hemodynamic changes, careful post-operative monitoring of renal function, electrolytes, CPK post TURBT, and ruling out obstructive etiology with renal imaging.

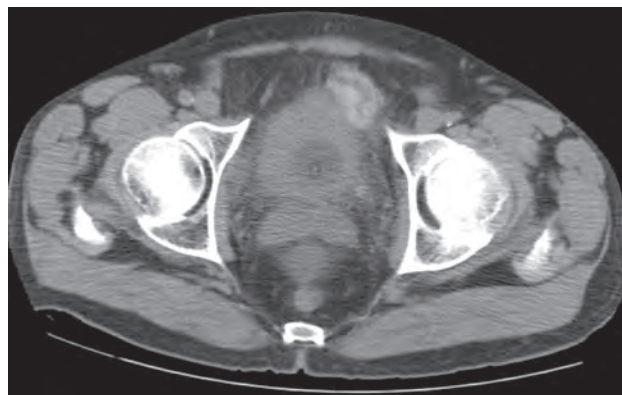

## TH-PO134

**Dimensions of Muddy Brown Granular Casts and Anthropometrics in Patients With Acute Tubular Injury**

Mckinley H. Antley,<sup>1</sup> Dustin Chalmers,<sup>2,3</sup> Akanksh Ramanand,<sup>2,3</sup> Juan Carlos Q. Velez,<sup>2,3</sup> Michael G. Janech.<sup>1</sup> Ochsner Nephrology <sup>1</sup>College of Charleston, Charleston, SC; <sup>2</sup>The University of Queensland Ochsner Clinical School - New Orleans, New Orleans, LA; <sup>3</sup>Ochsner Medical Center, New Orleans, LA.

**Background:** "Muddy" brown granular casts (MBGC) are identifiable by microscopic examination of the urinary sediment (MicrExUrSed). The presence of MBGC is pathognomonic for acute tubular injury (ATI). Although, MBGC have been noted for years, there are no reports regarding their length nor width. The objective of this study was to measure MBGC using images obtained by light microscopy and correlate them to patient anthropometric and urine chemistry values.

**Methods:** At Ochsner Medical Center, data from patients seen in nephrology consultation who had a urine specimen subjected to MicrExUrSed is prospectively collected. Representative images from each case are routinely stored. A subset of patients with diagnosis of ATI as evidenced by visualization of abundant MBGC (>30% low power fields) were sampled. Images were obtained under bright field microscopy at 400x magnification with an accompanying stage micrometer for external calibration and were measured using ImageJ. Length was measured at 3 sections parallel to the longitudinal axis. Width was measured in 6 sections parallel to the transverse axis. A minimum of 15 MBGC were measured per specimen. Spearman rank test was performed to examine correlations between MBGC width and demographics, anthropometrics, and urine chemistry.

**Results:** height 1.70 ± 0.1 m, mean BMI 32 ± 7. Mean MBGC length was 98.1 ± 42.1 (range 39–72) µm. Mean width was 33.5 ± 12.3 (range 9–110) µm. Based on a previous report of cortical tubular diameters, MBGC width corresponded well with the median reported range of 30–40 µm. MBGC width did not correlate with age, race, sex, BMI or weight. Height was positively correlated with mean MBGC width (rho = 0.48, p<0.05). There was no significant correlation between mean MBGC width and urine sodium, potassium, chloride, creatinine, urea nitrogen, pH, specific gravity or total protein.

**Conclusions:** This is the 1<sup>st</sup> study reporting dimensions of MBGC from patients with ATI. MBGC length is highly variable compared to width. Because kidney size is known to correlate with height, the correlation of MBGC with height suggests that nephron size influences MBGC width. Clinical implications of these observations require further study.

**Funding:** NIDDK Support

## TH-PO135

**Hepcidin Deficiency Exacerbates Renal Pathology in Disseminating Candidiasis**

Sadat Kasem,<sup>1</sup> Annanya Agarwal,<sup>1</sup> Dhruv N. Desai,<sup>1</sup> Michail Lionakis,<sup>2</sup> Bornha Mehrad,<sup>1</sup> Yogesh M. Scindia.<sup>1</sup> <sup>1</sup>University of Florida, Gainesville, FL; <sup>2</sup>National Institutes of Health, Bethesda, MD.

**Background:** *Candida albicans* is a human fungal pathogen and accounts for more than 50% of all invasive fungal infections. Fungal growth within the kidney and consequent kidney failure are the major cause of mortality during disseminating candidiasis. *C. albicans* utilizes a range of iron acquisition mechanisms that contribute to its virulence. Patients with fungal infection have substantially increased transferrin saturation and serum iron concentrations independent of underlying hematological disorder. Thus, host iron handling may be critical checkpoint to the outcome of the infection. Using a murine model of systemic iron overload, we investigated whether *C. albicans*-induced pathology is influenced by iron availability.

**Methods:** Iron overloaded hepcidin knockout (Hamp<sup>-/-</sup>) and wild type (WT) litter mates were infected with *C. albicans* SC5314 and outcomes of infection were evaluated.

**Results:** Compared to WT mice, Hamp<sup>-/-</sup> mice displayed increased kidney fungal burden, pathology and had higher mortality. *C. albicans* was in yeast form in the WT kidneys but had transformed into hyphae in the iron rich renal tubular region of Hamp<sup>-/-</sup> mice.

The greater fungal burden was associated with loss of parenchyma and increased infiltration of p21 positive neutrophils in the kidneys of Hamp<sup>-/-</sup> mice, whereas the bone marrow neutrophil output in these mice had decreased.

**Conclusions:** Our data identify systemic iron overload as a susceptibility factor to *C. albicans* induced kidney failure. Hepcidin deficiency-induced kidney iron burden was associated transformation of yeast into hyphae, suggesting increased virulence. Increased p21 expression in neutrophils suggests impaired NETosis and may possibly explain increased fungal burden. Our data highlight importance of host iron metabolism in susceptibility to disseminating candidiasis.

**Funding:** Other NIH Support - NIAID, Commercial Support - Vifor Pharma

### TH-PO136

#### Autotomy of Primary Cilia in Ischemia-Reperfusion Injury: An Electron Microscopic Study

Kyu Youn Ahn,<sup>1</sup> Kwon Moo Park,<sup>2</sup> Ki-Hwan Han,<sup>3</sup> <sup>1</sup>Chonnam National University, Daegu, Jeollanam-do, Republic of Korea; <sup>2</sup>Kyungpook National University, Daejeon, Republic of Korea; <sup>3</sup>Ewha Womans University, Seoul, Republic of Korea.

**Background:** Primary cilia are present in renal tubular cells and can change in length under certain conditions. Acute renal ischemia-reperfusion injury (I/R injury) can shorten primary cilia. It has been proposed that cilia may be rapidly fragmented and excreted into the urine. The purpose of this study was to examine the process of cilia fragmentation under high-resolution microscopy.

**Methods:** Sprague-Dawley rats were subjected to 30 minutes of ischemia by clamping bilateral renal pedicles and 6 hours of reperfusion. Kidney tissues and urine samples were processed for light and electron microscopy. Acetylated  $\alpha$ -tubulin antibodies were used to label the primary cilia, and specific marker proteins were used to differentiate the tubule segments.

**Results:** I/R injury resulted in cell damage mainly in the proximal tubule and collecting duct cells of the outer medulla, and significantly reduced the length of the primary cilia. In the proximal tubule, ciliary labeling was often located within the lumen. Some cilia remained on the surface of detached aquaporin 1-positive cells, while others were disconnected from the tubular cells. On the other hand, in the collecting duct, most of the cilia detected in the lumen were independently labeled regardless of the detached cells. Field emission scanning electron microscope (FE-SEM) revealed that the cilia fragmentation was related to the 'bulging', in which a portion of the cilia sprouts. The bulging of the cilia was not limited to the tip end and appeared as a single or multiple. Most of the sprouting parts were spherical or oval, and the size varied from about 90 to 280 nm.

**Conclusions:** These results demonstrate that the cilia fragments induced by I/R injury can originate from several different tubules. The autotomy of primary cilia may be specifically related to partial sprouting and regulated by dynamic physiological processes. This work was supported by funds from the National Research Foundation of Korea (NRF-2017R1D1A1B03030573 & 2020R1A2C1100184).

**Funding:** Government Support - Non-U.S.

### TH-PO137

#### A Rare Case of PR3-ANCA Vasculitis in the Setting of Mycobacterium Avium Complex (MAC) Infection

Gurpreet Kaur, Manasi Bapat. Alameda Health System, Oakland, CA.

**Introduction:** Anti-neutrophilic cytoplasmic antibody (ANCA) associated vasculitis is the most common systemic small vessel vasculitis to occur in adults. While the etiology is not always known, a variety of possible associations between infection and vasculitis have been reported. We present a case of PR3-ANCA vasculitis in the setting of Mycobacterium Avium Complex (MAC) infection.

**Case Description:** A 66-year-old man with history of Parkinson's disease and well controlled childhood asthma was admitted to the intensive care unit with acute dyspnea, fever and cough and was found to have ground-glass opacities throughout the right lung on CT chest. Given pulmonary infiltrates and history of sinusitis, ANCA titers were sent. Titers showed elevated c-ANCA titers 1:640 (normal <1:20), Proteinase 3 Ab > 100U/ml (normal 0 to 3.5 U/ml) and negative Myeloperoxidase. During hospitalization, he developed an AKI with creatinine increasing from 0.95 to 1.45 mg/dL (normal 0.50-1.30mg/dL) and microscopic hematuria. Kidney biopsy showed pauci-immune crescentic glomerulonephritis. Given kidney biopsy findings in the setting of elevated c-ANCA, the diagnosis of granulomatosis with polyangiitis (GPA) was made. Patient was started on induction therapy with Rituximab and high-dose steroids. Cultures obtained from bronchoscopy later returned positive for Mycobacterium Avium Complex (MAC). Given that the patient's respiratory symptoms had completely resolved, antimicrobial therapy for MAC was not initiated and patient was subsequently initiated on Rituximab based maintenance therapy for ANCA vasculitis. Patient achieved remission of hematuria as well as improvement in lung radiological findings with normalization of ANCA titers.

**Discussion:** Pulmonary infection may trigger vasculitis through induction on ANCA antigen expression on the surface of neutrophils. ANCA associated vasculitis (AAV) secondary to MAC is very rare and only a few cases have been reported so far. Kidney involvement in AAV is typically with rapidly progressive glomerulonephritis (RPGN) however our patient only had transiently elevated creatinine with hematuria without RPGN. Our case highlights the importance of considering AAV and testing for ANCA in a patient with hematuria and pulmonary symptoms even in the absence of characteristic RPGN.

### TH-PO138

#### Ultrasound Reduces Kidney Injury via a Postsynaptic P2X4-Dependent Mechanism in Sepsis-Associated AKI

Shuqiu Zheng, Junlan Yao, William Nash, Nabin Poudel, Eibhlin S. Goggins, Shuhei Kuwabara, Mark D. Okusa. University of Virginia, Charlottesville, VA.

**Background:** Purinergic X receptor (P2X) receptor subunits are present both in pre- and postsynaptic sites (Gordon, G.R.J et al. 2015). P2X4, one of the most sensitive purinergic ATP receptors, has been reported to exacerbate ischemic acute kidney injury (S.J. Han et al. 2020). We previously showed that pulsed ultrasound (pUS) reduced inflammation and acute kidney injury. However, the exact mechanism has not yet been well defined. Here, we utilized a mouse model of sepsis-associated acute kidney injury (SA-AKI) by injecting lipopolysaccharide (LPS) to investigate the effects of pUS on the expression and trafficking of P2X4 receptor during pathogenesis of SA-AKI.

**Methods:** C57/BL/6 mice received pUS 24 hours before LPS (5 mg/kg, ip) treatment. The parameters of pUS therapy followed the protocol previously published by us (PMID: 23907510). The expression of P2X4 was measured by immunofluorescence and RT-PCR respectively. ATP levels in the mouse kidney were determined by CellTiter-Glo Luminescent Cell Viability Assay Kit (G7571, Promega, Madison, WI), and the luminescence signal was normalized to the protein concentration of the homogenate. The measured luminescence signal is proportional to the amount of ATP.

**Results:** In vehicle treated animals, co-labeling with P2X4 and postsynaptic density 95 protein (PSD-95) showed that P2X4 is located mainly in lysosomes and partially colocalized with PSD-95. However, LPS induced injury upregulated P2X4 expression and translocated to the brush border and plasma membrane of proximal tubules, and whereas those issues were decreased in mice pretreated with pUS. In addition, the temporal changes observed with P2X4 mRNA overexpression correlated with a higher ATP release, pUS attenuated the release of ATP and the overexpression of P2X4 mRNA.

**Conclusions:** Our data suggest that LPS heightened brush border and membrane expression of P2X4 is temporally related to the release of ATP. ATP ligation of P2X4 in proximal tubules may lead to calcium influx and cell death. We believe that the protective mechanism of pUS in response to LPS appears to be associated with attenuated P2X4 receptor expression and signaling in proximal tubules.

**Funding:** NIDDK Support

### TH-PO139

#### Kynu Mediated Sex Dimorphism of AKI Through an NAD<sup>+</sup> Dependent Manner

Weiyuan Gong, Chuanming Hao. Fudan University, Shanghai, China.

**Background:** AKI is a disorder that is associated with high mortality and a high risk for development of CKD. It is well documented that female gender is associated with enhanced tolerance to kidney injury, the underlying mechanism is incompletely understood. Mounting evidence suggests that NAD<sup>+</sup> levels are associated with kidney tolerance to injury. The present study examined NAD<sup>+</sup> synthetic pathways and their association with gender related susceptibility to AKI.

**Methods:** IRI induced AKI was performed at 8-week-old C57BL/6J mice, bilateral renal pedicles were clamped for 22min(26min for 12-week-old female KYNU<sup>-/-</sup> and wt mice). The animals were euthanized 48 hours later. Prepubertal female/male mice were ovariectomized or castrated respectively, and euthanized after 5 weeks. The enzymes expression was examined using Immunoblot, qPCR. The metabolites of NAD<sup>+</sup> de novo pathway were examined using HPLC.

**Results:** Following IRI, male mice exhibited severe renal injury compared to female mice, manifested as higher BUN and Scr levels. Further investigation revealed that male kidney express lower levels of kynureninase (KYNU), one of the enzymes of the NAD<sup>+</sup> de novo pathway, at adult age and prepubertal castration significantly increase renal Kynu expression but not ovariectomy, demonstrating that the expression of KYNU is regulated by testosterone but not estrogen. We next measured the metabolites concentration in kidney and urine. Result showed no difference in the metabolite under physiological condition, however, with the insult of IRI, we observed elevated levels of intermediate metabolites and NAD<sup>+</sup> in female kidney compare to male, suggesting the NAD<sup>+</sup> de novo pathway was more activated in the female kidney, which may contribute to the NAD<sup>+</sup> synthesis and improve AKI. Thus, we generated KYNU knockout mice and found that genetic ablation of KYNU significantly decreased urinary and kidney metabolites and inhibited the NAD<sup>+</sup> de novo synthetic pathway, accompanied by sharpening kidney damage compared to wt mice following IRI, while supplementation with nicotinamide mononucleotide (NMN), an NAD<sup>+</sup> precursor, restored NAD<sup>+</sup> levels and significantly alleviated kidney injury in KYNU<sup>-/-</sup> mice.

**Conclusions:** We propose a KYNU-dependent mechanism, which contributes to the relative renoprotection of female after IRI by regulating NAD<sup>+</sup> levels. NAD<sup>+</sup> de novo pathway may be a potential target for IRI-AKI treatment.

**Funding:** Government Support - Non-U.S.

## TH-PO140

## Lineage Tracing and Single Cell Multiomics Reveal Long-Term Effects of Adaptive and Maladaptive Repair After AKI

Louisa M. Gerhardt, Kari A. Koppitch, Sam Cho, Andrew P. McMahon. McMahon Lab, USC Stem Cell Keck School of Medicine of the University of Southern California, Los Angeles, CA.

**Background:** Acute kidney injury (AKI) triggers a proliferative response as part of the intrinsic repair program that can result in adaptive or maladaptive repair of proximal tubule cells (PTCs). Maladaptive PTCs contribute to disease progression from AKI to chronic kidney disease (CKD), but the cellular and molecular understanding underlying the adaptive and maladaptive repair trajectories is limited.

**Methods:** We used genetic fate-mapping to label and trace proliferating (*Ki67*<sup>+</sup>) cells after ischemia-reperfusion injury. Combined snRNA- and ATAC-seq of lineage-traced cells isolated by FACS at 4 weeks and 6 months after AKI and controls was performed to generate a final dataset of 83,315 high-quality nuclei (after quality control and doublet removal). Published snRNA-seq data was used to assess transcriptomic changes early after AKI.

**Results:** Labeling *Ki67*<sup>+</sup> cells early after AKI revealed a broad proliferative response in kidney epithelial and non-epithelial cells, which was preceded by cell type-specific and global gene expression changes, such as downregulation of genes involved in transmembrane transport processes and upregulation of immediate early response genes. A heterogeneous population of maladaptive PTCs derived from all proximal tubule segments persisted until 6 months after AKI, although decreasing in abundance in time post AKI. Combined profiling of gene expression and chromatin accessibility in the same cell showed a specific activation of the transcription factors Rbpj, Klf6, Runx1 and Creb5 as well as members of the NF-κB and the AP-1 family in maladaptive PTCs, accompanied by corresponding changes in target gene expression. Regulatory factors of adaptively repaired PTCs, such as Maf and Hnf4a, were downregulated in maladaptive PTCs. Comparison of adaptively repaired PTCs with control PTCs suggested long-term effects of AKI on the transcriptional state of PTCs, including reduced expression of genes encoding critical transmembrane transport proteins.

**Conclusions:** This study provides the first combined snRNA- and snATAC-seq atlas of healthy and injured kidney tissue, defines the regulatory landscape of PTCs after adaptive and maladaptive repair and reveals long-term effects of AKI on PTCs even following adaptive repair.

**Funding:** NIDDK Support

## TH-PO141

## Tubular Cell Polyploidization Leads to a Senescent Profibrotic Phenotype and Is a Trigger of CKD

Elena Lazzeri,<sup>1</sup> Letizia De Chiara,<sup>1</sup> Paola Romagnani,<sup>1,2</sup> <sup>1</sup>Universita degli Studi di Firenze, Firenze, Italy; <sup>2</sup>Meyer Children's University Hospital, Florence, Italy.

**Background:** The occurrence of polyploidization in tubular epithelial cells (TC) is a process that increases the DNA content in TC in response to acute kidney injury (AKI). Evolutionary, polyploidy appears to be developed to tolerate conditions of high metabolic demand, sustaining a temporary functional recovery that is not accompanied by structural recovery leading over time to tissue fibrosis. The association of tissue polyploidization, senescence, and fibrosis has been demonstrated in other organs but in the kidney is currently unknown. In this study, we aimed to 1) characterize TC undergoing polyploidy, 2) investigate whether post-AKI fibrosis and senescence could be a consequence of TC polyploidization and 3) whether the latter is a driver of chronic kidney disease (CKD) development.

**Methods:** We performed single cell RNA-sequencing (scRNA-seq) on mouse kidneys after unilateral ischemia reperfusion injury to identify polyploid TC signature. In addition, we employed a conditional transgenic mouse model of increased polyploidization (Pax8/SAV1ko mice) and a treatment with senolytics was used followed by FACS and confocal microscopy analysis.

**Results:** scRNA-seq analysis revealed clusters of proximal TC enriched in genes associated with endoreplication-mediated polyploidy. A trajectory analysis suggested that TC polyploidization started with increased ribosome biogenesis, followed by YAP1 activation and culminated with a pro-fibrotic and senescent signature, suggesting polyploid TC may acquire a senescent phenotype. Indeed, polyploid TC progressively accumulate in the kidney as the mice aged and correlated with GFR decline and senescence. Importantly, sustained TC polyploidization in Pax8/SAV1ko mice was accompanied by increased senescence, fibrosis and a progressive kidney function decline, i.e. CKD. Isolation of polyploid TC proved that they actively transcribe and secrete pro-fibrotic and senescent factors. However, senolytic treatment demonstrated that removal of senescent polyploid TC in Pax8/SAV1ko mice was sufficient to halt CKD progression.

**Conclusions:** We have shown that: 1) polyploid TC exhibits a pro-fibrotic and senescent signature; 2) TC polyploidization leads to senescence, fibrosis and progression of CKD; 3) senolytics can block further ongoing polyploidization of TC, abolishing their senescent profibrotic phenotype and preventing CKD.

## TH-PO142

## Chronotherapy With Cinacalcet Has a Striking Effect on Inhibition of Parathyroid Gland Proliferation in Rats With Secondary Hyperparathyroidism

Søren Egstrand,<sup>1,2</sup> Maria L. Mace,<sup>2</sup> Marya Morevati,<sup>2</sup> Klaus Olgaard,<sup>2</sup> Ewa Lewin.<sup>1,2</sup> <sup>1</sup>Dept. of Nephrology, Herlev Hospital, Copenhagen, Denmark; <sup>2</sup>Dept. of Nephrology, Rigshospitalet, Copenhagen, Denmark.

**Background:** Secondary hyperparathyroidism (sHPT) is associated with parathyroid hyperplasia, bone and vascular disease. Cinacalcet is a modulator of the calcium-sensing receptor used to treat sHPT. Aim was to examine whether taking the circadian rhythm into account might improve treatment response.

**Methods:** CKD was induced by 5/6-nephrectomy in 40 rats. After 4 weeks, 20 CKD rats had Cinacalcet 2.5mg/d by oral gavage either morning (early inactive phase: *Cina1*, N=10) or evening (early active phase: *Cina2*, N=10). After 3 weeks, parathyroid glands, aorta and femur were harvested from Cinacalcet treated rats either morning or evening, 24 h since treatment, and compared to untreated CKD rats (*PNX1* and *PNX2*) and healthy rats. Parathyroid proliferation was assessed by Ki-67 immunostaining, aortic calcium content by the o-cresolphthalein method and bone by μCT.

**Results:** Ki-67 index was significantly decreased in *Cina1* (0.92±0.14%) compared to *Cina2* (2.46±0.37%, p=0.006) and to the two untreated CKD groups (3.45±0.47% and 4.14±0.47%, p=0.0002 and p=0.0001). In healthy control groups: 1.53±0.17% and 1.45±0.19% (Fig.1). Plasma PTH was decreased by 55% in *Cina1* compared to *PNX1* (2279±447pg/ml vs 5076±1740pg/ml) and by 29% in *Cina2* compared to *PNX2* (2667±594pg/ml vs 3756±911pg/ml). Aortic calcium content and bone porosity were similarly increased in all CKD groups.

**Conclusions:** Administration of Cinacalcet early in the inactive period markedly decreased the proliferation of the parathyroid glands in sHPT compared to dosing early in the active period indicating an advantage of chronotherapy in a translational model of sHPT.

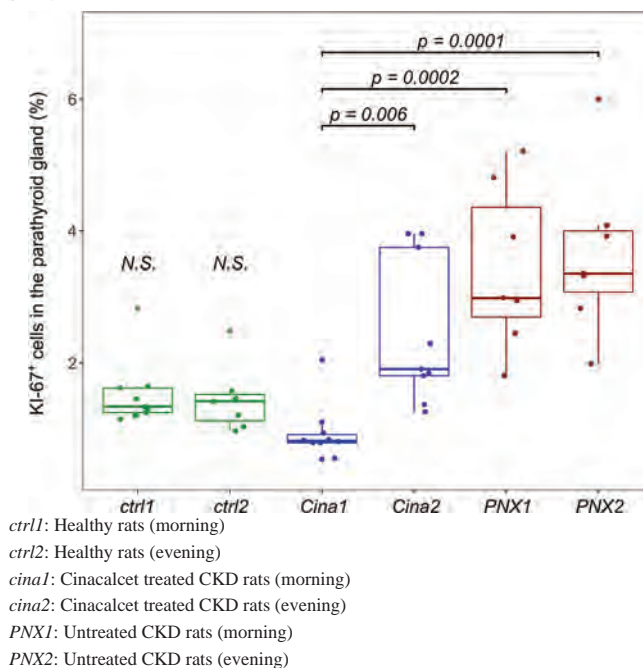

## TH-PO143

## Effect of Evocalcet on Parathyroid Calcium-Sensing Receptor and Vitamin D Receptor Expressions in Uremic Rats

Tomohiro Saito,<sup>1</sup> Masahide Mizobuchi,<sup>1</sup> Mariko Sakai,<sup>2</sup> Takehisa Kawata,<sup>2</sup> Tetsuya Kitayama,<sup>2</sup> Tadashi Kato,<sup>1</sup> Taihei Suzuki,<sup>1</sup> Hiroaki Ogata,<sup>3</sup> Fumihiko Koiwa,<sup>4</sup> Hirokazu Honda.<sup>1</sup> <sup>1</sup>Showa Daigaku, Shinagawa-ku, Japan; <sup>2</sup>Kyowa Kirin Kabushiki Kaisha, Chiyoda-ku, Japan; <sup>3</sup>Showa Daigaku Yokohama-shi Hokubu Byoin, Yokohama, Japan; <sup>4</sup>Showa Daigaku Fujioka Byoin, Yokohama, Japan.

**Background:** Little is known about the effect of recently developed calcimimetics evocalcet on the parathyroid calcium-sensing receptor (CaSR) and vitamin D receptor (VDR) expressions.

**Methods:** We examined the effect of evocalcet and cinacalcet on the CaSR and VDR expressions in 5/6 nephrectomized Sprague-Dawley rats fed a high-phosphate diet for 4 weeks to develop secondary hyperparathyroidism. These rats were divided into groups: baseline control (Nx4W), treated with vehicle (V), evocalcet (E), or cinacalcet (C). After 2 weeks of treatment, blood chemistries and parathyroid tissues were analyzed. CaSR and VDR expression were determined by immunohistochemistry. Normal rats were used as normal control (NC).

**Results:** The degree of kidney injury and hyperphosphatemia was similar in the uremic groups (Nx4W, V, E, and C). Serum iPTH levels were significantly higher in Nx4W (2424 pg/ml,  $p<0.01$ ) and V (2098 pg/ml,  $p<0.01$ ) than in NC (103 pg/ml). This increase was significantly suppressed in E (29 pg/ml,  $p<0.01$ ) and C (395 pg/ml,  $p<0.01$ ) compared with V. Serum calcium levels were significantly and equally lower in E (4.7mg/dl,  $p<0.01$ ) and C (5.7 mg/dl,  $p<0.01$ ) than in V (8.1 mg/dl). CaSR expression was significantly decreased in Nx4W (16.9 %,  $p<0.01$ ) and V (16.5 %,  $p<0.01$ ) compared with NC (45.0 %). The decreased expression was significantly and equally up-regulated in E (46.0 %,  $p<0.01$ ) and C (40.7 %,  $p<0.01$ ). A similar trend was observed in VDR expression (62.6% in NC, 16.2 % in Nx4W, 20.2 % in V, 62.2 % in E, and 83.6 % in C).

**Conclusions:** These results indicate that evocalcet can up-regulate the decreased parathyroid CaSR and VDR expressions in uremic rats, which could contribute to its suppressive effect on PTH.

**Funding:** Commercial Support - Kyowa Kirin Co., Ltd., Shizuoka, Japan., Clinical Revenue Support

#### TH-PO144

##### Antibody Production Requires Neither Vitamin D nor the Vitamin D Receptor

Lori A. Plum, William J. Blaser, Hector F. Deluca. *University of Wisconsin System, Madison, WI.*

**Background:** The idea that vitamin D plays a significant role in immunity, especially in fighting infectious disease, has been proposed repeatedly for many years. Because antibody production is of central importance to an organism's defense against infection, studies were conducted to determine if vitamin D functions in this area of immunity.

**Methods:** Two animal models were utilized: mice depleted of vitamin D and mice devoid of the vitamin D receptor. Vitamin D-deficient mice were generated from parents fed D-deficient diets and housed in rooms with UV-blocked light bulbs. The mice deficient in vitamin D were either given a low (0.235%) or high (0.87%) calcium diet lacking vitamin D. A third group of D-deficient mice was given diet containing vitamin D prior to the antigen challenge. All D-deficient mice were compared to mice that were never depleted of vitamin D. Male VDR knockout mice and wild-type littermates were generated in our vivarium from breeder stock obtained from JAX labs (Stock No. 006133). They were fed either a low (0.235%) or high (0.87%) calcium diet. All mice were challenged with the very antigenic protein, Keyhole Limpet Hemocyanin (KLH). Blood was collected at multiple time points after the KLH was injected intraperitoneally. A booster injection of KLH was administered 30-37 days after the first one to assess the impact of low vitamin D or ablated receptor on the secondary response. The amount of various classes and subclasses of antibodies was assessed using enzyme-linked immunoassays. Statistical analyses were developed and performed under the guidance of the University of Wisconsin-Madison CALS Statistical Consulting Group.

**Results:** Only a few statistically significant differences across dietary groups or between genotypes during the primary or secondary responses were noted. However, none of the differences were present in both animal models; and in some cases, the differences were present in a dietary group that would dictate a change also be present in another group, but there wasn't. Neither the absence of vitamin D or the vitamin D receptor nor hypocalcemia significantly altered the amount of total IgG, IgG1, IG3, IgA, or IgM antibodies.

**Conclusions:** Neither vitamin D nor its receptor are required to successfully mount an antibody response.

**Funding:** Other U.S. Government Support

#### TH-PO145

##### CKD Alters Parathyroid Pin1 Phosphorylation and Hence PTH mRNA Binding Proteins Leading to Secondary Hyperparathyroidism

Alia Hassan, Morris Nechama, Justin Silver, Iddo Z. Ben-Dov, Tally Naveh-Many. *Hadassah University Medical Center, Jerusalem, Israel.*

**Background:** Secondary hyperparathyroidism (SHP) is a common complication of CKD that increases morbidity and mortality. In experimental models of CKD and SHP, the increased PTH gene expression is due to enhanced PTH mRNA stability, mediated by changes in PTH mRNA interaction with stabilizing AUF1 and destabilizing KSRP. The isomerase Pin1 leads to KSRP dephosphorylation, but in SHP, parathyroid Pin1 activity is decreased and hence phosphorylated KSRP fails to bind PTH mRNA resulting in high PTH mRNA stability and levels. Here we aim to identify the up- and down-stream mechanisms by which CKD stimulates the parathyroid in SHP.

**Methods:** CKD and SHP were induced in rats and mice by adenine-rich high phosphorus diets. Parathyroid organ cultures and transfected cells were incubated with Pin1 inhibitors for their effect on PTH expression. Mass-spectrometry was performed on both parathyroid and PTH mRNA pulled down proteins.

**Results:** We characterized, for the first time, the global changes in protein expression and phosphorylation induced by kidney failure in the minute rat parathyroid glands. CKD led to changes in rat parathyroid proteome and phosphoproteome profiles, including KSRP phosphorylation at Pin1 target sites. Furthermore, both acute and chronic kidney failure led to parathyroid-specific Pin1 Ser16 and Ser71 phosphorylation, which disrupts Pin1 activity. Pharmacologic Pin1 inhibition, that mimics the decreased Pin1 activity in SHP, increased PTH expression ex-vivo in parathyroid glands in culture and in transfected cells, through the PTH mRNA protein-interacting element and KSRP phosphorylation. We also characterized the effect of Pin1 inhibition on global PTH mRNA interacting proteins.

**Conclusions:** Kidney failure leads to loss of parathyroid Pin1 activity by inducing Pin1 phosphorylation. This predisposes parathyroids to increase PTH production through impaired PTH mRNA decay that is dependent on KSRP phosphorylation at Pin1-target motifs. Pin1 and KSRP phosphorylation and the Pin1-KSRP-PTH mRNA axis thus drive SHP.

#### TH-PO146

##### The Effect of Carnitine Supplementation in a Rat Model of CKD-MBD

Keith G. Avin,<sup>1,2</sup> Ashley D. Troutman,<sup>1</sup> Neal X. Chen,<sup>2</sup> Shruthi Srinivasan,<sup>2</sup> Kalisha O'Neill,<sup>2</sup> Annabel Biruete,<sup>1,2</sup> Sharon M. Moe.<sup>2</sup> *<sup>1</sup>Indiana University-Purdue University Indianapolis, Indianapolis, IN; <sup>2</sup>Indiana University School of Medicine, Indianapolis, IN.*

**Background:** Carnitine affects the musculoskeletal system by shuttling fatty acids into the mitochondria for  $\beta$ -oxidation and adenosine triphosphate production. Lower carnitine levels are seen with primary and secondary CKD carnitine deficiency and are associated with impaired musculoskeletal health. We sought to determine if carnitine treatment can benefit CKD-MBD outcomes in CKD.

**Methods:** We used a slowly, progressive, naturally occurring, CKD rat model (Cy/+ rat) in these groups (n=12/gr): 1) normal littermates (NL), 2) CKD rats, 3) CKD + carnitine (250mg/kg, I.P. daily). Carnitine treatments began at 22 weeks and continued through 32 weeks of age (i.e., mild to severe CKD, respectively). At 32 weeks, the animals were terminated followed by tissue and blood collection. Data analysis included one-way ANOVA with Tukey's test.

**Results:** CKD rats had lower carnitine plasma levels compared to NL ( $p<0.05$ ). Carnitine-treated CKD rats had higher plasma carnitine levels when compared to CKD alone ( $56\pm 25$  mM vs.  $20\pm 3.5$  mM;  $p<0.0001$ ). Compared to NL, CKD increased blood urea nitrogen, serum creatinine, phosphorous, parathyroid hormone, intact FGF23, c-terminal FGF23 and vascular calcification (all comparisons  $p<0.04$ ). CKD bone volume and tibial number were lower, while tibial spacing was higher compared to NL (all comparisons  $p<0.04$ ). 10 weeks of carnitine treatment increased plasma levels of creatinine, phosphorus, PTH, intact FGF23 and c-terminal FGF23 in CKD rats (all comparisons  $p<0.04$ ). Carnitine treatment had no effect on vascular calcification, but increased cortical porosity in carnitine-treated CKD rats compared to CKD alone ( $p<0.04$ ).

**Conclusions:** Carnitine supplementation did not alter vascular calcification but negatively impacted bone-related outcomes and worsened biochemistries of CKD-MBD. The change in porosity is likely due to the increase in PTH that occurred in the CKD + carnitine animals. In summary, carnitine treatment for 10 weeks that achieved supraphysiologic levels had adverse effects on CKD-MBD, despite dosing that was tested at earlier time point in CKD, and was modest compared to other studies. Whether lower doses or shorter treatment has different effect is unknown. However, this study raises caution about the wide use of supplements containing carnitine by individuals with CKD.

**Funding:** NIDDK Support

#### TH-PO147

##### mTOR Activity Is Essential for Intact Parathyroid Gland Structure

Nareman Khalaily, Alia Hassan, Justin Silver, Morris Nechama, Oded Volovelsky, Tally Naveh-Many. *Hadassah University Medical Center, Jerusalem, Israel.*

**Background:** mTOR signaling links nutritional status and cell metabolism and is negatively regulated by tuberous sclerosis complex 1 (TSC1). mTOR is a significant regulator of parathyroid cell proliferation in CKD-induced secondary hyperparathyroidism (SHP). CKD leads to parathyroid mTOR pathway activation and the mTOR inhibitor rapamycin decreases parathyroid cell proliferation in vivo and in organ cultures. We now show that in addition to its roles in SHP-induced parathyroid cell proliferation, the mTOR pathway is central to maintaining intact parathyroid glands in mice with normal renal function.

**Methods:** We generated by cre-lox recombination mice with parathyroid-specific mTOR deletion or mTOR activation by TSC1 knockout (KO), combined with red fluorescent protein expression, to monitor the parathyroid glands and allow fluorescent guided microdissection. CKD was induced by an adenine high phosphorus diet. Serum PTH, calcium, phosphate, and urea were measured at different time points after birth. Microdissected parathyroid sections were analyzed by immunofluorescent staining.

**Results:** Parathyroid-specific mTOR KO mice had smaller, punctuated parathyroid glands, from early after birth, with low to normal serum PTH levels. Surprisingly, dietary-induced CKD increased serum PTH to similar levels in both mTOR KO and control mice, despite much smaller still disrupted parathyroid glands in KO mice. In contrast, ablation of the negative mTOR regulator TSC1 led to ~10-fold larger parathyroid glands compared to control mice at 1 month of age. However, serum PTH levels were similar, suggesting that more cells are needed to produce normal serum PTH in TSC1 KO mice. From the age of 2 month, the TSC1 KO mice had ~4-fold higher serum PTH levels and only ~5-fold larger glands compared to controls. CKD similarly increased serum PTH levels in TSC1 KO and control mice, with a reduced fold increase in the KO mice. Immunofluorescent staining for PTH, CaSR, GCM2, phosphorylated ribosomal protein S6, and proliferation markers further supported the phenotype of the mTOR and TSC1 KO mice.

**Conclusions:** This is the first demonstration that mTOR is central to parathyroid gland morphology and maintaining intact glands in the adult.

## TH-PO148

### Fibroblast Growth Factor 23 Induces Endothelial Glycocalyx Collapse and Cortex Stiffening in Patients on Hemodialysis: A Major Role for the C-Terminal Fragment

Josephine Koch,<sup>1</sup> Tamara Kunze,<sup>2</sup> Carl Vahldieck,<sup>2</sup> Benedikt Fels,<sup>2</sup> Wendy Dam,<sup>1</sup> Casper F. Franssen,<sup>1</sup> Jacob van den Born,<sup>1</sup> Kristina Kusche-Vihrog,<sup>2</sup> <sup>1</sup>Universitair Medisch Centrum Groningen, Groningen, Netherlands; <sup>2</sup>Universität zu Lubeck, Lubeck, Germany.

**Background:** Cardiovascular disease and endothelial dysfunction (ED) are common in patients with chronic kidney disease (CKD). CKD patients have elevated plasma fibroblast growth factor 23 (FGF23) which associates with higher incidence of cardiovascular events. Hallmarks of ED are damage of the endothelial glycocalyx (eGC) and cortex stiffening. Here we evaluated whether FGF23 directly induces changes in eGC and underlying endothelial cortex.

**Methods:** Human umbilical vein endothelial cells were incubated with uremic sera from hemodialysis patients with low ( $\leq 2,000$  RU/mL; n=6) or high ( $\geq 30,000$  RU/mL; n=6) FGF23, and with recombinant intact FGF23 and c-terminal FGF23 (each 30 ng/mL). Height of the eGC and stiffness of the eGC and cortex were assessed by atomic force microscopy. eGC components and cortical F-actin were quantified by immunofluorescence stainings.

**Results:** Patient sera with high FGF23 reduced eGC height (-12%;  $P < 0.0001$ ), increased eGC stiffness (+63%;  $P < 0.0001$ ) and enhanced cortical stiffening (+16%;  $P < 0.0001$ ) compared to patient sera containing low FGF23. Recombinant c-terminal FGF23 but not intact FGF23 induced similar effects compared to unstimulated controls (eGC height: -37%;  $P < 0.0001$ ; eGC stiffness: +69%;  $P < 0.0001$ ; cortical stiffness: +32%;  $P < 0.0001$ ). Quantification of three eGC glyco-epitopes revealed no differences upon intact FGF23 or c-terminal FGF23 incubation. F-actin increased by 36% after c-terminal FGF23 stimulation ( $P < 0.0001$ ), whereas intact FGF23 did not affect F-actin. Specificity was demonstrated by FGF23 blocking antibodies.

**Conclusions:** Our results indicate that c-terminal FGF23 and not intact FGF23 induces collapse of the eGC and stiffens the cortex. Our findings suggest c-terminal FGF23 having a pathophysiological role in the development of ED in hemodialysis patients.

**Funding:** Government Support - Non-U.S.

## TH-PO149

### Differential Regulation of FGF23 Production and Cleavage by Iron and EPO in Anemic Mice

Bridget Hunt-Tobey, Marta Martinez-Calle, Guillaume Courbon, Jadeah J. Spindler, John C. Von Drasek, Xueyan Wang, Aline Martin, Valentin David. <sup>Northwestern University Feinberg School of Medicine, Chicago, IL.</sup>

**Background:** Anemia affects over 2 billion people worldwide. In patients and animals, anemia leads to high circulating fibroblast growth factor (FGF)23 cleavage peptides due to simultaneous increased production and cleavage of intact (i)FGF23. Both iron deficiency and erythropoietin (EPO), which is secreted in response to anemia, independently increase FGF23 production and cleavage. However, their contribution to excess FGF23 in anemia is unknown.

**Methods:** To determine the contribution of iron deficiency and EPO to excess FGF23, we fed C57BL/6J mice from 3 to 6 weeks of age either control (Ctr), iron deficient (ID) or high iron (HI) diets to induce iron deficiency or iron overload anemia, respectively. In all mice, we measured hematological and iron metabolism parameters and circulating EPO and FGF23 levels.

**Results:** Both ID and HI mice developed anemia, as shown by similar and significant reductions of hemoglobin and red blood cell number. As a result, EPO levels increased in both ID and HI mice by 7 fold compared to Ctr mice. As expected, ID mice showed a reduction in iron, transferrin saturation (TSAT) and ferritin levels, as opposed to HI animals which showed higher iron, TSAT and ferritin compared to Ctr mice. As previously shown, ID triggered a 200% increase in total cFGF23 and a milder 20% increase in iFGF23 levels. In sharp contrast, anemic HI mice showed a 50% reduction in iFGF23 compared to Ctr mice, and only a 2 fold increase in total cFGF23 levels, suggesting that FGF23 cleavage increased despite normal FGF23 expression. In all mice, circulating total cFGF23 positively correlated with serum EPO levels. iFGF23 negatively correlated with serum iron, TSAT and ferritin only, but did not correlate with EPO levels.

**Conclusions:** In aggregate, these results suggest that iron deficiency, but not EPO, increases FGF23 production and that in anemia, elevated circulating EPO levels stimulate FGF23 cleavage independently of iron status.

**Funding:** NIDDK Support

## TH-PO150

### Endothelial Cell Dysfunction Promotes Phosphate-Induced Vascular Smooth Muscle Cell Calcification

Wei Chen,<sup>1,2</sup> Dario F. Riascos-Bernal,<sup>1</sup> Shari J. Zaslou,<sup>1</sup> Michael J. Ross,<sup>1</sup> Wenzhu Mowrey,<sup>1</sup> Yabing Chen,<sup>3</sup> Nicholas Sibinga.<sup>1</sup> <sup>1</sup>Albert Einstein College of Medicine, Bronx, NY; <sup>2</sup>University of Rochester, Rochester, NY; <sup>3</sup>The University of Alabama at Birmingham Department of Pathology, Birmingham, AL.

**Background:** The study objective was to understand interactions between two major vascular cell types – endothelial cells (ECs) and vascular smooth muscle cells (SMCs) – in the pathogenesis of phosphate-induced vascular calcification. Since vascular calcification

greatly resembles bone formation, understanding cellular interactions that are unique to the vasculature may help identify therapies that inhibit vascular calcification without adversely impacting bone health. Here, we tested the hypothesis that high phosphate (P) promotes EC dysfunction, which in turn enhances calcification of SMCs in culture.

**Methods:** To model distinct aspects of complex *in vivo* environment, we established an *in vitro* insert co-culture system of primary human aortic ECs and SMCs. We compared calcification of SMCs co-cultured with and without ECs. Calcification of SMCs was induced by high P media (2 mM calcium, 3 mM P), assessed by Alizarin Red staining, and quantified by calcium content. EC proliferation and viability were measured using a resazurin assay.

**Results:** After 7 days of incubation, SMCs co-cultured with ECs in regular media (1.6 mM calcium, 0.5 mM P) had minimal calcification ( $10 \pm 8$   $\mu$ g calcium/mg protein). In contrast, SMCs co-cultured with ECs and high P media showed overt calcification. SMC calcium content was significantly greater when co-cultured with ECs ( $102 \pm 18$   $\mu$ g calcium/mg protein) than without ECs ( $59 \pm 17$   $\mu$ g calcium/mg protein,  $p = 0.001$ ; Figure). Compared to regular media, high P decreased EC proliferation ( $p = 0.01$ ), but did not change EC viability ( $p = 0.56$ ), suggesting P-induced EC dysfunction.

**Conclusions:** Using a physiological model of co-cultured primary human cells, we found that high P induced EC dysfunction, which in turn worsened P-induced SMC calcification. These findings support the significance of cellular interactions in the pathogenesis of vascular calcification. Further studies are needed to elucidate the molecular mechanisms underlying these interactions.

**Funding:** NIDDK Support, Other NIH Support - NHLBI

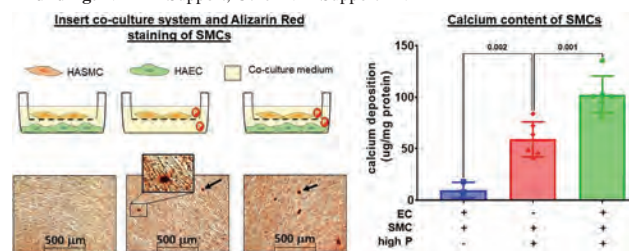

Human aortic ECs (HAECs) enhanced P-induced calcification of human aortic SMCs (HASMCs) in a co-culture system.

## TH-PO151

### FGF23 Drives Transcriptional and Genomic Accessibility Reprogramming as Identified in the KL-KO Mouse at the Single Cell Level

Emmanuel Solis, Rafiou Agoro, Sheng Liu, Jun Wan, Kenneth E. White. <sup>Indiana University School of Medicine, Indianapolis, IN.</sup>

**Background:** The high affinity FGF23/Klotho(KL)/FGFR receptor complex is critical for controlling 1,25D and phosphate utilization. However, KL is expressed in multiple nephron cell types thus the full spectrum and mechanisms dictating the spatial modes of FGF23-mediated actions remain undefined.

**Methods:** 10X Multiome (single cell RNAseq (scRNAseq) and the Assay for Transposase-Accessible Chromatin (scATACseq)) was used to test KL-dependent FGF23 activity. Kidneys from male KL-KO and wild-type (WT) littermates underwent nuclei isolation/library preparation. Nephron segment-specific RNA expression and chromatin accessibility clustering analysis was performed and alterations of key signaling pathways tested using Ingenuity Pathway Analysis (IPA).

**Results:** High quality sequencing was obtained from libraries of ~10,000 cells, and integrative scRNAseq and scATACseq analysis identified 26 UMAP clusters distinctly comprised of epithelial, endothelial, and immune cells. With the deletion of KL, Cyp24a1 was reduced in proximal tubule (PT) cells, consistent with lack of FGF23 activity in this model, validating our approach. Using cluster enriched markers, the PT was sub-segmented into S1, S2, S3 cells. IPA analyses on these populations demonstrated that in the KL-null vitamin D receptor (VDR) and PTEN signaling were upregulated in PT S1-S3, whereas phagosome formation, involved in protein maturation was down-regulated. Further, with loss of FGF23-mediated activity, genes associated with VDR and PPAR signaling were upregulated in PT S1-S2. However, transcripts associated with xenobiotic metabolism were increased specifically in PT-S3, suggesting a novel role of FGF23 in this segment. Distal convoluted tubule and connecting tubule exhibited decreases in mRNAs controlling Autophagy and CLEAR pathways, but increased AMPK-mediated signaling. Finally, scATACseq revealed increased accessibility of both the VDR and Osteopontin (Spp1) genes in the PT-S1.

**Conclusions:** Our studies pinpoint transcriptional and genomic accessibility reprogramming for specific kidney cell types due to loss of KL-mediated FGF23 bioactivity and show that FGF23/KL interactions control nephron segment-unique and -general mechanisms that regulate mineral metabolism. Identification of these pathways is critical for isolating novel FGF23-related disease targets.

**Funding:** NIDDK Support, Other NIH Support - Comprehensive Musculoskeletal Training Program (T32) pre-doctoral fellowship

## TH-PO152

**Increased Cardiac Fibroblast Growth Factor 23 in Physiologic Hypertrophy Does Not Change Kidney Sodium Dependent Phosphate Transporter Expression**

Isaac D. Campos,<sup>1</sup> Beatrice Richter,<sup>2</sup> Kylie Heitman,<sup>2</sup> Christopher Yanucil,<sup>2</sup> Madison Thomas,<sup>2</sup> David G. Westbrook,<sup>2</sup> Christian Faul.<sup>2</sup> <sup>1</sup>The University of Alabama at Birmingham Department of Medicine, Birmingham, AL; <sup>2</sup>The University of Alabama at Birmingham School of Medicine, Birmingham, AL.

**Background:** Fibroblast growth factor 23 (FGF23) is a phosphaturic hormone primarily produced by the bone that is elevated over the course of chronic kidney disease (CKD). In animal models of CKD, increased serum FGF23 levels cause *pathologic* cardiac hypertrophy via klotho-independent activation of FGF receptor 4 (FGFR4) and subsequent calcineurin/NFAT signaling in cardiomyocytes. Whether FGF23/FGFR4 also plays a role in *physiologic* cardiac hypertrophy, which is reversible and does not result in tissue damage, has previously been unknown. In mammals, physiologic cardiac hypertrophy is induced during pregnancy to ensure increased cardiac output. The same phenomenon is observed in intermediate feeding snakes, such as the Burmese python, where multiple organs, including the heart, undergo significant hypertrophic growth to meet the sudden increase in metabolic demands after feeding.

**Methods:** To investigate the role of FGFR4 signaling in physiologic cardiac hypertrophy we used virgin C57BL/6J wildtype and global FGFR4 knockout (KO) mice mated with male breeders. We investigate the effect of FGFR4 deletion on the process of adaptive cardiovascular hypertrophy at different time points during and after pregnancy. Virgin littermates served as controls. RTqPCR was used to measure gene expression.

**Results:** We found that mice in late pregnancy had significantly higher heart weight to tibia length ratios, regardless of the genotype. However, the area of individual cardiomyocytes was only significantly increased in wildtype mice. Serum FGF23 levels increased during pregnancy and quickly dropped after delivery and did not reduce kidney expression of NaPi 2a or 2c. We also treated neonatal rat ventricular myocytes (NRVMs) with serum from fasted and previously fed *P. bivittatus* in the absence and presence of an FGFR4-specific blocking antibody. We found that serum from snakes taken 12-hours and 3-days post-feeding significantly increased NRVM area, while serum from fasted snakes did not. This effect was abrogated in NRVM cultures co-treated with anti-FGFR4.

**Conclusions:** Our data suggests a significant role of FGFR4 in the induction of reversible physiologic cardiac hypertrophy in mice and snakes without the induced reduction of phosphate transporters in the kidney.

**Funding:** NIDDK Support

## TH-PO153

**Comparative Effectiveness of Alternative Treatment Approaches to Secondary Hyperparathyroidism (SHPT) in Patients on Maintenance Hemodialysis (HD)**

Alyssa C. Platt,<sup>1</sup> Jonathan A. Wilson,<sup>1</sup> Rasheeda K. Hall,<sup>1</sup> Patti Ephraim,<sup>5</sup> Sarah N. Morton,<sup>1</sup> Tariq Shafi,<sup>3</sup> Daniel E. Weiner,<sup>4</sup> L. Ebony Boulware,<sup>1</sup> Jane F. Pendergast,<sup>1</sup> Julia J. Scialla.<sup>2</sup> <sup>1</sup>Duke University, Durham, NC; <sup>2</sup>University of Virginia, Charlottesville, VA; <sup>3</sup>The University of Mississippi Medical Center, Jackson, MS; <sup>4</sup>Tufts Medical Center, Boston, MA; <sup>5</sup>Northwell Health, New Hyde Park, NY.

**Background:** Optimal approaches to treat SHPT in patients on HD are not established in randomized controlled trials (RCTs). Using observational data, we emulate RCTs of different parathyroid hormone (PTH) targets (Trial 1) and different primary agents (Trial 2) for treatment of HD-related SHPT.

**Methods:** Adults with kidney failure on HD at centers affiliated with a moderate-sized, not-for-profit, national dialysis provider were eligible for Trial 1 if they had new onset SHPT between 2009-2014. They were eligible for Trial 2 if they had SHPT and were using low to moderate dose vitamin D sterol, but were cinacalcet naïve. In both trials, patients had  $\geq 180$  days of Medicare primary payer before eligibility, and did not have contraindications to either arm or health status likely to limit follow-up. After eligibility, patients were observed for 30 days to define the treatment arm and then for 24 months for outcomes. In Trial 1, upward titration of either vitamin D sterols or cinacalcet in the 30 day period after new SHPT defined a proactive approach targeting lower PTH. Lack of upward titration defined a reactive approach. In Trial 2, the first upward titration defined a vitamin D-favoring (vitamin D first), cinacalcet-favoring (cinacalcet first), or undefined approach (no upward titration; excluded). The primary outcome was all-cause death; secondary outcomes include cardiovascular (CV) hospitalization or the composite of CV hospitalization or death.

**Results:** 1,152 patients were included in Trial 1 (635 proactive, 517 reactive). 3,001 patients were included in Trial 2 including multiple trials if eligible (6,268 vitamin D-favoring, 459 cinacalcet-favoring). The proactive approach associated with lower adjusted hazard of death (HR 0.71; 95% CI 0.52, 0.93), CV hospitalization (HR 0.78; 95% CI 0.63, 0.98), and their composite (HR 0.74; 95% CI 0.61, 0.89). Cinacalcet vs. vitamin D-favoring approach demonstrated modestly lower adjusted risk of death (HR 0.79; 95% CI 0.62, 0.99), but not CV hospitalization or the composite.

**Conclusions:** Proactive SHPT care is associated with better outcomes. A RCT of lower vs. higher PTH targets to prevent death and cardiovascular disease in patients with secondary hyperparathyroidism is justified.

**Funding:** NIDDK Support

## TH-PO154

**Rise in Serum Phosphate Levels Over the Past Decade Among US Hemodialysis Patients: Global Results From the DOPPS Practice Monitor**

Murilo H. Guedes,<sup>1</sup> Brian Bieber,<sup>2</sup> Almudena Vega,<sup>7</sup> Indranil Dasgupta,<sup>6</sup> John Hartman,<sup>8</sup> Kosaku Nitta,<sup>4</sup> Steven M. Brunelli,<sup>5</sup> Jochen G. Raimann,<sup>3</sup> Ronald L. Pisoni,<sup>2</sup> Bruce M. Robinson.<sup>2</sup> <sup>1</sup>Pontificia Universidade Catolica do Parana, Curitiba, Brazil; <sup>2</sup>Arbor Research Collaborative for Health, Ann Arbor, MI; <sup>3</sup>Renal Research Institute, New York, NY; <sup>4</sup>Tokyo Women's Medical University, Dept of Medicine, Tokyo, Japan; <sup>5</sup>Davita Clinical Research, Minneapolis, MN; <sup>6</sup>University Hospitals Birmingham NHS Foundation Trust, Birmingham, United Kingdom; <sup>7</sup>La Fundacion para la Investigacion Biomedica del Hospital Gregorio Maranon, Madrid, Spain; <sup>8</sup>Visonex, Green Bay, WI.

**Background:** KDIGO Guidelines (2009 and 2017) recommended lowering phosphate levels (PO) toward the normal range among dialysis patients. We describe trends over two decades in serum phosphate levels among in-center hemodialysis (ICHD) patients in the US, Japan, and 7 European countries

**Methods:** The Dialysis Outcomes and Practice Patterns Study (DOPPS) is prospective study of ICHD patients. A national sample is constructed in each country by stratified random sampling of dialysis centers, refreshed at 3-year intervals. This analysis includes annual mean serum phosphate levels from DOPPS 2-7 (2002-2021).

**Results:** In 2002, mean PO was 5.5 (Europe), 5.6 (Japan), and 5.7 (US) mg/dL. Levels declined in each region from 2002 to 2012 (-0.6 Europe, -0.4 Japan, -0.7 US). Since then, levels rose in US (to mean 5.6, 2021), were stable in Japan (5.3), and declined in Europe (4.8). In 2021, 52% (US), 27% (Europe), and 39% (Japan) had PO >5.5 mg/dL. In the US, overall phosphate binder PB use was stable (84-80% over 2015-2021), and PTH levels rose only modestly.

**Conclusions:** Among ICHD patients, phosphate trends over the past decade differ in the US (rising) than Japan (stable) and Europe (lower). The US trend contrasts with KDIGO recommendations and may reflect PB titration to higher targets along with more permissive dietary counseling. Hemodiafiltration use (none in US, common elsewhere) may also contribute. Optimal phosphate targets have yet to be ascertained by clinical trials, and effects on patient outcomes are uncertain.

**Funding:** Commercial Support - Global support for the ongoing DOPPS Programs is provided without restriction on publications by a variety of funders. For details see <https://www.dopps.org/AboutUs/Support.aspx>

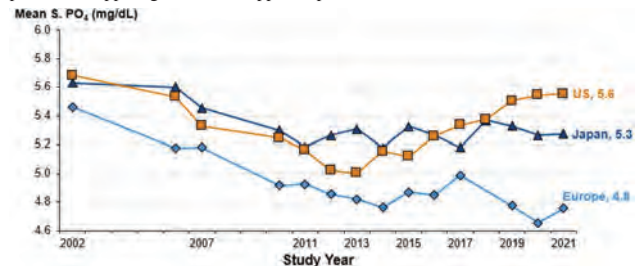

**Figure.** Serum phosphate trends among ICHD patients, from 2002 to 2021.

[DOPPS phases 2-7 included facilities from the US, Japan, and 7 European countries (Belgium, France, Germany, Italy, Spain, Sweden, United Kingdom). The period covers 123,997 patient-months from the US, 23,789 from Japan and 34,208 from Europe.]

## TH-PO155

**Target Serum Phosphate and Calcium Levels in Patients With CKD Undergoing Hemodialysis Receiving Prescriptions for Phosphate Binders: A Post Hoc Analysis of the LANDMARK Study**

Kiryu Yoshida,<sup>1,2</sup> Takuya Mizukami,<sup>1</sup> Masafumi Fukagawa,<sup>3</sup> Tadao Akizawa,<sup>1</sup> Hokuto Morohoshi,<sup>1</sup> Takehiko Sambe,<sup>1</sup> Hiroaki Ogata,<sup>2</sup> Naoki Uchida.<sup>1</sup> <sup>1</sup>Showa Daigaku, Shinagawa, Japan; <sup>2</sup>Showa Daigaku Yokohama-shi Hokubu Byoin, Yokohama, Japan; <sup>3</sup>Tokai Daigaku, Isehara, Japan.

**Background:** In contemporary CKD-MBD management, there is a need to reexamine optimal target values for phosphate (P) and calcium (Ca) to reduce cardiovascular event risk in patients on hemodialysis.

**Methods:** We performed a post-hoc analysis of the LANDMARK study. The outcomes were defined as cardiovascular events and all-cause death. 2135 patients on hemodialysis at risk for vascular calcification were analyzed using the time-dependent Cox proportional hazards model.

**Results:** In stratified analysis, there was no difference in cardiovascular events between the lower half of the target range (3.5 - 4.8 mg/dL) and the higher half (4.8 - 6.0 mg/dL) for P (adjusted HR 1.18 (95% CI 0.86 - 1.63; p = 0.309)). For corrected Ca, the risk was higher in the higher half of the target range (9.2 - 10.0 mg/dL) than in the lower half (8.4 - 9.2 mg/dL) (adjusted HR 1.84 (95% CI 1.38 - 2.45; p < 0.001)). There was no difference in all-cause mortality between the lower half and the higher half of the target range for P or corrected Ca.

**Conclusions:** Stricter management of P alone was not associated with cardiovascular events in patients on hemodialysis. On the other hand, stricter management of Ca may reduce cardiovascular risk.

#### Results of Time-Dependent Cox Proportional Hazards Model

Outcome	Variables	Number of observation points	Hazard Ratio (95% Confidence Interval)	P-value
Cardiovascular events	Phosphate (mg/dL)	3.5 - 4.8	1.00 (reference)	
		4.8 - 6.0	1.18 (0.86 - 1.63)	0.309
	Corrected Calcium (mg/dL)	8.4 - 9.2	1.00 (reference)	
		9.2 - 10.0	1.84 (1.38 - 2.45)	<0.001
All-cause mortality	Phosphate (mg/dL)	3.5 - 4.8	1.00 (reference)	
		4.8 - 6.0	0.94 (0.70 - 1.27)	0.709
	Corrected Calcium (mg/dL)	8.4 - 9.2	1.00 (reference)	
		9.2 - 10.0	1.24 (0.94 - 1.63)	0.133

#### TH-PO156

##### Etelcalcetide Improves Cardiac Dysfunction in Mice on a High Phosphate Diet

Maren Leifheit-Nestler, Isabel Vogt, Andrea Grund, Beatrice Richter, Dieter Haffner. *Hannover Medical School, Hannover, Germany.*

**Background:** High phosphate levels stimulate the synthesis of the phosphaturic hormone parathyroid hormone (PTH) and fibroblast growth factor (FGF) 23 and are associated with increased cardiovascular morbidity and mortality. In the secondary analysis of the EVOLVE trial, cinacalcet significantly reduced levels of PTH and FGF23 in patients on hemodialysis, and the latter was associated with a lower rate of cardiovascular events and death. Intravenous administration of etelcalcetide reduced FGF23 and improved the progression of left ventricular (LV) hypertrophy in hemodialysis patients. In the present study, we examined the specific cardiac effects of etelcalcetide in mice on a high phosphate diet (HPD).

**Methods:** After four months on a 2% HPD, male C57BL/6N mice were additionally treated with 1 mg/kg body weight/day etelcalcetide (KP-2326) via osmotic minipumps for two more months and compared to mice receiving HPD with vehicle or a 0.8% normal phosphate diet (NPD). The heart function was examined by echocardiography and parameters of the mineral metabolism were determined.

**Results:** Compared to the NPD group, mice on HPD had significantly higher serum phosphate, FGF23 and PTH levels and increased phosphaturia, which was associated with progressive kidney injury. Mice on HPD show a dilated left ventricle with decreased anterior and posterior wall thickness and increased LV end-systolic and end-diastolic diameters and volumes. Ejection fraction and fractional shortening were reduced in mice on HPD, indicating impaired systolic function. Etelcalcetide reduced HPD-induced FGF23 and PTH levels by 80% and 75%, respectively, and resulted in a significant reduction in serum calcium levels, but had no effect on persistent hyperphosphatemia and phosphaturia. Etelcalcetide effectively ameliorated the HPD-induced LV dilatation and systolic dysfunction.

**Conclusions:** In mice, HPD leads to hyperphosphatemia and high plasma FGF23 and PTH concentrations with subsequent LV dilatation and systolic dysfunction. Administration of etelcalcetide effectively prevents the HPD-induced pathological cardiac phenotype despite the presence of hyperphosphatemia, which is at least partly due to the normalization of the high plasma FGF23 and PTH levels.

**Funding:** Commercial Support - AMGEN Inc.

#### TH-PO157

##### ORCHESTRA Trial: Head-to-Head Comparison of Oral Calcimimetics Evocalcet and Cinacalcet in East Asian Hemodialysis Patients With Secondary Hyperparathyroidism

Xinling Liang,<sup>1</sup> Zhaohui Ni,<sup>2</sup> Chia-Chao Wu,<sup>3</sup> Kyubok Jin,<sup>4</sup> Yong-Lim Kim,<sup>5</sup> Kuo-Cheng Lu,<sup>6</sup> Tak Mao D. Chan,<sup>7</sup> Masafumi Fukagawa,<sup>8</sup> Jun Kinoshita,<sup>9</sup> Chisato Nagai,<sup>9</sup> Masahiro Kojima,<sup>9</sup> Xueqing Yu.<sup>1</sup> The Orchestra Study Group <sup>1</sup>Guangdong Provincial People's Hospital, Guangzhou, China; <sup>2</sup>Shanghai Jiao Tong University School of Medicine Affiliated Renji Hospital, Shanghai, China; <sup>3</sup>Tri-Service General Hospital, Taipei, Taiwan; <sup>4</sup>Keimyung University School of Medicine, Daegu, Republic of Korea; <sup>5</sup>Kyungpook National University Hospital, Daegu, Republic of Korea; <sup>6</sup>Taipei Tzu Chi Hospital, Taipei, Taiwan; <sup>7</sup>The University of Hong Kong, Hong Kong, Hong Kong; <sup>8</sup>Tokai University School of Medicine, Isehara, Japan; <sup>9</sup>Kyowa Kirin Co., Ltd., Chiyoda-ku, Japan.

**Background:** Cinacalcet is widely used to control secondary hyperparathyroidism (SHPT) in hemodialysis (HD) patients, but its upper gastrointestinal (GI) side effects may lead to lower adherence and thus suboptimal efficacy. Evocalcet (KHK7580) is a new oral calcimimetic which can suppress intact parathyroid hormone (iPTH) while inducing fewer upper GI side effects. To date, the experience with evocalcet is only limited to Japanese patients. To compare its efficacy and safety against cinacalcet in SHPT patients of other Asian ethnicities, we conducted a Phase 3 study in Mainland China, Taiwan, Hong Kong and South Korea. (NCT03822507)

**Methods:** In this multicenter, randomized and double-blind trial, HD patients with SHPT and iPTH level >300 pg/mL were randomized to receive evocalcet (n=203) or cinacalcet treatment (n=201) for 52 weeks, at daily dose range of 1-12 mg and 25-100 mg respectively. The primary endpoint was the mean % change in iPTH level from baseline in Week 50-52. Incidence of pre-specified GIAEs (abdominal discomfort, nausea, vomiting, abdominal distension, and decreased appetite) was also evaluated.

**Results:** Evocalcet showed non-inferiority to cinacalcet. The difference in mean % change in iPTH level from baseline in evocalcet (-34.7%) and cinacalcet (-30.2%) was -4.4% (95% CI [-13.1, 4.3]; non-inferiority margin, +15%). The difference in proportion of participants with ≥30% decrease in iPTH from baseline between evocalcet (67.3%) and cinacalcet (58.7%) was 8.6% (95% CI [-1.8, 19.1]). Effective iPTH reduction from baseline was also observed in subjects with high baseline iPTH of ≥1000 pg/mL (-46.1% in evocalcet, -37.1% in cinacalcet). Upper GI AEs occurred in 33.5% of patients receiving evocalcet, which is significantly lower than 50.5% for cinacalcet (p=0.001). Meanwhile, incidences of pre-defined Calcium decrease-related AEs were similar in two groups (61.6% in evocalcet, 61.0% in cinacalcet).

**Conclusions:** In East Asian HD patients with SHPT, the efficacy of evocalcet in reducing serum iPTH is non-inferior to cinacalcet, and evocalcet showed significantly reduced GI side effects compared with cinacalcet. Evocalcet therefore presents a preferable treatment alternative to cinacalcet for SHPT.

**Funding:** Commercial Support - Kyowa Kirin Co., Ltd.

#### TH-PO158

##### Calcium Sensing Receptor and Klotho Expression of Advanced Dialysis-Dependent Hyperparathyroidism

Tetsuhiko Sato,<sup>1</sup> Yamato Kikkawa,<sup>2</sup> Manabu Okada,<sup>1</sup> Masafumi Fukagawa,<sup>3</sup> <sup>1</sup>JRC Aichi Medical Center, Nagoya Daini Hospital, Nagoya, Japan; <sup>2</sup>Tokyo University of Pharmacy and Life Sciences, Hachioji, Japan; <sup>3</sup>Tokai University, School of Medicine, Isehara, Japan.

**Background:** Advanced parathyroid hyperplasia is often caused by long-term dialysis-dependent chronic kidney disease, resulted in more aggressive pathological pattern called nodular formation. Each intra-parathyroid gland nodule is thought to have monoclonal proliferation. Calcimimetics are expected to upregulate calcium sensing receptor (CaSR) expression and inhibit PTH synthesis and secretion. However, our surgical center has experienced over 20 parathyroidectomies in each year, although second-generation calcimimetics (intravenous and/or oral) are voluntarily used to control systemic PTH levels. The question remains how enlarged parathyroid glands develop calcimimetics-resistant phenotype, and eventually need surgical resection during this recent calcimimetics-era.

**Methods:** We hypothesized that Klotho expression in each parathyroid nodule may play a key role of advanced hyperparathyroidism, conducted the study of immunofluorescence of CaSR and Klotho expression, and examined the relation of enlarged parathyroid gland weight with immunoreactivity of CaSR and Klotho. We utilized surgically resected enlarged parathyroid glands to perform immunohistochemistry using primary antibodies to CaSR and Klotho.

**Results:** Presurgical PTH levels and total glandular weight on surgery was 520+/-278 pg/mL and 2307+/-1140 mg, respectively (mean+/-SD). Interestingly, parathyroid gland, ranging from 100 to 1000 mg weight possessed heterogenous CaSR (3+ positive to negative) and Klotho expression pattern. Each intra-gland nodule had a wide spectrum of immunoreactivity of CaSR with relatively weaker Klotho expression. In contrast, enlarged single-nodular parathyroid gland, ranging 1000 mg or greater did not harbor remarkable CaSR and Klotho expression.

**Conclusions:** In conclusion, profound use of "second-generation" calcimimetics may enhance CaSR in earlier phase of hyperplastic parathyroid glands, followed by Klotho downregulation, suggesting that multiple nodules of parathyroid hyperplasia have diverse CaSR response to calcimimetics. Aggressively progressed parathyroid glands ended up with overwhelmingly marked downregulation of both CaSR and Klotho. CaSR and Klotho interaction may play a key role of advanced dialysis-dependent hyperparathyroidism.

#### TH-PO159

##### Development of a Yeast-Based Assay to Identify Inhibitors of PiT-1 Phosphate Transporter

Joseph M. Sweeney, Myles Akabas. *Albert Einstein College of Medicine, Bronx, NY.*

**Background:** Advanced chronic kidney disease causes hyperphosphatemia, which may induce vascular calcification. Vascular calcification results from the extracellular precipitation of phosphate and calcium into the arterial walls. This process is actively driven by vascular smooth muscle cells and is dependent on PiT-1, a sodium-phosphate co-transporter. Vascular calcification may cause cardiovascular disease and increased mortality, yet no pharmaceuticals are available to directly attenuate vascular calcification. As PiT-1 plays a key role in the pathogenesis of vascular calcification, it is a promising drug target.

**Methods:** We obtained an *S. cerevisiae* yeast strain with one endogenous yeast phosphate transporter remaining. Using CRISPR/Cas9, we inserted the human PiT-1 gene into this yeast strain and knocked out the remaining endogenous phosphate transporter. The resulting yeast strain expressed PiT-1 as its sole phosphate transporter, confirmed with PCR and western blot. Since phosphate is vital for cellular functions, the proliferation rate of our strain is dependent upon PiT-1 phosphate transport activity. Yeast proliferation rates were measured using the Bioscreen C, which maintains yeast growth with continuous shaking, while periodically measuring turbidity at OD<sub>600</sub> over a period of days.

Key: TH - Thursday; FR - Friday; SA - Saturday; OR - Oral; PO - Poster; PUB - Publication Only

Underline represents presenting author.

**Results:** We determined the optimal media, pH, and sodium compositions for reproducible proliferation rates of our PiT-1 strain. We determined that media with 20 mM phosphate would provide the most sensitive threshold for identifying potential PiT-1 inhibitors. We identified several low-affinity PiT-1 inhibitors, including potassium sulfate ( $K_2SO_4$ ) and 2-(N-morpholino) ethane sulfonic acid (MES). The proliferation rate of our PiT-1 strain was more sensitive to increasing concentrations of these inhibitors compared to its parent strain.

**Conclusions:** We have developed an *S. cerevisiae* yeast strain expressing PiT-1 as its sole phosphate transporter. We have also determined proliferation conditions optimal for identifying inhibitors of PiT-1 phosphate transport. This method can be used to screen a small molecule library to identify more potent PiT-1 inhibitors. Our method may potentially be used to develop a high throughput screen for inhibitors of other phosphate transporters implicated in human pathophysiology.

**Funding:** Other NIH Support - MSTP Training grant, T32GM007288

## TH-PO160

### Efficacy and Safety of Tenapanor on Hyperphosphatemia in Japanese Hemodialysis Patients: Results of a Randomized Phase 3 Trial

Masafumi Fukagawa,<sup>1</sup> Kazuaki Ikejiri,<sup>2</sup> Jun Kinoshita,<sup>2</sup> Kaoru Nakanishi,<sup>2</sup> Tadao Akizawa,<sup>3</sup> *Tokai University School of Medicine, Isehara, Japan;* <sup>2</sup>Kyowa Kirin Co., Ltd., Tokyo, Japan; <sup>3</sup>Showa University School of Medicine, Tokyo, Japan.

**Background:** Phosphate binders (PB) are commonly used for hyperphosphatemia in hemodialysis (HD) patients, although some patients do not have sufficient phosphorus control. Poor adherence to PB due to adverse events and heavy pill burden often plays significant roles in such patients. Tenapanor (TEN) is a novel potent treatment for hyperphosphatemia that reduces serum phosphorus (sP) level through selective inhibition of sodium/hydrogen exchanger 3 antiporter and the reduction in paracellular phosphorus absorption. The purpose of this trial was to confirm the efficacy and safety of TEN on hyperphosphatemia in Japanese HD patients.

**Methods:** This was a multicenter, randomized, double-blind, placebo-controlled, parallel-group, phase 3 trial in Japanese HD patients. The trial comprised three periods (screening, up to 3-week washout, 8-week treatment). Patients in screening were enrolled when the sP level at the first dialysis session of the week was 3.5–6.0 mg/dL (the target range by Japanese Society for Dialysis Therapy) and increased by  $\geq 1.0$  mg/dL to 6.1–9.9 mg/dL after washout of PB. Enrolled patients were randomized 1:1 to the placebo or TEN groups. TEN 5 mg was administered twice/day at the starting dose and titrated in a stepwise manner within the range of 5, 10, 20 and 30 mg twice/day based on the sP level. The primary endpoint was the mean change in sP level at week 8 from baseline.

**Results:** One-hundred and sixty-four subjects were enrolled (82 subjects per group). The week 8 sP (primary endpoint) decreased 1.89 mg/dL in the TEN group and increased 0.05 mg/dL in the placebo group (difference  $-1.95$  mg/dL [95%CI  $-2.37$  mg/dL,  $-1.53$  mg/dL],  $p < 0.0001$ ). In the TEN group, the percentage of subjects achieving the target sP (3.5–6.0 mg/dL) gradually increased to 69.2% as the mean dose of TEN was up-titrated to 18.1 mg at the end. In each group, the major adverse event was diarrhea (TEN group: 74.4%, placebo group: 19.5%). In most of the patients, diarrhea was mild in severity and only two subjects withdrew for diarrhea in the TEN group.

**Conclusions:** TEN significantly decreased sP compared with placebo and was well tolerated in Japanese HD patients. These results suggest that TEN can be a new option for the hyperphosphatemia treatment.

**Funding:** Commercial Support - Kyowa Kirin Co., Ltd.

## TH-PO161

### Efficacy and Safety of Tenapanor Added to Phosphate Binders for Hemodialysis Patients Who Have Poorly Controlled Hyperphosphatemia on Existing Phosphate Binders: Results of a Randomized Phase 3 Trial

Junichiro J. Kazama,<sup>1</sup> Miho Kusakabe,<sup>2</sup> Jun Kinoshita,<sup>2</sup> Kaoru Nakanishi,<sup>2</sup> Masafumi Fukagawa,<sup>3</sup> Tadao Akizawa,<sup>4</sup> *Fukushima Medical University, Fukushima, Japan;* <sup>2</sup>Kyowa Kirin Co., Ltd., Tokyo, Japan; <sup>3</sup>Tokai University School of Medicine, Isehara, Japan; <sup>4</sup>Showa University School of Medicine, Tokyo, Japan.

**Background:** Despite the use of conventional phosphate binders (PB), phosphate management still remains a difficult issue among patients undergoing maintenance hemodialysis (HD) therapy. Tenapanor (TEN) selectively inhibits the intestinal sodium/hydrogen exchanger 3 and decreases paracellular phosphate absorption, which has a potential to improve phosphate management among those HD patients displaying hyperphosphatemia refractory to conventional PB. In this study, we evaluated the efficacy and safety of TEN added to PB for refractory hyperphosphatemia in Japanese HD patients.

**Methods:** This was a phase 3, randomized, multicenter, double-blind, placebo-controlled, parallel-group study. Patients whose serum phosphorus level was out of target range; 6.1–9.9 mg/dL on conventional PBs were eligible for this study. After a 2 weeks observation period, patients were randomized to TEN+PB or placebo + PB in 1:1 ratio. TEN was administered at initial dose of 5 mg twice a day and titrated within the range of 5, 10, 20, and 30 mg twice a day based on serum phosphorus levels, while the PB dosage was unchanged. The primary endpoint was the change in serum phosphorus level from baseline to week 8 after the start of TEN.

**Results:** One-hundred and sixty-nine subjects were randomized. The mean change in the serum phosphorus level from baseline to week 8 was  $-2.00$  mg/dL in the TEN group and  $-0.24$  mg/dL in the placebo group. The difference in the mean change

from baseline in serum phosphorus levels between the TEN and placebo groups was  $-1.76$  mg/dL (95%CI  $[-2.16, -1.37$  mg/dL],  $p < 0.0001$ ). The percentage achieving the target serum phosphorus level (3.5–6.0 mg/dL) after 8 weeks of treatment was 72.6% in the TEN group and 28.9% in the placebo group. Diarrhea was the most frequent adverse event (TEN=63.1%; placebo=14.1%), and all were of mild to moderate in severity.

**Conclusions:** TEN achieved a significant reduction in serum phosphorus levels compared with the placebo when added to PB therapy. This result suggests that TEN combined with PB could be a promising treatment option for hyperphosphatemia refractory to conventional PBs among HD patients.

**Funding:** Commercial Support - Kyowa Kirin Co., Ltd

## TH-PO162

### Reduction of Serum Phosphorus (sP) With Tenapanor (TEN) in Patients With CKD on Dialysis With Severe Hyperphosphatemia

Stuart M. Sprague,<sup>1</sup> Yang Yang,<sup>2</sup> David M. Spiegel,<sup>2</sup> David P. Rosenbaum,<sup>2</sup> *NorthShore University HealthSystem-University of Chicago Pritzker School of Medicine, Chicago, IL;* <sup>2</sup>Ardelyx, Inc., Waltham, MA.

**Background:** TEN is a first-in-class, investigational phosphate absorption inhibitor (PAI) that blocks paracellular phosphate absorption in the gastrointestinal tract by local inhibition of intestinal NHE3, providing a novel approach to managing hyperphosphatemia. TEN met the primary sP-lowering endpoint in 2 phase 3 monotherapy trials (BLOCK [NCT02675998], PHREEDOM [NCT03427125]) and was generally well tolerated. In patients with CKD, the risk of cardiovascular (CV) morbidity and mortality increases as sP levels increase. We evaluated the effect of TEN in patients with CKD on dialysis with severe hyperphosphatemia ( $\geq 7.5$  mg/dL) from BLOCK and PHREEDOM.

**Methods:** BLOCK had an 8-week open-label randomized treatment period (RTP; 3, 10, or 30 mg TEN twice a day [bid] dose titration), followed by a 4-week placebo-controlled randomized withdrawal period (RWP). PHREEDOM had a 26-week open-label RTP (30 mg TEN bid dose titration), followed by a placebo-controlled RWP of up to 12 weeks and a 14-week open-label safety extension. Both studies enrolled patients on maintenance dialysis with sP  $\geq 6.0$  and  $\leq 10.0$  mg/dL and an sP increase  $\geq 1.5$  mg/dL after phosphate binder washout. During the RTP of each study, we evaluated sP reduction (to last assessment during RTP) in patients with baseline sP  $\geq 7.5$  mg/dL.

**Results:** In BLOCK, 107/215 patients in the intent-to-treat (ITT) analysis set had a baseline sP  $\geq 7.5$  mg/dL across the 3 dose groups; these patients had a mean sP  $\pm$ SD reduction of  $1.78 \pm 1.73$  mg/dL from baseline to the end of the RTP, and the 37 patients from the 30 mg dose group had a  $1.91 \pm 1.83$  mg/dL sP reduction. In PHREEDOM, 204/407 patients in the ITT analysis sets had a baseline sP  $\geq 7.5$  mg/dL; these patients had a mean sP  $\pm$ SD reduction of  $1.94 \pm 1.86$  mg/dL. During the RTPs of both studies, the only adverse event reported in  $>10\%$  of patients with severe hyperphosphatemia in the safety analysis sets was diarrhea (BLOCK, 43.1%; PHREEDOM, 51.2%), which led to study drug discontinuation in 6.4% and 17.7%, respectively.

**Conclusions:** Tenapanor, a novel investigational PAI dosed as a single twice-daily tablet, provides a clinically meaningful sP reduction with an acceptable safety profile for patients with severe hyperphosphatemia on dialysis who are at high risk of CV morbidity and mortality.

**Funding:** Commercial Support - Ardelyx, Inc.

## TH-PO163

### The Predictive Value of Early Response to Tenapanor for the Treatment of Hyperphosphatemia in Patients Receiving Maintenance Dialysis

Daniel E. Weiner,<sup>1</sup> David M. Spiegel,<sup>2</sup> Yang Yang,<sup>2</sup> David P. Rosenbaum,<sup>2</sup> *Tufts University School of Medicine, Boston, MA;* <sup>2</sup>Ardelyx, Inc., Waltham, MA.

**Background:** Serum phosphorus (sP) control remains challenging for patients receiving maintenance dialysis. Despite adequate dialysis, dietary counseling, and use of phosphate binders, many patients fail to achieve and maintain target sP. Tenapanor is an investigational phosphate absorption inhibitor (PAI) dosed twice a day that blocks the paracellular absorption of dietary phosphate in the intestine. This post hoc analysis of the phase 3 PHREEDOM (NCT03427125) study evaluated whether an early sP reduction predicts continued sP control at week 12 and end of treatment.

**Methods:** In PHREEDOM, patients receiving maintenance dialysis with hyperphosphatemia were randomized 3:1 to tenapanor 30 mg twice a day or sevelamer. Early responders were defined as those with  $\geq 2$  of 3 sP measurements with a reduction of  $\geq 1.2$  mg/dL from baseline at weeks 1, 2, and 4. Early responders were assessed for continued response at week 12 (single measurement) and weeks 17, 22, and 26 defined as having sP  $\geq 1.2$  mg/dL lower than baseline at week 12 or  $\geq 1.2$  mg/dL lower than baseline for  $\geq 2$  of 3 sP measurements at weeks 17, 22, and 26 (end of treatment). Continued response rates were estimated using 2 approaches: Conservative – early responders who missed sP measurement at week 12 or missed  $\geq 2$  of 3 sP measurements at weeks 17, 22, and 26 were considered late non-responders; Observed Case – only the early responders who remained on treatment with sP measurement at week 12 or with  $\geq 2$  of 3 sP measurements at weeks 17, 22, and 26 were included in analysis.

**Results:** In PHREEDOM, 46.4% (189/407) of tenapanor-treated patients achieved an early response. The Table shows the proportion of early responders who remained responders at week 12 and end of treatment. Most early non-responders remained non-responders throughout the study.

**Conclusions:** Among patients receiving maintenance dialysis with an early response to tenapanor who remained on treatment,  $\approx 70\%$  maintained their response at week 12 and  $\approx 80\%$  continued to have a clinically meaningful therapeutic response at the end of treatment. This approach could help guide real-world clinical practice.

**Funding:** Commercial Support - Ardelyx, Inc.



Early Responders Who Achieved a Decrease in sP of $\geq 1.2$ mg/dL at Week 12 and $\geq 2$ of 3 Visits at the End of the 26-Week Treatment Period		
	Week 12	End of treatment
Conservative approach	57.1% (108/189)	58.2% (110/189)
Observed case approach	68.8% (108/157)	79.1% (110/139)

TH-PO164

**Changes in Serum Phosphorus Among In-Center Hemodialysis (HD) Patients Initiating Sucroferric Oxyhydroxide (SO) as Part of Routine Care After Kidney Transplant Failure: A 6-Month Follow-Up Study**  
Meijiao Zhou, Linda Ficociello, Claudy Mullon, Michael S. Anger. *Fresenius Medical Care, Waltham, MA.*

**Background:** Information on serum phosphorus (sP) management in patients who experience kidney transplant failure (KTF) and initiate dialysis is scarce. This retrospective database analysis aims to assess sP management with sucroferric oxyhydroxide (SO), an iron-based phosphate binder (PB), in post-KTF HD patients (pts) over a 6-month period.  
**Methods:** Eligible pts were adult post-KTF HD pts from Fresenius Kidney Care first prescribed SO monotherapy during 5/2018- 12/2019 who had sP measured in the month before SO start (baseline; BL). Included in the analysis were pts who initiated SO within 12 months from start of post-KTF HD. Comparisons were made between BL and the monthly follow up (FU; M1 through M6). Monthly or quarterly means were calculated using mixed effects linear regression for PB pill burden and lab measurements. A subgroup analysis was performed in pts with post-KTF HD < 3 months.

**Results:** At BL, pts (n=100) had mean age of 49 years and were on HD for an average of 5 months post-KTF. No PB prescriptions were recorded for 35% overall and 30% for pts with HD < 3 months post-transplant. For the overall pts prescribed PB, most were prescribed sevelamer (45%) or calcium acetate (31%). Among pts with HD < 3 months post-KTF, fewer patients were on calcium acetate (15%) and more on ferric citrate (19%, compared to 8% overall). After switching to SO, % of pts with sP  $\leq 5.5$  mg/dL increased from 20% to 26%- 35% during SO FU, with fewer PB pills per day in all pts; the trends were similar in pts with post-KTF HD < 3 months (Table). Significant decreases of serum calcium (sCa) and iPTH were also observed.

**Conclusions:** During a 6-month follow-up, significant reductions in sP, PB pills/day, serum calcium and iPTH were observed after pts switched to sucroferric oxyhydroxide within 1 year of returning to HD after kidney transplant failure.

**Funding:** Commercial Support - Fresenius Medical Care

	BL-M1 (n=1)	FU-M1	FU-M2	FU-M3	FU-M4	FU-M5	FU-M6	P-value*
PK, mL/min	7.5	4.3**	4.3**	4.5**	4.6**	4.7**	4.8**	<.0001
sP $\geq 5.5$ mg/dL, %	20	26	32.3*	35.4*	32*	34.4*	29.5*	0.01
iPTH, pg/mL	7.04	6.62*	6.61*	5.96*	6.58*	6.60*	6.05	0.06
sCa, mg/dL	9.15	8.99*	8.97*	8.96*	8.90*	8.84*	8.85*	0.01
iPTH, pg/mL	754	632**				557**		<.0001
PB, pills/day	7.4	4.7**	4.7**	4.6**	4.8**	4.9**	5.1**	<.0001
pts on post-KTF HD < 3 months (n=37)								
sP $\geq 5.5$ mg/dL, %	24.3	19.4	33.3	34.1	31.4	41.7	28.6	0.03
iPTH, pg/mL	7.11	6.68	6.83	6.28*	6.61	6.23*	6.73	0.02
sCa, mg/dL	9.17	9.12	9.18	8.98*	8.95*	8.9	8.95	0.01
iPTH, pg/mL	825	677*				646*		0.006

\*Quarterly iPTH were calculated, as iPTH were measured quarterly at FMC facilities.  
\*\*BL-M1, \*\*FU-M1 (n=1)  
\*P-values reflect Bonferroni adjustment and Sidak's CI test were used to test for statistical significance

TH-PO165

**Phosphate Removal During Conventional Hemodialysis Is Continuous and Depends on Pre-Dialysis Serum Levels and Bone Remodeling**  
Carolina M. Lima, Patricia T. Goldenstein, Luciene dos Reis, Vanda Jorgetti, Rosilene M. Elias, Rosa M. Moyses. *Universidade de Sao Paulo, Sao Paulo, Brazil.*

**Background:** Removal of phosphate (P) in conventional hemodialysis (HD) remains a cornerstone for CKD-MBD management. There is a disseminated belief that P removal after the first 90 minutes of HD is irrelevant. In addition, the main determinants of an intradialytic P balance are still a matter of debate.

**Methods:** We measured serum and dialysate P each 30 min during a HD session in 10 patients with severe hyperparathyroidism in 3 different periods: before parathyroidectomy (Pre-PTX), during hungry bone syndrome (HBS), and after stabilization of clinical status (Late-PTX). In each period, all patients were dialyzed 3 times, using a d[Ca] of 1.25, 1.5 or 1.75 mmol/L.

**Results:** P removal was higher in Pre-PTX than in HBS and Late-PTX (1098 ± 313 vs. 744 ± 195 and 842 ± 348 mg, respectively, p = 0.04), with no difference among d[Ca]. P removal correlated with pre-dialysis serum P (r = 0.421, p = 0.0001) and ultrafiltration volume (UF; r = 0.259, p = 0.014). Percentual serum P reduction in 90 minutes was 52.0%. From this point forward there was no significant change during HD. P removal in 90 minutes was 45.9%. However, despite serum P stabilization, after this point there was a continuous efflux of P, in any study period or d[Ca], of at least 10% every 30 minutes (Figure). GLM revealed that P removal was dependent, in order of importance, on the pre-dialysis serum P, UF and bone remodeling, explaining together 66.8% of P removal.

**Conclusions:** P removal during conventional HD is higher during the first 90 of therapy, achieving a smaller, but stable flux until the 240 minutes. An intradialytic negative P balance depends not only on the pre-dialysis serum P and UF but also on bone remodeling, which may change the P disposal on the bone surface.

**Funding:** Government Support - Non-U.S.

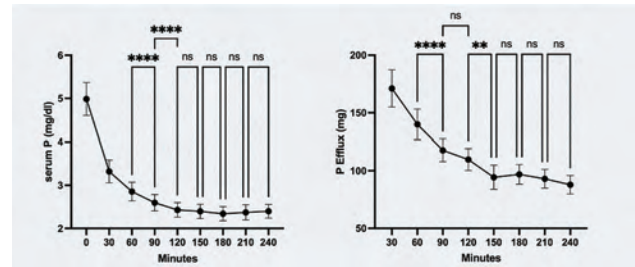

Left: serum P variation during dialysis

Right: P efflux during dialysis

TH-PO166

**Associations Between Serum Phosphate, Kt/V, and Creatinine Clearance Among Peritoneal Dialysis Patients: Preliminary Analysis From the PD-MONDO Initiative**

Murilo H. Guedes,<sup>1</sup> Maria Ines Diaz Bessone,<sup>6</sup> Lili Chan,<sup>2</sup> Ariella E. Mermelstein,<sup>3</sup> Andres E. De la torre quiroga,<sup>4</sup> Douglas R. Farrell,<sup>2</sup> Vincent Peters,<sup>5</sup> Constantijn Konings,<sup>5</sup> Guillermo Garcia-Garcia,<sup>4</sup> Jochen G. Raimann,<sup>3</sup> Adrian M. Guinsburg,<sup>6</sup> Thyago P. Moraes,<sup>1</sup> Peter Kotanko,<sup>3</sup> Jaime Uribarri,<sup>2</sup> *Pontificia Universidade Catolica do Parana, Curitiba, Brazil; <sup>2</sup>Icahn School of Medicine at Mount Sinai, New York, NY; <sup>3</sup>Renal Research Institute, New York, NY; <sup>4</sup>Hospital Civil de Guadalajara, Guadalajara, Mexico; <sup>5</sup>Catharina Hospital Eindhoven, Eindhoven, Netherlands; <sup>6</sup>Fresenius Medical Care, Buenos Aires, Argentina.*

**Background:** Serum phosphate (PO) control requires adequate dialysis, yet commonly used biomarkers of dialysis adequacy (Kt/V) may underestimate PO removal in peritoneal dialysis (PD) patients. We sought to explore if creatinine clearance (CrCl), in addition to Kt/V, yields a better prediction of PO in PD patients.

**Methods:** We performed a cross-sectional analysis of multiple cohorts of incident PD patients – Fresenius Medical Care Latin America (FMC-LATAM), Renal Research Institute (RRI), Mount Sinai Hospital, Hospital Civil Guadalajara, and the BRAZPD cohort. We extracted the first available PO, Kt/V, and CrCl after 90 days of PD start. We fit separate linear regression models between PO, CrCl, and Kt/V, adjusting for predictors of PO. We computed log-likelihood ratio tests (LRT) for the models with and without CrCl. Pooled estimates between datasets were summarized by conducting a meta-analysis using random effects.

**Results:** 16,814 patients were included. Across data sets, median age (max,min) was 56 (60,45), 55% male (50,62); Kt/V and CrCl were 2.1 (1.7,2.5) and 77 (57,96) L/week, respectively. Phosphate binder use was 70% across datasets. In most datasets, Kt/V and CrCl were inversely associated with PO in the models adjusted for age, sex, PO binder use, and normalized protein catabolic rate (nPCR) (Figure). The pooled results confirmed the findings, despite high heterogeneity. Adding CrCl to the Kt/V provided additional information for PO prediction in the largest datasets (LRT p<0.01 for FMC-LATAM and RRI).

**Conclusions:** In this international study of incident PD patients, Kt/V and CrCl were inversely associated with PO. CrCl provided extra information for PO prediction, suggesting that both CrCl and Kt/V could be used to monitor dialysis adequacy in PD patients.



Random effects meta-analysis of the associations between PO, CrCl, and Kt/V. Models adjusted for age, sex, PO binder use, and nPCR.

TH-PO167

**Serum Phosphorus and Kidney Disease Quality of Life (KDQoL) Among Maintenance Hemodialysis (HD) Patients**

Kamyar Kalantar-Zadeh,<sup>1</sup> Meijiao Zhou,<sup>2</sup> Linda Ficociello,<sup>2</sup> Claudy Mullon,<sup>2</sup> Michael S. Anger.<sup>2</sup> *<sup>1</sup>University of California Irvine, Orange, CA; <sup>2</sup>Fresenius Medical Care, Waltham, MA.*

**Background:** Dialysis patients experience lower health-related quality of life (QoL) compared to the general population. Previous studies have shown both high and low serum phosphorus (sP) concentrations were associated with lower physical component score of KDQoL among incident dialysis patients; however, the findings were not consistent. The aim of this study was to evaluate the associations between sP and KDQoL among HD patients on phosphate binders (PB).

**Methods:** Eligible patients were adults receiving in-center HD from Fresenius Kidney Care (FKC) facilities who filled out KDQoL-SF 36 during the year of 2019 and had available information on sP within 30 days prior to/on KDQoL survey completion date. Stratified random sampling were applied on 17,757 patients to select the analysis cohort defined by sP levels (<3.5 mg/dL, 3.5 to 5.5 mg/dL, >5.5 to 6.5 mg/dL, >6.5 to 7.5 mg/dL, >7.5 to 8.5 mg/dL, and >8.5 mg/dL), with 100 patients matched on age for each sP category. ANOVA and linear regression were used to examine the associations between sP and KDQoL. Higher scores represented better QoL. Age, gender, race, ethnicity, diabetes, CHF, cinacalcet use, BMI, vintage, Charlson Comorbidity Index (CCI), albumin, hemoglobin, calcium, iPTH, PB pills per day, total pills, TSAT, and spKt/V were considered in the multivariable analysis.

**Results:** Higher sP levels were associated with lower scores in KDQoL scales of symptoms/problems, burden of kidney disease, effects of kidney disease, and mental health (p<0.05; figure). After controlling for respective covariates, sP levels remained associated with symptoms/problems, burden of kidney disease, and effects of kidney disease.

**Conclusions:** Among HD patients who were prescribed PB monotherapy, higher serum phosphorus was associated with lower scores of KDQoL scales of symptoms/problems, burden of kidney disease, and effects of kidney disease. Prospective studies may be warranted to determine whether or to what extent QoL may improve with measures to lower sP.

**Funding:** Commercial Support - Fresenius Medical Care

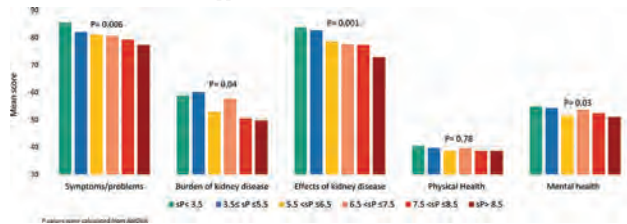

**TH-PO168**

**Associations Between Pill Burden and Kidney Disease Quality of Life (KDQoL) Among Patients on Maintenance Hemodialysis (HD) and the Impact of More Potent Phosphorus Binding Therapy**

**Kamyar Kalantar-Zadeh,<sup>1</sup> Linda Ficociello,<sup>2</sup> Meijiao Zhou,<sup>2</sup> Claudy Mullan,<sup>2</sup> Michael S. Anger.<sup>2</sup>** <sup>1</sup>University of California Irvine, Orange, CA; <sup>2</sup>Fresenius Medical Care, Waltham, MA.

**Background:** Patients who receive maintenance HD therapy have a high pill burden, which has been associated with lower health-related quality of life (HRQoL). We hypothesize that phosphate binder (PB) pill burden is associated with HRQoL in HD patients. Prior studies were conducted before more potent PB with lower pill burdens were frequently used.

**Methods:** This was a cross-sectional study of adult, in-center HD patients from Fresenius Kidney Care (FKC) facilities who filled out KDQoL-SF 36 in 2019, were prescribed PB monotherapy, with pill burden recorded within 30 days prior to/on KDQoL survey completion date (n=17,757). Stratified random sampling was used to select the study cohort (n=500) defined by PB pills/day (≤3, >3 to 6, >6 to 9, >9 to 12, and >12) and matched for age. As a sensitivity analysis, we examined the association between total pill burden (quartiles of total pills/day: ≤13, >13 to 18, >18 to 24, and >24) and KDQoL. Higher scores are indicative of higher quality of life. ANOVA, chi square, linear regression and logistic regression were utilized.

**Results:** PB pill burden was not significantly associated with KDQoL summary scores but was significantly associated with the *bothered by fluid restriction* question (Table). Total pill burden was associated with symptoms/problems (score of 84.1 to 78.2 from Q1 to Q4 of total pills), effects of kidney disease (80.0 to 75.6), physical health (41.4 to 36.1) and mental health (54.3 to 51.6), as well as the *bothered by fluid restriction* question (74.6 to 65.5).

**Conclusions:** Among HD patients, both higher PB pill burden and total daily pills were associated with higher likelihood to be bothered with fluid restriction. The additional fluid consumption needed to consume pills may need to be examined among patients who struggle with fluid restrictions.

**Funding:** Commercial Support - Fresenius Medical Care

	PBS3 (n=100)	3-PBS6 (n=100)	6-PBS9 (n=100)	9-PBS12 (n=100)	PB>12 (n=100)	Overall p value
Fluid restriction						
Mean score	78.0	71.5	75.5	71.3	65.3	0.04
Adjusted B (p value) <sup>1</sup>	0 (ref)	-7.7 (0.06)	2.9 (0.46)	-7.5 (0.07)	-12.2 (0.004)	0.04
% patients being bothered	51%	56%	55%	60%	73%	0.02
Adjusted OR (p value) <sup>2</sup>	1 (ref)	1.32 (0.34)	1.17 (0.39)	1.49 (0.18)	2.55 (0.002)	0.03

Considered covariates: age, gender, race, ethnicity, diabetes, CHF, cinacalcet use, BMI, vintage, Charlson Comorbidity Index (CCI), albumin, hemoglobin, calcium, iPTH, phosphorus, TSAT, and spKt/V.  
<sup>1</sup>Adjusted covariates: age, race, BMI and spKt/V  
<sup>2</sup>Adjusted covariates: age, race and BMI

**TH-PO169**

**Phosphate Homeostasis and Apparent Treatment Resistant Hypertension in CKD: The CRIC Study**

**Jing Chen,<sup>1,2</sup> Arnold B. Alper,<sup>1</sup> Halil K. Erol,<sup>1</sup> Siyi Geng,<sup>3,2</sup> Hua He,<sup>3,2</sup> Moh'd Sharshir,<sup>1</sup> Ismail Abubakar Ibrahim,<sup>1</sup> Suayp Oygen,<sup>1</sup> Joshua D. Bundy,<sup>3,2</sup> L. Lee Hamm,<sup>1,2</sup> Jiang He.<sup>3,2</sup>** <sup>1</sup>Tulane University School of Medicine, New Orleans, LA; <sup>2</sup>Tulane University Translational Science Institute, New Orleans, LA; <sup>3</sup>Tulane University School of Public Health and Tropical Medicine, New Orleans, LA.

**Background:** Abnormal phosphate (Pi) homeostasis is associated with vascular dysfunction. We studied the associations of Pi indices with apparent treatment resistant hypertension (ATRH) in CKD.

**Methods:** The CRIC Study enrolled 3939 CKD patients. 3556 without missing data were included in this analysis. ATRH was defined as SBP ≥140 or DBP ≥90 mm Hg while taking ≥3 BP medications or BP <140/90 mm Hg while taking ≥4 medications. Novel Pi overload index was calculated as [serum Pi x (urine Pi/Cr ratio) x alkaline phosphatase (a marker reflecting bone turnover)] to synergistically reflect the effect of high Pi intake on serum Pi, kidneys, and bones. Logistic regression models were used to examine the associations of baseline Pi overload index, serum Pi, FGF23, and PTH with ATRH.

**Results:** The Pi indices are significantly associated with ATRH (Table). The associations remain similar after adjusting for FGF23.

**Conclusions:** These data suggest that Pi overload is independently associated with ATRH. Maintaining normal Pi homeostasis may improve BP control.

**Funding:** NIDDK Support, Other NIH Support - National Institute of General Medical Sciences (NIGMS)

Multivariable-Adjusted Odds Ratios of ATRH (95% CI) Associated with Phosphate Indices

Quartile	ATRH
Phosphate Overload Index	
≤123	Reference
>123 to 177	1.03 (0.81, 1.31)
>177 to 262	1.26 (0.99, 1.61)
>262	1.63 (1.27, 2.10)
Serum Phosphate, mg/dL	
< 3.3	Reference
3.3 to < 3.7	1.07 (0.83, 1.37)
3.7 to < 4.2	1.11 (0.87, 1.41)
≥ 4.2	1.37 (1.06, 1.78)
FGF23, RTU/ml	
< 95.8	Reference
95.8 to < 145.5	1.07 (0.83, 1.38)
145.5 to < 239.2	1.33 (1.02, 1.73)
≥ 239.2	1.29 (0.97, 1.72)
Total Parathyroid Hormone, pg/mL	
< 35.0	Reference
35.0 to < 54.0	1.28 (0.99, 1.66)
54.0 to < 89.6	1.47 (1.14, 1.88)
≥ 89.6	1.70 (1.30, 2.23)

Adjusted for age, sex, race, BMI, physical activity, drinking, 24-h urine sodium, eGFR, diuretics, NSAIDs, HbA1c, IL-6, TNF-α, and TGF-β.

**TH-PO170**

**The Binder That Got Us in a Bind, Sevelamer Crystal Associated Bowel Necrosis: A Case Report**

**Sarah Hryzak, Arun Janakiraman, Sidney M. Kobrin, Abdallah Sassine Geara, Sandeep Aggarwal.** University of Pennsylvania, Philadelphia, PA.

**Introduction:** Crystal associated colonic necrosis is a rare iatrogenic complication most reported with kayexalate/sorbitol complex use. Sevelamer is a commonly prescribed and well tolerated phosphate binder used in patient's with advanced chronic kidney disease (CKD) for hyperphosphatemia. We report a case of biopsy proven colonic necrosis associated with sevelamer crystals.

**Case Description:** A 67-year-old male with history of IgA nephropathy now end stage renal disease (ESRD) status post failed cadaveric kidney transplant, atrial fibrillation, AAA s/p endovascular repair admitted with abdominal pain, nausea and vomiting found to be in septic shock. Imaging revealed pneumoperitoneum and sigmoid colon perforation. Work up for bowel perforation included evaluation of cardiac/embolic source with transthoracic echocardiogram with no intracardiac thrombi/vegetations. Abdominal vascular imaging showed intact AAA endograft without any endoleaks, dissection or mural thrombi. Work up for infectious, hypercoagulable and autoimmune causes for colitis were unrevealing. Patient underwent exploratory laparotomy with left hemi-colectomy. Anatomical pathology revealed crystalline resin within lumen and stoma ulceration (figure 1) compatible with sevelamer crystals, no evidence of viral inclusions and viable proximal resection margins.

**Discussion:** Colonic necrosis is more commonly known to be associated with various etiologies including cardio-embolic sources, underlying vascular disease, infectious processes and autoimmune conditions. Crystal associated colonic necrosis is a rarely reported cause. Our case report reveals a possible association between sevelamer administration and colonic injury. Large scale correlation studies need to be done to further explore the clinical pathological relationship between sevelamer and colonic necrosis.

**Key: TH - Thursday; FR - Friday; SA - Saturday; OR - Oral; PO - Poster; PUB - Publication Only**

**Underline represents presenting author.**

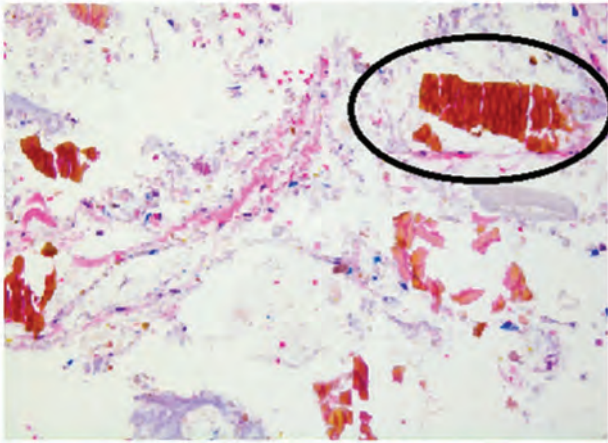

Figure 1. Colonic mucosal ulceration with an associated sevelamer crystal

### TH-PO171

#### Identification and Characterization of Mineralization Mediators Derived From Adrenal Glands

Shruti Bhargava,<sup>1,2</sup> Vera Jankowski,<sup>1</sup> Jonas Laget,<sup>3</sup> Bernard Jover,<sup>3</sup> Joachim Jankowski,<sup>1,2</sup> <sup>1</sup>Universitätsklinikum Aachen Institut für Molekulare Herz Kreislauf Forschung, Aachen, Germany; <sup>2</sup>Universiteit Maastricht Cardiovascular Research Institute Maastricht, Maastricht, Netherlands; <sup>3</sup>RD Nephrologie, Montpellier, France.

**Background:** Mineralization of vascular tissue is a common symptom of chronic kidney disease and is accompanied by a reduction in bone mineralization and density. In the current study, we investigated a novel systemic regulation of vascular mineralization processes by adrenal glands.

**Methods:** Bovine adrenal gland were homogenized and separated by chromatographic fractionation. The resulting fractions were assessed in cells, thoracic aortic rings and vitamin D3-nicotine renal failure rat model to study their effects on vascular and bone mineralization processes. Potential mediators were identified by mass spectrometry in complement with pertinent databases.

**Results:** We identified a novel peptide from bovine adrenal glands that inhibits transdifferentiation of aortic smooth muscle cells into osteoblast like cells, thereby hindering vascular mineralization. This peptide named 'Calcification Blocking Factor' (CBF) based on its protective effects against vascular mineralization is released from chromogranin A through enzymatic cleavage by calpain 1 and kallikrein. CBF reduced calcium content of aortic smooth muscle cells and thoracic aortic rings treated under calcifying culture conditions and in aortas from vitamin D3-nicotine (VDN) animals. CBF prevented aortic smooth muscle cell transdifferentiation into osteoblast-like cells in the vessel wall via the PIT-1 sodium-dependent phosphate transporter, inhibiting NF-κB activation and its downstream BMP2/p-SMAD signaling. CBF treated VDN animals showed a significantly lower pulse pressure which is a marker of arterial stiffness. Consistent with our preclinical results, concentration of CBF was found to be significantly reduced in patients with chronic kidney disease who are predisposed to vascular mineralization. Smaller fragments of the 19 aa peptide were analyzed to identify the active site of CBF.

**Conclusions:** In conclusion, we identified a novel peptide derived from adrenal glands which modulates vascular mineralization. Additionally, we identified smaller peptides that reduces vascular calcification by inhibiting smooth muscle cell transdifferentiation. These findings suggest a novel function of adrenal glands in calcium mineralization.

**Funding:** Government Support - Non-U.S.

### TH-PO172

#### Phosphate Inhibits Calcium-Sensing Receptor Expressed Endogenously in TT Cells

Khaleda A. Alghamdi, Sheherzad Salman, Donald T. Ward. *The University of Manchester Faculty of Biology Medicine and Health, Manchester, United Kingdom.*

**Background:** Calcium-sensing receptor (CaR) is the key controller of parathyroid hormone (PTH) secretion and extracellular calcium homeostasis. Hyperphosphataemia increases PTH secretion and we reported recently that pathophysiologic phosphate (Pi) concentrations can attenuate CaR activity directly in transfected HEK-293 cells and can increase PTH secretion from human and murine parathyroid cells (Centeno *et al.*, 2019, Nature Communications).

**Methods:** This was investigated further using thyroidal C cell-derived TT cells (ATCC), which express CaR endogenously. Intracellular Ca<sup>2+</sup> (Ca<sup>2+</sup>) mobilisation was assayed by epifluorescence microscopy, protein expression by immunoblotting and calcitonin secretion by ELISA.

**Results:** Co-stimulation of TT cells with the (CaR-activating) calcimimetic R568 (1µM) and spermine (1mM) elicited robust Ca<sup>2+</sup> mobilisation, that was inhibited 33±4% (P<0.001) by 2mM (pathophysiologic) Pi-containing buffer vs 0.8mM Pi control. In contrast, raising Pi concentration was without effect on carbachol-induced Ca<sup>2+</sup> mobilisation (acting via muscarinic receptors). Also, 1.2mM (high) sulphate elicited a similar CaR inhibition as for Pi (-28±16%; P<0.05 vs 0.3mM control). Next it was found that CaR-mediated stimulation of the TT cells with 1µM R568 & 1mM spermine (in 2mM Ca<sup>2+</sup> and 0.8mM Pi) increased calcitonin secretion, as expected, whereas the same stimulation in 2mM Pi (in the presence of 2.2mM Ca<sup>2+</sup> to correct for any reduction in free Ca<sup>2+</sup>) significantly blunted this response (P<0.05). CaR protein expression was confirmed in the TT cells by immunoblotting. However, CaR abundance was unaffected by overnight culture in media containing 2mM Pi (vs 0.8mM control) whereas CaR stimulation with 1µM R568 & 1mM spermine (in 0.8mM Pi) decreased CaR abundance by 20±4% (P<0.05). Therefore, sustained exposure to high Pi did not produce CaR downregulation at least in the thyroid-derived TT cells.

**Conclusions:** Therefore, pathophysiologic Pi treatment inhibits endogenous CaR-induced signalling and calcitonin secretion from thyroidal TT cells but without affecting CaR abundance. These results further support the idea that the CaR represents a mineral sensor, at which Pi acts directly as a non-competitive antagonist to limit CaR-induced suppression of PTH secretion.

**Funding:** Government Support - Non-U.S.

### TH-PO173

#### PTH Independent Hypercalcemia, Easily Missed Diagnosis: Case Report of Vitamin A Toxicity

Uzma Malik, Abhinaya Sridhar, Sanjeev Gupta, Savneek S. Chugh, Amol Mittal, Shruti Kore. *Westchester Medical Center, Valhalla, NY.*

**Introduction:** The first step in the evaluation of hypercalcemia is establishing the role of PTH in its pathogenesis. There are many causes of PTH independent hypercalcemia; Vitamin A toxicity is a rare cause of PTH-independent hypercalcemia.

**Case Description:** 51 years old male with history of well controlled diabetes, HIV with a suppressed viral load and CKD stage 2 was found to have hypercalcemia at a routine nephrology clinic visit. Patient reported no symptoms of hypercalcemia or decreased urine output. He also denied any weight loss, night sweats, decreased appetite. His vital signs and physical exam were unremarkable. Routine blood work was notable for hypercalcemia 10.5 mg/dL. Repeat testing 2 months later showed persistent hypercalcemia to 10.8 mg/dL. Initial work up revealed 25OH vitamin d 34; PTH 30pg/ml and phosphorus 3.3 mg/dL suggestive of PTH-independent hypercalcemia. Urinalysis was notable for 2+ glucose, no proteinuria. Urine protein to creatinine ratio was 62 mg/g. Given unclear cause of PTH independent hypercalcemia at this time, Vitamin A level was checked which was elevated to 94.6 mg/dL. However, patient denied excessive intake of vitamin A containing food. Patient was encouraged to hydrate well and was provided list of food items high in vitamin A and advised to avoid them. Repeat testing 3 months later showed Cr 1.34, Ca 9.9 and Vitamin A levels within normal limits.

**Discussion:** The tolerable upper daily intake level of vitamin A is approximately 3,000 µg RAE. However, Vitamin A toxicity can occur at what is considered to be "safe doses" (700 to 900 µg RAE) from dietary sources and supplementation. The mechanism of vitamin A-induced hypercalcemia is poorly understood. It is hypothesized to be secondary to increased osteoclastic activity, suppression of osteoblastic activity, and hormonal dysregulation of calcium homeostasis of parathyroid hormone and vitamin D. In setting of hypercalcemia and suppressed PTH, Vitamin A toxicity should be considered in the diagnostic workup along with malignancy, bone metastasis, vitamin D toxicity, granulomatous disease and immobility. A thorough dietary history and serum retinol levels should be checked. Treatment involves withdrawal of vitamin A sources and supportive care.

### TH-PO175

#### Successful Story of Conversion of Cinacalcet to Etelcalcetide During the COVID-19 Pandemic

Tarek A. Fouda, Abdullah I. Hamad, Tarek A. Ghonimi, Anees J. Alomari, Sahar Aly, Rania A. Ibrahim, Asma Abdelmagid, Mohed Y. Taha, Hassan A. Al-Malki. *Hamad Medical Corporation, Doha, Qatar.*

**Background:** Hamad general Hospital is the main provider of (HD) in Qatar with 932 patients. We established a team from dialysis nurses under direct nephrologist supervision for management of (MBD). We introduced Etelcalcetide in Qatar in May 2021 for HD patients unable to tolerate oral cinacalcet (GIT symptoms) especially during the COVID-19 pandemic where patients had difficulties dispensing medicine and have proper follow up

**Methods:** Our study followed patients from May 2021 till March 2022. We included HD for >6 months patients with (HPT) despite being on cinacalcet therapy. Patients recruited from all HD centers (4) in Qatar. Data collected through electronic medical records.

**Results:** 50 patients fulfilled inclusion criteria and were included in study period. Median (PTH) on cinacalcet was 946 pg/ml (Mean 1123pg/ml). After conversion to Etelcalcetide, PTH median level had significant improvement to 623 pg/ml (mean 749 pg/ml). Average improvement in PTH level was 46% (36% of patients with 50% improvement and 48% of patients with >50% improvement). The Median dose for Etelcalcetide was 21.5mg/week. (Patients with within our PTH target range (150-500pg/ml) improved from 8% in May 2021 (on cinacalcet) to 38% in March 2022 (on Etelcalcetide) p=0.0003) while patients with PTH above 800 decreased from 50% to 20% for the same period (p=0.001).

Reasons for conversion from Cinacalcet to Etelcalcetide were noncompliance due to GIT side effects (with resistant elevation of PTH despite optimal dose (90% of patients) also due to the COVID-19 pandemic and its effect in following medication in the face of shortage of our nurses and physician.

**Conclusions:** Our project to optimize MBD management in HD patients with uncontrolled HPT not tolerating Cinacalcet by utilizing Etelcalcetide showed significant improvement in PTH outcomes. It was well tolerated with no reported significant side effects. Utilizing MBD team proven to be a wise decision during the peak of the COVID-19 pandemic with physician shortage and service disturbances.

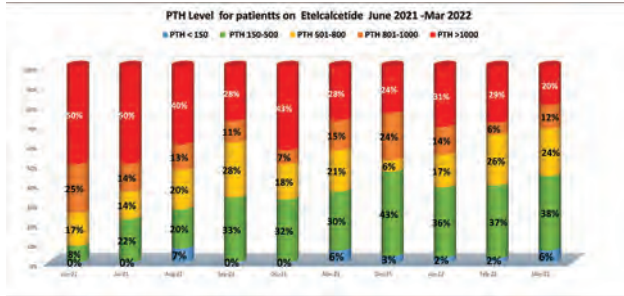

**TH-PO176**

**A Rare Case of Hypercalcemia in Primary Hypoparathyroidism due to Multiple Myeloma**

Muhammad Khalid Tahir, Arun U. Mahtani, Angela Grigos, Farhang Ebrahimi. *Richmond University Medical Center, Staten Island, NY.*

**Introduction:** - Incidence and prevalence of primary hypoparathyroidism (PHPT) in the United States: 0.08 and 37 per 100,000 person-years, respectively.<sup>1</sup> Seen in females above 45 years. - The most common cause of PHPT is iatrogenic.<sup>2</sup> - Hypercalcemia can also occur iatrogenically due to supplementation.<sup>3</sup> - Several cases linking primary hyperparathyroidism and multiple myeloma (MM) have been reported.<sup>4</sup> - To the author's knowledge, this is the first case of a patient having PHPT with concomitant MM.

**Case Description:** - A 50-year-old-male with a history of chronic kidney disease stage 3 (CKD stage 3), primary hypoparathyroidism since 1997 on calcium and calcitriol supplementation, and gastroesophageal reflux disease (GERD) presented with: lower back pain (LBP), increased urinary frequency, and chronic cough for 1 month. - Physical examination: LBP exacerbated with movement. - Labs: serum calcium of 17.5 mg/dL, serum sodium of 129 mmol/L, serum potassium of 5.2 mmol/L, total protein of 10.4 g/dL, albumin of 4 g/dL, and intact PTH of < 6.3 pg/mL. - Free Kappa/Lambda light chains: 9.4/1369.7. Elevated IgA levels: 3138.4. - SPECT showed no suspicious areas of MM. - Bone marrow biopsy: 41% of monoclonal intracellular lambda positive plasma cell (kappa to lambda ratio: < 0.01). Positive for cytoplasmic heavy chain IgA, partially positive for cluster of differentiation (CD)117, aberrantly positive for CD27, and negative for CD56. - Treatment: intravenous fluids, calcitonin, pamidronate, and chemotherapy.

**Discussion:** - 28% of patients with MM are hypercalcemic.<sup>5</sup> - PTH may be an inducer of MM through signaling pathways involving IL-6.<sup>6</sup> - First reported case of primary hypoparathyroidism in a patient with concomitant MM. - Large-scale studies needed to understand the relationship between PTH and MM. - Etiology of hypercalcemia in primary hypoparathyroidism should always be investigated.

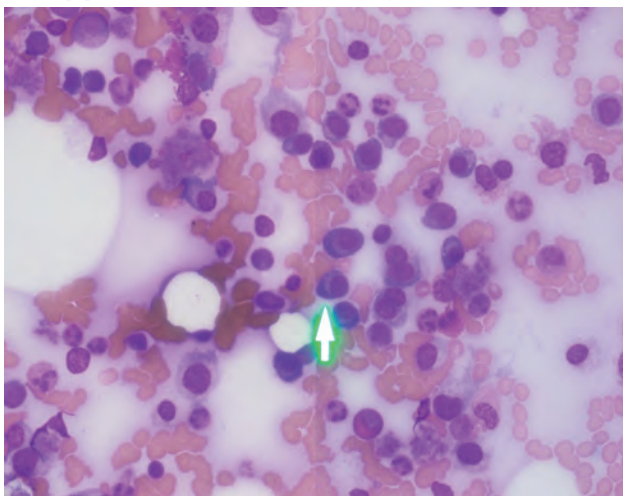

Bone marrow biopsy showing plasma cells

**TH-PO177**

**Klotho Protects Diabetic Nephropathy via Inhibiting Orai1 and TRPC5/6 Channels in Podocytes**

Ji-Hee Kim,<sup>1,3</sup> Bao T. Dang,<sup>1,3</sup> Kyu-Hee Hwang,<sup>1,3</sup> Nghia T. Pham,<sup>1,3</sup> Minseob Eom,<sup>2</sup> Seung-Kuy Cha.<sup>1,3</sup> <sup>1</sup>Department of Physiology, Yonsei University Wonju College of Medicine, Wonju, Republic of Korea; <sup>2</sup>Department of Pathology, Yonsei University Wonju College of Medicine, Wonju, Republic of Korea; <sup>3</sup>Mitohormesis Research Center, Yonsei University Wonju College of Medicine, Wonju, Republic of Korea.

**Background:** Klotho protein is predominantly produced in the kidney, where it regulates multiple renal ion channels to protect the kidney filter and renal diseases. Podocytes play a vital role in kidney filter function and are primary pathologic target for diabetic nephropathy (DN). Perturbation of Ca<sup>2+</sup> signaling has been implicated in podocyte dysfunction leading to DN. Here we demonstrated that Klotho ameliorates podocyte injury by stabilizing Orai1 and TRPC5/6 channel-mediated Ca<sup>2+</sup> signaling to prevent DN.

**Methods:** Type 2 diabetic *db/db* mice received *i.p.* injections of Klotho protein three times a week. The albumin/creatinine ratio, proteins & mRNA levels were analyzed at 11, 15 and 19-week-old *db/db* mice and *db/m* was used as a control group. Live-cell imaging and immunocytochemistry were performed in immortalized mouse podocytes.

**Results:** In a type 2 diabetic *db/db* mouse model, Klotho and synaptopodin were downregulated, while Orai1, TRPC5, and TRPC6 were overexpressed in early and late periods, respectively. Soluble Klotho suppressed Orai1- and TRPC5/6-mediated Ca<sup>2+</sup> entry in mouse cultured podocytes via inhibiting growth factors and/or insulin signaling. Mechanistically, soluble Klotho reduced cell surface abundance of Orai1 and TRPC5/6, but not TRPC3 by suppressing phosphoinositide-3-kinase-dependent trafficking of these channels. In addition, soluble Klotho downregulated protein expression of Orai1 and TRPC6 by inhibiting growth factor-driven SGK1 activation. Functionally exaggerated actin remodeling by Orai1 and TRPC6 activation was ameliorated by soluble Klotho. Notably, administration of Klotho protein in *db/db* mice suppressed phosphorylation of SGK1 and rescued dissolution of synaptopodin and WT-1. Finally, Klotho ameliorated podocyte foot process disruption and proteinuria in *db/db* mice.

**Conclusions:** Taken together, our results suggest that Klotho protects proteinuria and podocyte actin cytoskeletal remodeling through stabilizing Ca<sup>2+</sup> signaling mediated by Orai1 and TRPC5/6, which provides a new potential therapeutic strategy for the treatment of DN.

**Funding:** Government Support - Non-U.S.

**TH-PO178**

**The Combination of Empagliflozin and Atrasentan on Top of RAS Blockade Ameliorates Cardiorenal Syndrome in the *db/db* Type 2 Diabetic Mouse Model**

Ander Vergara,<sup>1,2</sup> Conxita Jacobs Cachá,<sup>1</sup> Carmen Llorens Cebrià,<sup>1</sup> Pamela Domínguez Báez,<sup>1</sup> Nerea Martos,<sup>1</sup> Irene Martínez Díaz,<sup>1</sup> Sheila Bermejo,<sup>1,2</sup> Michael P. Pieper,<sup>3</sup> Begoña Benito,<sup>1,2</sup> Maria Jose Soler.<sup>1,2</sup> <sup>1</sup>Nephrology and Renal Transplant Research Group <sup>1</sup>Vall d'Hebron Institut de Recerca, Barcelona, Spain; <sup>2</sup>Hospital Universitari Vall d'Hebron, Barcelona, Spain; <sup>3</sup>Boehringer Ingelheim Pharma GmbH & Co KG, Biberach an der Riß, Germany.

**Background:** Sodium-glucose cotransporter 2 inhibitors(SGLT2i) prevent cardiovascular events in diabetic patients. Moreover, their diuretic effect could attenuate the adverse events of endothelin receptor antagonists(ERAs), which have also shown beneficial effects in diabetes. The present study aimed to evaluate the cardiorenal protective effects of the SGLT2i, ERAs and ramipril combination vs treatment with ramipril alone in the *db/db* mouse.

**Methods:** Twelve weeks old *db/db* mice were treated for 8 weeks with different combinations of an SGLT2i(empagliflozin,10 mg/Kg/day), an ERA (atrasentan, 7 mg/Kg/day) and a renin-angiotensin system(RAS) blocker(ramipril,8 mg/Kg/day). Vehicle-treated diabetic and non-diabetic mice were included as controls. During the experiment, blood pressure(BP), glomerular filtration rate(GFR) and echocardiographic parameters were measured. Kidney and heart were collected at the end for histological studies.

**Results:** The triple therapy with empagliflozin, atrasentan and ramipril was superior to ramipril alone in reducing BP, preventing diabetic hyperfiltration (214µL/100g/min reduction in GFR vs 96µL/100g/min increase in non-treated *db/db*, *p*=0.040) and improving echocardiographic parameters of diastolic dysfunction, including left atrium diameter and isovolumetric relaxation time(Figure 1). Moreover, the combined therapy offered protection against diabetic injury in the kidney and heart, decreasing glomerular mesangial matrix, restoring podocyte density, and reducing both left ventricle(LV) cardiomyocyte hypertrophy (125µm<sup>2</sup> area vs 142µm<sup>2</sup> in non-treated *db/db*, *p*=0.032) and LV collagen deposition(Figure 1).

**Conclusions:** In experimental diabetes, combined therapy of ramipril, empagliflozin and atrasentan promotes both heart and kidney protective effects that outweigh the beneficial effects of ramipril alone.

**Funding:** Commercial Support - Boehringer Ingelheim, Government Support - Non-U.S.

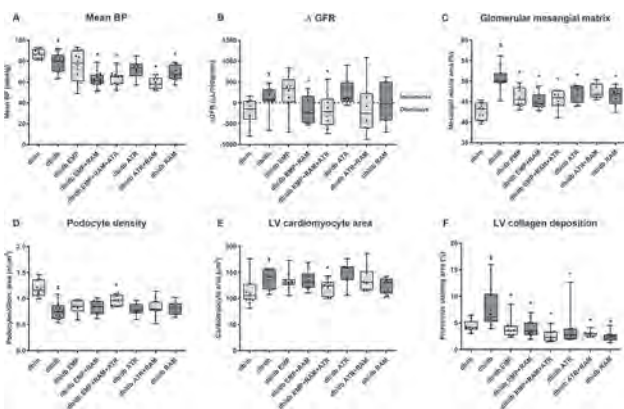

TH-PO179

The Characteristics and Mechanism of Cell Senescence in Patients With Diabetic Kidney Disease

Ying Zhang,<sup>1,2</sup> Xiaodong Zhu,<sup>1,2</sup> Xiaoliang Zhang,<sup>1,2</sup> Yu Zhao.<sup>1,2</sup> <sup>1</sup>Southeast University Zhongda Hospital, Nanjing, China; <sup>2</sup>Southeast University Medical College, Nanjing, China.

**Background:** Cellular senescence commonly occurs in renal innate cells of diabetic kidney disease (DKD) and autophagy may be involved. However, the features of senescent cells in different pathological stages of DKD, as well as the driving force behind cell senescence remain unknown. The study aims to investigate the characteristics of cell senescence in renal tissue during different pathological stages of DKD and their relationship with renal function and the role of autophagy in it.

**Methods:** Fifty DKD patients diagnosed by renal biopsy were divided into I IIa IIb III IV classes according to the pathologic typing. The other six normal kidney specimens taken from patients with renal trauma or tumor were as the control group. Serum creatinine and proteinuria were collected. Pathological changes in kidney were detected by PAS staining, and the expression of senescence marker p21 was demonstrated by immunohistochemistry. DKD rats were established by intraperitoneal injection with streptozotocin (STZ) and sacrificed respectively at 14w. HK-2 cells were cultured with 25mM glucose with or without autophagy inhibitor (chloroquine (CQ)) and activator (rapamycin). The expressions of LC3, p62 (autophagy proteins) and p53, p21 (senescence markers) were detected by immunohistochemistry and Western Blot.

**Results:** In kidney biopsies, the p21 expression was increased in interstitium and tubules and tightly associated with disease progression (p<0.05), which was proportional to the degree of deterioration of renal function. Similar trends were also observed in the levels of p21, p53, p62 and LC3 in DKD groups (p<0.05). Electronic microscope showed an increase in autophagosomes in the renal tubules of DKD rats. HK-2 cells treated with high glucose exhibited increased expression of p21, p53, p62 and LC3 (p<0.05). CQ elevated p21 and p53 compared to the high glucose group, whereas opposite trend was observed in the rapamycin treatment (p<0.05).

**Conclusions:** Our study demonstrated a positive correlation between cell senescence and progression of DKD, and autophagy attenuated the high-glucose-mediated renal tubule senescence.

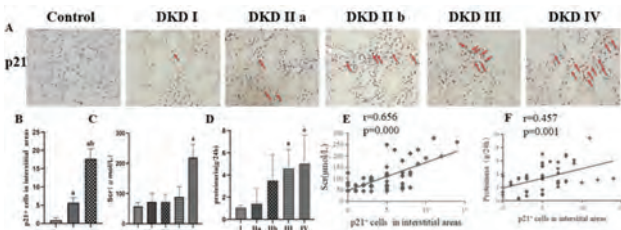

Fig 1. The expression of p21 and its associations with renal function in DKD patients. A: Immunohistochemistry of p21 (red arrows) (×400, bar = 50μm). B-D: Quantification of p21 and measurement of serum creatinine or proteinuria at different pathological stages in DKD. E-F: Analysis of the correlation between p21 and serum creatinine or proteinuria. The data are presented as the mean ± SD (n = 6 per group). a=0.05 vs. control, b=0.05 vs. I = IIa+IIb

TH-PO180

Senolytics, Dasatinib Plus Quercetin, Improve Kidney Function and Reduce Inflammation in Murine Diabetic Kidney Disease

Xiaohui Bian,<sup>2</sup> Zachary K. Snow,<sup>2</sup> Anastasia L. Smith,<sup>2</sup> Caroline J. Skaff,<sup>2</sup> Khaled Mosaad Elhousseiny,<sup>2</sup> Yi Zhu,<sup>3</sup> Tamara Tchkonja,<sup>3</sup> Seo Rin Kim,<sup>3</sup> James L. Kirkland,<sup>3</sup> Lilach O. Lerman,<sup>3</sup> LaTonya J. Hickson.<sup>1</sup> Mayo Translational and Regenerative Nephrology Research Laboratory <sup>1</sup>Mayo Clinic in Florida, Jacksonville, FL; <sup>2</sup>Shengjing Hospital of China Medical University Department of Nephrology, Shenyang, China; <sup>3</sup>Mayo Clinic Minnesota, Rochester, MN.

**Background:** Senolytic agents, dasatinib plus quercetin (D+Q), reduced systemic inflammation, macrophage infiltration, and senescent cell burden in adipose tissue in our pilot study of human participants with diabetic kidney disease (DKD). We hypothesized that D+Q would attenuate kidney injury and inflammation in a murine model of DKD.

**Methods:** Twelve-week-old male C57BL/6 mice were injected with 50 mg/kg/d STZ i.p. for 5 (+3) consecutive days (Figure). Mice with fasting glucose >250 mg/dL at day 100 were randomized to either D+Q (5 and 50 mg/kg, respectively) or vehicle gavage daily for 5 days and euthanized 20 days later. Kidney injury (Mac-2, KIM-1), inflammation (MCP-1, IL-6, IL-1β, TNFα), profibrotic markers (TGFβ1, fibronectin), cellular senescence (p16), and geroprotective factors (α-Klotho, Sirt-1) were examined by qPCR, and kidney function by serum creatinine. In vitro, we assessed the response to D+Q in renal tubular epithelial cells (HK2) injured by high glucose and TGF-β1.

**Results:** Oral D+Q improved kidney function and decreased kidney injury, profibrotic factors, and senescence marker p16 vs. vehicle-treated mice. In addition, pro-inflammatory (senescence-associated secretory proteins) kidney makers were reduced following D+Q. Finally, both α-Klotho and Sirt-1 increased in DKD tissue *in vivo* and HK2 cells *in vitro* after D+Q.

**Conclusions:** A “hit and run” treatment with D+Q can attenuate murine DKD injury by altering the inflammatory landscape, reducing senescent cell abundance, and restoring geroprotective factors. D+Q might represent a novel therapeutic strategy in DKD.

**Funding:** NIDDK Support

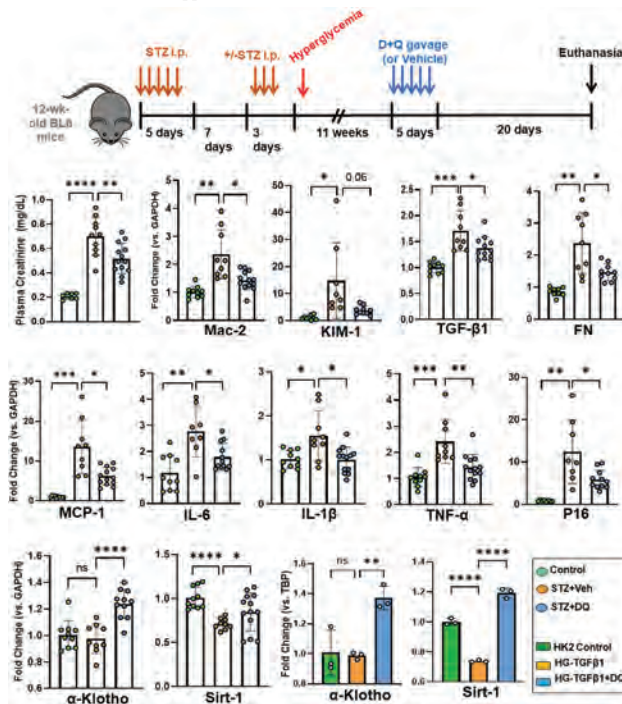

TH-PO181

Kidney Tubule Specific AMPK α1 Knockout Abolishes Female Protection From Diabetes and Affects Amino Acid Metabolism in Diabetic Mice

Hak Joo Lee,<sup>1,2</sup> Jingli Gao,<sup>1</sup> Liang Min,<sup>1</sup> Hongping Ye,<sup>1</sup> Anthony J. Franzone,<sup>1</sup> Goutam Ghosh-Choudhury,<sup>1,2</sup> Balakuntalam S. Kasinath,<sup>1,2</sup> Kumar Sharma.<sup>1,2</sup> Center for Precision Medicine <sup>1</sup>The University of Texas Health Science Center at San Antonio, San Antonio, TX; <sup>2</sup>South Texas Veterans Health Care System, San Antonio, TX.

**Background:** Reduced kidney AMPK activity is associated with progression of chronic kidney disease (CKD) which is ameliorated by AMPK stimulation in male mice, whereas female mice resist CKD from obesity and diabetes. Amino acids have been implicated in CKD but their mechanistic role is unclear. We hypothesized that kidney tubule specific deletion of AMPK catalytic α1 subunit abolishes female protection and dysregulates amino acid metabolism in diabetic mice.

**Methods:** 3-4 month old kidney specific AMPK  $\alpha 1$  knockout (KO) male and female mice (n=6-9 per group) were placed on normal fat diet or high fat diet (HFD) for 1 month, after which HFD groups received a low dose of streptozotocin. Urinary amino acids were measured by a targeted mass spectrometry platform.

**Results:** AMPK  $\alpha 1$  expression was significantly reduced in the kidney of AMPK  $\alpha 1$  KO mice without compensation by AMPK  $\alpha 2$ . Diabetes induced similar degree of hypertension and albuminuria in male WT and AMPK  $\alpha 1$  KO mice. Female WT mice resisted diabetes-induced hypertension and albuminuria. In contrast, albuminuria and systolic blood pressure were elevated in female diabetic AMPK  $\alpha 1$  KO mice. Diabetes increased urinary lysine level in male WT and AMPK  $\alpha 1$  KO mice. Diabetes-increased urinary lysine level was not observed in female WT mice, but it was increased in female diabetic AMPK  $\alpha 1$  KO mice. Urinary lysine level correlated with diabetes-induced albuminuria in male (p<0.001) and female (p<0.05) mice.

**Conclusions:** Female protection against diabetes is abolished in kidney tubule specific AMPK  $\alpha 1$  KO mice. Our data indicate that AMPK plays a pivotal role in female protection and regulates lysine metabolism in diabetic mice. AMPK could be used for a therapeutic target of diabetes-induced kidney injury and dysfunction of lysine homeostasis.

#### TH-PO182

##### Insulin Resistance Deregulates Immune Functions in the Collecting Duct That May Increase Urinary Tract Infection Risk

Laura Schwartz,<sup>1</sup> Vidhi Tyagi,<sup>1</sup> Kristin Bender,<sup>1</sup> John D. Spencer.<sup>1,2</sup> <sup>1</sup>Abigail Wexner Research Institute at Nationwide Children's Hospital, Columbus, OH; <sup>2</sup>The Ohio State University College of Medicine, Columbus, OH.

**Background:** Type 2 diabetes affects 10% of the population. Among comorbidities linked to diabetes is increased urinary tract infection (UTI) risk. The factors that increase UTI susceptibility remain unknown. Previously, we showed insulin resistance and disrupted insulin receptor signaling in kidney collecting ducts (CD) and intercalated cells (IC) increases UTI risk. Here, we assess how adipose-derived cytokines impact CD insulin sensitivity, uropathogenic *E.coli* (UPEC) susceptibility, and UTI defenses *in vitro*. To validate these effects *in vivo*, we profile the transcriptomes of IC and principal cells (PC) from obese, insulin resistant male and female mice.

**Methods:** To induce insulin resistance (IR) *in vitro*, mouse and human CD cells were cultured with adipokines or in hypoxic conditions followed by a 1-hour treatment with insulin. Western blotting evaluated insulin signaling and UTI defense targets. To determine if IR affects UTI susceptibility, UPEC attachment and invasion assays assessed were performed on CD cells cultured in IR conditions. To assess the effects of IR on CD immune defenses *in vivo*, we placed female and male C57BL/6 mice on a high-fat diet (HFD) or low-fat diet (LFD) for 8 weeks. We then enriched IC and PC populations from HFD and LFD mice using fluorescence activated cell sorting and performed RNA-seq analysis.

**Results:** TNF $\alpha$ , IL-1 $\beta$  and culturing CD cells in hypoxic conditions increased IR *in vitro*, as shown by decreased insulin receptor and PI3K/AKT activation following insulin treatment. Culturing cells in these conditions deregulated immune targets, including NF $\kappa$ B, MAP kinase, and integrated stress responses. They also resulted in greater UPEC attachment to and invasion of CD cells. Gene expression profiles between HFD- and LFD-fed murine IC and PC populations also revealed altered expression in innate immune pathways, including NF $\kappa$ B signaling and the integrated stress response.

**Conclusions:** These results suggest insulin resistance may directly impact immune mechanisms that shield the kidneys from UPEC. In part, this may be due to the production of adipose-derived circulating cytokines that dysregulate immune mechanisms like NF $\kappa$ B signaling and the integrated stress response. A deeper understanding of these mechanisms may provide insight into why people with insulin resistance or diabetes have increased UTI susceptibility.

**Funding:** NIDDK Support

#### TH-PO183

##### Spatial Mapping of Mesangial Cell Proliferative Signatures in the Diabetic Kidney

Ricardo Melo ferreira,<sup>1</sup> Mahla Asghari,<sup>1</sup> Carrie L. Phillips,<sup>1</sup> Samir V. Parikh,<sup>2</sup> Daria Barwinska,<sup>1</sup> Michael J. Ferkowicz,<sup>1</sup> Angela R. Sabo,<sup>1</sup> Timothy A. Sutton,<sup>1</sup> Ying-Hua Cheng,<sup>1</sup> Brad H. Rovin,<sup>2</sup> Tarek M. El-Achkar,<sup>1</sup> Pierre C. Dagher,<sup>1</sup> Katherine J. Kelly,<sup>1</sup> Michael T. Eadon.<sup>1</sup> KPMP <sup>1</sup>Indiana University School of Medicine, Indianapolis, IN; <sup>2</sup>The Ohio State University Wexner Medical Center, Columbus, OH.

**Background:** The renal mesangium undergoes adaptations in diabetic kidney disease (DKD). These changes include proliferation, hypertrophy, and mesangiolysis that ultimately lead to Kimmelstein-Wilson nodule formation. Using human reference nephrectomy and diabetic biopsy tissue, we sought to define the molecular transition of the mesangial cell (MC) as it undergoes these processes, including the coordinated signals arising from nearby degenerative podocytes and maladaptive glomerular capillary endothelial cells (GCECs).

**Methods:** We delineated the mRNA signature of renal mesangial cell adaptations in a merged KPMP / HubMAP snRNAseq atlas of reference and DKD specimens (>200,000 nuclei). The related signatures and cell neighborhoods in which they are expressed were localized with Seurat 3.2.3 to specific glomeruli within reference (N=6) and diabetic (N=10) kidney specimens using spatial transcriptomics. Spatial transcriptomic spots were selected based on glomerular cell type composition, and clustered based on the proportion of cell type signature, defining neighborhoods. Differential expression and pathway analysis further defined the signature of the neighborhoods.

**Results:** Transcriptome analysis revealed genes associated with MC fate in DKD. With the clustering analysis, we identified MC neighborhoods which included injured podocytes and maladaptive endothelial cells, more abundant in diabetic samples (p<0.05). Pathways enriched for those clusters are associated with morphology and development, and response to hypoxia. The trajectory of these molecular features was compared to histopathologic features (mesangial expansion, nodularity) within the specimens.

**Conclusions:** These studies suggest the existence of a temporal and spatial trajectory for mesangial cells in the progression of DKD, and describe the unique milieu of the diabetic glomeruli.

**Funding:** NIDDK Support

#### TH-PO184

##### Agnostic Mass Spectrometry Proteomics Identifies Glomerular Adipocyte Enhancer Binding Protein 1 (AEBP1) as a Novel Marker of Diabetic Kidney Disease

Sethu M. Madhavan,<sup>1</sup> John P. Shapiro,<sup>1</sup> Salem Almaani,<sup>1</sup> Anjali A. Satoskar,<sup>1</sup> Michael T. Eadon,<sup>2</sup> Tarek M. El-Achkar,<sup>2</sup> Pierre C. Dagher,<sup>2</sup> Brad H. Rovin,<sup>1</sup> Samir V. Parikh.<sup>1</sup> KPMP <sup>1</sup>The Ohio State University Wexner Medical Center, Columbus, OH; <sup>2</sup>Indiana University School of Medicine, Indianapolis, IN.

**Background:** Diabetic kidney disease (DKD) results from progressive glomerular inflammation and fibrosis frequently resulting in ESKD. Agnostic mass spectrometry (LC-MS/MS) proteomics was performed on kidney biopsies obtained from the Kidney Precision Medicine Project (KPMP) and potential biomarkers and molecular mediators of DKD were explored.

**Methods:** Frozen kidney biopsies with DKD (n=9) from the KPMP consortium and nephrectomy controls from OSU biorepository (n=4) were included. Biopsies were obtained from recruitment sites in the KPMP and histopathologic diagnoses were adjudicated by an expert committee in KPMP. Glomeruli and tubulointerstitium were isolated by laser capture microdissection and extracted protein was submitted for LC-MS/MS proteomics. Global normalization was performed by spectral counting. The glomerular proteome of DKD was compared to controls. Immunofluorescence microscopy and immunoperoxidase staining were performed in another cohort of DKD (n=5) from OSU biorepository. To determine specificity, proteomics comparison from other glomerular diseases (FSGS and MCD, n=13) was done.

**Results:** Glomerular AEBP1 was one of the most upregulated proteins in glomeruli of DKD compared to controls (4-fold, p=0.0008). AEBP1 was minimally expressed in healthy glomeruli but strongly stained by immunoperoxidase in DKD glomeruli. AEBP1 co-localized with nephrin and CD31 suggesting podocyte and endothelial expression in another cohort of diabetic glomeruli compared to controls. AEBP1 expression was similar to controls in FSGS and MCD.

**Conclusions:** We identified glomerular AEBP1 as a potential novel marker of DKD. AEBP1 has previously been shown to be induced by glucose, activates inflammatory mediators and associated with liver fibrosis in non-steatohepatitis. It has not been previously studied in kidney disease. Glomerular upregulation of AEBP1 in DKD and localization in podocytes and glomerular endothelial cells suggests its role in mediating glomerular inflammation and fibrosis in DKD. AEBP1 upregulation may be specific for DKD. The causal role of AEBP1 in the pathogenesis and progression of DKD will be further investigated within the KPMP consortium utilizing clinical and histology data and a multi-omic interrogation.

**Funding:** NIDDK Support

#### TH-PO185

##### The Evolving Role of the LXR/mTOR Signaling Axis in Diabetes-Induced Autophagy Alteration and Diabetic Kidney Disease

Sahar Alkhansa, Rachel Njeim, Foad N. Ziyadeh, Assaad Antoine Eid. American University of Beirut, Beirut, Lebanon.

**Background:** Diabetes is a metabolic disease that induces kidney injury and is considered the most common cause of end-stage kidney disease. It is well recognized that kidney cells depend on basal autophagy for survival and for conserving overall kidney integrity. New lines of research indicate that diabetes induces renal autophagy deregulation leading to kidney injury, yet the underlying mechanisms are not well elucidated. The mTOR complexes along with oxidative stress have emerged as potentially key players in mediating diabetes-induced autophagy imbalance. Alongside, the role of the Liver-X-Receptor (LXR), which is a nuclear receptor, has been also highlighted in diabetic kidney diseases (DKD). Nevertheless, the role of LXR in autophagy and its crosstalk with key mechanistic pathways in DKD remain to be identified. Herein, we investigate the role of the LXR/mTOR/Akt axis in autophagy and its possible link to podocyte injury in type 1 diabetes mellitus (T1DM).

**Methods:** T1DM was induced in 8-week-old C57BL/6J or FVB/NJ mice by streptozotocin (STZ) injection. Mice were treated with either LXR activator T0, mTORC1 inhibitor Rapamycin, mTORC2 inhibitor JR, or mTORC1/2 inhibitor PP242. Functional, histological, biochemical, and molecular parameters of the kidneys were assessed.

**Results:** Results show that T1DM induces autophagy deregulation which is accompanied by an increase in both mTORC1 and mTORC2 activity, a decrease in LXR expression, and an increase in the levels of superoxide anion generation through the NADPH oxidase 4 (Nox4) pathway. Inhibition of mTORC2 or mTORC1/2 restores the homeostatic functional renal levels by reducing proteinuria, restoring histological and phenotypical changes to near-normal levels, and inhibiting Nox4 expression. Of interest, these treatments ameliorate diabetes-induced autophagy homeostatic deregulation by

restoring the expression of LC3 and p62. Furthermore, activating LXR by T0 corrects the observed changes seen in the mTOR complexes, restores autophagy, and reverses diabetes-induced renal injury.

**Conclusions:** To our knowledge, this is the first study to provide evidence for a novel function of LXR/mTOR complexes in regulating autophagy in the onset of kidney disease in diabetes.

#### TH-PO186

##### Assessing the Influence of Sex on the CD1 Nephrectomized Streptozotocin-Induced Diabetic Kidney Disease Model

Ifeanyi K. Nmecha, Jackie Trink, Dan Zhang, Bo Gao, Melissa Macdonald, Joan C. Krepinsky. *McMaster University Faculty of Health Sciences, Hamilton, ON, Canada.*

**Background:** Diabetic kidney disease (DKD) is the leading cause of kidney failure in North America. DKD is characterized by a progressive increase in albuminuria, glomerular hypertrophy, expansion of the glomerular mesangium, thickening of the glomerular basement membrane, and tubulointerstitial fibrosis and atrophy. Recent studies have shown that sex and sex hormones are important factors to consider in the development and progression of DKD. Presently, the hallmarks of this disease have primarily been studied in male rodent models. Here we explored the influence of sex in the CD1 nephrectomized streptozotocin (STZ)-induced murine model.

**Methods:** To induce DKD, 8-week-old CD1 mice underwent a right nephrectomy. After 1 week of recovery, they were injected IP with 200mg/kg STZ and followed for 12 weeks. Outcomes included urinary albumin-to-creatinine ratio (ACR), blood pressure (BP), weight, kidney and glomerular hypertrophy and kidney pathology.

**Results:** STZ dose required reduction in females to 150mg/kg due to high initial mortality. However, females often required reinjection after 2 weeks at 100mg/kg to induce hyperglycemia. Males had a greater decrease in endpoint weight and increase in BP. Both sexes developed comparable hyperglycemia, kidney hypertrophy and albuminuria, although ACR was more variable in females. Glomerular hypertrophy was more pronounced in male diabetics, as was basement membrane thickening. Serum TGFβ1 levels were increased only in females, which may be related to their known greater TGFβ1 production after puberty compared to male mice. However, urine TGFβ1 increased comparably in both sexes. Accumulation of profibrotic proteins fibronectin and collagens I, III, IV, and markers of T-cell and macrophage infiltration were also similar between sexes.

**Conclusions:** Female mice required a modification of the STZ protocol to maintain survival, but induce hyperglycemia. While somewhat more pronounced in male mice, both sexes developed typical characteristics of DKD. Future studies evaluating the potential of therapeutic interventions can thus be assessed in both sexes in this model of DKD.

**Funding:** Government Support - Non-U.S.

#### TH-PO187

##### Investigating the Role of Early B Cell Factor 1 (EBF1) in Maintaining the Integrity of the Glomerular Filtration Barrier

Darrell C. Andrews, Jessica L. Davis, Eoin Brennan, John Crean, Catherine Godson. *University College Dublin, Dublin, Ireland.*

**Background:** Diabetic kidney disease (DKD) is the leading cause of end stage renal disease (ESRD) and organ failure worldwide. Current therapies are inadequate. Proteinuria is a hallmark of DKD and the onset of progressive proteinuria is associated with disease progression and reflects loss of glomerular filtration barrier (GFB) integrity. Defining the underlying mechanisms that lead to a compromised GFB during the progression of DKD is key to developing effective therapeutic strategies. EBF1 was previously identified by our GWAS analysis in a case (individuals with T1DM) vs. control (individuals with T1DM and no evidence of renal disease 15 years post-diagnosis) approach as associated with macroalbuminuria and ESRD (DOI: 10.1681/ASN.2019030218), however the precise mechanisms underlying the function of this gene in the kidney remain elusive.

**Methods:** In order to investigate the functional role of EBF1 in the kidney we utilised primary human mesangial cells and iPSC derived organoid cultures.

**Results:** Our previous investigations in Tg(l-fabp:DBP:EGFP) zebrafish demonstrated that morpholino mediated knockdown of EBF1 resulted in the loss of an albumin-like fluorescent tracer protein from the circulation and the development of generalised edema in zebrafish larvae, suggesting compromised glomerular barrier integrity in the absence of EBF1 and supporting a role for this gene in kidney function. EBF1 expression was investigated during iPSC derived organoid development. EBF1 was found to be most highly expressed in stromal cell populations. To investigate the precise molecular mechanisms underlying the functional role of EBF1 in such populations bulk RNA sequencing analysis was used to map deregulated transcripts in EBF1 knockdown human primary mesangial cells vs control. EBF1 target genes were inferred using motif enrichment analysis.

**Conclusions:** These findings further support a role for EBF1 in maintaining the integrity of the glomerular barrier integrity.

**Funding:** Government Support - Non-U.S.

#### TH-PO188

##### Ferroptotic Tubular Cell Death Is Facilitated in Diabetic Nephropathy in Mice

Francesca Maremonti,<sup>1</sup> Wulf Tonnus,<sup>1</sup> Anne M. Brucker,<sup>1</sup> Nina Himmerkus,<sup>2</sup> Florian Gembardt,<sup>1</sup> Christian Hugo,<sup>1</sup> Andreas Linkermann.<sup>1</sup> <sup>1</sup>*Technical University Dresden, Dresden, Germany;* <sup>2</sup>*Christian-Albrechts-Universität zu Kiel, Kiel, Germany.*

**Background:** Glycaemic dysregulation associated with diabetes mellitus is the cause of diabetic nephropathy (DN). DN progression involves renal tubular necrosis and glomerulosclerosis. Our previous data suggest that tubular damage involves a regulated form of iron-catalyzed necrosis referred to as ferroptosis. GIP (glucose-dependent insulinotropic polypeptide) is an endogenous polypeptide hormone secreted by enteroendocrine K cells of the lower gut. Its receptor, GIPR (GIP receptor) is a G-coupled transmembrane receptor placed on the surface of pancreatic β-cells. GIPR dominant-negative transgenic mice (GIPR<sup>dn</sup>) are the first murine model that exhibits typical late complications of diabetes such as DN and atherosclerosis.

**Methods:** We employed GIPR<sup>dn</sup> mice to study the mechanisms and progression of DKD. Besides histological assessment, we detected serum urea and serum creatinine concentrations over the first year of age at 7, 10, 25, 40, and 50 weeks of age. At all time points, kidney tubules were freshly prepared to assess spontaneous tubular death patterns and LDH release assays over 6 hours following isolation. We monitored cell death propagation by live tubular fluorescence microscopy using Sytox Green and performed Fluorescence Lifetime Microscopy (FLIM). We investigated two models of acute kidney injury (AKI) such as ischemia-reperfusion injury (IRI) and cisplatin-induced AKI.

**Results:** Blood glucose levels and serum concentrations of urea and creatinine of GIPR<sup>dn</sup> transgenic mice were significantly increased in comparison to littermate controls. The difference reached statistical significance from 7 weeks of age. LDH release assays alongside with fluorescence live tubular imaging indicated sensitization to ferroptosis of GIPR<sup>dn</sup> tubules. In the live imaging and in FLIM analysis of freshly isolated tubules, we detected synchronized regulated necrosis and accelerated cell death propagation between tubular cells in the GIPR<sup>dn</sup> transgenic mice. In keeping with these observations, we detected strongly increased sensitivity to all AKI models tested.

**Conclusions:** First, we identify the renal tubule as a primary site of injury in diabetic nephropathy. Second, we conclude that GIPR<sup>dn</sup> mice and diabetic renal tubules are particularly sensitive to ferroptosis. Third, we identify ferroptosis as a novel drug target for AKI in DN.

#### TH-PO189

##### Role of Toll-like Receptors in Hyperglycemia Induced Injury in Proximal Tubules and Podocytes

Rohit Upadhyay,<sup>1</sup> Rhea Bhargava,<sup>1,2</sup> Vecihi Batuman.<sup>1</sup> <sup>1</sup>*Tulane University School of Medicine, New Orleans, LA;* <sup>2</sup>*Harvard Medical School, Boston, MA.*

**Background:** Diabetic kidney disease (DKD) is a progressive microvascular complication of diabetes mellitus where hyperglycemia induces injury in proximal tubules as well as podocytes and eventually develops in to end-stage renal disease (ESRD). The dysregulated metabolic environment mimicking hyperglycemia initiates DKD. Toll like receptors (TLRs) are first line of defense in innate immunity; however, the role of TLRs in hyperglycemia induced injury in proximal tubules and podocytes has not been well understood.

**Methods:** Human kidney proximal tubule cells (PTCs; HK2 cell line) and human podocytes were exposed to high glucose media at different time points *in vitro*. Cell proliferation, ROS generation, NO production, m-RNA/ protein expressions and mitochondrial dysfunction was checked in the cells after treating them with high glucose.

**Results:** We identified a differential role of TLRs in PTCs and podocytes. TLRs 2, 3, 4, 6 and 9 were activated in PTCs and podocytes cultured in high glucose media. SIRT1 downregulation was correlated with expression of cell specific injury markers (LCN2 for PTCs and SYNPO for podocytes). NLRP3 was activated at late time points; however, TNFA was identified as most prominent upregulated cytokine in time dependent manner for both cell types.

**Conclusions:** TLRs-TNFA-NLRP3 axis mediated injury to PTCs and podocytes could be a novel mechanism and promising target to treat DKD.

#### TH-PO190

##### Protein-Bound Uremic Toxins as Biomarkers of Kidney Tubular Function in Murine Long-Term Diabetic Nephropathy

Sabbir Ahmed,<sup>1</sup> Rolf Sparidans,<sup>1</sup> Silvia M. Mihaila,<sup>1,2</sup> Roel Broekhuizen,<sup>2</sup> Roel Goldschmeding,<sup>2</sup> Tri Q. Nguyen,<sup>2</sup> Rosalinde Masereeuw,<sup>1</sup> Karin G. Gerritsen.<sup>2</sup> Prof. Roos' group, Pharmacology <sup>1</sup>*Universiteit Utrecht Utrechts Instituut voor Farmaceutische Wetenschappen, Utrecht, Netherlands;* <sup>2</sup>*Universitair Medisch Centrum Utrecht, Utrecht, Netherlands.*

**Background:** Kidney tubular damage is an important prognostic determinant in diabetic nephropathy (DN). A vital homeostatic function of the proximal tubule is the excretion of waste products, including protein-bound uremic toxins (PBUTs) that are actively being secreted via organic anion transporters (OATs), but accumulate in plasma in kidney dysfunction. We hypothesize that plasma concentration and renal clearance of PBUTs may be sensitive tubular function markers.

**Methods:** Diabetes mellitus was induced in C57Bl/6 mice by streptozotocin, which resulted in histopathological and functional kidney tubular damage after 6 and 8 months. PBTUs in plasma, 24h urine and kidney tissue were measured by LC-MS/MS.

**Results:** Among the PBTUs with the highest OAT affinity (*viz.* IS, HA and KA), plasma concentrations were 1.7-, 2.4- and 1.9-fold higher ( $p=0.005$ ,  $<0.001$ ,  $0.006$ ) after 6 months and 1.9-, 2.4- and 2.2-fold higher ( $p<0.001$ ,  $<0.001$ ,  $<0.001$ ) after 8 months in DN (Fig 1A-C), respectively. Their urinary excretions, normalized for plasma concentrations (*i.e.* a surrogate for clearance), were 2.4-, 5.4- and 2.3-fold lower ( $p=0.005$ ,  $<0.001$ ,  $0.01$ ) after 6 months and 2.3-, 1.6-, 2.1-fold lower ( $p=0.032$ ,  $0.017$ ,  $0.002$ ) after 8 months in DN (Fig 1D-F) respectively. The plasma concentration and clearance of these PBTUs correlated stronger with tubular atrophy, f4/80 scores and tubular injury markers than conventional filtration markers.

**Conclusions:** Tubular function is compromised in murine long-term DN, and plasma concentration and clearance of IS, HA and KA may represent biomarkers of kidney tubular function in DN. Future studies should focus on validation of the novel biomarkers in other species and forms of CKD.

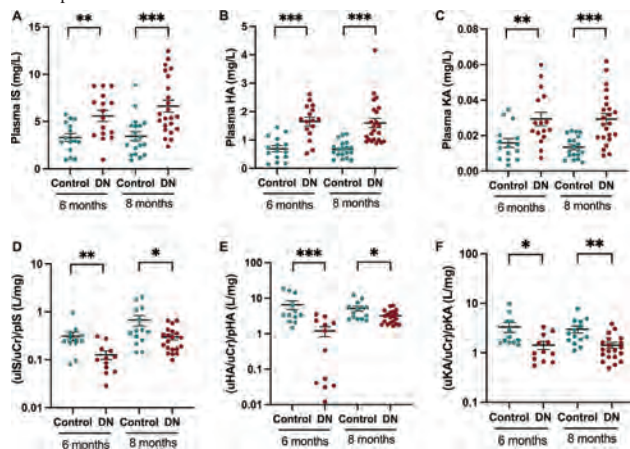

Plasma concentration of IS, HA and KA elevated (A-C), and clearance reduced in DN mice after 6 and 8 months (mean  $\pm$  SEM). DN: diabetic nephropathy; IS: indoxyl sulfate; HA: hippuric acid; KA: kynurenic acid.

## TH-PO191

### Nicotinamide Riboside Ameliorates a Depressive Phenotype in Diabetic Kidney Disease

Katelyn Dial, Komuraiah Myakala, Xiaoxin Wang, Bryce A. Jones, Olga C. Rodriguez, Brent T. Harris, Chris Albanese, Moshe Levi. Levi Lab Georgetown University, Washington, DC.

**Background:** Diabetic kidney disease (DKD) is a risk factor for depression. Decreased NAD<sup>+</sup> is correlated with the pathogenesis of DKD, and nicotinamide riboside (NR) supplementation restores kidney function in DKD. However, NR has never been investigated in models of DKD for its potential in treating the depressive phenotype.

**Methods:** Ten week-old db/m or db/db mice were administered 500 mg/kg NR either in the diet or drinking water for 20 weeks. At 18 weeks of treatment, mice underwent single-voxel 1H-MR-Spectroscopy (MRS) and behavioral evaluation such as the Open Field Test (OFT) and assessment of nesting behavior. After euthanasia, PAS staining, MALDI-guided SpatialOMx, IHC, ELISA, RT-qPCR and Western Blot analysis were performed on the mouse brain and kidneys.

**Results:** PAS staining showed mesangial expansion in db/db mouse kidneys, which was reduced with NR treatment. Urinary KIM-1 and albumin were increased in db/db mice and reduced with NR. NAD<sup>+</sup> levels were significantly decreased in the brain frontal cortex (FC) of db/db mice compared to control mice, and NR treatment restored NAD<sup>+</sup> levels to normal levels. db/db mice exhibited anxiety behavior in the OFT and built significantly less quality nests compared to db/m mice. Interestingly, NR significantly improved db/db mouse behavior in the OFT. MALDI showed reductions in FC N-acetylaspartate, lysophosphatidylcholine and adenosine monophosphate, and increases in FC and hippocampal (HPC) taurine and lysophosphatidylethanolamine in db/db mice compared to db/m. MRS of the FC showed increases in the relative concentrations of taurine, myo-inositol and glutamate to glutamine ratio in db/db mice compared to db/m. NR treatment of db/db mice reduced hippocampal expression of Iba1, GFAP, and STING and FC expression of MCP1. In addition, p-GSK3B and PGC1 $\alpha$  protein levels were significantly increased in the HPC of db/db mice and reduced by NR treatment.

**Conclusions:** Improvements in kidney function with NR treatment coincided with improvements in depressive behavior, reduced brain inflammation, enhanced expression of mitochondrial regulators, and changes in brain metabolites in the FC and HPC. This suggests that NR has potential benefits in the treatment of depression comorbid to DKD.

**Funding:** NIDDK Support, Other NIH Support - NIA Support

## TH-PO192

### MDM2 Promotes Diabetic Nephropathy by Targeting Integrin $\beta 8$ for Ubiquitin Degradation in Renal Pericytes

Yiling Cao, Jieyu Zeng, Xie Yaru, Chun Zhang. Department of Nephrology, Union Hospital, Tongji Medical College, Huazhong University of Science and Technology, Wuhan, China.

**Background:** Diabetic nephropathy (DN) is one of the most frequent diabetic chronic microvascular complications. Renal pericytes play a critical role in maintaining vascular homeostasis and are the major source of interstitial myofibroblasts in the fibrotic kidney. We previously reported that murine double minute 2 (MDM2), an E3 ubiquitin ligase, is essential in mediating mesangial cell proliferation and extracellular matrix accumulation. However, the mechanism of MDM2 in renal pericytes injury remains to be unknown. Transforming growth factor beta 1 (TGF- $\beta 1$ ) is a pivotal profibrotic mediator and integrin  $\beta 8$  sequesters latent TGF- $\beta 1$  to prevent its activation in mesangial cells. The present study sought to determine whether MDM2 could induce the activation of TGF- $\beta 1$  through integrin  $\beta 8$  ubiquitination, and lead to pericytes differentiation and endothelial cell damage.

**Methods:** We established STZ-induced DN mice model. Primary cultured pericytes and HBZY-1 were stimulated with high glucose (30 mM). The expressions of MDM2, Integrin  $\beta 8$ , TGF- $\beta 1$ , relative fibrotic markers and injury markers were measured by western blot and immunofluorescence. Inflammatory cytokines in culture medium were detected by Elisa kits.

**Results:** MDM2 and TGF- $\beta 1$  elevated, while integrin  $\beta 8$  decreased in pericytes of DN mice. After inhibiting MDM2 in pericytes and HBZY-1, the expression of integrin  $\beta 8$  increased. Silenced MDM2 or overexpressed integrin  $\beta 8$  could alleviate high glucose-induced TGF- $\beta 1$  expression and fibrosis and inflammatory response. Meanwhile, the levels of TNF- $\alpha$ , IL-6, TGF- $\beta 1$  in HBZY-1 culture medium were reduced after MDM2 knockdown or integrin  $\beta 8$  overexpression. GECs were cultured with the aforementioned medium. The injuries of GECs were reversed in the MDM2 knockdown or integrin  $\beta 8$  overexpression medium. MG132 prevented the decline of integrin  $\beta 8$  and immunoprecipitation showed integrin  $\beta 8$  ubiquitination was increased under high-glucose conditions. *In vivo*, immunofluorescence staining indicated pericytes differentiation into myofibroblasts and the microvascular rarefaction in DN mice.

**Conclusions:** These data indicated that the release of TGF- $\beta 1$  by ubiquitination-mediated integrin  $\beta 8$  degradation in pericytes is one of the downstream mechanisms of MDM2 profibrotic property, which contributes to pericytes differentiation into myofibroblasts and endothelial cell damage.

**Funding:** Government Support - Non-U.S.

## TH-PO193

### ACE Inhibition and GLP1 Receptor Agonism Have Direct Effects on the Glomerular Capillary Wall to Reduce Glomerular Albumin Permeability in Diabetes

Michael Crompton,<sup>1</sup> Matthew J. Butler,<sup>1</sup> Gavin I. Welsh,<sup>1</sup> Sagar Bhayana,<sup>2</sup> Rebecca R. Foster,<sup>1</sup> Agnes M. Benardeau,<sup>2</sup> Simon C. Satchell.<sup>1</sup> Bristol Renal <sup>1</sup>University of Bristol, Bristol, United Kingdom; <sup>2</sup>Novo Nordisk AS, Bagsvaerd, Denmark.

**Background:** The mainstay of therapeutics to protect from diabetic kidney disease are anti-hypertensive and anti-glycaemic agents, yet they seem to have additional protective effects on albuminuria. Our validated glomerular permeability assay was developed to directly measure the albumin permeability ( $Ps'_{alb}$ ) of capillary loops within individually trapped glomeruli. This *ex vivo* assay is independent of haemodynamic factors and tubular albumin handling – factors known to affect urine protein concentrations. Using our glomerular  $Ps'_{alb}$  assay, we aimed to understand whether renoprotective standard of care and new compounds could target the cells of the glomerular filtration barrier (GFB) directly.

**Methods:** A rat model of type 1 diabetes was utilised, whereby male Wistar rats were injected with streptozotocin (STZ, 50mg/kg I.P.). Rat glomeruli were isolated from perfused kidneys at week 4 and received a 1-hour treatment in 10% plasma with semaglutide (a glucagon-like peptide-1 receptor agonist), enalapril (an angiotensin-converting enzyme inhibitor), empagliflozin (a sodium-glucose co-transporter 2 inhibitor), angiotensin-1 (a positive control) or vehicle. Our glomerular  $Ps'_{alb}$  assay was used to measure changes in albumin permeability.

**Results:** Rats given STZ were significantly hyperglycaemic at week 1, which was sustained, confirming diabetes ( $P<0.001$ ). Diabetic rats developed albuminuria, with a significant increase in urine albumin:creatinine ratio at week 4 ( $P=0.0014$ ). Diabetes also induced a significant increase in  $Ps'_{alb}$  ( $P=0.005$ ), which was ameliorated by both semaglutide and enalapril to a level comparable with nondiabetic glomeruli. Empagliflozin had no significant effect on the diabetes-induced increase in  $Ps'_{alb}$ . In control glomeruli, semaglutide and enalapril alone had no effect compared with vehicle, suggesting no effect on otherwise healthy capillaries.

**Conclusions:** Semaglutide and enalapril both ameliorate the diabetes-induced increase in  $Ps'_{alb}$ , demonstrating a direct effect on the cells of the GFB in diabetes. Thus, a greater understanding of the mechanisms of glomerular protection mediated by these renoprotective compounds is needed to identify novel therapeutic strategies.

**Funding:** Commercial Support - Novo Nordisk



## TH-PO194

**Tenascin C: A Pathogenic Factor in Diabetic Nephropathy?**Sharma S, Prabhakar, Hemalata Deshmukh. *Texas Tech University Health Sciences Center, Lubbock, TX.*

**Background:** Diabetic nephropathy (DN) is the most common cause of end stage renal disease in most parts of the world. The exact pathogenesis of DN is still unclear but renal fibrosis is a common end-result of all pathogenic mechanisms in DN. Tenascin C (TC) is an extra cellular matrix glycoprotein with pleiotropic effects. TC was shown to interact with several growth factors such as VEGF, IGF, EGF, and TGF  $\beta$ , suggesting its potential role in fibrotic process. While Tenascin C has been incriminated in the progression of CKD, the role of TC in DN has not been studied. We hypothesize that given the potential biological effects of TC, it may be involved in the pathogenesis of DN.

**Methods:** To test our hypothesis we used ZSF rats, an established murine model of DN to examine the expression of TC in the kidneys. Both male and female rats were used and CD rats were used as non-diabetic controls. Rats were studied from 8<sup>th</sup> week to 40<sup>th</sup> week. The ZSF rats were provided a high fat high calorie diet (Purina 5008) to maintain hyperglycemia while control rats were given standard rat chow. All animals were euthanized at 40<sup>th</sup> week and kidneys harvested to prepare tissue homogenates. Urine samples were drawn at the start and end of the study period. Western blots were performed using TC specific antibody on the kidney homogenates to find the expression of TC.

**Results:** ZSF rats developed obesity, diabetes, hypertriglyceridemia, hypertension and proteinuric renal failure while CD rats remained nondiabetic without hypertension, obesity or kidney involvement. Male ZSF rats were heavier (650 gm vs 510 gm) and more hyperglycemic (295 mg/dl vs.210 mg/dl) than females while proteinuria and decreased kidney function were more severe in males versus female ZSF rats. Expression of TC was significantly increased in the kidneys of ZSF rats (males more than females) compared to CD rats.

**Conclusions:** We conclude that ZSF rats exhibit severe metabolic syndrome with stronger phenotypic characteristics in male vs. female ZSF rats. The increased renal expression of TC the ZSF kidneys suggests that they could be biomarkers of DN and may potentially have a pathogenic role.

**Funding:** Private Foundation Support

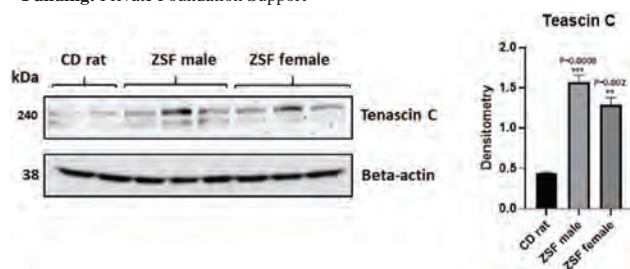

## TH-PO195

**L-Carnitine Ameliorates Diabetic Kidney Disease by Alleviating Mitochondrial Dysfunction in Spontaneously Diabetic Torii (SDT)-Fatty Rats**Sakuya Ito, Kensei Taguchi, Yusuke Kaida, Goh Kodama, Tomofumi Moriyama, Yunosuke Yokota, Kei Fukami. *Division of Nephrology, Department of Medicine, Kurume University School of Medicine, Kurume, Japan.*

**Background:** Abnormal fatty acid metabolism is associated with the progression of diabetic kidney disease (DKD). Carnitine plays a central role in fatty acid  $\beta$ -oxidation by transporting long-chain fatty acids from the cytoplasm to the mitochondria. Juvenile visceral steatosis (jvs) mice, described as an animal model for systemic carnitine deficiency, introduce a marked ectopic fat accumulation in the kidney. These findings suggest that abnormal carnitine dynamics in DKD cause ectopic fat accumulation due to abnormality of the fatty acid metabolism. However, the association between abnormalities of carnitine metabolism and the progression of DKD is unknown.

**Methods:** Spontaneously Diabetic Torii (SDT) fatty rat, an obese type 2 diabetic model was used. Unilateral nephrectomy was performed and 0.3% salt water was administered at 6 weeks of age, and created a renal dysfunction model in SDT fatty rat (DKD model). Age-matched male Sprague-Dawley (SD) rat was used as a control. Experiment 1: We compared 3 groups; SD rats (n=8), SDT fatty rats (n=8), DKD rats (n=8). Experiment 2: We compared 3 groups; SD rats with sham operation (n=8), DKD rats (n=7), DKD rats treated with L-carnitine administration (0.75% L-carnitine diet) for 10 weeks (n=6). All rats were sacrificed at 17 weeks old. Carnitine was measured by the tandem-mass spectrometry.

**Results:** Plasma and renal free carnitine levels and short/middle-long chain acylcarnitine ratio were significantly decreased in DKD rats compared with those in SD and SDT fatty rats. The renal expression levels of OCTN2, CPT1a, CPT2 and CrAT were significantly decreased in DKD rats. Similarly, PGC1 $\alpha$  activity were decreased in DKD rats. L-carnitine administration significantly improved renal function, urinary albumin excretion, interstitial fibrosis and renal ectopic fat accumulation in DKD model rats. L-carnitine administration ameliorated the decrease of renal OCTN2, CPT1a, CPT2 and CrAT protein expression, and significantly improved PGC1 $\alpha$  activity in DKD model rats. Furthermore, L-carnitine administration mitigated oxidative stress and mitochondrial dysfunction in DKD rats.

**Conclusions:** L-carnitine administration might be a promising therapeutic strategy for improving renal function by alleviating mitochondrial dysfunction in DKD rat model.

## TH-PO196

**Differential Expression of Myo-Inositol Oxygenase (MIOX) Modulates Severity of Obesity-Associated Diabetic Nephropathy in Mice**Isha Sharma, Susan E. Quaggin, Yashpal S. Kanwar. *Northwestern University Feinberg School of Medicine, Chicago, IL.*

**Background:** Myo-inositol oxygenase (MIOX) is predominantly expressed in renal proximal tubules. Overexpression of MIOX in the setting of diabetes leads to exacerbation of renal injury; conversely genetic ablation of MIOX lessens the progression of nephropathy.

**Methods:** Six-weeks-old, wild type (WT), MIOX overexpressing (MIOX-TG) and MIOX-knockout (MIOX-KO) mice were fed with high fat diet (HFD) for 16 weeks. In addition, ob/ob mice were bred with MIOX-KO to generate ob/KO mice.

**Results:** We observed that MIOX deletion had no effect on obesity-driven phenotypes including body weight, triacylglycerol, cholesterol or insulin levels. Interestingly, MIOX-KO and ob/KO had reduced HFD-induced renal damage, as assessed in H & E and PAS-stained kidney sections. Obese WT and MIOX overexpressing mice showed proteinuria assessed by SDS-PAGE, which was reduced in mice with MIOX deletion. In addition, tubular injury, as assessed by increased NGAL and Kim-1 expression was reduced after MIOX deletion. No significant change was observed in serum creatinine or urea levels among various strains of mice. MIOX expression and activity increased following HFD administration, which was accompanied by increased ROS generation and perturbed redox potential in kidney. The Reactive oxygen species-mediated damage caused by lipid peroxidation and lipoprotein toxicity was reduced in mice with MIOX genetic deletion. In addition, we observed MIOX overexpression increased O-GlcNacetylation of renal proteins, which was substantially less in MIOX-KO mice. Interestingly, MIOX-TG mice showed increased SREBP-1 expression. Results of co-immunoprecipitation suggested that SREBP-1 is stabilized by O-GlcNacetylation. SREBP-1 transient knockdown in Palmitate BSA treated HK-2 cells attenuated fibronectin deposition. Results of immunofluorescence studies suggested that MIOX-KO and ob/KO mice had considerably decreased expression of fibronectin compared to WT or MIOX-overexpressor mice

**Conclusions:** Together, our results suggest that some of the renal damage observed in the setting of obesity are ameliorated following MIOX gene disruption, and support pharmacologic downregulation of MIOX activity as a candidate therapy.

**Funding:** NIDDK Support

## TH-PO197

**A Signaling Module Linking DJ-1, PTEN, and PDGF Receptor  $\beta$  (PDGFR) Governs Activation of mTORC1 to Induce Proximal Tubular Epithelial Cell (PTEC) Injury in Diabetic Nephropathy (DN)**Falguni Das, Nandini Ghosh-choudhury, Balakuntalam S. Kasinath, Goutam Ghosh-Choudhury. *UTHSCSA, San Antonio, TX.*

**Background:** PTEN inactivation and PDGFR tyrosine kinase-mediated mTORC1 activation have emerged as the centerpiece in pathogenesis of DN and tumorigenesis. The familial Parkinson's disease protein DJ-1 causes cancer. We investigated the hypothesis that DJ-1 acts as a driver of PDGFR-mediated mTORC1 activation in the progression of DN.

**Methods:** Human PTECs, OVE26 and db/db mice, and activation-specific antibodies, immunoblotting, plasmid-derived expression vector, siRNAs and promoter-reporter transfections were employed.

**Results:** In PTECs, 25 mM glucose (HG) increased expression of DJ-1. In determining its role in PTEC pathology, we showed that siRNAs against DJ-1 inhibited HG-induced PTEC hypertrophy and fibronectin and collagen I ( $\alpha$ 2) protein expression and their transcription, while forced expression of FLAG-DJ-1 increased these phenomena. As Akt/mTORC1 signaling regulates these effects of HG, we tested involvement of DJ-1. siDJ-1 inhibited HG-stimulated phosphorylation of Akt, its substrates GSK3 $\beta$ , tuberin and PRAS40, and phosphorylation of S6 kinase, 4EBP-1 and mTOR. In contrast, FLAG-DJ-1 increased these phosphorylation events similar to HG. We have shown previously that HG-stimulated PTEC injury requires PDGFR stimulation of mTORC1 activity. Crucially, we showed that siDJ-1 decreased HG-stimulated phosphorylation of PDGFR at its docking sites of PI 3 kinase, whose function is known to be inactivated by PTEN, a dual specificity tyrosine and lipid phosphatase. Furthermore, we showed that HG increased association of DJ-1 with PTEN. We hypothesized that DJ-1-bound and inactivated PTEN lead to PDGFR phosphorylation. Interestingly, we showed that plasmid-derived expression of PTEN decreased HG-induced tyrosine phosphorylation of PDGFR and its substrate PI 3 kinase. In addressing the *in vivo* relevance of our results, in the renal cortex of OVE26 and db/db mice models of type 1 and type 2 diabetes, we found increased expression of DJ-1, PDGFR phosphorylation, mTORC1 activation and fibronectin and collagen I ( $\alpha$ 2) expression.

**Conclusions:** Together our results uncover a novel three layered molecular circuitry where PDGFR serves as a substrate of PTEN that is quenched by DJ-1 in PTEC injury in DN.

**Funding:** Veterans Affairs Support

## TH-PO198

Cell Surface GRP78 and Integrin  $\beta 1$  Regulate TGF $\beta 1$ -Mediated Profibrotic Responses in Diabetic Kidney Disease

Jackie Trink, Renzhong Li, Evan J. Squire, Kian S. O'Neil, Bo Gao, Joan C. Krepinsky. *McMaster University Faculty of Health Sciences, Hamilton, ON, Canada.*

**Background:** Diabetic kidney disease (DKD) is the leading cause of kidney failure in North America, characterized by glomerular accumulation of extracellular matrix proteins. High glucose (HG) induction of glomerular mesangial cell (MC) profibrotic responses play a central role in DKD pathogenesis. We recently showed that the endoplasmic reticulum resident protein GRP78 translocates to the cell surface (csGRP78) in response to HG. Here, with integrin  $\beta 1$  (Int $\beta 1$ ) as its coreceptor, it mediates PI3K/Akt activation and downstream profibrotic responses in MC. Transforming growth factor- $\beta 1$  (TGF $\beta 1$ ) is recognized as a central mediator of HG-induced profibrotic responses, but its inhibition is not feasible due to adverse effects. Here, we test whether csGRP78/Int $\beta 1$  can regulate TGF $\beta 1$  synthesis and activation by HG.

**Methods:** Primary MC were treated with 30mM HG. Standard molecular biology techniques were used for assessment.

**Results:** HG-induced TGF $\beta 1$  transcript upregulation and protein secretion were attenuated by specific inhibitory antibodies of either csGRP78 or Int $\beta 1$  and with siRNA knockdown of Int $\beta 1$ . The general integrin activator manganese (Mn) induced TGF $\beta 1$  upregulation and interestingly also induced translocation of GRP78 to the cell surface. Mn-induced TGF $\beta 1$  synthesis was attenuated by csGRP78 or Int $\beta 1$  inhibition. Once secreted, TGF $\beta 1$  resides in a latent state. We thus tested whether csGRP78/Int $\beta 1$  facilitated its activation. Inhibition of csGRP78 or Int $\beta 1$  as above prevented HG- and Mn-induced TGF $\beta 1$  signaling as assessed by activating phosphorylation of its downstream mediator Smad3. Conversely, the Int $\beta 1$ -activating antibody P4G11 induced both GRP78 cell surface translocation and TGF $\beta 1$  signaling. To confirm functionality of TGF $\beta 1$  signaling, MC were cocultured with the TGF $\beta 1$ -responsive mink lung epithelial cells (MLEC) stably expressing a PA11 promoter luciferase plasmid. HG-induced luciferase activity was attenuated by antibody inhibition of either csGRP78 or Int $\beta 1$ .

**Conclusions:** These data strongly support a role for csGRP78/Int $\beta 1$  in mediating HG-induced TGF $\beta 1$  upregulation, activation and profibrotic signaling in MC. Inhibition of csGRP78/Int $\beta 1$  signaling thus represents a novel target for attenuating fibrosis in DKD.

## TH-PO199

## Combination of Systemic ATRAP Deletion With Angiotensin II Stimulation Exacerbates Diabetic Nephropathy in Streptozotocin-Induced Diabetic Mice

Shinya Taguchi, Kengo Azushima, Hiromichi Wakui, Toru Suzuki, Shingo Urate, Eriko Abe, Shohei Tanaka, Shunichiro Tsukamoto, Kouichi Tamura. *Yokohama City University Graduate School of Medicine, Yokohama, Japan.*

**Background:** One of the obstacles to understanding the pathophysiology of diabetic nephropathy (DN) has been the lack of reliable animal models that replicate features of human DN. Angiotensin II (Ang II) type 1 receptor (AT1R)-associated protein (ATRAP) promotes internalization of AT1R from the cell surface into the cytoplasm, resulting in the suppression of the AT1R signaling pathway. We have recently reported that systemic ATRAP deletion exaggerates streptozotocin (STZ)-induced DN via activation of the renal renin-angiotensin system (Haruhara K, et al. *Kidney Int* 2022). However, the increase in albuminuria in STZ-induced diabetic ATRAP knockout mice is still modest with limited pathological changes in glomerulus. To establish more robust DN models, we examined the effect of Ang II stimulation on the development of DN in STZ-treated ATRAP knockout mice.

**Methods:** Eight-week-old male C57BL/6 mice (Ctrl) and systemic ATRAP-knockout mice (KO) were divided into three groups: 1) Ctrl-STZ, 2) Ctrl-STZ-Ang II, and 3) KO-STZ-Ang II. Hyperglycemia was induced by intraperitoneal injection of 55 mg/kg STZ for consecutive 5 days. From 4 weeks after STZ, Ang II (1000 ng/kg/min) was continuously administered for 6 weeks. During the experimental period, body weight (BW) and blood glucose (BG) were measured every 2 weeks. At the end of the experimental period, 24-hour urine samples were collected, and mice were euthanized to evaluate renal pathological changes.

**Results:** During the experimental period, BW gain and BG were not significantly different between the three groups. Nonetheless, the KO-STZ-Ang II group exhibited a remarkable increase in the urinary albumin excretion levels compared to the Ctrl-STZ and Ctrl-STZ-Ang II groups at the end of the experimental period (679.1 $\pm$ 583.7 vs 69.9 $\pm$ 10.0 vs 61.3 $\pm$ 8.2  $\mu$ g/day, respectively). Furthermore, the histopathological analysis revealed a worsening of DN, an exacerbation of mesangial expansion and interstitial fibrosis, in the KO-STZ-Ang II group.

**Conclusions:** The results of present study showed that systemic ATRAP deletion in combination with Ang II stimulation accelerated the development of DN in STZ-induced diabetic mice, suggesting a potential to become a promising mouse model replicating key features of human DN.

## TH-PO200

## IL-34 Mediate the Development of Diabetic Nephropathy by Promoting Macrophage Infiltration

Wang Y. Ning, Ke Zheng, Gangan Wang, Li X. Mei. *Peking Union Medical College Hospital, Dongcheng-qu, China.*

**Background:** Diabetic nephropathy (DN) is the leading cause of end-stage renal disease around the world. Macrophages contribute to the development of renal injury and sclerosis. IL-34, expressed by tubular epithelial cells (TECs), promotes macrophage survival and proliferation by binding to the cFMS receptor and PTPRZ receptor on macrophages in SLE and AKI. The role of IL-34 in diabetic nephropathy and its effect on the quantification and polarization of macrophages have not been elucidated.

**Methods:** To validate the role of IL-34 in diabetes kidney disease, we established progressive diabetes nephropathy by unilateral nephrectomy combined with a 60% high-fat diet and STZ (120mg/kg) injection(Unx+60%HFD+STZ) based on WT and IL-34 KO mice respectively. Meanwhile, the sham operation group was used as the experimental control group. After 16 weeks of injection with STZ, we collected the kidney samples to evaluate the injury extent of the kidney, and flow cytometry was used to evaluate the quantification and polarization direction of macrophages.

**Results:** In vivo, compared with the sham group, the mRNA level of IL-34 in kidney tissue was significantly up-regulated in WT-Unx+60%HFD+STZ. The result of HE staining and PAS staining showed that under the circumstance of unilateral nephrectomy model of high fat, IL-34 KO mice present less renal tissue pathological injury than WT mice. IL-34 KO-Unx+60%HFD+STZ mice had less infiltration of macrophages than WT - Unx+60%HFD+STZ renal tissue.

**Conclusions:** IL-34 accelerates the progression of diabetes by promoting macrophage infiltration, targeting IL-34 knockout can delay the progression of diabetic nephropathy.

**Funding:** Government Support - Non-U.S.

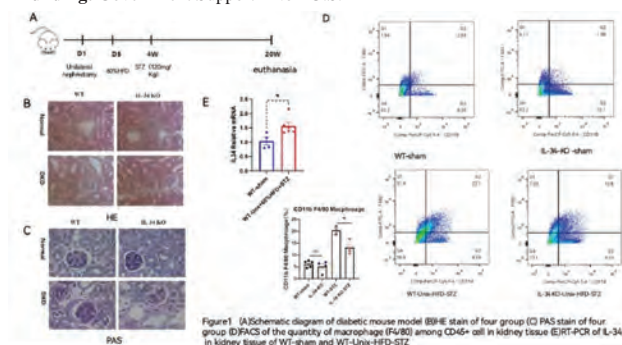

Figure 1 (A) Schematic diagram of diabetic mouse model (B) HE stain of four group (C) PAS stain of four group (D) FACS of the quantity of macrophage (CD45) among CD45+ cell in kidney tissue (E) RT-PCR of IL-34 in kidney tissue of WT-sham and WT-Unx+HFD+STZ

## TH-PO201

## Xanthine Oxidase Inhibition Ameliorates High Glucose-Induced Oxidative Stress by Activating AMPK Through the Purine Salvage Pathway in Glomerular Endothelial Cells

Yu Ah Hong,<sup>1,2</sup> Keum-Jin Yang,<sup>2</sup> Wonjung Choi,<sup>1,2</sup> Yoon-Kyung Chang,<sup>1,2</sup> Suk young Kim,<sup>1,2</sup> Cheol Whee Park.<sup>1</sup> <sup>1</sup>Catholic University of Korea School of Medicine, Seoul, Republic of Korea; <sup>2</sup>Catholic University of Korea Daejeon St Mary's Hospital, Daejeon, Republic of Korea.

**Background:** Oxidative stress plays a crucial role in the pathogenesis of diabetic kidney disease. Xanthine oxidase (XO) contribute to reactive oxygen species (ROS) production, and XO inhibitors have been reported to the protection of kidney diseases. We investigated the cytoprotective mechanism associated with activated AMP-activated protein kinase (AMPK) by XO inhibition in high glucose (HG) condition.

**Methods:** Glomerular endothelial cells (GENCs) exposed to HG were treated with or without febuxostat for 48 hours, and then the phosphorylation of AMPK and its related signaling pathway were evaluated.

**Results:** Febuxostat enhanced cell survival in a dose-dependent manner and decreased ROS in HG-treated GENCs. Febuxostat enhanced phosphorylation of AMPK, and activation of peroxisome proliferator-activated receptor (PPAR)-gamma coactivator (PGC)-1 $\alpha$  and PPAR- $\alpha$ , and dephosphorylation of the Forkhead box O (FoxO)3a in HG-treated GENCs. Febuxostat also suppressed NADPH oxidase expressions and enhanced SOD activity in HG-treated GENCs. The expressions of xanthine/hypoxanthine were significantly reduced, and the levels of xanthine oxidoreductase were increased in HG-treated GENCs, and these findings were attenuated by febuxostat. The intracellular AMP/ATP ratio was inhibited in HG-treated GENCs and enhanced by febuxostat. AMPK inhibition using small interfering RNA suppressed HPRT1 activity and suppressed PGC-1 $\alpha$ -FoxO3a signaling and finally abolished the antioxidant effects by febuxostat in HG-treated GENCs.

**Conclusions:** XO inhibition attenuates HG-induced oxidative stress through the activation of AMPK-PGC-1 $\alpha$ -FoxO3a-NADPH oxidase signaling via purine salvage pathway.

**Funding:** Government Support - Non-U.S.

## TH-PO202

**The HIV Protease Inhibitor Darunavir Restores Autophagy in Kidneys of Diabetic Mice**

Michael J. Ross, Heidi Karttunen, Xiaobo Gao. *Albert Einstein College of Medicine, Bronx, NY.*

**Background:** Despite the success of antiretroviral therapy (ART) in improving mortality, persons with HIV have increased risk of death, and kidney disease and diabetes are important contributors to their excess mortality. Data from our laboratory demonstrate that the HIV protease inhibitor darunavir (DRV) prevents kidney disease in HIV-transgenic mice via mechanisms independent of HIV protease and also reduces albuminuria and molecular markers of kidney injury in mice with diabetic kidney disease (DKD). Since autophagy is cytoprotective against HIV and diabetes-induced kidney injury, and autophagy is reduced in the kidneys of patients with DKD, we studied the effect of DRV upon autophagy in a murine model of DKD.

**Methods:** eNOS<sup>-/-</sup> 9 week-old C57BL/6 mice, which develop more severe nephropathy than wild-type C57BL/6 mice, underwent induction of diabetes by administration of 5 daily 50mg/kg doses of streptozotocin (STZ) injection. 14 weeks after diabetes induction, mice were treated with either DRV (100mg/kg) or control by daily oral gavage for 4 weeks. Urinary albumin creatinine ratio (ACR) assay, immunocytochemistry, western blotting and real-time PCR were performed with routine protocols in our laboratory.

**Results:** STZ induced severe sustained hyperglycemia and kidney injury in eNOS<sup>-/-</sup> mice, which resulted in marked increase urine ACR, which was reduced by DRV. Western blotting and immunofluorescence studies demonstrated marked accumulation of lipidated LC3 (LC3-II) and p62 in kidneys of diabetic eNOS<sup>-/-</sup> mice, indicating reduced autophagic flux. Accumulation of LC3-II and p62 in diabetic eNOS<sup>-/-</sup> kidneys was most apparent in tubular cells. DRV treatment reduced LC3-II and p62 in diabetic eNOS<sup>-/-</sup> mice to levels that were similar to non-diabetic mice.

**Conclusions:** Kidneys of diabetic eNOS<sup>-/-</sup> mice had reduced autophagic flux (accumulated LC3-II and p62) compared to non-diabetic mice, which was reversed by DRV. Our previous studies demonstrated that DRV reduced albuminuria and molecular markers of glomerular and tubular injury in mice with DKD. Our data suggest that DRV may protect against DKD via normalization of autophagic flux. Since reducing albuminuria may affect autophagy in tubular cells, future studies will determine whether the effect of DRV upon autophagy is independent of its effects on albuminuria.

**Funding:** NIDDK Support

## TH-PO203

**PGC1 $\alpha$  Modulates Mitochondrial Homeostasis in Tubular Cells of Diabetic Kidney Disease**

Siyang Ye,<sup>1,2</sup> Bin Li,<sup>1,2</sup> Yuting Fan,<sup>1,2</sup> Yi Lin,<sup>1,2</sup> Suchun Li,<sup>1,2</sup> Huajing Peng,<sup>1,2</sup> Hui Diao,<sup>1,2</sup> Wei Chen.<sup>1,2</sup> <sup>1</sup>Department of Nephrology, The First Affiliated Hospital, Sun Yat-sen University, Guangzhou, China; <sup>2</sup>NHC Key Laboratory of Clinical Nephrology (Sun Yat-sen University) and Guangdong Provincial Key Laboratory of Nephrology, Guangzhou, China.

**Background:** Tubular injury and dysregulated mitochondrial dynamics play pivotal roles in the pathogenesis of diabetic kidney disease (DKD). However, the potential mechanism by which mitochondrial dysfunction-initiated tubulopathy triggers intrarenal signaling and mediates DKD progression remains elusive. Our current study aims to investigate the effect of PGC1 $\alpha$ -modulated mitochondrial homeostasis on kidney tubular cells of DKD and to explore the underlying mechanisms.

**Methods:** Human renal proximal tubule epithelial cells (HK-2) were cultured in the presence of palmitic acid (PA, 500  $\mu$ M) plus high glucose (HG, 40 mM) to imitate the diabetic microenvironment. PGC1 $\alpha$  was overexpressed in cultured HK-2 cells through plasmid transfection to perform functional experiments. Mitochondrial status and the related molecular patterns were assessed using multiple standard molecular biology techniques.

**Results:** The transcript and protein expression profile of PGC1 $\alpha$  were significantly inhibited when HK-2 cells were exposed to PA plus HG. In parallel, transcription factor A (TFAM), the important mediator of mitochondrial biogenesis, as well as PTEN-induced kinase 1 (PINK1) and Parkin (parkin RBR E3 ubiquitin protein ligase), the key regulators of mitophagy, were significantly suppressed at both transcriptional and protein level, which resulted in obviously blunted mitochondrial biogenesis and mitophagy, as evidenced by reduced mitochondrial content including mitochondrial marker TOM20 (translocase of outer mitochondrial membrane 20), mitochondrial volume and mitochondrial DNA. Moreover, mitochondrial dysfunction led to dramatically elevated proinflammatory mediators including IL6, IL8, and ICAM1 (intercellular adhesion molecule 1) in cultured HK-2 cells. More importantly, PA plus HG-initiated perturbation of intracellular mitochondrial dynamics and inflammation were prevented by overexpression of PGC1 $\alpha$  in cultured HK-2 cells.

**Conclusions:** Findings from our study support an important role for PGC1 $\alpha$  in preventing DKD-induced mitochondrial dysfunction in tubular cells via maintaining the activation of TFAM and PINK1/Parkin signaling. Functionally, this enables the mitochondrial homeostasis and diminishes the consequent inflammation in the microenvironment of DKD. Means of targeting PGC1 $\alpha$ -regulated mitochondrial homeostasis represents a promising target for the treatment of DKD.

**Funding:** Government Support - Non-U.S.

## TH-PO204

**The Genetic Background Predicts the Kind of Renal Damage and Fibrosis Progression in Diabetic Patients**

Paola Pontrelli, Claudia Cinefra, Francesca Conserva, M. Rossini, Francesco Pesce, Loreto Gesualdo. *Universita degli Studi di Bari Aldo Moro, Bari, Italy.*

**Background:** Diabetic Nephropathy (DN) is the major causes of end-stage renal failure; renal damage in the diabetic patient can be real DN or non-diabetic renal disease (NDRD). We demonstrated that a characteristic feature only of real DN is an increase in Lys63-ubiquitination (PMID: 27881486; 29806072; 31388051; 34068941). The goal of this project was to identify single nucleotide polymorphisms (SNPs), associated to genes involved in Lys63 ubiquitination, able to predict the different kind of renal damage and the progression of kidney disease in diabetic patients.

**Methods:** We selected 10 HapMap SNPs within coding and regulatory sequences both of miR27b-3p and miR1228-3p, all involved in Lys63 ubiquitination, in order to evaluate their diagnostic and prognostic potential. 203 patients were enrolled in this study, in particular we included: diabetic patients with: i) DN, ii) NDRD, iii) without clinical signs of impaired renal function (T2D), iv) with coexistence of both conditions (ND+NDRD); non-diabetic patients with glomerulonephritis (CKD) or without renal damage (CTRL).

**Results:** The analyzed SNPs showed a different genotype frequency among all the patients classes. Interestingly, SNPs rs47, rs475, rs474, rs38 showed a statistically significant difference in genotype frequency comparing DN patients with CEU Population ( $p < 0.04$ , 0.05, 0.002, 0.001 respectively) and a control cohort enclosing CTRL and T2D ( $p < 0.02$ , 0.05, 0.001, 0.04 respectively). SNPs rs76, rs107, rs23 genotypes frequency was statistically different among DN patients and the control cohort ( $p < 0.001$ ). The genotype frequencies of the SNPs rs107 ( $p < 0.01$ ) and rs78 ( $p < 0.04$ ) resulted significantly related to tubular fibrosis in DN patients, while the SNPs rs47 ( $p < 0.03$ ) and rs76 ( $p < 0.02$ ) to the glomerular one. In order to evaluate the diagnostic power of the identified SNPs, we used a logistic regression model, and we observed that the SNP rs107, adjusted for age, sex, eGFR and glycaemic index, discriminate DN from NDRD ( $p < 0.05$ ; OR=1.002-1.008; 95% CI).

**Conclusions:** Our data demonstrated that the allelic forms of the analyzed SNPs are related to the different kind of renal damage in diabetic patients. Their prognostic and diagnostic potential could represent the starting point to create a new non-invasive diagnosis system based on clinical and genotyping data.

## TH-PO205

**Lipoxins Protect Against Diabetic Kidney Disease by Attenuating the Expression of Inflammatory Genes**

Phillip Kantharidis,<sup>1</sup> Madhura Bose,<sup>1</sup> Victoria Priori,<sup>2,1</sup> Muthukumar Mohan,<sup>1</sup> Eoin Brennan,<sup>3</sup> Catherine Godson,<sup>3</sup> Mark E. Cooper.<sup>1</sup> <sup>1</sup>Monash University Department of Diabetes, Melbourne, VIC, Australia; <sup>2</sup>Ecole de Biologie Industrielle, Cergy, France; <sup>3</sup>School of Medicine and Conway Institute, University College Dublin, Dublin, Ireland.

**Background:** Many factors contribute to the pathology observed in diabetic kidney disease (DKD) with chronic hyperglycaemia driving the increased generation of ROS and AGEs, ultimately leading to inflammation and kidney fibrosis. In recent years, there has been growing appreciation that the failure of effective resolution of inflammation may underpin DKD. In this context the efficacy of lipoxins [LXs], lipid mediators that promote the resolution of inflammation and suppress fibrosis has been proposed. Here we examined the efficacy of LXs and novel synthetic LX mimetics in experimental DKD compared to candesartan, the current standard of care.

**Methods:** Six-week-old male ApoE KO mice were rendered diabetic by five daily intra-peritoneal (IP) injections of streptozotocin (55mg/kg). Blood glucose and HbA1c were measured to determine diabetes status. Control and diabetic mice were randomly selected to receive vehicle (0.02% ethanol), LX<sub>4</sub> (5 $\mu$ g/kg), or two mimetics, AT-02-CT (1.7 $\mu$ g/kg) or AT-01-KG (3 $\mu$ g/kg) via IP (n=24/gp), twice weekly. At endpoint, mice were culled and kidneys collected for gene expression, immunohistochemistry and histology.

**Results:** Diabetic mice displayed elevated blood glucose, HbA1c and albuminuria compared to control. These changes were accompanied with significantly increased fibrotic (fibronectin, Col 1), inflammatory (TNF $\alpha$ , MCP1, IL-6) and adhesion markers (VCAM-1, ICAM-1). Administration of candesartan, LX<sub>4</sub> or the mimetics significantly reduced inflammatory and adhesion marker expression in diabetic kidney. LX<sub>4</sub> and the mimetics also resulted in significantly decreased albuminuria (~40%) and reduced mesangial expansion. LX<sub>4</sub> and the mimetics were equally effective against fibronectin, collagen 1 and inflammatory markers compared to candesartan alone. However, when compared to the combination treatment with candesartan, Lipoxins alone provide superior protection.

**Conclusions:** Our findings demonstrated that LX and synthetic LX mimetics protect against DKD by attenuating fibrotic and inflammatory signalling and improving kidney function. For some parameters, Lipoxins provided superior protection compared to candesartan, including the combination treatments with candesartan. These results support the use of Lipoxins as a novel pro-resolving approach for the treatment of DKD.

**Funding:** Government Support - Non-U.S.

## TH-PO206

## Small Molecule Screening Identifies TW-37 as a KIM-1 Inhibitor and Potential Anti-Fibrotic Molecule

Amrendra K. Ajay,<sup>1,2</sup> Yutaro Mori,<sup>1</sup> Venkata Sabbiseti,<sup>1</sup> Joseph V. Bonventre.<sup>1,2</sup>  
<sup>1</sup>Brigham and Women's Hospital Department of Medicine, Boston, MA; <sup>2</sup>Harvard Medical School, Boston, MA.

**Background:** Kidney Injury Molecule-1 (KIM-1) is a glycosylated protein upregulated following proximal tubular injury. With acute and chronic injury, KIM-1 mediates the uptake of apoptotic cells, oxidized lipids, advanced glycation end products (AGEs), and albumin bound to long chain fatty acids. Overexpression of KIM-1 causes chronic kidney disease (CKD) in mice.

**Methods:** We developed a high throughput cell-based functional assay for KIM-1 mediated uptake of ox-LDL, and screened 14,414 unique small molecules. After setting up a histological score based on the potential to inhibit cellular ox-LDL uptake for each compound, 240 potential hits were cherry-picked from the primary screening. Raman spectroscopy was employed to investigate the binding of KIM-1 to TW-37. The effectiveness of the selected compound was evaluated in a mouse model of kidney fibrosis.

**Results:** TW-37, a second-generation benzenesulfonyl derivative of gossypol, had the greatest inhibitory effect on ox-LDL uptake. TW-37 is known to have Bcl2 inhibitory activity; however, Bcl-2 blockade with another specific Bcl-2 inhibitor, ABT-263, did not inhibit KIM-1 dependent ox-LDL uptake. TW-37 is not toxic to cells at concentrations up to 11 $\mu$ M. TW-37 neither cleaves KIM-1 nor quenches the fluorophores in our assay systems. Our *in silico* docking revealed a putative TW-37 binding pocket which spans from residues 37 to 52 of KIM-1. TW-37 specifically binds to recombinant KIM-1 and not to the BSA as determined by Raman spectroscopy. We observed a drop in the loops and turn content (44 to 34.5 percent) and an enhanced beta sheet content (42 to 53.5 percent) in the KIM-1+TW-37 sample compared to native KIM-1 spectrum. TW-37 significantly inhibits the uptake of BODIPY-labeled palmitic acid bound to albumin. TW-37 reduces kidney fibrosis induced by palmitic acid-albumin (0.5 mmol/kg PA and 2.5 g/kg BSA) administration daily from days 7 to 14 after aristolochic acid (5 mg/kg) administration.

**Conclusions:** We have identified and characterized TW-37 as an inhibitor of KIM-1 binding. TW-37 protects mice from kidney fibrosis. Thus, TW-37 has potential use as a therapeutic for the treatment of kidney disease where chronic KIM-1 mediated uptake of luminal contents into the proximal tubule contributes to chronic injury and maladaptive repair.

**Funding:** NIDDK Support, Other NIH Support - American Heart Association

## TH-PO207

## ABCA1 Deficiency Primes Inflammasome via APE1/IRF1 Axis in Podocytes

Marie Ito, Javier T. Varona Santos, Margaret Z. Gurumani, Alexis J. Sloan, Sandra M. Merscher, Alessia Fornoni. University of Miami School of Medicine, Miami, FL.

**Background:** Decreased ATP Binding Cassette Transporter A1 (ABCA1) expression and Caspase-4-mediated noncanonical inflammasome have been described in diabetic kidney disease (DKD). However, a direct link between these two pathways as not been established.

**Methods:** To investigate the role of ABCA1 deficiency in inflammasome, we stably transfected human podocytes with scrambled siRNA as a negative control (siCO) and siABCA1 RNA (siABCA1). Podocytes with transient siRNA knockdown of Interferon regulatory factor 1 (IRF1) were used to study the role of IRF1 in inflammasome. Podocytes were treated with TAK-242 (TLR4 inhibitor) or APX3330 (APE1 redox inhibitor) to investigate the role of toll-like receptor 4 (TLR4) and Apurinic/aprimidinic endonuclease 1 (APE1) in IRF1 regulation. The nuclear fractions of siCO and siABCA1 podocytes were isolated using the ab109719 cell fractionation kit and protein levels of APE1 were evaluated by Western blot analysis. mRNA and protein levels of IRF1 and inflammasome-related genes (NLR family pyrin domain containing 3 (NLRP3), Caspase-4, Gasdermin D, Caspase-1 and Interleukin 1 $\beta$  (IL1 $\beta$ )) were quantified by Western blot analysis and real-time PCR.

**Results:** In siABCA1 podocytes, mRNA levels of IRF1, Caspase-4, GSDMD, Caspase-1 and IL1 $\beta$  but not of NLRP3 and protein levels of Caspase-4, GSDMD and IL1 $\beta$  were significantly increased compared to siCO podocytes. Since IRF1 regulates the expression of Caspase-4, GSDMD and/or Caspase-1 in macrophages, we conducted siRNA knockdown of IRF1 and find that IRF1 knockdown in siABCA1 podocytes prevented increases in Caspase-4, GSDMD and IL1 $\beta$  expression. As candidate mechanism in siABCA1-mediated IRF1 regulation, we next investigated the role of TLR4, which was shown by others to mediate NLRP3 activation in ABCA1 deficient proximal tubular cells, and of APE1, which is excreted from cells via ABCA1. Whereas TAK-242, did not decrease mRNA levels of IRF1 and Caspase-4, APX3330 abrogated siABCA1-induced expression of IRF1 and Caspase-4. APE1 protein expression was also increased in the nuclear fraction of siABCA1 podocytes compared to siCO.

**Conclusions:** These data indicate that ABCA1 deficiency in podocytes caused nuclear APE1 accumulation, which reduces transcription factors to increase the expression of IRF1 and IRF1 target inflammasome-related genes, leading to proptosis priming.

**Funding:** Other NIH Support - R01DK117599, R01DK104753, R01CA227493, Private Foundation Support, Clinical Revenue Support

## TH-PO208

## CXCL5 Inhibition Attenuates Diabetic Kidney Disease in a Mouse Model of Type 2 Diabetes Mellitus

Ting-Ting Chang,<sup>1</sup> Ching Chen,<sup>1</sup> Jaw-Wen Chen.<sup>2</sup> <sup>1</sup>National Yang Ming Chiao Tung University School of Medicine, Taipei, Taiwan; <sup>2</sup>Taipei Veterans General Hospital, Taipei, Taiwan.

**Background:** Diabetic kidney disease (DKD) is typically characterized by progressive proteinuria and decreasing glomerular filtration rate, which might finally progress to end stage renal disease. Chemokines are critically involved in the inflammatory progression in the development of DN. CXC motif chemokine ligand 5 (CXCL5), a CXC type chemokine, is found upregulated in clinical and experimental diabetes mellitus (DM). Given the potential involvement of CXCL5 in the development or progression of DKD, this study sought to investigate the direct impacts of CXCL5 inhibition on DKD in experimental type 2 DM.

**Methods:** *Lepr<sup>fl/y</sup>/JNarl* type 2 DM mice were used for a mouse model of DKD. Mice were randomly assigned to receive an anti-CXCL5 neutralizing monoclonal antibody or a control antibody for 4 weeks. Serum blood urea nitrogen (BUN), creatinine (Cre), and uric acid levels were examined before and after the treatment. Urinary albumin-to-creatinine ratio (UACR) and kidney-to-body weight ratio were measured. Renal glomerulosclerosis and fibrosis were also evaluated by Periodic acid-Schiff staining and Masson's trichrome staining after the treatment.

**Results:** Serum CXCL5 concentrations, body weight, and blood glucose levels were upregulated in the DKD mice. Serum BUN, Cre, and uric acid levels that were enhanced in DKD mice with a control antibody were decreased in mice treated with an anti-CXCL5 antibody. The UACR and kidney-to-body weight ratio were attenuated by the treatment of anti-CXCL5 antibodies compared to that of control antibodies. Furthermore, glomerular hypertrophy, glomerulosclerosis, and renal fibrosis were also reduced in DKD mice that received the anti-CXCL5 antibody.

**Conclusions:** Our pilot findings suggested that *in vivo* CXCL5 inhibition could improve renal function and reduce urinary albumin-to-creatinine ratios, glomerular hypertrophy, glomerulosclerosis, and renal fibrosis in DKD mice. The molecular mechanistic insights may be further explored to provide a novel theoretical basis for CXCL5 as a potential therapeutic target in DKD.

## TH-PO209

## Repeated Doses of Cisplatin (Cis)-Induced Renal Failure Is Associated With Increased Intestinal Permeability and Glucose Intolerance

Siddhartha S. Ghosh, Sarah Bu, Graham T. Gipson, Todd W. Gehr. Virginia Commonwealth University, Richmond, VA.

**Background:** Repeated doses of Cis have been shown to cause CKD. We show that Cis-induced renal failure can also cause glucose and insulin intolerance, and increased intestinal permeability, in addition to inflammation. We further show that sodium butyrate (NaB), a protector of the intestinal barrier improved renal function, glucose tolerance, and inflammation.

**Methods:** FVBn mice (n=5) were divided into Control (saline), Cis group (7 mg/kg cisplatin ip) every week for 4 weeks. Cis+NaB (7 mg/kg Cis+ NaB 400 mg/kg/day). Euthanized 8 weeks after the last Cisplatin injection. Glucose and insulin tolerance tests (GTT & ITT) were done 2 weeks and 1 week before sacrifice. Oral FITC dextran was used to assess intestinal permeability, 2 hours before sacrifice collected blood was analyzed for FITC and for renal function. Urine, kidney and colon were also harvested. Inflammatory cytokines TNF $\alpha$ , IL6, and IL1 $\beta$  of the kidney and colon were measured by qPCR and the results were further confirmed by western blots in the kidney. Colonic mucin was stained.

**Results:** As shown in the table there was deterioration of renal function, glucose tolerance, and intestinal permeability with Cis that was corrected by NaB. TNF $\alpha$ , IL6 and IL1 $\beta$  in the colon of cisplatin group were 2 to 3fold higher than control (p<0.05) that was significantly lowered by butyrate. Both qPCR and western showed increased cytokines in the kidney (3 to 7fold p<0.050). Butyrate reduced TNF $\alpha$  and IL6 but not IL-1 $\beta$ . A significant loss of mucin was observed in the colon of cisplatin treated mice which was abrogated with butyrate.

**Conclusions:** Cis-mediated inflammation and loss of colonic mucin likely changed intestinal permeability and caused hyperglycemia and renal dysfunction. Butyrate, a colonic nutrient, and HDAC inhibitor prevented intestinal permeability and inflammation resulting in improved renal function, GTT, and ITT.

	Control (C)	Cis	Cis+NaB
BUN (mg/dl)	62.2±4	177±72 (a)	91±11 (b)
Creatinine (mg/dl)	0.3±0.3	1.7±0.8 (a)	0.8±0.2 (b)
Urinary Protein /Creatinine ratio	105±9	119±2 (a)	107±6 **
GTT (mg *min/dl)	18626±4925	37943±4760 (a)	27762±1735 (b, c)
ITT (mg *min/dl)	520±577	6354±115 (a)	5151±201 (b)
Plasma FITC (mg/dl)	0.6±0.1	1.3±0.3 (a)	0.9±.17 (b)

Control vs Cis =a (p<0.05); Cis vs Cis+NaB=b (p<0.05); Control vs Cis+NaB=c (p<0.05)  
 \*\* Cis vs Cis+NaB (p=0.051)

## TH-PO210

### Role of Exosome-Mediated Intraglomerular Cross-Talk Between Mesangial Cells and Macrophages in the Progression of Diabetic Kidney Disease

Daisuke Fujimoto, Shuro Umemoto, Takashige Kuwabara, Ryosuke Date, Yusuke Hata, Teruhiko Mizumoto, Yuichiro Izumi, Masashi Mukoyama. *Department of Nephrology, Kumamoto University Graduate School of Medical Sciences, Kumamoto City, Japan.*

**Background:** Extracellular vesicles (EVs) are important mediators of intercellular communication in the regulation of physiological and pathophysiological processes. Particularly, exosome-mediated intercellular crosstalk has been addressed in several disorders such as cancer and lifestyle-related diseases. In diabetic kidney disease (DKD), it has been reported that macrophages infiltrating the mesangial region may play an important role through inducing local inflammation in glomeruli. However, mechanisms for DKD progression and roles of exosome-mediated processes remain elusive.

**Methods:** We focused on exosomes as possible key factors acting in a paracrine manner in glomeruli and examined the effects of mesangial cell (MC)-derived exosomes on macrophages in culture. In order to identify new therapeutic agents, we screened a validated compound library that can efficiently inhibit this mechanism and also studied their effects on DKD.

**Results:** Exosomes derived from MCs induced inflammation in macrophages, demonstrated by the NF $\kappa$ B transcriptional activity, and TNF $\alpha$  and IL-1 $\beta$  expressions. The effect was significantly enhanced in exosomes from MCs cultured under high-glucose conditions compared to low-glucose conditions. We observed that fluorescent-labeled exosomes were endocytosed by macrophages *in vitro* and *in vivo*. Next, we conducted drug screening using a compound library to find candidates that could specifically and effectively inhibit the inflammation process induced by exosomes. The screening was divided into four steps, and we succeeded in narrowing down the list to 30 candidate compounds from a total of 1,364 compounds. Finally, an HSP90 inhibitor, alvespimycin, was identified as a compound with strong inhibitory effects on both exosome uptake and the NF $\kappa$ B transcriptional activity. Treatment of a diabetic rat model with alvespimycin significantly reduced proteinuria and tended to suppress mesangial expansion.

**Conclusions:** Local inflammation by exosome-mediated crosstalk between MCs and macrophages could be involved in DKD progression. Furthermore, alvespimycin, one of the HSP90 inhibitors obtained by drug screening, can effectively ameliorate this process, suggesting that such mechanism could become a novel therapeutic strategy for DKD.

## TH-PO211

### SGLT2 Inhibitors Enhance Metallothionein Expression in Kidney Proximal Tubules of Adolescents With Type 2 Diabetes

Fadhl Alakwaa,<sup>1</sup> Phillip J. McCown,<sup>1</sup> Abhijit S. Naik,<sup>1</sup> Jennifer A. Schaub,<sup>1</sup> Rajasree Menon,<sup>1</sup> Edgar A. Otto,<sup>1</sup> Viji Nair,<sup>1</sup> Sean Eddy,<sup>1</sup> Laura Pyle,<sup>4</sup> Roger K. Harned,<sup>4</sup> Patricia E. Ladd,<sup>4</sup> Felix H. Eichinger,<sup>1</sup> Damian Fermin,<sup>1</sup> Wenjun Ju,<sup>1</sup> Jeffrey B. Hodgins,<sup>1</sup> Robert G. Nelson,<sup>3</sup> Frank C. Brosius,<sup>2</sup> Matthias Kretzler,<sup>1</sup> Petter Bjornstad.<sup>4</sup> Kidney Precision Medicine Project <sup>1</sup>University of Michigan, Ann Arbor, MI; <sup>2</sup>University of Arizona, Tucson, AZ; <sup>3</sup>National Institute of Diabetes and Digestive and Kidney Diseases, Phoenix, AZ; <sup>4</sup>University of Colorado School of Medicine, Aurora, CO.

**Background:** Oxidative stress is a main contributor to diabetic kidney disease (DKD), and SGLT2 inhibitors (SGLT2i) mitigate DKD onset in type 2 diabetes (T2D). An investigation of cell-type specific molecular reprogramming in the kidney with SGLT2i treatment was undertaken in young persons with T2D.

**Methods:** Single-cell RNA sequencing (scRNAseq) profiles of young persons (17 $\pm$ 2 years) with T2D, treated with SGLT2i (N=10, T2Di+) or not (N=6, T2Di-), and healthy controls (N=6, HC) were obtained from protocol kidney biopsies. Similarly derived scRNAseq data were available for living donors (N=20, LD), T2D Pima Indians with DKD (N=42), and Kidney Precision Medicine Project (N=12) cohorts. Analysis of scRNAseq data identified differentially expressed genes (DEGs). enrichR enabled pathway enrichment analysis of DEGs.

**Results:** All participants had normal to elevated GFR by iohexol clearance (185-224 ml/min). Similar occurrence of microalbuminuria (~20%) but lower HbA1c (6.1% vs. 7.3%) were observed in T2Di- compared to T2Di+ at screening. In the proximal tubular (PT) cluster (10,032 cells), 1003 genes elevated in T2Di- vs. HC were suppressed by SGLT2i (T2Di+ vs. T2Di-) while 176 repressed transcripts in T2Di+ were recovered with SGLT2i. Most metabolic pathways increased in T2Di- were suppressed in PT by SGLT2i, except metallothionein and insulin receptor signaling pathways, which were enhanced with SGLT2i exposure (p<0.05). Repression of metallothioneins in PT could be validated in two independent DKD cohorts (Fig.1).

**Conclusions:** SGLT2i treatment may rescue metallothionein expression in PT, consistent with a more favorable redox state.

**Funding:** NIDDK Support

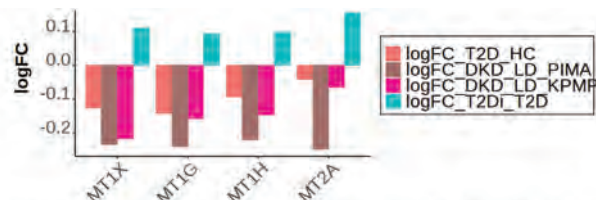

Fig. 1: Diabetic-associated down-regulation of MT genes in three cohorts (T2D, Pima Indians, KPMP). Treatment with SGLT2i (T2Di) in the youth onset T2D cohort, showed enhanced expression of MT genes relative to T2D. Abbreviations: MT-metallothionein, T2D-type 2 diabetes; LD-living donors; KPMP- Kidney Precision Medicine Project; SGLT2i- sodium-glucose cotransporter-2 inhibitors; logFC-log2 fold change.

## TH-PO212

### Platelets and Neutrophil Extracellular Traps Promote Glomerular Endothelial Dysfunction and Barrier Disruption in Diabetic Kidney Disease

Anubhuti Gupta, Kunal Singh, Khurram Shahzad, Berend H. Isermann, Shrey Kohli. *Universitätsklinikum Leipzig, Leipzig, Germany.*

**Background:** Diabetic kidney disease (DKD) is a major cause of end-stage renal failure contributing to morbidity and mortality worldwide. Therapies to prevent or reverse DKD progression are limited or lacking, respectively. Endothelial dysfunction, platelet-hyperactivity, immune cell infiltration and glomerular filtration barrier (GFB) disruption are associated with DKD. Mechanistic insights concerning the interplay between platelets and neutrophil extracellular traps (NETs) and ensuing endothelial dysfunction for DKD progression limited.

**Methods:** Renal function, platelet activation and NETs formation was evaluated in a mouse diabetes model. Therapeutic interventions (Aspirin, Anakinra, Solulin, GSK484) were performed after establishment of DKD to study disease reversal. *In vitro* studies were performed using glomerular endothelial cells (GENC), platelets and neutrophils exposed to high glucose (HG) in static and flow conditions.

**Results:** Experimental DKD in C57Bl6 mice resulted in albuminuria and increased fractional mesangial area that correlated with activated platelets (CD62P), NETs (H3Cit, NE, PAD4) within glomeruli and plasma NETs markers. In parallel, increased expression of inflammasome markers (NLRP3, IL1 $\beta$ ) and reduced expression of thrombomodulin (TM) was observed. *In vitro*, platelets and NETs exacerbate inflammasome markers (IL1 $\beta$ , NLRP3), reduce endothelial function markers (p-eNOS, KLF2, KLF4 and TM) in GENC and disrupted GFB (enhanced FITC-dextran leakage, disoriented VE cadherin) in HG conditions. Under flow condition, platelets enhanced NETs formation on GENC monolayers exposed to HG. Inhibition of platelet activation (Aspirin), amelioration of NETs (GSK484), targeting P-selectin mediated platelet-neutrophil interactions, IL-1 receptor inhibition (anakinra) or restoring TM expression (solulin) ameliorated these effects *in vitro* and *in vivo*. Further experiments evaluating the clinical relevance in diabetic patient cohorts are under progress.

**Conclusions:** Hyperglycemia promotes platelet-neutrophil interactions resulting in intraglomerular NETs formation, sterile inflammation, glomerular endothelial dysfunction and GFB disruption. This results in aggravated disease course and impaired renal health in DKD. Inhibition of platelets or NETs is a promising therapeutic strategy for DKD.

## TH-PO213

### miR-34a as a Potential Marker in Diabetic Kidney Disease

Anil K. Karihaloo,<sup>1</sup> Vivek Das,<sup>1</sup> Shuya Liu,<sup>2</sup> Wenjun Ju,<sup>3</sup> Viji Nair,<sup>3</sup> Laura Goea,<sup>4</sup> Markus Bitzer,<sup>3</sup> Christopher L. O'Connor,<sup>5</sup> Matthias Kretzler,<sup>3</sup> Tobias B. Huber.<sup>2</sup> <sup>1</sup>Novo Nordisk AS, Seattle, WA; <sup>2</sup>Universitätsklinikum Hamburg-Eppendorf, Hamburg, Germany; <sup>3</sup>University of Michigan Medical School, Ann Arbor, MI; <sup>4</sup>Bayer CropScience AG, Monheim, Germany; <sup>5</sup>Swiss Institute of Bioinformatics, Lausanne, Switzerland.

**Background:** Diabetic kidney disease (DKD) is the most common complication of diabetes. Various rodent models recapitulate human DKD only partially. Literature evidence suggests role of short non-coding microRNAs in DKD [1]. Through BEAT-DKD we have interrogated the transcriptional and post-transcriptional networks associated with DKD in BTBR Ob/Ob [2] mice in a multi-parametric design spanning across Genotype, Sex differences and course of the disease trajectory.

**Methods:** NanoString microRNA panel (n = 600) was used to profile 200 samples comprising of kidney, urine and serum. We used NACHO for quality control, quantification and limma for multivariable regression to identify microRNAs associating with the phenotypic differences between Ob/Ob vs WT, male vs female, and correlated with disease progression. Quantitative imaging assessment was used to identify kidney phenotypic differences in Ob/Ob vs WT. A support vector machines (SVMs)-based tool miRDB was used to predict functional microRNA-gene targets that are conserved between mice and human with confidence score  $\geq$  60 and significantly changed in DKD.

**Results:** miR-34a emerged as one of the strongest candidates up-regulated in Ob/Ob kidney and urine (adj.p-value < 0.05). miRDB identified 20 gene targets of miR-34a that are conserved between mice and human, differentially regulated (adj.p-value < 0.05) in human DKD glomerular RNAseq data and mouse DKD bulk RNAseq data. These miR-34a gene targets included AMAD12, AXL, PDGFRA, PROM-1, etc that enriched for pathways involved in DKD pathogenesis like cell adhesion, podocyte injury, hypoxia inducible factor (HIF)/vascular endothelial growth factor signalling.

**Conclusions:** Our integrative analysis, identified miR-34a and its conserved gene targets significantly changed in both DKD mice and human datasets, revealed molecular networks and pathways with underlying association with disease, thus indicating its potential role in DKD. References: 1. Loganathan TS, Sulaiman SA, Abdul Murad NA, et al. Interactions Among Non-Coding RNAs in Diabetic Nephropathy. *Front Pharmacol.* 2020;11:191. Published 2020 Mar 3. doi:10.3389/fphar.2020.00191 2. Hudkins, Kelly L et al. "BTBR Ob/Ob mutant mice model progressive diabetic nephropathy." *Journal of the American Society of Nephrology: JASN* vol. 21,9 (2010): 1533-42. doi:10.1681/ASN.2009121290

**Funding:** Government Support - Non-U.S.

## TH-PO214

### Diabetes Promotes Nitric Oxide Synthase Remodeling in Glomerular Podocytes

Mariia Stefanenko,<sup>1</sup> Marharyta Semenikhina,<sup>1</sup> Mykhailo Fedoriuk,<sup>1</sup> Joshua H. Lipschutz,<sup>1,3</sup> Alexander Staruschenko,<sup>2</sup> Oleg Palygin.<sup>1</sup> <sup>1</sup>Medical University of South Carolina, Charleston, SC; <sup>2</sup>University of South Florida, Tampa, FL; <sup>3</sup>VA Medical Center Ralph H Johnson, Charleston, SC.

**Background:** The release of nitric oxide (NO) by glomerular cells, together with the renin-angiotensin system (RAS), regulate glomerular filtration. Several reports indicate that NO levels in glomeruli are decreased during renal pathology development while restoring NO levels can benefit glomerular function. However, expression of NOS subunits in podocytes, especially under diseased conditions, was not established.

**Methods:** To detect NO production and NOS distribution in control and diabetes, we used confocal imaging of podocytes loaded with DAF-FM fluorescent marker. Freshly isolated glomeruli from the Type 2 Diabetic Nephropathy (T2DN) and control Wistar rats, and conditionally immortalized human podocyte cell line exposed to high glucose conditions (12 hrs) were used in the studies. NO production was detected in response to Ang II stimulation, and NOS distribution was determined using NOS1 and NOS2 commercially available inhibitors (Nω-Propyl-L-arginine hydrochloride and L-NIL, respectively).

**Results:** Under normal conditions, in response to Ang II application, rapid NO production was observed in cultured and Wistar rats isolated glomeruli podocytes. NO release was blocked by preincubation with corresponding NOS inhibitors. Our data indicate that NOS1 is predominant signaling in healthy podocytes (69±5% of total NO response). The rest of the RAS-mediated NO production was attributed to NOS2 (39±5%). Under diabetic conditions, NO release in response to Ang II has slightly decreased with the maximal amplitude of 78±10% of control. Moreover, high glucose drastically changes NOS distribution in cultured podocytes, where NOS2 signaling becomes predominant (89±7% of total NO response), and NOS1 becomes less significant.

**Conclusions:** The changes in the distribution of NO sources due to shifts in NOS subunit expression activity may be linked to an increase in oxidative and nitrosative stress. Here we demonstrated that under the condition of diabetes NOS2 activity becomes predominant and may be directly related to the rapid development of the pathological processes in podocytes. Further understanding this fundamental pathway in the glomerulus is essential for efficient treatment and prevention of the development of diabetic kidney disease.

**Funding:** NIDDK Support, Other NIH Support - NIDDK DK126720; UL1TR001450/ SCTR 2214; 101 BX000820, Veterans Affairs Support, Private Foundation Support, Clinical Revenue Support

## TH-PO215

### Truncated suPAR Simultaneously Causes Kidney Disease and Diabetes Mellitus

Ke Zhu,<sup>1</sup> Kamalika Mukherjee,<sup>2</sup> David C. Wei,<sup>1</sup> Salim Hayek,<sup>3</sup> Agnieszka Collins,<sup>2</sup> Kristin M. Corapi,<sup>2</sup> Mehmet M. Altintas,<sup>1</sup> Sushrut S. Waikar,<sup>4</sup> Antonio C. Bianco,<sup>5</sup> Sanja Sever,<sup>2</sup> Jochen Reiser.<sup>1</sup> <sup>1</sup>Rush University Medical Center, Chicago, IL; <sup>2</sup>Harvard Medical School, Boston, MA; <sup>3</sup>University of Michigan, Ann Arbor, MI; <sup>4</sup>Boston University, Boston, MA; <sup>5</sup>University of Chicago Division of the Biological Sciences, Chicago, IL.

**Background:** suPAR is an innate-immune derived circulating kidney disease risk factor, elevated plasma levels of which have been associated with diabetic nephropathy. Enzymatic cleavage of domain 1 (D1) from suPAR generates D2D3 fragment. The biological consequence of this fragment is unclear.

**Methods:** 1) we used an immunoprecipitation-mass spectrometry to determine the presence of D2D3 fragment in diabetic nephropathy patients with insulin dependence; 2) we generated a transgenic mouse model that drives D2D3 expression from adipocytes with consequent release into circulation. To stimulate D2D3 expression, we treated the control and D2D3 mice with high fat diet (HFD) for 6 months to measure proteinuria monthly. We analyzed the phenotypes of control and D2D3 mice by glucose tolerance test (GTT), glucose stimulated insulin secretion assay (GSIS) *in vivo* and *in vitro*; 3) we treated both mouse and human islets with recombinant D2D3 proteins purified from HEK293 cells, and performed *in vitro* GSIS to determine islet function; 4) we performed immunohistochemical staining using the control and D2D3 pancreas to explore if D2D3 influences the β-cell mass.

**Results:** Compared to controls, D2D3 mice with HFD developed significantly increased proteinuria and presented with reduced serum insulin levels. Under chow diet, both *in vivo* and *in vitro* GSIS were compromised in D2D3 mice and GTT of these mice was impaired as well. In consistence, isolated islets from WT mice or human pancreas treated with recombinant D2D3 protein displayed impaired response to high dose glucose,

as compared to the BSA-treated islets. α-/β-cells distribution pattern was dramatically altered in the D2D3 mice, with glucagon-positive α-cells being randomly dispersed among insulin-positive β-cells. β-cell mass in D2D3 mice was reduced to half of control levels, assessed by the decreased β-cell population in D2D3 islets. Moreover, treatment of mouse β-cell line (MIN6 cells) with D2D3 displayed reduced insulin secretion upon high glucose stimulation and impaired glycolysis and mitochondrial respiration.

**Conclusions:** Mouse D2D3 fragment regulates glucose homeostasis by playing a direct role in β-cell function. It also impairs podocyte function. Generation of D2D3 represents an inciting event in the immune-derived diabetic kidney disease.

**Funding:** NIDDK Support

## TH-PO216

### Diabetes Activates Dynein Mediated Trafficking and Degradation of Nephritin via AMPK/SP-1 Regulated Transcription

Hua Sun, Jillian Weidner. *The University of Iowa, Iowa City, IA.*

**Background:** Diabetic podocytopathy is the most prevalent acquired human podocytopathy. Diabetic podocyte injury initiates before the onset of microalbuminuria and eventually leads to 50% of renal failure in the US. We recognized an enhanced dynein-mediated trafficking of nephritin in diabetic podocyte injury, but the mechanism by which diabetes activates the dynein-drive pathogenesis remains unclear. Bioinformatic analysis predicts that dynein genes are under the regulation of specificity protein 1 (SP-1), a transcriptional factor that is modulated by AMP-activated protein kinase (AMPK) under diabetic condition. Therefore, we hypothesize that AMPK/SP-1 guided dynein transcription plays a key role in the early stage of diabetic podocytopathy.

**Methods:** Dynein expression was examined by real time PCR in podocytes growing under hyperglycemic or normoglycemic conditions, with or without manipulations of AMPK activity (by Compound C or AICAR), or knockdown of SP1 (using siRNA). AMPK activity was reflected by measuring Thr 172 phosphorylation. Live cell imaging and trajectory analysis were performed to study the dynein-dependent trafficking of nephritin to lysosomes or recycling endosomes. Dynein expression, as well as its correlations with AMPK activity and nephritin degradation were investigated in glomeruli isolated from Streptozotocin (STZ)-induced diabetic mice.

**Results:** 1. Upregulated expression of dynein was demonstrated in podocytes with prolonged exposure to high glucose, in which AMPK activity was found to be suppressed. This change could be rescued by the activation of AMPK using AICAR, or knockout of SP1. 2. Knockdown of dynein components that were upregulated by hyperglycemia attenuated the sorting of nephritin from recycling endosome to lysosomal system. 3. The increased expression of dynein and dynein-mediated trafficking of nephritin were verified in STZ-induced diabetic glomerulopathy in mice. These changes correlated with the inhibition of AMPK, ubiquitination degradation and depletion of nephritin, especially the surface nephritin.

**Conclusions:** Hyperglycemia suppresses AMPK, which in turn disinhibits SP-1 guided transcription of dynein. The increased expression of dynein in diabetes promotes the trafficking of nephritin from recycling pathway to lysosomal degradation system, depletes the surface nephritin, impairs the slit diaphragm and causes diabetic podocytopathy.

**Funding:** Other NIH Support - NICHD Child Health Research Career Development Award, University of Iowa (PI: Bassuk K12), Private Foundation Support

## TH-PO217

### Podocyte-Mediated Proximal Tubule Preconditioning Is Protective in Diabetic Kidney Disease

Bismark Owusu Frimpong, Nehaben A. Gujarati, Sandeep K. Mallipattu. *Stony Brook University, Stony Brook, NY.*

**Background:** Diabetic kidney disease (DKD) is a glomerulopathy, with inciting events occurring in cells that comprise the glomerulus. However, recent findings have implicated proximal tubule (PT) injury in the progression of DKD. Potential mechanisms by which PT can be preconditioned to prevent the progression of DKD remain poorly understood. The aim of this study is to demonstrate that podocyte-specific induction of a zinc finger transcription factor, Krüppel-like factor 6 (KLF6), attenuates DKD by preconditioning the PT against DKD progression.

**Methods:** Podocyte-specific induction of KLF6 (*hKLF6<sup>POD</sup>*) were generated using *NPHS2-rtTA* and *TRE-KLF6* mice, under doxycycline treatment. Diabetes was induced with UNX-STZ, with SHAM-Veh serving as the control. Single nucleus (sn)RNA-seq was conducted from kidney cortex of all mice. Conditioned media (CM) from podocytes isolated from *hKLF6<sup>POD</sup>* and control mice were collected. *CAMK1d* was knocked down in HK2 cells (*sh-CAMK1d*). CAMK1d signaling was pharmacologically inhibited using STO-609, an inhibitor of the upstream kinase CAMKK, in primary (1°) PT cells. Oxygen consumption rate (OCR) was measured with Seahorse Analyzer.

**Results:** Diabetic *hKLF6<sup>POD</sup>* mice exhibited less albuminuria, podocyte injury, glomerulosclerosis, and tubulointerstitial injury compared to diabetic controls. Clustering of the snRNA-seq data identified a subpopulation of PTs predominant in the *hKLF6<sup>POD</sup>* groups. Gene Set Enrichment Analysis of this subpopulation showed an enrichment for mitochondrial respiration pathways and upregulation in *Camk1d* gene expression and signaling. In assessing the role of CAMK1d in PTs, we found that *sh-CAMK1d* cells exhibited slower growth and lower cell viability with a larger proportion in s-phase of cell cycle compared to control cells. 1° PT cells treated with STO-609 validated this decrease in cell viability and OCR. Additionally, 1° PT cells primed with CM from *hKLF6<sup>POD</sup>* podocytes had preserved OCR compared to PT treated with CM from control podocytes in high glucose conditions.

**Conclusions:** These data suggest that podocyte-specific induction of *KLF6* preconditions the proximal tubules against DKD progression by upregulating CAMK1 $\delta$  signaling.

**Funding:** NIDDK Support, Veterans Affairs Support

#### TH-PO218

##### Developing hPSC-Derived Kidney Organoid Model for Emulating Key Pathological Features of Diabetic Nephropathy

Angelysia Cardilla, Tian Zhang, Mihir Y. Naik, Yun Xia. Lee Kong Chian School of Medicine, Singapore, Singapore.

**Background:** Diabetic nephropathy (DN) represents one of the leading causes of end-stage renal disease (ESRD). Current treatment of DN focuses primarily on controlling physiological symptoms without retarding or reversing disease progression. To date, most DN studies are based on animal models, though there is a major concern on how closely the animal models mimic human pathophysiology. A new DN model that presents higher relevance with human physiology is urgently needed to better understand the disease mechanisms of DN and to discover effective therapeutics.

**Methods:** In the past decades, organoids have become a powerful tool for modeling human diseases due to their ability to recapitulate the complexity of human organs. Here, we used state-of-the-art kidney organoid technology to emulate pathogenesis of diabetic nephropathy. Kidney organoids are derived *in vitro* from human pluripotent stem cells (hPSCs), harboring segmentally patterned nephron-like structures and stroma, as well as a vascular network. To emulate DN phenotypes, we exposed hPSC-derived kidney organoids to stress paradigms that are presented in pre-diabetic and diabetic states. We performed histopathological and functional analysis to evaluate organoid pathology under these conditions.

**Results:** Within diabetic kidney organoids, we observed multiple phenotypes that are characteristic of DN, including altered tissue architecture and compromised functionality. Particularly, the existence of an intrinsic vascular network enabled us to interrogate the deterioration of renal vasculature during the development of DN.

**Conclusions:** The new human stem cell-based kidney organoid model will allow us to study DN pathogenesis *in vitro* as well as *in vivo*, leading to identification of novel therapeutic agents with higher clinical potential.

#### TH-PO219

##### Cytochrome P450: Protagonists in the Story of Diabetic Kidney Disease

Batoul Dia, Elias Shamieh, Mohamad Noureldin, Hilda E. Ghadieh, Fuad N. Ziyadeh, Assaad Antoine Eid. American University of Beirut, Beirut, Lebanon.

**Background:** Diabetic kidney disease (DKD) is a debilitating complication and a major contributor to all-cause mortality in patients with diabetes. Cytochrome P450 (CYPs) epoxygenases metabolize arachidonic acid into the vasoactive and renal-active HETEs and EETs. Our group, among others, described the implication of CYPs and their metabolites in the pathogenesis of DKD by activating reactive oxygen species (ROS) production. More importantly, CYPs-encoding genes possess different polymorphisms that can alter the expression of these key enzymes, affecting the prognosis of patients with DKD. Besides, miRNAs that can be involved in DKD are recently gaining high interest. To our knowledge, the regulatory effect of miRNAs on the expression of different CYPs in DKD is not yet established. Herein, we hypothesize that in patients with diabetes, genetic variants in CYP enzymes known to be implicated in AA metabolism potentiate the development of DKD.

**Methods:** Blood and urine were collected from healthy volunteers, patients with type 2 diabetes (T2DM) with or without clinical manifestation of DKD. Urinary and circulating levels of 20-HETE and EETs were assessed and correlated with the expression of CYPs in the kidney biopsies. Furthermore, miRNA analysis was performed to study CYP enzymes regulation.

**Results:** Circulating levels of 20-HETE were increased in patients with DKD when compared to T2DM patients with no clinical signs of DKD, which in turn had higher levels of 20-HETE in comparison to the healthy volunteers. This was associated with an increased expression of CYP4A11 and CYP4F8 in the human kidney biopsies. In parallel, EETs levels were decreased in patients with T2DM and DKD as compared to patients with T2DM only and this was positively correlated with the decreased CYP2B6 expression in kidney biopsies. Of interest patients with DKD carry CYPs polymorph affecting their enzymatic activity and subsequently leading to increased 20-HETE and decreased EETs. The same may be concluded when it comes to our miRNA study.

**Conclusions:** This study may yield crucial findings about novel genetic and epigenetic pathways involved in diabetes-induced renal injury and may identify novel prognostic and diagnostic biomarkers associated to CYPs pathways alteration in DKD.

#### TH-PO220

##### $\beta_2$ Adrenergic Receptor Agonists as a Novel Treatment for CKD

Ehtesham Arif,<sup>1</sup> Danira Medunjanin,<sup>2</sup> Ashish K. Solanki,<sup>1</sup> Xiaofeng Zuo,<sup>1</sup> Yanhui Su,<sup>1</sup> Brennan Winkler,<sup>1</sup> Oleg Palygin,<sup>1</sup> Marc-Andre Cornier,<sup>1</sup> Bethany Wolf,<sup>3</sup> Kelly J. Hunt,<sup>3,2</sup> Joshua H. Lipschutz.<sup>1,4</sup> <sup>1</sup>Medical University of South Carolina Division of Nephrology, Charleston, SC; <sup>2</sup>Medical University of South Carolina Department of Public Health Sciences, Charleston, SC; <sup>3</sup>Department of Biostatistics, Medical University of South Carolina, Charleston, SC; <sup>4</sup>VA Medical Center Ralph H Johnson, Charleston, SC.

**Background:** We recently showed that formoterol, a long-acting beta 2 adrenergic receptor ( $\beta_2$ -AR) agonist, induced recovery from kidney injury in mice.

**Methods:** To determine the effect of formoterol on renal function in humans, we performed a competing risk regression in Veterans, aged 65 and over, with incident chronic kidney disease (CKD) stage 4 to compare the rate of end stage kidney disease (ESKD) progression in Veterans without and with chronic obstructive pulmonary disease (COPD), who use  $\beta_2$ -AR agonists. Additionally, we used a high fat diet (HFD), a murine model of type 2 diabetes, and streptozotocin, a murine model of type 1 diabetes, to examine the role of formoterol in diabetic nephropathy, the most common cause of ESKD.

**Results:** We found that COPD, by means of  $\beta_2$ -AR agonist intake, was protective against progression to ESKD. A 39.4% [HR:0.61 (95% CI: 0.51-0.72)] reduction in the rate of ESKD in Veterans with COPD compared to those without was observed after adjusting for age, diabetes, sex, and race-ethnicity. Animal studies indicate that there was a marked recovery from and reversal of diabetic kidney disease in HFD mice treated with formoterol compared to those treated with vehicle alone at the ultrastructural, histological, and functional levels. Similar results were seen after formoterol treatment in mice receiving streptozotocin. The mechanism of action appeared to be improvement in mitochondrial function.

**Conclusions:** Together these data indicate that  $\beta_2$ -AR agonists, especially formoterol, may be a novel treatment for diabetic nephropathy and perhaps other forms of CKD. If confirmed in a prospective randomized clinical trial this would be the first treatment able to reverse diabetic nephropathy.

**Funding:** NIDDK Support, Veterans Affairs Support

#### TH-PO221

##### Long Noncoding RNA ENST00000436340 Promotes Podocyte Injury of Diabetic Kidney Disease by Facilitating the Association of PTBP1 With RAB3B

Zhimei Lv,<sup>1,2</sup> Jinxiu Hu,<sup>2</sup> Rong Wang.<sup>1,2</sup> <sup>1</sup>Department of Nephrology, Shandong Provincial Hospital Affiliated to Shandong First Medical University, Jinan, China; <sup>2</sup>Department of Nephrology, Shandong Provincial Hospital, Shandong University, Jinan, China.

**Background:** Dysfunction and injury of podocytes has been regarded as an early pathologic characteristic of diabetic kidney disease (DKD), but the role of long noncoding RNAs in this process remains largely unknown. By performing RNA sequencing, we identified ENST00000436340 was significantly upregulated in DKD. However, its function and detailed molecular mechanisms are undefined.

**Methods:** real-time PCR was performed to verify ENST00000436340 expression in DKD. Spearman correlation analysis were used to evaluate the correlation between ENST00000436340 and kidney function. real-time PCR, WB, Immunofluorescence, and FITC-phalloidin staining were performed to assess the lesion of podocyte. MeRIP was performed to investigate the underlying mechanism of ENST00000436340 upregulation. FISH and subcellular fractionation assays were conducted to identify the localization of ENST00000436340 in podocytes. RNA pulldown, RIP and serial deletions assay were performed to explore the interaction between ENST00000436340, RAB3B and PTBP1.

**Results:** We discovered ENST00000436340 was upregulated in DKD, and we showed a correlation between upregulated ENST00000436340 and the severity of kidney injury. Function experiments showed that silencing of ENST00000436340 alleviated high glucose-induced podocyte injury and cytoskeleton rearrangement. Mechanistically, we showed that FTO-mediated m6A induced the upregulation of ENST00000436340, which interacted with PTBP1 and augmented PTBP1 binding to RAB3B mRNA, promoted RAB3B mRNA degradation, and thereby caused cytoskeleton rearrangement and inhibition of GLUT4 translocation, leading to podocyte injury.

**Conclusions:** We identified an ENST00000436340-PTBP1-RAB3B axis in regulating cytoskeleton rearrangement and GLUT4 translocation, leading to podocyte injury, which will provide insights into the prevent and treatment of DKD in the future.

**Funding:** Government Support - Non-U.S.

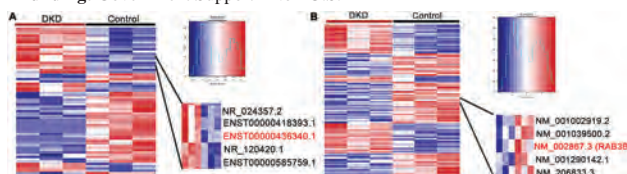

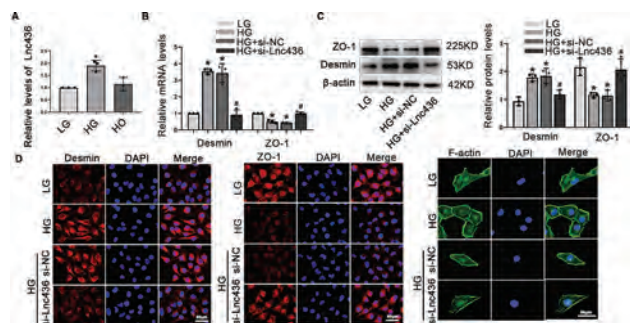

## TH-PO222

### Significant Differential Methylation of Telomere-Related Genes in Diabetic Kidney Disease and Its Potential Role in Regulating Gene Expression and Wnt Signalling

Claire Hill,<sup>1</sup> Niina Sandholm,<sup>3,4</sup> Jill Kilner,<sup>1</sup> Peter Rossing,<sup>2</sup> Maria Lajer,<sup>2</sup> Per-Henrik Groop,<sup>3,4</sup> Alexander P. Maxwell,<sup>1</sup> A.J. Mcknight,<sup>1</sup> <sup>1</sup>Centre for Public Health, Queen's University Belfast, Belfast, United Kingdom; <sup>2</sup>Steno Diabetes Center Copenhagen, Herlev, Denmark; <sup>3</sup>Folkhälsan Institute of Genetics, Folkhälsan Research Center, Biomedicum Helsinki, Helsinki, Finland; <sup>4</sup>Division of Nephrology, Department of Medicine, Helsinki University Central Hospital, Helsinki, Finland.

**Background:** Diabetic kidney disease (DKD) significantly impacts patients, families and health service globally. Accelerated cellular senescence has previously been suggested as a key target for therapeutic development within DKD. The telomere-protective chromosome end structures undergo shortening with advancing age and senescence.

**Methods:** Genotype data in telomere-related genes was extracted from genome-wide case-control association data (n=1,830) while telomere length was calculated relative to a single copy gene and established using quantitative polymerase chain reaction. Cases were defined as individuals with Type 1 Diabetes (T1D) with persistent proteinuria, hypertension, and retinopathy. Controls were individuals with T1D for at least 15 years, normoalbuminuric and not taking antihypertensive medication or ACE inhibitors. Quantitative CpG methylation values for telomere-related genes were extracted from epigenome-wide case-control association data (n=250).

**Results:** Telomere length was significantly shorter in DKD patients vs. controls (P=0.002); however, not sustained following covariate adjustment or replication. DKD and ESKD were nominally associated with telomere-related genetic variation, with Mendelian Randomisation highlighting no significant association between genetically-predicted telomere length and disease outcomes. Investigating 1,091 CpG sites in 378 telomere-related genes, 496 sites in 212 genes reached epigenome-wide significance (P≤10<sup>-8</sup>) for DKD association, and 412 sites in 193 unique genes for ESKD. Functional prediction via gene ontology analysis of differentially methylated genes revealed enriched processes such as developmental regulation and Wnt signalling. Harnessing previously published RNA-sequencing datasets, differential methylation was correlated with gene expression changes during DKD, highlighting prospective targets where epigenetic regulation may result in altered gene expression, potentially influencing disease outcomes.

**Conclusions:** This study utilised multiple telomere focused omic datasets to provide insights into the genomic landscape of DKD, highlighting genes and molecular pathways for downstream analysis to aid the development of diagnostic and therapeutic interventions for CKD.

**Funding:** Other NIH Support - National Institutes of Health (R01AG068937), Government Support - Non-U.S.

## TH-PO223

### Comparative Transcriptomics of Human and Mouse Diabetic Kidney Disease

Frederikke E. Sembach,<sup>1</sup> Mette V. Østergaard,<sup>1</sup> Jens Christian Nielsen,<sup>1</sup> Mikkel Christensen-Dalsgaard,<sup>1</sup> Martin R. Madsen,<sup>1</sup> Bo Feldt-Rasmussen,<sup>2</sup> Esteban Porrini,<sup>3</sup> Mads Hornum,<sup>2</sup> Lisbeth N. Fink,<sup>1</sup> <sup>1</sup>Gubra ApS, Hørsholm, Denmark; <sup>2</sup>Rigshospitalet, Kobenhavn, Denmark; <sup>3</sup>Hospital Universitario de Canarias, La Laguna, Spain.

**Background:** Transcriptome profiling is instrumental for investigating molecular mechanisms driving disease progression in diabetic kidney disease (DKD). However, a major impediment in DKD research is the scarcity of frozen kidney tissue specimens from patients with DKD. To overcome this challenge, the present study applied RNA sequencing of formalin-fixed paraffin-embedded (FFPE) kidney samples from an ongoing study in patients with DKD. The clinical translatability of an advanced DKD mouse model was assessed by comparison to the human transcriptome profile.

**Methods:** RNA sequencing was performed on FFPE kidney samples from patients undergoing nephrectomy as part of the European Nephrectomy BioBank project (ENBiBa). All patients included were diagnosed with obesity and hypertension and were divided into two groups based on presence of type 2 diabetes and DKD (n = 6), while nondiabetic patients with no kidney disease were included as controls (n = 8).

Also, RNA sequencing was performed on snap-frozen kidney cortex samples from a model of advanced DKD facilitated by adeno-associated virus (AAV)-mediated renin overexpression in uninephrectomized (UNx) *db/db* mice and healthy non-diabetic *db/m* controls.

**Results:** A total of 105 differentially expressed genes (DEGs) were identified in human DKD FFPE kidney samples, when compared to the human controls. Of these DEGs, a significant overlap of 32 genes were regulated in both human DKD and *db/db* UNx-ReninAAV mice, including upregulation of genes associated with extracellular matrix remodelling (*COL1A1*, *COL1A2*, *MMP14*, *VCAM1*). The tubular specific marker *UMOD* was downregulated in both human DKD patients and in *db/db* UNx-ReninAAV mice, indicating tubular injury, while solute carrier family genes (*SLC5A3*, *SLC12A1*) were only downregulated in human DKD patients.

**Conclusions:** Identification of regulated genes associated with DKD in this cohort of patients with obesity, diabetes and chronic kidney disease confirms the applicability of RNA sequencing of FFPE samples for analysing global gene expression changes and investigating molecular mechanisms involved in the progression of DKD. Transcriptome signatures in the *db/db* UNx-ReninAAV mouse indicates good clinical translatability, highlighting the use of this model in preclinical DKD research.

**Funding:** Commercial Support - Gubra ApS

## TH-PO224

### Allogeneic Neo-Islet (NI) Therapy of Spontaneously Type 1 Diabetic Dogs Durably Reduces Insulin Need and Hyperglycemia and Protects Renal Function: 3 Year Follow-Up From the INAD Study

Anna Gooch, Sabiha Sultana Chowdhury, Christof Westenfelder, SymbioCellTech, Salt Lake City, UT.

**Background:** We published that treatment with allogeneic NIs, organoids of Mesenchymal Stromal Cells and culture expanded islet cells functionally cured the diabetic state in NOD mice without requiring antirejection drugs or encapsulation. Dog and human NIs produced euglycemia in streptozotocin-diabetic NOD/SCID mice. We tested NI therapy under an FDA guided pilot study (INAD 012-776) in spontaneously diabetic, insulin dependent pet dogs. 6 dogs have been treated and followed for 3 years. We report here the progress of those 6.

**Methods:** Insulin dependent, diabetic pet dogs were studied: 10 enrolled; 8 treated; 6 followed ≥3 yrs. Pre- and post-treatment sera were tested for islet autoantibodies. Comorbidities and BG were treated. Allogeneic NIs were given once i.p. (2.5x10<sup>6</sup>/kg bw) without encapsulation or antirejection agents. Vital signs, BG, insulin need, antibody responses, SCr, BUN, urine protein, lipid profiles, adverse events (AEs) were monitored multiple times for 3 years post-therapy.

**Results:** 3 dogs had pre-treatment islet autoantibodies indicating autoimmunity. 50% of NI treated dogs showed a significant and durable reduction in BG, Fructosamine and HbA1c (12 to 6.8) levels, and 75% showed a significant, durable reduction in daily Insulin requirements (up to 50%). Body weights remained stable; blood pressures were normal. There was no deterioration in renal function, as assessed by SCr and BUN, and no microalbuminuria or proteinuria developed. Hb levels remained normal. Other preexisting comorbidities did not progress.

**Conclusions:** NIs engraft in the omentum, re-differentiate and physiologically produce and deliver insulin and other islet hormones, and are neither rejected by auto- or allo-immune attacks, as evidenced by (i) absent IgG responses to the administered NIs, and (ii) durably (≥ 3 yrs) improved BG and lowered insulin need. While no dog has achieved insulin independence, preclinical results with human NIs indicate that redosing could accomplish this. NI therapy is feasible, durably effective, and safe as no AEs or SAEs related to therapy have been observed to date. This therapy has significant translational relevance for both dog and human T1DM. A successful Pre-IND meeting has been held, and a human clinical trial is under preparation.

**Funding:** Commercial Support - SymbioCellTech

## TH-PO225

### NCOA1 Modulates Glomerulosclerosis in Diabetic Kidney Disease Through Regulating ITGA5

Lili Gai, Chun Zhang, Huazhong University of Science and Technology, Wuhan, China.

**Background:** Nuclear receptor coactivator 1 (NCOA1) is a member of NCOA family, which coactivate and potentiate the expression of target genes, regulating various biological events such as cell proliferation and fibrosis. Recent findings revealed a potential role of NCOA1 in metabolic related diseases and tissue fibrosis. However, its role in glomerulosclerosis of diabetic kidney disease (DKD) remains unclear. Previous data reported NCOA1 could directly enhance integrin alpha 5 (ITGA5) expression and thus promoting ITGA5-mediated biological events. ITGA5 is a cell adhesion protein, which also plays an indispensable role in various tissue fibrosis. Therefore, our study aims to explore whether NCOA1 can be involved in glomerulosclerosis in diabetic kidney disease by regulating ITGA5.

**Methods:** 1. The model of DKD was established by intraperitoneally injection of 150mg/kg streptozotocin in 8-week-old mice. 2. The expression of NCOA1 in renal cortex of DKD mice and glomerular mesangial cells (GMCs) treated by high glucose (HG) were detected by quantitative real-time polymerase chain reaction (qRT-PCR), western blot (WB) and immunofluorescence. The expression of Fibronectin and Collagen IV was detected by WB after HG treated GMCs were transfected with NCOA1 overexpression plasmid. 3. The expression of ITGA5 in vivo and vitro was detected by qRT-PCR, WB



and immunofluorescence in DKD, and the expression of Fibronectin and Collagen IV was detected by WB after HG treated GMCs were transfected with ITGA5 siRNA. 4. The expression of ITGA5 was detected by WB after HG treated GMCs were transfected with NCOA1 overexpression plasmid.

**Results:** 1. The expression of NCOA1 was significantly downregulated in DKD mice and HG-treated GMCs, while overexpression of NCOA1 by plasmid could attenuate HG-induced extracellular matrix (ECM) accumulation in GMCs. 2. The expression of ITGA5 was significantly upregulated in vivo and in vitro of DKD, while knocking down ITGA5 by siRNA could attenuate HG-induced ECM accumulation in GMCs. 3. The activation of ITGA5 induced by HG was obviously attenuated by NCOA1 overexpression in GMCs.

**Conclusions:** NCOA1 might be involved in glomerulosclerosis of DKD by regulating the expression of ITGA5.

## TH-PO226

### Therapeutic Modulation by Combined SGLT2 and ACE Inhibition of Glomerular Filtration in Streptozotocin (STZ)-Diabetic Mice In Vivo

Hannah Kroeger, Friederike Kessel, Jan Sradnick, Vladimir T. Todorov, Florian Gemhardt, Christian Hugo. AG Hugo *Universitätsklinikum Carl Gustav Carus, Dresden, Germany.*

**Background:** Diabetic kidney disease is the leading cause of end-stage renal disease in the Western world. SGLT2 inhibitors, besides ACE inhibitors show renoprotective effects in chronic kidney disease. The underlying renoprotective mechanism of combined SGLT2 inhibition and ACE inhibition therapy is not completely understood. Therefore, we aimed to investigate directly via intravital microscopy the hemodynamic changes in single glomeruli of diabetic mice treated with ACE and/or SGLT2 inhibitors.

**Methods:** Male C57BL/6 mice were injected with streptozotocin to induce type 1 diabetes. After five weeks of diabetes, mice were treated with enalapril, empagliflozin, or enalapril/empagliflozin for three days. We used longitudinal in vivo imaging to evaluate single nephron GFR (snGFR) and afferent as well as efferent arteriole diameter width during ACE and/or SGLT2 inhibition.

**Results:** The STZ-diabetic mice showed significant hyperfiltration (control 1003.0 ± 190.5 µl/min/100g b.w vs. diabetic 1329.4 ± 309.6 µl/min/100g b.w., p<0.05). Enalapril treatment led to a reduction of snGFR and significant efferent arteriole dilation (12.55 ± 1.46 µm vs. control 11.92 ± 1.04 µm, p<0.05) but did not affect afferent arteriole width. Reduced snGFR in diabetic mice as induced by empagliflozin was accompanied by afferent arteriole vasoconstriction (11.19 ± 2.55 µm vs. control 12.35 ± 1.32 µm, p<0.05) but no changes of the efferent arteriole width. Unexpectedly, combined treatment with enalapril/empagliflozin reduced snGFR without any significant alteration in afferent or efferent arteriole diameter width.

**Conclusions:** SGLT2 and ACE inhibitors appear as beneficial hemodynamic regulators of glomerular filtration during early stages of diabetes mellitus by regulating respectively the afferent and the efferent arteriole contractility. The underlying beneficial mechanisms of the combination therapy need further investigation.

## TH-PO227

### Role of Cellular Senescence and Epigenetic Drift in Interstitial Fibrosis of Diabetic Kidney Disease

Ayano Tsukagoshi, Yoshiro Maezawa, Hiyori Kaneko, Shintaro Ide, Masaya Koshizaka, Koutaro Yokote. *Chiba Daigaku Daigakuin Igaku Kenkyuin Igakubu, Chiba, Japan.*

**Background:** In recent years, the number of elderly patients with diabetes has been increasing. In diabetic kidney disease, accumulation of senescent cells and senescence-related epigenome changes may contribute to renal fibrosis.

**Methods:** We investigated senescence markers, histone and its methylation in human renal fibroblasts (HKF) after replicative senescence. In addition, we created elderly diabetes model using streptozotocin injection to 108-week-old mice, and evaluated the phenotypes.

**Results:** HKF was mitotically arrested at passage 18 (p18). P18 HKF showed characteristics of cellular senescence including positive staining for senescence-associated βGal (SAβ-Gal), elevated expressions of *CDKN2A*, *CDKN1A* and *IL6*, one of the senescence-associated secretory phenotype (SASP). RNA-seq and pathway analysis revealed that senescent HKFs were associated with "SASP-related pathway" and "epigenetic gene regulation". Interestingly, gene expression of histone methyltransferases such as *EHMT2*, *EZH2*, *PRMT1* and *SUV39H2* were decreased by 41%, 43%, 29% and 59%, respectively in p18 HKF compared to p12. In addition, by western blot, senescent HKFs showed a marked decrease of HistoneH3 and a concomitant loss of H3K9me3 and H3K27me3, suggesting the HKFs are undergoing the epigenetic drift. The kidneys of aged mice showed enlarged Masson's Trichrome-positive area (18.6% at 18 weeks vs. 34.3% at 120 weeks of age), irregular vascular structure, and increased number of PDGFRβ-positive cells, indicating fibrosis. These findings were worsened in aged mice with STZ diabetes. Tubules, podocytes and some interstitial cells in aged mice were positive for SAβ-Gal and P16 staining. When examined by Nephroseq database, *EHMT2* expression was significantly decreased in the tubule-interstitial region of human diabetic kidney disease. In addition, Camptothecin-induced senescence in HKF resulted in decreased extracellular matrix expressions such as *Acta2*, *Coll1a1* and *FN1* after Tgβ stimulation, suggesting that senescent kidney fibroblasts are responsible for inflammation, but they do not contribute to matrix production.

**Conclusions:** Senescent fibroblast with decreased histone methylation may provide increased SASP production, promote chronic inflammation and renal fibrosis.

## TH-PO228

### Multiparametric Magnetic Resonance Imaging Allows the Prediction of Diabetic Kidney Disease Progression

Kianoush Makvandi,<sup>1</sup> Paul Hockings,<sup>2,3</sup> Gert Jensen,<sup>1</sup> Johannes Hulthe,<sup>2</sup> Henrik Haraldsson,<sup>2</sup> Seema Baid-Agrawal,<sup>1</sup> *<sup>1</sup>Sahlgrenska universitetssjukhuset, Göteborg, Sweden; <sup>2</sup>Antaros Medical, Gotenburg, Sweden; <sup>3</sup>Medtech West, Chalmers University of Technology, Gothenburg, Sweden.*

**Background:** We recently showed that a comprehensive non-contrast multiparametric Magnetic Resonance Imaging (mpMRI) allowed functional and structural assessment of diabetic kidney disease (DKD). We further investigated whether the MRI biomarkers could predict disease progression.

**Methods:** In this prospective study, 38 DKD subjects aged 18–79 years and 20 age- and gender-matched healthy volunteers (HV) were included at baseline. 31 DKD subjects (2 stage 2, 13 stage 3, 14 stage 4, and 2 stage 5) and 17 HV were reexamined at 2 years ± 6 months. Clinical examination, iohexol clearance for measured glomerular filtration rate (mGFR), urine albumin:creatinine ratio and mpMRI were done at both visits. A wide range of MRI biomarkers associated with kidney hemodynamics, oxygenation and macro/microstructure were evaluated. Disease progression was defined by at least one of the following at 2 years: a) decrease in mGFR slope of >5 mL/year/1.73m<sup>2</sup>, b) worsening UACR category or c) any major adverse kidney event defined as sustained decrease in eGFR of >40%/doubling of serum creatinine from baseline, development of kidney failure with mGFR <15 mL/min/1.73m<sup>2</sup> or death from renal cause. Univariable logistic regression analyses were performed to discriminate between progressors and non-progressors using each imaging endpoint as a predictor variable.

**Results:** Mean 2-year mGFR decline (mL/min/1.73m<sup>2</sup>) in DKD patients was -2.7±5.37 and in HV -1.9 ± 10.71. R1 cortex (measure of longitudinal nuclear MR relaxation rate for molecular environment) showed an area under ROC curve of 0.88 (p=0.0074) in DKD subjects (Figure 1) and 0.69 (p=0.032) in the whole population.

**Conclusions:** The imaging biomarker R1 cortex, which reflects molecular environment- viscosity, fibrosis and inflammation (interstitial oedema, cellular swelling) showed significant predictive property for progression of DKD. A confirmatory study with R1 cortex as a pre-specified endpoint is required to confirm these results.

**Funding:** Commercial Support - Antaros Medical AB, AstraZeneca

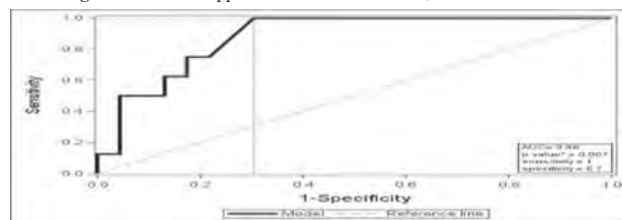

Figure 1. ROC-curve of R1 cortex for predicting progression in DKD patients who have progressed according to at least one of criteria defined in a, b or c

## TH-PO229

### Kidney Fat by Magnetic Resonance Spectroscopy in Type 2 Diabetes and Diabetic Kidney Disease

Niels S. Heinrich,<sup>1</sup> Rune P. Pedersen,<sup>2</sup> Ulrich Lindberg,<sup>2</sup> Ulrik B. Andersen,<sup>2</sup> Bryan Haddock,<sup>2</sup> Tine Hansen,<sup>1</sup> Alessia Fornoni,<sup>3</sup> Peter Rossing,<sup>1</sup> *<sup>1</sup>Steno Diabetes Center Copenhagen, Herlev, Denmark; <sup>2</sup>Rigshospitalet, Kobenhavn, Denmark; <sup>3</sup>University of Miami Katz Family Division of Nephrology and Hypertension, Miami, FL.*

**Background:** Ectopic fat is a major pathogenic factor in type 2 diabetes (T2D). The kidneys may be susceptible to ectopic fat and its lipotoxic effects, disposing them toward chronic kidney disease (CKD). In few smaller studies, using discrepant magnetic resonance methods, intra-kidney fat content appeared to be slightly higher in people with T2D and perhaps even higher with concomitant CKD. We investigated the reproducibility of these findings.

**Methods:** Cross-sectional study including 50 adults with T2D and CKD, 27 with T2D and no CKD and 29 without T2D or CKD; CKD defined as urine albumin creatinine ratio ≥ 30mg/g. Fat content in the kidney parenchyma was assessed by magnetic resonance spectroscopy (MRS) in a 3 Tesla MRI scanner with a single voxel point resolved spectroscopy sequence; echo time 40 ms repetition time 3000 ms.

**Results:** See descriptive statistics in Table. In preliminary MRS data, median [IQR] intra-kidney triglyceride content was 1.1 [0.2-2.0]%, 1.0 [0.5-1.7]%, and 1.7 [0.6-3.4]%, (p = 0.08; Kruskal-Wallis test), respectively, in the T2D and CKD, T2D but no CKD and non-T2D groups. In linear regression adjusting for age and sex, there were likewise no associations between groups and triglyceride content.

**Conclusions:** In T2D with or without CKD we found no trend toward higher intra-kidney fat when evaluated by MRS, despite higher body mass index. Intra-kidney fat content was generally minuscule, making differences difficult to detect. The use of sodium-glucose cotransporter-2 inhibitors and glucagon-like peptide-1 receptor agonists, mostly among T2D participants with CKD, may have affected the results as these agents may reduce ectopic fat. It is also possible that lipid species other than triglyceride differ across the three groups.

**Funding:** Private Foundation Support

	Type 2 diabetes with chronic kidney disease (n=50)	Type 2 diabetes without chronic kidney disease (n=27)	No type 2 diabetes or chronic kidney disease (n=29)
Age, years, mean ± SD	67 ± 7	66 ± 10	66 ± 8
Men, n	42	21	12
Body mass index, kg/m <sup>2</sup> , mean ± SD	31 ± 4	29 ± 4	26 ± 5
Diabetes duration, years, median [IQR]	19 [11-26]	17 [10-24]	NA
Urine albumin:creatinine ratio, mg/g, median [IQR]	95 [42-291]	6 [5-10]	5 [4-6]
Estimated glomerular filtration rate, ml/min/1.73m <sup>2</sup> , mean ± SD	76 ± 22	94 ± 11	89 ± 11
Sodium-glucose cotransporter-2 inhibitor, n	35	13	0
Glucagon-like peptide-1 receptor agonist, n	33	17	0

TH-PO230

Trajectory of Kidney Function Correlates With Renal Blood Flow

Evaluated by Magnetic Resonance Imaging in Diabetic Kidney Disease  
 Paul Hockings,<sup>1,2</sup> Kianoush Makvandi,<sup>3</sup> Gert Jensen,<sup>3</sup> Tim Unnerstall,<sup>3</sup> Henrik Leonhardt,<sup>3</sup> Henrik Haraldsson,<sup>1</sup> Johannes Hulthe,<sup>1</sup> Seema Baid-Agrawal,<sup>3</sup> <sup>1</sup>Antaros Medical, Molndal, Sweden; <sup>2</sup>MedTech West, Chalmers University of Technology, Gothenburg, Sweden; <sup>3</sup>Sahlgrenska universitetssjukhuset, Goteborg, Sweden.

**Background:** New non-invasive markers are needed to increase understanding of the pathogenesis of diabetic kidney disease (DKD). We recently showed that mean arterial flow (MAF) in renal arteries determined by magnetic resonance imaging (MRI) is tightly correlated with mGFR. Here we determine whether MAF tracks mGFR over two years in individual subjects.

**Methods:** In this prospective study, 38 subjects with DKD and 20 age- and gender-matched healthy volunteers (HV) were included at baseline (Visit 1). 31 DKD and 17 HV subjects were re-examined at 2 years (Visit 3) and included in the study. Measured glomerular filtration rate (mGFR) using iohexol clearance, urine albumin:creatinine ratio (UACR) and a variety of MRI techniques, including phase contrast MRI for MAF, were assessed at both visits.

**Results:** Mean and standard deviations (SD) for MAF, mGFR, and UACR for DKD and HV at both visits are shown in Table 1. Spearman rank correlation for mGFR vs MAF was 0.90 at Visit 1 and 0.89 at Visit 3. Figure 1 shows the trajectories of individual subjects over the 2-year period.

**Conclusions:** HV and DKD subjects showed similar mean changes in mGFR and MAF over 2 years, but much greater individual variability in HVs as shown by the increased SD of the delta values. In general, DKD subjects (mGFR <60 at baseline) follow the trend line with reduced MAF and mGFR at Visit 3. Changes in mGFR and MAF of HV may potentially be affected by hyperfiltration in some individuals whereas others may already have utilized their renal reserve. Changes may also be due to changes in medications.

**Funding:** Commercial Support - Antaros Medical; AstraZeneca

	DKD Subjects			HV Subjects		
	MAF (ml/min)	mGFR (ml/min/1.73m <sup>2</sup> )	UACR (mg/g)	MAF (ml/min)	mGFR (ml/min/1.73m <sup>2</sup> )	UACR (mg/g)
Visit 1	631±196	32±13	50±64	1114±226	82±9	1±0
Visit 3	521±188	29±14	119±219	1030±275	80±10	1±1
Delta	-110±105	-3±5	69±168	-111±206	-2±11	0±1

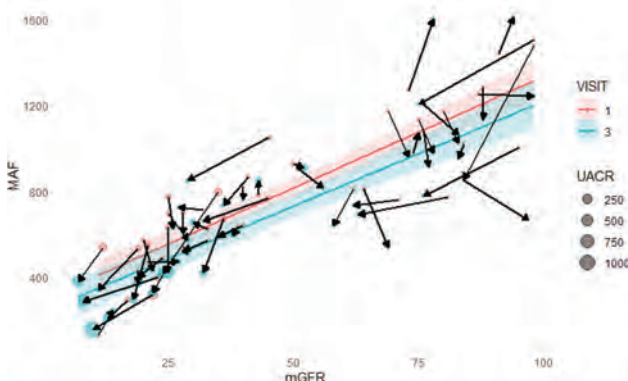

MAF in the renal artery vs mGFR at Visit 1 (red) and Visit 3 (blue). The size of the marker shows the UACR. Individual trajectories are connected by arrows.

TH-PO231

Youth-Onset Type 2 Diabetes Associated With Higher Risk of Kidney Failure

Helen C. Looker,<sup>1</sup> Pierre Jean Saulnier,<sup>2</sup> Tim Vigers,<sup>3</sup> Laura Pyle,<sup>3</sup> Petter Bjornstad,<sup>3</sup> Robert G. Nelson.<sup>1</sup> <sup>1</sup>National Institute of Diabetes and Digestive and Kidney Diseases; CKDS, Phoenix, AZ; <sup>2</sup>Universite de Poitiers, Poitiers, France; <sup>3</sup>University of Colorado Health, Aurora, CO.

**Background:** The prevalence of youth-onset type 2 diabetes (T2D) is increasing and may have a more severe phenotype than adult-onset T2D. Youth-onset T2D in American Indians is associated with more severe structural lesions than adult-onset T2D of similar duration. We examine risk of kidney failure in youth-onset (<25 years) and adult-onset (≥25 years) T2D in the same population.

**Methods:** American Indians with T2D and repeated measures of GFR were followed from first GFR measurement in the study after the age of 25 years for onset of kidney failure. Risk of kidney failure was examined by Cox proportional-hazards in participants with youth-onset T2D compared to adult-onset T2D.

**Results:** 85 participants had youth-onset T2D and 239 had adult-onset T2D. Youth-onset participants were younger, more often female, and had longer diabetes duration, poorer glycemic control, and higher GFR at baseline than adult-onset participants (Table). Over a median follow-up of 19.9 (IQR 9.3-28.3) years there were 95 cases of kidney failure (34 in youth-onset, 61 in adult-onset). The Hazard Rate Ratio (HRR) for incident kidney failure in youth-onset T2D was 2.08 (95% CI 1.23-3.53) times as high as in adult-onset T2D after adjustment for sex and baseline age. The association was attenuated by inclusion of HbA1c in the model (HRR 1.43, 95% CI 0.80-2.56). When younger age at onset was considered as a continuous variable, the HRR for kidney failure per year was 1.07 (95% CI 1.04-1.09) after adjustment for sex, baseline GFR, blood pressure, and HbA1c, reflecting a 7% higher risk of kidney failure for each earlier year of age at diabetes diagnosis.

**Conclusions:** Youth-onset T2D is associated with more severe structural lesions and a greater risk of kidney failure despite higher GFR at baseline. Poorer glycemic control in the youth-onset group may contribute to their more rapid progression of kidney disease.

**Funding:** NIDDK Support

	All (n=325)	Older onset (n=239)	Youth onset (n=86)	p-value
Age (years)	42.0 ± 10.2	45.5 ± 8.9	32.4 ± 6.9	<0.0001
Diabetes duration (years)	10.4 ± 6.8	9.8 ± 6.6	12.2 ± 6.8	0.004
Male sex (%)	106 (32.6%)	90 (37.7%)	16 (18.6%)	0.001
Body mass index (kg/m <sup>2</sup> )	35.5 ± 8.1	35.6 ± 7.7	35.1 ± 9.2	0.64
HbA1c (%)	9.2 ± 2.3*	8.9 ± 2.3**	10.0 ± 2.2	<0.0001
Mean arterial pressure (mmHg)	92.3 ± 10.8	92.8 ± 10.9	90.2 ± 10.3	0.06
Glomerular filtration rate (ml/min)	152 ± 50	144 ± 45	177 ± 53	<0.0001
Albumin:creatinine ratio (mg/g)	36 (11-120)*	40 (11-119)**	46 (18-147)	0.11

\*n=322; \*\*n=236

TH-PO232

Application of the Joslin Kidney Panel Using a Proximity Extension Assay: From Prognostics to Precision Medicine

Zaipul I Md Dom,<sup>1,2</sup> Narges M. Rashidi,<sup>3</sup> Helen C. Looker,<sup>4</sup> Mario Luca Morieri,<sup>1,2</sup> Eiichiro Satake,<sup>1,2</sup> Bozenna Krolewski,<sup>1,2</sup> Joseph Ricca,<sup>1</sup> Jonathan M. Wilson,<sup>5</sup> Robert G. Nelson,<sup>4</sup> Kevin L. Duffin,<sup>5</sup> Alessandro Doria,<sup>1,2</sup> Andrzej S. Krolewski,<sup>1,2</sup> <sup>1</sup>Joslin Diabetes Center, Boston, MA; <sup>2</sup>Harvard Medical School, Boston, MA; <sup>3</sup>Olink Proteomics, Watertown, MA; <sup>4</sup>National Institute of Diabetes and Digestive and Kidney Diseases, Phoenix, AZ; <sup>5</sup>Eli Lilly and Company, Indianapolis, IN.

**Background:** The Joslin Kidney Panel (JKP) of 21 circulating proteins is associated with increased risk of ESKD in patients with diabetes (Kobayashi *et al.* KI 2022). We evaluated the JKP as a tool for assessing prognosis in 4 diverse clinical settings.

**Methods:** Concentrations of the JKP proteins were measured in 4 cohorts on a custom-made OLINK platform using a proximity extension assay. Prognostic value of the JKP proteins for eGFR slope and ESKD during 7-15 years of follow-up was examined in 60 Joslin Kidney Study patients with T1D; for 10-year risk of ESKD in a cohort of 162 Pima Indians with T2D; and for predicting the beneficial effect of fenofibrate in 450 ACCORD trial participants. In addition, the effect of the JAK1/2 inhibitor, Baricitinib, on the 1-year changes of the JKP proteins was examined in 42 Baricitinib trial participants (25 placebo/17 Baricitinib).

**Results:** In the Joslin cohort, baseline levels of all proteins correlated strongly with eGFR slope (r = -0.4 to -0.7; p < 10<sup>-7</sup>) (Fig. 1A for KIM1) and all were significantly higher in patients who developed ESKD than in those who did not (FC = 1.3-5.4; p < 10<sup>-8</sup>) (Fig. 1B for TNF-RSF1A). In the Pima cohort, baseline levels of 20 proteins were associated with ESKD risk in univariable logistic model (ORs = 1.7-4.2; p < 10<sup>-7</sup>) (Fig. 1C) and the ORs remained significant for 19 proteins (excluding WFDC2 and PI3) after adjustment for key confounders. Fenofibrate treatment reduced loss of kidney function in ACCORD patients who had levels of two proteins above the median (Fig. 1D). Baricitinib significantly decreased levels of 5 proteins relative to placebo (Fig. 1E for TNF-RSF7 and IL-1RT1).

**Conclusions:** The JKP successfully identified patients at risk of progressive kidney disease and those with beneficial responses to specific reno-protective therapies.

**Funding:** NIDDK Support, Private Foundation Support

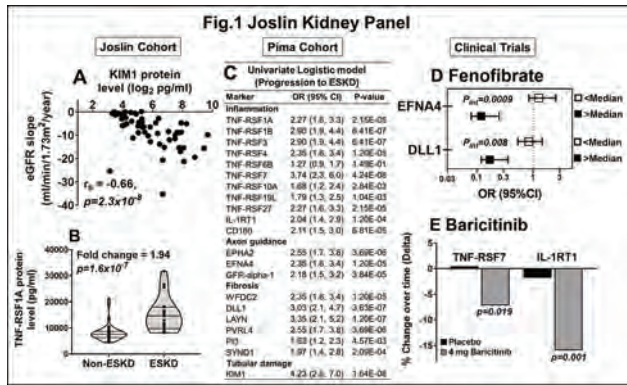

TH-PO233

**Correlation Between Albuminuria and Echocardiographic (Echo) Abnormalities in Individuals With Type 2 Diabetes (T2D): Insights From the Take Care of Me (TCoM) Program**

Hardik Vasanwala,<sup>1</sup> Susana Goncalves,<sup>2</sup> Kamlesh Khunti,<sup>3</sup> Peter Fenici,<sup>4,5</sup> Hiddo J. L Heerspink,<sup>6</sup> Shashank R. Joshi,<sup>7</sup> Mikhail Kosiborod,<sup>8</sup> Carolyn Lam,<sup>9,10</sup> Antonio Nicolucci,<sup>11</sup> Larisa Ramirez,<sup>12</sup> Alejandra Silva,<sup>12</sup> Filip Surmont,<sup>13</sup> Estefania Vazquez Mendez,<sup>14</sup> AstraZeneca, India, Bangalore, India; <sup>2</sup>AstraZeneca, Argentina, Buenos Aires, Argentina; <sup>3</sup>University of Leicester, Leicester, United Kingdom; <sup>4</sup>AstraZeneca, S.p.A, Milan, Italy; <sup>5</sup>School of Medicine and Surgery, Catholic University of Sacred Heart, Rome, Italy; <sup>6</sup>Department of Clinical Pharmacology of the University Medical Centre Groningen, Groningen, Netherlands; <sup>7</sup>Lilavati Hospital and Research Centre, Mumbai, India; <sup>8</sup>Saint Luke's MidAmerica Heart Institute, University of Missouri-Kansas City, Kansas city, MO; <sup>9</sup>National Heart Center, Singapore, Singapore; <sup>10</sup>Duke-National University of Singapore Medical School, Singapore, Singapore; <sup>11</sup>Center for Outcomes Research and Clinical Epidemiology, Pescara, Italy; <sup>12</sup>AstraZeneca, Latam, San Jose, Costa Rica; <sup>13</sup>AstraZeneca, China, Shanghai, China; <sup>14</sup>AstraZeneca, Mexico, Guadalajara, Mexico.

**Background:** Cardiovascular (CV) and renal diseases are the most common and morbid complications of T2D. The TCoM program, a subset of the iCaReMe global, cloud-based registry (NCT03549754), assessed the correlation between albuminuria and echo abnormalities in individuals with T2D.

**Methods:** Cross-sectional data of adults (>18 years) with T2D and no known cardio-renal complications (CRCs) at index visit, enrolled from routine clinical practice from Mexico, Argentina, Egypt, India, Malaysia, and the Philippines, were collected between December 2020 and December 2021. Correlation was assessed using Cramer's V-value and Fisher's exact/chi-square test.

**Results:** Of 12320 enrolled individuals (mean±SD age, 54.6±11.3 yrs; 59.3% women), 4853 had high/very high CV risk. Of these, 1506 (31%) had echo data; 450 (29.9%) of them had abnormal echo: 17.3% left ventricular hypertrophy, 16.8% left atrial enlargement, 4.3% diastolic dysfunction, 4.1% pulmonary hypertension, and 3.8% valvular disease. Echo abnormalities were significantly higher in individuals with albuminuria A2/A3 than those with A1 (33.5% vs 24.7%, p<0.05, v=0.094; Table). Significant correlation (p<0.05) was found between albuminuria and T2D duration (v=0.117), HbA1c (v=0.168), and CV risk (v=0.857).

**Conclusions:** Among individuals with T2D and high/very high CV risk from low-middle income countries, there is a significant correlation between albuminuria (stages A2/A3) and abnormal echo. Early detection of albuminuria through screening may be the key to effective management of CRCs in these individuals.

**Funding:** Commercial Support - AstraZeneca

Echocardiographic findings (N = 1506), n (%)				Albuminuria <sup>a</sup>		Cramer's V <sup>b</sup>	P-value <sup>c</sup>
				A1 n = 615 (40.8)	A2/A3 n = 891 (59.2)		
Abnormal, n = 450				152 (24.7)	298 (33.5)	0.0937	0.0003
Normal, n = 1056				463 (75.3)	593 (66.6)		

Categories	Echocardiogram findings (N = 1506), n (%)		Cramer's V <sup>b</sup>	P-value <sup>c</sup>	Albuminuria (N = 1043), n (%)		Cramer's V <sup>b</sup>	P-value <sup>c</sup>	
	Abnormal n = 450 (29.9)	Normal n = 1056 (70.1)			A1 n = 6928 (66.4)	A2/A3 n = 3503 (33.6)			
<b>BMI categories, kg/m<sup>2</sup></b>									
<25	83 (18.4)	188 (17.8)	0.036	0.3691	<25	1468 (21.2)	875 (25.0)	0.043	<0.0001
25-30	114 (25.3)	305 (28.9)			25-30	2210 (31.9)	1045 (29.8)		
>30	253 (56.2)	563 (53.3)			>30	3250 (46.9)	1583 (45.2)		
<b>T2D duration, years</b>									
<5	69 (22.0)	265 (25.1)	0.849	0.0044	<5	2549 (36.8)	927 (26.5)	0.117	<0.0001
5-10	60 (20.0)	274 (26.0)			5-10	1862 (26.9)	811 (23.2)		
>10	261 (58.0)	517 (49.0)			>10	3717 (53.2)	1765 (50.4)		
<b>HbA1c categories, %</b>									
<7	138 (30.7)	248 (23.5)	0.088	0.0029	<7	2316 (33.4)	718 (20.5)	0.168	<0.0001
7-10	201 (44.7)	473 (44.8)			7-10	3189 (46.0)	1620 (46.2)		
>10	111 (24.7)	335 (31.7)			>10	1936 (27.6)	1116 (31.9)		
<b>Hypertension</b>									
No	200 (44.4)	670 (63.3)	0.181	<0.0001	No	4496 (64.9)	2082 (59.4)	0.055	<0.0001
Yes	249 (55.3)	379 (35.9)			Yes	2377 (34.3)	1387 (39.6)		
<b>Cardiovascular risk (assessed as per ESC/EASD guidelines 2019)</b>									
Low	47 (10.4)	227(21.5)	0.175	<0.0001	Low	5277 (76.2)	15 (0.4)	0.857	<0.0001
Moderate	1 (0.2)	24 (2.3)			Moderate	627 (9.1)	3 (0.03)		
High	17 (3.8)	74 (7.0)			High	292 (4.3)	1 (0.03)		
Very high	385 (85.6)	731 (69.2)	Very high	725 (10.5)	348 (99.5)				

Factors associated with echocardiographic abnormalities and albuminuria

TH-PO234

**Endotrophin as a Marker of Complications in a Type 2 Diabetes Cohort**

Ninna H. Tougaard,<sup>1</sup> Alexandra L. Møller,<sup>3,2</sup> Pernille F. Rønn,<sup>1</sup> Tine Hansen,<sup>1</sup> Federica Genovese,<sup>3</sup> Morten A. Karsdal,<sup>3</sup> Daniel Guldager Kring Rasmussen,<sup>3</sup> Peter Rossing,<sup>1,2</sup> Steno Diabetes Center Copenhagen, Herlev, Denmark; <sup>2</sup>Kobenhavns Universitet Sundhedsvidenskabelige Fakultet, Kobenhavn, Denmark; <sup>3</sup>Nordic Bioscience, Herlev, Denmark.

**Background:** Hyperglycemia-mediated tissue injury eventually leads to fibrosis affecting various organ systems. We investigated whether endotrophin, a profibrotic signaling molecule, reflecting collagen VI formation, in serum and urine was associated with risk of developing complications in an unselected population with type 2 diabetes.

**Methods:** Endotrophin was measured by the PRO-C6 ELISA in serum and urine from 774 persons with type 2 diabetes recruited between 2012 and 2016. Urinary values were normalized to urine creatinine levels. Outcomes were identified through national registers and medical records and included a composite kidney endpoint (≥40% decline in kidney function or kidney failure), first major adverse cardiovascular event (MACE), all-cause mortality, progression of albuminuria, incident heart failure and sight-threatening eye disease. Cox proportional hazards models adjusted for conventional risk factors were applied.

**Results:** The cohort included 254 (33%) females, mean ±SD age was 65 ±12 years, diabetes duration 17 ±8.8 years, eGFR 76 ±24 ml/min/1.73m<sup>2</sup> and median [Q1:Q3] urinary albumin excretion was 12.5 [5.5:73.5] mg/g or g/24h. Depending on outcome, median follow-up ranged from 3.0 to 6.0 years. A doubling of serum endotrophin was independently associated with the composite kidney endpoint, first MACE, all-cause mortality and incident heart failure, but not with progression of albuminuria or incident sight-threatening eye disease (Table). A doubling of urine endotrophin was independently associated with progression of albuminuria and incident heart failure, but not with the other outcomes (Table).

**Conclusions:** Serum endotrophin was a risk marker for mortality, kidney and cardiovascular complications in type 2 diabetes. Urine endotrophin was a risk marker for progression of albuminuria and incident heart failure.

	Hazard ratio by doubling of endotrophin (95% CI)			
	Serum (crude)	Serum (adjusted)	Urine (crude)	Urine (adjusted)
Kidney failure or decline in kidney function (≥40%) (n=49,756)	2.78 (2.06-3.76)***	1.80 (1.13-2.87)*	1.19 (0.97-1.46)	1.07 (0.86-1.31)
First major cardiovascular event (n=66,546)	1.78 (1.34-2.38)*	1.54 (1.04-2.28)*	1.01 (0.83-1.24)	1.01 (0.82-1.24)
All-cause mortality (n=156,764)	2.34 (1.96-2.79)***	1.69 (1.31-2.19)***	1.02 (0.90-1.16)	1.01 (0.89-1.13)
Progression of albuminuria (n=91,764)	1.52 (1.18-1.97)**	1.31 (0.96-1.79)	1.21 (1.05-1.41)*	1.20 (1.04-1.39)*
Incident heart failure (n=2,678)	2.23 (1.60-3.10)***	1.63 (1.02-2.60)*	2.27 (1.67-3.16)***	1.79 (1.09-2.95)*
Incident sight-threatening diabetic eye disease (n=23,626)	1.78 (1.10-2.89)*	1.74 (0.91-3.34)	0.99 (0.72-1.36)	0.87 (0.62-1.22)

\*p<0.05, \*\*p<0.01, \*\*\*p<0.001, \*\*\*\*p<0.0001

Associations between endotrophin and complications incidence estimated by Cox proportional-hazards model

TH-PO235

**Longitudinal Changes (Deltas) of Circulating Proteins During Fast Progression to ESKD in Diabetes: Results of a Global Proteomics Study**  
 Hiroki Kobayashi,<sup>1,3</sup> Helen C. Looker,<sup>2</sup> Eiichiro Satake,<sup>1</sup> Robert G. Nelson,<sup>2</sup> Andrzej S. Krolewski,<sup>1</sup> <sup>1</sup>Research Division, Joslin Diabetes Center, Boston, MA; <sup>2</sup>Chronic Kidney Disease Section, National Institute of Diabetes and Digestive and Kidney Diseases, Phoenix, AZ; <sup>3</sup>Division of Nephrology, Hypertension, and Endocrinology, Nihon University School of Medicine, Tokyo, Japan.

**Background:** We recently showed that approximately 6-10% of patients with diabetes have fast progressive kidney function decline (FPKD) that leads to ESKD from normal kidney function within 2-15 years. However, the disease processes underlying FPKD is not well understood. Similarly, the way to identify patients at risk of FPKD is unknown. This study aims to answer this question by examining longitudinal changes (referred to as DELTAs) in concentration of circulating proteins associated with FPKD.

**Methods:** Using the OLINK proteomics platform, we measured concentration of 452 proteins at baseline and at follow-up (median interval 3-4 years apart) in two cohorts of patients with diabetes and normal kidney function at baseline. These participants were followed for 7 to 15 years. The Joslin Cohort had 106 T1D patients; 47 developed ESKD. The Pima Indians Cohort had 77 patients with T2D; 37 developed ESKD. We evaluated the association of DELTAs (expressed as % change from baseline value/year) with progression to ESKD using logistic regression model.

**Results:** In both cohorts, DELTAs for the same 74 circulating proteins were robustly associated with fast progression to ESKD. The set of 74 proteins was significantly enriched for tumor necrosis factor (TNF) receptors (p<0.001) and immunoregulatory receptors (p<0.001) and was depleted of proteins classified as enzymes (p<0.001). DELTAs for four of these proteins CD27 (TNF-R7), TNF-R2, SIRPB1 and LAYN predicted ESKD with power similar to DELTAs for eGFR and UACR. The C-statistics for the clinical model was 0.879 and increased to 0.921 - 0.924 when combined with these proteins.

**Conclusions:** In conclusion, the disease process underlying fast progression to ESKD in diabetes manifests as increased circulation of multiple TNF and other receptors but no other proteins. Measuring DELTAs of the four proteins can be used to monitor fast progression to ESKD in addition to current clinical markers, such as eGFR.

**Funding:** Other NIH Support - NIH DK041526, NIH DK110350

TH-PO236

**Novel Urinary Metabolite Biomarkers in Diagnosis of Diabetic Kidney Disease**

Cai Feng Shi, Ai Qin He, Xiaomei Wu, Junwei Yang, Yang Zhou. *Second Affiliated Hospital of Nanjing Medical University, Nanjing, China.*

**Background:** To exploration and application of novel urinary metabolite biomarkers in diagnosis of diabetic kidney disease (DKD).

**Methods:** Healthy individuals and type 2 diabetes (T2DM) patients admitted to the Second Affiliated Hospital of Nanjing Medical University from January to December 2020 were enrolled. Two separated cohorts-discovery cohort (n = 116) and validation cohort (n = 119) were included, which were divided into three groups: healthy control group, simple T2DM group, and T2DM + DKD group. Demographic and laboratory data were collected, and the urinary metabolites were detected by ultraperformance liquid chromatography coupled to tandem mass spectrometry. Partial least squares discriminant analysis and orthogonal partial least squares discriminant analysis were used for multi-dimensional modeling. Machine learning based on Boruta algorithm was used to screen potential markers. Wilcoxon test was used for comparison of metabolite data between two groups, and Kruskal-Wallis test was used for comparison between multiple groups. Binary logistic regression analysis was used for statistical modeling, and receiver operating characteristic (ROC) curve was used to evaluate diagnostic efficacy.

**Results:** A total of 160 metabolites were detected in morning urine samples by targeted quantitative metabolomics. Sixty-two differential metabolites were screened out from the discovery cohort, mainly enriched in amino acid metabolic pathway, and 17 of them were candidate markers for diagnosis of DKD. Fifteen differential metabolites and seven candidate markers (isovaleric acid; isobutyric acid; leucine; s-adenosylhomocysteine; propionic acid; oxoadipic acid; propionylcarnitine) were verified in the validation cohort. The diagnostic model of the combined marker was constructed by integrating the 7-candidate urinary metabolic markers. The diagnostic efficacy of the combined marker in both the discovery cohort and the validation cohort (the area under ROC curve of the discovery cohort was 0.888, 95%CI 0.814—0.963; the area under ROC curve of the validation cohort was 0.811, 95%CI 0.734—0.887) were significantly higher than that of a single metabolic marker.

**Conclusions:** There were significant differences in urine metabolites between simple T2DM patients and T2DM with DKD patients. The combination of various urine metabolic markers may be a novel strategy to diagnose DKD.

**Funding:** Government Support - Non-U.S.

TH-PO237

**Multi-Marker Biomarker Panel Predicts Adverse Cardiovascular and Kidney Outcomes in People With Diabetes and Albuminuric CKD in the CREDENCE Trial**

Michael K. Hansen,<sup>1</sup> Muthiah Vaduganathan,<sup>2</sup> Eshetu Tefera,<sup>1</sup> Yshai Yavin,<sup>1</sup> Naveed Sattar,<sup>3</sup> Hiddo J. L Heerspink,<sup>4</sup> James Januzzi,<sup>5</sup> <sup>1</sup>Janssen Research & Development, LLC, Spring House, PA; <sup>2</sup>Division of Cardiovascular Medicine, Brigham and Women's Hospital and Harvard Medical School, Boston, MA; <sup>3</sup>University of Glasgow BHF Glasgow Cardiovascular Research Centre, Glasgow, United Kingdom; <sup>4</sup>Department of Clinical Pharmacy and Pharmacology, University of Groningen, Groningen, Netherlands; <sup>5</sup>Massachusetts General Hospital, Harvard Medical School, Boston, MA.

**Background:** Circulating biomarkers reflecting different mechanistic pathways may identify patients at greatest clinical risk and who may be most likely to benefit from sodium glucose co-transporter-2 inhibitors. We evaluated the prognostic value of 4 biomarkers (N-terminal pro-B-type natriuretic peptide [NT-proBNP], high sensitivity cardiac troponin T [hs-cTnT], insulin-like growth factor binding protein 7 [IGFBP7], and growth differentiation factor 15 [GDF15]) either alone or in combination in people with T2D and CKD.

**Methods:** Among 2,627 participants in the CREDENCE trial with available biomarker data, we created a multi-marker panel assigning 1 point for each elevated concentration of NT-proBNP, hs-cTnT, IGFBP7, and GDF15. Multivariable Cox regression analysis was used to examine the association with risk of cardiac and kidney outcomes using each biomarker alone or as a multi-marker panel compared to a base clinical model alone for each outcome.

**Results:** Among all participants at baseline, 61% had elevated levels of NT-proBNP >125 pg/mL, 69% had hs-cTnT ≥14 ng/L, 50% had IGFBP7 >122 ng/mL, and 77% had GDF15 >1800 pg/mL. Overall, 7%, 15%, 23%, 27%, and 28% had 0, 1, 2, 3, and 4 elevated biomarkers. Increasing numbers of elevated biomarkers independently predicted each outcome in a graded fashion (Figure). Canagliflozin consistently reduced outcomes across multi-marker scores (P<sub>interaction</sub> >0.20 for all).

**Conclusions:** Biomarkers of myocardial injury and remodeling are frequently abnormal in T2D and CKD and, when combined, may identify patients at the greatest risk of progressing to cardiovascular and kidney outcomes.

Figure. Multi-Marker Risk Panel and Cardiovascular and Kidney Outcomes in CREDENCE

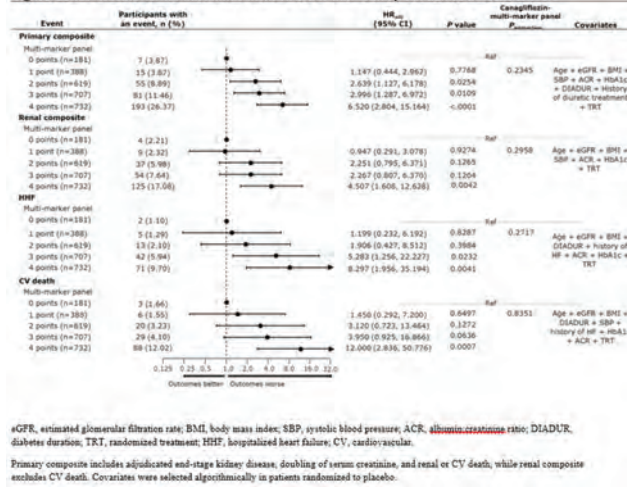

TH-PO238

**Higher Plasma ADMA Levels and Lower ADMA and SDMA Fractional Excretion Were Associated With Risk of Atherosclerotic Cardiovascular Disease in Diabetic Kidney Disease**

Sarah J. Schrauben,<sup>1</sup> Amanda H. Anderson,<sup>2</sup> Chi-yuan Hsu,<sup>4</sup> Joachim H. Ix,<sup>6</sup> Tariq Shafi,<sup>8</sup> Michael Shlipak,<sup>9</sup> Jing Chen,<sup>3</sup> Thomas H. Hostetter,<sup>7</sup> Julia Brown,<sup>5</sup> Rupal Mehta,<sup>10</sup> Raymond R. Townsend,<sup>1</sup> Jesse C. Seegmiller,<sup>11</sup> Paul L. Kimmel,<sup>12</sup> Vasan S. Ramachandran,<sup>13</sup> Harold I. Feldman,<sup>1</sup> Jeffrey R. Schelling.<sup>14</sup> <sup>1</sup>University of Pennsylvania Perelman School of Medicine, Philadelphia, PA; <sup>2</sup>Tulane University, New Orleans, LA; <sup>3</sup>Tulane University School of Medicine, New Orleans, LA; <sup>4</sup>University of California San Francisco, San Francisco, CA; <sup>5</sup>University of Illinois Chicago, Chicago, IL; <sup>6</sup>University of California San Diego, La Jolla, CA; <sup>7</sup>University of North Carolina System, Chapel Hill, NC; <sup>8</sup>University of Mississippi, University Park, MS; <sup>9</sup>San Francisco VA Health Care System, San Francisco, CA; <sup>10</sup>Northwestern University Feinberg School of Medicine, Chicago, IL; <sup>11</sup>University of Minnesota Medical School Twin Cities, Minneapolis, MN; <sup>12</sup>National Institute of Diabetes and Digestive and Kidney Diseases, Bethesda, MD; <sup>13</sup>Boston University School of Medicine, Boston, MA; <sup>14</sup>Case Western Reserve University, Cleveland, OH.

**Background:** CKD is associated with cardiovascular disease (CVD), especially among those with diabetes, but it is difficult to prospectively identify those who will experience such events. The uremic solutes asymmetric dimethyl arginine (ADMA), symmetric dimethyl arginine (SDMA), and trimethyl methylamine-N-oxide (TMAO), may help identify these high-risk individuals.

**Methods:** We performed a case-cohort study among 766 Chronic Renal Insufficiency Cohort Study participants with diabetes, eGFR <60 ml/min/1.73m<sup>2</sup> and no atherosclerotic CVD (ASCVD) or heart failure at baseline. Cases were those who developed the primary outcome: incident ASCVD events (myocardial infarction, stroke, peripheral artery disease). Participants were randomly selected for the subcohort. Secondary outcomes were incident heart failure, and CKD progression (end-stage kidney disease or 40% eGFR decline). Uremic solute concentrations of TMAO, ADMA, SDMA in plasma and urine were determined with liquid chromatography-tandem mass spectrometry. Weighted Cox regression models related uremic solute concentrations in the plasma (modelled per SD) and urine (modeled as fractional excretion) with primary and secondary outcomes and were adjusted for: age, sex, race, education, blood pressure, cholesterol, hemoglobin A1c, smoking, BMI, hsCRP, serum creatinine, cystatin C, and proteinuria.

**Results:** Higher ADMA plasma concentrations were associated with risk of ASCVD (HR 1.52, 95% CI: 1.16-1.96) but not with heart failure. Plasma TMAO and SDMA concentrations were not associated with ASCVD, heart failure, or CKD progression. Lower ADMA and SDMA fractional excretion were associated with risk of ASCVD (HR 3.13, 95% CI: 1.41-6.67 and HR 2.33, 95% CI 1.11-4.76, respectively).

**Conclusions:** In persons with CKD and diabetes, higher plasma ADMA concentrations were associated with increased risk of ASCVD events. The data suggest new mechanistic insights whereby altered renal handling of ADMA and its enantiomer, SDMA, may lead to increased plasma concentrations and CVD risk. If confirmed, strategies to enhance renal ADMA and SDMA excretion could have potential therapeutic value.

**Funding:** NIDDK Support

TH-PO239

**The Pro-Fibrotic Molecule Endotrophin as a Risk Marker of Complications in a Type 1 Diabetes Cohort**

Alexandra L. Møller,<sup>1,2</sup> Ninna H. Tougaard,<sup>3</sup> Pernille F. Rønn,<sup>3</sup> Tine Hansen,<sup>3</sup> Federica Genovese,<sup>1</sup> Morten A. Karsdal,<sup>1</sup> Daniel Guldager Kring Rasmussen,<sup>1</sup> Peter Rossing.<sup>3,4</sup> <sup>1</sup>Nordic Bioscience A/S, Herlev, Denmark; <sup>2</sup>University of Copenhagen, Department of Biomedical Sciences, Copenhagen, Denmark; <sup>3</sup>Steno Diabetes Center Copenhagen, Herlev, Denmark; <sup>4</sup>University of Copenhagen, Department of Clinical Medicine, Copenhagen, Denmark.

**Background:** Hyperglycemia can trigger pathological pathways leading to fibrosis where extracellular matrix (ECM) components are accumulated. We investigated the potential of endotrophin (ETP), a molecule generated during collagen type VI (COL6) formation, as a risk marker for complications in an unselected population with type 1 diabetes.

**Methods:** We measured ETP by the PRO-C6 ELISA in serum and urine from 1468 persons with type 1 diabetes recruited between 2012-2016. Urinary values were normalized to urine creatinine levels. Participants were followed for a median of up to 6.4 years. Outcomes were identified through national registers and included a composite renal endpoint (≥40% decline in kidney function or kidney failure), first MACE, all-cause mortality, progression of albuminuria, incident heart failure (HF), incident cardiovascular disease (CVD), and incident sight-threatening eye disease. Cox proportional hazards models adjusted for conventional risk factors were applied. For each outcome, we excluded participants previously diagnosed with the outcome.

**Results:** The cohort included 712 (49%) females, mean±SD age was 51±16 years, eGFR 94±23 ml/min/1.73m<sup>2</sup>, and median (IQR) urinary albumin excretion was 5.5 (3.5-11.5) mg/g or g/24h. A doubling of serum ETP was independently associated with the composite renal endpoint, all-cause mortality, and progression of albuminuria, but not with first MACE, incident HF, CVD, or sight-threatening eye disease after adjustment (Table). Urine ETP was not associated with outcomes after adjustment.

**Conclusions:** Serum ETP was a risk marker for mortality and kidney complications in type 1 diabetes. Biomarkers of ECM remodeling, such as serum ETP, may identify persons with active pro-fibrotic processes at risk for complications related to diabetes.

HR by doubling of serum ETP (95% CI)

	Unadjusted	P value	Adjusted	P value
Renal endpoint (n=30/1462)	4.83 (3.46-6.75)	<0.001	3.39 (1.98-5.82)	<0.001
First MACE (n=82/1316)	1.91 (1.48-2.48)	<0.001	1.28 (0.90-1.80)	0.2
All-cause mortality (n=93/1468)	2.13 (1.69-2.68)	<0.001	1.44 (1.03-2.0)	0.032
Progression of albuminuria (n=80/1359)	1.72 (1.38-2.32)	<0.001	1.82 (1.32-2.52)	<0.001
Incident HF (n=23/1420)	2.11 (1.32-3.37)	0.002	0.76 (0.37-1.56)	0.4
Incident CVD (n=68/1215)	2.0 (1.52-2.64)	<0.001	1.43 (1.0-2.05)	0.052
Incident sight-threatening eye disease (n=52/1168)	0.93 (0.60-1.45)	0.7	0.98 (0.60-1.61)	>0.9

TH-PO240

**Interaction of Glycation and Carbamylation in Diabetic CKD: Insights From the CRIC Study**

Mengyao Tang,<sup>1</sup> James P. Lash,<sup>2</sup> Sahir Kalim.<sup>1,3</sup> <sup>1</sup>Massachusetts General Hospital, Boston, MA; <sup>2</sup>University of Illinois Chicago UI Health, Chicago, IL; <sup>3</sup>Harvard Medical School, Boston, MA.

**Background:** Glycated hemoglobin (A1c) is used to predict glycation burden and clinical outcomes in diabetic patients. However, the reliability of A1c in CKD has been questioned, with concerns including the competition between the two post-translational protein modifications, glycation and carbamylation, on the same protein amino groups. Whether carbamylation modifies the impact of A1c on outcomes in patients with diabetic CKD is unclear.

**Methods:** In 1,427 participants from the Chronic Renal Insufficiency Cohort (CRIC) study with co-existing CKD and diabetes, multivariable Cox regression models were applied to evaluate the association between A1c and CKD progression (ESRD or 50% eGFR decline) or first cardiovascular disease (CVD) event (congestive heart failure, myocardial infarction, or stroke), stratified by quartiles of carbamylated albumin (C-Alb) levels.

**Results:** The mean age of participants was 60 years, mean eGFR was 38.1 mL/min/1.73 m<sup>2</sup>, mean A1c was 7.5%, and median C-Alb was 8.4 mmol/mol. During an average of 7.9 years of follow up, every 1% increase in A1c was associated with higher risks of CKD progression (HR 1.07, 95% CI 1.02, 1.12), and CVD (HR 1.09; 95% CI 1.04, 1.15) in adjusted models. However, in the highest C-Alb quartile, A1c was no longer associated with CKD progression or CVD; while in the lowest C-Alb quartile, A1c remained an independent risk factor for the adverse outcomes (Figure 1). Interaction testing between A1c and C-Alb was significant for CKD progression.

**Conclusions:** In patients with co-existing CKD and diabetes, the association between A1c and adverse clinical outcomes is modified by high carbamylation levels. This finding may explain why A1c is not as reliable in patients with CKD compared to the general diabetic population.

**Funding:** NIDDK Support

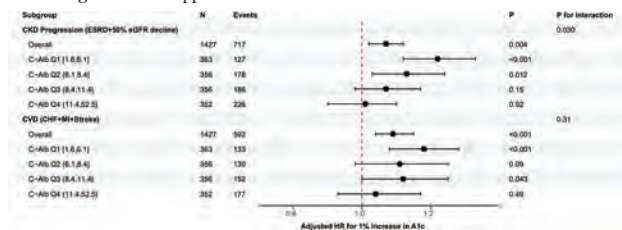

**Figure 1.** Association of hemoglobin A1c with outcomes in CRIC participants with CKD and diabetes, stratified by quartiles of C-Alb levels. Note hemoglobin A1c's diminished HRs at higher C-Alb quartiles. The models are adjusted for age, sex, race/ethnicity, BMI, smoking status, CVD, HTN, ACEI/ARB, and LDL.

TH-PO241

**Nesfatin-1 and Tubulointerstitial Damage in Diabetic Kidney Disease: A Possible Biomarker for the Histological Severity**

Sayoko Miyake,<sup>1,2</sup> Yoshihisa Nakatani,<sup>1</sup> Yukihito Nakano,<sup>1</sup> Shuji Arima.<sup>1</sup> <sup>1</sup>Kinki Daigaku Byoin, Osakasayama, Japan; <sup>2</sup>Kinki Daigaku Igakubu Daigakuin Igaku Kenkyuka, Osakasayama, Japan.

**Background:** Although adipokines are known to contribute to the pathogenesis of diabetic kidney disease (DKD), pathological significance of nesfatin-1, an adipokine in DKD remains unclear. We studied the possible associations between serum nesfatin-1 concentrations and histological renal damages in 56 persons with biopsy-proved DKD.

**Methods:** The relation between serum nesfatin-1 concentrations, clinical parameters and renal histological damage were cross-sectionally investigated. The relation between serum nesfatin-1 concentrations and renal outcomes were also examined longitudinally.

**Results:** Serum nesfatin-1 concentrations showed a significant negative correlation with age, total cholesterol, and high-density lipoprotein cholesterol, but not with other clinical parameters. Persons were divided into the following three groups based on serum nesfatin-1 concentrations (pg/mL): low- (log average: 1.99), normal- (log average: 3.05), and high-group (log average: 3.60). Histological analysis of tubulointerstitial lesions showed higher interstitial fibrosis and tubular atrophy scores and more severe interstitial infiltration in the group with low serum nesfatin-1 concentrations than in

the other groups. However, there was no significant relation between serum nesfatin-1 concentrations and the severity of glomerular lesions nor renal outcomes.

**Conclusions:** Serum nesfatin-1 concentrations showed a strong correlation with diabetic tubulointerstitial damage level, suggesting its clinical utility as a biomarker for histological injury in DKD.

**TH-PO242**

**Assessing the Inflammatory Landscape of Human Diabetic Kidney Disease (DKD) Through NanoString Digital Spatial Profiling Technology**  
 Khaled Mosaad Elhousseiny,<sup>1</sup> Lynn D. Cornell,<sup>2</sup> Xiaohui Bian,<sup>1</sup> Yaohua Ma,<sup>1</sup> LaTonya J. Hickson,<sup>1</sup> Mayo Translational and Regenerative Nephrology Research Laboratory <sup>1</sup>Mayo Clinic in Florida, Jacksonville, FL; <sup>2</sup>Mayo Clinic Minnesota, Rochester, MN.

**Background:** Inflammation contributes to DKD pathogenesis and progression. We examined the inflammatory signature of kidney biopsy tissue from subjects with DKD compared to those with normal histology and tubulointerstitial nephritis (TIN)

**Methods:** Core needle biopsy samples were stained with a fluor-labeled antibodies against pan-cytokeratin (epithelium), CD45 (T-cell), and CD68 (macrophage) plus the nuclear dye (STYO13). It also contained 77 target antibodies, each labeled with a unique oligonucleotide barcode. Regions of interest (ROI) were selected based on kidney compartments, and two segments were collected from each ROI: cytotkeratin-positive = tubule, cytotkeratin-negative/STYO13-positive = interstitium. Antibody-bound oligonucleotides were liberated by UV laser irradiation of computer-defined masks to collect oligonucleotides and then quantified using nCounter technology. Data were normalized to the geometric mean of three housekeeping proteins (GAPDH, histone H3, S6). Differential expression was assessed using the linear mixed model

**Results:** Surface protein expression of inflammatory cells (**Figure:** red, yellow) were increased in the tubules and interstitium of DKD (n=5) and TIN kidney (n=4) compared to normal (n=2) patients. Infiltration of interstitial CD68+ macrophages were higher in DKD vs. normal, yet lower vs. TIN (P < 0.05). Similarly, CD45+ and CD8+ T-cells were significantly increased in DKD vs. normal tubulointerstitium but decreased vs. TIN. While, CD66b+ granulocytes were higher in DKD tubulointerstitium (vs. normal), it did not show significant difference between DKD and TIN

**Conclusions:** The inflammatory landscape of DKD is characterized by tubulointerstitial infiltration of macrophages, T-cells and granulocytes which is not as robust as TIN but significantly higher than normal healthy kidney tissue. Hence, targeting pro-inflammatory pathway in DKD may represent an important therapeutic targeting for DKD

**Funding:** NIDDK Support

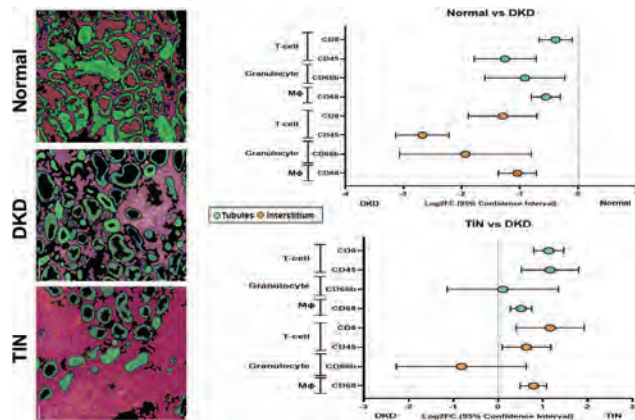

**TH-PO243**

**Association of Urine Biomarkers of Tubule Health With Mortality in Patients With Diabetes and CKD**

George Vasquez-Rios,<sup>1</sup> Ronit Katz,<sup>3</sup> Mary Cushman,<sup>4</sup> Chirag R. Parikh,<sup>5</sup> Paul L. Kimmel,<sup>6</sup> Sushrut S. Waikar,<sup>7</sup> Sarah J. Schraub,<sup>8</sup> Jason H. Greenberg,<sup>9</sup> Mark J. Sarnak,<sup>10</sup> Michael Shlipak,<sup>11</sup> Joachim H. Ix,<sup>12</sup> Orlando M. Gutierrez,<sup>2</sup> CKD Biomarkers Consortium <sup>1</sup>Icahn School of Medicine at Mount Sinai, New York, NY; <sup>2</sup>The University of Alabama at Birmingham School of Medicine, Birmingham, AL; <sup>3</sup>University of Washington School of Medicine, Seattle, WA; <sup>4</sup>University of Vermont College of Medicine, Burlington, VT; <sup>5</sup>Johns Hopkins University, Baltimore, MD; <sup>6</sup>National Institute of Diabetes and Digestive and Kidney Diseases, Bethesda, MD; <sup>7</sup>Boston Medical Center, Boston, MA; <sup>8</sup>University of Pennsylvania Perelman School of Medicine, Philadelphia, PA; <sup>9</sup>Yale School of Medicine, New Haven, CT; <sup>10</sup>Tufts Medical Center, Boston, MA; <sup>11</sup>San Francisco VA Health Care System, San Francisco, CA; <sup>12</sup>University of California San Diego, La Jolla, CA.

**Background:** Biomarkers of kidney tubular health are associated with the risk of kidney failure in individuals with chronic kidney disease (CKD) and diabetes, independently of other factors. Whether these biomarkers are also associated with mortality remains unclear.

**Methods:** Among 560 individuals with diabetes and an estimated glomerular filtration rate (eGFR)  $\leq 60$  ml/min/1.73m<sup>2</sup> randomly sampled from the Reasons for Geographic and Racial Differences in Stroke (REGARDS) study (47% male, 53% Black), we measured urine biomarkers in stored baseline visit samples: monocyte chemoattractant protein-1 [MCP-1], alpha-1-microglobulin [a1m], kidney injury molecule-1 [KIM-1], epidermal growth factor [EGF], chitinase-3-like protein 1 [YKL-40], and uromodulin [UMOD]. Associations of biomarkers with all-cause and cause-specific mortality were examined in Cox regression models, adjusted for age, sex, race, education, and urine creatinine to account for differences in tonicity, blood pressure, body mass index, smoking, coronary heart disease, stroke, eGFR, and urine albumin.

**Results:** The baseline mean (SD) age was 70 (9) years, mean (SD) eGFR was 40 (3) ml/min/1.73m<sup>2</sup>, and median [IQR] albumin-to-creatinine ratio was 33 [10,213] mg/g. Over a mean (SD) of 6 (3) years of follow-up, 310 participants died from causes adjudicated as cardiovascular (n=121), cancer (n=30), or other (n=159). In fully adjusted models, each 2-fold higher concentration of KIM-1 and YKL-40 was associated with a higher risk of all-cause mortality: hazard ratio (HR) 1.15, 95%CI 1.01,1.31 and 1.13, 95%CI 1.07,1.20, respectively. Higher UMOD was associated with a lower risk of cardiovascular death (HR 0.87, 95%CI 0.77,0.99), and higher MCP-1 was associated with a higher risk of cancer-related death (HR 1.52, 95%CI 1.05,2.18) in fully adjusted models. Finally, biomarkers associated with other causes of death in fully adjusted models included: KIM-1 (1.25, 95%CI 1.04,1.50), EGF (1.38, 95%CI 1.05,1.82), and YKL-40 (1.18, 95%CI 1.08,1.29).

**Conclusions:** Higher urine concentrations of KIM-1 and YKL-40 are associated with an increased risk of all-cause mortality over 6 years in individuals with diabetes and CKD independently of established risk factors, eGFR, and urine albumin.

**Funding:** NIDDK Support

**TH-PO244**

**Gene Polymorphism in Organic Anion Transporters Determine the Long-Term Efficacy and Safety of Atrasentan in Patients With Type 2 Diabetes and CKD**

Johannes D. Smeijer,<sup>1</sup> Jeroen Koomen,<sup>1</sup> Donald E. Kohan,<sup>2</sup> John McMurray,<sup>3</sup> George L. Bakris,<sup>4</sup> Ricardo Correa-Rotter,<sup>5</sup> Fan Fan Hou,<sup>6</sup> Dalane Kitzman,<sup>7</sup> Hirofumi Makino,<sup>11</sup> Vlado Perkovic,<sup>8,9</sup> Peter Rossing,<sup>10</sup> Dick de Zeeuw,<sup>1</sup> Hiddo J. L. Heerspink,<sup>1,8</sup> <sup>1</sup>Universitair Medisch Centrum Groningen, Groningen, Netherlands; <sup>2</sup>University of Utah Health, Salt Lake City, UT; <sup>3</sup>University of Glasgow, Glasgow, United Kingdom; <sup>4</sup>University of Chicago Pritzker School of Medicine, Chicago, IL; <sup>5</sup>Instituto Nacional de Ciencias Medicas y Nutricion Salvador Zubiran, Ciudad de Mexico, Mexico; <sup>6</sup>Southern Medical University Nanfang Hospital, Guangzhou, China; <sup>7</sup>Wake Forest University School of Medicine, Winston-Salem, NC; <sup>8</sup>The George Institute for Global Health, Newtown, NSW, Australia; <sup>9</sup>University of New South Wales, Sydney, NSW, Australia; <sup>10</sup>Steno Diabetes Center Copenhagen, Herlev, Denmark; <sup>11</sup>Okayama Daigaku, Okayama, Japan.

**Background:** The plasma exposure of the endothelin receptor antagonist atrasentan varies between individuals and is associated with nephroprotective effects and the risk of heart failure. We examined the influence of genetic polymorphisms on atrasentan plasma exposure and pharmacodynamic effects.

**Methods:** We performed a genetic sub-study of the SONAR trial in adults with type 2 diabetes, and estimated glomerular filtration rate (eGFR) 25–75 mL/min/1.73 m<sup>2</sup>, and urine albumin-to-creatinine ratio (UACR) of 300–5000 mg/g. Single nucleotide polymorphisms (SNPs) were determined in pre-specified membrane transporters, metabolizing enzymes and the endothelin-1 peptide, based on expected relevance for atrasentan PK/PD. The associations between genotype, atrasentan plasma exposure and the effect of atrasentan on the pre-specified kidney and heart failure hospitalization (HHF) outcomes was assessed with Cox proportional hazards regression models.

**Results:** Of 3668 randomized patients, 2329 (63.5%) consented to genotype analysis. Two SNPs in the SLCO1B1 gene (rs4149056 and rs2306283), encoding the hepatic organic anion transporter 1B1 (OATP1B1), showed the strongest association with atrasentan plasma exposure. Based on their SLCO1B1 genotype, patients were classified into normal- or slow OATP1B1 transporter phenotypes. The slow OATP1B1 transporter phenotype group (15.9% of total cohort) had a 20.3% higher atrasentan AUC<sub>0-inf</sub> compared to the normal phenotype (geometric mean AUC 49.7 versus 41.3 ng.h/mL; p<0.001). Among patients with a normal OATP1B1 transporter phenotype, the hazard ratio with atrasentan for the primary kidney and HHF outcomes were 0.61 (95%CI 0.45-0.81) and 1.35 (95%CI 0.84-2.13), respectively. In contrast, in the slow transporter phenotype HRs for kidney and HHF outcomes were 1.95 (95%CI 0.95-4.03, p-interaction normal phenotype=0.004), and 4.18 (95%CI 1.37-12.7, p-interaction normal phenotype=0.060) respectively.

**Conclusions:** Genetic polymorphisms in OATP transporters are associated with significant between-patient variability in atrasentan plasma exposure and long-term efficacy and safety.

TH-PO245

Family-Based Whole-Genome Sequencing Identifies FRAS1 as a Novel Gene for Rapid Renal Decline in Diabetes

Matthew B. Neeley,<sup>1</sup> Barry Moore,<sup>2</sup> Shuwei Li,<sup>3</sup> Dermot F. Reilly,<sup>3</sup> Jose M. Lazaro guevara,<sup>2</sup> Melissa H. Pezzolesi,<sup>1</sup> Edgar J. Hernandez,<sup>2</sup> Mary Helen Black,<sup>3</sup> Mark Yandell,<sup>2</sup> Antonio R. Parrado,<sup>3</sup> Marcus G. Pezzolesi.<sup>1,2</sup>  
<sup>1</sup>University of Utah, Division of Nephrology and Hypertension, Department of Internal Medicine, Salt Lake City, UT; <sup>2</sup>University of Utah, Department of Human Genetics, University of Utah School of Medicine, Salt Lake City, UT; <sup>3</sup>Janssen Research and Development LLC, Spring House, PA.

**Background:** Progressive renal decline is the central manifestation of diabetic nephropathy (DN) and ultimately leads to end-stage renal disease. To accelerate discovery of novel genes that contribute to rapid renal decline and DN, we developed an innovative family-based approach that integrates electronic medical record data, a unique population-based genealogy resource, and next-generation sequencing.

**Methods:** Kindred-specific risk of rapid renal decline was used to quantify the familial standardized incidence ratio and identify pedigrees with excess clustering of rapid renal decline. Whole genome sequencing (WGS) was performed in 60 individuals from 6 pedigrees ascertained for the Utah Diabetes Study, followed by unified linkage analysis and rare variant association testing. To replicate findings, we performed variant-/gene-level association tests using whole exome sequencing (WES, n=450K), WGS (n=150K), renal function biomarkers, and kidney disease endpoints available in the UK Biobank.

**Results:** Among these pedigrees, we identified a rare pathogenic variant in *FRAS1* shared by 5 affected members of one family. Sanger sequencing confirmed the carrier status of these affected family members and identified 2 additional carriers (including 1 with impaired renal function) and 4 non-carriers of the *FRAS1* variant in this family. In the UK Biobank, a population-based cohort of primarily healthy individuals at the time of baseline blood draw, we observed nominal variant association with increased risk of CKD, nephrotic syndrome, and glomerulonephritis (all p<5x10<sup>-3</sup>). *FRAS1* putative loss-of-function and deleterious singletons in aggregation were nominally associated with reduced eGFR (p<5x10<sup>-3</sup>).

**Conclusions:** These data suggest that rare pathogenic variants in *FRAS1* contribute to increased risk of DN and, importantly, progression of rapid renal decline. *FRAS1* encodes an extracellular matrix protein that mediates integrity of glomeruli and is downregulated in glomeruli of mice with DN; further supporting *FRAS1*'s potential role in kidney disease in individuals with diabetes. These findings highlight the power of family-based genetics in well-phenotyped cohorts and its ability to discover novel genes that contribute to rapid renal decline and DN.

**Funding:** NIDDK Support, Commercial Support - Janssen Research and Development

TH-PO246

Phenome-Wide Association Study of Common Genetic Variants in the DPP4 Gene and GLP1R Gene and Kidney Outcomes of European Ancestry Individuals in the Million Veteran Program (MVP)

Jefferson L. Triozzi,<sup>1</sup> Hua-Chang Chen,<sup>1,2</sup> Ran Tao,<sup>1,2</sup> Otis D. Wilson,<sup>1,2</sup> Guanchao Wang,<sup>1,2</sup> Talat Alp Ikizler,<sup>1,2</sup> Alexander Bick,<sup>1</sup> Edward D. Siew,<sup>1,2</sup> Cassianne Robinson-Cohen,<sup>1</sup> Adriana Hung,<sup>1,2</sup> Million Veteran Program <sup>1</sup>Vanderbilt University Medical Center, Nashville, TN; <sup>2</sup>VA Tennessee Valley Healthcare System, Nashville, TN.

**Background:** Incretin mimetics, including dipeptidyl-peptidase 4 inhibitors and glucagon-like peptide 1 receptor agonists, are antihyperglycemic agents that activate neurohormonal pathways to suppress appetite and increase glucagon secretion. Although incretin mimetics are associated with glucose control and improved cardiovascular outcomes, their effect on kidney outcomes is not clearly demonstrated.

**Methods:** We tested the association of one single nucleotide polymorphism (SNP) in the *DPP4* gene encoding dipeptidyl peptidase 4 (rs11695223 [intronic]) and two SNPs in the *GLP1R* gene encoding glucagon-like peptide 1 hormone receptor (rs1030505420 [missense], rs2268647 [intronic]) in a phenome-wide association study (PheWAS) using electronic health record data from European ancestry individuals in the MVP. The *GLP1R* variants are considered drug proxies for agonism. We mapped 1311 clinical diagnoses based on ICD-codes using PheWAS methodology in up to 458,165 individuals of European ancestry. PheWAS was performed by fitting logistic regression models adjusting for age, sex, and ten principal components of ancestry, regressed against the SNPs of interest. Level of significance was set using Bonferroni at 0.05/1311 or p=3.81E-05.

**Results:** The *DPP4* variant was associated with multiple ICD-codes for kidney disease with PheWAS significance. The *GLP1R* variants did not reach PheWAS significance (Table 1).

**Conclusions:** Our study shows that the *DPP4* SNP is associated with kidney outcomes, including ESRD, CKD, urinary calculus, and microscopic hematuria. The *GLP1R* SNPs were associated with T2DM with renal manifestations and CKD, but these did not reach PheWAS significance. Further study is needed to elucidate mechanisms by which incretin pathways affect kidney outcomes.

**Funding:** Veterans Affairs Support

DPP4		GLP1R	
rs11695224 (intronic)	rs10305420 (missense)	rs2268647 (intronic)	
<i>Associations meeting PheWAS significance</i>			
Microscopic hematuria OR 0.83 p=5.69E-14	T2DM OR 0.96 p=3.21E-13	T2DM OR 1.03 p=3.84E-08	
Urinary calculus OR 0.91 p=1.28E-07	Morbid obesity OR 0.96 p=6.91E-09	Obesity OR 1.02 p=2.26E-07	
CKD OR 1.06 p=2.71E-06	T2DM with retinopathy OR 0.95 p=6.77E-07	T2DM with neuropathy OR 1.03 p=9.23E-06	
CKD Stage 3 OR 1.07 p=2.57E-05	T1DM OR 0.94 p=1.17E-05	Edema OR 1.02 p=3.03E-05	
ESRD OR 1.17 p=3.80E-05		Insulin Pump OR 1.06 p=2.17E-05	
<i>Renal associations below PheWAS significance</i>			
CKD Stage 4 OR 1.13 p=4.22E-05	T2DM with renal manifestations OR 0.96 p=0.00015	CKD stage 3 OR 1.02 p=0.003	
Hypertensive CKD OR 1.07 p=4.84E-05	Renal sclerosis OR 0.82 p=0.009	T2DM with renal manifestations OR 1.03 p=0.005	

TH-PO247

Proteomic Analyses Identify Novel Predictors of Diabetic Kidney Disease in Youth-Onset Type 2 Diabetes

Laura Pyle,<sup>1</sup> Tim Vigers,<sup>1</sup> Laure K. El ghormli,<sup>2</sup> Ian H. de Boer,<sup>3</sup> Robert G. Nelson,<sup>4</sup> Anita T. Layton,<sup>8</sup> Kumar Sharma,<sup>5</sup> Sushrut S. Waikar,<sup>6</sup> Hiddo J. L. Heerspink,<sup>9</sup> Neil H. White,<sup>10</sup> Kalie L. Tommerdahl,<sup>1</sup> Amy S. Shah,<sup>7</sup> Rose Gubitosi-Klug,<sup>11</sup> Petter Bjornstad.<sup>1</sup> <sup>1</sup>University of Colorado Anschutz Medical Campus, Aurora, CO; <sup>2</sup>The George Washington University Milken Institute of Public Health, Washington, DC; <sup>3</sup>University of Washington, Seattle, WA; <sup>4</sup>National Institutes of Health, Bethesda, MD; <sup>5</sup>The University of Texas Health Science Center at San Antonio, San Antonio, TX; <sup>6</sup>Boston University, Boston, MA; <sup>7</sup>Cincinnati Children's Hospital Medical Center, Cincinnati, OH; <sup>8</sup>University of Waterloo, Waterloo, ON, Canada; <sup>9</sup>University Medical Center Gronigen, Gronigen, Netherlands; <sup>10</sup>Washington University in St Louis, St Louis, MO; <sup>11</sup>Case Western Reserve University, Cleveland, OH.

**Background:** Diabetic kidney disease (DKD) develops by young adulthood in up to 50% of people with youth-onset type 2 diabetes (Y-T2D), increasing risk of dialysis and premature death. Understanding mechanisms responsible for early DKD is key to management and prevention; accordingly, we sought to identify multiprotein signatures of DKD in Y-T2D.

**Methods:** We measured 7604 Aptamers in 374 baseline plasma samples from the Treatment Options for type 2 Diabetes in Adolescents and Youth (TODAY) study, using the SomaScan 7K Proteomic (SomaLogic) platform. Urine albumin-to-creatinine ratio (UACR) was assessed annually for up to 15 years. Incident micro- and macroalbuminuria were defined as UACR ≥30 and ≥300 mg/g on ≥2 of 3 measures. We evaluated prediction of micro- and macroalbuminuria in separate Cox regression models adjusted for HbA1c, triglycerides, blood pressure, and estimated insulin sensitivity. Gene set enrichment analysis (GSEA) identified pathways of interest. The false discovery rate was controlled at 5% and we report q-values.

**Results:** Participants were 14±2 years of age, 37% male; 43% developed either micro- or macroalbuminuria. Seven proteins predicted time to microalbuminuria, while 8 proteins predicted time to macroalbuminuria, with 2 proteins in common: nerve epidermal growth factor-like 1 (NELL1) (micro: HR 1.56 per 1 SD [95% CI 1.33, 1.83], q=0.0003; macro: 1.95 [1.44-2.63], q=0.017) and FAMI89A2 (micro: 1.58 [1.33, 1.87], q=0.0008; macro: 1.79 [1.36, 2.35], q=0.038). GSEA identified gene sets, including one related to semaphorin interactions, associated with microalbuminuria and macroalbuminuria (Figure).

**Conclusions:** Novel proteins, including those interacting with semaphorins, which play an important role in inflammation and cellular repair, predict incident albuminuria in Y-T2D.

**Funding:** NIDDK Support



Figure. Top pathways from Gene Set Enrichment Analysis for microalbuminuria (top) and macroalbuminuria (bottom).

TH-PO248

**Transcriptome Analysis of Human Kidney Tissues to Explore Prognostic Factors in Diabetic Kidney Disease With Nodular Lesion**

Toshiyuki Imasawa,<sup>1</sup> Hiroyuki Unoki-Kubota,<sup>3</sup> Daishi Hirano,<sup>2</sup> Yasushi Kaburagi,<sup>3</sup> <sup>1</sup>National Hospital Organization Chiba-Higashi National Hospital, Chiba, Japan; <sup>2</sup>Department of Pediatrics, The Jikei University School of Medicine, Tokyo, Japan; <sup>3</sup>Diabetes Research Center, Research Institute, National Center for Global Health and Medicine, Tokyo, Japan.

**Background:** The prognosis of diabetic kidney disease (DKD) with nodular lesion (NL) is poor. However, there are cases in which the prognosis is not poor even in the presence of NL. The mechanism of why these patients do not have a poor prognosis remains unclear.

**Methods:** Twelve patients with a histological diagnosis of DKD with NL and no other renal comorbidities who had undergone kidney biopsy within the past 10 years and had been followed up for at least 3 years at a single institution with a uniform treatment strategy were included. Total RNA was extracted from renal biopsy tissues in formalin-fixed paraffin-embedded blocks and gene expression profile of the kidney was analyzed using microarray. The good prognosis (GP) group was defined as patients with an annual eGFR decline rate of < 5 ml/min/1.73 m<sup>2</sup>.

**Results:** The eGFR, urinary protein, and rate of sclerotic glomeruli at the time of renal biopsy in the poor prognosis (PP; n=6) and GP groups (n=6) were 47±18 and 45±15 ml/min/1.73 m<sup>2</sup>, 7.5±4.2 and 4.0±2.7 g/gCre, and 19±13% and 26±14%, respectively, none of which differed between the two groups. In the microarray analysis, genes with little or no expression (raw signals < 50 and [processed signals] < 0.3) were excluded and then 14227 genes were used for the analyses. A total of 1496 differentially expressed genes (DEGs) were selected by the criteria of P-values < 0.05 and |fold change| ≥ 2. Using the Ingenuity Pathway Analysis system, 15 canonical pathways and 9 diseases or functions annotations were found to be enriched. In addition, 73 upstream regulators were enriched, including CCN5 which was predicted to be significantly activated in the GP group. Moreover, one regulatory effect and 25 networks were revealed to be associated with the DEGs. The associated regulatory effect was 'viral infection' in which CCN5 is predicted to regulate the expression of CDH1, CD24, and ESR1 genes. The top five networks with a score of > 30 contained ESR1, extracellular signal-regulated kinase, and AKT which were predicted to be activated in the GP group.

**Conclusions:** Some factors identified in the present study have been reported to be as renoprotective factors in the past, which imply that they function to prevent the progression of DKD with NL.

**Funding:** Government Support - Non-U.S.

TH-PO249

**ND-13, a DJ-1 Derived Peptide, as a Novel Pharmacological Approach to Activated Nrf2 in the Prevention of Inflammation Activation in Diabetic Nephropathy**

Santiago Cuevas,<sup>1,2</sup> Virginia C. Sanchez,<sup>1</sup> Adrián Luna García,<sup>1</sup> Maksym Kupchyk,<sup>1</sup> Leonor Andugar-Rocamora,<sup>2</sup> Cristina M. López,<sup>1</sup> Inmaculada Ros Madrid,<sup>2</sup> Laura H. Navarro,<sup>1</sup> Florentina Rosique,<sup>2</sup> <sup>1</sup>BioMedical Research Institute of Murcia (IMIB-Arrixaca), Murcia, Spain; <sup>2</sup>Clinical University Hospital Virgen de la Arrixaca, Murcia, Spain.

**Background:** The inflammasome is a crucial regulator of renal inflammation and a key factor in the pathogenesis of renal diseases. DJ-1 is a renal protein with antioxidant and anti-inflammatory properties with the capacity to prevent Nuclear factor erythroid 2-related factor 2 (Nrf2) degradation. Nrf2 is a transcription factor that activates the expression of numerous proteins with antioxidant properties. ND-13 is a peptide consisting of 13 highly conserved aas from the DJ-1 sequence. In this study, we determined the capacity of ND-13/Nrf2 pathway to attenuate inflammasome activation in renal diseases.

**Methods:** Mouse bone marrow macrophages (BMM) were treated with Bardoxolone, an Nrf2 inducer, and ND-13. Diabetes was induced in C57Bl/6 mice via injection of STZ and treated with ND-13. Peripheral blood mononuclear cells (PBMCs) were isolated from the blood of patients with diabetic nephropathy and controls and were plate and stimulated with LPS/ATP and treated with ND-13 and MCC950, an inflammasome inhibitor.

**Results:** The IL-1β concentration in the medium of BMM increased by NLRP3 inflammasome stimulation by LPS/ATP, and decreased in macrophages pre-treated with Bardoxolone (65.07±26%, n=4, P<0.05) but not pre-treated with ND-13, however, in presence of H<sub>2</sub>O<sub>2</sub> (100nM), ND-13 significantly decreased IL-1β release after NLRP3 activation (88.6±1.2%, n=4, P<0.05). These data were confirmed by Bardoxolone and ND-13 concentration-response curve. Peritoneal macrophages from diabetic mice were obtained and plated. STZ treatment increased the IL-1β production compared with the control, suggesting that inflammasome may be activated in diabetes and ND-13 treatment normalized its activity. PBMCs isolated from the blood of patients were plate and stimulated with LPS/ATP, and patients with diabetic nephropathy presented a trend to increase IL-1β release compared to controls and diabetic individuals and ND-13 could have a role in the prevention of inflammasome activation.

**Conclusions:** All these data point out that DJ-1/Nrf2 pathway stimulation is a promising approach to decreasing immune cells inflammasome activation, and ND-13 could be a new approach to attenuate inflammation in renal diseases.

**Funding:** Government Support - Non-U.S.

TH-PO250

**Glomerular Permeability Associates With Higher Risk of Kidney Failure and Death in Type 2 Diabetes**

Pierre Jean Saulnier,<sup>1,2</sup> Helen C. Looker,<sup>1</sup> Anita T. Layton,<sup>3</sup> Kevin V. Lemley,<sup>4</sup> Robert G. Nelson,<sup>1</sup> Petter Bjornstad,<sup>5</sup> <sup>1</sup>National Institute of Diabetes and Digestive and Kidney Diseases, Chronic Kidney Disease Section, Phoenix, AZ; <sup>2</sup>University of Poitiers, Poitiers, France; <sup>3</sup>University of Waterloo, Waterloo, ON, Canada; <sup>4</sup>University of Southern California, Los Angeles, CA; <sup>5</sup>University of Colorado, Aurora, CO.

**Background:** Hydrodynamic models of hindered solute transport are used to characterize the size selective properties of the glomerular barrier. One model assumes the glomerular capillary is perforated by restrictive cylindrical pores of identical pore radius and a parallel shunt pathway of nonrestrictive pores characterized by a parameter, ω<sub>0</sub>, that estimates the fraction of total filtrate passing through the shunt. We reported previously that type 2 diabetes (T2D) associated with an increase in ω<sub>0</sub>. Here we examine whether ω<sub>0</sub> associates with incident kidney failure or death in Pima Indians with T2D.

**Methods:** Iothalamate GFR and fractional clearance of dextrans of graded sizes were measured in 185 adults (74 men, 111 women) with T2D. ω<sub>0</sub> was computed from the dextran sieving data. Hazard ratios (HR) for kidney failure or death were expressed per 1 standard deviation (SD) increase of ω<sub>0</sub> by Cox regression after adjusting for age, sex, GFR, ACR, HbA1c and mean arterial blood pressure (MAP).

**Results:** At baseline, mean age (±SD) was 43±10 years, diabetes duration 8.8±8.7 years, HbA1c 8.9±2.4%, MAP 93±12 mm Hg, GFR 147±46 ml/min, and median (IQR) ACR was 41 (10-229) mg/g. During a median follow-up of 29 years, 70 participants developed kidney failure and 134 died, 60 after developing kidney failure. Baseline ω<sub>0</sub> was higher in participants who developed kidney failure (0.00262 ± 0.00095 vs 0.00204 ± 0.00077, P=0.0016) or died (0.00240 ± 0.00086 vs 0.00188 ± 0.00097, P=0.015). After adjustment, each 1 SD increase in baseline ω<sub>0</sub> associated with increased risk of kidney failure (HR: 1.60, 95% CI 1.20-2.14) and death (HR: 1.34, 95% CI 1.06-1.68) [Table].

**Conclusions:** Enhanced transglomerular passage of test macromolecules associated with kidney failure and death, independent of albuminuria and GFR, suggesting that mechanisms responsible for impaired glomerular barrier size selectivity are important determinants of adverse health outcomes in T2D.

**Funding:** NIDDK Support, Other NIH Support - N01-DK-6-2285 and N01-DK-7-2291

Hazard ratio for kidney failure and death according to baseline shunt coefficient (ω<sub>0</sub>)

	Kidney failure 70 events/185		Death 134 events/185	
	HR (95%CI)	P-value	HR (95%CI)	P-value
Shunt coefficient (ω <sub>0</sub> ) per 1 SD	Crude: 2.00 (1.55-2.57)	<0.0001	1.50 (1.25-1.81)	<0.0001
Shunt coefficient (ω <sub>0</sub> ) per 1 SD	Adjusted*	1.60 (1.20-2.14)	1.34 (1.06-1.68)	<0.0001

\*adjusted for age sex GFR ACR HbA1c and MAP

TH-PO251

**Association of Triglycerides to High-Density Lipoprotein Cholesterol Ratio With Incident Cardiovascular Disease but Not ESKD Among Patients With Biopsy-Proven Diabetic Nephropathy**

Takayuki Uemura,<sup>1</sup> Masatoshi Nishimoto,<sup>1</sup> Masahiro Eriguchi,<sup>1</sup> Hiroyuki Takami,<sup>1</sup> Hikari Tasaki,<sup>1</sup> Riri Furuyama,<sup>1</sup> Fumihiko Fukata,<sup>1</sup> Takaaki Kosugi,<sup>1</sup> Katsuhiko Morimoto,<sup>2</sup> Masaru Matsui,<sup>3,1</sup> Ken-ichi Samejima,<sup>1</sup> Kazuhiko Tsuruya,<sup>1</sup> <sup>1</sup>Nara Medical University, Kashihara, Japan; <sup>2</sup>Nara Prefecture Seiwa Medical Center, Ikoma, Japan; <sup>3</sup>Nara Prefecture General Medical Center, Nara, Japan.

**Background:** Increased triglycerides (TG) and decreased high-density lipoprotein cholesterol (HDL-C) are dyslipidemias characteristic of diabetes. Here, we aimed to examine the associations of TG/HDL-C ratio with subsequent cardiovascular disease (CVD) and kidney outcomes among patients with diabetic nephropathy.

**Methods:** A retrospective observational study consists of patients with biopsy proven diabetic nephropathy between June 1981 and December 2014. Patients complicated with other kidney diseases were excluded. Exposure of interest was TG/HDL-C ratio measured at the time of kidney biopsy. The outcome variables were kidney histological findings, incident CVD and end-stage kidney disease (ESKD). The association between TG/HDL-C ratio and histological findings was examined using logistic regression models. The association of TG/HDL-C ratio with incident CVD and ESKD was examined using Cox proportional hazard models.

**Results:** A total of 353 subjects were divided into quartiles based on TG/HDL-C ratio: Quartile 1 (reference), <1.96; Quartile 2, 1.96–3.10; Quartile 3, 3.11–4.55; and Quartile 4, ≥4.56. TG/HDL-C ratio was not a predictor of any histological findings in the fully adjusted model. During median follow-up periods of 6.2 and 7.3 years, 152 and 90 subjects developed incident CVD and ESKD, respectively. Higher TG/HDL-C ratio was independently associated with a higher incidence of CVD even after adjustments for potential confounders (hazard ratio (HR) [95% confidence interval (CI)] for Quartile 3 vs. reference; 1.73 [1.08–2.79] and Quartile 4 vs. reference; 1.86 [1.10–3.17]). Although there was a weak association between TG/HDL-C ratio and incident ESKD in the univariable model, the association was not significant in the fully adjusted model.

**Conclusions:** Among patients with biopsy-proven diabetic nephropathy, higher TG/HDL-C ratio was independently associated with a higher incidence of CVD. The effect of TG/HDL-C ratio on kidney dysfunction would be inconclusive, and further studies are now warranted.



## TH-PO252

**An Interim Analysis of Clinical and Histopathological Results of the Transformative Research in Diabetic Nephropathy (TRIDENT) Study**

**Samer Mohandes,<sup>1</sup> Amin Abedini,<sup>1</sup> Mustafa AL-Obaidi,<sup>1</sup> Kishor B. Devalaraja-Narashimha,<sup>2</sup> Lori Morton,<sup>2</sup> John T. Liles,<sup>3</sup> Erding Hu,<sup>4</sup> Lea Sarov-Blat,<sup>4</sup> Gurmanna Kalra,<sup>4</sup> Paolo Guarnieri,<sup>6</sup> Anil K. Karihaloo,<sup>5</sup> Matthew Palmer,<sup>1</sup> Katalin Susztak.<sup>1</sup>** <sup>1</sup>University of Pennsylvania, Philadelphia, PA; <sup>2</sup>Regeneron Pharmaceuticals Inc, Tarrytown, NY; <sup>3</sup>Gilead Sciences Inc, Foster City, CA; <sup>4</sup>GlaxoSmithKline USA, Philadelphia, PA; <sup>5</sup>Novo Nordisk Inc, Plainsboro, NJ; <sup>6</sup>Boehringer Ingelheim Pharmaceuticals Inc, Ridgefield, CT.

**Background:** The incidence of Diabetic Kidney Disease (DKD) continues to grow and remains a significant health burden. DKD presents with variable speed of decline in kidney function with little reliable indicators or understanding of underlying mechanisms. The TRIDENT study is a multicenter, prospective, observational study of patients with Diabetes mellitus undergoing a clinically indicated kidney biopsy with a goal to further understand the underlying mechanisms. Herein, we report an interim analysis of available results.

**Methods:** Subjects with DM undergoing clinically indicated kidney biopsy at 19 medical centers were eligible. Extra kidney biopsy core was obtained for the study. Histological lesions were scored by a single pathologist. Baseline characteristics were obtained at the time of enrollment. Follow up visits were scheduled every 6 months for 18 months and monitoring up to 4 years.

**Results:** We consented 412 subjects and obtained kidney tissue samples for 330 subjects. We did not encounter any major biopsy related adverse event. Using histological criteria 146 subjects had DKD. Baseline characteristics obtained include Age (mean 54 years), Gender (Male 55%), Race (White 52.3%, black 37.4%), DM type (90.6% type 2), BMI (mean 32.8 kg/m<sup>2</sup>), presence of hypertension (94.8% present), smoking (57%). The enrollment GFR ranged (4-123 ml/min/1.73 m<sup>2</sup>) baseline urine protein to creatinine ratio (UPCR) ranged (0-22 g/g). We observed that baseline GFR showed a significant but weak negative correlation with Interstitial fibrosis, intimal fibrosis and mesangial hyaline. Baseline UPCR correlated with insudative lesions, epithelial hyperplasia, interstitial fibrosis and foot process effacement. Patients with fast progression (average decrease of GFR >5 ml/min/1.73m<sup>2</sup>/year) had higher baseline HbA1c, baseline UPCR, arteriolar hyalinosis, foot process effacement, microvillous transformation and RPS class.

**Conclusions:** This interim analysis demonstrates the importance of histological analysis to determine kidney function decline in DKD.

**Funding:** Commercial Support - Regeneron Pharmaceuticals Inc, Gilead Sciences Inc, Novo Nordisk Inc, GlaxoSmithKline, Boehringer Ingelheim Pharmaceuticals

## TH-PO253

**Role of Matrix Metalloproteinase-9 During Diabetic Ketoacidosis:****Results From the Diabetic Kidney Alarm (DKA) Study**

**Isabella L. Melena,<sup>1,2</sup> Federica Piani,<sup>1</sup> Kalie L. Tommerdahl,<sup>1</sup> Madison S. Baca,<sup>1</sup> Alexis Macdonald,<sup>1</sup> Laura Pyle,<sup>1</sup> Daniël H. van Raalte,<sup>3</sup> David Cherney,<sup>4</sup> Kelly R. Bergmann,<sup>5</sup> Robert G. Nelson,<sup>6</sup> Richard J. Johnson,<sup>1</sup> Gabriel M. Carafuentes,<sup>1</sup> Petter Bjornstad.<sup>1</sup>** <sup>1</sup>University of Colorado Denver School of Medicine, Aurora, CO; <sup>2</sup>Washington University in St Louis School of Medicine, St Louis, MO; <sup>3</sup>Amsterdam Universitair Medische Centra, Duiwendrecht, Netherlands; <sup>4</sup>University of Toronto School of Medicine, Toronto, ON, Canada; <sup>5</sup>Children's Minnesota, Minneapolis, MN; <sup>6</sup>National Institute of Diabetes and Digestive and Kidney Diseases Phoenix Epidemiology and Clinical Research Branch, Phoenix, AZ.

**Background:** Matrix metalloproteinases (MMPs) are involved in the pathophysiology of acute and chronic kidney disease. However, their role in acute kidney injury (AKI) and proximal tubular dysfunction, a common complication of diabetic ketoacidosis (DKA), is unknown. We examined changes in MMP-9 during and 3 months after episodes of DKA in youth with known or new onset type 1 diabetes (T1D).

**Methods:** Serum samples were collected from youth with DKA at 2 time points: 0-8 hours after starting an insulin infusion and 3 months after hospital discharge. Mixed-effects models evaluated the changes in serum MMP9 and associations with serum copeptin and uric acid and adjustments were made for estimated glomerular filtration rate (eGFR) calculated by serum creatinine and cystatin C. Data are reported as mean and standard deviation (SD) or standard error (SE), or  $\beta$ -estimates and SE for mixed-effects models.

**Results:** We enrolled 40 youth (52% boys, age [mean $\pm$ SD] 11 $\pm$ 4 years, venous pH 7.2 $\pm$ 0.1, blood glucose 451 $\pm$ 163 mg/dL). 17% of participants (n=7) met criteria for AKI. Concentrations of MMP-9 were significantly higher during episodes of DKA compared to 3 months follow-up (mean $\pm$ SE: 1504.6 $\pm$ 137 vs. 668.7 $\pm$ 159 ng/mL,  $p=0.0003$ ). At 0-8 hours, participants with AKI had significantly higher MMP-9 (2256.9 $\pm$ 310.1 vs. 1344.7 $\pm$ 143.5 ng/mL,  $p=0.01$ ). Higher serum MMP9 was associated with higher serum copeptin, a surrogate marker of vasopressin, ( $\beta$  $\pm$ SE: 12.4 $\pm$ 3.6 per 1 pmol/L increment in copeptin) and higher uric acid ( $\beta$  $\pm$ SE: 123.9 $\pm$ 42.2 per 1 mg/dL increment in uric acid).

**Conclusions:** In our study, DKA and accompanying AKI associated with elevated concentrations of serum MMP-9, a marker of oxidative stress and remodeling, potentially highlighting the underlying mechanisms of kidney injury during DKA.

**Funding:** Other NIH Support - NIH CTSA Grant UL1 TR002535, Private Foundation Support

## TH-PO254

**The Effect of Diabetes in Morbidly Obese Patients on Protein Profiles of Circulating Extracellular Vesicles Before and After Bariatric Surgery**

**Haekyung Lee,<sup>1,2</sup> Junghyun Cho,<sup>1</sup> Eui Suk Chung,<sup>1</sup> Hyoungnae Kim,<sup>1,2</sup> Jin seok Jeon,<sup>1,2</sup> Soon hyo Kwon.<sup>1,2</sup>** <sup>1</sup>Soonchunhyang University Hospital, Yongsan-gu, Seoul, Republic of Korea; <sup>2</sup>Soonchunhyang University Hospital Kidney Center, Yongsan-gu, Seoul, Republic of Korea.

**Background:** Obesity and diabetes are often associated with cardiometabolic diseases, with substantial prognostic heterogeneity. We sought to identify proteomic signatures of circulating extracellular vesicles (EVs) of obesity with or without diabetes before and after bariatric surgery.

**Methods:** Circulating EV proteins were analyzed before and 6 months after bariatric surgery in 30 morbidly obese patients with (n = 12) or without (n = 18) diabetes and compared to those in 37 healthy volunteers.

**Results:** Bariatric surgery induced weight loss and improvements in fasting glucose, but urine albumin (p <0.01) decreased only in non-diabetic obese patients. A total of 26 and 271 EV proteins were significantly differentially expressed in diabetic obese patients compared to non-diabetic obese patients before and after bariatric surgery, respectively. Expression of proteins involved in the complement system and immunoglobulin-mediated immune response was upregulated in both non-diabetic and diabetic obese patients, whereas that of proteins involved in leukocyte- and lymphocyte-mediated immunity was downregulated in both groups after surgery (Figure 1). Expression of proteins involved in glycosylphosphatidylinositol phospholipase D activity and lipid catabolism was downregulated in diabetic obese patients, whereas that was upregulated in non-diabetic obese patients following surgery.

**Conclusions:** Diabetic obese patients have distinct EV protein signatures before and after bariatric surgery compared with non-diabetic obese patients. These obesity- and diabetes-specific EV protein expression profiles and their associated pathways may provide insight into the mechanisms responsible for the development of diabetes in obese patients.

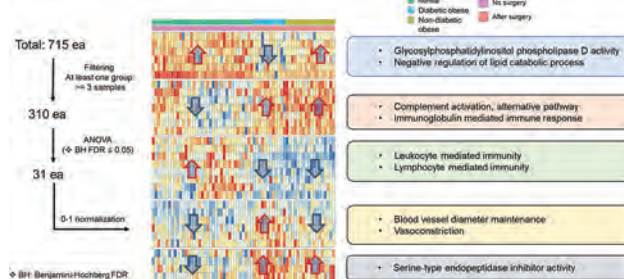

**Figure 1.** Functional interpretation of significantly altered extracellular vesicle proteins after bariatric surgery

## TH-PO255

**Predictors of Persistent Medication Use in Diabetic Kidney Disease (DKD)**

**Susanne B. Nicholas,<sup>1</sup> Kenn B. Daratha,<sup>2</sup> Radica Z. Alicic,<sup>2,3</sup> Cami R. Jones,<sup>2</sup> Lindsey M. Kornowski,<sup>2</sup> Samuel T. Fatoba,<sup>4</sup> Sheldon X. Kong,<sup>4</sup> Rakesh Singh,<sup>4</sup> Keith C. Norris,<sup>1</sup> Katherine R. Tuttle.<sup>2,3</sup>** <sup>1</sup>CURE-CKD <sup>1</sup>University of California Los Angeles, Los Angeles, CA; <sup>2</sup>Providence St Joseph Health, Spokane, WA; <sup>3</sup>University of Washington, Seattle, WA; <sup>4</sup>Bayer AG, Leverkusen, Germany.

**Background:** Angiotensin-converting enzyme inhibitors (ACEi) or angiotensin II receptor blockers (ARB) have been the standard-of-care for DKD for >2 decades, yet few patients receive them. The aim of this study was to identify predictors of persistent use of medications used to treat DKD.

**Methods:** From the Providence and UCLA Health Center for Kidney Disease Research, Education, and Hope Registry (CURE-CKD) of electronic health records, we derived demographic, clinical, and prescription medication data for patients  $\geq$ 20 years old with DKD. ACEi/ARB, sodium-glucose cotransporter-2 inhibitor (SGLT2), and glucagon-like peptide receptor agonist (GLP-1 RA) use was determined at baseline and over time during 2019-2020. A multiple logistic regression model was created for each medication class to predict persistent medication use ( $\geq$ 90 days).

**Results:** Patients with DKD (N=21,658) were 50% women, 70 $\pm$ 13 (mean $\pm$ SD) years of age and White (UCLA: 50%, Providence: 69%). Baseline measures were 2021 CKD-EPI eGFR of 58 $\pm$ 22 mL/min/1.73 m<sup>2</sup>, urine albumin-to-creatinine ratio of 66 (45-113; median, IQR) mg/g, and systolic blood pressure of 131 $\pm$ 16 mm Hg. Median follow-up time was 1 year during 2019-2020. Baseline versus persistent use of ACEi/ARBs were 66% versus 36%; SGLT2i, 5% versus 4%; and GLP-1 RA, 6% versus 5%, respectively. Longer follow-up time predicted higher, while lack of commercial insurance predicted lower, persistent use of each medication class. Positive predictors of persistent ACEi/ARB use were men, non-White race, hypertension, higher eGFR, other medication use, and longer follow-up time (Figure).

**Conclusions:** In typical patients with DKD treated in contemporary clinical practice, use of ACEi/ARB, SGLT2i, and GLP-1 RA is suboptimal and wanes over a short period of time with disparities in persistent use for those without commercial insurance. Inclusive strategies are needed to implement and maintain optimal DKD therapy for all groups of people.

**Funding:** Other NIH Support - NIMHD, Other U.S. Government Support, Commercial Support - Bayer

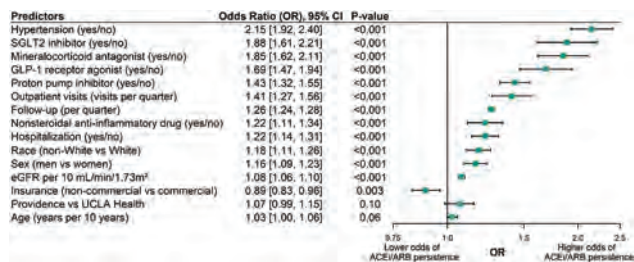

Predictors of persistent ACEi/ARB use in DKD, 2019-2020

TH-PO256

Network Collagen VIII Increases Fibrotic Remodeling and Risk of Arteriovenous Fistula Maturation Failure

Roberto I. Vazquez-Padron,<sup>1,2</sup> Miguel G. Rojas,<sup>1</sup> Marwan Tabbara,<sup>1</sup> Simone Pereira-Simon,<sup>1</sup> Nieves Santos,<sup>1</sup> Mohd Ahmar Rauf,<sup>1</sup> Akshara Sree Challa,<sup>1</sup> Juan C. Duque,<sup>1</sup> Laisel Martinez.<sup>1</sup> <sup>1</sup>University of Miami School of Medicine, Miami, FL; <sup>2</sup>VA Miami Healthcare System, Miami, FL.

**Background:** Excessive postoperative fibrosis is associated with maturation failure of arteriovenous fistulas (AVF). Therefore, targeted therapies that modulate extracellular matrix (ECM) deposition may represent a plausible strategy to improve maturation outcomes.

**Methods:** Transcriptome-wide changes during the vein to AVF transformation were studied in 38 stage 5 chronic kidney disease patients undergoing surgeries for two-stage AVF creation (19 matured, 19 failed) using whole-genome RNA sequencing. Pairwise bioinformatic analyses followed by validation experiments were used to identify changes during postoperative ECM remodeling in association with maturation failure.

**Results:** A total of 3,637 transcripts were differentially expressed (DEG) between veins and AVFs independent of maturation outcome, with >87% upregulated after AVF creation. Over 250 core ECM and ECM-affiliated genes stood out in terms of expression levels and magnitude of fold change, including fibrillar collagens I and III, basement collagens IV and VIII, and multiplexin collagen XVIII. We identified 102 DEGs in association with AVF failure, only eight of which were upregulated in AVFs that failed and which included COL8A1. Upregulation of collagen VIII in AVFs that failed was validated by immunohistochemistry. In vitro experiments with primary smooth muscle cells (SMC) from basilic veins confirmed that the canonical TGFβ-Smad2/3 pathway was primarily responsible for COL8A1 expression. Importantly, inhibition of COL8A1 by siRNA modulated the SMC response to TGFβ signaling and decreased the expression of fibronectin and fibrillar COL1A1 in response to TGFβ stimulation.

**Conclusions:** This work supports an important role for collagen VIII in fibrotic remodeling and failure of newly created AVF.

**Funding:** NIDDK Support, Other NIH Support - NHLBI, Veterans Affairs Support

TH-PO257

Planning Vascular Access Creation: The Promising Role of the Kidney Failure Risk Equation

Bernardo Marques da Silva,<sup>1</sup> Onassis Silva,<sup>1</sup> Mariana Soares,<sup>2</sup> Cristina Outerelo,<sup>1</sup> Maria A. Fortes,<sup>1</sup> Jose A. Lopes,<sup>1</sup> Joana Gameiro,<sup>1</sup> <sup>1</sup>Centro Hospitalar Universitario Lisboa Norte EPE, Lisboa, Portugal; <sup>2</sup>Faculdade de Medicina da Universidade de Lisboa, Lisboa, Portugal.

**Background:** Planning the vascular access (VA) is essential in pre-dialysis patients although optimal timing for VA referral and placement is still debatable. Current guidelines suggest referral for VA placement with an eGFR 15-20ml/min/1.73m<sup>2</sup>. The kidney failure risk equation (KFRE) is an easily calculated equation to predict probability of KRT. The aim of this study was to validate KFRE in patients referred to VA assessment.

**Methods:** We conducted a retrospective analysis of all adult patients with CKD who were referred to the multidisciplinary VA consult, for the first VA placement, at C.H.U. Lisboa Norte between January 2018 and December 2019. The 4-variable KFRE was calculated. Requirement of KRT, mortality and vascular access placement were assessed in a 2-year follow-up. We used the Cox logistic regression to predict KRT requirement and calculated the ROC curve.

**Results:** 256 patients were included and 64.5% were male. At the time of VA consult, mean age was 70.4±12.9 years, eGFR was 16.09±10.43ml/min/1.73m<sup>2</sup>, albuminuria was 1339.4±208.1mg/24h and the mean calculated risk score was 30.44±24.80%. 159 patients required KRT (62.1%) and 72 (28.3%) died in the 2-year follow-up. VA was created in 214 (83.6%) patients, though only 50.9% patients had a functional VA for hemodialysis. The KFRE accurately predicted KRT requirement within 2-years [38.3±23.8 vs 17.6±20.9%, p<.001; HR 1.05 95% CI (1.06-1.12), p<.001], with an auROC of 0.788, [p<.001, 95% CI (0.733-0.837)]. The optimal KFRE cut-off was >20%, with a HR of 9.2 [95% CI (5.06-16.60), p<.001]. 135 (52.7%) patients had KFRE≥20% at the time for VA referral and mean time from VA consult to KRT initiation was significantly lower in these patients (10.98±9.64 vs 16.50±11.14 months, p=0.002). On a sub-analysis of patients with an eGFR<20ml/min/1.73m<sup>2</sup>, a KFRE≥20% was also a significant predictor of 2-year requirement of KRT, with an HR of 6.61 [CI 95% (3.49-12.52), p<.001].

**Conclusions:** KFRE accurately predicted 2-year KRT requirement in this cohort of patients. We have successfully demonstrated that a KFRE ≥20% can be used in addition to eGFR when referring patients for VA planning and help to establish higher priority patients for VA placement. The authors suggest referral for VA creation when eGFR<20ml/min/1.73m<sup>2</sup> and KFRE≥20%.

TH-PO258

Successful Arteriovenous Fistula Creation Slows Rate of eGFR Decline

John Mowrey, Andrew I. Chin, Suresh Appasamy. *University of California Davis, Sacramento, CA.*

**Background:** In patients with advanced CKD, a slower rate of eGFR decline after arteriovenous fistula (AVF) placement has been observed. The mechanism(s) for these findings remain unclear. We retrospectively examined the rates of eGFR decline, before and after successful AVF creation in preparation for HD, in patients who had advanced CKD.

**Methods:** CKD-Epi equation without race correction was used to estimate GFR. Using linear regression of eGFR, before and after AVF placement, rate of eGFR decline in ml/min/month was found in a population of 4 patients with advanced CKD. Successful AVF maturation was defined as either successful use in patients who started HD or clearance for use by surgery in patients not yet on HD. The slope of eGFR decline before and after AVF creation was compared retrospectively.

**Results:** Mean eGFR of our population was 13.5 ± 2.69 ml/min at time of creation of AVF, with an average age of 69. We observed an average rate of eGFR decline of 0.52 ± 0.22 ml/min/month prior to AVF creation, the average rate of decline after successful AVF placement was 0.08 ± 0.03 ml/min/month. Average pre AVF placement observation time was 4.75 ± 2.05 years, and average pre-dialysis time observed after AVF creation was 5.75 ± 3.9 years.

**Conclusions:** In advanced CKD patients who have HD AVFs that successfully mature, eGFR rate of decline appeared to dramatically slow after AVF creation. We additionally analyzed blood pressure and medications in these fairly extensive observation periods before and after AVF placement, and believe AVF placement to have an independent benefit. Proposed mechanisms include alterations in vascular physiology, changes in hemodynamics, improved patient adherence and closer medical monitoring that often follows AVF placement. We believe this case series adds to the growing body of data that suggests an impact on eGFR after a successful AVF creation.

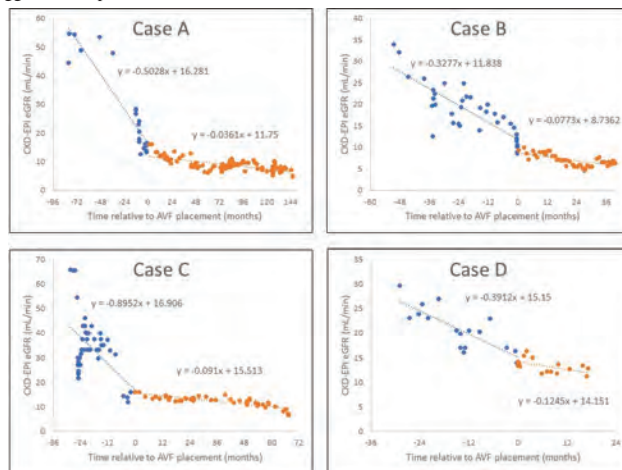

TH-PO259

Patient Perspectives on Arteriovenous Fistula Use: Implications for Racial Disparities

Dipal Patel,<sup>1</sup> Timmy C. Lee,<sup>2</sup> Yi Zhang,<sup>2</sup> Mae Thamer,<sup>3</sup> Michael Allon,<sup>2</sup> Deidra C. Crews.<sup>1</sup> <sup>1</sup>Johns Hopkins University, Baltimore, MD; <sup>2</sup>The University of Alabama at Birmingham College of Arts and Sciences, Birmingham, AL; <sup>3</sup>Medical Technology and Practice Patterns Institute, Bethesda, MD.

**Background:** Placement and maintenance of arteriovenous fistulas (AVFs) are a key quality metric in the care of patients on hemodialysis (HD). Compared to White patients, Black patients are less likely to undergo AVF placement, experience successful AVF use, and maintain AVF patency. We examined factors influencing AVF use in a group of predominantly Black patients receiving HD.

**Methods:** Semi-structured individual interviews were conducted via telephone or teleconference with 59 patients receiving HD at one of eleven facilities affiliated with an academic nephrology practice in the Southern U.S. Interviews were audiorecorded and transcripts were coded for thematic analysis.

**Results:** Transcripts from 53 Black and 6 White patients were used for analysis [Table 1]. Common themes influencing patient perspectives on AVF use centered around the circumstances of dialysis initiation, pre-dialysis and ongoing patient education, and comparisons of different access types including their impact on patients' lives [Figure 1].

The following experiences were highlighted: 1) the vast majority of patients experienced “crash” dialysis starts through a CVC, even when receiving pre-dialysis care, 2) patients who voiced trust of their medical care teams reported a higher level of comfort with AVF placement, 3) pre-AVF patients had a poor understanding of the steps of a fistula procedure and post-surgical care, and 4) when comparing access types, patients most commonly reported CVCs to be troublesome due to showering restrictions and infection concerns, whereas fistulas carried higher risks of pain, bleeding, and altering patient appearance.

**Conclusions:** Patient perspectives on AVF placement, use, and maintenance may inform our understanding of racial disparities in the AVF care continuum.

**Funding:** Other NIH Support - NIH R01MD013818

Patient Demographics	Pre-AVF (n=15)	Maturing AVF (n=8)	Failed AVF (n=5)	AVF in Use (n=31)	Total (n=59)
Age in years (average [range])	48 (29, 66)	52 (26, 75)	58 (49, 68)	53 (20, 83)	52 (20, 83)
Race (B=Black, W=White)	12B, 3W	7B, 1W	4B, 1W	30B, 1W	53B, 6W
Gender (M=Male, F=Female)	9M, 6F	6M, 2F	2M, 3F	18M, 13F	35M, 24F
Dialysis vintage in days (average [range])*	715 (32, 2715)	783 (48, 4400)	2721 (489, 3844)	1448 (51, 4361)	1263 (32, 4400)

\*Dialysis vintage data is for 52 of the 59 patients

**Pre-AVF**  
 Circumstances of dialysis initiation: "I know that I couldn't get a fistula in the beginning because they had to emergency dialysis on me."  
 Patient education on continuum of fistula care: "I'm not sure about how it goes, where I do think it would be kind of easier."  
 Patient views of dialysis access options: "They've told me that it's easier, that they can deal with it better than the port-catheter, because as far as the port-cath is, you know it's hard."

**Maturing AVF**  
 "I kept swelling up and then they ended up taking me my kidneys wasn't working. At the time, it wasn't going nowhere... during the next doctor's appointment, though, I went to the hospital."  
 "I have little weights that I try to use... my fistula was created by interventional radiology, and then it required three other procedures to try to get it to work... I don't think I've been told -- I've asked what I can do... But I haven't been told that I can do anything different than what I've been doing."  
 "I don't know yet, because I'm still scared to get stuck myself, so I don't know what I'd say to them. I don't want to get stuck. I've seen their needles. They're huge."

**AVF in Use**  
 "They told me I had a bad kidney. And after that, they were teaching me... I went to classes, looked at films, and they had a thing that showed how it could be done..."  
 "Like certain people stick me or whatever, and then they bleed when I get home, overnight with I sleep. And then I have to get it checked out to make sure everything okay! That surprised me a lot. It scared me too."  
 "... With my fistula, it's inside my body so the doctors there are less of getting infected than their catheter, because that catheter... I had to make sure I cleaned that area around there really, really good. It was a bunch of maintenance on that catheter. With the fistula, they put it in, it healed. We use it. Bingo."

TH-PO260

**Isometric Exercise and Arteriovenous Fistula for Haemodialysis: The Impact on Maturation Process**

Iratí Tapia, Diana Oleas. *Consorti Sanitari de Terrassa, Terrassa, Spain.*

**Background:** Arteriovenous fistula (AVF) is the gold standard vascular access (VA) for end-stage chronic kidney disease patients. Postoperative exercises may help to improve maturation. Nevertheless, scarce scientific evidence has been reported about their utility until date. **Objectives:** To assess the effect of a postoperative isometric exercises program on native VA maturation in our patients with stages 5-5D chronic kidney disease.

**Methods:** A 24 months prospective single-center study. After surgery, all patients were randomized to an isometric exercise group (EG) or a control group (CG). An agreed with Rehabilitation, isometric exercises protocolled program, was performed in EG. CG received usual care. Demographical data, muscle strength using handgrip(HG) dynamometer, main Doppler ultrasound (DUS) measurements (outflow vein (OV) diameter and humeral artery blood flow rate (BFR), clinical and DUS maturation as well as medical (hematoma, stenosis, thrombosis, pseudoaneurysm, aneurysm) or surgical VA complications were assessed at 4 and 8 weeks postoperatively.

**Results:** 67 patients; 7 drop out. 30 EG, 30 CO, 71,7 % men. Mean age 68,6±13,0 years. 60% Radiocephalic AVF. Demographic data, HG and DUS measurement at baseline were similar. A significant increase in HG was observed only in EG at the end of study (20,7±8,1 vs 25,1±10,3Kg, p=0,001). DUS measurements statistically increased for both groups (OV diameter: EG 3,2 ± 0,8 vs. 6,2 ± 1,5 mm; CG 2,9 ± 0,7 vs. 5,6 ± 6,2 mm; humeral artery BFR: EG 142,7± 35,2 vs. 1536,2 ± 679,2 ml/min; CG 134,6± 36,6 vs. 1170,4 ± 537.1ml/min) at the end of study. EG group obtained highest clinical maturation at 4 (CG 33.3% vs EG 70%; p=0,009) and 8 weeks (CG 33% vs EG 76,7%;p=0,002). Similarly, DUS maturation was better in EG at 4 (CG 40% vs EG 80%; p=0,003) and 8 weeks respectively (CG 43,3%vs EG 83,3%;p=0,003). These results were also observed in EG both distal and proximal territories for all these periods. There were not differences in medical or surgical VA complications during the study.

**Conclusions:** The isometric exercises protocolled program improve clinical and DUS maturation in our patients. This effectiveness was observed in both distal and proximal territories. Further studies are required to support the benefits of postoperative isometric exercises in the vascular access maturation process.

TH-PO261

**Novel Method to Monitor Arteriovenous Fistula Maturation: Impact on Catheter Residence Time**

Laura Rosales, Xiaoling Ye, Hanjie Zhang, Brenda K. Chan, Marilou Mateo, Seth Johnson, Peter Kotanko. *Renal Research Institute, New York, NY.*

**Background:** Timely assessment of arterio-venous fistula (AVF) maturation is essential to reduce the residence time of central venous catheters (CVC). We used central-venous oxygen saturation (ScvO<sub>2</sub>) and estimated upper-body blood flow (eUBBF) to monitor AVF maturation. We now report CVC residence time in patients with and without ScvO<sub>2</sub>-based AVF maturation monitoring.

**Methods:** Newly created AVF were monitored employing ScvO<sub>2</sub>-based AVF maturation during a clinical quality improvement project (QIP) conducted in two Renal Research Institute (RRI) clinics (QIP clinics). ScvO<sub>2</sub> was measured by Crit-Line (Fresenius Medical Care, Waltham, MA); eUBBF was computed as reported [Rosales (2019), doi: 10.1159/000494742]. Time-to-event analysis compared CVC residence time post-AVF creation between QIP and three non-QIP control groups (CG). CG 1: concurrent controls from 2 non-QIP RRI clinics (N=134 patients); CG 2: concurrent controls from the 2 QIP RRI clinics (N=48); CG 3: historic (2014-6) pre-QIP controls from the 2 QIP RRI clinics (N=57). Censoring events were death, dialytic modality change, transplantation, lost to follow up, and end of observation period (Nov. 2021).

**Results:** The QIP group comprised 44 patients (age 59 ±17 years; 27 males). The 4 groups did not differ regarding age, race, and sex. Six months after AVF creation, the fraction of patients with CVC still in place was 21% in the QIP group; CG 1 58%; CG 2 67%; CG 3 68%. The Kaplan-Maier curve differed significantly between groups (P<0.0001, log rank test. Fig 1).

**Conclusions:** Compared to three control groups, CVC residence time was shorter in patients with ScvO<sub>2</sub>-based assessment of AVF maturation. Tracking of ScvO<sub>2</sub> and eUBBF is a non-invasive means to follow AVF maturation, trigger timely interventions, and shorten CVC residence time.

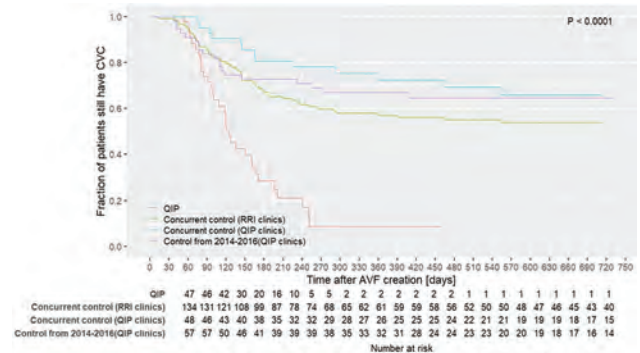

**Figure 1:** Catheter residence time after AVF creation. ScvO<sub>2</sub>-based monitoring of AVF maturation (QIP; red); concurrent control (4 RRI clinics; green); concurrent controls (2 QIP clinics; cyan); historic controls (QIP clinics; purple).

TH-PO262

**Predictors of Arteriovenous Fistula Maturation**

Tiago L. Cerqueira,<sup>1,2</sup> Tamires O. Barros,<sup>1</sup> Isabela L. Pimenta,<sup>1</sup> Mayra M. Palotti,<sup>1</sup> Roberto L. Oliveira.<sup>1</sup> *Hospital Evangelico, Belo Horizonte, Brazil;* <sup>2</sup>*Dresden International University GmbH, Dresden, Germany.*

**Background:** 89% of patients with End Stage Kidney Disease (ESKD) choose hemodialysis (HD) as kidney replacement modality, which requires a vascular access. Arteriovenous fistula (AVF) is the preferred access for its lowest risk of complications, despite high chances of failure. We aim to find predictors of AVF maturation after creation based on HD patient's clinical and vascular mapping (VM) characteristics.

**Methods:** This is a 4 dialysis centers' retrospective cohort of patients on HD who had their AVF created between April 2014 and September 2018 in Minas Gerais, Brazil. The follow-up period was 1 year. Demographic, medical history and VM data were extracted from electronic health records. The primary outcome was to achieve fistula used successfully for hemodialysis (FUSH) criteria. A univariate analysis and a multivariate logistic regression were conducted to find clinical variables that were independent predictors of FUSH. Software: IBM® SPSS Statistics 23.

**Results:** 789 AVFs created were included. 569 (72%) achieved FUSH, while 220 (28%) failed. On univariate analysis, AVF failure was associated with female (p = 0.01), diabetes as ESKD cause (p > 0.01), higher Charlson Index (p > 0.01), lower albumin levels (p = 0.03), and less use of ARB/ACE inhibitor (p > 0.01). In the logistic regression, positively independent predictors of FUSH were: male (OR 1.46, 95% IC 1.05-2.04, p = 0.03); ESKD cause – compared to diabetic nephropathy, hypertensive or glomerular nephropathy (respectively, OR 5.44, 95% IC 2.22-13.33, p > 0.01; OR 1.68, 95% IC 1.08-2.62, p = 0.02); ARB/ACE inhibitor use (OR 1.89, 95% IC 1.36-2.65, p > 0.01), an increase in albumin (OR 1.45, 95% IC 1.04-2.01, p = 0.03) and phosphate levels (OR 1.11; 95% IC 1.00-1.23, p = 0.04); AVF type - brachiocephalic was more likely to mature than radiocephalic (OR 1.86, 95% CI 1.18-2.94, p = 0.01) and an increase in the standardized vein diameter (OR 1.53, 95% IC 1.25-1.87, p > 0.01). Having a prior failed AVF was a negative predictor of FUSH (OR 0.69, 95% IC 0.49-0.98, p = 0.04). The two most important variables for the model were primary cause of CKD, followed by the type of AVF and vein diameter.

**Conclusions:** We found clinical and VM variables that are independent predictors of FUSH, which will aid the development of an AVF maturation score to help vascular access decision-making for patients with ESKD on HD.

**Funding:** Private Foundation Support

TH-PO263

Long-Term Hemodialysis Access Survival of Arteriovenous Fistulas

Tiago L. Cerqueira,<sup>1,2</sup> Isabela L. Pimenta,<sup>1</sup> Roberto L. Oliveira,<sup>1</sup> Mayra M. Palotti,<sup>1</sup> Tamires O. Barros.<sup>1</sup> <sup>1</sup>Hospital Evangelico, Belo Horizonte, Brazil; <sup>2</sup>Dresden International University GmbH, Dresden, Germany.

**Background:** Vascular access is crucial for patients with End Stage Kidney Disease (ESKD) who choose hemodialysis (HD). Arteriovenous fistula (AVF) is the preferred type for its lowest risk of complications and mortality. Thus, it is important to consider AVF longevity when planning for a vascular access. We aim to compare three AVFs – radiocephalic (RC), brachiocephalic (BC) and brachio basilic (BB) – regarding their access survival to guide shared-decision making of the most appropriate vascular access for our patients.

**Methods:** This is a 4 dialysis centers’ retrospective cohort of patients on HD who had their AVF created between April 2014 and September 2018 in Minas Gerais, Brazil. Follow-up was until March 2021. We conducted a survival analysis comparing RC, BC and BB AVFs by Kaplan-Meier curve and Cox-regression, controlling for age, gender, cause of ESKD, previous catheter on the AVF side and previously failed AVF history. When proportional hazards were not met, Cox-Regression with time-dependent covariate was done. Censoring: loss to follow-up, leaving HD modality or death. Software used: IBM® SPSS Statistics 23.

**Results:** 789 AVFs were included in the study: 28% (220) RC, 38% BC (304) and 34% (265) BB. 56% were male with 58±13.5 years of age. Common causes of ESKD were diabetic (40%), hypertensive (22%) and glomerular (8%) nephropathies. 63% had a previous catheter on the AVF side, while 49% had a previously failed AVF. 220 (28%) had early AVF failure after surgery. Median time to successful maturation was 10 weeks for RC and BC and 9 weeks for BB. Median follow-up time was 108 weeks. In the uncontrolled analysis, we found no differences in access survival between RC and BC AVFs (p = 0.3). RC had better survival after 30 weeks than BB (p = 0.02, HR = 1.2, 95% CI 1.02-1.48) and BC was also better than BB after 7 weeks (p = 0.00, HR = 1.5, 95% CI 1.13-1.97). After controlling for confounders, we found that RC became worse than BB (p = 0.00, HR = 0.8, 95% CI 0.68-0.93) before 30 weeks, but had similar survival after that period. BC remained better than BB (p = 0.03, HR = 1.35, 95% CI 1.02-1.77) after 7 weeks. Surprisingly, RC became worse than BC (p = 0.46, HR = 0.78, 95% CI 0.61-0.99).

**Conclusions:** Patient characteristics influence AVF survival in several ways. BC AVFs appear to have the longest access survival after cofounder control.

**Funding:** Private Foundation Support

TH-PO264

Retrospective Analysis Comparing Atrioventricular Fistula Successful Use Rates for Hemodialysis (FUSH) at 6 Months to Prediction by Lok Failure-to-Mature Tool

Rashed Alfarra, Iskra Myers, Joseph C. Parker. East Carolina University, Greenville, NC.

**Background:** Atrioventricular fistula (AVF) is the preferred vascular access for dialysis patients. AVFs have high non-maturation rate. Lok et al, developed a clinical prediction tool to identify AVFs at risk for Failure To Mature (FTM). The equation includes patient’s age, race, presence of peripheral vascular disease (PVD), coronary artery disease (CAD), and has achieved good prediction accuracy with 69% failure rate in the highest risk category. We aimed to validate the Lok’s FTM equation in our patients at East Carolina dialysis unit.

**Methods:** Retrospective chart review identified 43 patients who received AVF from 12/01/2009 to 12/01/2020 at ECU dialysis unit. Demographic and clinical data was obtained from electronic medical records. The primary outcome was AV FUSH at 6 months. The FTM equation risk score was retrospectively applied to our patient cohort and compared with the observed clinical outcomes using Receiver Operating Characteristic in SPSS v28.

**Results:** In total 43 AVFs were created during the study period. Mean age was 55 +/- 20 years, 89% were African American, 30% of the patients had CAD, 14% had PVD. FUSH at 6 months was 53.5%. We examined the external validity of Lok’s model by applying it to our population. 22% of patients with lowest risk score had non maturation at 6 months. 14% of the patients with highest risk scores all lost access within one year of AVF creation despite having FUSH at 6 months.

**Conclusions:** Despite increased number of AVF creations since Fistula First Initiative, outcomes on maturation rates are suboptimal. Reasonable FUSH rates at 6 months can be achieved. FTM equation was not validated in our cohort. Possible reason is our population cohort (mostly African American) vs Lok’s FTM cohort (mostly Caucasian population).

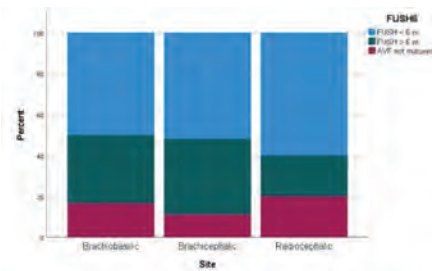

Figure 1: Percentage of Fistulas Used Successfully for Hemodialysis (FUSH) based on AVF location.

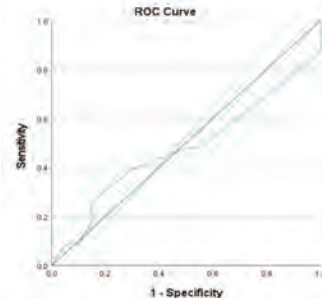

Figure 2: ROC curve of the FTM predictor score in the ECU dialysis cohort.

TH-PO265

The Association Among Carotid Intima-Media Thickness, Pulse Wave Velocity, and Vascular Access Failure in Hemodialysis Patients

Jong-woo Yoon, Hyunsuk Kim, Jineop Kim, Seok-hyung Kim, Gwangho Choi. Hallym University Medical Center, Chuncheon Sacred Heart Hospital, Chuncheon, Republic of Korea.

**Background:** Patients with chronic kidney disease (CKD) or end stage renal disease (ESRD) have an increased risk of cardiovascular mortality and morbidity. We aimed to compare the value of IMT with tests such as coronary CT and Pulse wave velocity(PWV) as predictors of cardiovascular risk in ESRD patients undergoing maintenance dialysis and examine their association with cardiovascular disease.

**Methods:** We reviewed the participants’ medical records, including height, body weight, smoking status, alcohol intake, medication history, etiology of ESRD, HD vintage, and blood pressure which were measured during hemodialysis. Carotid doppler was performed by an skilledsonographer who are unaware of the aims of the study and blinded to the laboratory findings. For PWV measurement, Patients lie down, rest for at least 5 minutes, and prohibit smoking and coffee for 3 hours before the measurement. BaPWV is measured by recording pulse waves of both arm and both ankles from the pressure signal obtained by measuring 4-extremity blood pressure.

**Results:** One hundred patients were included, of whom 51 (50.5%) were men. The median age was 66years (interquartile range 58-76 years). The median vintage of hemodialysis was 47.5 months (range 31.3-89.1 months). There were no significant differences between high IMT group and low IMT group in sex, hemodialysis vintage, end-stage renal disease etiology, and type of vascular access. However, age was significantly older in the high IMT group. IMT was significantly associated with PWV (hazard ratio [HR] 2.109; 95% CI 1.037-4.291, P = 0.039). After adjusting for age, sex and presence of diabetes, IMT was independently associated with PWV (HR 2.110, 95% CI 1.036-4.298, P = 0.040). The risk of recurrent vascular access failure was higher in the high IMT group (HR 1.615, 95% CI 1.460-5.669, P = 0.034).

**Conclusions:** IMT was associated with PWV and recurrent access failure. Thus IMT may be suggested as a potential predictor of vascular access failure.

TH-PO266

Long Term Outcomes of Stenting in Treating Thigh Arteriovenous Grafts

Ammar Almejmi,<sup>1</sup> Masa Abaza,<sup>2</sup> Sloan Almejmi,<sup>1</sup> Vinay Narasimha Krishna,<sup>1</sup> Alian Albalas.<sup>1</sup> <sup>1</sup>The University of Alabama at Birmingham, Birmingham, AL; <sup>2</sup>University of Alaska Anchorage, Anchorage, AK.

**Background:** Stents are used to manage the outflow stenotic lesions that complicate upper extremity arteriovenous grafts (AVGs) to improve the survival. In this study, we sought to investigate the effect of stents on the overall survival of “thigh” AVGs.

**Methods:** This was a retrospective review of patients who received dialysis via thigh AVGs. Data on demographics, comorbidities, AVG intervention history was collected. Both primary and secondary AVG survival rates were calculated using Kaplan-Meier analysis. Multivariate analysis was performed to determine the predictors of the graft survival.

**Results:** This study included 407 thigh AVGs; 53.2% females; 92.4% African Americans; and 92% hypertensive. Graft thrombosis (67.1%) and elastic recurrent stenotic lesions (32.9%) were the main indications for stent deployment. During follow up, the median secondary graft survival in the stent versus no-stent groups was 86.1 ( $\pm 15.5$ ) vs 34.1 ( $\pm 5.3$ ) months ( $p=0.001$ ), respectively. Multi-variables Cox-regression analysis revealed that AVG thrombosis, stenting and hypertension were the main predictors of the AVG survival (Table 1 and Figure 1).

**Conclusions:** The use of stents to manage the outflow lesions appears to improve the overall thigh AVG survival specially in thrombosed grafts.

**Figure 1: Thigh AVG cumulative secondary patency showing the different groups**

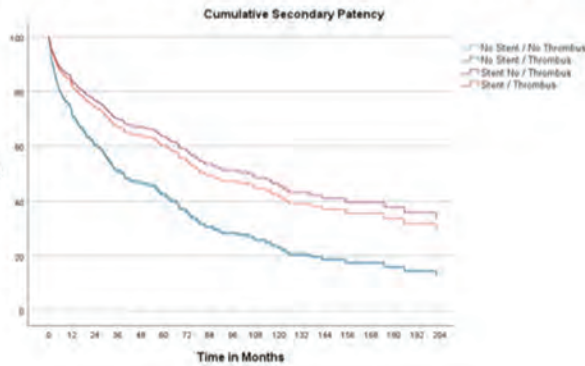

**Table 1: Significant predictors of thigh AVG secondary patency**

Variable	Hazard Ratio	Lower	Upper	p
Hypertension	2.1	1.2	3.5	0.015
No-Stent and No thrombosis	1*			
No-Stent with thrombosis	1.0	0.7	1.3	0.821
Stent without thrombosis	0.5	0.2	1.2	0.128
Stent with thrombosis	0.6	0.4	0.9	0.008

\*No stent/no thrombosis is the reference category;  $p < 0.05$  is considered significant

**TH-PO267**

**Arteriovenous-Oscillometry to Assess Fistula Function**

Veit Busch,<sup>1,2</sup> Joachim Streis,<sup>1</sup> Niklas Mueller,<sup>4,3</sup> Sandra Müller,<sup>3</sup> Felix S. Seibert,<sup>6,7</sup> Thomas Felderhoff,<sup>1</sup> Timm H. Westhoff.<sup>6,7</sup> <sup>1</sup>Fachhochschule Dortmund, Dortmund, Germany; <sup>2</sup>Nephroital, Kamen, Germany; <sup>3</sup>Universitätsklinikum Munster Medizinische Klinik D, Munster, Germany; <sup>4</sup>Klinikum der Universität München Medizinische Klinik und Poliklinik III, München, Germany; <sup>5</sup>Technische Universität Wien Institut für Diskrete Mathematik und Geometrie, Wien, Austria; <sup>6</sup>Marienhospital Herne Medizinische Klinik I Innere Medizin, Herne, Germany; <sup>7</sup>Ruhr-Universität Bochum Medizinische Fakultät, Bochum, Germany.

**Background:** We recently demonstrated that pulse wave analysis may be useful in functional fistula monitoring using tonometric measurement. We now aimed to evaluate if convenient oscillometric devices are applicable to detect flow below 500 ml/min.

**Methods:** We recorded pulse waves ambilaterally with the vicorder® device at the brachial artery in 53 patients with native fistula and analyzed them with the use of a specifically developed matlab® application. The key parameters consisted of normalized variables assessed by the mean slope in the time sections between the footpoint, the systolic maximum (T1), the diastolic notch, the first diastolic inflection point and the end of diastole: Specifically in the second section (slope2) and the sum of all four sections (slopeΣ). We furthermore assessed the amplitude of uncalibrated relative volumetric change in the measuring cuffs of the vicorder® device during cardiac cycle (AMP). Flow was measured with the use of duplex sonography.

**Results:** There were marked differences in the wave contours of the fistula and non-fistula side (Figure 1). Medians (fistula/non-fistula) of slope2, slopeΣ and AMP were -0.00150/-0.00322 [relative amplitude/ms,  $p < 0.001$ ], 0.01094/0.01187 [relative amplitude/ms,  $p=0.006$ ] and 1850/725 [relative volumetric change,  $p < 0.001$ ] (Wilcoxon test of related samples). T1 was delayed at the fistula arm ( $204 \pm 3.4$  ms versus  $162 \pm 5.3$  ms at the non-fistula arm,  $p < 0.001$ ). ROC-analyses of parameter values measured at the fistula arm to detect low flow fistula demonstrated AUCs (with CI) of 0.652 (0.437-0.866,  $p=0.167$ ) for slope2, 0.732 (0.566-0.899,  $p=0.006$ ) for slopeΣ and 0.775 (0.56-0.991,  $p=0.012$ ) for AMP (Figure 2).

**Conclusions:** Fistula functional monitoring with oscillometry is feasible and is a promising clinical application to detect a low flow fistula.

Clinical characteristics

N	Age	BMI	Gender	Fore/upper arm fistula	Diabetes	Permanent AF	CHD	HFrEF
53 (100%)	66±2.2 [years]	25.6±0.6 [kg/m <sup>2</sup> ]	2.53 [m/f]	2.31	30 (56.6%)	17 (32.1%)	18 (34%)	5 (9.4%)

**Fistula Stenosis**

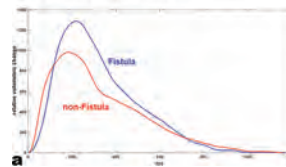

**After Treatment**

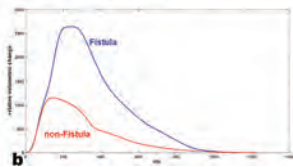

Exemplary pulse waves at the fistula and non-fistula arm of one patient before and after treatment of fistula-stenosis.

**TH-PO268**

**The Initial Experience of Endovascular Arteriovenous Fistula Creation in a Multi-Ethnic Population From Singapore**

Ru Yu Tan, Hsien Ts'ung Tay, Kun D. Zhuang, Suh Chien Pang, Tng R. Alvin, Chee Wooi Tan, Chye Chung Gan, Chee Chin Phang, Kiang Hiong Tay, Tze tec Chong, Chieh-suai Tan. *Singapore General Hospital, Singapore, Singapore.*

**Background:** The technique of endovascular arteriovenous fistula (EndoAVF) creation was made available in Singapore end of 2021. This study reports the initial experience of EndoAVF creation in a tertiary center in Singapore.

**Methods:** The patients referred for creation of new AVF was offered EndoAVF. Enrolled patient had vein mapping performed according to protocol and underwent EndoAVF creation if suitable. Data was collected prospectively for patients who underwent EndoAVF creation.

**Results:** A total of 15 patients were enrolled and underwent vein mapping. Of which, 11 patients were deemed suitable for EndoAVF creation and underwent the procedure under regional anesthesia. The patients have a mean age of  $60 \pm 10$  years and were predominantly male (64%) and of Chinese (91%) ethnicity. The etiology of end-stage renal disease was diabetes mellitus (55%) followed by chronic glomerulonephritis (36.4%) and others (9%). Seven patients (64.6%) were already on hemodialysis via tunneled dialysis catheter while the remaining 4 patients were pre-emptive creation. EndoAVFs were successfully created in 10 (91%) patients. The anastomoses were radial-radial (50%) and ulnar-ulnar (50%). The brachial artery blood flow immediately, at 1- and 2-month post-creation was  $544 \pm 191$ ,  $612 \pm 217$ , and  $830 \pm 401$  mls/min, respectively. At 3-month, post-creation, 9 EndoAVF was assessed to be matured on clinical examination with a median maturation time of 70 (45, 95) days. Eight patients had successful 2-needle cannulation at a median time of 75 (52,128) days. Two patients required endovascular intervention to assist in maturation.

**Conclusions:** EndoAVF creation seemed feasible in the Asian population and may represent an attractive alternative to open surgery. Long-term data regarding its patency and cost-effectiveness needs to be evaluated in future studies

**Funding:** Private Foundation Support

**TH-PO269**

**A Comparison Between the Efficacy and Safety of Endovascular Arteriovenous Fistula Creation and Surgically Created Fistulas: A Systematic Review and Meta-Analysis**

Yoshinosuke Shimamura,<sup>1,2</sup> Scientific Review WorkshopS Peer Support Group (SRWS-PSG) <sup>1</sup>Teine Keijinkai Byoin, Sapporo, Japan; <sup>2</sup>Scientific Review WorkshopS Peer Support Group, Osaka, Japan.

**Background:** Endovascular arteriovenous fistula (eAVF) is a novel strategy for hemodialysis vascular access. We aimed to determine whether eAVF had better clinical efficacy and safety than surgical AVF (sAVF) in patients with chronic kidney disease (CKD).

**Methods:** In May 2021, we searched Cochrane CENTRAL, MEDLINE, EMBASE, Clinical Trials.gov, and the WHO International Clinical Trials Registry Platform for systematic reviews and meta-analyses of randomized controlled trials and observational studies that had assessed the efficacy and safety outcomes of eAVF compared with sAVF in patients with CKD requiring AVF creation. Pairs of two authors independently and in duplicate extracted data, assessed the risk of bias, and rated certainty of evidence. Using random-effects models, pooled odds ratios (ORs) with 95% confidence intervals (CIs) were calculated for binary outcomes, and median differences (MDs) with 95% CIs were calculated for continuous outcomes. Heterogeneity and certainty of evidence were assessed using the Grading of Recommendation, Assessment, Development, and Evaluation approach.

**Results:** In seven studies (860 patients), ORs (95% CIs) for fistula maturation, procedural technical success, and all adverse events were 0.58 (0.05-6.91), 0.69 (0.04-11.98), and 6.31 (0.64-62.22), respectively. eAVF incurred less medical expenditure than sAVF (MD, USD \$12,760; 95% CI -197,100 to -58,200). No studies reported patient satisfaction. The certainty of evidence was very low in most outcomes.

**Conclusions:** eAVF use in routine clinical practice for patients with CKD is limited. Multicenter randomized controlled trials are needed to confirm the efficacy and safety of eAVFs in selected populations.

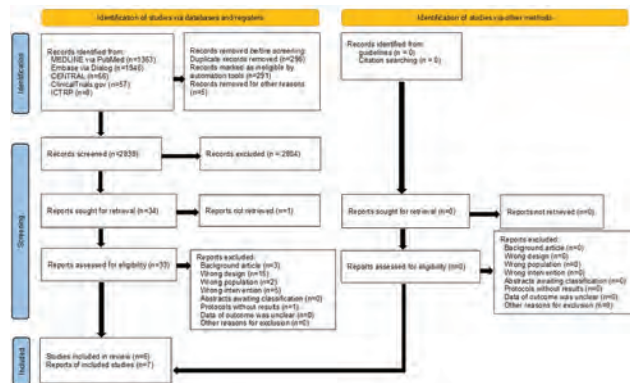

Preferred Reporting Items for Systematic reviews and Meta-Analyses flow diagram

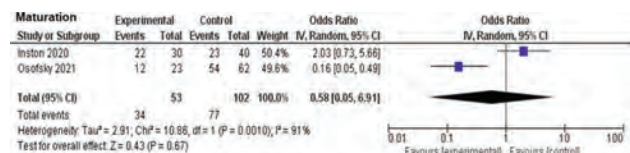

Forest plot for the primary outcome

TH-PO270

A Novel Electronic Surveillance Program to Track Bloodstream Infections in Haemodialysis Patients (SpO-T-BSI)

Ben Lazarus,<sup>1,2</sup> Kevan Polkinghorne,<sup>1,2</sup> Alex Duong,<sup>2</sup> Mechelle K. Seneviratne,<sup>2</sup> Benjamin A. Rogers,<sup>1,2</sup> <sup>1</sup>Monash University, Clayton, VIC, Australia; <sup>2</sup>Monash Health, Clayton, VIC, Australia.

**Background:** Accurate surveillance of ARBSI among haemodialysis patients is important for delivering high quality healthcare. Existing surveillance systems require substantial manual data collection, which may be prone to error and resource intensive. A system that uses automated analysis of routinely collected data may be more accurate and less burdensome. We aimed to measure the incidence of haemodialysis access-related bloodstream infection (ARBSI) using routinely collected electronic health data.

**Methods:** We linked routinely collected data from the electronic medical record (EMR) between 1<sup>st</sup> January 2021 and 31<sup>st</sup> December 2021 to laboratory blood culture data identifying haemodialysis (HD) treatments, access modality, and positive blood cultures among adult HD patients. We calculated exposure time by access type. For patients with a positive blood culture within 30 days of HD treatment the source of infection was assessed by manual review of the EMR. Definitions for HD catheter-related BSI (HDCRBSI) and arteriovenous ARBSI (AV-ARBSI) followed those used by the Center for Disease Control National Healthcare Surveillance Network.

**Results:** In total we identified 648 patients who received haemodialysis, 21,189 catheter days and 127,873 arteriovenous access days of exposure, and 51 cases of positive blood cultures, of which 10 were HDCRBSI, 4 were AV-ARBSI, 11 were contaminants, and 26 were from alternative sources. The incidence rate of HDCRBSI (0.47 events per 1000 catheter days, 95% CI, 0.18-0.76) was 15.1 times higher (95% CI 4.35 – 65.90) than for AV access-related BSI (0.03 events per 1000 access days, 95% CI, 0.0006-0.06)

**Conclusions:** Routinely collected electronic health data can be used to enhance the surveillance of access related bloodstream infections, although clinical assessment of positive cultures is still required.

**Funding:** Government Support - Non-U.S.

TH-PO271

Multifaceted Interventions to Prevent Haemodialysis Catheter-Related Bloodstream Infections Outside the Intensive Care Unit: A Systematic Review and Meta-Analysis

Ben Lazarus,<sup>1,2</sup> Elisa K. Bongetti,<sup>1,3</sup> Jonathan E. Ling,<sup>3,1</sup> Martin P. Gallagher,<sup>2,4</sup> Sradha S. Kotwal,<sup>2,5</sup> Kevan Polkinghorne,<sup>1,3</sup> <sup>1</sup>Monash University, Clayton, VIC, Australia; <sup>2</sup>The George Institute for Global Health, Newtown, NSW, Australia; <sup>3</sup>Monash Health, Clayton, VIC, Australia; <sup>4</sup>University of New South Wales, Sydney, NSW, Australia; <sup>5</sup>Prince of Wales Hospital and Community Health Services, Randwick, NSW, Australia.

**Background:** Central venous catheters (CVCs) are widely used for haemodialysis access, but frequently lead to burdensome and costly bloodstream infections. It is unclear whether haemodialysis catheter-related bloodstream infections (HDCRBSI) or access-related bloodstream infections (ARBSI) can be prevented through multifaceted interventions. We sought to determine whether the implementation of a multifaceted intervention in ambulatory haemodialysis services can prevent HDCRBSI or ARBSI compared to usual care.

**Methods:** We searched PubMed, EMBASE, and the Cochrane Central Register of Controlled Trials from inception to 23<sup>rd</sup> April 2022 using a sensitive keyword search strategy (PROSPERO CRD42021252290). All randomized trials, interrupted time series (ITS), and before-after studies that examined the effect of multifaceted interventions on incidence of HDCRBSI or ARBSI were included. Two authors independently extracted data and assessed risk of bias and quality of evidence using validated tools. Random effects meta-analysis of the intervention effect was planned for HDCRBSI and ARBSI outcomes.

**Results:** We evaluated 8824 non-duplicate citations, 117 full texts and included 20 unique studies, of which 15 assessed HDCRBSI and 5 assessed ARBSI only. Among the eight HDCRBSI studies eligible for meta-analysis, two cluster randomized trials had conflicting results, two ITS studies reported an effective intervention but with conflicting patterns of effect, and all four before-after studies reported a favourable effect with serious risk of bias. None of the ARBSI studies were eligible for meta-analysis. The overall GRADE of evidence for an intervention effect on HDCRBSI and ARBSI was very low.

**Conclusions:** Most studies report a favourable effect of multifaceted interventions on HDCRBSI, but the quality of evidence is very low and studies with lower risk of bias showed less or no effect. Further high-quality studies are warranted.

**Funding:** Government Support - Non-U.S.

TH-PO272

Tunnelled Central Venous Haemodialysis Catheter Tip Design and Risk of Catheter Dysfunction

Ben Lazarus,<sup>1,2</sup> Kevan Polkinghorne,<sup>1,3</sup> Sarah E. Coggan,<sup>2</sup> Nicholas A. Gray,<sup>5,6</sup> Girish S. Talaulikar,<sup>7,8</sup> Martin P. Gallagher,<sup>2,9</sup> Sradha S. Kotwal,<sup>2,4</sup> on behalf of the REDUCCTION investigators <sup>1</sup>Monash University, Clayton, VIC, Australia; <sup>2</sup>The George Institute for Global Health, Newtown, NSW, Australia; <sup>3</sup>Monash Health, Clayton, VIC, Australia; <sup>4</sup>Prince of Wales Hospital and Community Health Services, Randwick, NSW, Australia; <sup>5</sup>Sunshine Coast University Hospital, Sunshine Coast, QLD, Australia; <sup>6</sup>University of the Sunshine Coast, Maroochydore DC, QLD, Australia; <sup>7</sup>Canberra Hospital, Canberra, ACT, Australia; <sup>8</sup>Australian National University, Canberra, ACT, Australia; <sup>9</sup>University of New South Wales Faculty of Medicine, Sydney, NSW, Australia.

**Background:** It is unknown whether the design of the tunnelled haemodialysis catheter (TCVC) tip influences the risk of catheter dysfunction. In small, randomized controlled trials symmetrical tip catheters have favourable rheology compared to step-tip catheters. We aimed to determine whether TCVC tip design influences the risk of catheter dysfunction requiring removal.

**Methods:** We conducted a post-hoc analysis using data from the REDUCing the burden of dialysis Catheter Complications study (2016-2020). TCVC were classified into three distinct designs: symmetrical, step or split tips. Non-tunnelled catheters were excluded as were TCVC with missing tip design (n=945), and those with missing reason for removal (n=267) leaving 6209 TCVC in 4652 participants. The primary outcome was time to catheter removal due to poor flow as assessed by the treating clinician. Death and other reasons for catheter removal were considered competing events. We compared the risk of catheter dysfunction across different catheter tip designs using raw proportions and a multivariable Fine and Gray model with robust cluster variance estimators for clustering by service.

**Results:** Overall, 354 of 3881 (9.1%), 258 of 1873 (13.8%), and 39 of 455 (8.6%) TCVC with symmetrical, step and split tip designs respectively, were removed for catheter dysfunction. Relative to catheters with a symmetrical tip, catheters with step tip had a 53% higher risk of catheter dysfunction, which persisted after multivariable adjustment (subdistribution hazard ratio = 1.53, 95% CI: 1.24 – 1.89). No difference was observed for split tip catheters (SHR = 0.66, 95% CI: 0.31 – 1.38).

**Conclusions:** Tunnelled HD CVCs with a step tip have a higher risk of dysfunction than those with a symmetrical tip. Prospective, large randomized controlled trials are warranted to confirm this observation.

**Funding:** Government Support - Non-U.S.

TH-PO273

Reducing Staphylococcus epidermidis Catheter-Related Bloodstream Infections in Dialyzed Patients: Experience From the Hemodialysis Centre in Prince Mansour Military Hospital, Kingdom of Saudi Arabia

Najlaa AIMalki, Hichem Abidi. Al Hada Military Hospital, Taif, Saudi Arabia.

**Background:** Catheter-related bloodstream infections (CRBSIs) are a major cause of morbidity and mortality in hemodialysis. Although Methicillin-resistant Staphylococcus epidermidis (MRSE) is a leading causative agent, little literature deals with the mitigation of related CRBSIs, particularly in hemodialysis settings. A flare of MRSE CRBSIs occurred in PMMH HD center starting from August 2019, unveiled when instituting dialysis events surveillance (in March 2020) and studying historical data. A specific improvement project was designed to tackle this flare.

**Methods:** Fifteen percent of the patients had MRSE colonized catheters and were thought to represent a reservoir for the spread of the microorganism in the center. In the absence of specific international guidelines and the paucity of specific literature, mitigation actions were built on general infection control principles and analogy with Staphylococcus aureus, in consultation between nephrologists, infection control physician, infectious disease specialist, and nurses. An aggressive strategy of “seek and eliminate” against MRSE was adopted.

**Results:** Results were exceptional. MRSE CRBSI rates were significantly lowered towards the pre-flare period rates during the intervention period (April 2020 to August 2020), and post-intervention rates were maintained even lower to date (April 2022).

**Conclusions:** Assignment of a dedicated infection control professional to the hemodialysis center and implementation of the dialysis events surveillance with study of historical CRBSI data, allowed for the detection of the reported flare. Despite the lack of specific guidelines and literature, mitigation actions decided collectively allowed for a prompt and sustained control of MRSE CRBSIs.

**Main interventions**

<ul style="list-style-type: none"> <li>+ Targeted Active surveillance cultures:                     <ul style="list-style-type: none"> <li>- Newly accepted patients</li> <li>- Patients returning dialysis in the centre after hospitalization or dialysis in other centres (for three sessions or more)</li> </ul> </li> <li>+ Removal/exchange of CVC:                     <ul style="list-style-type: none"> <li>- Surveillance: Patients found to have paired central and peripheral positive blood cultures will have their CVC removed/exchanged and treated as per clinical CRBSI guidelines.</li> <li>- CVC lumen colonization: Patients with isolated positive central line cultures (clinical or surveillance BC) will be treated by antibiotic lock. If colonization is still present after lock therapy, CVC will be removed/exchanged.                             <ul style="list-style-type: none"> <li>- Clinical CRBSIs:                                     <ul style="list-style-type: none"> <li>- Immediate removal for:   <ul style="list-style-type: none"> <li>- Clinically and hemodynamically unstable patient.</li> <li>- Persistent fever 48 h to 72 after initiation of systemic antibiotics.</li> </ul> </li> <li>- Metastatic complications, including suppurative thrombophlebitis, endocarditis.</li> <li>- Presence of a tunnel-site infection.</li> </ul> </li> <li>- Infections due to S aureus, Pseudomonas aeruginosa, fungi, or mycobacteria. Due to local high prevalence and incidence, CRBSI with Meticillin-resistant S. Epidermidis.</li> <li>- Delayed removal for persistent bacteraemia 7 days after initiating antibiotics in stable asymptomatic patients.</li> </ul> </li> <li>+ Prophylactic lock therapy                     <ul style="list-style-type: none"> <li>- All cases where CVC removal/change is indicated (clinical or surveillance) but not done should receive long-term prophylactic lock therapy (weekly TPA)</li> <li>- This includes patients at higher risk for CRBSI</li> </ul> </li> <li>+ Extra interventions for MRSE:                     <ul style="list-style-type: none"> <li>- Decolonisation protocol for patients with MRSE CVC colonization, present or recurrent MRSE CRBSI.</li> <li>- Contact precautions for MRSE CVC colonization or active MRSE CRBSI</li> <li>- Extra emphasis on hand hygiene and disinfection (skin and surfaces) practices.</li> </ul> </li> </ul> </li></ul>	<ul style="list-style-type: none"> <li>- Detect patients with colonized CVCs that represent a potential reservoir for future CRBSIs</li> <li>- Promptly remove/exchange colonized CVCs.                     <ul style="list-style-type: none"> <li>- Decontaminate CVC. If colonization persists, remove/exchange CVC (to avoid future CRBSI and possible transmission to other patients).</li> <li>- Optimize treatment of CRBSI by immediately removing source of infection in clinically severe cases and/or epidemiologically significant organisms.</li> <li>- Persistent bacteraemia after 7 days is considered a proxy for treatment failure.</li> </ul> </li> <li>- When removal/exchange of CVC is not feasible or declined by the patient, long-term prophylactic lock therapy will help decrease the risk of future CRBSIs.</li> <li>- Minimize burden of MRSE body carriage (main source for CVC lumen colonization)</li> <li>- Avoid spread of MRSE between patients</li> </ul>
---	--

hemodialysis center- with a physically present most responsible nephrologist, and a full-time infection control professional- which set the stage for further quality improvement initiatives.

**Improvement project main interventions**

<ul style="list-style-type: none"> <li>+ Point prevalence study for all patients with catheters.                     <ul style="list-style-type: none"> <li>- Draw Central and peripheral blood cultures from all patients with CVCs</li> </ul> </li> <li>+ Emphasize department's program of 'fistula first' for patients likely to be dialysed in a foreseeable future.</li> <li>+ Adopt % of patients first dialysed through fistula as a quality indicator.</li> <li>- Adopt the % of patients with exclusive CVC &gt; 90 days as a quality indicator.</li> <li>+ Infection control job-specific training and monitoring of practices for HD staff</li> <li>+ Assign a full-time infection control professional to oversee IPC related activities.</li> <li>- Update competency checklists for nurses and remain. Assess competency regularly.</li> <li>- Daily observations of procedures and practices</li> <li>+ Housekeeping staff training and monitoring</li> <li>- Assign specific HK staff for HD units to be trained about the specificities of HD setting</li> <li>- Regular monitoring of HK practices with feedback                     <ul style="list-style-type: none"> <li>- Use triple-bucket system to avoid contamination</li> </ul> </li> <li>+ Ensure permanent senior medical supervision of activities</li> <li>- Appoint a consultant nephrologist to be responsible (and physically present) for HD centre activities</li> <li>+ Main raw (non-RO) water treatment and distribution systems</li> <li>- Empty all tanks urgently, clean and disinfect internal surfaces before refilling with water.</li> <li>- Cleaning and then disinfection of the whole piping system either by superheating, hyper-chlorination or both is urgently needed. Contracting with a specialized company is warranted.</li> <li>- Draw a new pipeline from the water treatment plant to directly feed the HD building (both RO and non-RO systems).</li> <li>- Provide tools for water sampling and necessary containers and chemicals (e.g. sodium thiosulfate).</li> <li>- Hand hygiene fountains and sinks need to be changed as design is not conform to standards. All HH sinks missing in several areas of the HD units.</li> <li>- Set a water management program for the facility supervised by a water management committee.</li> </ul>	<ul style="list-style-type: none"> <li>+ Implement surveillance of all positive blood cultures from haemodialysis patients</li> <li>- Calculate rates of CRBSIs and follow trends over time                     <ul style="list-style-type: none"> <li>+ Antimicrobial stewardship activities</li> <li>- Review appropriateness of empirical antibiotics according to local microbiology</li> <li>- Update policy for clinical management of CRBSIs according to latest international guidelines</li> <li>- Consult with ID specialist</li> </ul> </li> <li>+ Ensure infection control/vascular access care supplies availability</li> <li>- Secure continuously a minimum stock of supplies for at least 3 months (PPE, Skin disinfectant, surface disinfectant, Biopatch, transparent dressing,...)</li> <li>+ Staffing level (nurse to patient ratio)</li> <li>- Nurses are working at approximately 60% of the recommended nurse to patient ratio. Urgent recruiting of new staff is needed.</li> <li>+ Change ice-making machines</li> <li>- Install new machines with automatic dispensing (no direct contact with ice for dispensing).</li> <li>- A schedule for cleaning and disinfection according to manufacturer's instructions should be implemented.</li> <li>- Microbiological quality of water to be checked regularly + RO water system</li> <li>- Change the two raw water tanks in the RO room to be conforming with recommended design and easy to clean</li> <li>- Urgently follow up with the RO Company to fix the problem of low return water temperature. Closely monitor thereafter to make sure the problem is solved.</li> <li>- A written policy for water sampling techniques from RO system should be in place.</li> <li>- Install a water chiller after the raw water tanks in the RO room.</li> <li>- Change the malfunctioning pumps to avoid critical situation of loss of pressure.</li> <li>- Recruit or train a water technician for PMMH.</li> </ul>
---	--



**TH-PO275**

**Concordance Between Site Reporting and Clinical Adjudication of Catheter-Related Infectious Events in Australian and New Zealand Kidney Services**

Jayson Catiwa,<sup>1</sup> Sarah E. Coggan,<sup>1</sup> Alan Cass,<sup>5</sup> Nicholas A. Gray,<sup>3</sup> Stephen Jan,<sup>1</sup> Stephen P. McDonald,<sup>6</sup> Kevan Polkinghorne,<sup>2</sup> Girish S. Talaulikar,<sup>4</sup> Martin P. Gallagher,<sup>1</sup> Sradha S. Kotwal,<sup>1</sup> REDUCCTION Trial Investigators <sup>1</sup>The George Institute for Global Health, Newtown, NSW, Australia; <sup>2</sup>Monash University, Clayton, VIC, Australia; <sup>3</sup>Sunshine Coast University Hospital, Sunshine Coast, QLD, Australia; <sup>4</sup>ACT Health, Canberra City, ACT, Australia; <sup>5</sup>Charles Darwin University, Casuarina, NT, Australia; <sup>6</sup>Royal Adelaide Hospital, Adelaide, SA, Australia.

**Background:** Hemodialysis catheter-related bloodstream infection (HD CRBSI) are a significant source of morbidity and mortality among dialysis patients. Varying definitions and interpretations of HD CRBSI have made meaningful comparisons difficult. Attempts at systematically improving infection rates require a consistent approach in measuring HD CRBSI and understanding the feasibility and accuracy of this reporting is crucial.

**Methods:** We conducted an analysis of HD CRBSI events reported prospectively by all participating Australian and New Zealand (ANZ) kidney services between December 2016 to March 2020 within the REDUCCTION trial. Adult patients in a participating site who had a HD catheter inserted at any time after commencement of the trial or in whom the kidney service assumed the care of such catheter were included in the data collection. HD CRBSI events were assessed against the central adjudicators' outcomes using the REDUCCTION trial's endpoint definition and adjudication process. We estimated the concordance between site-reported HD CRBSI and the corresponding adjudication outcomes using Cohen's kappa statistic (κ) according to site clustering and implementation tranches in Australian sites as the New Zealand sites only participated in the observational phase.

**Results:** The REDUCCTION trial has collected data on 7,258 patients and 12,630 catheters, representing 1.3 million catheter days across ANZ kidney services. A total of 779 HD catheter-related infectious events were reported by 42 ANZ sites within the 40-month trial period. The concordance from baseline to the last tranche of intervention

**TH-PO274**

**Catheter-Related Bloodstream Infections in Dialyzed Patients: Improvement Project in Hemodialysis Centre in Prince Mansour Military Hospital, Taif Region, Kingdom of Saudi Arabia**

Najlaa AlMalki, Hichem Abidi. Al Hada Armed Forces Hospital Nephrology Department Al Hada Military Hospital, Taif, Saudi Arabia.

**Background:** Prevention of catheter-related bloodstream infections (CRBSIs) - a leading cause of morbidity and mortality in hemodialysis- is a multifaceted approach, mainly based on well-designed and implemented infection control and water quality programs. An extensive outbreak (attack rate of 35%) of CRBSIs with Xanthomonas occurred in PMMH HD Centre in 2019. A regional multidisciplinary team was invested with the mission of building on the investigation findings throughout the outbreak period, to set strategies to avoid similar situations in the future. We report the results of the improvement project that was built on the root cause analysis of this Xanthomonas outbreak.

**Methods:** The multidisciplinary team proceeded with an in-depth investigation including literature, system change, Reverse Osmosis/ raw water systems, and infection control practices reviews; incorporating findings and actions taken by the local team. A root cause analysis was conducted based on collected data. Recommendations from the committee were formulated as an improvement project.

**Results:** The outbreak was officially declared over by the end of the intervention period (March 2020). During the post-intervention period (April 2020 to April 2022), a single case of Xanthomonas CRBSI occurred. An estimated overall 85% of the project recommendations were implemented.

**Conclusions:** Outbreaks of healthcare-associated infections are extremely stressful and challenging. Yet, lessons learned when investigating and mitigating such events could set sound foundations for quality improvement initiatives. The goals of the presented project were achieved successfully, mainly by instituting a new leadership system for the

**Key: TH - Thursday; FR - Friday; SA - Saturday; OR - Oral; PO - Poster; PUB - Publication Only**

**Underline represents presenting author.**

implementation range from moderate to almost perfect. The overall concordance for HD CRBSI between sites and central adjudicators was  $\kappa=0.71$  (95%CI 0.66-0.76).

**Conclusions:** Our study revealed a substantial level of concordance in HD CRBSI reporting between the participating kidney services and the *REDUCCION* trial adjudicators, demonstrating reliability in Australian and New Zealand site-based reporting of HD CRBSI rates. While ascertaining HD CRBSI using a standardized definition allowed for comparable adjudication of outcomes with reliable benchmarking among ANZ kidney services, this remains unknown elsewhere in the world.

**Funding:** Government Support - Non-U.S.

#### TH-PO276

##### Rapid Incidence and Emergence of Catheter-Related Bloodstream Infections (CRBSIs) Among CVC-Dependent Hemodialysis Patients

Kenneth Massey,<sup>1</sup> Krithika Rajagopalan,<sup>2</sup> Roxanna Seyedin.<sup>2</sup> <sup>1</sup>CorMedix Inc, Berkeley Heights, NJ; <sup>2</sup>Antilitics Inc., Dover, MA.

**Background:** Kidney failure patients receiving hemodialysis (HD) via a central venous catheter (CVC) are at high risk of developing catheter-related bloodstream infections (CRBSIs), resulting in increased mortality, hospitalizations, and long-term complications (LTCs). A claims-based algorithm was developed to assess real-world outpatient/inpatient (OP/IP) CRBSIs among CVC-dependent HD (CVC-HD) patients.

**Methods:** A retrospective analysis of merged data from United States Renal Data System (USRDS), CROWNWeb (dialysis orgs.), and Medicare claims (2013-2018) was conducted. Among incident CVC-HD (2014-2017) patients with 1 year pre- and  $\geq$  1-year post-index data (n=51,783), CRBSI incidence was the first date of OP/IP CRBSI occurrence. OP CRBSI was the first oral/intravenous antibiotic prescription within  $\pm$ 1 day of the first OP emergency/urgent care visit post-CVC insertion. IP CRBSI was the first occurrence of either sepsis/bacteremia and ICD-9/10 CMs 999.32, T80211x; 999.31, T80219x, T80218x claims or sepsis/bacteremia diagnosis without occurrence for pneumonia, gangrene, or urinary tract infections. CRBSI incidence proportion and rates, median days to CRBSI, proportion of CRBSIs at days 30 and 90, and 1-year post-CRBSI LTC rates were assessed.

**Results:** The CVC-HD cohort's mean age was 63 (SD:15.3); 47% (n=7,822) were female and 29% (n=4,898) were African American. CRBSI incidence proportion and rates were approximately 33% (n=16,813) and 4.5 per 1000-catheter days, respectively. In total 81% (n=13,559) of CRBSIs were diagnosed IP and 19% (n=3,254) were diagnosed in OP settings. Overall, 33% and 47% developed CRBSIs within 30- and 90-days post-CVC insertion, respectively. Median days to CRBSI were 107 days (interquartile range: 294 days). Frequently reported LTCs were HF (58%), dysrhythmia (54%), PVD (41%), stroke (17%), and MI (13%).

**Conclusions:** Of the 1/3<sup>rd</sup> of CVC-HD patients with CRBSIs, 33% and 47% developed CRBSI within 30- and 90-days post-CVC insertion, respectively. High rates of HF, PVD, stroke, and MI were reported 1-year post-CRBSI. Assessment of the incremental burden of clinical complications and costs associated with CRBSIs is warranted and underway. Early and high incident CRBSI rates underscore the importance of interventions that can prevent CRBSIs among CVC-HD patients.

**Funding:** Commercial Support - CorMedix Inc

#### TH-PO277

##### Central Venous Catheters in Hemodialysis: A Reasonable Alternative?

Anna Buckenmayer, Bianca Möller, Claudia Ostermaier, Joachim Hoyer, Christian S. Haas. *Philipps-Universität Marburg, Marburg, Germany.*

**Background:** Arteriovenous fistulas are the gold standard for access in dialysis patients; central venous catheters (CVC) provide a potential alternative, especially in multimorbid and elderly patients. CVCs are considered to be of elevated risk for complications; however, it remains unclear, if they have relevant impact on clinical outcome. The objective of this study was to provide a quantitative and qualitative analysis of CVC associated complications in hemodialysis patients. Additionally, estimated and actual mortality should be evaluated.

**Methods:** In a retrospective study at the University Hospital Marburg, Germany, patients receiving hemodialysis via CVC between January 2015 and June 2021 were included. Data on duration of CVC use was collected, as well as reasons for catheter implantation and explantation, CVC related complications and comorbidities (diabetes, hypertension, heart failure, peripheral vascular disease, dementia). Additionally, estimated 6-month mortality at time of dialysis start was calculated by Cohen Modell and compared to actual death rate.

**Results:** 478 CVCs were analyzed in 351 patients. Mean patient age was 66.5 $\pm$ , comparable with the average age of dialysis patients in Germany. Initiation of dialysis was the main reason for CVC implantation and catheters were used 309 days on average. Death was the most common reason for termination of CVC use (31.1%), followed by a change of mode in renal replacement therapy (hemodialysis via fistula, begin of peritoneal dialysis, kidney transplantation) or termination of dialysis (29.6%). No correlation was noted between age, type and frequency of complications (dysfunction, thrombi, infection, death). Overall, CVC infections were rare (0.6 per 1.000 catheter days). Complications were significantly associated with arterial occlusive disease, heart failure and dementia (p<0.05). Of note, actual 6-month mortality was lower than the predicted risk to die within half a year (14.3% vs. 19.6%, p<0.05).

**Conclusions:** This study shows that (1) CVCs are predominantly implanted for initiation of hemodialysis; (2) serious complications are rare; (3) occurrence of complications is independent of age but associated with certain comorbidities; and (4) CVC patients survive longer than predicted. This data suggests that an individual approach for vascular access in hemodialysis patients is needed.

#### TH-PO278

##### Early Transition From Non-Tunneled to Tunneled Hemodialysis Vascular Access for Vessel Preservation in Critically Ill Patients With AKI

Mohammad A. Sohail, Tarik Hanane, James E. Lane, Tushar J. Vachharajani. *Cleveland Clinic, Cleveland, OH.*

**Background:** Strategies for vessel preservation currently remain focused on patients with advanced CKD to ensure future viable arteriovenous access. Given that AKI requiring kidney replacement therapy (KRT), or AKI-D, occurs in approximately 6-7% of critically ill patients, and that 10-30% of AKI-D survivors remain KRT dependent at hospital discharge, vessel preservation should be considered early in these patients as well. We report our experience of early conversion of non-tunneled dialysis catheters (NTDC) to tunneled dialysis catheters (TDC) in patients in whom KRT was anticipated beyond 7 days, as a potential strategy for vessel preservation in AKI-D patients in the medical intensive care unit (MICU).

**Methods:** We reviewed MICU patients with AKI-D from 5/2020-4/2021 who had their NTDCs converted early to TDCs within 10 days, based on our collaborative care model involving interventional nephrology and MICU teams. Data on the number of NTDCs placed prior to TDC insertion and time to conversion from NTDC to TDC was collected. The control group included patients who received TDCs between 5/2019-4/2020 prior to the implementation of our care model. Characteristics/outcomes of the two groups were compared using t-tests/chi-square tests and two-tailed P-values <0.05 were considered significant.

**Results:** 380 and 102 critically ill AKI-D patients underwent transition from NTDCs to TDCs prior to and after implementation of our care model respectively. The number of NTDCs placed prior to transition to TDCs was significantly higher (mean $\pm$ SD [range]: 1.51 $\pm$ 0.71 [1-6] vs. 0.95 $\pm$ 0.73 [0-3]; p<0.001), and the time to conversion from NTDCs to TDCs was significantly longer (mean  $\pm$  SD [range]: 11.17 $\pm$ 5.32 [2-27] vs. 4.82 $\pm$ 3.26 [0-10] days; p<0.001) in patients before vs. after the advent of our care model.

**Conclusions:** Critically ill patients with AKI-D often remain KRT-dependent past hospital discharge and may eventually progress to ESKD, which merits earlier enactment of vessel preservation strategies. Our collaborative care model was one such initiative which resulted in less frequent central venous trauma with fewer NTDC insertions as well as shorter time to conversion to TDCs. This may not only promote vessel preservation, but also streamline transitions of care and reduce the incidence of CLABSI and catheter dysfunction.

#### TH-PO279

##### Cytokines Associated With Changes in Echocardiographic Parameters After Arteriovenous Fistula Creation in Hemodialysis Patients

Juan C. Duque, Karen Manzur-Pineda, Laisel Martinez, Christopher Montoya, Adriana Dejan, Marwan Tabbara, Roberto I. Vazquez-Padron. *University of Miami School of Medicine, Miami, FL.*

**Background:** Pulmonary hypertension (PH) is common in patients with end-stage kidney disease (ESKD) and is associated with increased all-cause and cardiovascular mortality. It is widely believed that arteriovenous fistula (AVF) creation and long-term hemodialysis contribute to the pathogenesis and/or exacerbate PH. Systemic cytokines are elevated in CKD and ESKD patients compared with the general population. However, whether cytokine levels interfere with vascular and cardiac remodeling after AVF creation remains unknown. There is scarce data on the long-term effect of AVF creation and cytokine expression on PH and echocardiographic changes.

**Methods:** A retrospective study of 38 patients who underwent AVF creation between 2019 and 2020. Cytokine levels, including chemokines, interferons, interleukins, and growth factors, were measured in preoperative plasma samples using multiplex and echocardiographic evaluations before and after surgery. A stepwise linear regression analysis was performed looking for the correlation between right ventricular systolic pressure (RVSP) change pre- and post-AVF and demographic traits, comorbidities, cytokines, and other echocardiographic parameters such as right atrial pressure (RAP) during systole, left ventricular mass (LVM), tricuspid regurgitation (TR), mitral E/E' ratio, and ejection fraction (EF).

**Results:** The median time for the preoperative echocardiogram was 0.3 years (interquartile range [IQR] 0.2-0.7 years) before AVF creation, while the follow-up echo was done 1.3 (0.6-2.1) years after surgery. Thirty-seven percent of the patients had RVSP>37 mmHg at baseline. The RVSP after AVF creation decreased in 29% of the patients, and 24% remained stable. There was a significant decrease in LVM (224 [171-285] vs. 194 [147-236], P=0.045) after surgery. Smoking (p=0.047), along with high levels of GRO (p=0.001) and TGF $\beta$ -1 (p=0.012), are associated with worsening of RVSP post-AVF creation, while high levels of IL-4 (p=0.002) are associated with an improvement in RVSP post-AVF creation.

**Conclusions:** Our results suggest that elevated systemic cytokines pre and post AVF creation are associated with a significant elevation of RVSP in the ESKD population.

**Funding:** NIDDK Support, Other NIH Support - R01-DK121227, K08-HL151747



TH-PO280

Arteriovenous Shunts and Right Heart Function

Richard E. Wing, Nikhila S. Rao, Nilesh S. Rao, Peihuan R. Tsai, Thu H. Le. University of Rochester Medical Center, Rochester, NY.

**Background:** Emerging evidence suggests that right ventricular dysfunction (RVD) is a major determinant of adverse health outcomes. Data regarding the effect of AV shunt placement on right heart function (RHF) is sparse.

**Methods:** We conducted a cross-sectional study on patients who received maintenance hemodialysis (HD) who were followed by URM nephrology faculty. We identified subjects who underwent ambulatory echocardiograms (echos) within two years of each other. Original echocardiographic images were re-analyzed to assess RHF. Subjects who underwent construction of an AV shunt between echocardiograms (Group 1) were compared to subjects who did not undergo AV shunt construction between echos (Group 2).

**Results:** We identified 558 subjects with echos completed within two years of each other. Screening 300 of these subjects identified 54 who had two ambulatory echos within 2 years. Thus far, pairs of ambulatory echos have been analyzed for 10 subjects. RVD is defined as abnormality in any of the following: Myocardial Systolic Excursion Velocity (S') < 9.5 cm/sec, Tricuspid Annular Plane Systolic Excursion (TAPSE) < 17 mm, Right Ventricular Free Wall Strain (RVFWS) > -20%, or Right Ventricular Fractional Area Change (RVFAC) < 35%. Details are summarized in Table 1. Findings are reported as counts for discrete parameters or means for continuous parameters (standard deviation). All 20 echos had measurable TAPSE and RVFAC. In Group 1, S' could not be determined in the 1st echo for one subject and the 2nd echo in another subject. In Group 2, RVFWS could not be determined in the 2nd echo in one subject. All unmeasurable parameters were assumed to be normal.

**Conclusions:** RVD is remarkably common in patients with ESRD receiving hemodialysis. Larger studies with longitudinal data are needed to assess the impact of AVF on RVD in patients receiving maintenance hemodialysis.

Parameter	AVF created between echos		AVF not created between echos	
N	6		4	
Age at Surgery	62 (13)		58 (13)	
Male	5		2	
White	3		4	
BMI	29 (3)		29 (5)	
Upper Arm Position	4		4	
	Echo 1	Echo 2	Echo 1	Echo 2
S' < 9.5 cm/s	1	2	2	3
TAPSE < 17 mm	1	1	1	1
RVFAC < 35%	0	1	0	0
RVFWS > -20 %	1	2	1	0
RVD	1	3	2	3

Table 1. Select demographic, physical, and echocardiogenic parameters.

TH-PO281

Saving Vascular Access and Reducing Risks of Complications in Catheter Related Thrombosis: Our Experience With the FlowTriever® Device

Gabino M. Maza Rodas, Ali I. Gardezi. University of Wisconsin-Madison, Madison, WI.

**Introduction:** Among patients undergoing hemodialysis, around 18% of prevalent HD patients with ESRD use central venous catheter as vascular access. Catheter related thrombosis is a relatively common complication in patients with long term central venous catheter resulting in catheter malfunction, loss of vascular access and risk of venous thromboembolism.

**Case Description:** 71 years old female with a past medical history of heparin induced thrombocytopenia, diabetes type 2, hypertension, end stage renal disease on intermittent hemodialysis who presented with shortness of breath. On exam, patient was hypertensive and hypoxic on room air. She had a right femoral vein tunneled hemodialysis catheter. Patient had magnetic resonance angiogram (MRA), which was negative for pulmonary embolism but showed a thrombus within the inferior vena cava associated with the tip of the dialysis catheter. MRA of abdomen, pelvis and right lower extremity to evaluate extent of thrombosis. Thrombus was nonocclusive and extended from the level of the renal veins to the liver. Anticoagulation with Apixaban was started. Interventional cardiology performed aspiration thrombectomy of the right atrium, inferior vena cava and catheter related thrombi using FlowTriever® system, and which enabled us to preserve access and minimize risks of thromboembolism.

**Discussion:** Anticoagulation is the mainstay of treatment for catheter related thrombosis, provided there are no contraindications. For catheter-tip atrial thrombus, the catheter should remain in place to reduce the risk of embolization until the thrombus has resolved. If symptomatic thrombus is present, catheter should be removed. However, if vascular access is limited, it is possible to preserve the catheter. Other therapies include catheter directed therapy with local administration of a thrombolytic agent or physical aspiration of the thrombus, or both. In some instances, with thrombus extension > 6 cm, systemic thrombolysis may be considered as a second-line therapy. At our institution,

we have available the FlowTriever® system, in which a large bore sheath is introduced for placement of suction catheter, which is connected to a retraction aspirator, providing vacuum for clot aspiration. The advantage is that it can remove large volumes of thrombus rapidly.

TH-PO282

A Cross-Sectional Epidemiological Study on the Status of Vascular Access in Hemodialysis Patients in Southwest China

Wei Zhou,<sup>1</sup> Santao Ou,<sup>10</sup> Xisheng Xie,<sup>2</sup> Rong Gong,<sup>3</sup> Jian Xiao,<sup>3</sup> Guang Zeng,<sup>4</sup> Youwen Xiao,<sup>5</sup> Song Wang,<sup>6</sup> Yu Wen,<sup>7</sup> Heping Zhang,<sup>8</sup> Qiang He,<sup>1</sup> Guisen Li,<sup>1</sup> Fei Deng.<sup>1</sup> <sup>1</sup>Sichuan Academy of Medical Sciences and Sichuan People's Hospital, Chengdu, China; <sup>2</sup>Department of Nephrology, Nanchong Central Hospital, Nan chong, China; <sup>3</sup>Department of Nephrology, Guangyuan Central Hospital, Guang yuan, China; <sup>4</sup>Department of Nephrology, No. 2 People's Hospital of Neijiang, Nei jiang, China; <sup>5</sup>Department of Nephrology, Leshan People's Hospital, Le shan, China; <sup>6</sup>Department of Nephrology, Mianyang Central Hospital, Mian yang, China; <sup>7</sup>Department of Nephrology, Ziyang People's Hospital, Ziyang, China; <sup>8</sup>Department of Nephrology, Affiliated Hospital of Chuanbei Medical College, Chuan bei, China; <sup>9</sup>Department of Nephrology, Chengdu Third People's Hospital, Cheng du, China; <sup>10</sup>The Affiliated Hospital of Southwest Medical University, Luzhou, China.

**Background:** Hemodialysis is an important method to maintain the life of patients with end-stage renal disease. The number of hemodialysis patients in southwest China is increasing year by year, but there are few studies on the current situation of vascular access for hemodialysis patients in this region.

**Methods:** A cross-sectional survey study was conducted using a questionnaire. Statistical analysis was performed to determine the influence of the first choice of dialysis access modality, level of open surgery and interventional surgery in the hospital.

**Results:** A total of 228 hospitals in southwest China with 30,068 hemodialysis patients were included in this study. The number of patients with long-term hemodialysis access as autogenous arteriovenous fistula (AVF) was the highest, accounting for 81.35%. The number of patients whose first hemodialysis access was AVF was lower (32.29%) and the number of patients whose first hemodialysis access was temporary catheter was the highest (57.42%). 61.40% of physicians preferred femoral vein placement for initial hemodialysis patients. Grade A tertiary hospital (the highest level of hospital in China) had a significant effect (95% CI 0.021-0.744) on physicians' choice of whether to place a central venous temporary catheter or a long-term catheter for the first time. Local economic situation (estimated by house price per square meter) was an independent influence on the ability of hospitals to perform open procedures for hemodialysis access (95% CI 1.407-44.657, 95% CI 2.791-77.801).

**Conclusions:** Currently, more than half of hemodialysis patients in southwest China still have their first hemodialysis access as femoral vein placement, but 81.35% of patients end up with AVF as long-term hemodialysis access. Hospital grade had a significant impact on the physician's choice of the type of central venous catheter to be placed for the first time. The economic level of the city where the hospital was located also had a significant effect on the level of hospital prescribing and interventional procedures.

TH-PO283

Analysis of Use and Outcomes of Peripherally Inserted Central Venous Catheters in Advanced CKD and ESKD

Richard Barrios, Marie A. Sosa, Efrén Chavez. University of Miami Health System, Miami, FL.

**Background:** Peripherally inserted central venous catheter (PICC) placement is an independent risk factor for AVF failure suspected due to venous injury resulting from thrombosis, intimal hyperplasia, and stenosis. The overall probability of achieving any permanent vascular access is lower for patients exposed to PICCs.

**Methods:** This is a cross-sectional, retrospective study aimed to investigate incidence of PICC placement in adult patients with advanced CKD (defined as eGFR <30 ml/min/1.73m<sup>2</sup>) and ESKD based on ICD-10 diagnoses admitted to UHealth Tower (UHT) from 10/2020 to 2/2022. Hospice patients were excluded.

**Results:** From a total of 1,074 patients with advanced CKD/ESKD admitted to UHT over 15 months 87 out of 1,074 patients (8.1%) had a PICC placed. Of these 87 patients, 49%, 6.0%, and 45% carried a diagnosis of CKD-4, CKD-5, and ESKD, respectively. Most of the patients who experienced PICC placement were men (n=48) with a median age of 69 years, white (n=51) and Hispanic/Latino (n=50). A total of 9 out of 87 (9.1%) of PICCs placed within this population were complicated by DVT formation. The veins cannulated during PICC insertion were predominantly basilic vein (73.5%) and brachial vein (20.6%). The majority of the PICCs placed were dual lumen catheters (n=62). Indications for PICC placement were the following: ICU care (59.75%), prolonged antibiotic therapy (23%), chemotherapy (10.3%), TPN (4.6%) and other IV medications or frequent blood draws (3.45%).

**Conclusions:** There is a high prevalence of PICC insertion in advanced CKD/ESKD patients at UHT. We observed an incidence of PICC-related DVTs of 9.1% in our analysis, which is higher compared to a 2.4% PICC-related DVT incidence described in the literature. Nearly 60% of PICCs were placed in the ICU, 81% of PICCs were ≥2 lumens with a diameter ≥5 Fr. Catheters with a larger diameter and higher number of lumens are associated with a higher thrombotic risk. Nevertheless, in patients with CKD stage 3B or greater, PICC placement is generally contraindicated, and recommendations should be individualized considering the likelihood of requiring KRT, urgency of the situation, and

availability of resources. In advanced CKD/ESKD patients who have an absolute need for prolonged central venous access the implementation of alternative interventions should be encouraged.

**Funding:** Private Foundation Support

#### TH-PO284

##### Arteriovenous Fistula (AVF) Placement Unmasking Chronic Aortic Dissection

**Sagar Patel,** Gautam B. Bhavne. *Vanderbilt University Medical Center, Nashville, TN.*

**Introduction:** Swelling in the arm of an AVF can be a symptom of a stenotic or occlusive vascular process. It is often seen with a deep vein thrombosis (DVT) or central stenosis related to prior central lines or pacemakers. Here, we describe a rare presentation of a chronic aortic dissection being discovered as a result of AVF placement and subsequent swelling from mass effect of aorta.

**Case Description:** A 68 year old male with history of coronary artery disease, pacemaker placed 10 years ago, hypertension, and stage 5 chronic kidney disease with a left upper extremity brachio-basilic AVF placed 3 weeks prior presented with 2 weeks of worsening swelling in his left arm. He had some numbness and tingling in his arm but denied any pain. He was afebrile with BP 132/80 and HR 62. Exam showed significant swelling throughout his left arm even above the fistula and into the shoulder. Fistula had weak thrill and bruit. Collateral veins were noted in left chest/neck area that patient reported had been present for a few years. Duplex ultrasound showed DVT in the paired brachial veins. However, the degree and location of swelling was not consistent with the location of DVT. It was suspected that he had central stenosis related to his pacemaker. The initial plan was to perform a fistulogram to diagnose and treat such a stenosis. However, decision was made to pursue CT scan with contrast for further evaluation with understanding of risks of worsening kidney function. CT scan showed aneurysmal ascending aorta of 5.5cm and aortic dissection involving ascending thoracic aorta and aortic arch with mass effect on left brachiocephalic vein. Patient was transferred to ICU for esmolol drip. CT surgery reported there was no need for surgical intervention as the dissection appeared chronic in nature. Patient's kidney function worsened after contrast and a right IJ tunneled dialysis catheter was placed, and he was initiated on hemodialysis which was tolerated well without hemodynamic instability.

**Discussion:** Swelling associated with an AVF is often presumed to be from an intravascular process such as a thrombus or central stenosis which can be diagnosed and treated by fistulogram. However, external compression by mass effect should also be taken into consideration. Cases such as ours as well as other reported cases of tumors causing similar presentation highlight the importance of CT imaging in the evaluation of AVF related swelling.

#### TH-PO285

##### Arteriovenous Fistula Recirculation Results in Persistent Hypoglycemia in an ESRD Patient Through an Insulin-Independent Mechanism

**Jun Li,** Jyotsana Thakkar. *Montefiore Medical Center, Bronx, NY.*

**Introduction:** End-Stage Renal Disease (ESRD) patients who are on hemodialysis (HD) are vulnerable to low blood glucose levels due to reduced insulin clearance, changes of glucose metabolism and hemodialysis *per se*. It has been reported that up to 3.6% of ESRD admission presents with hypoglycemia. These patients have a poor prognosis, with a mortality up to 30%. We present a unique case in which persistent hypoglycemia was caused by arteriovenous Fistula (AVF) recirculation.

**Case Description:** A 45-year-old African American male with medical history of ESRD on HD, pulmonary hypertension, presented with left upper extremity AVF malfunction and persistent hypoglycemia. Patient had no history of diabetes and was not on any glucose-lowering medications. The blood glucose level was 44-62 mg/dl which was refractory to 50% dextrose treatment. Laboratory tests including serum Insulin (2.2 µU/ml), C-peptide (4.03), Proinsulin and cortisol level were acceptable. Thyroid function tests and liver function tests were within normal range. AVF duplex showed a radial artery to cephalic vein fistula with average volume flow of 163.23 ml/min. The outflow cephalic vein with >50% stenosis seen at distal forearm and occluded in the upper arm. Angiogram demonstrated a stenosis in the fistula outflow just distal to the elbow. AVF recirculation study was performed during HD session. Peripheral BUN (blood urea nitrogen- mg/dl): 80, Arterial BUN: 32, Venous BUN: < 3. Percent recirculation =  $([P - A] \div [P - V]) \times 100 = ([80 - 32] \div [80 - 3]) \times 100 = 62\%$ . This further confirms the AVF recirculation in addition to the AVF duplex study. Patient also exhibited persistent hyperkalemia due to the low clearance of malfunctioned AVF. Patient then underwent HD through a new HD catheter placed via the right internal jugular vein, after which patient's blood glucose level improved rapidly to 83-115 mg/dl without extra dextrose administration.

**Discussion:** Hypoglycemia in ESRD patients has been attributed to deficiency of precursors of gluconeogenesis, impaired glycogenolysis, diminished renal gluconeogenesis and reduced renal insulin clearance. In the present case, persistent hypoglycemia in the setting of normal insulin level, rapidly corrected by effective HD, indicates that an unknown dialyzable molecule suppressing glycogenolysis or gluconeogenesis might be involved in this process.

#### TH-PO286

##### A Dialysis Dilemma in Achondroplasia

**Mahendra L. Agraharkar,**<sup>1,2</sup> Neelam Jaju.<sup>3</sup> Space City Associates of Nephrology <sup>1</sup>The University of Texas Medical Branch at Galveston, Galveston, TX; <sup>2</sup>Baylor College of Medicine, Houston, TX; <sup>3</sup>Bhaskar Medical College and Bhaskar General Hospital, Yenkapally, India.

**Introduction:** Achondroplasia is not an uncommon skeletal dysplasia caused by a variant Fibroblast Growth Factor Receptor 3 (FGFR3) gene leading to deformed limbs, spine and skull with an incidence of ~1:25,000 live births. Renal failure is not a feature but comorbidities may render them dialysis dependent. Unlike the general population, they encounter many problems such as erroneous GFR estimation due to poor musculature, limitations in modality selection and dialysis access placement, transportation, BP monitoring due to hypoplastic limbs, positioning in a recliner and selecting a dialysis unit that satisfies the above requirements.

**Case Description:** A 3' tall 51-year-old achondroplastic female weighing 90 lbs presented with shortness of breath. She had multiple abdominal and lung surgeries causing ventral hernia and a tracheostomy. She was hypoxic, acidemic, hyperkalemic, and volume expanded with a creatinine of 2.99 mg/dl. Ventral hernia precluded peritoneal dialysis. We dialyzed her by placing a tunneled catheter.

**Discussion:** Achondroplastics needing dialysis can encounter a multitude of problems. Low muscle mass hinders GFR estimation. Respiratory compromise and abdominal surgeries prohibit peritoneal dialysis. Hypoplastic limbs prevent AV shunts and right sized central venous catheters for such patients are unavailable. In the US, there are no pediatric freestanding dialysis units and the adult dialysis centers are not equipped for such patients. Patients with tracheostomy are dialyzed in an isolation unit by a nurse certified in tracheostomy care. There are no applicable formulae for GFR estimation nor for measuring adequacy in such patients. Dialysis in this population has not been described. We describe the problems we faced and potential solutions that can be offered. Awareness of this condition is essential in this potentially growing population.



Note: BP cuff wraps entire limb.

#### TH-PO287

##### Case of Elevated Dialysis Access Venous Pressures From Cephalic Arch Pseudo-Stenosis

**Abdul Hannan A. Rasheed,**<sup>1,2</sup> Sylvester Barnes.<sup>1,2</sup> <sup>1</sup>Edward Hines Junior VA Hospital, Hines, IL; <sup>2</sup>Loyola University Health System, Maywood, IL.

**Introduction:** The patient is a 75-year-old male with ESRD getting hemodialysis via left brachiocephalic AVF created in March 2017. In May 2021, he was found to have elevated venous pressures (VP) of up to 260mmHg during dialysis causing frequent alarms.

**Case Description:** Duplex US of the access showed a patent brachiocephalic AVF with evidence of a significant stenosis at the cephalic / subclavian vein junction with a velocity ratio of 7.8 (659cm/s ÷ 83.8cm/s)(Fig 1). Based on the elevated VP and significant V2/V1 > 3.5 fistulogram was indicated. A fistulogram was performed which showed no significant stenosis within the fistula, as well as no significant stenosis in the central circulation. However, it showed significant angular entry of the cephalic vein at the subclavian junction (Fig 2)

**Discussion:** This case representing pseudo-stenosis, shows the difference of findings detected by the two modalities most commonly used for assessment of dialysis access. The duplex findings can be explained by the both the sharp angle of entry of the cephalic vein to the subclavian vein, along with the significant diameter difference. Since flow must remain constant then velocity has to increase accounting for the smaller diameter and increased vessel tortuosity. If the result was still in question, IVUS could be deployed to document the luminal diameter. The decision was made to follow the patient clinically and if the patient developed problems with prolonged bleeding or excessively high VPs then the patient would have a covered stent placed in the cephalic arch to straighten out the venous tortuosity. So far to date the patient has not had any increase in VPs from the current state nor any episodes of prolonged bleeding.

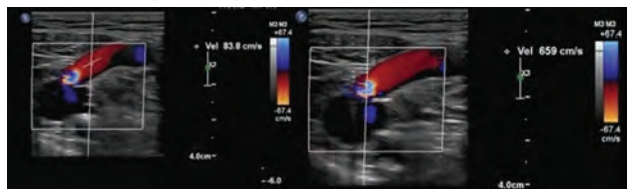

Figure 1: Duplex US

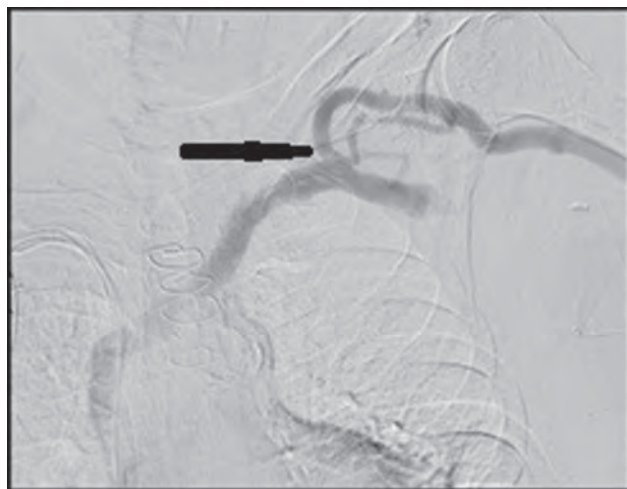

Figure 2: Fistulogram of AVF

#### TH-PO288

##### Morphometric Characterization of Arteriovenous Fistula (AVF) Explants Reveals Collagen and Versican as Dominant Components of Mature AVF Wall

Saran Lotfollahzadeh,<sup>1,2</sup> Nagla El zinad,<sup>4</sup> Yichi Zhang,<sup>5</sup> Murad Elsadawi,<sup>4</sup> Merche Balcells,<sup>6</sup> Vijaya B. Kolachalama,<sup>5</sup> Vipul C. Chitalia.<sup>1,3</sup> <sup>1</sup>Boston University School of Medicine, Boston, MA; <sup>2</sup>Renal Section, Department of Medicine, Boston University School of Medicine, Boston, MA; <sup>3</sup>Veterans Affairs Boston Healthcare System, Boston, MA; <sup>4</sup>Boston University Medical Campus, Boston, MA; <sup>5</sup>Computation Biology, Boston University School of Medicine, Boston, MA; <sup>6</sup>Institute of Medical Engineering and Sciences, Massachusetts Institute of Technology, Cambridge, MA.

**Background:** Arteriovenous Fistula (AVF) is the lifeline of patients with End-Stage Kidney Disease (ESKD) on hemodialysis. AVF undergoes profound remodeling to accommodate arterial pressure and flow, a process called arterIALIZATION of the vein. Despite the central importance of this process in functional AVF, there is a dearth of studies on humans characterizing the components of walls of the mature AVFs.

**Methods:** The morphology of AVF explants was probed with Masson Trichrome, Sirius Red, and Versican. This was followed by a color-based segmentation pipeline with a machine learning approach to quantify the components of AVF explants. Vascular smooth muscle cells were characterized using functional markers.

**Results:** Twenty-one patients had AVFs explanted for aneurysm (71.42%), pseudoaneurysm, stenosis, or aesthetic reasons (each in 9.52%). Neointimal hyperplasia characterized by intimal thickening was present in all AVFs. Other features included calcification, inflammatory infiltrate, needle track injury, and thrombus. Quantitative histological analysis of Masson Trichrome and Sirius red stains showed that in the AVF wall, collagen, vSMCs, and proteoglycan constituted 27.78%, 19.80%, and 31.45% of the

wall, respectively. Compared to vSMC, the collagen and Versican were in the ECM by 1.40 fold and 2.76 fold, respectively. ( $p < 0.001$ ) Collagen was deposited in a concentric manner in the explanted AVFs with aneurysms and in an eccentric manner in the AVFs with pseudoaneurysms. vSMCs showed minimal staining of Ki67 and prominent staining of MYH11,  $\alpha$ -smooth muscle actin, and Calponin, all markers of differentiated vSMCs with secretory phenotype.

**Conclusions:** This study confirms collagen and versican as prominent components of AVF walls and vSMCs with secretory features in the wall of AVF. This study now seeds future investigation to examine the regulation of the components of ECM in the arterIALIZATION of the vein.

**Funding:** NIDDK Support

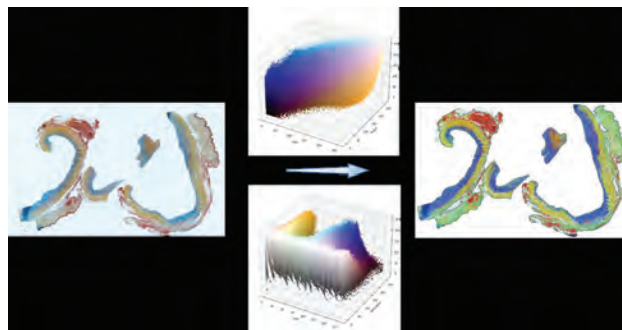

Color and textile-based analysis

#### TH-PO289

##### Impact of Dialysate Flow Rates on Dialysis Adequacy: A Systematic Review and Meta-Analysis

Yasmin A. Iman,<sup>1</sup> Paul Komenda,<sup>1,2</sup> Karen Hovhannissyan,<sup>2</sup> Ruth Ewruhjakpor,<sup>1</sup> Kelley L. Gorbe,<sup>2</sup> Ryan J. Bamforth,<sup>1</sup> Reid Whitlock,<sup>1</sup> David T. Collister.<sup>3</sup> <sup>1</sup>Seven Oaks General Hospital, Winnipeg, MB, Canada; <sup>2</sup>Quanta Dialysis Technologies Ltd, Alcester, United Kingdom; <sup>3</sup>University of Alberta Faculty of Medicine & Dentistry, Edmonton, AB, Canada.

**Background:** Patients with kidney failure on hemodialysis (HD) require adequate removal of uremic solutes and fluid. Historically, dialysis adequacy is measured by multiplying dialyzer clearance of urea (K) by duration of dialysis session (t) adjusted for patient volume of distribution (V). There are many ways of improving dialysis adequacy, including, increasing dialysis time and frequency, maximizing blood flow rates, and using higher surface area dialyzers. However, the relative impact of dialysate flow rates on dialysis adequacy is poorly described. This systematic review and meta-analysis examines the impact of dialysate flow rates on dialysis adequacy.

**Methods:** We searched EMBASE, MEDLINE, and the Cochrane Library from inception until April 2022 for randomized controlled trials of any design and observational studies comparing higher dialysate flow rates (>500mL/min) and lower dialysate flow rates (<500mL/min) vs. a standard dialysate flow rate (500 mL/min) in adults (age ≥18 years) treated with chronic HD (>90 consecutive days) for the outcome of dialysis adequacy, measured by Kt/V. We used random effects meta-analysis to estimate pooled mean difference in Kt/V at fixed dialysis durations, blood flows and dialyzers.

**Results:** A total of 3118 studies were identified in the literature search. Of those, 11 met eligibility criteria and were included for analysis. In the 10 comparisons (n = 732) of a higher dialysate flow rate (560-800 mL/min) vs. a dialysate flow rate of 500 mL/min, a higher dialysate flow rate was associated with an increase in single pooled Kt/V (spKt/V) of 0.12 (95% CI: 0.06-0.18). In the 2 comparisons (n = 24) of a dialysate flow rate of 500 mL/min vs. a lower dialysate flow rate of 300 mL/min, a dialysate flow rate of 500 mL/min showed an increase in spKt/V (mean difference = 0.16) but limited data precluded a meta-analysis.

**Conclusions:** In our systematic review and meta-analysis, we found a higher dialysate flow rate is associated with an improvement in dialysis adequacy compared with a standard dialysate flow rate. More studies are needed to compare a dialysate flow rate of 500 mL/min vs. a dialysate flow rate of 300 mL/min as some self-care HD systems are unable to attain dialysate flow rates >500 mL/min due to the use of batch-based dialysate or limitations of water systems.

**Funding:** Commercial Support - Quanta Dialysis Technologies

#### TH-PO290

##### Effect of Dialysate Flow Rate (DFR) Reduction on Adequacy in a Chronic Hemodialysis Unit

Sam Beavin, Sadiq Ahmed. *University of Kentucky, Lexington, KY.*

**Background:** The Covid-19 pandemic has introduced a number of challenges in managing populations with both acute kidney failure and those dependent on chronic dialysis. Due to a shortage of outpatient dialysis supplies, on February 14, 2022, the Dpt. of Veteran's Affairs issued a memorandum to dialysis units requiring a contingency standard of care. This required a universal reduction of dialysate flow rate to 500 cc/min. Prior to this change, the standard prescription at the Lexington, KY VA unit was 750 cc/min. We evaluated the effect of this change on the adequacy of our dialysis population.

**Methods:** Data was collected for sp Kt/V urea and urea reduction ratio for 17 chronic hemodialysis patients for the two months prior and three months following the reduction of dialysate flow rate to 500 cc/min from the previous standard of 750 cc/min. There was no change of blood flow rate or dialysis time during this 5 month period for all the patients included.

**Results:** A trend towards lower clearance values as measured by single-pool Kt/V and urea reduction ratio was noted between January and April of 2022. Table 1 shows the average spKt/V and URR for each month. The majority of patients maintained adequate spKt/V of >1.2 and urea reduction ratio of >65%. However, 4 patients (23.5% of the population) failed to reach Kt/V and URR goal in April 2022.

**Conclusions:** Though this represents only 17 patients from one dialysis unit, the data suggests a significant decline in adequacy due to this reduction in dialysis flow rate to 500 cc/min. Until the current dialysis supply shortage has been addressed, adaptive measures such as utilizing higher efficiency dialyzers or increasing blood flow rates may be necessary.

Table 1

Month	Mean URR	Mean Kt/V
December	0.75	1.61
January	0.74	1.58
February	0.72	1.50
March	0.72	1.51
April	0.70	1.42

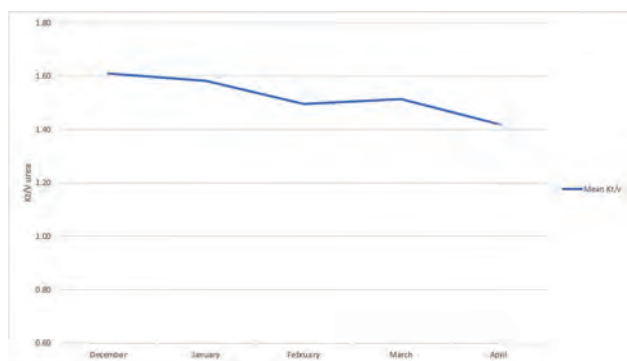

Average Kt/V trend

TH-PO291

**Using the Seraph® 100 Microbind Affinity Blood Filter Under Slow Flow Conditions Through a Non-Dialysis Catheter**

Malin-Theres Seffer,<sup>1</sup> Julius Schmidt,<sup>2</sup> Jan T. Kielstein.<sup>1</sup> <sup>1</sup>Academic Teaching Hospital Braunschweig, Braunschweig, Germany; <sup>2</sup>Medizinische Hochschule Hannover, Hannover, Germany.

**Background:** The Seraph® 100 is a single use biomimetic device aimed to remove pathogens from the bloodstream, usually operated under blood flow rates of 100 – 350 mL/min, requiring a large bore central line / dialysis catheter. Aim of our study was to evaluate the pressure / blood flow curve in vitro using saline as well as human plasma and to evaluate the usability of the Seraph® 100 in the clinical practice.

**Methods:** Patients and study protocol Blood plasma was obtained from five voluntary donors during regular therapeutic plasma exchange. Sham hemofiltration with the Seraph® 100 For all experiments primed a standard hemoperfusion blood tubing system as well as the Seraph® 100 (Exthera Medical, CA, USA) with a total filling volume of about 2200 mL with normal saline (n=5) or with human plasma and connected the hemoperfusion circuit with a 20 cm tri lumen central venous line (2 x 18 G and 1 x 16 G, Certofix® safety trio s720, B. Braun REF: 4167408S-07; Lot: 19D30A8551) that was inserted into a reservoir. The Multifiltrate (Fresenius Medical Care GmbH, Germany) was used to pump the saline through the adsorber. Blood flow was raised in steps of 10 ml beginning at 20 ml up to 100 ml. Arterial and venous pressure was recorded at the different blood pump speeds. In two patients the Seraph® 100 in the hemoperfusion circuit of a Multifiltrate (Fresenius Medical Care GmbH, Bad Homburg, Germany), was connected to a five lumen 20 cm catheter (Certofix Safety Quinto S1220, B. Braun, Melsungen, Germany) 1 x 12 G, 1 x 16 G, 3 x 18 G) that was inserted into the right internal jugular vein. Blood flow as well as arterial and venous pressure and TMP were recorded through the 24 h treatment.

**Results:** All five in vitro runs using either saline and human plasma could be performed without any technical difficulties.

**Conclusions:** A blood flow rate of 50 mL/min can be achieved with a 16 G and 18 G vascular access of central lines. Even long treatment hours (up to 25 hours) under low flow conditions to optimize exposure of patient's blood to the Seraph 100 adsorption media can be achieved.

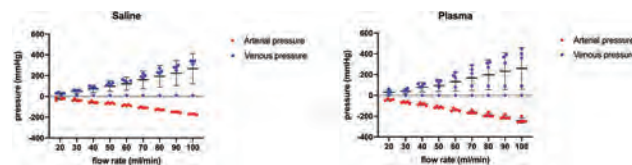

Relationship between blood pump speed and the arterial as well as venous pressure using saline / plasma.

TH-PO292

**Point-of-Care Ultrasound for Assessing Arteriovenous Fistula Maturity in Outpatient Hemodialysis**

Jessie C. Fullmer,<sup>1,2</sup> Steven Weiss,<sup>2</sup> George N. Coritsidis.<sup>1</sup> <sup>1</sup>Westchester Medical Center Health Network, Valhalla, NY; <sup>2</sup>Atlantic Dialysis Management Services, Queens, NY.

**Background:** Point-of-care ultrasound (POCUS) in end-stage renal disease (ESRD) is on the rise. Presently the decision to cannulate an arteriovenous fistula (AVF) is based on its duration since surgery, surgeon clearance, and physical exam. This study examines the effects of POCUS on decreasing the time to AVF cannulation and reducing time spent with a central venous catheter (CVC).

**Methods:** Patients were prospectively recruited between January 2021 and May 2022 after new AVF placement in patients at 5 separate dialysis units, while in patients at 5 other units patients had POCUS within 3 weeks of AVF creation and were followed for a minimum of 3 months following fistula creation. Recommendation for cannulation was made once the following parameters were met: diameter > 6 mm (with no appreciable narrowing of more than 20% throughout), depth < 6 mm from skin surface, and length > 6 cm. Demographic data, as well as time to cannulation and CVC removal, number of infections, complications, and interventions were compared between POCUS and non-POCUS cohorts. A Kruskal-Wallis test was conducted to compare the effect of the POCUS use on the number of successful cannulation in weeks 1 through 6.

**Results:** The POCUS cohort had significantly less cannulating complications than seen in the control group p<0.02. There were no blood stream infections seen in the POCUS group, and one in the control. The average time to decannulation from AVF placement was 103 days in the POCUS group vs 145 days in the control.

**Conclusions:** Point-of-care ultrasound facilitates early and safe arteriovenous fistula cannulation leading to a reduction in central venous catheter time and risk of cannulation injury. These findings on a larger scale should result in decreased infections seen when using POCUS.

TH-PO293

**Application of Percutaneous Transluminal Angioplasty in the Replacement of Tunnel-Cuffed Catheter in Maintenance Hemodialysis Patients**

Hao Ding, Hong Ye, Xueqin Bian, Yuan Luo. *The Second Affiliated Hospital of Nanjing Medical University, Nanjing, China.*

**Background:** One of the emerging complications of tunnel-cuffed catheter (TCC) is the stuck catheter which is the condition that a catheter is not removable from a central vein using standard techniques. This article focuses on outcome and security of percutaneous transluminal angioplasty (PTA) in replacement of TCC in maintenance hemodialysis (MHD) patients.

**Methods:** The clinical data of 62 MHD patients with dysfunctional catheter from January 2015 to January 2021 admitted to the Second Affiliated Hospital of Nanjing Medical University were retrospectively analyzed. All patients underwent digital subtraction angiography (DSA) to identify superior vena cava stenosis and were treated with suitable balloon under the guidance of DSA. The technique of PTA was used to replace the stuck catheters and was also used to disrupt the fibrin sheaths or to dilate the occlusive vein. The pathological manifestations of the fibrin sheath around the catheter were then determined, and the complications during the operation and the function of the catheter were observed and follow up for 6 months.

**Results:** TCC was successfully replacement in 62 patients with treatment of superior vena cava stenosis by PTA under the guidance of DSA and no serious complications such as balloon rupture, severe bleeding, pulmonary embolism and malignant arrhythmia occurred during and after surgery. The dialysis blood flow of after surgery is about 220- 280ml/min and the primary catheter site patency rate was 85% at 3 months and 70% at 6 months. The stuck catheter in the superior vena cave were found in six cases which were successfully removed with the technique of PTA. Among them, 3 cases showed severe calcified fibrin sheath, and another 3 cases showed severe superior vena cava stenosis. The pathological showed the inner layer of fibrin sheath is composed of lymphocytes, plasma cells, neutrophils, macrophages and other inflammatory cells. The outer layer of fibrin sheath is composed of collagen and fibroblasts.

**Conclusions:** Endothelial injury, activation of inflammatory pathways and fibrin sheath formation caused by inflammatory cell aggregation during catheter placement are important pathophysiological mechanisms of catheter dysfunction. Embedded catheters can be successfully managed by PTA which shows advantages of minimal complications, lesser trauma and better tolerance.

**Funding:** Government Support - Non-U.S.

## TH-PO294

**FDA Reported Complications Associated With endoAVF Fistula Devices**  
 Rahul R. Abraham, Erin L. Mayeux, Oluwadamilola Adisa, Atlee Baker, Braeden Mccutchan, David Okuampa, Haley E. Gould, Marjorie Blochouse, Bharat Sachdeva. *LSU Health Shreveport, Shreveport, LA.*

**Background:** Medical device reports (MDRs) are submitted to U.S. Food and Drug Administration (FDA) for all suspected device-associated injuries and deaths. The Manufacturer and User Facility Device Experience (MAUDE) database compiles all MDRs to monitor device outcomes. We review all reported MDRs for WavelinQ® (Bard Peripherals) and the Ellipsys® (Medtronic) used for percutaneous creation of dialysis AVF.

**Methods:** All reported incidents of all endoAVF devices to the FDA database from August 2018-March 2022 were imported to excel, and descriptive statistical analysis was carried out.

**Results:** Events were divided into device-related when the incident involved mechanical device malfunction and patient-related if the subject experienced a complication during endoAVF creation. There were 200 events reported for WavelinQ® over 3.12 years, with a rate of 65 events/year. 81% of total events were device-related issues, with the most common reports of failure to cut (41%), material deformations (28%), and failure of magnets to align (23%) during the AVF creation. 19% were patient-related, including, vessel stenosis (35%), vessel spasm (14%), Ischemic neuropathy (11%), and death (8%). Ten events (5%) were reported with the 6F system, and all others were related to the 4F system. Eleven events were reported for Ellipsys® over a period of 2.03 years, with a rate of 5.41 events reported per year (3.44 device-related and 1.97 patient-related); 36% of total events were device-related issues, with the most common problems being failure to advance (50%), inability to activate the device (25%) and material deformation (25%). Nearly two-thirds (64%) of events were patient-related complications, including thrombosis (57%), hematoma (29%), and stenosis of the vessel (14%).

**Conclusions:** WavelinQ® system had predominant device-related issues, while two-thirds of the Ellipsys® related events were patient-related. MAUDE database cannot calculate the actual incidence rate of events or make comparisons, as physicians voluntarily report the complications, and the prevalence of the use of these devices is unknown. There is limited information available regarding post-market real-life experience on these two devices. Providers need to be aware of the commonly reported device and patient-related complications associated with endoAVF devices.

## TH-PO295

**Permcath Survival: A 3-Year Retrospective Study in a Tertiary Hospital**  
 Raymond S. Piggott, Lynn Redahan, Yvonne M. O'Meara, Denise M. Sadlier. *Mater Misericordiae University Hospital, Dublin, Ireland.*

**Background:** Arterio-venous fistula (AVF) are the preferred access for patient's requiring chronic intermittent haemodialysis. However, permanent dialysis catheters (*permcaths*) are frequently used as an alternative access. In this retrospective study the indications, complications and outcomes of permcath insertion were studied in a single tertiary centre.

**Methods:** Using the electronic medical record and interventional radiology database, all patients who underwent a permcath placement were examined from 1<sup>st</sup> January 2020 to 31<sup>st</sup> March 2022. In addition to demographic information, data with regard to subsequent permcath removal, exchange and outcome was obtained. Any patient undergoing permcath placement for any other purpose other than intermittent haemodialysis were excluded from the study. Data with regard to whether the patient had been referred and/or undergone AVF fistula or other vascular access formation was also reviewed. Permcath removal was defined as no further need of permcath while permcath exchange was defined as temporary removal and/or direct exchange due to malfunction and/or sepsis. All data recorded was done so in compliance with data protection legislation.

**Results:** 118 patients underwent permcath placement during this time, age range 18-90 years (median age = 63 years), male: female 58%:42%, average Kt/V >1.78/week and average blood flow 300 ml/min. The average life span of a removed permcath was 197 days (range = 7-819 days). 37 permcaths were removed: 45% (n = 17) due to renal recovery, 30% (n = 11) due to successful AVF placement, 2% (n = 1) transitioned to peritoneal dialysis and 18% (n = 3) underwent successful renal transplantation. 32 permcaths were exchanged: 19% (n = 6) were due to sepsis, 6 patients required more than one permcath exchange (range 2-5 exchanges) due to blocked permcath, permcath dislodgement, exposed cuff and inadequate flows. In all of these patients there was no alternative access.

**Conclusions:** Permcaths are a reliable method of vascular access but their utility is often impeded by complications and a relatively short lifespan. They should not replace AVFs as the preferred haemodialysis access

## TH-PO296

**Global Dialysis Vascular Access Care: A Multi-Specialty Interest**  
 Mohamed Hassanein,<sup>1</sup> Nora H. Hernandez Garcilazo,<sup>2</sup> Si Yuan Khor,<sup>2</sup> Hassan Elmaleh,<sup>3</sup> Khaled M. Moustafa,<sup>4</sup> Tushar J. Vachharajani.<sup>5</sup> <sup>1</sup>University of Mississippi Medical Center, Jackson, MS; <sup>2</sup>Michigan State University, East Lansing, MI; <sup>3</sup>Ministry of Health In Egypt, Cairo, Egypt; <sup>4</sup>Medical Research Institute, Alexandria, Egypt; <sup>5</sup>Cleveland Clinic, Cleveland, OH.

**Background:** The history of dialysis vascular access dates back to 1924 in Germany when Dr. George Haas connected an artery and vein using a glass cannula. Since then, dialysis vascular access care has evolved robustly through scientific contributions from

researchers worldwide. We sought to identify the global distribution and contribution of medical specialties to the medical literature on dialysis vascular access care over the past 3 decades.

**Methods:** We performed a thorough literature search of articles related to dialysis vascular access published in the English medical literature from 1991 to 2021. We identified and analyzed 2,768 articles from 74 countries worldwide and stratified them by article type and medical specialty.

**Results:** Out of 2,768 articles, 41.5% (1148) originated from the United States, followed by China (5.1%), United Kingdom (4.6%), Germany (3.6%), India (3.4%), Japan (3.1%) and Canada (2.9%). Forty-three percent of search results (1205) were observational studies, followed by 27% (761) case reports/series, 16.5% (458) review articles, 12% (335) clinical trials and 0.3% (9) meta-analyses. The majority of articles (49%) were published in nephrology journals, followed by 14%, 10%, 8%, and 4% of articles published in general medicine, surgery, vascular medicine, and interventional radiology journals, respectively.

**Conclusions:** Dialysis vascular access care is provided by specialists with multiple backgrounds across the globe. Thirty-nine percent of the evidence is published from developing countries. Retrospective observational studies along with case reports/series provide 88% of the current evidence for clinical practice. Barely 12% of the published literature is from prospective clinical trials. Even though providers with multiple training backgrounds are involved with dialysis vascular access care, almost 49% of the scientific evidence is published in journals catering to the nephrologists. The literature trend highlights the need for better collaboration across all specialties to effectively improve patient care.

## TH-PO297

**Agng and Arteriovenous Fistula Remodeling in a Mouse Model**  
 Brayden Fairbourn,<sup>1</sup> Amani Oumar,<sup>1</sup> Marina Knysheva,<sup>2</sup> Yuxia He,<sup>1,3</sup> Lisa Lesniewski,<sup>1,3</sup> Tony J. Donato,<sup>1,3</sup> Alfred K. Cheung,<sup>1,3</sup> Yan-Ting E. Shiu.<sup>1,3</sup> <sup>1</sup>The University of Utah, Salt Lake City, UT; <sup>2</sup>The University of Utah School of Medicine, Salt Lake City, UT; <sup>3</sup>VA Salt Lake City Health Care System, Salt Lake City, UT.

**Background:** Arteriovenous fistulas (AVFs) are the preferred type of hemodialysis vascular access, but up to 60% fail to mature, i.e., have sufficiently large vein lumen area and blood flow. This failure rate is higher in old than young patients, and yet the biology of AVF remodeling has not been studied in the context of aging. To investigate the effects of aging on AVF development, we focused on the mammalian target of rapamycin (mTOR) and sirtuin-1 (SIRT1), two primary regulators of aging and arterial functions. We hypothesized that aging-related increased mTOR and decreased SIRT1 in the veins impair AVF development in old mice.

**Methods:** The protein levels of mTOR and SIRT1 in native external jugular veins (EJVs) of young (3 months) and old (18 months) C57BL/6 mice were determined by immunohistochemistry. Carotid-external jugular AVFs were created in young and old mice with or without treatment of either the mTOR inhibitor rapamycin (8 mg/kg) or the SIRT1 activator SRT1720 (100 mg/kg) by intraperitoneal injections (IPs). IPs began on the day of AVF creation and were repeated daily for rapamycin and twice a week for SRT1720 for 1 week until the mice were euthanized. Histological morphometry was used to quantify AVF % open lumen area and neointimal lesion area, and the transcriptomes were quantified by RNA sequencing.

**Results:** The protein level of mTOR increased approx. 2.4 fold and SIRT1 decreased approx. 3.4 fold from young to old EJVs. Without treatments, the % open lumen area in old (20±4%, n=3) was smaller than in young (48±3%, n=2) AVFs. The RNAseq data showed that collagen degradation and extracellular matrix organization were downregulated while fibrosis and inflammation were upregulated in old vs. young AVFs (n=3 each). In young AVFs, rapamycin increased the % open lumen areas to 74±13% (n=3), but STR1720 made no change (45±9%, n=4). In old AVFs, both treatments decreased neointimal lesion area approx. 1.9 fold and increased the % open lumen areas (rapamycin: 34±12%, n=3; SRT1720: 64±35%, n=3).

**Conclusions:** Our results suggest the potential of mTOR inhibition and SIRT1 activation to improve AVF maturation rates in patients of older age. With the population of older patients with end-stage kidney disease climbing quickly, it is imperative to develop methods to improve AVF maturation in older patients.

**Funding:** NIDDK Support, Other NIH Support - NHLBI, Veterans Affairs Support

## TH-PO298

**Vascular Access Management Story in Outsourcing Hemodialysis Program in Saudi Arabia**  
 Dujanah H. Mousa, Elhussein K. Ibrahim, Abdulaziz O. Alqadhi, Ibrahim A. Assiri, Ahmed I. Abouras, Badawi A. Altaher, Mohammed H. Ismail, Hassan A. Musa, Ali Alharbi. *Diaverum AB, Riyadh, Saudi Arabia.*

**Background:** VA is the backbone of successful Hemodialysis. AVF is longer in survival and less in complications than an AVG or CVC. Outsourcing Program in Saudi Arabia has looked after more than 5K pats since 2014 and Provides VA management as part of the bundle service. Aim: To show our experience in managing VA challenges.

**Methods:** We retrospectively analyzed a VA project between 2014 to 2021.

**Results:** In 2014, we had an AVF of 60% and a high rate of CVC of almost 33%. Over time, more clinics are established and ramping up pats with a challenge to achieve the CVC contractual target of 15% or less. During the first 2years, limited resources in three main cities serving all patients. Providing the services at local hospitals is on the contract's terms, and patients were resistant to travel for vascular procedures. Targets could not deliver, and the cost was high. We analyzed patient factors such as dialysis

Key: TH - Thursday; FR - Friday; SA - Saturday; OR - Oral; PO - Poster; PUB - Publication Only

Underline represents presenting author.

vintage, resistance to change, and education. We headhunted for the right VA surgeon who is committed and willing to travel between different cities. Also looked for accredited theater facilities in different cities where our clinics are allocated and rented to deliver the VA procedures. A structured VA Management team was created with dedicated and knowledgeable staff to lead the roadmap to success. Our surgeons in one geographical region were inspired to start a new business model, and they were sub-contracted per capita to deliver our targets, which proved to be successful and valuable. Digitization to support and coordinate between clinics, surgeons, and regional vascular supervisors, keeping finance in the loop to eliminate discrepancies and secure budget efficiency. Therefore, a strategy was implemented, supervised, re-evaluated, and improved over time. Patient care is delivered as near home as possible, and patient satisfaction is ensured. Medical targets achieved and cost observed. Patients grew to 4300 in 2021; we achieved AVF/G 83.8% and CVC 16.1%, with a cost reduction of 25%

**Conclusions:** Organized and keen VA team with custom Designed System for Tracking and close supervision of different clinic's VA status and procedures will improve VA services, deliver targets and reduce costs in any hemodialysis setup.

#### TH-PO299

##### Predicting Hemodialysis Arteriovenous (AV) Access Stenosis Using Artificial Intelligence

Omar S. Elbita,<sup>1</sup> Michael E. Brier,<sup>1,2</sup> Adam E. Gaweda,<sup>1</sup> Zygimantas C. Alsaukas,<sup>1</sup> <sup>1</sup>University of Louisville, Louisville, KY; <sup>2</sup>VA Robley Rex Medical Center, Louisville, KY.

**Background:** AV access flow dysfunction due to underlying stenosis or thrombosis is associated with significant morbidity and cost to the healthcare system. In this proof of concept study we have used artificial intelligence (AI) to reliably predict the occurrence of AV access stenosis using intradialytic data routinely collected and stored in the electronic medical record (EMR).

**Methods:** Data were obtained from the dialysis and interventional nephrology electronic medical record for the years 2018 to 2020. Routinely collected information were obtained and segmented by patient and treatment day into one-month sequences. A Recurrent Neural Network was trained to predict one week ahead of time for the following stenosis events: central venous, arterial anastomosis, venous anastomosis, or thrombosis, as obtained from interventional procedure records. The model was trained in Matlab/Simulink (MathWorks, Natick, MA) using 80% of the data for training and 20% for validation.

**Results:** Twenty-seven patients were included in the analysis with a total of 177 events. Two models were developed, a reduced model (Model 1) using mean systolic and diastolic blood pressure and mean venous and arterial pressure recorded during dialysis as predictors. Model 2 contained the variables in Model 1 plus the gradients of those parameters during dialysis. The ROC for the predictions are shown in Figure 1 (ROC=0.859). 75% of the events were identified one week in advance with a false positive rate of about 5%.

**Conclusions:** An AI-based approach using data from the EMR successfully predicted AV access stenosis. The strength of the approach is that predictions were trained using data from patients that had an event leading to discontinuation of dialysis and referral to interventional nephrology unlike procedures developed for access surveillance. This could be used as a supplementary tool to routine AV access monitoring.

##### Receiver Operating Curve

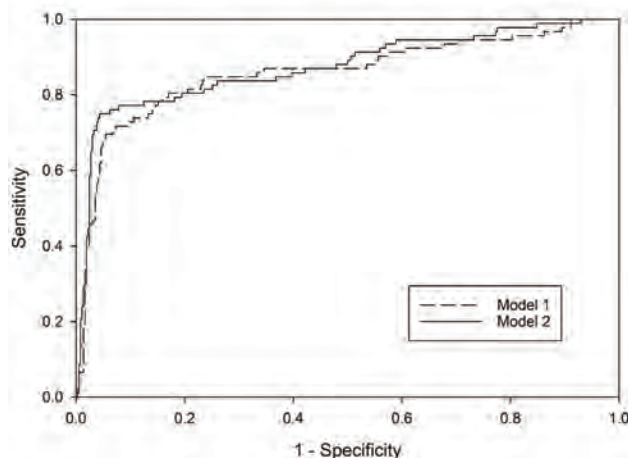

#### TH-PO300

##### Kidney Failure Risk Equation for Vascular Access Planning: A Nationwide Observational Cohort Study From Sweden

Ulrika Hahn Lundström,<sup>1</sup> Chava L. Ramspek,<sup>2</sup> Friedo W. Dekker,<sup>2</sup> Juan J. Carrero,<sup>1</sup> Ulf Hedin,<sup>1</sup> Marie Evans,<sup>1</sup> <sup>1</sup>Karolinska Institutet, Stockholm, Sweden; <sup>2</sup>Leids Universitair Medisch Centrum, Leiden, Netherlands.

**Background:** The optimal timing of arteriovenous (AV) access creation remains a challenge. Our aim was to study if a Kidney Failure Risk Equation (KFRE) threshold would improve AV access planning.

**Methods:** From 28,798 patients included in the Swedish Renal Registry-chronic kidney disease 2008-2020 we generated two cohorts; first visit when KFRE was >40% (KFRE40), and first visit when estimated glomerular filtration rate (eGFR)<15 ml/min/1.73m<sup>2</sup> (eGFR15). The cohorts were followed until start of kidney replacement therapy (KRT) and death, the proportion of patients starting hemodialysis with a working access and test diagnostics for the two methods were described.

**Results:** The eGFR decline was faster in KFRE40 compared to the eGFR15 (-2.0 vs -0.95 ml/min/1.73m<sup>2</sup> per year). KFRE40 had superior positive predictive value for KRT initiation at 2 years (56% versus 43% for eGFR15). KFRE40 had higher specificity (90% versus 79% for eGFR15), while eGFR15 had higher sensitivity (88% versus 75% for KFRE40). If all patients potentially had undergone successful AV access surgery at KFRE40, 75% of patients would ever start dialysis with an AV access; in two years 13% would die and 31% be alive with an unused access. For AV access surgery at eGFR15, 88% would ever initiate KRT with an AV access; in two years 17% would die, and 40% live with an AV access never used.

**Conclusions:** Using KFRE >40% as decision threshold would increase the proportion of patients starting with a working AV access at the cost of more patients experiencing unnecessary surgery. The KFRE threshold >40% could complement decision making for vascular access creation.

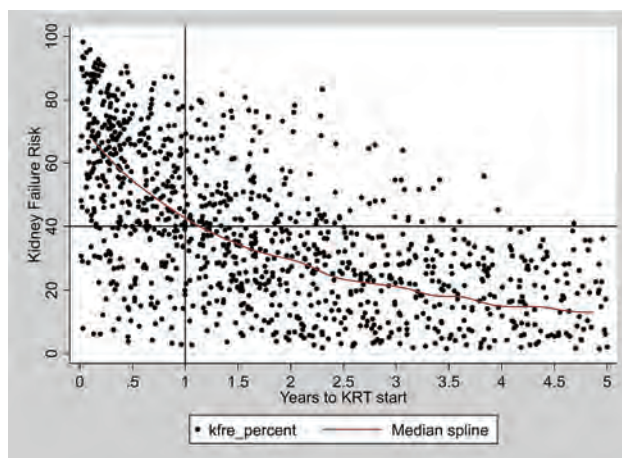

Development of KFRE in nephrology-referred patients, in the year before Hemodialysis initiation

#### TH-PO301

##### Cardiac Tissue Chip Model of Arteriovenous Fistula-Associated Hemodynamics Recapitulates Changes Seen in Mouse AVF Model

Timmy C. Lee,<sup>1,2</sup> Tatyana Isayeva Waldrop,<sup>1</sup> Caleb Graham,<sup>1</sup> William A. Gard,<sup>1</sup> Kevin A. Ingle,<sup>1</sup> Palaniappan Sethu,<sup>1</sup> <sup>1</sup>The University of Alabama at Birmingham School of Medicine, Birmingham, AL; <sup>2</sup>Birmingham Veterans Affairs Medical Center, Birmingham, AL.

**Background:** Cardiovascular events are the primary cause of death among dialysis patients. While arteriovenous fistulas (AVFs) are the access of choice for hemodialysis patients, AVF creation leads to a volume overload (VO) state. We developed a three-dimensional (3D) cardiac tissue chip (CTC) with tunable pressure and stretch to model the acute hemodynamic changes associated with AVF creation to complement our murine AVF model of VO. In this study, we aimed to replicate the hemodynamics of murine AVF models in vitro and hypothesized that if 3D cardiac constructs were subjected to "volume overload" conditions, they would display fibrosis and key gene expression changes seen in AVF mice.

**Methods:** Mice underwent either AVF or sham procedure and sacrificed at 28 days. Cardiac tissue constructs (Fig 1) composed of h9c2 rat cardiac myoblasts and normal adult human dermal fibroblasts in hydrogel were seeded into devices and exposed to 100 mg/10 mmHg pressure (0.4 s/0.6 s) at 1 Hz for 96 hours. Controls were exposed to "normal" stretch and experimental group exposed to "volume overload". RT-PCR and histology were performed on the CTC and mice left ventricles (LVs), and transcriptomics of mice LVs were performed.

**Results:** Our CTC constructs and mice LV both demonstrated cardiac fibrosis as compared to control fibers and sham-operated mice, respectively. Our gene expression studies in our CTC constructs and mice LV demonstrated increased expression of genes associated with extracellular matrix production, oxidative stress, inflammation,

and fibrosis in the VO conditions vs control conditions. Our transcriptomics studies demonstrated activated upstream regulators related to fibrosis, inflammation, and oxidative stress such as collagen type 1 complex, TGF $\beta$ 1, CCR2, and VEGFA and inactivated regulators related to mitochondrial biogenesis in LV from mice AVF.

**Conclusions:** Our CTC model yields similar fibrosis-related histology and gene expression profiles as our murine AVF model. The CTC can play a critical role in understanding cardiac pathobiology of VO states similar to what is present after AVF creation and used in evaluating therapies.

**Funding:** Other NIH Support - National Institutes of Heart, Lung, and Blood Institutes, Veterans Affairs Support

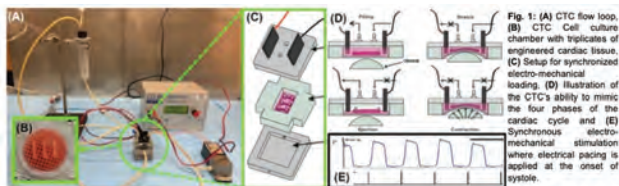

### TH-PO302

#### Influence of Hemodynamic Changes on Venous Endothelial Cell Adaptation After Arteriovenous Fistula Creation

Taylor G. Lewis,<sup>1</sup> Tatyana Isayeva Waldrop,<sup>2</sup> Maheshika S. Somarathna,<sup>2</sup> Kevin A. Ingle,<sup>2</sup> Timmy C. Lee,<sup>2</sup> <sup>1</sup>Rosalind Franklin University of Medicine and Science Chicago Medical School, North Chicago, IL; <sup>2</sup>The University of Alabama at Birmingham Department of Medicine, Birmingham, AL.

**Background:** The arteriovenous fistula (AVF) is considered the lifeline for ESRD patients, but AVF non-maturation is currently a great problem facing vascular access. Maturation is influenced by both hemodynamic changes and the uremic syndrome. Impaired vessel dilatation is the major characteristic of endothelial dysfunction, predominately explained by a decrease in bioavailable nitric oxide (NO) produced by eNOS. In response to oscillatory shear stress, immediate activation of the MCP1 gene results in monocyte adhesion to inflamed endothelium. The goal of this study is to evaluate the influence of hemodynamics on endothelial function using both in vivo and in vitro systems.

**Methods:** For the in vivo system, femoral end-to-side AVFs were created in rats. 7 days after creation, the AVFs and contralateral control veins were harvested, sectioned, and stained for eNOS expression. Samples were harvested for western blot analysis of MCP1 and eNOS protein expression. For the in vitro system, human umbilical venous endothelial cells (HUVECs) were cultured in silicone vessel-like structures set to mimic either laminar (LSS) or oscillatory (OSS) shear stress. HUVECs were isolated and stained for eNOS and MCP1 expression. Additionally, samples were isolated for western blot analysis of MCP1 and eNOS protein expression.

**Results:** In vivo AVF samples displayed less eNOS staining compared to contralateral vein samples. Western blot shows significantly greater eNOS expression in control veins (control=0.347, AVF=0.286,  $p=0.043$ ) and significantly greater MCP1 expression in AVF veins (control=0.181, AVF=0.599,  $p=0.0002$ ). In HUVECs, eNOS expression was significantly greater in LSS (eNOS=77.85, MCP1=22.49  $\mu^2$ /nuclei,  $p=0.0061$ ) and MCP1 expression was significantly greater in OSS (eNOS=54.83, MCP1=449.5  $\mu^2$ /nuclei,  $p=0.0049$ ). Western blot shows significantly greater eNOS expression under LSS (LSS=0.345, OSS=0.263,  $p=0.023$ ) and significantly greater MCP1 expression under OSS (LSS=0.369, OSS=0.689,  $p=0.033$ ).

**Conclusions:** In in vivo and in vitro studies, disturbed flow reduces eNOS production and increases inflammation as evidenced by increased levels of MCP-1 in the venous endothelium. Therapies that enhance endothelial function and reduce inflammation in the setting of disturbed flow may reduce AVF maturation failure.

**Funding:** NIDDK Support, Other NIH Support - National Heart, Lung, and Blood Institute, Veterans Affairs Support

### TH-PO303

#### A 3D-Printed Ultrasound Probe Holder to Facilitate Ease of Ultrasound-Guided Arteriovenous Fistula (AVF) Cannulation

Hannah M. O'Keefe,<sup>1</sup> Noor Adebah Mohamed Razif,<sup>2</sup> Ella B. Donders,<sup>2</sup> Daniel Byrne,<sup>2</sup> Basem Fouda,<sup>2</sup> Fiona Leigh,<sup>1</sup> Julio L. Chevarria.<sup>1</sup> <sup>1</sup>Tallaght University Hospital, Dublin, Ireland; <sup>2</sup>The University of Dublin Trinity College, Dublin, Ireland.

**Background:** Ultrasound guidance has the potential to reduce complications due to mis-cannulation such as haematomas and infiltration. Ultrasound-guided needle insertion requires confidence and practice, and particularly for early users can be cumbersome and even require an additional person to hold the probe. The creation of a probe holder was felt to have the potential to facilitate a single person to perform real time ultrasound-guided needling, rather than using ultrasound initially and marking the AVF, or requiring an additional person to assist.

**Methods:** Using an iterative prototyping approach, a 3D-printed probe holder was created which allows horizontal and vertical adjustment of the probe position, 360 degrees range of motion for the probe and the ability to hold the probe in a stationary position. The authors consist of Biomedical Engineering Masters students, Nephrologists and a Vascular Access Nurse Specialist from two Irish institutions who collaborated to create this 3D printed prototype. A computer-aided design (CAD) model was created using

SolidWorks (Dassault Systemes, USA). The model was designed in parts and printed with the Original Prusa i3 MK3S+ using polylactic acid thermoplastic as the material.

**Results:** The final design consists of a flat base which can be placed on a bed or table, with two semi-circular structures to keep the arm stable and reduce mobility, and a boss-head mechanism to be able to adjust the horizontal and vertical position of the probe holder. There is a proximal hinge and a ball and socket joint, which provide additional range of motion in all directions. The probe holder itself is ridged to facilitate different orientations of the probe. The probe is secured to the ridged probe holder by an elastic band. The model was tested using a Mindray TE7 linear probe.

**Conclusions:** The authors present a functional device which can potentially facilitate the use of real time ultrasound-guided cannulation. This solution is cost effective, estimated at \$20.01 including materials, print time and energy consumption. The instructions are freely available online at <https://www.med3dp.com/nice-us-probe-holder>. Further testing of use in the clinical setting is required to assess issues with utilisation and whether the potential benefits are realised.

### TH-PO304

#### Sodium Zirconium Cyclosilicate (SZC) Binds Ammonium (NH<sub>4</sub><sup>+</sup>) in the GI Tract

Fernando A. Marmol Mosquera,<sup>1</sup> Mohammed Q. Badaruddin,<sup>1</sup> Athar Baig,<sup>1</sup> Minghao Ye,<sup>1</sup> Jan Wysocki,<sup>1</sup> Krister Bamberg,<sup>2</sup> Daniel Battle.<sup>1</sup> <sup>1</sup>Northwestern University Feinberg School of Medicine, Chicago, IL; <sup>2</sup>Translational Science and Experimental Medicine, Early Cardiovascular, Renal and Metabolism (CVRM), BioPharmaceuticals R&D, AstraZeneca, Gothenburg, Sweden.

**Background:** Sodium zirconium cyclosilicate (SZC) is a non-absorbed, non-polymeric inorganic cation exchanger that selectively captures Potassium (K<sup>+</sup>) in the exchange for hydrogen (H<sup>+</sup>) and Sodium (Na<sup>+</sup>) in the gastrointestinal tract. The ionic diameter of NH<sub>4</sub><sup>+</sup> and K<sup>+</sup> in aqueous solution are similar in size and both are bound by SZC in vitro, suggesting that SZC binds not only K<sup>+</sup> but also NH<sub>4</sub><sup>+</sup> in the gastrointestinal tract. This hypothesis was studied in mice placed in metabolic cages to collect feces and urine for comparison of ammonium excretion concurrently on a regular diet followed a diet with added SZC.

**Methods:** Mice (CD-1 background) on a regular diet for 2 days were switched to a diet containing SZC (6g/Kg BW) for the following 3 days and placed in metabolic cages designed to collect urine and feces separately but simultaneously over a period of 6 hours to be able to assess fecal and urine NH<sub>4</sub><sup>+</sup> excretion. Feces NH<sub>4</sub><sup>+</sup> was measured using a non-enzymatic assay, where ammonia forms indophenol, a highly colored product easily quantifiable by colorimetry. In all fecal samples NH<sub>4</sub><sup>+</sup> was concurrently measured with and without 50 mEq KCl<sup>-</sup> solution to release NH<sub>4</sub><sup>+</sup> from SZC present in the feces.

**Results:** When SZC was added to the diet the fecal NH<sub>4</sub><sup>+</sup> excretion measured after release of NH<sub>4</sub><sup>+</sup> with KCl was significantly higher than in absence of KCl<sup>-</sup> (2.2  $\pm$  0.2 and 1.6  $\pm$  0.2  $\mu$ mol/6hrs), respectively  $p=0.0005$  (fig, right panel). In the regular diet, used as a negative control, addition of KCl to the samples had no significant effect on measured fecal NH<sub>4</sub><sup>+</sup> (1.9  $\pm$  0.3 vs 1.8  $\pm$  0.3  $\mu$ mol/6hrs,  $p=0.55$ ) (fig, left panel).

**Conclusions:** In feces from normal mice on a diet with added SZC there is a substantial amount of NH<sub>4</sub><sup>+</sup> sequestered in the K<sup>+</sup> binder. This is consistent with the hypothesis that SZC binds NH<sub>4</sub><sup>+</sup> in the GI tract and hence may offer therapeutic opportunities on top of its known K<sup>+</sup> binding action used to treat hyperkalemia.

**Funding:** Commercial Support - AstraZeneca

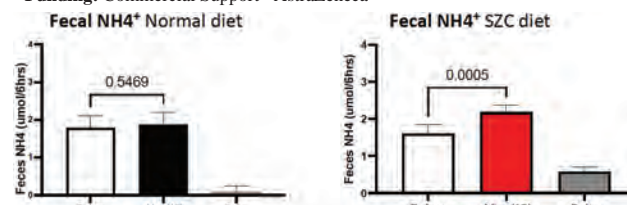

### TH-PO305

#### Renal Adaptation to Increased Fecal Potassium Excretion by Sodium Zirconium Cyclosilicate

Fernando A. Marmol Mosquera,<sup>1</sup> Mohammed Q. Badaruddin,<sup>1</sup> Athar Baig,<sup>1</sup> Minghao Ye,<sup>1</sup> Seyedmohammadebrahim Tahaei,<sup>2</sup> Jan Wysocki,<sup>1</sup> Paul A. Welling,<sup>2</sup> Krister Bamberg,<sup>3</sup> Daniel Battle.<sup>1</sup> <sup>1</sup>Northwestern University Feinberg School of Medicine, Chicago, IL; <sup>2</sup>Johns Hopkins Medicine, Baltimore, MD; <sup>3</sup>Translational Science and Experimental Medicine, Early Cardiovascular, Renal and Metabolism (CVRM), BioPharmaceuticals R&D, AstraZeneca, Gothenburg, Sweden.

**Background:** Potassium (K<sup>+</sup>) binders, like sodium zirconium cyclosilicate (SZC) which is very selective for K<sup>+</sup>, are increasingly used for treatment of hyperkalemia. While the efficacy of SZC is clinically proven regardless of underlying condition associated with hyperkalemia, the renal response has not been well studied. We hypothesized that any enhancement on fecal K<sup>+</sup> excretion should elicit a renal response characterized by a switch from the normal secretory mode to a reabsorptive mode as a mechanism to conserve K<sup>+</sup> and prevent total K<sup>+</sup> depletion. This hypothesis was studied in normal mice and in mice with CKD caused by 5/6 nephrectomy to mimic the clinical setting where K<sup>+</sup> binders are typically used.

Key: TH - Thursday; FR - Friday; SA - Saturday; OR - Oral; PO - Poster; PUB - Publication Only

Underline represents presenting author.

**Methods:** Mice (CD-1 background) on a regular diet for 2 days were switched to a diet containing SZC for the following 3 days and placed in metabolic cages designed to collect urine and feces separately but simultaneously over a period of 6 hours to be able to assess fecal and urine K<sup>+</sup> excretion.

**Results:** The SZC diet resulted in an increase in fecal potassium (K<sup>+</sup>) excretion in normal mice (from 15 ± 3 to 68 ± 9 μmol/6hrs p<0.0003) and a similar increase in mice with CKD (from 25 ± 2.6 to 87 ± 7.1 μmol/6hrs p=0.003). Urine potassium K<sup>+</sup> excretion, in normal mice decreased markedly (from 89 ± 6.9 to 52 ± 3.7 μmol/6hrs p<0.0003), whereas in CKD mice urine K<sup>+</sup> excretion also decreased but to a lesser extent (from 81 ± 5.2 to 60 ± 5.1 μmol/6hrs p<0.0086). As a result, the increase of total potassium excretion (Fecal + Urine) during the SZC containing diet was statistically significant in CKD (from 106 ± 8.5 to 147 ± 13 μmol/6hrs p=0.012) but not in normal mice (from 104 ± 7.1 to 120 ± 10.9 μmol/6hrs p=0.1428) (fig.1)

**Conclusions:** In a mouse model of CKD caused by kidney ablation there is a compensatory decrease in renal K<sup>+</sup> excretion during fecal K<sup>+</sup> loss caused by SZC which is less pronounced than in normal mice owing to less effective K<sup>+</sup> renal reabsorption.

**Funding:** Commercial Support - AstraZeneca

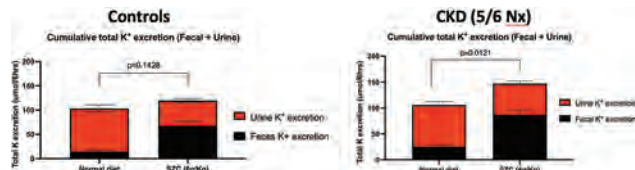

### TH-PO306

#### A Novel Mouse Model of Renal Tubular Protein-Induced Nephropathy Mimics Sjögren Syndrome With Kidney Injury

Tiantian Ma, Xiaoxiao Shi, Limeng Chen. *Peking Union Medical College Hospital, Dongcheng-qu, China.*

**Background:** By immunization with allogeneic renal tubular homogenate, we tried to establish an experimental mouse model of primary Sjögren's syndrome (SS) with renal injuries which was not available now.

**Methods:** Proteins extracted from the salivary glands (SG) of normal mice were emulsified in an equal volume of Freund's complete adjuvant at a concentration of 2 mg/mL (the SG group), while renal tubular proteins at a concentration of 1 mg/mL or 3 mg/mL (the RT group). For disease induction, each 8-week-old female C57BL/6 mouse received subcutaneous multi-injections on the back with 0.1 mL of the above emulsion on days 0 and 7, respectively. On day 14, a booster injection was carried out with a half dose of the proteins emulsified in Freund's incomplete adjuvant. Mice injected with phosphate buffered saline (PBS) served as the control group. At 5 weeks postimmunisation, serum creatinine, 24-hour water intake, urine volume and urine electrolyte excretion were determined. Serum levels of anti-SSA and anti-SSB autoantibodies were determined by ELISA. The pathology of SG tissues and the proximal tubular injury was evaluated by light microscopy and electron microscope.

**Results:** Both the SG group and the RT group developed a typical disease profile of SS, including increased water intake, reduced saliva secretion, positive serum anti-SSA and anti-SSB autoantibodies and pathologically lymphocytic infiltrations in SG. For kidney, despite similar serum creatinine and urea nitrogen levels, both the SG group and the RT group presented with renal tubular dysfunctions including decreased urine osmolality, increased urine output, proteinuria, decreased serum potassium levels, and increased urinary potassium and phosphorus excretion compared to the control group. Kidney pathology showed swollen and exfoliated tubular epithelial cells, brush border cilia lodging and dissolving with focal lymphocytic infiltrations in both the two groups. By electron microscope, we observed the disorderly dissolution of brush border cilia, smaller, ruptured mitochondria and increased mitochondrial membrane density were observed in the 1 mg/mL RT group, but not in the 3 mg/mL RT group.

**Conclusions:** This study first established a mouse model of SS with kidney injuries which was induced by immunizing mice with renal tubular protein and adjuvant.

**Funding:** Government Support - Non-U.S.

### TH-PO307

#### Cadmium Attenuates Tonicity Responsive Gene Expression in Kidney Cells via RNA Polymerase II Pausing

Amy Y. Zhao, Princes Kamuche, Don Delker, Jason A. Watts. *National Institute of Environmental Health Sciences, Research Triangle Park, NC.*

**Background:** The kidney is a target organ for many environmental exposures, such as the heavy metal cadmium. Cadmium is taken up by renal epithelial cells, where it accumulates, leading to acute and chronic renal injury. While cadmium is a known nephrotoxin, the transcriptional regulatory mechanisms preceding cadmium-induced renal injury remain largely unexplored. Previously, we identified RNA polymerase II (RNA Pol II) pausing as a mediator of the osmotic stress response. Here, we investigate the transcriptional response to environmental stress and identify cadmium as a modifier of RNA Pol II pausing regulation.

**Methods:** Cultured renal proximal tubule cells (RPTEC/TERT1) and inner medullary collecting duct cells (IMCD) were exposed to hypertonic salt and cadmium chloride. Changes in transcription were monitored by measuring RNA Pol II gene occupancy, and gene expression was measured by qPCR and RNA-seq.

**Results:** We began by characterizing the expression of *PAX2* and *PAX8*. These transcription factors are induced in response to hypertonic stress and acute kidney injury, and they are regulated by RNA Pol II pausing. In collecting duct and proximal tubule cells, hypertonic stress led to dose-dependent induction of *PAX2/8*, whereas cadmium treatment resulted in dose-dependent *PAX2/8* repression in both cell types. When combined with hypertonic stress, cadmium treatment abrogated the induction of *PAX2/8*. We extended these results by RNA-seq and identified over 600 genes where cadmium exposure resulted in attenuated gene activation following hypertonic stress. To determine how cadmium mediates this effect, we performed chromatin immunoprecipitation and found that RNA Pol II is recruited to gene promoters following hypertonic stress, but its release into productive elongation is impaired in the presence of cadmium.

**Conclusions:** Cadmium exposure attenuates tonicity responsive gene expression through stabilization of paused RNA Pol II. This effect on transcription regulation represents a new aspect of cadmium nephrotoxicity, where blocking induction of genes that allow adaptation to hypertonic stress leads to greater cellular injury. These results have implications for renal conditions associated with environmental exposures, such as chronic kidney disease of unknown etiology.

**Funding:** Other NIH Support - NIEHS, Private Foundation Support

### TH-PO308

#### Guanine Quadruplex-Mediated Pausing of Mitochondrial RNA Polymerase Regulates ATP Generation in Renal Proximal Tubule Cells

Jason A. Watts, Don Delker, Ryan J. Snyder. *National Institute of Environmental Health Sciences, Research Triangle Park, NC.*

**Background:** This project identifies the role of mitochondrial RNA polymerase (mtRNAP) pausing in the regulation of ATP production and transporter function in renal proximal tubule cells (RPTECs). In the nucleus, RNA polymerase II transcribes with punctuated pauses that are coupled to regulation of gene expression; however, RNA polymerase pausing has not been studied in the regulation of mitochondrial gene expression. Here, we sought to characterize the role of nucleic acid sequence and secondary structure in the regulation of mtRNAP pausing. Guanine quadruplexes (G4) are secondary structures formed by non-canonical base-pairing between guanine residues. We found that stabilization of G4 in RPTECs results in increased mtRNAP pausing and mitochondrial dysfunction.

**Methods:** We utilized the precision nuclear run-on assay (PRO-seq) to characterize the location of mtRNAP in cultured human fibroblasts and RPTECs. We assessed ATP production using the extracellular flux assay and quantified transporter function in RPTECs by measuring transport of a glucose analog (2-NBDG).

**Results:** Using fibroblasts from different individuals, we identified over 400 locations where mtRNAP pauses at precise locations on mtDNA. These brief stops occur most often after mtRNAP has transcribed through guanine-rich regions predicted to form G4 structures. We experimentally validated G4 formation at sites where mtRNAP pauses and show that G4-stabilization with a small-molecule (RHPS4) results in more mtRNAP pausing, impaired transcription, and decreased ATP production. As RPTECs are dependent on ATP from oxidative phosphorylation to drive solute reabsorption, we asked if impaired mitochondrial transcription affects transporter function. Using differentiated RPTECs grown on transwells, we show treatment with RHPS4 results in significantly decreased glucose transport.

**Conclusions:** Mitochondria dysfunction is implicated in acute and chronic kidney disease. The results presented here demonstrate that G4 regulate pausing of mtRNAP and that stabilization of G4s impedes mitochondrial transcription, compromises oxidative phosphorylation, and impairs proximal tubule function. In kidney disease, the role of G4-mediated mitochondria dysfunction warrants further study.

**Funding:** Other NIH Support - NIEHS, Private Foundation Support

### TH-PO309

#### The AE4 (Slc4a9) Transporter Is Essential for Renal Acid-Base Sensing

Helga Vitzthum,<sup>1</sup> Mirjam Koch,<sup>1</sup> Leya Eckermann,<sup>1</sup> Samuel L. Svendsen,<sup>2</sup> Peder Berg,<sup>2</sup> Kimberley Dreger,<sup>1</sup> Christian A. Hübner,<sup>4</sup> Carsten A. Wagner,<sup>3</sup> Jens G. Leipziger,<sup>2</sup> Catherine Meyer-Schwesinger,<sup>1</sup> Heimo Ehmke.<sup>1</sup>  
<sup>1</sup>Universitätsklinikum Hamburg-Eppendorf Zentrum für Experimentelle Medizin, Hamburg, Germany; <sup>2</sup>Aarhus University, Department of Biomedicine, Aarhus, Denmark; <sup>3</sup>University of Zurich and National Center of Competence in Research NCCR Kidney, Zurich, Switzerland; <sup>4</sup>University Hospital Jena Institute of Human Genetics, Jena, Germany.

**Background:** Renal acid (H<sup>+</sup>) and base (HCO<sub>3</sub><sup>-</sup>) secretion into the urine rapidly change upon systemic acid-base imbalances. Central for this task are specialized cells in the distal nephron, the  $\alpha$ - and  $\beta$ -intercalated cells (ICs). How these cells sense acid-base disturbances is a long-standing question. Interestingly, the base secreting  $\beta$ -ICs almost exclusively express the Na<sup>+</sup>-dependent Cl<sup>-</sup>/HCO<sub>3</sub><sup>-</sup> exchanger AE4 (Slc4a9). AE4 is considered to play an important role in the maintenance of salt-water balance. This proposed function could not be confirmed in our analyses of AE4 knockout mice. Here we analyzed whether the AE4 is involved in the regulation of pendrin-dependent HCO<sub>3</sub><sup>-</sup> secretion in  $\beta$ -ICs upon base or acid loading.

**Methods:** Ae4 knockout mice (*Slc4a9*<sup>-/-</sup>) and wild-type littermates (*Slc4a9*<sup>+/+</sup>) received a normal or salt deficient diet for up to 7 days combined with an oral alkali or acid loading. The acid-base status, renal abundance and subcellular distribution of pendrin and Ae4, and activity of pendrin were analyzed.



**Results:** Wild-type mice elicited a proper response to alkali loading, characterized by an increase of pendrin mRNA and protein abundance, a shift of pendrin to the apical membrane, an enhanced pendrin activity in  $\beta$ -ICs, and an elevated urinary  $\text{HCO}_3^-$  excretion. Upon acid loading both, Ae4 and pendrin abundance were reduced in wild-type mice. In contrast, Ae4 knockout mice failed to initiate any change of pendrin abundance or subcellular distribution upon base or acid loading. The failure to adapt pendrin activity and urinary  $\text{HCO}_3^-$  secretion upon base loading culminated in severe metabolic alkalosis under salt restricted conditions.

**Conclusions:** The basolateral transporter Ae4 is an essential part of the renal sensing mechanism for changes in acid-base status, and an insufficient function of Ae4 precludes the proper reaction of  $\beta$ -ICs to alkalosis or acidosis.

#### TH-PO310

##### The Proximal Tubule Regulates Collecting Duct Phenotypic and Remodeling Responses to Acidosis

Hyun-Wook Lee,<sup>1</sup> Jill W. Verlander,<sup>1</sup> Susan M. Wall,<sup>2</sup> Autumn N. Harris,<sup>3</sup> I. D. Weiner.<sup>1,4</sup> <sup>1</sup>University of Florida College of Medicine, Gainesville, FL; <sup>2</sup>Emory University, Atlanta, GA; <sup>3</sup>University of Florida College of Veterinary Medicine, Gainesville, FL; <sup>4</sup>North Florida/South Georgia Veterans Health System, Gainesville, FL.

**Background:** The collecting duct responds to acidosis with several phenotypic and remodeling responses that increase net acid excretion. The current studies examine whether the proximal tubule (PT) regulates these collecting duct responses.

**Methods:** We examined mice with deletion of proteins present only in the PT, either the A variant or both A and B variants of the electrogenic Na-bicarbonate cotransporter, isoform 1 (NBCe1). These deletions disrupt PT bicarbonate, ammonia, and citrate responses to acidosis. We then quantified the collecting duct phenotypic responses to the spontaneous metabolic acidosis that was spontaneously present and the remodeling responses to exogenous acid loading. 2-oxoglutarate was measured using H-NMR.

**Results:** Both NBCe1-A KO and combined renal NBCe1-A/B KO caused severe metabolic acidosis. In NBCe1-A KO mice, despite this acidosis, Type-A intercalated cells in the inner stripe of the outer medulla (ISOM) exhibited decreased height and reduced H-ATPase, anion exchanger 1, Rhesus B glycoprotein, and Rhesus C glycoprotein expression. Similar findings were present in mice with combined kidney-specific NBCe1-A/B deletion. Pendrin expression in non-A, non-B intercalated cells and in Type B intercalated cells was not altered by NBCe1-A KO despite the associated acidosis. Ultrastructural analysis showed decreased apical plasma membrane and increased vesicular H-ATPase in the ISOM Type-A intercalated cell in NBCe1-A KO mice. The collecting duct remodeling response to acidosis was also disrupted by PT NBCe1 deletion. In WT mice, acid-loading increased the proportion of Type-A intercalated cells in the connecting tubule and the ISOM, and it decreased the proportion of non-A, non-B intercalated cells and Type-B intercalated cells in the CNT and cortical collecting duct, respectively. These changes were absent in NBCe1-A KO mice. Urinary 2-oxoglutarate, which can alter intercalated cell function, did not differ significantly between WT and KO mice, either under basal conditions or after acid-loading.

**Conclusions:** Collecting duct phenotypic characteristics and remodeling responses to acidosis depend on intact proximal tubule acid-base responsiveness in two different genetic models. We conclude that proximal tubule-dependent signaling mechanisms are a major determinant of the collecting duct responses to metabolic acidosis.

**Funding:** NIDDK Support

#### TH-PO311

##### Glycosuria in Tubule-Specific mTORC2 Knockout Mice Resolves on a High Potassium Diet

John E. Demko, Bidisha Saha, Enzo Takagi, Anna D. Manis, David Pearce. University of California San Francisco, San Francisco, CA.

**Background:** Insulin signaling promotes proximal tubule glucose transport and suppresses gluconeogenesis (GNG). An important feature of proximal tubule GNG is dual regulation by insulin and pH. The kinase mTORC2 is known to be regulated by insulin signaling in multiple cell types, but its mechanistic role in proximal tubule glucose homeostasis is unknown.

**Methods:** Rictor is a critical component of the mTORC2 complex. Tubule-specific Rictor KO mice (TRKO) were generated using doxycycline inducible Pax8-Cre Rictor<sup>fl</sup>. Mice were adapted to 1% K<sup>+</sup> diet and then switched to either a 0.5% K<sup>+</sup> or 3% K<sup>+</sup> diet for 2 days. An additional cohort of mice were maintained on a 0.5% K<sup>+</sup> diet for 2 weeks for glucose (1g/kg), insulin (0.75U/kg), and pyruvate (2g/kg) tolerance testing after overnight fasts. Renal function, serum glucose, and urine glucose were measured in metabolic cages during the last 24 hours of all experiments. Proteins were measured via Western blot from whole kidneys.

**Results:** TRKO mice on a 0.5% K<sup>+</sup> diet had urinary glucose of 470±96.7mg/dL (n=5) and control mice had 30.0±7.98mg/dL (n=7; p<0.001). After 12 hours (n=3 per group) and 2 days (n=6 per group) on a 3% K<sup>+</sup> diet, there was no significant difference in urinary glucose between TRKO and control mice. TRKO mice on a 3% K<sup>+</sup> diet also developed hyperkalemia and elevated BUN after 2 days. There were no differences in serum glucose during glucose and insulin tolerance tests between groups at any timepoint. Serum glucose during pyruvate tolerance test was higher in TRKO mice compared to controls (n=6 per group) at 90 (194 vs 149mg/dL; p<0.01) and 120 minutes (182 vs 150mg/dL; p<0.05). There was no difference in PEPCK, plasma membrane SGLT2 or GLUT2 abundance between TRKO and control mice after 2 days on either 0.5% or 3% K<sup>+</sup> diets.

**Conclusions:** This study demonstrates the importance of mTORC2 in glucose handling and metabolism by the renal tubules. Increased serum glucose during pyruvate tolerance testing in TRKO mice suggests increased GNG, likely because mTORC2 KO impairs insulin signaling and fails to suppress renal GNG. The resolution of glycosuria in TRKO mice on a 3% K<sup>+</sup> diet may be due to mTORC2-independent suppression of GNG by K<sup>+</sup> and merits further investigation. Future studies will focus on identifying the molecular defect causing increased GNG in TRKO mice, and the basis for glycosuria suppression by K<sup>+</sup>.

**Funding:** NIDDK Support

#### TH-PO312

##### NBCe1-B/C Knockout Mice Exhibit an Impaired Respiratory Response to Metabolic Acidosis Resulting in Increased Ammonia Excretion

Clayton Brady, Mark Parker. University at Buffalo Jacobs School of Medicine and Biomedical Sciences, Buffalo, NY.

**Background:** Sodium-bicarbonate cotransporter variants NBCe1-B and NBCe1-C (NBCe1-B/C) are expressed in the brainstem while variants NBCe1-A and NBCe1-B are expressed in the proximal tubule. NBCe1-A is the primary renal variant and is important to the kidney response to metabolic acidosis (MAc). Less understood is the role of NBCe1-B/C, but they are thought to play a role in both the respiratory and renal responses to MAc. We tested this hypothesis in NBCe1-B/C knockout (KO<sub>NBCe1</sub>) mice.

**Methods:** We validated an NBCe1-B/C specific antibody and used it to confirm the presence/absence of NBCe1-B in the kidney and NBCe1-B/C in the brainstem of WT and KO<sub>NBCe1</sub> mice. MAc was induced by adding 0.5% sucrose + 0.28M NH<sub>4</sub>Cl to drinking water. The abundance response of kidney NBCe1-B to MAc was quantified in WT mice by western blot. To assess the effect of MAc on acid-base status, WT and KO<sub>NBCe1</sub> mice were subjected to control (0.5% sucrose in drinking water) or MAc conditions for 1-3 days followed by cardiac puncture and blood-gas/electrolyte analysis. 24-hour urine collections were assessed for ammonia excretion, titratable acid (TA) excretion, and pH. The respiratory response was assessed using whole-body plethysmography, with WT and KO<sub>NBCe1</sub> mice assessed each day of a 3-day MAc-challenge.

**Results:** After 3-days of MAc, NBCe1-B kidney abundance was 3.6x that of controls in WT mice, supporting evidence of a role for NBCe1-B in the kidney during MAc. Surprisingly, however, KO<sub>NBCe1</sub> mice had a greater recovery in plasma [HCO<sub>3</sub><sup>-</sup>] and higher pCO<sub>2</sub> levels, but a similar recovery in plasma pH to WT mice. This was associated with a greater increase in ammonia excretion in KO<sub>NBCe1</sub> males but not females, whereas there were no differences in changes in TA excretion or urine pH between WT and KO<sub>NBCe1</sub> mice. In regards to the respiratory response, over the 3-day MAc challenge WT mice exhibited a maximum increase in minute volume of 10% whereas in KO<sub>NBCe1</sub> mice minute volume did not significantly change.

**Conclusions:** The impaired respiratory response to MAc in KO<sub>NBCe1</sub> mice leads to elevated ammonia excretion and a greater recovery in plasma [HCO<sub>3</sub><sup>-</sup>]. We suggest this is because, although normally the respiratory response to MAc lowers pCO<sub>2</sub> in order to help maintain plasma pH, this decrease in pCO<sub>2</sub> also has an inhibitory effect on renal ammoniogenesis.

**Funding:** NIDDK Support, Other NIH Support - NEI R01-EY028580

#### TH-PO313

##### Abstract Withdrawn

#### TH-PO314

##### Generation of a ATP6V1G3-Cre Mice With High Kidney Intercalated Cell Specificity

Vijay Saxena, Samuel Arregui, David S. Hains, Andrew L. Schwaderer. Indiana University School of Medicine, Indianapolis, IN.

**Background:** The kidney collecting duct is composed of principal cells (PCs) and intercalated cells (ICs). Principal cells maintain sodium and water balance while intercalated cells maintain acid-base homeostasis. Recent studies have shown that ICs are the critical cells to defend against uropathogen invasion. For focused studies of IC cells, a novel *Atp6v1b1*-Cre (B1-Cre) mice (generated by Dr. Raoul Nelson group) were crossed with *TdTomato-flox* mice to enrich ICs from kidney. B1-Cre mice strain is very useful for enriching ICs from kidney, we noticed that they also labeled kidney resident CD45<sup>+</sup> immune cells hence limiting their use for enrichment and gene expression studies. Additionally, *Atp6v1b1* is expressed in a range of tissues including the lung, brain, pancreas, skin and gastrointestinal tract. Here we report the generation of *Atp6v1g3*-Cre mice using CRISPR/CAS technology which labels kidney ICs without any expression on kidney resident immune cells and minimal extra kidney expression.

**Methods:** To generate the mouse, a CRISPR targeting site, *Atp6v1g3* gRNA 76/59 in intron 1 nearby the 3' end of exon 1 with acceptable predicted efficiency and specificity was designed. A T2A-cre-PolyA cassette was inserted into exon1 by CRISPR/Homology directed repair (HDR) strategy. The resulting transcript under the control of endogenous *Atp6v1g3* promoter express a short peptide (27aa of *Atp6v1g3* N terminal and 17aa of T2A) and the Cre recombinase. CRISPR/cas9 gRNA was injected to the zygotes of pronuclei of fertilized eggs and F0 progeny was generated. F0 progeny mice were genotyped by Real-Time PCR (RT-PCR) for G3-Cre expression and bred to wild type C57BL/6 mice to maintain colony of mice.

**Results:** *Atp6v1g3-Cre* were crossed with *TdTomato<sup>flax/flax</sup>* mice to generate *Atp6v1g3-Cre<sup>+/+</sup>/TdTomato<sup>flax/flax</sup>* mice. ICs were flowsorted and their relative enrichment was confirmed by RT-PCR. *TdTomato* expression was analyzed on Flowcytometer and immunofluorescence which revealed expression on ICs but not on CD45<sup>+</sup> immune cells along with minimal extra kidney expression in various tissues as examined by immunofluorescence and RT-PCR.

**Conclusions:** The *Atp6v1g3-Cre* mouse will be a useful tool for kidney IC specific studies.

**Funding:** NIDDK Support

### TH-PO315

#### Stable Transduction of Recombinant NHERF1 Protein in Opossum Kidney Cells

**Kenneth B. Gagnon,<sup>1</sup> Madhavi J. Rane,<sup>2</sup> Eleanor D. Lederer.<sup>1,3</sup>** <sup>1</sup>The University of Texas Southwestern Medical Center, Dallas, TX; <sup>2</sup>University of Louisville School of Medicine, Louisville, KY; <sup>3</sup>VA North Texas Health Care System, Dallas, TX.

**Background:** NHERF1 (Na<sup>+</sup>-hydrogen exchanger regulatory factor isoform 1) is a cytoplasmic scaffolding protein containing two internal postsynaptic density 95/disc large/zona occludens binding domains and a carboxy-terminal ezrin-binding domain. NHERF1 anchors the Na<sup>+</sup>-dependent phosphate cotransporter type IIa (Npt2a) in the brush border membrane of proximal tubules through its cross-linking of Npt2a with the actin-filament binding protein, Ezrin. The opossum kidney (OK) cell line, originally derived from a female Virginia Opossum (*Virginia delphi*), has been extensively used as a model of proximal tubular epithelia. A sub-clone of the OK cell line (OK-H) expresses low levels of endogenous NHERF1 and lacks PTH-mediated inhibition of sodium-dependent phosphate uptake.

**Methods:** We PCR cloned full-length mouse NHERF1 into a bacterial expression vector and transformed BL21 *E. coli* to over-express the HIS-tagged recombinant NHERF1 (rmNHERF1) protein. We purified rmNHERF1 utilizing the upstream poly-histidine tag and immobilized metal affinity chromatography. We added purified rmNHERF1 to OK-H cells at different concentrations and time points to assess the *in vitro* stability of the recombinant protein by SDS-PAGE and immunoblotting. We also transduced OK-H cells with rmNHERF1 for 4 and 24 h and measured radiolabeled phosphate uptake compared to non-transduced OK-H cells.

**Results:** Immunoblotting whole cell lysates transduced with rmNHERF1 for 4 h with both an anti-HIS and an anti-NHERF1 antibody demonstrate a significant dose-dependent increase in rmNHERF1 expression in OK-H cells. Similarly, OK-H cells transduced with rmNHERF1 for 4, 8, 24, and 48 h demonstrates stable temporal expression of the recombinant protein with minimal lysosomal degradation. We also detected Npt2a expression in transduced OK-H cells compared to non-transduced controls. Radiolabeled phosphate uptake of OK-H cells transduced with rmNHERF1 for 4 h and 24 h did not produce a significant increase in phosphate uptake.

**Conclusions:** We have demonstrated the stable introduction of recombinant mouse NHERF1 protein in NHERF1-deficient opossum kidney cells with a resulting increase in Npt2a expression but not concurrent increase in phosphate uptake activity suggesting that the recombinant fusion protein may be inert or trapped within an intracellular vesicle following endocytic transduction.

**Funding:** Veterans Affairs Support

### TH-PO316

#### Kidney Function Differs Between 4.5-Month Virgin and 12-Month Breeder Female Sprague Dawley Rats

**Timothy M. Reilly,<sup>1</sup> Donna Ralph,<sup>1</sup> Brandon E. McFarlin,<sup>1</sup> Aurelie Edwards,<sup>2</sup> Alicia A. McDonough.<sup>1</sup>** <sup>1</sup>University of Southern California Keck School of Medicine, Los Angeles, CA; <sup>2</sup>Boston University, Boston, MA.

**Background:** Most studies of experimental hypertension and kidney disease are conducted in young virgin rodents, whereas human diseases are often associated with mid-life, suggesting that studies in older animals may offer translational advantages.

**Methods:** To assess age-based differences, we compared kidney function in virgin female (F) rats at 4.5 mo (240 gm), equivalent to 18-20 yr old humans, to 12 mo female breeders (320 gm), equivalent to 40 yr humans (n=6/group).

**Results:** Body, kidney and heart weights, as well as GFR (FITC sinistrin) were increased 30% between 4.5 and 12 mo. During 3 hr after a saline volume challenge, 4.5 mo F excreted twice the %Na and volume injected as 12 mo F. Responses to a 2% K<sub>meat</sub> were equivalent in 4.5 and 12 mo F. Baseline lithium clearance fell ~25% (P=0.05) between 4.5 and 12 mo. Abundance of transporters, channels, and claudins varied along the nephron (Fig 1, \*P<0.05). SGLT1 (not SGLT2) and AQP2 phosphorylation increased 50% between 4.5 and 12 mo. Sodium pump (NKA) subunits were lower by ~50% in 12 mo vs 4.5 mo, paralleled by ~25% lower K-pNPPase activity in both cortex and medulla at 12 mo indicating changes in kidney energetics with age. NKCC2 and NCC phosphorylation decreased between 4.5 and 12 mo, however, diuretic tests with thiazides and furosemide were not depressed in parallel, perhaps reflecting impact of tubular flow and/or renal energetics.

**Conclusions:** Kidney function is significantly different in adult (12 mo) vs young (4.5 mo) F rats suggesting that middle aged rats may be more appropriate for (patho) physiology studies.

**Funding:** NIDDK Support

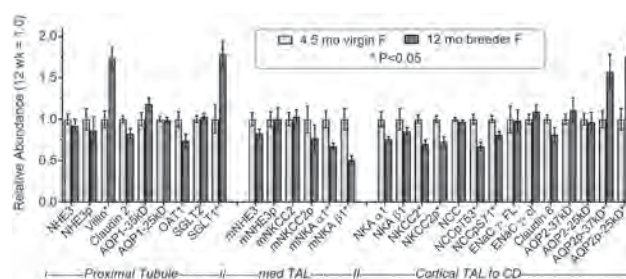

### TH-PO317

#### FOX11 Promotes Expression of V-ATPase and Gpr116 in M1 Cells

**Mackenzie Kui, Jennifer L. Pluznick, Nathan Zaidman.** Johns Hopkins Medicine, Baltimore, MD.

**Background:** G protein-coupled receptors (GPCRs) are a diverse family of integral membrane proteins. We previously reported that GPR116 (ADGRF5), an adhesion-class GPCR, is a critical regulator of vacuolar-type H<sup>+</sup>-ATPase (V-ATPase) surface expression in A-type intercalated cells (AICs) in mouse kidney cortical collecting ducts. The V-ATPase is a multi-subunit proton pump that localizes to the plasma membrane in specialized acid-secreting epithelial cells. FOX11 is a transcription factor that regulates V-ATPase expression in ICs and other mitochondria-rich cells. Recently, FOX11 was identified as a key regulator of CFTR-rich pulmonary ionocytes which express both V-ATPase and GPR116. We hypothesized that GPR116 is transcriptionally regulated by FOX11 in ICs.

**Methods:** We cloned FOX11 from whole mouse kidney into an expression vector (pFOX11), transfected it into the immortalized M1 mouse collecting duct cell line, and assessed changes. We localized FOX11 by RNAScope *in situ* hybridization.

**Results:** Transfection with pFOX11 increased expression (qRT-PCR) of GPR116 in M1 cells (N=3, CT±SD: pFOX11=33.1±1.3, mock=38.4±1.4), but not HEK293 cells. GPR116 transcripts co-localize in pFOX11 transfected M1 cells, as well as mouse collecting ducts, as determined by RNAScope. Furthermore, pFOX11 upregulates transcripts of several V-ATPase subunits in M1 cells, including ATP6V1B1 (N=3, CT±SD: pFOX11=32.9±1.5, mock=undetected), ATP6V1G3 (pFOX11=30.2±0.6, mock=undetected), and ATP6V0D2 (pFOX11=31.6±0.3, mock=37.7±2.0). Surprisingly, ATP6V0A4 was not sensitive to transfection with pFOX11 (pFOX11=34.3±0.7, mock=34.7±1.1). Immunofluorescence microscopy revealed cytoplasmic localization of V-ATPase (β1/2 antibody) in FOX11-expressing M1 cells. No V-ATPase protein is detected by microscopy in mock transfected M1 cells. Additionally, transfection with pFOX11 caused an increase in SLC4A9 (pFOX11=33.5±1.1, mock=undetected), SLC26A4 (pFOX11=33.2±1.0, mock=36.0±0.6) and GPR110 (pFOX11=36.9±2.7, mock=undetected). AQP6, CAR2, and CLCN5 transcripts are not sensitive to pFOX11 in M1 cells, and SLC4A1 is not detected.

**Conclusions:** FOX11 upregulates GPR116 and V-ATPase in M1 cells, generating IC-like cells *in vitro*. FOX11 is also a transcriptional regulator of GPR110 (ADGRF1), an adhesion GPCR similar to GPR116. Finally, GPR116 may be a universal and genetically coded regulator of V-ATPase surface expression in FOX11-positive cells.

**Funding:** NIDDK Support

### TH-PO318

#### PKA Regulates the WNK-SPAK-NCC/NKCC2 Signaling Pathway Through Phosphorylation of WNK4 and I-1

**Hector Carbajal-Contreras,<sup>1,2</sup> Adrian R. Murillo-de-Ozores,<sup>1,2</sup> German R. Magaña,<sup>1,2</sup> Laurent Bourqui,<sup>3</sup> Norma H. Vázquez,<sup>1,2</sup> Johannes Löffing,<sup>3</sup> Gerardo Gamba,<sup>1,2</sup> Maria Castañeda-Bueno.<sup>1,2</sup>** <sup>1</sup>Unidad de Fisiología Molecular <sup>1</sup>Universidad Nacional Autónoma de México, Ciudad de México, México; <sup>2</sup>Instituto Nacional de Ciencias Médicas y Nutrición Salvador Zubiran, Ciudad de México, México; <sup>3</sup>Universitat Zurich, Zurich, Switzerland.

**Background:** We have previously shown that vasopressin signaling in the kidney increases the phosphorylation of the Na<sup>+</sup>-Cl<sup>-</sup> cotransporter (NCC) and the Na<sup>+</sup>-K<sup>+</sup>-Cl<sup>-</sup> cotransporter 2 (NKCC2) through an increase in the phosphorylation of WNK4's RRxS motifs. Previous work has also highlighted the importance of Inhibitor-1 (I-1) and protein phosphatase 1 (PP1) in the regulation of these transporters' phosphorylation in response to cAMP. Since WNK4, SPAK and NCC/NKCC2 have all been linked to PP1-mediated dephosphorylation, we sought to dissect the individual importance of each component in this proposed pathway.

**Methods:** We transfected HEK293 cells with NKCC2, NCC, PP1, I-1, SPAK, WT WNK4 or a WNK4 mutant which lacks a *bona fide* PP1-binding site (WNK4 PP1b) in distinct combinations. Cells were stimulated with 30 nM forskolin for 30 minutes. Protein extracts were subjected to immunoblot to assess the abundance of these proteins and their phosphorylated forms. Immunoprecipitation was carried out in order to assess pNCC and pNKCC2.

**Results:** We found an increase in pSPAK with forskolin exclusively in the presence of WNK4. While the presence of I-1 by itself is not sufficient to upregulate pSPAK in cells lacking WNK4, it increases the dynamic range of SPAK phosphorylation in the presence of WT WNK4. WNK4 PP1b is highly active at baseline and can be further phosphorylated and activated with forskolin, but is not phosphorylated to a greater degree in the presence of I-1. NKCC2's phosphorylation is decreased with the cotransfection of PP1 and can be regulated by forskolin in the presence of I-1, independently of WNK-SPAK upregulation.

Key: TH - Thursday; FR - Friday; SA - Saturday; OR - Oral; PO - Poster; PUB - Publication Only

Underline represents presenting author.

The addition of WNK4 and I-1 to NKCC2-expressing cells further increased the dynamic range of pNKCC2 regulation by forskolin. pNCC was not increased by forskolin with I-1 alone, but was upregulated in the presence of WNK4.

**Conclusions:** WNK4 is a node in cAMP signaling where kinase and phosphatase signaling converge in the modulation of its phosphorylation-dephosphorylation balance. NKCC2 and NCC show distinct regulatory patterns by PP1, which hints towards specific regulatory mechanisms for each transporter. These findings add to the understanding of the transduction of cAMP signaling in the kidney in response to hormones such as ADH, PTH and epinephrine.

#### TH-PO319

##### Burmese Cat Mutation, the C-Terminus-Truncated WNK4, Diminishes NCC Activation by Potassium Depletion

Xiao-Tong Su,<sup>1</sup> Hector Carbajal-Contreras,<sup>2</sup> Maria Castañeda-Bueno,<sup>2</sup> Avika Sharma,<sup>1</sup> Gerardo Gamba,<sup>2</sup> Eric J. Delpire,<sup>3</sup> Chao-Ling Yang,<sup>1</sup> David H. Ellison.<sup>1</sup> <sup>1</sup>Oregon Health & Science University, Portland, OR; <sup>2</sup>Instituto Nacional de Ciencias Médicas y Nutrición Salvador Zubirán, Mexico City, Mexico; <sup>3</sup>Vanderbilt University, Nashville, TN.

**Background:** The Na-Cl cotransporter (NCC) in the distal convoluted tubule (DCT) plays an important role in regulating renal potassium (K) excretion by controlling sodium delivery to the distal nephron. NCC is inhibited when K intake is high and activated when K intake is low to modulate K excretion. WNKs (with-no-lysine kinases, mainly WNK1 and WNK4 in DCT) phosphorylate and activate SPAK (SPS1-related proline/alanine-rich kinase), which stimulates NCC phosphorylation and activation. An autosomal recessive mutation in Burmese cats, a popular pet breed, leads to hypokalemia. This mutation is responsible for a premature WNK4 protein truncation lacking the C-terminus, which contains a WNK/WNK interaction domain, SPAK binding motif and several phosphorylation sites. Here, we tested whether this mutation inhibits NCC activity by abrogating WNK activity *in vivo* and *in vitro*.

**Methods:** The Burmese cat mutation was introduced to create Burmese cat mouse line using CRISPR. Control and Burmese cat mice were treated with either control (NK) or low K (LK) diet for 7 days and blood and kidney were harvested.

**Results:** Burmese cat mice do not have any phenotype in blood chemistry at baseline. Yet, when challenged with LK diet for 7 days, they showed obvious hypokalemia (2.8 mM). Total and phospho-NCC were reduced in Burmese cat mice at baseline, and LK induced an increase in pNCC. Yet, the expression level was still lower than that in the control mice. WNK4 can be observed within WNK bodies in control mice on LK diet; whereas it is present within WNK bodies in Burmese cat mice on both NK and LK diets. Immunofluorescence showed less apical pS383- and pT243-SPAK, but more pS383-SPAK within WNK bodies in Burmese cat mice. WNK1/KS-WNK1 is not visible in control mice on both diets but is more evident within WNK bodies in Burmese cat mice. When the truncated WNK4 was transfected into HEK293 cells, direct WNK4-SPAK interaction was abolished. Thus, preserved WNK-WNK interaction may be responsible for the recruitment and phosphorylation of SPAK in WNK bodies.

**Conclusions:** Hypokalemia in Burmese cats results from defective NCC function, as the WNK4 C-terminus is crucial for SPAK-mediated effects. Loss of function in WNK4 leads to a compensatory increase in WNK1/KS-WNK1 WNK body formation.

**Funding:** NIDDK Support, Veterans Affairs Support

#### TH-PO320

##### Dietary Potassium Restriction Activates a Proliferative Cell Population to Remodel the Distal Convoluted Tubule

Xiao-Tong Su, Ryan J. Cornelius, James A. McCormick, Chao-Ling Yang, David H. Ellison, Jonathan W. Nelson. Oregon Health & Science University, Portland, OR.

**Background:** Low dietary K intake has adverse health effects. Dietary K restriction rapidly activates a *potassium switch* in the distal nephron to maintain homeostasis by reducing K excretion at the expense of sodium retention. When prolonged, dietary K stress leads to profound remodeling of distal convoluted tubule (DCT), making chronic adaptation largely structural. Knepper and colleagues recently described a unique cell population in the DCT that expresses proliferative markers. Here, we tested whether dietary K restriction activates this population rapidly, and plays a central role in chronic K balance.

**Methods:** Female NCC (Na-Cl cotransporter)-Cre-INTACT (Isolation of Nuclei Tagged in specific Cell Types, which fluorescently labels nuclei) mice were provided either control (NK) or K deficient (KD) diet for 4 days and kidneys were harvested for targeted single-nucleus RNA-seq (NovaSeq) (3 mice per diet).

**Results:** Unbiased clustering and UMAP visualization revealed 12 clusters, with most cells from the DCT (78%) indicating the success of the enrichment process. Among those, 70% were from DCT1 and 30% from DCT2. There was a small population (<1%) enriched in proliferation-related genes, such as *Top2a*, *Cenpp*, and *Mki67*. KD resulted in a 6-fold increase in the number of proliferating cells. To determine the origin of this population, we performed trajectory analysis, which allows us to order each cell according to its progress along a learned trajectory, expressed as Pseudotime, to indicate the distance between a cell and trajectory start. This analysis indicated that the proliferating population arises from DCT1 cells. Four-day KD treatment also decreased the *Enac* (*Scnn1g*) and *kallikrein* (*Klk1*) expression in DCT2, indicating that some DCT2 cells may reprogram to retain potassium in response to the short-term KD. We have shown previously that KD increases calciuresis; here, KD also decreased expression of calcium-handling genes, such as *Slc8a1*, *Calb* and *Vdr*.

**Conclusions:** Our results suggest that a unique population of cells originating from DCT1 has the potential to proliferate during KD leading to remodeling. DCT cells also reprogram transcriptionally to maintain electrolyte balance, likely contributing to the adverse effects of low potassium intake.

**Funding:** NIDDK Support, Veterans Affairs Support

#### TH-PO321

##### Maintaining Potassium Balance on the High-Potassium Alkaline Diet via Proximal Tubule RAS-Stimulated Sodium Delivery

Bangchen Wang,<sup>1</sup> Jun Wang-France,<sup>2</sup> Steven C. Sansom.<sup>2</sup> <sup>1</sup>Duke University Health System, Durham, NC; <sup>2</sup>University of Nebraska Medical Center, Omaha, NE.

**Background:** The angiotensin II (ANGII) activated WNK4-SPAK pathway regulates the Na, Cl cotransporter (NCC) in the distal convoluted tubule (DCT) to control the Na delivered to the connecting tubule (CNT) and cortical collecting duct (CCD), where it stimulates K secretion as a mechanism to maintain K balance (3.6 mM < P[K] < 5.5 mM). We previously found that K balance was maintained in mice given a 5% K diet that was accompanied by alkaline loading anions (HK) but not by acid-loading anions (HK-Cl). We designed these experiments to determine whether HK enhances Na delivery as a mechanism to stimulate K secretion and whether ROMK and ANGII were involved in this process.

**Methods:** Wild type (WT), ROMK knockout (ROMK-KO), liver angiotensinogen II knockout (LKO), and liver plus proximal tubule angiotensinogen double knockout mice (DKO) were given either a high K diet with alkaline loading anions (HK; 5% K-citrate/carbonate/Cl) or a high K diet with acid loading anions (HK-Cl; 5% KCl) and placed in metabolic cages for 6 days. Glomerular filtration rate (GFR) was determined by FITC-inulin. Urine and plasma [Na] and [K] were determined by flame photometry. Urine pH was determined by a Mettler Toledo pH meter. The AT2 agonist, compound 21 (C21) was given to a group of DKO mice at 5 mg/Kg/min for 6 days.

**Results:** When WT were given HK (n=13) and HK-Cl (n=15), the respective means  $\pm$ SEM of urine pH were 8.40  $\pm$ 0.52 and 5.68  $\pm$ 0.49, P[K] were 4.62 mM  $\pm$ 0.16 and 5.72  $\pm$ 0.30 mM, and rates of Na excretion (UNaV; mmole/day) were 428.8  $\pm$ 29.6 and 289.3  $\pm$ 22.7. GFR was not significantly different between HK (370.8  $\pm$ 20.2 ml/day; n=6) and HK-Cl (419.9  $\pm$ 19.7 ml/day; n=5). When ROMK-KO was given HK (n=9) and HK-Cl (n=7), the P[K] was 5.15  $\pm$ 0.17 mM and 6.37  $\pm$ 0.35 mM, respectively and the UNaV was 308.2  $\pm$ 20.2 and 194.2  $\pm$ 12.0, respectively. When given HK, LKO (P[K] = 4.52  $\pm$ 0.11 mM, n=4), but not DKO (P[K] = 7.0  $\pm$ 1.0 mM, n=4), maintained K balance. C21 restored K balance in DKO on HK (P[K] = 4.28  $\pm$ 0.25 mM, n=3) and increased UNaV from 177.8  $\pm$ 25.3 to 326.9  $\pm$ 58.6 (n=3).

**Conclusions:** These results show that: 1. The thick ascending limb and ROMK were not involved in the ability of HK mice to enhance Na delivery and maintain K balance. 2. For HK mice, PT-generated ANGII, via AT2 receptors, enhances Na delivery to the CNT and CCD to stimulate K secretion and maintain K balance.

**Funding:** NIDDK Support

#### TH-PO322

##### GDF15 Is Necessary for the Physiological Adaptation to Hypokalemia

Samia Lasaad,<sup>1,2</sup> Christine Walter Lamouroux,<sup>1,2</sup> Chloe Rafael,<sup>1,2</sup> Luciana Morla,<sup>1,2</sup> Alain Doucet,<sup>1,2</sup> Nicolas Picard,<sup>4</sup> Anne Blanchard,<sup>1,3</sup> Gilles Crambert,<sup>1,2</sup> Lydie Cheval.<sup>1,2</sup> <sup>1</sup>Centre de Recherche des Cordeliers, INSERM, Sorbonne Université, Université Paris Cité, Laboratoire de Physiologie Rénale et Tubulopathies, Paris, France; <sup>2</sup>CNRS EMR 8228 – Unité Métabolisme et Physiologie Rénale, Paris, France; <sup>3</sup>Assistance Publique Hôpitaux de Paris, Hôpital Européen Georges Pompidou, Centre d'Investigation Clinique, Paris, France; <sup>4</sup>Laboratory of Tissue Biology and Therapeutic Engineering, UMR 5305 CNRS, University Lyon 1, Lyon, France.

**Background:** Population in industrialized countries consume less potassium (K<sup>+</sup>) than recommended and this may, in the long term, contribute to the development of cardiovascular pathologies. To face a K<sup>+</sup> restriction, and avoid hypokalemia two synergistic mechanisms are induced by our organism. The external regulation adapting the renal and fecal excretion of K<sup>+</sup> to the intake and the internal regulation controlling the storage or release of K<sup>+</sup> from cellular compartment (muscle). The kidney adapts its function to retain K<sup>+</sup> by increasing the number of type-A intercalated cells (ICA). A transcriptomic analysis, we published a few years ago, revealed that the TGF $\beta$ -related growth factor GDF15 was upregulated in renal collecting ducts of K<sup>+</sup> depleted animals. We hypothesize that GDF15 may have an impact on both the external and internal balance of K<sup>+</sup> homeostasis and is therefore necessary to the physiological adaptation to hypokalemia.

**Methods:** We used C57BL/6J mice wild type or knockout for the *Gdf15* gene, put on a control or low-K<sup>+</sup> diet. Metabolism cages were used for metabolic analysis. Number of ICA was determined by immunofluorescence on microdissected tubules. Muscle mass was assessed by TD-NMR. Urine samples of healthy human volunteers (HHV), K<sup>+</sup> depleted or not for a week, were collected from a previous study and GDF15 expression was analyzed by ELISA.

**Results:** Under a K<sup>+</sup> depletion we showed: 1/ an increase of *Gdf15* expression along the nephron, mostly in the collecting duct, and in the intestine, plasma and urine of mice, 2/ a relationship between GDF15 levels and K<sup>+</sup> restriction in HHV, 3/ a delayed renal adaptation in GDF15-KO mice, leading to hypokalemia. The adaptation issue is partly explained by the absence of proliferation of ICA. The renal effect of GDF15 depends on the ErbB2 receptor. Finally, we demonstrated that GDF15 also regulates the internal balance by inducing a loss of muscle, releasing K<sup>+</sup> in the plasma.

Key: TH - Thursday; FR - Friday; SA - Saturday; OR - Oral; PO - Poster; PUB - Publication Only

Underline represents presenting author.

**Conclusions:** Altogether, these results demonstrate that GDF15 is a key factor that orchestrates synergistically both the regulation of the internal and external potassium balance.

**Funding:** Government Support - Non-U.S.

### TH-PO323

#### Utilizing Chemogenetic Tools to Study Sodium-Chloride Cotransporter Regulation

Tanner Bradford, Kevin J. Martz, David H. Ellison, Jonathan W. Nelson. *Oregon Health & Science University, Portland, OR.*

**Background:** In the Distal Convoluted Tubule (DCT), sodium balance is primarily determined by the sodium-chloride cotransporter (NCC). When phosphorylated, NCC reabsorbs sodium away from the lumen of the nephron. Dephosphorylation of NCC inactivates the transporter, resulting in increased sodium excretion. A similar effect is leveraged by a class of anti-hypertensive medications called thiazides, which block NCC activity. To determine whether GPCRs play a role in NCC regulation, we implemented a cell-specific chemogenetic approach with Designer Receptors Exclusively Activated by Designer Drugs (DREADDs). DREADDs stimulate GPCR (G-protein-coupled receptor) signaling within a targeted cell and have been previously used to activate neurons through calcium release. We hypothesize that DREADD activation within the DCT will change NCC activity.

**Methods:** We bred DCT-specific inducible Cre Recombinase mice (NCC-creERT2) to conditional Gq-GPCR coupled mice (Gq-DREADD) to create DCT-DREADD mice. First, we performed metabolic cage experiments examining thiazide responses within these animals. Next, we activated Gq-GPCR signaling in DCT cells by intraperitoneal injection of the DREADD-specific agonist deschloroclozapine (DCZ). To confirm that DCZ-induced DREADD activation alters electrolyte handling along the nephron we measured sodium excretion (UNaV) following DCZ administration. To investigate kinetics, we performed a timecourse experiment measuring pNCC from 15 minutes to 24 hours after DREADD activation using western blots.

**Results:** DREADD expression confirmed along the DCT in transgenic mice. DCT-DREADD mice maintain an intact thiazide response before DREADD activation, indicating DREADD expression does not alter DCT function at baseline. Intraperitoneal injection of the DREADD-specific agonist deschloroclozapine (DCZ) reduced NCC phosphorylation by more than 80% within 1 hour, with recovery of pNCC between 4-6 hours in both males and females. Concomitant with the effects on NCC, DCT-DREADD activation increased UNaV by 215% compared to controls.

**Conclusions:** We posit that the chemogenetic activation of DCT leads to a release of intracellular calcium and rapid activation of the phosphatase required for the dephosphorylation of NCC. We are currently using HEK293 cells co-transfected with DREADD and NCC to test various phosphatase inhibitors, to determine the identity of the DREADD-induced phosphatase.

**Funding:** NIDDK Support, Veterans Affairs Support, Private Foundation Support

### TH-PO324

#### Single Tubule RNAseq From Gitelman Syndrome Mice Revealing Magnesium and Calcium Handling in Distal Renal Tubules

Chih-Chien Sung, Yu-Juei Hsu, Chien-Ming Lin, Shih-Hua P. Lin. *Tri-Service General Hospital, National Defense Medical Center, Taipei, Taiwan.*

**Background:** Gitelman syndrome (GS) is characterized by salt-losing hypotension, hypokalemic metabolic alkalosis, hypomagnesemia, and hypocalcemia caused by a specific mutation in the thiazide-sensitive sodium chloride co-transporter (NCC) gene *Slc12a3*. However, magnesium ( $Mg^{2+}$ ) and calcium ( $Ca^{2+}$ ) regulation associated gene in the distal renal tubules remains unclear.

**Methods:** We performed small samples RNA-seq from manual microdissection of distal convoluted tubules (DCTs) in nonsense *Ncc Ser707X (S707X)* homozygous knockin mice (*NccS707X/S707X* mice) ( $n=4$ ) and wild type (WT,  $n=4$ ). Cortical thick ascending limbs of Henle (cTALs), connecting tubule (CNT), cortical collecting duct (CCD) were also microdissected.

**Results:** Among DCT makers, *Slc12a3* (NCC) and *Pvalb* (Parabumin) were significantly downregulated ( $\text{Log}_2\text{TPM}_{S707X/WT}$ : -4.45,  $P=0.0003$ ; -6.888258295,  $P=0.0003$ , respectively).  $Mg^{2+}$  transporters of *Trpm6*, and *Trpm7* gene expression were both significantly downregulated. *Egf* and *Cnm2* have been reported to increase TRPM6 trafficking or activity, were also decreased in DCT segment. Among  $Ca^{2+}$  transporter related genes, *Trpv5* was only slightly increased, but other *Atp2b4*, *Calb1* and *Pvalb* decreased in DCT. Claudins including *Cldn10*, *Cldn16*, and *Cldn19*, involving paracellularly reabsorption of  $Ca^{2+}$  and  $Mg^{2+}$ , were not changed in cTALs.

**Conclusions:** Our small samples RNA-Seq from dissected DCT highlight the possible molecular pathway of hypomagnesemia and hypocalcemia in GS. Inactivation of *Slc12a3* gene may affect the DCT development causing loss of  $Mg^{2+}$  associated transporters. The pathogenesis of hypocalcemia is still complex and needs further experiments to explore.

**Funding:** Government Support - Non-U.S.

### TH-PO325

#### Discovery and Characterization of VU0493206, the First Small-Molecule Activator of Kir4.1/Kir5.1 Channels

Samantha J. Mcclenahan,<sup>1</sup> Elena Isaeva,<sup>2</sup> Christine A. Klemens,<sup>3</sup> Alexander Staruschenko,<sup>3</sup> Jerod S. Denton.<sup>1</sup> <sup>1</sup>Vanderbilt University Medical Center, Nashville, TN; <sup>2</sup>Medical College of Wisconsin, Milwaukee, WI; <sup>3</sup>University of South Florida, Tampa, FL.

**Background:** Heteromeric  $K_{ir}4.1/K_{ir}5.1$  potassium channels play key roles in regulating distal tubule potassium sensing and sodium chloride transport. Mutations in *KCNJ10* and *KCNJ16*, encoding  $K_{ir}4.1$  and  $K_{ir}5.1$ , respectively, lead to several renal tubulopathies. Given the importance of  $K_{ir}4.1/K_{ir}5.1$  in maintenance of renal salt and water homeostasis, we sought to develop pharmacological tools for exploring its physiology, druggability, and therapeutic potential.

**Methods:** Fluorescence-based thallium flux assays were used for high-throughput screening (HTS) of small-molecule libraries for novel  $K_{ir}4.1/K_{ir}5.1$  activators. Whole-cell and cell-attached patch clamp techniques were used to characterize effects of VU0493206 on  $K_{ir}4.1/K_{ir}5.1$  channel activity. A voltage-sensitive dye was used to characterize effects of VU0493206 on mCCD<sub>Cl1</sub> cell membrane potential.

**Results:** We performed a HTS of 87,475 compounds for novel channel modulators, leading to the discovery of 427 inhibitors and 107 activators of heteromeric  $K_{ir}4.1/K_{ir}5.1$  channels. Here, we report the discovery and characterization of VU0493206, the first small-molecule activator of  $K_{ir}4.1/K_{ir}5.1$  channels. In whole-cell patch clamp experiments, VU0493206 activates  $K_{ir}4.1/K_{ir}5.1$ -mediated currents by approximately 600% at -120 mV with an  $EC_{50}$  of 11  $\mu M$ . Cell-attached patch clamp recordings indicates activation is mediated by an increase in single channel current amplitude and number of open channels. VU0493206 hyperpolarizes the membrane potential of mCCD<sub>Cl1</sub> renal epithelial cells, consistent with activation of endogenously expressed  $K_{ir}4.1/K_{ir}5.1$  channels. At doses up to 30  $\mu M$ , VU0493206 is selective for  $K_{ir}4.1/K_{ir}5.1$  over 11 other members of the  $K_{ir}$  channel family. Depletion of plasmalemmal  $PIP_2$  and mutation of  $PIP_2$ -binding sites on the channel prevents  $K_{ir}4.1/K_{ir}5.1$  activation by VU0493206. Heteromeric channels carrying a novel loss-of-function mutation in  $K_{ir}5.1$  (T64I) are activated by VU0493206, suggesting that some disease-causing mutations in  $K_{ir}4.1/K_{ir}5.1$  may be rescued with activators.

**Conclusions:** We anticipate that VU0493206 and other small-molecule modulators will be useful for exploring the integrative physiology and therapeutic potential of  $K_{ir}4.1/K_{ir}5.1$  heteromeric channels.

**Funding:** NIDDK Support

### TH-PO326

#### A Role for the Adrenal Clock in Renin-Angiotensin-Aldosterone System Regulation

Annalisse R. Mckee, Hannah M. Costello, G. R. Crislip, Kityan Cheng, Alexandria Juffre, Victor M. Mendez, Lauren G. Douma, Michelle L. Gumz. *University of Florida, Gainesville, FL.*

**Background:** Circadian rhythms are regulated by the circadian clock and critical for most physiological functions, with disruption of these rhythms linked to adverse renal outcomes. Our lab has a particular interest in the clock protein BMAL1 as global BMAL1 knockout (KO) mice have impairment of diurnal rhythm of renal sodium (Na) handling. Although, rhythm of renal Na handling in kidney-specific BMAL1 KO mice remained intact. The adrenal hormone, aldosterone, which is stimulated by the renin-angiotensin system (RAS), has an influence on renal electrolyte handling. With limited known on the role of the adrenal clock on RAS, aldosterone, and renal excretory function, our goal was to test the hypothesis that adrenal BMAL1 is required for normal circadian rhythms of RAS and renal Na excretion.

**Methods:** AS-BMAL1 male mice and littermate controls ( $n=5-6$ ) were placed in metabolic cages to assess urinary 12-hour aldosterone excretion by ELISA and renal Na rhythm by flame photometry during normal Na diet and 7 days Na depletion. Kidneys were collected from a separate cohort of mice ( $n=7-8$  per genotype) at 6AM and 6PM on normal salt diet for isolation of RNA and then qPCR to analyze gene expression for *Renin*.

**Results:** Here, we show urinary aldosterone levels were increased with blunted night/day difference in AS-BMAL1 KO male mice under normal salt and low salt conditions compared with controls (ANOVA interaction  $p=0.0407$ ). Na balance was calculated, showing a trend for a significant interaction between genotype and time ( $p=0.05$ ), appearing more positive during their inactive period. Finally, there was a significant interaction between time and genotype in *Renin* gene expression (ANOVA interaction  $p=0.0126$ ).

**Conclusions:** In conclusion, loss of BMAL1 in the adrenal gland resulted in altered rhythm of both *Renin* gene expression and aldosterone levels, with a trend for significant disturbance in renal Na handling. Future studies aim to look at sex differences in the RAS system in AS-BMAL1 KO mice, as only males were investigated here.

**Funding:** Private Foundation Support

## TH-PO327

**Adrenal-Specific Knockout of the Circadian Clock Protein BMAL1 Alters Kidney Clock Gene Expression**

Hannah M. Costello, Annalisse R. Mckee, G. R. Crislip, Kityan Cheng, Alexandria Juffre, Lauren G. Douma, Michelle L. Gumz. *University of Florida, Gainesville, FL.*

**Background:** Circadian rhythms are internal variations in physiological function coordinated by the molecular clock, comprised of 4 core clock proteins – BMAL1, CLOCK, CRY, and PER. Our lab has an interest in how peripheral circadian clocks, including the kidney and adrenal clocks, contribute to renal function. Many renal processes exhibit a circadian rhythm, such as urine flow rate. It is known that kidney clocks contribute to its regulation, but the kidney clocks are disrupted in many animal models of kidney disease. However, little is known about how the kidney clocks tick. Previous data from the lab has shown that kidney-specific knockout (KO) of PER1 altered adrenal clock gene expression. This led to our hypothesis of adrenal-kidney clock cross talk and a role for the adrenal clock in the regulation of kidney clock expression.

**Methods:** To test this, we utilized the adrenal-specific aldosterone synthase Cre positive (AS)-BMAL1 KO mouse model. Kidneys from AS-BMAL1 KO male mice and littermate Cre negative, floxed control (CNTL) male mice ( $n=7-8/\text{genotype}$ ) were collected at 6AM and 6PM. Kidneys were separated into cortex and medulla before RNA was isolated for clock gene expression analysis using qPCR.

**Results:** Here, we show significant differences in clock gene expression in the kidney cortex but no changes in the kidney medulla of AS-BMAL1 KO compared with CNTL. There was a significant interaction between time and genotype in *Bmal1*, *Clock* and *Cry1* (ANOVA interaction  $p=0.010$ ,  $p=0.043$ , and  $p=0.024$ , respectively) in the kidney cortex. Sidak multiple comparisons showed increases in *Bmal1* ( $p=0.0070$ ) and *Cry1* ( $p=0.024$ ) at 6AM in KO animals vs. CNTL, whereas *Clock* was reduced at 6PM ( $p=0.011$ ). No genotype effects were detected in *Cry2* and *Per1* expression. There were no significant differences in clock gene expression in the kidney medulla between genotypes. All clock genes in both cortex and medulla demonstrated a significant time of day effect ( $p<0.01$ ).

**Conclusions:** BMAL1 KO in the adrenal gland has differential effects on kidney clock gene expression in a region-specific manner, with changes only in the cortex. Future work will utilize tissue-specific clock KO models to focus on whether peripheral clock cross talk contributes to regulation of renal function and how they work together in a cell-specific manner.

**Funding:** Private Foundation Support

## TH-PO328

**Assessment of Sodium Excretion in Kidney-Specific BMAL1 Knockout Mice in Response to an Acute Salt Load**

G. R. Crislip, Hannah M. Costello, Kityan Cheng, Charles B. Drucker, I. Jeanette Lynch, Lauren G. Douma, Charles S. Wingo, Michelle L. Gumz. *University of Florida, Gainesville, FL.*

**Background:** BMAL1 is a core clock transcription factor responsible for the tissue-specific regulation of thousands of genes. Male kidney-specific BMAL1 knockout (KS-BMAL1 KO) mice exhibit lower blood pressure compared to control mice (CNTL). The goal of this study was to determine the natriuretic response to an acute salt load in the presence and absence of the sodium-potassium-chloride-cotransporter 2 (NKCC2) by inhibition with furosemide in KS-BMAL1 KO and control mice (CNTL).

**Methods:** We generated the KS-BMAL1 KO using floxed exon 8 BMAL1 mice crossed with kidney-specific cadherin Cre+ mice. These mice exhibit decreased BMAL1 expression in the thick ascending limb, distal convoluted tubule, and collecting duct cells. Floxed Cre- littermates were used as control mice (CNTL). Mice were placed in metabolic cages and fasted during their inactive period (N=6). At the start of their active period, mice were injected with a saline bolus (1.5 mL)  $\pm$  furosemide (30 mg/kg). Urine was collected for each hour for 7 hours. Three- and two-way ANOVA were used for statistical analysis.

**Results:** There was no genotype difference in cumulative sodium excretion. Mice injected with furosemide excreted more sodium compared to saline alone (final volume in saline alone vs. furosemide; CNTL:  $0.14\pm 0.01$  vs.  $0.22\pm 0.02$ ; KS-BMAL1 KO:  $0.14\pm 0.02$  vs.  $0.25\pm 0.01$  mEq;  $P<0.0001$ ). Cumulative urinary volume exhibited the same trends. Likewise, cumulative sodium excretion rates were similar between genotypes and furosemide caused faster excretion over the course of collections.

**Conclusions:** BMAL1 does not appear to control NKCC2 activity under the conditions tested. As expected, furosemide leads to greater and quicker diuresis and natriuresis. We have shown that blood pressures difference between CNTL and KS-BMAL1 KO is amplified following potassium depletion with high salt diet. Assessing natriuresis in response to an acute salt load in mice fed a potassium depleted, high salt diet may provide additional insight.

**Funding:** NIDDK Support, Veterans Affairs Support, Private Foundation Support

## TH-PO329

**Claudin-10b Role in the Basolateral Infoldings of the Thick Ascending Limb**

Catarina Quintanova,<sup>1</sup> Nina Himmerkus,<sup>1</sup> Kerim Mutig,<sup>2</sup> Dominik Müller,<sup>2</sup> Tilman Breiderhoff,<sup>2</sup> Dorothee Günzel,<sup>2</sup> Markus Bleich.<sup>1,2</sup> *Christian-Albrechts-Universität zu Kiel, Kiel, Germany; <sup>2</sup>Charite Universitätsmedizin Berlin, Berlin, Germany.*

**Background:** The thick ascending limb (TAL) of the loop of Henle is responsible for salt reabsorption and thus for urine concentration. The paracellular pathway is determined by the combination of claudin expression in the tight junctions (TJ). In the TAL there is a mosaic expression of either claudin-10b or claudin-3/claudin-16/claudin-19 in a complex. Claudin-10b TJ confer a sodium (Na<sup>+</sup>) permeability. Remarkably, claudin-10b is also expressed extra-junctional in the infoldings of the basolateral membrane.

**Methods:** Freshly isolated single murine TAL segments of C57Bl6 and kidney specific (Ksp-Cre) Claudin-10 knockout (cKO) mice were investigated by immunofluorescence (IF) or western blot (WB). Dissected TAL were transferred into bath solution (37 °C) and microperfused under constant pressure and measured under different basolateral solutions to assess infolding accessibility by the Na<sup>+</sup>/K<sup>+</sup>-ATPase (NKA) inhibitor ouabain or by fluorescein. To loosen the intermembrane protein contacts, we removed calcium (Ca<sup>2+</sup>) from the basolateral bath solution.

**Results:** In single TAL segments, we performed triple staining with claudin-10, NKA and the chloride channel subunit Barttin. The localization of all proteins co-localized in the infoldings and NKA and Barttin expression were not changed in IF or WB by cKO. The relative speed of ouabain inhibition was higher in the cKO and in Ca<sup>2+</sup>-free conditions. Further, we tested the diffusion of fluorescein into the infoldings. In the WT, upon re-addition of Ca<sup>2+</sup> we were able to trap more fluorescein when compared to the cKO.

**Conclusions:** Claudin-10b KO has no direct influence on the expression and localization of other important basolateral transport proteins. However, the increased speed of ouabain inhibition and the decrease of fluorescein trapping in the absence of Claudin-10b and Ca<sup>2+</sup>-free situations suggests a role of claudin-10b in the stabilization of the infoldings by forming a complex between neighboring invaginated membranes.

## TH-PO330

**CRISPR/Cas9-Mediated Suppression of the Focal Segmental Glomerulosclerosis Protein Actinin-4 (ACTN4) in Thick Ascending Limbs (TALs) Increases Sodium Chloride Reabsorption by Regulating NKCC2 Trafficking**

Dipak Maskey,<sup>1,2</sup> Pablo A. Ortiz.<sup>1,2</sup> *<sup>1</sup>Department of Physiology, Wayne State University, Detroit, MI; <sup>2</sup>Hypertension and Vascular Research Division, Internal Medicine, Henry Ford Hospital, Detroit, MI.*

**Background:** Mutations in ACTN4 are known to cause focal segmental glomerulosclerosis. However, the role of ACTN4 in nephron ion transport has not been studied. We used a proteomics screen to find interacting proteins for the Na/K/2Cl cotransporter NKCC2 in the Thick Ascending Limb (TAL) and identified ACTN4. We showed that NKCC2 levels at the apical surface are controlled by endocytosis. ACTN4 has been involved in endocytosis in other cells. Therefore, we hypothesized that ACTN4 is a part of protein complex that binds apical NKCC2 and promotes its endocytosis.

**Methods:** Adeno-associated virus (AAV)-mediated CRISPR/Cas9, Western blot, metabolic cages, Uni-nephrectomy, and Immunoprecipitation

**Results:** To study the role of ACTN4 in NKCC2 endocytosis, we developed an adeno-associated virus (AAV)-mediated CRISPR/Cas9 approach to decrease ACTN4 expression in TALs. We tested 4 gRNAs targeting ACTN4 in neuroblastoma Neuro 2a/HF-Cas9-ROSA26 cells and selected the most effective guide, which decreased ACTN4 protein expression by 70-80% ( $n=3$ ) and we packed this gRNA into AAV (AVV-U6-gRNA-ACTN4). To study the role of ACTN4 in TAL NaCl reabsorption, we uni-nephrectomized rats (right kidney removal), and a week later transduced the left kidneys with AV-pNKCC2Cas9 plus AAV-gRNA-ACTN4 or AV-pNKCC2-Cas9 alone (control). After 3 weeks, rats were placed in metabolic cages to measure bumetanide-induced natriuresis (4h) as an index of NKCC2-mediated NaCl absorption. We found that bumetanide induced UNa excretion was higher in rats transduced with Cas9-ACTN4, compared to rats transduced with Cas9 alone (Cas9 Control:  $2880\pm 381$  vs Cas9-ACTN4:  $4181\pm 190$   $\mu\text{mol Na/4h}$ ,  $n=5$ ,  $p<0.05$ ). Surface to total NKCC2 ratio was increased by 30±5% in TALs from rats transduced with Cas9-ACTN4 ( $p<0.05$ ,  $n=3$ ) whereas ACTN4 expression was 40±4% lower than control Cas9 rats ( $n=3$ ,  $p<0.05$ ). Recombinant ACTN4 (GST-ACTN4) or immunoprecipitation of ACTN4, pulled down NKCC2 from TAL lysates ( $n=4$ ), suggesting that ACTN4 regulates surface NKCC2 involves protein-protein interactions.

**Conclusions:** We conclude that ACTN4 binds NKCC2 to regulate its surface expression. Selective depletion of ACTN4 in TALs using CRISPR/Cas9 enhances surface NKCC2 and TAL NaCl reabsorption, indicating that regulation of the ACTN4-NKCC2 interaction is important for renal NaCl reabsorption.

**Funding:** NIDDK Support, Private Foundation Support

## TH-PO331

**Differentiated Tubuloids to Model Human Distal Nephron (Patho) Physiology**

Carla Pou Casellas,<sup>1,2</sup> Fjodor Yousef Yengej,<sup>1,2</sup> Carola Ammerlaan,<sup>1,2</sup> Charlotte Olde Hanhof,<sup>3</sup> Emre Dilmen,<sup>3</sup> Joost Hoenderop,<sup>3</sup> Maarten B Rookmaaker,<sup>1</sup> Hans Clevers,<sup>2,1</sup> Marianne C. Verhaar.<sup>1</sup> <sup>1</sup>Universitair Medisch Centrum Utrecht, Utrecht, Netherlands; <sup>2</sup>Hucrecht Institute, Utrecht, Netherlands; <sup>3</sup>Radboudumc, Nijmegen, Netherlands.

**Background:** The distal nephron segments are essential for electrolyte, acid-base and volume homeostasis. Tubuloid culture allows ample expansion (exp) of primary human renal epithelium from urine or tissue. Here we differentiate tubuloids into thick ascending limb of Henle (TAL) and principal cells (PC), characterize these at mRNA, protein and functional levels, and establish an *in vitro* human lithium (Li<sup>+</sup>) tubulopathy model.

**Methods:** Tubuloids were grown from kidney tissue of 4 donors in exp medium. After differentiation (diff) for 7 days, tubuloids were studied by qPCR, single cell RNA sequencing (scSeq) and immunofluorescence (IF)/-histochemistry (IHC). ScSeq data was compared with human kidney tissue. Electrolyte transport was tested using the FluxOR™ II assay. Diff tubuloids were exposed to 10 mM Li<sup>+</sup> or Na<sup>+</sup> (control) and analyzed by the same techniques.

**Results:** Diff increased transcription of NKCC2 in the TAL (1269-fold, P<0.05), NCC (39-fold, P<0.05) in the distal convoluted tubule (DCT), and ENaCa (8-fold, P<0.05) and AQP2 (569-fold, P=0.06) in PC (n=4). Tubuloids in exp consisted of proliferative progenitors, whereas diff produced TAL and PC, with some DCT cells (n>3.000 cells/sample). Diff reduced progenitor markers and upregulated clinically relevant genes (e.g. NKCC2, ROMK, ENaC, AQP2, Na/K-ATPase, HNF1β, CAII) to levels reflecting tissue counterparts. IF/IHC confirmed polarized NKCC2, AQP2 and AQP3 protein expression. Luminal NKCC2 demonstrated furosemide-inhibitable TI<sup>+</sup> (replacing K<sup>+</sup>) uptake (n=3). Apical Li<sup>+</sup> treatment suppressed AQP2 and upregulated the intercalated cell marker Pendrin, in contrast to Na<sup>+</sup> or basolateral Li<sup>+</sup>. Li<sup>+</sup> also upregulated proliferation, pro-inflammatory and tumor-associated genes. In addition, Li<sup>+</sup> effects observed only in animal studies were seen, including downregulation of NKCC2, which was confirmed by IF and functional assays.

**Conclusions:** Tubuloid diff produces TAL and PC that resemble *in vivo* counterparts. TAL cells demonstrated electrolyte reabsorption, their main function. Treatment with Li<sup>+</sup> caused changes in line with diabetes insipidus, tubulointerstitial nephritis and tumors seen *in vivo*. Taken together, differentiated tubuloids enable modeling of the human distal nephron in health and disease.

**Funding:** Government Support - Non-U.S.

## TH-PO332

**Proteomic Characterization and Plasticity of Human Collecting Duct Principal and Intercalated-Like Cells Derived From Pluripotent Stem Cell-Derived Ureteric Bud Organoids**

Mohammad Zarei,<sup>1,4</sup> Kyle McCracken,<sup>2,4</sup> Ankit B. Patel,<sup>1,4</sup> Dennis Brown,<sup>3,4</sup> Amity F. Eaton,<sup>3,4</sup> Robyn J. Eisert,<sup>4</sup> Marian Kalocsay,<sup>4</sup> Joseph V. Bonventre.<sup>1,4</sup> <sup>1</sup>Brigham and Women's Hospital, Boston, MA; <sup>2</sup>Boston Children's Hospital, Boston, MA; <sup>3</sup>Massachusetts General Hospital, Boston, MA; <sup>4</sup>Harvard Medical School, Boston, MA.

**Background:** Using a new protocol to create human ureteric bud organoids we have developed a human collecting duct (hCD) principal cell (hPC) line from ureteric bud organoids differentiated from human pluripotent stem cells. hPC cells form a mitochondria-rich cuboidal epithelium that generates a high transepithelial resistance and ENaC-dependent transepithelial potential (TEP) when grown on transwell filters.

**Methods:** The hCD cells, including a cell line with stably integrated lentivirus to permit doxycycline-inducible FoxI1 expression were grown under standard conditions and on transwell filters. Tandem-Mass Tag (TMT) Mass Spectrometry was performed on cells treated with various hormones +/- antagonists for 24 h and compared with untreated controls.

**Results:** EM revealed a mitochondrial-rich cuboidal hPC epithelium with small apical microvilli. Amiloride-sensitive TEP was responsive to aldosterone, dexamethasone, hydrocortisone, and vasopressin, and these hormones induced partially overlapping but distinct changes in the proteome. The mineralocorticoid antagonists finerenone and spironolactone both decreased the aldosterone-stimulated TEP but showed some differential effects on the proteome. Finerenone and spironolactone decreased the aldosterone-activated amiloride-sensitive TEP. Sixteen different conditions were evaluated, and principal component analysis revealed very good reproducibility of duplicates and good separation of conditions. Conversion of hPCs to intercalated-like cells (hICs) with FoxI1 was associated with the induction of certain carbonic anhydrase isoforms and multiple V-type H<sup>+</sup>-ATPase subunits (ATP6 [V1] A, B1, D, E1, F, G1, H) and [V0] A4, D2)). Expression of ATP6V1B1 and ATP6V0A4 confirmed by immunofluorescence.

**Conclusions:** hCD cells exhibit functional and proteomic responsiveness to both glucocorticoid and mineralocorticoid hormone signaling, which induce distinct and overlapping changes in protein expression. The transcription factor FoxI1 is sufficient to induce expression of V-type H<sup>+</sup>-ATPase subunits to drive the acid secretory phenotype.

**Funding:** NIDDK Support, Other NIH Support - NCATS, T32, Benjamin J. Lipps Fellowship of ASN, Private Foundation Support

## TH-PO333

**Claudin-19 Expression in the Thick Ascending Limb Is Required for Tight Junctional Localization of Claudin-16**

Caroline Prot-Bertoye,<sup>1,2</sup> Camille Griveau,<sup>1</sup> Wung-Man Evelyne Ling,<sup>1</sup> Gaëlle Brideau,<sup>1</sup> Lydie Cheval,<sup>1</sup> Henrik Dimke,<sup>3,4</sup> Pascal Houllier.<sup>1,2</sup> <sup>1</sup>Centre de Recherche des Cordeliers, INSERM, Sorbonne Université, Université Paris Cité, CNRS ERL 8228 - Laboratoire de Physiologie Rénale et Tubulopathies, Paris, France; <sup>2</sup>APHP, Hôpital Européen Georges Pompidou, Service de Physiologie, Paris, France; <sup>3</sup>Department of Cardiovascular and Renal Research, University of Southern Denmark, Odense, Denmark; <sup>4</sup>Department of Nephrology, Odense University Hospital, Odense, Denmark.

**Background:** The kidney plays a key role in mineral homeostasis. Paracellular calcium and magnesium reabsorption in the renal thick ascending limb (TAL) involves claudin (CLDN) 16 and CLDN19: accordingly, pathogenic variants in both gene cause Familial Hypomagnesemia with Hypercalciuria and Nephrocalcinosis (FHHNC) with severe renal calcium and magnesium wasting. In the TAL, the expression pattern of claudins at the tight junction is mosaic: tight junctions express either CLDN16/CLDN19 or CLDN10b. CLDN16 deficiency decreases paracellular permeability to calcium and magnesium and CLDN10 deficiency decreases paracellular sodium to chloride permeability ratio. However, the function of CLDN19 *in vivo* remains uncertain; whether CLDN19 alters CLDN16 or CLDN10 localization *in vivo* is unknown.

**Methods:** We determined the localization of CLDN19 in sections of frozen and paraffin embedded kidney from wild-type and *Cldn19* deficient mice using antibodies directed against the protein and examined the role of *Cldn19* deletion on CLDN16 and CLDN10 localization.

**Results:** CLDN19 localizes to the TAL, where it is expressed in basolateral membrane domains in the outer medulla and the cortex; its expression at the tight junction of TALs is restricted to the outer stripe of outer medulla and cortex, where it colocalizes with CLDN16. In TALs from *Cldn19* deficient mice, CLDN16 is expressed in basolateral membrane domains but not at the tight junction. In contrast, *Cldn19* deletion does not alter CLDN10 localization.

**Conclusions:** *In vivo*, the CLDN19 protein is required for the proper CLDN16 expression at the tight junction. This finding gives a molecular explanation to the shared renal phenotypic characteristics of FHHNC caused by either CLDN16 or CLDN19 variants.

## TH-PO334

**Sodium Magnetic Resonance Imaging Shows Impairment of the Counter-Current Multiplication System in the Diabetic Model Mice Kidney**

Yusuke Nakagawa,<sup>1</sup> Ryohei Kaseda,<sup>1</sup> Yuya Suzuki,<sup>1</sup> Yasuhiko Terada,<sup>2</sup> Tomoyuki Haishi,<sup>3,4</sup> Susumu Sasaki,<sup>1</sup> Ichiei Narita.<sup>1</sup> <sup>1</sup>Niigata University, Niigata, Japan; <sup>2</sup>Tsukuba University, Tsukuba, Japan; <sup>3</sup>International University of Health and Welfare, Narita, Japan; <sup>4</sup>MRTechnology Inc., Tsukuba, Japan.

**Background:** Sodium Magnetic Resonance Imaging (<sup>23</sup>Na-MRI) is a technique for imaging <sup>23</sup>Na. It is possible to non-invasively assess sodium distributions, especially sodium concentration in the counter-current multiplication system in the kidney, which forms a sodium concentration gradient from the cortex to the medulla, enabling efficient water reabsorption. Although knowledge regarding the mechanisms of sodium reabsorption through channels or transporters has been accumulated, the distribution of the sodium concentration in the entire kidney has not been delineated in kidney diseases. Applying <sup>23</sup>Na-MRI to disease model mice may expand the scope of prior studies and elucidate the pathogenesis of sodium gradient impairments. We investigated whether <sup>23</sup>Na-MRI can detect changes in sodium concentrations under normal conditions in mice and in disease models such as a mouse model with diabetes mellitus.

**Methods:** <sup>23</sup>Na-MRI was performed with a 9.4T vertical standard-bore superconducting magnet using C57BL/6Jcl administered of furosemide (10 mg/kg BW), BKS.Cg-Lepr<sup>db</sup>/+ Lepr<sup>db</sup>/Jcl (db/db) mice and its corresponding control BKS.Cg-m/+m/+Jcl (m+/m+) mice. The sodium gradient of the kidney between the cortex and medulla was compared.

**Results:** The corticomedullary sodium gradient of the kidney significantly decreased 20 min after administration of furosemide, an NKCC2 inhibitor involved in the formation of the counter-current multiplication system (pre-1.53±0.16, post-2.19±0.3, P<0.05, N=7). The signal intensity of the medullary region in the kidney was lower in db/db mice (db/db 209.6±42.4 mmol/L, m+/m+ 333.5±54.4 mmol/L, P<0.01, N=7 each) and the corticomedullary sodium gradient of db/db mice was significantly decreased compared to m+/m+ mice (db/db 1.64±0.36, m+/m+ 2.28±0.21, P<0.01).

**Conclusions:** <sup>23</sup>Na-MRI revealed reductions in the corticomedullary sodium gradients and impairment in the counter-current multiplication system in db/db mice at very early stages of diabetes mellitus. <sup>23</sup>Na-MRI may be useful for diagnosing diabetic kidney disease and elucidating the pathogenesis of sodium gradient impairments.

**Funding:** Government Support - Non-U.S.

## TH-PO335

**Activation of PDK1/RSK Results in Aquaporin-2 S256 Phosphorylation and Membrane Accumulation After Downregulation of EGFR Signaling**  
Richard S. Babicz, Pui Susan W. Cheung, Richard Bouley, Noah Baylor, Dennis Brown. Program in Membrane Biology *Massachusetts General Hospital, Boston, MA.*

**Background:** Vasopressin (VP) activates PKA, resulting in phosphorylation and membrane accumulation of AQP2. Epidermal growth factor receptor (EGFR) inhibition with erlotinib also induces AQP2 membrane trafficking with a phosphorylation pattern similar to VP, but without increasing PKA activity. Here, we identified the novel kinase pathway(s) that are activated when EGFR signaling is inhibited.

**Methods:** We used several inhibitors that block EGFR signaling to identify which pathway inhibited erlotinib-induced AQP2 membrane accumulation in LLC-PK1 cells, and rat kidney slices. We incubated purified GST-AQP2 c-terminus with recombinant kinase and 10uCi (Y32P) ATP using PKA as a positive control and our purified kinase target (RSK). Inhibitors of PKA and RSK and purified GST-AQP2 S256A c-terminus were negative controls. RSK phosphorylated AQP2 at S256, and we asked if the intermediate kinase PDK-1 stimulated RSK activity and AQP2 phosphorylation by western blotting, and membrane accumulation by immunocytochemistry.

**Results:** Inhibiting 90 kDa ribosomal S6 kinase (RSK) significantly reduced erlotinib-induced S256 phosphorylation. Upon blocking or knocking down RSK, erlotinib no longer induced AQP2 membrane accumulation. In rat kidneys, RSK was expressed in medullary principal cells. Erlotinib did not induce AQP2 membrane accumulation when cells/tissues were pre-treated with the RSK inhibitor, BI-D1870. Using purified proteins, RSK directly phosphorylated WT- but not S256A-AQP2, similar to PKA. We conclude that RSK phosphorylates AQP2 at S256 upon EGFR inhibition by erlotinib. RSK is activated by phosphorylation of a critical S221 residue by the intermediate kinase PDK-1. Incubation of cells/tissues with PS210, a direct activator of PDK-1, caused a significant increase in both RSK S221 and AQP2 S256 phosphorylation, and plasma membrane accumulation of AQP2.

**Conclusions:** Activation of PDK1/RSK upon erlotinib exposure is a key step in stimulating AQP2 membrane accumulation via direct RSK-mediated phosphorylation of the critical S256 C-terminal residue. This represents a novel, VP-independent pathway by which collecting duct water permeability could be modulated.

**Funding:** NIDDK Support

## TH-PO336

**Using CRISPR-Cas9/Phosphoproteomics to Identify Kinase Substrates: Calcium/Calmodulin-Dependent Protein Kinase 2 $\delta$**

Euijung Park, Chin-Rang Yang, Lihe Chen, Viswanathan Raghuram, M. A. Knepper. *National Heart Lung and Blood Institute, Bethesda, MD.*

**Background:** Arginine vasopressin (AVP) plays a critical role in the regulation of water permeability in renal collecting duct (CD) cells via the V2 vasopressin receptor, which triggers a rise of intracellular cAMP and Ca<sup>2+</sup>. Ca<sup>2+</sup> stimulates a wide range of cellular processes including actin cytoskeleton rearrangement, in part through Ca<sup>2+</sup>/CaM-dependent signaling. One potential target, strongly expressed in CD cells, is Ca<sup>2+</sup>/CaM-dependent protein kinase 2 $\delta$  (Camk2 $\delta$ ). Here, we deleted Camk2 $\delta$  in mpkCCD cells and carried out phosphoproteomics to identify Camk2 $\delta$  target proteins.

**Methods:** Using two different gRNAs which target the Camk2 $\delta$  kinase domain, CRISPR/Cas9-mediated Camk2 $\delta$  knock-out cell lines were created. We carried out large-scale proteomic and phosphoproteomic analysis in the presence of dDAVP, (V2 selective AVP analog, 0.1 nM, 30 min) using TMT quantification versus wild-type cells to identify direct targets of Camk2 $\delta$ .

**Results:** The quantitative phosphoproteomics revealed that, of the 11570 phosphopeptides quantified, 78 were significantly increased and 60 were decreased. Of the 60 downregulated sites, *Tpd52* were previously identified as Camk2 $\delta$  targets in existing literature, but 59 of the identified sites are novel. Motif analysis of the decreased phosphorylation sites revealed a novel target preference of -(R/K)-X-X-p(S/T)-X-D- where R,K,S,T and D are standard single letter amino acid codes, X means "any amino acid" and p indicates the phosphorylated amino acid. *Gene Ontology (GO)* analysis identified that Camk2 $\delta$ -mediated protein phosphorylation is likely to be involved in regulation of actin polymerization as well as chromatin organization. In standard proteomics (n=5198), 23 proteins significantly increased and 24 were decreased. *GO* term analysis mapped the regulated proteins to chromatin organization and histone modification, consistent with the phosphoproteomic data.

**Conclusions:** We identified multiple novel Camk2 $\delta$  phosphorylation targets that have potential roles in vasopressin's action to regulate water transport in the renal collecting duct, especially with regard to Ca<sup>2+</sup>/CaM-dependent regulation of the actin cytoskeleton and chromatin organization. The large increase in the number of recognized phosphorylation targets allowed identification of a new target sequence preference motif for Camk2 $\delta$ .

## TH-PO337

**The Long-Term Effect of Vasopressin on Transcriptome and DNA Accessibility in Cortical Collecting Duct**

Hiroaki Kikuchi,<sup>1</sup> Lihe Chen,<sup>1</sup> Hyun Jun Jung,<sup>2</sup> Euijung Park,<sup>1</sup> Mark A. Knepper.<sup>1</sup> Epithelial Systems Biology Laboratory, Systems Biology Center <sup>1</sup>National Institutes of Health, Bethesda, MD; <sup>2</sup>Johns Hopkins University, Baltimore, MD.

**Background:** Vasopressin binds to V2 receptors in collecting duct principal cells triggering protein kinase A (PKA)-dependent signaling and increased expression of the *Aqp2* gene. Vasopressin signaling is important not only for *Aqp2* transcription, but also for cyst genesis in autosomal dominant polycystic kidney disease (ADPKD), which is one of the world's most common inherited life-threatening conditions. However, signaling pathways responsible for long-term vasopressin action in native renal collecting duct cells are incompletely understood.

**Methods:** Experiments were done in mice undergoing administration of vehicle (Veh) or vasopressin analog, desmopressin (dDAVP) by osmotic minipumps (2 ng/hour, 5days) without water restriction (n=4 mice for each group). Spot urine samples were collected on each day until day 5 and the urine osmolality was monitored. RNA-seq transcriptomics and ATAC-seq-based DNA accessibility assessment were carried out in microdissected cortical collecting ducts (CDs).

**Results:** Spot urine osmolality was significantly increased by 5 day dDAVP treatment compared to Veh treatment (3063  $\pm$  323, 2243  $\pm$  354 mosm/kg, respectively). Single tubule RNA-seq of CCDs showed that there were 485 genes that were increased (Padj less than 0.05 and log2 dDAVP/Veh greater than 0.50) and 2317 transcripts that were decreased (Padj less than 0.05 and log2 dDAVP/Veh less than -0.50) out of a total of 12,653 transcripts with TPM values greater than 1. *Aqp2* mRNA abundance was increased by 140% in the cortical CD by dDAVP. *Aqp3* was also significantly increased by 90%. In contrast to dDAVP effects in cultured mpkCCD cells, cell cycle-related transcript such as *Cdk1*, *E2f1* and *Mki67* were highly upregulated by dDAVP (dDAVP:Veh ratio=10.30, 5.76 and 5.03). Motif analysis (HOMER) of sequences corresponding to ATAC-seq peaks significantly upregulated by dDAVP, revealed binding site motifs corresponding to Ets-Family, Klf-Family and E2f-family transcription factors.

**Conclusions:** Long-term infusion of dDAVP is associated with gene expression changes consistent with cellular proliferative effects in native mouse CDs, which could be due to either a direct or an indirect action of dDAVP. Future studies will examine the molecular mechanisms involved and a possible connection to the role of V2 receptors in the development and/or progression of ADPKD.

## TH-PO338

**The Role of Poly (ADP-Ribose) Polymerase 1 in Vasopressin-Mediated AQP2 Expression**

Hyo-Ju Jang,<sup>1</sup> Euijung Park,<sup>2</sup> Hyun Jun Jung,<sup>3</sup> Tae-Hwan Kwon.<sup>1</sup> <sup>1</sup>Kyungpook National University School of Medicine, Daegu, Republic of Korea; <sup>2</sup>National Institutes of Health, Bethesda, MD; <sup>3</sup>Johns Hopkins University School of Medicine, Baltimore, MD.

**Background:** Poly(ADP-ribose)ylation (PARylation) mediated by poly(ADP-ribose) polymerases (PARPs), catalyzes the transfer of ADP-ribose from NAD<sup>+</sup> molecules to acceptor proteins. We previously demonstrated that tankyrase, one of PARPs family, regulates AQP2 expression via  $\beta$ -catenin-mediated transcription. We aimed to examine the role of PARP1, the most abundant protein in the PARPs family, in the AQP2 regulation.

**Methods:** 1) immunoblotting for PARP1 in mpkCCDc14 cells; 2) pulldown assay of biotin-conjugated NAD<sup>+</sup> and immunoprecipitation (IP) assay using poly(ADP-ribose) (PAR) antibody; 3) qRT-PCR and immunoblotting for AQP2; and 4) bioinformatics for elucidating PARP1 substrates and interacting proteins in kidney collecting duct (CD) cells.

**Results:** Immunoblots showed that PARP1 cleavage (both 89 kDa and 25 kDa) was induced by dDAVP (10<sup>-9</sup> M) treatment in whole cell lysate, nuclear, and cytoplasm extracts of mpkCCDc14 cells, respectively. dDAVP (10<sup>-9</sup> M, 24 h) increased the abundance of total PARylated proteins in biotin-NAD<sup>+</sup> pulldown and IP assays of PAR in mpkCCDc14 cells. dDAVP-induced AQP2 mRNA and protein expression was significantly attenuated in mpkCCDc14 cells with siRNA-mediated PARP1 knockdown. Since PARP1 cleavage induced by dDAVP was not affected despite PARP1 knockdown, PARP1 cleavage is unlikely to be involved in AQP2 regulation. In contrast to PARP1 knockdown, inhibition of PARP1 activity by PARP inhibitor (PJ34) did not affect dDAVP-induced AQP2 mRNA and protein upregulation, suggesting that PARylation mediated by PARP1 was not involved in AQP2 regulation. Bioinformatics study revealed 408 proteins interacting with PARP1 and 763 substrates proteins of PARP1 in the kidney CD cells. Among them, 604 proteins were mapped on the vasopressin V2 receptor (V2R) signaling pathway.  $\beta$ -catenin, which is phosphorylated (S552) by dDAVP, was identified as the PARP1 interacting protein mapped on the V2R signaling. Immunoblotting demonstrated that dDAVP-induced pS552- $\beta$ -catenin expression in the whole cell lysate as well as nucleus in mpkCCDc14 cells was significantly attenuated in the presence of PARP1 knockdown.

**Conclusions:** PARP1 plays a role in vasopressin-mediated AQP2 regulation via  $\beta$ -catenin, as the vasopressin-responsive interacting protein of PARP1, but unlikely through the PARylation of proteins and/or PARP1 cleavage in the kidney CD cells.

**Funding:** Government Support - Non-U.S.

## TH-PO339

## LRBA Is Essential for Urinary Concentration and Body Water Homeostasis

Yu Hara,<sup>1</sup> Fumiaki Ando,<sup>1</sup> Daisuke Oikawa,<sup>3</sup> Koichiro Ichimura,<sup>2</sup> Tamami Fujiki,<sup>1</sup> Shintaro Mandai,<sup>1</sup> Takayasu Mori,<sup>1</sup> Koichiro Susa,<sup>1</sup> Eisei Sohara,<sup>1</sup> Tatemitsu Rai,<sup>1</sup> Fuminori Tokunaga,<sup>3</sup> Shinichi Uchida.<sup>1</sup> <sup>1</sup>Tokyo Ika Shika Daigaku, Bunkyo-ku, Japan; <sup>2</sup>Juntendo Daigaku Igakubu Daigakuin Igaku Kenkyuka, Bunkyo-ku, Japan; <sup>3</sup>Osaka Koritsu Daigaku Igakubu Daigakuin Igaku Kenkyuka, Osaka, Japan.

**Background:** Protein kinase A (PKA) directly phosphorylates aquaporin-2 (AQP2) water channels in renal collecting ducts to reabsorb water from urine for the maintenance of systemic water homeostasis. Over 50 functionally distinct PKA-anchoring proteins (AKAPs) respectively create compartmentalized PKA signaling to determine the substrate specificity of PKA. Identification of an AKAP responsible for AQP2 phosphorylation is an essential step toward elucidating the molecular mechanisms of urinary concentration.

**Methods:** PKA activation by several compounds is a novel screening strategy to uncover PKA substrates whose phosphorylation levels were well correlated with that of AQP2. The leading candidate in this assay proved to be an AKAP termed lipopolysaccharide-responsive and beige-like anchor protein (LRBA). We generated *Lrba* knockout mice to examine pathophysiological roles of LRBA.

**Results:** LRBA colocalized with AQP2 at the same intracellular vesicles in the subapical region of renal collecting ducts. AQP2 phosphorylation at S256 and S269 via vasopressin / cAMP / PKA signaling was severely impaired in *Lrba* knockout mice, leading to the defective AQP2 trafficking to the apical plasma membrane. *Lrba* knockout mice showed water diuresis and subsequent compensatory increase in serum vasopressin levels. Urine osmolality did not elevate even by the administration of exogenous vasopressin. Most of the PKA substrates other than AQP2 were adequately phosphorylated by PKA in the absence of LRBA, demonstrating that LRBA-anchored PKA preferentially phosphorylated AQP2 in renal collecting ducts.

**Conclusions:** LRBA is the first PKA-anchoring protein discovered to be crucial for PKA-induced AQP2 phosphorylation and urinary concentration.

**Funding:** Government Support - Non-U.S.

## TH-PO340

## Insulin-Regulated Aminopeptidase Is Required for Appropriate Dilution of Urine After Acute Hypotonic Stress

Yvonne Zuchowski, Andrew S. Terker, Raymond C. Harris, Juan Pablo Arroyo Ornelas. Vanderbilt University Medical Center, Nashville, TN.

**Background:** Vasopressin is a peptide hormone that regulates water balance and acts on the type 2 vasopressin receptor (V2R) to stimulate water reabsorption in the kidney via the water channel aquaporin-2 (AQP2). The insulin-regulated aminopeptidase (IRAP) is a zinc-dependent aminopeptidase that degrades vasopressin. However, the impact of IRAP KO on water balance is unknown.

**Methods:** Adult (8-12 week) IRAP wildtype (WT) and KO male mice were used for experimentation (4-6/group). Immunofluorescence and immunoblotting were performed on kidneys at baseline to localize IRAP and assess AQP2 protein amount. Urine and plasma electrolytes were measured before and after water load (1ml sterile water/IP) or 24hr water restriction. Urine osmolality was measured in IRAP KO before and after administration of the V2R antagonist, OPC 31260 (10mg/kg/IP).

**Results:** IRAP was expressed in the glomerulus, the loop of Henle, and the collecting tubules. At baseline, IRAP KO mice had increased urine osmolality (1995 vs 781 p<0.01 mOsm/L) and elevated copeptin (110 vs 53 p<0.05 pg/ml), but total AQP2 protein expression (1.10 vs. 1.00 p=NS) was not different between WT and KO mice. After 24hr water restriction, urine osmolality increased in both WT (781 to 3626 mOsm/L p<0.0001) and KO mice (1995 to 4200 mOsm/L p<0.001), but there were no differences between groups. However, after acute water load, urine osmolality in WT mice decreased (987 vs 380 mOsm/L p<0.05) but not in IRAP KO mice (3280 vs 2801 mOsm/L p=NS). Treatment with OPC31260 decreased urine osmolality in IRAP KO mice (221 vs 1067 p<0.05). Additionally, serum sodium levels after water load were lower in IRAP KO compared to WT (127 vs 133 mEq/L p<0.05).

**Conclusions:** At baseline, IRAP KO mice have higher urine tonicity and higher copeptin than WT mice. Urine osmolality is similar between groups after 24hr water restriction suggesting normal concentrating ability. However, IRAP KOs are unable to dilute their urine in response to an acute water load. Treatment with a V2R antagonist decreased urine osmolality in IRAP KO, suggesting that persistent V2R activation contributes to the baseline elevated urine osmolality in IRAP KO mice.

**Funding:** NIDDK Support, Private Foundation Support

## TH-PO341

## Tight Junction Component-Encoding Gene Regulation in Renal Collecting Duct Principal Cells

Shuang Cao,<sup>1,2</sup> Janna Leiz,<sup>1</sup> Christian Hinze,<sup>1,2</sup> Kai M. Schmidt-Ott.<sup>1,2</sup> <sup>1</sup>Charité Universitätsmedizin Berlin, Berlin, Germany; <sup>2</sup>Max Delbrück Center, Berlin, Germany.

**Background:** Tight junctions mediate epithelial barrier characteristics and paracellular transport. In renal collecting ducts, the molecular composition of tight junctions is important for the renal regulation of osmolality and electrolyte balance. It is incompletely understood how gene regulatory networks in collecting duct principal cells control tight junction component-encoding gene expression.

**Methods:** We conducted bioinformatic predictions based on mouse and human single-nuclei sequencing data sets and performed in situ hybridization on mouse kidney sections and CRISPRi-based knockdown experiments in inner medullary collecting duct (IMCD3) cells.

**Results:** Renal single-cell regulatory network prediction based on coregulation and motif enrichment identified a series of candidate collecting duct principal cell transcription factors predicted to be important for tight junction-encoding gene regulation, which included the transcription factor Ets homologous factor (Ehf). In situ hybridization validated co-expression of Ehf and its predicted target claudin 7 (Cldn7) in mouse collecting ducts *in vivo*. *In vitro* CRISPRi-mediated knockdown of Ehf in IMCD3 cells was successfully achieved and its effects on tight junction component-encoding gene expression are currently being evaluated.

**Conclusions:** Preliminary data suggest that the transcription factor Ehf regulates tight junction component-encoding genes in collecting duct principal cells.

**Funding:** Government Support - Non-U.S.

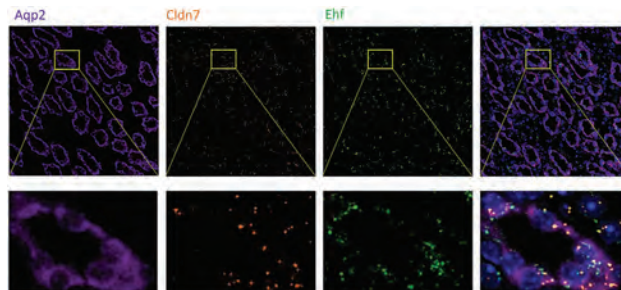

In situ hybridization validate co-expression of Ehf and Cldn7

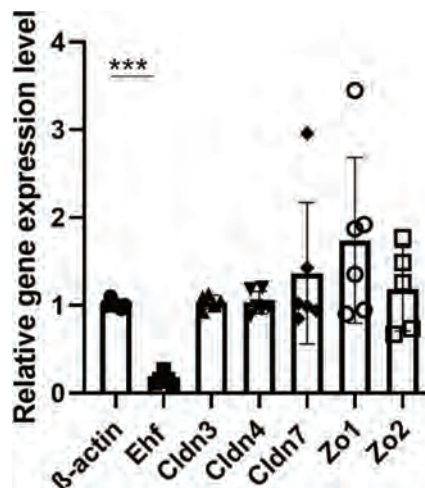

Ehf knockdown show the mRNA level change of TJs

## TH-PO342

## Regulation of Glomerulotubular Balance IV: Implication of Aquaporin 1 in Flow-Dependent Proximal Tubule Transport and Cell Volume

Zhaopeng Du,<sup>1</sup> Qingshang Yan,<sup>1</sup> Alan M. Weinstein,<sup>2</sup> Tong Wang.<sup>1</sup> <sup>1</sup>Yale School of Medicine, New Haven, CT; <sup>2</sup>Weill Medical College of Cornell University, New York, NY.

**Background:** In proximal tubule (PT), glomerulotubular balance (GTB) derives from the impact of axial flow to regulate  $\text{Na}^+$  and  $\text{HCO}_3^-$  transport by modulating luminal membrane NHE3 and H-ATPase activity with little change of cell volume. The water channel, aquaporin-1 (AQP-1) is the principal water pathway for isotonic water absorption in the kidney proximal tubule.

**Methods:** We investigated flow-mediated fluid ( $J_v$ ) and  $\text{HCO}_3^-$  ( $J_{\text{HCO}_3^-}$ ) absorption in proximal tubules ( $S_1$ ) of mouse kidney by microperfusion *in vitro* in wild-type (WT) and AQP-1 KO mice. The PTs ( $S_2$ ) were isolated and perfused in vitro under low (5nl/min) and high (20nl/min) perfusion rates and the  $J_v$  and  $J_{\text{HCO}_3^-}$  were measured. The experiments were simulated in an adaptation of a mathematical model of rat PT.



**Results:** An increase in perfusion rate from 5 to 20 nl/min increased  $J_v$  by 73% and  $J_{\text{HCO}_3}$  by 106% in proximal tubules of WT mice. AQP-1 knockout significantly decreased  $J_v$  by 28% and 72% at low and high flow rates respectively compared with WT control. In contrast, the  $J_{\text{HCO}_3}$  was not reduced at either low or high flow rates. The fractional increase in  $J_v$  by flow was completely abolished, but fractional increase in  $J_{\text{HCO}_3}$  was not reduced by AQP-1 KO. The cell volume showed no significant difference at either low or high flow rates or between WT and AQP-1 KO mice. In addition, renal clearance experiments showed significantly higher urine flow in KO mouse but there was no significant difference in either  $\text{Na}^+$  and  $\text{K}^+$  excretion or  $\text{HCO}_3^-$  excretion. The acid-base parameters of blood pH,  $\text{PCO}_2$ ,  $\text{HCO}_3^-$  and urine pH were the same in both WT and KO mouse. In model calculations, tubules whose tight junction (TJ) Pf was that assigned to rat TJ, showed no difference in  $J_v$  between WT and KO; whereas TJ Pf set to 25% of rat, predicted  $J_v$  concordant with our observations from AQP1 KO.

**Conclusions:** These results affirm the dominance of AQP-1 in mediating isotonic water absorption by mouse PT and demonstrate that flow-stimulated  $\text{HCO}_3^-$  reabsorption is intact and independent of AQP-1. With reference to the model, the findings also suggest that tight junctional water flux in proximal tubule is less prominent in mouse than in rat kidney.

**Funding:** NIDDK Support

## TH-PO343

### TAZ Regulates the Vasopressin-Induced AQP2 Trafficking and Protein Expression in Kidney Collecting Duct Cells

Hong Seok Choi, Hyo-Ju Jang, Tae-Hwan Kwon. *Kyungpook National University School of Medicine, Daegu, Republic of Korea.*

**Background:** Aquaporin-2 (AQP2) is the vasopressin-regulated water channel protein in the kidney collecting duct (CD) cells. Transcriptional coactivator with PDZ-binding motif (TAZ) is a downstream effector of the hippo signaling pathway. TAZ regulates the expression of target genes by acting as a transcription cofactor and acts as a mechanotransducer that detects various cell responses. Since TAZ is known to regulate the activity of Tonically-Responsive Enhancer Binding Protein (TonEBP), a transcription factor of AQP2, and to affect the arrangement of the cytoskeleton, we aimed to study the role of TAZ in the vasopressin-induced AQP2 trafficking and protein abundance.

**Methods:** 1) siRNA-mediated knockdown of TAZ in mpkCCDc14 cells; 2) immunocytochemistry of AQP2; 3) qRT-PCR and semiquantitative immunoblotting of AQP2.

**Results:** To induce AQP2 expression in mpkCCDc14 cells, cells were pretreated with dDAVP ( $10^{-9}$ M) for 48 h, and dDAVP stimulation was withdrawn for the next 6 h for the experiments. When the cells were treated again with dDAVP ( $10^{-9}$ M) for 15 and 30 min, AQP2 was translocated to the cell membrane. In contrast, the AQP2 trafficking was markedly attenuated, and it was mainly observed in the cytoplasm in the cells with siRNA-mediated TAZ knockdown (TAZ-KD). Phalloidin staining demonstrated that stress fiber formation was markedly enhanced in the TAZ-KD, suggesting that excessive stress fiber formation is likely to inhibit AQP2 trafficking. To study the changes of AQP2 mRNA and protein abundance, cells were treated with dDAVP ( $10^{-9}$  M) for 12 h. In the control mpkCCDc14 cells, dDAVP induced AQP2 mRNA ( $3,575 \pm 477\%$  of the control) and AQP protein ( $270 \pm 18\%$ ). In contrast, the dDAVP-induced increase of AQP2 mRNA ( $50 \pm 5\%$  of the control) and protein abundance ( $99 \pm 17\%$ ) was not observed in TAZ-KD. In addition, to avoid the effects of dDAVP pretreatment, cells were stimulated with dDAVP ( $10^{-9}$ M, 24 h) without the periods of pretreatment and withdrawal. Semiquantitative immunoblotting revealed that dDAVP increased AQP2 protein abundance in the control, whereas it was not observed in TAZ-KD. TonEBP was significantly decreased ( $52 \pm 4\%$ ) in TAZ KD.

**Conclusions:** TAZ knockdown is associated with an inhibition in AQP2 trafficking, at least partly, due to an excessive stress fiber formation, and downregulation of AQP2, possibly via decreased TonEBP expression.

**Funding:** Government Support - Non-U.S.

## TH-PO344

### Tamoxifen Affects Regulation and Localization of AQP3 and AQP4 in Response to Lithium-Induced Nephrogenic Diabetes Insipidus and Unilateral Ureteral Obstruction in Rats

Stine Julie Tingskov,<sup>1</sup> Mariagrazia D'Agostino,<sup>2</sup> Frédéric H. Login,<sup>1</sup> Lene N. Nejsum,<sup>1</sup> Rikke Norregaard.<sup>1</sup> The Nørregaard Lab <sup>1</sup>Aarhus Universitet, Aarhus, Denmark; <sup>2</sup>Universita degli Studi di Bari Aldo Moro, Bari, Italy.

**Background:** Estrogen is known to play a role in the regulation of water homeostasis, and it has been shown that estrogen affects AQP2 expression. Previously, we have demonstrated that the selective estrogen receptor modulator, tamoxifen (TAM) regulates AQP2 in different animal models, namely the lithium-induced nephrogenic diabetes insipidus (NDI) model and the unilateral ureteral obstruction (UUO) CKD model. AQP3 and AQP4 are also affected in response to NDI and UUO. However, it is not known whether TAM influences AQP3 and AQP4 levels and cellular localization.

**Methods:** In the first model rats were treated for 14 days with lithium to induce NDI and TAM treatment (25 and 50 mg/kg by oral gavage) was initiated one week after onset of lithium administration. For the second model rats were subjected to 7 days of UUO. Tamoxifen (50 mg/kg) was given 5 days before the operation and was continued for 7 days after UUO. Levels and cellular localization of AQP3 and AQP4 were evaluated by immunohistochemistry and western blot analysis. To study the intracellular localization and trafficking of AQP3, Madin-Darby Canine Kidney (MDCK) cells stably expressing AQP3 (AQP3-EGFP) were treated with either LiCl or TGF- $\beta$  alone or combined to TAM.

**Results:** Western blot analysis showed that lithium treatment decreased AQP3 total protein levels, which was not significantly affected by TAM. However, TAM affects AQP3 localization to be more lateral in lithium-treated rats. After UUO, AQP3 and AQP4 protein levels were reduced, which was attenuated by TAM. Immunohistochemistry analysis confirmed these results. In AQP3-MDCK cells, AQP3 localized mainly within the cytoplasm after LiCl and TGF- $\beta$  treatment. In the presence of TAM, AQP3 seems to relocalize into the plasma membrane.

**Conclusions:** These findings indicate that TAM affects the localization of AQP3 in Li-exposed rats and MDCK cells. TAM also prevents downregulation of inner medullary AQP3 and AQP4 in UUO rats. Therefore, TAM might have a therapeutic potential in obstruction-associated dysregulation of fluid metabolisms.

## TH-PO345

### Nephrogenic Diabetes Insipidus a Rare Complication of Renal Tubular Acidosis

Alexandra Rosario Aulet,<sup>1,2</sup> Adrián A. Miró C6,<sup>2</sup> Jose Torres Cintron.<sup>1</sup> <sup>1</sup>Sistema de Salud Episcopal San Lucas, Ponce, Puerto Rico; <sup>2</sup>Hospital San Cristobal, Ponce, Puerto Rico.

**Introduction:** Hypokalemia is a common electrolyte disturbance, seen in hospitalized patient caused by either gastrointestinal or urinary losses. Although uncommon, the latter can occur due to renal tubular acidosis type 1 (RTA type 1), a disorder characterized by impaired distal tubular acidification leading to hypokalemia, nephrocalcinosis and recurrent renal stones. Severe hypokalemia, in turn, can lead to cardiac arrhythmias, weakness, paralysis, rhabdomyolysis, respiratory failure, and nephrogenic diabetes insipidus (DI).

**Case Description:** This is the case of a 50-year-old Hispanic female patient with a past medical history of systemic lupus erythematosus, lupus nephritis by kidney biopsy (type V membranous), chronic kidney disease stage G1/A3, nephrolithiasis, hypertension, and diabetes mellitus type 2 who presented to the emergency department due to a progressive flaccid paralysis ultimately requiring intubation for airway protection. Her laboratory work up was remarkable for severe hypokalemia (1.5mmol/L), hyperchloremia (128.70mmol/L), metabolic acidosis (pH:7.2), urinary alkalosis (pH of 7.0) and a positive urinary anion gap (37mmol/L), all compatible with the diagnosis of RTA type 1. Despite efforts to improve hypokalemia, patient's potassium levels remained critically low and she developed polyuria (5.5 L/day) which in turn resulted in severe hypernatremia. The diagnosis of nephrogenic DI was made, and the patient was treated with amiloride, aggressive intravenous fluid and electrolyte replacements. Eventually, with complete resolution of symptoms and plans of discharge.

**Discussion:** Nephrogenic DI is an uncommon complication of RTA type 1, triggered by severe electrolyte disturbances, in this case severe hypokalemia. Treatment of choice for Nephrogenic DI would be hydrochlorothiazide, but taking into account patients prevalent severe hypokalemia amiloride was prescribed. We want to bring into light the importance of diagnosing and treating of severe electrolyte disturbances to avoid severe complications as seen in nephrogenic DI, as seen in this patient.

## TH-PO346

### Hyponatremia Secondary to SIADH in a Patient With a Meningioma

Sarah Monaghan, Samantha Peterson, Chetachi E. Odelugo, Bradley S. Coolidge, Tauseef A. Sarguroh. *Franciscan Health Inc, Mishawaka, IN.*

**Introduction:** Severe hyponatremia, defined by a serum sodium less than 120 meq/L, is a serious and life-threatening electrolyte imbalance that may result in severe neurologic complications if not carefully managed. A common etiology is syndrome of inappropriate antidiuretic hormone secretion (SIADH) characterized by euvolemic hyponatremia in the setting of hypotonic serum and hyperosmolar urine. This is caused by increased antidiuretic hormone (ADH) from either the pituitary or ectopic source in the absence of stimuli, and results in impaired water excretion due to the inability to suppress ADH. While tumors are often associated with SIADH, a rare association is with a meningioma, as presented in this case.

**Case Description:** An 81 year old female with Hypertension not on a thiazide diuretic presented with weakness and fatigue. She was found to have severe symptomatic hyponatremia. Her initial serum sodium was 114 meq/L, serum osmolality was 257 mosm/kg, urine sodium was 49 mmol/L and urine osmolality was 433 mosm/kg. Further work up showed cortisol of 20.3 ug/dL and TSH of 1.57. Patient was euvolemic on physical exam and was given 100 mL bolus of 3% saline on presentation. Over the course of her admission, serum sodium improved with fluid restriction alone. A CT brain showed a 1.9 cm extra-axial calcified mass along the left frontal dura consistent with a meningioma. Patient's sodium gradually improved without complications and she was discharged.

**Discussion:** This case highlights a rare presentation of severe hyponatremia from SIADH due to a meningioma. SIADH may be from a medication, central nervous system disturbances, or malignancies/tumors. In addition to treating hyponatremia, it is important for physicians to consider further workup of underlying malignancy or tumors in the absence of common causes of SIADH.



## TH-PO347

**WNK1 Is a Chloride-Sensing Scaffold That Potently Regulates mTORC2 Activity and ENaC**

Bidisha Saha,<sup>1</sup> Deise C. Leite-Dellova,<sup>1,2</sup> Enzo Takagi,<sup>1</sup> John E. Demko,<sup>1</sup> Waheed Shabbir,<sup>1</sup> David Pearce.<sup>1</sup> <sup>1</sup>University of California San Francisco, San Francisco, CA; <sup>2</sup>Universidade de Sao Paulo Faculdade de Medicina Veterinaria e Zootecnia, Sao Paulo, Brazil.

**Background:** mTORC2 is a multiprotein signaling complex that regulates a variety of cellular processes induced by hormones and growth factors. Recent evidence suggests that mTORC2 is also involved in cell autonomous action, as it responds to local extracellular  $K^+$  concentration to rapidly stimulate SGK1 phosphorylation and downstream target, ENaC, an epithelial sodium channel, in renal epithelial cells. Here we show that WNK1 has a pivotal role in mediating cell autonomous responses to local  $K^+$  concentration that activates mTORC2.

**Methods:** We generated WNK1 knockout mpkCCD cells and WNK1 and SIN1 (a component of mTORC2 complex) double knockout HEK293 cells using CRISPR/Cas9 system. mpkCCD cells were grown on Transwell filters and incubated in media containing different  $[K^+]$ , with or without WNK kinase inhibitor. Amiloride-sensitive current was measured before the cells were processed for immunoblot analysis. For intracellular  $Cl^-$  measurement, HEK293 cells were transfected with mCl-YFP plasmid and fluorescence signals were measured and analyzed. For modulation of intracellular  $[Cl^-]$ , cells were incubated in media containing different  $[Cl^-]$  and ionophores. Cells were then processed for immunoblot and Co-IP analysis.

**Results:** Our results showed that the effect of extracellular  $K^+$  on SGK1 phosphorylation and ENaC activity is dependent on elevated intracellular  $[Cl^-]$  and on presence of chloride-binding protein kinase WNK1, but not on its kinase activity. Intracellular  $Cl^-$  stimulates the scaffolding activity of WNK1, which physically interacts with both SGK1 and mTORC2 and enhances SGK1 recruitment to mTORC2. This results in a selective increase in SGK1 phosphorylation, and activation of ENaC which drives  $K^+$  secretion.

**Conclusions:** These findings establish a novel mode of chloride-regulated WNK1 action that regulates mTORC2 activity selectively towards SGK1 phosphorylation and ENaC activation, independently of its kinase activity and reveals a dual role of WNK1's  $Cl^-$ -sensing property on epithelial ion transport regulation: one, low  $[Cl^-]$ -dependent activation of NCC through catalytic mechanism and the second, high  $[Cl^-]$ -dependent activation of ENaC through non-catalytic scaffolding mechanism; the coupling of both pathways is significantly implicated in DCT2, controlling  $K^+$  secretion.

**Funding:** NIDDK Support

## TH-PO348

**WNK1 Is a Central Osmolality Sensor for Arginine Vasopressin (AVP) Release**

Xin Jin, Jian Xie, Chou-Long Huang. Department of Medicine, Division of Nephrology, University of Iowa Carver College of Medicine, Iowa City, IA.

**Background:** Terrestrial animals are subject to constant stress of water deprivation. Maintaining internal osmolality constancy is essential for life. The circumventricular organs (CVO's) of brain including the organum vasculosum of the lamina terminalis (OVLT) and subfornical organ (SFO) lack a blood-brain barrier. Neurons in OVLT and SFO detect increases in serum osmolality (tonicity) that stimulates the production of AVP in paraventricular nuclei (PVN) to be released in the posterior pituitary. Current hypothesis for osmolality sensors focuses on mechanosensitive membrane proteins. The role of intracellular molecules is unknown.

**Methods:** Metabolic cage studies were performed in mice with neuronal-specific conditional knockout (cKO) of Wnk1, mice in which WNK1 in OVLT is deleted by stereotaxic injection of Cre-recombinase carrying retrograde AAV virus injected into PVN, and mice in which Kv3.1 channel on OVLT is knock down by injection of shRNA. Urine output, water intake, serum, urine osmolality, serum AVP and copeptin levels were measured. Action potential in OVLT neurons is recorded in isolated brain slice recording.

**Results:** WNK1 kinase in OVLT is activated by water restriction evident by increased serine-382 phospho-WNK1. Neuronal-specific cKO of Wnk1 causes polyuria with decreased urine osmolality that persists in water restriction. Circulating levels of AVP and copeptin are lower in water-restricted cKO mice versus controls. Neuronal tracing using retrograde virus reveals that WNK1 localized in PVN-projecting OVLT neurons is responsible. Hyperosmolality-induced increases in action potential firing in OVLT neurons is blunted by Wnk1 deletion or pharmacological WNK inhibitors. Knockdown of Kv3.1b channel in OVLT by shRNA reproduces the phenotypes.

**Conclusions:** WNK1 in OVLT detects extracellular hypertonicity leading to AVP release by activating Kv3.1 and increasing action potential firing through OVLT→PVN neuronal network. Our results provide novel insights that an intracellular protein kinase WNK1 functions as an osmosensor for extracellular tonicity. They support the biophysical studies that extraction of water from the catalytic core of WNK kinase domain activates kinase activity.

**Funding:** NIDDK Support

## TH-PO349

**Dietary Magnesium Ion ( $Mg^{2+}$ ) Restriction Reduces Epithelial Sodium Channel (ENaC) Activity**

Yujiro Maeoka, Avika Sharma, Luan T. Nguyen, James A. McCormick. Oregon Health & Science University, Portland, OR.

**Background:** Hypokalemia occurs in 40 to 60% of patients with hypomagnesemia, and can result in cardiac arrhythmia and sudden death. Along the distal nephron, a decrease in intracellular  $Mg^{2+}$  releases the  $Mg^{2+}$ -mediated inhibition of renal outer medullary  $K^+$  (ROMK) channels and increases  $K^+$  secretion. However, several animal studies have shown that hypomagnesemia alone cannot cause hypokalemia. Epithelial sodium channel (ENaC)-mediated sodium entry provides the driving force for  $K^+$  secretion via ROMK, but how hypomagnesemia affects ENaC activity remains unknown. We tested the hypotheses that (i) dietary  $Mg^{2+}$  restriction lowers ENaC activity, maintaining  $K^+$  homeostasis, and (ii) combined  $Mg^{2+}/Na^+$  restriction activates ENaC, causing hypokalemia.

**Methods:** To assess ENaC activity during  $Mg^{2+}$  restriction, we performed Western blot for ENaC and an amiloride response test using C57/BL6 mice fed normal (NL) [ $Mg^{2+}$  0.15% (wt/wt); NaCl ~0.49%] or low  $Mg^{2+}$  (LM) [ $Mg^{2+}$  0.0015–0.003% (wt/wt); NaCl ~0.49%] diets for 3 days. To evaluate the interaction with low  $Na^+$  intake, which stimulates aldosterone secretion, we analyzed plasma  $[K^+]$  and ENaC activity using mice fed NL or combined low sodium and low  $Mg^{2+}$  (LS/LM) [ $Mg^{2+}$  0.0015–0.003% (wt/wt),  $Na^+$  ~0.000007%] diets for 7 days.  $K^+$  content was the same in each diet [ $K^+$  ~0.8% (wt/wt)].

**Results:** The abundances of cleaved  $\alpha$ - and  $\gamma$ -ENaC, which correlate with ENaC activity, were lower on a LM diet compared with NL diet. Amiloride response test showed a milder natriuretic effect on a LM diet, suggesting lower ENaC activity. In addition, plasma [ $Mg^{2+}$ ] correlated with cleaved  $\alpha$ -ENaC abundance, but not plasma  $[K^+]$  levels. In contrast, mice fed a LS/LM diet exhibited lower plasma  $[K^+]$  levels compared with mice fed NL or LS diets. Cleaved  $\alpha$ - and  $\gamma$ -ENaC abundances on LS/LM diet were similar to NL diet.

**Conclusions:** Together, these suggest that ENaC activity is lower following dietary  $Mg^{2+}$  restriction but higher with combined  $Mg^{2+}/Na^+$  restriction, suggesting higher plasma aldosterone is required to stimulate  $K^+$  secretion. This likely explains why  $Mg^{2+}$  restriction alone cannot cause hypokalemia *in vivo*, and provides new insights into the mechanisms of hypomagnesemia-induced hypokalemia.

**Funding:** NIDDK Support

## TH-PO350

**Regulation of SGK1 Phosphorylation and Activity by mTORC2**

Enzo Takagi, Junliang Chen, Feng Wang, Bidisha Saha, David Pearce. University of California San Francisco, San Francisco, CA.

**Background:** mTORC2 is a multi-subunit kinase complex comprising core components mTOR kinase, Rictor, mSin1 and mLST8, which has received increasing attention during recent years. The principal direct targets of mTORC2 phosphorylation include Akt (known for glucose regulation) and SGK1 (known for regulation of renal

tubule ion transporters, particularly ENaC). However, structural information regarding mTORC2 has been limited, particularly in the context of SGK1 regulation. To gain greater structural insight into mTORC2 in the context of phosphorylating SGK1 we used cryo-EM complemented by mTORC2 kinase assays.

**Methods:** Core mTORC2 subunits were expressed in Expi293F cells and purified and cryo-EM grids prepared. Cryo-EM was performed using Krios at SLAC for high energy electrons for density maps of human mTORC2. Structures were solved for apo-complex at overall 3.23 Å resolution, and for co-complex with SGK1 at 3.38. Structural data predicted functional importance of mSin1-Arg-83, which was investigated through kinase assays in mSin1-deficient HEK293T cells transfected with WT and Arg-83-Ala mutant mSin1.

**Results:** The overall shape of mTORC2 in the SGK1 co-complex was similar to the apo-complex. Interestingly, the conformation of the mSin1 N-terminal domain was markedly altered in the SGK1 co-complex compared with the apo. First, an extended domain of mSin1 upstream of Arg-83 became unobservable, likely due to increased flexibility. Second, the Arg-83 side chain showed a large rotation toward a negatively charged patch within Rictor, appears to form a salt bridge with Rictor Asp-1679. Kinase assays performed using mTORC2 expressed in mSin1-deficient HEK-293T cells further supported the importance of mSin1 Arg-83: an Ala mutant of that residue selectively disrupted SGK1 phosphorylation, but not that of Akt.

**Conclusions:** These findings provide new structural and functional insights into mTORC2 substrate-specific activities and suggest new testable predictions, particularly with respect to mTORC2 regulation of SGK1 and ENaC. Further, these findings provide a potential avenue toward highly selective mTOR modulators with potential clinical utility.

**Funding:** NIDDK Support

### TH-PO351

#### Genetic and Physiological Effects of Insulin-Like Growth Factor-1 (IGF-1) on Human Urate Homeostasis

David B. Mount,<sup>1,2</sup> Megan P. Leask,<sup>3</sup> Tony Merriman,<sup>3</sup> Asim Mandal.<sup>1</sup>  
<sup>1</sup>Brigham and Women's Hospital, Boston, MA; <sup>2</sup>Veterans Affairs Boston Healthcare System, Boston, MA; <sup>3</sup>Division of Rheumatology and Clinical Immunology, University of Alabama, Birmingham, AL.

**Background:** Metabolic syndrome and hyperinsulinemia are associated with hyperuricemia. Insulin infusion in healthy volunteers elevates serum urate (SU) by activating net urate reabsorption in the renal proximal tubule, whereas IGF-1 infusion reduces SU by mechanisms unknown. Variation within the *IGF1R* gene also impacts on SU levels.

**Methods:** Co-localization analyses of SU GWAS signal at *IGF1R* and eQTL signals in *cis* using COLOC2; RT-PCR, Western blotting, and urate transport assays in a proximal tubule cell line, transfected HEK 293T cells, and *Xenopus laevis* oocytes.

**Results:** Genetic association at *IGF1R* with SU is stronger in women and is mediated by control of *IGF1R* expression. Epistatic interaction between *IGF1R* and each of *SLC2A9* and *ABCG2* was found to affect SU differentially between men and women. IGF-1, via IGF-1R, stimulated urate uptake in human renal proximal tubule epithelial cells (PTC-05) and transfected HEK 293T cells, through activation of IRS1, PI3K/Akt, MEK/ERK and p38 MAPK; urate uptake was inhibited in the presence of uricosuric drugs, specific inhibitors of protein tyrosine kinase (PTK), PI3 kinase (PI3K), ERK and p38 MAPK. In *Xenopus laevis* oocytes expressing individual urate transporters, IGF-1 via endogenous IGF-1R stimulated urate transport mediated by GLUT9, OAT1, OAT3, ABCG2 and ABCC4 and inhibited insulin's stimulatory action on GLUT9a and OAT3. IGF-1 significantly activated Akt and ERK and IGF-1-stimulation of urate transport was significantly affected by specific inhibitors of PI3K, ERK and PKC in oocytes.

**Conclusions:** The combined results of infusion, genetics, and transport experiments suggest that IGF-1 reduces SU by activating urate secretory transporters and inhibiting insulin's action. IGF-1 antagonizes the effects of insulin on urate transporters, indicating complex interactions in hyperuricemia associated with metabolic syndrome and hyperinsulinemia.

**Funding:** Other NIH Support - NIAMS

### TH-PO352

#### Caffeine Inhibits Basal and Insulin-Activated Urate Transport

David B. Mount,<sup>1,2</sup> Asim Mandal.<sup>1</sup> <sup>1</sup>Brigham and Women's Hospital, Boston, MA; <sup>2</sup>Veterans Affairs Boston Healthcare System, Boston, MA.

**Background:** Caffeine inhibits insulin signaling and has beneficial effects in metabolic syndrome/hyperinsulinemia. Coffee drinking also has beneficial effects in gout, via mechanisms unknown. We hypothesized that caffeine would specifically block insulin-activated urate transport, which in turn mediates the association between hyperinsulinemia and hyperuricemia.

**Methods:** We examined the effect of caffeine and adenosine on <sup>14</sup>C-urate transport in absence and presence of insulin, on activation of insulin signaling pathways in human renal epithelial cell line (PTC-05), and on individual urate transporters expressed in *Xenopus laevis* oocytes.

**Results:** We found that both caffeine and adenosine inhibited both basal and insulin-stimulation of net <sup>14</sup>C-urate uptake in PTC-05 proximal tubular cells. In *Xenopus laevis* oocytes expressing individual urate transporters, caffeine efficiently inhibited the basal urate transport activity of GLUT9 isoforms, OAT4, OAT1, OAT3, NPT1, ABCG2 and ABCC4 at >0.2 mM; adenosine had weaker effects on basal urate transport. The IC-50 of caffeine for basal urate transport was 613 μM for GLUT9a, 1080 μM for GLUT9b, 145 μM for OAT1, 8 μM for murine OAT3, 582 μM for OAT10, and 4860 μM for URAT1. Caffeine at lower concentrations (<0.2 mM) very effectively inhibited insulin-activation

of urate transport activity of GLUT9, OAT10, OAT1, OAT3, NPT1, ABCG2 and ABCC4, with concomitant inhibition of insulin-activated Akt and ERK phosphorylation. For example, the IC-50 of caffeine for insulin-activated GLUT9a urate transport was 205 μM. In contrast, adenosine had no effect on insulin-activated Akt and ERK phosphorylation.

**Conclusions:** Caffeine and adenosine inhibit basal urate transport mediated by multiple urate transporters. Caffeine also potentially inhibits insulin-activated urate transport, with a significantly lower IC-50 for GLUT9a insulin-activated transport versus basal transport. To the extent that GLUT9a is postulated to be the major insulin-activated reabsorptive pathway for urate in the proximal tubule (Front Physiol. 2021 Aug 2;12:713710), caffeine potentially provides a unique *in vivo* probe for insulin-activated renal urate reabsorption. Additionally, these results provide an explanation for the beneficial effects of caffeine in gout, worthy of further exploration.

**Funding:** Other NIH Support - NIAMS

### TH-PO353

#### Molecular Simulation of the R154H Variation in Calcium Channel TRPV5 Associated With Kidney Stone Disease

Lingyun Wang, Ji-Bin Peng. *Division of Nephrology, Department of Medicine, Nephrology Research and Training Center, University of Alabama at Birmingham, Birmingham, AL.*

**Background:** TRPV5 is a calcium channel that is essential for active calcium reabsorption in the kidney. Recent studies reveal that a single nucleotide polymorphism (rs4236480) in the TRPV5 gene is associated with the calcium stone multiplicity in patients from Taiwan and calcium stone risk in patients from India. The rs4236480 variation results in an arginine to histidine change in amino-acid position 154 (R154H) at the ankyrin repeat domain of TRPV5. Our previous study shows that the R154H variation slightly reduces the calcium transport activity of TRPV5, although the reduction did not reach statistical significance. A potentially small functional difference caused by the R154H variation may be challenging to detect using biochemical and physiological approaches. Thus, the molecular simulation approach was employed to assess the structural impact of this variation on the TRPV5 channel.

**Methods:** The model of human TRPV5 in complex with phosphatidylinositol 4,5-bisphosphate (PIP<sub>2</sub>) was set up based on the Cryo-EM structure of rabbit TRPV5 with dioctanoyl PIP<sub>2</sub>. To mimic the membrane environment, the modeled TRPV5 was embedded in a lipid bilayer composed of 307 1-palmitoyl-2-oleoyl-sn-glycero-3-phosphocholine lipids using CHARMM-GUI web server, and then water molecules and counterions were added on both sides of the bilayer. The R154H variation was then introduced into the model. Three 100-ns independent molecular dynamics simulations were performed for the TRPV5 model with and without the variation using AMBER18.

**Results:** Structural analysis reveals that R154 in two of the four subunits forms a hydrogen bond with E250, which also forms a hydrogen bond with K301. This hydrogen bond network not only stabilizes the dynamics of K301 but also those of the adjacent residues R302 and R305. However, when the R154H variation is introduced into the TRPV5 model, the hydrogen bond network is disrupted and the dynamical flexibility of R302 and R305 is increased. Since R302 and R305 are involved in the binding of PIP<sub>2</sub>, the binding between PIP<sub>2</sub> and the channel was assessed by the binding free energy. Our results indicate that the R154H variation results in a modest yet significant reduction in binding free energy between the TRPV5 channel and PIP<sub>2</sub>.

**Conclusions:** The R154H variation alters the function of TRPV5 at least in part by weakening the binding of PIP<sub>2</sub> to the channel.

**Funding:** NIDDK Support

### TH-PO354

#### Experimental CKD Increases Per-Nephron Sodium Reabsorption and Impairs Acute Kaliuresis

Kuangyu Wei,<sup>1</sup> Martin Gritter,<sup>1</sup> Hester van Willigenburg,<sup>1</sup> Joris I. Rotmans,<sup>2</sup> Ewout J. Hoorn.<sup>1</sup> <sup>1</sup>Erasmus MC, Rotterdam, Netherlands; <sup>2</sup>Leids Universitair Medisch Centrum, Leiden, Netherlands.

**Background:** Chronic kidney disease (CKD) predisposes to salt-sensitive hypertension and hyperkalemia. This suggests alterations in tubular sodium (Na<sup>+</sup>) and potassium (K<sup>+</sup>) handling, but how CKD changes this is unclear.

**Methods:** CKD was induced by 5/6<sup>th</sup> nephrectomy (5/6<sup>th</sup> Nx) in rats. The estimated glomerular filtration rate (eGFR) was measured by a validated plasma creatinine- and urea-based equation. We compared Na<sup>+</sup> and K<sup>+</sup> transporter activity in CKD and sham-operated rats by assessing the response to furosemide, hydrochlorothiazide (HCTZ), or amiloride. Furthermore, the responses in plasma K<sup>+</sup> and urine K<sup>+</sup> excretion were studied after 16h fasting followed by 3h 0% K<sup>+</sup>, 2.5% potassium chloride (KCl), or 2.5% potassium citrate (KCit) diet.

**Results:** A trend towards a greater natriuretic response in 5/6<sup>th</sup> Nx than sham rats was observed after furosemide, while no differences were observed with HCTZ or amiloride (Table). After correction for eGFR, this corresponded to a 4.3, 2.7, and 4.2-fold increase in per-nephron Na<sup>+</sup> reabsorption in the thick ascending limb, distal convoluted tubule, and collecting duct, respectively in 5/6<sup>th</sup> Nx compared to sham rats. In 5/6<sup>th</sup> Nx rats, the kaliuretic response to furosemide and HCTZ was lower than in sham rats, although this only reached significance for the latter. Amiloride produced a similar K<sup>+</sup>-sparing effect in 5/6<sup>th</sup> Nx and in sham rats. This corresponded to an unchanged per-nephron kaliuresis in 5/6<sup>th</sup> Nx despite greater distal Na<sup>+</sup> delivery compared to sham rats. Both the 2.5% KCl and 2.5% KCit diet caused significantly less kaliuresis and higher plasma K<sup>+</sup> in 5/6<sup>th</sup> Nx compared to sham rats. After correction for eGFR, 5/6<sup>th</sup> Nx increased the kaliuretic response to the 2.5% KCl and 2.5% KCit diets compared to sham rats (2.9 and 2.6-fold, respectively).

Key: TH - Thursday; FR - Friday; SA - Saturday; OR - Oral; PO - Poster; PUB - Publication Only

Underline represents presenting author.

**Conclusions:** Experimental CKD increases per-nephron Na<sup>+</sup> reabsorption in the thick ascending limb, distal convoluted tubule and collecting duct. The impaired thiazide-induced kaliuretic response points towards an impaired kaliuretic response to an increased distal Na<sup>+</sup> delivery in CKD. These alterations in Na<sup>+</sup> and K<sup>+</sup> handling may explain the tendency towards salt-sensitive hypertension and hyperkalemia in CKD.

Diuretic	Furosemide (6 mg/kg i.p.)			HCZT (30 mg/kg i.p.)			Amloride (0.6 mg/kg i.p.)		
	Sham	5/6 <sup>th</sup> Nx	p	Sham	5/6 <sup>th</sup> Nx	p	Sham	5/6 <sup>th</sup> Nx	p
ΔU <sub>Na</sub> (μmol)	105.5 ± 273.6	1223.1 ± 240.6	0.09	741.8 ± 196.6	628.4 ± 303.5	0.39	611.6 ± 340.0	712.2 ± 462.7	0.64
ΔU <sub>K</sub> (μmol)	154.6 ± 106.8	56.0 ± 113.9	0.09	337.7 ± 165.9	42.2 ± 278.4	0.01	-187.1 ± 167.4	-222.4 ± 264.7	0.7

- ΔU<sub>Na</sub> and ΔU<sub>K</sub>: natriuretic and kaliuretic responses from 6-h excretions (diuretic minus vehicle), respectively

Diet	0% K			2.5% KCl			2.5% KCitrate		
	Sham	5/6 <sup>th</sup> Nx	p	Sham	5/6 <sup>th</sup> Nx	p	Sham	5/6 <sup>th</sup> Nx	p
ΔU <sub>K</sub> (μmol/hr)	-28.3 ± 28.7	-20.5 ± 21.4	0.54	260.1 ± 46.1	191.5 ± 28.7	<0.01	242.4 ± 66.8	165.1 ± 40.3	<0.01
Plasma K <sup>+</sup> (mEq/L)	4.2 ± 0.2	4.0 ± 0.3	0.18	4.2 ± 0.3	5.5 ± 0.6	<0.01	4.5 ± 0.3	5.6 ± 0.4	<0.01

- ΔU<sub>K</sub>: kaliuretic response from 3-h excretion rate (feeding minus fasting)

Table

TH-PO355

**A Case of Nephrotic Syndrome in an Individual With Severe Autosomal Dominant Polycystic Kidney Disease**

Juan D. Salcedo Betancourt, Shani Shastri, Anil K. Pillai, Ronak Lakhia. *The University of Texas Southwestern Medical Center, Dallas, TX.*

**Introduction:** Individuals with ADPKD often have sub-nephrotic range proteinuria. However, nephrotic range proteinuria with symptoms of nephrotic syndrome is rarely reported and presents a diagnostic challenge.

**Case Description:** A 36-year-old Indian woman with ADPKD diagnosed by imaging and genetic testing 12 years prior to evaluation presented with new-onset edema of hands, legs, and face and worsening hypertension. 24-hour urine collection revealed proteinuria of 6.7g. Serum creatinine remained at baseline. Comprehensive serological workup was negative. Additional history revealed that she was taking Ayurvedic supplements for several months prior to the onset of symptoms. Review of CT scan with interventional radiology identified one small area of preserved renal parenchyma as a potential biopsy target. US-guided kidney biopsy identified membranous nephropathy (MN). Serum and tissue anti-phospholipase A2 receptor antibodies were negative. Age-appropriate malignancy screening was negative. Treatment with Angiotensin II receptor blocker (ARB) and discontinuation of herbal supplements resulted in partial remission (UP/Cr 1.4 g/day) after 2 months, improved blood pressure and resolution of edema.

**Discussion:** Only a handful of ADPKD cases with biopsy-proven MN have been reported. Use of mercury-containing ayurvedic supplements has been implicated with MN. Renal biopsy is needed for ADPKD patients with nephrotic-range proteinuria to exclude coexisting glomerular disease. Though kidney biopsy confers a significantly greater risk of complications compared to a non-cystic kidney, it can often be safely performed by an interventional radiologist well versed with ADPKD. Referral to tertiary care centers with multidisciplinary teams for ADPKD should be considered. This case underlines the importance of renal biopsy in patients with ADPKD with nephrotic-range proteinuria, for accurate diagnosis and appropriate treatment.



**Figure 1.** A. Non-contrast CT sagittal section displays bilateral enlarged cystic kidneys. B. Renal ultrasound was used to perform kidney biopsy. The left kidney had a small region of non-cystic parenchyma that was biopsied (red arrows).

TH-PO356

**Confirmatory Genetic Testing Uncovers the Unexpected: A Rare Dual PKD1/PRKCSH Diagnosis in Familial Autosomal Dominant Polycystic Kidney Disease**

Tarek Darwish,<sup>1</sup> Katya Brossart,<sup>2</sup> Kathryn M. Curry,<sup>2</sup> Sumit Punj,<sup>2</sup> <sup>1</sup>Kansas City Kidney Specialists, Overland Park, KS; <sup>2</sup>Natera, Inc., Austin, TX.

**Introduction:** Autosomal dominant polycystic kidney disease (ADPKD) and autosomal dominant polycystic liver disease (ADPLD) have considerable genetic and phenotypic overlap and are characterized by hepatic and renal cysts. ADPKD and ADPLD show independent inheritance, and risk of progressive disease in either organ varies greatly by genotype. Molecular diagnosis can inform prognosis and clinical management. We report a rare dual diagnosis of ADPKD and ADPLD in the context of multigenerational ADPKD, and, to our knowledge, the first finding of dual PKD1/PRKCSH pathogenic variants.

**Case Description:** A 50-year-old woman with ADPKD and preserved renal function presented with significant abdominal distension consistent with hepatomegaly. Imaging revealed multiple renal and hepatic cysts. Family history was notable for ADPKD in the patient’s mother, maternal grandmother, and the grandmother’s siblings. The patient’s 20-year-old daughter has renal cysts but normal kidney function. Genetic testing with a 385-gene NGS panel covering multiple genes associated with cystic diseases (the Renasight™ Test) was used to determine genetic etiology. Heterozygous pathogenic variants were identified in PKD1 (c.3957\_3994dup (p.Asp1332Glyfs\*27)), and PRKCSH (c.374\_375del (p.Glu125Valfs\*21)) which are associated with ADPKD and ADPLD respectively. Both variants are predicted to be truncating. Typically, truncating PKD1 variants cause severe PKD and mild-to-severe PLD. PRKCSH-associated pathogenic variants cause mild-to-severe PLD, with absent-to-mild PKD3. Family history suggests maternal inheritance of the PKD1 variant. Absence of severe hepatic features in prior generations suggests a de novo PRKCSH variant. A family history of ADPLD cannot be confirmed due to the variable expressivity and reduced penetrance of ADPLD, and limited ADPKD-ADPLD-related phenotypic data. Cascade testing is recommended.

**Discussion:** Single-gene confirmatory genetic testing for suspected ADPKD or ADPLD can be too narrow to capture an unexpected genetic etiology. This case highlights the value of unbiased genetic testing to confirm clinically diagnosed ADPKD. The presence of PRKCSH-related PLD in a patient with known ADPKD confers greater risk of hepatic disease progression, with implications for clinical management. This result enables familial testing for ADPKD and ADPLD risk in relatives.

TH-PO357

**Elucidating the Genetic Architecture of Cystic Kidney Disease**

Omid Sadeghi-Alavijeh, Melanie M. Chan, Daniel P. Gale. *University College London Department of Renal Medicine, London, United Kingdom.*

**Background:** Up to 15% of polycystic kidney disease (PKD) cases are unsolved, leading to an unmet clinical need. Using whole genome sequencing data provided by the 100,000 Genomes Project (100KGP), we sought to systematically characterise the genetic architecture of PKD.

**Methods:** We performed a sequencing-based genome-wide association study in 1,102 unrelated PKD patients and 20,088 ancestry-matched unaffected controls. The analysis was inclusive of individuals with diverse genetic ancestry. Enrichment of common, low-frequency (minor allele frequency [MAF] > 0.1%) and rare (MAF < 0.1%) single-nucleotide variant (SNV), indel and rare structural variant (SV) alleles on a genome-wide and per-gene basis was sought using a generalised linear mixed model approach to account for population structure.

**Results:** Gene-based analysis of rare SNVs/indels predicted to be damaging revealed PKD1 (P=1.13x10<sup>-309</sup>), PKD2 (P=1.96x10<sup>-150</sup>), DNAJB11 (P=3.52x10<sup>-7</sup>) and COL4A3 (P=1.26x10<sup>-6</sup>) as significantly associated with the cystic phenotype. Depleting for “solved” cases led to the discovery of a significant association at IFT140 (P=3.46x10<sup>-17</sup>) and strengthening of the COL4A3 (P=9.27x10<sup>-7</sup>) association (Figure 1), driven exclusively by heterozygous variants in both genes. After depleting for IFT140 and COL4A3 causative variants, no other genes were identified. Genome-wide analysis of over 18 million common and low-frequency variants did not reveal any statistically significant associations with disease.

**Conclusions:** These findings represent a thorough examination of the genetic architecture of a national PKD cohort using well-controlled statistical methodology. Causative monoallelic mutations in IFT140 have recently also been reported in other cohorts associated with a milder phenotype than PKD1/2-associated disease. The association with COL4A3 suggests that in some circumstances cystic kidney disease may be the presenting feature of type IV collagenopathy and further work is needed to understand the biological mechanism underlying this observation.

**Funding:** Other NIH Support - Medical Research Council (UK)

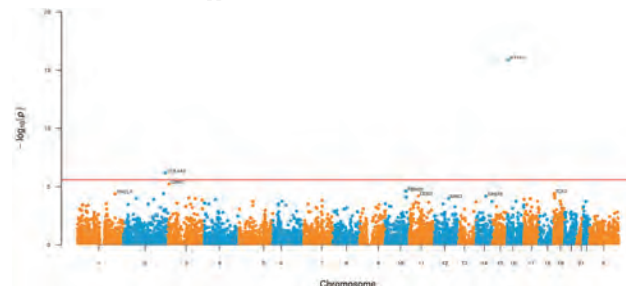

**Figure 1 -** Gene based Manhattan plot of the cystic cohort deplete for solved cases versus controls.

TH-PO358

**Inherited Cystic Kidney Diseases Database for Individualized Genetic Analysis: Baseline Characteristics**

Jeongmin Cho,<sup>1</sup> Yong Chul Kim,<sup>1</sup> Kook-Hwan Oh,<sup>1</sup> Curie Ahn,<sup>1</sup> Kyu-Beck Lee,<sup>3</sup> Yaerim Kim,<sup>4</sup> Eun Hui Bae,<sup>5</sup> Hee Gyung Kang,<sup>6</sup> Yo Han Ahn,<sup>6</sup> Yun Kyu Oh.<sup>2</sup> <sup>1</sup>Seoul National University Hospital, Jongno-gu, Seoul, Republic of Korea; <sup>2</sup>Seoul National University Seoul Metropolitan Government Boramae Medical Center, Dongjak-gu, Seoul, Republic of Korea; <sup>3</sup>Kangbuk Samsung Medical Center, Jongno-gu, Seoul, Republic of Korea; <sup>4</sup>Keimyung University School of Medicine, Daegu, Republic of Korea; <sup>5</sup>Chonnam National University Hospital, Gwangju, Republic of Korea; <sup>6</sup>Seoul National University Children's Hospital, Seoul, Republic of Korea.

**Background:** Inherited cystic kidney disease (iCKD) is a genetic disorder caused by mutation of genes related to function of cilium resulting in renal and extrarenal cysts. Identification of iCKD genes in each case is necessary for precise treatment. However, pipeline for individualized genetic analysis has not been established yet.

**Methods:** This is a 3-year prospective, multicenter cohort study at 11 hospitals from May 2019 to December 2021. Patients with over 3 renal cysts in both kidneys were enrolled. Baseline demographics, co-morbidities, kidney complications, volume of kidney and liver, and genetic profiles are investigated.

**Results:** A total of 805 patients were enrolled. Clinically typical polycystic kidney disease (PKD) were 71.1% (577) whereas 21.1% (170) were atypical with absence of a family history or atypical findings in CT. Pediatric patients were 7.2% (58) (Figure 1). Median age of individuals was 45 years and 49.6% were male. Average eGFR was  $75.3 \pm 33.4$  mL/min/1.73m<sup>2</sup>. Median (25-75<sup>th</sup> percentile) total kidney volume (TKV) and total liver volume (TLV) were 1085.0 (595.0-1784) mL and 1557.0 (1277.0-2163.0) mL. Distribution by Mayo classification was as follows: 1A 108 (14.9%), 1B 198 (27.4%), 1C 234 (32.3%), 1D 111 (15.3%), and 1E 73 (10.1%). A total of 23 genes including PKD1, NV, PKD2, DM, COL4A5 were identified in 545 patients using targeted gene panel of 89 genes related to cilopathy (Figure 2). PKD1 mutation increased from 15.3% of Mayo 1A to 70.0% of 1E. PKD1 mutation was correlated with cyst infection, kidney pain, and cyst hemorrhage.

**Conclusions:** This is the first nationwide cohort for Korean iCKD. We report the baseline characteristics and genetic findings prior to detailed molecular analysis.

**Funding:** Government Support - Non-U.S.

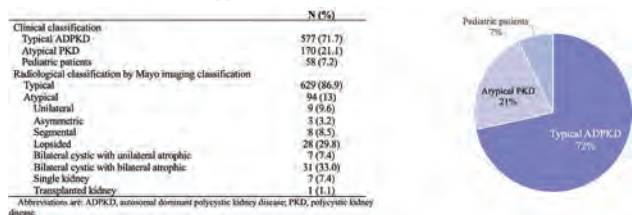

Figure 1. Clinical classification of overall participants (n=805)

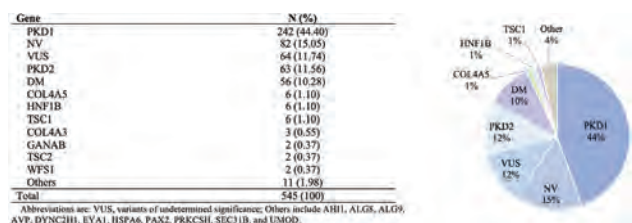

Figure 2. Gene distribution by targeted gene panel of 89 cystogenesis-related genes (n=545)

TH-PO359

**A Cohort of Patients With Autosomal Dominant Polycystic Kidney (ADPKD) With the Same Germline Mutation: The Contribution of Other Genetic Variants Can Determine the Extreme Phenotypic Variability**

Carlotta Caprara,<sup>1</sup> Valentina Corradi,<sup>1</sup> Matteo Rigato,<sup>1</sup> Barbara Mancini,<sup>1</sup> Marta Proglio,<sup>1</sup> Fiorella Gastaldon,<sup>1</sup> Claudio Ronco,<sup>1</sup> Monica Zanella.<sup>1</sup> Ospedale San Bortolo di Vicenza, Vicenza, Italy.

**Background:** Autosomal Dominant Polycystic Kidney Disease (ADPKD) is a major genetic disorder affecting up to 12.5 million individuals worldwide and it is the fourth most common global cause for renal replacement therapy. ADPKD is a chronic, progressive condition characterized by the development and growth of cysts in the kidneys and other organs and by additional systemic manifestations. Two principle causative genes have been identified: PKD1 and PKD2. ADPKD phenotype is highly variable intra and interfamily. The aim of the study was to describe a cohort of ADPKD patients with the same PKD2 genetic mutation and try to find a genetic contribution to the extreme phenotypic variability of the subjects.

**Methods:** We performed linkage analysis to define disease haplotype. We performed NGS with Sophia Genetic “Nephropathies Solution” Panel. This panel analyzed 44 genes (target region 105.8kb) involved in different types of nephropathies. We considered variants with autosomal dominant transmission, that are categorized as Vous or likely pathogenic (Class 3 and 4 of ACMG).

**Results:** We enrolled 29 patients (17 M, 12F) from 12 different families (same geographical area) characterized by the same PKD2 (NM\_000297.4) disease haplotype and the same germline mutation c.2533C>T (p.Arg845Ter). 4 patients out of 29 (13.8%) reported a variant in collagen’s genes: 2 patients share COL4A3 NM\_000091.5:c.4421T>C (p.Leu1474Pro) variant and 2 patients share COL4A4 NM\_000092.5:c.2996G>A (p.Gly999Glu) variant. These variants are associated to Thin Basement Membrane Nephropathy (TBMN) and patients with these variants express worst renal clinical phenotype (2pt microhematuria and proteinuria; 1 pt early ESRD).

**Conclusions:** The analysis did not find out a single “extra” variant that was common among patients with the same clinical course, but highlight variants that may be associated with some phenotypic manifestations not only associated with ADPKD. Study different variants in genes other than “classic” PKD1 and PKD2 can help to better interpret the phenotypic difference, especially in patients that share causative mutation where we expect a “similar genetic impact”.

TH-PO360

**PKD1 and PKD2 Copy Number Variations (CNVs) in Extended Toronto Genetic Epidemiologic Study of Polycystic Kidney Disease (eTGESP)**

Amirreza Haghighi,<sup>2,1</sup> Ning He,<sup>1</sup> Saima Khawaja,<sup>1</sup> Matthew B. Lanktree,<sup>4</sup> Andrew Paterson,<sup>3</sup> York P. Pei.<sup>1</sup> <sup>1</sup>University Health Network, Toronto, ON, Canada; <sup>2</sup>Brigham and Women’s Hospital, Boston, MA; <sup>3</sup>SickKids Research Institute, Toronto, ON, Canada; <sup>4</sup>St. Joseph’s Healthcare Hamilton, Hamilton, ON, Canada.

**Background:** Autosomal dominant polycystic kidney disease (ADPKD) is genetically heterogeneous and primarily due to mutations in PKD1 or PKD2. Although CNVs including genomic deletion/duplication in PKD1 and PKD2 are uncommon, they explain a subset of cases with no mutations detected by NGS studies. Here, we report our results of a CNV screen in a cohort of 1,811 patients from 1,271 different families from eTGESP.

**Methods:** We screened all study patients for PKD1 and PKD2 mutations by targeted NGS and multiplex ligation-dependent probe amplification (MLPA) in NGS mutation-negative cases. Standard algorithms for sequence alignment, base calling, and QC filtering were applied to identify rare (MAF ≤1%) deleterious variants of high and moderate impact as predicted by multiple predictive algorithms. MLPA was performed using two kits (Probesix P351-D1 and P352-E1) from MRC Holland; all detected CNVs were validated by Sanger sequencing and droplet digital PCR (ddPCR) whenever possible.

**Results:** NGS-based screen failed to detect any definitive PKD1 or PKD2 mutations in 253/1,271 (20%) of families. Follow-up testing with MLPA identified CNVs in 29 of 253 (11.5%) NGS screen-negative families, including 15 with heterozygous PKD1 deletions, 12 with heterozygous PKD2 deletions, and 2 with heterozygous PKD1 duplications; one PKD1 CNV mosaic was also identified.

**Conclusions:** In this large cohort study from a single geographical region, we found PKD1 and PKD2 CNVs are rare causes of ADPKD, but account for 2.3% (29/1,271) of the entire study cohort and ~10% of our NGS screen-negative families. MLPA provides an important follow-up test for NGS-based PKD1 and PKD2 screen.

TH-PO361

**Mutation Spectrum of the Extended Toronto Genetic Epidemiologic Study of Polycystic Kidney Disease (eTGESP)**

Amirreza Haghighi,<sup>2,1</sup> Ighli di Bari,<sup>1</sup> Saima Khawaja,<sup>1</sup> Ning He,<sup>1</sup> Ioan-Andrei Iliuta,<sup>1</sup> Xuewen Song,<sup>1</sup> Matthew B. Lanktree,<sup>4</sup> Andrew Paterson,<sup>3</sup> Jordan Lerner-Ellis,<sup>5</sup> York P. Pei.<sup>1</sup> <sup>1</sup>University Health Network, Toronto, ON, Canada; <sup>2</sup>Brigham and Women’s Hospital, Boston, MA; <sup>3</sup>SickKids Research Institute, Toronto, ON, Canada; <sup>4</sup>St. Joseph’s Healthcare Hamilton, Hamilton, ON, Canada; <sup>5</sup>Mount Sinai Hospital: Sinai Health, Toronto, ON, Canada.

**Background:** Autosomal dominant polycystic kidney disease (ADPKD) is the most common hereditary kidney disease worldwide. Mutations in PKD1 and PKD2, respectively, account for 85% and 15% of the genetically resolved cases in clinical series enriched with high-risk patients. Here, we report the ADPKD mutation spectrum of a large cohort of relatively unselected patients from a single geographical region.

**Methods:** We performed mutation screening in 2,171 patients from 1,606 different families from the Greater Toronto Area (population 6.8 million) using NGS targeted sequencing and multiplex ligation-dependent probe amplification of PKD1 and PKD2, as well as NGS of a panel of 50 cystic disease genes. Standard algorithms for sequence alignment, base calling, and QC filtering were applied to identify rare (MAF ≤1%) deleterious variants as predicted by multiple algorithms.

**Results:** We detected PKD1 and PKD2 mutations in 1205 (75%) families, non-PKD1 and PKD2 (i.e. ALG8, ALG9, PKHD1, GANAB, PRKCSH, SEC63, LRP5, WFS1, TSC1-2, COL4A1, and COL4A3-5) rare putative pathogenic variants in 120 (10%) families, with no mutations detected in 281 (15%) families. Among the PKD1 and PKD2 genetically resolved families, 916 (76%) and 289 (24%) were due to mutations in PKD1 and PKD2, respectively. Adjusted for exon size across all 46 exons in PKD1, we found an enrichment of truncating mutations in exon 44. We also found over 100 recurrent mutations in ≥ 2 different families (haplotype analysis is in progress).

**Conclusions:** We found extensive genic and allelic heterogeneity in ADPKD with a higher prevalence of *PKD2* mutations than reported in the clinical series. We also found non-*PKD1* and non-*PKD2* cystic disease mutations in 10% of families, while 15% of the families remained genetically unresolved.

Recurrent PKD1 and PKD2 Mutations

Gene Name	Number of different pathogenic mutations	Number of pathogenic mutations in ≥ 2 different families	Number of pathogenic mutations in ≥ 3 different families
PKD1	840	72	38
PKD2	203	38	25

PKD1 and PKD2 mutation classes in genetically resolved cases

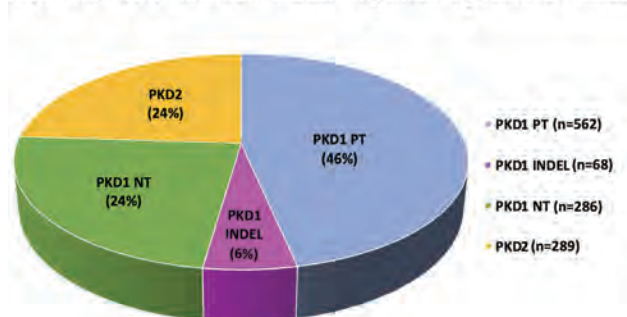

TH-PO362

Families With Complex Genetics in the Extended Toronto Genetic Epidemiologic Study of Polycystic Kidney Disease (eTGESP)

Amirreza Haghighi,<sup>1,2</sup> Ighli di Bari,<sup>2</sup> Saima Khawaja,<sup>2</sup> Ning He,<sup>2</sup> Ioan Andrei Iliuta,<sup>2</sup> Xuewen Song,<sup>2</sup> Matthew B. Lanktree,<sup>4</sup> Andrew Paterson,<sup>3</sup> York P. Pei,<sup>2</sup> <sup>1</sup>Brigham and Women's Hospital, Boston, MA; <sup>2</sup>University Health Network, Toronto, ON, Canada; <sup>3</sup>SickKids Research Institute, Toronto, ON, Canada; <sup>4</sup>St. Joseph's Healthcare Hamilton, Hamilton, ON, Canada.

**Background:** Autosomal dominant polycystic kidney disease (ADPKD) is genetically heterogeneous and primarily due to mutations in *PKD1* or *PKD2*. Complex inheritance with bilineal disease arising from two independently segregating *PKD1*, or *PKD1* and *PKD2* mutations have been reported in a small number of families. Here, we define the prevalence and clinical features of ADPKD families with complex genetics in 1,811 patients from 1,271 different families from eTGESP.

**Methods:** All study patients underwent *PKD1* and *PKD2* mutation screening by targeted Next-Generation sequencing and multiplex ligation-dependent probe amplification in mutation-negative cases, as well as targeted NGS with a cystic disease panel of 50 genes. Standard algorithms for sequence alignment, base calling, and QC filtering were applied to identify rare (MAF ≤1%) deleterious variants of high and moderate impact as predicted by multiple predictive algorithms. Families with complex genetics were defined as those with two putative pathogenic mutations in *PKD1*, in *PKD1* and *PKD2*, or in *PKD1* or *PKD2* with another non-*PKD1* and non-*PKD2* cystic disease mutation.

**Results:** We found complex genetics in 71/993 (7.2%) of genetically resolved families. Among the families with complex genetics, 48 (68%) carried two *PKD1* mutations, 5 (7%) carried both a *PKD1* and *PKD2* mutation, and 18 (25%) carried either a *PKD1* or *PKD2* mutation with a second mutation in another cystic disease genes (i.e. *ALG8*, *ALG9*, *PKHD1*, *PRKCSH*, *SEC63*, *WFS1*, and *COL4A5*). Analyses of phenotype-genotype correlations in these families are currently in progress.

**Conclusions:** Gene locus and allelic heterogeneity have been shown to account for a significant proportion of disease variability in ADPKD. Here, we found complex genetics in 7% of a large cohort of families harboring two cystic disease mutations; the presence of a second mutation may potentially act as a modifier of the main effect mutation and contributes to the within-family disease variability.

TH-PO363

Patients With Autosomal Dominant Polycystic Kidney Disease (ADPKD) Without a Clear Family History Have Rapid Progression and Poor Prognosis

Vasiliki Gkika, Michaela Louka, Eirini Tigka, Angelos Drakopoulos, Myrto Kostopoulou, George I. Tspiranlis. Department of Nephrology, General Hospital of Athens "G. Gennimatas", Athens, Greece.

**Background:** A small percentage of patients with ADPKD have no clear family history. The clinical course and prognosis of the disease in this subgroup of patients may be different. The present study investigates the progression and prognostication of End Stage Renal Disease (ESRD) in a large cohort of patients with and without a family history of ADPKD.

**Methods:** This study enrolled 291 patients who were being followed in a specialized outpatient ADPKD clinic. Patients having a total of more than 10 kidney cysts in a recent Magnetic Resonance Imaging (MRI) scan were included in the study even if they had no clear family history or confirmatory genetic test. At enrollment, Total Kidney Volume (TKV) was calculated by MRI and the Mayo Clinic Imaging Category (MCIC) was

determined. The prediction of ESRD based on the Mayo Clinic formula (which takes into consideration age, TKV, e-GFR, gender, race, and MCIC) was also calculated. Demographics, medical, and laboratory data were recorded using a standardized form. T-test,  $\chi^2$  and Mann-Whitney test were used for statistical analysis.

**Results:** Of the 291 patients included in the study, 34 (12%) had no clear family history of ADPKD and 257 (88%) had a clear family history. Age, gender, presence or not, and age at diagnosis of hypertension as well as BMI were similar in the two groups. The age at diagnosis of ADPKD was similar between patients with and without a clear family history as well as, the e-GFR, the stage of Chronic Kidney Disease and albuminuria. The TKV tended to be higher in patients without a clear family history than in those with a family history of ADPKD (2210 ml vs. 1650 ml, p=0.09) and the same was valid for the height-adjusted TKV (p=0.08). In MCIC 1C, 1D, and 1E, more patients without a known family history of ADPKD were classified than patients with a family history of ADPKD (89% vs 70%), and vice versa in MCIC 1A and 1B (11% vs 30%) (p=0.04). Finally, the ESRD prediction was 16 years for the patients without a clear family history and 34 years for those with a clear family history of ADPKD (p=0.025).

**Conclusions:** Patients with ADPKD without a clear family history tend to have a more rapid progression and a worse renal prognosis than those with a clear family history of ADPKD.

TH-PO364

Effects of Kinship on Disease Progression and Variability in Families With Autosomal Dominant Polycystic Kidney Disease

Elhussein A. Elhassan,<sup>1,2</sup> Kane E. Collins,<sup>2</sup> Edmund H. Gilbert,<sup>2</sup> Gianpiero Cavalleri,<sup>2</sup> Katherine A. Benson,<sup>2</sup> Peter J. Conlon.<sup>1,2</sup> <sup>1</sup>Beaumont Hospital, Dublin, Ireland; <sup>2</sup>Royal College of Surgeons in Ireland, Dublin, Ireland.

**Background:** Autosomal dominant polycystic kidney disease (ADPKD) is the most common monogenic nephropathy in humans that recognised with striking variability in kidney disease severity among affected relatives and families. Here, we evaluate variation in phenotype between families of adult Irish patients affected by ADPKD and the impact of kinship on disease progression.

**Methods:** Phenotypic details (age, sex, kinship with index patient, age at initial presentation, hypertension and urological events, and PROPK score) and renal survival (time to end-stage kidney disease (ESKD) and eGFR decline) were collected. A combination of molecular methods, including targeted NGS, were used for diagnosis of ADPKD, patients with disease-causing *PKD1* and *PKD2* variants were included for analysis. We assessed variability between families based on the age of onset of ESKD. To account for the impact of kinship on disease progression, we used a frailty model using detailed phenotypic features of patients with available genetic diagnosis.

**Results:** In total, we studied 103 unrelated families (369 patients), a majority (65/103;63.1%) of whom had a diagnostic variant at *PKD1* gene, with average age of 55.2±14.5 years; 55.3% females. Mean age at initial presentation was 30.2±13.8 years. At last follow up, 262 (71%) patients developed ESKD at 49.3±11 years. The remaining individuals had CKD with average creatinine and eGFR 133.2±114.7 and 51.2±25, respectively, and median annual eGFR decline 3.1 (IQR 1.3 – 5.25) ml/yr. Median variance in age at ESKD between families was 7 years, and among families with at least two ESKD patients, 34 (33%) families had wide delta difference in age of ESKD (i.e. >10 years difference). In the univariate frailty model, kinship has significantly associated with time to renal failure (P=<0.001) taking into account each phenotypic and genetic factors of interest which are associated with disease severity. However, using a multivariate frailty model, we observed no statistical impact of kinship in age at ESKD among ADPKD families, except those with earlier initial presentation (HR: 0.96; 95% CI 0.94 – 0.98; P=<0.001).

**Conclusions:** Wide variability in age of ESKD among families with ADPKD is present in at least 33% of families and the impact of family effects was evident on factors related with disease progression.

TH-PO365

Genetic Identification of Inherited Cystic Kidney Diseases Using Next Generation Sequencing: Results From a 3-Year Korean Prospective Genetic Cohort

Hayne C. Park,<sup>1</sup> Jinwoo Lee,<sup>3</sup> Yong Chul Kim,<sup>3</sup> Curie Ahn,<sup>2</sup> Yaerim Kim,<sup>6</sup> Hee Gyung Kang,<sup>5</sup> Jungmin Choi,<sup>7</sup> Kook-Hwan Oh,<sup>3</sup> Yun Kyu Oh.<sup>3,4</sup> <sup>1</sup>Kangnam Sacred Heart Hospital, Yeongdeungpo-gu, Seoul, Republic of Korea; <sup>2</sup>National Medical Center, Seoul, Republic of Korea; <sup>3</sup>Seoul National University College of Medicine, Seoul, Republic of Korea; <sup>4</sup>Seoul National University Seoul Metropolitan Government Boramae Medical Center, Seoul, Republic of Korea; <sup>5</sup>Seoul National University Children's Hospital, Seoul, Republic of Korea; <sup>6</sup>Keimyung University School of Medicine, Daegu, Republic of Korea; <sup>7</sup>Korea University College of Medicine and School of Medicine, Seoul, Republic of Korea.

**Background:** Inherited cystic kidney disease is a spectrum of disorders in which clusters of renal cysts develop as the result of genetic mutations. We performed a 3-year, prospective, multicenter cohort study to demonstrate genetic profiles in the Korean patients with inherited cystic kidney disease using next generation sequencing.

**Methods:** From May 2020 to May 2022, a total of 824 patients (751 adults, 73 children) with more than 3 renal cysts in both kidneys were enrolled from 11 centers. Demographic, laboratory, and imaging data as well as family pedigree were collected at baseline. Renal function was evaluated annually thereafter. The patients were clinically

Key: TH - Thursday; FR - Friday; SA - Saturday; OR - Oral; PO - Poster; PUB - Publication Only

Underline represents presenting author.

divided into typical polycystic kidney disease (PKD), atypical PKD, and pediatric cases. We have introduced a gene panel with 89 ciliopathy-related genes as a screening method. We additionally performed *PKD1* targeted exome sequencing with long-range polymerase chain reaction (PCR) and/or multiplex ligation-dependent probe amplification (MLPA) for clinically typical PKD cases. We performed whole exome sequencing to reveal pathogenic variants in atypical PKD and pediatric cases as well as undiagnosed cases.

**Results:** The mutation detection rate of the gene panel was 57.5%. Long-range PCR & *PKD1* targeted exome sequencing were performed on 174 patients, which additionally documents pathogenic variants in 26 cases. Whole exome sequencing was performed in a total of 126 cases, and additional causative gene mutations were found in a total of 18 cases. Therefore, the final mutation detection rate through primary and secondary genetic analysis was 63%. In addition to the well-known *PKD1* and *PKD2* genes, *GANAB*, *HNF1β*, *COL4A1*, *COL4A3*, *COL4A5*, *PAX2*, *UMOD*, and *IFT140* were discovered as cystogenesis-related genes. As for prognosis-related genes, *PKD1* genotype was closely related to the poor prognosis of kidney disease, while *PKD2*, *GANAB*, and *HNF1β* were genotypes showing good prognosis. On the other hand, genotypes did not predict the severity of polycystic liver and cerebral aneurysms.

**Conclusions:** We found that the cyst formation-related gene panel was useful as a screening test and that genetic diagnosis can be useful for screening high-risk groups when the clinical prognosis is ambiguous.

**Funding:** Government Support - Non-U.S.

**TH-PO366**

**Factors Associated With Severity of Polycystic Liver in Patients With Autosomal Dominant Polycystic Kidney Disease: Results From an Inherited Cystic Kidney Disease Genetic Cohort Study**

Hayne C. Park,<sup>1</sup> Jinwoo Lee,<sup>3</sup> Yong Chul Kim,<sup>3</sup> Curie Ahn,<sup>2</sup> Yaerim Kim,<sup>5</sup> Hee Gyung Kang,<sup>6</sup> Jungmin Choi,<sup>7</sup> Kook-Hwan Oh,<sup>3</sup> Yun Kyu Oh.<sup>3,4</sup> <sup>1</sup>Kangnam Sacred Heart Hospital, Seoul, Republic of Korea; <sup>2</sup>National Medical Center, Seoul, Republic of Korea; <sup>3</sup>Seoul National University College of Medicine, Seoul, Republic of Korea; <sup>4</sup>Seoul National University Seoul Metropolitan Government Boramae Medical Center, Seoul, Republic of Korea; <sup>5</sup>Keimyung University School of Medicine, Daegu, Republic of Korea; <sup>6</sup>Seoul National University Children's Hospital, Seoul, Republic of Korea; <sup>7</sup>Korea University College of Medicine and School of Medicine, Seoul, Republic of Korea.

**Background:** Polycystic liver (PLD) is the most common extrarenal manifestation of autosomal dominant polycystic kidney disease (ADPKD). We have analyzed genetic and clinical factors related to the severity of PLD among the patients with Korean ADPKD.

**Methods:** A total of 480 adult patients with ADPKD were enrolled from May 2019 to April 2022. Demographic, clinical, and laboratory data were collected at the initial study visit. Liver volumes were measured using Image J by one professional radiologist and adjusted for height (HtLV) before analysis. The severity of PLD was defined by previous study: no cyst (Gr0), HtLV<1000mL/m (Gr 1), HtLV 1000-1800mL/m (Gr 2), HtLV>1800mL/m (Gr 3). Targeted exome sequencing was done by gene panel including 89 ciliopathy-related genes. Genetic and clinical factors were compared between PLD groups.

**Results:** The mean age was 44 years old and female comprised of 54%. The patients with liver cysts (n=298 in Gr 1, n=120 in Gr 2, n=62 in Gr 3) showed higher frequency of ADPKD-related complication such as hypertension (87.4% vs. 71.5%, p<0.001), proteinuria (27.9% vs. 14.9%, p=0.001), and cerebral aneurysm (10.0% vs. 1.7%) compared to those without liver cysts (n=229 in Gr 0). The patients in Gr 2 and 3 showed older age (53.3±8.1 and 45.0±12.9 vs. 41.9±13.4, p<0.001), higher number of childbirth (1.78±0.82 and 1.64±1.05 vs. 1.27±1.07, p=0.004), and higher prevalence of hypertension (93.5% and 84.2% vs. 65.8%, p<0.001). The patients with severe PLD (Gr 3) demonstrated higher serum level of alkaline phosphatase compared to Gr1 and Gr 2 (95.9±75.4 vs. 56.6±30.1 and 66.1±35.3 IU/L, p<0.001). Interestingly, Gr 3 PLD group showed higher proportion of double variants (25.4 vs. 13.5% and 16.2%) compared to Gr1 and Gr2 groups. The combination of *PKD1* and collagen type IV variants were highly prevalent in severe PLD groups.

**Conclusions:** The PLD severity was associated with female gender, higher number of childbirth, and frequent PKD-related complications. Double variants, especially the combination of *PKD1* and collagen type IV variants, were associated with severe PLD.

**Funding:** Government Support - Non-U.S.

**TH-PO367**

**Genetic Variants and Phenotypic Heterogeneity in Autosomal Dominant Polycystic Kidney Disease**

Marta Vespa, Maria Teresa Sciarone Alibrandi, Giancarlo Joli, Romina Bucci, Martina Catania, Liliana Italia De Rosa, Lorena Citterio, Maria Vittoria Vergani, Michele Paolisi, Pierpaolo Bianco, Giuseppe Vezzoli, Paolo Manunta. *IRCCS Ospedale San Raffaele, Milano, Italy.*

**Background:** Adpkd is the most common genetic renal disease usually caused by the mutation of the genes *PKD1*-*PKD2*. The main feature is bilateral renal enlargement with progressive loss of kidney function. One of the most typical aspect of this disease is the intra-interfamiliar phenotypical variability.

**Methods:** We led an observational retrospective cross sectional study on 191 PKD pts to evaluate the phenotypical variability based on causal genes and modifier genes, that can influence clinical features: hypertension, sodium sensitivity etc.

**Results:** Among the polymorphisms, rs4961, rs3731566, rs4293393, rs10900555 seem to have influence on renal phenotype. We observed different disease trend outcomes

between wild type patients and those with the rs4961 (*ADD1*) and rs4293393 (*UMOD*) variants. In our cohort rs3731566 (*ADD3*) significantly correlates with a worse kidney function and an early ESRD. On the other hand, rs10900555 (*REN*) correlates with ESRD before age 60. By analyzing the interactions between the potential modifier genes and the causal genes, we found that the most severe mutation, the *PKD1* truncating one, seems to delete the effects of *ADD1* and *UMOD*, something that did not happen with *ADD3*, which AA genotypic presence correlates with a worse outcome, despite the kind of *PKD1* mutation. Our hypothesis is that, despite the phenotypic effect of *PKD1T*, we were still able to find modifier genes capable to generate a significant change in phenotype.

**Conclusions:** Our results lead the way to further analysis, specifically regarding the pharmacogenomics aspect and the functional interactions among these proteins

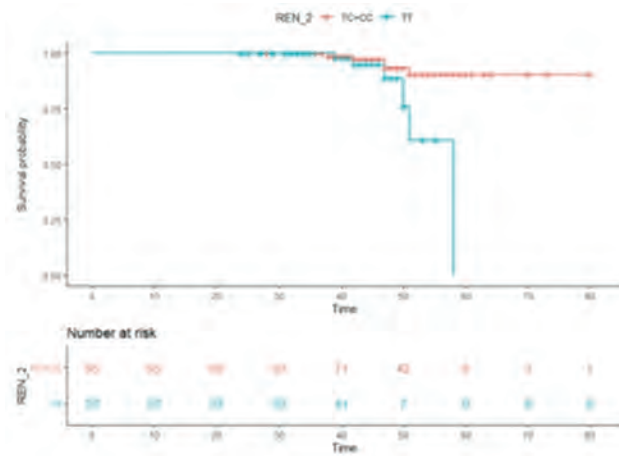

Kaplan-Meier for ESRD according to rs1090055 genotype

PKD MUTATION	rs3731566	Mean	SD	N.
PKD1nt	AA	60.90	32.34	11
	AG+GG	66.33	29.12	22
PKD2	AA	69.38	32.08	10
	AG+GG	73.25	36.78	4
PKD1T	AA	50.02	28.00	23
	AG+GG	66.30	30.78	36

eGFR according to ADD3 and PKD1/2

**TH-PO368**

**Characterization of Genetically Defined ARPKD-PKHD1 Patients Enriched for Childhood/Adult Onset**

Christian Hanna,<sup>1</sup> Tabinda Jawaid,<sup>1</sup> Sarah R. Senum,<sup>1</sup> Maroun Chedid,<sup>1</sup> Charles D. Madsen,<sup>1</sup> Fouad T. Chebib,<sup>2</sup> Vicente E. Torres,<sup>1</sup> Mounif El-Youssef,<sup>1</sup> Peter C. Harris.<sup>1</sup> <sup>1</sup>Mayo Clinic Minnesota, Rochester, MN; <sup>2</sup>Mayo Clinic in Florida, Jacksonville, FL.

**Background:** ARPKD is generally considered a pediatric disorder with prominent phenotypic variability related to kidney and liver involvement ranging from fetal demise to surviving into adulthood. Studies have shown phenotypic overlap between ARPKD and other ciliopathies. We aimed to characterize the clinical course in genetically defined ARPKD-*PKHD1* patients (pts).

**Methods:** Through research or clinical genetic testing, pts were identified with biallelic *PKHD1* variants. Identified families were characterized by segregation, imaging, and clinical phenotypes from chart review.

**Results:** Out of 47 pts with biallelic *PKHD1*, 37 (31 families) with complete clinical data were included (Table 1). Median age (Q1, Q3) at diagnosis and last follow-up were 1 (0, 20) and 30 yrs (20, 44), respectively, with a mean ± SD follow-up period of 19 ±12.5 yrs. Seventeen pts (46%) had in utero/infantile-onset (<1 yr), 10 (27%) with childhood-onset (1-17 yrs), and interestingly 10 (27%) with an adult-onset presentation with a median age of 42 (40, 44). At last follow up, kidney replacement therapy was present in 38%, portal hypertension in 65%, and liver transplant in 8%. Three pts (8%) died (1 neonate and 2 with adult-onset ARPKD). Kidney cysts, liver cysts, and nephrolithiasis (NL)/nephrocalcinosis (NC) were found in 89%, 24%, and 49%, respectively. Nephromegaly, hypertension, and kidney failure were more prevalent in utero/infantile-onset, and NL/NC in adult-onset (p≤0.05). A truncating (T) plus nontruncating (NT) variant were identified in 46% (17/37) and two NT variants in 54% (20/37); none had two T variants. No correlation was found between the genotypic group and diagnosis age (p=0.17).

**Conclusions:** In ARPKD-*PKHD1* patients we found high variability in kidney and/or liver phenotypes, including adult-onset ARPKD in the 5th decade and high prevalence of NL/NC. ARPKD should be considered a differential diagnosis in adults with fibrocystic hepatorenal disease with or without nephromegaly and NL/NC.

**Funding:** NIDDK Support

Table 1. Characteristics of 37 genetically defined ARPKD/*PKHD1* patients

	n (interim/total) n=17	Childhood-onset n=10	Adult-onset n=10	Total n=37	p-value
Females, n (%)	8 (47.0)	7 (70.0)	7 (70.0)	22 (59.5)	0.36
Age at diagnosis (years), Median (IQR)	0 (0, 0)	5 (2.5, 6)	42 (40.3, 43.8)	1 (0, 30)	<0.01
Age at last visit, years Median (IQR)	22 (8, 27)	22 (28.5, 35.8)	48 (56.5, 64.3)	30 (22, 44)	0.01
Mean (SD) follow-up, years	22 (11, 3)	19.5 (8.5)	14 (11, 4)	19 (22.8)	0.51
Nephromegaly at diagnosis, n (%)	17 (100.0)	8 (80.0)	5 (50.0)	30 (81.1)	<0.01
Hypertension, n (%)	14 (82.3)	5 (50.0)	1 (10.0)	22 (59.5)	0.02
Kidney failure, n (%)	10 (58.8)	3 (30.0)	1 (10.0)	14 (37.8)	0.03
Age at CRT, years Median (IQR)	9.5 (4.5, 15.3)	30 (20, 36.5)	45	11.5 (6, 16.8)	0.06
Portal hypertension, n (%)	9 (52.9)	6 (60.0)	9 (90.0)	24 (64.9)	0.13
Age at portal hypertension diagnosis, Median (IQR)	5 (3, 10)	10.5 (9.3, 13.3)	45 (42, 48)	12.5 (7.3, 42.3)	<0.01
Liver transplant, n (%)	2 (11.8)	1 (10.0)	0 (0.0)	3 (8.1)	0.53
Kidney cysts, n (%)	12 (70.6)	9 (90.0)	7 (70.0)	32 (86.5)	0.05
Liver cysts, n (%)	1 (5.9)	5 (50.0)	2 (20.0)	9 (24.3)	0.05
NL/NC, n (%)	4 (23.5)	5 (50.0)	9 (90.0)	18 (48.6)	<0.01
Genotype, n (%)					
<i>PKHD1</i> <sup>miss</sup>	7 (41.2)	3 (30.0)	7 (70.0)	17 (45.9)	
<i>PKHD1</i> <sup>trunc</sup>	10 (58.8)	7 (70.0)	3 (30.0)	20 (54.1)	0.17

Table 1

**TH-PO369**

**Experience With Genetic Testing at a Large Polycystic Kidney Disease-Focused Program**

Allen Chao, Ying Gao, Jordan Jiang, Diana Etwaru, Adesuwa N. Osunde, Laalasa Varanasi, Stephen L. Gluck, Gabriel Loeb, Meyeon Park. *University of California San Francisco, San Francisco, CA.*

**Background:** We are a center that provides specialized care for patients with autosomal dominant polycystic kidney disease (PKD). Genetic testing in PKD has historically been used in the context of diagnostic uncertainty, pre-transplant evaluation, and pre-implantation genetic testing for mutation for in vitro fertilization. Since development of the Renasight panel test (Natera) in April 2020, we have offered genetic testing more routinely due to greater accessibility and ease of testing. We sought to determine how many patients seen in our center underwent genetic testing, results of testing, and differences between individuals who desired testing and those who declined.

**Methods:** We searched our electronic medical record to determine how many patients with PKD were seen in clinic appointments since the Renasight test became available (May 1, 2020). We described the range of genetic test results in the PKD1 and PKD2 genes and compared characteristics of individuals with and without genetic testing using t-test and chi-square.

**Results:** 225 patients in total were identified. 79 patients had genetic testing. 76 underwent Renasight panel test; 3 already had genetic testing by other companies (GeneDx, Prevention Genetics, Athena Diagnostics). 39 (49.4%) were women. 48 (60.8%) were White, 7 (8.9%) were Black, 16 (20.3%) were Asian, 2 (2.5%) were Latinx, 6 (7.6%) were another race category. Age range was 22 to 84 years and median age (IQR) was 47 (36, 59). Out of the 76 Renasight tests, 47 (61.8%) were positive for mutations in PKD1 (39) or PKD2 (8). 14 (18%) were noted to have variants of uncertain significance in either of these genes. Of the known pathogenic mutations, 33 (44%) were truncating, 24 (32%) were nontruncating. The majority of mutations were nonsense (35%) and missense (30%). Individuals with genetic testing had a lower presence of family history of PKD than those without genetic testing (63% v 80%, p=0.01). There was no difference in age or gender between groups.

**Conclusions:** Genetic testing for PKD1 and PKD2 has become more accessible due to development of the Renasight panel test. Individuals with PKD with no family history especially seem motivated to undergo testing. Future work to understand motivators and barriers to genetic testing as well as understanding of costs to patients associated with testing should be pursued.

**TH-PO370**

**Tolvaptan Use at a Large PKD-Focused Program**

Allen Chao, Ying Gao, Jordan Jiang, Adesuwa N. Osunde, Diana Etwaru, Laalasa Varanasi, Stephen L. Gluck, Meyeon Park. *University of California San Francisco, San Francisco, CA.*

**Background:** We are a center that provides multidisciplinary care for patients with autosomal dominant polycystic kidney disease (PKD). We sought to evaluate current tolvaptan use and reasons for tolvaptan discontinuation at our center.

**Methods:** We used the Jynarque Risk Evaluation Mitigation System database to determine tolvaptan prescriptions for patients registered through our clinic. We used our clinic database to derive clinical and demographic characteristics of these patients. We compared characteristics of individuals who were actively taking tolvaptan with those who were prescribed tolvaptan but were not taking it using t-test and chi-square.

**Results:** 67 patients prescribed tolvaptan were identified. 36 (57.3%) were women. 49 (73.1%) were White, 1 (1.5%) were Black, 9 (13.4%) were Asian, 5 (7.5%) were Latinx, 3 (4.5%) were Other race category. Age range was 22 to 72 years; median age (IQR) 45 (39, 53). 24 (58.5%) were on therapy for longer than 18 months. Among

active patients, 34 (83%) were on the 45/15mg dose; 4 (10%) on 60/30mg; 3 (7%) on 90/30mg. 26 (38.8%) were inactive. Reasons for inactivity included 4 who never started. Discontinuation occurred due to aquretic symptoms (4); reached transplant (2); acute kidney injury (2); insurance (2); "got tired of it" (2); liver function test abnormalities (1); pregnancy (1); gastrointestinal symptoms (1); the remainder had no specific reason (7). There was no difference between eGFR at time of initiation between active and inactive groups (67 v. 58 ml/min/1.72m<sup>2</sup>); family history of PKD (88% versus 77%); or Mayo classification (Table). Those without Mayo classification had ultrasound lengths > 16.5 cm.

**Conclusions:** Reasons for tolvaptan discontinuation cannot be immediately identified based on clinical or demographic characteristics. Physicians should work with patients who would benefit from tolvaptan to overcome potential barriers to continued use of this medication.

Mayo Class by Active (left column) versus Inactive (right column) status (Number of patients (%))

1A	1 (2.9%)	1 (5.6%)
1B	4 (11.8%)	1 (5.6%)
1C	11 (32.4%)	4 (22.2%)
1D	11 (32.4%)	4 (22.2%)
1E	6 (17.7%)	4 (22.2%)

**TH-PO371**

**PKD2 Founder Mutation Is the Most Common Mutation of Polycystic Kidney Disease in Taiwan**

Daw-yang Hwang,<sup>1</sup> Chih-Chuan Yu,<sup>3</sup> An Fu Lee,<sup>1</sup> Ming-Yen Lin,<sup>3</sup> Siao Muk Cheng,<sup>1</sup> Yi-Wen Chiu,<sup>3</sup> Edgar A. Otto,<sup>4</sup> Friedhelm Hildebrandt.<sup>2</sup> Taiwan ADPKD Consortium <sup>1</sup>National Health Research Institutes, Zhunan, Taiwan; <sup>2</sup>Boston Children's Hospital, Boston, MA; <sup>3</sup>Kaohsiung Medical University Chung Ho Memorial Hospital, Kaohsiung, Taiwan; <sup>4</sup>University of Michigan Michigan Medicine, Ann Arbor, MI.

**Background:** Autosomal Dominant polycystic kidney disease (ADPKD) is the most common inherited adult kidney disease. Although ADPKD is primarily caused by *PKD1* and *PKD2*, the identification of several novel causative genes in recent years has revealed more complex genetic heterogeneity than previously thought. To study the disease-causing mutations of ADPKD, a total of 920 families were collected and their diagnoses were established via clinical and image studies by Taiwan PKD Consortium investigators.

**Methods:** Amplicon-based library preparation with next generation sequencing, variant calling, and bioinformatic analysis was used to identify disease-causing mutations in the cohort. Microsatellite analysis along with genotyping and haplotype analysis was performed in the *PKD2* p.Arg803\* family members. The age of mutation was calculated to estimate the time at which the mutation occurred or the founder arrived in Taiwan.

**Results:** Disease-causing mutations were identified in 634 families (68.9%) by detection of 364 *PKD1*, 239 *PKD2*, 18 *PKHD1*, 7 *GANAB*, and 6 *ALG8* pathogenic variants. 162 families (17.6%) had likely causative but non-diagnostic variants of unknown significance (VUS). A single *PKD2* p.Arg803\* mutation was found in 17.8% (164/920) of the cohort in Taiwan. Microsatellite and array analysis showed that 80% of the *PKD2* p.Arg803\* families shared the same haplotype in a 250kb region, indicating those families may originate from a common ancestor 300 years ago.

**Conclusions:** Our findings provide a mutation landscape as well as evidence that a founder effect exists and has contributed to a major percentage of the ADPKD population in Taiwan.

**Funding:** Government Support - Non-U.S.

**TH-PO372**

**Reduced Penetrance of ALG9-Associated Cystic Kidney Disease in a Real-World Cohort**

Lauren Beretch,<sup>1</sup> Umayma Abdullatif,<sup>2</sup> Kenan M. Alrejjal,<sup>2,4</sup> Emily Hendricks,<sup>1</sup> Darbey Raible,<sup>1</sup> Dinah Clark,<sup>1</sup> Sumit Punj,<sup>1</sup> Abdul A. Abdellatif.<sup>3,2</sup> <sup>1</sup>Natera, Inc., Austin, TX; <sup>2</sup>CLS Health, Webster, TX; <sup>3</sup>Baylor College of Medicine, Houston, TX; <sup>4</sup>MedStar Washington Hospital Center, Washington, DC.

**Background:** Recently, heterozygous loss-of-function variants in *ALG9* have been associated with autosomal dominant polycystic kidney and liver disease. Variable expressivity and reduced penetrance were reported in the limited cohorts studied with these conditions. The goal of this study was to assess the frequency of polycystic kidney and/or liver disease in individuals with heterozygous loss-of-function variants in *ALG9* from a real-world cohort of patients referred for clinical genetic testing.

**Methods:** A retrospective review of laboratory data and clinical information from test requisition forms was conducted. Participants with a clinically ordered genetic panel for kidney disease (the Renasight™ test) between May 2020 and April 2022 and a heterozygous pathogenic (P) or likely pathogenic (LP) variant in *ALG9* were included in this study.

**Results:** Among the 15 patients that met inclusion criteria, patients were predominantly female (10/15) and Caucasian (6/15). The median age at the time of genetic testing was 51 years (range 23-62 years). Patients were most often referred for genetic testing due to chronic kidney disease (8/15) and/or cystic kidney disease (7/15). All of the reported *ALG9* variants were classified as LP and were predominantly nonsense variants (8/15). In this cohort, 47% (7/15) patients were reported to have cystic or polycystic kidneys and one patient (1/7) was reported to have liver cysts. Only one patient (1/15) was reported to have a relevant family history.



**Conclusions:** In this real-world cohort, reduced penetrance was observed in *ALG9* heterozygotes, consistent with previous literature. These results may underrepresent the prevalence of autosomal dominant polycystic kidney and liver disease in *ALG9* heterozygotes as complete clinical information is not always provided on the test order form. In addition, 43% (3/7) of patients with a cystic phenotype and an *ALG9* variant also had a variant of uncertain significance (VUS) in separate genes related to cystic disease, for which additional data are needed to understand the impact on their phenotype. Future research can help further our understanding of the association between *ALG9* variants and cystic phenotypes.

**TH-PO373**

**Phenotypic Expression Among *HNF1B* Pathogenic Variant Carriers**

Brian Fang,<sup>1</sup> Alex R. Chang,<sup>2</sup> Uyenlinh L. Mirshahi,<sup>4</sup> Kashyap A. Patel,<sup>3</sup> Michael Weedon,<sup>3</sup> <sup>1</sup>Geisinger Commonwealth School of Medicine, Scranton, PA; <sup>2</sup>Geisinger Medical Center, Danville, PA; <sup>3</sup>University of Exeter, Exeter, United Kingdom; <sup>4</sup>Geisinger Health, Danville, PA.

**Background:** Patients with *HNF1B* variants have shown variable phenotypic expression even between individuals with the same mutation between and within families. As most studies focus on patients with disease-specific cohorts, the phenotypic spectrum of *HNF1B* in the general population remains unclear.

**Methods:** We used data from 172,589 participants in the Geisinger MyCode/DiscoverEHR study, an unselected health system-based cohort with exome sequencing and EHR data. Variants were classified according to ACMG-AMP guidelines. Participants with pathogenic/likely pathogenic (PLP) variants in *HNF1B* and 17q12 microdeletion were identified and were matched 1:1 by age decade, sex, and genetic ancestry with individuals without *HNF1B* pathogenic variants or 17q12 deletion (non-carriers). Patient medical records were examined to ascertain phenotypic features related to *HNF1B* clinical spectrum. Comparisons between individuals with and without *HNF1B* were made using Fisher exact test and t-tests.

**Results:** There were a total of 25 participants with 17q12 microdeletion and 11 heterozygotes for PLP single nucleotide variants (6 individuals with 5 protein truncating variants, 5 individuals with 4 missense variants). All 36 participants with *HNF1B* PLP variants were matched 1:1 to 36 non-carriers. *HNF1B* pathogenic variants were associated with higher risk of diabetes (25% vs. 2.8%; p=0.01, any kidney/liver cyst ICD code 13.9% vs. 0%; p=0.05), hypomagnesemia <1.75 mg/dL (33% vs. 0%; p<0.001), and lower mean eGFR (67.4 vs. 88.2 ml/min/1.73m<sup>2</sup>; p=0.01). In focused chart review of the 36 carriers, 2 (5.6%) had end-stage kidney disease, and 22 (61.1%) had renal imaging, including 18 with computed tomography or magnetic resonance imaging of the abdomen. Of those with available imaging, 9/22 (40.9%) had bilateral renal cysts, 1/17 (6%) had liver cysts, 6/17 (35.3%) had atrophic or hypoplastic pancreas. Individuals with 17q12 microdeletion were more likely to have diabetes (40% vs. 9%; p=0.1) and bilateral renal cysts (among 22 with imaging: 8/12 [66.7%] vs. 1/10 [10%]; p=0.01) compared to those heterozygous for PLP single nucleotide variants.

**Conclusions:** In an unselected health system-based cohort, we demonstrated variable penetrance and the wide spectrum of disease manifestations ranging from diabetes, renal cysts, and pancreatic abnormalities in patients with *HNF1B* pathogenic variants.

**TH-PO374**

**Six Novel *PDK1* Mutations Identified From Six Chinese Families With Autosomal Dominant Polycystic Kidney Disease**

Jing Zhuang, Ailima Aierken, Dilina Yalikun, Jun Zhang, Xiaoqin Wang, Hong Jiang, People's Hospital of Xinjiang Uygur Autonomous Region, Urumqi, China.

**Introduction:** ADPKD is the monogenetic kidney cystic disease, mainly resulting from mutations in either polycystic kidney disease 1 (*PKD1*) or *PKD2* genes. Our study aimed to characterize variants in Chinese patients by identifying pathogenic genes related to ADPKD to further unravel its pathogenesis

**Case Description:** Clinical data and genetic information of six Chinese ADPKD adult patients were analyzed using the next-generation sequencing technique. Their family members were analyzed for the specific variant using Sanger sequencing. In pedigree A, the male proband with chronic kidney disease (CKD) stage 2, hypertension (HT) and polycystic liver disease (PL) showed missense mutation (c.8447T>C and c.4247T>G) in *PKD1*. In pedigree B, the female proband with CKD stage 2, HT, PL and intracranial arachnoid cyst showed a nonsense mutation (c.3298\_3301delGAGT) in *PKD1*. In pedigree C the female proband with CKD stage 5, HT and PL showed missense mutation (c.4798A>G and c.6406C>T) in *PKD1*. In pedigree D, the female proband with CKD stage 3 and ovarian cyst (OC) showed a missense mutation (c.7567G>A) in *PKD1*. In pedigree E, the male proband with CKD stage 5, HT, PL and Epididymal cyst (EC) showed a nonsense mutation (c.11215C>T) and a missense mutation (c.11717G>C) in *PKD1*. In pedigree F, the male proband with CKD stage 5 and HT showed a nonsense mutation (c.7703+5G>C) in *PKD1*. Family members carried the same mutations as the probands respectively. Six novel mutation sites have been discovered in *PKD1*: c.4247T>G; c.3298\_3301delGAGT; c.4798A>G; c.7567G>A; c.11717G>C; c.7703+5G>C.

**Discussion:** The newly discovered *PKD1* mutation site enriches the ADPKD gene mutation spectrum in the domestic population, which contributes to the early diagnosis and prognosis prediction of ADPKD patients, and provides relevant genetic information for early clinical intervention.

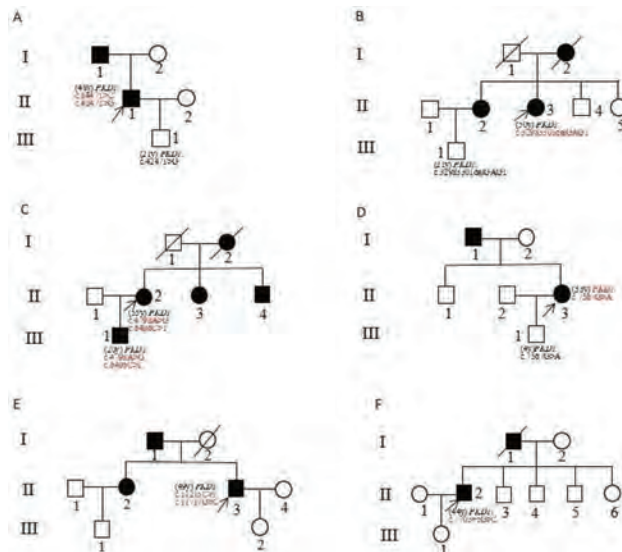

**TH-PO375**

**Clinical Characterization of Monoallelic-*PKHD1* Subjects**

Tabinda Jawaid, Christian Hanna, Sarah R. Senum, Charles D. Madsen, Vicente E. Torres, Peter C. Harris. Mayo Clinic Minnesota, Rochester, MN.

**Background:** ARPKD results from biallelic pathogenic variants of *PKHD1*. There is also limited literature indicating that monoallelic *PKHD1* variants can develop kidney and/or liver cysts. We aimed to characterize patients with monoallelic-*PKHD1* identified from ARPKD families or from genetic screening of subjects with kidney and/or liver cysts.

**Methods:** Genetic testing was performed using a target next-generation sequencing panel consisting of known PKD and ciliopathy genes and segregation was performed by Sanger sequencing. Individuals with single defined pathogenic or likely pathogenic *PKHD1* variants were characterized by imaging and the clinical phenotype determined from chart review; ones with other significant genetic variants were excluded.

**Results:** A total of 28 monoallelic-*PKHD1* subjects with complete clinical and imaging details were identified; 6 from ARPKD families and 22 from genetic screening. Females accounted for 57.1% (16/28) with a median age at diagnosis of 48 years (range 1.2-74). Only kidney cysts were found in 32.1% (9/28), 7.1% (2/28) had only liver cysts, and 60.7% (17/28) had cysts in both organs, with the number of cysts ranging from 1 to >20. Ten subjects were initially diagnosed following imaging for related symptoms: flank pain (6/22), hematuria (3/22), or abnormal physical examination (1/22). However, the majority (18/28) were diagnosed incidentally, with imaging performed for donor evaluation or reasons unrelated to cystogenesis. Hypertension was found in 57.1% (16/28). Two subjects (5.7%) with other kidney comorbidities had a kidney transplant, and 17.8% (5/28) were kidney donors, although a few cysts were present. The median eGFR was 60 mL/min/1.73m<sup>2</sup> (range 5-126), and only one patient died, at the age of 71. Other phenotypes included nephrolithiasis (35.7%), pancreatic cysts (7.1%), renal mass resulting in nephrectomy (7.1%), intracranial aneurysm (3.5%), and medullary sponge kidney (3.5%). The type of pathogenic variant was truncating in 35.7% (10/28) and non-truncating in 64.2% (18/28).

**Conclusions:** Monoallelic pathogenic *PKHD1* variants have a variable clinical impact and are not usually associated with a decline in kidney function but may account for a significant group of individuals diagnosed with kidney and/or liver cysts. Limited evidence of multiple family members being affected suggests reduced expressivity of the phenotype.

**Funding:** NIDDK Support

**TH-PO376**

**Monoallelic *COL4A3/A4/A5* Pathogenic Variants Mimicking Autosomal Dominant Polycystic Kidney Disease**

Tabinda Jawaid,<sup>1</sup> Sarah R. Senum,<sup>1</sup> Charles D. Madsen,<sup>1</sup> Hamad Ali,<sup>2,3</sup> Vicente E. Torres,<sup>1</sup> Peter C. Harris.<sup>1</sup> <sup>1</sup>Mayo Clinic Minnesota, Rochester, MN; <sup>2</sup>Kuwait University, Dasman, Kuwait; <sup>3</sup>Dasman Diabetes Institute, Dasman, Kuwait.

**Background:** Alport syndrome is caused by biallelic pathogenic variants to *COL4A3* and *COL4A4* and hemizygous *COL4A5* variants, but the pathogenicity of heterozygous variants at these loci is now apparent. The basement membrane disease phenotype results in hematuria, proteinuria and kidney failure, and deafness. Kidney cysts have also been occasionally associated with this disorder and we aimed to determine if the etiology of some ADPKD diagnosed patients are *COL4A3/A4/A5* pathogenic variants.

**Methods:** ADPKD spectrum patients were genetically screened with a targeted next-generation sequencing panel including PKD, other kidney, and ciliopathy genes, and segregation performed by Sanger sequencing. Individuals with single pathogenic/likely pathogenic *COL4A3/A4/A5* variants were characterized by imaging and the clinical phenotype determined from chart review. Cases with variants in more than one gene were excluded.

**Results:** A total of 16 families with an ADPKD spectrum diagnosis (25 patients) had single *COL4A3/A4/A5* pathogenic variants (Table 1), including 3 *COL4A5* males. Kidney cyst numbers ranged from 1 to >18 with significant variation in cyst size; liver cysts were documented in three individuals. Phenotypes identified at the diagnosis included: hematuria (36%), proteinuria (14.2%), and abdominal pain (19%) and on detailed workup, gross hematuria (16%) microhematuria (56%), proteinuria (44%), and hypertension (48%) were characterized. Two patients had kidney transplants. The median age at diagnosis was 46.5 years (4 - 73) with a median eGFR of 61 mL/min/1.73m<sup>2</sup>; ranging from 11 to 120; 1 male *COL4A5* subject had an eGFR of 15. Glycine substitutions in the triple helix region of the protein accounted for 22 out of 25 patients.

**Conclusions:** Individuals with heterozygous pathogenic variants to *COL4A3/A4/A5* can present with multiple kidney cysts, resulting in an ADPKD spectrum diagnosis, although most patients have additional Alport related phenotypes. Genetic screening panels of PKD patients should include the *COL4A3/A4/A5* genes.

**Funding:** NIDDK Support

**Table 1:** characteristics of single *COL4A3/A4/A5* pathogenic variants

	<i>COL4A3</i> n=7	<i>COL4A4</i> n=11	<i>COL4A5</i> n=7	Total n=25
Families	2 (6)	1 (2)	1 (5)	4 (13)
n (members)				
Singletons, (n)	1	9	2	12
Females, n (%)	3 (42.8)	3 (27.2)	4 (57.1)	10 (40)
Age at diagnosis median (Q1, Q3)	55 (33,63)	50 (22,73)	31 (4,46)	46.5 (4,73)
Kidney function (eGFR) median (Q1, Q3)	51 (11, 112)	56 (39,105)	61 (15,120)	61 (11,120)
Transplant, n (%)	1 (14.2)	1 (9)	0	2 (8)
Gross hematuria, n (%)	1 (14.2)	1 (9)	2 (28.5)	4 (16)
Microhematuria, n (%)	3 (42.8)	4 (36.3)	6 (85.7)	14 (56)
Proteinuria, n (%)	3 (42.8)	4 (36.3)	4 (57.1)	11 (44)
Hypertension, n (%)	6 (85.7)	5 (45.4)	1 (14.2)	12 (48)
Renal cysts, n (%)	7 (100)	7 (63.6)	4 (57.1)	18 (72)
# Renal cysts (Q1, Q3)	1, >13	3, >18	2, 13	1, >18

**TH-PO377**

**Type IV Collagen Variants in Patients With Polycystic Kidneys**

Matthew B. Lanktree,<sup>1</sup> Amirreza Haghighi,<sup>2</sup> Saima Khawaja,<sup>2</sup> Ioan-Andrei Iliuta,<sup>2</sup> Andrew Paterson,<sup>3</sup> York P. Pei.<sup>2</sup> <sup>1</sup>McMaster University Faculty of Health Sciences, Hamilton, ON, Canada; <sup>2</sup>University Health Network, Toronto, ON, Canada; <sup>3</sup>The Hospital for Sick Children, Toronto, ON, Canada.

**Background:** Gene panel and whole exome sequencing of patients with cystic kidney disease have led to the discovery of unexpected phenotypic heterogeneity of genetic kidney diseases. Mutations in type IV collagen genes (*COL4A3/COL4A4/COL4A5*) have long been recognized as the cause of Alport syndrome and thin basement membrane disease. More recently, type IV collagen mutations have also been associated with focal segmental glomerulosclerosis. Among patients clinically selected and submitted for genetic assessment of polycystic kidneys, we sought to compare the prevalence of type IV collagen mutations between those with and without a pathogenic *PKD1* or *PKD2* variant.

**Methods:** 808 participants of the Ontario Polycystic Kidney Disease registry provided DNA samples for targeted gene panel sequencing. Sequencing results from *PKD1*, *PKD2*, *COL4A3*, *COL4A4*, and *COL4A5* were analyzed here. Participant charts were reviewed to analyze their cystic phenotype and obtain measurements of total kidney volume and kidney function.

**Results:** 34 participants had a suspected pathogenic rare variant in a type IV collagen gene with a median age of 49 (range 24 – 72). One male was hemizygous for a *COL4A5* variant (p.P151T), while the remaining variants were carriers of a heterozygous variant. Type IV collagen variants were more prevalent in patients who did not also have a *PKD1* or *PKD2* rare variant compared to those with them (31 out of 315 patients compared to 3 out of 493;  $P < 1 \times 10^{-5}$ ). Of 31 type IV collagen variants without a *PKD1* or *PKD2* mutation 20 had atypical cystic distributions, 11 had a cystic appearance consistent with typical autosomal dominant polycystic kidney disease (ADPKD), and only 2 had a high-risk Mayo classification (class C or worse). 3 of 34 patients with a type IV collagen variant had reached an eGFR < 30 ml/min/1.73m<sup>2</sup>.

**Conclusions:** In patients with polycystic kidneys and gene panel sequencing results, type IV collagen mutations were more common in those without a *PKD1* or *PKD2* mutation compared to those with them, suggesting type IV collagen mutations may be associated with a cystic phenotype. Both typical and atypical cystic imaging patterns were observed but generally smaller age- and height-adjusted kidney volumes were observed.

**Funding:** Private Foundation Support, Clinical Revenue Support

**TH-PO378**

**Monoallelic IFT140 Variants and Atypical Cystic Kidney Disease in the 100,000 Genomes Project**

Eric G. Olinger,<sup>1</sup> Ruxandra Neatu,<sup>1</sup> Ian J. Wilson,<sup>1</sup> John A. Sayer.<sup>1,2</sup> <sup>1</sup>Newcastle University Faculty of Medical Sciences, Newcastle upon Tyne, United Kingdom; <sup>2</sup>Freeman Hospital, Newcastle upon Tyne, United Kingdom.

**Background:** Autosomal dominant polycystic kidney disease (ADPKD) is characterized by progressive kidney cysts and is an important cause for kidney failure. ADPKD is genetically heterogeneous and most commonly caused by mutations in *PKD1* and *PKD2*. However, ~5% of families remain without a molecular diagnosis. Monoallelic

variants in *IFT140* have been recently described in atypical ADPKD and large databases are instrumental for a better description of this new disease entity.

**Methods:** Whole genome sequencing (WGS) in the context of the Genomics England 100,000 Genomes Project (100kGP) was carried out in 64,185 subjects, including 1,291 probands with cystic kidneys. This research was made possible through access to the data and findings generated by the 100kGP (www.genomicsengland.co.uk).

**Results:** We report a 28-year-old man with *PKD1/2*-negative cystic kidneys and recruited into the 100kGP. A review of his imaging revealed an atypical pattern of kidney cysts (Figure) and he was noted to have preserved kidney function and normotension. Of his two children one had kidney cysts aged 8 years. WGS data revealed a heterozygous predicted loss of function (pLOF) variant in *IFT140* in the index patient and his affected child. Analysis of 100kGP data identified 26 pLOF variants in a total of 152 individuals from 111 different families. Among these 152 individuals, kidney cyst(s) were described in 38 individuals (25%), CKD in only 7 (5%) and kidney failure in 6 individuals (4%). Overall, 26 out of 1,291 (2%) probands with cystic kidney disease as their primary recruitment groups had *IFT140* pLOF variants. Mean age at diagnosis was 48.4±18.1 years. Only ICD term Q61 (cystic kidney disease) showed phenome-wide significant association with *IFT140* monoallelic pLOF variants (p=2.9x10<sup>-9</sup>, OR=5.6 (3.3-9.2)).

**Conclusions:** *IFT140* pLOF variants are an important cause of atypical ADPKD without apparent extrarenal manifestations and should be considered in *PKD1/2*-negative patients, especially those with mild clinical course and preserved kidney function.

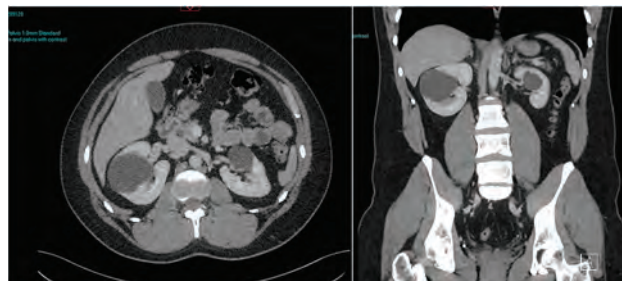

Figure: Abdominal CT showing few large kidney cysts

**TH-PO379**

**Design of a Prospective Observational Study of Patients With Rare Kidney Diseases**

Kendrah O. Kidd,<sup>1</sup> Abigail Taylor,<sup>1</sup> Victoria C. Robins,<sup>1</sup> Lauren Martin,<sup>1</sup> Adrienne H. Williams,<sup>1</sup> Anthony J. Bleyer.<sup>1,2</sup> <sup>1</sup>Wake Forest University School of Medicine, Winston-Salem, NC; <sup>2</sup>Univerzita Karlova, Praha, Czechia.

**Background:** Autosomal dominant tubulointerstitial kidney disease (ADTKD) is a rare disease, with less than 2,000 patients identified. Obtaining prospective data on rare diseases is difficult due to small numbers of patients, a wide geographic distribution, and limited funding. We describe the use of the REDCap data system to develop a biorepository, send automated emails, and establish longterm follow-up. Here we present results at one year.

**Methods:** At baseline, we collect serum/urine for biomarkers, serum creatinine, and initial survey, including BP, medications, diet history. Serum creatinine is measured at a commercial laboratory or by participant's physician. Quarterly visits are paired with a short survey. There is a nested cohort study of pregnancy or SGLT2 inhibitor use. A secure REDCap project was designed to capture data. After the initial visit, the REDCap program sends email reminders for quarterly laboratory visits and survey.

**Results:** Recruitment began in March 2021, with current enrollment 145 (Table). We have collected 478 serum creatinine measurements from 132 patients with paired survey data. We have 87 patients who have completed Visit 1 (4 months), 60 who have completed Visit 2 (8 months) and 24 who have completed Visit 3 (12 months). 15 patients missed one quarterly visit, 6 missed 2, and one missed 3. Phone call reminders have been needed for approximately 35 patients.

**Conclusions:** Automation of data collection decreases study team manpower and is highly effective. Longer term follow-up is required to see if attrition develops. We believe this system could be employed for other rare kidney diseases.

**Funding:** Private Foundation Support

**Study Participants**

	ADTKD-MUC1	ADTKD-UMOD
Consented (n)	67	78
Male n (%)	25 (38%)	27 (35%)
Age (y)	44±15	43±13
Non-smoker n (%)	64 (95%)	78 (100%)
Vegetarian or Vegan n (%)	1 (2%)	3 (4%)
BMI	25±4.5	26±6
Systolic BP	124±12	122±12
Diastolic BP	80±11	78±9
eGFR >60 (n (%))	17 (25%)	21 (26%)
eGFR 30 to <60 (n (%))	31 (51%)	28 (49%)
eGFR <30 (n (%))	16 (24%)	11
SGLT2i Nested Cohort (n)	12	11
Pregnancy nested cohort (n)	5	2

## TH-PO380

**Increased Susceptibility and 9-Fold Increased Mortality From COVID-19 in Patients With ADTKD-MUC1**

Kendrah O. Kidd,<sup>1,2</sup> Petr Vyletal,<sup>2</sup> Alice Kim,<sup>1</sup> Abigail Taylor,<sup>1</sup> Martina Zivna,<sup>2</sup> Christoforos Stavrou,<sup>3</sup> Peter J. Conlon,<sup>4</sup> Richard E. Hogan,<sup>4</sup> Gregory Papagregoriou,<sup>5</sup> Stanislav Kmoch,<sup>2,1</sup> Anthony J. Bleyer,<sup>1,2</sup> *Wake Forest Baptist Medical Center, Winston-Salem, NC; <sup>2</sup>Univerzita Karlova, Praha, Czechia; <sup>3</sup>Evangelismos Private Hospital, Pafos, Cyprus; <sup>4</sup>Beaumont Hospital, Dublin, Ireland; <sup>5</sup>Panepistimio Kyprou, Nicosia, Cyprus.*

**Background:** Patients with autosomal dominant tubulointerstitial kidney disease due to *MUC1* mutations (ADTKD-*MUC1*) have a frameshift mutation on one allele of the *MUC1* genotype, resulting in production of an abnormal MUC1frameshift protein on one allele and normal MUC1 on the other allele. The C variant of the rs4072037 SNP increases production of MUC1 or MUC1fs if it is contained in the corresponding promoter. In addition to the kidneys, MUC1 is expressed in the nose and lungs. ADTKD-*UMOD* has a very similar clinical presentation, but *UMOD* is expressed only in the kidney.

**Methods:** We conducted a survey (after emergence of the delta variant) using the REDCAP database of 957 individuals in our ADTKD cohort to determine if COVID-19 infection was more severe in ADTKD-*MUC1* patients.

**Results:** There were 89 ADTKD-*MUC1* and 132 ADTKD-*UMOD* respondents, with similar age, body mass index, transplant rates, vaccination rates. 25/89(28%) ADTKD-*MUC1* individuals developed COVID-19 vs. 21/132(16%) ADTKD-*UMOD* individuals (odds ratio 2.35(1.6-3.1) (p=0.028). 10/41 (24%) ADTKD-*MUC1* individuals died of COVID-19 vs. 1/30 (3%) ADTKD-*UMOD* individuals (p=0.013), with an odds ratio of 9.4 (7.2-11.5). The mean plasma mucin1 level in 13 infected and 23 uninfected ADTKD-*MUC1* individuals was 6.40±3.4 vs.10.89±3.82 U/mL (p=0.0012). Of ADTKD-*MUC1* individuals who developed COVID-19, only 19% had the CC phenotype (associated with increased MUC1 production) vs. 51% of the ADTKD-*MUC1* individuals who did not develop COVID-19 (p=0.01). There was no difference in rs4073037 genotype frequencies in the ADTKD-*UMOD* group. Of the 10 ADTKD-*MUC1* patients who died, 8 were transplanted, with only 3 greater than 60 years of age. 50 percent had received 2 COVID-19 vaccines.

**Conclusions:** Patients with ADTKD-*MUC1* have a 2-fold increased odds of developing COVID-19 and a 9-fold increased mortality from COVID-19. Among ADTKD-*MUC1* patients, those producing less MUC1 were more likely to develop COVID-19.

**Funding:** Private Foundation Support

## TH-PO381

**Good Nutritional Status Is Associated With Preserved Kidney Function in Ambulatory Patients With Autosomal Dominant Polycystic Kidney Disease**

Jinwoo Lee,<sup>1,2</sup> Yong Chul Kim,<sup>1,2</sup> Hayne C. Park,<sup>4,5</sup> Curie Ahn,<sup>6</sup> Kyu-Beck Lee,<sup>7,8</sup> Yeong Hoon Kim,<sup>9,10</sup> Yaerim Kim,<sup>11,12</sup> Seungyeup Han,<sup>11,12</sup> Eun Hui Bae,<sup>13,14</sup> Kook-Hwan Oh,<sup>1,2</sup> Yun Kyu Oh.<sup>1,3</sup> *<sup>1</sup>Seoul National University College of Medicine Department of Internal Medicine, Seoul, Republic of Korea; <sup>2</sup>Seoul National University Hospital, Jongno-gu, Seoul, Republic of Korea; <sup>3</sup>Seoul National University Seoul Metropolitan Government Boramae Medical Center, Dongjak-gu, Seoul, Republic of Korea; <sup>4</sup>Hallym University College of Medicine, Chuncheon, Gangwon, Republic of Korea; <sup>5</sup>Kangnam Sacred Heart Hospital, Yeongdeungpo-gu, Seoul, Republic of Korea; <sup>6</sup>National Medical Center, Seoul, Republic of Korea; <sup>7</sup>Sungkyunkwan University School of Medicine, Suwon, Republic of Korea; <sup>8</sup>Kangbuk Samsung Medical Center, Jongno-gu, Seoul, Republic of Korea; <sup>9</sup>Inje University College of Medicine, Busan, Republic of Korea; <sup>10</sup>Inje University Busan Paik Hospital, Busan, Republic of Korea; <sup>11</sup>Keimyung University School of Medicine, Daegu, Republic of Korea; <sup>12</sup>Keimyung University Dongsan Medical Center, Daegu, Republic of Korea; <sup>13</sup>Chonnam National University Medical School, Gwangju, Republic of Korea; <sup>14</sup>Chonnam National University Hospital, Gwangju, Republic of Korea.*

**Background:** Malnutrition is one of common complications in autosomal dominant polycystic kidney disease (ADPKD). We examined whether nutritional status is associated with preservation of kidney function using a cohort of ambulatory ADPKD patients after stratification by subjective global assessment (SGA) score and propensity scores-based matching.

**Methods:** A total of 805 patients were prospectively enrolled in 11 tertiary medical centers of Korea from May 2019 to December 2021. Among those of 805 patients, 721 patients were included for descriptive analysis and 273 patients with 1-year follow-up data on kidney function and urine proteinuria were finally analyzed to evaluate the effect of nutritional status on kidney function. Subjective global assessment (SGA) was used to assess the nutritional status of patients with ADPKD. The primary outcome was eGFR decline >3 after 1 year follow-up according to nutritional status assessed by SGA (SGA 7 vs. SGA 3-6). Logistic regression model were used to calculate odds ratio (OR) for the primary outcome. Because several baselines differed between two groups, we matched propensity scores with nearest neighbor method.

**Results:** The mean patient age was 46.3 ± 13.9 years, and 51.0% of the patients were female. The mean eGFR was about 75 ml/min/1.73m<sup>2</sup> and CKD stage 1 was the most common with about 42%. Among 273 patients with available 1-year follow-up data, 107 patients (39.2%) had a eGFR decline >3. The incidence of 1-year eGFR decline

>3 was 391.9 per 1,000 person-year. When multivariable logistic regression model was conducted, SGA 3-6 (malnourished status) was identified as significant factors related with 1-year eGFR decline >3 (adjusted OR = 1.18 [1.01-1.37]; *P* < 0.001). Despite matching propensity scores, the preserved kidney function rate in SGA 7 group (well-nourished status) were still higher than in SGA 3-6 group.

**Conclusions:** Good nutritional status is associated with preserved kidney function in ambulatory ADPKD patients. Future randomized clinical trials should determine the causality between them, and the present results will be a basis for these.

**Funding:** Government Support - Non-U.S.

## TH-PO382

**Kidney Phosphate Wasting Predicts Worse Outcomes in Patients With Polycystic Kidney Disease**

Laixi Xue,<sup>1</sup> Esther Meijer,<sup>2</sup> Martin H. De Borst,<sup>2</sup> Ron T. Gansevoort,<sup>2</sup> Robert Zietse,<sup>1</sup> Ewout J. Hoorn,<sup>1</sup> Mahdi Salih,<sup>1</sup> on behalf of the DIPAK Consortium *<sup>1</sup>Erasmus MC, Rotterdam, Netherlands; <sup>2</sup>Universitair Medisch Centrum Groningen, Groningen, Netherlands.*

**Background:** Autosomal dominant polycystic kidney disease (ADPKD) is the most common inherited chronic kidney disease (CKD) which often leads to kidney failure. Patients with ADPKD have disproportionately high levels of the phosphaturic hormone fibroblast growth factor 23 (FGF23) for their CKD-stage, but only a subgroup seems to develop kidney phosphate wasting. Because phosphate wasting is considered a marker for tubular dysfunction, we hypothesize it is associated with worse kidney outcomes in ADPKD patients.

**Methods:** We included 670 patients with ADPKD from the DIPAK observational cohort with serial measurements of kidney function (eGFR) and MRI-based total kidney volume (TKV). We measured baseline serum c-terminal FGF23 levels and calculated the ratio of tubular maximum reabsorption rate of phosphate to glomerular filtration rate (TmP/GFR) using the Bijvoet formula. We defined a TmP/GFR <0.8 mmol/L as kidney phosphate wasting. We used linear mixed models and Cox regression models to study the association of TmP/GFR ratios with eGFR decline over time and the hazard ratios for composite kidney outcome (≥ 40% estimated GFR decline, incident of kidney failure or kidney replacement therapy).

**Results:** Phosphate excretion was measured in 604 patients (age 48± 12 years, 39% male, eGFR 63±28 mL/min/1.73m<sup>2</sup>). Mean TmP/GFR was 0.76± 0.23 mmol/L and mean FGF23 was 121± 74 RU/mL. Kidney phosphate wasting was observed in 357 (59%) patients. Male gender, eGFR and FGF23 were independently associated with TmP/GFR (*P*<0.05 for all). During follow-up of 3 years, 145 kidney outcomes were observed. After adjusting for risk factors for kidney function decline (including gender, genotype and TKV), every 0.1 mmol/L decrease in TmP/GFR was associated with a steeper eGFR decline of 0.15 ml/min/1.73m<sup>2</sup>/year (p=0.01) and 1.17 times higher risk of the kidney outcome (95% CI 1.04 to 1.31, p=0.007). FGF23 or hypophosphatemia were not associated with the composite kidney outcome.

**Conclusions:** In patients with ADPKD, phosphate wasting is highly prevalent and is independently associated with an increased risk for disease progression. This effect was not mediated by FGF23 or serum phosphate levels. Our results suggest that TmP/GFR adds to the current prognostic models for ADPKD.

## TH-PO383

**Urinary Citrate Is Associated With Kidney Outcomes in Early Polycystic Kidney Disease**

Laixi Xue,<sup>1</sup> Daniel R. Rocha,<sup>2</sup> Hiago M. Sousa,<sup>2</sup> Ana Matos,<sup>2</sup> Ewout J. Hoorn,<sup>1</sup> Mahdi Salih,<sup>1</sup> Ita P. Heilberg,<sup>2</sup> *<sup>1</sup>Erasmus MC, Rotterdam, Netherlands; <sup>2</sup>Universidade de Sao Paulo, Sao Paulo, Brazil.*

**Background:** Patients with autosomal dominant polycystic kidney disease (ADPKD) are prone to develop hypocitraturia at early stages of disease, predisposing them to calcium microcrystal formation. Recent animal studies demonstrated that microcrystal lodging in the tubules initiate cyst formation and growth. Therefore, we hypothesize that patients with ADPKD and lower urinary citrate levels are at increased risk of rapid disease progression.

**Methods:** We included patients with ADPKD in which urinary citrate levels were measured between 2002-2021 at our outpatient clinic at the Universidade Federal de São Paulo, Brazil. We collected baseline urine metabolic profiling, ultrasound-based total kidney volumes (TKV) and eGFR values at baseline and follow-up. We used linear mixed models to evaluate the association of urine citrate excretion with eGFR slope and Kaplan-Meier and Cox-regression models to assess the risk rate to a kidney outcome (eGFR decline >40%, kidney failure or kidney replacement therapy).

**Results:** From a total of 736 screened patients, 95 met our inclusion criteria. Patients were 33± 14 years, 66% were females, with a relatively preserved kidney function (eGFR of 91± 29 mL/min/1.73m<sup>2</sup>). Median follow-up was 11 years (IQR 5-15y). Lower citrate levels were associated with male sex, larger TKV and lower eGFR (p<0.05 for all). The urine citrate/creatinine ratio (uCit/Cr) correlated with eGFR and TKV (R<sup>2</sup>= 0.17 and 0.22, *P*< 0.001 for both). Patients with the lowest tertile of uCit/Cr (T1) had an eGFR decline of 3.7, compared to 3.3 (T2) and 2.3 ml/min/1.73m<sup>2</sup>/year (T3) (p=0.04 for T1 vs. T3). Median kidney survival time was lower in patients with lower levels of uCit/Cr (9 vs. 18 years for T1 vs. T3, p= 0.002). Adjusted for age, sex and baseline eGFR, each log unit decrease in uCit/Cr was associated with a 5-fold higher risk for a kidney outcome.

**Conclusions:** Low urinary citrate excretion is associated with a more rapid eGFR decline and worse kidney survival in patients with ADPKD, independent of other disease determinants. Our findings suggest urinary citrate may add to current prognostic markers of disease progression in ADPKD.

Key: TH - Thursday; FR - Friday; SA - Saturday; OR - Oral; PO - Poster; PUB - Publication Only

Underline represents presenting author.

TH-PO384

The Burden of Psychiatric Disorders in Polycystic Kidney Disease

Uyi J. Imasuen, Brady M. Dangelser, Ali D. Jandal, Gauri Bhutani. *University of Wisconsin School of Medicine and Public Health, Madison, WI.*

**Background:** Epidemiology of psychiatric illness in Polycystic kidney disease (PKD) is not well known.

**Methods:** We performed a retrospective cohort study using EMR data at our institution to determine the frequency of select psychiatric disorders in patients with "PKD" and chronic kidney disease from other causes ("non-PKD/CKD") seen at our Nephrology clinic between 1/1/2000 – 4/30/2020. Psychiatric disorders and the two cohorts were identified using ICD-9/10 codes. Patients with unclear diagnostic codes and diabetes were excluded. The date of the first visit to Nephrology clinic was regarded as "Index date". The prevalence of psychiatric disorders at the index date as well as incidence of these disorders after the index date were compared between "PKD" and "non-PKD/CKD" cohorts.

**Results:** A total of 661 PKD patients and 5,204 non-PKD/CKD patients were seen at our center over the study duration. Patients in PKD cohort were younger at presentation (Index date; mean 53 years vs 61 years in non-PKD/CKD; p<0.01) and more often male (57% [376] vs 52% [2636]; p=0.03). Majority of patients in both groups identified as white (90% [594] vs 87% [4392]). At the Index date, PKD patients were more often employed (37% [244] vs 28% [1380], p<0.01), married (58% [378] vs 56% [2748], p=0.048), had higher eGFR (median [IQR] 55 [31-84] vs 45 [29-61] mL/min/1.73m<sup>2</sup>, p<0.01) and lower Charlson comorbidity index (2 [0-4] vs 4 [3-6], p<0.01). Follow-up was shorter in the PKD cohort pre-index date (18 [0-82] vs 35 [0-99] months; p<0.01) but longer post-index date (84 [45-132] vs 52 [20-97]; p<0.01). Apart from depression, both the prevalence and incidence of other psychiatric disorders (bipolar, anxiety, schizophrenia, ADHD) were similar between the two groups. The multivariable models adjust for age, sex, race, Charlson score and appropriate follow up time. [table]

**Conclusions:** Despite lower burden of comorbid illness and better socio-economic factors, the burden of psychiatric disorders in PKD patients is considerable and similar in frequency to non-PKD/CKD.

Prevalence and Incidence of Psychiatric Disorders

	Prevalence, % (N)		Adjusted Odds ratio (PKD vs CKD)		Incidence, rate per 1000 person years		Adjusted hazard ratio (PKD vs CKD)	
	PKD N=661	CKD N=5024	Ratio (95% CI)	P-value	PKD N=661	CKD N=5024	Ratio (95% CI)	P-value
Depression	15 (98)	22 (1104)	0.78 (0.6-0.98)	0.04	23.1	23.5	1.09 (0.89-1.34)	0.41
Bipolar	3.6 (24)	3 (150)	1.21 (0.76-1.9)	0.42	1.2	1.9	0.67 (0.55-1.39)	0.57
Anxiety	18 (116)	21 (1041)	1.04 (0.83-1.31)	0.72	26.4	29.3	0.94 (0.5-1.78)	0.85
Schizophrenia	2.9 (19)	3.4 (171)	1.13 (0.69-1.85)	0.62	4.1	6.94	0.6 (0.25-1.45)	0.26
ADHD	1.8 (9)	1.7 (87)	0.7 (0.34-1.45)	0.33	2.34	2.34	1.02 (0.85-1.24)	0.77

TH-PO385

The MANGROVE Phase 2 Trial: Study Design and Baseline Characteristics of Patients With Autosomal Dominant Polycystic Kidney Disease

Ron T. Gansevoort,<sup>1</sup> Antonio Pisani,<sup>2</sup> Miguel Hueso,<sup>3</sup> Dávinia Van den Bergh,<sup>4</sup> Willem Hettema,<sup>5</sup> Karine Muller,<sup>4</sup> Ann Fieuw,<sup>4</sup> Wladyslaw Sulowicz.<sup>6</sup>  
<sup>1</sup>Department of Nephrology, University Medical Centre Groningen, University Hospital Groningen, Groningen, Netherlands; <sup>2</sup>Department of Nephrology, University of Naples Federico II, Naples, Italy; <sup>3</sup>Department of Nephrology, Bellvitge University Hospital, Barcelona, Spain; <sup>4</sup>Galapagos, NV, Mechelen, Belgium; <sup>5</sup>Galapagos, NV, Leiden, Belgium; <sup>6</sup>Department of Nephrology, Jagiellonian University, Kraków, Poland.

**Background:** Autosomal dominant polycystic kidney disease (ADPKD) is characterized by renal cyst development, mainly driven by chloride secretion that is mediated by the cystic fibrosis transmembrane conductance regulator (CFTR) channel.<sup>1</sup> Although the underlying molecular mechanism is not fully known, CFTR inhibitors have been shown to reduce cyst growth *in vitro* and *in vivo*.<sup>1</sup> With only one approved treatment, there is an unmet need for novel ADPKD therapies. MANGROVE is an ongoing phase 2a, proof-of-concept trial, evaluating the efficacy and safety of the CFTR inhibitor GLPG2737 in patients with ADPKD.

**Methods:** MANGROVE (NCT04578548; 2019-003521-21) comprises a randomized, double-blind, placebo-controlled treatment period and an open-label extension (OLE) treatment period (each 52 weeks with 4 weeks follow up). Adults (18–50 years) with rapidly progressing ADPKD (total kidney volume [TKV] >750 mL, Mayo class 1C–1E) and age-dependent estimated glomerular filtration rate (eGFR) (18–40 years: 30–90 mL/min/1.73 m<sup>2</sup>; >40–50 years: 30–60 mL/min/1.73 m<sup>2</sup>) were randomized 2:1 to receive GLPG2737 or matching placebo once daily for 52 weeks at baseline. Patients who completed double-blind treatment could enter the OLE. MANGROVE assessed treatment differences between GLPG2737 and placebo. Primary outcomes included change in height-adjusted TKV and frequency and severity of adverse events. Secondary outcomes included change in eGFR and estimated exposure to GLPG2737.

**Results:** The study enrolled 66 patients with ADPKD with a mean±SD age of 40.3±6.3 years, most of whom (92.4%) had arterial hypertension. Key disease characteristics and concomitant medication are reported in the table.

**Conclusions:** Study inclusion criteria were designed to enrich for patients with a high chance of rapid disease progression and were successful in doing so, as shown by the baseline patient characteristics. 1. Jouret F, Devuyt O. *Cell Signal* 2020;73:109703.

**Funding:** Commercial Support - Galapagos NV and AbbVie Inc.

Table. Baseline characteristics of patients with autosomal dominant polycystic kidney disease in the MANGROVE study (NCT04578548; 2019-003521-21).

	N=66
Gender, male, %	51.5
Age, years, mean±SD	40.3±6.3
Height, cm, mean±SD	175.6±10.5
Weight, kg, mean±SD	82.0±14.2
Systolic blood pressure, mmHg, mean±SD	131.2±9.1
Diastolic blood pressure, mmHg, mean±SD	83.6±6.6
Arterial hypertension, n/N (%)	61/66 (92.4)
Current medication for arterial hypertension <sup>a</sup>	59/61 (96.7)
Angiotensin-converting enzyme-based <sup>b</sup>	29/59 (49.2)
Angiotensin receptor blocker-based <sup>b</sup>	23/59 (39.0)
Other <sup>b</sup>	29/59 (49.2)
eGFR, mL/min/1.73m <sup>2</sup> , mean±SD	54.2±16.3
eGFR category, n (%)	
Stage 1: normal or high, ≥90 mL/min/1.73m <sup>2</sup>	1 (1.5)
Stage 2: mildly decreased, 60–89 mL/min/1.73m <sup>2</sup>	25 (37.9)
Stage 3a: mildly to severely decreased, 45–59 mL/min/1.73m <sup>2</sup>	18 (27.3)
Stage 3b: moderately to severely decreased, 30–44 mL/min/1.73m <sup>2</sup>	20 (30.3)
Stage 4: severely decreased, 15–29 mL/min/1.73m <sup>2</sup>	2 (3.0)
Total kidney volume, mL, mean±SD (n=64)	2165.7±1153.3
Height-adjusted total kidney volume, mL, mean±SD (n=64)	1227.4±629.0

<sup>a</sup>The denominator represents the total number of patients with arterial hypertension. <sup>b</sup>The denominator represents the total number of patients on current medication for arterial hypertension. eGFR, estimated glomerular filtration rate; SD, standard deviation.

TH-PO386

Characteristics of the US ESRD Population With Autosomal Dominant Polycystic Kidney Disease

Mirjana Stevanovic,<sup>1</sup> Martha L. Graber.<sup>2</sup> <sup>1</sup>Dartmouth Guarini School of Advanced Studies, Hanover, NH; <sup>2</sup>Dartmouth College Geisel School of Medicine, Hanover, NH.

**Background:** We present recent data concerning US individuals with autosomal dominant polycystic kidney disease (ADPKD) and ESRD

**Methods:** We used data from the US Renal Data System (USRDS) 2014 – 2018 to compare prevalent persons with ESRD and ADPKD to those without ADPKD

**Results:** Persons with ADPKD (N = 42714) comprised 3.1% of the US ESRD population. ADPKD accounted for 99.4% of all adult cystic disease categories (data not shown). Persons with ADPKD were younger on entry to the ESRD program by 4.9 years, more likely to be female and White, to have had nephrology care, to have initiated with peritoneal dialysis or transplant, and to have received a living donor kidney. There was no difference in the risk of death.

**Conclusions:** The vast majority, 99.4%, of persons with adult cystic diseases on entry to the ESRD program have a diagnosis of ADPKD. Those with ADPKD comprised 3.1% of the total US ESRD population, a figure consistent with data from the USRDS 1998 annual report, Europe and Japan, but lower than has been commonly reported in the US. We estimate that 3 - 7% of all US persons with ADPKD are on dialysis or have a transplant at any one time. On entry to the ESRD program individuals with ADPKD were younger, more likely to be White and female, to have had prior nephrology care, to have initiated renal replacement therapy with peritoneal dialysis or transplant and to have received a living donor graft than those with ESRD without ADPKD. There was no significant difference in the risk of death during a five year period. These findings contribute to our understanding of the epidemiology, risks, and outcomes of ADPKD.

**Funding:** Other NIH Support - NIDDK/COBRE award number P30DK117468

Table 1. Characteristics of US Individuals with Autosomal Dominant Polycystic Kidney Disease and End Stage Renal Disease

	Unadjusted		Age-adjusted	
	Coefficient/OR (95% CI)	p-value	Coefficient/OR (95% CI)	p-value
Female Sex	1.20 (1.17, 1.22)	<0.001	1.22 (1.19, 1.24)	<0.001
Age at first ESRD service (Mean ± SD)	-0.25 (1.28, 1.74)	<0.001	-0.26 (1.30, 1.79)	<0.001
HR (Mean ± SD)	1.49 (1.48, 1.50)	<0.001	1.52 (1.45, 1.59)	<0.001
Race				
White	2.70 (2.72, 2.86)	<0.001	2.96 (2.88, 3.04)	<0.001
Black/African American	0.25 (0.24, 0.26)	<0.001	0.25 (0.25, 0.25)	<0.001
Asian	0.62 (0.62, 0.63)	<0.001	0.62 (0.62, 0.63)	<0.001
Hispanic ethnicity	0.58 (0.57, 0.60)	<0.001	0.55 (0.55, 0.57)	<0.001
Pre-ESRD care by a nephrologist	3.43 (3.39, 3.46)	<0.001	3.29 (3.26, 3.31)	<0.001
First ESRD event modality type				
Hemodialysis	0.274 (0.269, 0.280)	<0.001	0.282 (0.280, 0.286)	<0.001
Peritoneal dialysis	2.00 (1.99, 2.00)	<0.001	1.97 (1.91, 1.91)	<0.001
Transplant	6.01 (5.96, 6.03)	<0.001	5.93 (5.77, 6.01)	<0.001
First Kidney Transplant	3.01 (3.03, 3.13)	<0.001	3.14 (3.02, 3.27)	<0.001
Living first transplant donor (n)	4.1 (4.12, 4.21)	<0.001	4.1 (4.11, 4.21)	<0.001
Death	0.602 (0.619, 0.627)	<0.001	0.602 (0.618, 0.606)	<0.001

<sup>a</sup>Linear regression coefficient for Age at first ESRD service and HR, and odds ratios (OR) from logistic regression for all other variables. For all ORs, non-ADPKD patients were used as the reference group.

TH-PO387

The Predicting Renal Outcomes in Polycystic Kidney Disease (PROPKD) Score for Estimating Risk of Rapid Progression and Treatment Benefit in Autosomal Dominant Polycystic Kidney Disease (ADPKD)

Vitalay Fomin, Huan Jiang, Sharin Roth. *Otsuka Pharmaceutical Development & Commercialization Inc., Princeton, NJ.*

**Background:** The PROPKD scoring system for ADPKD demonstrated its utility for identifying patients at risk of rapid progression to loss of kidney function in a post hoc analysis of the TEMPO 3:4 trial (Corney-LeGall *Nephrol Dial Transplant* 2018). Given that TEMPO 3:4 enrolled a relatively young cohort (18–50 years) with early chronic kidney disease (>80% in stages G1–G2), we evaluated PROPKD for predicting disease

progression and tolvaptan benefit in a broader population that included subjects in the REPRISE trial (Torres *N Engl J Med* 2017), who were older (18–65 years) with more advanced disease (95% in stages G3–G4).

**Methods:** Per PROPKD scoring, subjects were assigned points for male sex (+1), hypertension (+2) or first urologic event before age 35 (+2), and mutation (*PKD2*: 0; non-truncating *PKD1*: +2; truncating *PKD1*: +4). For subjects <35 years without hypertension or urologic events, 0 was assigned to these variables and overall score calculated as the sum of the remaining factors. Total score ranged from 0–9, with 0–3 low risk (LR), 4–6 intermediate risk (IR), and 7–9 high risk (HR) for rapid progression. Annualized decline in estimated GFR (eGFR; mL/min/1.73 m<sup>2</sup>/yr) was calculated by regressing eGFR against time by subject from month 1 to month 12 in REPRISE, and from week 3 to month 36 in TEMPO 3:4, to exclude the early hemodynamic effect of tolvaptan.

**Results:** A population of 210 LR, 548 IR, and 430 HR was analyzed. Whereas there were no significant differences in annualized eGFR decline between risk groups among tolvaptan-treated subjects (LR -2.57, IR -2.69, HR -2.86), in untreated (placebo) subjects, decline was more rapid in higher risk groups (LR -2.82, IR -3.49, HR -4.04; *P*<0.01 for HR vs LR). Tolvaptan had a significant treatment effect vs placebo for IR and HR, but not LR (Table).

**Conclusions:** In a population with a broad spectrum of disease characteristics, the PROPKD scoring system predicted rapidity of eGFR decline in untreated ADPKD and supported the benefit of tolvaptan in patients at elevated risk of rapid progression.

**Funding:** Commercial Support - Otsuka Pharmaceutical Development & Commercialization Inc.

Table. Annualized eGFR decline by PROPKD risk group and treatment in TEMPO 3:4 and REPRISE

	Low Risk		Intermediate Risk		High Risk	
	Tolvaptan (n=126)	Placebo (n=84)	Tolvaptan (n=326)	Placebo (n=222)	Tolvaptan (n=244)	Placebo (n=186)
Change in eGFR (mL/min/1.73 m <sup>2</sup> )	-2.57	-2.82	-2.69	-3.49	-2.86	-4.04
P-value for difference between treatments	0.6184		0.0102		0.0033	
Relative treatment effect	8.7%		22.9%		29.2%	

**TH-PO388**

**Parameters Associated With Progression, Prognosis, and Tolvaptan Indication in Autosomal Dominant Polycystic Kidney Disease (ADPKD)**  
Vasiliki Gkika, Michaela Louka, Eirini Tigka, Angelos Drakopoulos, Myrto Kostopoulou, George I. Tspiranlis. *Department of Nephrology, General Hospital of Athens “G. Gennimatas”, Athens, Greece.*

**Background:** The identification of possible risk factors for the progression of ADPKD is an emerging field, especially after the introduction of tolvaptan as the first disease-specific treatment. This study aims to explore the associations between epidemiological, clinical, and imaging data in a large cohort of ADPKD patients.

**Methods:** This study was from a single ADPKD outpatient clinic and were included patients with a recent Magnetic Resonance Imaging (MRI) for the measurement of Total Kidney Volume (TKV). For all patients, the Mayo Clinic Imaging Category (MCIC) and the prediction of End Stage Renal Disease (ESRD) based on the Mayo Clinic formula were calculated. Patients eligible for tolvaptan treatment (MCIC 1C, 1D, 1E, age<55 years old and e-GFR≥25 mL/min) were identified. We examined for possible associations using multinomial logistic regression and linear regression models.

**Results:** A total of 250 patients were included. Based on measurements of height-adjusted TKV (ht-TKV) and age, 8% of the patients were classified as 1A, 20% as 1B, 34% as 1C, 25% as 1D and 13% as 1E, MCIC. In multivariable analysis, patient’s age, male sex, parent’s age at ESRD (adjusted for patient age) and hypertension were associated with log (ht-TKV). Parent’s age at ESRD differed significantly between the MCICs of the offspring. The younger the parent diagnosed with ESRD, the more likely the patient will be diagnosed in the 1E stage. Similarly, there were significant differences in the presence and age of hypertension onset. In 157 patients (74 females and 83 males) who were eligible for tolvaptan treatment, the age at ADPKD diagnosis, at hypertension onset, and the parent’s age at ESRD were significantly lower when compared to non-eligible patients. Finally, factors associated with the prediction score of ESRD were hypertension, uric acid, and the age at ESRD of the affected parent.

**Conclusions:** As a heritability estimator, the age at ESRD of the affected parent was significantly associated with a worse phenotype, prognosis, and tolvaptan indication. Hypertension was associated with poor prognosis and an aggravated phenotype, whereas age at diagnosis of the disease and hypertension onset were associated with tolvaptan indication in ADPKD.

**TH-PO389**

**The PROPKD Score Is Associated With the Progression of Renal Involvement in Patients With Autosomal Dominant Polycystic Kidney Disease Treated With Tolvaptan**  
Tomofumi Moriyama, Kensei Taguchi, Yusuke Kaida, Yunosuke Yokota, Goh Kodama, Sakuya Ito, Kei Fukami. *Division of Nephrology, Department of Medicine, Kurume University School of Medicine, Kurume, Japan.*

**Background:** The PROPKD score has been proposed to evaluate the risk of the progression to end stage renal failure in patients with autosomal dominant polycystic kidney disease (ADPKD), based on gender (male: 1point), hypertension under 35 years old (2 points), urological event under 35 years old (2 points), and gene mutation (PKD1

truncating mutation: 4 points, PKD1 non-truncating mutation: 2 points, PKD2: 0 point). Although tolvaptan has benefits for renal involvement, whether PROPKD score could predict future renal involvement in patients with ADPKD treated with tolvaptan is unknown. Thus, we explored the effects of tolvaptan on the annual changes in total kidney volume (%TKV) and estimated glomerular filtration rate (%eGFR) according to the PROPKD score in these patients.

**Methods:** 32 ADPKD patients treated tolvaptan for at least a year were retrospectively analyzed (the mean observation period: 3.6 years). We examined the decline in renal function, %TKV by computed tomography, and gene mutation. The association between %eGFR and %TKV change before and after tolvaptan treatment, annual TKV change (%TKV) and PROPKD score was analyzed.

**Results:** We identified gene mutations in ADPKD patients: PKD1 truncating mutation (n=15), PKD1 non-truncating mutation (n=5), PKD2 mutation (n=6), and mutation not found (n=6). Mean %TKV and eGFR were 1843 ± 986 ml and 54.7 ± 21.0 ml/min/1.73 m<sup>2</sup>, respectively. The mean PROPKD score was 3.3±2.4 points and showed a significant negative correlation with %eGFR before and after tolvaptan treatment (p=0.044/0.016), and no significant correlation with %TKV before and after tolvaptan treatment.

**Conclusions:** The higher PROPKD score, the faster the decrease in %eGFR during tolvaptan therapy, suggesting that the PROPKD score may be useful as a predictor of the risk of progression to renal failure after tolvaptan introduction.

**TH-PO390**

**Visceral Adiposity Is Strongly Associated With Kidney Growth in Early-Stage Autosomal Dominant Polycystic Kidney Disease (ADPKD)**  
Kristen L. Nowak,<sup>1</sup> Courtney Steele,<sup>1</sup> Zhycing You,<sup>1</sup> Sumana Ramanathan,<sup>2</sup> Adriana Gregory,<sup>2</sup> Berenice Y. Gitomer,<sup>1</sup> Michel Chonchol,<sup>1</sup> Timothy L. Kline.<sup>2</sup> *HALT-PKD trial <sup>1</sup>University of Colorado - Anschutz Medical Campus, Aurora, CO; <sup>2</sup>Mayo Clinic Minnesota, Rochester, MN.*

**Background:** We have previously described that overweight and obesity, measured by body-mass index (BMI), are associated with kidney disease progression in individuals with early stage ADPKD. Adipocytes do not simply act as a fat reservoir, but are active endocrine organs, and particularly in visceral adipose tissue, can promote release of pro-inflammatory cytokines and adipokines. Numerous signaling pathways promoted by adipocytes are also implicated in cystogenesis, potentially by promoting a pro-cystogenic milieu. We hypothesized that greater abdominal adiposity would be associated with more rapid kidney growth in early-stage ADPKD patients.

**Methods:** 60 non-diabetic participants with ADPKD and estimated glomerular filtration rate (eGFR) >60 mL/min/1.73m<sup>2</sup> who participated in HALT Study A and had magnetic resonance imaging (MRI) with full coverage of visceral adipose tissue were selected. Body composition parameters, including subcutaneous and visceral adipose tissue, were calculated. The L3-level was determined based on sagittal views and the center slice was selected at the L3-level axial slice. The tissue regions were segmented using ITK-Snap in the axial view and area was calculated by the product of the number of voxels and the in-plane image resolution. The longitudinal (5-yr) association of abdominal adiposity (interaction of visceral, subcutaneous, and total adiposity with time) with height-corrected total kidney volume (htTKV) by MRI was evaluated using linear mixed effects regression models.

**Results:** Mean±s.d. age was 39±7 years, eGFR was 89±16 mL/min/1.73m<sup>2</sup>, and median (IQR) htTKV was 605 (409, 935) mL/m. Greater abdominal subcutaneous (β-estimate 0.16 [95% CI 0.016, 0.30]; all values are presented as x10<sup>2</sup>; p=0.03), visceral (β-estimate 0.22 [95% CI 0.13, 0.31]; p<0.0001), and total abdominal adipose tissue (β-estimate 0.28 [95% CI 0.15, 0.41]; p<0.0001) were associated with a greater increase in htTKV after adjustment for demographics, study randomization, clinical characteristics including eGFR, baseline liver volume, and genotype.

**Conclusions:** Abdominal adiposity, and particularly visceral adiposity, are strongly and independently associated with longitudinal increase in htTKV in a small cohort of patients with early-stage ADPKD.

**Funding:** NIDDK Support, Private Foundation Support

**TH-PO391**

**Cerebrovascular Function in Early-Stage Autosomal Dominant Polycystic Kidney Disease (ADPKD)**  
Courtney Steele, Ester Oh, Taylor Struemph, Heather Farmer-Bailey, Berenice Y. Gitomer, Michel Chonchol, Kristen L. Nowak. *University of Colorado - Anschutz Medical Campus, Aurora, CO.*

**Background:** Cerebrovascular dysfunction, characterized by reduced cerebrovascular reactivity, cerebral hypoperfusion, and increased pulsatile flow within the brain precedes the onset of dementia and is linked to cognitive dysfunction. PKD has been described to increase risk of dementia as compared to propensity score matched controls, and intracranial aneurysms are also more prevalent in patients with ADPKD. However, cerebrovascular function has not been previously characterized in patients with ADPKD.

**Methods:** Using Transcranial Doppler, we compared middle cerebral artery (MCA) blood flow-velocity response to hypercapnia (normalized for blood pressure and end-tidal CO<sub>2</sub>; a measure of cerebrovascular reactivity) and MCA pulsatility index (PI; a measure of cerebrovascular stiffness) in patients with early-stage ADPKD vs. age-matched healthy controls. We also administered the NIH cognitive toolbox (cognitive function) and measured carotid-femoral pulse-wave velocity (CFPWV; aortic stiffness).

**Results:** Fifteen participants with ADPKD (9F, 27±4 yrs [mean±s.d.], estimated glomerular filtration rate [eGFR]: 106±22 mL/min/1.73m<sup>2</sup>) were compared to 15 healthy controls (8F, 29±4 yrs, eGFR: 107±11 mL/min/1.73m<sup>2</sup>). MCA PI was unexpectedly lower in ADPKD (0.71±0.07) vs. controls (0.82±0.02 A.U.; p<0.001); however, normalized

MCA blood flow-velocity response to hypercapnia did not differ between groups  $2.0 \pm 1.2$  vs.  $2.1 \pm 0.8$  % $\Delta$ /mmHg;  $p=0.85$ ). Lower PI was associated with a lower crystallized composite score, which persisted after adjustment for age, sex, eGFR, and education ( $\beta = 0.55$ ,  $p<0.01$ ); the crystallized composite score (adjusted for education) was lower in ADPKD ( $109.9 \pm 11.7$ ) vs. controls ( $118.0 \pm 8.7$ ;  $p<0.05$ ). There was no association of PI with CFPWV (which was greater in the ADPKD group), suggesting PI reflects vascular properties other than arterial stiffness in this population ( $r=0.01$ ,  $p=0.96$ ).

**Conclusions:** PI is lower in early-stage ADPKD, with preservation of cerebrovascular reactivity to hypercapnia. Low PI could be a risk factor for aneurysms in APKD, as low MCA PI and carotid PI are associated with the presence of aneurysms in a population of middle-aged/older healthy adults. Follow-up research on this observation is merited.

**Funding:** NIDDK Support

#### TH-PO392

##### Altitude, Resting Metabolic Rate, and Autosomal Dominant Polycystic Kidney Disease

**Cortney Steele**, Erin R. Coleman, Taylor Struempfler, Diana George, Claire Winslow H. Winslow, Berenice Y. Gitomer, Michel Chonchol, Kristen L. Nowak. *University of Colorado - Anschutz Medical Campus, Aurora, CO.*

**Background:** Autosomal dominant polycystic kidney disease (ADPKD) is the most commonly inherited progressive kidney disease and is known to alter metabolic pathways and influence mitochondrial energy production, which in turn could modulate resting metabolic rate (RMR). Acute altitude exposure may influence RMR in those with ADPKD, however, data are lacking.

**Methods:** ADPKD patients were enrolled in clinical trials at the University of Colorado Anschutz Medical Campus. RMR assessments were performed at baseline in Aurora, CO (elevation 5,403') via indirect calorimetry. Living elevation was determined by city and state of residence. Participants were stratified into those living at low altitudes (<4,000') and those living at high altitudes ( $\geq 4,000'$ ). RMR equations Harris-Benedict (H-B) and Mifflin-St Jeor (M) were calculated. In a subset of participants, height adjusted-total kidney volume (htTKV) was measured via magnetic resonance imaging (MRI) as an indicator of disease severity. Independent t-tests were used to determine differences between those living at low/high altitudes. Analysis of covariance and linear regression analyses were also performed.

**Results:** Baseline characteristics of 64 participants were included (42 females (F),  $46 \pm 10$  yrs of age (mean $\pm$ s.d.), body mass index (BMI)  $32.3 \pm 5$  kg/m<sup>2</sup>, and RMR  $1721 \pm 289$  kcal/day). Those living at <4,000' and  $\geq 4,000'$  elevation had similar baseline characteristics ( $p>0.05$ ). After adjusting for age, sex, and BMI, those living at low altitudes tended to have a higher RMR when measured at high altitude than those living at high altitudes ( $p=0.09$ ). Percent differences between indirect calorimetry and prediction equations (H-B and M) were greater in those living at low altitudes performing the RMR assessment at altitude ( $p<0.05$ ). Only a subset of participants had calculated htTKV values ( $n=22$ , 11 F,  $46 \pm 10$  yrs of age, BMI  $33.9 \pm 5$  kg/m<sup>2</sup>, and RMR  $1809 \pm 239$  kcal/day). Increasing RMR was associated with an increase in htTKV ( $r=0.50$ ,  $p=0.02$ ); the association remained after adjusting for BMI ( $r=0.46$ ,  $p=0.04$ ).

**Conclusions:** In ADPKD patients living at low altitudes, altitude exposure appeared to elevate RMR when compared to those living at high altitude. Higher RMR may be associated with greater disease severity. Further research is needed to confirm these preliminary data.

**Funding:** NIDDK Support, Private Foundation Support

#### TH-PO393

##### Impact of Pregnancy on the Progression of Total Kidney Volume in Autosomal Dominant Polycystic Kidney Disease

**Jin hyuk Paek**, Yaerim Kim, Woo Yeong Park, Seungyeup Han, Kyubok Jin. *Keimyung University School of Medicine, Daegu, Republic of Korea.*

**Background:** Previous studies reported that pregnant women with autosomal dominant polycystic kidney disease (ADPKD) had poor fetal outcomes and maternal complications. In ADPKD, total kidney volume is recognized as a prognostic biomarker for risk assessment. During pregnancy, the kidneys increase in size about 30%. However, there has been no study to evaluate the impact of pregnancy on the progression of total kidney volume and renal outcome among ADPKD patients.

**Methods:** This prospective multicenter cohort study enrolled 693 adult patients from October 2019 to June 2021 at 8 medical centers in Korea. Patients with more than 3 renal cysts in both kidneys were eligible to be recruited. The height-adjusted total kidney volume (htTKV) and Mayo Clinic imaging classification were measured by the ellipsoid equation. Three hundred thirty-seven male patients were excluded from the analysis.

**Results:** In total of 356 female patients, 280 patients (78.7%) had experienced pregnancy. The mean estimated glomerular filtration rate was  $77.5 \pm 31.8$  ml/min/1.73m<sup>2</sup> and the mean htTKV was  $1316.3 \pm 1013.0$  ml/m. Patients who experienced pregnancy showed significantly larger htTKV compared with those without pregnancy ( $1367.2 \pm 1057.6$  vs.  $1128.5 \pm 806.4$ , respectively,  $p = 0.035$ ). In patients who experienced pregnancy, age, body mass index, waist circumferences, and creatinine level was higher than patients without pregnancy. There was significant relation between pregnancy and large htTKV (OR = 1.978, 95% CI = 1.174–3.333,  $p = 0.010$ ). However, gravidity was not significantly associated with the Mayo imaging classification (OR = 0.692, 95% CI = 0.412–1.162,  $p = 0.164$ ).

**Conclusions:** This study indicated that pregnancy might influence on the progression of htTKV in ADPKD patients. However, it did not affect the prognosis of the kidney.

#### TH-PO394

##### Bilateral Renal Cysts and CKD in Association With Neurofibromatosis

**Seif Bugazia**, Lisa A. Schimmenti, Marie C. Hogan. *Mayo Clinic Minnesota, Rochester, MN.*

**Introduction:** Neurofibromatosis with CKD has rarely been reported. Cases lack description of kidney phenotype. Renal gene panels do not evaluate the *NF2* gene.

**Case Description:** A 67yo male was referred with CKD & bilateral renal cysts, bilateral sensorineural hearing loss, tinnitus & balance difficulty. He used a hearing aid to his left & was deaf in his right ear. He had bilateral cataracts & cataract surgery, bilateral vestibular schwannomas & a dural-based meningioma treated with gamma knife and bevacizumab (d/c'ed due to side effects). Lumbar, thoracic & cervical MRI imaging showed no schwannomas. MRI (fig.1) revealed bilateral kidney cysts (total kidney vol= 1257ml). Functional studies revealed a functioning right & non-functional left kidney. Whole exome renal panel (custom >150 genes) to determine the cause of cystic renal disease was unrevealing. We next performed next generation sequencing using a schwannomatosis panel revealing *NF2*: c. 1396C>T, with a mosaic truncating pathogenic variant in *NF2*, encoding a premature stop codon, p.Arg466Ter, in Exon 13 (variant allele fraction 2%, 28 variant reads/ 1112 wild type reads, both strands of 4 amplicons, Q score:36) & confirmed by High Resolution Melting Curve Analysis.

**Discussion:** We describe bilateral cystic disease in a *NF2* patient with CKD. Individuals with mosaic pathogenic variants occurring in distal exons tend to have a 'milder' clinical course. The pathogenic variant detected in Exon 13 was found in 2% of blood cells. *NF2* comprehensive variant analysis (sequencing all exons & del/dup analysis) detects pathogenic variants in >90% of non-founder *NF2* patients & in 65-70% of sporadic patients (lower detection due to mosaicism frequently present in founder cases). The proband & his at risk children received genetic counseling.

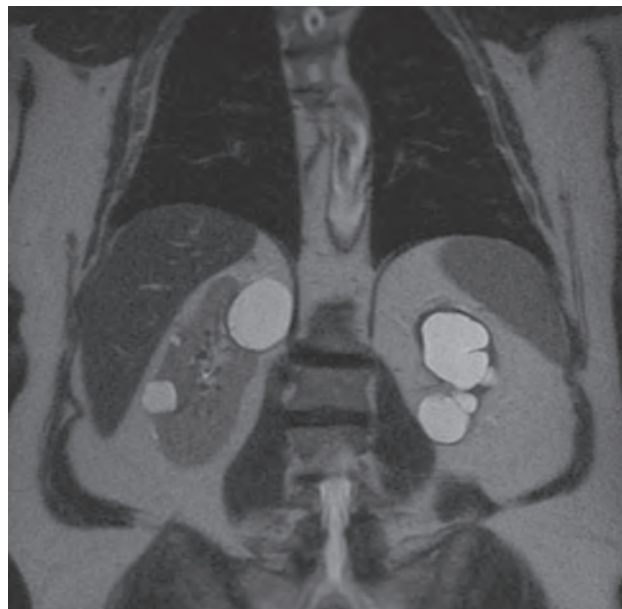

Mild bilateral cystic kidney disease in *NF2* mosaic case.

#### TH-PO395

##### Four Year Outcomes, Efficacy, and Safety of Foam Sclerotherapy for Cysts in ADPKD and Autosomal-Dominant Polycystic Liver Disease (ADPLD)

**Seif Bugazia**, Adriana Gregory, Vicente E. Torres, Laureano J. Rangel, Emily Bendel, Newton Neidert, Marie C. Hogan. *Mayo Clinic Minnesota, Rochester, MN.*

**Background:** In 2017 we migrated from alcohol to sotradecol foam sclerotherapy (SFS) in our practice, because of perceived improved efficacy. We studied changes in liver/kidney vols (TKV/TLV), renal fxn (ADPKD SFS cases) & QOL (LASA, PLD-Q).

**Methods:** Four-year data was analyzed from 1/1/2017-12/31/2021 in those who completed at least one SFS procedure. Segmentation was used to determine TKV/TLV before & after SFS (coronal MRI/axial CT) using artificial intelligence software. Impact on GFR decline, changes in TKV/TLV & adverse events (AEs) following SFS were assessed. Paired t-test was used for TKV/TLV (absolute & % annual change wrt baseline, IQR [Q1, Q3], changes in PLD-Q scores pre/post, multivariable logistic regression examined GFR trajectories pre/post SFS.

**Results:** We performed 160 SFS sessions ( $n=127$  pts; 79 kidney; 41 with paired data; 81 liver, 6 liver/ kidney combined procedures (35 with paired data) in ADPKD ( $n= 86$ ), ADPLD ( $n= 10$ ), Cysts NOS ( $n= 19$ ) cases. For cases with multi-procedures with available paired data: kidney (2 SFS,  $n=10$ , 3 SFS  $n= 2$ ); for liver, six had 2, one had 5 sessions. SFS was associated with a 26% [IQR -44, -6] reduction in TKV ( $p < 0.0001$ ) with respect to baseline ( $n = 41$ ; median, -191ml [IQR, -682, -83ml];  $P < 0.0001$ ). SFS

was associated with a median difference of 277ml/yr TKV reduction (mean % +/- from baseline) in the treated kidneys (n = 41; [IQR, 77, - 683] mL) when compared with the contralateral untreated kidney for the same patient;  $P < 0.001$ ). SFS was associated with 8% [IQR -15, 1%] reduction of TLV ( $p=0.007$ ) wrt baseline (n = 35; median, -243ml [IQR, -573, 47];  $P < 0.03$ ). There was no change in GFR slope in the SFS treated cases; ( $p=0.87$ ; signed rank test). Most patients with flank/back/abdominal pain & distension had improvement in their symptoms; PLDQ (n=14) improved ( $p= .004$ ) as did LASA QOL scores ( $p=.002$  (n=22)). AEs: Five contrast leaks (retroperit/intracalyceal), 5 (4%) pain requiring 2 ER visits, 1 cholangitis; (hospitalized); 1 abortive SFS where the proceduralist unable to penetrate cyst.

**Conclusions:** SFS led to substantial changes in TKV and TLV and corresponding improvement in QOL related reductions in mass effects. There was no detectable benefit on eGFR decline in those who had SFS of kidney cysts in the ADPKD cases.

**Funding:** Private Foundation Support

**TH-PO396**

**Bone Mineral Density in Autosomal Dominant Polycystic Kidney Disease (ADPKD) Patients After Kidney Transplantation**

Dalia Zubidat,<sup>1</sup> Christian Hanna,<sup>1</sup> Maroun Chedid,<sup>1</sup> Jad G. Sfeir,<sup>1</sup> Fouad T. Chebib,<sup>2</sup> <sup>1</sup>Mayo Clinic Minnesota, Rochester, MN; <sup>2</sup>Mayo Clinic in Florida, Jacksonville, FL.

**Background:** ADPKD is caused by pathogenic variants in *PKD1* or *PKD2*, encoding polycystin-1 and -2 proteins. Polycystins are expressed in animal models' osteoblasts and chondrocytes, and their loss-of-function is associated with low bone density (BMD) and volume. It is unclear whether these variants have an impact on bone strength in patients with ADPKD; thus, we examined bone phenotype in ADPKD after kidney transplantation to minimize the confounding effect of chronic kidney disease-related renal osteodystrophy.

**Methods:** This single-center retrospective observational study retrieved data from adult patients who received a kidney transplant between 01/2005 and 03/2020. Patients with available at and post-transplant dual-energy X-ray absorptiometry (DXA) of the hip and/or lumbar spine (LS) were included. ADPKD patients (n=373) were matched 1:1 by age ( $\pm 2$  years) at kidney transplantation and sex with non-ADPKD patients (n=373). (Figure.1).

**Results:** DXA was obtained at a mean of 6 years following transplant. As compared to non-ADPKD, patients with ADPKD had slightly higher BMD T-scores at left femoral neck (FN) (-1.3 vs. -1.6,  $p < 0.01$ ), right FN (-1.3 vs. -1.4,  $p < 0.01$ ), left total hip (TH) (-0.5 vs. -1.1,  $p < 0.01$ ) and right TH (-0.7 vs. -1.1,  $p < 0.01$ ) but worse T-score at LS (-0.8 vs -0.4,  $p = 0.01$ ). ADPKD patients continued to have higher BMD T-scores in FN and TH, after adjusting for receiving preemptive kidney transplants.

**Conclusions:** Our findings suggest that BMD by DXA is generally preserved in patients with ADPKD following kidney transplantation, despite slightly lower T-scores at the LS.

	ADPKD (n=373)	non-ADPKD (n=373)	p value
Male, n (%)	210 (56.3)	210 (56.3)	1.000
Caucasian, n (%)	355 (95.1)	315 (84.4)	<0.001
Age at kidney transplant (years), Mean ( $\pm$ SD)	54.5 ( $\pm$ 10.0)	54.5 ( $\pm$ 10.1)	0.90
Age at DXA scan (years), Mean ( $\pm$ SD)	60.8 ( $\pm$ 10.7)	60.5 ( $\pm$ 10.4)	0.76
Preemptive kidney transplant, n (%)	238 (63.8)	167 (44.7)	<0.001
eGFR (ml/min/1.73m <sup>2</sup> ), Median (Q1, Q3)	48.3 (36.7, 61.9)	48.6 (35.6, 61.5)	0.64
Time from kidney transplant to DEXA scan (years), Mean ( $\pm$ SD)	6.7 ( $\pm$ 4.7)	6.0 ( $\pm$ 5.2)	0.07
Body mass index (BMI) kg/m <sup>2</sup> at time of DXA, median (Q1, Q3)	27.7 (24.5, 32.3)	29.2 (24.7, 35.6)	0.08
Medication use, n (%)			
Maintenance steroids post-transplantation	290 (77.7)	298 (79.8)	0.47
Biphosphonate (within 2 years of DEXA)	65 (17.4)	70 (18.7)	0.63
Denosumab (within 2 years of DEXA)	6 (1.6)	11 (2.9)	0.21
Active vitamin D (within 3 months of DEXA)	37 (9.9)	42 (11.2)	0.55

**Table 1** - Baseline demographic, and clinical, characteristics in ADPKD and non-ADPKD patients post kidney transplantation.

**TH-PO397**

**Effect of Kidney Transplantation on Total Kidney Volume in Subjects With Autosomal Polycystic Kidney Disease**

Juan Carlos Ramirez-Sandoval, Aaron H. Perez, Estefania R. Linares, Elisa N. Hernández, Jorge Gaytan Arocha, Ricardo Correa-Rotter. *Instituto Nacional de Ciencias Medicas y Nutricion Salvador Zubiran, Ciudad de Mexico, Mexico.*

**Background:** There is limited evidence of the rate of cyst progression after kidney transplantation in patients with Autosomal Polycystic Kidney Disease (APKD).

**Methods:** Prospective cohort study. The primary objective was to compare the total kidney volume (TKV) before and after transplantation in kidney transplant recipients (KTR) with ADPKD. As a secondary objective, we compared the growth rate of KTR with a cohort of APKD patients who did not undergo transplantation. TKV was assessed with computed tomography/magnetic resonance images performed consecutively. TKV was assessed using ellipsoid equation. TKV growth were classified according to the Mayo Clinic Criteria.

**Results:** We included 30 patients with APKD who underwent kidney transplant (age  $49 \pm 10.1$  years, 11 [37%] females, dialysis vintage 3 [1-6] years, unilateral peritransplant nephrectomy in 4 [13%]). A rapid progression previous transplant (TKV increase  $>4.5\%$  per year, class 1D and 1E) was identified in 20 (66%) cases. Transplantation was associated with a significant decrease in KTV after transplantation in 27 (90%) KTR. Median TKV reduced from 2964 (IQR 1843-3878) mL to 943 (IQR 383-1598) mL after 6 years of follow-up ( $P < 0.001$ ), with a mean rate of volume decrease of 39% and 63% after 2 and 6 years of transplant respectively (Figure). Compared to the cohort of non-transplanted APKD patients (n=92), the growth rate was similar in KTR ( $P=0.67$ ). Even in 3 (10%) KTR without regression, the annual growth was  $<1.5\%$  per year after transplant.

**Conclusions:** Kidney transplantation reduced rapidly polycystic kidneys volume in the first 2 years after transplantation, and this decline was continuous during the 6 years of follow-up. These data would reduce the need for prophylactic nephrectomy in asymptomatic APKD patients prior to kidney transplantation.

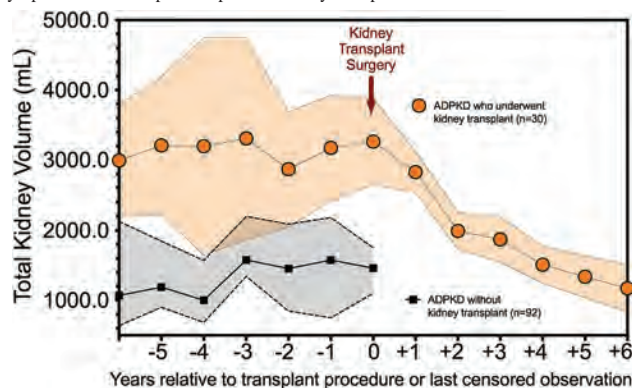

**TH-PO398**

**A Novel CT Imaging-Radiomics Approach for Kidney Function Evaluation in Autosomal Dominant Polycystic Kidney Disease**

Luca Calvaruso,<sup>1,2</sup> Pietro Manuel Ferraro,<sup>1,2</sup> Pierluigi Fulignati,<sup>1,2</sup> Luigi Larosa,<sup>3</sup> Luca Boldrini,<sup>3</sup> Huang Elena Tran,<sup>3</sup> Claudio Votta,<sup>3</sup> Giuseppe Grandaliano.<sup>1,2</sup> <sup>1</sup>Dipartimento di Scienze Mediche e Chirurgiche, U.O.C. Nefrologia, Fondazione Policlinico Universitario A. Gemelli IRCCS, Roma, Italy, Rome, Italy; <sup>2</sup>Università Cattolica del Sacro Cuore, Largo Agostino Gemelli 8, 00168, Roma, Italy, Rome, Italy; <sup>3</sup>Department of Diagnostic Imaging, Oncological Radiotherapy, and Hematology - Fondazione Policlinico Universitario "A. Gemelli" IRCCS, Rome, Italy.

**Background:** The aim of this study is to develop and validate a model based on radiomics to predict kidney function among patients with autosomal dominant polycystic kidney disease (ADPKD) studied by CT for determination of total kidney volume (TKV).

**Methods:** We retrospectively selected a cohort of 58 patients with ADPKD who underwent CT scan in 2021, including 31 patients with eGFR  $\geq 60$  mL/min/1.73 m<sup>2</sup> (class 0) and 27 with eGFR  $< 60$  mL/min/1.73 m<sup>2</sup> (class 1). An expert radiologist generated a region of interest (ROI) segmentation for cystic kidney compounds, obtaining 58 ROIs from which we extracted 217 radiomic features using a dedicated software. We built three different logistic regression models: a height-adjusted TKV (Ht-TKV) model, a radiomic model based on the most statistically significant radiomic feature from univariate analysis ( $F_{cm.sum.var}$ ), and a model from the combination of the above. Area under the curve (AUC) of the receiver operating characteristic (ROC) and accuracy were employed to evaluate models performance in discriminating between the two eGFR classes. Internal 3-fold cross-validation (CV) was performed.

**Results:** The Ht-TKV, radiomic and combined models presented respectively an AUC (95% confidence interval) of 0.79 (0.67-0.91), 0.84 (0.73-0.94), 0.85 (0.75-0.95), confirmed by the CV. Mean (standard deviation) values of the accuracy over CV iterations were 0.67(0.09), 0.78(0.08), 0.79(0.08) for the three models.

**Conclusions:** The Ht-TKV-radiomic combined model based on CT images from polycystic kidneys resulted the most effective in the prediction of baseline kidney function in our cohort. Further studies should implement a model extension to predict kidney function slope in order to confirm the role of radiomics in ADPKD management.

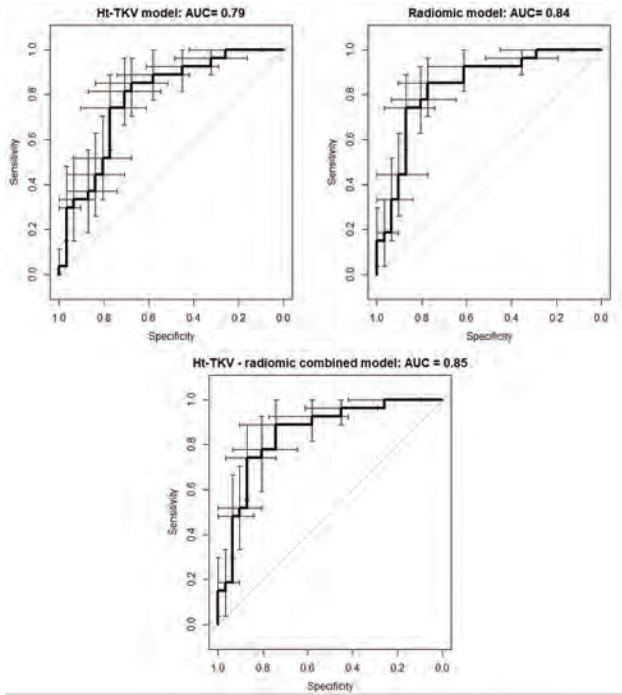

**TH-PO399**

**Total Kidney Volume (TKV) Is Associated With Health-Related Quality of Life (HRQoL) Among Patients With Autosomal Dominant Polycystic Kidney Disease (ADPKD)**

Istvan Mucsi, Muhammad T. Hassan, Seung Heyck Lee, Saima Khawaja, Ning He, David Hillier, Korosh Khalili, York Pei. *University Health Network, Toronto, ON, Canada.*

**Background:** ADPKD is the most common hereditary kidney disease and imposes significant physical and emotional burden on affected patients. The association of health-related quality-of-life (HRQoL) with disease severity markers (DSMs) including total kidney volume (TKV) has been assessed in a few previous studies, but results were inconclusive, in part due to small sample size. In this cross-sectional study we assessed the association between TKV and domains assessed by the short for (SF)-36 questionnaire in a large cohort of patients with ADPKD recruited in Toronto between January 2017 to December 2021.

**Methods:** Participants completed the study questionnaire that included questions about sociodemographic characteristics and the SF-36 questionnaire. Clinical data was abstracted from medical records. eGFR was estimated from serum creatinine using the CKD-EPI (Chronic Kidney Disease Epidemiology Collaboration) equation. All study patients had their TKV measured by MRI and completed a comprehensive PKD1 and PKD2 mutation screen. In addition to assess the association between HRQoL scores and TKV, both as continuous variables, we also generated binary HRQoL variable defining poor HRQoL as the lowest quartile; this quartile then was compared to the rest of the sample.

**Results:** Of the 306 participants (mean[SD] age 49[15] years) 45% were male. Mean (SD) eGFR was 79(27) ml/min/1.73m<sup>2</sup>, 12 (4%) of participants had eGFR <30, no patients were on dialysis. Median (interquartile range [IQR]) TKV was 567 (338-933) ml, 149 (49%) had TKV > 1000 ml. Of the SF-36 domains physical function (rho=-0.28, p<0.001) general health perception (rho=-0.19, p<0.001), bodily pain (rho=-0.13, p=0.02) and the physical component score (rho=-0.26, p<0.001) correlated with TKV. Mutation class was not associated with HRQoL domains. In multivariable regression models (adjusted for age, sex and eGFR) TKV was significantly associated with the general health perception domain.

**Conclusions:** In patients with ADPKD, TKV was significantly correlated with several HRQoL SF-36 domains. Some of these associations were confounded by age and eGFR, but poor general health perceptions remained independently associated with TKV.

**Funding:** Government Support - Non-U.S.

**TH-PO400**

**Evaluation of Advanced MRI Cystic Biomarkers at Kidney Failure in Patients With Autosomal Dominant Polycystic Kidney Disease**

Stijn Wigerinck,<sup>1,2</sup> Maroun Chedid,<sup>1</sup> Adriana Gregory,<sup>1</sup> Hasan-Daniel N. Kaidbay,<sup>1,3</sup> Christian Hanna,<sup>1</sup> Sarah R. Senum,<sup>1</sup> Peter C. Harris,<sup>1</sup> Timothy L. Kline,<sup>1</sup> Vicente E. Torres,<sup>1</sup> Fouad T. Chebib,<sup>1</sup> PKD Center Mayo Clinic Rochester <sup>1</sup>Mayo Clinic Minnesota, Rochester, MN; <sup>2</sup>Katholieke Universiteit Leuven, Leuven, Belgium; <sup>3</sup>Lebanese American University, Beirut, Lebanon.

**Background:** Height-adjusted total kidney volume, a surrogate of cystic expansion, is associated with decline in GFR. In a recent cohort of patients with ADPKD who reached end stage kidney failure (ESKD), HiTKV at ESKD was 12.3% smaller with each decade of age. This raised the question about the contribution of non-cystic volume to the worsening of kidney function in older patients. We aimed to assess various imaging biomarkers to understand the characteristics of the ADPKD kidneys at ESKD

**Methods:** This is a retrospective cross-sectional study of patients with ADPKD with ESKD evaluated at Mayo Clinic with available MRI imaging and genotype (N=50, 11 excluded due to incomplete MR coverage, 1 with NMD). Using an automated instance cyst segmentation algorithm, we obtained the following imaging parameters: HiTKV, Mayo Imaging Class (MIC), cyst number, total cystic volume (TCV), cyst index (TCV/TKV), cyst parenchyma surface area (CPSA), and total parenchymal volume (TPV).

**Results:** Thirty-nine patients were divided in 3 groups based on age at ESKD (<46, 46-56 and >56 yo) (Table). Baseline characteristics and ADPKD genotype are shown in table. Most patients in groups 1 and 2 were MIC1D-1E and most patients in group 3 were MIC1B-1C (P<0.01). Cyst index at ESKD was similar at all ages. Age correlated weakly (P<0.01) with HiTKV, cyst number, CSA, CPSA, and cyst index (R<sup>2</sup> 0.01, 0.01, 0.01, 0.02, and 0.03 respectively) and negatively with TPV (R<sup>2</sup> 0.1). HiTKV correlated (P<0.01) positively with cyst number, TCV, CPSA and TPV (R<sup>2</sup> 0.30, 0.95, 0.90 and 0.67, respectively).

**Conclusions:** The lower TPV in older patients and the negative correlation between age and TPV are consistent with the hypothesis that vascular changes and fibrosis are important determinants of GFR decline in older patients. HiTKV at ESKD correlated positively with cyst number, TCV, TPV CPSA. Cyst index at ESKD was similar at all ages.

Age group:	<46 yo N = 13	46-56 yo N = 13	>56 yo N = 13	P-value
Male, N (%)	5 (38)	6 (46)	4 (31)	0.7
Mayo Imaging Classification				<0.01
MIC B, N (%)	0 (0)	0 (0)	4 (31)	
MIC C, N (%)	0 (0)	4 (31)	7 (54)	
MIC D, N (%)	6 (46)	7 (54)	2 (15)	
MIC E, N (%)	7 (54)	2 (22)	0 (0)	
ADPKD Genotype				0.7
PKD1 truncating, N (%)	11 (85)	4 (31)	6 (46)	
PKD1 non truncating, N (%)	2 (15)	6 (46)	5 (38)	
PKD2, N (%)	0 (0)	3 (23)	1 (8)	
No mutation detected (NMD), N (%)	0 (0)	0 (0)	1 (8)	
Cyst index (%)	0.59 (± 0.07)	0.61 (± 0.08)	0.6 (± 0.12)	0.8
Cyst surface area (mm <sup>2</sup> ), N (%)	1155 (± 596.6)	1041 (± 514.6)	796 (± 397.2)	0.3
Cyst parenchyma surface area (mm <sup>2</sup> ), N (%)	888 (± 477.8)	759 (± 395.6)	572 (± 369.1)	0.2

**TH-PO401**

**The Effect of Trans-Arterial Embolization of Renal Artery for Autosomal Dominant Polycystic Kidney Disease on the Recurrence of Cyst Infection**

Hiroki Mizuno. *Toranomon Byoin Bunin, Kawasaki, Japan.*

**Background:** Trans-arterial embolization of the renal artery (RTAE) is one of the procedures which reduces the mass effect of the enlarged polycystic kidney due to ADPKD after the initiation of renal replacement therapies (RRTs). In contrast, cyst infection is one of the life-threatening complications of ADPKD, however, the effect of RTAE on recurrence of cyst infection has not been reported yet.

**Methods:** A retrospective analysis was conducted to assess the risk factors of recurrence of cyst infection. Cyst infection was defined as the in-hospital episode of fever, abdominal pain, and positive results of any cultures (blood, urine, or cyst fluid) after excluding the differential diagnosis of cyst infection. Patients not receiving RRTs were excluded because RTAE was a treatment for the patients under receiving RRTs. Recurrence was defined as the second episode of cyst infection within three years after the first episode of cyst infection. Predictors were collected from medical charts. Survival analyses were planned to determine the risk factors of recurrence.

**Results:** Among 883 episodes from 305 patients who were clinically suspected of renal cyst infection, 45 patients were eligible for the recurrence group and 58 patients were eligible for the no recurrence group. Compared with the no recurrence group, the recurrence group had a higher rate of the past history of recurrence and liver cyst infection. There was no difference in treatment status and conditions at discharge between groups. Kaplan-Meire curves showed that five factors, including (1) MRI detected cyst infection, (2) age over 70 years old, (3) negative history of RTAE, (4) positive culture of extended-spectrum of beta-lactamase-producing Gram-negative rods or Enterococcus faecium (ESBL/faecium group), and (5) negative result of cyst culture, were significantly more likely to recurrence. After adjusting related variables, Cox hazard proportionally analysis revealed that previous history of RTAE (HR 0.49(0.26-0.94), p=0.03), ESBL/faecium group (1.96 (1.01-3.80)p=0.05), the negative result of drainage group (HR 2.27 (1.06-4.84)) were significantly associated with recurrence of cyst infection.



**Conclusions:** In this retrospective cohort study, we found the negative history of RTAE, ESBL/faecium group, and negative results of cyst culture could be the risk factors for recurrence of cyst infections.

#### TH-PO402

##### Antibiotic Use and Kidney Stone Disease in Patients With Autosomal Dominant Polycystic Kidney Disease

Berenice Y. Gitomer<sup>1</sup>, Zhiying You,<sup>1</sup> Godela M. Brosnahan,<sup>1</sup> Wei Wang,<sup>1</sup> Katharina Hopp,<sup>1</sup> Kristen L. Nowak,<sup>1</sup> Arlene B. Chapman,<sup>2</sup> Ronald D. Perrone,<sup>3</sup> Vicente E. Torres,<sup>4</sup> Alan S. Yu,<sup>5</sup> Michel Chonchol.<sup>1</sup>  
<sup>1</sup>University of Colorado, Denver, CO; <sup>2</sup>University of Chicago Pritzker School of Medicine, Chicago, IL; <sup>3</sup>Tufts Medical Center, Boston, MA; <sup>4</sup>Mayo Clinic Minnesota, Rochester, MN; <sup>5</sup>The University of Kansas Medical Center, Kansas City, KS.

**Background:** Kidney stone disease (KSD) occurs in ~20% of patients with autosomal dominant polycystic kidney disease (ADPKD) and is associated with overall disease morbidity, including risk for faster kidney disease progression. Recent evidence suggests that changes in the normal gut microbiome linked with antibiotic use play a causal role in kidney stone disease in the non-ADPKD population. However, antibiotic exposure as a novel risk factor for kidney stone formation has not been explored in ADPKD patients, who are frequently treated with antibiotics for urinary tract and cyst infections.

**Methods:** We analyzed use of the following oral antibiotic classes: cephalosporin, fluoroquinolone, nitrofurantoin/methenamine, sulfa, and broad-spectrum penicillin in the HALT-PKD patient cohort. Antibiotic use preceding self-reported KSD (prior to the report of a kidney stone) was compared to those with no KSD (NKSD) by chi-square test.

**Results:** One hundred and forty three patients reported oral antibiotic exposure over the course of the HALT-PKD study. Antibiotic exposure was significantly higher in patients with subsequent KSD compared to those with NKSD (figure 1). Patients with KSD have a significantly faster rate of decline in eGFR compared to patients without a kidney stone, mean slope of annual decline in NKSD compared to KSD  $-3.64 \pm 4.1$  vs.  $-5.2 \pm 8.3$ .

**Conclusions:** Antibiotic exposure may represent a novel risk factor for kidney stone disease in patients with ADPKD or KSD may lead to antibiotic exposure in this population. Further studies are necessary to address these questions and to better understand the associated mechanisms.

**Funding:** NIDDK Support

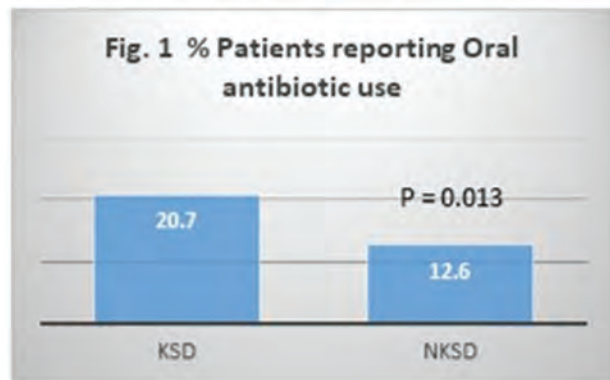

#### TH-PO403

##### Systemic Inflammation and Kidney Stone Disease in Autosomal Dominant Polycystic Kidney Disease

Berenice Y. Gitomer<sup>1</sup>, Zhiying You,<sup>1</sup> Godela M. Brosnahan,<sup>1</sup> Wei Wang,<sup>1</sup> Katharina Hopp,<sup>1</sup> Kristen L. Nowak,<sup>1</sup> Arlene B. Chapman,<sup>2</sup> Ronald D. Perrone,<sup>3</sup> Vicente E. Torres,<sup>4</sup> Alan S. Yu,<sup>5</sup> Michel Chonchol.<sup>1</sup>  
<sup>1</sup>University of Colorado, Denver, CO; <sup>2</sup>University of Chicago Pritzker School of Medicine, Chicago, IL; <sup>3</sup>Tufts Medical Center, Boston, MA; <sup>4</sup>Mayo Clinic Minnesota, Rochester, MN; <sup>5</sup>The University of Kansas Medical Center, Kansas City, KS.

**Background:** In preliminary studies, we have shown that autosomal dominant polycystic kidney disease (ADPKD) patients with kidney stone disease (KSD) experience faster decline in kidney function compared to those with no kidney stone disease (NKSD). Kidney stone disease affects ~20 to 30% of patients with ADPKD, a much higher prevalence compared to the general population. As KSD is associated with increased inflammation in non-ADPKD patients, we assessed whether KSD, also associates with increased inflammation in ADPKD patients with KSD.

**Methods:** Baseline serum levels of a panel of pro-inflammatory biomarkers (OLINK, Boston MA) were determined among participants in the HALT PKD clinical trials. Levels were compared between 40 ADPKD patients with self-reported KSD and 46 age, sex and estimated glomerular filtration rate (eGFR) matched NKSD ADPKD patients. Elevated IL-6 levels were confirmed by ELISA (Meso Scale Diagnostic Inc., Rockville, MD).

**Results:** Mean age and eGFR was  $40 \pm 11$  years and eGFR  $75 \pm 27$  ml/min/1.73m<sup>2</sup> in KSD patients and  $41 \pm 9$  years and eGFR  $80 \pm 26$  ml/min/1.73m<sup>2</sup> in NKSD. Six pro-inflammatory biomarkers in serum were significantly increased in ADPKD patients with KSD compared to ADPKD patients with no NKSD these included interleukin 6 (IL6), fibroblast growth factor 23 (FGF23), monocyte chemoattractant protein 3 (MCP3), chemokine C-C motif ligand 20 (CCL20), osteopontin (OPG) and interleukin 24 (IL24). Higher IL6 levels in KSD patients were confirmed by ELISA (KSD (N= 50)  $1.58 \pm 2.01$  vs NKSD (N = 75)  $0.97 \pm 1.07$  pg/ml; P = 0.03).

**Conclusions:** ADPKD patients with KSD have evidence of increased inflammation based on higher circulating levels of pro-inflammatory cytokines. Increased inflammation associated with KSD may represent a further injury to the cystic kidney. In the literature, it has been shown that further injury to the cystic kidney exacerbates disease progression. Thus, it is intriguing to speculate that KSD may be a risk factor for kidney disease progression in patients with ADPKD. Further studies will be required to determine the effects of inflammation on disease progression in ADPKD.

**Funding:** NIDDK Support

#### TH-PO404

##### Urinary Clusterin Associates With Height Corrected Total Kidney Volume in Autosomal Dominant Polycystic Kidney Disease

Berenice Y. Gitomer, Wei Wang, Jessica Ringling, Kristen L. Nowak, Anna Jovanovich, Zhiying You, Katharina Hopp, Michel Chonchol. *University of Colorado, Denver, CO.*

**Background:** Clusterin, also known as apolipoprotein J (ApoJ), is a secreted glycoprotein expressed in various tissues and body fluids. Kidney and urinary clusterin levels (uclusterin) are related to renal tubular injury and are induced in acute kidney injury, diabetic kidney diseases as well as animal and human cystic diseases including ADPKD. We have previously shown that urinary Kim-1 a kidney injury biomarker is associated with estimated glomerular filtration rate (eGFR) and height corrected total kidney volume (HtTKV) in different stages of ADPKD. Thus, we hypothesized that uclusterin may represent a similar biomarker of HtTKV or eGFR in ADPKD patients.

**Methods:** Baseline urinary clusterin/Cr levels were measured in ADPKD participants from our clinical trial examining the effect of pravastatin on ADPKD progression. Eighty patients with baseline estimated glomerular filtration rate (eGFR)  $\geq 45$  ml/min/1.73m<sup>2</sup> (CKD Epi equation) who completed the study were included in this cross-sectional study. Clusterin levels in a spot urine sample collected at baseline were measured by ELISA (R&D systems) and normalized by urine creatinine. The association of baseline urinary clusterin/Cr with Ln transformed height corrected total kidney volume (Ln-HtTKV) or eGFR were evaluated using correlation analysis and linear regression with covariate adjustment.

**Results:** Participants were  $42 \pm 11$  years old at the baseline. Forty-eight (60%) were female. Mean BMI was  $26.6 \pm 5.7$  kg/m<sup>2</sup> and systolic blood pressure (SBP) was  $123 \pm 11$  mmHg. Baseline eGFR was  $90 \pm 19$  ml/min/1.73 m<sup>2</sup> and HtTKV  $761 \pm 396$  ml/m. Baseline urinary clusterin/Cr was  $0.22 \pm 0.14 \times 10^{-3}$ . Urinary clusterin/Cr level correlated with baseline Ln-HtTKV  $0.31$  ( $\beta$  1.13, 95% CI 0.34, 1.92)  $p=0.006$ . The association remained significant even after adjustment for sex age, BMI and SBP. However, there was no association between uClusterin/Cr with eGFR.

**Conclusions:** Urinary Clusterin/Cr is associated with HtTKV in ADPKD. It might serve as an early biomarker in monitoring disease progression in ADPKD.

**Funding:** Other U.S. Government Support

#### TH-PO405

##### Microbiome-Related Changes In Autosomal Dominant Polycystic Kidney Disease

Jelena Klawitter, Peter H. Smith, Michel Chonchol, Berenice Y. Gitomer, Uwe Christians, Jost Klawitter. *University of Colorado Denver School of Medicine, Aurora, CO.*

**Background:** Autosomal dominant polycystic kidney disease (ADPKD) is a genetic disorder characterized by uncontrolled growth of cysts in the kidney. Many studies have reported immune system activation and infiltration of immune cells in ADPKD. In recent years, more details have emerged about the symbiotic relationship between the immune system and the microbiome. Our previous metabolomics study showed that concentrations of several microbiota-originated metabolites were altered in children with ADPKD. Here, we aimed to identify these metabolites and their contribution to ADPKD severity and progression.

**Methods:** Indoles and short chain fatty acids (SCFAs) were quantified in 146 patient plasma samples collected at the baseline of HALT-A PKD trial as well as in 80 healthy subjects using liquid chromatography-mass spectrometry assays. Multiple stepwise linear regression was used to calculate the associations between the microbiota-derived metabolites and ADPKD severity and progression (as calculated by the height-corrected total kidney volume (HtTKV) and estimated glomerular filtration rate (eGFR)).

**Results:** Indole acetic acid (IAA) and 5-hydroxyindole acetic acid (5-HIAA) were not only higher in ADPKD patients as compared to healthy subjects but were also positively associated with HtTKV at baseline (beta=0.201, p=0.013 and beta=0.254; p=0.002, respectively). SCFAs butyrate and hydroxybutyrate were lower in ADPKD patients versus healthy subjects and both negatively associated with HtTKV (beta=-0.181, p=0.004 and beta=-0.317, p<0.001, respectively; all after adjustment for age, race, sex, body mass index, systolic blood pressure). Using the same model, 5-HIAA was shown to associate negatively and butyrate positively with kidney function/ eGFR. Furthermore,

baseline para-cresol was the only metabolite that significantly associated with yearly % change in HtTKV, whereas 5-HIAA and butyrate remained associated with yearly change in eGFR in patients with ADPKD.

**Conclusions:** Alteration in plasma levels of indole metabolites and SCFAs was observed between patients with ADPKD and healthy subjects. Several of these microbiota-derived metabolites associated with the disease severity (HtTKV and/or eGFR) and were predictive of disease progression. Follow-up studies using microbiome-targeted therapy to restore a healthy host-microbiota homeostasis could prove beneficial in patients with ADPKD.

**Funding:** NIDDK Support

#### TH-PO406

##### Matrix Metalloproteinase-7 in Urinary Extracellular Vesicles Predicts Disease Progression in Polycystic Kidney Disease

Martijn H. van Heugten,<sup>1</sup> Charles J. Blijdorp,<sup>1</sup> Esther Meijer,<sup>2</sup> Robert Zietse,<sup>1</sup> Mahdi Salih,<sup>1</sup> Ron T. Gansevoort,<sup>2</sup> Ewout J. Hoorn.<sup>1</sup> <sup>1</sup>Erasmus MC Afdeling Inwendige Geneeskunde, Rotterdam, Netherlands; <sup>2</sup>Universiteit Groningen Faculteit Medische Wetenschappen, Groningen, Netherlands.

**Background:** Autosomal dominant polycystic kidney disease (ADPKD) has a highly variable rate of disease progression, and currently available biomarkers are unable to adequately identify high risk patients. Our aim was to identify a protein biomarker in urinary extracellular vesicles (uEVs) which can be non-invasively measured to differentiate rapid from slow disease progression.

**Methods:** Patients were selected from the clinical DIPAK trial. We created a discovery (n=10) and confirmation cohort (n=10) including patients with rapid and slow disease progression (eGFR decline  $\geq 4$  or  $< 2$  mL/min/1.73 m<sup>2</sup>/year). uEVs were isolated from 50 mL spot urines by a three-step differential ultracentrifuge protocol, and uEV-proteins were quantified by mass tag labeled and tandem mass spectrometry. A third validation cohort (n=24) was created to validate the mass spectrometry findings with immunoblotting. All patients were matched for established risk factors for disease progression, including age, sex, baseline eGFR, and genetic mutation, and had equal height adjusted total kidney volume.

**Results:** We identified 2,727 and 1,115 unique uEV-proteins with over 60% annotated for the extracellular exosome (Benjamini  $p < 0.01$ ). In the discovery and confirmation cohort, a significantly different uEV-protein abundance was found for 65 and 36 proteins, respectively. Matrix metalloproteinase 7 (MMP-7), a protein previously implicated in kidney disease progression in ADPKD, was consistently higher by 47% and 64% in patients with rapid disease progression in both cohorts ( $p < 0.05$ ). Pathway analysis showed enrichment of Wnt-signaling (q-value  $< 0.05$ ) of which MMP-7 is a downstream mediator. In the validation cohort, MMP-7 was also higher by 120% in uEVs of patients with rapid disease progression ( $p < 0.05$ ).

**Conclusions:** uEV-associated MMP-7 distinguishes patients with slow or rapid ADPKD progression independently of established disease progression markers. MMP-7 is a novel and biologically plausible urinary biomarker for ADPKD which we are currently validating in a larger cohort of patients using a high-throughput assay.

**Funding:** Private Foundation Support

#### TH-PO407

##### Urinary Prostaglandin E2 Excretion Is Associated With Disease Progression in Polycystic Kidney Disease

Frank Geurts,<sup>1</sup> A. L. Messchendorp,<sup>2</sup> Ron T. Gansevoort,<sup>2</sup> Esther Meijer,<sup>2</sup> Robert Zietse,<sup>1</sup> Mahdi Salih,<sup>1</sup> Robert A. Fenton,<sup>3</sup> Ewout J. Hoorn.<sup>1</sup> <sup>1</sup>Erasmus MC, Rotterdam, Netherlands; <sup>2</sup>University Medical Center Groningen, Groningen, Netherlands; <sup>3</sup>Aarhus Universitet, Aarhus, Denmark.

**Background:** In cell and animal models of autosomal dominant polycystic kidney disease (ADPKD) cyst growth is enhanced by prostaglandin E2 (PGE2). Here, we hypothesize that higher urinary PGE2 excretion in patients with ADPKD is associated with faster disease progression.

**Methods:** We used samples from the DIPAK study, a prospective multi-center cohort of patients with ADPKD, and measured 24h urine PGE2 and its metabolites (PGEM). Linear mixed models were used to analyze the association of PGE excretion with disease progression assessed by eGFR slope. The relation between urinary PGE excretion and a composite outcome of 40% loss of eGFR or kidney failure was analyzed using Cox regression models. PGE excretions were log transformed prior to analysis.

**Results:** Urinary PGE2 and PGEM excretion was measured in 590 patients (48±12 years, eGFR 73±28 mL/min/1.73m<sup>2</sup>) and independently associated with height adjusted total kidney volume (htTKV,  $\beta$  0.10  $p=0.04$ ). A total of 504 patients were available for the eGFR slope and survival analysis (median of 4.2 eGFR measurements and 3.1 years of follow-up). The mean eGFR slope in the linear mixed model was -2.9 mL/min/1.73m<sup>2</sup>/year. A higher urinary excretion of PGE2 and PGEM were both significantly associated with faster eGFR decline. When correcting for htTKV, this effect persisted for PGEM (Table). Higher urinary PGE2 (HR 2.02  $p=0.02$ ) and PGEM (HR 3.65  $p=0.008$ ) excretion was associated with a higher incidence of kidney failure or 40% loss of eGFR after correcting for baseline characteristics, but this effect lost statistical significance after correction for htTKV (PGE2: HR 1.75  $p=0.12$ , PGEM: HR 2.51  $p=0.051$ ).

**Conclusions:** Higher urinary PGE2 and PGEM excretion is associated with faster eGFR decline in ADPKD. The relation of PGE2 with htTKV suggests cyst-related production. Our findings suggest that in patients with ADPKD, PGE2 and PGEM should be further investigated as markers of disease progression or even as potential therapeutic targets.

Table 1: Linear mixed model of urinary PGE and PGEM excretion with eGFR slope.

variables	Model 1		Model 2		Model 3	
	$\beta$	p-value	$\beta$	p-value	$\beta$	p-value
PGE2 ng/24h	-1.2	0.001	1.2	0.002	-0.24	0.5
PGEM ng/24h	+1.9	<0.001	-1.5	0.004	-1.11	0.03

model1: unadjusted, model2: adjusted for age, sex BMI, albuminuria and PKD mutation, model3: model2+hTKV

#### TH-PO408

##### Discovery of Next-Generation Anti-miR-17 Oligonucleotide RGLS8429 for Treatment of Autosomal Dominant Polycystic Kidney Disease (ADPKD)

Edmund Lee,<sup>1</sup> Tania M. Valencia,<sup>1</sup> Francesca Varrone,<sup>1</sup> Tate Owen,<sup>1</sup> Harini Ramalingam,<sup>2</sup> Ronak Lakhia,<sup>2</sup> Vishal Patel,<sup>2</sup> Cindy L. Berman,<sup>3</sup> Rekha Garg,<sup>4</sup> Denis Drygin.<sup>1</sup> <sup>1</sup>Regulus Therapeutics Inc, San Diego, CA; <sup>2</sup>The University of Texas Southwestern Medical Center Department of Internal Medicine, Dallas, TX; <sup>3</sup>Berman Consulting, Wayland, MA; <sup>4</sup>PharmaDRS Consulting, San Diego, CA.

**Background:** ADPKD is mostly caused by *PKD1* or *PKD2* mutations, which reduce levels of their encoded proteins polycystin-1 (PC1) or polycystin-2 (PC2). Levels of PC1 and PC2 in urinary exosomes are lower in ADPKD patients than healthy volunteers and correlate inversely with disease severity in ADPKD patients. The miR-17 family of miRNAs is upregulated in human and mouse forms of ADPKD. Genetic deletion or pharmacological inhibition of miR-17 increases PC1 and PC2 levels and attenuate cyst growth in preclinical ADPKD models. Likewise, re-expression of PC1 and PC2 rapidly reverses disease progression in ADPKD mice. Importantly, treatment with the first-generation anti-miR-17 oligonucleotide RGLS4326 (1mg/kg) resulted in a statistically significant increase in urinary exosome PC1 and PC2 levels in patients with ADPKD. Together, these results suggested targeting miR-17 is an attractive therapeutic approach for treating ADPKD.

**Methods:** During development of RGLS4326, dose-limiting CNS toxicity was observed in mice and monkeys receiving high doses of RGLS4326 in nonclinical toxicity studies. Further investigations revealed that CNS toxicity was caused by direct off-target inhibition of the neuroreceptor,  $\alpha$ -amino-3-hydroxy-5-methyl-4-isoxazolepropionic acid receptor (AMPA-R), by RGLS4326. Here, we discuss the discovery and characterization of the next-generation anti-miR-17 oligonucleotide RGLS8429 which has a similar efficacy profile as RGLS4326 without the affinity for AMPA-R.

**Results:** Like RGLS4326, RGLS8429 was designed to distribute preferentially to the kidney and inhibit miR-17 function. RGLS8429 showed similar potency profiles in inhibiting miR-17 function compared to RGLS4326 in vitro. RGLS8429 also showed similar pharmacodynamic and pharmacokinetic profiles after a single subcutaneous dose, and similar efficacy profile in ADPKD mouse models after repeat dosing, compared to RGLS4326 in vivo. As RGLS8429 did not cause off-target binding and inhibition of the AMPA-R, no CNS-related toxicity was observed in single- or repeat-dose toxicity studies in mice and monkeys.

**Conclusions:** A Phase 1b clinical trial evaluating RGLS8429 in ADPKD patients is planned for the second-half of 2022.

**Funding:** Commercial Support - Regulus Therapeutics

#### TH-PO409

##### Altered Lipid Metabolism in Autosomal Dominant Polycystic Kidney Disease Patients Treated With Tolvaptan

Matteo Bargagli,<sup>1,2</sup> Manuel Anderegg,<sup>1</sup> Pietro Manuel Ferraro,<sup>3,2</sup> Daniel G. Fuster.<sup>1</sup> Daniel G. Fuster Research Team <sup>1</sup>Department of Nephrology and Hypertension, Inselspital, Bern University Hospital, University of Bern, Bern, Switzerland; <sup>2</sup>Dipartimento Universitario di Medicina e Chirurgia Traslocazionale, Università Cattolica del Sacro Cuore, Rome, Italy; <sup>3</sup>U.O.C. Nefrologia, Fondazione Policlinico Universitario A. Gemelli IRCCS, Roma, Italy.

**Background:** Dyslipidemia is a common finding in patients with autosomal-dominant polycystic kidney disease (ADPKD), and lower HDL is associated with faster disease progression. Vasopressin interacts with both glucose and lipid regulation pathways, hence Tolvaptan treatment might induce changes in lipid and glucose homeostasis in ADPKD patients.

**Methods:** We conducted an exploratory analysis in the Bern ADPKD registry, a prospective observational cohort study. Glucose and lipid metabolism parameters were measured at baseline and every 12 months thereafter. Patients taking Tolvaptan at baseline were excluded from the analysis. Multivariable mixed-effects regression models adjusted for age, sex, BMI, eGFR, TSH and medications use, including antidiabetic and lipid-lowering drugs, were used to assess changes in plasma glucose and lipid metabolism parameters associated with Tolvaptan treatment.

**Results:** A total of 189 participants (122 without and 67 with subsequent Tolvaptan treatment) were included in the analysis. At baseline, 58 (31%) patients had high total cholesterol, 26 (14%) low HDL, 61 (32%) high LDL and 41 (22%) high triglycerides. During follow-up, Tolvaptan treatment was associated with reduced HDL ( $\beta$  -0.186; 95% CI -0.260, -0.111;  $p < 0.001$ ), increased LDL ( $\beta$  0.216; 95% CI 0.001, 0.430;  $p = 0.048$ ) and triglycerides ( $\beta$  0.381; 95% CI 0.130, 0.633;  $p = 0.003$ ) levels. No significant changes were observed in total cholesterol, plasma glucose or hemoglobin A1c.

**Conclusions:** Chronic Tolvaptan treatment is associated with a significantly altered plasma lipid profile in ADPKD patients. Our data suggest that patients taking Tolvaptan should undergo regular lipid parameter testing.

#### TH-PO410

### The Analysis of Long-Term Course of Tolvaptan Treatment and the Study Using Kidney and Liver Derived Cyclic AMP in Autosomal Dominant Polycystic Kidney Disease

Yoshihisa Nakatani, Yukihito Nakano, Shuji Arima. *Kinki Daigaku Igakubu Daigakuin Igaku Kenkyuka, Osakasayama, Japan.*

**Background:** cAMP (Cyclic AMP) in the kidney and liver of ADPKD (Autosomal dominant polycystic kidney disease) persons cannot be measured directly. We will calculate the cAMP secreted from the kidney and liver and examine the increase of their volumes and renal prognosis.

**Methods:** Sixty ADPKD persons who have visited Kindai University hospital from January 2016 to January 2022. ADPKD was diagnosed, and twenty-five of them were introduced to TVP by hospitalization. After diagnosis, eGFR, plasma / urine cAMP and kidney volume were measured over time and examined. Renal and hepatic Plasma and urine cAMP was calculated.

**Results:** Renal cAMP was correlated with kidney volume at eGFR 30 or higher, but hepatic cAMP did not correlate with liver volume. However, abnormally high liver cAMP was observed in patients who had no longer infected with giant hepatic cyst, which was correlated with the size of the cyst. Renal cAMP was not significantly correlated with  $\Delta$ eGFR, but the higher the renal cAMP, the higher the rate of renal volume increase. Before and after oral administration of TVP, renal cAMP decreased significantly from  $18.0 \pm 8.0$  to  $10.4 \pm 3.4$ , but hepatic cAMP showed almost no change. TKV changed to the rate of +9.27% (before administration), -3.96% (1 year later), -0.80% (2 years later), and +4.24% (3 years later) by TVP administration. And the  $\Delta$ eGFR is -6.7 ml / min (before administration)  $\rightarrow$  1 year later -3.6 ml / min (1 year later), -3.0 ml / min (2 years later)  $\rightarrow$  -3.5 ml / min (3 years later). So, we could suppress enlargement on kidney volume and the decline in renal function. Although renal cAMP dramatically decreased in an abbreviated time in patients who began to take TVP, there were any cases in which renal cAMP increased again during treatment if the amount of TVP taken was not sufficient.

**Conclusions:** Renal cAMP can be a marker for the predict of ADPKD renal volume development and the increase of TVP dose. However, it was found that hepatic cAMP was not a marker for liver volume development and was not affected by TVP.

#### TH-PO411

### Number Needed to Harm (NNH) Analysis of Tolvaptan in Patients With Autosomal Dominant Polycystic Kidney Disease (ADPKD)

Sasikiran Nouna,<sup>1</sup> Keith A. Betts,<sup>2</sup> Retesh K. Kumar,<sup>3</sup> Xiaoyu Nie,<sup>2</sup> Ancilla Fernandes.<sup>1</sup> <sup>1</sup>Otsuka Pharmaceutical Development & Commercialization, Inc., Princeton, NJ; <sup>2</sup>Analysis Group Inc, Los Angeles, CA; <sup>3</sup>Otsuka Pharmaceutical Europe Ltd, Wexham, United Kingdom.

**Background:** ADPKD is the most prevalent monogenic kidney disease and can lead to progressive loss of kidney function and ultimately, kidney failure. Tolvaptan is the first approved treatment to slow kidney function decline in adults at risk of rapidly progressing ADPKD. The potential risk of liver injury associated with tolvaptan is closely monitored in the United States Food and Drug Administration Risk Evaluation and Mitigation Strategy (JYNARQUE REMS) program. The objective of this study is to assess the safety profile of tolvaptan related to liver function using the NNH approach.

**Methods:** Individual patient-level data from the TEMPO 3:4 trial (NCT00428948) was used to evaluate liver function abnormalities, serious alanine aminotransferase (ALT) or aspartate aminotransferase (AST) elevation adverse events (AEs) over 12 months and 24 months of treatment. Liver function abnormalities were defined as ALT > 3 times (3x) and > 5 times (5x) the upper limit of the normal range (ULN). NNH was calculated as the reciprocal of the difference in the proportion of patients experiencing a given outcome between tolvaptan and placebo.

**Results:** This study included 961 patients in the tolvaptan arm and 483 in the placebo arm. The NNHs for ALT > 3xULN were 56.19 (95% confidence interval [CI]: 33.60, 171.33) over 12 months and 39.81 (25.59, 89.57) over 24 months, which suggests that for every 100 patients treated with tolvaptan instead of placebo, only 1.78 and 2.51 additional patients would have ALT > 3xULN over 12 and 24 months, respectively. The proportions of patients with ALT > 5xULN and serious ALT or AST elevation were not statistically different between the two arms in either period, yielding NNH values above 135, which suggests that for every 100 patients treated with tolvaptan instead of placebo, fewer than one additional patient would experience ALT > 5xULN or serious ALT or AST elevation over 12 or 24 months.

**Conclusions:** The large NNH values help further characterize the safety profile of tolvaptan by demonstrating an acceptable benefit-risk profile.

**Funding:** Commercial Support - Otsuka Pharmaceutical Development & Commercialization, Inc., Princeton, NJ, USA

#### TH-PO412

### Multicenter Real-Life Experience With Tolvaptan Treatment in Patients With Autosomal Dominant Polycystic Kidney Disease

Parikshit Duriseti,<sup>1</sup> Stijn Wigerinck,<sup>1</sup> Maroum Chedid,<sup>1</sup> Yeshwanter Radhakrishnan,<sup>1</sup> Michael A. Mao,<sup>2</sup> Musab S. Hommos,<sup>3</sup> Arvind K. Garg,<sup>4</sup> Ziad Zoghby,<sup>1</sup> Mira T. Keddiss,<sup>3</sup> Christopher L. Trautman,<sup>2</sup> Erin Dahlen,<sup>2</sup> Melissa K. Gay,<sup>1</sup> Jennifer E. McFadden,<sup>3</sup> Samrat V. Bhat,<sup>4</sup> Peter C. Harris,<sup>1</sup> Stephen B. Erickson,<sup>1</sup> Marie C. Hogan,<sup>1</sup> Vicente E. Torres,<sup>1</sup> Fouad T. Chebib.<sup>2</sup> <sup>1</sup>Mayo Clinic Minnesota, Rochester, MN; <sup>2</sup>Mayo Clinic in Florida, Jacksonville, FL; <sup>3</sup>Mayo Clinic Scottsdale, Scottsdale, AZ; <sup>4</sup>Mayo Clinic Health System, La Crosse, WI.

**Background:** Autosomal dominant polycystic kidney disease (ADPKD) is the most common monogenic cause of ESKD. Tolvaptan was approved for the treatment of ADPKD patients who are at risk of rapid progression. The goal of our study is to examine the real-life experience of tolvaptan in ADPKD following its FDA approval.

**Methods:** We retrospectively identified 95 patients initiated on tolvaptan for management of ADPKD at Mayo Clinic across Minnesota, Florida, Arizona, and Wisconsin. Patients started on tolvaptan while enrolled in clinical trials were excluded. Baseline data including age, Mayo imaging classification (MIC), height-adjusted total kidney volume (htTKV) at tolvaptan initiation, and eGFR were documented. Monthly or quarterly laboratory monitoring including serum LFTs, sodium, creatinine, and urine osmolality were collected. Patient registry was created in electronic medical record and nursing surveillance program was utilized in monitoring labs and side effects on tolvaptan.

**Results:** Ninety-two patients started on tolvaptan between June 2018 and May 2022 were included in the study. Of whom, 58% were female, 91% were white with mean (SD) age at initiation of 40.7 (9.6) years. Mean (SD) htTKV at baseline was 1234.9 (909.9) mL/m. Based on Mayo imaging classification, 2% had MIC1B, 43% MIC1C, 28% MIC1D and 22% MIC1E. At last follow-up, 4% were on 30mg, 9% on 45mg, 57% on 60mg, 18% on 90 mg and 12% on 120mg. Tolvaptan was discontinued in 23 (25%) patients. Aquaresis-related side effect was the main reason for drop-out (10.8%). Other reasons included concern for hepatotoxicity (5.4%), non-compliance with lab monitoring (4.3%), nausea (1%), AKI (1%), and lack of coverage by insurance for prescription renewal (1%). Of 5 patients in whom tolvaptan was stopped with concern for hepatotoxicity, none (0%) reached Hy's Law for drug-induced liver injury.

**Conclusions:** In this multicenter real-life experience, tolvaptan was well tolerated in treating patients with ADPKD. The main reasons for discontinuation of therapy included aquaresis affecting quality of life and concern for hepatotoxicity. Our findings are concurrent with data from clinical trials for tolvaptan in ADPKD.

#### TH-PO413

### Tolvaptan Modifies Patient Risk Class Distribution Over Time in Autosomal Dominant Polycystic Kidney Disease (ADPKD): An Analysis of Data From the TEMPO 3:4 Trial

Neera K. Dahl,<sup>1</sup> Fouad T. Chebib,<sup>2</sup> Frederic F. Rahbari-Oskoui,<sup>3</sup> Hina Japes,<sup>4</sup> Huan Jiang,<sup>4</sup> LaRee A. Tracy,<sup>4</sup> Linda McCormick,<sup>4</sup> Katherine Maringer,<sup>4</sup> Ronald D. Perrone,<sup>5</sup> Ali Nourbakhsh.<sup>4</sup> <sup>1</sup>Yale School of Medicine, New Haven, CT; <sup>2</sup>Mayo Clinic Minnesota, Rochester, MN; <sup>3</sup>Emory University School of Medicine, Atlanta, GA; <sup>4</sup>Otsuka Pharmaceutical Development & Commercialization Inc., Princeton, NJ; <sup>5</sup>Tufts Medical Center, Boston, MA.

**Background:** The ADPKD risk classification system developed by Irazabal et al (*J Am Soc Nephrol* 2015;26:160) estimates the expected rate of eGFR decline based on patient height-adjusted total kidney volume (htTKV) and age. Patients with typical imaging findings on MRI (class 1) can be categorized for their anticipated slope of eGFR decline from slow progressors (subclass 1A) through rapid progressors (subclass 1E). Subclass assignment remains stable over time for most, but not all patients, dependent on htTKV growth. To evaluate effects of tolvaptan on ADPKD risk subclass over time, we analyzed data from the TEMPO 3:4 trial.

**Methods:** A post hoc analysis compared changes in risk subclass between subjects randomized to tolvaptan or placebo. Subjects in subclasses 1B-1E were identified from baseline MRI and age. The proportions of subjects (completers only) in each baseline subclass who shifted to a different subclass over 36 months were compared using a Cochran-Mantel-Haenszel mean score statistic for association between treatment groups.

**Results:** Consistent with earlier findings by Irazabal et al, most subjects in the TEMPO 3:4 placebo arm remained in their baseline subclass, with some progressing to a higher risk subclass and a smaller proportion dropping into a lower risk subclass (**Figure**). In the tolvaptan arm, by contrast, the proportion who progressed to a higher risk subclass was smaller than that who dropped into a lower risk subclass. Subjects receiving placebo were statistically more likely to progress to a higher risk subclass than those receiving tolvaptan in baseline subclasses 1C ( $P < 0.0001$ ) and 1D ( $P = 0.0087$ ).

**Conclusions:** Reduction of htTKV growth by tolvaptan in ADPKD improved the population risk profile during the 3-year period of treatment with tolvaptan or placebo.

**Funding:** Commercial Support - Otsuka Pharmaceutical Development & Commercialization Inc.

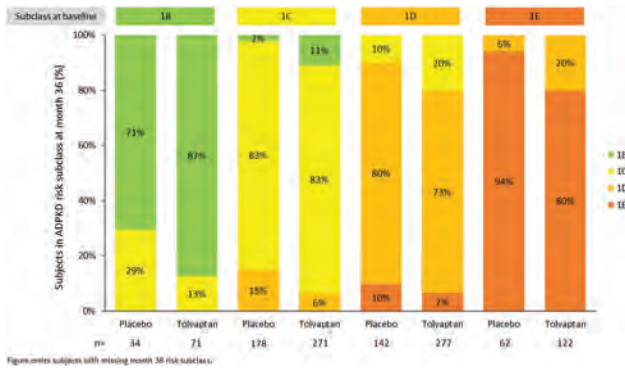

Figure 2. Shift in ADPKD risk subclass to month 36 by baseline subclass and treatment arm

TH-PO414

Treatment of Autosomal Recessive Polycystic Kidney Disease With CFTR Modulators

Liudmila Cebotaru, Murali K. Yanda. Johns Hopkins University, Baltimore, MD.

**Background:** ARPKD is associated with systemic and portal hypertension, fibrosis of the liver and kidney and enlarged kidneys, with fusiform dilation of the collecting ducts. Although it has been postulated that CFTR plays a role in fluid secretion in ADPKD, the opposite is true in ARPKD. For example, a double mutant of CFTR and polycystin/polyductin mice develop massively enlarged kidneys and die from renal failure at ~24 days after birth (Nakanishi et. al (2001). *J. Am. Soc. Nephrol.* **12**, 719-725). Thus, knocking down CFTR makes the disease worse.

**Methods:** We conducted experiments in *pkhd1<sup>Pkhd1del3-4del3-4</sup>* deletion model and cholangiocyte cultures from *pkhd1<sup>del3-4del3-4</sup>* mice. We injected male and female mice with 30 mg/kg of VX-809 every other day for 30 days beginning at 5 days old and necropsied them at 35 days. Cultured cholangiocytes were treated with VX-809 (10 μM).

**Results:** The *del3-4* mice develop biliary cysts by 35 days old. The biliary cysts were reduced by VX-809. To understand the factors responsible, we stained liver sections with Ki67 a marker of proliferation and CK19, a marker of cholangiocytes to evaluate proliferation. We detected a 50-fold higher % of cells staining positive for both Ki67 and CK 19, a substantial increase compared to WT, demonstrating that increased proliferation had occurred within the bile duct. The proliferation as indicated by a reduction in positive staining was significantly reduced by VX-809. Significantly, less CFTR protein was detected in the total cell lysate by western blot in the *del14* cholangiocytes compared to wt cells, showing that in the absence of functional FPC, the steady-state levels of CFTR fall. Next, we determined the location of CFTR in *del3-4* mouse cholangiocytes using confocal microscopy. CFTR co-localization with the apical membrane marker WGA in *del3-4* cholangiocytes was greater than in wt. Importantly, the co-localization was reduced in the presence of VX-809. VX-809 increased the co-localization of CFTR with the basolateral membrane marker Na<sup>+</sup>/K<sup>+</sup> ATPase in *del3-4* cholangiocytes.

**Conclusions:** These data indicate that VX-809 reduces proliferation and the presence of CFTR at the apical membrane while increasing CFTR at the basolateral membrane. These data suggest that in the absence of FPC, CFTR is degraded and mislocalized. Demonstration of liver cyst reduction increases the therapeutic potential of VX-809 as a treatment of ARPKD.

**Funding:** NIDDK Support

TH-PO415

Integrated Analysis of Human and Mouse Kidney Transcriptomic Profiling Unveils the Role of ELF3 in Kidney Fibrosis

Hailong Hu,<sup>1</sup> Xiangchen Gu,<sup>1</sup> Jeffrey H. Miner,<sup>2</sup> Katalin Susztak.<sup>1</sup> <sup>1</sup>University of Pennsylvania Perelman School of Medicine, Philadelphia, PA; <sup>2</sup>Washington University in St Louis School of Medicine, St Louis, MO.

**Background:** Progressive and irreversible glomerulosclerosis and tubulointerstitial fibrosis is associated with loss of kidney function in patients with chronic kidney disease (CKD). Mice could be an excellent model organism to model to study glomerulosclerosis and fibrosis, however, individual mouse models does not fully recapitulate the complexity of the human disease.

**Methods:** Here we performed phenotypic characterization (glomerulosclerosis, fibrosis and kidney function) and RNA sequencing of five mouse kidney disease models including unilateral ureteral obstruction (UUO), folic acid nephropathy (FAN), tubule-specific overexpression of Notch1 and podocyte-specific expression of APOL1 risk variant, and the *Col4a3* knockout, Alport syndrome model. RNA sequencing was also conducted to quantify unbiased gene expression in 95 human kidney samples, including controls and diabetic kidney disease. We used ELF3 chromatin immunoprecipitation and sequencing (ChIP-seq) data. Finally, we generated mice with tubule-specific genetic deletion of *Elf3* and induced disease by folic acid injection.

**Results:** We identified 131 genes (including 6 transcription factors) that were commonly regulated in mouse kidney disease models and in CKD patients. Amongst the transcription factors, we identified ELF3 as a key transcriptional factor strongly associated with renal fibrosis in all mouse models and patient samples. ELF3 was mostly expressed in kidney tubular epithelial cells. Tubule-specific ELF3 knockout mice (KspCre

Elf3<sup>fl/fl</sup>) were phenotypically normal at baseline. KspCre Elf3<sup>fl/fl</sup> mice showed less severe renal fibrosis compared with wild-type mice after folic acid injection. ChIP-seq data analysis indicated ELF3 binding to *Stat3* and *Twist1*; genes associated with epithelial-to-mesenchymal transition and disease development.

**Conclusions:** These results indicate the key role of tubule-specific *ELF3* in kidney fibrosis. Interfering *ELF3* expression may provide a new therapeutic target for CKD treatment.

TH-PO416

Single-Cell Transcriptomics Indicate That CD163+ Kidney Macrophages Are Pro-Inflammatory and May Orchestrate Further Immune Cell Recruitment to Kidney Lesions in ANCA-Associated Glomerulonephritis

Yosta Vegting,<sup>1,2</sup> Aldo Jongejan,<sup>3</sup> Ester B. Remmerswaal,<sup>1,2</sup> Perry Moerland,<sup>3</sup> Jesper Kers,<sup>4,5</sup> Liffert Vogt,<sup>1,6</sup> Frederike J. Bemelman,<sup>1,2</sup> Marc Hilhorst.<sup>1,2</sup> <sup>1</sup>Amsterdam UMC location University of Amsterdam, Department of Internal Medicine, Section of Nephrology, Amsterdam, Netherlands; <sup>2</sup>Amsterdam Institute for Infection and Immunity, Amsterdam, Netherlands; <sup>3</sup>Amsterdam UMC location University of Amsterdam, Department of Epidemiology & Data Science (EDS), Bioinformatics Laboratory, Amsterdam, Netherlands; <sup>4</sup>Amsterdam UMC location University of Amsterdam, Department of Pathology, Amsterdam, Netherlands; <sup>5</sup>Leiden University Medical Center, department of Pathology, Leiden, Netherlands; <sup>6</sup>Amsterdam Cardiovascular Sciences, Microcirculation, Amsterdam, Netherlands.

**Background:** Anti-Neutrophil Cytoplasmic Antibodies (ANCA)-associated glomerulonephritis (AGN) affects up to 90% of patients with ANCA-vasculitis and may result in end-stage kidney disease. In AGN kidney biopsies, CD163<sup>+</sup> macrophages are abundantly present and linked to disease activity. However, their exact role in the maintenance or resolution of local inflammation remains unclear.

**Methods:** CD163<sup>+</sup> kidney macrophages were studied using single-cell RNA sequencing of fresh kidney biopsies of 3 active ANCA patients and one patient receiving a nephrectomy for renal cell carcinoma. Cells were sorted for living (CD45<sup>+</sup>) immune cells by flowcytometry and whole transcriptome analysis was performed using 10X Genomics' technology. To aid in the multiomic characterization, 2 samples were incubated with an oligo-antibody cocktail and T and B Cell Receptor Repertoires were sequenced.

**Results:** Over 29,000 cells were sequenced; 2,300 (8%) were identified as CD68<sup>+</sup> macrophages. In patient and control samples, 498/19,689 (2.5%) and 320/9,605 (3.3%) cells expressed CD163, respectively. Comparison of gene-expression between CD163<sup>+</sup> macrophages of the two groups showed significant upregulation of pro-inflammatory cytokines and chemokines (Log2FoldChange ANCA vs control) (IL1B 1.62, CXCL2 2.25, CXCL3 3.26, CXCL8 2.19, CCL3 1.81, CCL4 2.04), and the complement system (C1Qa 1.79, C1Qb 1.94, C1Qc 1.37, C5aR1 1.43). Expression of CCL17 was downregulated (CCL17 -6.57).

**Conclusions:** CD163<sup>+</sup> kidney macrophages are pro-inflammatory and may orchestrate further immune cell recruitment to active kidney lesions in AGN.

**Funding:** Private Foundation Support

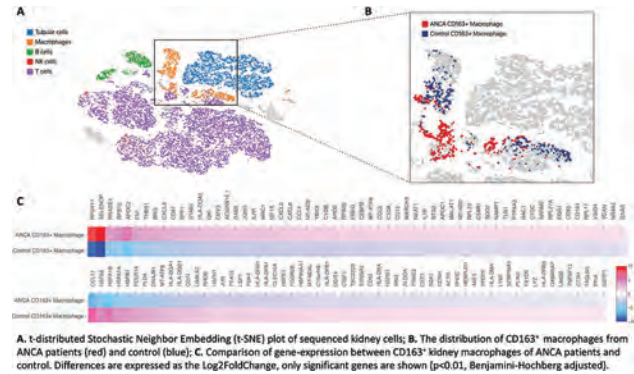

A. t-distributed Stochastic Neighbor Embedding (t-SNE) plot of sequenced kidney cells; B. The distribution of CD163<sup>+</sup> macrophages from ANCA patients (red) and control (blue); C. Comparison of gene-expression between CD163<sup>+</sup> macrophages of ANCA patients and control. Differences are expressed as the Log2FoldChange, only significant genes are shown (p<0.01, Benjamini-Hochberg adjusted).

	Pt. 1	Pt. 2	Pt. 3	C. 1
Sex	F	F	M	F
Age, years	71	56	40	83
Serological subtype	PR3	PR3	MPG	X
BVAS	17	14	16	X
VDI	1	0	0	X
BSE, mm/μ	33	81	NA	NA
CRP, mg/L	14.6	30.1	11.7	0.8
eGFR, mL/min/1.73m <sup>2</sup>	56	63	5	67
Immunosuppressive treatment	MTX	MPNS	MPNS	No
Kidney biopsy histology				
Total number of glomeruli, n	20	12	35	
Crescents, n	2	6	3	
IFTA, %	10	NA	90	

MTX = methotrexate; MPNS = methylprednisolon; NA = not available; Pt. = Patient, C. = Control

## TH-PO417

**The Spatially Resolved Transcriptome Signatures of Glomeruli in CKD**  
 Laura Perin,<sup>1,2</sup> Hasmik Soloyan,<sup>1</sup> Jeremy Clair,<sup>6</sup> Paolo Cravedi,<sup>3</sup> Andrea Angeletti,<sup>4</sup> Laith Al-Rabadi,<sup>5</sup> Roger E. De Filippo,<sup>1</sup> Stefano Da Sacco,<sup>1</sup> Kevin V. Lemley,<sup>1</sup> Sargis Sedrakyan.<sup>1</sup> <sup>1</sup>Children's Hospital Los Angeles, Los Angeles, CA; <sup>2</sup>University of Southern California, Los Angeles, CA; <sup>3</sup>Mount Sinai Health System, New York, NY; <sup>4</sup>Istituto Giannina Gaslini, Genova, Italy; <sup>5</sup>University of Utah Health, Salt Lake City, UT; <sup>6</sup>Pacific Northwest National Laboratory, Richland, WA.

**Background:** Using Digital Spatial Profiling (DPS), we described for the first-time the human spatial glomerular transcriptomic map that may characterize the molecular mechanisms underlying progressive diseases in Alport syndrome (AS), focal segmental glomerulosclerosis (FSGS), and membranous nephropathy (MN).

**Methods:** Nanostring GeoMX DSP was performed in paraffin sections of AS, FSGS, and MN (normal biopsies from partial nephrectomy were used as control). Tubular and glomerular regions of interest (ROI, n=106) were manually selected and sequenced following Nanostring protocols. After QC analysis (dynamic range and gene expression above noise), and subsequent Q3 normalization, data processing was performed in R v4.0.2 using the package RomicsProcessor v1.0.0. Different analytical tools were used to determine similarities/differences between healthy and diseased glomeruli.

**Results:** By DPS, we revealed significant heterogeneity of transcriptional programs among glomeruli within the same disease as well as across different diseases. By regression analysis we showed that increasing pathology scores in AS, FSGS, and MN correlated with specific increasing or decreasing genes, mostly associated with cellular adhesion. By trajectory analysis we revealed that glomeruli (from all 3 diseases) having low pathology scores showed transcriptional signatures that were significantly different from non-diseased glomeruli, indicating that histological features may not always represent transcriptional changes. We identified a transcriptional signature comprised of genes (*ADAMTS13*, *HOXB8*, and *ZNF346*) and pathways for SRP-dependent co-translational protein targeting to membrane and selenocysteine synthesis that were modulated in all diseased glomeruli. By correlation analysis, we identified new glomerular cell-specific genes that highly correlated with known podocyte markers (*WT1*, *NPHS1*, *NPHS2*), glomerular endothelial cells (*EHD3*), and mesangial cells (*PDGFRb*).

**Conclusions:** Defining transcriptional programs at the single glomerulus level is a powerful way of gaining insight into the pathophysiology of kidney disease with the potential of clarifying biological processes key to understanding mechanisms of disease progression and allowing the discovery of potential new therapeutic targets for CKD patients.

**Funding:** NIDDK Support

## TH-PO418

**Biomarkers of the Aging Kidney: A Proteomic Analysis of Renal Microstructures at Different Cortical Depths**

Mariam P. Alexander, Akhilesh Pandey, Aidan F. Mullan, Nicholas B. Larson, Aleksandar Denic, Gunveen Sachdeva, Muhammad Sohaib Asghar, Andrew D. Rule. *Mayo Clinic Minnesota, Rochester, MN.*

**Background:** While we have improved understanding of age-related microstructural changes of the glomeruli & tubulointerstitium, the molecular processes are unclear. We performed proteomic profiling of glomeruli & tubulointerstitium at different cortical depths in young & aged human kidneys to identify a signature of aging.

**Methods:** Laser capture microdissection of non-scarred glomeruli & tubulointerstitium from superficial & deep cortex from 16 young (mean age, 30y) & 16 old (mean age, 78y) radical nephrectomy wedge-sections with <10% fibrosis (non-tumor) followed by mass spectrometry-based proteomics.

**Results:** A total of 3228 & 3652 proteins were identified in the glomeruli & tubulointerstitium compartment, respectively. Protein signatures between old & young, differentially expressed at p<0.05 (ANOVA with a Holm-Bonferroni correction) with an absolute log2 fold change >1 were identified as potential markers for aging (Figure 1). More proteins were differentially expressed in the deep (19) vs superficial cortex (7). The glomeruli of older people, from the superficial cortex, showed decreased *APOL1* & *AHSG* (Fetuin-A), [role in CKD], & *PHGDH*, [serine biosynthesis] & glomeruli of older people from deep cortex showed decreased complement factor *D* & *GAS2* [regulator of apoptosis & senescence]. The glomeruli of older people from deep cortex, showed increased *CSTA* [anti-apoptotic role] & *ApoD* [an anti-stress protein induced by oxidative stress]. Superficial tubulointerstitium of older people showed increased *HKDC1* [glucose homeostasis], &  $\alpha$ -crystallin B chain [p53-target gene for apoptosis]. The deep tubulointerstitium of older people, showed overexpression of proteins involved in mitochondrial function, as well as *TIMP3* & *elastin* [increased in diabetic nephropathy].

**Conclusions:** Proteins, particularly of deep cortex, that regulate matrix remodeling, mitochondrial function, inflammation, & metabolic homeostasis may play a role in aging.

**Funding:** NIDDK Support

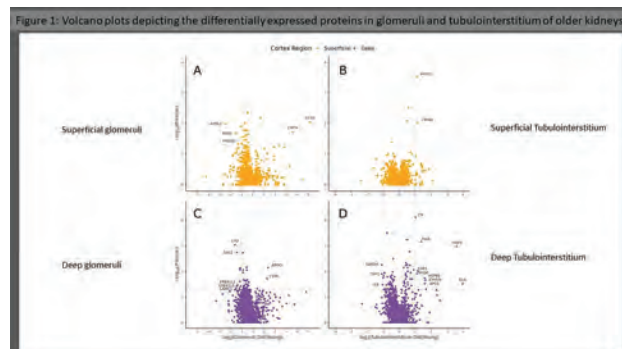

Figure 1

## TH-PO419

**Single Nuclei RNA-Seq Reveals Cell-Type Specific Responses to Disease and Enalapril in the gddY Mouse Model of IgA Nephropathy**

N. E. Olson,<sup>1</sup> Mark McConnell,<sup>1</sup> Phillip J. McCown,<sup>2</sup> Edgar A. Otto,<sup>2</sup> Viji Nair,<sup>2</sup> Marvin Gunawan,<sup>1</sup> Sean Eddy,<sup>2</sup> Jennifer H. Cox,<sup>1</sup> Matthias Kretzler,<sup>2</sup> Toshiki Kano,<sup>3</sup> Yusuke Suzuki,<sup>3</sup> Andrew J. King.<sup>1</sup> <sup>1</sup>Chinook Therapeutics Inc, Seattle, WA; <sup>2</sup>University of Michigan, Ann Arbor, MI; <sup>3</sup>Juntendo University Faculty of Medicine, Tokyo, Japan.

**Background:** IgA nephropathy (IgAN) is defined by the deposition of IgA-containing immune complexes in the mesangium that induce kidney injury. To better understand the mechanisms of IgAN progression and cellular response to ACE inhibitor enalapril (ACEi) we performed snRNA-seq of kidney cortex from control mice, gddY mice, a spontaneous IgAN model and gddY mice treated with ACEi for 8 weeks.

**Methods:** Nuclei from naive (n=6), gddY (n=8), and ACEi-treated gddY mice (n=8) were isolated from kidney cortex and sequenced using the 10x Genomics Platform and analyzed using Seurat 4.0. QC filters were applied and nuclei were used to identify significant differentially expressed genes (DEGs) ( $\log_2 FC \geq 0.25$ ,  $p\text{-adj} \leq 0.05$ ). DEGs for each cell type were identified by comparing gddY vs. naive, or gddY vs. ACEi-treated gddY mice. Ligand/Receptor (L/R) analysis was performed using Connectome.

**Results:** After QC filters were applied, 152,059 nuclei remained, resulting in good representation across all major kidney cell types. We identified failed repair (FR) proximal tubule cells as the most expanded kidney cell type in gddY (5.6-fold) with the highest number of DEGs (779) compared to naive mice; the number of mesangial cells, fibroblasts, and endothelial cells also increased in gddY mice. FR cells showed a Tnf activation signature induction. L/R analysis shows FR cells are a source of Tnf stimulation for fibroblasts and Ccl2 stimulation of leukocytes. The response to ACEi, measured by gene expression changes, varied widely across kidney cell types. Ascending thin limb cells showed the smallest gene expression changes with 7 DEGs and VSMC/Pericytes showed the greatest gene expression changes with 377 DEGs. FR cells showed a modest response to ACEi, with 170 DEGs. When we compared gene expression changes after ACEi with those dysregulated in the gddY model, we found ACEi primarily induced *de novo* gene expression. For VSMC/P, 32 genes were reversed while 320 showed *de novo* expression with ACEi treatment compared to untreated gddY.

**Conclusions:** This study provides novel cell-type specific molecular insights into the pathogenesis of glomerulonephritis and subsequent tubular injury and identified cell-type specific differences in response to ACEi in an IgAN mouse model.

**Funding:** Commercial Support - Chinook Therapeutics, Inc

## TH-PO420

**Collapsing Phenotype Is a Consequence of HIV-Induced Profibrotic and Compromised Transition of Parietal Epithelial Cells in APOL1 Renal Risk Milieu**

Vinod Kumar,<sup>1,2</sup> Ashwani Malhotra,<sup>2</sup> Pravin C. Singhal.<sup>2</sup> <sup>1</sup>Post Graduate Institute of Medical Education and Research Department of Dermatology Venereology and Leprosy, Chandigarh, India; <sup>2</sup>Northwell Health Feinstein Institutes for Medical Research, Manhasset, NY.

**Background:** HIV-infected patients with African ancestry carrying APOL1 renal risk alleles (ARRAs G1 and G2) have a several-fold higher risk of developing HIVAN than patients having APOL1-G0. HIV induces APOL1 in parietal epithelial cells (PECs). Since the expression of APOL1 (wild-type, G0) in monocytes make them resistant to cellular injury and HIV replication, its potential in PECs in general and ARRAs, in particular, has not been investigated. We hypothesized that HIV-mediated PECs' proliferation and the transition are compromised in the ARRAs (G1/G2) milieu & result in their accumulation in Bowman's space, manifesting collapsing phenotype.

**Methods:** The cultured human parietal epithelial cells (hPECs) were transfected with vector, G0, G1 & G2 & analyzed for their proliferative, fibrotic, & podocyte (PD)-specific differentiation phenotype (transition markers) using western blotting (WB). For phenotype-specific proliferative, profibrotic, and transition markers under the HIV milieu, V/G0/G1/G2-PECs were transfected with HIV(NL4-3) for 48hr (n=4) & analyzed by WB. The expression of mTOR signaling and PECs' transition markers was measured

using Western blotting and miR193a expression by RT-PCR to evaluate the involved mechanisms. Renal tissues from control & Tg26 (a HIVAN model) mice were analyzed for miR193a & mTOR expression by FISH & IHC in PECs

**Results:** In vitro studies, G1/G2-PECs displayed an increased expression of profibrotic (CD44, PERK,  $\alpha$ -SMA, Fibronectin, Vimentin, MMP9, SNAIL) but an attenuated expression of transition markers in control and HIV milieu when compared to G0-PECs; in contrast, G0-PECs showed attenuated expression of profibrotic but an enhanced expression of transition markers in HIV milieu. These findings indicate that PEC to PD transition is compromised in G1/G2-PECs in the control and HIV milieu. G1/G2-PECs also displayed increased expression of p-mTOR, p-70S6K, p-4EBP, & p-eEF indicating the activation of mTOR signalling. Renal cortical sections of Tg26 mice showed an increased accumulation of PECs in their Bowman's space and increased miR193a & mTOR expression by PECs compared to control mice.

**Conclusions:** Accumulation of PECs in Bowman's space is a consequence of compromised transition in profibrotic PECs in APOL1 renal risk (G/G2) milieu in HIV-infected patients

**Funding:** NIDDK Support, Government Support - Non-U.S.

## TH-PO421

### Glomerular Annexin A3 and Cathepsin C Staining in COVID-19-Associated and HIV-Associated Nephropathy (HIVAN)-Associated Collapsing Glomerulopathy

Michelle T. Barati,<sup>1</sup> Jessica L. Hata,<sup>3</sup> Michael E. Brier,<sup>1,2</sup> Kenneth R. McLeish,<sup>1</sup> Jon B. Klein,<sup>1,2</sup> Michael Merchant.<sup>1</sup> <sup>1</sup>University of Louisville, Louisville, KY; <sup>2</sup>Robley Rex Va Medical Center, Louisville, KY; <sup>3</sup>Norton Healthcare, Louisville, KY.

**Background:** Prior studies demonstrated glomerular tuft staining for annexin A3 (Anxa3), a marker of parietal epithelial cells (PECs), and cathepsin C (Ctsc), a master regulatory protease, distinguishing primary collapsing glomerulopathy (CG) from other glomerular diseases. We hypothesized these staining patterns would differentiate COVID-19 associated CG (COVID-19+/CG+) from COVID-19(-) without CG (COVID-19-/CG-).

**Methods:** Biopsy sections used were from patients with COVID-19 infections and a pathologist-based tissue diagnoses including CG (COVID-19+/CG+; n=4) or lacking CG diagnosis (COVID-19-/CG-; n=6) were stained for Anxa3 and Ctsc using published protocols. HIVAN-associated CG (n=4) biopsies were used as a secondary CG control. Historical controls data for non-CG biopsies (PMID:32561683). Glomerular staining was tabulated as for PEC staining, phenotypic characteristics of normal and activated (enlarged nuclei, hypertrophic/enlarged cuboidal shape cells, vacuolization) PECs, and for glomerular tuft to Bowman's capsule adhesions or cellular PEC bridges. Globally scarred glomeruli were omitted from analysis. Serial section staining was used to demonstrate Anxa3 and Ctsc co-localization. Differences in the mean (i) number of glomeruli staining OR (ii) glomerular tuft area stained for Anxa3 and Ctsc per biopsy were compared by one-tailed t-test assuming an increase in staining in CG over non-glomerular disease. A p-value <0.05 was used for statistical significance.

**Results:** All COVID-19+/CG+ and HIVAN patients with CG demonstrated extensive Anxa3 and Ctsc glomerular tuft staining. The frequency of glomerular tuft Anxa3 and Ctsc staining and percent glomerular area was significantly (p<0.05) increased in biopsies with COVID-19+/CG+, compared to COVID-19-/CG- (log2FC 2.8-2.9). No statistical difference in frequency or area stained for Anxa3 and Ctsc was observed between COVID-19+/CG+ and HIVAN-associated CG.

**Conclusions:** Anxa3 and Ctsc glomerular tuft expression is increased significantly in COVID-19 and HIVAN patients with CG, mirroring our findings in primary CG. These data support the hypotheses that (a) migration of activated PECs into the glomerular tuft is a prevalent event in both primary CG and virus-associated secondary CG, and (b) glomerular Anxa3 or Ctsc may be therapeutic biomarkers of CG.

**Funding:** NIDDK Support, Other NIH Support - NIGMS, NIAAA, NIEHS, Veterans Affairs Support

## TH-PO422

### Identification of Noninvasive Surrogates as Predictors of Response to FT011 in Kidney Disease

Sean Eddy,<sup>1</sup> Andrew Kompa,<sup>2</sup> John R. Hartman,<sup>1</sup> Felix H. Eichinger,<sup>1</sup> Brad A. Godfrey,<sup>1</sup> Wenjun Ju,<sup>1</sup> Amanda J. Edgley,<sup>2</sup> Robyn G. Langham,<sup>2,3</sup> Laura H. Mariani,<sup>1</sup> Darren J. Kelly,<sup>2,3</sup> Matthias Kretzler.<sup>1</sup> <sup>1</sup>University of Michigan, Ann Arbor, MI; <sup>2</sup>University of Melbourne, Fitzroy, VIC, Australia; <sup>3</sup>Certa Therapeutics, Melbourne, VIC, Australia.

**Background:** Interstitial fibrosis is not only a common endpoint of injury in most kidney diseases, it is also a strong predictor of disease progression. With the development of a novel agent FT011, that has demonstrated anti-fibrotic efficacy in preclinical models, and an excellent safety profile in Phase I studies, a pharmacotranscriptomic analysis of the effects in rats was undertaken. Comparative analysis with human kidney RNAseq profiles was then performed to identify potential predictive clinical and biomarker profiles of patients from the NEPTUNE cohort most likely to respond to FT011 treatment.

**Methods:** RNAseq profiles were generated from kidneys harvested at 12 weeks in Sprague Dawley rats who had undergone Sham (n=9), subtotal nephrectomy (STNx, n=8), or STNx+FT011 treatment (n=8). Differentially expressed gene (DEG) profiles were generated, and enrichment analysis performed. Ortholog mapping was performed using Ensembl to map animal profiles onto human kidney RNAseq profiles from the NEPTUNE cohort (n=388). Urine biomarker profiles were generated NEPTUNE biobanked urine.

**Results:** At week 12 STNx+FT011 attenuated proteinuria and plasma creatinine compared to STNx (p<0.05). DEG profiles for STNx vs Sham (9373, q<0.01) and STNx+FT011 vs STNx (4996, q<0.1) comparisons were performed. 4546 DEGs were shared and direction of expression was reversed by FT011 in 99.9% of these genes. The top 500 DEGs were carried forward as an FT011 response signature. Top enriched pathways and upstream regulators of the signature were fibrosis pathways and TGF $\beta$ -1 (p<0.001). The signature was then mapped onto human expression profiles. The signature was elevated in kidney biopsy profiles of patients with FSGS and MN, was negatively correlated with eGFR (p<0.001), and positively correlated with UPCR (p<0.01). Non-invasive urine biomarkers also showed strong correlation with the signature (p<0.001).

**Conclusions:** FT011 treatment reduced a fibrosis-associated transcriptional profile in the STNx rat model. The signature was highly significant in human kidney disease profiles, associated with more advanced disease, and strongly correlated with non-invasive biomarkers, offering a promise of identifying patients with an intrarenal profile best responsive to FT011 in clinical trials.

**Funding:** NIDDK Support, Commercial Support - Certa Therapeutics

## TH-PO423

### The Loss of Peroxidase Causes a Sex-Dependent Susceptibility to Vascular Mechanical Injury

Selene Colon, Gautam B. Bhawe. Division of Nephrology and Hypertension Vanderbilt University Medical Center, Nashville, TN.

**Background:** The normal inflammatory response consists of an immune system upregulation that protects by eliminating pathogens and promotes recovery through tissue repair. There is increasing evidence that inflamed tissues' remodeled extracellular matrix (ECM) directly affects the inflammatory response, leading to changes associated with diseases that affect various organ systems, including the vasculature and kidney. Peroxidase (Pxdn) is an extracellular matrix (ECM) associated heme peroxidase that catalyzes the formation of sulfilimine cross-links in collagen IV. Collagen IV is the prominent constituent of basement membranes (BM), a specialized sheet-like ECM that underlies cell layers in all tissues. The Pxdn knock-out (Pxdn<sup>-/-</sup>) mice generated in our lab exhibit reduced BM cross-links and strength. Using the unilateral nephrectomy with angiotensin II infusion (Unx + Ang II) model of kidney injury, we wanted to determine if the initiation and progression of glomerular injury depends significantly on GBM strength and resilience.

**Methods:** Utilizing 129S4/SvJaeJ wildtype and Pxdn<sup>-/-</sup> mice, we removed one kidney and simultaneously inserted an osmotic mini-pump for the constant subcutaneous dosing of angiotensin II, leading to hypertension-induced mechanical stress. We monitored blood pressure and body weight and collected blood and urine to measure kidney function every other week. We planned to sacrifice animals four weeks post-uninephrectomy, but Pxdn<sup>-/-</sup> female mice began to die around three weeks post-surgery. To account for this, we shortened the timeline to two weeks post-uninephrectomy.

**Results:** Injured female Pxdn<sup>-/-</sup> mice presented with a significant decrease in survival after 2-weeks and an increase in CD4+ T-cells and F4/80+ macrophages in the vasculature. They also had an increase in renal fibrosis and trended towards a decrease in renal function compared to all other mice. We also discovered that the exacerbated injury in female Pxdn<sup>-/-</sup> mice was reversed after ovariectomy.

**Conclusions:** In this work, we found that the loss of Pxdn disproportionately affects females more than males in the Unx + Ang II model of kidney injury. This dramatic vascular inflammatory phenotype is the first sex-specific phenotype attributed to Pxdn protein expression. It suggests that the loss of Pxdn and sex contribute to renal fibrosis and vascular inflammation in response to vascular mechanical injury.

**Funding:** NIDDK Support, Private Foundation Support

## TH-PO424

### Pressure-Dependent Molecular Transport in Native and Enzymatically Crosslinked Glomerular Basement Membrane

Dan Wang, Nicholas J. Ferrell. The Ohio State University Wexner Medical Center, Columbus, OH.

**Background:** Glomerular basement membrane (GBM) is a thin layer of extracellular matrix (ECM) that supports podocytes and endothelial cells and regulates their behavior and function. The role of the GBM in determining the permeability of the glomerular filter in health and disease is not fully understood. The GBM has been proposed to act as a compressible membrane with increased selectivity under applied pressure. Multiple kidney diseases are characterized by increased enzymatic crosslinking of the ECM. We hypothesized that enzymatic crosslinking would increase GBM permeability under pressure by increasing GBM stiffness and reducing pressure dependent compression.

**Methods:** Glomeruli were isolated from porcine kidneys by sieving. Stiffness of native and microbial transglutaminase (mTG) crosslinked decellularized glomeruli were measured by a customized compression assay. GBM membranes were made by pressure compacting decellularized glomeruli on a supporting membrane in a stirred cell. FITC-Ficoll sieving coefficients were measured at high and low pressure on native and crosslinked GBM. Diffusional permeability was determined by measuring passive transport of Ficoll through the GBM in the absence of applied pressure.

**Results:** Stiffness of decellularized glomeruli was significantly increased (4.1-fold) after crosslinking with mTG (100  $\mu$ g/mL). mTG did not affect FITC-Ficoll diffusional permeability of GBM, suggesting minimal alteration of pore structure in the absence of applied pressure. The sieving coefficient curves of native GBM show a reduction in molecular cut-off with increasing pressure, indicative of membrane compression effects. Crosslinked membranes did not show significant compression effects on sieving coefficient.

**Conclusions:** We developed a GBM in vitro model to investigate the molecular transport. We use the native and crosslinked GBM as healthy and pathological conditions, respectively. mTG had minimal effect on molecular transport during diffusive transport. Native GBM behaved as a compressive filter, restricting large molecule transport at high pressure. This effect was mitigated in enzymatically crosslinked GBM due to the decreased degree of compressibility suggesting that disease mediated enzymatic crosslinking may contribute to glomerular filtration defects in chronic kidney disease.

**Funding:** Other U.S. Government Support, Private Foundation Support

#### TH-PO425

##### ZNF185 Prevents Stress Fiber Formation Through the Inhibition of RhoA in Endothelial Cells

Soichiro Suzuki, Fumiaki Ando, Yu Hara, Tamami Fujiki, Shintaro Mandai, Koichiro Suga, Takayasu Mori, Eisei Sohara, Tatemitsu Rai, Shinichi Uchida. *Tokyo Ika Shika Daigaku, Bunkyo-ku, Japan.*

**Background:** Cyclic adenosine monophosphate (cAMP)/protein kinase A (PKA) signaling promotes endothelial barrier function to prevent plasma leakage induced by inflammatory mediators. Although PKA is a major effector of vascular permeability, the molecular mechanisms underlying PKA signaling pathway in endothelial cells remain to be determined. In this study, we used a cAMP inducer, forskolin, and a phospho-PKA substrate antibody to identify ZNF185 as a novel PKA substrate. ZNF185 has been described as a protein involved in the regulation of cell differentiation and proliferation of cancers. However, its physiological relevance in endothelial cells has not yet been established.

**Methods:** We investigated the function of ZNF185 in human umbilical endothelial cells (HUVECs).

**Results:** ZNF185 is an actin cytoskeleton-associated protein and colocalized with F-actin in endothelial cells. ZNF185 also interacted with PKA which autophosphorylated ZNF185 itself. Both phospho-ZNF185 and F-actin accumulated at plasma membrane region in response to forskolin to stabilize the cortical actin structure. By contrast, ZNF185 knockdown disrupted actin filaments and promoted stress fiber formation without inflammatory mediators. Constitutive activation of RhoA was induced by ZNF185 knockdown, which resulted in forskolin-resistant endothelial barrier dysfunction. ZNF185 was essential for cAMP/PKA/RhoA signaling for the suppression of endothelial hyperpermeability.

**Conclusions:** ZNF185 is necessary for the maintenance of cytoskeletal actin structures in endothelial cells.

#### TH-PO426

##### Adaptive Remodeling of Mesangial Matrix Proteoglycan Composition During IgA Nephropathy

Kerstin Ebefors, Alva Johansson, Roberto Boi, Jenny C. Nystrom. *Goteborgs universitet Sahlgrenska Akademin, Goteborg, Sweden.*

**Background:** IgA nephropathy (IgAN) is characterized by galactose deficient IgA (gd-IgA1) containing immune complexes in the mesangium, leading to activation of the cells, proliferation, matrix expansion and local inflammation. The exact composition of the mesangial matrix and its role in disease progression is not fully known. One important group of proteins in matrixes are proteoglycans (PGs). PGs are composed of a core protein to which glycosaminoglycan (GAG) side chains are attached. The most common GAGs are heparan sulfate (HS) and chondroitin sulfate (CS). Both the core protein and GAGs determine the properties of PGs and changes in PG composition could be of importance for disease progression. In this study, we aimed to elucidate the role of changes in the PG expression in IgAN.

**Methods:** Human MCs expression of PGs after stimulation with gd-IgA1 was investigated using a glycoproteomics which gives information about both the core protein identity and the the GAGs attached. Immunofluorescence was used for quantification of GAGs. ELISA was used to investigate specific PGs. In vivo and in vitro validation was done using a previously published transcriptomic data set of glomeruli from patients with IgAN in combination with a proteomic data set of HMCs treated with gd-IgA (Liu et al JASN 2017).

**Results:** Glycoproteomics identified 13 PGs in the medium and 5 in the cell lysate and their corresponding GAGs, of which the majority was CS PGs. More PGs were identified in the cells treated with control IgA (cIgA) or gd-IgA1 than the controls. Immunohistochemistry revealed that gd-IgA1 treatment of MCs does not lead to a total increase in GAGs, but rather to a switch from HS to CS GAGs. This was found to be true also in the already published proteomic data set on MCs treated with gd-IgA1. In vivo validation revealed that in IgAN there are more CS upregulated than HS in IgAN. Bikunin, the most upregulated CS PG, expression was validated using ELISA, and found to not be expressed by cells before stimulation with IgA, but then highly upregulated.

**Conclusions:** In conclusion, this study gives a comprehensive view of the PGs expressed by MCs and their alterations in response to gd-IgA1 as part of the expansion of the mesangium in IgAN. The switch of HS GAGs to CS GAGs could be involved in driving inflammation/proliferation but the role of this switch needs further investigation.

**Funding:** Private Foundation Support, Government Support - Non-U.S.

#### TH-PO427

##### Pathological Changes After Methylprednisolone (MP) Pulse Therapy in IgA Nephropathy

Byoung-Soo Cho. *Dr. Cho's Kidney Clinic, Seoul, Republic of Korea.*

**Background:** IgA nephropathy is one of the most common chronic glomerulonephritis and 30-45% fall into CKD over a period of 20-25 years. Lots of therapeutic regimens are tried such as ACEi, ARB, omega-3, corticosteroids, MP pulse therapy and recently many kinds of complement inhibitors, Nefecon, Atacicept, Atrasentan etc., however need a longterm follow up studies to confirm the efficacy. Up to now most centers regarded proteinuria as a most important prognostic marker in IgA nephropathy. In order to confirm the efficacy of proteinuria as a prognostic marker, we performed follow up renal biopsy who showed normalized proteinuria aDuring last 7 yearsour clinic performed 1,500 cases of renal biopsy after MP pulse therapy

**Methods:** During last 7 years our clinic performed 1,500 cases of renal biopsies at OPD level, of which 494 cases (32.9%) were IgA nephropathy patients. We performed follow up renal biopsy in 120 cases who showed normalized urinalysis findings Renal biopsy findings were divided into 3 groups, Group A: improved pathological findings. Group B : no significant pathologic changes. Group C: aggravated pathological findings such as increased glomerulosclerosis, tubulointerstitial changes, tubular atrophy etc. One cycle of MP pulse therapy consist of methylprednisolone (20-30mg/kg, max 1gm/day) IV for 3 consecutive days. Depends on pathologic findings we performed 3 to 15 cycles.

**Results:** Male to female ratio were 59:61, Mean age were 31.1 years old. Of the 120 follow up renal biopsies, 60 cases (50%) showed improved pathological findings (Group A) such as reduced or disappearance of electron dense deposits, restoration of foot processes, decreased mesangial proliferation, 50 cases (40%) showed no significant pathological changes compare to initial pathological findings (Group B), 10 cases (10%) showed aggravated pathological findings such as increased glomerulosclerosis, aggravated interstitial fibrosis and tubular atrophy even though clinically improved such as normalized urinalysis findings, stabilized BP and improvement of eGFR. (Group C)

**Conclusions:** Only 50% of the clinically improved IgA nephropathy patients showed improved pathological findings Decreased proteinuria could not be a prognostic marker of improvement of IgA nephropathy Follow up renal biopsy might be mandatory procedure even though clinically improved such as disappearance of proteinuria

**Funding:** Private Foundation Support

#### TH-PO428

##### Interstitial LRP1 Expression Is Associated With Glomerular Disease

Marwin Groener,<sup>1,2</sup> Tilman Jobst-Schwan,<sup>3</sup> Mario Schiffer.<sup>3</sup> *<sup>1</sup>Yale School of Medicine, New Haven, CT; <sup>2</sup>Research Center on Rare Kidney Diseases (RECORD), Erlangen, Germany; <sup>3</sup>Universitätsklinikum Erlangen Medizinische Klinik 4 Nephrologie und Hypertensiologie, Erlangen, Germany.*

**Background:** Low density lipoprotein receptor-related protein 1 (LRP1) is a large evolutionarily conserved endocytic transmembrane receptor that is ubiquitously expressed. However, little is known about its function in the kidney. The goal of this study was to investigate LRP1 expression in different nephron segments in healthy and diseased human renal tissue as well as the developing kidney.

**Methods:** Immunohistochemistry with two antibodies targeted towards the intracellular and extracellular domains of LRP1 were used to assess spatial distribution of LRP1 in healthy human renal tissue and in biopsies of minimal change disease, focal segmental glomerulosclerosis, and membranous nephropathy. Perinatal and adult mouse kidneys were assessed with immunohistochemistry for LRP1. Published kidney RNA and ATAC sequencing databases were used to evaluate LRP1 transcription levels in different renal cell types.

**Results:** In healthy human tissue, intracellular LRP1 signal was detected in distal tubules (DT), loop of Henle (LH), and collecting ducts (CD), whereas extracellular domain signal was found in proximal tubules (PT) and weaker in LH. No glomerular or interstitial signal was found with either antibody. Surprisingly, marked glomerular and interstitial LRP1 expression was seen in all glomerulopathies. Glomerular expression did not co-localize with nephrin and had a mesangial pattern. Interstitial LRP1 was pronounced in the peritubular space. In P0 mouse kidneys, LRP1 signal was primarily found in the interstitium and S-shaped body, whereas adult mouse tissue predominantly expressed LRP1 in the PT. RNA and ATAC sequencing database analysis indicated preferential transcription of LRP1 in mesangial cells and fibroblasts.

**Conclusions:** Interstitial LRP1 expression is markedly induced in human proteinuric glomerulopathies. Interestingly, the developing mouse kidney has similar interstitial LRP1 expression which is lost in mature renal tissue. Our findings demonstrate an association of interstitial LRP1 with glomerular disease and kidney development. Further research is needed to elucidate the role of LRP1 in renal disease and its potential as a drug target.

**Funding:** Private Foundation Support, Government Support - Non-U.S.

## TH-PO429

**A Novel Non-Invasive Biomarker Targeting LG3 From Perlecan Can Identify Lupus Nephritis (LN) Patients and Differentiate LN Subclasses**  
 Clara F. Laursen,<sup>1</sup> Alexandra L. Møller,<sup>1</sup> Nadja Sparding,<sup>1</sup> Federica Genovese,<sup>1</sup> Morten A. Karsdal,<sup>1</sup> Zdenka Hruskova,<sup>2</sup> Vladimir Tesar.<sup>2</sup> <sup>1</sup>Nordic Bioscience, Herlev, Denmark; <sup>2</sup>Univerzita Karlova, Praha, Czechia.

**Background:** Perlecan is an extracellular matrix (ECM) protein important for kidney development and function. Unbalanced turnover of ECM proteins is a hallmark of chronic and fibrotic diseases. Cleavage fragments of perlecan could thus provide important knowledge in kidney disease pathologies. LG3 is a fragment liberated from endorepellin, a signalling molecule from perlecan with antiangiogenic and autophagic properties where LG3 harbours most of the activity. LG3 has been demonstrated to be associated with e.g. end-stage renal disease (ESRD), chronic allograft nephropathy and lupus nephritis (LN). In LN, LG3 autoantibodies have been suggested to contribute to the characteristic microvascular damage occurring. Until now it has not been possible to distinguish LG3 from endorepellin or intact perlecan by ELISA.

**Methods:** We developed a technically robust and accurate competitive enzyme-linked immunosorbent assay biomarker, with a monoclonal antibody specifically targeting the N-terminal site of LG3 generated by BMP-1 cleavage. The LG3 assay was validated in healthy donor serum, plasma heparin, EDTA and urine samples. Moreover, the biological relevance of LG3 was evaluated in serum (n=48) and urine (n=52) from patients with LN, as well as serum (n=65) and urine (n=48) from age and gender-matched healthy controls for comparison. All urine values were corrected for urinary creatinine.

**Results:** Levels of LG3 were significantly elevated in patients with LN in both serum (P<0.0001) and urine (P=0.0008), compared to healthy controls. Moreover, urine LG3 levels were able to significantly distinguish patients diagnosed with class IV or class IV+V LN, with class IV being the most common subclass as well as having the worst prognosis, from the other subclasses (P=0.0023). Class IV LN can further be divided into diffuse segmental (S) or global (G) LN, with significantly increased levels of urine LG3 levels in class IV-G LN (P=0.0430), associated with a higher risk of ESRD compared to class IV-S.

**Conclusions:** These results suggest a possible association of LG3 with LN pathogenesis and demonstrates the diagnostic potential of the biomarker. To evaluate the prognostic, predictive and pharmacodynamic potential of the novel biomarker more studies need to be conducted.

## TH-PO430

**Study of Profile of Urinary TGF-β1 in Glomerular Diseases**

Akshay R. Kulkarni, Atul Sajgure, Charan B. Bale, Pavan Wakhare, Nilesh Shinde, Abhijit S. Chavan, Tushar A. Dighe. *Dr. D.Y. Patil Medical College, Hospital & Research Centre, Pimpri, Pune, Dr. D. Y. Patil Vidyapeeth, Pune, India.*

**Background:** Transforming Growth Factor-β1 (TGF-β1) is associated with fibrosis in many organ systems including the kidney, where it can be induced by angiotensin, proteinuria and hypoxia. Numerous studies have identified TGF-β1 as being upregulated during the course of progressive renal injury. Similarly, inhibition of TGF-β1 has been shown to ameliorate renal injury. TGF-β1 is not only involved in extra cellular matrix accumulation, fibrosis and progressive renal impairment, but also plays a role in changes to the glomerular filtration barrier and induction of proteinuria. Direct inhibition of TGF-β1 in models of renal disease reduces proteinuria. Our study aimed to study the profile of urinary TGF-β1 in glomerular diseases.

**Methods:** It was a prospective, observational study, done at a tertiary care centre in western India, over a period of 1 year. 15 subjects with biopsy proven glomerular diseases and 5 healthy controls were enrolled in the study. These participants underwent all routine laboratory investigations and urinary TGF-β1 estimation on a 24 hour urine sample by Flowcytometry method. Cytometric array capture beads of 20 ul were mixed in 20 ul of urine in 1.5 ml tubes. After mixing, samples were incubated at room temperature for 2 hours. After incubation, 50 ul phosphate Buffered Saline was added and centrifuged at 5000 rpm for 5 mins. After centrifugation, 70 ul volume was removed. In the sample 20 ul Detection beads were added and samples were incubated for 2 hours. After incubation 160 ul buffer was added and samples were analyzed using multicolor flowcytometry. Every sample was processed thrice and average value (pg/ml) was considered for analysis of all the subjects.

**Results:** Of the 20 study participants, 11 were males and 9 were females. Average age in glomerular disease patients (group A) was 35.73± 14.25 years and that in control group (group B) was 30.2±5.02 years. Urinary TGF-β1 level in group A had mean value of 50.35 ±6.52 (pg/ml), while that in group B was 19.29 ±3.48 (pg/ml). The values for TGF-β1 in test samples (group A) were found significantly higher in comparison to control (group B). (p<0.0001). Mean value of UPCR was 5.50 ±5.11 in group A and 0.17±0.11 in group B.

**Conclusions:** Urinary TGF-β1 levels were significantly high in glomerular disease patients compared to healthy individuals.

## TH-PO431

**Piperazine Ferulate Protects Mice Against Unilateral Ureteral Obstruction-Induced Interstitial Renal Fibrosis Through TGF-β/Smad3 Signaling**  
 Jun H. Luo,<sup>1</sup> Yun Tang,<sup>1</sup> Bo Li,<sup>2</sup> Qiong Xiao,<sup>1</sup> Lu H. Ding,<sup>1</sup> Xiang Zhong,<sup>1</sup> Yi Li,<sup>1</sup> Guisen Li.<sup>1</sup> <sup>1</sup>Sichuan Academy of Medical Sciences and Sichuan People's Hospital, Chengdu, China; <sup>2</sup>Chengdu Hanpharm Limited Company, Cheng du, China.

**Background:** Tubulointerstitial fibrosis is the ultimate pathological feature of CKD progression. Unfortunately, there is no clinical treatment with efficiency and no side effects. Piperazine ferulate (PF), a ferulic acid derivative, is commonly used as an adjunctive therapy for various types of glomerular diseases. However, the role of PF in tubulointerstitial fibrosis in CKD is still unclear. Current study aimed to elucidate the role and mechanism of PF in murine tubulointerstitial fibrosis with unilateral ureteral obstruction.

**Methods:** 36 male C57 mice aged from 6 to 8 weeks were randomly divided into six groups (n=6): sham-operated group, interstitial fibrosis group, PF low dose intervention for interstitial fibrosis group, PF medium dose intervention for interstitial fibrosis group, PF high dose intervention for interstitial fibrosis group, PF alone group. Mice with unilateral ureteral obstruction were operated to establish a mouse model of interstitial fibrosis. And the mice accepted PF once per day by gavage following surgery. The mechanism of action of ferulic acid piperazine on interstitial fibrosis in mice was investigated by immunohistochemistry and western blotting.

**Results:** The results showed that the degree of fibrosis in the interstitial fibrosis group was severe, compared to that of mice in the sham-operated group. However, the degree of fibrosis in PF intervention following unilateral ureteral obstruction group was moderate. There was a significant positive correlation between this reduction and the dose of PF. Immunohistochemistry and western blotting showed that the protein expression levels of FN, Col-1, α-SMA, TGF-β1 and p-smad3 were significantly increased in the kidney tissues of mice with interstitial fibrosis. However, the protein expression levels of FN, Col-1, α-SMA, TGF-β1 and p-smad3 were significantly decreased in the kidney tissues of mice with interstitial fibrosis compared with those with ferulic acid piperazine intervention. And the expression of these proteins was significantly and negatively correlated with the dose of ferulic acid piperazine.

**Conclusions:** It indicated the protective role of PF in mice against unilateral ureteral obstruction-induced interstitial renal fibrosis through TGF-β/Smad3 signaling.

## TH-PO432

**Ferroptosis Is Activated in TGF-β/Smad3 Dependent Renal Fibrosis**

Kaixiang Liu, Yu Min, Yi Li, Guisen Li, Li Wang, Xiang Zhong. *Sichuan Academy of Medical Sciences and Sichuan People's Hospital, Chengdu, China.*

**Background:** Renal fibrosis is not only the main pathological feature of chronic kidney disease (CKD), but also a reliable prognostic index for disease progression. Ferroptosis is a new pattern of cell death, which is involved in many diseases. However, the role of ferroptosis in renal fibrosis is still unclear. The aim of the study was to explore the functional role and potential mechanism of ferroptosis in renal fibrosis of unilateral ureteral obstruction (UUO) mice.

**Methods:** Male C57 mice aged from 6 to 8 weeks were operated by UUO surgery to construct kidney fibrosis models. Erastin and Ferrostatin was separately intraperitoneally injected into UUO mice after ligating the ureter to increase or inhibit the expression of ferroptosis in the kidney. The expression of fibrosis markers (FN, Col-1, α-SMA), TGF-β/Smad3 signaling and ferroptosis indexes (GPX4 and SLC7A11) were determined by immunohistochemistry (IHC), western blotting and electron microscopy. The mechanism of ferroptosis in renal fibrosis was investigated in Smad3 KO mice, and full-length transcriptome was also applied in Sham and UUO group.

**Results:** The results showed that the fibrosis markers (FN, Col-1, α-SMA) and TGF-β, P-Smad3 were increased, and the expression of GPX4 and SLC7A11 were decreased in UUO group, further electron microscopy also revealed mitochondrial changes of ferroptosis. After treated with Erastin in UUO mice, the degree of renal fibrosis was significantly increased compared with UUO group. In contrast, Ferrostatin alleviated the expression of renal fibrosis by inhibiting ferroptosis. With knockdown of Smad3, ferroptosis were decreased while renal fibrosis was alleviated by IHC and western blotting. Full-length transcriptome showed the activation of TGF-β/smard3 pathway was related to the inhibition of GPX4 in renal fibrosis. Moreover, the result of Co-IP showed there is an interaction between GPX4 and P-Smad3.

**Conclusions:** This study found that ferroptosis played an important role in TGF-β/Smad3-dependent renal fibrosis and the inhibition of Smad3 could attenuated kidney fibrosis by inhibiting GPX4 mediated ferroptosis.



## TH-PO433

**REDX12271 Is a Novel, Selective DDR1 Inhibitor With the Potential to Treat Multiple Chronic Kidney Diseases**

Kay Eckersley, Inder Bhamra, James Ryan, Michal S. Andrae, Daniel J. Wilcock, Shân Preece, Peter R. Bunyard, Clifford D. Jones, Richard Armer. *Redx Pharma plc, Nether Alderley, United Kingdom.*

**Background:** Discoidin domain receptors (DDR1) are collagen-activated receptor tyrosine kinases which have been shown to be highly expressed in many fibrotic diseases. The protective role of REDX12271, a novel and selective orally bioavailable small molecule inhibitor of DDR1, was investigated in a mouse unilateral ureteral obstruction (UO) model. REDX12271 exhibits nanomolar potency in cells and target engagement in the kidney as measured by suppression of phospho-DDR1. Efficacy was demonstrated via suppression of pro-fibrotic genes and through reduction of  $\alpha$ -SMA and collagen deposition.

**Methods:** For the prophylactic regime, mice were subjected to treatment with vehicle or REDX12271 via oral gavage at 15 mg/kg BID and 50 mg/kg BID for one day prior to surgery and for a further 7 days post UO. Control animals were not subjected to UO. At sacrifice, obstructed kidneys were collected and processed for kidney markers of inflammation and fibrosis. For therapeutic intervention, mice were subjected to UO and subsequently from day 5 to treatment with vehicle or REDX12271 via oral gavage at 15 mg/kg BID and 50 mg/kg BID. Animals were sacrificed at day 10 and kidneys were collected and processed for histological analysis of collagen deposition and myofibroblast transformation in stained tissue sections.

**Results:** Animals treated with REDX12271 had a statistically significant reduction in histological markers of inflammation and fibrosis in the mouse UO model. REDX12271 suppressed inflammation and fibrosis in the prophylactic model of UO as measured by histological staining for F4/80 and  $\alpha$ -SMA respectively. In the therapeutic regime, animals treated with REDX12271 had a statistically significant reduction in fibrosis compared to vehicle as measured by histological staining for  $\alpha$ -SMA and Picrosirius Red.

**Conclusions:** These data show that REDX12271 reduces inflammation and fibrosis in UO models. To our knowledge this is the first example of selective inhibition of DDR1 with a small molecule giving rise to efficacy in mouse UO models. Selective inhibition of DDR1 represents an attractive approach for further investigation towards the development of new treatments for CKD.

**Funding:** Commercial Support - Redx Pharma PLC

## TH-PO434

**Importance of Monoclonal Gammopathy of Undetermined Significance (MGUS) Surveillance and Difficulty in Diagnosing Monoclonal Gammopathy of Renal Significance (MGRS) in Low-Grade Lymphomas**  
Sidrah Abidi, Krishnakumar D. Hongalgi, Kelly H. Beers, Swati Mehta. *Albany Medical Center, Albany, NY.*

**Introduction:** Mantle cell lymphoma is considered a benign pathology rarely warranting treatment in an indolent phase. Immunoglobulin (Ig) deposition without clinically evident decline in kidney function is referred to as monoclonal gammopathy of unknown significance (MGUS). However, undetected kidney involvement could manifest as renal failure and multi-organ failure.

**Case Description:** A 49-year-old male with past medical history of untreated indolent mantle cell lymphoma was admitted to the hospital with hypoxic respiratory failure, pulmonary hemorrhage, purpuric lower extremity rash and acute kidney failure requiring hemodialysis. Patient's creatinine in 2018 was 1.24mg/dl corresponding to eGFR > 60ml/min/m<sup>2</sup>. Patient had a bone marrow biopsy in 2018 confirming mantle cell lymphoma but as per oncology it did not warrant treatment and his kidney function was not monitored. During the hospitalization, patient was non-oliguric. Creatinine was initially 1.98mg/dl then increased to a peak of 6.82mg/dL. Workup revealed non-nephrotic proteinuria, elevated rheumatoid factor, and low complement levels. Kidney biopsy showed membranoproliferative glomerulonephritis with IgM and C3 deposition on immunofluorescence and no evidence of vasculitis. Patient was diagnosed with cryoglobulinemia-associated glomerulonephritis. Our patient was treated with a combination of plasmapheresis, high dose glucocorticoids and IV immunoglobulins, but failed to improve. He was eventually started on chemotherapy including cyclophosphamide, rituximab, and vincristine. Patient was on kidney replacement therapy for several weeks then recovered renal function. He was in remission for several weeks but unfortunately expired after an episode of cardiac arrest secondary to severe anemia.

**Discussion:** Monoclonal gammopathy of renal significance (MGRS) in a smoldering or low-grade lymphoma needs close monitoring of renal function and clonal proliferation with close collaboration with oncology, nephrology and pathology. Our case demonstrates the importance of early detection and treatment.

## TH-PO435

**Unmasking a New Disease: Membranous Glomerulopathy With Masked IgG Kappa Deposits: A Case Report**

Saijeda Alleyne, Mohamed Anwar Abdus Samad. *WellSpan York Hospital Department of Internal Medicine, York, PA.*

**Introduction:** Membranous-like glomerulopathy with masked IgG kappa [IgG- $\kappa$ ] deposits (MGMD) is a novel glomerular disease first described in 2014. By light microscopy and electron microscopy, it is indistinguishable from membranous nephropathy. MGMD is characterized by weak to negative immunoglobulin staining on routine immunofluorescence (IF) but strong IgG- $\kappa$  restricted staining upon pronase

digestion of formalin-fixed paraffin-embedded tissue. Here, we describe a case of membranous-like glomerulopathy with masked IgG-kdeposits found in a pregnant woman with nephrotic range proteinuria.

**Case Description:** 34-year-old woman Gravida 2 Para 1 with history of hypertension was found to have 3+ proteinuria on routine prenatal work up at 11 weeks of gestation. Her urinalysis also showed microscopic hematuria and 24-hour urine proteinuria estimation revealed over 4 grams. She was also found to have mild hypoalbuminemia and hyperlipidemia. She did not have peripheral edema. She denied any history of kidney disease, preeclampsia or eclampsia with prior pregnancy or any miscarriages. Her CBC and kidney function were within normal limits. Subsequently serologic work up was sent which revealed weakly positive ANA ~1: 40 but negative anti double-stranded DNA, anti-PLA R2 antibody, ANCA, C3, C4, serum and urine protein electrophoresis, serum free light chain ratio. Relevant viral studies were negative. She then underwent a kidney biopsy which revealed MGMD. She deferred immunosuppressive therapy and chose to be managed conservatively with strict blood pressure and low salt diet.

**Discussion:** There have been 14 cases documented of patients with MGMD in the literature associated with female patients less than 40 years of age with some form of autoimmune disease or hemolytic anemia. To our knowledge, this will be the first reported case in a pregnant woman. The etiology of the phenomenon is unknown however given this new discovery, continued documentation of these case presentations can aid in furthering research to investigate pathogenesis and subsequently treatment.

## TH-PO436

**Smoldering Pauci-Immune Glomerulonephritis Associated With Recent Tofacitinib Induction in a Patient With Rheumatoid Arthritis**

Michael B. Neinast, Xueguang (Gary) Chen. *Southern Illinois University School of Medicine, Springfield, IL.*

**Introduction:** Pauci-immune glomerulonephritis is typically associated with rapidly progressive glomerulonephritis. Roughly 90% of cases involve circulating levels of ANCA antibodies associated with systemic vasculitis. We present a case of smoldering glomerulonephritis diagnosed after recent initiation of tofacitinib, a Janus kinase (JAK) inhibitor, for rheumatoid arthritis.

**Case Description:** 35-year-old female with seronegative rheumatoid arthritis (RA) was started on tofacitinib for increased flares associated with methotrexate discontinuation for pregnancy planning. Labs obtained prior to initiation included ANA, dsDNA antibodies, and anti-Smith antibodies, were negative. Her symptoms improved however kidney function began to decline. After eight months of treatment, her creatinine increased from 1.1 g/dL with eGFR 60 to 1.22 with eGFR of 50, prompting referral to nephrology. A broad workup was thus obtained. ANA and dsDNA were both positive at 1:320 in homogenous pattern and 50 IU (low positive), respectively. UA showed microscopic hematuria with 3-5 RBCs/hpf with dysmorphism. Anti-MPO was equivocal at 20 AU/mL. Anti-PR3 was negative at 3 AU/mL (normal <19; positive >26). Anti-GBM antibodies were negative. On follow up two weeks later, her creatinine had increased to 1.31 with eGFR 46. Renal biopsy was pursued to rule out lupus nephritis. Renal biopsy revealed sclerosing glomerulonephritis with 60% glomeruli affected, most consistent with pauci-immune type with accompanying mild interstitial fibrosis and tubular atrophy. The patient was started on high dose prednisone and weekly rituximab infusions for four weeks. Prednisone was tapered over three months until discontinued. Her renal function improved over the treatment course and stabilized at her pre-treatment level of creatinine 1.1 g/dL with eGFR 67. Rituximab infusions were continued every six months for maintenance suppression of vasculitis.

**Discussion:** This case raises the concern of a novel adverse event of tofacitinib given new auto-Abs and worsening renal function. There have not been any GN associations with this drug class in the literature though interestingly, tofacitinib has been trialed in treatment of giant cell arteritis with some success. More research is required for further clarification.

## TH-PO437

**AA Amyloidosis Presenting With Renal Amyloidoma**

Deepti Gunasekaran, Randy L. Luciano. *Yale University, New Haven, CT.*

**Introduction:** Amyloidoma is a localized tumor like deposit of amyloid protein. It has been described in a variety of tissues including skin, soft tissue, respiratory tract, and spleen; commonly in the absence of systemic disease. Very few cases of amyloidoma of the kidney are reported. Here, we describe a rare case of systemic amyloidosis with a renal mass showing biopsy proven AA amyloidosis.

**Case Description:** A 59-year-old male without comorbidities was admitted to the hospital following a motor vehicle collision with lower back pain. Physical exam was significant for 2+ pitting edema in bilateral lower extremities. Labs revealed a creatinine of 7.8 mg/dL from 1.0 mg/dL, four years ago. Urine albumin creatinine ratio was elevated at 4.1 g/g of creatinine. Further work up was significant for elevated CRP, positive Hepatitis C antibody and viral PCR. CT of the abdomen showed a 3.5 cm solid renal mass arising from the anterior aspect of the lower pole of the right kidney and L2-L3 osteomyelitis. Biopsy of the mass and renal parenchyma showed enlarged glomeruli with marked mesangial expansion by amorphous, pale eosinophilic and silver negative material. Similar deposits were also seen in the interstitium and in perivascular distribution. Congo red stain was positive for amyloid in glomerular (mesangial), perivascular and interstitial areas. Immunohistochemistry for Amyloid A was positive. He was started on maintenance hemodialysis and was discharged on long term intravenous antibiotics for osteomyelitis.

**Discussion:** The radiographic features of amyloidosis are typically non-specific. In early stages, kidneys may be enlarged but in 50% of cases, they are small with thinned cortex. Our case demonstrates a rare instance of renal amyloidoma formation by a focal,

tumor like infiltrative process as seen on CT abdomen. Radiographic findings may precede the clinical presentation and can expedite further work up and treatment. In the work up of solid renal mass, amyloidosis must be considered along with more common conditions such as renal cell carcinoma, multiple myeloma or lymphoma.

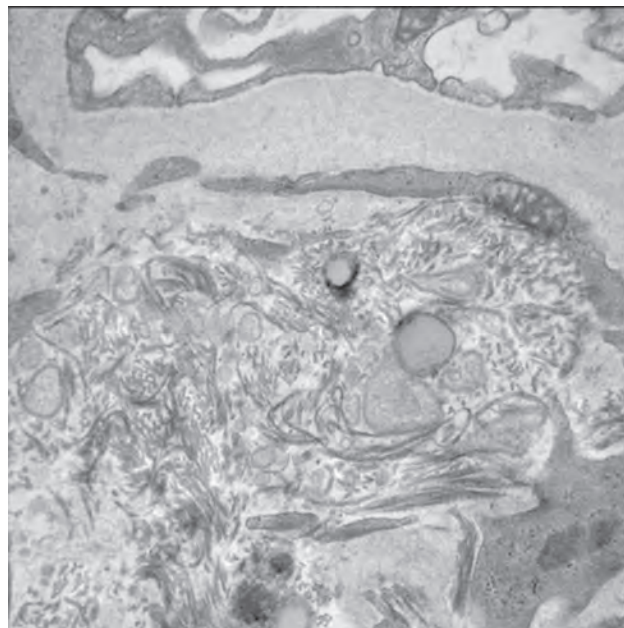
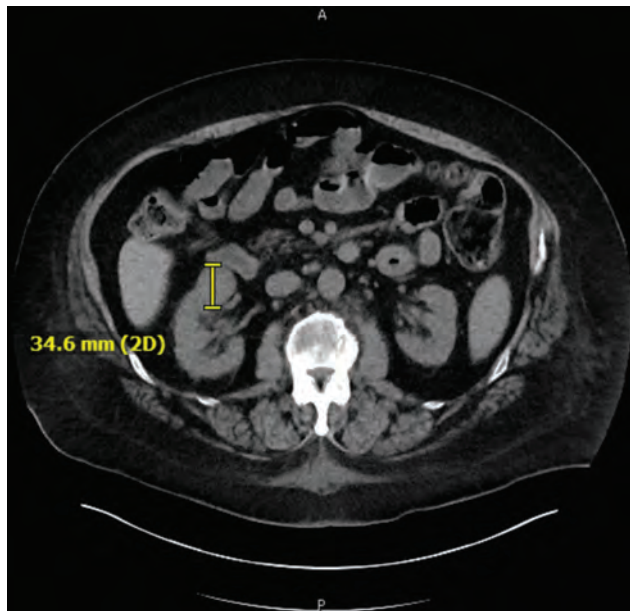

TH-PO438

**Collagenofibrotic Glomerulopathy in a Patient With Waldenstrom Macroglobulinemia**

Deepthi Gunasekaran, Anushree C. Shirali. Yale University, New Haven, CT.

**Introduction:** Collagenofibrotic glomerulopathy(CG) is a rare disease characterized by type III collagen deposition in the glomerular mesangial matrix and subendothelial space. It is unclear if this is a primary kidney disease or a systemic process. We report a unique case of CG in the setting of long-standing diabetes mellitus(DM) and malignancy.

**Case Description:** An 84-year-old female was referred to Nephrology for AKI. Her medical history was significant for CKD III, Waldenstrom macroglobulinemia(WM), lymphoplasmacytic lymphoma in remission after rituximab/bendamustine therapy, and DM with retinopathy, requiring insulin. She had no family history of kidney disease and an unremarkable physical exam. Labs were significant for creatinine of 1.9 mg/dl from a baseline of 1.3 mg/dl. UPCR was 0.33 mg/mg of creatinine and UACR was 95.3 mg/g of creatinine. Kappa-lambda light chain(LC) ratio was elevated at 4.98. Serum and urine immunofixation revealed IgM kappa monoclonal components. Kidney biopsy showed glomeruli with mesangial expansion and matrix deposition(weakly PAS positive, congo red negative) and diffuse tubular injury. Immunohistochemical stain for collagen type III showed 1+ mesangial staining. Electron microscopy showed mesangial deposits of collagen fibrils with periodicity. Her creatinine improved to baseline over the next 6 months without further therapy.

**Discussion:** Prior CG cases described patients ranging from 2-66 years, typically presenting with nephrotic proteinuria. While some cases have occurred de novo, others have shown association with lymphoma and DM. Our case is unique with advanced age and sub-nephrotic proteinuria. Although she had increasing kappa LCs and DM, there were no overt signs of WM, such as amyloid, or of DM on biopsy. This case raises the potential of CG as another manifestation of kidney involvement in WM.

TH-PO439

**Granulomatosis With Polyangiitis (GPA) Presenting as a Renal Mass in a Young Man With a Solitary Kidney**

Naief N. Abudaff, Sagar Patel, Agnes B. Fogo, Neil S. Sanghani. Vanderbilt University Medical Center, Nashville, TN.

**Introduction:** GPA is a rare autoimmune ANCA-associated vasculitis. GPA has varied extrarenal presentations including fevers, arthralgias, sinusitis, and respiratory failure from diffuse alveolar hemorrhage. In the kidney, it classically presents as RPGN with the quadrad of increased creatinine, microscopic hematuria, proteinuria and hypertension. Here, we describe a rare presentation of GPA with a renal mass.

**Case Description:** A 20M with a solitary left kidney presented due to persistent fevers and AKI. He had a one month history of fevers, arthralgias, nosebleeds, left flank pain, weight loss, and had been treated for presumed UTI. Vital signs were T 101.7F, HR 109 bpm, and BP 148/78mmHg. Urinalysis was positive for heme and albumin without any nitrites with 38 WBCs and 138 RBCs, urine protein/creatinine ratio was 1, creatinine 2.7 mg/dL (from 1.1 mg/dL), CRP 173 mg/L, ESR 140 mm/hr. Renal ultrasound showed a 16.5cm left kidney with a small amount of perinephric fluid and a complex fluid collection, 8.5x7.3x4.9cm, in the left upper pole, concerning for pyelonephritis and abscess. He was treated with IV antibiotics and percutaneous abscess drainage was planned. CT showed an atrophic right kidney with chronic UPJ obstruction and a left upper pole lesion that appeared more mass-like [A]. Biopsy of the mass was performed, revealing extensive necrosis, including vasculitis of arteries [B] and pauci-immune necrotizing crescentic glomerulonephritis [C]. Anti-PR3 was then detected. Urine, blood and tissue cultures returned negative. The patient was diagnosed with GPA and treated with rituximab and prednisone and defervesced. Six months later, creatinine was stable at 1.5 mg/dL from a peak of 3.8 mg/dL

**Discussion:** Renal masses are a rare presentation of GPA. The diagnosis is often made incidentally after partial or radical nephrectomy. This case exemplifies the utility of percutaneous kidney biopsies as a nephron-sparing procedure, particularly useful in patients with reduced nephron mass, and the importance of histopathology in arriving at a diagnosis.

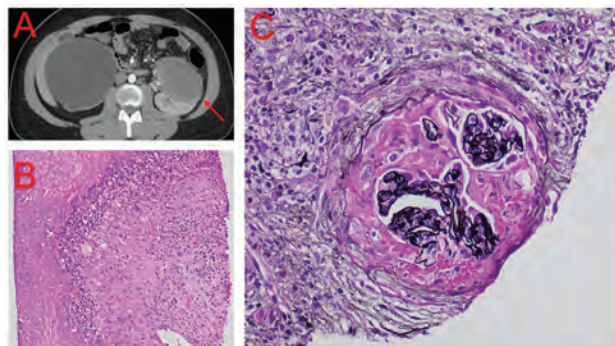

## TH-PO440

Abstract Withdrawn

## TH-PO441

**TNF-Treated Kidney Organoids Recapitulate Poor Outcome Nephrotic Syndrome**

Matthew Fischer,<sup>1</sup> Moritz Lassé,<sup>2</sup> Sean Eddy,<sup>1</sup> Jamal El Saghir,<sup>1</sup> V. Vega-Warner,<sup>1</sup> Matthias Kretzler,<sup>1</sup> Markus M. Rinschen,<sup>3,2</sup> Jennifer L. Harder.<sup>1</sup> <sup>1</sup>University of Michigan Michigan Medicine, Ann Arbor, MI; <sup>2</sup>Universitätsklinikum Hamburg-Eppendorf Zentrum für Innere Medizin, Hamburg, Germany; <sup>3</sup>Aarhus Universitet, Aarhus, Denmark.

**Background:** Nephrotic syndrome (NS) includes heterogeneous rare diseases (i.e. FSGS and MCD) complicating therapeutic development and intervention; individuals with NS could benefit greatly from a precision medicine-based approach. Human pluripotent stem cell derived kidney organoids (hKOs) provide an opportunity to identify pathomechanisms and therapeutics pertinent to subgroups of NS patients. We recently identified 3 subgroups of proteinuric individuals in NEPTUNE (1 with poorer outcomes) based on kidney tissue transcription profiles. Differential gene expression and pathway analysis of the poor outcome subgroup revealed a 272-gene signature of TNF activation, a pattern also seen in TNF-treated hKOs. The aim of this study was to further evaluate alterations induced in TNF-treated hKOs to assess their ability to capture the TNF-associated disease state.

**Methods:** hKOs were treated with TNF up to 48h. hKO lysates and culture media were analyzed for changes in gene and protein expression by a combination of qRT-PCR, ELISA, IF, proteomics, bulk and single cell RNAseq. Genes reflecting the TNF-induced hKO response were then evaluated in the NEPTUNE cohort tissue based bulk and single nuclear RNAseq datasets.

**Results:** Proteomic analysis of hKOs identified 320 peptides differentially expressed by TNF treatment, an overlap of 1.7% with the 272-gene TNF signature. Interrogation of the NEPTUNE cohort subgroups revealed that summary expression of genes encoding this peptide set was significantly increased in the poor outcome subgroup. Further evaluation of proteins secreted in TNF-treated hKO cultures revealed increased C3 and VCAM, both in the original 272-gene TNF signature. Expression of C3 and VCAM1 was higher in kidney tubular cells in NEPTUNE individuals with high TNF activation scores.

**Conclusions:** We discovered a set of peptides from TNF-treated hKOs that captured disease relevant molecular events in poor outcome NS. Further, we found that genes encoding TNF-induced proteins secreted by hKOs were also expressed by tubular cells in individuals with poor outcome NS. Our findings demonstrate the ability of the TNF-treated kidney organoid model to identify pathomechanistic elements relevant to a subset of individuals with nephrotic syndrome and to aid in discovery of non-invasive biomarkers.

**Funding:** Other NIH Support - NCATS

## TH-PO442

**APOL1 Inhibitors Reverse Established Proteinuria in an APOL1-Mediated Kidney Disease Mouse Model**

Angelo Blasio, Kelly E. Sullivan, James J. Mann, Guanyu Wang, Shyamesh Kumar, Franklin Bright, Audrey Bouillez, Kevin Daniel, Suganthini Nanthakumar, Aldo A. Rosario, Monica A. Aragon Mejia, Thomas F. Heighton, Evanthia Nanou, Jennifer Proctor, Brinley Furey, Anne Fortier, Timothy J. Senter, Leslie Dakin, Brandon Zimmerman. *Vertex Pharmaceuticals Incorporated, Boston, MA.*

**Background:** APOL1-mediated kidney disease (AMKD) is a progressive, proteinuric nephropathy caused by gain-of-function variants (*G1* or *G2*) in *APOL1*. There are currently no treatments addressing the underlying cause of AMKD. Our previous data showed that novel small molecule APOL1 inhibitors prevent proteinuria prophylactically in a model of transient AMKD. In a Ph2a trial, the APOL1 small molecule inhibitor inaxaplin (IXP; VX-147) significantly reduced proteinuria in participants with 2 *APOL1* variants, proteinuria, and FSGS. Here we demonstrate that another small molecule APOL1 inhibitor with similar potency to IXP intervenes therapeutically in a novel mouse model of AMKD.

**Methods:** To develop a mouse model of AMKD, we utilized transgenic APOL1 mice homozygous for the *APOL1 G2* mutation ( $G2_{\text{Homo}}$ ). Osmotic pumps were implanted into  $G2_{\text{Homo}}$  and wild-type FVB (control) mice to deliver a continuous infusion of interferon  $\gamma$  (IFNg) or saline.  $G2_{\text{Homo}}$  mice were treated with a small molecule APOL1 inhibitor or vehicle 5 days after IFNg or saline infusion was initiated. Proteinuria and body weight were assessed daily. Kidney sections were evaluated histologically and quantitative image analysis assessed APOL1 expression and nephrin levels in glomeruli.

**Results:** Administration of IFNg in  $G2_{\text{Homo}}$  mice led to a dramatic increase in proteinuria within 5 days and significant loss in body weight. Proteinuria remained stable and elevated for 2 weeks. Treatment with APOL1 inhibitor significantly reduced proteinuria, returning it to baseline within a week, and restored body weight. Modest histological changes and nephrin loss in glomeruli were observed in the vehicle group and absent in the APOL1 inhibitor treatment group. Control mice injected with IFNg and  $G2_{\text{Homo}}$  mice injected with saline did not develop proteinuria or have signs of kidney disease.

**Conclusions:** We demonstrated that APOL1 inhibitors reverse proteinuria after APOL1-mediated damage is initiated and protect against disease progression during constant inflammatory challenge. These data support the results of the Ph2a trial with IXP.

## TH-PO443

**Blocking CHOP-Dependent TXNIP Shuttling to Mitochondria Attenuates Albuminuria and Mitigates Kidney Injury in Nephrotic Syndrome**

Sun-Ji Park,<sup>1</sup> Yeawon Kim,<sup>1</sup> Chuang Li,<sup>1</sup> Junwoo Suh,<sup>2</sup> Jothilingam Sivapackiam,<sup>1</sup> Tássia Mangetti Gonçalves,<sup>1</sup> George Jarad,<sup>1</sup> Guoyan Zhao,<sup>1</sup> Fumihiko Urano,<sup>1</sup> Vijay Sharma,<sup>1</sup> Ying M. Chen.<sup>1</sup> <sup>1</sup>Washington University in St Louis, St Louis, MO; <sup>2</sup>Case Western Reserve University, Cleveland, OH.

**Background:** Albuminuria, a defining feature of glomerular disease, also leads to glomerulosclerosis and interstitial fibrosis. The molecular mechanism underlying albuminuria-induced kidney injury remains poorly understood.

**Methods:** We utilized hereditary nephrotic syndrome (NS) (*Lamb2*<sup>-/-</sup> mice) and adriamycin-induced NS models, *Chop*<sup>-/-</sup> and *Txnip*<sup>-/-</sup> mice to investigate the regulation and function of TXNIP (thioredoxin-interacting protein). Glomeruli and tubule isolation, primary podocyte and tubular cell culturing, mitochondrial and nuclear fractionation, as well as confocal and electron microscopy were employed. Mitochondrial reactive oxygen species (ROS) levels were assessed by flow cytometry in cells and by <sup>68</sup>Ga-Galuninox PET/CT imaging in live animals for the first time.

**Results:** we have identified CHOP (C/EBP homologous protein)-TXNIP as critical molecular linkers between albuminuria-induced endoplasmic reticulum (ER) dysfunction and mitochondria dyshomeostasis. TXNIP is a ubiquitously expressed redox protein that binds to and inhibits antioxidant enzyme, cytosolic thioredoxin 1 (Trx1) and mitochondrial Trx2. However, little is known about the regulation and function of TXNIP in NS. *TXNIP* gene expression correlates with disease severity and decline of kidney function in human proteinuric kidney disease based on Nephroseq database. We demonstrate that CHOP upregulation induced by albuminuria drives TXNIP induction in both podocytes and tubules, as well as TXNIP shuttling from nucleus to mitochondria, where it is required for mitochondrial ROS production. The increased ROS accumulation in mitochondria oxidizes Trx2, thus liberating TXNIP to associate with mitochondrial NLRP3 to activate inflammasome, as well as releasing mitochondrial apoptosis signal-regulating kinase 1 (ASK1) to induce mitochondria-dependent apoptosis. Importantly, inhibition of TXNIP translocation and mitochondrial ROS overproduction by CHOP deletion suppresses NLRP3 inflammasome activation and p-ASK1-dependent mitochondria apoptosis, thereby improving kidney function in NS.

**Conclusions:** NS is a leading cause of chronic kidney disease affecting 500 million people worldwide. Targeting TXNIP represents a promising therapeutic strategy for the treatment of NS.

**Funding:** NIDDK Support, Other NIH Support - NIBIB and NHLBI, Other U.S. Government Support, Commercial Support - Mallinckrodt Pharmaceutical

TH-PO444

**UPARANT Succinate and N19004 Preserve Podocyte Injury by Adriamycin and Focal Segmental Glomerulosclerosis Sera: Drug Screening by an In Vitro Model of Glomerular Filtration Barrier**

Deborah Mattinzoli,<sup>1</sup> Silvia Armelloni,<sup>1</sup> Min Li,<sup>1</sup> Masami Ikehata,<sup>1</sup> Carlo Alfieri,<sup>1,2</sup> Giuseppe. Castellano.<sup>1,2</sup> <sup>1</sup>Fondazione IRCCS Ca' Granda Ospedale Maggiore Policlinico, Milan, Italy; <sup>2</sup>Università degli Studi di Milano, Milano, Italy.

**Background:** Idiopathic focal segmental glomerular sclerosis (FSGS) accounts for up to 25-40 % of nephrotic syndrome with a frequent post-transplant recurrence due to a circulating permeability factor causing glomerular filtration impairment. In FSGS, an elevated level of soluble urokinase-type plasminogen activator receptor (suPAR) is implicated in podocytes' (PODO) alteration. We investigated the potential role of uPAR receptor inhibitors UPARANT succinate (US) and N19004 in preserving PODO structure and function.

**Methods:** Both UPARANT inhibitors were tested on ADRIA and FSGS-PODO injury models investigating the actin dynamic by IF actin and cofilin (CFL1) quantification. PODO differentiation and adhesion capacity were assessed by Wilms tumor 1 transcription factor (WT1), Integrin (ITG3), Nephhrin (NPHS1) mRNA and protein expression. The functional barrier filtration capacity was assessed by a three-dimensional PODO-endothelial cell co-culture system.

**Results:** US and N19004 significantly protected PODO cytoskeleton with a well-orderly actin-filament and a foot processes effacement recovery after ADRIA-induced damage (vs ADRIA p=0.007, p<0.0001). Moreover, US or N19004 inhibited the ADRIA-induced actin-binding CFL1 phosphorylation (vs ADRIA p<0.0001 for both) already at 10nM. The activation of WT1, transcription factors of major PODO functional molecules such as ITG3 and NPHS1, was assessed. In addition, we found a NPHS1 perinuclear and cell processes distribution restoration upon drug treatment. Finally, uPAR receptor inhibitors recovered the functional barrier filtration capacity by the PODO-ENDO co-culture system upon activation by 3 FSGS sera patients. In the ADRIA-model only for N19004 at 100nM the recovery appears (vs CTRL p=0.02), conversely in the FSGS-model both US (vs CTRL p<0.05) and N19004 (vs CTRL p<0.02) improved the filtration functionality.

**Conclusions:** In conclusion, both drugs initiate a regain of the PODO plasticity and functionality, strongly encouraging future in-depth studies.

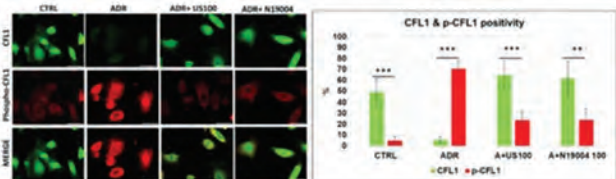

TH-PO445

**SH3BP2-Mediated Immune Activation in Idiopathic Nephrotic Syndrome (NS)**

Tarak Srivastava,<sup>1,4</sup> Trupti Joshi,<sup>3</sup> Wei Hao,<sup>2</sup> Yujie Wang,<sup>2</sup> Debbie Gipson,<sup>2</sup> Laura H. Mariani,<sup>2</sup> Mukut Sharma.<sup>4</sup> <sup>1</sup>Children's Mercy Hospitals and Clinics, Kansas City, MO; <sup>2</sup>University of Michigan, Ann Arbor, MI; <sup>3</sup>University of Missouri, Columbia, MO; <sup>4</sup>Kansas City VA Medical Center, Kansas City, MO.

**Background:** Immunopathogenesis of NS in minimal change disease (MCD) and focal segmental glomerulosclerosis (FSGS) remains largely unknown. SH3BP2, an adaptor protein, forms a signaling complex (signalosome) with Src, Syk, etc. to integrate immune signaling pathways involved in activation of T-, B-cells, MΦ, etc. Significance of the SH3BP2 signaling in NS-associated immune activation is not known.

**Methods:** RNA sequencing data from glomerular compartment of biopsy proven MCD or FSGS (NEPTUNE consortium) were analyzed to generate a Z-score for each gene for each patient. Individual gene Z-scores in the SH3BP2 signalosome were averaged to calculate the composite SH3BP2 Signalosome Score. IMPRes algorithm was used to visualize potential pathways for SH3BP2 gene. Clinical parameters from these subjects were used for statistical analysis to investigate outcome.

**Results:** Table shows significantly increased Z-score for the total SH3BP2 Signalosome Score in MCD (p=0.004) and in FSGS (p<0.001) compared to Control. SH3BP2 signalosome genes SH3BP2, VAV1, VAV2 and YWHAB were significantly increased in both MCD and FSGS. PLCG2 and YWHAG were also increased in FSGS. Downstream genes NFATc1 and MyD88 important in Sh3bp2-mediated signaling were also significantly upregulated in MCD and FSGS. IMPRes algorithm analysis suggests that SH3BP2 binds to PLCG2 and VAV2 for downstream signaling (Figure). SH3BP2 Signalosome Score was comparable between adults and children, and not associated with ESKD composite, ESKD and Remission.

**Conclusions:** SH3BP2 signaling complex is upregulated in biopsy from MCD and FSGS patients. SH3BP2-mediated immune activation needs comprehensive study using available mouse models with loss or gain of SH3BP2 function.

**Funding:** NIDDK Support, Private Foundation Support

Table: Table shows the Z-scores for the SH3BP2 Signalosome Score and individual genes in Control, minimal change disease (MCD) and focal segmental glomerulosclerosis (FSGS).

Glomerular Sequencing Data	CONTROL (n=8) Mean ± SD	MCD (n=89) Mean ± SD	p-value MCD vs Control	FSGS (n=93) Mean ± SD	p-value FSGS vs Control	p-value MCD vs FSGS
SH3BP2 Signalosome Score	-0.41 ± 0.21	-0.04 ± 0.27	0.004	0.08 ± 0.33	<0.001	0.020
<b>Genes for SH3BP2 and its known binding proteins which form the composite SH3BP2 Signalosome Score</b>						
SH3BP2	3.84 ± 0.67	4.45 ± 0.41	0.001	4.56 ± 0.43	<0.001	0.184
SRC	2.83 ± 0.37	3.08 ± 0.66	0.558	3.22 ± 0.67	0.255	0.360
LYN	3.45 ± 0.84	3.92 ± 1.10	0.422	4.33 ± 0.97	0.054	0.023
FYN	7.47 ± 0.76	6.69 ± 0.93	0.067	6.65 ± 0.95	0.051	0.959
SYK	3.92 ± 0.63	4.04 ± 0.64	0.471	4.40 ± 0.73	0.135	0.002
VAV1	0.19 ± 0.14	1.01 ± 0.70	0.006	1.33 ± 0.74	<0.001	0.006
VAV2	4.81 ± 0.38	5.44 ± 0.42	<0.001	5.31 ± 0.55	<0.001	0.152
VAV3	5.72 ± 0.75	5.17 ± 0.89	0.989	4.72 ± 0.93	0.203	0.023
LAT	0.05 ± 0.06	0.03 ± 0.04	0.772	0.05 ± 0.10	0.971	0.061
PLCG1	3.79 ± 0.30	4.02 ± 0.65	0.649	4.06 ± 0.80	0.561	0.938
PLCG2	7.72 ± 0.43	6.87 ± 1.37	0.166	6.48 ± 1.21	0.024	0.104
YWHAB	8.37 ± 0.27	8.97 ± 0.22	<0.001	9.03 ± 0.25	<0.001	0.218
YWHAE	9.04 ± 0.17	8.95 ± 0.19	0.411	8.94 ± 0.20	0.290	0.836
YWHAG	3.98 ± 0.55	4.37 ± 0.49	0.083	4.53 ± 0.51	0.009	0.106
YWHAH	6.99 ± 0.85	6.70 ± 1.27	0.792	7.04 ± 1.18	0.994	0.150
YWHAQ	9.25 ± 0.14	9.34 ± 0.25	0.701	9.31 ± 0.33	0.850	0.792
YWHAZ	9.74 ± 0.23	9.77 ± 0.33	0.956	9.82 ± 0.35	0.810	0.688
SFN	0.06 ± 0.06	0.13 ± 0.20	0.861	0.25 ± 0.44	0.279	0.035
<b>Genes for downstream proteins recruited by the SH3BP2 Signalosome</b>						
NFATC1	3.12 ± 0.33	4.43 ± 0.89	<0.001	4.48 ± 0.84	<0.001	0.922
MyD88	5.73 ± 0.31	6.46 ± 0.32	<0.001	6.56 ± 0.46	<0.001	0.187

TABLE

Figure: Left: Box-plot to compare SH3BP2 Signalosome Score Z-scores in the glomerular transcriptome dataset from Control, minimal change disease (MCD) and focal segmental glomerulosclerosis (FSGS). Right: Results of analysis using IMPRes algorithm to visualize the interaction of SH3BP2 gene with genes in the glomerular transcriptome. SH3BP2 recruits VAV2 and PLCG2 followed by changes in multiple genes downstream.

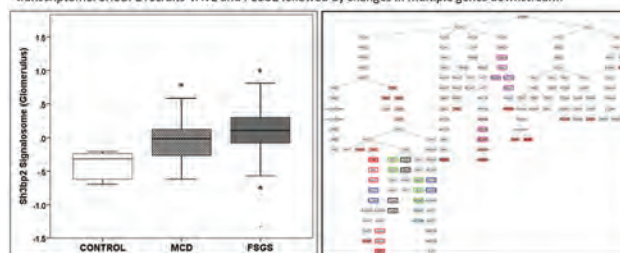

FIGURE

TH-PO446

**Proteomic Identification of Urine Biomarkers of Pediatric Nephrotic Syndrome**

Timothy Cummins,<sup>1</sup> Michael Merchant,<sup>1</sup> Daniel W. Wilkey,<sup>1</sup> Saeed A. Jortani,<sup>1</sup> Madhavi J. Rane,<sup>1</sup> Laura H. Mariani,<sup>2</sup> Julie Dougherty,<sup>3</sup> Yu Kamigaki,<sup>3</sup> Wimal Pathmasiri,<sup>4</sup> Susan Mcritchie,<sup>4</sup> Susan J. Sumner,<sup>4</sup> William E. Smoyer,<sup>3</sup> Jon B. Klein.<sup>1,5</sup> <sup>1</sup>University of Louisville, Louisville, KY; <sup>2</sup>University of Michigan, Ann Arbor, MI; <sup>3</sup>Nationwide Children's Hospital, Columbus, OH; <sup>4</sup>University of North Carolina System, Chapel Hill, NC; <sup>5</sup>Robley Rex VA Medical Center, Louisville, KY.

**Background:** The molecular pathophysiology of nephrotic syndrome (NS) remains unclear for the majority of children. While most children with minimal change disease (MCD) have a good response to glucocorticoid (GC) therapy, those with focal segmental glomerulosclerosis (FSGS) often respond poorly, with either no remission or only partial remission of proteinuria. Development of glomerular disease biomarkers that reliably predict response to treatment and/or define molecular pathways regulating treatment responsiveness vs. resistance could greatly improve outcomes in pediatric NS. We hypothesized that comparison of urine proteomes in children with MCD vs. FSGS could identify urinary biomarkers able to distinguish disease activity and molecular pathways regulating these differences.

**Methods:** We performed quantitative proteomic analyses of sequential urine samples from children with biopsy-proven MCD and FSGS enrolled in the CureGN Consortium to identify and compare putative mechanistic differences between disease activity and remission in FSGS and MCD. We analyzed 216 patient urine specimens by 2D-LC-MS/MS and identified 1,100 unique proteins using MaxQuant and Scaffold-5 Q+, applying strict FDR (1%) with 2-peptide identification required. Proteomics data were analyzed using MetaboAnalyst 5.0 to conduct univariate and multivariate statistical analyses to identify candidate urine biomarkers of disease activity vs. remission in FSGS and MCD.

**Results:** Urine proteome profiles in children with partial remission (UPCR 0.3-1.5) in both FSGS and MCD were nearly indistinguishable from the active (UPCR 1.5-3.5) or nephrotic (UPCR >3.5) states. Notably, proteomic profiles in complete remission (UPCR<0.3) were clearly distinct from all other levels of disease activity for both FSGS and MCD. Additionally, urinary ORM1 and C3 levels were significantly elevated in the nephrotic state vs. complete remission, with proteomic findings confirmed on subsequent immunoassays.

**Conclusions:** These findings suggest urinary ORM1 and C3 are candidate biomarkers of disease activity in childhood nephrotic syndrome, which may also have mechanistic implications for disease progression or treatment resistance.

**Funding:** NIDDK Support

## TH-PO447

## Metabolomics Provides Insights Into Remission of Pediatric Nephrotic Syndrome During Treatment

Susan Mcritchie,<sup>1</sup> Wimal Pathmasiri,<sup>1</sup> Laura H. Mariani,<sup>2</sup> Timothy Cummins,<sup>3</sup> Michael Merchant,<sup>3</sup> Saeed A. Jortani,<sup>4</sup> Julie Dougherty,<sup>5</sup> Yu Kamigaki,<sup>5</sup> Jon B. Klein,<sup>3,6</sup> William E. Smoyer,<sup>5,7</sup> Susan J. Sumner.<sup>1</sup> <sup>1</sup>The University of North Carolina at Chapel Hill Nutrition Research Institute, Kannapolis, NC; <sup>2</sup>University of Michigan, Ann Arbor, MI; <sup>3</sup>University of Louisville School of Medicine, Louisville, KY; <sup>4</sup>University of Louisville, Louisville, KY; <sup>5</sup>Nationwide Children's Hospital, Columbus, OH; <sup>6</sup>VA Robley Rex Medical Center, Louisville, KY; <sup>7</sup>The Ohio State University, Columbus, OH.

**Background:** Children diagnosed with focal segmental glomerulosclerosis (FSGS) or minimal change disease (MCD) vary in response to therapy and risk of relapse. Those with persistent proteinuria and/or frequent relapses have the highest risk of disease progression, but little is known about the mechanism of kidney damage in these forms of nephrotic syndrome. Metabolomics studies the changes in downstream metabolites in biological pathways and enables capturing perturbations in metabolic pathways that can provide insights into mechanisms underlying disease pathophysiology and response to treatment. Developing non-invasive biomarkers to predict and/or define mechanisms of response to treatment is an urgent need for glomerular disease. Thus, we sought to identify perturbed biological pathways in pediatric patients with MCD or FSGS to understand the underlying mechanisms in nephrotic proteinuria (NP; UPCr>3.5) vs. complete remission (CR; UPCr<0.3).

**Methods:** Urine specimens obtained from pediatric patients enrolled in the prospective CureGN Study with biopsy-confirmed MCD or FSGS were analyzed with <sup>1</sup>H NMR metabolomics. 147 urine samples from those in CR or with NP were used as a discovery set. A second cohort of 112 similarly categorized samples acted as a replication set. Binned NMR data were analyzed using multivariate analyses, hypothesis testing, and logistic regression. NMR bins were library-matched to metabolites and those that were important to differentiating CR and NP in both data sets were used for pathway enrichment analyses.

**Results:** Metabolomics analysis could clearly differentiate CR from NP in patients with MCD or FSGS. Aminoacyl t-RNA biosynthesis, pathways related to immune responses, and amino acid metabolism were among the top enriched pathways in the remission state compared to those with NP.

**Conclusions:** Metabolomics can clearly differentiate pediatric patients with biopsy-confirmed MCD and/or FSGS with nephrotic proteinuria vs. complete remission. Metabolic perturbations in the identified pathways warrant further investigation using targeted metabolomics to develop non-invasive predictive biomarkers towards identifying potential novel therapeutic targets in patients with nephrotic syndrome.

**Funding:** NIDDK Support

## TH-PO448

## Patient-Specific Multi-Omic Analysis of Plasma Proteomics and Metabolomics of Steroid Resistance in Childhood Nephrotic Syndrome

Sagar Bhayana,<sup>1</sup> Yue Zhao,<sup>1</sup> Michael Merchant,<sup>4</sup> Timothy Cummins,<sup>4</sup> Julie Dougherty,<sup>2</sup> Yu Kamigaki,<sup>2</sup> Wimal Pathmasiri,<sup>5</sup> Susan Mcritchie,<sup>5</sup> Laura H. Mariani,<sup>6</sup> Susan J. Sumner,<sup>5</sup> Jon B. Klein,<sup>4</sup> William E. Smoyer.<sup>2</sup> <sup>1</sup>Novo Nordisk AS, Bagsvaerd, Denmark; <sup>2</sup>Nationwide Children's Hospital, Columbus, OH; <sup>3</sup>The Ohio State University, Columbus, OH; <sup>4</sup>University of Louisville, Louisville, KY; <sup>5</sup>University of North Carolina System, Chapel Hill, NC; <sup>6</sup>University of Michigan, Ann Arbor, MI.

**Background:** Nephrotic syndrome (NS) is a clinical syndrome defined by massive proteinuria. Glucocorticoid (GC) therapy is the mainstay therapy for inducing remission, but 20-30% of children present with or develop GC resistance. Unfortunately, we lack both effective treatments for steroid resistant NS (SRNS) and clinically validated biomarkers to predict SRNS vs. steroid sensitive NS (SSNS) at presentation. To bridge this gap, we performed a patient-specific integrated analysis of published plasma proteomics and metabolomics data from children with SRNS and SSNS.

**Methods:** Proteomic LC-MS/MS and metabolomic NMR data from 15 paired (pre- and post-GC treated) NS plasma samples (n=7 SSNS; n=8 SRNS) underwent joint pathway analyses using MetaboAnalystR v3.0. The Log<sub>2</sub> fold change (LFC) was calculated as the ratio of post- to pre-GC-treatment. Proteins with LFC<-10 or >10 and metabolites with LFC<-1 or >1 were included. An enrichment index was calculated by: [(#SRNS w/ pathway activated/ Total #SRNS)-(#SSNS w/ pathway activated/ Total #SSNS)]x100%.

**Results:** Hypergeometric analyses identified 34 pathways ( $P<0.005$ ) that were enriched in post- vs pre-GC-treated SRNS and/or SSNS patients. Using  $\pm 25\%$  cut-off as an enrichment index, 12 of 34 pathways were enriched in SRNS and/or SSNS patients, narrowed to 5 pathways with enrichment in at least 3 patients within either group. Nicotinate/ Nicotinamide pathway & Butanoate metabolism were frequently enriched in SRNS patients, whereas Lysine metabolism, Mucin type O-glycan biosynthesis, & Glycolysis/ Gluconeogenesis were frequently enriched in SSNS patients. In-depth pathway network analyses performed in each patient indicated NAMPT, NMNAT1, NT5C2, SETMAR and 3-hydroxybutyrate as more frequently upregulated in SRNS patients, while ALDH1B1, ACAT1, AASS, ENPP1 and Pyruvate were more frequently upregulated in SSNS patients. Subsequent immunoblotting of the same plasma samples validated significant upregulations of NAMPT in SRNS and ALDH1B1/ACAT1 in SSNS.

**Conclusions:** These findings demonstrate the ability of patient-specific integration of omics data to distinguish pathway alterations in SRNS vs. SSNS, and highlight potentially distinct perturbations in energy metabolism between these groups.

**Funding:** NIDDK Support

## TH-PO449

## Immunological Profile in Nephrotic Patients With Minimal Change Nephrotic Syndrome Is Distinct From Focal Segmental Glomerulosclerosis

Chang-Yien Chan,<sup>1,2</sup> Liangjian Lu,<sup>2</sup> Sharon Teo,<sup>2</sup> Kong Peng Lam,<sup>3</sup> Kar Hui Ng,<sup>1,2</sup> Hui Kim Yap.<sup>1,2</sup> <sup>1</sup>Department of Paediatrics, Yong Loo Lin School of Medicine, National University of Singapore, Singapore, Singapore; <sup>2</sup>Kho Teck Puat-National University Children's Medical Institute, National University Health System, Singapore, Singapore; <sup>3</sup>Bioprocessing Technology Institute, Agency for Science, Technology and Research (A\*STAR), Singapore, Singapore.

**Background:** We have previously shown that immunological subtypes in patients with childhood-onset idiopathic nephrotic syndrome (INS) in relapse were different between focal segmental glomerulosclerosis (FSGS) and minimal change nephrotic syndrome (MCNS), where a subgroup of FSGS patients demonstrated T-cell downregulation of stimulated CD154 and IFN $\gamma$ . This study aimed to determine if the immunological profiles are indeed distinct in FSGS and MCNS by further characterizing the T-cell transcription regulator gene expression and phenotype.

**Methods:** A total of 38 patients with childhood-onset INS in relapse consisting of 21 MCNS (median age 14 years, range 2-35 years) and 17 FSGS (median age 13 years, range 4-25 years) and 8 healthy controls (median age 19 years, range 4-27 years) were recruited. Gene expression of T-cell transcription regulators were performed on purified stimulated CD4 T-cell using real-time PCR. Lymphocyte subset (T-cell exhaustion marker (PD1), T-cell subsets: memory (CD45RA, CCR7), naive (CD45RO, CD62L), follicular helper (CXCR5, CD127), Treg (FoxP3, CTLA-4) and invariant NKT (TCR  $\alpha 24$ -Ja18) staining was performed by the lysed whole blood method. Statistical analysis was done using Mann-Whitney U tests.

**Results:** Gene expression of Th2 (*GATA3*) and Th17 (*RORGT* and *RORC*) transcription factors were significantly upregulated in relapse MCNS compared to relapse FSGS (Table 1). Moreover, gene expression of *NFATC2*, transcription factor regulating ROR $\gamma$ t transcription through RORC, was also significantly increased in relapse MCNS. Gene expression of *MAF* and *CMIP* (C-Maf-inducing protein) were significantly higher in relapse MCNS compared to healthy controls. Phenotype analysis showed that relapse FSGS had significant upregulation of Tfh cells (CXCR5) (18.0% $\pm$ 1.0%) compared to relapse MCNS (14.0% $\pm$ 1.1%) ( $P=0.005$ ) and controls (11.5% $\pm$ 0.5%) ( $P<0.001$ ).

**Conclusions:** We have demonstrated distinct T-cell profiles between relapse MCNS characterized by Th2 and Th17 phenotypes, and relapse FSGS characterized by Tfh phenotype.

**Funding:** Government Support - Non-U.S.

Table 1: Transcription regulator gene expression in stimulated CD4 T-cells in INS patients MCNS and FSGS in relapse (RL) and healthy controls (C).

Gene	MCNS RL	FSGS RL	Controls	P value	
				MCNS vs FSGS	MCNS vs C
<i>GATA3</i>	0.17 $\pm$ 0.017	0.12 $\pm$ 0.015	0.13 $\pm$ 0.017	<b>0.054</b>	0.078
<i>MAF</i>	0.027 $\pm$ 0.0041	0.018 $\pm$ 0.0040	0.015 $\pm$ 0.0038	0.067	<b>0.054</b>
<i>CMIP</i>	0.017 $\pm$ 0.0012	0.014 $\pm$ 0.0019	0.013 $\pm$ 0.0014	0.055	<b>0.037</b>
<i>RORGT</i>	0.012 $\pm$ 0.0019	0.007 $\pm$ 0.0015	0.007 $\pm$ 0.0016	<b>0.032</b>	0.080
<i>RORC</i>	0.00018 $\pm$ 0.00002	0.00012 $\pm$ 0.00002	0.00014 $\pm$ 0.00003	<b>0.032</b>	0.16
<i>NFATC2</i>	0.014 $\pm$ 0.0011	0.010 $\pm$ 0.0012	0.011 $\pm$ 0.0015	<b>0.016</b>	0.073

Results are expressed as mean $\pm$ SEM.

## TH-PO450

## Differences in Peripheral Blood Cell DNA Methylation Between Nephrotic Syndrome Subgroups

Samantha J. Hayward,<sup>1,2</sup> Agnieszka Bierzynska,<sup>1</sup> Gavin I. Welsh,<sup>1</sup> Matthew Suderman,<sup>3</sup> Moin Saleem.<sup>1</sup> Bristol Renal <sup>1</sup>University of Bristol Translational Health Sciences, Bristol, United Kingdom; <sup>2</sup>Southmead Hospital, Bristol, United Kingdom; <sup>3</sup>MRC Integrative Epidemiology Unit, Bristol, United Kingdom.

**Background:** Genetic and observational research suggest that at least 4 mechanistically different subgroups of paediatric nephrotic syndrome (NS) exist: genetic steroid resistant NS (SRNS), non-genetic SRNS, steroid sensitive NS (SSNS) and circulating factor disease (CFD). We explored differences in DNA methylation (DNAm), an epigenetic mechanism, between the 4 different NS subgroups.

**Methods:** 322 patients were selected from the NephroS-NURTURE NS cohort. All patients were diagnosed with NS  $\leq 30$  years of age. Patients were split *a priori* into the 4 NS subgroups based upon their genetic and clinical data. Peripheral blood cell DNAm values were generated using the Illumina EPIC array ( $>850,000$  CpG sites). Generalised linear models were used to assess differences in DNAm between the NS subgroups at each individual CpG site. Differentially methylated regions (DMRs) were assessed using the dmrff R package. All analyses were adjusted for cell type proportions, age and sex. Sex chromosomes were excluded from the analyses. A Bonferroni adjusted p value of  $5.88 \times 10^{-8}$  was used as a significance threshold.

**Results:** Differing DNAm was identified at 7 individual CpG sites and 1 DMR (p values <5.88 x 10<sup>-7</sup>) between the NS subgroups. Only 1 of these CpG sites reached our significance threshold (Figure 1, p=1.88x10<sup>-8</sup>); differing DNAm at this site was detected between patients with non-genetic SRNS and genetic SRNS. This CpG is found in the transcriptional start site of a transcribed pseudogene, which has plausible biological links to kidney disease.

**Conclusions:** We have identified a shortlist of interesting sites of differing DNAm between the 4 NS subgroups. Further work, utilising machine learning approaches, to reveal DNAm-based signatures that discriminate between NS subgroups is underway.

**Figure 1. Differences in DNAm between the genetic SRNS and non-genetic SRNS groups**

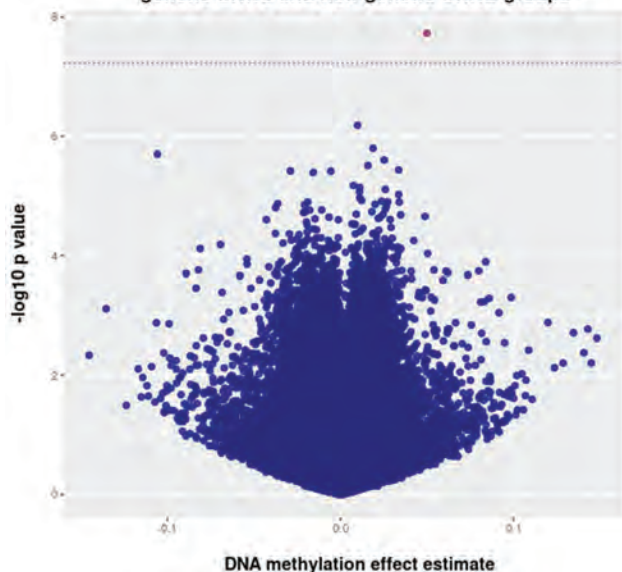

**TH-PO451**

**Childhood Membranous Nephropathy: A Histopathologic Analysis of 118 Cases**  
 Tiffany Caza, Christopher P. Larsen. *Arkana Laboratories, Little Rock, AR.*

**Background:** Membranous nephropathy (MN) is a rare etiology of nephrotic syndrome in children, accounting for less than 5% of renal biopsies. Unlike MN in adults, where the majority of cases are positive for phospholipase A2 receptor (PLA2R), PLA2R positivity is less frequent and the antigen is unknown in a greater proportion of cases. We present the largest case series of pediatric MN to date with a total of 118 patients.

**Methods:** Cases of MN diagnosed in individuals ≤18 years of age were identified from a biopsy database. Light, immunofluorescence, and electron microscopy findings were reviewed. Antigenic subtyping was performed through immunostaining for phospholipase A2 receptor (PLA2R), thrombospondin type 1-domain containing 7A (THSD7A), exostosin 1/2 (EXT), neural epidermal growth factor-like 1 (NELL1), and semaphorin 3B (SEMA3B).

**Results:** A total of 118 cases of pediatric MN were identified over a 16-year period (2006-2022). The mean age of patients was 14.7 ± 2.6 years and included 47 males and 71 females. The majority of cases did not show significant chronicity, with a mean global glomerulosclerosis of 4.3 ± 10.0% and moderate or severe interstitial fibrosis in only 5.1%. Immunofluorescence studies showed 31.4% with IgA deposits, 100% IgG, 30.5% IgM, 78.8% C3, and 15.3% C1q. Mesangial deposits were seen in 62.7% and tubular basement membrane deposits in 9.3% of cases. Antigen types included 34.7% PLA2R, 0.8% THSD7A, 23.7% EXT1/2, 3.4% NELL1, 5.0% SEMA3B, and 32.2% of unknown antigen type.

**Conclusions:** Pediatric MN has a female predominance, often is without significant chronic injury, and has a high frequency of cases of unknown antigen type. There is a higher proportion of EXT1/2-positive cases than reported in adults.

**Funding:** NIDDK Support

**TH-PO452**

**Minor Antigens in Membranous Nephropathy Identified by Mass Spectrometry**

Tiffany Caza,<sup>1</sup> Samar Hassen,<sup>1</sup> Christian Herzog,<sup>2</sup> Aaron J. Storey,<sup>2</sup> Ricky Edmondson,<sup>2</sup> John M. Arthur,<sup>2</sup> Daniel J. Kenan,<sup>1</sup> Christopher P. Larsen.<sup>1</sup>  
<sup>1</sup>Arkana Laboratories, Little Rock, AR; <sup>2</sup>University of Arkansas for Medical Sciences, Little Rock, AR.

**Background:** Multiple autoantigens have been identified in membranous nephropathy (MN) by tissue-based proteomics. However, the antigenic targets of disease are unknown for >10% of MN and >50% of cases of membranous lupus nephritis. We identified multiple new targets in PLA2R-/THSD7A-/EXT-/NELL1-quadrate negative MN biopsies through mass spectrometry (MS) of immune complexes recovered from biopsy tissue of patients with MN.

**Methods:** MN cases negative for PLA2R, THSD7A, EXT1/2, and NELL1 were identified from a biopsy database. Protein G immunoprecipitation was used to recover immune complexes from frozen kidney biopsy tissue, followed by interrogation by mass spectrometry (MS). Potential antigens were confirmed through paraffin immunofluorescence of protein targets, followed by co-localization of the candidate protein with IgG within immune deposits. A consecutive series of 81 PLA2R-negative MN biopsies was screened to determine the frequency for each of the protein targets in MN.

**Results:** Seven novel antigenic targets were identified within isolated immune complexes from MN biopsies by MS, including FCN3, CD206, EEA1, SEZ6L1, NPR3, MSP1, and VASN. Peptides from these proteins were not enriched in PLA2R (n=47), THSD7A (n=49), NELL1 (n=54), or EXT1/2 (n=51) control cases. Between 3-30 unique peptides were detected for each novel antigen. Separate from the index cases, a series of 81 PLA2R-negative MN cases were screened for each antigen by paraffin immunofluorescence. Frequencies were FCN3 (1/81), CD206 (1/81), EEA1 (5/81), SEZ6L1 (1/81), MSP1 (2/81), and VASN (7/81). No additional cases of NPR3 were identified in screening (likely <1% of cases). All cases showed co-localization of IgG within glomerular immune deposits.

**Conclusions:** Seven novel protein targets were identified in MN, each having a low frequency of overall cases. Further work is required to examine for circulating antibodies and to determine whether unique histopathologic characteristics or disease associations exist.

**Funding:** NIDDK Support

**TH-PO453**

**Neuron-Derived Neurotrophic Factor (NDNF) Is a Novel Protein Associated With Membranous Nephropathy (MN)**

Sanjeev Sethi,<sup>1</sup> Benjamin J. Madden,<sup>1</sup> Fernando C. Fervenza,<sup>1</sup> Mark Haas.<sup>2</sup>  
<sup>1</sup>Mayo Foundation for Medical Education and Research, Rochester, MN; <sup>2</sup>Cedars-Sinai Medical Center, Los Angeles, CA.

**Background:** Primary MN is commonly associated with antibodies to target antigen PLA2R. The other target antigens in primary MN include THSD7A, NELL1, SEMA3B, HTRA1 and PCDH7. Taken together, these antigens account for approximately 80-90% of primary MN. The target antigen is unknown in the remaining 10-20% primary MN.

**Methods:** We performed laser microdissection of glomeruli followed by mass spectrometry (MS) in 250 cases of PLA2R-negative MN to identify novel antigenic targets in MN. This was followed by immunohistochemistry (IHC) to localize the target antigen along the glomerular basement membrane (GBM). Western blot analyses were performed to detect antibodies to novel antigen using serum/IgG eluate of frozen biopsy tissue.

**Results:** MS studies revealed high total spectral counts (average 29.6, range 19-36) of a novel protein Neuron-derived neurotrophic factor (NDNF) in 3 (1.6%) of the 250 cases (Fig 1). All cases were negative for known antigens including PLA2R, THSD7A, EXT1/EXT2, NELL1, SEMA3B, PCDH7, FAT1, CNTN1 and NCAM1. The median age was 53 years (range 30-73), serum creatinine 3.1 mg/dL (1.4-10), proteinuria 9.7 gms/day (3.1-11) at presentation. One patient had history of HIV and NSAID use, with the biopsy showing acute interstitial nephritis in addition to MN. All cases showed IgG (2-3+) and C3 (2-3+) along GBM, tubular atrophy and interstitial fibrosis was less than 20%, and EM showed stage I-II in all cases. IHC showed granular staining for NDNF along the GBM (Fig 2), control cases were negative. Western blot studies are ongoing.

**Conclusions:** NDNF is a likely novel antigenic target in primary MN.

Identified Proteins	Accession Number	Molecular Weight	ave of 31	Case1	Case2	Case3
Protein NDNF OS=Homo sapiens OX=9606 GN=NDNF PE=1 SV=2	ip Q8T873 NDNF_HUMAN	65 kDa	0	36	19	34
Secretory phospholipase A2 receptor OS=Homo sapiens OX=9606 GN=PLA2R1 PE=1 SV=2	ip Q13918 PLA2R_HUMAN	369 kDa	3	0	2	2
Immunoglobulin gamma 3 heavy chain OS=Homo sapiens OX=9606 PE=1 SV=2	ip P0DC55 IGG3_HUMAN	49 kDa	34	45	36	52
Immunoglobulin heavy constant gamma 2 OS=Homo sapiens OX=9606 GN=IGHG2 PE=1 SV=2	ip P01859 IGHG2_HUMAN	36 kDa	27	29	27	38
Immunoglobulin heavy constant gamma 3 OS=Homo sapiens OX=9606 GN=IGHG3 PE=1 SV=2	ip P01860 IGHG3_HUMAN	41 kDa	28	42	32	53
Immunoglobulin heavy constant gamma 4 OS=Homo sapiens OX=9606 GN=IGHG4 PE=1 SV=1	ip P01861 IGHG4_HUMAN	36 kDa	34	33	11	16
Complement C3 OS=Homo sapiens OX=9606 GN=C3 PE=1 SV=2	ip P01024 C3_HUMAN	187 kDa	68	145	84	172
Complement C3 OS=Homo sapiens OX=9606 GN=C3 PE=1 SV=4	ip P01021 C3S_HUMAN	188 kDa	4	43	10	51

MS studies show high total spectral counts of novel protein NDNF in 3 cases, IgG with higher counts of IgG1 and IgG3, and C3.

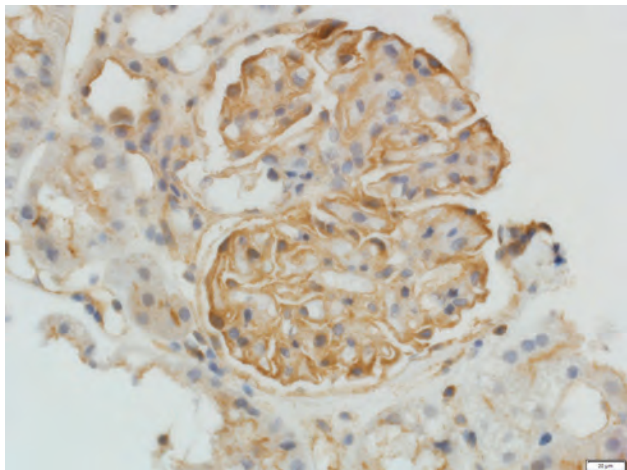

IHC shows granular staining for NDNF along the GBM in a case of NDNF-associated MN.

TH-PO454

**NSAID-Associated Membranous Nephropathy (MN) Is Associated With PCSK6**

Sanjeev Sethi, Marta I. Casal Moura, Benjamin J. Madden, Fernando C. Fervenza. Mayo Foundation for Medical Education and Research, Rochester, MN.

**Background:** Drugs are an important secondary cause of MN. The most common drugs associated with MN are non-steroidal anti-inflammatory drugs (NSAIDs). The target antigen in NSAID-associated MN is not known.

**Methods:** We performed laser microdissection of glomeruli followed by mass spectrometry (MS) in 250 cases of PLA2R-negative MN to identify novel antigenic targets of MN. This was followed by immunohistochemistry to localize the target antigen along the glomerular basement membrane (GBM) and western blot analyses of serum/ eluate of frozen biopsy tissue to detect binding of IgG to the novel antigenic target.

**Results:** MS studies revealed high total spectral counts (average 44.8) of a novel protein Proprotein Convertase Subtilisin/Kexin Type 6 (PCSK 6) in 4 (1.6%) of the 250 cases (Fig 1). The mean age was 55 (± 4.5) years, serum creatinine 0.88 (±0.2) mg/dL, proteinuria 8.0 (± 4.2) gms/day, and serum albumin 1.7 gms/dL (± 0.8) at presentation. No underlying disease association was found in all cases except for heavy NSAID use of >2 years in 3 of the 4 cases that included ibuprofen, naproxen, and meloxicam. In 1 patient, clinical charts were not available. All cases were negative for known antigens including PLA2R, THSD7A, EXT1/EXT2, NELL1, SEMA3B, PCDH7, FAT1, CNTN1 and NCAM1. All cases showed IgG (3+) and C3 (2+) along GBM, tubular atrophy and interstitial fibrosis was less than 10%, and EM showed stage I-II in all cases. Importantly, western blot analyses (Fig 2) using eluate from frozen tissue showed IgG binding to PCSK6 in the NSAID-associated MN (lane 2) but not in PLA2R-positive MN (lane 3).

**Conclusions:** PCSK6 is a likely novel antigenic target in NSAID-associated MN.

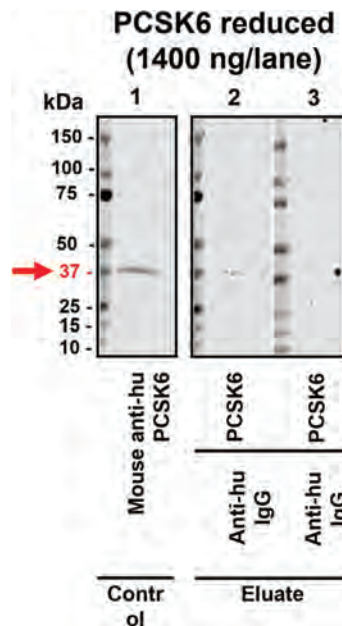

Western blot studies.

TH-PO455

**The Role of Complement in Primary Membranous Nephropathy**

Valentina Bruno,<sup>1,2</sup> Carolina G. Ortiz-Sandoval,<sup>1</sup> Sarah M. Moran,<sup>5</sup> Emily E. Bowen,<sup>1,4</sup> Daniel C. Cattran,<sup>3</sup> Christoph Licht.<sup>1,2</sup> <sup>1</sup>The Hospital for Sick Children, Toronto, ON, Canada; <sup>2</sup>University of Toronto, Toronto, ON, Canada; <sup>3</sup>Toronto General Research Institute, Toronto, ON, Canada; <sup>4</sup>University of Bristol, Bristol, United Kingdom; <sup>5</sup>University College Cork, Cork, Ireland.

**Background:** Primary membranous nephropathy (PMN) is the leading cause of nephrotic syndrome in adults and a common cause of end-stage kidney disease (ESKD). The Heymann's nephritis rat model of PMN shows that proteinuria is complement-mediated. However, the pathogenetic role of complement in human PMN remains unclear. Our preliminary data showed complement deposition on podocytes exposed to serum of PMN patients (from the Toronto GN Registry), leading to disruption of actin cytoskeleton (Figure 1a-b). We aim to demonstrate that complement activation can have both structural and functional effects on podocytes.

**Methods:** An in-vitro model of immortalized human podocytes (from Moin Saleem, Bristol, UK) was used for all the experiments. Cells pre-sensitized with anti-CD59 were exposed to 50% normal human serum (NHS) to obtain complement deposition. Changes in intracellular calcium levels were monitored using a fluorescent dye (Fluo8-AM), acquiring images every 20 seconds (up to 10 minutes) by confocal microscopy. Calcium effects on mitochondrial membrane potential were measured by flow cytometry using tetramethylrhodamine, methyl ester (TMRM) dye. Intracellular adenosine triphosphate (ATP) changes were analyzed by bioluminescence. Wound healing assays were performed to study functional effects on cell migration.

Identified Proteins	Accession Number	Molecular Weight	TSC				
			Case1	Case2	Case3	Case4	Case5
Proprotein convertase subtilisin/kexin type 6 (PCSK6) (PCSK6) (PCSK6) (PCSK6) (PCSK6)	gi 991912 PCSK6_HUMAN	596 kDa	0	20	25	110	18
Secretory phospholipase A2 receptor (OS-Human sapiens) (OS-HUMAN) (OS-HUMAN) (OS-HUMAN) (OS-HUMAN)	gi 121818 PLA2R_HUMAN	169 kDa	3	0	0	3	0
Complement C3 (OS-Human sapiens) (OS-HUMAN) (OS-HUMAN) (OS-HUMAN) (OS-HUMAN)	gi 991912 C3_HUMAN	187 kDa	46	30	115	303	33
Complement C5 (OS-Human sapiens) (OS-HUMAN) (OS-HUMAN) (OS-HUMAN) (OS-HUMAN)	gi 991912 C5_HUMAN	188 kDa	4	3	17	41	0

MS studies.

**Results:** Complement activation led to a significant rise in the intracellular calcium levels. Loss of mitochondrial membrane potential was also observed, together with intracellular ATP decrease, disruption of the actin cytoskeleton and impaired cell migration (Figure 1c-e).

**Conclusions:** Complement is active in PMN, leading to both structural and functional effects on podocytes. Further studies are needed to better understand the consequences on the podocyte energy machinery and the possibility of its reversibility by using complement inhibitors. Our research of such alternate therapy could lead to improvement in outcome in PMN where, despite current therapies, up to one third of patients develops ESKD.

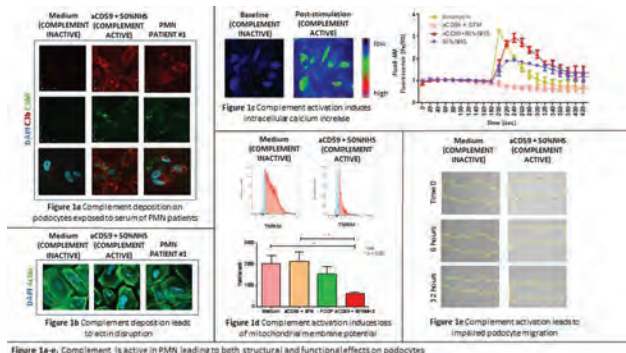

TH-PO456

**A Phase 1b/2a Single Arm Open-Label Study of VB119, an Anti-CD 19 Monoclonal Antibody (Mab), in Active Primary Membranous Nephropathy (PMN): An Interim Report**

Frank B. Cortazar,<sup>1</sup> Jamie P. Dwyer,<sup>3</sup> Stephen B. Thomas,<sup>2</sup> Gregory F. Keenan,<sup>2</sup> <sup>1</sup>New York Nephrology, Vasculitis and Glomerular Center, Albany, NY; <sup>2</sup>ValenzaBio, Inc, Bethesda, MD; <sup>3</sup>University of Utah Health, Salt Lake City, UT.

**Background:** PMN is a common cause of the nephrotic syndrome. Approximately 70% of cases of PMN are caused by autoantibodies directed against the phospholipase A2 receptor (PLA2R), with the remaining cases caused by autoantibodies against other target antigens, some of which are yet to be defined. Current immunosuppressive therapies fail to achieve complete remission in the majority of patients and treatment-related toxicity remains a concern. VB119 is a Mab which targets the CD19 epitope expressed on maturing B-cells- from pro-B-cell through short-lived plasma cells- but notably not on long-lived plasma cells. The broader spectrum of VB119 compared with anti-CD20 Mabs may translate into improved efficacy in the management of autoantibody-mediated diseases, including MN.

**Methods:** Enroll approximately 30 participants with biopsy-proven active PMN as evidenced by > 2 gm/gm UPCR proteinuria on first morning void. Eligible participants will receive VB119 at baseline and 14 days later. Participants with ≥ a 25% improvement in proteinuria at 6 months are eligible to receive a subsequent cycle of VB119. Laboratory monitoring includes B-Cell counts, Anti-PLA2R, proteinuria and pharmacokinetic assessments of VB 119. Safety, tolerability and clinical status will be monitored over 18 months.

**Results:** As of May 2022, 3 participants have been enrolled and administered VB119. One participant has been followed for 18 weeks, he is a 59-yo with a hx of relapsing PLA2R-associated MN with a clinical relapse. He was treated with 100mg of VB119 at day 1 and an additional dose 14 days later. The infusions were well tolerated. The change in assessed laboratory values from baseline to week 18 are shown in the figure. There were no treatment related adverse events.

**Conclusions:** The initial participant treated with VB119 for PMN experienced a reduction in proteinuria and an immunological remission by 18 weeks. All participants receiving VB119 and having observations ≥6 weeks through September 15, 2022 will be reported.

**Funding:** Commercial Support - ValenzaBio, Inc

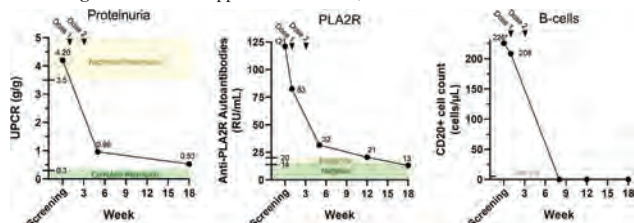

Proteinuria, PLA2R and Total B-cell change over time

TH-PO457

**Relevance of Anti-PLA2R Levels in Therapy Decision and Prediction of Therapy Outcome Using Cyclophosphamide and Steroid Treatment in Patients With Membranous Nephropathy**

Iana Heckler. *EUROIMMUN US Inc, Mountain Lakes, NJ.*

**Background:** Detection of anti-phospholipase A2 receptor (PLA2R) antibodies in patients with primary membranous nephropathy (MN) supports diagnosis as well as disease monitoring. An individualised therapy approach was introduced for anti-PLA2R positive MN patients at the Radboud University Medical Center. Immunosuppressive treatment (cyclophosphamide combined with steroids) was stopped when anti-PLA2R results by indirect immunofluorescence testing (IIFT) became negative. Here, we evaluated the relevance of anti-PLA2R levels for therapeutic decisions and the outcome of MN, comparing qualitative and quantitative detection methods.

**Methods:** Stored serum samples were retrieved for beginning of treatment (baseline), decision point, and follow-up. Anti-PLA2R levels were determined qualitatively by IIFT as well as quantitatively by enzyme-linked immunosorbent assay (ELISA) and chemiluminescence immunoassay (ChLIA) at baseline as well as after treatment and correlated to immunological remission and persistence.

**Results:** Patients sampled at the beginning of the therapy were grouped according to tertiles of anti-PLA2R levels determined by ChLIA (n[lowest tertile] = 20, n[middle tertile] = 20, n[highest tertile] = 20). Lower anti-PLA2R levels were seen in patients with relapsing disease. Higher anti-PLA2R levels were associated with more severe proteinuria. Patients in the lowest tertile of anti-PLA2R were more likely to develop immunological remission after 8 weeks of therapy. At baseline, 50/50 (100%) tested positive in IIFT and ChLIA as well as 48/50 (94%) in ELISA. After 8 weeks on treatment, immunological remission based on IIFT was found in 37/51 (73%) patients. At this point, the overall agreement compared to IIFT was 92% for ChLIA and 82% for ELISA. With ChLIA, anti-PLA2R titers >5 RU/mL after 8 weeks of therapy were found in 4% of IIFT negative patients with persistent remission, vs 55% of IIFT negative patients with early relapse (p=0.006).

**Conclusions:** Individualised treatment of MN patients with cyclophosphamide and steroids has been recently introduced. In this respect, the quantitative determination of anti-PLA2R levels adds further value. Of the examined quantitative methods, ChLIA demonstrated the highest agreement with IIFT. Additional studies are needed to evaluate the impact on clinical decision making and outcome.

TH-PO458

**Urinary Single-Cell Sequence Analyzes the Urinary Macrophage in Different Outcomes of Membranous Nephropathy**

Xi Liu, Chen Yu. *Tongji University School of Medicine, Shanghai, China.*

**Background:** Great progresses have been made in diagnosis and treatment of membranous nephropathy, but some patients still do not respond to the immunosuppressive treatment. We performed single-cell sequencing to analysis the urine cells of patients with and without complete remission of MN. Hope to provide some insights for understanding the different outcome of MN.

**Methods:** Urine single-cell RNA sequencing was performed on 12 healthy controls (HC) and 15 patients with MN. The patients were divided into complete remission group (CR, n=9) and no remission group (NR, n=6).

**Results:** 1) Macrophages were the largest group in urine cells, they were 48.02%, 68.96% and 20.95% in the HC, CR and NR group, respectively. 2) Urinary macrophages expressing FIColin-1 and S100 calcium binding protein A8 were mainly in HC group and CR group, indicating that they were derived from bone marrow and peripheral blood, while the urinary macrophages expressing the regulator of G-protein signaling 1 and HLA-DPA1, mainly in the NR group, were derived from renal resident macrophages. 3) In healthy adults, urine macrophages expressed the metallothionein family, indicating that they can regulate anti-inflammatory and proinflammatory functions bidirectionally. In the CR group, the urine macrophages showed strong proinflammatory properties. In the NR group, the urinary macrophages mainly associated with the level of proteinuria and the impaired renal function (Figure 1).

**Conclusions:** Our study confirmed the feasibility and effectiveness of urinary single-cell sequencing technology. We firstly delineated urinary cell maps of the MN patients. Not only in origin but also in function of urine macrophages were different in the NC, CR and NR group.

**Funding:** Government Support - Non-U.S.



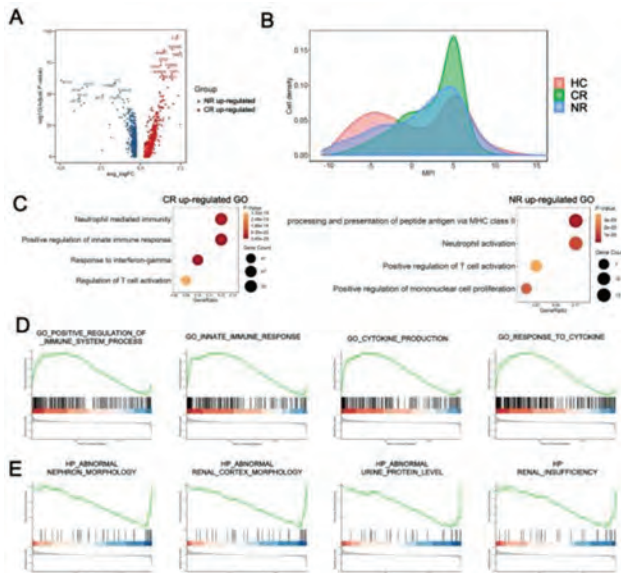

Polarity analysis of urinary macrophages in the CR group and the NR group

TH-PO459

Resolving Focal Segmental Glomerulosclerosis Recurrence in Human Allografts at Single Cell Resolution

Jennifer M. McDaniels,<sup>1</sup> Amol C. Shetty,<sup>1</sup> Thomas Rousselle,<sup>1</sup> Canan Kescu,<sup>3</sup> Cem Kescu,<sup>3</sup> Elissa Bardhi,<sup>1</sup> James D. Eason,<sup>3</sup> Daniel G. Maluf,<sup>1</sup> Lorenzo G. Gallon,<sup>2</sup> Valeria R. Mas.<sup>1</sup> <sup>1</sup>University of Maryland Baltimore, Baltimore, MD; <sup>2</sup>Northwestern University Feinberg School of Medicine, Chicago, IL; <sup>3</sup>The University of Tennessee Health Science Center, Memphis, TN.

**Background:** FSGS, characterized by proteinuria and podocyte injury, is one of the leading causes of end stage renal disease. However, pathogenesis is poorly understood. This study identified cell-population changes, cell-cell interactions, and cell-type specific injury pathways contributing to FSGS recurrence in kidney allografts.

**Methods:** Single nuclei RNA-seq was performed on allograft biopsies showing normal histology (N=4) and FSGS-related glomerular damage (first (T1) N=3 and second recurrence (T2) N=2). Downstream analyses were done using UMAP, gene and pathway enrichment, and intra- and inter-cluster comparative transcriptomics.

**Results:** 40,078 single nuclei partitioned into 17 clusters (Fig.1A). Proximal tubular cluster 1 was most abundant in normal allografts (21.02%) and diminished in T1 (16.92%) and T2 (15.50%), likely due to apoptosis. Two distinct podocyte clusters (POD1-2) were identified (Fig.1A). Despite shared canonical cell markers (Fig.1B), 516 and 222 DEGs were identified in POD2 vs POD1 at T1 and T2, respectively, indicating phenotype heterogeneity. POD1 was enriched in Wnt signaling and actin filament pathways whereas POD2 was enriched in ECM accumulation, epithelial cell differentiation, and cell-cell adhesion pathways. We identified 8 immune clusters, of which T memory cells were increased in FSGS allografts (T1: 26.87%; T2: 35.74%) compared to normal (4.75%) (Fig.1C). Ligand-receptor analysis revealed proinflammatory signals transmitted between podocytes and immune cells.

**Conclusions:** FSGS is characterized by a complex cellular and transcriptomic landscape, leading to kidney injury. T1 and T2 interventions require a more targeted approach based on their unique cell-type specific molecular injury pathways.

**Funding:** NIDDK Support

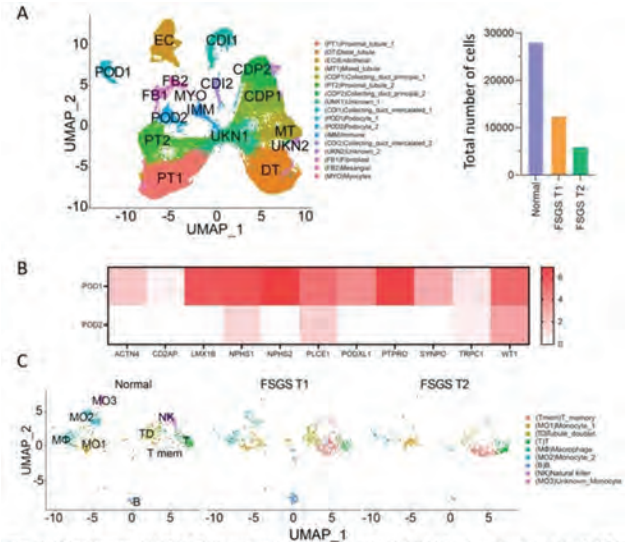

Fig 1. Single nuclei FSGS transcriptomics. A. (left) UMAP visualization of 40,078 nuclei generating 17 clusters. (right) Total number of nuclei assessed per sample group. B. Heatmap of shared podocyte (POD) cell markers expression profile. Color key, Log<sub>2</sub> fold change. C. UMAP visualization of 8 distinct immune cell clusters per sample group.

TH-PO460

Membranous Nephropathy Over the Counter? NELL Yes!

Umair Ali, Neriman Gokden, John M. Arthur, Manisha Singh. University of Arkansas for Medical Sciences, Little Rock, AR.

**Introduction:** Membranous nephropathy (MN) is a common cause of nephrotic syndrome. An autoimmune response to M-type phospholipase-A2-receptor (PLA2R) is usually associated with primary MN while antibodies like Neural-epidermal growth-factor-like-1 (NELL1) are related to secondary causes like malignancy or Lipoic acid (LA) ingestion. We present a case of MN with over-the-counter supplement use.

**Case Description:** A 65 year old man presented to hospital with lower limb swelling associated with a rash with history of diabetes, hypertension and benign prostatic hyperplasia. Examination showed bilateral pitting edema to lower limbs with a purpuric rash. Lab work showed HbA1c of 12.3%, serum albumin at 1.4 mg/dl, serum creatinine of 2.4 mg/dl. Urinalysis showed protein +3 and RBC +1 with 24-hour urine protein of 21 grams. Serological workup was negative for autoimmune conditions and infections. Renal biopsy showed MN. Immunotyping was negative for PLA2R and THSD7A but positive for NELL1 (figure shown). Age-appropriate malignancy screen was negative. Based on NELL-1 immunotyping, an extensive review of medications was done. He used NSAIDs intermittently and also over-the-counter multivitamins including lipoic acid 1800 mg. The over-the-counter medications were stopped. The patient was treated with IV methyl-prednisone 1 gm for three days, followed by tapering oral prednisone. However, due to severe exacerbation of hyperglycemia, we switched to a steroid-sparing regimen with rituximab and tacrolimus. His edema subsided at the one-month follow-up visit and proteinuria improved to 6 grams.

**Discussion:** Lipoic-acid supplements are considered antioxidants, insulin-mimetic, and are a frequently used over-the-counter medication. Studies show an association between NELL1 and LA ingestion, though the number of cases known is only a few. In our case, a search for supplement use was made after the biopsy results, especially the immunotyping, leading to a tailored treatment plan. Treatment options are limited. We used rituximab with tacrolimus for this patient with uncontrolled DM. Addressing the driver of the disease, optimizing patient-specific treatment, following proteinuria for assessing remission are the mainstays of treatment of secondary MN

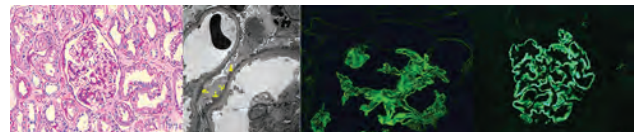

Renal Biopsy with PAS,EM & Immunotyping (NELL1)

## TH-PO461

**NELL1 Renal Biopsy Antigen Staining of Membranous Nephropathy Preceded Clinical Lymphoma Recurrence**

Ayesha A. Khan, Sam Albadri, Nabeel Aslam, Michael A. Mao. *Mayo Clinic, Jacksonville, FL.*

**Introduction:** Membranous nephropathy (MN) is the most common cause of nondiabetic nephrotic syndrome (NS) in Caucasian adults. New MN associated antigens with clinicopathological relevance have been discovered. NELL1 antigen has a reported prevalence of 16% in PLA2R- or THSD7A-negative patients.

**Case Description:** A 70-year-old Caucasian male with history of primary GI follicular lymphoma diagnosed in 2015 and CLL presented for evaluation of nephrotic syndrome. Following Rituximab for one year, remission was declared with negative endoscopies with biopsies and inactive PET scan. Creatinine was 1.27 mg/dL, urine microscopy showed WBC 14/HPF and RBC 4/HPF, and a 24-hour urine revealed 12.9 g protein and measured CrCl 94.2 ml/min. Noninvasive work-up included negative hepatitis B, C, HIV, antiphospholipase A2 receptor, ANCA, ANA, and complement C3 and C4. Serum monoclonal protein study was positive, however serum free light chains and UPEP were normal. Renal biopsy was performed. Light microscopy showed immune complex membranous nephropathy with immunofluorescence showing 2-3+ granular capillary IgG and C3 staining with equal kappa/lambda staining. Immunohistochemistry was performed with PLA2R, THSD7A, and NELL1. NELL1 stained positive (Fig 1). After work-up for secondary etiologies, the patient was treated with Rituximab with ongoing improvement in proteinuria (24-hour urine protein 648 mg after one year).

**Discussion:** This case of NELL1-associated membranous nephropathy associated with lymphoma highlights the clinical utility of renal biopsy antigen staining for diagnosis and management. The onset of NS secondary to membranous nephropathy can occur at different stages in malignancies. It is possible that this NELL1-associated MN may precede clinically detectable underlying malignancy. Studies have proposed monitoring serologic NELL1 antibodies to aid management of progression, recurrence, or remission of the disease.

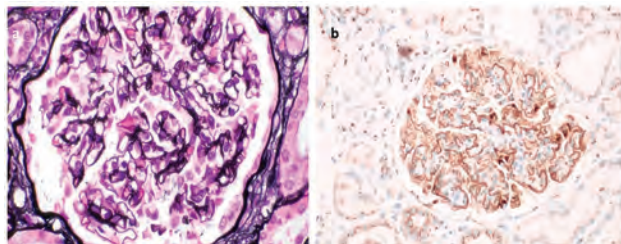

(b) IHC stain NELL-1

## TH-PO462

**A Rare Case of Membranous Nephropathy in a Patient With Immune-Mediated Necrotizing Myositis: Rituximab Escape**

Farah S. Abuazzam,<sup>1</sup> Sami M. Akram,<sup>1</sup> Amir Abdi Pour,<sup>1</sup> Roy O. Mathew,<sup>2</sup> Lakshmi Ganesan,<sup>1</sup> Sayna Norouzi.<sup>1</sup> <sup>1</sup>Loma Linda University, Loma Linda, CA; <sup>2</sup>VA Loma Linda Healthcare System, Loma Linda, CA.

**Introduction:** Rituximab (RTX) has been established as a treatment option for membranous nephropathy (MN). Here, we report a rare case of MN in a patient who was maintained on RTX for the treatment of immune-mediated necrotizing myositis (IMNM).

**Case Description:** A 42-year-old male with a history of IMNM, presented with bilateral lower limb edema. He reported frequent IMNM relapses followed by remission with RTX for 10 years as he failed the other immunosuppressive therapies due to serious adverse effects including leukopenia. On labs, the urine protein creatinine ratio was 7683 mg/g. Glomerular filtration rate by cystatin C was normal. Antinuclear antibodies (ANA) were positive. Complements were normal. Antibodies to double-stranded DNA (dsDNA) and phospholipase A2 receptors were negative. Renal biopsy showed diffuse subepithelial deposits and tubuloreticular inclusions on electron microscopy (EM) (Fig 1) and immunofluorescence staining for IgG and C3. Steroids and tacrolimus were added to RTX for the treatment of the new-onset MN and his condition remains stable.

**Discussion:** This is the first report of MN in the setting of RTX-treated IMNM. In our case, MN onset had occurred while the patient was on RTX for a long duration which suggests mechanisms other than B cell depletion may be at work. The presence of another autoimmune disease (IMNM) suggests immune-mediated MN unamenable to RTX. Another possible mechanism is the development of local or low level of antibody formation that would not be peripherally detected as positive dsDNA but may be enough to elicit a local response although the lack of hypocomplementemia, dsDNA, and the characteristic histopathological and clinical systemic lupus features makes lupus nephritis unlikely. This report demonstrates a need for further elucidation of the pathogenesis of secondary MN to improve patient care.

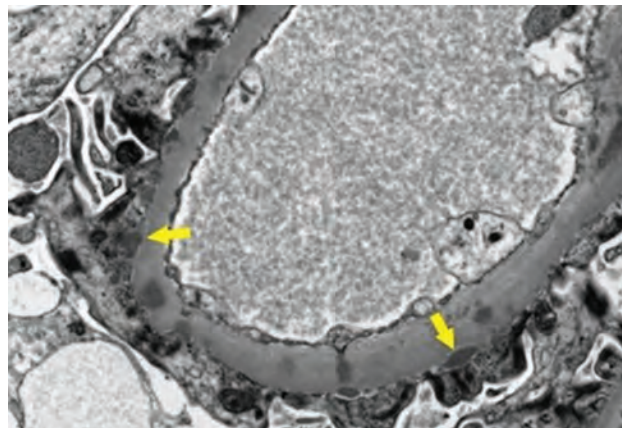

EM: subepithelial deposits in the glomerular basement membrane (arrows)

## TH-PO463

**Successful Remission of Exostosin-2 Positive Membranous Nephropathy Associated With Autoimmune Hepatitis With Azathioprine and Steroids**

Mohamed Hassanein, Maria Clarissa Tio, Bushra Syed. *University of Mississippi Medical Center, Jackson, MS.*

**Introduction:** Membranous Nephropathy (MN) is an autoimmune disease characterized by immune complex deposition in the glomerular basement membrane (GBM). Recently, Exostosin-1 and 2 (EXT1/EXT2) were reported as target antigens of the GBM especially in patients with autoimmune diseases, particularly lupus. We report a case of EXT2-positive MN associated with autoimmune hepatitis that was successfully treated with azathioprine (AZA) and steroids.

**Case Description:** A 46-year-old female with a history of hypertension, prediabetes, obesity, thrombotic thrombocytopenic purpura (treated with plasmapheresis, steroids and rituximab) and newly diagnosed biopsy-proven autoimmune hepatitis (on AZA) was referred to the nephrology clinic for hematuria and proteinuria. Labs showed intact kidney function with a creatinine 0.5 mg/dL, mild transaminitis and positive anti-nuclear antibodies (ANA). Urine studies showed 3-5 red blood cells per high power field and a urine protein: creatinine ratio of 1.2 g/g (normal <0.2 g/g). A complete serological workup including viral hepatitis, human immunodeficiency virus (HIV), anti-double stranded (DS) DNA antibodies, phospholipase A-2 Receptor (PLA2R) antibodies, and monoclonals were all unremarkable. Kidney biopsy showed EXT2-positive MN with background acute tubular injury and minimal interstitial fibrosis and tubular atrophy. She was started on losartan and prednisone taper with plan to transition from AZA to mycophenolate. Due to insurance related problems, she was unable to transition to mycophenolate. She was continued on AZA, losartan and steroids and went into complete remission 2 months later with a UPCR of 0.18 g/g.

**Discussion:** EXT-associated MN has been strongly linked to autoimmune diseases, particularly lupus. EXT positivity is thought to confer a better prognosis with lower progression to kidney failure compared to EXT-negative MN. Although our patient was positive for ANA and had no history or signs of lupus, patients with EXT-positive MN are thought to be more prone to develop lupus later in life. Treatment is controversial, including rituximab, cyclophosphamide, and steroids. To the best of our knowledge, this is the first case of EXT-positive MN associated with autoimmune hepatitis treated with AZA and steroids.

## TH-PO464

**A Case of Primary Membranous Nephropathy (MN) After Booster Injection of the BNT162b2 COVID-19 Vaccine (Pfizer-BioNTech)**

Cesar Zambrano, Andres J. Azuero, Hisham Bahmad, Ayman Layka. *Mount Sinai Medical Center, Miami Beach, FL.*

**Introduction:** All currently authorized COVID-19 vaccines have proven to be safe, effective and reduce risk of severe illness. Glomerular disease have been reported after administration of COVID-19 messenger RNA (mRNA) vaccines. We report on the development of nephrotic syndrome from Primary Membranous nephropathy after third injection of the BNT162b2 COVID-19 vaccine.

**Case Description:** 34 years old female with no significant past medical history except migraine headaches, presented to the outpatient setting reporting intermittent and gradually progressing lower extremities edema for 3 months; accompany by abdominal and lower back swelling, facial edema and foamy urine. She received her 3<sup>rd</sup> dose of COVID-19 vaccine 1-2 weeks before symptoms appearance. On evaluation, she was normotensive, preserved kidney function (Creatinine 0.85 BUN 9 eGFR >60), hypoalbuminemia (Alb 1.1 g/dL), nephrotic-range proteinuria (Spot urine protein 869.9 mg/dL, Urine Creatinine 79.9mg/dL, 24hr Urinary protein excretion estimation 11000mg/g [11g/day]), elevated cholesterol (572mg/dL) and triglycerides (220 mg/dL). She has negative ANA, ANCA, DNA Ds Ab, Hepatitis profile, HIV. Her Anti-phospholipase A2 receptor (anti-PLA2R) antibody came back positive (247 relative units/ml [ $<14$ , negative;  $>20$ , positive]) She underwent kidney biopsy showing global 3+ Subendothelial electron dense deposits

(IgG, C3, Kappa, Lambda), 100 % foot process effacement, IF staining positive for PLA2R, consistent with Primary Membranous Nephropathy Stage II. She was started on High-dose steroids and later switched to Tacrolimus 2mg BID, and received Rituximab x 2 doses with major improvement in symptoms and proteinuria.

**Discussion:** MN is more common in male in their early 50s. The fact our patient doesn't fit this category, her temporal association with vaccination and the exclusion of other explanatory factors, supports a potential connection between COVID-19 vaccination and glomerular disease. To our knowledge, this is only the second case reporting association of COVID-19 mRNA vaccine and MN. Together with a report from Relapse MN after vaccination and one case of Minimal Change disease, we highlight the possible role of COVID vaccination causing immune glomerular dysregulation. Further studies are needed to elucidate the early postvaccination immune response mechanism.

#### TH-PO465

##### Relapsed Membranous Nephropathy After COVID-19 Vaccination

Roy Rajan,<sup>1,2</sup> Clay A. Block,<sup>1,2</sup> Thomas M. Kaneko,<sup>1,2</sup> Jason R. Pettus,<sup>1,2</sup> Elizabeth J. Brant,<sup>1,2</sup> <sup>1</sup>Dartmouth-Hitchcock Health GraniteOne, Lebanon, NH; <sup>2</sup>Dartmouth College Geisel School of Medicine, Hanover, NH.

**Introduction:** *De novo* and relapsed glomerulonephritis (GN), including membranous nephropathy (MN), have been reported after COVID-19 mRNA-vaccination. We report a case of MN that relapsed following COVID-19 vaccination after 26 years of remission.

**Case Description:** A 78-year-old man presented with nephrotic syndrome (UPC 8.0). His history was notable for primary MN diagnosed by kidney biopsy in 1994. He was treated with prednisone and ACE inhibitor with full resolution of proteinuria. He received COVID-19 vaccine (mRNA-1273, Moderna) March 3 and April 1, 2021. Between the two doses, he had onset of leg swelling. This was attributed to amlodipine, which was discontinued by his PCP. After the second dose of vaccine, edema progressed to anasarca. Urine protein was 5.73g/day. Two months later, the UPC was 8.0, serum creatinine 0.86 mg/dL, and serum albumin 2.7mg/dL. Anti-PLA2R was positive (24RU/mL, ref. >19RU/mL). Renal biopsy showed recurrent MN, EM stage 3-4, PLA2R1 positive. Due to regional surge of COVID-19 Omicron variant, immunosuppression was held to administer EvuShield for COVID-19 prophylaxis. Proteinuria improved initially without intervention (UPC 2.7) but increased again (UPC 4.7) a month later. Rituximab was initiated three months after biopsy resulting in undetectable anti-PLA2R 1 week after treatment, with reduction in UPC to 3.7 and improvement of anasarca 2 weeks after treatment.

**Discussion:** Onset or relapse of GN after vaccination historically has rarely been reported. There are numerous reports of *de novo* or relapsed GN after COVID-19 infection, and increasing reports of GN after COVID-19 vaccination with mRNA and traditional vaccine platforms. The pathogenesis of GN in this setting has not been established. Nonspecific immune activation and specific COVID-19-related immune reaction have been postulated. MN related to COVID-19 vaccination, although rarely reported, has been treated with standard immunosuppression with favorable results. Management of MN and other forms of GN will evolve with greater understanding of disease course in the setting of COVID-19 infection and vaccination. Patients with a history of GN, including MN, should be counseled about the possibility of relapse with COVID-19 infection or vaccination, even if their original disease was remote.

#### TH-PO466

##### Not All Light-Chain Restricted Pattern Is Light Chain Disease

Arvin Daneshmand,<sup>1,4</sup> Donghyang Kwon,<sup>2</sup> Steven A. Burka,<sup>2,3</sup> Negiin Pourafshar,<sup>2</sup> <sup>1</sup>Georgetown University School of Medicine, Washington, DC; <sup>2</sup>MedStar Georgetown University Hospital, Washington, DC; <sup>3</sup>The George Washington University Hospital, Washington, DC; <sup>4</sup>University of Florida College of Medicine, Gainesville, FL.

**Introduction:** Light Chain Deposition Disease (LCDD) is a disease characterized by widespread tissue deposition of monoclonal Ig light chains (LC), often in association with immunoproliferative disorders.<sup>1</sup> The clinical course of LCDD most often involves the kidney, as this is the primary site of LC uptake and degradation, and results in renal insufficiency. Microscopy most often reveals nodular sclerosing glomerulopathy or tubular basement membrane thickening, particularly with κ-LCs.<sup>2</sup> Rarely, renal involvement may take the form of subepithelial deposits otherwise characteristic of membranous nephropathy (MN).<sup>3,4</sup> Here we highlight a case of kappa-predominant MN with no significant immunoglobulin deposition in a patient with monoclonal gammopathy.

**Case Description:** Our patient is a 66yo female who presented with severe lower extremity edema and hypertension (SBP 200's), found to have nephrotic syndrome with UPC 10.8, Cr 0.78. On further evaluation, labs revealed a small M spike of 0.12, gamma globulin 0.64, and alpha-2-globulin 1.26 on SPEP. Subsequent abdominal fat pad aspiration and colonoscopy with rectal biopsy were negative for amyloidosis. A bone marrow biopsy, FISH study, and flow cytometric analysis were all negative for hematologic malignancy. Left kidney biopsy in 05/2021 was notable for MN with granular kappa-predominant staining with no Ig deposition and mild chronic tubulointerstitial disease. Negative Congo Red stain excluded amyloidosis. She was determined to have monoclonal gammopathy of renal significance (MGRS) and was initiated on Velcade/dexamethasone. Initial serum Kappa free light chain level was 44.2, with subsequent improvement to 27.3 and reductions in proteinuria and edema.

**Discussion:** This patient found benefit to chemotherapy for MN secondary to MGRS. In summary, MGRS may cause nephrotic syndrome with only light chain subepithelial deposition in the absence of other tubular or glomerular toxicities.

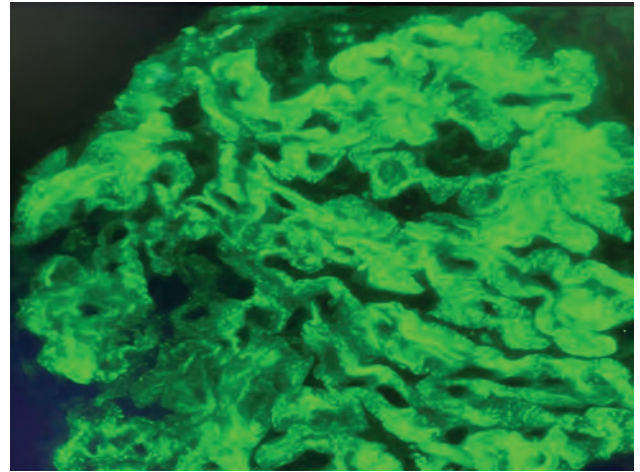

Kappa Stain

#### TH-PO467

##### Two Case Reports of Cytomegalovirus Induced Collapsing Focal Segmental Glomerulosclerosis in Immunocompetent Hosts

Marco Ramos, Mohamed O. Omer, Ihab Jameel, Suhaib A. Andrabi. *Harlem Hospital Center, New York, NY.*

**Introduction:** Collapsing focal segmental glomerulosclerosis (cFSGS) refers to a distinct pattern of glomerulopathy characterized by a glomerular capillary collapse in a segmental global manner, podocyte proliferation, and tubulointerstitial injury. Viral infections like HIV, Parvovirus B19, and CMV seem to be prominent triggers for the development of a conventional histological pattern of FSGS. CMV-associated renal disease has been described only in transplant and immunocompromised patients.

**Case Description:** Case 1 18-year-old female with history of asthma and HbSS disease presented with fever, nausea, vomiting, and neck pain. Physical examination revealed a temperature of 102 F, icterus, negative meningeal signs, no rales, rhonchi or wheezing. Initial creatinine 0.2 mg/dL. COVID-19 PCR was negative but IgG antibodies positive. Patient developed non-oliguric AKI with fluid overload requiring hemodialysis. CMV IgM and CMV PCR were positive. She received antibiotic therapy and also ganciclovir. Biopsy revealed collapsing FSGS with acute tubular injury. A week after completion of ganciclovir therapy creatinine returned to baseline of 1.7 mg/dL. Case 2 40-year-old African American male with history of diabetes and asthma presented with fever, fatigue, epigastric pain and chest pain. Initial creatinine 1.2 mg/dL, hepatic function (AST 333 U/L, ALT 265 U/L, ALK 207 U/L), ferritin (13682 ng/ml), triglycerides (276 mg/dl) and proteinuria (urine protein/creatinine ratio: 2, urine albumin/creatinine:1016 mg/gm). Patient developed anuric renal failure which required hemodialysis. Biopsy revealed collapsing FSGS with diffuse podocyte effacement, moderate tubular atrophy, and interstitial fibrosis. CMV DNA antibodies were positive. Methylprednisolone and valganciclovir were started with patient creatinine trending down to 3.7 mg/dL. Three weeks following discharge, creatinine levels were 1.5 mg/dL with decreased proteinuria.

**Discussion:** Collapsing FSGS in immunocompetent patients is uncommon. Reports mention benefits of ganciclovir and steroid therapy for CMV infection in immunocompromised patients. CMV infection should be considered in patients with systemic inflammatory disease and severe renal failure, as early treatment with steroids and antivirals helps preserve renal function.

#### TH-PO468

##### Biopsy Proven Minimal Change Disease in a Patient With Primary Biliary Cholangitis

Bahman J. Moghadam, William Wallace, Yan Zhong. *University of Southern California, Los Angeles, CA.*

**Introduction:** Primary biliary cholangitis (PBC) is an autoimmune liver disease characterized by circulating anti-mitochondrial antibodies (AMA). Though rare, PBC has been associated with varied renal disorders including glomerular diseases such as minimal change disease (MCD). This is a case of biopsy proven MCD in a patient with PBC treated with steroid and achieving complete recovery.

**Case Description:** A 70-year-old Hispanic lady with recent diagnosis of PBC presented with new onset dyspnea and anasarca. One month prior, she was evaluated for elevated alkaline phosphatase and abnormal liver function tests (LFTs) including AST/ALT and bilirubin. Workup showed antinuclear antibody titer of 1:1280 and AMA titer of 1:160 resulting in a clinical diagnosis of PBC without need for liver biopsy. On her current hospitalization, serum creatinine was at baseline 1.01 mg/dL, urine protein/creatinine ratio was 12.95 gm/day and serum albumin 1.7 g/dL. Nephrotic work up was unrevealing. Kidney biopsy showed extensive foot process effacement, consistent with MCD (Figure 1). Given worsening renal function and persistent anasarca, Prednisone 60mg with taper, diuretic and angiotensin-converting enzyme inhibitor were prescribed. At one month follow up she had resolution of nephrotic syndrome and normalization of LFTs.

Key: TH - Thursday; FR - Friday; SA - Saturday; OR - Oral; PO - Poster; PUB - Publication Only

Underline represents presenting author.

**Discussion:** MCD is a clinical and pathological entity defined by proteinuria and hypoalbuminaemia without in the absence of glomerular infiltrates or immunoglobulin deposits. It is thought that MCD is caused by an aberrant immune response and as such, the coexistence of PBC and MCD has previously been postulated to be a result of induction of cell-mediated immunity. Perhaps the combined autoimmune nature of PBC and immune mediated pathology of MCD is what makes the clinical course responsive to steroids. Review of a larger case series could allow for more in-depth insights.

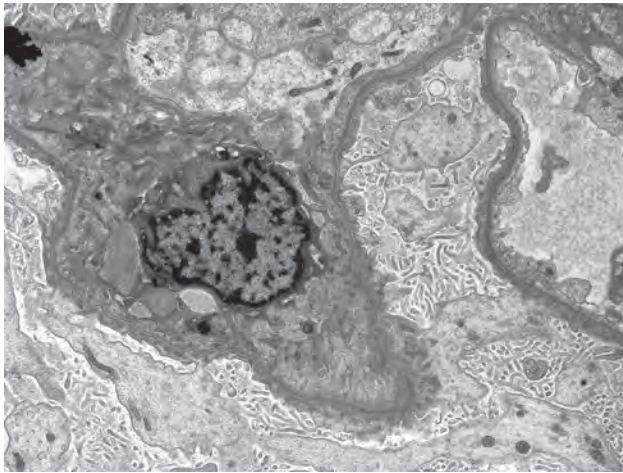

Extensive foot process effacement with minimal change nephropathy

#### TH-PO469

##### A Case of Minimal Change Disease Associated With Salmonella Infection, Treated Successfully With Antibiotics

Syed Hasni,<sup>1</sup> Jennine Michaud,<sup>2</sup> Michael Yudd.<sup>2</sup> Rutgers New Jersey Medical School <sup>1</sup>Rutgers New Jersey Medical School, Newark, NJ; <sup>2</sup>Veterans Health Administration Operations, East Orange, NJ.

**Introduction:** This case is the first to our knowledge of Salmonella bacteremia associated with Minimal Change Disease in adults. The patient's course lends further support to the hypothesis of a causal relationship between infections and MCD

**Case Description:** 69-year-old male with pmh of HTN, treated HCV, who presented with a 3-week h/o diarrhea, abd. pain and LE edema. P/E showed ascites and LE edema. UA had >500 mg/dL protein, p/c ratio of 5, sediment with oval fat bodies and fatty casts, serum alb 2.2g/dL and cr of 1.1 mg/dL. Proteinuria workup negative for HIV, HBV, RPR, ANA, SPEP, UPEP, complements normal, HCV VL undetectable. Kidney biopsy showed MCD. Diarrhea resolved but proteinuria persisted, and patient was treated with oral prednisone 1mg/kg. 3 weeks later, patient developed UTI symptoms and received empiric ciprofloxacin. Urine culture grew Salmonella species group D. Blood cultures done following treatment were positive for Salmonella species group D. Clinical course complicated by relapsed Salmonella bacteremia, Salmonella vertebral osteomyelitis, ATN requiring temporary hemodialysis. With completion of steroid taper, prolonged IV antibiotic treatment and resolution of Salmonella infection, proteinuria resolved and never recurred.

**Discussion:** The infectious diseases leading to secondary MCD include Syphilis, Ehrlichiosis, Mycoplasma, HIV, TB, Echinococcus and Schistosomiasis. Our case demonstrates Salmonella can also cause a secondary MCD. In MCD, microbial products and/or interleukins bind to Toll-like receptors or IL receptors leading to CD80 expression, which in turn, may interfere with nephrin expression/phosphorylation. Angiotensin-like-4 is thought to induce proteinuria by reducing anionic sites at the glomerular basement membrane level. Several candidate molecules have been considered as possible circulating factors. Often, with appropriate anti-microbial therapy of the underlying infectious disease, the MCD will abate.

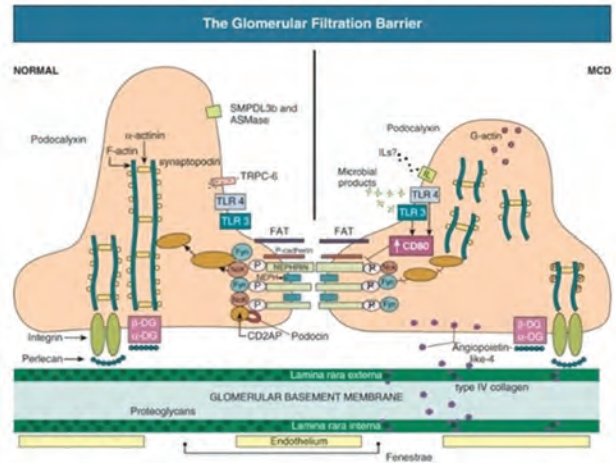

Glomerular filtration barrier in healthy state (left) and in MCD (right)

#### TH-PO470

##### Syphilis and HIV Co-Infection: A Dual Attack on the Kidneys

Sylvester Dorobisz, Ali Mehdi, George Thomas, Kristen Tomaszewski, Laura Ferreira Provenzano, Michael W. George. Cleveland Clinic, Cleveland, OH.

**Introduction:** HIV-associated nephropathy (HIVAN) remains an important cause of kidney failure in persons of African ancestry due to the association with APOL1. Syphilis infections are increasing in incidence and have notable kidney manifestations. Here we present a case of kidney failure in the setting of an HIV and syphilis co-infection.

**Case Description:** A 54-year-old black male presented to the emergency department with recurrent chest pain and malaise. His cardiac evaluation was unrevealing but he had lower extremity edema on examination. His creatinine on presentation was 1.5mg/dl (baseline: 1.1mg/dl) increasing to 5.83mg/dl during the hospitalization. A urinalysis had 3+ proteinuria and 3+ hematuria and urine protein creatinine ratio was 8.2 g/g. A kidney ultrasound revealed no hydronephrosis. His albumin was 1.8 g/dL and serologic work up revealed negative ANA, ANCA, M protein, PLA2R antibodies, hepatitis panel and normal complements. An HIV test was negative a week prior. His CBC was normal but he had a depleted haptoglobin and elevated LDH at 969 U/L. A kidney biopsy revealed focal segmental glomerulosclerosis with collapsing and membranous features along with acute tubular injury and mild interstitial fibrosis. Immunofluorescence was negative. An HIV RNA test came back positive at 1,980,000 copies/mL suggesting an acute retroviral illness. Syphilis screen also came back positive. It was thus thought that the HIV accounted for the collapsing features while the syphilitic infection led to the membranous component. Along with diuresis for volume overload, antiretroviral therapy and penicillin were started. His creatinine stabilized at 2 mg/dl at outpatient follow-up with improving proteinuria.

**Discussion:** Both syphilis and HIV can cause proteinuric kidney injury. HIVAN is well described with glomerular collapsing features on biopsy in the setting of uncontrolled HIV. This case illustrates that HIVAN can also occur in the setting of an acute HIV infection where the HIV screening test can be negative. HAART therapy remains the cornerstone of management with unfavorable prognosis. Membranous nephropathy is the most common pathologic finding of syphilitic nephropathy with excellent response to syphilis treatment. This case serves as a reminder to consider this entity in our differentials particularly with the resurgence of this infection.

#### TH-PO471

##### A Case of Anti-Brush Border Antibody Disease

Nicholas W. Salupo,<sup>1</sup> Laura Biederman,<sup>2</sup> Jennifer L. Jackson.<sup>1</sup> <sup>1</sup>Kettering Health, Dayton, OH; <sup>2</sup>The Ohio State University Wexner Medical Center, Columbus, OH.

**Introduction:** Anti-brush border antibody (ABBA) disease is a rare disorder characterized by tubulointerstitial damage due to antibodies against the renal proximal tubular brush border. IgG-containing deposits are found in the tubular basement membrane (TBM) and glomerular subepithelial space. Detection of anti-megalin (LRP2) antibodies is pathognomonic. There is not much evidence detailing this condition.

**Case Description:** A 65 year old male with hypertension, peripheral vascular disease, hepatitis C, and benign prostatic hypertrophy with worsening GFR after acute kidney injury. Serum creatinine was 1.8-2.0 mg/dL. There was no hematuria, proteinuria, or urinary eosinophilia. He had normal complements, antinuclear antibody was negative, no monoclonal proteins were seen on SPEP, urinary kappa lambda light chain ratio was 1.26, and unremarkable imaging. Kidney biopsy showed moderate chronic parenchymal changes with many TBM and Bowman's capsule electron dense deposits immunoreactive for polyclonal IgG and glomerular segmental, subepithelial electron dense deposits with membranous pattern immunodominant for polyclonal IgG. Anti-megalin staining was positive along tubular basement membranes.

**Discussion:** This case demonstrates a rare, but possibly increasing, disease process. The inciting cause remains unknown but the differential diagnosis includes systemic lupus erythematosus, Sjögren's syndrome, idiopathic hypocomplementemic tubulointerstitial nephritis, and IgG4-related disease. Biopsy findings of TBM deposits on the apical aspect of the TBM are most suspicious for anti-brush border antibody disease. Definitive diagnosis is made with the anti-megalin staining. Treatment, necessary if impaired renal function persists, consists of immunosuppression to stall further renal deterioration.

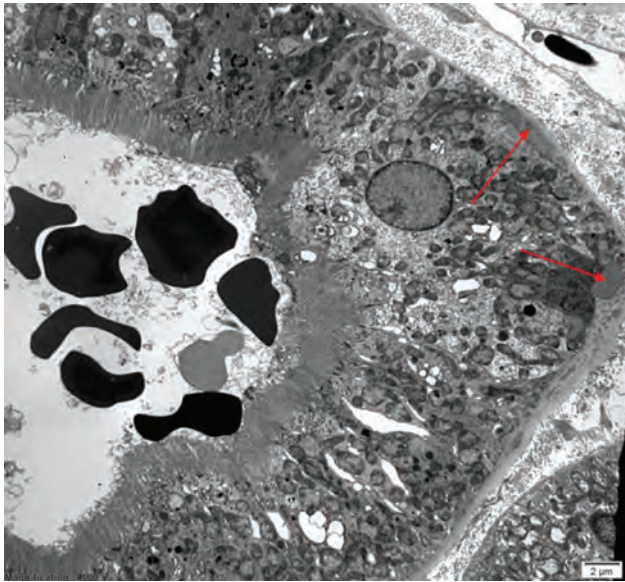

Tubular basement membrane deposits on the luminal aspect of TBM

**TH-PO472**

**Incidence of Cardiovascular Events Among Glomerular Disease Participants in the Cure Glomerulonephropathy Network (CureGN)**

Shikha Wadhvani,<sup>1</sup> Sarah Mansfield,<sup>2</sup> Abigail R. Smith,<sup>2</sup> Bruce M. Robinson,<sup>2</sup> Isa Ashoor,<sup>3</sup> Aftab S. Chishti,<sup>4</sup> Salim Hayek,<sup>6</sup> Michelle A. Hladunewich,<sup>13</sup> Siddharth S. Madapoosi,<sup>6</sup> Laura H. Mariani,<sup>5</sup> Amy K. Mottl,<sup>10</sup> Michelle M. O'Shaughnessy,<sup>8</sup> Afshin Parsa,<sup>9</sup> David T. Selewski,<sup>11</sup> Chia-Shi Wang,<sup>12</sup> Donald J. Weaver,<sup>7</sup> Myda Khalid.<sup>5</sup> CureGN ERO Writing Group <sup>1</sup>Northwestern University Feinberg School of Medicine, Chicago, IL; <sup>2</sup>Arbor Research Collaborative for Health, Ann Arbor, MI; <sup>3</sup>LCMC Health, New Orleans, LA; <sup>4</sup>Kentucky Children's Hospital, Lexington, KY; <sup>5</sup>Riley Hospital for Children at Indiana University Health, Indianapolis, IN; <sup>6</sup>University of Michigan, Ann Arbor, MI; <sup>7</sup>Levine Children's Hospital, Charlotte, NC; <sup>8</sup>University College Cork, Cork, Ireland; <sup>9</sup>National Institutes of Health, Bethesda, MD; <sup>10</sup>The University of North Carolina at Chapel Hill, Chapel Hill, NC; <sup>11</sup>Medical University of South Carolina, Charleston, SC; <sup>12</sup>Emory University School of Medicine, Atlanta, GA; <sup>13</sup>Sunnybrook Health Sciences Centre, Toronto, ON, Canada.

**Background:** Cardiovascular (CV) events are known extra-renal complications of glomerular disease that cause increased rates of hospitalization, morbidity, and mortality. This analysis describes CV outcomes in CureGN, a prospective cohort study of adults and children with biopsy-proven minimal change disease (MCD), focal segmental glomerulosclerosis (FSGS), membranous nephropathy (MN), or IgA nephropathy/vasculitis (IgA) from 65 US and 6 international sites.

**Methods:** Multivariable Cox regression was used to estimate associations with first post-enrollment CV event, among those without prior CV events.

**Results:** The cohort included 2423 participants (566 MCD, 615 FSGS, 546 MN, 696 IgA). At enrollment, median age was 31 yrs (IQR 14-51), with 35% children, 57% male, 13% Hispanic, and 16% Black. At enrollment, median eGFR was 83 ml/min/1.73m<sup>2</sup> (IQR 54-103) and median UPCr was 1.2 g/g (IQR 0.2-3.9). Median follow-up was 3.8 years (IQR 2.2-5.1). Overall, 96 participants (22 children, 74 adults) experienced at least one CV event post-enrollment, most commonly arrhythmia followed by heart failure. The cumulative incidence at 1-, 3-, and 5-years post-enrollment was 0.2%, 1.3%, and 1.9%, respectively, for children, and 1.4%, 4.4%, and 7.1%, respectively, for adults. Higher hazard of first CV event post-enrollment was associated with older age (HR=1.1 per 5 yrs), lower eGFR at enrollment (HR=0.88 per 10 mL/min/1.73 m<sup>2</sup>), and higher UPCr (HR=1.03 per g/g) [Figure]. Glomerular disease subtype was not associated with hazard of CV event (p=0.58).

**Conclusions:** CV events were associated with older age and kidney disease severity, but not glomerular disease subtype, in this cohort. Further study and longer follow-up will improve understanding of CV risk in patients with glomerular disease and inform practice guidelines.

**Funding:** NIDDK Support

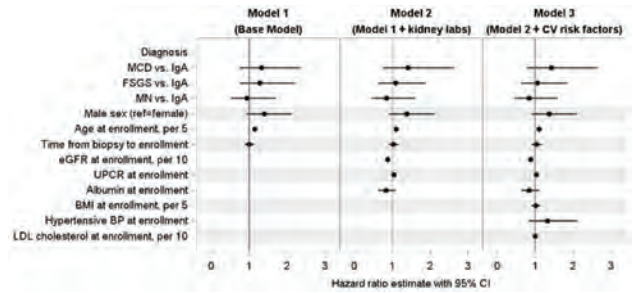

Sequential time from enrollment to first cardiovascular event Cox models

**TH-PO473**

**Incidence of Thromboembolic Events Among Glomerular Disease Participants in the Cure Glomerulonephropathy Network (CureGN)**

Myda Khalid,<sup>1</sup> Sarah Mansfield,<sup>3</sup> Abigail R. Smith,<sup>3</sup> Bruce M. Robinson,<sup>3</sup> Eman Abdelghani,<sup>4</sup> Amira Al-Uzri,<sup>5</sup> Sharon M. Bartosh,<sup>8</sup> Debbie Gipson,<sup>6</sup> Bryce A. Kerlin,<sup>4</sup> Michelle N. Rheault,<sup>9</sup> John Sperati,<sup>7</sup> Tarak Srivastava,<sup>11</sup> Craig S. Wong,<sup>10</sup> Shikha Wadhvani.<sup>2</sup> CureGN ERO Writing Group <sup>1</sup>Riley Hospital for Children at Indiana University Health, Indianapolis, IN; <sup>2</sup>Northwestern University Feinberg School of Medicine, Chicago, IL; <sup>3</sup>Arbor Research Collaborative for Health, Ann Arbor, MI; <sup>4</sup>Nationwide Children's Hospital, Columbus, OH; <sup>5</sup>Oregon Health & Science University, Portland, OR; <sup>6</sup>University of Michigan, Ann Arbor, MI; <sup>7</sup>Johns Hopkins Medicine, Baltimore, MD; <sup>8</sup>University of Wisconsin-Madison, Madison, WI; <sup>9</sup>University of Minnesota Medical School Twin Cities, Minneapolis, MN; <sup>10</sup>University of New Mexico School of Medicine, Albuquerque, NM; <sup>11</sup>Children's Mercy Hospitals and Clinics, Kansas City, MO.

**Background:** Thromboembolic (TE) events are well-known complications of glomerular disease, but incidence rates and risk factors are not well-defined. This analysis describes TE outcomes in CureGN, a prospective cohort study of adults and children with biopsy-proven minimal change disease (MCD), focal segmental glomerulosclerosis (FSGS), membranous nephropathy (MN), or IgA nephropathy/vasculitis (IgA) from 65 US and 6 international sites.

**Methods:** Multivariable Cox regression was used to estimate associations with first post-enrollment TE event, among those without a prior event.

**Results:** Among 2423 participants (566 MCD, 615 FSGS, 546 MN, 696 IgA), enrollment characteristics were: median age 31 yr (IQR 14-51), 35% children, 57% male, 13% Hispanic, 16% Black, median eGFR 83ml/min/1.73m<sup>2</sup> (IQR 54-103), median UPCr 1.2 g/g (IQR 0.2-3.9). Median follow-up was 3.8 years (IQR 2.2-5.1). Overall, 46 participants (12 children, 34 adults) experienced at least one TE event, most commonly deep vein thrombosis, followed by pulmonary embolism. The cumulative incidence at 1-, 3-, and 5-years post-enrollment was 0.6%, 1.5%, and 1.8%, respectively, for children, and 1.9%, 3.3%, and 4.4%, respectively, for adults. First TE events were associated with Black race (HR=2.3, 95% CI=1.2-4.5) and lower serum albumin ((HR=0.67 per g/dL, 95% CI=0.47-0.94), as well as with older age, tobacco use, higher body mass index, and lower eGFR [Figure]. Glomerular disease subtype was not associated with TE events (p=0.74).

**Conclusions:** TE events frequently complicate glomerular disease and in this cohort were associated with particular demographic and clinical characteristics. Additional data will extend understanding of thromboembolic risk in patients with glomerular disease and inform practice guidelines.

**Funding:** NIDDK Support

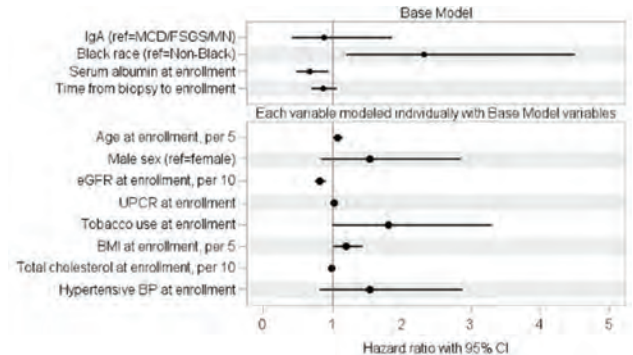

Cox regression models for time to thromboembolic event

TH-PO474

COVID-19 Infection and Vaccination in Patients With Glomerular Disease: An Analysis of the Cure Glomerulonephropathy (CureGN) Study

Dorey A. Glenn,<sup>1</sup> Chia-Shi Wang,<sup>4,5</sup> Margaret Helms,<sup>3</sup> Gaia M. Coppock,<sup>10</sup> Myda Khalid,<sup>6</sup> Abigail R. Smith,<sup>3</sup> Katherine R. Tuttle,<sup>7,8</sup> Bruce M. Robinson,<sup>3</sup> Raed Bou Matar,<sup>9</sup> Debbie Gipson,<sup>2</sup> Andrew S. Bombard,<sup>11</sup> Laura H. Mariani,<sup>2</sup> on behalf of the CureGN consortium <sup>1</sup>University of North Carolina at Chapel Hill School of Medicine, Chapel Hill, NC; <sup>2</sup>University of Michigan, Ann Arbor, MI; <sup>3</sup>Arbor Research Collaborative for Health, Ann Arbor, MI; <sup>4</sup>Emory University, Atlanta, GA; <sup>5</sup>Children's Healthcare of Atlanta Inc, Atlanta, GA; <sup>6</sup>Riley Hospital for Children at Indiana University Health, Indianapolis, IN; <sup>7</sup>Providence Health and Services, Renton, WA; <sup>8</sup>University of Washington, Seattle, WA; <sup>9</sup>Cleveland Clinic Children's Hospital, Cleveland, OH; <sup>10</sup>University of Pennsylvania, Philadelphia, PA; <sup>11</sup>Columbia University, New York, NY.

**Background:** Persons with glomerular diseases (GD) are vulnerable to severe COVID19 infection, yet may be hesitant to receive vaccines. We sought to understand predictors for severe COVID19 infection in GD and the effectiveness and safety of COVID19 vaccines.

**Methods:** CureGN is a prospective observational study of patients with minimal change disease, focal segmental glomerulosclerosis, membranous nephropathy, or IgA Nephropathy. Beginning in July 2021, a questionnaire was administered at study visits to assess evidence of COVID19 infection, vaccination, and clinical features of COVID19-related hospitalizations. Severe infection was defined as COVID19-associated hospitalization or death. Predictors of severe infection were evaluated using multivariable logistic regression models, adjusting for age, vaccination status, and comorbidities (base model), then individually adjusting for immunosuppression, race, ethnicity, GD subtype, eGFR, and UPCR. eGFR slope pre- and post- infection or COVID19 vaccination were estimated using interrupted time series analyses.

**Results:** From July 2021 to March 2022, 1182 participants were surveyed with 177 (15%) reporting COVID19 infection. Of those, 39 (22%) developed severe illness, including 2 deaths. Over study follow-up, the proportion of vaccine-eligible participants who had received ≥1 COVID19 vaccine increased from 55% to 70%. Lower eGFR pre-infection was associated with a higher odds of severe infection [OR[95%CI]: 1.19 [1.04,1.37] per 10 unit decrease in eGFR (base model). COVID19 infection was associated with a 5.04 (SD 2.31) unit drop in eGFR at the time of infection. No change in eGFR was seen following vaccination (Figures 1a and b). Crude vaccine effectiveness was 80% for "any" and 86% for "severe" infection.

**Conclusions:** COVID19 infection resulted in high rates of hospitalization and acute decline in eGFR among GD patients. Vaccination was associated with lower rates of COVID19 infection and severe disease and did not affect kidney function in the short term.

**Funding:** NIDDK Support

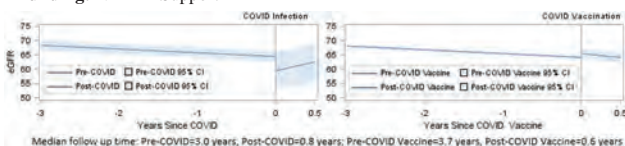

Figure 1: eGFR slope pre- and post-COVID19 Infection (a) and vaccination (b).

TH-PO475

Challenges in Diagnosis and Management of Glomerular Disease in a Resource-Limited Setting

Raja Ramachandran,<sup>1</sup> Ifeoma I. Ulasi,<sup>3</sup> Ugochi C. Onu,<sup>3</sup> Vivekanand Jha,<sup>2</sup> <sup>1</sup>Postgraduate Institute of Medical Education and Research, Chandigarh, India; <sup>2</sup>George Institute for Global Health, UNSW, Delhi, India; <sup>3</sup>College of Medicine, University of Nigeria, Iku-Ozalla, Nigeria.

**Background:** Glomerular diseases are the leading driver of non-diabetic chronic kidney disease (CKD) disability-adjusted life years in third world countries. Proper diagnosis and treatment rely on access to resources, including kidney biopsy, ancillary testing and access to evidence-based therapies.

**Methods:** After an initial pilot phase, we conducted a cross-sectional internet-based survey among nephrologists in countries of Asia, Africa and Eastern Europe. In the survey, we collected the baseline demographic data, the ability to perform and appropriately interpret a kidney biopsy, and access to complementary investigations and treatment practices.

**Results:** 298 kidney care specialists took part in the survey (64% from academic/university hospitals). Eighty-two percent performed kidney biopsy. About 61% of the respondents could not get a kidney biopsy in >50% of patients with suspected glomerular disease. About 43% of the respondents from Africa had access only to light microscopy. Overall, the inability to undertake and fully evaluate a biopsy and perform ancillary investigations was more profound in Africa than in Asia. Sixty per cent of the participants reported >75% of their patients meeting the cost of diagnosis and treatment by out-of-pocket expenses. Empirical use of immunosuppression was higher in Africa than in Asia. The main barriers to diagnosis and treatment included a delayed presentation, incomplete diagnostic work-up and high cost of treatment.

Key: TH - Thursday; FR - Friday; SA - Saturday; OR - Oral; PO - Poster; PUB - Publication Only

Underline represents presenting author.

**Conclusions:** There are major barriers to implementing a guideline-driven approach to the diagnosis and treatment of patients with glomerular disease in limited-resource countries.

TH-PO476

GSTM1 Deletion Associates With Progression of Glomerular CKD

Rebecca Levy,<sup>1</sup> Kimberly J. Reidy,<sup>2</sup> Rick Kaskel,<sup>2</sup> Thu H. Le,<sup>1</sup> Michal L. Melamed,<sup>2</sup> NEPTUNE Investigators <sup>1</sup>University of Rochester Medical Center, Rochester, NY; <sup>2</sup>Albert Einstein College of Medicine, Bronx, NY.

**Background:** Risk factors for progression in glomerular disease are not well-understood. A common deletion in *GSTM1* is associated with progression in a variety of CKD etiologies but has not been previously reported in glomerular disease.

**Methods:** We performed a secondary analysis of the prospective NEPTUNE cohort. The exposure is ≥1 copy of nonfunctional *GSTM1*. The primary outcome is 40% reduction in eGFR or ESKD. Secondary outcomes include proteinuria remission and relapse. Analysis was by multivariable logistic regression with adjustment for potential confounders.

**Results:** Baseline characteristics of the study cohort are shown in Table 1. Of the 513 subjects, 60% were male, 57% were White, and they had a mean age of 30.4. At baseline, subjects with *GSTM1* deletion were younger with worse kidney function; they were more likely to have FSGS and self-identify as Black. Participants were followed for a mean of 2.4±1.6 years; 118 participants developed the primary outcome, 88 (23%) in the *GSTM1* 1/1 group and 30 (32%) in the *GSTM1* deletion group. After adjustment for demographics and baseline severity, *GSTM1* deletion is associated with progression of CKD (OR 1.91, CI 1.12-3.27) but not with changes in proteinuria.

**Conclusions:** *GSTM1* deletion is associated with progression of CKD in glomerular disease but unlikely involves proteinuric pathways in this cohort.

	Total (n=513)	Reference (n=406)	Deletion (n=107)	p
Age	30.4±22.3	31.7±22.8	24.9±18.9	0.006
Male	308 (60%)	245 (60%)	63 (59%)	0.8
Race				<0.001
Multiracial	24 (4.8%)	17 (4.2%)	7 (7.0%)	
Native American	1 (0.2%)	0	1 (1.0%)	
Asian	57 (11%)	57 (14%)	0	
Black	112 (22%)	34 (8.5%)	78 (79%)	
Pacific Islander	2 (0.4%)	2 (0.5%)	0	
White	287 (57%)	281 (70%)	6 (6.1%)	
Unknown	18 (3.6%)	11 (2.7%)	7 (7.1%)	
Hispanic	107 (21%)	92 (23%)	15 (15%)	0.1
Diagnosis				<0.001
Membranous	83 (17%)	77 (21%)	6 (5.9%)	
Minimal Change	146 (31%)	122 (33%)	24 (24%)	
FSGS	158 (33%)	107 (29%)	51 (50%)	
Other	89 (19%)	68 (18%)	21 (21%)	
Baseline				
eGFR	84.2±38.1	86.5±37.5	73.4±38.8	0.002
UPCR	4.2±6.3	4.5±6.7	3.9±4.2	0.6
HTN	214 (43%)	172 (43%)	42 (42%)	0.9

TH-PO477

Assessing the Form of Predictor-Outcome Association for Machine Learning Models of Patient-Reported Outcomes in Nephrotic Syndrome

Jeremy Rubin,<sup>1</sup> Laura H. Mariani,<sup>2</sup> Abigail R. Smith,<sup>3</sup> Jarcy Zee,<sup>1</sup> <sup>1</sup>University of Pennsylvania Perelman School of Medicine, Philadelphia, PA; <sup>2</sup>University of Michigan Michigan Medicine, Ann Arbor, MI; <sup>3</sup>Arbor Research Collaborative for Health, Ann Arbor, MI.

**Background:** Penalized regression models can be used to identify and rank risk factors for poor quality of life, but they often assume covariates have linear associations with the outcome. There is no standard, automated method for determining the optimal functional forms (shapes of relationships) between predictors and the outcome in high-dimensional data settings.

**Methods:** We propose a novel algorithm, Ridge regression for functional form Identification of continuous Predictors (RIP), that models each continuous covariate with linear, quadratic, quartile, and cubic spline basis components in a ridge regression model to capture potential nonlinear relationships between continuous predictors and outcomes. We used a simulation study to test the performance of RIP compared to standard and spline ridge regression models. Then, we applied RIP to identify top predictors of baseline Patient-Reported Outcomes Measurement Information System (PROMIS) adult global mental and physical health scores using demographic and clinical characteristics among N=107 glomerular disease patients enrolled in the Nephrotic Syndrome Study Network (NEPTUNE).

**Results:** RIP resulted in better predictive accuracy in 56-80% of simulation repetitions under a variety of data characteristics. When applied to the PROMIS scores in NEPTUNE, RIP resulted in the lowest error for predicting physical scores, but the highest error for the mental scores. Further, RIP identified functional forms of top predictors of the physical scores that were missed by the other models [Figure 1].

**Conclusions:** The RIP algorithm can capture nonlinear functional forms of predictors that are missed by standard ridge regression models. The top predictors of PROMIS scores vary greatly across methods. RIP should be considered alongside other machine learning models in the prediction of patient-reported outcomes.

Figure 1. Top Predictors of Physical PROMIS Scores

Ranking	RIP	Regular Ridge Regression	Spline Ridge Regression
1	Annual household income	Annual household income	Annual household income
2	Hemoglobin (quartile)	Chloride	WBC
3	WBC (spline, quartile)	Alcohol use	Alcohol use
4	Alcohol use	Shortness of breath	Blood Urea Nitrogen
5	eGFR at baseline (quartile, spline)	Nausea and/or vomiting	Participant age
6	Blood Urea Nitrogen (spline, quad)	Number of times received ER care	Shortness of breath
7	Shortness of breath	Total number of days hospitalized	Age of biological father
8	Participant age (spline)	Any edema present	Chloride
9	Number of times seen provider for well/check visits (quartile, spline)	Hypertension at baseline	Nausea and/or vomiting
10	Age of biological father (spline)	eGFR at baseline	Number of times seen provider for well/check visits
11	Number of times seen by wellness provider for illness/injuries (quartile)	Blood Urea Nitrogen	Number of times received ER care
12		Race of father	

For the RIP algorithm, functional forms per predictor are given in parentheses by the predictor name. Num of times are past 6 mos.

TH-PO478

Evaluating the Predictors of Structural Features in Kidney Biopsies From Adults With Focal Segmental Glomerulosclerosis

Katherine R. Tuttle,<sup>1,2</sup> Clint Abner,<sup>3</sup> Patrick D. Walker,<sup>3</sup> Kaijun Wang,<sup>4</sup> Martin C. Bunke,<sup>4</sup> Ji Haeng Heo,<sup>5</sup> Andrew Rava.<sup>5</sup> <sup>1</sup>Providence Health, Spokane, WA; <sup>2</sup>University of Washington, Seattle, WA; <sup>3</sup>Arkana Laboratories, Little Rock, AR; <sup>4</sup>Travere Therapeutics Inc, San Diego, CA; <sup>5</sup>Genesis Research LLC, Hoboken, NJ.

**Background:** Focal segmental glomerulosclerosis [FSGS] is a lesion of glomerular injury in patients with nephrotic syndrome. The aim of this study was to assess clinical predictors of FSGS histological severity among adults undergoing kidney biopsy.

**Methods:** A real-world data study was performed using the Arkana Biopsy database (1Jan2016–31May2020). Inclusion criteria: ≥18 years, ≥1 FSGS positive biopsy, no prior kidney transplant. Associations between chronic kidney disease [CKD] stage (eGFR by 2021 CKD-EPI-creatinine equation) and nephrotic range proteinuria (<3.0 g/g or <3.5 g/day vs. ≥3.0 g/g or ≥3.5 g/day) at the time of biopsy and FSGS structural features (severe: interstitial fibrosis and tubular atrophy [IFTA] >25% and global glomerulosclerosis [GS] >50% vs. non-severe) were analyzed using multivariate logistic regression. Models were adjusted for age, sex, race, and hypertension status.

**Results:** In 2,011 patients with biopsy proven FSGS, CKD stage 3A (OR 4.5, p=0.002) and CKD stages 3B–5 (OR 12.2–22.1, p<0.001) predicted severe histological features, whereas nephrotic range proteinuria did not (Table 1). Younger age at biopsy, non-White racial identity, and hypertension also predicted severe histologic features (p<0.05).

**Conclusions:** Severe histologic features of FSGS are predicted by later CKD stage, but not nephrotic range proteinuria, at the time of kidney biopsy. Strategies for earlier diagnosis before onset of eGFR decline and severe structural injury, particularly in younger, non-White, and hypertensive patients, are needed to improve kidney disease outcomes in patients with FSGS.

**Funding:** Commercial Support - Travere Therapeutics, Inc

Table 1: Clinical predictors of severe histological features of FSGS

Predictor	Odds Ratio (95% CI)	p-value
CKD Stage 1	Ref.	-
CKD Stage 2	1.1 (0.3–3.3)	0.905
CKD Stage 3A	4.5 (1.7–11.7)	0.002
CKD Stage 3B	12.2 (5.0–29.9)	<0.001
CKD Stage 4	16.1 (6.6–39.3)	<0.001
CKD Stage 5	22.1 (8.3–58.7)	<0.001
Nephrotic proteinuria: No	Ref.	-
Nephrotic proteinuria: Yes	1.1 (0.8–1.6)	0.505
Age: 18–44 years	Ref.	-
Age: 45–64 years	0.6 (0.4–0.9)	0.011
Age: 65+ years	0.4 (0.3–0.7)	<0.001
Sex: Female	Ref.	-
Sex: Male	0.8 (0.6–1.2)	0.347
Race: White	Ref.	-
Race: Other (Non-White)	2.6 (1.8–3.7)	<0.001
Hypertension: No	Ref.	-
Hypertension: Yes	3.7 (1.1–12.9)	0.038

TH-PO479

Longitudinal Proteinuria Trajectories and Their Association With Kidney Failure in Minimal Change Disease and Focal Segmental Glomerulosclerosis: A CureGN Study

Abigail R. Smith,<sup>1</sup> Margaret Helmut,<sup>1</sup> Anand Achanti,<sup>1,3</sup> Salem Almaani,<sup>2</sup> Diego H. Aviles,<sup>3</sup> Isabelle Ayoub,<sup>2</sup> Pietro A. Canetta,<sup>4</sup> Daniel C. Cattran,<sup>5</sup> Dhruvi P. Chen,<sup>6</sup> Yelena Drexler,<sup>1,7</sup> Alessia Fornoni,<sup>7</sup> Debbie Gipson,<sup>1,5</sup> Rick Kaskel,<sup>8</sup> Jeffrey B. Kopp,<sup>9</sup> Louis-Philippe Laurin,<sup>14</sup> Dana Rizk,<sup>10</sup> Bruce M. Robinson,<sup>1</sup> William E. Smoyer,<sup>11</sup> Julia M. Steinke,<sup>16</sup> Brenda W. Gillespie.<sup>12</sup> <sup>1</sup>Arbor Research Collaborative for Health, Ann Arbor, MI; <sup>2</sup>The Ohio State University Wexner Medical Center, Columbus, OH; <sup>3</sup>LSU Health New Orleans, New Orleans, LA; <sup>4</sup>Columbia University Irving Medical Center, New York, NY; <sup>5</sup>University of Toronto, Toronto, ON, Canada; <sup>6</sup>University of North Carolina System, Chapel Hill, NC; <sup>7</sup>University of Miami Health System, Miami, FL; <sup>8</sup>Albert Einstein College of Medicine, Bronx, NY; <sup>9</sup>National Institute of Diabetes and Digestive and Kidney Diseases, Bethesda, MD; <sup>10</sup>UAB Health System, Birmingham, AL; <sup>11</sup>Nationwide Children's Hospital, Columbus, OH; <sup>12</sup>University of Michigan, Ann Arbor, MI; <sup>13</sup>Medical University of South Carolina, Charleston, SC; <sup>14</sup>Universite de Montreal, Montreal, QC, Canada; <sup>15</sup>University of Michigan Michigan Medicine, Ann Arbor, MI; <sup>16</sup>Spectrum Health Helen DeVos Children's Hospital, Grand Rapids, MI; <sup>17</sup>University of Miami School of Medicine, Miami, FL.

**Background:** Proteinuria often guides treatment decisions and measures response in glomerular disease. We characterized longitudinal proteinuria trajectories in patients with MCD and FSGS and assessed associations with kidney failure (KF).

**Methods:** Participants with MCD and FSGS enrolled in the Cure Glomerulonephropathy (CureGN) study with a first diagnostic kidney biopsy in the 5 years prior to enrollment and ≥2 years of follow-up were included. Participants were grouped based on proteinuria trajectory in the first 2 years post-enrollment using latent class trajectory analysis. Associations between group membership and incidence of KF beyond 2 years post enrollment were assessed using multivariable Cox regression.

**Results:** 887 participants (423 MCD, 464 FSGS) were included. Median age was 17 years (IQR 8–44); 53% were male; 22% were Black. Median follow-up time from enrollment was 4.5 years (IQR 3.4–5.7). Mean (SD) eGFR (ml/min/1.73m<sup>2</sup>) and UPCr (g/g) at enrollment were 89.3 (33.0) and 2.5 (3.2), respectively. Three groups were identified (Figure); Group 1 (78%) had consistently low UPCr (<1); Group 2 (12%) had high UPCr at enrollment that decreased by the start of year 2 to <2; Group 3 (10%) had consistently high UPCr (>6). Groups 1 and 2 were approximately evenly split between MCD and FSGS (48% and 52% for Group 1, 56% and 44% for Group 2), while Group 3 was predominantly FSGS (65%). Group 3 had higher hazard of progression to KF after 2 years post-enrollment compared to Group 1 (HR=3.4, 95% CI=1.6–7.3), after adjusting for diagnosis, age, eGFR at enrollment, and years from biopsy to enrollment. No interaction between diagnosis and proteinuria trajectory was detected (p=0.24).

**Conclusions:** Longitudinal proteinuria trajectories add additional information beyond diagnosis and baseline disease severity when characterizing risk of KF in patients with MCD and FSGS.

**Funding:** NIDDK Support

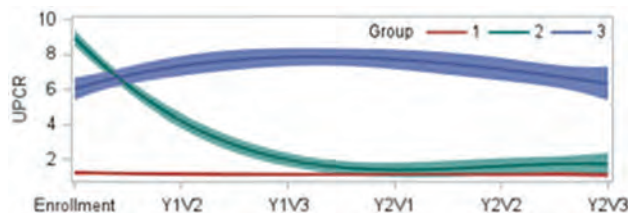

Mean UPCr trajectories with 95% confidence intervals.

TH-PO480

Design of a Phase 2/3 Adaptive Trial Evaluating Inaxaplin in APOL1-Mediated Kidney Disease

Ronald Falk,<sup>1</sup> Laura Barisoni,<sup>2</sup> David Friedman,<sup>3</sup> Debbie Gipson,<sup>4</sup> Michael Lipkowitz,<sup>5</sup> Akinlolu Ojo,<sup>6</sup> Martin Pollak,<sup>3</sup> Madalina Chiriac,<sup>7</sup> Mariana Faria-Urbina,<sup>7</sup> Yang Song,<sup>7</sup> George Manos,<sup>7</sup> Anna Ferreira,<sup>7</sup> Ogo I. Egbuna,<sup>7</sup> Glenn Chertow.<sup>8</sup> <sup>1</sup>UNC, Chapel Hill, NC; <sup>2</sup>Duke University, Durham, NC; <sup>3</sup>BIDMC, Harvard Medical School, Boston, MA; <sup>4</sup>University of Michigan, Ann Arbor, MI; <sup>5</sup>Georgetown University Hospital, Washington DC, DC; <sup>6</sup>University of Kansas School of Medicine, Kansas City, KS; <sup>7</sup>Vertex Pharmaceuticals Incorporated, Boston, MA; <sup>8</sup>Stanford University School of Medicine, Stanford, CA.

**Background:** There is a critical need for therapies targeting the underlying cause of APOL1-mediated kidney disease (AMKD), a proteinuric nephropathy caused by 2 APOL1 variants (G1 or G2) that affects about 100,000 people in US and Europe. Inaxaplin (IXP; VX-147) is a small molecule inhibitor of APOL1 pore function. In a Ph2a trial, IXP significantly reduced proteinuria by 47.6% in participants with 2 APOL1 variants, proteinuria, and focal segmental glomerulosclerosis (FSGS). We describe the design of a Ph2/3 trial evaluating IXP in adults with AMKD.

**Methods:** This randomized, double-blind, placebo-controlled, Ph2/3 adaptive trial in adults with AMKD will first evaluate different doses of IXP to select a dose for Ph3 and subsequently evaluate the efficacy and safety of the selected IXP dose in the Ph3 portion of the trial. Participants aged 18 to 60 years, with 2 *APOL1* variants, urine protein to creatinine ratio (UPCR) of  $\geq 0.7$ g/g to  $< 10$ g/g, estimated glomerular filtration rate (eGFR) of  $\geq 25$  to  $< 75$  mL/min/1.73m<sup>2</sup>, and on stable standard-of-care medications may be eligible to enroll. In Ph2, ~66 participants will be randomized to receive 1 of 2 daily doses of IXP or placebo for 12wks. Ph3 (~400 participants) will begin after Ph2 enrollment is complete.

**Results:** The primary endpoint for the final analysis is reduction in the rate of decline of kidney function as measured by eGFR slope in participants receiving IXP versus placebo at ~2 years. The secondary efficacy endpoint for the final analysis is time to composite clinical outcome, which is defined as a sustained decline of  $\geq 30\%$  from baseline in eGFR, the onset of end-stage kidney disease (i.e., maintenance dialysis for  $\geq 28$  days, kidney transplantation, or a sustained eGFR of  $< 15$  mL/min/1.73m<sup>2</sup>), or death. The final trial analysis will occur when participants have  $\geq 2$  years of eGFR data and when ~187 composite clinical outcomes have occurred. The trial has a pre-planned interim analysis at Week 48 evaluating proteinuria, as measured by the percent change from baseline in UPCR, and eGFR slope.

**Conclusions:** This Ph2/3 adaptive trial will determine the efficacy and safety of IXP in preserving kidney function and reducing proteinuria in a broad population with AMKD.

**Funding:** Commercial Support - Vertex Pharmaceuticals

**TH-PO481**

**APOL1 Genotyping and Proteinuric Kidney Disease**

Kate Bramham,<sup>1</sup> Vincent Audard,<sup>2</sup> Jean-Jacques Boffa,<sup>3</sup> Diego Echeverri,<sup>4</sup> Bertrand Knebelmann,<sup>5</sup> Kieran Mccafferty,<sup>6</sup> Thomas Powell,<sup>7</sup> Christopher Provenzano,<sup>8</sup> Nauman Shahid,<sup>9</sup> Mohamad Zaidan,<sup>10</sup> John Bauman,<sup>11</sup> Aurelia Zamauskaitė,<sup>12</sup> George Manos,<sup>12</sup> Silva Krause,<sup>12</sup> Mariana Faria-Urbina,<sup>12</sup> Ogo I. Egbuna,<sup>12</sup> Glenn Chertow.<sup>13</sup> *King's College London, London, United Kingdom;* <sup>2</sup>*Nephrology and Renal Transplantation Department, Institut National de la Santé et de la Recherche Médicale (INSERM) U955, Henri Mondor Hospital, Assistance Publique des Hôpitaux de Paris (AP-HP), Paris Est Créteil University, Créteil, France;* <sup>3</sup>*Hôpital Tenon, Paris, France;* <sup>4</sup>*South Florida Nephrology Associates, Lauderdale Lakes, FL;* <sup>5</sup>*Necker Hospital, APHP, Université Paris Cité, Paris, France;* <sup>6</sup>*Bart's Health NHS Trust, London, United Kingdom;* <sup>7</sup>*Columbia Nephrology Associates, Columbia, SC;* <sup>8</sup>*St. Clair Nephrology, Detroit, MI;* <sup>9</sup>*Eastern Nephrology Associates, Greenville, NC;* <sup>10</sup>*Nephrology and Renal Transplantation Department, Bicêtre University Hospital, Assistance Publique des Hôpitaux de Paris (AP-HP), Paris Saclay University, Le Kremlin-Bicêtre, France;* <sup>11</sup>*Labcorp Drug Development, Morrisville, NC;* <sup>12</sup>*Vertex Pharmaceuticals Incorporated, Boston, MA;* <sup>13</sup>*Stanford University School of Medicine, Palo Alto, CA.*

**Background:** Two toxic gain-of-function variants (*G1* or *G2*) in *APOL1* are genetic factors driving a progressive, proteinuric nephropathy referred to as *APOL1*-mediated kidney disease (AMKD). *APOL1* variants are common in persons of recent African ancestry, but *APOL1* genotyping is not routine and therefore their prevalence is not well-known. We report interim data of a trial estimating the prevalence of *APOL1* genotypes in participants with chronic kidney disease (CKD).

**Methods:** Up to 2,500 participants of recent African ancestry or geographic origin with focal segmental glomerulosclerosis (FSGS) or other nondiabetic kidney disease (NDKD) and a urine protein to creatinine ratio of  $\geq 0.1$ g/g will be enrolled (Table). Blood samples are used to determine genotypes using a polymerase chain reaction (PCR) assay; Sanger sequencing is used to confirm accuracy of the PCR assay. We will assess the percent of participants with 2 *APOL1* variants.

**Results:** Interim analysis included 738 participants, 213 (28.9%) with FSGS and 525 (71.1%) with NDKD, of whom 110 (51.6%) and 124 (23.6%), respectively, have 2 *APOL1* variants (*G1* or *G2*). The table shows the distribution of participants with 2 *APOL1* variants by disease state and region.

**Conclusions:** Using a highly sensitive genotyping assay to generate one of the largest *APOL1* genotyping datasets, we show preliminary data on the noteworthy prevalence of 2 *APOL1* variants in participants with proteinuric CKD and recent African ancestry across geographies. These results underscore the importance of *APOL1* genotyping in routine care to identify AMKD, optimize patients' disease management, and enable referral for clinical trials of *APOL1* inhibitors.

**Funding:** Commercial Support - Vertex Pharmaceuticals

**Table1. Baseline Demographics and APOL1 Genotyping Results**

	FSGS N = 213	NDKD N = 525	Total N = 738
<b>Age (years), mean (SD)</b>	43.5 (14.4)	55.7 (14.6)	52.2 (15.5)
<b>Country, n (%)</b>			
United States	160 (75.1)	482 (91.8)	642 (87.0)
United Kingdom	29 (13.6)	20 (3.8)	49 (6.6)
France	23 (10.8)	19 (3.6)	42 (5.7)
Spain	1 (0.5)	3 (0.6)	4 (0.5)
Puerto Rico	0	1 (0.2)	1 (0.1)
<b>G1/G1, G1/G2, or G2/G2 APOL1 genotype, n (%)</b>	110 (51.6)	124 (23.6)	234 (31.7)
G1/G1	55 (25.8)	58 (11.0)	113 (15.3)
G1/G2	45 (21.1)	54 (10.3)	99 (13.4)
G2/G2	10 (4.7)	12 (2.3)	22 (3.0)
<b>G1/G1, G1/G2, or G2/G2 APOL1 genotype by country, n (%)<sup>a</sup></b>			
United States/Puerto Rico	73 (45.6)	114 (23.6)	187 (29.1)
Europe	37 (69.8)	10 (23.8)	47 (49.5)
United Kingdom	20 (69.0)	8 (40.0)	28 (57.1)
France	17 (73.9)	1 (5.3)	18 (42.9)
Spain	0	1 (33.3)	1 (25.0)

*APOL1*: Apolipoprotein L1; FSGS: focal segmental glomerulosclerosis; IA: interim analysis; NDKD: nondiabetic kidney disease

Notes: Eligible participants are 12 to 60 years of age and of African ancestry or geographic origin (Black, Caribbean, African American, Sub-Saharan African, Cuban, Mexican, Puerto Rican, South or Central American, or other Spanish culture/origin). For more information about the trial, please see <https://apol1program.com/>. This table includes participants in the Full IA Set with a genotyping result. Percentages were calculated based on the number of participants in the full IA set, unless otherwise specified.

<sup>a</sup> Percentages were calculated based on the total number of participants in each country per disease state.

**TH-PO482**

**A Steep Slope: APOL1 High Risk Genotype and GFR Decline Among Black Patients With Membranous Nephropathy**

Dhruvi P. Chen, Candace D. Henderson, Mary M. Collie, Yichun Hu, Susan L. Hogan, Ronald Falk. *University of North Carolina System, Chapel Hill, NC.*

**Background:** Genetic variants in the Apolipoprotein L1 (*APOL1*) gene contribute to kidney disease burden in black patients, but the influence in membranous nephropathy (MN) has not been studied.

**Methods:** Black MN patients enrolled in the Glomerular Disease Collaborative Network or Cure Glomerulonephropathy Network with DNA or *APOL1* genotyping and non-black MN patients were included. eGFR was calculated using the non-race-based CKD-Epi equation for adults  $> 26$  years and Schwartz for  $< 18$  years. For ages 18-26, equations were combined. eGFR slopes estimated using linear mixed effects models with random effect for each group, assuming an unstructured covariance and adjusting by group. Fisher's exact, Wilcoxon rank, and Kaplan-Meier curves with log rank tests were used for time to ESKD.

**Results:** Among 118 black MN patients, 16 (14%) had high risk *APOL1* risk alleles (2 *APOL1* alleles), and 102 (86%) had low risk alleles (0 or 1 alleles, n = 53 and n = 49, respectively). High risk *APOL1* patients were younger at disease onset compared to low risk *APOL1* and non-black patients (n=573). Despite similar GFR at diagnosis, GFR decline was worse in those with 2 *APOL1* risk alleles (-15.3mL/min/1.73m<sup>2</sup>/year) compared to black MN patients with 0 (-3.3mL/min/1.73m<sup>2</sup>/year) or 1 risk allele (-3.0mL/min/1.73m<sup>2</sup>/year) and non-black MN patients (-2.4mL/min/1.73m<sup>2</sup>/year). Time to ESKD was faster in the high risk *APOL1* group compared to low risk *APOL1* or non-black MN patients (logrank p<0.05).

**Conclusions:** The prevalence of high risk *APOL1* variant among black MN patients is comparable to the general black population. The high risk *APOL1* genotype conferred worse eGFR decline and faster time to ESKD in MN. Black patients with low risk *APOL1* alleles had a similar GFR decline to the non-black MN patients. *APOL1* is a valuable clinical prognostic marker in black patients with MN.

**Funding:** NIDDK Support, Commercial Support - Vertex Pharmaceuticals, Government Support - Non-U.S.



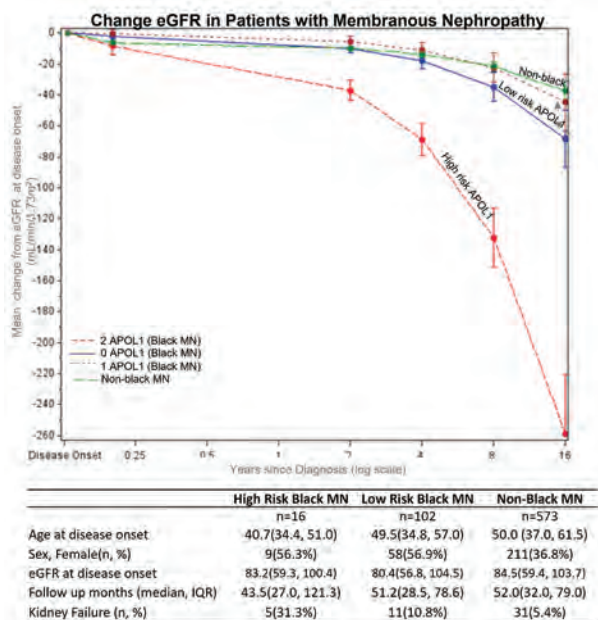

TH-PO483

**Ofatumumab in Rituximab-Resistant and Rituximab-Intolerant Patients With Membranous Nephropathy**

Manuel A. Podesta<sup>1,2</sup>, Valentina Portalupi,<sup>3</sup> Alessia Gennarini,<sup>3</sup> Alessandro Villa,<sup>2</sup> Nadia Rubis,<sup>2</sup> Giuseppe Remuzzi,<sup>2</sup> Piero L. Ruggenenti.<sup>3,2</sup>  
<sup>1</sup>Università degli Studi di Milano, Milano, Italy; <sup>2</sup>Istituto di Ricerche Farmacologiche Mario Negri Centro Aldo e Cele Dacco, Ranica, Italy; <sup>3</sup>Aziende Socio Sanitarie Territoriale Papa Giovanni XXIII, Bergamo, Italy.

**Background:** Rituximab (RTX) has become the mainstay therapy for patients with membranous nephropathy (MN) at high risk of progression to kidney failure. However, this treatment is effective only in ~65% of patients, and exposure to repeated RTX infusions may be complicated by hypersensitivity reactions, which contraindicate re-treatment. Ofatumumab, a human anti-CD20 antibody with higher cytotoxicity, could overcome these limitations.

**Methods:** In this retrospective cohort study, we enrolled adult patients with MN who either experienced hypersensitivity reactions (RTX-intolerant, n=5) or failed to achieve complete or partial remission after RTX administration (RTX-resistant, n=12), and were treated with ofatumumab as a rescue therapy (50-300 mg).

**Results:** After a median follow-up time of 1 year, 58.8% of patients achieved complete or partial remission of the nephrotic syndrome (41.7% in RTX-resistant and 100% in RTX-intolerant). In patients with positive anti-PLA<sub>2</sub>R at baseline (n=12), 58.3% achieved serological remission during the follow-up (50% in RTX-resistant and 100% in RTX-intolerant). Reduction in urinary protein excretion was closely mirrored by an increase in serum albumin levels (Figure 1). Measured GFR increased by a median of 13.4% at 24 months compared to baseline. There were 14 non-serious infusion-related adverse events in 9 patients, all of which completely resolved.

**Conclusions:** Ofatumumab may represent a viable option for the treatment of MN patients who are resistant or intolerant to RTX.

Baseline characteristics

	Overall (n=17)	RTX-Resistant (n=12)	RTX-Intolerant (n=5)
Age (years)	51.0±13.6	53.3±14.5	45.6±10.3
mGFR (mL/min/1.73m <sup>2</sup> )	52.1 [38.6; 75.4]	41.9 [37.8; 72.8]	67.4 [55.8; 85.4]
Serum Albumin (g/dL)	2.5±0.5	2.5±0.5	2.6±0.6
Urinary Protein (g/24h)	9.0±4.3	10.3±4.3	6.2±2.8
Serum Anti-PLA <sub>2</sub> R (RU/mL)	66 [14; 117]	66 [11; 146]	53 [18; 89]
Ofatumumab Dose (mg)	300 [100; 300]	300 [63; 300]	300 [100; 300]
MN Onset (years)	9.9±5.1	8.5±5.3	13.2±2.4

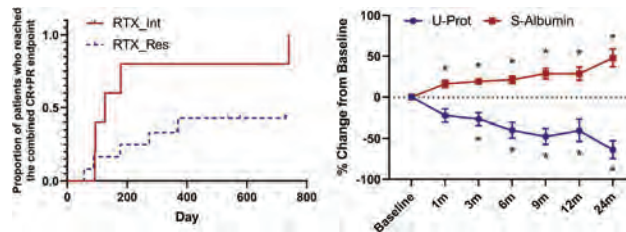

(L) Cumulative incidence of CR/PR in RTX-intolerant and -resistant patients. (R) % change in proteinuria and serum albumin after Ofatumumab.

TH-PO484

**Analysis of Serum Belimumab Pharmacokinetics in Primary Membranous Nephropathy: Data From the REBOOT Study**

Patrick H. Nachman,<sup>1</sup> Lia Weiner,<sup>2</sup> Sharon Chung,<sup>3</sup> Linna Ding,<sup>4</sup> William T. Barry,<sup>2</sup> ITN080AI REBOOT Study Investigators <sup>1</sup>University of Minnesota Health, Minneapolis, MN; <sup>2</sup>Rho, Inc., Durham, NC; <sup>3</sup>Immune Tolerance Network, San Francisco, CA; <sup>4</sup>National Institute of Allergy and Infectious Diseases, Bethesda, MD.

**Background:** Patients with primary membranous nephropathy (PMN) are known to lose immunoglobulin in the urine at rates affected by the severity of proteinuria. This loss could impact the dosing of monoclonal antibodies used for treatment. Belimumab (BEL), an IgG1 monoclonal antibody, has been detected in the urine of patients with PMN receiving this therapy. We conducted this study to examine the relationship between serum BEL exposure and baseline proteinuria to inform dosing in PMN.

**Methods:** REBOOT is a two-part clinical trial examining the efficacy of BEL and rituximab therapy in PMN (NCT03949855). Part A is an open-label study examining how baseline proteinuria affects BEL exposure. Participants received subcutaneous BEL at a dose of 200 mg weekly. Serum BEL trough levels were drawn after each of the first 4 doses. The relationship between BEL exposure and baseline proteinuria was assessed using longitudinal mixed models, which included the defined low (>4 to ≤ 8 g/day) and high (≥ 8 g/day) proteinuria subgroups.

**Results:** The baseline proteinuria of the 12 evaluated participants ranged from 4.1-21.3 g/day, with 4 participants in the low and 8 participants in the high proteinuria groups. The ratio of the mean serum BEL trough levels at week 4 between the high and low proteinuria groups was 0.78 (95% CI 0.52-1.2). Regression models predicted that a 1 g/day increase in proteinuria results in a 1.9% decrease in trough levels (p=0.262). Figure 1 shows the serum trough levels after the fourth BEL dose by baseline proteinuria level, and the predicted BEL levels from regression modeling.

**Conclusions:** This data suggests that serum BEL exposure is not significantly associated with baseline proteinuria levels in PMN, and does not support increasing the dose of BEL in individuals with higher levels of proteinuria.

**Funding:** Other NIH Support - Division of Allergy, Immunology, and Transplantation, National Institute of Allergy and Infectious Diseases, Commercial Support - GlaxoSmithKline, plc

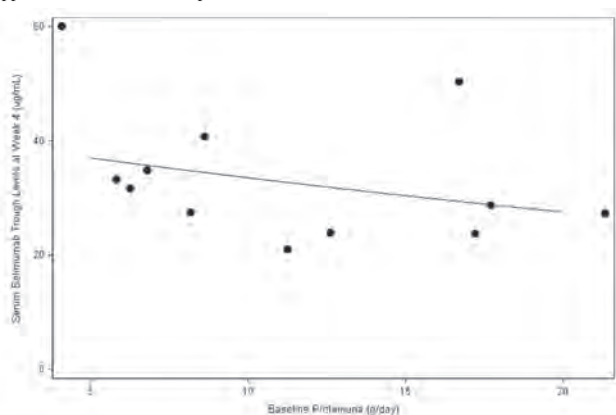

Figure 1: Week 4 serum belimumab trough levels by baseline proteinuria. The line presents the predicted belimumab level values from a mixed model.

## TH-PO485

**A Large International Registry Study on Membranous Nephropathy Recurrence Post-Transplant**

Frank E. Hullekes,<sup>1,2</sup> Paolo Cravedi,<sup>3</sup> Leonardo V. Riella.<sup>1,2</sup> The Post-Transplant Glomerular Disease (TANGO) Consortium <sup>1</sup>Massachusetts General Hospital, Boston, MA; <sup>2</sup>Harvard Medical School, Boston, MA; <sup>3</sup>Icahn School of Medicine at Mount Sinai, New York, NY.

**Background:** Membranous nephropathy (MN) is one of the major causes of nephrotic syndrome in adults worldwide and frequently recurs after transplant. Disease activity is driven by underlying autoimmune processes, leading to circulating autoantibodies directed against glomerular podocyte antigens. Multiple target proteins have been associated with MN in the past decade, including PLA2R and THSD7A. No clear clinical and immunological characteristics have been associated with recurrent MN, as most studies were single-centers and underpowered.

**Methods:** Through the Post-Transplant Glomerular Disease (TANGO) Consortium, we initiated a multi-center retrospective cohort study aiming to investigate MN recurrence after transplant. Adult patients with biopsy-proven MN, transplanted between 2005-2018 were identified to study the incidence of recurrent MN, any potential predictors, and treatment regimens. Serum samples were retrieved for a subset of patients to identify a potential role of podocyte autoantibodies in predicting and detecting recurrence.

**Results:** 22,921 patients were screened by 16 transplant centers across three continents. Among these, 188 kidney transplant patients with biopsy-proven MN were included for data analysis. The cumulative incidence for recurrence was 30% (95% CI: 16-42) at 10 years post-transplant. The median time to diagnose recurrence was 4.9 years [IQR: 2.2-7.6]. Graft survival rates were similar between patients with and without a recurrence. Age at diagnosis, race, time from diagnosis to end-stage kidney disease (ESKD), BMI, time on dialysis, HLA mismatch, living donor, and early steroid withdrawal were not associated with recurrence.

**Conclusions:** Through the TANGO-Consortium, we identified the largest cohort to date of MN transplant patients. MN recurred in 30% but did not impact graft survival. Ongoing analysis of pre- and post-transplant serum samples will assess the correlation between autoantibody titers and risk of recurrence.

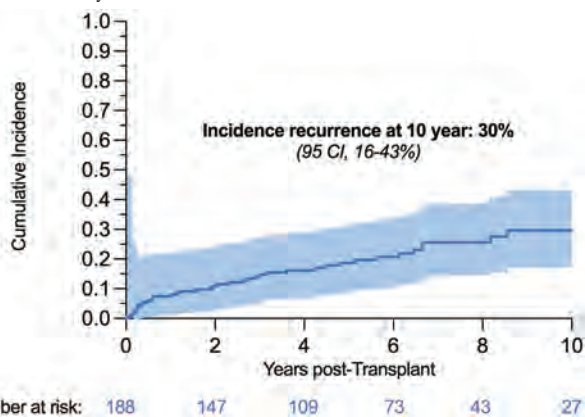

Cumulative incidence of MN recurrence

## TH-PO486

**Voclosporin for Lupus Nephritis: Assessment of Long-Term Safety and Efficacy Including Renal Outcome Over 3 Years of Treatment in the Phase 3 AURORA 1 and AURORA 2 Studies**

Samir V. Parikh,<sup>1</sup> Cristina Arriens,<sup>3</sup> Lucy S. Hodge,<sup>2</sup> Christopher Mela,<sup>2</sup> Henry Leher.<sup>2</sup> <sup>1</sup>The Ohio State University Wexner Medical Center, Columbus, OH; <sup>2</sup>Aurinia Pharmaceuticals Inc, Victoria, BC, Canada; <sup>3</sup>Oklahoma Medical Research Foundation, Oklahoma City, OK.

**Background:** In AURORA 1, adding voclosporin to mycophenolate mofetil (MMF) and low-dose steroids led to significant reductions in proteinuria at 1 year in patients with lupus nephritis (LN). We report on the recently completed AURORA 2 study evaluating voclosporin compared to placebo in patients treated for an additional 2 years after AURORA 1.

**Methods:** Patients with LN completing AURORA 1 were eligible to continue on the same double-blinded treatment of voclosporin or placebo in AURORA 2; all patients received MMF and low-dose steroids. Outcomes assessed over the 3 year treatment period of both studies included adverse events (AEs), eGFR, urine protein-creatinine ratio (UPCR), good renal outcome and renal flare. Good renal outcome was defined based on achievement of an adequate response (i.e. sustained reduction in UPCR to  $\leq 0.7$  mg/mg) and without renal flare (i.e. an increase to UPCR  $> 1$  mg/mg from a post-response UPCR of  $< 0.2$  mg/mg or an increase to UPCR  $> 2$  mg/mg from a post-response UPCR of 0.2 to 1.0 mg/mg), as adjudicated by a blinded Clinical Endpoints Committee.

**Results:** Overall rates of serious AEs in the voclosporin (26.7% of 116 patients) and control arm (28.0% of 100 patients) were similar. There were no deaths in the voclosporin arm during AURORA 2; four deaths occurred in the control arm (pulmonary embolism, n=1; coronavirus infection, n=3). Mean corrected eGFR was within the normal range and stable over the study period. The reductions in UPCR achieved in AURORA 1 were

maintained in AURORA 2 and significantly more patients in the voclosporin arm achieved a good renal outcome (66.4% in voclosporin vs 54.0% in control; p-value=0.045). Renal flare occurred in 24 of 101 patients with adequate response in the voclosporin arm and 19 of 73 patients in the control arm (23.8% in voclosporin vs 26.0% in control; p-value=0.662); 69.8% of all patients with renal flares completed study treatment.

**Conclusions:** Voclosporin was well-tolerated over three years of treatment. The significant reductions in proteinuria initially achieved in AURORA 1 were maintained throughout AURORA 2 and more patients in the voclosporin arm achieved a good renal outcome. These data provide evidence of a long-term treatment benefit of voclosporin in patients with lupus nephritis.

**Funding:** Commercial Support - Aurinia Pharmaceuticals Inc.

## TH-PO487

**Zetomizomib (KZR-616), a First-in-Class Selective Immunoproteasome Inhibitor for the Treatment of Lupus Nephritis: Preliminary Results From the Phase 2 MISSION Study**

Samir V. Parikh,<sup>1</sup> Richard Furie,<sup>4</sup> Amit Saxena,<sup>2</sup> Richard Leff,<sup>3,5</sup> Steven Y. Hua,<sup>3</sup> Li Long,<sup>3</sup> Noreen R. Henig.<sup>3</sup> <sup>1</sup>The Ohio State University Wexner Medical Center, Columbus, OH; <sup>2</sup>NYU Langone Health, New York, NY; <sup>3</sup>Kezar Life Sciences Inc, South San Francisco, CA; <sup>4</sup>Northwell Health, New Hyde Park, NY; <sup>5</sup>Richard L Leff MD LLC, Chadds Ford, PA.

**Background:** The MISSION study (NCT03393013), a Phase 1b/2, open-label study is to evaluate safety, tolerability, and exploratory efficacy of zetomizomib in patients with systemic lupus erythematosus (SLE) +/- lupus nephritis (LN). In the completed Phase 1b portion, zetomizomib was safe and well-tolerated and resulted in improvement across disease activity measures as well as biomarkers. The Phase 2 fully enrolled in Nov 2021, and here we present preliminary results from this signal-seeking study.

**Methods:** MISSION Phase 2 evaluated zetomizomib at 60 mg subcutaneously (SC) once weekly (QW) for 24 weeks (1<sup>st</sup> dose: 30 mg) in patients with active LN (Class III or IV  $\pm$  Class V) with urine protein to creatinine ratios (UPCR)  $\geq 1$  despite background therapy. Safety, tolerability, UPCR, renal function, SLE disease activity, and biomarkers were measured. Interim analysis of laboratory data was performed.

**Results:** As of October 1, 2021, 5 patients reached end of treatment (Week [W] 25), and 10 patients reached W13; 80% female; mean age 39.4 years; median LN duration 7.6 years; mean UPCR 2.2 (assessed from 24-hour collections); mean eGFR 78.5 mL/min/1.73 m<sup>2</sup>; all patients were on prednisone, and 8 and 5 patients were on mycophenolate mofetil or mycophenolic acid and hydroxychloroquine, respectively. At end of treatment, 3 of 5 patients achieved a  $\geq 50\%$  reduction in UPCR; 4 of the 5 patients had renal responses (2 complete renal response and 2 partial renal response). Zetomizomib administration improved UPCR and key biomarkers (eg, anti-dsDNA) as early as W13, and was associated with a favorable safety/tolerability profile. The most common adverse event (AE) was injection site reaction. Most AEs were mild to moderate (Grade  $\leq 2$ ). Two Serious AEs were reported in 2 patients (1 related and 1 unrelated). There were no discontinuations due to drug-related AEs. No opportunistic infections were reported.

**Conclusions:** Zetomizomib 60 mg SC QW demonstrated a favorable safety and tolerability profile in patients with active LN who were on stable background therapy in MISSION Phase 2. Zetomizomib led to clinically meaningful reductions in proteinuria and improvement in key SLE biomarkers. An updated analysis of the completed Phase 2 MISSION study will be shared.

**Funding:** Commercial Support - Kezar Life Sciences, Inc

## TH-PO488

**Long-Term Safety and Efficacy of Voclosporin in Patients With Lupus Nephritis and Low eGFR**

Ramesh Saxena,<sup>1</sup> Christopher E. Collins,<sup>2</sup> Vanessa Birardi,<sup>2</sup> Anna Pavlova-Wolf.<sup>2</sup> <sup>1</sup>The University of Texas Southwestern Medical Center, Dallas, TX; <sup>2</sup>Aurinia Pharmaceuticals Inc, Victoria, BC, Canada.

**Background:** Voclosporin (VCS) is a novel calcineurin inhibitor approved for the treatment of adults with lupus nephritis. In the Phase 3 AURORA 1 study, addition of VCS to mycophenolate mofetil (MMF) and steroids increased rates of complete renal response at 1 year. Efficacy was maintained for an additional 2 years in the AURORA 2 continuation study. Here we report on a post-hoc analysis of the long-term safety and efficacy of VCS in patients with low estimated glomerular filtration rate (eGFR) at baseline using 3 years of pooled data from these studies.

**Methods:** Patients from AURORA 1 with a baseline eGFR  $> 45$  and  $< 60$  mL/min/1.73 m<sup>2</sup> who also participated in AURORA 2 were included in this analysis. Patients completing AURORA 1 were eligible to enter AURORA 2 on the same blinded therapy (VCS or placebo) in combination with MMF and steroids. Urine protein creatinine ratio (UPCR) and eGFR changes from baseline were measured.

**Results:** The analysis included 27 patients with low eGFR (13 in the VCS arm and 14 in the control arm) of whom 23 completed 3 years of treatment (12 and 11 patients, respectively). Mean corrected eGFR at baseline for the VCS and control arms was 52.6 and 50.9 mL/min/1.73 m<sup>2</sup>, respectively. At 6 months, mean eGFR was 62.0 and 63.4 mL/min/1.73 m<sup>2</sup> in each arm, respectively, and remained stable in both arms throughout the 3 years of treatment (Figure 1). Safety outcomes were comparable between arms and consistent with the overall study population. Mean UPCR at AURORA 1 baseline was 4.8 mg/mg in the VCS arm and 4.0 mg/mg for the control arm. At 3 months, mean UPCR decreased to 1.7 mg/mg and 2.5 mg/mg in each arm, respectively. Mean UPCR continued to improve throughout AURORA 1, and the reductions were maintained in AURORA 2 for both treatment arms.

Key: TH - Thursday; FR - Friday; SA - Saturday; OR - Oral; PO - Poster; PUB - Publication Only

Underline represents presenting author.

**Conclusions:** In this post-hoc analysis of patients with lupus nephritis and low eGFR at baseline, patients treated with VCS achieved rapid and sustained reductions in proteinuria with no decrease in mean eGFR or unexpected adverse events during 3 years of treatment.

**Funding:** Commercial Support - Aurinia Pharmaceuticals Inc.

Figure.1 Mean Corrected eGFR in Patients with Low eGFR at Baseline (n=27)

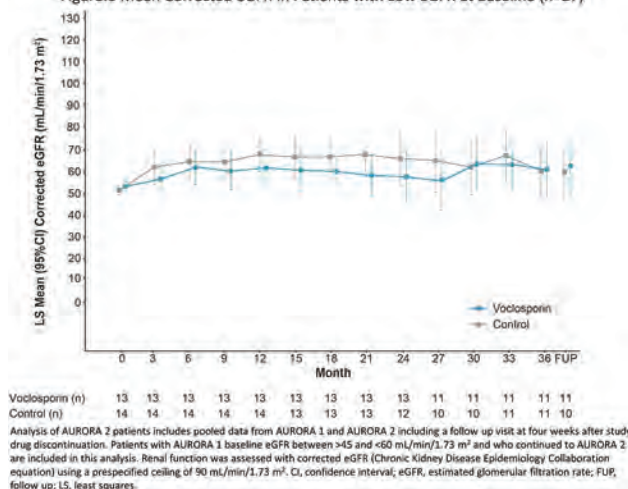

TH-PO489

**Repeat Kidney Biopsy Findings of Lupus Nephritis Patients in Clinical Remission Treated With Mycophenolate Associated With Belimumab or Mycophenolate Plus Standard of Care Therapy**

Ana Malvar,<sup>1,2</sup> Valeria G. Alberton,<sup>1</sup> Cecilia Recalde,<sup>1,2</sup> Pedro J. Davila Terreros,<sup>1</sup> Ricardo M. Heguido.<sup>1</sup> <sup>1</sup>Hospital Fernandez, Buenos Aires, Argentina; <sup>2</sup>Organizacion Medica de Investigacion, Buenos Aires, Argentina.

**Background:** Early and intensive treatment of Lupus nephritis determines an accelerated decrease in inflammation and, subsequently, reduces the extent of tissue that progresses to scarring and future renal failure. Addition of Belimumab to standard of care treatment showed to increase the possibility of achieving a complete kidney response with less renal events during follow up. The aim of this study was to assess the “post hoc” analysis of the clinical and histological differences between patients enrolled in the BLISS LN trial (BLNT) in a single center

**Methods:** All the participants (20, one male) had an initial renal biopsy (Bx1), used at screening for the BLNT and fulfilled the trial satisfactorily. Once the BLNT and the Open Label Extension (OLE) were finished, they continued to receive mycophenolate (MMF) and concomitant medications. Mean follow up was 70,7 (± 8,2 months). All the patients were re-biopsied (Bx2) either if they presented a flare or after a minimum period of 36-month with at least 12 months of Complete Clinical Response (CCR) so as to assess inactivity. CCR was defined as proteinuria ≤ 500 mg/d and eGFR > 60 ml/min/m2 and eGFR > 60 ml/min/m2 with no decrease of > 20% from baseline (BLNT randomization). Complete Histological Remission (CHR) was defined as an activity index = 0 at Bx2. NIH activity (AI) and chronicity (CI) indices, CCR, CHR and the occurrence of flares in each arm were compared.

**Results:** Clinical and histological data are shown in the Table. AI and CI are presented as median (SD).

**Conclusions:** Though the small number of patients the arm treated with MMF plus belimumab seemed to achieve more frequently a complete histological and clinical response with lower CI in the Bx2 and fewer relapses during treatment and long follow up. (Statistical analysis was not done due to the small sample)

**Funding:** Private Foundation Support

Arm Treatment	CCR Bx2 (n)	CHR Bx2 (n)	AI Bx1	AI Bx2	CI Bx1	CI Bx2	Flares (n)
MMF + Placebo (n=10)	7	5	7,6 (4,1)	2,7 (3,8)	2,1 (1,9)	4,5 (2,4)	2
MMF + Belimumab (n=10)	10	9	5,8 (4,5)	0,4 (1,0)	1,6 (1,9)	3,5 (1,0)	0

TH-PO490

**Persistent Excretion of Serpin-A3 Indicates Lack of Response to Therapy in Class III and IV Lupus Nephritis**

Miguel A. Martinez-Rojas,<sup>1,2</sup> Andrea Sanchez Navarro,<sup>2</sup> Juan M. Mejia-Vilet,<sup>2</sup> Rosalba Pérez-Villalva,<sup>1</sup> Norma Bobadilla.<sup>1,2</sup> <sup>1</sup>Universidad Nacional Autonoma de Mexico, Ciudad de Mexico, Mexico; <sup>2</sup>Instituto Nacional de Ciencias Medicas y Nutricion Salvador Zubiran, Ciudad de Mexico, Mexico.

**Background:** We previously reported that urinary Serpin-A3 excretion (uSerpA3) is significantly elevated in patients with active lupus nephritis (LN). Here, we evaluated the course of uSerpA3 during the 1<sup>st</sup>-year of treatment and its association with response to therapy in patients with proliferative LN.

**Methods:** An observational longitudinal study including sixty Mexican adults with proliferative LN followed during the 1<sup>st</sup>-year after LN-flare. uSerpA3 was detected by Western blot at flare and after 3, 6, and 12-months. Response to therapy was determined 1-year after the LN-flare. We evaluated the correlation between uSerpA3 and histological parameters at LN-flare. The temporal association between uSerpA3 and response to therapy was analyzed with linear mixed models. uSerpA3 prognostic performance for response was evaluated with ROC curves.

**Results:** Among the 60 patients studied, 21 (35%) were class III and 39 (65%) class IV. The uSerpA3 was higher in class IV than in class III LN (6.98 vs. 2.89 DPI/mg-creatinine, p=0.01). Furthermore, uSerpA3 correlated with the histological activity index (r=0.29, p=0.02). There was a significant association between the temporal course of uSerpA3 and the response to therapy. Responders showed a significant drop in uSerpA3 at 6<sup>th</sup>-month compared to LN-flare (p<0.001), while non-responders persisted with elevated uSerpA3. Moreover, uSerpA3 was significantly lower at flare in responders compared to non-responders (2.69 vs. 6.98 DPI/mg-creatinine, p<0.05). Furthermore, uSerpA3 was able to identify non-responders since the 3<sup>rd</sup>-month after LN-flare, (AUC=0.77).

**Conclusions:** The uSerpA3 is an early indicator of kidney inflammation and predictor of clinical response to therapy in patients with proliferative LN.

**Funding:** Government Support - Non-U.S.

TH-PO491

**Post Hoc Analysis of the DialCheck Tool to Predict Renal Failure in IgA Nephropathy (IgAN)**

Francesco P. Schena,<sup>1,2</sup> Vito walter Anelli,<sup>3</sup> Giandomenico Cornacchia,<sup>3</sup> Daniela I. Abbrescia,<sup>4</sup> Tommaso Di noia,<sup>3</sup> <sup>1</sup>Universita degli Studi di Bari Aldo Moro, Bari, Italy; <sup>2</sup>Schena Foundation, Bari, Italy; <sup>3</sup>Politecnico di Bari, Bari, Italy; <sup>4</sup>Fondazione Schena, Bari, Italy.

**Background:** We have developed the DialCheck tool to predict renal failure (RF) in patients with IgAN (KI 2021). The tool is based on two different artificial neural networks. The first network predicts RF development while the second predicts the time frame to reach the outcome. The application of the tool in the clinical practice shows discordance between predicted and observed probabilities to develop KF in about 20% of IgAN patients. We have conducted a post-hoc analysis to evaluate the discordance between predicted and observed probabilities to reach KF.

**Methods:** Baseline demographic and laboratory data were analyzed using mean ± standard deviation (SD) or median and interquartile range (IQR) for continuous variables. The D’Agostino-Pearson normality test was applied to the data in order to assess their distribution. The categorical variables were expressed as absolute numbers or percent frequency. Dichotomous and polychotomous baseline characteristics were compared using the Chi-square test. Continuous baseline characteristics were compared using the Student’s t-test or the Mann-Whitney U test. All analyses were performed using GraphPad Prism Software version n.5 (GraphPad Software, San Diego, CA). The statistical significance value of p<0.05 was adopted.

**Results:** Tool performance was analyzed in the retrospective cohort of 1,116 European adult IgAN patients followed for a median time of 88 months (IQR 49 - 134). Discordance was observed in 216 (19.35%) IgAN patients. In the first set of patients with predicted no RF and reached outcome, subjects were older and hypertensives. They had high value of serum creatinine, reduced renal function and moderate or severe renal lesions. Many of those patients did not receive therapy or were non-responders to therapy. In the second set of patients the tool predicted RF but this outcome was not reached, the patients were responders to therapy. Thus, in the discordant group (prediction did not match the observed outcome) therapy was strongly associated with outcome (P<0.0001).

**Conclusions:** The DialCheck tool could help physicians to determine the prognosis of the disease as well as could help patients to plan for their future. The non-correct prediction of RF in a small number of cases may be due to no therapy or non-responders to therapy.

**Funding:** Government Support - Non-U.S.

TH-PO492

**The Significance of Crescents on the Clinical Features and Outcomes of Primary Immunoglobulin A Nephropathy**

Yongjing Du,<sup>1,2</sup> Shasha Chen,<sup>1</sup> Wei Wang.<sup>1</sup> <sup>1</sup>Sichuan Academy of Medical Sciences and Sichuan People’s Hospital, Chengdu, China; <sup>2</sup>Chengdu Second People’s Hospital, Chengdu, China.

**Background:** It is still controversial whether the proportion of crescents below 50% can be an independent predictive risk factor for poor prognosis in IgAN patients.

**Methods:** We retrospectively analyzed biopsy-proven primary IgAN patients in Sichuan Provincial People’s Hospital from 2007 to 2019. The patients were divided into 5 groups based on crescent proportion as follows: 0 (n=647), <10% (n=221), 10% to 24% (n=272), 25% to 49% (n=80), and ≥50% (n=22). The primary endpoint was defined as ESKD, and the secondary endpoint was the combined renal endpoint (≥50% reduction in eGFR or ESKD).

**Results:** 1242 patients with biopsy-proven IgAN were recorded. 47.9% had different proportions of crescents. Compared with the non-crescent group, patients in the crescent group had lower levels of hemoglobin and albumin, higher levels of blood urea nitrogen, 24h urinary protein and hematuria, a higher proportion of mesangial hypercellularity, endocapillary hypercellularity, segmental glomerulosclerosis, and tubular atrophy/interstitial fibrosis (T1/T2) (p<0.05). During the median follow-up of 43 months (range 6-151), 63 individuals (7.0%) reached the primary outcome of ESKD and 99 patients (11.1%) reached the combined renal endpoint. 34 (7.5%), 21 (13.3%), 24 (12.2%), 14 (21.5%) and 6 (31.6%) patients reached the combined renal endpoint in the above five

groups in crescents 0, <10%, 10–24%, 25–49% and ≥50%, respectively. Multivariate Cox regression showed that crescents ≥50% was an independent risk factor for the progression of ESKD and crescents ≥25% was an independent risk factor for the combined renal endpoint. 274 (62.6%) cases in the crescent group and 254 (55.7%) cases in the non-crescent group received immunosuppressive therapy. The risk of combined renal endpoint increased with the increase proportions of crescents in IgAN patients without immunosuppressive therapy ( $p < 0.05$ ). Crescents ≥25% was an independent risk factor for poor prognosis in IgAN patients receiving immunosuppressive therapy. The receiver operating characteristic curve showed that IgAN patients with crescents >43.7% had a higher risk of poor prognosis.

**Conclusions:** IgAN patients with crescents had more severe clinicopathological features and poorer prognosis. IgAN patients with crescents >43.7% had a higher risk of poor prognosis, even after receiving immunosuppressive therapy.

**TH-PO493**

**External Validation of the International IGA Nephropathy Prediction Tool Among a Filipino Cohort of Patients**

Princess Jasmine A. Mala. National Kidney and Transplant Institute, Quezon City, Philippines.

**Background:** IgA nephropathy is the most common glomerulonephritis in the world. The incidence rate of primary GN varies between 0.2/100,000/year and 2.5/100,000/year. It is the most common glomerulonephritis (34.4%) in the Philippines. Recently, a new International IgAN prediction tool was published and was validated in large multi-ethnic cohort, hence, this study aimed to validate this tool among Filipino cohort.

**Methods:** This was a retrospective, cohort study among Filipino IgA nephropathy patients determining their score utilizing the International IgAN prediction tool. This was conducted at National Kidney and Transplant Institute from January 2015- 2017. The list of all patients who fulfilled the inclusion criteria was retrieved.

**Results:** A total of 151 participants were included in the study, with a mean age of 33 years and predominantly females (61.59%). The mean creatinine was 1.5 mg/dL and an eGFR of 56 mL/min/1.73m<sup>2</sup>. Using the International IgAN prediction tool, the predicted eGFR decline was highest at 46% among the highest risk group. Model discrimination result showed C statistics = 0.66. Result using the International IgAN prediction tool overestimated the observed risk of primary outcome at 3 years post biopsy. Result showed both the observed and the predicted eGFR showed a higher decline among the highest IgAN risk group.

**Conclusions:** Utilizing the International IgAN prediction tool among Filipino cohort able to predict the decline in eGFR even as early as 36 months from the time of biopsy. This tool can be used among Filipinos in predicting decline in eGFR.

**Table 1. Clinical and demographic profile of patients at baseline (n=151)**

	Median (Range); Frequency (%)
Age, years	33 (18-71)
Sex	
Male	58 (38.41)
Female	93 (61.59)
Creatinine at biopsy, mg/dL	1.5 (0.5-9.9)
Estimated GFR at biopsy, mL/min/1.73m <sup>2</sup>	55 (7.37-147)
Blood pressure at biopsy, mmHg	
SBP	120 (100-150)
DBP	80 (60-90)
Proteinuria at biopsy, g/day	2.42 (0.11-7.60)
Use of ACE inhibitor or ARB at the time of biopsy	101 (66.89)
MEST histologic score	
M1	62 (41.06)
E1	33 (21.85)
S1	132 (87.42)
T1	66 (43.71)
T2	24 (15.89)
Crescents	0 (0)
Immunosuppression use at or prior to biopsy	17 (11.26)
IgAN predicted 3-year risk of 50% decline in eGFR or ESRD, %	13.88 (1.64-61.18)

MEST: M1, mesangial score >0.5; E1, presence of endothelial hypercellularity; S1, presence of segmental glomerular sclerosis or tuft adhesions; T0, T1, T2 if <25% 25–50%, >50% tubular atrophy or interstitial fibrosis.

**TH-PO494**

**Proteinuria and Its Association With Disease Progression in IgA Nephropathy: Analysis of the UK National RaDaR IgA Nephropathy Cohort**

David Pitcher,<sup>1</sup> Fiona E. Braddon,<sup>1</sup> Bruce M. Hendry,<sup>2</sup> Alex Mercer,<sup>3</sup> Kate Osmaston,<sup>1</sup> Moin Saleem,<sup>4,5</sup> Retha D. Steenkamp,<sup>1</sup> A. Neil Turner,<sup>6</sup> Kaijun Wang,<sup>2</sup> Jonathan Barratt,<sup>7,8</sup> Daniel P. Gale,<sup>9,10</sup> <sup>1</sup>UK Renal Registry, Bristol, United Kingdom; <sup>2</sup>Travere Therapeutics Inc, San Diego, CA; <sup>3</sup>JAMCO Pharma Consulting, Stockholm, Sweden; <sup>4</sup>University of Bristol, Bristol, United Kingdom; <sup>5</sup>Bristol Royal Hospital for Children, Bristol, United Kingdom; <sup>6</sup>University of Edinburgh, Edinburgh, United Kingdom; <sup>7</sup>University of Leicester, Leicester, United Kingdom; <sup>8</sup>Leicester General Hospital, Leicester, United Kingdom; <sup>9</sup>Royal Free Hospital, London, United Kingdom; <sup>10</sup>University College London, London, United Kingdom.

**Background:** Primary IgA nephropathy (IgAN) is the most common form of glomerulonephritis worldwide and a major cause of renal failure. Here we investigate the relationship between proteinuria (PU) measured over follow-up (FU) and rate of renal function loss and renal survival in patients from the UK National Registry of Rare Kidney Diseases (RaDaR) IgAN Cohort. Since 2013, patients with biopsy-proven IgAN and eGFR <60 mL/min/1.73m<sup>2</sup> or PU ≥0.5g/24h have been enrolled from 87 kidney units across the UK, with automated collection of retrospective and prospective laboratory data.

**Methods:** 923 patients met the eligibility criteria, including diagnosis date, PU measurements in FU (within 2yr from diagnosis and ≥2 values if FU >3yr), no ESKD (CKD stage 5 or renal replacement therapy) or death within 6mo from diagnosis or prior to first PU value. Longitudinal PU, assessed as time-average protein-to-creatinine ratio (TA-PCR), and eGFR slope were calculated over the full duration of FU or until ESKD or death. For survival analyses, ESKD/death was applied, with survival time calculated from diagnosis to last FU.

**Results:** Characteristics at diagnosis and clinical outcomes of the study population are summarized in Fig.1a. Increasing grades of TA-PCR were associated with more rapid decline in eGFR (ANOVA  $p < 0.001$ , Fig.1c) and greater risk of ESKD/death (Log-rank  $p < 0.001$ , Fig.1b; Cox regression  $p < 0.001$ , Fig.1c).

**Conclusions:** Proteinuria exposure over time is significantly associated with disease progression and renal outcomes in IgAN. In particular, TA-PCR below 100 mg/mmol (-1g/24h) is very strongly associated with slower loss of renal function and lower risk of ESKD or death.

**Funding:** Commercial Support - Travere Therapeutics, Inc

Figure 1: Characteristics at diagnosis and clinical outcomes (a), Kaplan Meier survival curves (incl. 95% CI) (b) and outcomes (c) for patients categorized by TA-PCR

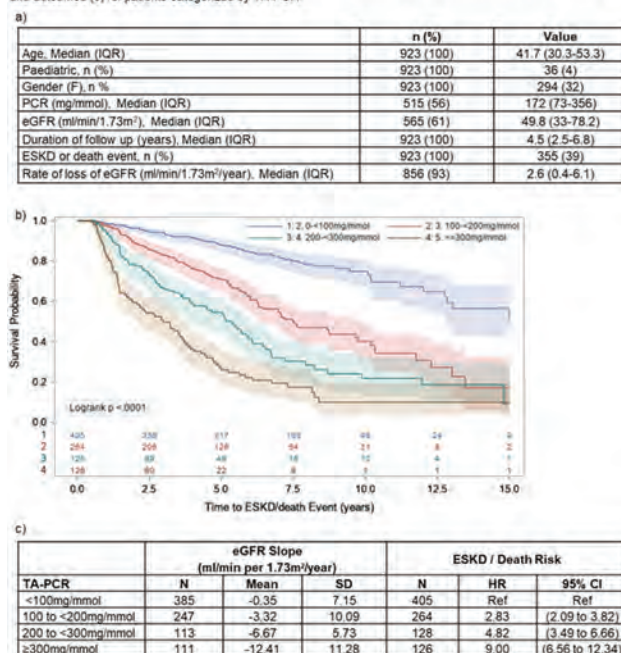

## TH-PO495

## Gut Microbiota Profiles in IgA Nephropathy Patients and Their Household Members

Yaerim Kim,<sup>1</sup> Sehoon Park,<sup>2</sup> Jin hyuk Paek,<sup>1</sup> Woo Yeong Park,<sup>1</sup> Kyubok Jin,<sup>1</sup> Seungyeup Han,<sup>1</sup> Jung Pyo Lee,<sup>3</sup> Dong Ki Kim,<sup>2</sup> <sup>1</sup>Keimyung University School of Medicine, Daegu, Republic of Korea; <sup>2</sup>Seoul National University Hospital, Jongno-gu, Seoul, Republic of Korea; <sup>3</sup>Seoul National University Seoul Metropolitan Government Boramae Medical Center, Dongjak-gu, Seoul, Republic of Korea.

**Background:** Although immunoglobulin A nephropathy (IgAN) is not a definite genetic disease, it has an autoimmune trait of complex architecture with a solid genetic predisposition. Herein, we aimed to evaluate the difference in microbiota profile among patients with IgAN, their household members and unrelated healthy controls.

**Methods:** We prospectively recruited subjects with IgAN and their household member and healthy control between July 2019 and August 2021. Gut microbiota was analyzed using the Illumina MiSeq system based on the 16S rRNA gene. We compared the abundance of the microbiome in each level of phylum, class, order, family, and genus between the groups using Mann-Whitney U test. Also, we tried to find a specific genus representing the disease severity based on the Oxford classification.

**Results:** A total of 73 subjects (IgAN 45, household member 14, healthy control 14) were finally included in the study. The mean age of each group was 38.2, 44.0, and 32.3 years old in IgAN, household members, and healthy controls, respectively. The mean eGFR was 97.6, 101.5, and 113.7 mL/min/1.73 m<sup>2</sup>, respectively. The primarily observed phylum was Actinobacteria, Firmicutes, and Bacteroidetes. Among Firmicutes phylum, *Blautia* and *Anaerobutyricum* were found to be significantly higher in subjects with IgAN (13.7% and 4.1%) than in household members (9.2% and 1.5%) and healthy controls (8.6% and 2.1%). The abundance of *Dorea* was higher in IgAN than a household member, but not than healthy control. On the contrary, *Prevotella* and *Ruminococcus* were higher in IgAN than healthy control, not a household member. *Bifidobacterium* was significantly lower in M1, but *Clostridium* was higher in M1. *Holdemanelia* and *Coprococcus* were significantly higher in E1. *Prevotella* and *Coprococcus* were higher in S1, but *Streptococcus* was lower in S1. There was no identified genus to distinguish T and C scores.

**Conclusions:** The gut microbiota was well discriminated subjects with IgAN from household members and healthy controls. In addition, it was also differently observed according to the status of pathologic findings of IgAN. These results may provide a basis for further metagenomics analysis using a family cohort of IgAN.

## TH-PO496

## Health State Utility Values for Immunoglobulin A Nephropathy (IgAN)

Mo Zhou,<sup>1</sup> Mark E. Bensink,<sup>2</sup> Nisha C. Hazra,<sup>3</sup> Chunyi Xu,<sup>1</sup> Bruce M. Hendry,<sup>2</sup> Claire C. Sharpe,<sup>4</sup> Zheng-Yi Zhou,<sup>3</sup> <sup>1</sup>Analysis Group Inc Boston, Boston, MA; <sup>2</sup>Travere Therapeutics Inc, San Diego, CA; <sup>3</sup>Analysis Group Inc, London, United Kingdom; <sup>4</sup>Wilkins and Sharpe Ltd., London, United Kingdom.

**Background:** IgAN has been shown to be associated with significant clinical burden to patients with progression to kidney failure resulting in reduced health-related quality of life (HRQL). Utility values are a preference-based measure quantifying the HRQL of a disease. To date, no studies have reported utility values specifically for IgAN. The objective of this study was to estimate utility values for the spectrum of health states related to IgAN from the societal perspective in the UK.

**Methods:** Utilities for IgAN were elicited from the UK general public via computer-assisted telephone interviews. Respondents were shown written vignettes describing several health states for IgAN with different chronic kidney disease (CKD) stages, proteinuria levels, and dialysis status, and for a health state with nephrotic syndrome. Vignettes were validated by five nephrologists experienced in treating IgAN in the UK. Time tradeoff (TTO) was used to estimate utilities. For each health state, the moderator assessed the number of years in an imperfect health state a respondent was willing to give up to live in full health. The utilities for the health states, ranging from -1 (worse than death) to +1 (perfect health), were calculated based on responses. TTO utilities were validated with Visual Analogue Scale (VAS) ratings.

**Results:** TTO-derived utilities (n=200) decreased as IgAN-associated CKD/proteinuria severity increased: mean (SD) CKD stage 1/2, 0.84 (0.17) and 0.71 (0.23); CKD stage 3, 0.68 (0.23) and 0.61 (0.25); CKD stage 4, 0.55 (0.26) and 0.49 (0.27) for proteinuria <1g/day and proteinuria ≥1g/day, respectively. Within a CKD stage, utilities associated with proteinuria ≥1g/day were 0.06-0.13 lower than those with proteinuria <1g/day (p<0.001), with mean decrement of 0.09. The mean (SD) utility for CKD stage 5 with and without dialysis was 0.38 (0.30) and 0.42 (0.28), respectively (p<0.001). The mean (SD) utility for nephrotic syndrome was 0.43 (0.33). VAS and TTO results were consistent.

**Conclusions:** Utilities decreased with IgAN CKD stage progression and increased proteinuria. Treatments that reduce proteinuria and slow the rate of decline in kidney function have the potential to improve the HRQL of patients with IgAN.

**Funding:** Commercial Support - Travere Therapeutics, Inc., San Diego, CA

## TH-PO497

## Atrasentan for the Treatment of IgA Nephropathy: Interim Results From the AFFINITY Study

Anjay Rastogi,<sup>1</sup> Michelle N. Rheault,<sup>2</sup> Sung Gyun Kim,<sup>3</sup> Nam D. Vo,<sup>4</sup> Dwarakanathan Ranganathan,<sup>5</sup> Lesley A. Inker,<sup>6</sup> David K. Packham,<sup>7</sup> Mark Vishnepolsky,<sup>8</sup> Khushboo Sheth,<sup>9</sup> Todd DeVries,<sup>9</sup> Marianne Camargo,<sup>9</sup> Andrew J. King,<sup>9</sup> Charlotte Jones-Burton,<sup>9</sup> Muh Geot Wong,<sup>10</sup> <sup>1</sup>University of California Los Angeles, Los Angeles, CA; <sup>2</sup>University of Minnesota Division of Pediatric Nephrology, Minneapolis, MN; <sup>3</sup>Hallym University Sacred Heart Hospital, Anyang, Gyeonggi-do, Republic of Korea; <sup>4</sup>Mountain Kidney and Hypertension Associates, Asheville, NC; <sup>5</sup>Royal Brisbane and Women's Hospital, Herston, QLD, Australia; <sup>6</sup>Tufts Medical Center, Boston, MA; <sup>7</sup>Melbourne Renal Research Group, Reservoir, VIC, Australia; <sup>8</sup>Kidney Specialists of Southern Nevada, Las Vegas, NV; <sup>9</sup>Chinook Therapeutics Inc, Seattle, WA; <sup>10</sup>Concord Repatriation General Hospital, Sydney, NSW, Australia.

**Background:** Endothelin A (ET<sub>A</sub>) receptor activation drives proteinuria, inflammation, and fibrosis in patients with glomerular diseases. Atrasentan, a potent and selective ET<sub>A</sub> receptor antagonist, represents a potential therapy to reduce proteinuria and preserve kidney function in patients with IgA nephropathy (IgAN) and other glomerular diseases. AFFINITY is a global, phase 2, open-label basket study to evaluate the efficacy and safety of atrasentan in adult patients with IgAN, Alport syndrome, FSGS & DKD. Here we present interim results of the IgAN cohort through week 24 of treatment.

**Methods:** Eligibility criteria for the IgAN cohort include adults with biopsy-proven IgAN; eGFR ≥30 mL/min/1.73 m<sup>2</sup>, UPCr ≥0.5 g/g and <1.0 g/g (first morning void) and on max tolerated/stable RASi. Patients are treated orally with 0.75 mg atrasentan daily for 52 weeks. The primary endpoint is change in 24-hour UPCr from baseline to Week 12.

**Results:** Twenty patients have enrolled in the IgAN cohort. Median age was 45 years, with 50% women, 45% White and 45% Asian. Baseline 24-hour total urine protein was 1.1 g/day (geometric mean; GM), 70% of subjects having total urine protein of >1 g/day, and median eGFR is 46 mL/min/1.73m<sup>2</sup>. GM percent reduction from baseline in 24-hour UPCr was 49.9% at week 12 (95% CI 39.8, 58.3; n=18) and 58.6% at week 24 (95% CI 50.5, 65.5; n=13; Figure). There were no treatment-related severe adverse events (AEs). Treatment-emergent AEs observed in 16 patients were mild or moderate in severity, and most have resolved. One patient discontinued treatment due to a related AE of headache at week 13.

**Conclusions:** Treatment with atrasentan in addition to standard of care was generally well-tolerated and resulted in a clinically meaningful reduction in proteinuria at weeks 12 and 24, strongly supporting the therapeutic potential of ET<sub>A</sub> receptor blockade with atrasentan in patients with IgAN.

**Funding:** Commercial Support - Chinook Therapeutics, Inc

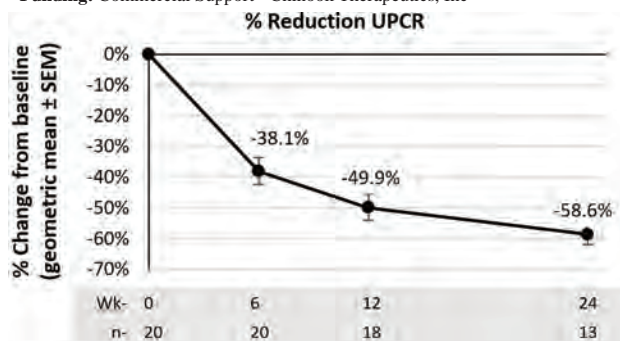

## TH-PO498

## A Phase 2a Study to Evaluate the Safety and Efficacy of Tegoprobart (AT-1501) in Patients With IgA Nephropathy (IgAN)

Jonathan Barratt,<sup>1</sup> Adrian Liew,<sup>9</sup> Dana Rizk,<sup>3</sup> Lisa Willcocks,<sup>10</sup> Richard A. Lafayette,<sup>4</sup> Muh Geot Wong,<sup>7</sup> Vladimir Tesar,<sup>6</sup> Jeffrey D. Bornstein,<sup>2</sup> Heather N. Reich,<sup>5</sup> Sydney C. Tang,<sup>8</sup> <sup>1</sup>University of Leicester, Leicester, United Kingdom; <sup>2</sup>Eledon Pharmaceuticals, Irvine, CA; <sup>3</sup>University of Alabama at Birmingham, Birmingham, AL; <sup>4</sup>Stanford University School of Medicine, Stanford, CA; <sup>5</sup>University of Toronto Temerty Faculty of Medicine, Toronto, ON, Canada; <sup>6</sup>Univerzita Karlova, Praha, Czechia; <sup>7</sup>The University of Sydney, Sydney, NSW, Australia; <sup>8</sup>The University of Hong Kong Li Ka Shing Faculty of Medicine, Hong Kong, Hong Kong; <sup>9</sup>Mount Elizabeth Medical Centre, Singapore, Singapore; <sup>10</sup>Addenbrooke's Hospital, Cambridge, United Kingdom.

**Background:** IgAN is the most common autoimmune nephropathy, with a young age of onset and a slow progressive course. ~40% of affected patients progress to kidney failure within 20 years of diagnosis. Therapeutic options that delay progression are limited, and more options are needed. Tegoprobart is a next generation monoclonal antibody directed against CD40 ligand (CD40L; CD154), a target important in both cell and antibody mediated immunity. Inhibiting CD40L is expected to disrupt the

pathophysiology of IgAN both upstream, by blocking antibody and immune complex formation, and downstream, by interfering with the cell based inflammatory response in the glomeruli. A Phase 2a dose-finding, open-label study, AT-1501-N205, to evaluate the safety and efficacy of tegoprobart in patients with IgAN is underway.

**Methods:** 42 adults with biopsy proven IgAN and proteinuria  $\geq 0.75\text{g}/24\text{h}$  will be enrolled into 2 sequential open-label cohorts assessing the efficacy of 10mg/kg and 5mg/kg of tegoprobart administered IV every 3 weeks. The cohorts are staggered such that the 5mg/kg cohort will not proceed if futility is seen with the 10mg/kg cohort. The cohorts have the same inc/exc criteria, visit schedule and endpoints. The primary endpoint is change from baseline of urine protein to creatinine ratio after 24 weeks of therapy. The study will continue through Week 96 to assess change in eGFR.

**Results:** The study design includes interim analyses for futility after 12 subjects in each cohort complete 24 weeks. Futility in the 10mg/kg cohort would end the trial. Futility in the 5mg/kg cohort, would result in termination of that cohort only. Results will be presented for each cohort's interim analysis, when each cohort completes weeks 24 and 96.

**Conclusions:** Inhibition of CD40L has potential as a treatment for IgAN. This Phase 2 trial will assess 2 doses of tegoprobart in patients with IgAN, evaluating the drug's ability to reduce proteinuria and prevent decline in eGFR.

**Funding:** Commercial Support - Eledon Pharmaceuticals

**Study Design**

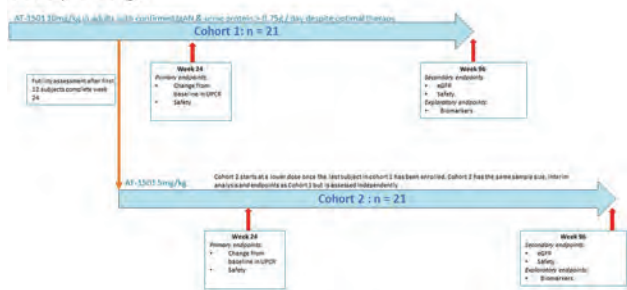

**TH-PO499**

**Phase 1 Study in Healthy Adults of the Safety, Tolerability, Pharmacokinetics, and Pharmacodynamics of ALPN-303, a Dual BAFF/APRIL Antagonist for the Treatment of Autoimmune Glomerulonephritides (GN)**

Stacey R. Dillon,<sup>1</sup> Pille Harrison,<sup>1</sup> Jason Lickliter,<sup>2</sup> Kristi L. Manjarrez,<sup>1</sup> Alina Smith,<sup>1</sup> Mary C. Lessig,<sup>1</sup> Russell J. Sanderson,<sup>1</sup> Allison G. Chnyk,<sup>1</sup> Katherine Lewis,<sup>1</sup> Hany Zayed,<sup>1</sup> Rupert H. Davies,<sup>1</sup> Stanford Peng.<sup>1</sup> <sup>1</sup>Alpine Immune Sciences Inc, Seattle, WA; <sup>2</sup>Nucleus Network Ltd, Melbourne, VIC, Australia.

**Background:** Therapeutic agents targeting the B-cell cytokines BAFF and/or APRIL have demonstrated promising clinical potential in autoantibody-related GN such as lupus nephritis (LN) and IgA nephropathy (IgAN), and other B-cell-related diseases such as systemic lupus erythematosus; however, there is still need for more safe and efficacious therapies. ALPN-303 is an Fc fusion protein of an engineered TACI variant TNFRSF domain (vTD) which mediates more potent inhibitory activity than WT TACI-Fc or BAFF- or APRIL-specific antibodies. In preclinical studies, ALPN-303 demonstrated enhanced PK and immunomodulatory properties vs. WT TACI-Fc, which may translate to lower and/or less frequent doses in humans. ALPN-303 also suppressed autoantibodies, renal IgG deposition, and nephritis in mouse models. ALPN-303 may therefore significantly improve clinical outcomes in GN and other B-cell-related diseases.

**Methods:** In this first-in-human study (NCT05034484), adult HVs are randomized into single ascending dose cohorts of intravenous (IV) or subcutaneous (SC) ALPN-303 or placebo. Subjects are followed to assess safety and PK, circulating immunoglobulins (Ig), and circulating leukocyte populations by flow cytometry.

**Results:** ALPN-303 has been well tolerated in all cohorts evaluated to date, and overall exhibits dose-related PK and expected PD effects, including dose-related reductions in serum Ig. To date there have been no treatment-related serious adverse events, no infusion-related or injection site reactions, and no adverse trends in safety laboratories. Dose escalation is expected to complete by the time of the meeting; the presentation will include all available safety, PK, and PD data.

**Conclusions:** ALPN-303 to date demonstrates acceptable safety and tolerability and exhibits PK and PD that appear to differentiate favorably vs WT TACI-Fc. These findings support future clinical development of ALPN-303 in multiple autoantibody-related GN, as well as other B-cell- and/or autoantibody-related diseases.

**Funding:** Commercial Support - Alpine Immune Sciences, Inc

**TH-PO500**

**Characterization of Patients With Thrombotic Microangiopathy and Triggering/Associated Events: A Global aHUS Registry Analysis**

Andrew M. Siedlecki,<sup>1</sup> Imad Al-Dakkak,<sup>2</sup> Ekaterina Anokhina,<sup>3</sup> Nicole Isbel,<sup>3</sup> Veronique Fremeaux-Bacchi,<sup>4</sup> Rodney D. Gilbert,<sup>5</sup> Larry A. Greenbaum,<sup>6</sup> Gema Ariceta,<sup>7</sup> Gianluigi Ardissino,<sup>8</sup> Franz S. Schaefer,<sup>9</sup> Eric Rondeau,<sup>10</sup> Christoph Licht.<sup>11</sup> <sup>1</sup>Department of Internal Medicine, Renal Division, Brigham and Women's Hospital, Boston, MA; <sup>2</sup>Alexion, AstraZeneca Rare Disease, Boston, MA; <sup>3</sup>Department of Nephrology, Princess Alexandra Hospital, Brisbane, QLD, Australia; <sup>4</sup>Laboratoire d'Immunologie, Hôpital Européen Georges Pompidou, Paris, France; <sup>5</sup>Regional Paediatric Nephro-Urology Unit, Southampton Children's Hospital, Tremona Road, Southampton, United Kingdom; <sup>6</sup>Division of Pediatric Nephrology, Emory University School of Medicine and Children's Healthcare of Atlanta, Atlanta, GA; <sup>7</sup>Department of Pediatric Nephrology, Vall d'Hebron Hospital, and the Autonomous University of Barcelona, Barcelona, Spain; <sup>8</sup>Centro per la Cura e lo Studio della Sindrome Emolitico-Uremica, Fondazione IRCCS Ca' Granda Ospedale Maggiore Policlinico, Milan, Italy; <sup>9</sup>Division of Pediatric Nephrology, Heidelberg University Hospital, Heidelberg, Germany; <sup>10</sup>Urgences Néphrologiques et Transplantation Rénale, Hôpital Tenon, Paris, France; <sup>11</sup>Division of Nephrology, The Hospital for Sick Children, Toronto, ON, Canada.

**Background:** Atypical hemolytic uremic syndrome (aHUS), a rare disease of complement dysregulation, leads to thrombotic microangiopathy (TMA). In this study, we characterize patients (pts) with triggering/associated events occurring prior/up to aHUS onset from the Global aHUS Registry (NCT01522183).

**Methods:** All pts with triggering/associated events prior/up to aHUS onset and enrolled in the Registry from 2011 to July 2021 were included. Pts with an alternative clinical diagnosis after enrollment were excluded.

**Results:** In total, 349 pts with triggering/associated events were included, of which 75% were adults ( $\geq 18$  years) (n=229) and 25% (n=78) were pediatric pts (<18 years). Most pts (n=307, 88%) had only one triggering/associated event, and in those, the most frequent triggering/associated events were malignancy in adults (n=51; 22%) and acute infection (n=28; 36%) in pediatric pts. The mean time from event to aHUS onset in these categories were 22 and 0.03 months, respectively. The least frequent were bone marrow transplant (1.7%) and C3 glomerulopathy (0.9%) in adults, and C3 glomerulopathy (0%), and drug-induced aHUS (0%) in pediatric pts. Autoimmune disorders (n=36) had the longest time from event to aHUS onset (41 months), while acute infection (n=53) and malignant hypertension (n=26) had the shortest (0.03 months). The most common triggering and associated events combinations were drug-induced aHUS and malignancy (n=7).

**Conclusions:** This study suggests that triggering events can be organized into clinically relevant categories. The frequency of triggering/associated events occurring prior/up to aHUS differ in pediatric and adult populations. The interval between triggering/associated events and the eventual diagnosis of aHUS differ by type of event.

**Funding:** Commercial Support - Alexion, AstraZeneca Rare Disease

Table: Patient characteristics per triggering/associated condition

Triggering/associated condition	Number of patients n/N (%)	Sex, F/M (%)	Number of patients $\geq 18$ years n/N (%)	Age at aHUS onset, years median (IQR)	Time from triggering/associated condition to aHUS onset, months median (IQR)
Malignancy	58/97 (18.6)	29/58 (63.2)	116/112 (1)	52.10 (47.26, 70.28)	22.36 (1.65, 95.01)
Acute infection*	59/97 (17.3)	28/63 (52.6)	28/63 (52.6)	15.68 (1.48, 33.18)	0.03 (0.03, 0.23)
Autoimmune Disease	36/97 (11.7)	25/68 (68.4)	4/39 (11.1)	29.43 (28.77, 59.06)	40.94 (2.65, 187.77)
Kidney Transplant	31/97 (8.1)	18/83 (85.3)	4/31 (12.9)	40.89 (32.14, 58.86)	0.25 (0.02, 1.54)
Malignant hypertension	26/97 (8.1)	14/28 (53.8)	6/28 (21.6)	29.79 (13.00, 47.59)	0.03 (0.03, 0.69)
aHUS onset up to 30 days	25/97 (8.1)	9/26 (34.6)	25/25 (100.0)	0.05 (0.03, 0.26)	0.02 (0.02, 0.78)
Chronic infection*	14/97 (4.4)	8/14 (57.1)	1/14 (7.1)	45.97 (37.98, 55.31)	32.59 (0.03, 135.13)
Drug-induced	4/97 (1.5)	2/4 (50.0)	0/4 (0.0)	37.21 (28.21, 58.71)	34.76 (0.95, 128.23)
Bone marrow transplant	1/97 (0.1)	4/1 (400.0)	0/1 (0.0)	43.42 (28.20, 43.12)	39.15 (0.83, 104.84)
C3 glomerulopathy	0/97 (0.0)	2/1 (100.0)	0/0 (0.0)	28.17 (22.65, 35.78)	0.33 (0.03, 0.62)

\*includes any infection occurring in the 90 days prior to onset of aHUS. †includes all other triggering/associated conditions (n=64) prior to onset of aHUS. ‡includes the combination of patients with the leading/primary reported condition.

**TH-PO501**

**PLASMIC Score to Aid Diagnosis of Atypical Hemolytic Uremic Syndrome: A Post Hoc Analysis of Data From C5 Inhibitor Trials**

Miguel Uriol Rivera,<sup>1</sup> Ana I. Avila Bernabeu,<sup>2</sup> Robert Makar,<sup>3</sup> John Booth,<sup>4</sup> Frank R. Ernst,<sup>4</sup> Angels Comas,<sup>5</sup> Christoph Gasteyer,<sup>6</sup> Ching Lum,<sup>7</sup> Ioannis Tomazos,<sup>7</sup> Yan Wang,<sup>7</sup> Pavan K. Bendapudi.<sup>3,8</sup> <sup>1</sup>Glomerular Diseases Unit, Son Espases University Hospital, Palma de Mallorca, Spain; <sup>2</sup>Nephrology Department, Dr Peset University Hospital, Valencia, Spain; <sup>3</sup>Harvard Medical School, Boston, MA; <sup>4</sup>CTI Clinical Trial & Consulting Services, Covington, KY; <sup>5</sup>Alexion, AstraZeneca Rare Disease, Barcelona, Spain; <sup>6</sup>Alexion, AstraZeneca Rare Disease, Zurich, Switzerland; <sup>7</sup>Alexion, AstraZeneca Rare Disease, Boston, MA; <sup>8</sup>Division of Hematology and Blood Transfusion Service, Massachusetts General Hospital, Boston, MA.

**Background:** Thrombotic microangiopathies (TMAs) are rare disorders presenting as thrombocytopenia, microangiopathic hemolytic anemia and organ damage. Atypical hemolytic uremic syndrome (aHUS) is a complement-mediated TMA, with/without a trigger. aHUS is diagnosed by excluding thrombotic thrombocytopenic purpura (TTP) and other TMAs. PLASMIC scores (PSs) can facilitate earlier diagnosis of severe ADAMTS13 deficiency. In suspected TTP cases, a PS (min-max: 0-7, 7 components; see

Figure legend) is calculated. A score of  $\geq 6$  suggests a high probability of ADAMTS13 activity  $<10\%$  and TTP. This study aimed to understand PS distribution in aHUS patients and its importance in assisting earlier diagnosis and appropriate treatment.

**Methods:** PSs were calculated for patients with aHUS from the safety set of eculizumab (NCT01522170) and ravulizumab (NCT02949128) trials, using the first measure of PS components at screening. Relative and cumulative distributions of PS were calculated.

**Results:** PS distributions were similar in both trials, with all patients scoring between 3–7 and ~50% scoring 4 (Figure). Scores 3–5, indicating probable aHUS rather than TTP, were observed in 86% of eculizumab patients and 88% of ravulizumab patients. Across PS components, platelet count and creatinine thresholds were met by the fewest patients ( $\leq 22.2\%$ ).

**Conclusions:** This analysis shows that PS  $<6$  is observed in most patients with confirmed aHUS. However, a PS  $\geq 6$  does not completely exclude aHUS. Assessing ADAMTS-13 activity remains essential to accurately distinguish between TTP and aHUS.

**Funding:** Commercial Support - Alexion, AstraZeneca Rare Disease

Table Demographics, clinical characteristics at LFU, and laboratory parameters at BL and LFU

Variable	Cohort A: long-term follow-up without progression to ESKD			Cohort B: developed ESKD following treatment initiation		
	All patients (N=249)	Children (N=110)	Adults (N=139)	All patients (N=53)	Children (N=21)	Adults (N=32)
Any mutation found for Anti-ECV antibody positive (N)	112	65	57	20	8	12
Age at aHUS onset, years (Mean (SD), IQR)	21.8 (4.1, 28.7)	7.5 (0.8, 7.3)	28.7 (18.3, 31.4)	30.1 (10.6, 48.1)	2.1 (0.4, 11.0)	39.7 (20.3, 56.1)
Time from aHUS onset to treatment initiation, months (Mean (SD), IQR)	3.1 (0.6, 7.1)	1.8 (0.6, 38.4)	0.8 (0.4, 2.4)	0.5 (0.5, 6.8)	0.7 (1.2, 3.1)	0.8 (4.2)
Time from enrollment to last follow-up (Mean (SD), IQR)	5.0 (1.8, 8.4)	3.0 (1.3, 6.8)	5.8 (3.3, 8.3)	1.5 (1.5, 5.8)	2.3 (2.3, 7.0)	1.6 (1.5, 3.1)
Treatment duration, years (Mean (SD), IQR)	4.4 (1.7, 8.2)	4.7 (3.0, 6.5)	4.0 (1.8, 5.8)	1.5 (1.5, 9.3)	1.5 (1.5, 7.9)	1.8 (1.8, 5.8)
eGFR, mL/min/1.73 m <sup>2</sup> (Mean (SD), IQR)	25.9 (13.4, 37.1)	27.5 (16.4, 35.4)	41.8 (24.2, 58.1)	20.5 (16.9, 25.0)	35.5 (28.9, 39.0)	16.4 (12.8, 17.6)
Platelet count $\times 10^9/L$ (Mean (SD), IQR)	140 (68, 120)	245 (130, 288)	170 (70, 244)	228 (82, 213)	215 (89, 215)	111 (55, 110)
LDH (U/L) (Mean (SD), IQR)	578 (127, 1344)	308 (172, 237)	252 (104, 1877)	329 (193, 294)	309 (128, 1039)	188 (136, 996)

Figure: Relative PLASMIC Score distributions in patients from eculizumab and ravulizumab trials

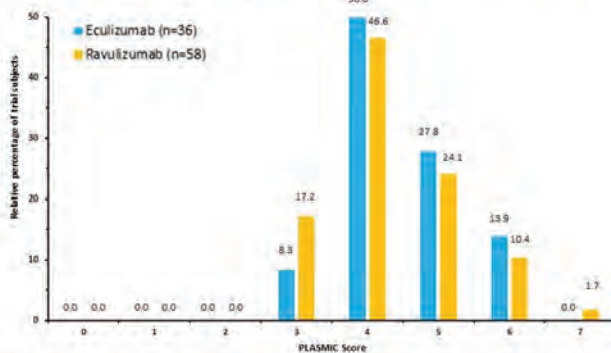

PLASMIC Score is comprised of 7 components: platelet count  $<30 \times 10^9/L$ , hemolysis (indirect bilirubin  $>2 \text{ mg/dL}$ , reticulocyte count  $>2.5\%$  or undetectable haptoglobin), no active cancer/cancer therapy within past year, no transplant history, MCV  $<9 \times 10^{14} \text{ L}$ , INR  $<1.5$  and creatinine  $<2.0 \text{ mg/dL}$ . aHUS, atypical hemolytic uremic syndrome; INR, international normalized ratio; MCV, mean corpuscular volume

TH-PO502

Long-Term Outcomes in Eculizumab-Treated Patients Enrolled in the Global aHUS Registry

Larry A. Greenbaum,<sup>1</sup> Imad Al-Dakkak,<sup>2</sup> Ekaterina Anokhina,<sup>3</sup> Gianluigi Ardissino,<sup>4</sup> Gema Ariceta,<sup>5</sup> Gurinder Kumar,<sup>6</sup> Christoph Licht,<sup>7</sup> Andrew M. Siedlecki,<sup>8</sup> Johan Vande walle.<sup>9</sup> <sup>1</sup>Division of Pediatric Nephrology, Emory University School of Medicine and Children's Healthcare of Atlanta, Atlanta, GA; <sup>2</sup>Alexion, AstraZeneca Rare Disease, Boston, MA; <sup>3</sup>Alexion, AstraZeneca Rare Disease, Zurich, Switzerland; <sup>4</sup>Center for HUS Prevention Control and Management, Fondazione IRCCS Ca' Granda-Ospedale Maggiore Policlinico, Milan, Italy; <sup>5</sup>Paediatric Nephrology Department, University Hospital Vall d'Hebron, Barcelona, Spain; <sup>6</sup>Department of Paediatrics, Sheikh Khalifa Medical City, Abu Dhabi, United Arab Emirates; <sup>7</sup>Division of Nephrology, The Hospital for Sick Children, Toronto, ON, Canada; <sup>8</sup>Department of Medicine, Brigham and Women's Hospital, Harvard Medical School, Boston, MA; <sup>9</sup>Pediatric Nephrology Unit, Ghent University Hospital, Ghent, Belgium.

**Background:** The global atypical hemolytic uremic syndrome (aHUS) Registry (NCT01522183) is the largest repository of real-world data on patients with aHUS. We report long-term (LT) outcomes with eculizumab (ecu) treatment in two patient cohorts: those with LT follow-up (FU) without progression to end-stage kidney disease (ESKD) and those who developed ESKD during treatment. Our aim was to determine whether LT ecu preserves kidney function.

**Methods:** The analysis included registry patients enrolled between Apr 2012–Nov 2021 and treated with ecu for  $\geq 90$  days. Cohort A included patients with  $\geq 3$ -year FU, no ESKD, and two creatinine values; near treatment start and after  $\geq 3$ -year observation. Cohort B included patients who developed ESKD after treatment with no FU duration specified.

**Results:** Demographics and laboratory parameters (baseline [BL], last FU [LFU]) are shown in the Table. For Cohort A, 249 patients met inclusion criteria; at LFU, eGFR improved, 7% received acute dialysis (9% of adults, 6% of children) and two adults died. For Cohort B, 56 patients met inclusion criteria; at LFU, 48% received a kidney transplant (38% of adults, 68% of children), 89% received dialysis (95% of adults, 79% of children) and eight died (six adults, two children). BL eGFR was lower in patients who progressed to ESKD (Cohort B, N=56) than in patients who did not progress (Cohort A, N=249). Platelet and LDH levels improved in both cohorts at LFU.

**Conclusions:** In a real-world setting, eGFR was stable in most patients receiving ecu. Some patients demonstrated hematologic benefits but no renal response; they had lower BL eGFR and initiated treatment late.

**Funding:** Commercial Support - Alexion, AstraZeneca Rare Disease

TH-PO503

Early Eculizumab Withdrawal in Patients With Atypical Hemolytic Uremic Syndrome in Native Kidneys Is Safe and Cost-Effective: Results of the CUREiHUS Study

Romy N. Bouwmeester, Caroline Duineveld, Kioa L. Wijnsma, Eddy M. Adang, Lambertus P. Van den heuvel, Jack F. Wetzels, Nicole Van De Kar. on behalf of the CUREiHUS study group Radboud UMC, Nijmegen, Netherlands.

**Background:** The introduction of eculizumab has improved outcome in patients with atypical hemolytic uremic syndrome (aHUS). The optimal treatment strategy is debated. It is unknown if unbiased withdrawal of eculizumab is a safe strategy. Here we report the results of the CUREiHUS study, an observational study monitoring eculizumab discontinuation in Dutch aHUS patients after 3 months of therapy.

**Methods:** All pediatric and adult aHUS patients with native kidneys and first-time eculizumab treatment (n=21) were evaluated. In addition, an extensive cost-effective analysis was conducted.

**Results:** In the period from January 2016 till October 2020 we included 21 patients. All patients showed full recovery of hematological thrombotic microangiopathy (TMA) parameters after start of eculizumab. A renal response was noted in 18 patients. After a treatment duration of 13.6 weeks (range 2.1–43.9), eculizumab was withdrawn in all patients. During follow-up (80.7 weeks (0.0–236.9)), a relapse occurred in four patients (19.0%). Median time to first relapse was 14.3 weeks (7.1–62.0). Eculizumab was re-initiated within 24 hours in all relapsing patients. At last follow-up, there were no chronic sequelae, i.e. no clinically relevant increase in serum creatinine, proteinuria and/or hypertension, in the relapsing patients. No predictors of relapse could be determined. The total medical expenses of our population were only 30% of the fictive expenses made when patients would have received eculizumab every fortnight.

**Conclusions:** It is safe and (cost-) effective to discontinue eculizumab after three months of therapy in patients with aHUS in native kidneys. Larger data registries are needed to determine factors to predict relapse(s) and short- and long-term outcomes.



## TH-PO504

## Clinical and Histologic Profile of C3 Glomerulopathy: A Retrospective Study

Soumita Bagchi,<sup>1</sup> Adarsh Barwad,<sup>2</sup> Geetika Singh,<sup>2</sup> Arunkumar Subbiah,<sup>1</sup> Dipankar M. Bhowmik,<sup>1</sup> Sanjay K. Agarwal.<sup>1</sup> <sup>1</sup>Nephrology Department, All India Institute of Medical Sciences, New Delhi, India; <sup>2</sup>Pathology Department, All India Institute of Medical Sciences, New Delhi, India.

**Background:** C3 glomerulopathy(C3G) is a type of glomerular disease characterized by the predominant deposition of complement component C3 in the glomeruli due to the abnormal activation of the alternate complement pathway. Our understanding of the disease is still evolving. We evaluated the clinical profile of patients with C3G in our renal biopsy cohort.

**Methods:** Patients with biopsy proven C3G diagnosed between 2015 to 2020 were included in this retrospective study. Demographic characteristics, laboratory investigations and treatment details were obtained from medical records. Biopsy records were reviewed for histologic features. Complete remission (CR) was defined as 24-hour urine protein of <500 mg/d with stable eGFR and partial remission (PR) was defined as atleast 50% reduction in proteinuria with stable eGFR with a decline of proteinuria to <3.5g/day. The study was approved by the institute ethics committee with a waiver of consent. Renal progression was defined as sustained >50% decline in eGFR or end stage renal failure.

**Results:** 33 patients were diagnosed with C3G during the study period. Median age at presentation was 23(IQR 18-30) years and 69.7% were males. 51.5% had hypertension. Median estimated glomerular filtration rate(eGFR) was 49(IQR 22.5-97.8) ml/min/1.73m<sup>2</sup>, median serum albumin was 2.7(IQR 2.3-3.5) g/dl and median proteinuria was 4.3(IQR 3.0-7.4) g/day at presentation. 51.5% patients had microscopic hematuria. 51.4% cases had low C3 levels. On histology 4 patients had dense deposit disease (DDD) while 29 were diagnosed with C3 glomerulonephritis (2 cases had crescents). 52.9% cases received renin angiotensin system (RAS) blockade therapy. 29 patients received initial immunosuppression with: steroids (8), mycophenolate mofetil+steroids (20) or cyclophosphamide+steroids (1). Only 9 patients achieved reduction in proteinuria with stable eGFR: 5 had partial remission and 4 had complete remission. Of the 20 patients who received MMF, only 7(35%) had remission. During a median follow up of 29 (IQR 6.7 to 44.1) months, 15(45.4%) patients had sustained >50% decline in eGFR or had progressed to end stage renal failure.

**Conclusions:** C3G presents at a young with significant proteinuria. Patients respond poorly to currently available immunosuppression with high risk of worsening kidney function.

## TH-PO505

## 12M Interim Analysis of an Open-Label, Non-Randomized Extension of a Phase 2 Study to Evaluate the Long-Term Efficacy, Safety, and Tolerability of Iptacopan in Subjects With C3G

Carla M. Nester,<sup>1</sup> Ute Eisenberger,<sup>2</sup> Alexandre Karras,<sup>3</sup> Liz Lightstone,<sup>4,5</sup> Manuel Praga,<sup>6</sup> Giuseppe Remuzzi,<sup>7</sup> Maria Jose Soler,<sup>8</sup> Junhao Liu,<sup>9</sup> Matthias Meier,<sup>10</sup> Ronda Tawfik,<sup>11</sup> Guido Junge,<sup>11</sup> Andrea Biondani,<sup>10</sup> Angelo J. Trapani,<sup>9</sup> Nicholas Webb,<sup>10</sup> Edwin K. Wong.<sup>12,13</sup> <sup>1</sup>University of Iowa Molecular Otolaryngology and Renal Research Laboratories, Iowa City, IA; <sup>2</sup>Department of Nephrology, University Hospital Essen, University of Duisburg-Essen, Essen, Germany; <sup>3</sup>Hopital European Georges Pompidou, Paris, France; <sup>4</sup>Centre for Inflammatory Disease, Department of Immunology and Inflammation, Imperial College London, London, United Kingdom; <sup>5</sup>Imperial College Renal and Transplant Centre, Imperial College Healthcare NHS Trust, Hammersmith Hospital, London, United Kingdom; <sup>6</sup>Department of Medicine, Complutense University. Hospital Universitario 12 de Octubre, Madrid, Spain; <sup>7</sup>Istituto di Ricerche Farmacologiche Mario Negri, Bergamo, Italy; <sup>8</sup>Hospital Universitari Vall d'Hebron, Barcelona, Spain; <sup>9</sup>Novartis Pharmaceuticals Corporation, East Hanover, NJ; <sup>10</sup>Novartis Pharma AG, Basel, Switzerland; <sup>11</sup>Novartis Institutes for BioMedical Research Basel Department of Translational Medicine, Basel, Switzerland; <sup>12</sup>Newcastle University, Newcastle upon Tyne, United Kingdom; <sup>13</sup>National Renal Complement Therapeutics Centre, Royal Victoria Infirmary, Newcastle upon Tyne, United Kingdom.

**Background:** Iptacopan (LNP023) is an oral, first-in-class, selective inhibitor of factor B, a key component of the alternative complement pathway (AP). We have previously reported data from a Ph2 study in native and recurrent C3G (NCT03832114) showing that 12W iptacopan treatment results in a 45% reduction in proteinuria in native C3G. Here we present the effects of 12M iptacopan treatment.

**Methods:** Adults with native (CoA) or recurrent C3G post kidney transplant (CoB) received iptacopan for at least 12W before entering this Ph2 extension trial (NCT03955445). The primary efficacy objective was to assess the effect of iptacopan on a composite endpoint of 1) stable/improved eGFR [ $\leq 10\%$  reduction from baseline], 2)  $\geq 50\%$  reduction from baseline in UPCr, and 3)  $\geq 50\%$  increase from baseline in serum C3 after 12M treatment.

**Results:** Of 27 patients completing the 12W Ph2 study, 26 (16CoA, 10CoB) entered the extension for treatment with iptacopan 200mg b.i.d. 53% of CoA patients met the composite renal endpoint criteria at 12M; proteinuria was reduced by 57% ( $p < 0.0001$ ; Fig1), eGFR increased by 6.83 mL/min/1.73 m<sup>2</sup> ( $p = 0.0174$ ; Fig2) and C3 increased by 253% ( $p < 0.0001$ ). eGFR was stable and C3 levels increased by 96% in CoB. Proteinuria

reduction was not assessed in CoB as median baseline proteinuria was normal (18.4g/moL). Iptacopan was generally well-tolerated and most AEs were of mild severity in both cohorts. Biomarkers demonstrated substantial AP inhibition.

**Conclusions:** Long-term treatment with iptacopan results in further proteinuria reduction and eGFR improvement beyond that previously reported following 12W treatment in native C3G. Stable eGFR was seen in recurrent C3G, with stable increases in serum C3 levels found in both cohorts. The ongoing Ph3 APPEAR-C3G (NCT04817618) study is evaluating the efficacy of iptacopan in native C3G patients.

**Funding:** Commercial Support - Novartis Pharma AG

Figure 1: Cohort A - UPCr

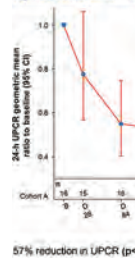
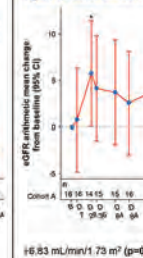

Figure 2: Cohort A - eGFR



## TH-PO506

## Impact of First-Line Use of Caplacizumab on Treatment Outcomes in Immune Thrombotic Thrombocytopenic Purpura: News From the REACT-2020 Cohort

Linus A. Volker,<sup>1,2</sup> Jessica K. Kaufeld,<sup>3</sup> Lucas Kuehne,<sup>1</sup> Thomas Osterholt,<sup>1</sup> Franziska Grundmann,<sup>1</sup> Martin Kann,<sup>1,2</sup> Paul T. Brinkkoetter.<sup>1,2</sup> <sup>1</sup>University Hospital of Cologne, Cologne, Germany; <sup>2</sup>Exzellenzcluster CECAD in der Universität zu Köln, Köln, Germany; <sup>3</sup>Medical School Hannover, Hannover, Germany.

**Background:** The von Willebrand factor-directed nanobody caplacizumab has greatly changed the treatment of immune thrombotic thrombocytopenic purpura (iTTP) in recent years. While data from randomized controlled trials established efficacy and safety, there has been a lack of information regarding patient selection, tailoring of therapy duration, effect on adjunct treatment, and outcomes in the real-world setting. Here, we report 113 iTTP episodes treated with standard of care including caplacizumab and 119 historical control episodes treated without caplacizumab.

**Methods:** Patients with an episode of iTTP defined by an ADAMTS13 activity below 10 percent or relapsing thrombotic microangiopathy in patients with an established diagnosis of iTTP and 18 years of age or older were eligible. REACT-2020, registered at clinicaltrials.gov as #NCT04985318, is an observational retrospective cohort study. From October 2018 until May 2021, data from patients in Germany and Austria with an acute episode of iTTP receiving caplacizumab were gathered retrospectively.

**Results:** Caplacizumab may lower iTTP-related mortality and refractoriness and decrease the number of daily plasma exchange and hospital stay. These benefits, however, vanish in patients not receiving caplacizumab first-line within 72 hours after diagnosis and until at least partial ADAMTS13 remission. In addition, we observed an increase in use of rituximab over time. Exacerbations were less frequent in caplacizumab-treated patients (14 % vs. 39 %). In an aggregated analysis of all available iTTP cohorts, caplacizumab resulted in significant absolute risk reduction of 2.87 % for iTTP-related mortality (number needed to treat 35) and a relative risk reduction of 59 %.

**Conclusions:** Caplacizumab may improve patient-centered outcomes if given in the first-line within 72 hours and until at least partial ADAMTS13 remission.

## TH-PO507

## Practice Patterns of Induction Therapy in Severe ANCA-Associated Vasculitis: An International Physician Survey

Lillian Xu,<sup>1</sup> Faten F. Aqeel,<sup>1</sup> Ojaswi S. Tomar,<sup>2</sup> Tingting Li,<sup>2</sup> Duvuru Geetha.<sup>1</sup> <sup>1</sup>Johns Hopkins Medicine, Baltimore, MD; <sup>2</sup>Washington University in St Louis School of Medicine, St Louis, MO.

**Background:** Therapies for ANCA-associated vasculitis (AAV) have evolved over the last 3 decades. In light of new data on plasma exchange (PLEX) and glucocorticoid (GC) use, as well as recent approval of avacopan (AVP), various medical societies have updated their AAV management guidelines. Here, we explored practice patterns of induction therapy in severe AAV and ascertained differences in management by physician specialty, practice setting, and volume of AAV patients.

**Methods:** A 65-item anonymous research survey addressing physician/practice characteristics, AAV induction therapy approaches, prophylactic measures, and laboratory monitoring was sent to physicians by e-mail and social media platforms after IRB approval. Practice patterns within the last 5 years were examined based on physician specialty, practice setting, and volume of AAV patients. Descriptive statistics, chi-square, t-test, and Fisher's exact were used as appropriate.

**Results:** There were 308 responses (52% nephrologists, 41% rheumatologists). Of all participants, 29% practiced in the United States, 20% in India, 9% in the United Kingdom, 6% in Canada, and the remainder in other countries. Pulse methylprednisolone (MeP) was used by 94%, reduced dose GC by 70%, PLEX by 38%, rituximab (RTX) by 92%, cyclophosphamide (CYC) by 89%, and AVP by 12%. There were significant differences

Key: TH - Thursday; FR - Friday; SA - Saturday; OR - Oral; PO - Poster; PUB - Publication Only

Underline represents presenting author.



in use of reduced dose GC, PLEX, and RTX brand by physician specialty and by AAV patient volume (Table). Significant differences were seen in regards to pulse MeP dose ( $p < 0.001$ ), treatment of severe AAV presentations ( $p < 0.001$ ), CYC route and duration ( $p = 0.005$ ,  $p < 0.001$ ), and PJP prophylaxis ( $p < 0.005$ ) by physician specialty, RTX and AVP use by volume of AAV patients ( $p = 0.003$ ,  $0.001$ ), and CYC use by practice setting ( $p < 0.001$ ).

**Conclusions:** Our survey highlights significant differences in AAV induction therapy practices based on specialty, practice setting, and AAV patient volume. Additionally, one third of physicians continue to use standard GC.

**Funding:** Clinical Revenue Support

Practice Patterns	Physician Specialty		P-value	Volume of AAV Patients		P-value
	Nephrology	Rheumatology		< 50/year	> 50/year	
Use of reduced dose GC	83%	54%	<0.001	67%	78%	0.001
Use of PLEX	49%	25%	<0.001	34%	52%	0.009
Use of RTX brand	35%	17%	0.001	32%	13%	0.009
Use of AVP	14%	10%	0.29	9%	23%	0.001

**TH-PO508**

**Kinetics of B Cell Repopulation After Rituximab in ANCA-Associated Vasculitis: Clinical Significance and Predictive Factors**

Federica Mescia,<sup>1,2</sup> Chiara Salviani,<sup>1</sup> Stefania Affatato,<sup>1,2</sup> Mattia Tonoli,<sup>1,2</sup> Alice Guerini,<sup>1,2</sup> Martina Tedesco,<sup>1,2</sup> Daniele Moratto,<sup>1</sup> Gina A. Gregorini,<sup>3</sup> Marco Chiarini,<sup>1</sup> Francesco Scolari,<sup>1,2</sup> Federico Alberici,<sup>1,2</sup> <sup>1</sup>Azienda Socio Sanitaria Territoriale degli Spedali Civili di Brescia, Brescia, Italy; <sup>2</sup>Università degli Studi di Brescia, Brescia, Italy; <sup>3</sup>Independent researcher, Brescia, Italy.

**Background:** Despite the increasing use of Rituximab (RTX) in ANCA-Associated Vasculitis (AAV), it remains unclear what the optimal dosing is, especially for maintenance. A deeper understanding of post-RTX BC repopulation is needed to better tailor treatment.

**Methods:** This is a single center, 10-year retrospective study including newly diagnosed, ANCA-positive patients with GPA/MPA receiving RTX induction with no fixed-schedule maintenance. CD19+BC were monitored with flow cytometry. Data were censored after repeat RTX. Repopulation was defined as CD19+BC > 10 cells/ $\mu$ l.

**Results:** The cohort included 71 AAV patients, with a majority of females (62%), MPA syndrome (75%) and MPO-ANCA positivity (75%). Most had renal involvement (79%), with median eGFR 23 ml/min/1.73m<sup>2</sup> (IQR 9-48). During median follow-up of 55 months, 44 patients (62%) repopulated BCs. Median time to repopulation was 39 months (range 7-102). Comparing patients with/without repopulation at 12/24/36/48 months, there was a trend for lower flare risk and higher infection risk with ongoing BC depletion, reaching statistical significance only at 48 months (log-rank test). In exploratory univariate Cox regression, risk of BC repopulation was positively associated with eGFR and female gender, with a trend for negative association with older age, MPA presentation (vs. GPA), and steroid pulses. Among these variables, only eGFR (HR 1.22 per 10 ml/min/1.73m<sup>2</sup>, 95%CI 1.04-1.43,  $p = 0.016$ ) and gender (HR 2.73 for female, 95%CI 1.39-5.38,  $p = 0.004$ ) were independent predictors of time to BC repopulation in the multivariate model (Figure 1).

**Conclusions:** A subset of AAV patients develop sustained post-RTX BC depletion, which associates with long-term reduced flare risk and increased infection risk. Renal impairment and male gender are key predictors of delayed BC repopulation. These observations further highlight the need for tailored immunosuppression.

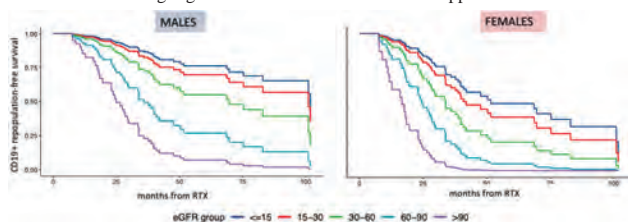

Fig. 1: Expected time to BC repopulation curves across different eGFR groups and gender, according to multivariate Cox model

**TH-PO509**

**Prognosis of Diffuse Crescentic Fibrillary Glomerulonephritis**

Vincent Javague,<sup>1,2</sup> Samar M. Said,<sup>1</sup> Lihong Bu,<sup>1</sup> Frank Bridoux,<sup>2</sup> Fernando C. Fervenza,<sup>1</sup> Nelson Leung,<sup>1</sup> Samih H. Nasr,<sup>1</sup> <sup>1</sup>Mayo Clinic Minnesota, Rochester, MN; <sup>2</sup>Centre Hospitalier Universitaire de Poitiers, Poitiers, France.

**Background:** Diffuse crescentic involvement is very rare in fibrillary glomerulonephritis (FGN). Little is known about the prognosis and the therapeutic management of these patients.

**Methods:** We retrospectively reviewed the pathology archives at Mayo Clinic and University Hospital of Poitiers from 1997-2021 for FGN with crescents involving  $\geq 50\%$  of glomeruli.

**Results:** Twenty-two patients (50% female, 91% Caucasian, median age 59 years) were included (incidence of 2.7% in biopsies of FGN). All patients presented with rapidly progressive glomerulonephritis (RPGN) and 9 required dialysis at diagnosis.

Eight patients had CKD stage  $\geq 3$ . Associated conditions included autoimmune disease in 6, malignancy in 3 and hepatitis C in 2 cases. Four had positive ANCA and 1 had an anti-GBM antibody. By light microscopy, the median % of glomeruli with crescents was 64%. Glomeruli showed strong staining for DNAJB9 in 11 tested cases. By immunofluorescence, all cases showed glomerular positivity for IgG (polytypic in 19/22) with IgG4 restriction in most cases, and linear GBM staining mimicking anti-GBM nephritis in 6. Nineteen patients received immunosuppressive therapy (steroids alone,  $n = 3$ ; or with cyclophosphamide,  $n = 11$ ; rituximab,  $n = 4$ ; rituximab + cyclophosphamide,  $n = 1$ ) associated with plasmapheresis in 4 cases. Kaplan-Meier analysis showed poor renal outcome with a median renal survival of 3 weeks (Figure). Three patients received kidney transplantation without evidence of recurrence 18-, 48- and 56-months post transplantation, respectively.

**Conclusions:** Our study highlights a dismal kidney prognosis of crescentic FGN regardless of the type of therapy and suggests that kidney transplant is probably the best option for fit patients with RPGN secondary to diffuse crescentic FGN.

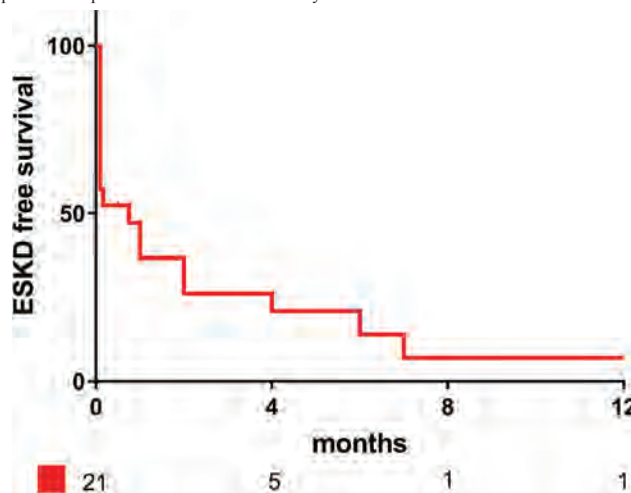

Kaplan-Meier renal survival analysis.

**TH-PO510**

**Renal Tubulointerstitial Injury in Patients With Cryoglobulinemia**

Chen Minting, Xiaoxiao Shi, Yubing Wen, Peng Xia, Xuemei Li, Limeng Chen. *Department of Nephrology, State Key Laboratory of Complex Severe and Rare Diseases, Peking Union Medical College Hospital, Chinese Academy of Medical Science and Peking Union Medical College, Beijing, China.*

**Background:** Kidney tubulointerstitial (TI) involvement in patients with cryoglobulinemia (CG-TI) was rare and their clinicopathological characteristics and renal prognosis remain unclear.

**Methods:** We recruited 199 inpatients with CG in our hospital. A total of nine cases of CG-TI were identified based on the tubular dysfunctions or TI injuries in kidney pathology. Their medical document, kidney pathology, treatment regimens, and follow-up data were reviewed and analyzed.

**Results:** The nine CG-TI patients had a median age at diagnosis of 49 (43-60) years with the male (44%). The primary causes of CG were primary Sjogren's syndrome (33.3%) and monoclonal gammopathy of renal significance (22.2%). Mixed (II + III) cryoglobulinemia accounted for the majority (88.9%). The anemia (66.7%), fever (55.6%), and cutaneous lesions (33.3%) were the most common extrarenal manifestations. The mean eGFR level was 40.04 ml/min/1.73m<sup>2</sup>. About 88.9% had proteinuria with a mean urine protein level of 1.01 g/d. Two patients had prominent proximal tubular injuries, presenting as Fanconi syndrome. Besides the cryoglobulinemic glomerulonephritis (GN) with a membranoproliferative GN, kidney pathology showed obvious tubulointerstitial injuries, with interstitial inflammatory infiltrates, tubular atrophy, and interstitial fibrosis. Intracapillary deposits were the short fibrillary substructure by electron microscopy. Seven patients received immunosuppressive treatment or chemotherapy. Followed the mean of 30±4 months, their renal function recovered within a year and stabilized thereafter.

**Conclusions:** We reported the rare cases series of CG-TI, which responded well to immunosuppressive treatment or chemotherapy.

**TH-PO511**

**Idiopathic Nodular Glomerulosclerosis Associated With APOL1 Mutation**

Shahzad Zonoozi, Divya Shankaranarayanan, Anam Tariq, Dominic S. Raj. *The George Washington University, Washington, DC.*

**Introduction:** Idiopathic nodular glomerulosclerosis (ING) is a pathologic diagnosis with features indistinguishable from diabetic nodular glomerulosclerosis in the absence of abnormal glucose metabolism. ING has been associated with hypertension (HTN), smoking and obesity. We present a case of ING in a non-smoker.

**Case Description:** A 58-year-old African American male non-smoker with HTN and obesity presented for evaluation of 5-6 months of leg edema and uncontrolled HTN. Evaluation revealed anemia, thrombocytopenia, creatinine (Cr) 2.7mg/dL, albumin 2.6g/dL and hemoglobin A1c 5.5%. Serologic work up was negative. Random urine protein/Cr ratio was 13.4g/g Cr and so patient underwent a kidney biopsy. Biopsy demonstrated 1/10 globally sclerotic glomeruli with nodular expansion and mild-moderate mesangial hypercellularity. Glomerular basement membrane was thickened. Interstitial fibrosis and tubular atrophy affected 60-70% of cortex with marked interstitial inflammatory infiltrate. Electron microscopy showed extensive podocyte foot process effacement. Immunofluorescence showed glomeruli with trace granular peripheral capillary wall staining with IgM, C1q and C3. Overall, findings suggestive of nodular glomerulosclerosis, chronic thrombotic microangiopathy (TMA), chronic active interstitial nephritis and moderate arteriosclerosis. Additionally, the patient underwent genetic evaluation, which revealed 2 risk alleles in the APOL1 gene (G1 and G2) as well as carrier status for SLC6A19 and a variant of unknown significance in NPHS1.

**Discussion:** Our patient presented with nephrotic syndrome and was found to have ING and TMA on biopsy. Although ING has been linked to HTN and smoking, our patient was a non-smoker, whose workup revealed risk alleles in the APOL1 gene. As far as we are aware this is the first report of an association between ING and the APOL1 gene.

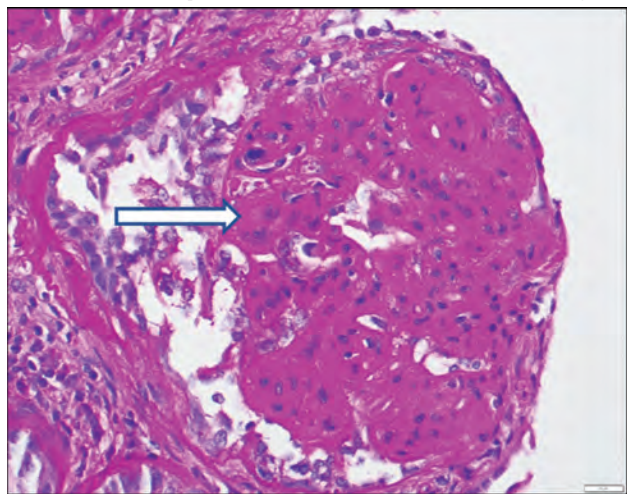

Figure 1. Light microscopy showing nodular glomerulosclerosis

**TH-PO512**

**Hemophagocytic Lymphohistiocytosis (HLH) and Collapsing Focal Segmental Glomerulosclerosis (cFSGS) in an Immunocompetent Patient With Cytomegalovirus and Epstein-Barr Virus Viremia**

Mingyue He, Edva Noel, Sheetal Koul, Avrum Gillespie, Serban Constantinescu, Iris J. Lee, Lewis Katz, School of Medicine at Temple University, Philadelphia, PA.

**Introduction:** cFSGS is an aggressive variant of FSGS characterized by collapse and sclerosis of the glomerular tuft, nephrotic syndrome, and rapidly progressive renal failure often resistant to treatment. Patients of African ancestry are disproportionately affected. To our knowledge, this is the first reported case of cFSGS and HLH in an immunocompetent host with CMV and EBV viremia successfully treated with steroids and ganciclovir.

**Case Description:** A 56-year-old African American female was admitted with fever, dry cough, nausea/vomiting, and 30 lb weight loss over the past 6 months. Her persistent fevers led to an infectious workup and testing for HLH. Studies showed EBV viremia (9300 copies/ml), CMV viremia (15,567 IU/ml), hypertriglyceridemia, elevated soluble CD25, hyperferritinemia, and evidence of hemophagocytosis on bone marrow biopsy. 1 week later, she developed oliguric AKI with a peak creatinine of 8.3 mg/dl and 8.8 gm proteinuria. Serologies were all negative and complements were normal. A kidney biopsy showed cFSGS, acute tubulointerstitial nephritis. Immunofluorescence was negative. She was treated with dexamethasone for HLH and ganciclovir for CMV. 1.5 months later, her viremia resolved, abnormal markers improved, and her renal function normalized.

**Discussion:** The onset of HLH-related markers coinciding with CMV and EBV viremia suggests secondary HLH, likely triggered by viral infection. Rapid response to steroids and ganciclovir supports CMV infection as a driver of HLH and cFSGS development. HIV-associated cFSGS is well established, however, association with CMV and EBV are rare. Increased interferon production in response to viral infection may provide the "second hit" for podocyte damage in AA patients with high-risk APOL1 alleles. HLH-related inflammation and cytokine dysregulation with markedly elevated Interferon levels may also contribute to cFSGS. cFSGS is a rare complication of CMV, EBV infection and HLH. Testing for these is not routinely performed for immunocompetent patients, therefore these potential causes of cFSGS may be under-recognized. Cases of idiopathic cFSGS should be screened for viral infection and HLH, as anti-viral therapy combined with steroids may result in the resolution of renal disease.

**TH-PO513**

**Cerebral Venous Thrombosis in an Adult With Relapsing Minimal Change Disease: A Case Report and Literature Review**

Matthias Bergmann,<sup>1,2</sup> Christine Segal,<sup>1</sup> Bertrand L. Jaber.<sup>1,2</sup> <sup>1</sup>Saint Elizabeth's Medical Center, Brighton, MA; <sup>2</sup>Tufts University School of Medicine, Boston, MA.

**Introduction:** Minimal change disease (MCD) is a well-known cause of fulminant nephrotic syndrome (NS) and associated with thrombotic events. Cerebral venous thrombosis (CVT) is a potentially fatal, albeit rare complication. We present a case of relapsing MCD complicated by CVT and intracranial hemorrhage (ICH), and provide a systematic review of cases with NS-associated CVT.

**Case Description:** A 51-year-old woman with biopsy-proven MCD in remission previously treated with glucocorticoids presented with headache, vomiting, and confusion after relapse of the NS. Proteinuria was 14.7 g/g creatinine and serum albumin was 2.5 g/dL. Brain MRI was consistent with CVT complicated by ICH. One month prior, she had been initiated on an oral combination contraceptive for menstrual cramps. She was treated with anticoagulation and glucocorticoids and died before being able to undergo catheter-based therapy.

**Discussion:** Our systematic review of 33 cases with NS-associated CVT is shown in Table 1. Average proteinuria was 9.32 g/day (0.05-24.30), and average serum albumin was 1.8 g/dL (0.7-3.6). 14 patients (70%) had MCD. Most reported symptoms were headache (83%), nausea/vomiting (47%), and altered mental status (30%). 5 patients (15%) developed ICH. 20 patients (91%) received anticoagulation and 5 patients (23%) underwent catheter-based therapies. 5 patients (19%) died from the sequelae of CVT, 3 of which (60%) had ICH. In conclusion, MCD might be related to a higher risk of CVT due to its fulminant manifestation of the NS. Additional prothrombotic triggers, such as oral contraceptives, should be avoided. Neurological symptoms are often non-specific and threshold for MRI should be low in patients with the NS.

<b>Patient demographic characteristics</b>	
Men (n = 28)	54%
Mean age (n = 28)	39 years old
Ethnicity (n = 6)	
White	50%
Black	17%
Asian	33%
<b>Neurological clinical presentation (n = 30)</b>	
Headache	83%
Nausea/vomiting	47%
Confusion/loss of consciousness	30%
Visual changes	23%
Seizure	10%
Diplopia	7%
Other focal neurological deficits	17%
<b>Neurological imaging findings in addition to CVST (n = 33)</b>	
Ischemic infarct	9%
Intracranial hemorrhage	15%
<b>Nephrotic syndrome-related characteristics at time of neurological presentation</b>	
Status of nephrotic syndrome (n = 25)	
Initial presentation	64%
Relapse	32%
In Remission	4%
Kidney biopsy findings (n = 20)	
Minimal change disease	70%
Lupus nephritis (membranous nephropathy and diffuse proliferative glomerulonephritis)	10%
IgM nephropathy	5%
Focal segmental glomerulosclerosis (FSGS)	5%
Amyloidosis	5%
Interstitial nephritis	5%
Mean urinary protein excretion (n = 21)	9.32 gm/gm or gm/day
Mean serum albumin (n = 25)	1.8 gm/dL
Current use of immunosuppressive therapies (n = 28)	
Glucocorticoids	21%
Azathioprine	14%
Rituximab	4%
Not reported	4%
<b>Management of CVST (n = 22)</b>	
Use of anticoagulation	
Parenteral anticoagulation	91%
Unfractionated heparin infusion	86%
Low-molecular-weight heparin	45%
Oral anticoagulation	41%
Not reported	77%
Use of antiplatelet agents	
Use of catheter-based thrombolytic therapy	23%
Chemical thrombolysis	23%
Mechanical thrombectomy	14%
Not reported	9%
<b>Clinical outcomes</b>	
Residual neurological deficits, excluding death (n = 21)	5%
Death (n = 26)	19%

The sample sizes provided in parentheses represent the number of evaluable cases for each variable of interest.

**Table 1.** Characteristics of 33 patients with nephrotic syndrome-associated cerebral venous thrombosis (CVT)

TH-PO514

**Membranous Nephropathy in the Setting of Adult-Onset Still Disease: A Rare Association**

Shruti Shettigar, Surafel K. Gebreselassie, Shane A. Bobart. *Cleveland Clinic Florida, Weston, FL.*

**Introduction:** Adult onset still's disease (AOSD), is a multi-system, autoimmune, inflammatory disorder. Typically, if a patient with AOSD presents with proteinuria, the initial concern is secondary renal amyloidosis given the severity and persistence of inflammation. We present a case of a patient with AOSD and proteinuria with biopsy proven membranous nephropathy (MN). The association of AOSD with MN is rare and to our knowledge, there is only one other published case of AOSD subsequently being diagnosed with MN.

**Case Description:** A 19 year old African American female presented to the Nephrology clinic for evaluation of non-nephrotic range proteinuria. Approximately 2 years prior at another institution, she presented with rash, arthralgia, and nightly fevers with severely elevated inflammatory markers and low positive ANA (1:80). She was diagnosed with Still's disease and treated initially with prednisone followed by canakinumab an IL-1 $\beta$  inhibitor for 1 year. Symptoms persisted with development of lymphadenopathy, hepatomegaly, ferritin as high as 15797 ng/ml and CRP 137 mg/dL. She was then treated with three other biologics including anakinra (IL-1R antagonist), tocilizumab (IL-6R antagonist) and then maintained on sarilumab (IL-6R antagonist). At Nephrology presentation, urinalysis showed no hematuria but 3+ proteinuria, confirmed to be 1.4 grams/24 hr. Serum albumin was 3.2 g/dL and serum creatinine 0.45 mg/dL. She was normotensive and had no edema on examination. Additional serological work up was unrevealing with negative dsDNA, normal C3 and C4, negative PLA2R, extractable nuclear antigens, ANCA, cryoglobulin, no infectious causes and HbA1c 5.8. Given persistent proteinuria, a kidney biopsy was done with unrevealing light microscopy, mild foot process effacement and subepithelial immune-complex type deposits on electron microscopy. On immunofluorescence, 3+ IgG, kappa and lambda within the distribution of subepithelial deposits confirmed the diagnosis of an early membranous nephropathy. PLA2R and Congo red stain were both negative. She was started on losartan with improvement in proteinuria to 0.6 grams.

**Discussion:** While secondary renal amyloidosis remains a clinical concern in AOSD presenting with proteinuria, clinicians should perform a kidney biopsy as other lesions such as membranous nephropathy may be rarely associated.

TH-PO515

**Mercury Toxicity due to Skin Lightening Products as a Cause of Mercury-Associated Membranous Nephropathy (M-MN)**

Karim El Hachem,<sup>1</sup> Joshua Trebach,<sup>2</sup> Rohan Bansal,<sup>2</sup> Stephen C. Ward,<sup>1</sup> Bob S. Hoffman,<sup>2</sup> Ira S. Meisels.<sup>1</sup> <sup>1</sup>*Icahn School of Medicine at Mount Sinai, New York, NY;* <sup>2</sup>*New York University, New York, NY.*

**Introduction:** Mercury-associated Nephrotic Syndrome (NS) presents as Minimal Change Disease or less commonly as Membranous Nephropathy. Skin lightening products (i.e, creams) are commonly used in certain areas of the world. Unfortunately, these products often contain inorganic mercury, which can be absorbed through the skin. Chronic mercury exposure leads to systemic toxicity with subsequent peripheral neuropathy, dermatitis, renal impairment and autoimmune phenomena. We report a case of M-MN.

**Case Description:** A 38-year-old woman recently immigrated from Senegal was referred for NS evaluation. Her exam was notable for a normal blood pressure, 1+ bipedal edema and eczematous lichenified lesions on her back, shoulders, hands and feet. Additional history taking elicited use of several skin lightening products for more than 10 years, which prompted testing for mercury levels. See Table1 for laboratory results, and Figure1 for biopsy findings. She received diuretics, ARB and high-intensity statin therapy and received no immunosuppression. In consultation with toxicology, she was treated with dimercaptosuccinic acid. After her first round of chelation, her proteinuria mildly improved, her serum mercury level decreased by half while her urine mercury levels appropriately rose. Additional chelation is planned.

**Discussion:** Although rare, M-MN can be encountered in the US despite the limited use of unregulated products containing mercury. We highlight the importance of careful history taking and suggest questioning patients about the use of such products as part of the initial work up and evaluation of NS.

	Initial Presentation	At completion of 1st round of DMSA
Creatinine, serum (0.57 - 1.00 mg/dL)	0.56	0.6
Albumin, blood (3.8 - 4.8 g/dL)	2.4	2.5
Total protein, serum (6.0 - 8.5 g/dL)	4.7	4.4
Hemoglobin (11.1 - 15.9 g/dL)	14.8	12.9
Platelet (150 - 450 x10E3/uL)	451	443
Total Cholesterol (100 - 199 mg/dL)	732	365
HDL Cholesterol (>39 mg/dL)	54	.61
LDL Cholesterol, calculated (0 - 99 mg/dL)	630	268
Triglycerides (0 - 149 mg/dL)	183	191
Urine Protein/Cr ratio (mg/gm creatinine)	10.611	7.518
Urine Albumin/Cr ratio (mg/gm creatinine)	7.321	4.821
Phospholipase A2 Receptor Ab, IgG : <14.0 - Negative; 14.0 - 19.9 - Borderline; >19.9 - Positive.	<1.8	<1.8
WBC on UA	0	0
Mercury Blood (0.0 - 14.9 ug/L) [Environmental Exposure <15.0; Occupational Exposure BEI Inorganic Mercury 15.0]	20.3	10.5
Mercury Urine, random (0 - 19 ug/L)	228	196
Urine Mercury/Cr ratio (0 - 5 ug/g creatinine)		
[Environmental Exposure: < 5; Occupational Exposure: BEI 35]	139	228

Table 1. Laboratory results of the patient on initial presentation and at completion of first round of therapy with Dimercaptosuccinic acid (DMSA) at 30 mg/kg, 3 times daily for 5 days followed by 10 mg/kg twice daily for 14 days. Total DMSA dose of 30.5 gm administered. Additional work up was negative including ANA, C3, CA, HSIAG, HCV Ab, HIV and RPR. Serum and Urine Immunofixation showed no monoclonal protein. Normal Kappa/Lambda ratio, Hemoglobin A1c 5.0%.

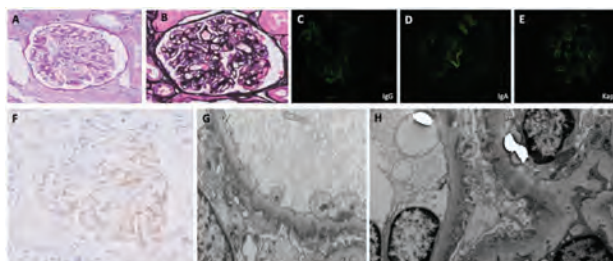

Figure 1. Kidney Biopsy findings- (A) and (B) - Light Microscopy showing thickened capillary loops on (A) PAS and (B) Jones Silver stain. (C), (D) and (E)- Immunofluorescence findings showing 1-2+ segmental staining for IgG, IgA and Kappa respectively. IF was negative for IgM, C1q, C3, Fibrinogen, lambda and albumin. (F)- Immunohistochemical stain for Anti-Phospholipase A2 Receptor shows patchy and wispy staining - but without definitive granular diffuse or linear pattern such as that seen with primary PLA2R membranous nephropathy- interpreted as negative. (G) and (H)- Electron microscopy showing diffuse foot process effacement with several capillary loops containing small, patchy subepithelial deposits with associated subepithelial spines[G] with no mesangial deposits (H) or endothelial tubuloreticular inclusions noted.

TH-PO516

**Anti-PLA2R Membranous Nephropathy Associated With Multiple Sclerosis: First Case Report**

Milena V. Cunha, Vinicius S. Silveira, Lucas A. Souza, Guilherme D. Silva, Leandro T. Lucato, Livia B. Cavalcante, Lecticia Jorge, Cristiane B. Dias, Irene L. Noronha, Luis Yu. *Universidade de Sao Paulo, Sao Paulo, Brazil.*

**Introduction:** Membranous nephropathy (MN) is a common cause of adult nephrotic syndrome, 80% are considered primary, in which the main antigens are the M-type phospholipase A2 receptor (PLA2R), thrombospondin type 1 domain-containing 7A (THSD7A) and neuro epidermal like growth factor 1 (NELL-1). Recently, new antigens have been described, including contactin-1, a podocyte and neuronal adhesion molecule with similarities with PLA2R and THSD7A, responsible for a MN associated with chronic inflammatory demyelinating polyneuropathy (CIDP).

**Case Description:** 57 years old, white male, who complained of legs swelling, foamy urine and arterial hypertension in the last 4 months. He also complained of left acute painful vision loss 5 days ago. His laboratory exams demonstrated: Creatinine 1.4g/dl; Urine1 - protein 5g/L, Leukocytes0, Eritrocytes0; urine protein/creatinine ratio 8.8g/g; serum albumin 2.1g/dl; cholesterol 270mg/dl; Complement C3 and C4 normal. Serum anti-PLA2R 406UR/ml (Elisa). Screening for other autoimmune diseases, infections and cancer resulted negative. Kidney biopsy revealed stage 1/2 MN (Fig 1) and immunofluorescence showed diffuse granular subepithelial deposits of IgG and C3. Cranial NMR revealed periventricular white matter alterations suggestive of demyelinating CNS disease (Fig 2) and optic neuritis.

**Discussion:** This is the first report of an anti-PLA2R MN with concurrent MS. A common pathogenesis is suggested, similarly to MN associated to CIDP. We suggest that the immune response in the primary MN may have unmasked other podocyte antigens, such as contactin 1, causing simultaneously the neurological involvement. Further investigation is necessary for pathogenesis elucidation.

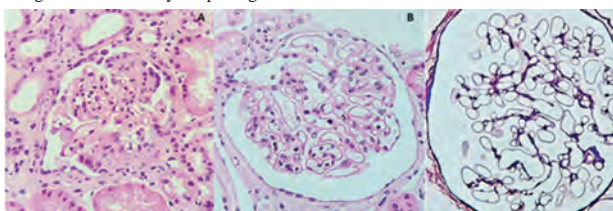

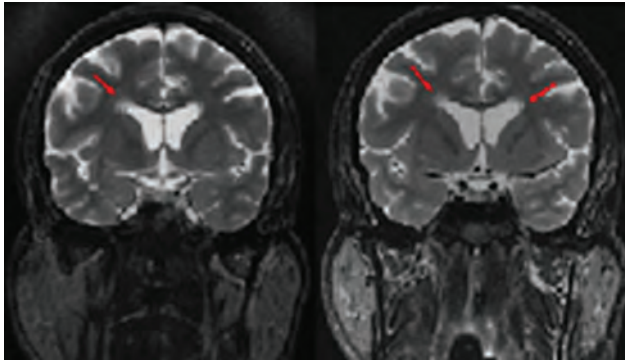

## TH-PO517

### Systemic AL Amyloidosis With an Undetectable Plasma Cell Dyscrasia: A Rare Entity

Jorge Gaytan Arocha, Juan Carlos Ramirez-Sandoval, Ricardo Correa-Rotter, Juan M. Mejia-Vilet. *Instituto Nacional de Ciencias Medicas y Nutricion Salvador Zubiran, Ciudad de Mexico, Mexico.*

**Introduction:** AL Amyloidosis is characterized by a plasma cell dyscrasia that can be detected in 99% by monoclonal protein on abnormal serum free light chain (sFLC) concentrations or immunofixation electrophoresis (IFE).

**Case Description:** A 47-year-old man was admitted to the emergency department and afterward to the intensive care unit due to severe COVID-19-associated pneumonia. Initial laboratory studies showed: hemoglobin 12.1 g/dL, creatinine 2 mg/dL, albumin 1.69 g/dL, AST 20 U/L, ALT 19 UI, urine analysis with no erythrocytes, urine protein/creatinine ratio 4.9 g/g, HbA1c 5.5%, C3 150 mg/dL, C4 35 mg/dL. Serological testing for hepatitis B, C, HIV, ANA, and anti-PLA<sub>2</sub>R were negative. After three months of hospitalization, the patient was discharged home and lost his outpatient follow-up. He returned five months later with a nephrotic syndrome. Laboratory studies showed: creatinine 1.47 mg/dL, urine proteins 5.7g/day, sFLC λ 90.1 mg/L (8.3-27), sFLC κ 43 mg/L (6.7-22.4), sFLC ratio 0.48 (0.31-1.56), urine and serum protein electrophoresis negative, urine and serum IFE negative. We performed a renal biopsy, consistent with amyloidosis with positivity for Congo red staining. Immunofluorescence reported light chain restriction +++ for λ (figure 1) and was negative for IgG, IgM, IgA, C1q, C3c, κ, and albumin. A bone biopsy reported no evidence of plasmatic cell neoplasia and was negative for Congo red staining. An echocardiogram showed no evidence of amyloid affection. Hematology stratified the patient as low risk, so they started protocol for autologous stem cell transplantation as definitive treatment but decided to consider CyBorD as induction therapy.

**Discussion:** This case illustrates a patient with systemic AL amyloidosis without evidence of plasma cell dyscrasia by conventional techniques. It could be explained because the hematologic disease is so subtle that it goes undetected. The parameter for response in his follow-up will be the improvement of proteinuria, as we cannot measure classic criteria of hematologic response.

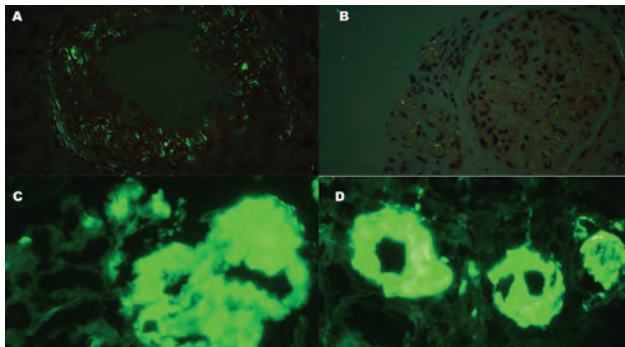

Figure 1

## TH-PO518

### Abiotrophia defectiva-Induced Cryoglobulinemic Glomerulonephritis

Michael Turk, Patricia Khalil. *Allegheny Health Network, Pittsburgh, PA.*

**Introduction:** Infection-related glomerulonephritis (GN) has several unique presentations. Some microorganisms may not be detected on routine diagnostic testing. *Abiotrophia defectiva*, for instance, is a nutritionally deficient streptococcus that is slow growing on culture media. Here, we describe a case of *A. defectiva* associated GN and infective endocarditis (IE).

**Case Description:** A 65-year old female with past medical history of paroxysmal A-fib, mitral valve repair due to chordae tendinae rupture presented to her PCP office with myalgias in the setting of elevated inflammatory markers so was sent to Rheumatology for

further work up, which was significant for Creatinine (Cr) of 1.0, microscopic hematuria, positive c-ANCA, PR3 serologies and rheumatoid factor, but normal complement levels. She was negative for dsDNA and Hepatitis B & C. Her symptoms of worsened with fatigue and malaise so she was referred to the hospital for admission. At this point, her Cr had risen to 1.5. Urine microscopy showed dysmorphic RBCs. She underwent kidney biopsy which showed immune complex mediated focal segmental GN with crescent formation. Immunofluorescence showed granular, mesangial and capillary loop staining for IgM and C3. Electron microscopy showed subendothelial and mesangial immune deposits. CD68 staining was positive in macrophages, consistent with cryoglobulins. These results were consistent with cryoglobulinemic GN. In the meantime, she became more short of breath, and transthoracic echo was obtained which showed severe transvalvular mitral regurgitation along with a mobile echodensity arising from the mitral valve, new from echo 1 month prior. A transesophageal echo confirmed the presence of a vegetation, consistent with IE. Her blood cultures, drawn about 5 days prior, finally resulted as positive for pansusceptible *A. defectiva* in 1/4 bottles. She was treated with antibiotics and underwent surgical repair of her mitral valve.

**Discussion:** *A. defectiva* has been described in the literature as a rare cause of culture negative IE however there has only been one case of ANCA GN associated with this bacteria. This case highlights the importance of a thorough infectious workup that goes beyond blood cultures in patients with biopsy proven cryoglobulinemic GN, especially in hepatitis-negative patients. Should all patients with similar presentation undergo more advanced imaging such as TEE to evaluate indolent infections?

## TH-PO519

### When the Eyes Become the Window for the Kidneys: A Case of Rapidly Progressive C3 Glomerulonephritis

Andres J. Azuero,<sup>1</sup> Jillian Caldwell,<sup>2</sup> Adetokunbo A. Taiwo,<sup>2</sup> Alex A. Velar,<sup>1</sup> Margaret K. Yu,<sup>2</sup> <sup>1</sup>Mount Sinai Medical Center, Miami Beach, FL; <sup>2</sup>Stanford University, Stanford, CA.

**Introduction:** C3 glomerulonephritis (C3GN) is a rare disease caused by dysregulation of the alternative complement pathway. We present a case of rapidly progressive C3GN with visual symptoms.

**Case Description:** A 21 year old woman presented to the Ophthalmology clinic for worsening blurry vision over 3 months. Blood pressure was 220/144 mmHg. Fundoscopic exam revealed bilateral central venous and arterial vascular occlusion, extensive cotton wool spots, few hemorrhages, and hypopigmented choroidal spots. Laboratory data was notable for hemoglobin 10.8 g/dL and serum creatinine of 3.49 mg/dL. Urinalysis had 3+ protein and 2+ blood. Urine protein/creatinine ratio was 5.3 g/g and 24 hour urine protein was 4.6 g. Serologic evaluation for glomerulonephritis was unremarkable. Kidney biopsy showed 75% global glomerulosclerosis, few fibrocellular crescents, 90% interstitial fibrosis and tubular atrophy. Immunofluorescence showed 3+ diffuse granular staining in the mesangium for C3, consistent with C3GN. Immunosuppression was not given due to the advanced fibrosis on her biopsy. The patient had rapid progression of disease and required initiation of hemodialysis 7 months after her diagnosis as a bridge to renal transplant. Genetic testing was inconclusive; several variants of uncertain significance were identified and thought to be benign. No gammopathy was identified.

**Discussion:** Most cases of C3GN manifest as nephritic or nephrotic syndrome and it is common for patients to have preserved kidney function at presentation. ESKD tends to develop over 10 years. It is unusual for C3GN to be a rapidly progressive disease, as observed in this case. In a series of 114 patients with C3GN, only 10% progressed to ESKD over a median of 22 months. This patient's eye exam was suggestive of hypertensive disease and Purtscher-like retinopathy, a rare angiopathy that may result from complement activation; its correlation with severity of renal disease remains uncertain. In addition to nonspecific therapy for proteinuria, MMF plus steroids or eculizumab alone may be considered based on the severity of proteinuria and degree of renal fibrosis. Additional studies are needed to establish if rapidly progressive cases are treatment responsive or have a higher recurrence risk after kidney transplantation.

## TH-PO520

### An Atypical Case of IgG4 Nephropathy

Andres J. Azuero, Cesar Zambrano, Alex A. Velar, Jonathan Da Costa. *Mount Sinai Medical Center, Miami Beach, FL.*

**Introduction:** IgG4 disease is a rare fibroinflammatory condition that affects many organ systems. We present a case of isolated IgG4 Nephropathy in a patient with HIV.

**Case Description:** A 61 yr old male with history of controlled HIV on HAART presented to the Nephrology clinic for 1 year of progressively worsening bilateral lower extremity edema. He had no other associated urinary, respiratory, cardiovascular or rheumatologic symptoms. Laboratory data was remarkable for: UA with 4+ protein, 10 to 30 WBC, 10 RBC and hyaline casts. Creatinine was 1.45mg/dl, BUN 20mg/dl, Albumin 2.4g/dl and a 24 hr urine protein excretion of 9gr. Kidney biopsy showed chronic active tubulointerstitial nephritis with many IgG4 staining plasma cells and eosinophils. Glomerular capillary wall staining for IgG, C3, Kappa and lambda was present with negative PLA2R immunostaining. Findings suggested IgG4-KD with mixed phenotype of both TIN and MGN. IgG4 levels, serologies for post-infectious, autoimmune and hematologic diseases were normal and there were no imaging findings of retroperitoneal fibrosis, renal masses, hepatitis/pancreatitis or neoplastic disease. The patient was treated with an ARB, a diuretic and 1 mg/kg of prednisone. He has had a good response to treatment without signs of relapse.

**Discussion:** IgG4 disease with isolated renal involvement has been described in a minority of case report series. There is uncertainty of whether this is a distinctive phenotypic hallmark or a time sensitive matter. Most cases are characterized by TIN

Key: TH - Thursday; FR - Friday; SA - Saturday; OR - Oral; PO - Poster; PUB - Publication Only

Underline represents presenting author.

and only about 7% present with MGN and nephrotic range proteinuria. Of those, half of the subjects had a mixed histology with both TIN and MGN as our patient did. TIN is presumed to be responsible for disease progression and fibrosis. Most cases have a favorable response to prednisone. Rituximab can be considered in case of severity or recurrence. Lack of robust data make it difficult to establish whether these histologic findings correlate with response to treatment and/or relapse. Our patient's case is extremely rare given the lack of systemic and serologic features of the disease on top of a complex renal histology. It is uncertain whether his history of HIV contributes to this atypical presentation as both conditions are T cell mediated. Lack of signs of HIV nephropathy on his biopsy make IgG4 the most likely etiology.

#### TH-PO521

##### Narsoplimab Treatment for Recurrent IgA Nephropathy Stabilized eGFR and Proteinuria

Joshua Storrar,<sup>1</sup> Francesco Rainone,<sup>1</sup> Rachel Middleton,<sup>1</sup> Jonathan Barratt,<sup>2</sup>  
<sup>1</sup>Northern Care Alliance NHS Foundation Trust, Salford, United Kingdom;  
<sup>2</sup>Leicester General Hospital, Leicester, United Kingdom.

**Introduction:** IgA nephropathy (IgAN) recurrence is a risk post-transplantation, and treatment options are limited. The complement system plays an important role in the pathogenesis of IgAN. Narsoplimab is an investigational mAb that targets the effector enzyme of the lectin pathway of complement, MASP-2. We present the first report of a complement inhibitor being used for treatment of recurrent IgAN.

**Case Description:** A 53-year-old male with hypertension diagnosed with IgAN in 2010 underwent a live related kidney transplant in 2014. Transplant biopsy in 2019 due to rising proteinuria (peak urine protein:creatinine ratio [uPCR] 429 g/mol) revealed strong mesangial positivity for IgA with weaker C3 staining. EM supported diagnosis of recurrent IgAN. The patient was monitored for 17 months with repeat biopsy undertaken in Nov 2020 due to falling estimated glomerular filtration rate (eGFR, 30 ml/min/1.73m<sup>2</sup>), rising uPCR (818 g/mol), and symptomatic worsening oedema. The patient was treated with budesonide, along with compassionate use narsoplimab, which was started Feb 2021 for 18 weeks, and completed Jul 2021 (Fig). eGFR from start to end of treatment remained stable from 21 ml/min/1.73m<sup>2</sup> to 18 ml/min/1.73m<sup>2</sup>, whereas it dropped significantly in the 6 months prior from 36 ml/min/1.73m<sup>2</sup> to 21 ml/min/1.73m<sup>2</sup>. uPCR from start to end of treatment dropped significantly from 1,191 g/mol to 467 g/mol. A biopsy taken in Jul 2021 showed features of advanced recurrent IgAN. The patient received 5 more infusions of narsoplimab between Dec 2021 and Jan 2022, but subsequently progressed to end-stage kidney disease and began dialysis.

**Discussion:** This is the first time narsoplimab has been reported to stabilize eGFR and uPCR in a patient with recurrent IgAN. The lack of complement degradation products seen with IF on kidney biopsy post-treatment suggests that stabilization is due to complement inhibition. Further reports of narsoplimab use in progressive recurrent IgAN are eagerly awaited.

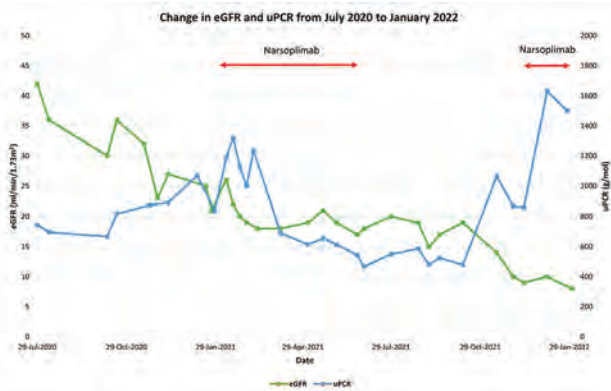

#### TH-PO522

##### A Case of Fibrillary Glomerulonephritis Presenting With Asthma Responsive to Corticosteroids

Bobak Sharifi,<sup>1</sup> Corey J. Cavanaugh,<sup>1</sup> Negiin Pourafshar,<sup>2</sup> <sup>1</sup>University of Virginia, Charlottesville, VA; <sup>2</sup>Georgetown University, Washington, DC.

**Introduction:** Fibrillary glomerulonephritis (FGN) is a rare cause of rapidly progressive glomerulonephritis (RPGN). The typical FGN clinical presentation includes renal insufficiency, hematuria, proteinuria and nephrotic syndrome. Rarely extrarenal manifestations are seen. Herein we describe a case of FGN presenting with asthma.

**Case Description:** A 51-year-old female with a history of celiac disease, tobacco abuse, and Hashimoto's thyroiditis was admitted twice in a two-week period for refractory lower extremity edema, periorbital rash, wheezing, and fevers. She was initially admitted to the medicine service for asthma exacerbation and bacterial pneumonia, which dramatically improved with antibiotics and corticosteroids. Unfortunately, she re-presented 2 weeks later, with recurrence of dyspnea and wheezing. Her creatinine rose to 2.5mg/dL, above a baseline of 0.8mg/dL over two weeks. Chest CT on admission showed ground glass opacities that resolved on repeat scan in three weeks. Her urinalysis was significant for large blood and protein to creatinine ratio of 5.8g. She had

hypoalbuminemia 2.2g/dL and edema. Serologic workup including SPEP, HIV, Hepatitis C, ANCA, and Anti-GBM were negative, only ANA was positive at 1:80. Kidney biopsy was performed, and electron microscopy revealed randomly arranged fibrils ranging from 15-23nm in diameter, immunofluorescence with linear deposition of IgG, C3, fibrin, kappa and lambda light chains. A single crescent was noted in one of seventeen glomeruli. Stains for DNAJB9 showed diffuse granular staining of both the mesangial and capillary loop basement membrane within the glomeruli. She was treated with prednisone (1mg/kg) to target asthma and glomerular disease with a 3-month taper, losartan, and an SGLT2 inhibitor. Her proteinuria decreased from 5.8g/g to 1g/g at one year follow up for partial remission. She quit smoking completely and her pulmonary symptoms resolved. Creatinine fell to 1.8mg/dL and remained stable for 2 years.

**Discussion:** FGN has a poor prognosis and there are no randomized controlled trials to guide optimal therapy. Our case highlights the difficulty in recognition and management of patients with RPGN as multiple etiologies with unusual presentations can provide dilemmas in management. This atypical presentation of RPGN with asthma and improvement with steroids and smoking cessation is particularly unique.

#### TH-PO523

##### Membranoproliferative Glomerulonephritis (MPGN) in the Setting of Unicentric Castleman Disease

Ali W. Rizvi,<sup>1</sup> Dale M. Kobrin,<sup>1</sup> Naman Gupta,<sup>1</sup> Michael Turk,<sup>1</sup> Luba Muaddi,<sup>1</sup> Swati Arora.<sup>1</sup> Allegheny Health Network, Pittsburgh, PA.

**Introduction:** Castleman's disease (CD) is a rare lymphoproliferative disorder with histopathological abnormalities - divided primarily into unicentric and multicentric disease. Thought to be an inflammatory process, renal involvement has been described extensively in the setting of multicentric disease, especially associated with HHV-8. However, similar reports in unicentric disease are rather limited.

**Case Description:** A 33 year old female with asthma developed hematuria and proteinuria in the setting of chronic right flank pain and intermittent night sweats for about 2 years. With a stable creatinine (Cr) level of 0.7 mg/dL, blood work was negative for C3, C4, cryoglobulins, and hepatitis panels. UA showed no hematuria, but did reveal 0.6 - 1.0 g of proteinuria. Imaging revealed 2 mesenteric soft tissue nodules, largest measuring 2.4 cm. A renal biopsy was significant for immune complex MPGN with kappa and c3. PET-CT at 1 year revealed hypermetabolic mesenteric nodules suspicious for malignancy. Nodular biopsy showed atypical B-lymphoid infiltrate initially concerning for marginal cell lymphoma. Referral to Mayo Clinic was confirmatory for hyaline vascular unicentric Castleman's disease. HHV8, PCR for B-cell receptor gene rearrangement and FISH for t(11:18) were negative. Referral made to Rheumatology for MPGN and moderate concern for systemic lupus erythematosus (SLE) with ANA 1:160 and BC4d, however no systemic symptoms of SLE. Follow-up imaging showed a decrease in lymphadenopathy from 2.3 to 1.6 cm, with plan for conservative management. Patient's proteinuria persisted at 821.5 mg with plan for ACE inhibitor but avoided in the setting of the patient's third pregnancy.

**Discussion:** Renal involvement is typical in multicentric CD so, we present a unique case of unicentric CD associated with MPGN. Persistent proteinuria and MPGN with ANA 1:160 and BC4d placed lupus nephritis versus Castleman's induced nephropathy on the differential. However, lack of SLE symptoms, normal complement and double stranded DNA indicated a unique disease presentation of Castleman's with proteinuria.

#### TH-PO524

##### Membranoproliferative Glomerulonephritis Associated With Tuberculosis, "the Great Imitator": Case Report

Rodolfo A. Moreno,<sup>1,2</sup> Guillermo Navarro Blackaller,<sup>3,4</sup> Angel D. Natareno,<sup>1,2</sup> Werner De León,<sup>5</sup> Mario Sierra,<sup>1,2</sup> Jonathan Chavez.<sup>3,4</sup> <sup>1</sup>Centro Medico Militar, Guatemala, Guatemala; <sup>2</sup>Universidad Mariano Galvez de Guatemala Facultad de Ciencias Medicas y de la Salud, Guatemala, Guatemala; <sup>3</sup>Hospital Civil de Guadalajara Unidad Hospitalaria Fray Antonio Alcalde, Guadalajara, Mexico; <sup>4</sup>Universidad de Guadalajara, Guadalajara, Mexico; <sup>5</sup>SERPAT, Guatemala, Guatemala.

**Introduction:** Tuberculosis (TB) is a multisystemic disease of pulmonary predominance caused by Mycobacterium tuberculosis; the kidney can be affected in different ways but as Membranoproliferative glomerulonephritis (MPGN) its an unusual presentation.

**Case Description:** A 19-year-old Guatemalan male patient with a 3-day history of malaise and fever. No previous medical history. On evaluation at the ER presented with hypertension and AKI with progressive elevation of SCr (admission 2.54mg/dl, max 6.45mg/dl) associated with proteinuria and hematuria. Laboratories: hypoalbuminemia (2.5g/dl), proteinuria 12g/day, hypocomplementemia (C3 0.04, C4 normal) ANAs, ANCA's HIV, HBV, HCV, urine culture negative, Kinyoun stain in urine with BAAR (+). Renal biopsy was performed, that reported MPGN with 50% of globally sclerosed glomeruli, 3 cellular crescents, mesangial proliferation, endocapillary hypercellularity, basement membranes with formation of double contours and "wire loops". IF: IgM (+++), C4d (+++) with diffuse granular pattern in glomerular basement membranes and subendothelium, tubulointerstitium with lymphocytic infiltrates. The patient received methylprednisolone pulses for 3 doses, oral prednisone (1mg/kg/day) and tapered until suspended and 4-drug anti-TB regimen with improvement in SCr to 3.9mg/dl and normalization of complement C3 at 10 days.

**Discussion:** The pathogenesis of TB-associated MPGN is unknown. Histopathologically it can mimic different types of glomerulopathies (IgAN, collapsing, mesangiocapillary, membranous, crescentic GN, membranoproliferative and PIGN). Antibodies against M. tuberculosis activate the complement pathway generating the

formation of antigen-antibody complexes that generate MPGN. The specific treatment is not yet known due to the rarity of the presentation, but antifibrotics and steroids are suggested in case of crescents.

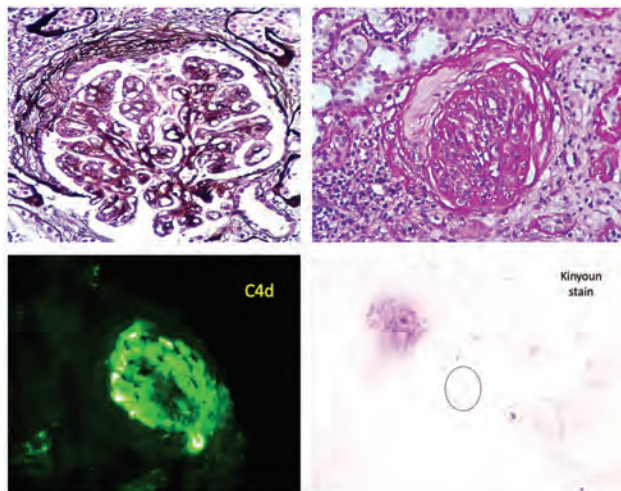

#### TH-PO525

##### Methemoglobinemia With Dapsone Prophylaxis in a Patient With Minimal Change Disease

Manuel J. Rovira-Gonzalez, Robert Pargament. *WellSpan York Hospital Department of Internal Medicine, York, PA.*

**Introduction:** Methemoglobinemia has been most commonly associated with medication and anesthetic use, dapsone and benzocaine being the most common agents. Methemoglobinemia leads to tissue hypoxia by creating ferric ( $Fe^{3+}$ ) hemes where oxygen is unable to bind, increasing the affinity of oxygen to hemoglobin, and therefore, reducing oxygen delivery to tissue. In the case of dapsone, it is the potent hydroxylated amine oxidant metabolites that causes dapsone's adverse effects including methemoglobinemia and hemolytic anemia. Clinical presentation of methemoglobinemia results in refractory hypoxemia, cyanosis, and dark-colored arterial blood.

**Case Description:** A case report about a 42-year-old male with minimal change disease required pneumocystis jiroveci pneumonia prophylaxis due to high dose steroids. Patient was started on dapsone due to side effects and availability from alternative medications. Patient was tested negative for glucose-6-phosphate dehydrogenase deficiency prior to starting dapsone. Since starting therapy, patient developed progressive dyspnea upon exertion for two weeks with intermittent hypoxia. He was also on therapeutic enoxaparin due to hypercoagulability state from nephrotic syndrome. Patient presented with hypoxia and dyspnea upon exertion, however, speaking in complete sentences and with no cyanosis or overt findings of hypervolemia. Patient remained hypoxemic despite supplemental oxygen. An arterial blood gas was performed and showed methemoglobin levels of 10.6 percent. Patient was treated with methylene blue with resolution of methemoglobinemia and hypoxemia after second dose. Trimethoprim-sulfamethoxazole was started for pneumocystis jiroveci pneumonia prophylaxis. He was safely discharged home.

**Discussion:** Patients can present with methemoglobinemia without classical symptoms; however, desaturations, a saturation gap, and shortness of breath are other signs and symptoms to be aware of in the absence of cyanosis. It is unclear if nephrotic syndrome increases risk of methemoglobinemia due to dapsone. We want to increase awareness of reported cases and further association is needed to understand the pathophysiology in dapsone-induced methemoglobinemia in patients with nephrotic syndrome.

#### TH-PO526

##### Beguiling but Harmful: IgA Nephropathy Manifests

Maria E. Rivera, Jesus D. Vega-Colon, Alexis Rivera Gonzalez, Ileana E. Ocasio Melendez, Krystahl Z. Andujar-Rivera. *Universidad de Puerto Rico Escuela de Medicina, San Juan, Puerto Rico.*

**Introduction:** IgA nephropathy (IgAN) is the most common pattern of primary glomerular disease worldwide and remains a leading cause of CKD. Given its prevalence, attention should be paid to risk factors of progression.

**Case Description:** A 22-year-old female with atopic dermatitis, complains of 6-month history of worsening bilateral leg edema associated with frothy dark urine. Denied recent skin, respiratory or gastrointestinal infections. No use of NSAID's or other nephrotoxins. No family history of renal disease. Toxic habits were remarkable for marijuana smoking. Examination revealed blood pressure 166/88 mmHg and pitting edema +2 up to shins. Laboratory results notable for anemia, BUN 25.7 mg/dL, creatinine 2.64 mg/dL, albumin 2.2 g/dL and bicarbonate 21.8 mmol/L and uric acid 5.9 mg/dL. Urinalysis with proteinuria, hematuria, granular casts and fat oval bodies. Urine protein-creatinine ratio of 8,300 mg/g, consistent with nephrotic range proteinuria. Testing for HIV, Hepatitis B and C, ANA, complements C3/C4, and serum free light chains were

normal. Renal biopsy showed mesangial proliferation with crescent formation by light microscopy with IgA staining in IF. EM showed mesangial and subendothelial deposits with foot processes effacement. There was moderate glomerulosclerosis and interstitial fibrosis. Treatment was started with prednisone 60 mg daily, furosemide, low sodium diet, losartan and atorvastatin. A month after diagnosis, patient presented with worsening renal function and edema. Despite medical treatment, patient continued to deteriorate requiring kidney replacement therapy. Unfortunately, patient did not recover and was discharged home dependent of hemodialysis.

**Discussion:** IgAN may present in a myriad of ways. From progressive CKD to nephritic syndrome, and all the spectrum in between. After diagnosis, one fourth of patients will progress to ESKD within 20-25 years of presentation. Our patient presented with nephrotic syndrome and rapidly progressive glomerulonephritis with multiple markers for poor prognosis like hypertension, proteinuria above 1 gm/day, and histologic predictors of disease progression such as chronic fibrotic disease, tubular atrophy and interstitial fibrosis on biopsy. Overall, the prognosis of IgAN may be difficult to predict but identifying these risk factors early may guide clinicians and patients.

#### TH-PO527

##### A Case of Lupus Nephritis (LN) With Concomitant Renal Thrombotic Microangiopathy (TMA) Treated With Eculizumab as a Rescue Treatment

Nehemias Guevara,<sup>1,2</sup> Mahmoud Ali,<sup>1,2</sup> Sae Morita,<sup>1,2</sup> Marjorie Mailing Flores Chang,<sup>1,2</sup> William M. Paredes,<sup>1,2</sup> Hamed Sarikhani,<sup>1,2</sup> Bessy Suyin Flores Chang,<sup>1,2</sup> <sup>1</sup>St Barnabas Hospital, Bronx, NY; <sup>2</sup>Albert Einstein College of Medicine, Bronx, NY.

**Introduction:** LN is a common and severe consequence of SLE, however, LN and TMA together are not common. When both are present the outcome is worse. To date, there are no clear guidelines for standard therapy, however, eculizumab has been used as rescue therapy with a favorable outcome

**Case Description:** 28 year old female with a PMH of SLE since 2013, LN class IV/V, recurrent serositis, sickle cell trait with chronic pain, schizophrania, and asthma consulted with encephalopathy and generalized pain. Vital signs: BP: 106/76, HR:100 beats/min, RR: 16 breaths/min, T: 97.5 F, SatO2: 100% on room air. The patient was found to be in acute respiratory failure due to fluid overload and was subsequently intubated. Physical examination: agitated, tachypneic, dry mucous membranes, lung crackles bilaterally in lower fields, S1 S2 present, bilateral lower pitting edema 2+ up to the thighs. Blood work was remarkable for normocytic anemia, hyperkalemia, acute renal failure superimposed to chronic renal failure, transaminitis, and elevated troponin levels. The patient was started on IV antibiotics and emergent hemodialysis. Pulse steroids with solumedrol were also initiated for a possible lupus flare. Immunological workup revealed low C3, C4 with positive anti-double-strand DNA antibodies. Patient underwent a kidney biopsy which revealed focal crescentic glomerulonephritis with membranous and sclerosing features consistent with lupus nephritis class IV (A/C) and V. As well revealed active chronic TMA, moderate tubular atrophy, and interstitial fibrosis. (Images 1,2 3) The patient did not improve with standard therapy (plasmapheresis, mycophenolate, steroids), prompting the use of eculizumab, after which the patient presented improvement (table 1), and dialysis was discontinued

**Discussion:** TMA associated LN represents a progressive and dismal outcome with variable responses to standard treatment. The mechanism of TMA in autoimmune diseases is associated with the alternative complement pathway where Eculizumab plays an important role and is currently being explored in the treatment for LN. Our patient presented with LN + TMA, failed standard treatment, and improved with Eculizumab. We hope in the near future Eculizumab will be the standard therapy for this type of association

#### TH-PO528

##### Antinuclear Antibody Negative Lupus Presenting as Nephritis

Ananthaxmi Vangapalli. *Albert Einstein Medical Center, Philadelphia, PA.*

**Introduction:** Lupus nephritis (LN) is a serious and common complication of systemic lupus erythematosus (SLE) that predisposes to significant morbidity and mortality. Studies show that prompt diagnosis and treatment improve patient survival.

**Case Description:** 24-year-old Asian-American female with no known past medical history presented to ED for 4 days of fatigue, shortness of breath, and rash. She reports symptoms were there for one year with arthralgias involving bilateral knees, hands and fingers and toes with morning stiffness without significant joint swelling. She noticed episodes of skin rash on extremities, worsened with scratching with an exaggerated pathway. She has been taking Advil for joint pains. SH: She was born in America. She works as a designer for Pfizer. Labs showed creatinine 2.11 from normal baseline a year ago, with Urine protein to creatinine ratio of 2 grams. Hemoglobin 7 with normal MCV. Platelets, PT/INR, PTT, LDH, and haptoglobin are normal. D-dimer elevated to 2600. Her ANA was negative. CT abdomen pelvis showed hepatosplenomegaly and multiple enlarged lymph nodes. On exam vital signs are normal. Dry mucous membranes and diffuse popular rash in the lower extremities. She underwent a renal biopsy which revealed lupus-like glomerulonephritis, class v/class IV, mild acute tubular necrosis, moderate interstitial inflammation, and mild to moderate interstitial fibrosis. It was called lupus-like nephritis given immunofluorescence negative and multiple deposits on EM. Lymph node biopsy which showed reactive hyperplasia. She was started on Cellcept 1500 mg twice daily and prednisone 60mg daily.

**Discussion:** Literature review on antinuclear antibody (ANA)-negative and seronegative LN revealed the following patient presentations: (1) renal-limited or renal and extra-renal manifestations of SLE with negative serologies and (2) renal and extra-renal manifestations of SLE with negative serologies at presentation who develop positive

Key: TH - Thursday; FR - Friday; SA - Saturday; OR - Oral; PO - Poster; PUB - Publication Only

Underline represents presenting author.

serologies later in follow-up. Both groups represent a unique and challenging cohort of patients who may require longer follow-up and further testing to rule out other glomerular diseases that may mimic LN on renal biopsy. The absence of SLE-related serologies should be weighed against a high pre-test probability of ANA-negative or seronegative LN. If highly suspected, the patient should be treated promptly with close monitoring.

### TH-PO529

#### Identifying the Etiology of Thrombotic Microangiopathy (TMA) Diagnosed by Kidney Biopsy Using Machine Learning Tools (Unsupervised Clustering)

Simon Moubarak,<sup>1</sup> Mariam P. Alexander,<sup>2</sup> Jaleh Zand,<sup>1</sup> Mireille El Ters,<sup>1</sup> Ladan Zand.<sup>1</sup> <sup>1</sup>Mayo Clinic Department of Internal Medicine, Rochester, MN; <sup>2</sup>Mayo Clinic, Department of Laboratory Medicine and Pathology, Rochester, MN.

**Background:** Thrombotic microangiopathy is a pathologic term that encompasses disorders with different etiologies. Identifying the cause of the TMA lesion remains a clinical challenge. Most TMA cases share similar morphologic findings on microscopy which poses a challenge to determine the cause based on biopsy alone.

**Methods:** We searched renal pathology database at Mayo Clinic between 2010-2020 and identified patients with lesion of TMA on native kidney biopsy as their primary diagnosis who had an established associated cause for TMA. We recorded features commonly associated with TMA lesion by reviewing the biopsy report. We used consensus clustering approach (an unsupervised machine learning technique) using only the kidney biopsy variables to cluster the patients. We then looked to see which etiology of TMA was most prevalent in each cluster and which biopsy features were most predictive of finding that specific etiology.

**Results:** There were 168 adult patients with average age of  $50.3 \pm 16.9$  with 52% male. The most common cause of TMA was malignant hypertension (mHTN) (n=81, 48.2%), drug-induced (n=36, 21.4%), lupus (9, 5.4%) and scleroderma (9, 5.4%). We identified 3 distinct clusters with cluster 1 (n=69), cluster 2 (n=47), cluster 3 (n=52). Cluster 1 was mainly composed of patients with mHTN followed by SRC. Presence of fibrin thrombi in the vessel in addition to presence of mucoid intimal edema and hyperplastic changes in the vessel ("onion skinning") with absence of arteriosclerosis and fibrin tactoids were predictive of such diagnosis. Cluster 2 was mainly composed of patients with pregnancy associated TMA, non-immune drug induced TMA (VEGF inhibitor most common 67%), post BMT and myeloproliferative disease. Presence of severe tubular injury and absence of mucoid intimal edema, fibrin thrombi and arteriosclerosis were predictive of this cluster. Cluster 3 was composed of patients with lupus associated TMA, immun-mediated drug-induced TMA (gemcitabine 60% of cases) followed by aHUS. Presence of mesangiolysis and absence of hyperplastic changes of the vessel were predictive of this cluster.

**Conclusions:** This is the first study to use unsupervised machine learning to help identify the etiology of TMA lesion that is seen on native kidney biopsies by identifying biopsy features that are predictive.

### TH-PO530

#### Clinical and Molecular Correlates of Quantitative Foot Process Effacement Assessment in the NEPTUNE Cohort

Marco Delsante,<sup>1</sup> Giovanni Maria Rossi,<sup>1</sup> Paride Fenaroli,<sup>1</sup> Giuseppe D. Benigno,<sup>1</sup> Francesco Peyronel,<sup>7</sup> Enrico Cocchi,<sup>2</sup> Jonathan P. Troost,<sup>3</sup> Sean Eddy,<sup>3</sup> Laura Barisoni,<sup>4</sup> Matthias Kretzler,<sup>3</sup> Jarcy Zee,<sup>5</sup> Umberto Maggioro,<sup>1</sup> Avi Z. Rosenberg.<sup>6</sup> <sup>1</sup>Università degli Studi di Parma, Parma, Italy; <sup>2</sup>Columbia University Irving Medical Center, New York, NY; <sup>3</sup>University of Michigan Michigan Medicine, Ann Arbor, MI; <sup>4</sup>Duke Medicine, Durham, NC; <sup>5</sup>University of Pennsylvania, Philadelphia, PA; <sup>6</sup>Johns Hopkins Medicine, Baltimore, MD; <sup>7</sup>Meyer Children's Hospital, Florence, Italy.

**Background:** Foot process effacement (FPE) is the ultrastructural hallmark of podocytopathies and is traditionally a visual estimate of percentage foot process loss (%FP). Foot process width (FP-W) could be a more accurate measure of FPE, but whether FP-W robustly correlates with clinical outcomes or gene expression is unknown

**Methods:** %FP was extracted from NEPTUNE study core data. FP-W was measured on micrographs >4000x in minimal change disease (MCD) or FSGS NEPTUNE participants. FPE relationship with laboratory markers of nephrotic syndrome (NS) and CKD was examined. We used weighted gene coexpression network analysis (WGCNA) of gene expression biopsy data to identify Gene Modules (GM) that correlated with FPE and tested a subset of single genes (Sub-GSE) known to be differentially expressed in podocytopathies

**Results:** 55 MCD and 36 FSGS patients had longitudinal follow-up, 42 had gene expression data. %FP were similar between the two groups, FP-W was slightly higher in FSGS versus MCD. %FP and FP-W were associated with longitudinal changes in clinical parameters of NS. Larger FPE extent on biopsy showed greater improvement of serum albumin, cholesterol, and UPCr during follow up (P<0.05); this correlation was attenuated when corrected for %FP. WGCNA (Fig. 1) and Sub-GSE showed that FPE is associated with increased expression of GM, including complement-related genes

**Conclusions:** FPE extent is associated with NS improvement, likely reflecting sensitivity to therapies. FP-W does not add prognostic information beyond %FP. FPE is associated with several genes expression (i.e. complement factors)

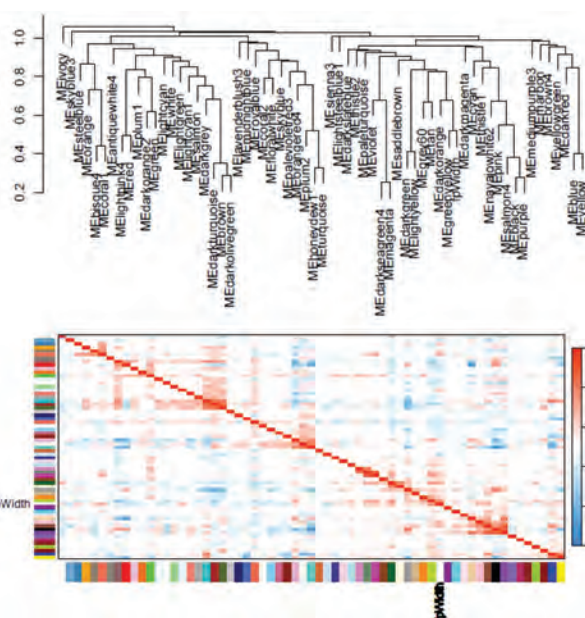

Eigengene network (Gene Modules and the FP-W)

### TH-PO531

#### An In Situ Ascorbate Peroxidase Labeling in Secreted Exosomes Identifies Oxidative Stress-Induced Exosome Proteome Alteration in Renal Proximal Tubules

Sang-Ho Kwon,<sup>1</sup> Byung Rho Lee,<sup>1</sup> Sekyung Oh,<sup>2</sup> Chang Min Lee.<sup>1</sup> <sup>1</sup>Augusta University, Augusta, GA; <sup>2</sup>Catholic Kwandong University College of Medicine, Incheon, Republic of Korea.

**Background:** The extracellular vesicle exosome mediates intercellular communication by transporting macromolecules such as proteins and ribonucleic acids. Determining cargo contents with high accuracy will help decipher the biological processes that exosomes mediate in various contexts.

**Methods:** Here we report an *in situ* labeling approach for exosome cargo profiling, termed Exosome-Proximal APEX Labeling (EPAL), which bypasses the exosome isolation steps. In EPAL, proteins either in the exosome biogenesis vesicles in cells or in secreted exosomes in the conditioned medium can specifically be biotinylated by expressing a variant of the engineered ascorbic peroxidase APEX that is fused to an exosome cargo protein such as CD63.

**Results:** Mass spectrometry analysis of the proteins biotinylated in exosomes secreted by kidney proximal tubule-derived cells reveals that oxidative stress can induce an alteration in exosome protein contents, including accumulation of ribosomal proteins in exosomes.

**Conclusions:** In sum, our new method specifically labels exosome proteins with a genetic, chemical means *in situ* either in live cells or in secreted exosomes, thereby probing proteins packaged in exosomes and identifying where exosomes originate. This method might be useful to discover exosome-based biomarkers for kidney diseases.

**Funding:** NIDDK Support, Other NIH Support - NCI

### TH-PO532

#### PPAR $\alpha$ in Proximal Tubules Maintains Systemic Energy Homeostasis During Starvation

Daiki Aomura,<sup>1</sup> Takayuki Nimura,<sup>1</sup> Yosuke Yamada,<sup>1</sup> Makoto Harada,<sup>1</sup> Koji Hashimoto,<sup>1</sup> Motoko Yanagita,<sup>2</sup> Yuji Kamijo.<sup>1</sup> <sup>1</sup>Shinshu Daigaku Igakubu Fuzoku Byoin, Matsumoto, Japan; <sup>2</sup>Kyoto Daigaku Igakubu Fuzoku Byoin, Kyoto, Japan.

**Background:** Peroxisome proliferator-activated receptor alpha (PPAR $\alpha$ ) is a nuclear transcription factor mainly expressed in the liver and renal proximal tubules (PTs). PPAR $\alpha$  is especially activated under energy deficient conditions, such as starvation and severe organ injury, to maintain tissue energy homeostasis by accelerating fatty acid oxidation (FAO). Although earlier research has studied the importance of systemic PPAR $\alpha$  in the homeostasis of renal energy metabolism, the role of renal PPAR $\alpha$  remains unknown. The present study assessed this issue using PT-specific PPAR $\alpha$  knock-out mice under fasting conditions.

**Methods:** *Ppara*<sup>flax/flax</sup> mice were bred with *Ndrp1*-CreERT2 transgenic mice to generate *Ndrp1*-CreERT2-*Ppara*<sup>flax/flax</sup> mice (PTs-PPAR $\alpha$ -CKO). PT-specific defects in PPAR $\alpha$  expression after 3 days of tamoxifen injection was then confirmed in the PTs-PPAR $\alpha$ -CKO mice by quantitative PCR and immunohistochemical staining. To assess the role of PPAR $\alpha$  in PTs, tamoxifen-treated 13-week-old *Ppara*<sup>flax/flax</sup> mice (controls) and PTs-PPAR $\alpha$ -CKO mice were fasted for 0, 24, and 48 hours (n=5-7 in each group).

Key: TH - Thursday; FR - Friday; SA - Saturday; OR - Oral; PO - Poster; PUB - Publication Only

Underline represents presenting author.

**Results:** Without fasting, the renal gene expressions related to FAO and ketogenesis were significantly lower in the PTs-PPAR $\alpha$ -CKO mice. Although observed phenotypes were similar between the groups, blood glucose level was slightly but significantly lower in the PTs-PPAR $\alpha$ -CKO animals. Under fasting conditions, the renal gene expressions concerning PPAR $\alpha$ , FAO, and ketogenesis were dramatically increased in controls, which was not seen in the knock-out mice. The decrease in blood glucose level with fasting was significantly more severe for PTs-PPAR $\alpha$ -CKO. Moreover, the hepatic gene expressions related to glycogenolysis, gluconeogenesis, PPAR $\alpha$ , FAO, and ketogenesis were all significantly more increased in PTs-PPAR $\alpha$ -CKO mice.

**Conclusions:** Our results demonstrated that PTs-PPAR $\alpha$ -CKO mice were prone to hypoglycemia upon starvation. PPAR $\alpha$  in PTs may play a role in the homeostasis of serum glucose level and systemic energy metabolism.

## TH-PO533

### Human Scattered Tubular Cells Represent a Heterogeneous Population of Glycolytic Dedifferentiated Proximal Tubule Cells

Martijn van den Broek,<sup>1,2</sup> Jennifer Eymael,<sup>1</sup> Laura Miesen,<sup>1</sup> Valerie J. Villacorta Monge,<sup>1</sup> Bartholomeus T. van den Berge,<sup>1,3</sup> Fieke Mooren,<sup>1</sup> Meyke Hermsen,<sup>1</sup> Péter Bándi,<sup>1</sup> Brigith Willemssen,<sup>1</sup> Sandrine Florquin,<sup>7,8</sup> Roy Wetzels,<sup>1</sup> Rafael Kramann,<sup>5,6</sup> Jack F. Wetzels,<sup>3,4</sup> Jitske Jansen,<sup>1,2</sup> Bart Smeets,<sup>1</sup> Smeetslab <sup>1</sup>Department of Pathology, Radboud Institute for Molecular Life Sciences, Radboud UMC, Nijmegen, Netherlands; <sup>2</sup>Department of Pediatric Nephrology, Radboud Institute for Molecular Life Sciences, Radboud UMC, Amalia Children's Hospital, Nijmegen, Netherlands; <sup>3</sup>Department of Nephrology, Radboud Institute for Molecular Life Sciences, Radboud UMC, Nijmegen, Netherlands; <sup>4</sup>Department of Nephrology, Radboud Institute for Health Sciences, Radboud UMC, Nijmegen, Netherlands; <sup>5</sup>Division of Nephrology and Clinical Immunology, RWTH Aachen University, Aachen, Germany; <sup>6</sup>Institute of Experimental Medicine and Systems Biology, RWTH Aachen University, Aachen, Germany; <sup>7</sup>Department of Pathology, Amsterdam UMC, University of Amsterdam, Amsterdam, Netherlands; <sup>8</sup>Amsterdam Institute for Infection and Immunology, Amsterdam, Netherlands.

**Background:** Scattered tubular cells (STCs) are a phenotypically distinct cell population in the proximal tubule that increase in number after acute kidney injury. Since much of our knowledge about STCs comes from animal experiments, we aimed to characterize the human STC population.

**Methods:** 3D tissue analysis was performed on consecutive immunostained kidney slides. The percentage of STCs was determined using immunofluorescent staining for aquaporin-1 to detect proximal tubule epithelial cells (PTECs) and phosphofructokinase-platelet (PFKP) to detect STCs. STC (CD13+CD24+CD133+) and PTEC (CD13+CD24-CD133-) cells were sorted (FACS) from 5 separate normal nephrectomy samples. Sorted cells were used as input for bulk RNA sequencing.

**Results:** 3D tissue analysis revealed that STCs prefer to locate in the sharp inner bends of the tubule in groups rather than as single cells. STCs are barely present in young kidney tissue (<2 years) and their number significantly increases with age. Also, we observed an increased number of STCs with increased acute tubular injury (KIM-1) as well as interstitial fibrosis (a-SMA). RNA bulk sequencing revealed an upregulation of NF $\kappa$ B, TNF $\alpha$  and other inflammatory pathways in STCs, whereas normal proximal tubular function, metabolism and especially the TCA cycle and oxidative phosphorylation were downregulated. Histologically, we confirmed a glycolytic isoform switch in STCs from pyruvate kinase-Liver (PKL) to PK-Muscle 2 (PKM2) and from PFKL to PFKF. The transcriptome of STCs did not show signs of cellular senescence, confirmed by immunostaining for p53, p16 and lamin B1. Immunostaining and a single-cell RNA sequencing database showed that STCs are in a transient state representing a heterogeneous population with different marker expression, ligand-receptor interactions and pathway activity.

**Conclusions:** Human STCs represent a heterogeneous population of dedifferentiated PTECs showing a metabolic shift towards glycolysis, which could facilitate cellular survival after kidney injury.

## TH-PO534

### The Location and Character of Focal Segmental Glomerulosclerosis Lesions: The Prevalence, Overlap, and Clinical Relevance

Takaya Ozeki,<sup>1</sup> Michifumi Yamashita,<sup>2</sup> Fadhil Alakwaa,<sup>1</sup> Viji Nair,<sup>1</sup> Jarcy Zee,<sup>3</sup> Jeffrey B. Hodgin,<sup>1</sup> Lihong Bu,<sup>4</sup> Avi Z. Rosenberg,<sup>5</sup> Cynthia C. Nast,<sup>2</sup> Matthias Kretzler,<sup>1</sup> Laura Barisoni,<sup>6</sup> Laura H. Mariani,<sup>1</sup> <sup>1</sup>University of Michigan, Ann Arbor, MI; <sup>2</sup>Cedars-Sinai Medical Center, Los Angeles, CA; <sup>3</sup>University of Pennsylvania, and Children's Hospital of Philadelphia, Philadelphia, PA; <sup>4</sup>Mayo Clinic Minnesota, Rochester, MN; <sup>5</sup>Johns Hopkins University School of Medicine, Baltimore, MD; <sup>6</sup>Duke University, Durham, NC.

**Background:** The glomerular lesions in focal segmental glomerulosclerosis (FSGS) are histologically heterogeneous for location (L) and characteristics (C). The aim of this study is to investigate the quantitative relationship and clinical relevance of L and C of FSGS lesions.

**Methods:** 134 FSGS participants from the Nephrotic Syndrome Study Network (NEPTUNE) with NEPTUNE digital pathology scoring system (NDPSS) glomerular descriptors, were included. 21 descriptors characterizing L and C of FSGS lesions were grouped into 4 L: Perihilar (PH), Tip (TIP), Mid-glomerular, and Undetermined (UN); and 7 C: Sclerosis (SCL), Hyalinosis (HYA), Cellular-lesion (CEL), Foam cells,

Collapsing-lesion (COL), Epithelial hypertrophy, and Epithelial hyperplasia (HYP). Prevalence and correlations of L and C were analyzed. Patients were grouped based on L or C using consensus clustering. Complete remission (CR) and composite renal outcome (eGFR 40% decline or ESKD) were compared among L-based and C-based clusters by Kaplan-Meier method. Subgroup analyses were performed in nephrotic (NS) (UPCR>3.5 with albumin<3.0 or diffuse foot process effacement, n=41) and non-NS group (n=93).

**Results:** 863/4614 (18.7%) glomeruli contained at least 1 of 21 descriptors.  $\geq$  2 L or C were observed in 48.3% and 91.0% of the biopsies, respectively. Correlations with Spearman's rho>0.5 were observed in TIP-CEL, UN-SCL and COL-HYP. TIP and CEL were more frequent in NS group, while PH, SCL and HYA were more frequent in non-NS group. There were no differences in the clinical outcomes among the L-based nor C-based clusters in overall cohort and non-NS group. In NS group, a difference in CR was observed between 2 C-based (but not L-based) clusters in NS group (p=0.048): A cluster with worse CR rate had higher frequency of all 7 C lesions than the better CR cluster.

**Conclusions:** The application of NDPSS allowed for the quantification of heterogeneity and overlap in location and morphologic characters of FSGS lesions within and across kidney biopsies, with different trends between NS and non-NS participants. In NS participants, high frequency and more variety of C were associated with lower CR rate; while neither L nor C showed impact on clinical outcomes in non-NS participants and NS + non-NS participants together.

**Funding:** NIDDK Support, Other NIH Support - NCATS

## TH-PO535

### Visualizing and Quantifying Biological Age in the Kidney

Susan M. Sheehan, Seamus Mawe, Mandy Chen, Ron Korstanje, John M. Mahoney. The Jackson Laboratory, Bar Harbor, ME.

**Background:** The kidney is one of the organs with noticeable age-related changes in structure and function. However, we do not understand the mechanisms and timing involved in kidney aging. The Geropathology Research Network (GRN) published a grading scheme for aged mice in several tissues, including the kidney. Use of this grading scheme is labor intensive, requires expert knowledge to implement, and has large interscorer variability. Using image analysis and machine learning approaches, we developed a high-throughput classifier that can be used to improve the quantification and resolve the unknown mechanisms of aging.

**Methods:** Using the same slides as the GRN, which includes male mice from two strains (C57BL/6 and CB6F1) and combining them with additional C57BL/6J mice, we developed a training set that includes 12 mice at four ages (8, 13, 20 and 32 months). We adopted a light deep learning architecture (LinkNet) and trained the model on images from ImageNet to develop an ordinal classifier that provides us with pixel level information about aging. By looking at the predictions, we can ascertain how likely a tissue is young or old age at a given pixel. Additionally, we can generate an overall age score for each kidney.

**Results:** After we trained the classifier, we tested the classifier in an additional set of male and female C57BL/6J mice. We can distinguish between young and old tissue and see a strong correlation with the scores using the GRN grading. We wanted to determine whether kidneys age uniformly or if specific regions or structures age faster than others. We developed a method that allows us to 'paint' our aging scores onto kidneys and see that aging happens first in a thin band in the renal cortex, which aligns with the findings of pathologists.

**Conclusions:** Our tool can be used to measure biological age in the kidney and is critical in developing and evaluating interventions that affect kidney health span and overall lifespan. The tool, and tutorials about how to apply this to your own data set, are made publicly available at agingmice.org. We are now applying this tool to more diverse and larger datasets and refining our ability to quantify and localize kidney aging such that we can understand the mechanisms that change spatially and structurally with age.

**Funding:** Other NIH Support - Nathan Shock Center

## TH-PO536

### Modified Immune Cell (MIC) Therapy Disrupts Tertiary Lymphoid Structures in Murine Lupus Nephritis

Gerald Ponath,<sup>1</sup> Claudius Speer,<sup>2</sup> Iris I. Arnold,<sup>2</sup> Asa Hidmark,<sup>1</sup> Lei Wang,<sup>1</sup> Christian Kleist,<sup>3</sup> Anita Schmitt,<sup>4,1</sup> Volker Daniel,<sup>1,5</sup> Gerhard Opelz,<sup>1,5</sup> Peter Terness,<sup>1,5</sup> Michael Schmitt,<sup>4</sup> Martin G. Zeier,<sup>2</sup> Christian Morath,<sup>2,1</sup> Matthias Schaefer,<sup>2,1</sup> <sup>1</sup>Tolerogenix GmbH, Heidelberg, Germany; <sup>2</sup>University of Heidelberg, Department of Nephrology, Heidelberg, Germany; <sup>3</sup>University of Heidelberg, Department of Nuclear Medicine, Heidelberg, Germany; <sup>4</sup>University of Heidelberg, Department of Internal Medicine V, Heidelberg, Germany; <sup>5</sup>University of Heidelberg, Department of Immunology, Heidelberg, Germany.

**Background:** Induction of tolerance can be achieved with Modified Immune Cells (MIC) by infusion of mononuclear cells challenged with mitomycin C (MMC). Although MIC treatment has been successful in several animal models for autoimmunity and in clinical studies of solid organ transplantation, the mechanism of immunosuppression is not fully elucidated. In lupus nephritis, the glomerular deposition of immune complexes is associated with accumulating immune cells in the kidney. The infiltrating immune cells frequently establish tertiary lymphoid structures (TLS) supporting adaptive autoimmune responses toward locally displayed antigens. Since TLS display a high persistence to peripheral B cell depletion, the destruction of TLS presents an essential treatment goal in lupus nephritis. In this study, we used lupus nephritis prone NZB/W F1 mice to show the destruction of TLS in the kidney after MIC treatment.

Key: TH - Thursday; FR - Friday; SA - Saturday; OR - Oral; PO - Poster; PUB - Publication Only

Underline represents presenting author.



**Methods:** Splenocytes of syngeneic donor mice were incubated with MMC and injected into recipient's tail vein after matching for disease activity. Disease activity was monitored by body weight, protein excretion, serum creatinine and dsDNA. Kidney histopathology was performed by immunofluorescent microscopy. Densitometric measurement of regulatory markers in immune cell subsets were computationally quantified.

**Results:** Independent of treatment, >86% of animals displayed dense lymphocytic aggregates proximal to the pelvic wall of the medulla and the arcuate arteries within the cortex of kidneys. Cell type composition of TLS changed drastically after MIC treatment leading to diminished B-cells, a decreased B-cell/T-cell ratio, and a T cell dominated phenotype. Furthermore, a loss of organization of the TLS was observed after MIC treatment. The strict separation of B-cell and T-cell areas was abrogated, and germinal centers were disintegrated. However, regulatory T-cells remained unchanged indicative of a B-cell centric treatment mechanism.

**Conclusions:** Our data provides a putative *in vivo* mechanism how MIC treatment inhibits progression of active lupus nephritis by the destruction of tertiary lymphoid structures within the kidney.

**Funding:** Commercial Support - TolerogenixX GmbH

## TH-PO537

### Expression of GLA, HNRNP2, and RPL36A Genes in Fabry Disease Male and Female Cell Lines

Md S. Islam, Mohammed A. Al-Obaide, Tetyana L. Vasylyeva. *Texas Tech Health Science Center, Amarillo, TX.*

**Background:** Fabry disease (FD) is a rare genetic disorder caused by mutations in the  $\alpha$ -galactosidase A (*GLA*) gene resulting in  $\alpha$ -galactosidase A enzyme deficiency. Despite, enzyme replacement therapy, FD patients often remain symptomatic indicating that other mechanisms might be associated with this disease. Our previous in-vitro study showed that knockdown of the first locus (*RPL36A*) in the readthrough transcription *RPL36A-HNRNP2* locus leads to decreased expression of *GLA*, *RPL36A*, and *HNRNP2*. We also observed *GLA* c.1033\_1034delTC deletion in male FD patients greatly reduces the expression levels of *GLA*, *RPL36A*, and *HNRNP2*, and at lower, but significant levels in females, as compared with healthy males and females. Based on this finding we have hypothesized that regulation of *GLA* genes by its adjacent loci *RPL36A* and *HNRNP2* might play a significant role during the pathogenesis of FD. To analyze the expression status of *GLA*, *RPL36A* and *HNRNP2* genes in different male and female FD patient-derived cell lines.

**Methods:** FD cell lines were purchased for three female and male patients along with one fibroblast-derived control cell line from Coriell Institute for Medical Research, and were grown as per supplier instructions. Then, harvested cell mRNA expression analysis by qRT-PCR was performed.

**Results:** qRT-PCR revealed that *GLA* mRNA expression was downregulated in both female and male FD cell lines except for Gm0881 (FD MALE with R220X). Unexpectedly, *GLA* had more reduction in expression in female than male cell lines. Although the Gm0881 cell line showed high *GLA* mRNA expression, it has no *GLA* enzymatic activity due to c.658C>T in exon 5, resulting in a stop codon [Arg220Ter (R220X)]. This suggested the key functional importance of this mutation in *GLA* activity vs. *GLA* expression. Downregulation of *HNRNP2* expression was also observed in the FD cell lines irrespective of male and female source, except in the Gm02774 cell line. But, unlike *GLA* expression, *HNRNP2* had a higher reduction in the male than the female cell lines. Similarly, *RPL36A* was downregulated in all FD cell lines irrespective of whether the cells were male or female-derived.

**Conclusions:** Dysregulation of expression of *GLA* and its two conjugative loci *RPL36A* and *HNRNP2* demonstrate differences based on sex in cell lines derived from male and female FD patients.

**Funding:** Commercial Support - Sanofi

## TH-PO538

### Osteopontin Is a Key Orchestrator of Plasminogen Activator Inhibitor-1 (PAI-1) Induced Tubular Pathologies

Cody C. Gifford,<sup>1,2</sup> Brian Meyerson,<sup>4</sup> Roel Goldschmeding,<sup>3</sup> Rohan Samarakoon,<sup>2</sup> Paul J. Higgins.<sup>2</sup> <sup>1</sup>*Brigham and Women's Hospital Department of Medicine, Boston, MA;* <sup>2</sup>*Albany Medical College Center for Cell Biology and Cancer Research, Albany, NY;* <sup>3</sup>*Universitair Medisch Centrum Utrecht Afdeling Pathologie, Utrecht, Netherlands;* <sup>4</sup>*Albany Medical Center, Albany, NY.*

**Background:** Sustained tubular PAI-1 expression, evident in various renal diseases, promotes epithelial dedifferentiation, G2/M arrest and a prominent fibrotic response. It is unclear whether PAI-1-induced tubular maladaptive repair is linked to induction/secretion of pro-inflammatory/fibrotic molecules.

**Methods:** Employing cytokine protein array analysis as an un-biased approach, we identified novel factors upregulated in human kidney epithelial cells (HK2) stably overexpressing PAI-1 (termed CMV-PAI-1) compared to vector controls (termed CMV-Con). We identified specific cytokines pertinent to PAI-1-driven tubular pathologies via gene silencing approaches. Human fibrotic kidneys and obstructed rat kidneys were used to investigate the *in vivo* correlation between PAI-1 and associated cytokines via immunohistochemistry.

**Results:** Stable tubular PAI-1 expression resulted in induction and secretion of several cytokines/growth factors, including robust upregulation (15-fold) of osteopontin (OPN). Upregulation as well as co-localization of OPN and PAI-1 in the tubules of

obstructed rat and human diabetic kidney sections (compared to respective control kidneys) suggested a potential relationship between PAI-1 and OPN during disease progression. shRNA-directed silencing of OPN in CMV-PAI-1 overexpressing HK2 renal tubular cells, indeed, attenuated PAI-1-mediated fibronectin, collagen-1 and p21 protein expression. Furthermore, OPN suppression in CMV-PAI-1 cells also reduced expression of the pro-fibrotic transcription factors, Twist, Snail1, p53 and phosphorylated-SMAD3. Twist gene depletion similarly ameliorated fibrotic maladaptive responses evident in CMV-PAI-1-transductants. Mechanistically, PAI-1-induced OPN upregulation requires downregulation of Iktho and upregulation of TGF- $\beta$ 1-receptor signaling.

**Conclusions:** PAI-1 is a novel regulator of renal OPN induction observed during renal injuries. OPN is a key effector cytokine involved in PAI-1-induced tubular dysfunction and is an upstream control element of Twist and p53 transcription factors that drive fibrotic reprogramming. Targeting OPN induction in the kidney, therefore, is a new strategy to attenuate PAI-1-induced tubular dysfunction and CKD progression.

**Funding:** Other NIH Support - GM057242, Private Foundation Support

## TH-PO539

### Differential Alterations of Hippo Signaling Pathway in Kidney Cells After Unilateral Ureteral Obstruction

Yaochun Zhang,<sup>1,2</sup> Zhenhua Li,<sup>1,2</sup> Liangjian Lu,<sup>1,2</sup> Nurul Jannah Binti Ahmad,<sup>1,2</sup> Chang-Yien Chan,<sup>1,2</sup> Jun Li Ng,<sup>1,2</sup> Hui Kim Yap,<sup>1,2</sup> Kar Hui Ng.<sup>1,2</sup> <sup>1</sup>*National University of Singapore, Singapore, Singapore;* <sup>2</sup>*National University Health System, Singapore, Singapore.*

**Background:** The Hippo signaling pathway regulates physiological functions. Renal fibrosis enhances nuclear translocation of the Hippo signalling effectors YAP/TAZ. We previously analyzed single cell RNA sequencing (scRNA-Seq) databases and observed heterogeneity in Hippo signaling activation status in different kidney cells. Here, we aimed to study the differential alterations of Hippo signaling in kidney cell clusters after unilateral ureteral obstruction (UO), a process which causes fibrosis.

**Methods:** Ligation of left ureters was performed in rats. The kidneys were harvested after 7 days' obstruction (UUO7) and cell transcriptomics were profiled with RNA-Seq. Separately, publicly available single-cell transcriptomics of UUO2, UUO7 and wild-type mice (GEO: GSE140023) were re-analyzed with Seurat v4.0. Gene Set Enrichment Analysis (GSEA) was performed with evolutionary conserved YAP target genes to compare the Hippo pathway activation status in UUO and normal states. Cellular distributions of YAP were confirmed with immunohistochemistry.

**Results:** The UUO kidneys displayed extensive tubular dilation. Intense Yap nuclear localization was observed in all dilated tubules and some medullary interstitial cells. GSEA revealed upregulation of Yap target genes (NES = 1.50,  $P = 0.02$ ) in UUO rats. scRNA-Seq on the UUO2 mouse kidneys showed significant upregulation of Yap target genes in five kidney cell clusters, namely podocytes, cluster 5 (PT5) and cluster 9 (PT9) of proximal tubular cells (PT), principal cells of collecting duct and epithelial cells of inner medullary collecting duct. In contrast, only PT5 was upregulated in UUO7 kidneys. Additionally, two other cell clusters, PT1 and the distal convoluted tubular cells, showed significant upregulation of Yap target genes. Interestingly, while the evolutionary conserved gene set was upregulated in PT7, PT8, PT9, thick ascending limb and endothelial cells in UUO2, it was downregulated in UUO7, though these were not significant.

**Conclusions:** The Hippo signalling pathway was differentially altered in kidney cells after UUO. Different trends in some cell clusters between UUO2 and UUO7 mice may imply the Hippo signaling pathway exert different effects in the acute and chronic phases of ureteral obstruction.

**Funding:** Government Support - Non-U.S.

## TH-PO540

### Sodium Chloride Induces Human Tubular Epithelial Cell CCL26 Expression That Associates With Monocyte Accumulation in the Human Kidney

Jessica Schmitz,<sup>1</sup> Nicolas Brauns,<sup>1</sup> Anne M. Breloh,<sup>1</sup> Jan H. Braesen,<sup>1</sup> Hermann G. Haller,<sup>1</sup> Sibylle Von Vietinghoff.<sup>2,1</sup> <sup>1</sup>*Medizinische Hochschule Hannover, Hannover, Germany;* <sup>2</sup>*Universitätsklinikum Bonn, Bonn, Germany.*

**Background:** Renal immune cells serve as sentinels against ascending bacteria but also promote detrimental inflammation. The kidney medulla is characterized by extreme electrolyte concentrations. We here address how its main osmolytes, NaCl and urea, regulate tubular cell cytokine expression and monocyte chemotaxis.

**Methods:** Immunohistology was performed in human kidney sections, human monocyte function and tubular cell cytokine production was analyzed in cell culture.

**Results:** In the healthy human kidney, more monocytes were detected in medulla than cortex. The monocyte gradient was attenuated in patients with medullary NaCl depletion by loop diuretic therapy and in the nephrotic syndrome. Renal tubular epithelial cell gene expression responded similarly to NaCl and tonicity control mannitol, but not urea. NaCl significantly upregulated chemotactic cytokines, most markedly *CCL26*, *CCL2* and *CSF1*. This induction was inhibited by ROS scavenger *n*-acetylcysteine. In contrast urea, the main medullary osmolyte in catabolism, dampened tubular epithelial *CCL26* and *CSF1* expression. Renal medullary chemokine and monocyte marker expression decreased in catabolic mice. NaCl-, but not urea-stimulated tubular epithelium or *CCL2* and *CCL26* promoted human classical monocyte migration. *CCL26* improved bactericidal function. In the human kidney medulla, monocyte densities correlated with tubular *CCL26* abundance.

**Conclusions:** Medullary-range NaCl, but not urea, promotes tubular cytokine expression and monocyte recruitment. Our results delineate CCL26 expression in the kidney and determine its antibacterial function. This may contribute to the pyelonephritis vulnerability in catabolism but can possibly be harnessed against pathologic inflammation.

**TH-PO541**

**IgG Subclass Switch in Fibrillary Glomerulonephritis: Possible Natural History of the Disease**

Laura Biederman, Dalia Y. Ibrahim, Anjali A. Satoskar, Tibor Nadasdy, Sergey V. Brodsky. *The Ohio State University, Columbus, OH.*

**Background:** Fibrillary glomerulonephritis (FGN) is an uncommon glomerular disease characterized by non-periodic fibrillar deposits of immunoglobulins usually positive for polyclonal IgG. Staining for IgG subclasses routinely performed and is usually dominant for IgG4. However, the natural history of this disease is not well documented.

**Methods:** Kidney biopsies with FGN were identified in a renal pathology database at Ohio State Wexner Medical Center from 12/1/2006 to 3/1/2022, when routine IgG subclass staining was performed. A total of 164 cases with IgG subclass data were reviewed, and seven patients with a diagnosis of FGN who had both an original diagnostic kidney biopsy and a follow up kidney biopsy were identified.

**Results:** A total of 164 cases of FGN were identified since 12/2006 with IgG subclass staining. Of those, 39 were dominant for IgG1, 67 were dominant for IgG4, and 58 had co-dominant staining for IgG1 and IgG4. Among these, a total of 7 patients had a repeat biopsy after their initial diagnosis. Of these 7, at initial biopsy, 71% of the patients with repeat biopsy showed dominant subclass staining for IgG4, with the remaining showing dominant staining for IgG1 alone or IgG1 and IgG2. Two patients showed IgG subclass switching, both from IgG4 dominance to IgG1, and both were biopsied at more than 4 years after the initial diagnosis. Of the 5 patients with repeat biopsies who did not show subclass switching, 2 had repeat biopsies at 1 year or less, 2 had repeat biopsies between 1 and 5 years after initial diagnosis, and 1 had a repeat biopsy at 9 years or more. The other patient biopsied at more than 9 years showed IgG1 dominance on both the initial and subsequent biopsies.

**Conclusions:** FGN is an uncommon disease with a poorly understood natural history. Changes in IgG subclass staining from IgG4 to IgG1 may be part or the natural history of the disease.

	Initial Biopsy Subclass	Subsequent Biopsy Subclass	Years after initial diagnosis
Patient 1	IgG4 and IgG1	IgG1	4
Patient 2	IgG4 and IgG1	IgG1	>10
Patient 3	IgG4 and IgG1	IgG4 and IgG1	3
Patient 4	IgG1	IgG1	9
Patient 5	IgG1 and IgG2	IgG1 and IgG2	3
Patient 6	IgG4 and IgG1	IgG4 and IgG1	<1
Patient 7	IgG4 and IgG1	IgG4 and IgG1	<1

**TH-PO542**

**Utilization of 129S1/Sv Mice as a Model for Anticoagulant Related Nephropathy**

Sergey V. Brodsky,<sup>1</sup> Ajay kumar Medipally,<sup>1</sup> Min Xiao,<sup>1</sup> Galina Mikhailina,<sup>2</sup> Anjali A. Satoskar,<sup>1</sup> Laura Biederman,<sup>1</sup> <sup>1</sup>The Ohio State University, Columbus, OH; <sup>2</sup>Unity Hospital, Rochester, NY.

**Background:** We previously demonstrated that excessive anticoagulation with warfarin or dabigatran may result in acute kidney injury in some patients with chronic kidney disease and named it anticoagulant related nephropathy (ARN). An animal model of 5/6 nephrectomy rats treated with warfarin or dabigatran reproduces the main pathologic features of ARN. We had reported that C57BL/6 mice only partially develop ARN showing increased serum creatinine and hematuria but no red blood cell (RBC) casts in the kidney. The aim of this study was to investigate whether ARN can develop in 129S1/SvImJ mice.

**Methods:** 5/6 nephrectomy was performed in 129S1/SvImJ mice. Three weeks after the surgery, mice were treated with warfarin (1.0 mg/kg/day and 1.5 mg/kg/day) for 7 days. Serum creatinine, hematuria, and prothrombin time (PT) were monitored daily. Renal morphology was evaluated at the end of the studies.

**Results:** Treatment with warfarin resulted in PT elevation 2-3 folds from baseline (1.0 mg/kg/day warfarin) and 4-5 folds from baseline (1.5 mg/kg/day warfarin) by day 7. Serum creatinine elevation by day 7 was dose-dependent. Similarly, hematuria was increased in a dose-dependent manner. Histologically, some animals had RBCs in the tubules with acute tubular epithelial cell injury.

**Conclusions:** Our findings suggest that 129S1/SvImJ mouse strain could be more suitable animal model to study ARN than C57BL/6 mouse strain.

**Funding:** NIDDK Support

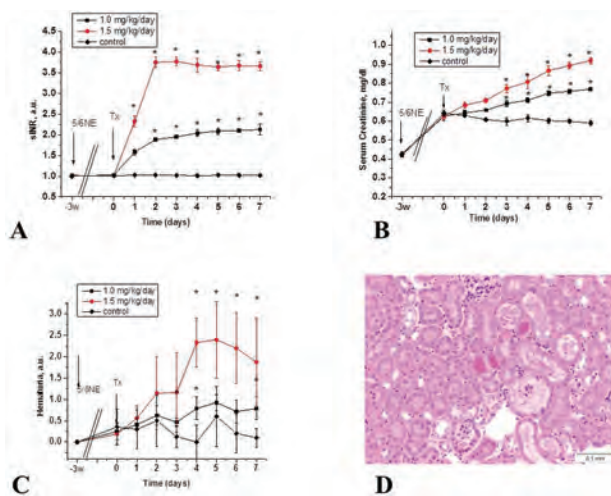

Figure 1. Effects of warfarin treatment on kidney function in 129S1/SvImJ mice.

A – Coagulation effects of warfarin treatment in 129S1/SvImJ mice. sINR was calculated as PT increase from control (as described in Methods).

B – Changes in serum creatinine in 129S1/SvImJ mice treated with warfarin.

C – Effects of warfarin treatment on hematuria in 129S1/SvImJ mice.

D – Representative image of red blood cell casts in the tubules in a 129S1/SvImJ mouse treated with 1.0 mg/kg/day warfarin for 7 days.

**TH-PO543**

**CD39 Expression Is Significantly Upregulated in Polarized Macrophage in ANCA Associated Vasculitis Patients**

Benito Yard, Anna-Isabelle Kälsch. *Ruprecht Karls Universität Heidelberg, Mannheim, Germany.*

**Background:** Monocytes concurrently stimulated for 6 days with CSF1 and of IFN $\gamma$  followed by TLR4 activation, are poorly stimulating T-cell proliferation despite increased expression of co-stimulatory molecules. Substitution of IFN $\gamma$  for IL-4 increases the ability to stimulate T-cell proliferation. These concurrently stimulated (CS) macrophages are tentatively referred as CSM1 and CSM2 respectively. We assessed if CSM1 and CSM2 macrophages from active, therapy naïve, ANCA associated vasculitis (AAV) patients (MPA: n=4 GPA: n=7) differ in phenotype and function from healthy controls (HC, n=12).

**Methods:** Phenotype and function were assessed by FACS and allogeneic mixed leucocyte reaction (MLC) respectively.

**Results:** Our study reveals that: 1) AAV patients had significantly more monocytes in peripheral blood as compared to HC. 2) both CD39 and CD73 expression were significantly higher in CSM1 than in CSM2 Macrophages, both in AAV patients and HC. However, surface expression of CD39 on CSM1 macrophages in AAV patients was significantly higher than in HC. 3) IL-17 production in MLC was higher for CSM1 as compared to CSM2 macrophages and blunted by addition of adenosine deaminase. No differences between AAV patients and HC were found. 4) Addition of the pan adenosine receptor NECA to anti-CD3 stimulated T-cells increased IL-17 production and resulted in T-cells with a non-pathogenic Th17 phenotype that were able to suppress proliferation of mitogen activate T-cells.

**Conclusions:** In keeping that adenosine signalling plays important regulatory roles in immunity, the finding that CD39 on CSM1 macrophages is increased in AAV patient warrants further studies on the functionality of these cells.

**TH-PO544**

**Structures of Megalin/LRP2 at Extracellular and Endosomal pH**

Andrew Beenken,<sup>1</sup> Jonathan M. Barasch,<sup>1</sup> Lawrence Shapiro,<sup>2</sup> <sup>1</sup>Columbia University Irving Medical Center, New York, NY; <sup>2</sup>Columbia University, New York, NY.

**Background:** The low-density lipoprotein receptor-related protein 2 (LRP2 or megalin) mediates endocytosis in species ranging from worms to humans and is implicated in diseases of the kidney and brain. The structural basis for its function remains one of the great unknowns of kidney biology. To understand the mechanisms of its ligand-binding and trafficking, we have solved structures of LRP2 at extracellular and endosomal pH.

**Methods:** We purified endogenous LRP2 from mouse kidney by isolating proximal tubule apical membrane, solubilizing in detergent, and purifying LRP2 from solubilized membrane using ion exchange chromatography and gel filtration. Protein was frozen in vitreous ice and then imaged with a Titan Krios microscope. Data was processed to yield cryo electron microscopy (cryo-EM) maps with resolutions of 2.8Å and 3.0Å for LRP2 at extracellular and endosomal pH, respectively.

**Results:** At each pH, LRP2 adopts a homodimeric assembly stabilized by pH-dependent interfaces (Figure). A significant change in tertiary structure between the two structures is mediated by pH-sensitive Ca<sup>2+</sup>-coordinating sites. At endosomal pH, Ca<sup>2+</sup> dissociates from multiple sites including both homodimer and intramolecular interfaces, enabling large-scale domain rearrangements that bury ligand-binding sites. A subset of human Donnai-Barrow loss of function missense mutations appear to impair homodimer assembly of LRP2 by perturbing pH-sensitive interfaces.

**Conclusions:** This work lays the foundation for further understanding the function and mechanism of the critical proximal tubule endocytic receptor, LRP2. In particular, our structural data highlights the central importance of pH-sensitive Ca<sup>2+</sup> switches in LRP2's structural transitions during cellular trafficking. Based on analysis of our structures and published genetic data, we unexpectedly find that LRP2 homodimerization appears conserved, necessitating a re-evaluation of the structural biology of related receptors, including LRP1 and LDLR.

**Funding:** Other NIH Support - NIH R01-DK124667

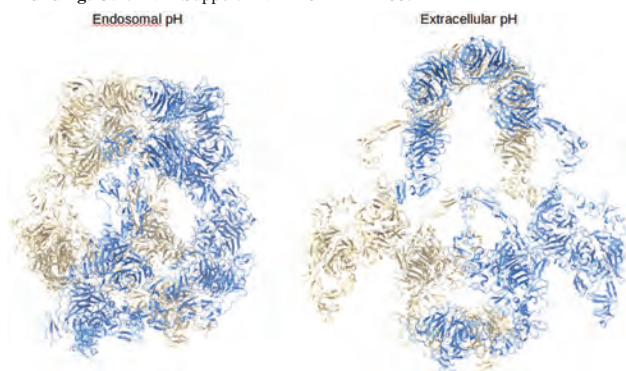

Structures of the LRP2 homodimer at endosomal and extracellular pH

TH-PO545

**HMGB1 and Antiphospholipid Antibodies Are Involved in the Pathogenesis of Systemic Lupus Erythematosus**

Hui Guan, Xiaohua Wang, Chun Tang, Keping Wu, Jiashi Chen, Zhihua Zheng. Department of Nephrology, Center of Kidney and Urology, The Seventh Affiliated Hospital, Sun Yat-Sen University, Shenzhen, China.

**Background:** Antiphospholipid antibodies (aPLs) are involved in the multiorgan damage of systemic lupus erythematosus (SLE). High Mobility Group Protein 1 (HMGB1) can promote the secretion of autoantibodies in SLE. The study aims to explore the role of HMGB1 and aPLs in the pathogenesis of lupus nephritis.

**Methods:** Antiphospholipid antibodies and HMGB1 levels were detected by enzyme-linked immunosorbent assays. Enzyme-linked immunospot assay was used to detect the ability of B cells to secrete antibodies.

**Results:** Anti-phosphatidylserine (PS) antibodies were significantly different between the SLE and control groups, while anti-phosphatidylserine/prothrombin (PS/PT) and anti-prothrombin (PT) were not. Anti-PS IgG antibodies were positively correlated to disease activity in SLE patients, while others were not. HMGB1 of SLE patients was correlated with anti-PS antibodies. HMGB1 protein stimulated peritoneal B-1a cells of C57 mice to secrete anti-PS IgG antibodies, which could not be blocked by TLR4 inhibitors (CLI-095).

**Conclusions:** Anti-PS antibodies and HMGB1 are involved in the pathogenesis of SLE.

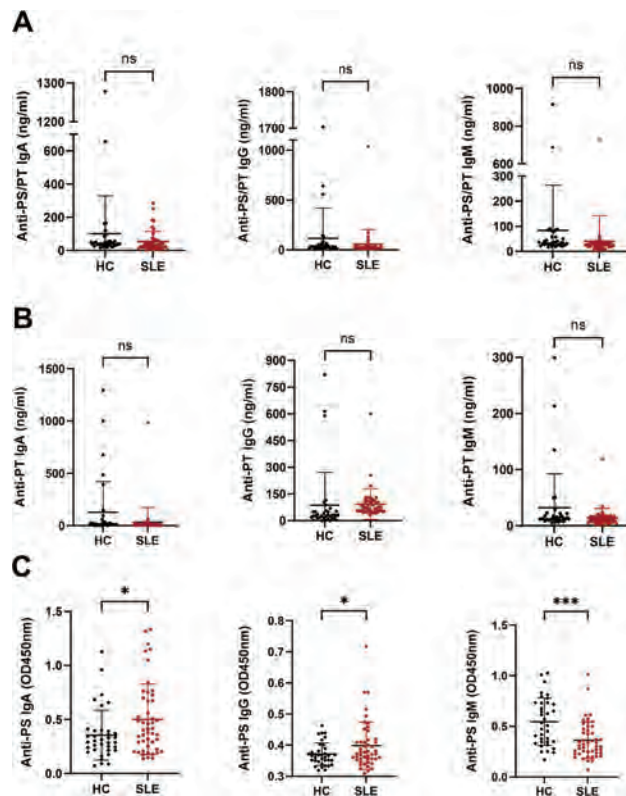

Comparison of antiphospholipid antibodies between healthy controls and SLE patients.

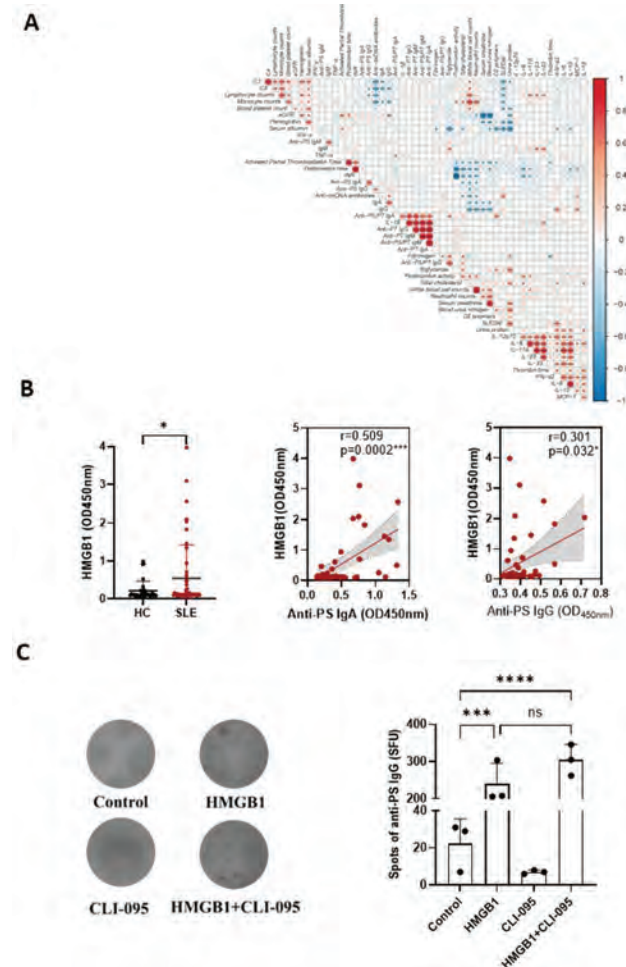

Antiphospholipid antibodies and HMGB1 were involved in the pathogenesis of SLE.

Key: TH - Thursday; FR - Friday; SA - Saturday; OR - Oral; PO - Poster; PUB - Publication Only  
Underline represents presenting author.

## TH-PO546

**Auto-Inhibitory Domain of HIPK2 Is a Novel Inhibitor of NF- $\kappa$ B Signaling in Kidney Cells**Ye Feng, Kyung Lee, John C. He. *Icahn School of Medicine at Mount Sinai, New York, NY.*

**Background:** We previously identified HIPK2 as a key protein kinase that regulates pro-apoptotic (p53), pro-fibrotic (TGF- $\beta$ ) and pro-inflammatory (NF- $\kappa$ B) pathways in renal tubular cells (RTEC) and diseased kidneys. As HIPK2 has multiple functional domains, mapping the individual domains required for distinct downstream pathway activation may be an optimal approach towards targeting specific HIPK2-dependent pathway. In this study, we have elucidated a novel function and mechanism of auto-inhibitory domain (AID) of HIPK2 (HIPK2-AID) in regulation of renal inflammation and fibrosis.

**Methods:** Plasmids encoding different functional domains of HIPK2 were constructed. To determine the functional role of HIPK2-AID in RTEC, we used HK2 cells. In vivo, we generated a mouse model in which expression of HIPK2-AID is induced specifically in RTECs. In this model, we examined the effects of HIPK2-AID on renal inflammation and fibrosis after creation of unilateral ureteral obstruction (UUO).

**Results:** We identified that HIPK2-AID fragment was released after Caspase 6-mediated cleavage of HIPK2. Interestingly, HIPK2-AID could act as a dominant negative to suppress TNF $\alpha$ -induced NF- $\kappa$ B (p65) transcriptional activation in HK2 cells. Mechanistically, HIPK2-AID's interaction with p65 resulted in its cytoplasmic sequestration, thereby reducing its transcriptional activity: Co-localization of p65 and HIPK2-AID in cytosol was confirmed by confocal microscopic analysis. In TNF $\alpha$ -stimulated cells, HIPK2-AID attenuated I $\kappa$ B- $\alpha$  phosphorylation and blocked p65 nuclear translocation, resulting in NF- $\kappa$ B pathway inactivation. Consistently, overexpression of HIPK2-AID specifically in RTECs attenuated p65 nuclear translocation in tubular cells and reduced macrophage infiltration in the kidney of UUO mice. The levels of p65 and I $\kappa$ B- $\alpha$  phosphorylation in the UUO kidneys were also downregulated with HIPK2-AID overexpression.

**Conclusions:** Collectively, our findings suggest that HIPK2-AID functions as a potential inhibitor of NF- $\kappa$ B signaling and HIPK2-AID or its analogues could be developed as anti-inflammatory agents to treat kidney disease.

**Funding:** NIDDK Support, Veterans Affairs Support

## TH-PO547

**Diagnostic Performance of a Unique Fragment of Human Fetuin-A for Patients Undergoing Native Kidney Biopsy**Ming-Tsun Tsai,<sup>1</sup> Wei-Cheng Tseng,<sup>1</sup> Tzu-Ling Tseng,<sup>2</sup> *<sup>1</sup>Taipei Veterans General Hospital, Taipei, Taiwan; <sup>2</sup>Bio Preventive Medicine Corp., Hsinchu, Taiwan.*

**Background:** Fetuin-A is a hepatokine secreted into the systemic circulation and regulates many biological processes. The relationship between fetuin-A and progression of chronic kidney disease (CKD) has been studied intensively, but its role in CKD and its complications remains to be clarified. Several types of post-translational modifications (PTMs) on fetuin-A are identified in patients with CKD, implying the possible effects of these modifications on renal structure and function.

**Methods:** A commercial immunoassay, DNLite-IVD103 supplied by Bio Preventive Medicine Corp., was used to measure urine levels of a unique PTM fetuin-A (uPTM-Fet-A) in a cohort of patients undergoing native kidney biopsies. Relationships between uPTM-Fet-A, clinical characteristics, and tubulointerstitial damage were analyzed with logistic regression. Furthermore, the accuracy of the uPTM-Fet-A in predicting the severity of tubulointerstitial fibrosis was evaluated by constructing receiver operating characteristic curves.

**Results:** To analyze the relationship between uPTM-Fet-A and clinical features, we divided the patients into two groups according to median levels of uPTM-Fet-A (65.6 ng/mg). The high-level group had a larger percentage of elderly male patients and patients with decreased renal function, higher levels of proteinuria, and severe renal fibrosis than the low-level group. After multivariate adjustment, renal impairment, hypoalbuminemia, and high-grade proteinuria were independently correlated with elevated levels of uPTM-Fet-A. Moreover, compared with the urine protein-to-creatinine ratio (uPCR), uPTM-Fet-A had a better performance in the diagnosis of different extents of renal fibrosis.

**Conclusions:** Our results suggested that uPTM-Fet-A may be a potential diagnostic biomarker for patients with CKD.

**Funding:** Government Support - Non-U.S.

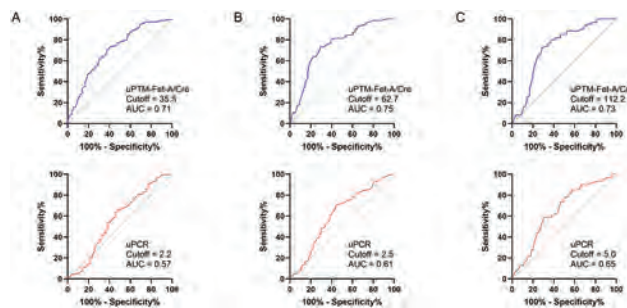

ROC curve analyses comparing the predictability in distinguishing the different grades of IFTA of the uPTM-Fet-A/Cr (ng/mg) with uPCR (mg/mg). The area under the curve (AUC) represents the probability to discriminate the presence of > 10% (A), > 25% (B), or > 50% (C) IFTA in the tissue samples.

## TH-PO548

**Afferent but Not Efferent Vagus Nerve Stimulation Reduces Endotoxin-Induced Acute Lung Injury via Vagosympathetic Communication**Nabin Poudel, Shuhei Kuwabara, Shinji Tanaka, Eibhlin S. Goggins, Mark D. Okusa. *UVA Health, Charlottesville, VA.*

**Background:** Vagus nerve stimulation (VNS) has a potent anti-inflammatory effect during inflammatory conditions such as acute kidney injury (AKI), arthritis, and experimental sepsis. Sepsis is an acute life-threatening condition that results from hyperactivation of the immune system as a response to infection and involves injury to multiple organs such as kidneys and lungs. We previously showed that VNS is protective in ischemia reperfusion injury induced AKI. We hypothesized that VNS protects mice from sepsis induced acute lung injury (ALI).

**Methods:** VNS was performed by exposing the left cervical vagus nerve (VN) and stimulating either electrically (eVNS) in C57BL/6 mice or optogenetically (optoVNS) in transgenic mice expressing channelrhodopsin-2 specifically in either afferent or efferent VN. Unidirectional selective VNS was performed by applying bupivacaine to one end of VN followed by VNS. Local sympathetic denervation was achieved by intranasal instillation of 6-hydroxydopamine. Hypothalamo-pituitary-adrenocortical (HPA) axis was blocked using mifepristone. 24 hours after VNS, animals were instilled with lipopolysaccharide intranasally to induce ALI followed by analysis of bronchoalveolar lavage (BAL) and lung tissues at 6 hours. Flow cytometry was performed to quantify immune cell infiltration. Luminex was performed to quantify cytokine levels. H&E staining was performed to evaluate extent of lung injury.

**Results:** We observed a significant reduction in immune cell infiltration in the alveolar space after eVNS. Selective central eVNS to stimulate afferent VN also reduced LPS induced leukocyte counts in the BAL, while selective distal eVNS failed to exert this effect. Moreover, optoVNS of anterograde afferent VN ameliorated lung injury which was abrogated by local sympathetic denervation of the lung and airway. Blocking the HPA axis did not alter the protective effect of VNS. Cytokine analysis showed that afferent VNS decreased pro-inflammatory cytokines Cxcl1, Cxcl10, RANTES, and Vegfa.

**Conclusions:** Our previous and current data collectively suggest that VNS can be an effective therapeutic approach for acute inflammatory conditions such as AKI and ALI. This phenotype is mediated by reduced cytokine production and an overall reduction in inflammatory cells recruitment in the target organ.

**Funding:** NIDDK Support

## TH-PO549

**Hirudin Alleviates Renal Fibrosis by Regulating PDGFB Pathway Based on Bioinformatics**Ying Li, Weijian Xiong. *Chongqing Hospital of Traditional Chinese Medicine, Chongqing, China.*

**Background:** RIF is the final pathological manifestation of most patients with CKD and a precursor of end-stage renal disease. In recent years, many reports have confirmed the therapeutic effect of hirudin in renal disease. Our study was committed to revealing the hirudin's reduction to renal fibrosis (RF) as well as the molecular mechanism.

**Methods:** To begin with, we commenced both the identification and the determination to the hirudin targeted proteins and its down-stream signaling pathways with the methods of bioinformatics, molecular docking and coprecipitation. After that, we validated hirudin's interaction with PDGFB with the assays of molecular docking and immunoprecipitation.

**Results:** With the help of CTD database, 10 target proteins of hirudin were obtained, and N proteins were screened by mass spectrometry analysis. 5 proteins were screened out and 5 flag-target overexpressed plasmid vectors were constructed respectively, which were verified by immunoprecipitation in NRK-52E cells. We found that only PDGF-BB is capable of binding to hirudin. Subsequently, we confirmed that hirudin inhibits the EMT caused by PI3K-AKT by reducing the phosphorylation of PDGFR $\beta$  in vitro.

**Conclusions:** Hirudin reduces the phosphorylation level of PDGFR $\beta$  by binding to PDGF-BB.

**Funding:** Government Support - Non-U.S.

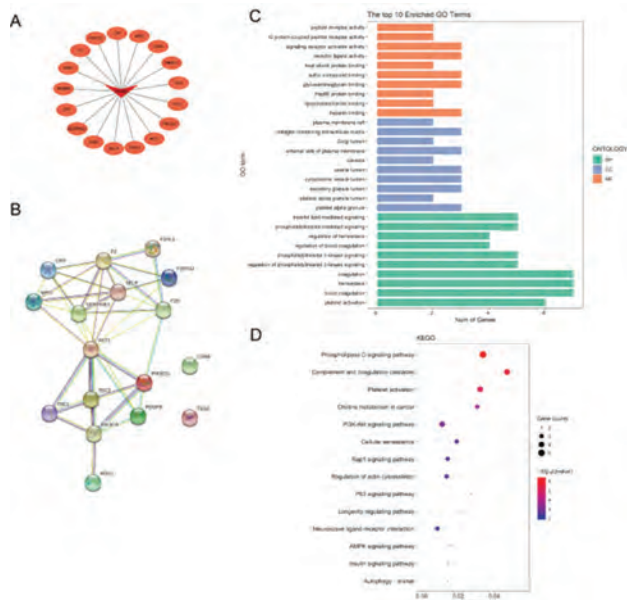

**Results:** Most of the biomarkers were significantly increased within the ESRD group compared to normal plasma. Annexin V (23.64%,  $p < 0.001$ ), L-FABP (1983%,  $p < 0.0001$ ), D-dimer (650.53%,  $p < 0.0001$ ), TNF-alpha (35.87%,  $p < 0.0001$ ), IL-6 (317.21%,  $p < 0.0001$ ), CRP (2214.43%,  $p < 0.0001$ ), NO (151.74%,  $p < 0.0001$ ), vWF (183.03%,  $p < 0.0001$ ), and MCP-1 (67.49%,  $p < 0.0001$ ) showed significant increase when compared to normal volunteers. Varying levels of correlations were noted within some of these biomarkers. Other measured biomarkers did not demonstrate any significant differences between the ESRD and control groups.

**Conclusions:** This study suggests that thrombo-inflammatory biomarkers may be helpful in the diagnosis of CRS in ESRD patients. This multi-parametric profiling may be helpful in risk stratification and prediction of adverse outcomes within ESRD patients and the development of CRS.

**Funding:** Private Foundation Support

**TH-PO551**

**Upregulation of IRF4 Correlates With Renal Damage in Systemic Lupus Erythematosus**

Yu Liu,<sup>1</sup> Chun Tang,<sup>1</sup> Xiaohua Wang,<sup>1</sup> Yan Lei,<sup>1</sup> Li Na,<sup>1</sup> Enyi Zhu,<sup>1</sup> Hui Guan,<sup>1</sup> Xiaoping Liu,<sup>2</sup> Zhihua Zheng.<sup>1</sup> <sup>1</sup>The seventh Affiliated Hospital of Sun Yat-Sen University, Shenzhen, China; <sup>2</sup>Guangzhou Women and Children's Medical Center Institute of Pediatrics, Guangzhou, China.

**Background:** Transcription factor interferon regulatory factor 4 (IRF4) plays an essential role in driving maturation and differentiation of Ab secreting plasma cells. Our study aims to investigate the expression and localization of IRF4 in systemic lupus erythematosus (SLE) and its correlation with clinical characteristics.

**Methods:** The expression of IRF4 in PBMCs from 31 SLE patients and 17 healthy controls (HC) were checked by qPCR and Western blotting. Meanwhile, the relationship between the IRF4 mRNA level and clinical manifestations were analyzed. Furthermore, the distribution patterns of IRF4 and plasma cells were identified in kidneys of MRL/lpr mice and C57BL/6 mice by immunofluorescence staining.

**Results:** Among patients with active disease but not in remission, the mRNA and protein expression of IRF4 in PBMCs were remarkably increased compared to that in HC group. The mRNA level of IRF4 was positively correlated with frequency of peripheral blood B cells and serum IgA level in SLE patients. Moreover, patients with increased IRF4 mRNA level have a significantly higher frequency of renal damage. Consistently, elevated mRNA and protein expression patterns of IRF4 were observed in kidneys from MRL/lpr mice compared to that from C57BL/6 mice. Besides, IRF4 was found mainly expressed in plasma cells in spleens of MRL/lpr mice, which was notably higher than that of C57BL/6 mice. Also, IRF4 significantly co-localized with CD138<sup>+</sup> plasma cells among kidneys from MRL/lpr mice.

**Conclusions:** Upregulated IRF4 may be clinically involved in renal damage in SLE.

**Funding:** Other NIH Support - Shenzhen Municipal Science and Technology Innovation Commission (Project-ID JCYJ20210324123414040), and Guangdong Basic and Applied Basic Research Foundation (Project-ID 2019A1515110488 and 2020A1515110306)

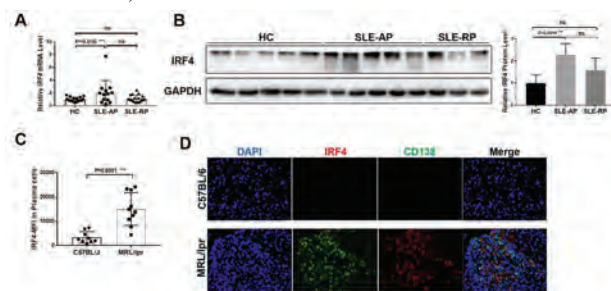

**Figure 1. IRF4 is upregulated in SLE patients and MRL/lpr mice.** (A) RT-qPCR for IRF4 mRNA levels in PBMCs of healthy controls (HC; n=17), SLE in active period (SLE-AP, n=13) and remission period (SLE-RP, n=18); (B) Western blotting for IRF4 protein levels in healthy controls and SLE patients; (C) Flow cytometry analysis for MFI of IRF4 in plasma cells in spleens of C57BL/6 mice and MRL/lpr mice; (D) Double staining of IRF4 with CD138 by immunofluorescence staining in kidneys of C57BL/6 mice and MRL/lpr mice.

**TH-PO552**

**Association Between Ongoing Antithrombotic Agents and Renal Biopsy Bleeding Complication**

Ryumon Miyashita,<sup>1,2</sup> Keita Hirano,<sup>1,2</sup> Ichiro Ohkido,<sup>2</sup> Nobuo Tsuboi,<sup>2</sup> Takashi Yokoo.<sup>2</sup> <sup>1</sup>Ashikaga Sekijui Byoin, Ashikaga, Japan; <sup>2</sup>Tokyo Jikeikai Ika Daigaku, Minato-ku, Japan.

**Background:** Numbers of kidney disease patients with prescribed antithrombotics have been growing because of their increased cardiovascular risk. Stopping them prior to renal biopsy can lead to delays in diagnosis and treatment, and increase the likelihood of ischemic events. Since there have been few studies examining bleeding complications due to continued antithrombotics up to the time of renal biopsy, we aimed to retrospectively examine this risk of bleeding in our historical cohort of renal biopsy.

**TH-PO550**

**Thrombo-Inflammatory Biomarkers of Cardiorenal Syndrome in ESRD**  
Vinod K. Bansal, Pranathi Karumanchi, Fakiha Siddiqui, Mark Jaradeh, Debra Hoppensteadt, Jawed Fareed. Loyola University Health System, Maywood, IL.

**Background:** Cardiovascular complications commonly occur in patients with end-stage renal disease (ESRD) and lead to a 20-fold increase in mortality relative to the general population. The strong interdependence between ESRD and cardiovascular complications may be explained through cardiorenal syndrome (CRS). CRS comprises a spectrum of disorders involving both the heart and kidneys in which acute or chronic dysfunction in one organ may induce consequential pathogenesis in the other organ. Previous studies have demonstrated that inflammation and thrombosis are integral to CRS development and key cardiac and renal biomarkers are elevated in CRS patients. This study aims to profile thrombo-inflammatory biomarkers in ESRD patients to establish relevance to CRS.

**Methods:** Plasma samples were collected from 95 ESRD patients following approval by an IRB at Loyola University Medical Center. Control group was comprised of plasma samples (N=50), obtained from a commercial source (George King Biomedical, USA). Thrombo-inflammatory biomarkers, including Annexin V, MPO, Troponin, L-FABP, VEGF, D-dimer, TNF-alpha, IL-6, CRP, eNOS, Nitrotyrosine, MDA, NEFA, NO, vWF and MCP-1 were measured using commercially available ELISA methods. Results were compiled as group means±SEM and analyzed using GraphPad software.

**Methods:** Patients undergoing ultrasound-guided renal biopsy at our hospital between 2013 and 2021 were enrolled. Observation period was one week before and after renal biopsy. Exposure was any antithrombotics continued during the observation period. Control was no antithrombotics during this period. Primary outcome was change in hemoglobin levels from the day of biopsy to one day after. Secondary outcome was any macroscopic hematuria within 7 days after biopsy. Matching with 1:1 ratio on the basis of derived propensity scores for the treatment with antithrombotic agents was used to balance baseline characteristics between exposure and control.

**Results:** Among enrolled 1392 patients, 156 patients in antithrombotic group (antiplatelet 117 [75.0%], anticoagulant 33 [21.2%], both of them 6 [3.8%]) were matched. The top two most commonly prescribed antiplatelet and anticoagulant agents were Acetylsalicylic acid and Clopidogrel, and Warfarin and Apixaban, respectively. Difference in change of hemoglobin levels between antithrombotic and control groups was not significant (mean -0.14 g/dl, standard error 0.12, 95% confidence interval [CI] -0.37 to 0.10, P=0.243). The risk of macroscopic hematuria after renal biopsy in antithrombotic group was not significant compared to control (odds ratio 0.85, 95% CI 0.45 to 1.62, P=0.623).

**Conclusions:** Our retrospective single center study has demonstrated that continuing antithrombotic agents at the time of renal biopsy was not significantly associated with increased risk of bleeding.

### TH-PO553

#### Factors Associated With Excessive Glomerular Hypertrophy in Patients With CKD: Renal Biopsy-Based Study

Ryo Zamami, Kentaro Kohagura, Yusuke Ohya. *Ryukyuu Daigaku, Nakagami-gun, Japan.*

**Background:** Loss of nephrons leads to compensatory hypertrophy of the residual glomeruli, and glomerular hypertrophy beyond the compensatory range due to impaired renal autoregulation triggers progressive renal dysfunction. Various factors have been reported to as a cause of glomerular hypertrophy, but it is unclear which factors are most associated with excessive glomerular hypertrophy. In this study, we used renal biopsy specimens to determine which factors are most associated with excessive glomerular hypertrophy.

**Methods:** Subjects were 104 patients who underwent renal biopsy at the University of the Ryukyus Hospital from 2016 to 2017, excluding those with less than 5 glomeruli collected. Predicted maximum glomerular diameter was determined by simple regression analysis using the glomerular density and maximum glomerular diameter of each specimen, and the difference between the measured and predicted maximum glomerular diameter was defined as the glomerular hypertrophy index (GHI). Multiple regression analysis was used to determine the most relevant factors for the GHI using following factors associated with impaired renal autoregulation as variables: age, gender, systolic blood pressure, body mass index (BMI), creatinine clearance, serum uric acid level (SUA), HbA1c, protein intake, and use of renin-angiotensin-aldosterone system inhibitors. The fourth quartile of GHI was defined as the excessive glomerular hypertrophy group, and multiple logistic analysis was performed using the same variables.

**Results:** The median age of the subjects was 49 years, and the median eGFR was 67 ml/min/1.73 m<sup>2</sup>. In simple regression analysis, BMI, HbA1c, and SUA were significantly associated with GHI. In multiple regression analysis, BMI and HbA1c were significantly associated with GHI independently of other factors, with standardized partial regression coefficients of 0.325 and 0.249, respectively. In multiple logistic analysis, only BMI was associated with excessive glomerular hypertrophy.

**Conclusions:** BMI may lead to excessive glomerular hypertrophy in patients with chronic kidney disease.

### TH-PO554

#### Daily Variability of Urinary Extracellular Vesicles in Healthy Patients

Margaret Selesky,<sup>1</sup> Samantha G. Upson,<sup>2</sup> Luca Musante,<sup>3</sup> Hayretin Yavuz,<sup>4</sup> Michael A. Harding,<sup>4</sup> Uta Erdbruegger.<sup>4</sup> *<sup>1</sup>University of Virginia School of Medicine, Charlottesville, VA; <sup>2</sup>University of Virginia, Charlottesville, VA; <sup>3</sup>University of Pennsylvania, Philadelphia, PA; <sup>4</sup>UVA Health, Charlottesville, VA.*

**Background:** Urinary extracellular vesicles (uEVs) have been shown to parallel physiologic and pathologic processes in the kidney, but minimal literature exists studying the daily variability of EV secretion in healthy patients. In this pilot study, we used Nanoparticle Tracking Analysis (NTA) to study particle and EV secretion in urine throughout a 24-hour collection in 9 healthy individuals.

**Methods:** We collected every void during a 24-hour period for 9 healthy individuals starting with the second morning void and ending with the first of the following day for a total of 61 samples and an average of 6.8 voids per individual. We created a 24-hour collection sample by combining 20% of each void and quantitated creatinine concentration in each void using the picrate alkaline colorimetric assay. EVs were separated from urine with differential centrifugation at 4,600g and 21,500g to remove cells and debris and to pellet EV respectively. The uEV pellet was washed 3 times with a low ionic strength buffer and centrifuged at 25,000g serially to collect uEVs. We performed particle count and sizing on each final pellet using an NTA instrument (ZetaView PMX-120; Particle Metrix). Nanoparticle concentration was normalized to creatinine concentration for each void to account for hydration status. Paired t-test was used to evaluate whether any individual void was significantly different from the 24-hour collection, defined as p<0.05.

**Results:** Neither median diameter nor nanoparticle concentration were significantly different between any individual void and the 24-hour sample on paired t-test (Figure 1), although the difference between median diameter of the second morning void and 24-hour sample were closest to significantly different (p=0.09).

**Conclusions:** We found no difference in uEV concentration or median diameter between any individual void in a 24-hour collection and the 24-hour sample. Further studies are needed to dissect the mechanisms of uEV size differences and variability of uEV markers like AQP2.

Void (n)	Average median diameter, nm (SD)	t	p	Average nanoparticle concentration/creatinine concentration, particles/g (SD)	t	p
2 <sup>nd</sup> (9)	161.13 (16.7)	-1.90	0.09	1.96e12 (3.03e12)	0.77	0.46
3 <sup>rd</sup> (9)	166.25 (17.0)	-0.85	0.42	1.83e12 (1.83e12)	1.162	0.28
4 <sup>th</sup> (9)	166.51 (18.0)	-0.97	0.36	1.15e12 (1.08e12)	-0.56	0.59
5 <sup>th</sup> (9)	169.11 (11.5)	-0.40	0.70	1.33e12 (9.53e11)	-0.61	0.56
6 <sup>th</sup> (8)	171.87 (7.95)	0.51	0.63	2.56e12 (2.60e12)	1.66	0.14
7 <sup>th</sup> (4)	169.43 (13.0)	0.52	0.64	8.17e11 (2.22e11)	-0.10	0.93
1 <sup>st</sup> (9)	167.31 (4.9)	-0.72	0.49	1.36e12 (6.82e11)	-0.33	0.75

Paired t-test comparing void to 24-hour

### TH-PO555

#### Aging Aggravates Oxidation Processes and Collagen Accumulation in the Experimental AKI-to-CKD Transition

Laura Marquez-Exposito,<sup>1,2</sup> Lucia Tejedor,<sup>1,2</sup> Floris Valentijn,<sup>3</sup> Vanessa Marchant,<sup>1,2</sup> Roel Goldschmeding,<sup>3</sup> Marta Ruiz-Ortega.<sup>1,2</sup> *<sup>1</sup>Universidad Autonoma de Madrid, IIS-FJD, Madrid, Spain; <sup>2</sup>REDinREN, Madrid, Spain; <sup>3</sup>University Medical Center Utrecht, Utrecht, Netherlands.*

**Background:** Chronic kidney disease (CKD) is very frequent in aged patients, being associated to a high mortality. Our group has previously described a dysfunctional redox-regulated mechanisms and an early activation of cellular senescence in 1 year old C57BL/6 mice. Moreover, in folic acid (FA)-induced Acute Kidney Injury (AKI) in these mice, exacerbation of tubular injury, necroinflammation and cellular senescence was observed. However, mechanisms leading to AKI-to-CKD transition in the aging are completely unknown.

**Methods:** A single low-dose of FA (125mg/kg) were injected to young (3 months) and aged (12 months) mice and kidneys were studied after 10 days.

**Results:** First, a Kaplan-Meier curve showed a 91% of survival in the FA-young group, whereas only a 46% of FA-aged group survived. The higher mortality in aging mice was observed at day 8 corresponding to the AKI-to-CKD transition phase. The PAS staining in survival mice showed higher inflammatory infiltrating cells in FA-aged mice compared to FA-young mice, but tubular dilatation and renal dysfunction were similar between groups. The assessment of cellular senescence mechanisms through the activation of DNA-Damage Responses, such as phosphorylation of H2AX histone and the cycline-dependent kinase inhibitors, such as p21cip1 and p16ink4a, demonstrated not significant differences between FA-damaged groups. On the contrary, gene expression levels of several Senescence-Associated Secretory Phenotype, such as *Ccn2*, and the proinflammatory factors *Tnfa* and *Ccl5*, were found augmented in FA-aged mice. Collagen accumulation, evaluated by a picrosirius red staining, showed higher deposition in FA-aged mice. Moreover, LOX and LOXL2 protein levels were significantly increased in FA-aged mice. On the other hand, NRF2 antioxidant protein evaluation and total protein nitration by 3-nitrotyrosine, showed an increase in the FA-aged mice, demonstrating a deregulation in the cellular oxidation and antioxidant response associated to aging in these mice.

**Conclusions:** Our study showed that AKI-to-CKD transition in aging mice is characterized by increased mortality, inflammatory cell infiltration and kidney fibrosis. The mechanisms involved in increased susceptibility to CKD progression might be mediated by deregulation of redox processes and sustained inflammation.

**Funding:** Government Support - Non-U.S.

### TH-PO556

#### Detrimental Role of Hypoxia-Inducible Factor Asparaginyl Hydroxylase (FIH) in CKD

Anna Faivre,<sup>1</sup> Romain Dissard,<sup>1</sup> Willy Kuo,<sup>2</sup> Thomas Verissimo,<sup>1</sup> David Legouis,<sup>1</sup> Gregoire Arnoux,<sup>1</sup> Maja Lindenmeyer,<sup>3</sup> Solange Moll,<sup>4</sup> Carsten C. Scholz,<sup>2</sup> Vartan Kurtcuoglu,<sup>2</sup> Sophie M. De Seigneux.<sup>1</sup> *<sup>1</sup>Universite de Geneve Departement de physiologie cellulaire et metabolisme, Geneve, Switzerland; <sup>2</sup>Universitat Zurich Physiologisches Institut, Zurich, Switzerland; <sup>3</sup>Universitätsklinikum Hamburg-Eppendorf Zentrum für Innere Medizin, Hamburg, Germany; <sup>4</sup>Hopitaux Universitaires Geneve, Geneve, Switzerland.*

**Background:** The roles of hypoxia and hypoxia inducible factor (HIF) during chronic kidney disease (CKD) are much debated. Interventional studies with HIF- $\alpha$  activation in rodents yielded contradictory results. The HIF pathway is regulated by three prolyl and one asparaginyl hydroxylases; while prolyl hydroxylase inhibition is a well-known method to stabilize HIF- $\alpha$ , little is known about the effect of the inhibition of the asparaginyl hydroxylase Factor Inhibiting HIF (FIH).

**Methods:** We used a model of progressive proteinuric CKD and a model of obstructive nephropathy with unilateral fibrosis. In these models, we assessed hypoxia with pimonidazole and vascularization with high-definition three-dimensional micro-CT

Key: TH - Thursday; FR - Friday; SA - Saturday; OR - Oral; PO - Poster; PUB - Publication Only

Underline represents presenting author.

imaging. We analyzed a database of 217 CKD biopsies from stage 1 to 5 for transcription and we randomly collected 15 CKD biopsies from various severity degrees to assess FIH expression. Finally, we modulated FIH activity *in vitro* and *in vivo* using a pharmacologic approach, to assess its relevance in CKD.

**Results:** In our model of proteinuric CKD, we show that early CKD stages are not characterized by hypoxia or HIF activation. At late CKD stages, some areas of hypoxia are observed, but interestingly these are not colocalizing with fibrosis. In mice and in humans, we observed a downregulation of the HIF pathway, together with an increased FIH expression in CKD, according to its severity. Modulating FIH *in vitro* affects cellular metabolism, as described previously. *In vivo*, pharmacologic FIH inhibition increases the glomerular filtration rate of control and CKD animals and is associated with a reduced development of fibrosis.

**Conclusions:** The causative role of hypoxia and HIF activation in CKD progression is questioned. A pharmacological approach of FIH downregulation seem promising in proteinuric kidney disease.

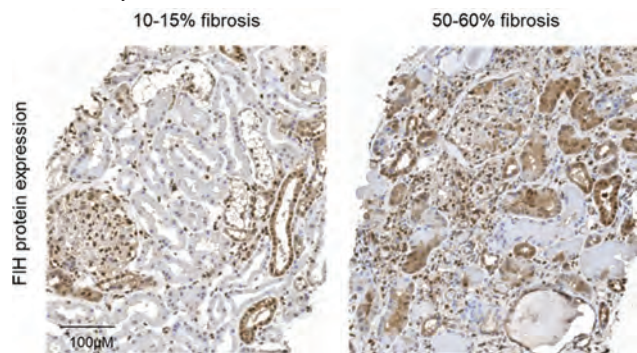

**TH-PO557**

**Renal Pathology Global Practice Variation**

Joseph Gaut,<sup>1</sup> Joris Roelofs,<sup>2</sup> Surya V. Seshan,<sup>3</sup> Joel M. Henderson,<sup>4</sup> Shreeram Akilesh,<sup>5</sup> Swarnalata Gowrishankar,<sup>6</sup> Thorsten Wiech,<sup>7</sup> Luiz A. Moura.<sup>8</sup>  
<sup>1</sup>Washington University in St Louis School of Medicine, St Louis, MO; <sup>2</sup>Amsterdam UMC Locatie AMC, Amsterdam, Netherlands; <sup>3</sup>Weill Cornell Medicine, New York, NY; <sup>4</sup>Boston University, Boston, MA; <sup>5</sup>University of Washington, Seattle, WA; <sup>6</sup>Apollo Hospitals, Hyderabad, India; <sup>7</sup>Universitätsklinikum Hamburg-Eppendorf, Hamburg, Germany; <sup>8</sup>Universidade de Sao Paulo, Sao Paulo, Brazil.

**Background:** Renal pathology relies on special histologic stains and ancillary techniques. Global practice variation is not well documented. This study aims to examine global renal biopsy pre-analytic and analytic variability in the current era.

**Methods:** The Renal Pathology Society membership was surveyed between Aug 24, 2021 - Oct 22, 2021 with 66 questions. 126 members responded.

**Results:** Respondents represented 47% North America, 26% Asia, 19% Europe, 4% South America, 3% Central America, 1% Australia, and 1% Africa. Most have a practice processing 500 - 1000 biopsies annually, most being native kidney biopsies. The survey consisted of questions regarding general practice variables, tissue preparation, and processing for light, immunofluorescence, and electron microscopy. The most variable survey responses are summarized in Table 1. The remaining responses that were more consistent were not shown.

**Conclusions:** There is significant variation in renal biopsy processing and extent of pathologic evaluation across the globe. Paraffin immunofluorescence is not widely available nor are THSD7A, collagen IV isoform, and DNAJB9 immunostains. EM is only used routinely in ~50% of biopsies. Morphometric measurement of fibril thickness varies in practice. Despite the wide range of resources available in differing global settings, most pathologists have access to many ancillary tests. Improved access to adequate resources is needed to standardize global renal biopsy practice. These data reveal many potential sources of variability across all processing phases and microscopic techniques. Further study is needed to understand the impact on renal pathology practice.

Table 1

Question	Response (%)
Where are renal biopsies divided for LM, IF, EM?	Bedside/procedure (32); lab (56); nephrologists/radiologists (42)
Who divides the biopsy?	Pathologist (44); trainee (16); tech (59); surgeon (6); nephrologist (33); radiologist (16)
Total # slides prepared for 1 biopsy	4-5 (3.8); 6-8 (30); 9-10 (21); >10 (30)
# H&E slides for 1 biopsy	1 (16); 2 (37); 3 (32); 4 (15)
# PAS slides for 1 biopsy	1 (34); 2 (27); 3 (28); 4 (10)
# Silver slides for 1 biopsy	0 (2); 1 (53); 2 (25); 3 (16); 4 (4)
Section thickness for Congo Red	<5 µm (12); 5 µm (18); 7 µm (24); >7 µm (44); do not use (2)
Do you offer paraffin IF?	Yes (49); No (51)
PLA2R immunostaining	Yes IF (26); Yes IHC (32); Yes sendout (17); No (26)
DNAJB9 immunostaining	Yes IF (4); Yes IHC (23); Yes sendout (23); No (50)
THSD7A immunostaining	Yes IF (5); Yes IHC (13); Yes sendout (19); No (63)
Collagen IV isoforms staining	Yes IF (27); Yes IHC (33); Yes sendout (22); No (48)
Morphometric fibril thickness - how many measurements?	<10 (26); 10-20 (34); 20-50 (10); >50 (3); minimum (13); No (25)

**TH-PO558**

**The Cleveland Clinic Kidney Biopsy Epidemiology Project**

Gilda M. Portalatin,<sup>1</sup> Hanny Sawaf,<sup>2</sup> Shruti Shettigar,<sup>1</sup> Astrid I. Carrión Rodríguez,<sup>1</sup> Leal C. Herlitz,<sup>2</sup> Surafel K. Gebreselassie,<sup>1</sup> Shane A. Bobart.<sup>1</sup>  
<sup>1</sup>Cleveland Clinic Florida, Weston, FL; <sup>2</sup>Cleveland Clinic, Cleveland, OH.

**Background:** The kidney biopsy is the gold standard for diagnosing kidney disease. Large-scale, epidemiological studies describing the prevalence of biopsy proven kidney diseases are lacking. We aimed to determine the spectrum and prevalence of biopsy proven kidney disease across the Cleveland Clinic.

**Methods:** We identified all patients who had a native kidney biopsy performed/ reviewed at the Cleveland Clinic from January 2015 to September 2021. Clinical and demographic characteristics were obtained by retrospective chart review. Results were stratified by age, race and state to assess any epidemiological trends in kidney disease.

**Results:** Over 9600 patients were identified. After excluding transplant/donor biopsies and unavailable records, we had 4148 patients with native biopsy data. The mean age at biopsy was 57 years old, with 46% female. There were 3256 patients in Ohio and 349 patients in Florida. Self-reported racial demographics were 72.9% white (5.1% Hispanic), 21.7% black, 3.1% multi-racial, and 1.6% Asian. Diagnoses identified were: FSGS (15.2%), diabetic kidney disease (DKD) (14.6%), IgA nephropathy (7.7%), lupus nephritis (7.0%), pauci-immune glomerulonephritis (6.6%), membranous nephropathy (5.1%), acute interstitial nephritis (AIN) (3.0%), and amyloidosis (2.7%). When stratified by age groups 0-18, 19-64, 65-85 and over 85 years old, AIN and pauci-immune glomerulonephritis were more prevalent in those >85 years. Among those <65 years old, lupus nephritis, IgA nephropathy and minimal change disease was more prevalent. In Ohio, there was a higher percentage of black (23.4% vs 17%) and non-Hispanics (96.3% vs 79.2%) vs Florida with more white (74.8% vs 71.8%) and Hispanics (20.8% vs 3.7%). Pauci-immune glomerulonephritis was more commonly seen in whites, while DKD, FSGS and lupus nephritis were more prevalent in black patients. Notably, the prevalence of membranous nephropathy, a disease that primarily affects whites, was similar between white and black patients in our cohort (5.0 vs 5.2%).

**Conclusions:** Our study catalogues the spectrum of biopsy proven kidney disease across the US Cleveland Clinic enterprise. Key demographic and geographical trends have been identified. Future studies include an in depth look at clinical outcomes and clinic trails for specific glomerular diseases at our Florida and Ohio campuses.

**Funding:** Private Foundation Support

**TH-PO559**

**Baseline Characteristics of Renal Biopsy Cohort of Patients With CKDu in Nicaragua**

Cristian J. Urey,<sup>1</sup> Nelson B. Garcia Salazar,<sup>1</sup> Biruh Workeneh,<sup>2</sup> Alexei V. Mikhailov,<sup>3</sup> Michael H. Carstens,<sup>3</sup> Sreedhar A. Mandayam.<sup>2,1</sup> *MINSA, Chinandega, Nicaragua; <sup>2</sup>The University of Texas MD Anderson Cancer Center, Houston, TX; <sup>3</sup>Wake Forest Baptist Medical Center, Winston-Salem, NC.*

**Background:** CKDu represents a devastating form of kidney disease in young adults in Central America with no traditional risk factors for CKD. Renal biopsy studies of patients with CKDu have been rare. We report the baseline characteristics of a cohort of patients with CKDu that underwent renal biopsy in Leon and Chinandega, Nicaragua

**Methods:** Study was approved by local IRB and MINSA, Nicaragua. After signing informed consent, patients with CKDu were identified by treating nephrologists and admitted to Hospital Escuela Oscar Danilo Rosales Argüello for renal biopsy. Ultrasound guided percutaneous renal biopsy was performed under conscious sedation and local anesthesia. 2-3 cores were sampled in each patient and verified for adequacy

**Results:** 32 patients were screened for kidney biopsy for CKDu with baseline CBC, BP and Coagulation panel 24 hours pre biopsy. 3 patients were not biopsied for safety concerns (small kidney size, uncontrolled HTN). 14 were female, Mean age of patients was 34 years. Mean serum creatinine at biopsy was 1.4mg/dl. All patients had post biopsy ultrasound to r/o bleeding complications and labs at 24 hours to confirm absence of significant bleeding or other complications

**Conclusions:** Ultrasound guided percutaneous renal biopsy can be safely conducted in resource poor settings to help diagnose and manage patients with CKDu.

**TH-PO560**

**Survey of Utility of Renal Pathology Society-Sponsored Existing Classifications**

Suman Setty,<sup>1</sup> Shreeram Akilesh,<sup>4</sup> Marjan Afrozian,<sup>3</sup> Volker Nickleleit,<sup>5</sup> Joseph Gaut,<sup>2</sup> Research and Scientific Committee, Renal Pathology Society <sup>1</sup>University of Illinois Chicago UI Health, Chicago, IL; <sup>2</sup>Washington University in St Louis School of Medicine, St Louis, MO; <sup>3</sup>The University of Texas Medical Branch at Galveston, Galveston, TX; <sup>4</sup>University of Washington School of Medicine, Seattle, WA; <sup>5</sup>University of North Carolina System, Chapel Hill, NC.

**Background:** The Renal Pathology Society with an international membership has sponsored many classifications over the years. We revisit these classifications with the intent to examine their impact on pathology practice and impressions of their relevance to patient care.

**Methods:** A survey was constructed and released to the renal pathologist community on March 12, 2022. The survey closed on April 21, 2022 with 266 respondents. Of these 247 completed surveys were analyzed.

**Results:** Forty % of respondents practice solely renal pathology and 60% in part. Of the 60%, 65% (102/157) practice at least 25% renal pathology. Of the 259 respondents, 132 (51%) were from North America, 62 (24%) from Asia, 48 (19%) Europe, 10 (4%) South America, <2% from Australia and <1% from Africa. Survey responses are summarized in Table 1. Between 15 and 30% of the pathologists who report the classifications as written, use a synoptic version. Also, of those surveyed, 169/198 (85%) find templates to be useful for their reporting purposes.

**Conclusions:** We surveyed members for their impression of Renal Pathology Society -Sponsored classifications of renal diseases. Responses were received from mainly N. America, Europe and Asia of whom the majority have a substantial renal pathology practice. A majority of those surveyed were familiar with all the publications and use the recommended definitions and terminology as outlined in the publication or use most of the descriptive elements in their reports. The principal reason for not using classifications is the belief that they do not have clinical utility or that clinicians do not use information derived from the classifications e. g. 31% for IgA nephropathy vs 91% for diabetic nephropathy. Also, at best 30% of the pathologists who report the classification as written, use a synoptic version.

Table 1. Analysis of Questionnaire

	Lupus Nephritis (Bojars et al., 2018)	IgA Nephropathy (Trinadhi et al., 2017)	Diabetic Nephropathy (Fervoz et al., 2016)	Glomerulonephritis (Sethi et al., 2015)	Standard Reporting (Chang et al., 2012)
Familiarity with classifications	233/247 (94%)	228/247 (92%)	206/247 (83%)	182/247 (74%)	154/247 (62%)
Pathologists using the recommended definitions and terminology as outlined in the publication or using most of the descriptive elements in their reports (such that the classification can be retrospectively assigned)	214/217 (99%)	202/208 (97%)	159/232 (69%)	153/204 (75%)	128/199 (64%)
Of the pathologists who report the classification as written, the following use a synoptic version	55/185 (29%)	57/188 (30%)	15/94 (16%)	15/73 (21%)	10/67 (15%)
Pathologists who believe that clinicians use the information derived from the classification	167/185 (90%)	157/193 (81%)	54/95 (57%)	68/75 (91%)	58/59/70 (84%)
Of those who do not use the classification, those not seeing a clinical utility or who think that clinicians do not make use of the information in the report	16/42 (38%)	12/43 (28%)	144/185 (78%)	59/134 (44%)	41/117 (35%)
Pathologists who would like to see an update including description of utility of the various elements	132/210 (63%)	143/208 (69%)	156/232 (67%)	130/201 (65%)	131/198 (66%)

TH-PO561

**A Novel Activity and Chronicity Index for Histologic Assessment of Renal Biopsies in ANCA-Associated Vasculitis**

Bogdan Obrisca,<sup>1</sup> Alexandru F. Procop,<sup>1</sup> George Terinte-Balcan,<sup>2</sup> Roxana A. Jurubita,<sup>1</sup> Alexandra Vornicu,<sup>1</sup> Mihaela Gherghiceanu,<sup>2</sup> Gener Ismail.<sup>1</sup>  
<sup>1</sup>Fundeni Clinical Institute, Bucharest, Romania; <sup>2</sup>Victor Babes National Institute of Pathology, Bucharest, Romania.

**Background:** Prediction of renal outcome in ANCA-associated vasculitis (AAV) remains a major challenge. We aimed to evaluate a novel score for histologic assessment of renal biopsies in AAV.

**Methods:** A semiquantitative activity (AI) and chronicity (CI) index were assessed in relation to achievement of remission or ESRD. The AI consisted of the percentage of normal glomeruli, cellular/fibrocellular crescents, fibrinoid necrosis, neutrophil infiltration, the severity of interstitial inflammation, the presence of tertiary lymphoid organs, arteritis and TMA. The CI consisted of a total glomerulosclerosis score, the percentage of glomeruli with fibrous crescents, the severity of IFTA and the presence of arteriosclerosis.

**Results:** 27 patients with AAV were included in the study. Their mean age was 60±10 years, 70% were females and 74% had a pANCA-vasculitis. The baseline eGFR was 21±16 ml/min, while 70.4% of patients achieved a remission and 22.5% progressed to ESRD. The baseline eGFR significantly correlated with AI (r=-0.53;p=0.005), CI (r=-0.37;p=0.05) and individual components, cellular/fibrocellular crescent score (r=-0.44;p=0.02), interstitial inflammation score (r=-0.5;p=0.009) and tubular atrophy score (r=-0.38;p=0.04)(Figure 1). Non-responders had higher median AI [11.5 (IQR:6.5-16.25)], CI [8.5(IQR:5.7-10)] and cellular/fibrocellular crescent score [6(IQR:2.5-6)] compared to responders [8(IQR:5-12); 6(IQR:5-8) and 2(IQR:2-4), respectively]. Patients that progressed to ESRD had higher AI [11(IQR:6-13.2)] and fibrinoid necrosis score [3(IQR:1.5-4.5)] compared to non-progressors [8(IQR:5.5-14) and 0(IQR:0-4)].

**Conclusions:** This novel histologic score correlated with the baseline severity of renal involvement in AAV and may be useful for predicting the renal outcome.

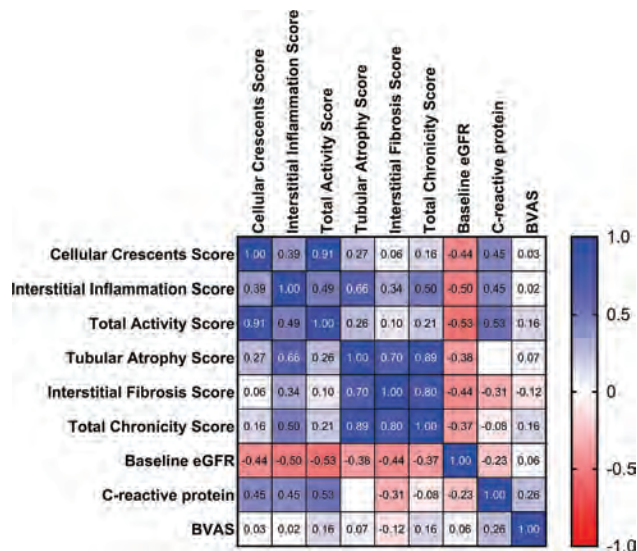

Figure 1. Variables correlation.

TH-PO562

**Development of a Multiple Convolutional Neural Network Facilitated Immunofluorescence Assessment of Glomerular Diseases**

Peng Xia,<sup>1</sup> Xueyuan Zhang,<sup>2</sup> Yubing Wen,<sup>1</sup> Baichuan Zhang,<sup>2</sup> Xuesong Zhao,<sup>1</sup> Fei Ren,<sup>3</sup> Limeng Chen.<sup>1</sup> <sup>1</sup>Peking Union Medical College Hospital, Beijing, China; <sup>2</sup>Beijing Zhijian Life Technology Co. LTD, Beijing, China; <sup>3</sup>Institute of Computing Technology Chinese Academy of Sciences, Beijing, China.

**Background:** Immunofluorescence (IF) tests of renal tissue are important in diagnosing glomerular diseases. We developed a multiple CNN facilitated program to generate suggested IF diagnosis of glomerular diseases.

**Methods:** A dataset of 2747 IF images of glomerulus, including IgA Nephropathy (IgAN, n=759), Idiopathic Membranous Nephropathy (IMN, n=1050), anti-glomerular basement membrane antibody disease (anti-GBM disease, n=64), Mesangial Proliferative Glomerular Nephritis (MPGN, n=63), Poststreptococcal Glomerulonephritis (PSGN, n=83) and other glomerular diseases (n=728) including Lupus Nephritis, Diabetic Nephropathy and Secondary MN from Peking Union Medical College Hospital were used for training and validation datasets. Another 869 images from 183 patients were used as test dataset. The program included a CNN trained as glomeruli location module and a CNN trained as deposition appearance and location classifier (Figure 1). The performance of the program was evaluated by sensitivity, specificity and F1 score. F1 was computed as 2×True Positive / (2×True Positive+False Positive+False Negative).

**Results:** The program was accurate common glomerular diseases. The sensitivity of diagnosing suspected IgAN and IMN were 95.9% and 91.1%, and the specificity were 99.1% and 97.1%. The corresponding F1 score were 0.972 and 0.911. The program showed specific diagnostic performance for uncommon glomerular diseases. The specificity of diagnosing suspected anti-GBM disease, MPGN, PSGN and C3 glomerulonephritis were 100%, 100%, 100%, and 98.9% (Table 1).

**Conclusions:** This multiple CNN facilitated diagnostic program were useful in IF assessment of glomerular diseases.

The proposed program showed good IF diagnostic performance of glomerular diseases

	Accuracy	Sensitivity	Specificity	F1 Score
IgAN (n=75)	97.8%	95.9%	99.1%	0.972
IMN (n=1050)	95.6%	91.1%	97.1%	0.911
Anti-GBM disease (n=64)	98.9%	85.7%	100%	0.923
MPGN (n=63)	98.4%	66.7%	100%	0.800
PSGN (n=83)	98.9%	60.0%	100%	0.750
C3 glomerulonephritis (n=5)	98.4%	80.0%	98.9%	0.727
Other glomerular diseases (n=32)	92.3%	90.6%	92.7%	0.806

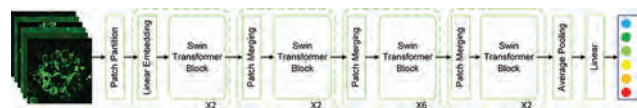

Figure 1 Overview of the CNN trained for deposition appearance and location classification



TH-PO563

**Feasibility and Utility of Intraoperative Kidney Biopsy Specimen Adequacy Verification With a Portable Digital Microscope**

Ali Shueib, Pedro J. Martinez Pitre, Muner Mohamed, Juan Carlos Q. Velez. Ochsner Nephrology Ochsner Medical Center, New Orleans, LA.

**Background:** Retrieval of optimal tissue specimens during a percutaneous kidney biopsy (PKB) is critical for establishing diagnoses. Lack of widespread availability of a pathologist during the procedure or of a regular light microscope in the procedural room are barriers that may result in submission of inadequate specimens, often agglomerular, impairing the ability to make a diagnosis. We examined the feasibility and utility of using a portable digital microscope (pDigMICRO) for intraoperative verification of kidney tissue biopsy specimen adequacy.

**Methods:** We reviewed cases at Ochsner Medical Center in which a PKB was performed by a nephrologist and a pocket-size battery-operated pDigMICRO was used for verification of specimen adequacy immediately upon each tissue core retrieval. Images obtained at 50X and 1000X magnification were wirelessly captured in a smartphone and transferred to a secure server for storage. Demographics, clinical data, and pathology reports were collected. Based on total number of retrieved glomeruli examined under light microscopy, immunofluorescence, and electron microscopy, optimal PKB was defined as  $\geq 15$ .

**Results:** A total of 20 patients were included, median age 58 (31-70), 40% women, 40% self-identified black, median BMI 28 (25-38). Median serum creatinine at the time of PKB 1.5 (0.7-5.2) mg/dL. Indications for PKB were proteinuria (90%), AKI (30%) and hematuria (20%). All PKBs were performed with a 16 g needle. An average of 2.6 cores were obtained after an average of 3.8 needle passes. Glomeruli were visualized with pDigMICRO in all cases (100%). A pathological diagnosis was achieved in all cases (100%). Nineteen (95%) cases were optimal for diagnosis, none (0%) were agglomerular. Median number of glomeruli retrieved per biopsy was 26 (6-53). No patient required an intervention or blood transfusion. One patient developed gross hematuria that resolved spontaneously.

**Conclusions:** Use of pDigMICRO allowed for verification of tissue adequacy in a similar manner to that previously reported utilizing standard methods of adequacy verification. This approach may be a viable tool to improve performance of PKB in centers without access to a pathologist or a regular light microscope, such as in those performed by interventional radiologists.

TH-PO564

**Safety and Adequacy of Kidney Biopsy Procedure in Patients With Obesity**

Long Qian,<sup>1</sup> Jason N. Weinstein,<sup>1</sup> Hannah C. Melchinger,<sup>1</sup> David G. Hu,<sup>2</sup> Steven Menez,<sup>2</sup> Heather Thiessen Philbrook,<sup>2</sup> Randy L. Luciano,<sup>1</sup> Mark A. Perazella,<sup>1</sup> Melissa M. Shaw,<sup>1</sup> Chirag R. Parikh,<sup>2</sup> Francis P. Wilson,<sup>1</sup> Dennis G. Moledina.<sup>1</sup> <sup>1</sup>Yale University, New Haven, CT; <sup>2</sup>Johns Hopkins University, Baltimore, MD.

**Background:** Obesity is considered a risk factor for kidney biopsy-related complications. Here we compared the safety and adequacy of kidney biopsy procedures between obese and non-obese patients.

**Methods:** We included patients from the Yale kidney biopsy cohort enrolled between 2015-2017. Using linear regression analysis, we tested the association of class 2 obesity (body mass index  $\geq 35\text{kg/m}^2$ ) with post-biopsy drop in hematocrit (hct) and number of glomeruli sampled, adjusting for pre-biopsy risk factors and needle gauge. We conducted a supplementary analysis using data from the Johns Hopkins University (JHU).

**Results:** Of the 337 patients at Yale, 76 (23%) had obesity. Obese patients were more likely to undergo biopsy using 18- (vs 16-) gauge needle (48 (66%) vs 113 (45%),  $P=0.002$ ). Obese patients had a lesser drop in hct from pre- to post-biopsy in univariable analysis (2.1% vs 3.0%; unadjusted difference -0.95% (95% CI -0.14, -1.75); adjusted for pre-biopsy risk factors -0.92 (-1.73, -0.11)%). Obesity was not associated with hct drop after further adjusting for needle gauge [-0.78 (-1.59, 0.03)%]. However, fewer glomeruli were sampled from obese patients [-2.6 (-4.6, -0.7) glomeruli]. At JHU (N=78, 12 obese), where all biopsies were performed using 18G needle, obesity was not associated with hct drop (0.40 (-1.26, 2.05)%). Meta-analysis of the two cohorts found no association of obesity with hct drop [-0.48 (-1.74, 0.78)%].

**Conclusions:** Obese patients did not have a greater risk of post-biopsy hematocrit drop than those without obesity but tended to have fewer glomeruli available for diagnosis. Future studies could examine techniques to improve diagnostic yield of kidney biopsy for obese patients.

**Table. Association of obesity with kidney biopsy-related hematocrit drop**

Site	Difference in drop in hematocrit between obese vs. non-obese (95% CI)		
	Model 1	Model 2	Model 3
Yale (n=337)	-0.95 (-1.76, -0.14)	-0.91 (-1.72, -0.10)	-0.78 (-1.59, 0.03)
JHU (n=78)	0.40 (-1.26, 2.05)	0.47 (-1.29, 2.23)	0.47 (-1.29, 2.23)
Combined	-0.48 (-1.74, 0.78)	-0.45 (-1.72, 0.83)	-0.41 (-1.53, 0.71)

Footnote: Linear regression analysis showing association of class 2 obesity with hematocrit drop after kidney biopsy. Beta coefficient and 95% confidence intervals shown. A negative coefficient indicates that there was lesser drop in hematocrit among those with obesity. Model 1 is univariable. Model 2 controls for platelet count, international normalized ratio, and blood urea nitrogen. Model 3 additionally controls for needle gauge (16 vs. 18)

**Figure. Metanalysis of biopsy-related hemoglobin drop in Yale and JHU cohorts**

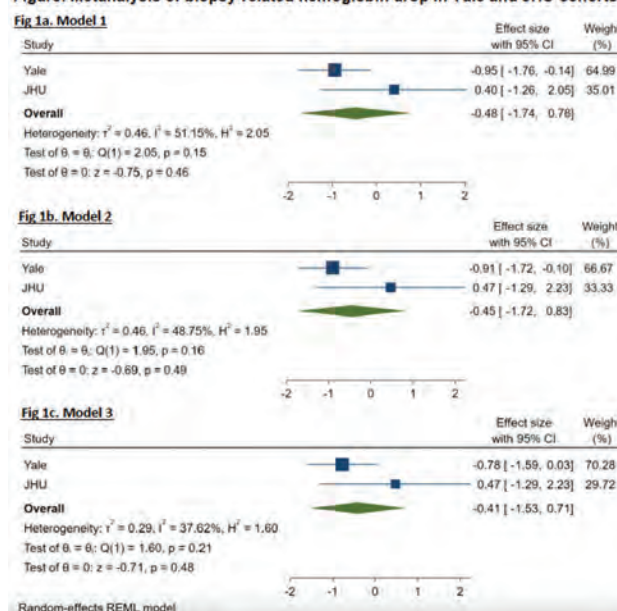

TH-PO565

**Stain-Independent Segmentation and Quantification of Kidney Histopathology Using Deep Learning**

Peter Boor,<sup>1</sup> David Laurin Hölischer,<sup>1</sup> Barbara M. Klinkhammer,<sup>1</sup> Roman D. Bülow,<sup>1</sup> Johannes Lotz,<sup>2</sup> Nick Weiss,<sup>2</sup> Christoph Daniel,<sup>3</sup> Kerstin U. Amann,<sup>3</sup> Nassim Bouteldja.<sup>1</sup> <sup>1</sup>Universitätsklinikum Aachen, Aachen, Germany; <sup>2</sup>Fraunhofer-Institut für Digitale Medizin MEVIS, Bremen, Germany; <sup>3</sup>Friedrich-Alexander-Universität Erlangen-Nürnberg, Erlangen, Germany.

**Background:** In digital pathology, many image analysis tasks are challenged by the need for exhaustive and time-consuming data annotations to tackle various sources of variability in the image domain. Thus, there is a great need for methods addressing data variation without the manual overhead. E.g., in clinical routine and preclinical research, different tissue stainings are used that show differently colored and textured tissue. Deep learning (DL) models however are typically trained and thus limited to a single stain.

**Methods:** In this work, we deal with this inter-stain variation and propose a methodological concept based on stain augmentation to make DL models stain independent. We comprehensively compare this approach with two state-of-the-art methodologies including stain translation and image registration. Our aim was to make a pretrained and stain-specific DL segmentation model applicable to various other stains without the need for data annotations. We employed our previously published DL model that segments six major kidney structures from PAS-stained histopathology in different species.

**Results:** Validation on various immunohistochemical stainings in mice and humans showed that the proposed stain augmentation significantly outperformed both baseline approaches in all stains. It provided high segmentation accuracies in all structures and stains, even in held-out stains not seen during training. We used the stain-augmented model to facilitate compartment-specific morphometrical analysis of immunostainings in animal models and patient biopsies for the efficient analysis of inflammation and fibrosis.

**Conclusions:** This benchmark study suggests that stain augmentation is a highly effective approach to yield stain independence in DL models without manual overhead. This opens new possibilities for efficient and exhaustive computational immunohistomorphometry.

**Funding:** Government Support - Non-U.S.

TH-PO566

**Computational Assessment of Early Diabetic Nephropathy**

Lindsey Claus,<sup>1</sup> Yichi Zhang,<sup>1</sup> Yi Zheng,<sup>1</sup> Tejus Surendran,<sup>1</sup> Vipul C. Chitalia,<sup>1</sup> Patrick D. Walker,<sup>2</sup> Clarissa A. Cassol,<sup>2</sup> Vijaya B. Kolachalama,<sup>1</sup> <sup>1</sup>Boston University, Boston, MA; <sup>2</sup>Arkana Laboratories, Little Rock, AR.

**Background:** Patients with diabetic nephropathy (DN) often have glomerular, tubular, interstitial, and vascular lesions on biopsy, though a recently proposed DN classification focuses on glomerular features. While it is important to quantify the extent of these histopathological manifestations across all stages of DN, we sought to investigate whether these findings can be identified in early DN patients.

**Methods:** A deep learning framework known as a feature pyramid network (FPN) was implemented to classify digitized renal biopsies as class I or II DN. PAS-stained whole slide images (WSIs) of cases with class I (n=23) or class II (n=77) DN were divided into training, validation, and test sets in 3:1:1 ratio. This process was repeated five times to achieve a 5-fold cross validation. The FPN expected two inputs, 224x224-pixel patches cropped from WSIs and 16x downsampled WSIs, to learn and combine features at two levels of magnification. Class activation maps (CAMs) were generated to visualize informative regions on the WSIs.

**Results:** Our FPN model achieved an accuracy of 0.8 and an F1 score of 0.6. On a representative set of test images, we found the majority (~84%) of patches identified by CAMs as highly informative for model prediction contained tubules or interstitium, not just glomerular regions (Fig. 1).

**Conclusions:** Our study identified several regions on the biopsy images as informative for prediction of class I vs II DN. Further analysis can elucidate the importance of various histopathological features of early stage DN.

**Funding:** NIDDK Support, Other NIH Support - Diacom, NHLBI

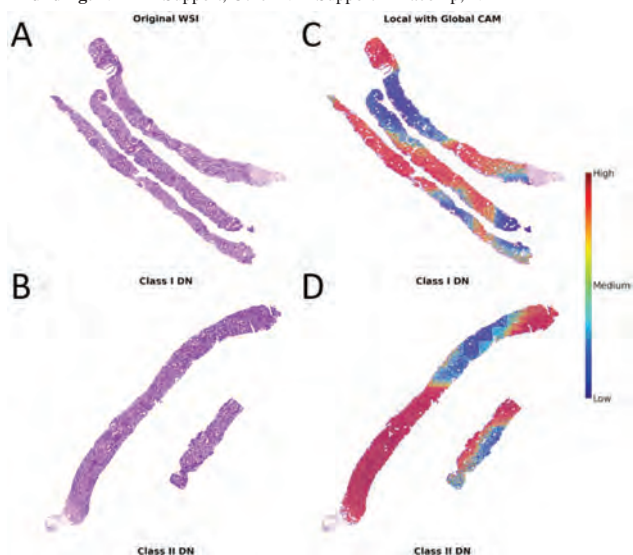

(A and B) Whole slide images and their class labels (Class I & II DN). (C and D) Class activation maps generated on the images, indicating the regions highly associated with the corresponding label. The warmer the color, the higher the probability of a region contributing to the DN class prediction.

TH-PO567

**Machine-Learning-Quantified Lupus Nephritis Histological Features Correlate With NIH Activity and Chronicity Index Subscores**

Solange Moll,<sup>1</sup> Cary D. Austin,<sup>3</sup> Balazs Toth,<sup>3</sup> Filip Kos,<sup>2</sup> Stephanie Hennek,<sup>2</sup> Christina Jayson,<sup>2</sup> Brian H. Baker,<sup>2</sup> Benjamin Trotter,<sup>2</sup> Webster U. Lincoln,<sup>3</sup> Jacqueline A. Brosnan-Cashman,<sup>2</sup> Thomas Schindler,<sup>4</sup> Murray Resnick,<sup>2</sup> Anthony Chang,<sup>5</sup> Ilan Wapinski,<sup>2</sup> Michael Montalto,<sup>2</sup> Jay P. Garg,<sup>3</sup> Wei Tew,<sup>3</sup> Marco Prunotto,<sup>4</sup> <sup>1</sup>Universite de Geneve, Geneve, Switzerland; <sup>2</sup>PathAI, Boston, MA; <sup>3</sup>Genentech Inc, South San Francisco, CA; <sup>4</sup>F Hoffmann-La Roche AG, Basel, Switzerland; <sup>5</sup>University of Chicago Pritzker School of Medicine, Chicago, IL.

**Background:** Histologic evaluation of renal biopsies is necessary for lupus nephritis (LN) diagnosis and treatment decisions; however, interobserver variability and poor quantitation limit the utility of histology-based metrics for precision medicine. To mitigate these challenges, we developed ML-based models to quantify histologic features in LN.

**Methods:** 374 hematoxylin and eosin (H&E)-stained whole-slide images (WSI) of non-LN kidney and LN biopsies were obtained, mainly from a LN cohort at the University of Geneva and a clinical trial of obinutuzumab (OBZ) in proliferative LN (NCT02550652). WSI were split into training (286; 76%) and validation (88; 24%) sets. Expert pathologist annotations trained deep convolutional neural networks, yielding two distinct segmentation models covering anatomic regions and histopathological features. Model performance was tested on a held-out set of 94 WSI. For each model, 20-30 image frames were annotated by 3-5 pathologists to derive ground truth consensus. Whole slide

predictions on 73 baseline cases from the OBZ trial were correlated to manual revised NIH LN activity and chronicity index (CI) subscores and kidney function metrics using Spearman method.

**Results:** The model performed comparably to pathologists on both WSI and frames identifying tissue regions (e.g. cortex,  $F1_{model}=0.78$ ;  $F1_{pathologist}=0.75$ ) and tissue features (e.g. interstitial inflammation,  $F1_{model}=0.68$ ;  $F1_{pathologist}=0.60$ ). ML-quantified interstitial inflammation and sclerotic glomeruli regions correlated with the NIH activity index interstitial inflammation ( $r=0.638$ ;  $p<0.0001$ ) and CI glomerulosclerosis subscores ( $r=0.702$ ;  $p<0.0001$ ), respectively, as well as with eGFR, creatinine, and UPCR ( $r=0.32 - 0.47$ ;  $p<0.01$ ).

**Conclusions:** We developed ML models that quantify histologic features on LN H&E biopsies, revealing significant correlations with NIH disease index subscores and kidney function metrics. The findings demonstrate the feasibility of ML for quantifying LN histologic features. The utility of this approach in predicting treatment response is being evaluated.

**Funding:** Commercial Support - Genentech, PathAI

TH-PO568

**Accurate and Regional Assessment of Tubular Diameter Predicts Progressive CKD After Radical Nephrectomy**

Aleksandar Denic,<sup>1</sup> Amr Moustafa,<sup>1</sup> Mrunanjali Gaddam,<sup>1</sup> Aidan F. Mullan,<sup>1</sup> Anthony C. Luehrs,<sup>1</sup> Laura Barisoni,<sup>2</sup> Andrew D. Rule,<sup>1</sup> <sup>1</sup>Mayo Foundation for Medical Education and Research, Rochester, MN; <sup>2</sup>Duke University, Durham, NC.

**Background:** Manual morphometry of near to normal adult kidneys demonstrated that larger glomerular volume but not cross-sectional tubular area predicts progressive CKD. We hypothesized that a more accurate and regional assessment of enlarged tubular size may be prognostic for progressive CKD.

**Methods:** Periodic Acid Schiff-stained sections from benign parenchyma from 1453 radical nephrectomies were scanned into whole slide images. The mean true diameter of circular or oval shaped (minor axis) tubules was determined separately for proximal and distal tubular profiles in the superficial, middle, and deep cortical regions. Cox models assessed the risk of CKD progression (defined as dialysis, kidney transplantation, or a 40% decline from postnephrectomy baseline eGFR) with proximal and distal tubular diameters at different depths. Cox models were unadjusted, and adjusted for age, sex, body mass index, hypertension, diabetes, eGFR, and proteinuria.

**Results:** Among 1453 patients (mean age, 64 years; postnephrectomy baseline eGFR, 50.9 ml/min per 1.73 m<sup>2</sup>), 114 progressive CKD events, and 272 non-cancer deaths occurred during a median 3.4 years. As shown in the Table, larger proximal tubular diameter predicted CKD progression only in the superficial cortex; while larger distal tubular diameter predicted CKD progression in all cortical regions, though, more strongly in the superficial cortex. None of the tubular measures predicted non-cancer mortality.

**Conclusions:** Measurement of average proximal and distal tubular diameters separately at different depths was predictive of progressive CKD. Tubular hypertrophy of more distal nephron segments in the superficial cortex appears to be more prognostic of progressive CKD than deeper tubules and more proximal segments.

**Funding:** NIDDK Support

Tubular measures as predictors of CKD progression from 4 months following a radical nephrectomy.				
N=1453, 114 CKD events	Unadjusted		Adjusted for clinical characteristics*	
	HR (95% CI)	P value	HR (95% CI)	P value
<b>Superficial</b>				
Mean proximal tubular diameter	1.33 (1.12, 1.59)	0.001	1.28 (1.05, 1.56)	0.01
Mean distal tubular diameter	1.59 (1.34, 1.88)	<0.0001	1.52 (1.26, 1.84)	<0.0001
<b>Middle</b>				
Mean proximal tubular diameter	1.11 (0.93, 1.33)	0.26	1.11 (0.91, 1.34)	0.30
Mean distal tubular diameter	1.41 (1.19, 1.66)	<0.0001	1.35 (1.12, 1.63)	0.002
<b>Deep</b>				
Mean proximal tubular diameter	1.21 (1.02, 1.45)	0.03	1.15 (0.95, 1.40)	0.13
Mean distal tubular diameter	1.37 (1.13, 1.64)	0.001	1.26 (1.02, 1.56)	0.03

\*Adjusted for age, sex, BMI, hypertension, diabetes, post-surgery baseline eGFR and proteinuria.

Key: TH - Thursday; FR - Friday; SA - Saturday; OR - Oral; PO - Poster; PUB - Publication Only

Underline represents presenting author.

TH-PO569

**Computationally Derived “Functional” Tubule Density Is Prognostic of Outcome in Glomerular Diseases**

Fan Fan,<sup>1</sup> Bangchen Wang,<sup>2</sup> Takaya Ozeki,<sup>3</sup> Jeremy Rubin,<sup>4</sup> Yijiang Chen,<sup>1</sup> Jeffrey B. Hodgin,<sup>3</sup> Laura H. Mariani,<sup>3</sup> Lawrence B. Holzman,<sup>5</sup> Kyle Lafata,<sup>6</sup> Anant Madabhushi,<sup>1,7</sup> Laura Barisoni,<sup>2</sup> Jarcy Zee,<sup>4</sup> Andrew Janowczyk.<sup>1,8</sup>  
<sup>1</sup>Case Western Reserve University Department of Biomedical Engineering, Cleveland, OH; <sup>2</sup>Duke University Department of Pathology, Durham, NC; <sup>3</sup>University of Michigan Department of Internal Medicine, Ann Arbor, MI; <sup>4</sup>University of Pennsylvania Perelman School of Medicine, Philadelphia, PA; <sup>5</sup>University of Pennsylvania Department of Medicine, Philadelphia, PA; <sup>6</sup>Duke University Department of Radiation Oncology, Durham, NC; <sup>7</sup>VA Northeast Ohio Healthcare System, Cleveland, OH; <sup>8</sup>Precision Oncology Center, Lausanne University Hospital, Lausanne, Switzerland.

**Background:** While tubular atrophy (TA) is associated with a decrease of functional tubules (FT) and disease progression in kidney diseases, reproducible visual quantification of TA remains challenging. In our study, the value of computationally derived FT density (FT pixel area per cortical pixel area) was explored.

**Methods:** N=239 PAS-stained whole slide images from the NEPTUNE digital pathology repository were studied (135 FSGS, 51 MCD, and 53 MCD-like). The kidney cortex was manually annotated by pathologists and a validated deep learning (DL) model was used to segment cortical FTs (Fig.1). Cortical FT density was subsequently computed for each biopsy. Spearman’s correlation coefficient was used to measure the correlation between the FT density and visually scored TA. Kaplan-Meier curves were estimated, and a log-rank test was used to assess the association between FT density measured in quartiles and the composite disease progression outcome of time from biopsy to 40% eGFR decline or kidney failure.

**Results:** The FT density decreased from MCD to MCD-like and to FSGS biopsies (Fig.2). There was a strong negative association between FT density and TA ( $\rho=-0.75$ ,  $p<0.001$ ). There was a significant difference in disease progression for subjects within different quartiles of FT; those with FT density < 0.39 having worse outcomes. Each 0.1 increase in FT density (< 0.49) was associated with 46% decreased hazards of disease progression, but when FT density was > 0.49, the association was not significant.

**Conclusions:** DL-derived FT density is a robust and feasible approach to measuring the status of the tubulointerstitium and a biomarker of clinical outcome, with potential predictive value in assessing the risk of progression.

**Funding:** NIDDK Support, Other NIH Support - NIH-NCI, Veterans Affairs Support, Private Foundation Support

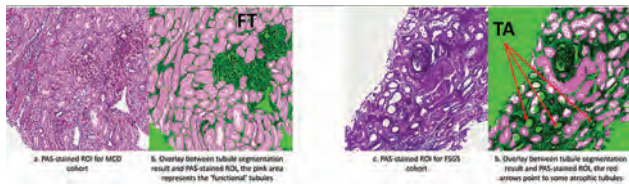

DL model tubule segmentation results

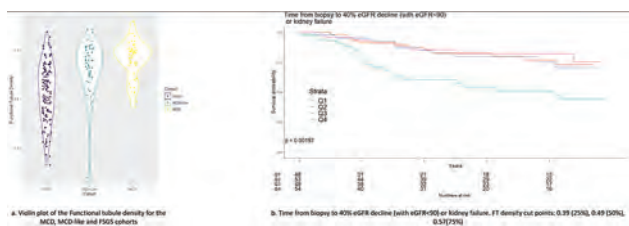

a: FT density for three different cohorts, b: Kaplan-Meier curves of FT density association with outcome

TH-PO570

**A Computational Pipeline for Segmentation and Classification of Tubules**

Pinaki Sarder,<sup>1</sup> Brandon Ginley,<sup>1</sup> Nicholas Lucarelli,<sup>1</sup> Yijiang Chen,<sup>6</sup> Jeffrey B. Hodgin,<sup>2</sup> Avi Z. Rosenberg,<sup>3</sup> Charles E. Alpers,<sup>5</sup> Anant Madabhushi,<sup>6</sup> Laura Barisoni,<sup>4</sup> Ulysses G. Balis.<sup>2</sup> KPMP <sup>1</sup>University of Buffalo, Buffalo, NY; <sup>2</sup>University of Michigan, Ann Arbor, MI; <sup>3</sup>Johns Hopkins University, Baltimore, MD; <sup>4</sup>Duke Medicine, Durham, NC; <sup>5</sup>University of Washington, Seattle, WA; <sup>6</sup>Case Western Reserve University, Cleveland, OH.

**Background:** The highly repetitive kidney structure is well-suited for high-throughput segmentation using unsupervised methods. Herein, we combined image-based, machine learning (ML) tools to realize a computational pipeline for image curation, segmentation, and classification.

**Methods:** 25 chronic kidney disease and 10 healthy reference tissue were first curated using HistoQC, an open source tool for qualification of whole slide images (WSIs), for histology and imaging artifacts in WSIs that would interfere with ML techniques. WSIs

were then processed by the Human-AI-Loop pipeline, a deep-learning-based supervised image segmentation tool, to generate binary masks of all tubules. Segmented tubules were then extracted and processed at the pixel level by the spatially invariant vector quantization (SIVQ) algorithm, which is prepackaged as the validated identification of pre-qualified regions algorithm (VIPR). SIVQ mines a composite vector of biological content inherent in single pixel domains by extracting local kernel goodness-of-fit to a library of pre-selected Fourier signatures of histological primitives. Renal pathologists manually labeled each segmented tubules as normal and abnormal proximal, normal and abnormal distal, and abnormal indeterminate.

**Results:** 3 machine learning-based tubular classes (1-3) were identified by VIPR. There was >95% correlation between manual scoring of proximal tubules (normal and abnormal) and class 1, manual scoring of distal tubules (normal and abnormal) vs. class 2, and for normal vs. abnormal tubular morphology.

**Conclusions:** Our tools will enable development of large scale feature extraction and statistical quantification of different sub-classes of tubules from giga-pixel size kidney WSIs. This pipeline unleashes the power of artificial intelligence in precision nephrology with the promise of deriving novel digital image biomarkers that can potentially inform disease progression or alignment with molecular markers for theragnostic discoveries.

**Funding:** NIDDK Support

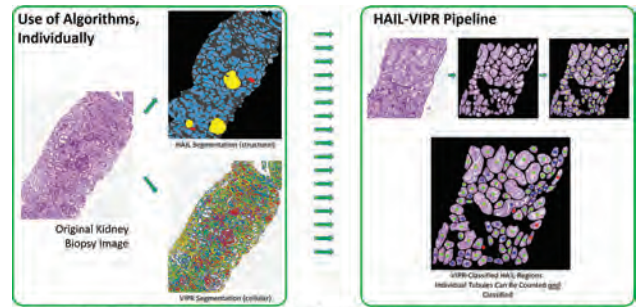

Pre-segmentation of tubules by initial use of HAIL allows for subsequent classification of biological tubule context of with VIPR, yielding much higher classification fidelity, owing to the exclusion of other nephron structures from the unsupervised pool of pixels under interrogation. Reduction of the background pixels from foreground areas increases classification performance.

TH-PO571

**A Novel Pipeline for the Tissue Transformation, 3D Imaging, and Visualisation in Virtual Space of Optically Cleared Human Renal Tissue**

Keith Siew, Zhongwang Li, Stephen B. Walsh. University College London, London, United Kingdom.

**Background:** Kidney biopsies have been the gold standard for diagnosis of pathological kidney diseases for almost 70 years. However, due to the small volume of tissue obtained from a needle biopsy traditional histopathological examinations are limited by the number of sections that can be obtained, with no two sections capturing the exact same histological features, sometimes necessitating multiple biopsies to be taken to ensure there is enough material to work with & that an accurate representation of the kidney histology is obtained. Developing a non-destructive 3D histopathology would allow for 60+ stains to be colocalised within their intact anatomical context, therefore reducing the risk of missing pathologies & need to re-biopsy patients.

**Methods:** Human renal biopsies & transplant rejected tissue routinely donated for research at the Royal Free Hospital were used for this study. These samples were fixed in formaldehyde, before undergoing tissue transformation following the SHIELD protocol (Park et al., 2018, doi:10.1038/nbt.4281). These were then delipidated & stained using the LifeCavas Technologies platforms, & optically cleared by refractive index matching prior to rapid 3D fluorescent lightsheet microscopy. These data were then preprocessed using imageJ & Imaris, before being imported into Syglass for 3D virtual reality visualisation using Oculus Quest 2 headsets.

**Results:** In less than 24h we were able to take fresh tissue, rapidly transform, multiplex stain and image immune cell infiltration (CD3), antibodies (IgA, IgM, IgG), complement (C1q), endothelium (CD31), Interstitium (Collagen IV), Nuclei (Histone H3), cytosol (Eosin) or tubule segment markers (Tomato Lectin - DCT/TAL marker (green); see figure 1). We were able to visualise these data with a histopathologist in virtual 3D space, where it was possible to toggle between the different markers, reorientate and resection the sample with ease.

**Conclusions:** See virtual reality headset demo at presentation.

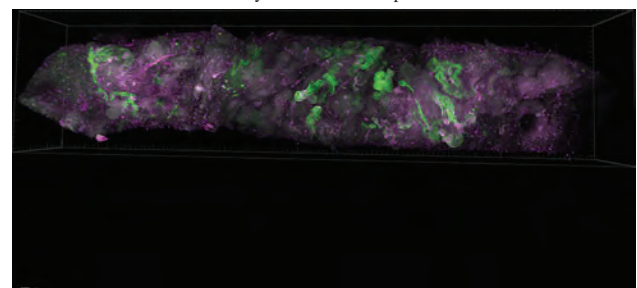

## TH-PO572

**Integration of Spatial Transcriptomics and Morphology in Assessing Atubular vs. Connected Glomeruli**

Haichun Yang,<sup>1</sup> Ruining Deng,<sup>2</sup> Jianyong Zhong,<sup>1</sup> Yuankai Huo,<sup>2</sup> Agnes B. Fogo,<sup>1</sup> <sup>1</sup>Vanderbilt University Medical Center, Nashville, TN; <sup>2</sup>Vanderbilt University, Nashville, TN.

**Background:** We previously found that atubular glomeruli increased in mice with proximal tubule-specific injury compared to normal mice. We have developed AI algorithms to identify such atubular glomeruli from serial whole slide images (WSI) and also found subvisual morphologic features in 2D slides that could be detected by 3D AI. Using spatial transcriptomics, we aimed to assess the topography of gene expression and any correlation with morphologic alterations quantified by AI.

**Methods:** Wild-type (WT) and transgenic mice with tubular cell expression of the diphtheria toxin (DT) receptor were studied. All mice were injected with DT at week 0 and week 1 and sacrificed 6 weeks later. 19 serial sections from paraffin block tissue were cut, and all except the middle section were scanned for atubular glomeruli assessment by AI. The middle section was then used for spatial transcriptome. The morphologic features in the resulting 3D reconstructed atubular vs connected glomeruli were quantified by AI.

**Results:** Atubular glomerular were increased in DT vs WT mice (19.2% vs. 5.8%). The glomerular volume was increased, and the ratio of columnar to flat parietal epithelial cells (PECs) ratio was significantly decreased in atubular compared to connected glomeruli. Using spatial transcriptomic analysis, 412 differentially expressed genes were detected in atubular glomeruli in WT vs DT mice, while 6795 genes were differentially expressed comparing the connected glomeruli in WT vs DT mice. By comparing transcriptomics in atubular vs connected glomeruli in the same mouse, 170 differentially expressed genes were detected. Among them, genes related to extracellular matrix organization (such as *DAG1*, *TIMP2*), or related to cell migration (such as *FLNA*, *MYLK*) were upregulated.

**Conclusions:** Spatial transcriptomic sequencing complemented AI-assisted morphology assessment, uncovering potential mechanisms driving extracellular matrix organization, regulation of cell migration and PEC alterations in the pathogenesis of atubular glomeruli.

**Funding:** NIDDK Support

## TH-PO573

**Automated Tools for Renal Biopsy Diagnosis**

Zhongwang Li, Stephen B. Walsh, Keith Siew. *University College London, London, United Kingdom.*

**Background:** Histological examination of the glomeruli in renal biopsies is essential for diagnosing many kidney diseases. However, manual identification and characterisation of glomeruli in biopsies requires trained histopathologists and can be tedious time-consuming task. Thus, development of automatic tools to help accelerate diagnostic workflow and improve detection accuracy is an unmet need. Such tools should have the ability to detect and count glomeruli of various sizes, shapes, and disease status across whole slide image (WSI) biopsies, annotate these in the image. Advanced functionality could then be developed to classify glomeruli based on disease features (e.g. fibrosis, mesangial expansion) and generate preliminary biopsy reports for review by the histopathologist.

**Methods:** Routine renal biopsies collected at Royal Free Hospital with patients' consent for research were used for this study (n=300). 2-5um biopsy sections were acquired as 8-bit RGB WSI using an Axio Scan Z.1 (20x/0.8NA). To ensure the general applicability of the model, multiple common histochemical stains (H&E, PAS, Silver stain) were imaged and included in the training dataset. These digitised slides were then manually annotated by histopathologists and nephrologists using QuPath (version 0.3.2) on Wacom Cintiq Pro 32 interfaces to capture the features described in the matching to biopsy reports. "You only look once" (YOLO) is a real-time object detection system that has previously been used to identify glomeruli in PASM stained section. For our work, we decided to adapt this approach using the latest version of YOLO that can function under multiple conditions (e.g. different stains and magnifications), and a Convolutional Neural Network (CNN) model may then be used to classify various glomerular diseases.

**Results:** Using the location information given by YOLO, the glomerular images could be cropped from the original image and tabularised alongside morphometric and histopathological readouts from our U-NET model that could segment the identified glomeruli from the background tissue and quantify features (e.g. % area of fibrosis).

**Conclusions:** This work shows that an automated image analysis pipeline can identify, quantify and characterize glomeruli in 2D slides in seconds, with obvious utility for pathologists and clinicians. Further work to expand the functionality of this model and to validate it further in larger datasets is warranted.

## TH-PO574

**Modulation of Linear Ranges in Immunohistochemistry and Immunofluorescence Assays**

Michael J. Ferkowicz,<sup>1</sup> Seshi R. Sompuram,<sup>2</sup> Daria Barwinska,<sup>1</sup> Tarek M. El-Achkar,<sup>1</sup> Steve Bogen.<sup>2</sup> KPMP <sup>1</sup>Indiana University School of Medicine, Indianapolis, IN; <sup>2</sup>Boston Cell Standards, Boston, MA.

**Background:** Assays for the detection of specific proteins in tissue sections are usually performed by immunohistochemistry (IHC) or immunofluorescence (IF). These are qualitative assays, indicating whether the protein is detectable or undetectable. Attempts have been reported to express relative quantification of protein analytes (in IHC or IF) by describing the staining as weak, moderate, strong, or as percent of positive cells.

However, the actual linear range of these assessments has not been determined. The ability to determine the quality of an antibody or lot over time is crucial. Connecting the presence of staining to cellular protein concentrations has never been possible. We hypothesize that using IHC/IF calibrators, newly developed by our group, it will be feasible to characterize linear ranges of IHC and IF assays. By adjusting the reagents or staining protocol, it is possible to adjust the linear ranges for greater or lesser analytic sensitivity.

**Methods:** Four calibrator targets (analytes), developed for the Kidney Precision Medicine Project (KPMP) - Aquaporin-1 (AQP1), Uromodulin (UMOD), Myeloperoxidase (MPO) and CD3 were covalently attached to glass microbeads across a range of concentrations simulating different cellular expression levels. The cell-sized microbeads were then adhered to microscope slides, stained, and imaged by confocal microscopy. Mean fluorescence intensity of microbeads across ten concentrations was measured.

**Results:** Assessment of mean fluorescent intensity revealed that all four assays have a linear range of detection when measured by either IF or IHC. Furthermore, we observed that IF can demonstrate a broader linear range due to the inherent ability to tune the confocal microscope.

**Conclusions:** IHC/IF calibrators are a useful tool for assessing antibody quality, lot to lot consistency, and degradation over time. These data also establish a foundation for using IHC and IF assays for quantifying cellular expression levels of proteins in tissue sections.

**Funding:** NIDDK Support

## TH-PO575

**Development of a Computational Modeling Tool for Automated Detection of Urinary Casts and Acanthocytes**

Josean O. Flores Santiago, Juan Carlos Q. Velez. *Ochsner Nephrology Ochsner Health Network LLC, New Orleans, LA.*

**Background:** Microscopic examination of the urinary sediment (MicrExUrSed) is a tool of proven clinical utility. However, it requires training and expertise for proper identification of urinary casts. Incorrect cast identification may lead to flawed clinical-decision making. We hypothesized that a machine learning approach could be used to create a tool for automated real-time identification of urinary casts.

**Methods:** We accessed a database of MicrExUrSed images routinely obtained and stored as part of a prospective research cohort. Images were captured with a smartphone camera adapted to the microscope eyepiece. Images were categorized and labeled by trained observers and divided into datasets for classification and object detection tasks. Input contained annotations about illumination, staining, and magnification. Bounding boxes for 3 major structures: casts, cells, and crystals were fed into the model. We performed preliminary experimentation on a subset of images (308 images containing 572 casts and 107 acanthocytes) to train a YOLOv5 object detection model to identify acanthocytes and 4 types of clinically relevant urinary casts: muddy brown-granular, granular, waxy casts, and cellular casts. Images were preprocessed using YOLOv5 data augmentation technique. The model was trained with empty weights and on pre-trained models, with image sizes of 640 and 1280, batches of 6 and 16, and 300 epochs.

**Results:** After model development and training, performance was tested in 75 additional images containing acanthocytes and casts. The best performance was obtained with YOLOv5m with 640 image size, a batch of 6, and 300 epochs. It achieved a mean average precision (mAP) of 0.7618, which is above the performance of benchmark databases. The model performed equally accurately for acanthocytes and casts.

**Conclusions:** To our knowledge, this is the first implementation of computational model/machine learning for real-time automated identification of findings from MicrExUrSed. In this dataset, the different illumination techniques, degree of magnification, high-resolution images, and staining techniques served as different backgrounds that increased the model performance even with a small number of training data. More work is needed to expand the capability of the tool to other unique structures.

## TH-PO576

**Cumulative Smoking Dose Is a Risk Factor for Renal Arteriolar Hyalinization and Glomerular Sclerosis in Individuals Without CKD: A Cross-Sectional Study**

Eri Ataka,<sup>1</sup> Yuta Matsukuma,<sup>1</sup> Kenji Ueki,<sup>1</sup> Akihiro Tsuchimoto,<sup>1</sup> Yasuhiro Okabe,<sup>1</sup> Kosuke Masutani,<sup>2</sup> Toshiaki Nakano,<sup>1</sup> Takanari Kitazono.<sup>1</sup> <sup>1</sup>*Kyushu Daigaku, Fukuoka, Japan;* <sup>2</sup>*Fukuoka Daigaku, Fukuoka, Japan.*

**Background:** Cigarette smoking is an established risk factor for the development of chronic kidney disease (CKD). However, the renal pathological lesions related to smoking have not been clearly elucidated in healthy participants. In this study, we investigated the relationship between cumulative smoking dose and renal microstructural features in participants without CKD.

**Methods:** We evaluated the time-zero biopsy specimen of 547 living kidney donors. Renal arteriolar hyalinization, intimal thickening of small-medium arteries, glomerular sclerosis and interstitial fibrosis and tubular atrophy (IF/TA) were investigated.

**Results:** In total, 199 participants (36.4%) had smoking history, 92 (16.8%) of them were with <20 pack-years and 107 (19.6%) were with ≥20 pack-years. Increase in cumulative smoking dose was significantly associated with the prevalence of arteriolar hyalinization in multivariable logistic analysis. Odds ratio (OR) (95% confidence interval [CI]) for arteriolar hyalinization per 20 pack-years increase was 1.52 (1.18-1.95) and those of the group with <20 pack-years and with ≥20 pack-years vs. non-smokers were 1.73 (1.01-2.94) and 2.38 (1.43-3.97), respectively. Increase in smoking dose was also related to the prevalence of >10% global glomerular sclerosis. OR (95% CI) for >10% global glomerular sclerosis per 20 pack-years increase was 1.25 (0.98-1.58) and those

Key: TH - Thursday; FR - Friday; SA - Saturday; OR - Oral; PO - Poster; PUB - Publication Only

Underline represents presenting author.

of the group with <20 pack-years and with ≥20 pack-years vs non-smokers were 1.39 (0.77-2.52) and 1.93 (1.11-3.35), respectively. Intimal thickening of small- to medium-sized arteries and IF/TA were not associated with smoking dose.

**Conclusions:** Cumulative smoking dose was an independent risk factor for renal arteriolar hyalinization and abnormal glomerulosclerosis in individuals without chronic kidney disease.

**TH-PO577**

**Urine Biomarkers of Systemic Lupus Erythematosus Identified Using Liquid and Gas Chromatography/Mass Spectrometry (LC-QTOF-MS and GC-QTOF-MS)**

Gustavo Aroca Martinez,<sup>1</sup> Lisandro Pacheco,<sup>1</sup> Alejandra R. Sánchez,<sup>1</sup> Ada L. Carmona Martes,<sup>2</sup> Elkin Navarro.<sup>1</sup> <sup>1</sup>Universidad Simon Bolivar, Barranquilla, Colombia; <sup>2</sup>Universidad del Atlantico, Barranquilla, Colombia.

**Background:** Systemic lupus erythematosus (SLE or lupus) is a chronic autoimmune disease, and kidney involvement with SLE, lupus nephritis (LN), is a frequent and severe complication of SLE that increases patient morbidity and mortality. The current gold standard for classifying LN progression is a renal biopsy, an invasive procedure with potential risks. Undergoing a series of biopsies for monitoring disease progression and treatments is unlikely suitable for patients with LN. Thus, there is an urgent need for non-invasive alternative biomarkers that can facilitate LN class diagnosis. Such biomarkers will be very useful in guiding intervention strategies to mitigate or treat patients with LN. The current study aims to explore new biomarker candidates for non-invasive diagnosis of LN and explore the pathogenic mechanisms that contribute to renal injury.

**Methods:** A metabolomics approach using LC-QTOF-MS in both positive and negative electrospray ionization (ESI) modes and GC-QTOF-MS was developed for comparison of urine metabolic profile of 23 LN patients, 16 SLE patients, and 10 healthy controls (HCs). Differential metabolites were evaluated with univariate (UVA) and multivariate (MVA) analysis using a nonparametric *t* test, principal component analysis (PCA) and orthogonal partial least squares regression (OPLS-DA).

**Results:** Both UVA and MVA showed a clear discrimination in the urinary metabolome between LN, SLE and HCs. The significant altered metabolites between LN and SLE correspond mainly to fatty acyls, amino acids, bile acids in particular methylglutamic acid, monopalmitin methyl-L-proline, 3-oxo-4-pentenoic acid, glutaric acid, 3-hydroxyglutaric acid, citraconic acid, glutamine, glycocholic acid and ureidoisobutyric acid. Analysis of metabolic pathways shows disturbances in biosynthesis of alanine, aspartate and glutamate metabolism, citrate cycle (TCA cycle) and glutamine and glutamate metabolism.

**Conclusions:** The urinary metabolome of SLE and LN patients made it possible to determine metabolic alterations and discriminate LN patients from SLE patients. If confirmed in larger studies, these urine metabolites may serve as biomarkers to help discriminate between SLE with and without renal involvement.

**TH-PO578**

**A Clinical Tool for Prediction of Bleeding Complications After Percutaneous Renal Biopsy**

Nicolas Bergeron, Stephanie Lord, Sébastien Dion, David Philibert, Simon Desmeules, Mohsen Agharazii. CHU de Quebec-Universite Laval, Quebec, QC, Canada.

**Background:** Kidney biopsy is a diagnostic procedure which may result in bleeding-related complications. Developing a tool for risk stratification could help predict such risk and would benefit shared decision-making. The aim of the present study was to derive and verify such a tool from training and validation cohorts.

**Methods:** This is a single-center study of 1450 ultrasound-guided native kidney biopsies performed for diagnosis of kidney disease between 2007 and 2020 at a tertiary academic hospital in Quebec, Canada. Major bleeds were defined by hematoma/hematuria with 1 g/dL drop in hemoglobin (Hb) and requiring transfusion, bleeding requiring hospitalization or transfer to ICU, hemorrhagic shock, angioembolization, nephrectomy, or death. Two thirds of the cohort was randomly selected and used as the training set (n=987) for the identification of the determinants of major bleeds, using univariate and multivariate logistic regression analysis, and the rest was used as validation cohort.

**Results:** In the training cohort (59% male) the mean age, weight, Hb and platelet counts were 55±17 years, 79±20 kg, 11.4± 2.5 g/dL, and 243± 100 × 10<sup>9</sup>/L, respectively, while the median eGFR was of 33 mL/min/1.73m<sup>2</sup> (IQR: 12-62). In this group, major bleeding occurred in 57 patients (5.8%). Major bleeding was higher with younger age, lower pre-biopsy Hb, the use of anticoagulant within the week prior to the biopsy (defined as the use of direct-acting oral anticoagulants, warfarin, i.v. heparin, therapeutic doses of low molecular weight heparin), and higher INR at the time of kidney biopsy. The probability of risk was defined by the following equation: Probability of bleeding=  $e^{(-2.426054-0.017820*Age + 0.910106*Anti\_Coag -0.026364*Hb + 3.142164*INR)}$  / (1 +  $e^{(-2.426054-0.017820*Age + 0.910106*Anti\_Coag -0.026364*Hb + 3.142164*INR)}$ ) The AUC of the equation was 0.741 (Min-Max: 0.740 - 0.742) in the training cohort. In our validation cohort, with similar characteristics, major bleedings occurred in 18 patients (3.9%). The AUC of the equation predicted well the risk in the validation cohort (AUC of 0.733 (Min-Max: 0.711 - 0.747)).

**Conclusions:** This study proposes an equation for the estimation of the probability of major bleeding after percutaneous renal biopsy.

**TH-PO579**

**Urine Sediment Examination: Comparison Between Laboratory-Performed vs. Nephrologist-Performed Microscopy**

Remy Fadel, Jonathan J. Taliercio, Susana Arrigain, Jesse D. Schold, James F. Simon, Ali Mehdi, Georges Nakhoul. Cleveland Clinic, Cleveland, OH.

**Background:** Urine microscopy is a standard component of the urinalysis and one of the oldest tests in medicine. In more recent years, it is increasingly performed by automated analyzers rather than clinicians. However, we believe that urine sediment evaluation by a nephrologist continues to serve a critical role in the assessment of patients with kidney disease.

**Methods:** Using our Electronic Medical Records, we identified 387 adult patients with acute kidney injury that had urine microscopy with sediment analysis performed both by the laboratory and by a nephrologist within 72 hours of each other. We collected data to determine the following: number of RBCs (≤ 5 or > 5 HPF), number of WBCs (≤ 5 or > 5 HPF), presence of casts (<1 or ≥ 1 LPF), type of casts (hyaline, fine granular, coarse granular, muddy brown, WBC and RBC casts), and presence of dysmorphic RBCs. We used Kappa statistics to evaluate agreement between automated urine microscopy versus nephrology review.

**Results:** The reported agreement was moderate for RBCs with 75% of samples in agreement (Kappa 0.46 – 95% CI: 0.37, 0.55), none to slight for WBCs with 72% of samples in agreement (Kappa 0.36 – 95% CI: 0.27, 0.45), and there was no agreement for casts (Kappa 0). Nephrologists detected 12 dysmorphic RBC's (Kappa 0) while the laboratory did not detect any. Additionally, the laboratory only detected hyaline and fine granular casts, whereas nephrologists reported coarse granular / muddy brown, RBC and WBC casts.

**Conclusions:** Urine microscopy can provide important diagnostic information about underlying kidney disease. In our study, we report a disagreement between automated vs. nephrologist performed analysis. A nephrologist is more likely to recognize the presence of coarse granular, muddy brown, WBC and RBC casts, and dysmorphic red blood cells in urine. Nephrologist-performed UA is superior to laboratory-performed UA as correct identification of these casts carries important diagnostic and prognostic value when evaluating kidney disease.

**Type of casts agreement**

Frequency	Cast Group epic					Cast Group Sediment					Total
	1 No	2 Hyaline or FG	3 CG or MBC	4 WBC	5 RBC	1 No	2 Hyaline or FG	3 CG or MBC	4 WBC	5 RBC	
1 No	67	61	74	5	5	212					
2 Hyaline or FG	47	49	62	3	9	170					
3 CG or MBC	0	0	0	0	0	0					
4 WBC	0	0	0	0	0	0					
5 RBC	1	0	1	1	0	3					
Total	115	110	137	9	14	385					

Kappa 0.01 (95%CI-0.04, 0.07)

**TH-PO580**

**Isolated Penile Calciphylaxis in ESRD**

Kelly Ingram,<sup>1</sup> Raj Jessica Thomas,<sup>3</sup> Nathan Johnson,<sup>4</sup> Douglas J. Grider.<sup>1,2</sup> <sup>1</sup>Virginia Tech Carilion School of Medicine, Roanoke, VA; <sup>2</sup>Dominion Pathology Associates, Roanoke, VA; <sup>3</sup>Cleveland Clinic, Cleveland, OH; <sup>4</sup>Advanced Dermatology and Skin Cancer Center, PLLC, Fayetteville, AR.

**Introduction:** Calciphylaxis is a vascular occlusive disease associated with ESRD. The pathophysiology is not well understood, but it is considered a manifestation of severely dysregulated calcium-phosphorous metabolism. Blood vessel lumens undergo progressive medial calcification and intimal fibrosis resulting in thrombosis, ischemia, and tissue death. It commonly involves the lower extremities, but penile involvement is rare.

**Case Description:** A 75-year-old male presented to the ED with a 3-week history of progressive pain with focal erythematous macules/patches on the glans penis. Past medical history included ESRD with peritoneal dialysis and anuria. The rash consisted of necrotic crust at the urethral meatus (Fig. 1A) and white circinate and hemorrhagic purpuric patches on the proximal glans (Fig. 1B). Wound culture was positive, but histopathology also revealed fibrointimal hyperplasia (bracket), calcified thrombus (solid arrow), and calcification of a vessel (dotted arrow) (Fig. 2A). von Kossa staining indicated calcium deposition, confirming the diagnosis of calciphylaxis (Fig. 2B). The patient declined additional treatment and died 1 month later.

**Discussion:** Calciphylaxis develops rapidly and has a poor prognosis with a mortality rate of 40-80%; therefore, early diagnosis and intervention are critical. Calciphylaxis is an important differential in ESRD patients and special stains, such as the von Kossa, are essential to avoid overlooking subtle calcifications. Calciphylaxis requires a multidisciplinary approach involving nephrology, urology, surgery, and palliative care. Treatment includes sodium thiosulfate, hemodialysis, wound care, pain management, and tissue debridement or amputation.

Lab Results

Test	Results (Reference Range)
Calcium	7.9 mg/dL (8.5-10.7 mg/dL)
Phosphorous	8.0 mg/dL (2.5-4.6 mg/dL)
BUN	51 mg/dL (6-30 mg/dL)
GFR	5 mL/min/1.73m <sup>2</sup> (>60 mL/min/1.73m <sup>2</sup> )
Creatinine	8.6 mg/dL (0.5-1.3 mg/dL)
PTH	852.4 pg/mL (18.4-88.0 pg/mL)
Wound Culture	4+ Gram Negative Rods and Gram Positive Cocci

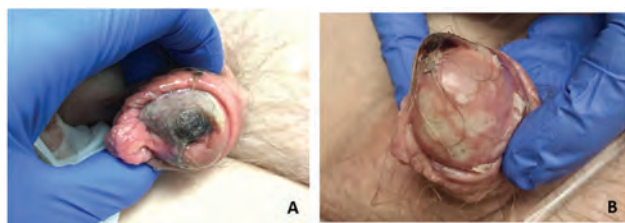

Fig. 1

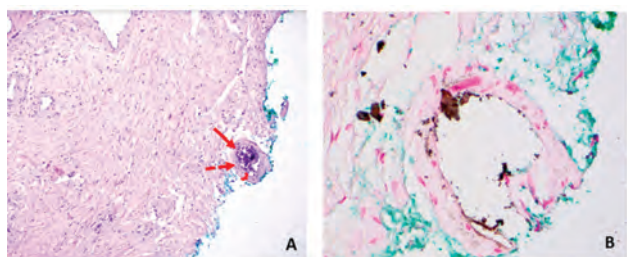

Fig. 2

TH-PO581

Effects of Obesity on Pheresis Outcomes

Aniesh Bobba,<sup>1</sup> Karthik Gangu,<sup>2</sup> Ellil O. Krishnaraju,<sup>1</sup> Christina Mariyam joy,<sup>2</sup> <sup>1</sup>John H Stroger Jr Hospital of Cook County, Chicago, IL; <sup>2</sup>Medical College of Wisconsin, Milwaukee, WI; <sup>3</sup>University of Missouri, Columbia, MO.

**Background:** The prevalence of obesity is on the uptrend in the United States. The degree of obesity can affect the estimation of plasma volume calculations while performing pheresis. In this study, we investigate the effect of Body Mass Index(BMI) on post-pheresis hospital outcomes.

**Methods:** We performed a retrospective study by utilizing the 2016 to 2018 National inpatient sample, and we included patients aged 18 or older who underwent pheresis for any cause during hospitalization. Patients were subdivided based on BMI. Categorical variables were compared using the Chi-square test. A multivariate logistic regression model was used for all-cause mortality and intubation rates.

**Results:** Of the 77,170 patients who had pheresis 50,222 patients were obese (BMI>30), a total of 23,922 were in the extreme obesity(BMI>40) category. The mean age in extreme obesity group was 49 years and women formed 66.15% of the group. Extreme Obesity was associated with increased odds of intubation and in-hospital mortality. The in-hospital mortality rate adjusted Odds ratio(aOR) was 1.32(1.02-1.72, p = 0.03) and need for mechanical ventilation 1.68 (1.42-2.01, p <0.001). Patients with BMI< 25 had increased odds of mechanical ventilation(aOR = 1.54, p<0.001) and trend towards increased mortality(aOR=1.28, p=0.059).

**Conclusions:** Pheresis in extreme obesity is associated with an increased risk of mechanical ventilation and in-hospital mortality. Further investigations into interventions and protocols to improve outcomes should be undertaken.

TH-PO582

Transdermal Estrogen Provides Comparable Effectiveness With Desmopressin in Preventing Uremic Bleeding in CKD Patients Undergoing Kidney Biopsy: A Pilot Randomized, Double-Blinded Controlled Trial

Aschariya Wipattanakitcharoen, Paweena Susantitaphong, Pisut Katavetin, Kearkiat Praditpornsilpa, Somchai Eiam-Ong, Kullaya Takkavatakarn. King Chulalongkorn Memorial Hospital, Bangkok, Thailand.

**Background:** In CKD patients, impairment of renal function and accumulation of uremic toxins increase the risk of post-biopsy bleeding due to platelet dysfunction. A previous study revealed that estrogen could shorten the prolonged bleeding time. We conducted this study to compare the effectiveness of transdermal estrogen and desmopressin, the most common agent used in uremic patients, in preventing post-biopsy bleeding complications.

**Methods:** This non-inferiority, randomized, double-blinded, placebo-controlled trial enrolled patients with eGFR of less than 60 mL/min/1.73m<sup>2</sup> undergoing kidney biopsy. Participants were randomly assigned to receive either transdermal estrogen patches (50 mcg/day) for 7 days or intravenous desmopressin (0.4 mcg/kg). The primary outcome

was the incidence of post-biopsy bleeding complications (hematoma or gross hematuria). The secondary outcomes were hematoma size, changes in hemoglobin levels, platelet function assay by PFA-200, and adverse events.

**Results:** Twenty-one CKD patients underwent randomization to transdermal estrogen (n=10) or desmopressin (n=11) treatment. Transdermal estrogen provided comparable post-biopsy bleeding event to desmopressin (60% and 45.5%; p=0.67). There were no significant differences in hematoma size (7.44±8.4 cm<sup>2</sup> and 7.31±11.9 cm<sup>2</sup>; p=0.98) and hemoglobin change (-0.63±1.1 g/dL and -1.2±1.3 g/dL; p=0.31) between transdermal estrogen and desmopressin respectively. A significant improvement of platelet function represented by a decrease in closure times of PFA-200 assay with collagen and epinephrine (Col/EPI) was observed in desmopressin compared with transdermal estrogen (-50±32.6 sec and 20.3±36.4 sec; p<0.001). Sodium levels significantly decreased in patients receiving desmopressin (-6.0±4.3 mmol/L; p<0.05). There was no thromboembolism event observed.

**Conclusions:** In CKD patients, transdermal estrogen provided comparable effectiveness to desmopressin in preventing post-biopsy bleeding complications, hematoma size, and hemoglobin change without increased risk of thromboembolism and hyponatremia.

**Funding:** Other NIH Support - The Kidney Foundation of Thailand

TH-PO583

CKD Disrupts the Intestinal Mucosal Barrier by Altering Occludin Expression

Georgia Andriana Georgopoulou,<sup>1</sup> Pinelopi Bosgana,<sup>2</sup> Marios Papatotiriou,<sup>1</sup> Anne-Lise de Lastic,<sup>3</sup> Evangelos Papachristou,<sup>1</sup> Dimitrios S. Goumenos,<sup>1</sup> Vasiliki Zolota,<sup>2</sup> Stelios F. Assimakopoulos.<sup>4</sup> <sup>1</sup>Division of Nephrology, Department of Internal Medicine, University of Patras Medical School, Patras, Greece; <sup>2</sup>Department of Pathology, University of Patras Medical School, Patra, Greece; <sup>3</sup>Division of Hematology, Department of Internal Medicine, University of Patras Medical School, Patra, Greece; <sup>4</sup>Division of Infectious Diseases, Department of Internal Medicine, University of Patras Medical School, Patra, Greece.

**Background:** The gut barrier function is compromised in chronic kidney disease (CKD) resulting in increased gut permeability. However, little is known on the potential implicated mechanism(s). This study was undertaken to investigate intestinal occludin expression (a molecular component of epithelial tight junctions) in patients with CKD of various stages.

**Methods:** Thirty-three patients with CKD stage I-IV (n=17) or end-stage kidney disease (ESKD) (n=16) and 11 healthy controls were subjected to duodenal biopsy. Specimens were examined histologically and the villous height/crypt depth ratio and apoptotic body count (by morphology) in the cryptal epithelium was recorded. The expression of occludin in the intestinal epithelium was evaluated by immunohistochemistry. Circulating endotoxin concentration was evaluated by enzyme-linked immunosorbent assay.

**Results:** Patients with CKD stage I-IV or ESKD presented significantly higher serum endotoxin concentrations as compared to controls (P<0.001, respectively). There was an increase of cryptal apoptotic body count in CKD and ESKD patients (P<0.001 vs. controls) and a trend towards decreased villous height/crypt depth ratio. Occludin expression was significantly decreased in CKD and ESKD patients as compared to controls (P<0.001) (Table 1). Interestingly, a gradient of occludin expression from the crypt to the tip of the villi was recorded; occludin expression was retained in crypts, it was reduced in the middle part of the villi, while greater loss of its expression was observed at the upper part.

**Conclusions:** Decreased intestinal occludin expression, observed mainly at the upper third of the villi and increased crypt epithelial apoptosis might represent important mechanisms for intestinal barrier dysfunction and hyperpermeability in patients with CKD or ESKD.

TABLE 1: Occludin immunohistochemical expression: (%) of positive enterocytes (mean±SD)

	CKD stage I to IV (n=17)	ESKD (n=16)	CKD (total) (n=33)	Healthy controls (n=11)
Total occludin (%) of enterocytes	75.3±6.2*	77.2±9.6*	76.3±8*	90.9±9.4
Tip of villi (%)	44.7±25*	50.6±29*	47.7±27*	86.4±13.6
Middle of villi (%)	84.7±6.2*	85.27.9*	84.3±7*	97.3±4.7
Crypt (%)	97±5.9	93.3±10.9	95.1±8.9	99±3

\*p<0.001 vs. controls

TH-PO584

Renal Biopsy in Systemic Infections: Expect the Unexpected

Bangchen Wang, Alexandra Grand, Micah Schub, Harpreet K. Singh, David I. Ortiz Melo, David N. Howell. Duke University Health System, Durham, NC.

**Introduction:** Infection-related glomerulonephritis is well recognized and often included in the differential diagnosis in patients with ongoing infections. It can be missed, however, if the infection is unusual or undetected. We present three cases where the renal biopsy findings prompted the identification or treatment of systemic infections.

**Case Description:** Case 1: A 84-year-old male presented with acute kidney injury (AKI) and a new purpuric rash. Clinically, IgA nephropathy was suspected. A renal biopsy showed active glomerulonephritis with abundant neutrophils, focal segmental tuft necrosis, and one cellular crescent. Predominantly mesangial immune complex deposits containing IgA and IgG were seen. The findings suggested IgA-rich

infection-associated glomerulonephritis. Infectious workup was positive for COVID-19, suggesting exacerbation of IgA nephropathy by recent COVID-19 infection. Case 2: A 31-year-old female status post kidney transplant for granulomatosis with polyangiitis (GPA) had recent pregnancy with preterm delivery, disseminated herpes simplex virus (HSV) infection with HSV hepatitis, and AKI. Urine culture was positive for *E. coli*. The differential diagnosis included HSV nephritis, drug reaction, rejection, recurrent GPA, thrombotic microangiopathy (TMA), and pyelonephritis. A renal biopsy showed proliferative glomerulonephritis with subendothelial and mesangial immune complex deposits containing IgG and C3. The findings were most consistent with infection-related immune complex glomerulonephritis, most likely related to the HSV infection. Case 3: A 78-year-old female presented with AKI, proteinuria, hematuria, and positive p-ANCA. Clinically, ANCA vasculitis was suspected, and the renal biopsy did show focal, segmental, necrotizing glomerulonephritis. However, immunofluorescence and electron microscopy showed IgM-rich immune complex deposits in the mesangium. The unusual presentation of ANCA glomerulonephritis was suggestive of an underlying infection. Bartonella antibody panel showed very high titers; the patient was treated with antibiotics for Bartonella endocarditis.

**Discussion:** Infection-related glomerulonephritis has a wide variety of presentations histologically and clinically. The three cases we present here emphasize the importance of recognizing these entities to help guide treatment and improve patient care.

## TH-PO585

### Renal Involvement in Sarcoidosis-Lymphoma Syndrome: A Report of Two Cases

Siarhei Dzedzik,<sup>1</sup> Ilya Glezerman,<sup>2</sup> Hye-Ran Park,<sup>3</sup> Steven Salvatore,<sup>4</sup> Surya V. Seshan.<sup>4</sup> <sup>1</sup>New York-Presbyterian Hospital, New York, NY; <sup>2</sup>Memorial Sloan Kettering Cancer Center, New York, NY; <sup>3</sup>Kidney Care Specialists-Medical Associates of Drexel Hill, Drexel Hill, PA; <sup>4</sup>Weill Cornell Medicine, New York, NY.

**Introduction:** Sarcoidosis-lymphoma syndrome (S-LS) is a condition characterized by the development of sarcoidosis and lymphoma in the same patient. Chronic inflammation is a putative mediator of this risk. Documented locations affected by sarcoidosis are lymph nodes, lung, bone marrow and spleen. Clinically significant renal involvement by sarcoidosis has not been reported in S-LS.

**Case Description:** Patient #1: 52-year-old male with small lymphocytic lymphoma (SLL) treated with steroids and rituximab (2018), sarcoidosis (2018) and chronic kidney disease (2019). In November 2021 he developed acute kidney injury, refractory hypercalcemia and lung nodules. Complete blood count (CBC) - hemoglobin 8.8 g/dL, WBC 6.2. Serum findings - creatinine 4.5 mg/dL (baseline 2.1 mg/dL), glucose 103 mg/dL, albumin 3.4 g/dL, calcium 13.2 mg/dL, ACE level 71 (normal <40). Patient #2: 58-year-old female with TP53-mutated chronic lymphocytic leukemia (CLL) treated with fludarabine, bendamustine and rituximab (2002). In 2019 patient started ibrutinib with good response. One year later she developed anterior uveitis, lymphadenopathy, fever and night sweats. Lymph node biopsy confirmed sarcoidosis. Steroid course was initiated with resolution of the symptoms. In November 2021, one month before kidney biopsy, PET-CT showed CLL progression. CBC - hemoglobin 13.2 g/dL, WBC 4.77. Serum findings - creatinine 1.9 mg/dL (baseline 1.0 mg/dL), glucose 67 mg/dL, albumin 3.9 g/dL, calcium 9.4 mg/dL, ACE level 42. In both cases there was no hematuria or proteinuria on urinalysis. Kidney biopsies demonstrated diffuse interstitial nephritis with non-casating granulomatous inflammation and widespread tubular atrophy with interstitial fibrosis suggestive of sarcoidosis. No other infections or medications could be implicated. No evidence of SLL/CLL was identified.

**Discussion:** The differential diagnosis of impaired kidney function in patients with hematologic malignancies is broad. Infections, drug toxicity and direct or indirect involvement by the malignancy should be considered. Renal biopsy remains a definitive modality for an accurate diagnosis. These cases represent the first reported description of renal sarcoidosis as a part of S-LS. Renal pathologists and nephrologists should be aware of this association for potential accurate diagnosis of both entities and appropriate treatment.

## TH-PO586

### Potential Factors for Specimen Adequacy and Bleeding Complications of Ultrasound-Guided Renal Biopsy

Kanin Thammavaranucupt,<sup>1</sup> Ittikorn Spanuchart,<sup>2</sup> <sup>1</sup>Chakri Naruebodin Medical Institute, Bang Phli, Thailand; <sup>2</sup>Mahidol University Faculty of Medicine Ramathibodi Hospital, Bangkok, Thailand.

**Background:** A kidney biopsy is indicated for establishing a definite diagnosis and guiding the treatment of various kidney diseases. While obtaining adequate tissue is important, procedure-related risks, particularly bleeding, need to be minimized. The angle and depth of the biopsy needle trajectory have been studied for the safety outcome however the data on tissue adequacy associated with these factors is little. We aimed to evaluate potential factors, including the needle cortical tangential angle and the needle-distance ratio, for tissue adequacy and complications in native kidney biopsy.

**Methods:** A retrospective study was conducted on adult patients who underwent ultrasound-guided native kidney biopsy by interventional radiologists at Ramathibodi Hospital between January 1<sup>st</sup>, 2016, and December 31<sup>st</sup>, 2020. Clinical, imaging and technical parameters were collected for analysis.

**Results:** Of 124 kidney biopsies, the demographic data includes the mean age of 51.5 years, male sex of 57.3%, BMI of 27.2 kg/m<sup>2</sup>, kidney size of 4.9x9.9 cm, the parenchymal thickness of 1.3 cm, increased echogenicity 73.4%, and loss of

corticomedullary differentiation 44.4%. The parenchymal thickness of the adequate group was higher than the suboptimal/inadequate groups (p=0.056). Loss of corticomedullary differentiation was higher in the suboptimal/inadequate group (p=0.045). The needle cortical tangential angle in the range of 30-60° yielded tissue adequacy of 64% compared to 16% with the angle out of range (p<0.01). The mean needle-distance ratios of the adequate, suboptimal, and inadequate groups were 0.64, 0.74, and 0.79 cm, respectively (p=0.01). Major bleeding occurred at 13.7%. In multivariable analysis, needle cortical tangential angle was statistically significant for the tissue adequacy outcome.

**Conclusions:** Our study showed the cortical tangential approach with the angle between 30°-60° had higher tissue adequacy than the angle out of 30°-60°. The needle-distance ratio toward one, loss of corticomedullary differentiation, and decreased parenchymal thickness showed a tendency of having suboptimal or inadequate tissue.

## TH-PO587

### Tenofovir Associated Hyaline Arteriosclerosis

Je Hoon Kim, Maxwell L. Smith, Leslie F. Thomas. Mayo Clinic Arizona, Scottsdale, AZ.

**Introduction:** Tenofovir Disoproxil Fumarate (TDF) is associated with various patterns of kidney injury. We present a case of hyaline arteriosclerosis (HA) associated with TDF.

**Case Description:** A 40-year-old Caucasian male with a history of epilepsy on Lacosamide and Brivaracetam, hepatitis C (HCV) treated with Sofosbuvir/Velpatasvir (SV), cutaneous sarcoid on Hydroxychloroquine, pre-exposure prophylaxis on Emtricitabine and TDF for seven years presented to nephrology clinic with asymptomatic elevation in creatinine (CR). Patient was diagnosed with HCV and started on SV one year prior to presentation. One month after starting treatment, patient's CR was elevated to 1.38 mg/dL from a baseline of 1.03 mg/dL. Near the end of HCV treatment, the patient developed a rash that was eventually biopsy proven to be cutaneous sarcoid. Additional workup for the rash also showed a positive p-ANCA/MPO without evidence of vasculitis and a persistently elevated CR of 1.56 mg/dL. Negative studies included HCV, HIV, sedimentation rate, A1c. Urine studies were also unremarkable. Blood pressures were normal and the only known potential nephrotoxic agents were TDF and Omeprazole. Patient's CR continued to rise and peaked at 1.85 mg/dL. A kidney biopsy was pursued. Kidney biopsy revealed HA. The renal cortex was intact with normal glomeruli. Immunofluorescence was negative. HA was thought to be due to TDF exposure. Fortunately, patient's CR stabilized at around 1.5 mg/dL without any intervention.

**Discussion:** TDF is a known potential nephrotoxin. Commonly described nephrotoxic patterns associated with TDF include proximal tubular dysfunction, acute and chronic kidney damage, nephrogenic diabetes insipidus and distal tubular acidosis. Small vessel disease, such as HA, due to TDF has never been described. HA is mainly seen in the elderly, patients with diabetes or hypertension or patients on calcineurin inhibitors. Our patient was taking 300 mg of TDF daily without any side-effects. The sudden increase in CR coincided with the start of SV. The concomitant use of TDF and SV increases the TDF concentration in the serum and may worsen renal function, as seen in our patient. Moreover, the twelve weeks of increased TDF exposure may have led to microvascular changes that ultimately resulted in HA. To our knowledge, this is the first case of HA associated with TDF in a young patient without any known risk factors.

## TH-PO588

### SeqStain Based Spatialomic Profiling of Human Kidney Tissues Identifies Cellular Neighborhoods

Ishwarya Venkatesh, Disha Varma, Kwi Hye Koh, Billy Nguyen, Vineet Gupta, David J. Cimbaluk. Team SeqStain Rush University Medical Center; Chicago, IL.

**Background:** An improved understanding of the underlying cellular heterogeneity of human kidney tissue is essential for providing an accurate disease diagnosis, rate of progression and potential therapeutic avenues for a variety of chronic kidney disease pathologies. Newer multiplex imaging based methods are providing such tools for implementation in the clinical setting in the future. We recently developed a novel tissue imaging method, termed SeqStain, for immunofluorescence based multiplexed tissue imaging and analyses. Here, we describe utility of this approach for improving our understanding of kidney tissue samples from healthy subjects and patients with various glomerular diseases.

**Methods:** SeqStain utilizes fluorescent DNA-tagged antibodies and antibody-fragments for analyzing tens of kidney-specific analytes in a single tissue section. We designed and optimized SeqStain multiplex panels with sets of antibodies to probe different histological regions relevant to the kidney and used conventional fluorescence microscopy set-up for imaging and analyses.

**Results:** We show that SeqStain is an efficient method for multiplex imaging of both paraffin-fixed and frozen tissue sections. Image acquisition using off-the-shelf components, and confocal microscopes that are widely available in laboratories, we were able to accurately image tens of antigens on single tissue specimens for healthy subjects, and from patients with lupus nephritis (LN) or diabetic nephropathy (DN). Automated analysis of the aligned tissue images showed enrichment of specific cellular clusters into distinct neighborhoods.

**Conclusions:** This newly developed imaging method, SeqStain, provides an easy to use and robust platform for deep profiling of kidney tissue specimen. The generated spatial maps will provide important new insights about the disease pathobiology and improve future diagnostics and therapeutics for LN and DN.

**Funding:** NIDDK Support, Private Foundation Support

## TH-PO589

### Temporal Trends in Prevalence of Blood Pressure Screening and Hypertension After Introduction of Clinical Practice Guidelines on Hypertension in Canadian Children: A Time-Series Analysis

Michael Wu,<sup>1</sup> Allison Dart,<sup>2</sup> Leanne Kosowan,<sup>2</sup> Smita Roychoudhury,<sup>1</sup> Alexander Singer,<sup>2</sup> Rahul Chanchlani,<sup>1</sup> <sup>1</sup>McMaster University, Hamilton, ON, Canada; <sup>2</sup>University of Manitoba, Winnipeg, MB, Canada.

**Background:** In 2016 & 2017 respectively, new Canadian & American guidelines for assessing pediatric hypertension (HTN) were introduced. It is unknown whether these guidelines have impacted blood pressure (BP) screening & HTN prevalence in primary care settings.

**Methods:** The study included 438,297 children (3-18 years) from seven Canadian provinces with 1+ encounter in the Canadian Primary Care Sentinel Surveillance Network (CPCSSN) database between January 1, 2011 & December 31, 2019. The study cohort had 3 phases: Jan 1, 2011-Dec 31, 2015 (era 1), Jan 1, 2016 – Dec 31, 2017 (wash out) & Jan 1, 2018-Dec 31, 2019 (era 2). HTN was defined by NHLBI guideline up to December 31, 2017 & AAP 2017 guideline thereafter. We performed an interrupted time series analysis to assess impact of the guideline recommendations on BP screening and HTN prevalence.

**Results:** 264,635 children in era 1 & 193,654 children in era 2 were evaluated. In era 1 and 2, there were 66,653 (25.2%) & 45,050 (23.3%) children, respectively with at least 1 BP measurement. Annual BP screening generally increased each year from 13.3% in 2011 to 20.2% in 2019. In Era 1, a total of 1.1% of children met HTN criteria with a mean onset age of 12.6 years (SD 4.1). In Era 2, a total of 2.0% of children met HTN criteria with a mean onset age of 14.1 years (SD 4.1). Time series analysis revealed a significant increase in BP screening and HTN after the guidelines' introduction (p=0.04 and p<0.0001 respectively).

**Conclusions:** BP screening and HTN prevalence generally increased between 2011 and 2019, with a significant increase in post-guideline BP documentation and children meeting HTN criteria following guideline implementation.

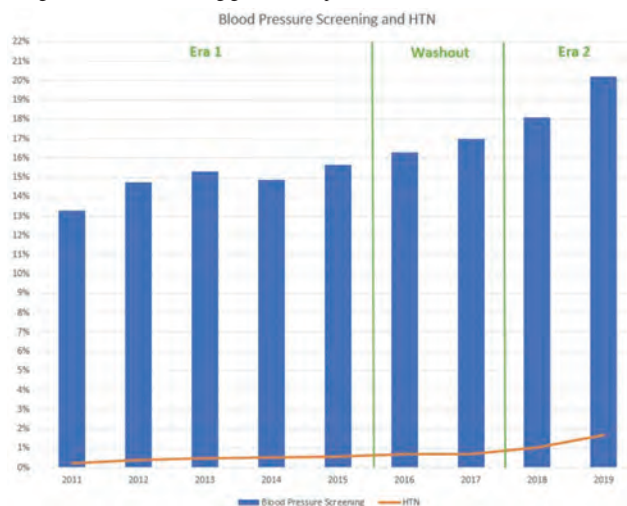

Proportion of children who received BP screening or who met HTN criteria from Jan 1, 2011 to Dec 31, 2019

## TH-PO590

### Low Birth Weight and Hypertension Severity in Youth Referred for Hypertension Disorders: A SUPERHERO Interim Analysis

Rachel A. Carrasquillo,<sup>1</sup> Victoria Giammattei,<sup>1</sup> Caroline Lucas,<sup>1</sup> Christine B. Sethna,<sup>3</sup> Carol Vincent,<sup>1</sup> Irina Viviano,<sup>1</sup> Donald J. Weaver,<sup>2</sup> Andrew M. South,<sup>1</sup> <sup>1</sup>Wake Forest University School of Medicine, Winston-Salem, NC; <sup>2</sup>Levine Children's Hospital, Charlotte, NC; <sup>3</sup>Cohen Children's Medical Center, Queens, NY.

**Background:** Pediatric hypertension (HTN) has short and long-term adverse health effects. While children with low birth weight (LBW, <2500 g) have an increased risk of HTN, it is unknown whether LBW is associated with more severe HTN once diagnosed. Our objective is to evaluate if youth referred for HTN disorders who had LBW are more likely to have worse blood pressure (BP).

**Methods:** Cross-sectional analysis of preliminary baseline data from The Study of the Epidemiology of Pediatric Hypertension (SUPERHERO) Registry, an ongoing multicenter retrospective cohort using bioinformatics to obtain electronic health record data from youth referred to subspecialty clinics for HTN disorders. Inclusion criteria were <19 years of age, initial visit 1/01/2016 to 12/31/2021 (index date), and ICD-10 diagnostic codes for HTN disorders. Exclusion criteria were pregnancy, kidney failure on dialysis, or kidney transplantation by ICD-10 codes. BP severity was based on the average of all BP measurements obtained on the index date. We classified BP based on age, sex, and

height per pediatric guidelines. We further defined high BP as elevated BP or any stage of HTN. LBW of any severity was based on ICD-10 diagnostic codes at the index date. We estimated  $\beta$ , RR, and OR with 95% CL using unadjusted generalized linear models.

**Results:** Of the 3295 participants, 29% identified as Black/African American, 17% Hispanic, 37% were female, and the median age was 14.2 years (IQR 10.5, 16.4); 52% had obesity. Only 1% (n=18) had an ICD-10 code for LBW, and 60% of the cohort had stage 1 or stage 2 HTN. LBW ICD-10 codes were associated with an 18% higher risk of high BP (RR 1.18, 95% CL 1.04 to 1.33) and 46% higher risk of HTN (RR 1.46, 95% CL 1.21 to 1.77).

**Conclusions:** Youth referred for HTN disorders who had ICD-10 codes for LBW had higher risk of more severe BP classification compared to those without these codes. It is likely that LBW status is not being heavily documented, hence it is unlikely that there is only 1% prevalence. Our findings could aid health care providers in HTN clinics to be more alert of a possible risk factor that needs to be taken into consideration. Ongoing analyses in this population include obtaining actual birth weight and investigating the association with target organ damage.

**Funding:** NIDDK Support, Other NIH Support - NHLBI K23-HL148394, L40-HL148910 (South), NCTAS UL1-TR001420 (WFUSM)

## TH-PO591

### Childhood Systolic Blood Pressure Predicts Hypertension in Young Adults: A 10-Year Follow-Up Study of Icelandic Children

Asdis H. Sigurdardottir,<sup>1</sup> Olafur S. Indridason,<sup>1,2</sup> Thordis J. Hrafnkelsdottir,<sup>1,3</sup> Sigurdur S. Stephensen,<sup>1,4</sup> Vidar O. Eddvardsson,<sup>1,4</sup> <sup>1</sup>Faculty of Medicine, School of Health Sciences, University of Iceland, Reykjavik, Iceland; <sup>2</sup>Division of Nephrology, Landspítali-The National University Hospital of Iceland, Reykjavik, Iceland; <sup>3</sup>Division of Cardiology, Internal Medicine Services, Landspítali-The National University Hospital of Iceland, Reykjavik, Iceland; <sup>4</sup>Children's Medical Center, Landspítali-The National University Hospital of Iceland, Reykjavik, Iceland.

**Background:** Although there is significant evidence for an association between childhood and adult clinic blood pressure (BP), data on the association of childhood BP and ambulatory BP (ABP) and hypertension in young adults are missing. The aim of this study was to examine the predictive value of childhood BP for ambulatory HTN in young adults.

**Methods:** Subjects were recruited from a cohort of 970 adults aged 20-22-years who participated in a population-based study of BP in 9-10-year-old Icelandic children. All participants underwent 4 resting BP measurements in childhood and the follow-up study included both clinic and ABP measurements. The 2017 AHA guideline was used to define HTN at follow-up and the fourth report on the diagnosis, evaluation, and treatment of high blood pressure in children and adolescents was used to define childhood BP percentiles. Logistic regression analysis was used to examine the relationship between childhood BP and HTN at follow-up.

**Results:** A total of 163 individuals, 66 (40%) men, participated in the follow-up study. At follow-up a total of 40 (24%) participants had HTN, of those 37 (23%) had ambulatory HTN, 11 had both clinic and ambulatory HTN and 3 had white-coat HTN only. There was an independent association between HTN at follow-up and absolute childhood systolic BP (SBP) (OR 1.08, CI95% [1.02 – 1.15]). Men were more likely to have HTN than women at follow-up (OR 3.00, CI95% [1.4 – 6.6], p<0.001). Men were also more likely than women to have ambulatory HTN at follow-up (OR 2.39, CI95% [1.12 – 5.25], p<0.05). One mm Hg increase in SBP at the age of 9-10 years was associated with a 10% rise in the probability of ambulatory HTN at age 20-22 years (OR 1.10, CI95% [1.01 – 1.21], p<0.05). Individuals with SBP >90<sup>th</sup> percentile were three times more likely to have ambulatory HTN (OR 3.4, CI95% [1.5 – 7.68], p<0.001) at follow-up. Diastolic BP (DBP) and body mass index (BMI) percentiles at the age of 9-10 years predicts neither clinic nor ambulatory HTN at the age of 20-22 years.

**Conclusions:** Male sex and SBP indices at the age of 9-10 years predicts both clinic and ambulatory HTN in young adults.

**Funding:** Government Support - Non-U.S.

## TH-PO592

### Anxiety Disorders and Hypertension in Children: Interim Analysis of the Study of the Epidemiology of Pediatric Hypertension (SUPERHERO) Registry

Christine B. Sethna,<sup>1</sup> Shupti Biswas,<sup>1</sup> Victoria Giammattei,<sup>2</sup> Caroline Lucas,<sup>2</sup> Carol Vincent,<sup>2</sup> Irina Viviano,<sup>2</sup> Donald J. Weaver,<sup>3</sup> Andrew M. South,<sup>2</sup> <sup>1</sup>Cohen Children's Medical Center, Queens, NY; <sup>2</sup>Wake Forest University School of Medicine, Winston-Salem, NC; <sup>3</sup>Levine Children's Hospital, Charlotte, NC.

**Background:** Studies in adults have linked anxiety disorders with hypertension, however not much is known about this relationship in children. The study aimed to assess the association of anxiety disorders with blood pressure classification and initial evaluation/management among youth referred for subspecialty evaluation of hypertension.

**Methods:** Interim analysis of baseline data from the SUPERHERO Registry, a multicenter retrospective cohort of youth referred for hypertension disorders, was conducted. Data were collected via standardized electronic health record queries. Inclusion criteria were initial visit to a subspecialty clinic for hypertension disorders identified by ICD-10 codes from 1/1/2016–12/31/2021 and age <19 years. Exclusion criteria were kidney failure on dialysis, kidney transplantation, or pregnancy by ICD-10 codes. The primary exposure was anxiety disorders identified by ICD-10 codes "other



anxiety disorder”, “reaction to severe stress, and adjustment disorders”, and “emotional disorders with onset specific to childhood”. Outcomes were blood pressure classification and orders for antihypertensive medication, echocardiogram, and urine protein/albumin. Associations were estimated using unadjusted generalized linear models.

**Results:** Of 3295 participants, median age was 14.2 years [10.5, 16.4], 63% were male, 29% identified as Black or African American, and 52% had obesity. There were 36 anxiety disorder diagnosis codes identified among 26 participants. Blood pressure classification included elevated blood pressure 17%, stage 1 hypertension 34%, and stage 2 hypertension 26%. Participants with anxiety disorders were more likely to identify as White and less likely to be prescribed anti-hypertensive medication (p <0.05). In regression analysis, participants with anxiety disorders were more likely to have orders placed for urine albumin (RR 1.26, CL 1.02 to 1.55).

**Conclusions:** In a large multicenter cohort of youth referred for subspecialty evaluation of hypertension disorders, patients with anxiety diagnoses were more likely to have urine tests ordered. It is very probable that anxiety disorders are underreported by ICD-10 codes in the electronic health record in this population.

**Funding:** NIDDK Support, Other NIH Support - NHLBI K23-HL148394, L40-HL148910

TH-PO593

Social Determinants of Health and Blood Pressure in Children: Interim Analysis of the Study of the Epidemiology of Pediatric Hypertension (SUPERHERO) Registry

Christine B. Sethna,<sup>1</sup> Shupri Biswas,<sup>1</sup> Victoria Giammattei,<sup>2</sup> Caroline Lucas,<sup>2</sup> Carol Vincent,<sup>2</sup> Irina Viviano,<sup>3</sup> Donald J. Weaver,<sup>3</sup> Andrew M. South.<sup>2,1</sup> <sup>1</sup>Cohen Children's Medical Center, Queens, NY; <sup>2</sup>Wake Forest University School of Medicine, Winston-Salem, NC; <sup>3</sup>Levine Children's Hospital, Charlotte, NC.

**Background:** Social determinants of health (SDoH) are known to impact chronic health conditions, however the relationship between SDoH and hypertension (HTN) in children has not been well-studied. The objective was to determine the association of unmet social needs (USN) with blood pressure (BP) classification and initial evaluation/management among youth referred for HTN.

**Methods:** Interim analysis of baseline data from the SUPERHERO Registry, a multicenter retrospective cohort of youth referred for HTN disorders, was conducted. Data were collected via standardized electronic health record queries. Inclusion criteria were initial visit to a subspecialty clinic for HTN disorders by ICD-10 codes from 1/1/2016-12/31/2021 and age <19 years. Exclusion criteria were dialysis, kidney transplantation, or pregnancy by ICD-10 codes. USN exposures included problems related to housing/economic circumstances, social environment, upbringing, and other psychosocial circumstances by ICD-10 codes. Unadjusted generalized linear models estimated the association of USN with outcomes of BP and orders for antihypertensive medication, echocardiogram, and urine protein.

**Results:** Of 3295 participants, median age was 14.2 years [10.5,16.4], 63% were male, 29% identified as Black, and 52% had obesity. There were 16 USN diagnosis codes identified among 10 participants: 13 housing/economic, 1 social environment, 1 upbringing, and 1 other psychosocial circumstance. BP classification included elevated BP 17%, stage 1 HTN 34%, and stage 2 HTN 26%. Participants with USN were more likely to have obesity and, among age ≥13 years, higher diastolic BP, p <0.05. Having USN was associated with HTN (RR 1.45, CL1.18-1.78), greater systolic BP (≥13 years only, β 13.0 mmHg, CL0.7-25.2), and greater diastolic BP (≥13 years only, β 12.4 mmHg, CL3.0-21.8). Those with USN were also more likely to have orders placed for antihypertensive medications (RR 1.93, CL1.03-3.59).

**Conclusions:** In a large multicenter cohort of youth referred for evaluation of HTN disorders, patients with USN were more likely to have HTN, greater BP and were more likely to be prescribed antihypertensive medications. Ongoing steps include multivariable analysis to further investigate SDoH in youth with HTN.

**Funding:** NIDDK Support, Other NIH Support - NHLBI K23-HL148394, L40-HL148910

TH-PO594

CKD Stage/Duration and Cardiovascular (CV) Risk Factors in Children With Proteinuric Glomerulopathies (GD)

Christine B. Sethna,<sup>1</sup> Kevin E. Meyers,<sup>2</sup> Tarak Srivastava,<sup>3</sup> Susan F. Massengill,<sup>4</sup> Donald J. Weaver,<sup>4</sup> Keisha L. Gibson,<sup>5</sup> Katherine R. Tuttle,<sup>6</sup> Katherine M. Dell,<sup>7</sup> Debbie Gipson,<sup>8</sup> Cheryl L. Tran,<sup>9</sup> Howard Trachtman,<sup>8</sup> Elizabeth C. Mitchell.<sup>1</sup> <sup>1</sup>Cohen Children's Medical Center, Queens, NY; <sup>2</sup>The Children's Hospital of Philadelphia, Philadelphia, PA; <sup>3</sup>Children's Mercy Hospitals and Clinics, Kansas City, MO; <sup>4</sup>Levine Children's Hospital, Charlotte, NC; <sup>5</sup>The University of North Carolina at Chapel Hill, Chapel Hill, NC; <sup>6</sup>Providence St Joseph Health, Renton, WA; <sup>7</sup>Case Western Reserve University, Cleveland, OH; <sup>8</sup>University of Michigan, Ann Arbor, MI; <sup>9</sup>Mayo Clinic Minnesota, Rochester, MN.

**Background:** Children with GD are at increased risk for CV disease, however the impact of CKD stage and disease duration has not been well studied.

**Methods:** Ambulatory blood pressure monitoring (N=90), echocardiography (N=119), pulse wave velocity (PWV) (N=44) and lipids (N=96) were performed in a cross-sectional study of children <21 yr with GD from 10 sites within Nephrotic Syndrome Study Network (NEPTUNE) and Cure Glomerulonephropathy Network (CureGN). Data were also obtained from children with GD in the Chronic Kidney Disease in Children (CKiD) study. Blood pressures (BP) were indexed to the 95%ile.

Left ventricular hypertrophy (LVH) was defined as >95%ile and >51 g/m<sup>2.7</sup>. The bedside Schwartz formula was used to estimate glomerular filtration rate (eGFR) and stage CKD. Disease duration was categorized as 0-<2, 2-<5, 5-<10 and >10 yrs. Analysis included Kruskal Wallis and chi-square tests.

**Results:** Of 144 children (age 14 [10.7-17] yr, 59% M), hypertension (HTN), isolated nocturnal HTN, LVH 95%ile and LVH>51 were present in 38.9%, 20.9%, 28.6% and 10.1%, respectively. There was a higher proportion of HTN and LVH with higher CKD stages. Office BP, BP loads and triglycerides were also greater in higher CKD stages (Table). PWV was higher in those with disease duration 2-5 years compared to other durations (6.15 vs. 4.5-5.26 m/s, p=0.03). No other measures were significantly different by disease duration.

**Conclusions:** CV risk factors are more prevalent in advanced CKD stages despite similar disease duration in children with GD. Longitudinal studies are needed to examine the effect of CKD stage/duration on CV risk factors in this high risk group.

**Funding:** Private Foundation Support

Table with 7 columns: Metric (eGFR or %ile), CKD Stage 1 (N=30), CKD Stage 2 (N=45), CKD Stage 3 (N=45), CKD Stage 4 (N=19), CKD Stage 5 (N=5), and P Value. Rows include Age (years), BMI (kg/m^2), PWV (m/s), Duration of disease (years), LVMI (g/m^2.7), LVMI >95%ile, LVMI >51 (g/m^2.7), PWV (m/s), ABPM HTN, Isolated Noct. HTN, Office SHS, Office DBS, Day SBP, Day DBP, Day SHS, Day DBP, Day LDBP, Day LDBP load, Night SBP, Night DBP, Night SHS load, Night DBP load, Total Cholesterol, LDL, HDL, and Triglycerides.

TH-PO595

Gaisbock Syndrome: A Rare Etiology of Secondary Hypertension Taylor Greene. The University of Oklahoma - Tulsa, Tulsa, OK.

**Introduction:** Gaisbock syndrome is an unusual clinical disorder first described in 1905 by Dr. Felix Gaisbock as hypertension in males attributed to elevated hematocrit levels without splenomegaly or abnormal leukocyte counts. The underlying pathophysiology for this syndrome was explained as psychiatric disorders that result in chronic stress, extracellular volume depletion due to diuresis, and hypoxemia due to obstructive sleep apnea as these conditions lead to relative and absolute polycythemia.

**Case Description:** 17-year-old Caucasian male without significant medical history was referred to nephrology clinic for new onset of hypertension with associated headache. He was initially seen by his family physician and evaluation revealed polycythemia with hemoglobin (Hb) of 20 g/dl, hematocrit of 57%, and hypertensive urgency with blood pressure of 160/110 mmHg. Physical exam was within normal limits with normal BMI. Secondary etiologies for hypertension evaluating for renal artery stenosis, Coarctation of the aorta, hyperaldosteronism, and Pheochromocytoma were all unrevealing. Hematological evaluation revealed negative JAK2 mutation and further genetic testing revealed a P50 mutation consistent with familial polycythemia. With other secondary causes ruled out, the patient's hypertension was attributed to Gaisbock syndrome due to familial polycythemia. The patient was initially treated with an Ace-inhibitor and Calcium channel blocker to control hypertension. Eventually one year after starting serial phlebotomy and attaining Hb of 15-16 g/dl, the patient was able to come off antihypertensive medications and remained normotensive while continuing phlebotomy.

**Discussion:** While rare, Gaisbock syndrome is a known phenomenon due to increased intravascular pressure from relative and absolute polycythemia. It can be difficult to differentiate, if hypertension is a consequence or its own diagnosis in some cases. It is important to consider other causes of secondary hypertension especially in patients with atypical presentations, such as this patient who was only 17 years old at onset of hypertension. Notably, Gaisbock syndrome does not have one singular etiology and thus treatment strategies may vary from patient to patient. In our patient, phlebotomy has proven to be an effective treatment in controlling hypertension. It is important to control hypertension as hyper viscosity poses an increased risk for thromboembolic complications.

TH-PO596

Primary Hypertension in Patients With Sickle Cell: Observations From an Adult Sickle Cell Kidney Disease Clinic

Jonathan Keyes, Oyintayo Ajiboye, Pooja Kalantri, Pooja D. Amarapurkar. Emory University School of Medicine, Atlanta, GA.

**Background:** Patients with Sickle Cell Disease (SCD) have lower blood pressures (BP). Relative hypertension (HTN) increases the risk for stroke, pulmonary HTN, and kidney dysfunction in SCD patients. Limited data exists about the prevalence of HTN in SCD population. We describe our observations from an adult SCD kidney clinic.

**Methods:** We performed a retrospective chart review of patients seen in the SCD kidney clinic at the Georgia Comprehensive Center between January 2021 to December 2021. Demographics, clinical characteristics, albuminuria, estimated glomerular filtration rate (eGFR), BP trends, number of antihypertensive medications, correlation of BP with albuminuria, eGFR and hyperkalemia were noted. Data analyses were generated using R-statistical software.

**Results:** During the study period 44 African American patients, 28 (64%) females and 16 (36%) males, with SCD were enrolled. The median age was 45 years. The sickle cell phenotypes were predominantly SS 38 (86%) [SC 4 (9.1%), hemoglobin S/high fetal hemoglobin 1 (2.3%), and sickle cell beta thalassemia 1 (2.3%)]. HTN was present in 23 (52%) patients. Median albumin to creatinine ratio (ACR) was 330 mg/g creatinine (IQR 75-941). ACR>300 was present in 14 (61%) patients with HTN and 9 (43%) without (p=0.23). The median eGFR at initial visit was 59ml/min/1.73m<sup>2</sup> (IQR 38-106). eGFR<60 mL/min was present in 12 (52%) with HTN and 4 (19%) without. Hyperkalemia (>5.5mg/dl) was present in 8 (35%) with HTN and 6 (29%) without HTN. The systolic BP range was 114-185. The diastolic BP range was 65-110. Of those with HTN, 16 (70%) were on angiotensin converting enzyme inhibitors (ACEI) or angiotensin receptor blockers (ARB), 7 (30%) on diuretics, 9 (39%) on calcium channel blockers, 10 (43%) on a combination of 2 medications.

**Conclusions:** Our study is unique in that 52% of our SCD patients had HTN on presentation. We observed a correlation between HTN, albuminuria, and decreased eGFR. Optimal HTN management is crucial but challenging. Diuretics can increase the risk of sickle crisis while ACEI/ARB may contribute to hyperkalemia. Further studies are needed to assess the epidemiology of HTN and determine optimal BP regimens for patients with SCD.

**TH-PO597**

**Blood Pressure Sensitivity to Sodium Is Accompanied by Distinct Microcirculatory Changes in CKD and Healthy Controls**

Jetta J. Oppelaar,<sup>1</sup> Emanuele Favaron,<sup>2,3</sup> Emma H. van Schijndel,<sup>1</sup> Wim Jan V. Boven,<sup>3</sup> Can Ince,<sup>2</sup> Liffert Vogt.<sup>1</sup> <sup>1</sup>Department of Nephrology, Amsterdam University Medical Center, Amsterdam, Netherlands; <sup>2</sup>Department of Intensive Care, Erasmus MC, Rotterdam, Netherlands; <sup>3</sup>Department of Cardiothoracic Surgery, Amsterdam University Medical Center, Amsterdam, Netherlands.

**Background:** In CKD, blood pressure (BP) is closely related to sodium (Na<sup>+</sup>) intake. CKD is characterized by microcirculatory alterations, which are thought to contribute to impaired Na<sup>+</sup> and water excretion leading to Na<sup>+</sup>-sensitive BP response. We investigated whether high Na<sup>+</sup> induces similar microcirculatory changes in CKD as compared to Na<sup>+</sup>-sensitive healthy volunteers.

**Methods:** We performed a randomized cross-over study in healthy controls (HC) and CKD patients (stage 2a-3, proteinuria >500 mg/d). All subjects followed both an 8-day low Na<sup>+</sup> diet (LSD, <50mmol/d) and high Na<sup>+</sup> diet (HSD, >200mmol/d). IFMAP increased after HSD, subjects were considered as Na<sup>+</sup>-sensitive (SS-HC). Microcirculation was assessed by using an angiopoietin-2 (Ang2) ELISA and sublingual incident dark field (IDF) imaging with and without nitro-glycerine (NTG).

**Results:** We included 9 SS-HC (median age 29) and 6 CKD patients (median age 49, mean proteinuria 1.2 g/d). The mean Na<sup>+</sup>-sensitive MAP increase was 4.8 in SS-HC and 9.8 mmHg in CKD. Ang2 levels increased after Na<sup>+</sup> loading in SS-HC, but not in CKD (Fig 1A). After LSD, no differences could be observed in microcirculatory parameters between SS-HC and CKD. In SS-HC, HSD did not influence vessel density or perfusion. In CKD, HSD resulted in lower total vessel density after NTG (Fig 1B). After NTG supplementation, total red blood cell perfusion was higher after LSD in CKD compared to SS-HC (57.52 and 46.00 mm<sup>2</sup>/mm<sup>2</sup>, p=0.02) but diminished in this group whereas an increase in SS-HC was observed after switching to HSD.

**Conclusions:** We show that BP sensitivity to Na<sup>+</sup> is accompanied by distinct microcirculatory changes in CKD as compared to SS-HC. In SS-HC Na<sup>+</sup> loading affects the vascular permeability, yet no differences could be observed in total amount of vessels. However, in CKD Na<sup>+</sup> loading decreases the amount and perfusion of small blood vessels, indicating that Na<sup>+</sup> affects the capacity to adequately perfuse tissues in CKD. Authors 1 and 2 contributed equally to this abstract

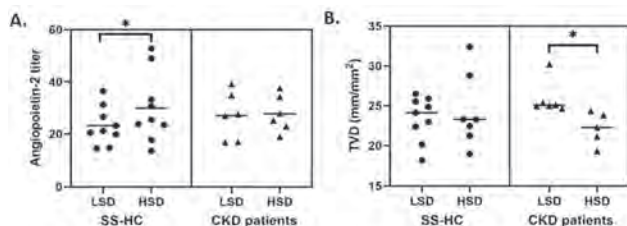

**A.** Na<sup>+</sup> loading resulted in an increase in Ang2 in SS-HC (23.17 vs 29.95, p=0.04). But not in CKD (27.07 vs 27.8, p=0.65). **B.** After NTG, total vessel density (TVD) was not affected by Na<sup>+</sup> loading in SS-HC. But, the amount of functional vessels significantly decreased in CKD (22.27 vs 25.06, p=0.01).

**TH-PO598**

**Gender Disparity on the Association Between Dietary Sodium Intake and Blood Pressure: Analysis of the NHANES 2017-2018**

Ekamol Tantisattamo,<sup>1,2</sup> Phuuwadith Wattanachayakul,<sup>3</sup> Watsachon Pangkanon,<sup>4</sup> Chawin Lopimpisuth,<sup>5</sup> Pakin Lalitnithi,<sup>5</sup> Chanattha Thimphithaya,<sup>6</sup> Chalothorn Wannaphut,<sup>7</sup> Nattanicha Chaisrimaneeapan.<sup>8</sup> <sup>1</sup>Division of Nephrology, Hypertension and Kidney Transplantation, University of California Irvine School of Medicine, Orange, CA; <sup>2</sup>Nephrology Section, Tibor Rubin Veterans Affairs Medical Center, Veterans Affairs Long Beach Healthcare System, Long Beach, CA; <sup>3</sup>Department of Microbiology, Faculty of Medicine Siriraj Hospital, Mahidol University, Bangkok, Thailand; <sup>4</sup>Faculty of Medicine, Srinakharinwirot University, Bangkok, Thailand; <sup>5</sup>Faculty of Medicine, Chulalongkorn University and King Chulalongkorn Memorial Hospital, Bangkok, Thailand; <sup>6</sup>Bangkok Metropolitan Administration General Hospital, Bangkok, Thailand; <sup>7</sup>Department of Medicine, Siriraj Piyamaharajakarun Hospital, Faculty of Medicine Siriraj Hospital, Mahidol University, Bangkok, Thailand; <sup>8</sup>Institute of Dermatology, Ministry of Public Health, Bangkok, Bangkok, Thailand.

**Background:** Women have greater blood pressure (BP) lowering response to low dietary sodium intake (DSI). Whether this gender disparity between DSI and BP remains unclear.

**Methods:** A cross-sectional study using data from the NHANES from 2017 to 2018 included participants ≥18 years old. Association between DSI and systolic blood pressure (SBP) was examined by multiple linear regression.

**Results:** Of 9,254 participants, mean±SD age was 34±26 and 51% were female. Up to 34% was White followed by Black and Mexican American. Body mass index was 25.8 kg/m<sup>2</sup> (IQR 20.4, 31.3). Median DSI was 2,816 mg/day (IQR 1920, 4028) and SBP was 117 mmHg (IQR 106, 131). Every 1,000 mg increase in DSI was associated with increase in 0.99 mmHg SBP (β 0.000099, P 0.480, 95%CI -0.000176, 0.000373). After stratifying by gender, higher DSI of 1,000 mg/day was associated with significantly decreased SBP of 1 mmHg in women; while SBP was 0.16 mmHg increase but non-significant in men (β<sub>women</sub> -0.001007, P <0.0001, 95%CI -0.001516, -0.000497 and β<sub>men</sub> 0.000161, P 0.326, 95%CI -0.000160, 0.000481). After adjusting for age, gender, race, body mass index, and interaction term between gender and DSI, SBP was 0.036 mmHg increase for every 1,000 mg higher DSI (β 0.000364, P 0.012, 95%CI 0.000080, 0.000649). With the same amount of DSI, SBP was 0.78 mmHg lower in women compared to men for every 1,000 mg incremental DSI (β<sub>interaction</sub> -0.000779, P 0.002, 95%CI -0.001261, -0.000297; Figure 1A-D).

**Conclusions:** Higher DSI is inversely associated with SBP levels in women, but not in men. This disparity and paradoxical relationship may explain better BP response to low dietary sodium intervention in women compared to men, although longitudinal studies are required to elucidate the mechanism.

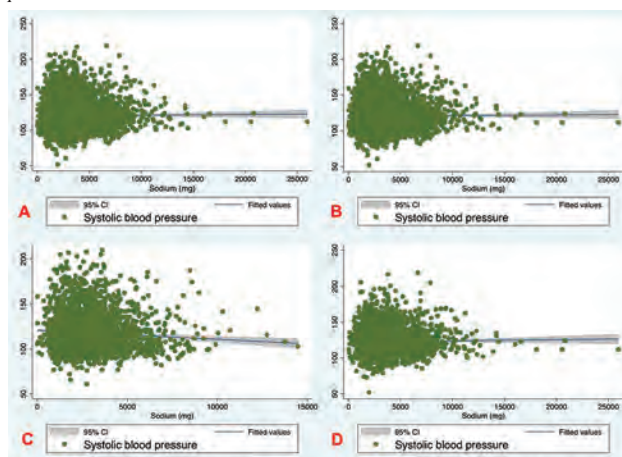

**Figure 1:** Scatter plot between dietary sodium intake and systolic blood pressure in the crude model (A), in the fully adjusted model (B), female (C), and men (D).

**TH-PO599**

**Adherence to Guidelines for Management of Hypertensive Emergency**

Lama Ghazi, James Nugent, Angela M. Victoria Castro, Francis P. Wilson. Yale University, New Haven, CT.

**Background:** Hypertensive emergencies, severe blood pressure (BP) elevation >180/120 associated with end organ damage, are associated with increased mortality. Rates of hospitalization for hypertensive emergencies have increased over the past 10 years especially among Black adults. We assessed the adherence to BP reduction goals for hypertensive emergency and the rates by race.

**Methods:** This is a retrospective study of patients admitted for hypertensive emergency from 2016-2018 within the Yale New Haven Health System. We used International Classification of Diseases codes, labs and manual chart review to assess end organ damage.

We then calculated percent adherence to BP reduction goals set by 2017 American College of Cardiology/American Heart Association guidelines in all patients and by race.

**Results:** We identified 596 patients admitted for hypertensive emergency. Patients were 65 ± 16 years, 50% male, 43% Black with median BP on admission of 207 [193, 226]/ 110 [94, 126] mmHg. Most patients were admitted with ischemic stroke followed by pulmonary edema (Table 1). BP reduction goals were not achieved among most patients at 6 hours and 24 hours regardless of end organ damage type. Black adults are less likely to achieve BP reduction for patients with hypertensive emergency and acute coronary syndrome (ACS) or hemorrhagic stroke (Figure 1).

**Conclusions:** Adherence to BP guidelines in treatment of patients admitted for hypertensive emergency was found to be suboptimal. Black patients with ACS and ischemic stroke had lower rates of BP control. Future efforts should focus on understanding the reasons behind the lack of guideline adherence and racial inequities in treatment.

Table 1. Achieved blood pressure reduction according to 2017 ACC/AHA guidelines

	AAA n= 14 (2.3%)	Pulmonary Edema n= 217 (36.5%)	ACS n= 116 (19.6%)	AKI n= 133 (22.3%)	Ischemic Stroke n= 94 (15.9%)	Hemorrhagic stroke n= 44 (7.4%)
Guideline Recommendations						
BP reduction ≥15% during the 1 <sup>st</sup> hour	11 (79)					
BP reduction by ≥25% over the 1 <sup>st</sup> hour		139 (63)	77 (66)	77 (59)		
BP reduction to <160/100-110 over 2-6 hours		100 (46)	50 (43)	25 (23)		
BP reduction to <140/90 over 24-48 hours		53 (24)	26 (22)	17 (15)		
BP reduced ≥35% over 24 hours if SBP>220 or DBP>120					Out of 54 patients 35 (65)	
BP reduced to 140-150 over 1 hour						38 (86)
Harmful BP reduced <140 over 1 hour						0 (0)

Figure 1. BP goal achieved by race for hypertensive emergency

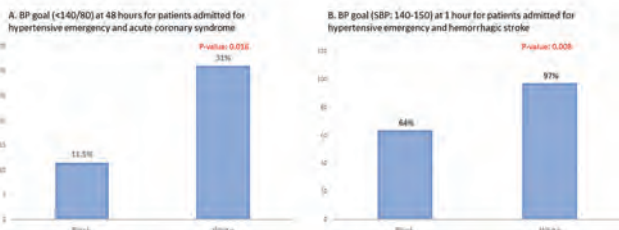

TH-PO600

Clinical Pharmacists Are Underutilized in the Management of Hypertension

Ahmad A. Masry,<sup>1</sup> Meenakshi Sambharia,<sup>1</sup> Linder Wendt,<sup>2</sup> Samantha E. Shaffer,<sup>4</sup> Melissa L. Swee,<sup>1</sup> Patrick Ten Eyck,<sup>2</sup> Korey Kennelty,<sup>4</sup> Heather Reisinger,<sup>2,3</sup> Diana I. Jalal.<sup>1,3</sup> <sup>1</sup>University of Iowa Carver College of Medicine, Iowa City, IA, United States, Iowa, IA; <sup>2</sup>Institute for Clinical and Translational Science, University of Iowa, Iowa City, IA, United States, Iowa, IA; <sup>3</sup>Center for Access & Delivery Research and Evaluation, Iowa City VAMC, Iowa City, IA, United States, Iowa, IA; <sup>4</sup>College of Pharmacy, University of Iowa, Iowa City, IA, United States, Iowa, IA.

**Background:** Previous studies have shown pharmacist-based interventions improve blood pressure (BP) control in individuals with hypertension. We evaluated provider attitudes towards clinical pharmacist support in the management of hypertension.

**Methods:** We surveyed primary care providers, internal medicine residents, nephrologists, cardiologists, nephrology and cardiology fellows, and nurse practitioners at the University of Iowa Hospitals and Clinics and the Iowa City VA Medical Center to determine the attitudes of providers towards clinical pharmacist management of high BP. Continuous data were summarized with medians and interquartile ranges and compared across strata using Wilcoxon rank sum tests. Categorical data were summarized with counts and percentages and compared across strata using Fisher's Exact Tests.

**Results:** 153 out of 413 providers completed the survey. We observed high confidence in the diagnosis and treatment of hypertension among all surveyed groups. Almost half (48%) indicated that they had never referred patients to the clinical pharmacist for management of BP medications and only 32% indicated they rarely did. Pharmacist utilization varied only slightly based on pharmacist availability. 70% agree that clinical pharmacists support clinical decision-making for the management of BP medications, improves the safety of treatment plans for patients taking BP medications, and reduces the burden on providers. Learners and primary care providers were less likely than non-learners and specialists, respectively to refer patients to a pharmacist for management of hypertension. Despite the conflicting evidence regarding home BP monitoring, 90% of the providers indicated that they ask their patients to monitor home BP and that they titrate medications according to home BP readings.

**Conclusions:** Clinical pharmacists are underutilized in our practice although providers expressed favorable perception of clinical pharmacists' roles in the management of hypertension. Interventions are needed to improve pharmacist utilization in the management of hypertension.

TH-PO601

Prevalence and Overlap of Cardio-Renal-Metabolic Conditions in US Adults, 2015-2018

John W. Ostrominski,<sup>1,2</sup> Suzanne V. Arnold,<sup>3</sup> Javed Butler,<sup>4</sup> Gregg C. Fonarow,<sup>5</sup> Jamie S. Hirsch,<sup>6</sup> Swetha R. Palli,<sup>7</sup> Bonnie M. Donato,<sup>7</sup> Christina Parrinello,<sup>8</sup> Eric B. Collins,<sup>9</sup> Tom O'Connell,<sup>10</sup> Mikhail Kosiborod,<sup>3</sup> Muthiah Vaduganathan.<sup>1,2</sup> <sup>1</sup>Brigham and Women's Hospital Carl J and Ruth Shapiro Cardiovascular Center, Boston, MA; <sup>2</sup>Harvard Medical School, Boston, MA; <sup>3</sup>Saint Luke's Mid America Heart Institute, Kansas City, MO; <sup>4</sup>Baylor Scott & White Health, Dallas, TX; <sup>5</sup>University of California Los Angeles David Geffen School of Medicine, Los Angeles, CA; <sup>6</sup>Donald and Barbara Zucker School of Medicine at Hofstra/Northwell, Hempstead, NY; <sup>7</sup>Boehringer Ingelheim Pharmaceuticals Inc, Ridgefield, CT; <sup>8</sup>Pine Mountain Consulting, Redding, CT; <sup>9</sup>Medicus Economics, LLC, Philadelphia, PA; <sup>10</sup>Medicus Economics, LLC, Boston, MA.

**Background:** Cardio-renal-metabolic (CRM) conditions are leading causes of death, disability, and economic burden. Individually, CRM conditions are prevalent in the US population, but the frequency with which CRM conditions coexist has not been comprehensively characterized.

**Methods:** Nationally representative, cross-sectional data on nonpregnant US adults aged ≥20 years from the 2015-2018 NHANES were evaluated. We calculated the proportion of participants with CRM conditions - overall and stratified by age - defined as cardiovascular disease (CVD); atherosclerotic CVD or heart failure), chronic kidney disease (CKD), or type 2 diabetes (T2D). CRM risk factors were also examined by CRM status.

**Results:** Of 9113 US adults included in the analysis (mean age 48.3 y [SD 0.44]; 51.0% women), 27.6% (~70 million adults using population weights) had ≥1 CRM condition, 8.7% had ≥2 CRM conditions, and 1.5% had all 3 CRM conditions (Figure). Individually, CVD was observed in 10.1% of participants, CKD in 14.7%, and T2D in 13.1%. CKD+T2D was the most common CRM dyad (3.2%), followed by CVD+CKD (2.1%) and CVD+T2D (1.9%). Among participants aged ≥65 years, 59.1% had ≥1 CRM condition, 24.5% had ≥2, and 4.9% had 3 CRM conditions. In this group, CVD+CKD (8.2%) was most common, followed by CKD+T2D (7.4%) and CVD+T2D (4.0%). Higher CRM comorbidity burden was associated with more severe CKD stage, additive CVD conditions, older age, male sex, Black race, greater prevalence of key CRM risk factors, and adverse socioeconomic characteristics. Among those with all 3 CRM conditions, 67%, 64%, 4%, and 3% of participants were on a statin, ACEi/ARB, GLP1-RA, or SGLT2i, respectively.

**Conclusions:** CRM conditions commonly intersect in the contemporary US population, with more than a quarter having ≥1 CRM condition. Use of disease-modifying evidence-based CRM therapies remains suboptimal.

Figure. Prevalence of cardio-renal-metabolic (CRM) conditions in all US adults vs. ages ≥65 years, 2015-2018

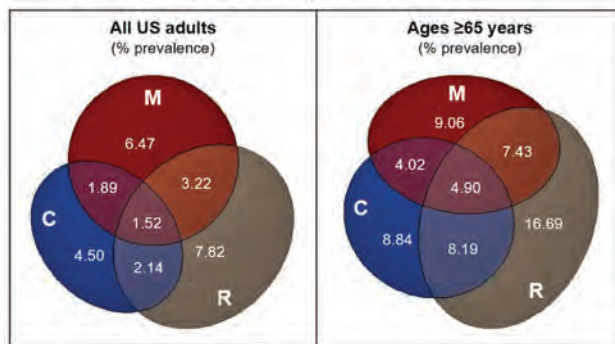

TH-PO602

Newer Guideline-Directed Medical Therapies Are Underutilized in 2021-2022 in Patients With Heart Failure and CKD

Mario Enrico Canonico,<sup>1,2</sup> Judith Hsia,<sup>2</sup> Christopher P. Cannon,<sup>3</sup> Marc P. Bonaca.<sup>1,2</sup> <sup>1</sup>CPC Clinical Research, Aurora, CO; <sup>2</sup>University of Colorado Denver School of Medicine, Aurora, CO; <sup>3</sup>Brigham and Women's Hospital Department of Medicine, Boston, MA.

**Background:** Chronic kidney disease (CKD) is a common comorbidity in patients with heart failure (HF). In 2021 and 2022, HF guidelines endorsed newer therapies such as angiotensin receptor-neprilysin inhibitors (ARNI) and sodium-glucose cotransporter-2 inhibitors (SGLT2i) as first-line medications to improve clinical outcomes in HF patients with or without CKD.

**Methods:** Patients with HF encounters from May 2021 to April 2022 were extracted from the University of Colorado health system TriNetX database. Use of guideline-directed medical therapy (GDMT) was compared by chi square and p for trend calculated across CKD stages. CKD stages were defined by eGFR; dialysis patients were excluded.

**Results:** Among 17990 patients with HF encounters, 51% had reduced (HF<sub>r</sub>EF) and 49% preserved ejection fraction (HF<sub>p</sub>EF). Mild CKD was more common among patients with HF<sub>r</sub>EF than HF<sub>p</sub>EF (Stage G1 25% vs 20%, p<0.0001; G2 40% vs 38%, p<0.05) while more severe CKD was more common in patients with HF<sub>p</sub>EF (G3 32% vs

37%, p<0.0001; G4 4% vs 5%, p=0.0005). Prevalence of hypertension, diabetes (DM), hyperlipidemia, prior myocardial infarction and peripheral artery disease increased with CKD stage (all p <0.0001). Older GDMT (B-blockers, ACE inhibitors, ARB) were widely prescribed (Figure). Use of mineralocorticoid receptor antagonists was intermediate, whereas use of newer GDMT (ARNI and SGLT2i) was less frequent. Among patients with HFrEF or HFpEF, those with DM were more likely to receive SGLT2i than those without T2D (p<0.0001 for each CKD stage).

**Conclusions:** ARNI and SGLT2i use even in 2021-2 was infrequent among patients with HF irrespective of CKD stage; SGLT2i use was particularly low in those without DM.

**Funding:** Commercial Support - Lexicon Pharmaceuticals, The Woodlands, TX, USA

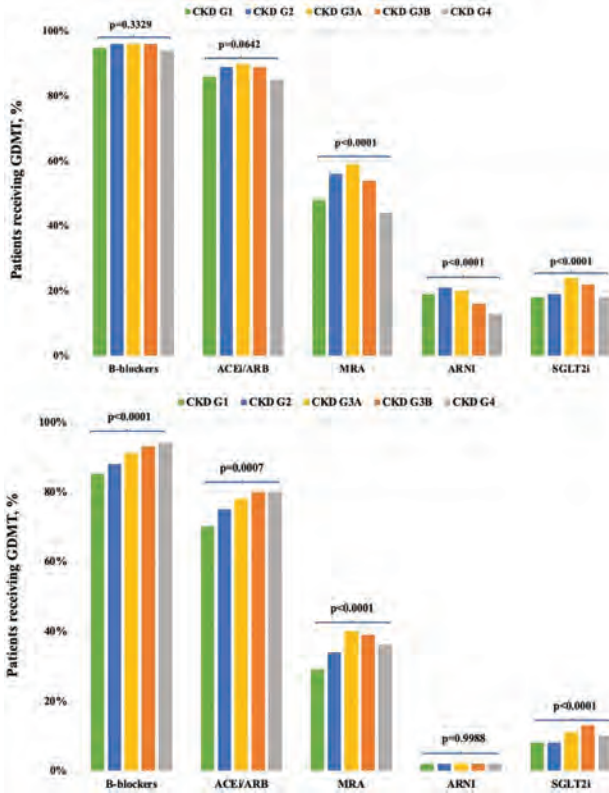

Use of GDMT in HFrEF (upper panel) and in HFpEF (lower panel) by CKD stage.

TH-PO603

**Association Between ACEI/ARB Use With Mortality, Heart Failure Admissions, and Kidney Failure Outcomes Among Patients Admitted for Acute Heart Failure Requiring Invasive Hemodynamic Monitoring**  
 Marcelle Tuttle,<sup>1</sup> Hocine Tighiouart,<sup>1,3</sup> Jake Gillberg,<sup>1</sup> Run Banlengchit,<sup>1</sup> Tatsufumi Oka,<sup>1</sup> Jeffrey M. Testani,<sup>2</sup> Michael S. Kiernan,<sup>1</sup> Mark J. Sarnak,<sup>1</sup> Wendy I. McCallum.<sup>1</sup> <sup>1</sup>Tufts Medical Center, Boston, MA; <sup>2</sup>Yale School of Medicine, New Haven, CT; <sup>3</sup>Tufts Medical Center Institute for Clinical Research and Health Policy Studies, Boston, MA.

**Background:** Angiotensin-converting enzyme inhibitors or angiotensin II receptor blockers (ACEI/ARB) are recommended for patients with heart failure. However, frequently ACEI/ARBs are discontinued or never started during hospitalizations for acute heart failure (AHF), despite evidence of their cardio- and renal-protective benefit.

**Methods:** Records for patients admitted to a quaternary academic center for AHF from 2015-2021 requiring hemodynamic monitoring were reviewed. Definitions included those who continued (ACEI/ARB on the admission and discharge list), started (ACEI/ARB on discharge list only), discontinued (ACEI/ARB on admission list only), or never started. Multivariable Cox regression models were used to examine the association of ACEI/ARB use with a composite outcome of death or AHF readmission and kidney failure (KF) requiring renal replacement therapy.

**Results:** We identified 727 patients admitted for AHF requiring hemodynamic monitoring and surviving to discharge. Mean (SD) age was 61 (14) years and eGFR was 57 (27) ml/min/1.73m<sup>2</sup>. 32% continued, 10% started, 20% discontinued and 38% never started ACEI/ARBs. Over a median follow-up of 5.7 months, compared to patients who continued on ACEI/ARBs, those who either stopped or never started ACEI/ARBs had higher risk of death or AHF hospitalization (Table). KF event numbers were small (n=54) but with similar trends not reaching statistical significance.

**Conclusions:** Among patients admitted for AHF requiring invasive hemodynamic monitoring, patients who were discontinued or never started on ACEI/ARB had an increased risk of death and heart failure hospitalization. Either this supports the importance

of ACEI/ARB benefit in this high acuity AHF cohort, or the inability to tolerate RAAS inhibition is a powerful prognostic factor.

**Funding:** Other NIH Support - NCATS

**Table.** Hazard ratios for composite of death and heart failure hospitalizations and kidney failure during follow-up based on ACEI/ARB use at admission and discharge for acute heart failure hospitalization

Composite of Death and Heart Failure Readmission				
	Continued	Started	Discontinued	Never Started
N	231	73	150	273
N of events	175	41	131	221
Unadjusted	Ref	0.70 (0.50, 0.98)	1.71 (1.36, 2.14)	1.38 (1.13, 1.69)
Adjusted	Ref	0.68 (0.48, 0.95)	1.48 (1.17, 1.88)	1.26 (1.03, 1.55)
Kidney Failure				
N	229	72	144	261
N of events	15	1	16	22
Unadjusted	Ref	0.25 (0.03, 1.90)	2.09 (1.03, 4.24)	1.74 (0.90, 3.37)
Adjusted	Ref	0.26 (0.03, 2.00)	1.65 (0.78, 3.48)	1.45 (0.74, 2.87)

Data are presented at hazard ratios (95% CI). Patients already on dialysis during hospitalization were excluded for the kidney failure outcome. Model was adjusted for age, sex, race, diabetes, hypertension, inotrope use, and baseline eGFR. Abbreviations: ACEI/ARB, angiotensin-converting enzyme inhibitors or angiotensin II receptor blockers; eGFR, estimated glomerular filtration rate

TH-PO604

**Patiromer for Hyperkalemia Management in Patients Receiving Renin-Angiotensin-Aldosterone System Inhibitors for Heart Failure (DIAMOND): Prespecified Analysis of Patients With or Without Diabetes**

Gerasimos Filippatos. On behalf of the DIAMOND Executive Committee National and Kapodistrian University of Athens, Athens, Greece.

**Background:** Renin-angiotensin-aldosterone system inhibitors (RAASi) are the cornerstone of treatment for heart failure with reduced ejection fraction (HFrEF) and chronic kidney disease; hyperkalemia (HK) can result in suboptimal RAASi use. The DIAMOND trial showed that treatment with patiromer, a novel potassium binder, maintained lower serum potassium (sK<sup>+</sup>) vs placebo, and facilitated optimal RAASi therapy, including mineralocorticoid receptor antagonists (MRAs), in patients with HFrEF. This prespecified analysis of the trial assessed patient subgroups with or without diabetes.

**Methods:** Patients with HFrEF with current or history of HK entered a single-blinded run-in phase of up to 12 weeks in which patiromer and RAASi were optimized. Patients were then randomized (1:1) to receive either double-blind continued patiromer or placebo (patiromer withdrawal). The primary endpoint was the mean change in sK<sup>+</sup> from baseline to the end of the trial. Secondary endpoints included sK<sup>+</sup> >5.5 mEq/L, durable enablement of MRA at target dose, investigator-reported adverse events of HK, HK-related hard outcome endpoints, and a win ratio of novel RAASi use score based on the sequence of all-cause mortality, cardiovascular hospitalization, and RAASi use. This prespecified analysis was performed in patients with or without diabetes.

**Results:** Of 1195 patients entering the run-in phase, 878 were randomized, of whom 356 (41%) had diabetes. Patiromer's treatment effect vs placebo was consistent in patients both with and without diabetes (Figure).

**Conclusions:** Patiromer can effectively control sK<sup>+</sup> and facilitate optimization of MRAs in patients with HFrEF irrespective of diabetes.

**Funding:** Commercial Support - Vifor Pharma

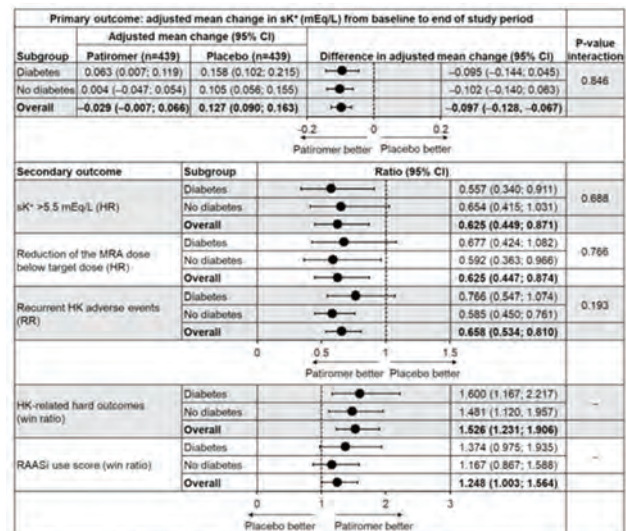

CI, confidence interval; HK, hyperkalemia; HR, hazard ratio; MRA, mineralocorticoid receptor antagonist; RAASi, renin-angiotensin-aldosterone system inhibitor; RR, rate ratio; sK<sup>+</sup>, serum potassium.

TH-PO605

Vitamin D Metabolites and Risk of Cardiovascular Disease in CKD
Simon Hsu, Nisha Bansal, Julia Brown, Michelle Denburg, Harold I. Feldman, Charles Ginsberg, Andrew N. Hoofnagle, Tamara Isakova, Bryan R. Kestenbaum, Benjamin Lidgard, Cassianne Robinson-Cohen, Leila R. Zelnick, Ian H. de Boer. University of Washington, Seattle, WA; University of Pennsylvania Perelman School of Medicine, Philadelphia, PA; Northwestern University Feinberg School of Medicine, Chicago, IL; Vanderbilt University Medical Center, Nashville, TN; University of Illinois Chicago, Chicago, IL; University of California San Diego, La Jolla, CA.

Background: The ratio of 24,25-dihydroxyvitamin D3 to 25-hydroxyvitamin D3 (vitamin D metabolite ratio, VDMR) is a measure of vitamin D status that may reflect tissue-level vitamin D receptor activation.

Methods: We conducted a longitudinal study to test associations of the VDMR and other vitamin D metabolites with risk of cardiovascular disease (CVD) in a random subset of participants from the Chronic Renal Insufficiency Cohort (CRIC; n=1111). Serum 24,25-dihydroxyvitamin D3, 25-hydroxyvitamin D3, and D3, and 1,25-dihydroxyvitamin D2 and D3 were measured by liquid chromatography-tandem mass spectrometry 1 year after enrollment (baseline for the current analysis). The primary outcome was composite CVD (heart failure, myocardial infarction/revascularization, stroke, and peripheral arterial disease). We used Cox regression to test associations of the VDMR, total 25-hydroxyvitamin D (25(OH)D), and total 1,25-dihydroxyvitamin D (1,25(OH)2D) with risk of CVD in participants without prevalent CVD (n=729). We also examined associations of these metabolites with left ventricular mass index (LVMI) measured at the year 1 study visit using linear regression. Analytic models adjusted for demographics, co-morbidity, medications, estimated glomerular filtration rate (eGFR) and proteinuria.

Results: The mean age of the study cohort was 59 years, 43% were female, and 42% were Black. There were 187 composite CVD events over a mean (standard deviation) follow-up of 9.6 (4.6) years among participants without prevalent CVD. Lower VDMR and 1,25(OH)2D were associated with risk of CVD prior to, but not after adjustment for eGFR and proteinuria (Table 1). Neither 25(OH)D, the VDMR, nor 1,25(OH)2D was associated with LVMI after full covariate adjustments.

Conclusions: The VDMR, 25(OH)D, and 1,25(OH)2D were not significantly associated with risk of incident CVD or with LVMI.

Funding: NIDDK Support

Table 1. Associations of vitamin D metabolites with composite cardiovascular disease events\*

Table with 5 columns: Metabolite, N events / N at Risk, Incidence rate (events/1000 person-years), Hazard Ratio (95% Confidence Interval) Model 1, Hazard Ratio (95% Confidence Interval) Model 2. Rows include 25(OH)D (mg/mL), VDMR, and 1,25(OH)2D.

\*Heart failure, myocardial infarction/revascularization, stroke, and peripheral arterial disease. Model 1: adjusted for age, sex, race and ethnicity, hypertension, diabetes, smoking status, systolic blood pressure, body mass index, medications: calcium, vitamin D receptor agonists, renin-angiotensin-aldosterone system inhibitors, beta-blockers, diuretics, statins. Model 2: additionally adjusted for estimated glomerular filtration rate and proteinuria.

TH-PO606

Effect of a 3-Year Lifestyle Intervention on Cardiac Parameters in People With CKD: Sub-Study of a Randomized Controlled Trial
Dev K. Jegatheesan, Rathika Krishnasamy, Tony Stanton, Nicole Isbel, Erin Howden, Kassia S. Beetham, Jeff S. Coombes. LANDMARK III Investigators Princess Alexandra Hospital, Woolloongabba, QLD, Australia; The University of Queensland, Saint Lucia, QLD, Australia; Baker Heart and Diabetes Institute, Melbourne, VIC, Australia; Australian Catholic University, Brisbane, QLD, Australia; Sunshine Coast University Hospital, Sunshine Coast, QLD, Australia.

Background: Chronic kidney disease (CKD) is associated with an increased risk of cardiovascular (CV) disease and mortality. We report the transthoracic echocardiogram (TTE) findings of a predefined sub-study of the LANDMARK III trial, which compared the effect of a nurse-led model of care on CV risk factor modification.

Methods: Adult patients with moderate CKD were randomized to either usual care (UC) or to the nurse-led multidisciplinary lifestyle intervention (LI) in addition to UC. The intervention group received lifestyle and medication advice (from nurse, exercise physiologist, dietitian, psychologist, diabetes educator and social worker) to ensure attainment of risk factor targets; undertook an 8-week supervised exercise training program and a 4-week behavioural modification program focusing on sustainable and self-manageable lifestyle goals. Patients were followed up for 3 years with TTE performed at baseline and annually.

Results: A total of 162 patients were randomized and 56% were male. Mean age was 60 ± 10 years, eGFR was 40 ± 9 ml/min/1.73m², ejection fraction (EF) was 66 ± 7% and global longitudinal strain (GLS) was 18.3 ± 4%. A significant between group difference in GLS (p < 0.001) was identified over the study period, with a significantly greater decline in GLS in the UC group and preservation of GLS in the LI group (-1.1% vs -0.4%, UC

vs LI). No significant changes in EF, left ventricular (LV) mass index, LV filling pressure fractional shortening or relative wall thickness were noted between groups.

Conclusions: A 3-year multidisciplinary LI in people with CKD preserved LV systolic function (GLS) compared to the UC group, who experienced a significant decline in GLS over the study period. This study further highlights that GLS may be a more sensitive marker of LV systolic function than EF in people with CKD.

TH-PO607

Adverse Drug Reactions (ADRs) and Underutilization of ACE Inhibitors and ARBs in CKD

L Parker Gregg, Peter Richardson, Julia Akeroyd, Glenn T. Gobbel, Jennifer Arney, Shehrezade A. Jafry, Adriana Hung, Michael E. Matheny, Salim S. Virani, Sankar D. Navaneethan. Baylor College of Medicine, Houston, TX; Vanderbilt University Medical Center, Nashville, TN; VA Tennessee Valley Healthcare System, Nashville, TN; Michael E DeBakey VA Medical Center, Houston, TX; University of Houston Clear Lake, Houston, TX.

Background: ACEi/ARB are underprescribed in patients with chronic kidney disease (CKD). We identified factors associated with never receiving an ACEi/ARB and associations with ADRs among patients with CKD.

Methods: Using the Veterans Affairs (VA) Corporate Data Warehouse, we identified patients with CKD stages 3-4 from 2005-2019 based on laboratory data. Groups were defined as those prescribed an ACEi/ARB at the time of meeting criteria for CKD (current user group), those for whom an ACEi/ARB had previously been prescribed and discontinued (discontinued group), and those who had never been prescribed an ACEi/ARB in the VA system (never prescribed group). Logistic regression assessed factors associated with never being prescribed an ACEi/ARB and odds of having a documented ADR in 17 categories.

Results: There were 889,453 (50.0%) individuals in the current group, 332,074 (18.6%) in the discontinued group, and 557,903 (31.4%) in the never prescribed group. In multivariable models, older and female participants were more likely to have never been prescribed an ACEi/ARB. Those with heart failure, diabetes, and hypertension had markedly lower odds of never being prescribed an ACEi/ARB (Figure 1A). A documented ADR was present in 2.9% and 1.0% of the discontinued and never groups, respectively. Compared to the discontinued group, the never prescribed group was less likely to have an ADR related to hyperkalemia (OR 0.5, 95% CI 0.4-0.5) or general, neurological, or gastrointestinal symptoms, but more likely to have angioedema (OR 1.2, 95% CI 1.1-1.3), cough (OR 1.1, 95% CI 1.05-1.2), peripheral edema (OR 1.3, 95% CI 1.1-1.4), dyspnea (OR 1.4, 95% CI 1.2-1.8), or allergic reaction (OR 1.4, 95% CI 1.2-1.5) (Figure 1B).

Conclusions: Rates of documented ADRs were low among patients not on ACEi/ARB. ADR types differed between the never prescribed and discontinued groups. Future research should address clinical inertia to prescribing these agents to slow the progression of kidney disease.

Funding: Veterans Affairs Support

Table with 3 columns: ADR Type, Never Documented ADR, Discontinued ADR, P-value. Rows include various ADR types like Acute kidney injury, Allergic reaction, Angioedema, etc.

TH-PO608

Cardiovascular Risk Factor Burden and Treatment Control in Patients With CKD: The Fukuoka Kidney Disease Registry (FKR) Study

Hiomasa Kitamura, Shigeru Tanaka, Hiroto Hiyamuta, Sho Shimamoto, Kazuhiko Tsuruya, Toshiaki Nakano, Takanari Kitazono. Kyushu Daigaku, Fukuoka, Japan; Fukuoka Daigaku, Fukuoka, Japan; Nara Kenritsu Ika Daigaku, Kashihara, Japan.

Background: Cardiovascular disease is a life-threatening complication of chronic kidney disease (CKD). Although cardiovascular risk factor management is important in patients with CKD, few reports detail the frequency of complications and the treatment of cardiovascular risk factors at different stages of CKD in clinical practice.

Methods: A total of 3,411 patients with non-dialysis-dependent CKD who participated in the Fukuoka Kidney Disease Registry Study were cross-sectionally analyzed. Patients were classified into five groups based on their estimated glomerular filtration rate and urinary albumin to urinary creatinine ratio according to Kidney Disease: Improving Global Outcomes 2012 guidelines, which recommend low, moderate, high, very high, and extremely high-risk groups. The primary outcomes were the cardiovascular risk factor burden and the treatment status of cardiovascular risk factors. The association between the CKD groups and the treatment status of each risk factor was examined using a logistic regression model.

Results: The proportion of patients with hypertension, diabetes mellitus, and dyslipidemia increased significantly as CKD progressed, whereas the proportion of patients who achieved cardiovascular risk factor treatment targets was significantly decreased. In the multivariable analysis, the odds ratios (ORs) of uncontrolled treatment targets

were significantly higher for hypertension (OR 7.43) and dyslipidemia (OR 1.45) in the extremely high-risk group than in the low-risk group.

**Conclusions:** Patients with non-dialysis-dependent CKD demonstrate an increased cardiovascular risk factor burden with CKD progression. Extremely high-risk CKD is associated with difficulty in managing cardiovascular risk factors.

TH-PO609

**Sex Hormone and Risk of Cardiovascular Disease and Mortality in Men and Women With CKD: A Systematic Review and Meta-Analysis**

Ester Oh,<sup>1</sup> Courtney Steele,<sup>1</sup> Zhiying You,<sup>1</sup> Kristen L. Nowak,<sup>1</sup> Anna Jovanovich.<sup>1,2</sup> <sup>1</sup>University of Colorado - Anschutz Medical Campus, Aurora, CO; <sup>2</sup>VA Eastern Colorado Health Care System, Aurora, CO.

**Background:** Patients with chronic kidney disease (CKD) commonly experience sex hormone disturbances, which may be associated with risk of cardiovascular disease (CVD) and mortality. A few studies examined the association of sex hormone levels with the risk of cardiovascular outcomes and mortality in a CKD population; however, no studies to date have systematically evaluated current evidence on the association of sex hormone levels with the risk of CVD events and CVD and all-cause death in male and female patients.

**Methods:** Articles were systematically searched in CINAHL, Cochrane, and PubMed from February 1955 through October 2021. A total of 1,698 articles were independently screened by two reviewers, and 17 prospective cohort studies were included. The sex hormones studied were testosterone, estradiol, prolactin, dehydroepiandrosterone sulfate, and relaxin. A random-effects model was used to generate a pooled hazard ratio (HR) to evaluate the association of testosterone levels with the risk of CVD and all-cause death.

**Results:** The sample size ranged from 111-2,419 and the mean age of subjects ranged from 52-72 years. The clinical conditions of the patients included those with non-dialysis CKD (mean/median eGFR between 15-51 mL/min/1.73 m<sup>2</sup>) and dialysis CKD (mean/median vintage between 6-125 months). The majority of the studies examined testosterone levels (11 out of 17 studies) and studied only male patients (12 out of 17 studies). A lower testosterone level was associated with a higher risk of CVD death [HR 4.37 (1.40-13.65), P=0.01] (Fig. 1A) and all-cause death [HR 1.96 (1.35-2.83), P=0.0004] (Fig. 1B) in men with CKD.

**Conclusions:** A lower testosterone level was associated with a higher risk of CVD and all-cause death. There is a strong need for additional studies examining the association of female sex hormones with the cardiovascular and mortality risk.

**Funding:** NIDDK Support, Veterans Affairs Support

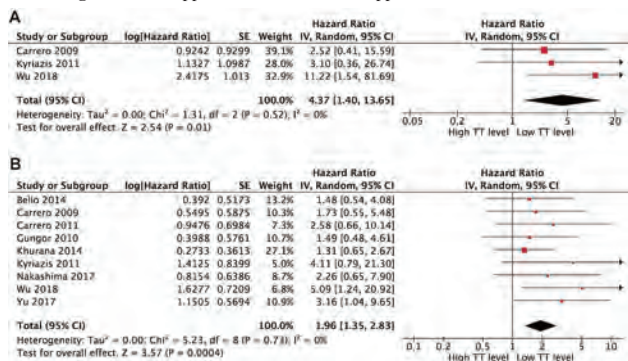

HR for CVD death (A) and all-cause death (B) comparing highest vs. lowest tertile of testosterone level in men with CKD

TH-PO610

**Testosterone and Endothelial Function in Females With CKD**

Nabilah Gulamhusein, Marriisa S. Buchan, Sofia B. Ahmed, Todd J. Anderson, Darlene Y. Sola, Milada Pajevic, Sandi M. Dumanski. University of Calgary Cumming School of Medicine, Calgary, AB, Canada.

**Background:** Cardiovascular disease is the leading cause of death in females with chronic kidney disease (CKD). Elevated testosterone has been associated with increased cardiovascular risk in postmenopausal women and premenopausal women with polycystic ovarian syndrome in the general population, but whether testosterone levels are associated with cardiovascular risk in this high-risk population is unknown. The goal of this study was to determine the association between testosterone levels and endothelial function, a validated measure of cardiovascular risk, in females with CKD.

**Methods:** A cross-sectional study was performed in premenopausal-aged females with CKD (18-51 years). Demographic and metabolic measurements were collected, alongside measurement of total testosterone. Standardized protocols were utilized to measure endothelial function, including right brachial artery flow-mediated dilation (FMD) and hyperemic velocity time integral (VTI). The associations between total testosterone and each outcome (FMD and VTI) were examined using multivariate linear regression analyses.

**Results:** 52 females with non-dialysis-dependent CKD (mean estimated glomerular filtration rate 84 ± 30 mL/min/1.73m<sup>2</sup>, range: 13 - 138 mL/min/1.73m<sup>2</sup>) and 9 females treated with dialysis (89% hemodialysis, 11% peritoneal dialysis) were enrolled, with a

mean age of 37 ± 8 years. Total testosterone levels ranged from <0.2nmol/L to 3.4nmol/L (mean testosterone 0.73 ± 0.63 nmol/L). No association was observed between estimated glomerular filtration rate and testosterone or body mass index and testosterone. There was a trend towards a negative relationship between age and testosterone (p=0.06). After adjusting for age and mean arterial pressure, testosterone was positively associated with VTI (R<sup>2</sup>=0.19, p<0.01), but not FMD (R<sup>2</sup>=0.05, p=0.43).

**Conclusions:** Reduced testosterone levels are associated with impaired microvascular endothelial function in young females with CKD, and may be an important marker of future cardiovascular risk. Given the high cardiovascular risk in the CKD population, further investigation into this risk factor is warranted.

**Funding:** Government Support - Non-U.S.

TH-PO611

**Glomerular Hyperfiltration as Risk Factor of Major Adverse Cardiovascular Events After Acute Myocardial Infarction**

Jin sug Kim, Kyung hwan Jeong, Hyeon Seok Hwang, Division of Nephrology, Department of Internal Medicine, Kyung Hee University, Seoul, Republic of Korea.

**Background:** A reduced glomerular filtration rate (GFR) is a definite risk factor for major adverse cardiovascular event (MACE) in patients with acute myocardial infarction (AMI). While glomerular hyperfiltration (GHF) is associated with early phases of kidney disease, it is unclear whether GHF is associated with higher risk of MACE.

**Methods:** We enrolled total 9,644 AMI patients with estimated GFR ≥60 mL/min/1.73 m<sup>2</sup> from prospective population-based national cohort between November 2011 and December 2015. GHF was defined as GFR > 90th percentile after adjustment for age, sex, lean body mass and history of diabetes and hypertension, systolic blood pressure, left ventricular ejection fraction (LVEF) and use of angiotensin converting enzyme inhibitor or receptor blocker. The primary endpoint was a combination of 3-year major MACEs after AMI occurrence.

**Results:** The GFR in 964 patients with GHF was 113.0 ± 13.1 and it was significantly higher than those in patients with normal GFR (87.7 ± 13.8; P < 0.001). The cumulative event rate of MACEs was significantly higher in patients with GHF (P = 0.033) In multivariable Cox-regression analysis, compared to patients with normal GFR, GHF increased the 1.39-fold risk of MACE (95% confidence interval [CI] 1.15-1.67). Patients with GHF had significantly higher risk of all-cause mortality (hazard ratio [HR] 1.70; 95% CI 1.30-2.23), cardiac death (HR 1.84; 95% CI 1.30-2.60) and ischemic stroke (HR 1.53; 95% CI 1.01-2.33). However, the risk of recurrent MI and rehospitalization for heart failure was not significantly increased.

**Conclusions:** The GHF was independently associated with increased risk of MACE after AMI and the hazardous effects of GHF was pronounced in all-cause mortality, cardiac death and ischemic stroke.

TH-PO612

**The Association of Ejection Fraction With Cardiac Arrest and Myocardial Infarction Differs by eGFR**

Katherine S. Ravi,<sup>1,2</sup> Thomas Mavranakas,<sup>3</sup> Aisha Khattak,<sup>7</sup> Karandeep Singh,<sup>6</sup> David M. Charytan,<sup>4,5</sup> Finnian R. McCausland,<sup>1,2</sup> <sup>1</sup>Brigham and Women's Hospital, Boston, MA; <sup>2</sup>Harvard Medical School, Boston, MA; <sup>3</sup>McGill University, Montreal, QC, Canada; <sup>4</sup>New York University School of Medicine, New York, NY; <sup>5</sup>NYU Langone Medical Center, New York, NY; <sup>6</sup>University of Michigan Medical School, Ann Arbor, MI; <sup>7</sup>The University of Texas Health Science Center at Houston, Houston, TX.

**Background:** Advanced chronic kidney disease (CKD) and left ventricular (LV) systolic dysfunction are potent risk factors for cardiovascular events. Here we explore if the association of LV ejection fraction (EF) with cardiac arrest, myocardial infarction (MI), ischemic stroke, and all-cause mortality differs by eGFR across earlier stages of CKD.

**Methods:** Using registry data from 2004-2014 from five Mass General Brigham hospitals, we performed an observational cohort study of 17,962 patients with eGFR 30-90mL/min/1.73m<sup>2</sup>. Cardiovascular outcomes were ascertained from ICD-9 codes. Cox regression models, incorporating an interaction term for continuous eGFR and LVEF, were fit and adjusted for age, sex, race, hypertension, diabetes mellitus, coronary artery disease, and left ventricular mass index.

**Results:** Mean age was 67 years, and 51% were male. The mean eGFR was 66±16 mL/min/1.73m<sup>2</sup> and LVEF 54±13%. Over a median of 0.96 (0.14-4.84) years there were 437 cardiac arrests, 4,634 MIs, 1,549 ischemic strokes, and 6,282 deaths. The association of LVEF with cardiac arrest differed according to eGFR (P-interaction <0.01). While there was no evidence of association of LVEF with cardiac arrest in the lowest quartile of eGFR (adjusted hazard ratio (aHR) 1.02; 95% CI 0.92-1.13), for each 5% increase in LVEF there was a 21% lower risk of cardiac arrest in the highest quartile of eGFR (aHR 0.79; 95% CI 0.66-0.94; Table). The association of LVEF with MI also decreased as eGFR declined (Table). There was no evidence of effect modification of LVEF by eGFR for ischemic stroke or mortality (P-interaction >0.3 for both).

**Conclusions:** Among patients with eGFR 30-90mL/min/1.73m<sup>2</sup>, the association of LVEF with cardiac arrest disappears at lower (vs. higher) levels of kidney function and is less pronounced for MI at lower (vs. higher) levels of kidney function. Further research is required to elucidate what factors beyond LVEF drive these outcomes in the setting of more advanced kidney disease.

**Funding:** NIDDK Support

**Risk of cardiac arrest and myocardial infarction per each increase in left ventricular ejection fraction of 5% according to eGFR quartile**

Outcome	eGFR (CKD-EPI, ml/min/1.73 m <sup>2</sup> )				P-Interaction
	Quartile 1 (30-54) N=4,598	Quartile 2 (55-68) N=4,400	Quartile 3 (69-80) N=4,671	Quartile 4 (81-90) N=4,293	
Cardiac Arrest	1.02 (0.92-1.13) P=0.72	0.97 (0.86-1.10) P=0.64	0.76 (0.63-0.92) P<0.01	0.79 (0.66-0.94) P=0.01	<0.01
Myocardial Infarction	0.94 (0.91-0.98) P<0.01	0.91 (0.87-0.95) P<0.001	0.90 (0.86-0.95) P<0.001	0.83 (0.79-0.88) P<0.001	<0.01

Abbreviations. eGFR: estimated glomerular filtration rate, CKD-EPI: Chronic Kidney Disease Epidemiology Collaboration, aHR: adjusted hazard ratio, CI: confidence interval, N: number.  
Cox regression model adjusted for age, gender, Black race, hypertension, diabetes mellitus, coronary artery disease, and left ventricular mass index.  
P-Interaction reported for eGFR quartile.

**TH-PO613**

**Rapid Resting Heart Rate Is Associated With ESRD Independent of CVD Risk Factors**

Chi pang Wen, Min Kuang Tsai. *National Health Research Institutes, Zhunan, Taiwan.*

**Background:** Rapid resting heart rate (RHR) has been associated with kidney diseases among individuals with cardiovascular diseases (CVD) but whether such an association exists among those without CVD, including ESRD, is unclear.

**Methods:** Data from a cohort comprising 442,714 adults who participated in a private medical screening program between 1996 and 2017 in Taiwan were analyzed. Participants' IDs were linked and identified 2,212 individuals undergoing dialysis or kidney transplant, with a median follow-up of 13 years. RHR was extracted from reading EKG performed in a supine position after rest. We grouped participants by RHR into 40-59, 60-69, 70-79, 80-89, and  $\geq 90$  beats/min. Cox proportional hazard model was used to develop hazard ratios (HRs) with 95% confidence intervals.

**Results:** Approximately one-fifth (22.2%) of the participants had rapid RHR at  $\geq 80$ /min, and one-third (32.6%) had normal RHR (60-69/min). Rapid RHR had a higher CKD proportion than those with normal RHR. RHR at 80-89/min was associated with a 24% increased ESRD (HR: 1.24, 95% CI: 1.09, 1.42), and, at  $\geq 90$ /min, with a 64% increased ESRD (HR: 1.64, 95% CI: 1.42, 1.90). Starting at 60/min, ESRD risk increased by 14% per 10 beats/min increase (HR: 1.14, 95% CI: 1.10, 1.19). By excluding participants with anyone with any of 4 CVD risks, such as smoking, hypertension, diabetes, or obesity, the significant increase remained in this new CVD risk-free sub-cohort.

**Conclusions:** Rapid resting heart rate ( $\geq 80$ /min) is associated with increased ESRD risks, independent of CVD risks. Rapid RHR should be considered as a risk factor for kidney-related diseases.

**TH-PO614**

**High-Density Lipoprotein Particle Size and Function Predict Cardiovascular Events in Patients With CKD**

Anna V. Mathew, Yun Han, Vetalise K. Chefor, Yanhong Guo, Y. Eugene Chen, Brenda W. Gillespie, Rajiv Saran, Subramaniam Pennathur. *University of Michigan, Ann Arbor, MI.*

**Background:** Chronic Kidney Disease (CKD) is a risk factor for cardiovascular disease (CVD) and 40% of patients with CKD exhibit clinical CVD with greater than 10-fold mortality compared to healthy subjects. Lipoprotein particle size profiles measured with nuclear magnetic resonance spectroscopy and cholesterol efflux capacity (CEC), a metric of high-density lipoprotein (HDL) function predict CVD in the general population. CEC also predicts incident CV events in patients with CKD, but the association of lipoprotein particle size with incident CV events and its link with CEC in CKD patients is unknown.

**Methods:** We quantified the CEC and lipoprotein particle profile of 325 subjects with stage 3-4 CKD (median follow-up of 2.5 years). To assess the association of lipoprotein particle size with incident CV events, we created Cox regression models controlled for various clinical factors, including age, gender, race, history of CVD, diabetes, systolic blood pressure, C reactive protein, renal function, urine protein, and total cholesterol.

**Results:** CEC [HR=1.46, p=0.03] was associated with CV events after adjustment for clinical factors. Increased HDL particle size [HR=2.56, p=0.002], Large HDL particles [HR=1.41, p=0.001], and HDL-cholesterol levels [HR=1.04, p=0.001] associate with decreased time to CV events, while a decrease in small VLDL particles [HR=0.97, p=0.02] particles increased the risk of CV events after adjusting for clinical factors.

**Conclusions:** CEC, HDL cholesterol, and particle size paradoxically were associated with incident CV events in the CKD population adding evidence to the altered HDL metabolism in patients with CKD-associated CVD.

**Funding:** Other NIH Support - NHLBI

**TH-PO615**

**Association of DNA Methylation Signatures With Premature Aging and Cardiovascular Death in Patients With ESKD: A Pilot Study**

Keiichi Sumida,<sup>1</sup> Khyobeni Mozhui,<sup>1</sup> Xiaoyu Liang,<sup>1</sup> Zhongji Han,<sup>1</sup> Yamini Mallisetty,<sup>1</sup> Csaba P. Kovacs,<sup>1,2</sup> <sup>1</sup>The University of Tennessee Health Science Center, Memphis, TN; <sup>2</sup>VA Memphis Medical Center, Memphis, TN.

**Background:** Patients with ESKD display features of premature aging, with extremely high cardiovascular (CV) mortality at a younger age. There is strong evidence that changes in DNA methylation (DNAm) contribute to age-related pathologies; however, little is known about their association with premature aging and CV death in patients with ESKD.

**Methods:** We assayed genome-wide DNAm in a pilot case-control study of 30 hemodialysis (HD) patients who died of CV events as cases and 30 matched HD controls who remained alive during follow-up of 2.0 years. DNAm was profiled on the Illumina EPIC BeadChip. Four established DNAm clocks (i.e., Horvath-, Hannum-, Pheno-, and GrimAge) were used to estimate epigenetic age (DNAmAge), and epigenetic age acceleration (EAA) were derived as the residuals of regressing DNAmAge on chronological age (cAge). An epigenome-wide association study (EWAS) was performed to identify differentially methylated CpGs associated with CV death, adjusted for cAge, sex, race, and top 5 principal components.

**Results:** Patient characteristics were similar between cases and controls, with a mean age of 63 years, 48% male, and 54% African American in both groups. All clocks performed well at predicting cAge (correlation between DNAmAges and cAge of  $r=0.76-0.89$ ). GrimAge had the largest absolute deviation from chroAge (mean, +21.3 years) (**Figure**). There was no significant difference in EAAs between groups. For EWAS, a CpG (cg22305782) in *FBXL19* had the strongest association with CV death with significantly lower DNAm in cases vs. controls ( $P_{FDR}=2.0 \times 10^{-6}$ ). *FBXL19* is involved in inflammation, apoptosis, and cell migration.

**Conclusions:** Overall, we observed more accelerated aging in patient with ESKD, although there was no difference in EAAs between groups. EWAS suggests a potential novel DNAm biomarker for premature CV death in ESKD.

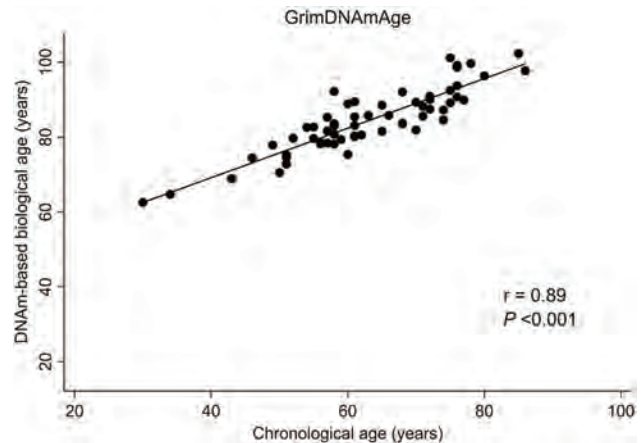

Correlation between cAge and GrimAge in 60 HD patients

**TH-PO616**

**Circulating Small Non-Coding RNA Profiles for Premature Cardiovascular Death in Hemodialysis Patients**

Keiichi Sumida,<sup>1</sup> Surabhi Naik,<sup>1</sup> Zhongji Han,<sup>1</sup> Yamini Mallisetty,<sup>1</sup> Cem Kuscü,<sup>1</sup> Csaba P. Kovacs,<sup>1,2</sup> Canan Kuscü,<sup>1</sup> <sup>1</sup>The University of Tennessee Health Science Center, Memphis, TN; <sup>2</sup>VA Memphis Medical Center, Memphis, TN.

**Background:** Patients with ESKD suffer from disproportionately high cardiovascular disease (CVD) burden. Circulating small non-coding RNAs (c-sncRNAs) have emerged as novel epigenetic regulators and are suggested as novel biomarkers and therapeutic targets for CVD; however, little is known about the associations of c-sncRNAs with premature CV death in ESKD.

**Methods:** Using plasma samples of 50 hemodialysis (HD) patients who died of CV events (cases) and of 50 HD controls who remained alive during a median follow-up of 2.0 years, matched by age, sex, race, and dialysis vintage, we performed c-sncRNAs profile using next-generation sequencing to identify differentially expressed microRNAs (miRNAs) between cases and controls. The association of differentially expressed miRNAs with CV mortality were examined using multivariable conditional logistic regression.

**Results:** Patient characteristics were similar between cases and controls, with a mean age of 63 years, 48% male, and 54% African American in both groups. Among 613 miRNAs detected in the plasma, five miRNAs (i.e., miR-129-1-5p, miR-500b-3p, miR-125b-1-3p, miR-3648-2-5p, and miR-3150b-3p) were identified to be significantly differentially expressed between cases and controls with cut-offs of  $p < 0.01$  and  $\log_2$  fold-change ( $\log_2FC$ )  $> 1$ . When using more stringent cut-offs of p-adjusted  $< 0.05$  and  $\log_2FC > 1$ , only miR-129-1-5p, which is involved in oxidative stress, inflammation, and cardiovascular pathophysiology, remained significant with higher levels of miR-129-1-5p

in cases than in controls (Figure A). The expression levels of miR-129-1-5p were significantly associated with risk of CV death (adjusted ORs [95%CI], 1.03 [1.00-1.06] for 1 increase in DESeq2 normalized counts), independent of matched variables, diabetes, history of CVD, and serum albumin and phosphorus levels (Figure B).

**Conclusions:** Circulating miR-129-1-5p may serve as a novel biomarker for premature CV death in ESKD.

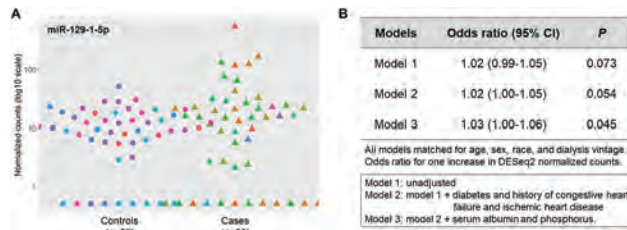

(A) MiR129-1-5p normalized counts in plasma of cases and controls; and (B) Odds ratios and 95% confidence interval for cardiovascular death associated with circulating miR-129-1-5p

TH-PO617

**Dysregulation of Fatty Acid Binding Protein and Its Relationship With Inflammatory Biomarkers in Atrial Fibrillation and Renal Dysfunction**

Vinod K. Bansal, Emily Bontekoe, Mark Jaradeh, Madeline T. Allen, Debra Hoppensteadt, Fakiha Siddiqui, Omer M. Iqbal, Jawed Fareed, Mushabbar Syed. Loyola University Health System, Maywood, IL.

**Background:** Atrial Fibrillation (AF) represents a complex multi-factorial syndrome and is associated with renal compromise. Thrombo-inflammation plays an important role in the pathogenesis of cardiorenal syndrome associated with AF. Fatty acid binding proteins (FABPs) regulate transport of fatty acids and other lipophilic mediators including eicosanoids. While upregulation of FABPs have been reported in AF and their relationship with inflammatory biomarkers is not fully understood. Liver fatty acid binding protein (L-FABP) also known as FABP-1 is a 14kDa protein expressed in the liver and tubular kidney cells. Kidney damage and other pathologic conditions secondary to AF result in the marked upregulation of this protein. This study was aimed to investigate the association of FABP with inflammatory biomarkers in the AF patient population and renal compromise.

**Methods:** Citrated blood samples from 70 AF patients with confirmed clinical diagnosis of atrial fibrillation were enrolled in this study. For comparison purposes normal human plasma collected from 50 normal healthy male and female individuals were used. Plasma prepared from these patients and normal individuals were analyzed for FABP-1 and such inflammatory biomarkers as IL-6, TNFa and inflammasome, using commercially available ELISA methods. All results were compiled and correlation analysis between FABP-1 levels and biomarkers of inflammation were carried out using GraphPad prism software.

**Results:** The AF patients showed a marked increase in FABP levels (13.1 ± 1.1ng/ml) with a broad range (2.1 ± 37.2) in comparison to normal (5.1 ± 0.2ng/ml SEM) with a range of (3.4 - 9.2 ng/ml). Marked increases in IL-6, TNFa and inflammasome were also noted (2 - 4 fold). FABP-1 showed varying degrees of positive correlation with inflammatory biomarkers.

**Conclusions:** These studies suggest that baseline plasma levels of FABP-1 is markedly increased in AF patients with renal compromise. Other biomarkers of inflammation are also upregulated and demonstrate varying degrees of correlation suggesting inter-relationship between FABP-1 and inflammatory processes. These results also suggest that atrial fibrillation and secondary damage to the kidneys contribute to the marked increase in FABP-1 and AF patients.

TH-PO618

**The Risks and Benefits of Aspirin for Primary and Secondary Prevention of Mortality, Cardiovascular Disease, and Kidney Failure**

Jonathan J. Taliercio,<sup>1</sup> Georges Nakhoul,<sup>1</sup> Ali Mehdi,<sup>1</sup> Daohang Sha,<sup>3</sup> Jesse D. Schold,<sup>1</sup> Matthew R. Weir,<sup>2</sup> Scott E. Kasner,<sup>3</sup> Mohamed Hassanein,<sup>4</sup> Sankar D. Navaneethan,<sup>5</sup> Alan S. Go,<sup>6</sup> Claudia M. Lora,<sup>7</sup> Bernard G. Jaar,<sup>8</sup> Teresa K. Chen,<sup>8</sup> Jing Chen,<sup>9</sup> Jiang He,<sup>9</sup> Mahboob Rahman.<sup>10</sup> <sup>1</sup>Cleveland Clinic, Cleveland, OH; <sup>2</sup>University of Maryland Baltimore, Baltimore, MD; <sup>3</sup>University of Pennsylvania, Philadelphia, PA; <sup>4</sup>The University of Mississippi Medical Center, Jackson, MS; <sup>5</sup>Baylor College of Medicine, Houston, TX; <sup>6</sup>University of California San Francisco School of Medicine, San Francisco, CA; <sup>7</sup>University of Illinois Chicago, Chicago, IL; <sup>8</sup>Johns Hopkins University, Baltimore, MD; <sup>9</sup>Tulane University, New Orleans, LA; <sup>10</sup>Case Western Reserve University, Cleveland, OH.

**Background:** CKD is a risk-enhancing factor for cardiovascular disease (CVD) and mortality. The role of aspirin use is unclear in this population since many clinical studies exclude or underrepresent CKD patients. We investigated the risks and benefits of aspirin use in primary and secondary prevention of CVD in the Chronic Renal Insufficiency Cohort (CRIC) Study.

**Methods:** We identified and analyzed 3,664 CRIC subjects based on absence or presence of pre-existing CVD between 2003 -2018. We performed an intention-to-treat analysis and used multivariable Cox proportional hazards model to examine associations of time varying aspirin use with mortality, a composite of CVD events (myocardial infarction, stroke, and peripheral arterial disease), kidney failure (including dialysis and transplant), and major bleeding.

**Results:** The overall cohort included 3,664 subjects, including 2,578 (70.3%) individuals in the primary prevention group. Mean age was 57 (+/- 11) years, 46% women, 42% black, 47% diabetic, and 86% hypertensive. The mean estimated Glomerular Filtration Rate (eGFR) was 45 ml/min/1.73 m<sup>2</sup> and median 24-hour urine protein was 0.2 grams/day. Median follow up was 11.5 (IQR: 7.4-13) years. Aspirin was not protective in all-cause mortality in those without pre-existing CVD (HR 0.89; 95% CI, 0.75 to 1.05, p=0.15) or those with CVD (HR 1.02; 95% CI, 0.91 to 1.14, p = 0.74). Aspirin was not associated with a reduction of the CVD composite in primary prevention (HR 0.97; 95% CI, 0.77 to 1.23, p=0.79) and in secondary prevention (HR 1.08; 95% CI, 0.89 to 1.31, p=0.46). Aspirin use was not associated with kidney failure (HR 0.95; 95% CI, 0.8 to 1.13, p=0.55) or major bleeding (HR 0.84; 95% CI, 0.61 to 1.15, p=0.27) in primary prevention.

**Conclusions:** Aspirin use in CKD patients was not associated with reduction in primary or secondary CVD events, progression to kidney failure, or major bleeding. More clinical studies are needed to assess the use of aspirin in primary and secondary prevention in the CKD population.

Outcome	Aspirin Users		Secondary Prevention	
	Primary Prevention	p-value	Hazard Ratio (95% CI)	p-value
Death	0.89(0.75-1.05)	0.16	1.02(0.91-1.14)	0.74
CVD Death	1.1(0.78-1.54)	0.59	1.11(0.91-1.34)	0.30
CVD Composite	0.94(0.74-1.19)	0.59	1.12(0.95-1.32)	0.16
Kidney Failure	0.96(0.81-1.15)	0.66	0.99(0.87-1.12)	0.83
Major Bleeding	0.85(0.63-1.15)	0.29	0.82(0.66-1.03)	0.08

TH-PO619

**Early Discontinuation of Aspirin Among Patients With CKD Undergoing Percutaneous Coronary Intervention With a Drug Eluting Stent: A Meta-Analysis**

Maria Carolina Festa, Sathiepan Rasasingam, Abhinav Sharma, Thomas Mavrakanas. McGill University Health Centre, Montreal, QC, Canada.

**Background:** Conflicting evidence exists to support whether short duration of dual antiplatelet therapy (DAPT) followed by P2Y12 inhibitor monotherapy reduces bleeding complications after coronary artery drug-eluting stent (DES) insertion, compared with standard 12-month DAPT, particularly among patients with CKD who are at increased risk of bleeding.

**Methods:** A Medline search identified randomized trials comparing up to 3 months of DAPT followed by P2Y12 inhibitor monotherapy versus twelve months of DAPT after insertion of a DES for any indication. Trials were included if they reported ischemic or bleeding outcomes among patients with CKD (eGFR < 60). The primary outcome was a composite of all-cause mortality, cardiac or cerebrovascular events, stent thrombosis (MACCE), and major bleeding events. Secondary outcomes were the individual components of the primary outcome, and clinically significant bleeding. The relative risk (RR) was estimated using a random-effects model.

**Results:** Six randomized trials were included for a total of 4,996 patients with CKD (14% of the trial population). Early discontinuation of aspirin was associated with a similar incidence of the primary outcome among patients with CKD compared with twelve-month DAPT (RR 0.97; 95% confidence interval [95% CI] 0.73-1.30). The relative risk of MACCE was also similar between the two arms (RR 1.02; 95% CI 0.85-1.23). The risk of clinically significant bleeding was significantly lower with early discontinuation of aspirin (RR 0.60; 95% CI 0.46-0.78).

**Conclusions:** P2Y12 inhibitor monotherapy after a shortened course of DAPT is associated with a similar risk of ischemic events and a lower risk of bleeding events after DES insertion among patients with CKD compared with 12-month DAPT.

**Funding:** Government Support - Non-U.S.



Relative risk of MACCE and of clinically significant bleeding with P2Y12 inhibitor monotherapy after shortened DAPT (P2Y12 monotherapy) versus 12-month DAPT (DAPT).



TH-PO620

**A Deep Learning System for Retinal Vessel Calibre Improves Cardiovascular Risk Prediction in Asians With CKD**

Cynthia C. Lim,<sup>1</sup> Crystal Chong,<sup>2</sup> Gavin Tan,<sup>2,3</sup> Ching-Yu Cheng,<sup>2</sup> Charumathi Sabanayagam,<sup>2,3</sup> <sup>1</sup>Singapore General Hospital, Singapore, Singapore; <sup>2</sup>Singapore Eye Research Institute, Singapore, Singapore; <sup>3</sup>Duke-NUS Medical School, Singapore, Singapore.

**Background:** Cardiovascular disease (CVD) and mortality is elevated in chronic kidney disease (CKD). Retinal vessel calibre in retinal photographs is associated with CVD risk and automated measurements from retinal photographs by a deep learning system (DLS) may aid CVD risk prediction.

**Methods:** Retrospective cohort study of 838 Chinese, Malay and Indian participants aged 40-80 years with CKD (estimated glomerular filtration rate (eGFR) <60 ml/min/1.73 m<sup>2</sup>) at the baseline visit (2004-2011) of the population-based Singapore Epidemiology of Eye Diseases Study. Retinal vessel calibre measurements were generated by DLS: central retinal arteriolar equivalent and central retinal venular equivalent at Zone<sub>B</sub> and Zone<sub>C</sub> (CRAE<sub>B</sub>, CRAE<sub>C</sub> and CRVE<sub>B</sub>, CRVE<sub>C</sub>, respectively). Incidence of CVD (defined as non-fatal acute myocardial infarction (AMI) and stroke, and death due to AMI, stroke and heart failure) in those who were free of CVD at baseline was ascertained until 31st December 2018. Risk factors (traditional and retinal-DLS measures) were examined using Cox proportional hazards regression models. Improvement in risk prediction by addition of retinal vascular parameters was assessed by net reclassification improvement (NRI).

**Results:** Baseline mean age was 67.8 (SD 8.8) years and eGFR 47.3 (11.8) ml/min/1.73 m<sup>2</sup>. Incidence of CVD was 30.3%. Multivariable regression models adjusting for traditional risk factors showed that eGFR and retinal parameters independently predicted 10-year CVD risk (Table 1). Addition of eGFR, retinal arteriolar calibre and retinopathy improved overall reclassification of incident CVD beyond traditional risk factors with NRI of 38.2% for Zone<sub>B</sub> and 44.9% for Zone<sub>C</sub> (p<0.001 for both).

**Conclusions:** Addition of kidney function and retinal vessel calibre measurements by DLS improved CVD risk prediction among Asians with CKD.

Table 1. Multivariable regression models for incident cardiovascular disease among Asians with chronic kidney disease

	Model 1	Model 2	Model 3	Model 4
	HR (95% CI)	HR (95% CI)	HR (95% CI)	HR (95% CI)
Age, per 3 year increase	1.05 (1.03-1.07)	1.05 (1.03-1.07)	1.05 (1.03-1.07)	1.05 (1.03-1.07)
Female, yes	0.79 (0.59-1.05)	0.79 (0.59-1.05)	0.83 (0.62-1.11)	0.82 (0.61-1.09)
Ethnicity				
Malay	Reference	Reference	Reference	Reference
Indian	1.53 (1.09-2.16)	1.71 (1.21-2.42)	1.47 (1.02-2.11)	1.54 (1.07-2.21)
Chinese	1.07 (0.71-1.53)	1.14 (0.76-1.70)	1.04 (0.70-1.56)	1.09 (0.73-1.63)
Total cholesterol, per 1 mmol/L increase	1.05 (0.99-1.10)	1.08 (0.97-1.19)	1.07 (0.97-1.19)	1.07 (0.97-1.19)
HDL cholesterol, per 1 mmol/L increase	0.91 (0.60-1.37)	1.02 (0.68-1.52)	1.01 (0.68-1.52)	1.02 (0.68-1.54)
Current smoking, yes	2.07 (1.45-2.96)	2.15 (1.65-2.81)	2.25 (1.57-3.24)	2.26 (1.57-3.26)
Systolic blood pressure, per 1 mmHg increase	1.01 (1.01-1.02)	1.01 (1.01-1.02)	1.01 (1.01-1.02)	1.01 (1.01-1.02)
DBP, per unit increase	1.11 (1.13-1.10)	1.10 (1.12-1.29)	1.18 (1.09-1.27)	1.17 (1.08-1.27)
eGFR, per 1 ml/min/1.73 m <sup>2</sup>		0.97 (0.96-0.98)		
Retinopathy present, yes			1.33 (0.95-1.87)	1.36 (0.97-1.91)
CRAE <sub>B</sub> per 50 decrease in vessel calibre			1.19 (1.15-1.48)	
CRVE <sub>B</sub> per 50 decrease in vessel calibre			1.15 (0.96-1.39)	
CRAE <sub>C</sub> per 50 decrease in vessel calibre				1.44 (1.18-1.75)
CRVE <sub>C</sub> per 50 decrease in vessel calibre				1.29 (0.99-1.48)

TH-PO621

**Associations Between Blood Pressure (BP) and Risk of CKD: A Clinically Adjudicated Study of 0.5 Million Chinese Adults**

Sarah Y. Ng,<sup>1</sup> Rebecca J. Sardell,<sup>1</sup> Peiling Chen,<sup>2</sup> Guang Chen,<sup>2</sup> Jingjing Wang,<sup>2</sup> Shuiqin Cheng,<sup>2</sup> Wenjing Fan,<sup>2</sup> Xia Liu,<sup>2</sup> Zhengming Chen,<sup>1</sup> Zhihong Liu,<sup>2</sup> Yiping Chen,<sup>1</sup> Colin Baigent,<sup>1</sup> Natalie Staplin,<sup>1</sup> William G. Herrington,<sup>1</sup> <sup>1</sup>MRC Clinical Trial Service Unit and Epidemiological Studies Unit, Oxford, United Kingdom; <sup>2</sup>National Clinical Research Center for Kidney Diseases, Jinling Hospital, Nanjing University School of Medicine, Nanjing, China.

**Background:** Observational studies from China show a positive, log-linear relationship between high BP with CKD, but have not adjudicated outcomes.

**Methods:** The China Kadoorie Biobank is a cohort of 0.5 million adults from 5 urban and 5 rural areas of China aged 30-79 years at recruitment between 2004-2008. Hospitalized kidney outcomes were ascertained by prospective linkage to health insurance databases with medical notes reviewed by nephrologist adjudicators. Cox models estimated associations between long-term average (i.e. "usual") BP with risk of CKD. Analyses were performed by time since recruitment and by kidney diagnosis.

**Results:** During a median of 11.1 years follow-up, 3,337 participants were hospitalized with CKD. Mean (SD) eGFR of adjudicator-confirmed CKD was 37.6 (27.0) ml/min/1.73m<sup>2</sup>. Each 10 mmHg higher usual SBP and 5 mmHg higher DBP were associated with a 28% (HR 1.28, 95% CI 1.25-1.32) and 24% higher risk (1.24, 1.21-1.28) of incident CKD (Fig 1). BP-CKD associations were unmodified by time since recruitment but the strengths of associations differed by kidney diagnosis. HRs for diabetic kidney disease, hypertensive nephropathy and glomerulonephritis per 10 mmHg higher SBP were 1.24 (1.14-1.35), 1.65 (1.52-1.78) and 1.18 (1.06-1.32) respectively (Fig 2).

**Conclusions:** Higher BP is linked to a range of kidney diseases with stronger associations in hypertensive nephropathy. Randomized data are needed to confirm causality.

Figure 1. Association between usual systolic blood pressure and diastolic blood pressure with risk of hospitalized CKD

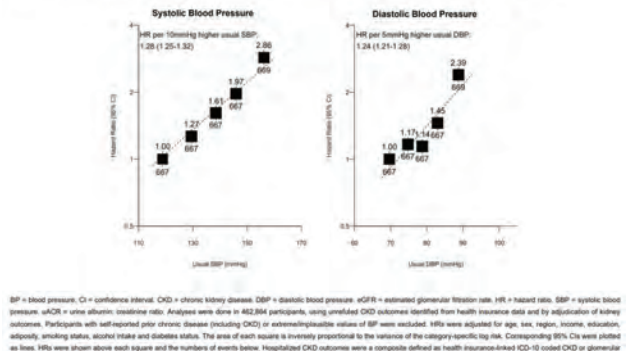
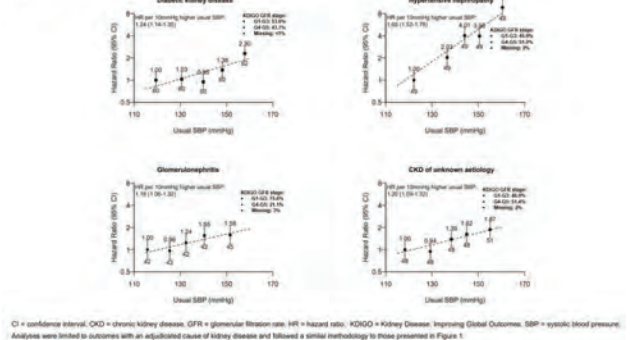

Figure 2. Association between usual systolic blood pressure with risk of hospitalized CKD, by kidney diagnosis



TH-PO622

**Association of Isolated Diastolic Hypertension With Risk of Renal and Cardiovascular Outcomes in CKD: A Report From the Chronic Renal Insufficiency Cohort (CRIC) Study**

Saud A. Alsaleh, Mirela A. Dobre, Sarah Delozier, Mahboob Rahman, Nishigandha Pradhan. *University Hospitals, Cleveland, OH.*

**Background:** Isolated Diastolic Hypertension (IDH) has drawn increased interest after the new definition of hypertension proposed by the 2017 ACC/AHA guidelines. Our analysis examined the prevalence of IDH, and the association of IDH with adverse renal and CV outcomes in patients with CKD

**Methods:** Participants in the CRIC Study; a multicenter observational cohort of ethnically diverse patients with CKD aged 21-74 years. IDH was defined as Systolic BP ≤ 130 and DBP >80. Outcomes were composite kidney events (50% decline in eGFR or onset of ESKD), composite CV events (MI, CHF, stroke, PAD) and all-cause mortality. Cox proportional hazards models adjusted for demographic and clinical covariates

**Results:** The cohort included 5621 participants with a mean age of 59 years; 44% were females and 43% were Black. 51% had diabetes. IDH was present in 6.1% of participants at baseline. After median follow up of 17 years, there was no statistically significant association between IDH and composite kidney outcome (Hazard ratio (HR) 1.17 95% CI 0.93-1.47, p 0.18). The findings were consistent in subgroups by age ≤60 years or >60 years (HR 1.14 95% CI 0.88-1.48, p=0.31 and HR 1.55 95% CI 0.84-2.83, p 0.16 respectively). No association was found between presence of IDH and risk of composite CV events (HR 0.91 (95% CI 0.65-1.27, p=0.58) or all-cause mortality (HR 0.82, 95% CI 0.57-1.19, p 0.30)

**Conclusions:** The Prevalence of IDH in this cohort of participants with CKD patients is 6.1%, similar to that in non-CKD populations. IDH is not associated with risk of adverse kidney and CV events irrespective of age

Association between IDH and clinical outcomes, compared to participants with normal systolic and diastolic BP

	Hazard Ratio (95% CI)	
	Unadjusted	Adjusted
Composite of MI, Stroke, CHF, PAD		
Isolated Diastolic hypertension	.55 (.41, .73), p < .001*	.91 (.65, 1.27), p = .576
Isolated Systolic hypertension	1.71 (1.52, 1.93), p < .001*	1.20 (1.03, 1.39), p = .022*
Systolic Diastolic hypertension	1.46 (1.26, 1.69), p < .001*	1.41 (1.17, 1.71), p < .001*
All-cause mortality		
Isolated Diastolic hypertension	.42 (.30, .58), p < .001*	.82 (.57, 1.19), p = .304
Isolated Systolic hypertension	1.58 (1.38, 1.80), p < .001*	1.11 (.94, 1.30), p = .221
Systolic Diastolic hypertension	1.23 (1.04, 1.45), p = .017*	1.42 (1.16, 1.74), p < .001*

TH-PO623

**Comparison of Cardiovascular Event Predictability Between the 2009 CKD-EPI Equation and the New 2021 CKD-EPI Equations in a Korean CKD Cohort: From the KNOW-CKD Study**

Ji Hye Kim, Kook-Hwan Oh. *Seoul National University Hospital, Jongno-gu, Seoul, Republic of Korea.*

**Background:** 2009 CKD-EPI creatinine (Cr) equation is commonly used for estimated glomerular filtration rate (eGFR). However, it contains race component which is not a biological factor and may cause biased racism. Therefore, 2021 CKD-EPI Cr and creatinine-cystatin C (Cr-Cys) equations omitting race factor were introduced. This study evaluated if new 2021 equations have better predictability for cardiovascular events (CVE) and all-cause mortality in Korean chronic kidney disease (CKD) cohort.

**Methods:** This study included 2207 CKD patients enrolled in Korean Cohort Study for Outcome in Patients With Chronic Kidney Disease (KNOW-CKD). eGFR was calculated using 2009 Cr (eGFR<sub>Cr</sub>), 2021 Cr and Cr-Cys (eGFR<sub>Cr-Cys</sub>) equations. Receiver operating characteristic (ROC) and net reclassification improvement (NRI) were used to compare predictability of each CKD-EPI equation for CVE and all-cause mortality combined.

**Results:** Overall prevalence of CVE and all-cause mortality were 9% and 7%. For CVE predictability, 10 mL/min/1.73m<sup>2</sup> increase in eGFR was associated with lower odds only in unadjusted model in all three equations (2009 eGFR<sub>Cr</sub>: HR 0.90, 95% CI [0.86, 0.95], 2021 eGFR<sub>Cr</sub>: HR 0.91, 95% CI [0.87, 0.96], 2021 eGFR<sub>Cr-Cys</sub>: HR 0.90, 95% CI [0.85, 0.95]). For CVE and all-cause mortality combined, 10 mL/min/1.73m<sup>2</sup> increase in eGFR was associated with lower odds in all three equations including multivariable model (2009 eGFR<sub>Cr</sub>: HR 0.93, 95% CI [0.89, 0.98], 2021 eGFR<sub>Cr</sub>: HR 0.94, 95% CI [0.89, 0.98], 2021 eGFR<sub>Cr-Cys</sub>: HR 0.92, 95% CI [0.87, 0.96]). Area under curves of ROC for both CVE (0.715, 0.716, 0.716) and CVE and all-cause mortality combined (0.747, 0.747, 0.751) did not show significant differences among the three equations. Compared to 2009 equation, both 2021 Cr (NRI 0.013, 95% CI [-0.002, 0.028], p=0.09) and Cr-Cys (NRI -0.001, 95% CI [-0.031, 0.029], p=0.94) equations did not show improved CVE predictability. Similar findings were observed for CVE and all-cause mortality combined for both 2021 Cr (NRI -0.019, 95% CI [-0.039, 0], p=0.06) and Cr-Cys (NRI -0.002, 95% CI [-0.023, 0.018], p=0.82).

**Conclusions:** Neither 2021 CKD-EPI Cr, nor Cr-Cys equations showed significant improvement in predicting CVE and all-cause mortality in Korean CKD patients compared to 2009 CKD-EPI Cr equation.

TH-PO624

**Structural Equation Modeling of Kidney Function Biomarkers Improves Incident Cardiovascular Risk Estimation**

Ryosuke Fujii,<sup>1,2</sup> Roberto Melotti,<sup>1</sup> Martin Gögele,<sup>1</sup> Laura Barin,<sup>1</sup> Dariush Ghasemi-Semeskandeh,<sup>1</sup> Giulia Barbieri,<sup>1</sup> Peter Paul Pramstaller,<sup>1</sup> Cristian Pattaro.<sup>1</sup> *<sup>1</sup>Eurac Research, Bolzano, Italy; <sup>2</sup>Fujita Health University, Toyoake, Japan.*

**Background:** While there is no biochemical trait that alone can represent the true kidney function of an individual, formulas have been developed to obtain the estimated glomerular filtration rate (eGFR) based on serum creatinine (eGFR<sub>crea</sub>) or cystatin C (eGFR<sub>cys</sub>) or their combination (eGFR<sub>crea/cys</sub>). However, a more general method that takes advantage of kidney function-related changes observed in other biomarkers is lacking.

**Methods:** In the Microisolates in South Tyrol (MICROS) study, we applied structural equation modeling (SEM) to derive a latent kidney function biomarkers based on serum creatinine, cystatin C, eGFR<sub>crea</sub>, and eGFR<sub>cys</sub> estimated with the CKD-Epi equations, uric acid (UA), and blood urea nitrogen (BUN), and accounting for sex and age (n=647). In an independent longitudinal dataset (n=670), we assessed the ability of the identified latent trait to predict increased risk of cardiovascular disease (CVD) over 10 years.

**Results:** Based on standard goodness-of-fit statistics, the best model was selected that included eGFR<sub>crea</sub>, eGFR<sub>cys</sub>, UA, and BUN. The corresponding latent trait showed a C-statistics [95% CI] of 0.70 [0.65–0.74] for a 10-year prediction of a Framingham risk score of ≥5%. The corresponding C-statistics for CKD-EPI eGFR<sub>crea</sub>, eGFR<sub>cys</sub>, and eGFR<sub>crea/cys</sub> were of 0.63 [0.58–0.68], 0.69 [0.65–0.74], and 0.66 [0.62–0.71], respectively.

**Conclusions:** The SEM-derived latent kidney trait showed better performance in 10-year CVD risk prediction over conventional eGFR estimation methods.

**Funding:** Private Foundation Support, Government Support - Non-U.S.

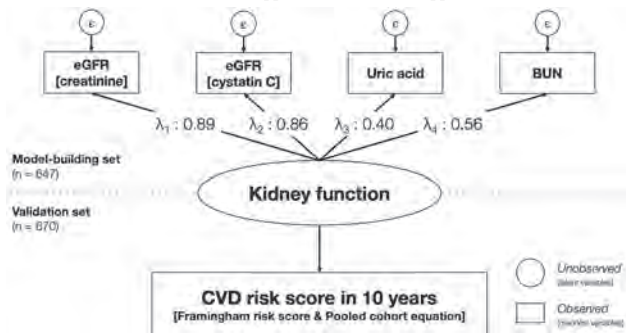

Conceptual figure of our SEM analysis and factor loadings from the best fitting model

TH-PO625

**Association Between Homocysteinemia and Mortality in CKD: A Propensity-Score Matched Analysis Using NHANES-National Death Index**

Jinsuk Bae,<sup>1,2</sup> Jehun Song,<sup>1,2</sup> Hyuk Huh,<sup>3</sup> Eunjin Bae,<sup>3</sup> Jeonghwan Lee,<sup>4,6</sup> Jung Pyo Lee,<sup>4,6</sup> Jong Soo Lee,<sup>1,2</sup> Kyung Don Yoo.<sup>1,2</sup> *<sup>1</sup>University of Ulsan College of Medicine, Songpa-gu, Seoul, Republic of Korea; <sup>2</sup>Ulsan University Hospital, Ulsan, Dong-gu, Republic of Korea; <sup>3</sup>Gyeongsang National University Graduate School of Medicine, Jinju, Gyeongsangnam-do, Republic of Korea; <sup>4</sup>Seoul National University Seoul Metropolitan Government Boramae Medical Center, Dongjak-gu, Seoul, Republic of Korea; <sup>5</sup>Inje University Busan Paik Hospital, Busan, Republic of Korea; <sup>6</sup>Seoul National University College of Medicine, Seoul, Republic of Korea.*

**Background:** Hyperhomocysteinemia (HHcy) is considered a risk factor for cardiovascular disease (CVD) including chronic kidney disease (CKD). In this study, we investigated the association between serum homocysteine (Hcy) level and mortality according to the presence of CKD.

**Methods:** Our study included data of 9,895 participants from the 1999–2016 National Health and Nutrition Examination Surveys (NHANES). Multivariable-adjusted Cox proportional hazards models using propensity-score were used to examine dose-response associations between Hcy level and mortality.

**Results:** Of 9,895 participants, 1032 (21.2%) participants were diagnosed with CKD. In a multivariate Cox regression analysis including all participants, Hcy level was associated with all-cause mortality, compared with the 1<sup>st</sup> quartile in the fully adjusted model (2<sup>nd</sup> quartile: hazard ratio (HR) 1.751, 95% confidence interval (CI) 1.348–2.274, p<0.001; 3<sup>rd</sup> quartile: HR 2.220, 95% CI 1.726–2.855, p<0.001; 4<sup>th</sup> quartile: HR 3.776, 95% CI 2.952–4.830, p<0.001). In the non-CKD group, there was a significant association with all-cause mortality; however, this finding was not observed in the CKD group. The observed pattern was similar after propensity score matching. In the non-CKD group, overall mortality increased in proportion to Hcy concentration (2<sup>nd</sup> quartile: HR 2.195, 95% CI 1.299–3.709, p = 0.003; 3<sup>rd</sup> quartile: HR 2.607, 95% CI 1.570–4.332, p<0.001; 4<sup>th</sup> quartile: HR 3.720, 95% CI 2.254–6.139, p<0.001). However, the risk of all-cause mortality according to the quartile of Hcy level did not increase in the CKD group.

**Conclusions:** This study found a correlation between the Hcy level and mortality rate only in the non-CKD group. These altered risk factor patterns may be attributed to protein-energy wasting or chronic inflammation status that is accompanied by CKD.

TH-PO626

**Calcification of Branches Is Superior to Abdominal Aortic Calcification in Predicting Mortality of Hemodialysis Patients**

Wen Shi, Xiaoliang Zhang. *Southeast University, Nanjing, China.*

**Background:** Vascular calcification (VC) is considered to be an important risk factor of cardiovascular events, which contributes to the leading cause of death in hemodialysis (HD) patients. Inspired by an extreme example of VC in dialysis patients, calciphylaxis, we hypothesized VC of branches was a better predictor of mortality than abdominal aortic calcification (AAC).

**Methods:** A cohort study was established including 237 HD patients. The calcification volume of abdominal aorta and its branches in CT were quantitatively evaluated through software 3DSlicer4.11. Patients were followed up to death or September 2020, and were randomly divided into training set and testing set in a ratio of 7:3. Lasso regression analysis, Cox regression and nomograms were used to construct a predictive model.

**Results:** The prevalence of total VC is 95.36%. AAC is the most prevalent (88.61%), followed by calcification of internal iliac artery (85.65%). AUC of Time-dependent ROC by internal iliac artery and mesenteric artery calcification for predicting mortality is significantly higher than the others. Internal iliac artery calcification (IIAC) was screened out as the most valuable predictor for all-cause death among the arteries. IIAC (HR=1.503, P<0.001), serum albumin (HR=0.911, P<0.001) and the history of cardio-cerebrovascular diseases (HR=1.735, P=0.017) were independent factors of mortality in HD patients. The nomogram based on Cox regression model is shown in Figure 1. The clinical decision curve shows the model's high value of clinical application. (Figure 2).

**Conclusions:** Calcification of branches, especially IIAC, is a better predictor for mortality of HD patients than AAC. Our concern with calcification of large arteries in HD patients needs to be shifted to smaller branches.

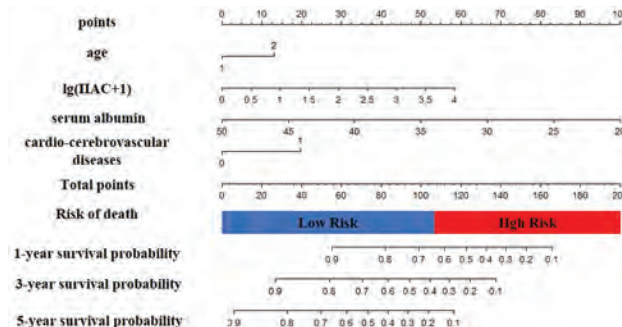

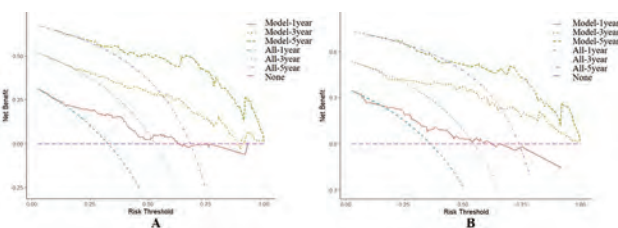

Decision curves of Cox regression model from training dataset(A) and testing dataset(B).

**TH-PO627**

**Cardiorenal Syndrome and Kidney Disease Progression in Patients With Heart Failure or CKD: Is the Heart Leading the Way?**

Carla Alexandra R. Santos Araujo,<sup>3,1</sup> Luís C. Mendonça,<sup>3</sup> Daniel Seabra,<sup>2</sup> Filipa Bernardo,<sup>4</sup> Marisa Pardal,<sup>4</sup> João Couceiro,<sup>4</sup> Hugo M. Martinho,<sup>4</sup> Daniel Dias,<sup>5</sup> Ricardo J. Dinis-Oliveira,<sup>6,7</sup> Cristina Gavina,<sup>2</sup> Tiago Taveira Gomes.<sup>5</sup>  
<sup>1</sup>Nephrology Department, Pedro Hispano Hospital, Matosinhos, Portugal; <sup>2</sup>Cardiology Department, Pedro Hispano Hospital, Matosinhos, Portugal; <sup>3</sup>UnIC@RISE, Department of Surgery and Physiology, Faculty of Medicine of the University of Porto, Porto, Portugal; <sup>4</sup>Medical Department, AstraZeneca, Lisbon, Portugal; <sup>5</sup>Department of Community Medicine, Information and Decision in Health, Faculty of Medicine, University of Porto, Porto, Portugal; <sup>6</sup>TOXRUN – Toxicology Research Unit, University Institute of Health Sciences, Advanced Polytechnic and University Cooperative (CESPU), CRL, Gandra, Portugal; <sup>7</sup>Department of Public Health and Forensic Sciences, and Medical Education, Faculty of Medicine, University of Porto, Porto, Portugal.

**Background:** Simultaneous occurrence of heart failure (HF) and chronic kidney disease (CKD) is known as cardiorenal syndrome (CRS). This study aims to assess CKD progression and estimate 1-year risk of end-stage renal disease (ESRD) in patients with HF, CKD and CRS.

**Methods:** Retrospective analysis of an integrated healthcare institution database from 2008-2019 was performed. We defined 4 incident cohorts: **Control** - 75 years old; **HF** - HF patients without CKD; **CKD** - CKD patients without HF; **CRS** - patients with HF and CKD. HF was defined as either: i) ejection fraction (EF) ≤40% and NT-proBNP ≥200pg/mL OR BNP ≥100pg/mL; ii) EF >40% in the presence of structural cardiac abnormalities. CKD was defined as eGFR ≤60mL/min (EPI-CKD). Kidney disease progression was evaluated by eGFR drop of ≥50% from baseline and ESRD defined by eGFR <15mL/min or any ICD-9/10 codes for dialysis. Hazard ratios and 95% confidence intervals were estimated using Cox regression models adjusted for age, sex, hypertension, myocardial infarction, stroke, peripheral artery disease and type 2 diabetes.

**Results:** We identified 3973 patients with HF, 13990 with CKD, 6784 with CRS and 16182 controls. Patients were 75-77 years old, mostly female and well treated with CV drugs. eGFR drop ≥50% from baseline was observed early at 60 days (7% in CKD, 9% in HF and 13% in CRS) and maintained throughout the observation period. ESRD risk was 4.0 in HF patients (3.1-5.3) and 4.1 in CKD patients (3.3-5.1). CRS was associated with the highest risk of ESRD development: 9.9 (7.9-12.4) (Figure 1).

**Conclusions:** Kidney disease progression was frequent in cardiorenal disease patients and occurred early in disease development. CRS establishment added a significant risk of early and fast ESRD. Although HF patients begin with higher eGFR, overall ESRD risk is similar which deserves future analysis.

**Funding:** Commercial Support - AstraZeneca

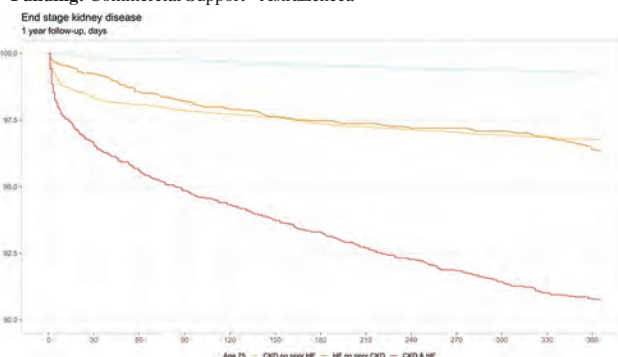

**TH-PO628**

**Cardiorenal Syndrome and Death Risk in Heart Failure or CKD Patients: An Urgent Call for Action**

Carla Alexandra R. Santos Araujo,<sup>1,2</sup> Luís C. Mendonça,<sup>1</sup> Daniel Seabra,<sup>5</sup> Filipa Bernardo,<sup>3</sup> Marisa Pardal,<sup>3</sup> João Couceiro,<sup>3</sup> Hugo M. Martinho,<sup>3</sup> Daniel Dias,<sup>4</sup> Ricardo J. Dinis-Oliveira,<sup>6,7</sup> Cristina Gavina,<sup>5</sup> Tiago Taveira Gomes.<sup>4</sup>  
<sup>1</sup>UnIC@RISE, Department of Surgery and Physiology, Faculty of Medicine of the University of Porto, Portugal, Porto, Portugal; <sup>2</sup>Nephrology Department, Pedro Hispano Hospital, Matosinhos, Portugal, Matosinhos, Portugal; <sup>3</sup>Medical Department, AstraZeneca, Lisbon, Portugal, Lisbon, Portugal; <sup>4</sup>Department of Community Medicine, Information and Decision in Health, Faculty of Medicine, University of Porto, Portugal, Porto, Portugal; <sup>5</sup>Cardiology Department, Pedro Hispano Hospital, Matosinhos, Portugal, Matosinhos, Portugal; <sup>6</sup>TOXRUN – Toxicology Research Unit, University Institute of Health Sciences, Advanced Polytechnic and University Cooperative (CESPU), CRL, Portugal, Gandra, Portugal; <sup>7</sup>Department of Public Health and Forensic Sciences, and Medical Education, Faculty of Medicine, University of Porto, Porto, Portugal, Porto, Portugal.

**Background:** Simultaneous occurrence of heart failure (HF) and chronic kidney disease (CKD) is known as cardiorenal syndrome (CRS). This study aims to estimate 1-year CRS risk in HF or CKD patients and 1-year risk of all-cause death, cardiovascular (CV) death and non-fatal major CV events (MACE) in HF, CKD and CRS patients.

**Methods:** Retrospective analysis of integrated healthcare institution database from 2008-2019. We defined 4 cohorts: **Control** - 75 years old; **HF** - HF patients without CKD; **CKD** - CKD patients without HF; **CRS** - HF and CKD patients. HF was defined as: i) ejection fraction (EF) ≤40% and NT-proBNP ≥200pg/mL OR BNP ≥100pg/mL; ii) EF >40% in the presence of structural cardiac abnormalities. CKD was defined as eGFR ≤60mL/min (EPI-CKD). Hazard ratios and 95% confidence intervals were estimated by Cox regression models adjusted for age, sex, hypertension, myocardial infarction, stroke, peripheral artery disease and type 2 diabetes.

**Results:** We identified 3973 HF patients, 13990 with CKD, 6784 with CRS and 16182 controls. Patients were 75-77 years old, mostly female and well treated with CV drugs. On follow-up 1293 CKD patients (9.2%) and 593 HF patients (14.9%) developed CRS. All-cause death risk was 4.7 (4.1-5.2) for HF and 4.9 (4.5-5.4) for CKD. CV death risk was 8.6 (6.8-10.8) for HF and 8.7 (7.1-10.6) for CKD. Non-fatal MACE risk was 7.4 (6.3-8.7) for HF, 4.6 (4.0-5.3) for CKD, and 7.1 (6.1-8.3) for CRS. CRS was associated with the highest risk of all-cause and CV death: 7.1 (6.4-7.9) and 13.7 (11.7-17.0), respectively (Figure 1). Most events occurred in first 90 days.

**Conclusions:** Cardiorenal disease was associated with very high short-term risk of CRS or death, with highest risk in CRS patients. These results support an urgent need for improved prevention of cardiorenal disease and CRS.

**Funding:** Commercial Support - AstraZeneca

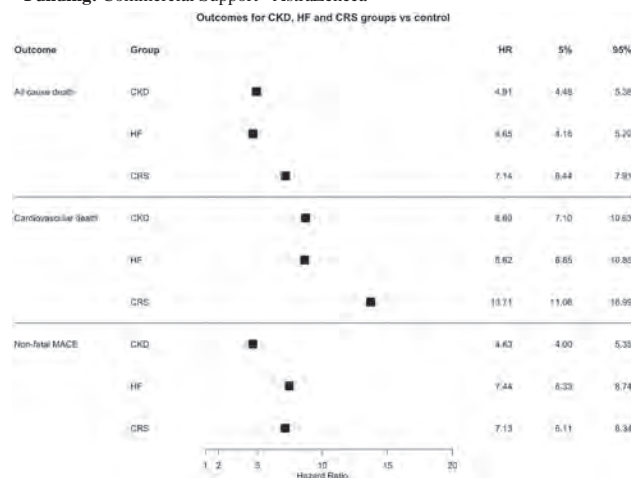

**TH-PO629**

**Cardiac Biomarkers and Kidney Function: A Bidirectional Mendelian Randomization Study**

Cassianne Robinson-Cohen,<sup>1</sup> Nicholas Vartanian,<sup>1</sup> Elvis A. Akwo,<sup>1</sup> Adriana Hung,<sup>1</sup> Talat Alp Ikizler,<sup>1</sup> Nisha Bansal.<sup>2</sup>  
<sup>1</sup>Vanderbilt University Medical Center, Nashville, TN; <sup>2</sup>University of Washington, Seattle, WA.

**Background:** Observational studies report strong associations between circulating cardiac biomarkers and kidney function. However, this evidence is vulnerable to bias from confounding and reverse causation. The aim of this study was to explore the causal direction of the relationship between kidney function and cardiac biomarkers using a bidirectional Mendelian Randomization (MR) approach.

**Methods:** Four cardiac biomarkers were studied, including NT-proBNP (N-terminal pro-B-type natriuretic peptide), galectin-3, growth differentiation factor-15 (GDF-15) and soluble ST2. Two-sample MR was used to estimate the causal effect of eGFR on these

biomarkers and then performed in the opposite direction. We used as instruments genetic variants associated with creatinine-based eGFR in a large trans-ethnic genome-wide association study (GWAS) among individuals from the Chronic Kidney Disease Genetics Consortium (CKDGen, n=765,348) and UK Biobank (UKB, n=436,581), explaining up to 8.9% of the variance in eGFR, and GWAS of cardiac biomarkers from the SCALLOP consortium (n=21,757).

**Results:** Genetically predicted lower levels of eGFR were associated with higher levels of galectin-3 ( $p=2.3 \times 10^{-9}$ ) and GDF-15 ( $p=3.9 \times 10^{-4}$ ), but not NT-proBNP or soluble ST2 (Figure 1). In the other direction, there was evidence of a causal relationship between higher soluble ST2 and lower eGFR ( $p=0.0032$ ), but not for any of the other biomarkers (Figure 2).

**Conclusions:** This MR study suggests that elevated galectin-3 and GDF-15, but not NT-proBNP or soluble ST2, are a consequence rather than a cause of reduced eGFR. Our findings also support a role for ST2 as a risk factor for reduced eGFR. Future work is needed to understand the mechanisms underlying these relationships and potential clinical utility of these biomarkers.

**Funding:** NIDDK Support

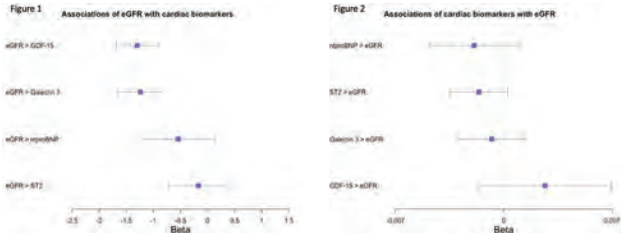

**TH-PO630**

**Association Between CKD Progression and Heart Failure: A Retrospective Cohort Study**

Silvia J. Leon Mantilla,<sup>1</sup> Reid Whitlock,<sup>1</sup> Clara Bohm,<sup>2</sup> Paul Komenda,<sup>2</sup> Claudio Rigatto,<sup>2</sup> Navdeep Tangri.<sup>2</sup> <sup>1</sup>Seven Oaks General Hospital, Winnipeg, MB, Canada; <sup>2</sup>University of Manitoba Max Rady College of Medicine, Winnipeg, MB, Canada.

**Background:** Heart failure (HF) and chronic kidney disease (CKD) are strongly interlinked through multifaceted inter-organ cross-talk that increase the risk of the co-existence of both conditions. HF and CKD separately and in combination, are associated with high symptom burden, mortality risk and increased healthcare costs. We sought to determine if heart failure is a risk factor for adverse renal outcomes and death in patients with CKD and to quantify the magnitude of its effect.

**Methods:** We conducted a retrospective cohort study using administrative health data from Manitoba, Canada. We included all adults (≥ 18 years) with prevalent CKD (as defined by KDIGO using CDK-EPI eGFR <60 mL/min/1.73 m<sup>2</sup> and/or proteinuria for over 3 months) between January 1st, 2007, and Jan 1st, 2018. We identified a subgroup of patients with HF at baseline. We examined the association of interim HF event (as time-dependent exposure) with study outcomes using time-dependent Cox models adjusted for demographics, comorbidities, eGFR, UACR, and medications (e.g., RAASi, beta blockers). The primary composite outcome was ≥ 40% decline in estimated glomerular filtration rate (eGFR), renal replacement therapy (chronic dialysis or kidney transplant), or all-cause mortality; DD40 events.

**Results:** Of the 18,880 prevalent CKD, 3,650 (19%) had history of HF at baseline. The mean eGFR was 51 ± 26 mL/min/1.73m<sup>2</sup> and the median UACR was 6.20 mg/mmol (IQR: 1.4 - 32.4). There were 4,546 (24%) patients with at least 1 interim HF event, with a median time to first interim HF event of 1.9 years. In time-dependent analysis, those with HF at baseline had a higher risk of DD40 events as well as its components after an interim HF event compared to those without interim HF events adjusted HR for DD40 (aHR): 1.98; 95%CI: 1.81-2.17. Similarly, in those without HF at baseline, interim HF hospitalization was associated with higher risk of DD40 events compared to those without interim HF events (aHR: 1.59; 95%CI: 1.50-1.69).

**Conclusions:** Interim heart failure is associated with an increased risk of a composite outcome of all-cause mortality, ESKD, and ≥ 40% decline in eGFR in patients with CKD irrespective of history of HF. These findings strongly support efforts to optimize treatment for primary and secondary prevention of heart failure hospitalizations in patients with CKD.

**Funding:** Private Foundation Support

**TH-PO631**

**Race-Free KDIGO Risk Categories and CVD Mortality Among Black US Adults, 1999-2019**

Juanly N. Rodriguez, Yelena Drexler, Richard Barrios, Neda Shahoori, Farid Isaac, Gabriel Contreras, Tali Elfassy. Filtering 305 University of Miami School of Medicine, Miami, FL.

**Background:** Mortality from cardiovascular disease (CVD) is high among those with CKD. Remarkable racial disparities in CVD risk and progression to ESKD exist between Black and non-Black adults. Elimination of the race coefficient to estimate GFR, while helping to mitigate these disparities, results in higher prevalence estimates for CKD among Blacks. In this study, we describe CVD mortality rates among Black US adults by KDIGO risk category using a race-free eGFR equation.

**Methods:** The National Health and Nutrition Examination Survey is a representative sample of US adults. We included 10,658 Black adult participants (1999-2018) with mortality data through 2019 linked from the National Death Index. Using serum creatinine, eGFR was calculated using the 2009 CKD-EPI and 2021 race-free CKD-EPI equations. Albumin-to-creatinine ratio (ACR in mg/g) was measured from spot urine samples. Participants were classified into four KDIGO risk categories (low, intermediate, high, or very high risk) based on ACR and eGFR. CVD mortality (CVD-M) was defined through ICD-10 codes as diseases of the heart or cerebrovascular disease. We used age adjusted Poisson regression models to estimate incidence densities (ID) per 1,000 person years (PY) and ID ratios (IDRs) for CVD-M.

**Results:** The population was comprised of 55.6% women with a mean age of 43 years. After an average follow-up of 9.9 years, 1,348 (11.5%) died of any cause and 438 (3.8%) died of CVD. Rates of CVD-M were not significantly different when using the 2009 CKD-EPI or 2021 race-free CKD-EPI equation to classify KDIGO risk. After removing the race coefficient, compared to the lowest KDIGO risk (ID: 2.3/1,000PY, 95% CI: 1.9, 2.8), CVD-M was 115% greater (IDR: 2.15, 95% CI: 1.69, 2.73) with intermediate KDIGO risk (ID: 5.0/1,000 PY, 95% CI: 4.2, 6.1), 200% greater (IDR: 3.00, 95% CI: 2.20, 4.09) with high KDIGO risk (ID: 7.0/1,000PY, 95% CI: 5.4, 9.1), and 428% greater (IDR: 5.28, 95% CI: 3.59, 7.78) with very high KDIGO risk (ID: 12.4/1,000PY, 95% CI: 9.3, 16.5).

**Conclusions:** Among Black US adults, CVD-M rates were similar using the 2009 CKD-EPI or 2021 race-free CKD-EPI equation. CVD-M rates were substantially higher with greater KDIGO risk, independently of the use of a race coefficient.

**Funding:** Private Foundation Support

**TH-PO632**

**Deep Learning Retinal Image Analysis for the Detection of CKD and Cardiovascular Risk Factors in the General Population**

Donal J. Sexton,<sup>1,4</sup> Roman Romero-Ortuno,<sup>2,4</sup> Silvin P. Knight,<sup>2</sup> Rozenn Dahyot,<sup>3,5</sup> Rose Anne M. Kenny,<sup>1,4</sup> Ali Karaali.<sup>1,5</sup> <sup>1</sup>Irish Longitudinal Study on Ageing (TILDA), Trinity College Dublin, Dublin, Ireland; <sup>2</sup>FRAILMatics group, TILDA, Trinity College Dublin., Dublin, Ireland; <sup>3</sup>Maynooth University, Maynooth, Ireland; <sup>4</sup>St James's Hospital, Dublin, Ireland; <sup>5</sup>ADAPT Research Centre, Dublin, Ireland.

**Background:** Retinal blood vessel patterns provide an opportunity to personalize an individuals risk assessment for CKD and cardiovascular risk factors (CVRF). In this study we propose a deep learning (DL) based prediction tool that uses retinal images from the Irish Longitudinal Study on Ageing (TILDA) to detect the existence of CKD in community dwelling individuals aged 50 years and over.

**Methods:** TILDA is a stratified random sample of the general population of Ireland. N=4569 participants underwent a detailed health assessment including retinal photography. We developed a convolutional neural network architecture inputting a single retinal image per participant for the prediction of CKD & CVRF. Binary cross entropy was used as a loss function. Analyses were conducted on the FRAILMatics HPC "Tinney".

**Results:** See Table 1 & Image 1 for results.

**Conclusions:** A DL retinal image algorithm has good discrimination for CKD, eGFR and CVRF in community dwelling individuals. The prediction emphasis of our DL algorithm focuses on slightly different structures within the retinal image to predict serum creatinine versus serum cystatin.

Results of Deep Learning Retinal Image Analysis for CKD

Classification Neural Network (Image only)		AUC
CKD by Serum Creatinine		0.68
CKD by Serum Cystatin C		0.71
Regression Neural Network (Image only)		MAE
Age		0.84 yrs
Systolic BP		16.55 mmHg
eGFR CKDEPI Creatinine		13.9 mL/min
eGFR CKDEPI Cystatin C		14.8 mL/min

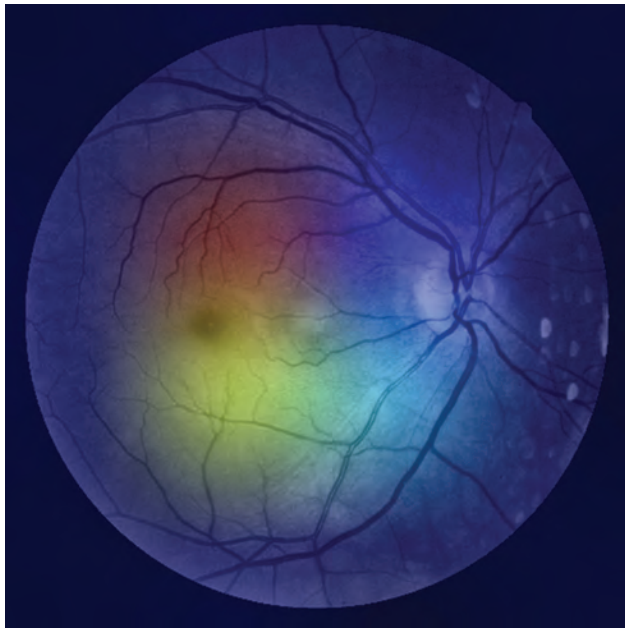

Attention Map demonstrating where within the retinal image the algorithm is focusing to predict CKD by Cystatin C. Red-Yellow-Blue in descending order of importance.

TH-PO633

ESKD as a Risk Factor for Acute Coronary Syndrome in Younger Patients

Millan L. Whittier, Meloney Oliveira, Augustine Manadan. Rush University Medical Center, Chicago, IL.

**Background:** End-stage kidney disease (ESKD) is a known risk factor for cardiovascular (CV) disease including acute coronary syndrome (ACS), arrhythmias and congestive heart failure. ESKD patients are at higher risk of CV related mortality compared to the general population. There is presently a paucity of population-based studies of ESKD as a risk factor for ACS in young patients. We aimed to compare the presence of ACS in hospitalized patients aged 18-40 to patients >40 years with and without ESKD while controlling for traditional CV risk factors.

**Methods:** Data was extracted from the 2016-2019 US National Inpatient Sample (NIS) database. Hospitalizations of adult patients with ACS as the principal diagnosis, with and without ESKD as the secondary diagnosis were evaluated. Age was divided categorically into 2 groups: adults 18-40 and >40 years. The primary outcome was the development of ACS. MV logistic regression analysis was used to adjust for confounders.

**Results:** There were 121,099,120 adult hospital discharges in 2016-2018 NIS database. Of those, 74,225 between 18-40 and 2,626,129 >40 years were hospitalized with a principal diagnosis of ACS. Traditional CV risk factors were associated with ACS hospitalizations in both age groups. In MV analysis of the 18-40 age group, the odds ratio (OR) for ESKD was 1.24 (P<0.001) (Table 1). Above the age 40, the OR for ESKD was 0.95 (P<0.001) (Table 1).

**Conclusions:** In younger patients, ESKD was strongly associated with ACS hospitalization in addition to the traditional CV risk factors. In the older group, traditional CV risk factors predominated in the association with ACS.

Multivariate Analysis of CV Risk Factors

Variables	ACS between ages 18 to 40			ACS in greater than age 40		
	Odds Ratio	P-Value	95% Confidence Interval	Odds Ratio	P-value	95% Confidence Interval
Diabetes	1.22	<0.001	1.166-1.287	1.17	<0.001	1.159-1.177
Hypertension	2.33	<0.001	2.256-2.435	0.95	<0.001	0.942-0.957
Hyperlipidemia	10.42	<0.001	9.917-10.953	2.69	<0.001	2.668-2.724
Obesity	1.97	<0.001	1.890-2.047	1.09	<0.001	1.080-1.103
Smoker	2.52	<0.001	2.426-2.612	1.71	<0.001	1.700-1.729
ESKD	1.24	<0.001	1.118-1.366	0.95	<0.001	0.931-0.961
Female	0.30	<0.001	0.288-0.312	0.61	<0.001	0.607-0.615
African American	1.00	0.938	0.892-1.132	0.67	<0.001	0.649-0.707
White	0.90	0.079	0.802-1.012	0.86	<0.001	0.824-0.894
Hispanic	0.78	<0.001	0.692-0.886	0.87	<0.001	0.829-0.907
Asian and Pacific Islander	1.13	0.126	0.967-1.310	1.05	0.061	0.998-1.104
Other Race	1.00	0.963	0.869-1.159	1.01	0.734	0.954-1.069

TH-PO634

Heart Failure: A Risk Factor for Progression to ESKD

Sydney E. Hartsell,<sup>1,2</sup> Xiangyang Ye,<sup>1,2</sup> Amara Sarwal,<sup>1,2</sup> Robert E. Boucher,<sup>1,2</sup> Adhish Agarwal,<sup>1</sup> Guo Wei,<sup>1,2</sup> Srinivasan Beddhu.<sup>1,2</sup> <sup>1</sup>The University of Utah School of Medicine, Salt Lake City, UT; <sup>2</sup>VA Salt Lake City Health Care System, Salt Lake City, UT.

**Background:** Despite much interest in cardiorenal syndrome, there is a paucity of data on whether heart failure (HF) is a risk factor for progression to end-stage kidney disease (ESKD).

**Methods:** We used the VA Informatics and Computing Infrastructure (VINCI) platform to identify a national cohort of veterans (N=993,929) with CKD stages 3A, 3B or 4 (two or more outpatient CKD-EPI eGFR 15 to <60 ml/min/1.73m<sup>2</sup> taken 60 days apart) from January 2010 to December 2015. Index date was defined as the date of second outpatient creatinine with follow-up through June 30, 2018. ICD9/10 codes defined baseline comorbidities and prevalent HF. We identified ESKD by linkage to the US Renal Data System, and mortality from VA CDW data. In separate multivariate Cox regression models, we related baseline HF with time to ESKD alone and a composite of ESKD/ death adjusted for demographics, comorbidities and baseline blood pressure.

**Results:** 19.4% had HF at baseline. The distribution of CKD 3A, 3B and 4 were 68.3%, 25.3% and 6.4% respectively. There were 21,706 ESKD events over 4.7 million person-years of follow-up, 409,539 deaths over 4.6 million person-years and 420,505 ESKD/death events over 4.6 million person-years of follow up. In the entire CKD cohort, HF was significantly associated with higher hazard of ESKD (HR1.27, 95% CI 1.23-1.31) and ESKD/death (HR1.90, 95% CI 1.89-1.92). Compared to those without HF and with stage 3A CKD, those with HF and more advanced CKD had higher risk of ESKD and ESKD/death (Fig 1 and Table).

**Conclusions:** HF is an independent risk factor for ESKD progression in CKD. Interventions that target HF might slow CKD progression to ESKD.

**Funding:** NIDDK Support, Other NIH Support - R01 DK118219 – NIDDK; R01 AG074592 – NIA; R01 DK128640 – NIDDK, Veterans Affairs Support

Adjusted Hazard of ESKD or Composite ESKD/Death

CKD Stage & Baseline HF Status	HR of ESKD	95% CI	HR of Composite	95% CI
3A & No HF	1 (reference)	-	1 (reference)	-
3A & HF	1.62	1.51-1.73	2.02	2.00-2.04
3B & No HF	4.41	3.95-4.28	1.40	1.39-1.41
3B & HF	5.45	5.15-5.76	2.62	2.59-2.65
4 & No HF	19.92	19.12-20.75	2.35	2.32-2.38
4 & HF	21.82	22.71-22.99	4.00	3.94-4.07

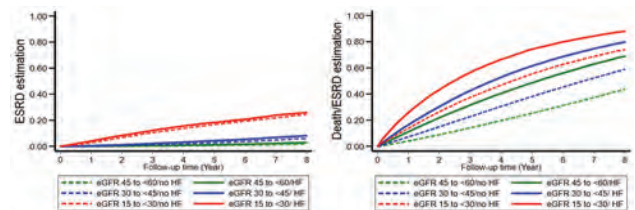

Fig. 1: ESKD and Composite Outcomes differ by HF and CKD stage (unadjusted Kaplan Meier Curves)

TH-PO635

Association of Microscopic Hematuria With Long-Term Mortality in Patients With Hypertensive Crisis

Saeyoung Jeong,<sup>1</sup> Mi-yeon Yu,<sup>1</sup> Jeong-Hun Shin,<sup>2</sup> Byung Sik Kim.<sup>2</sup> <sup>1</sup>Division of Nephrology, Department of Internal Medicine, Hanyang University College of Medicine, Hanyang University Guri Hospital, Guri, Republic of Korea; <sup>2</sup>Division of Cardiology, Department of Internal Medicine, Hanyang University College of Medicine, Hanyang University Guri Hospital, Guri, Republic of Korea.

**Background:** Microscopic hematuria is associated with an increased risk of chronic kidney disease and death in the general population. However, there are no data on the long-term mortality risk associated with microscopic hematuria among patients with hypertensive crisis. We hypothesized that microscopic hematuria at initial presentation in patients with hypertensive crisis would be associated with higher long-term mortality.

**Methods:** This retrospective study included patients admitted to the emergency department between 2016 and 2019 for hypertensive crisis (systolic blood pressure ≥180 mmHg or diastolic blood pressure ≥110 mmHg). Microscopic hematuria was defined as ≥3 red blood cells per high-power field on microscopic evaluation of urine.

**Results:** Among the 3,595 patients, 1,359 (37.8%) had microscopic hematuria. The 3-year all-cause mortality in patients with and without microscopic hematuria were 25.5% and 16.3%, respectively. After adjusting for confounding variables, patients with microscopic hematuria (adjusted HR, 1.30; 95% CI, 1.10–1.54) showed a significantly higher risk of 3-year all-cause mortality than patients without microscopic hematuria. In a subgroup analysis according to presence of proteinuria, microscopic hematuria was a significant predictor of all-cause mortality in patients without proteinuria (adjusted HR, 1.61; 95% CI, 1.28–2.03), but not in patients with proteinuria.

**Conclusions:** Microscopic hematuria was a significant predictor of all-cause mortality in patients with hypertensive crisis. Our study suggests that microscopic hematuria can serve as a useful prognostic marker and permit early detection of patients with an increased risk of death. Clinicians in the emergency department should consider screening for kidney function using urine analysis during the initial assessment of patients with hypertensive crisis.

**TH-PO636**

**Renal B-Cell Activating Factor Correlates With Worsened Allograft Pathology and Inflammation in a Rat Model of Antibody-Mediated Rejection**

Sarah E. Panzer, Nancy A. Wilson. *University of Wisconsin-Madison, Madison, WI.*

**Background:** B-cell activating factor (BAFF) promotes B cell maturation and correlates with renal disease activity in lupus nephritis. We hypothesized renal BAFF levels are increased in chronic-active antibody-mediated rejection (AMR).

**Methods:** A minor mismatch rat kidney transplant model was utilized, with experimental groups of syngeneic, allogeneic, and sensitized allogeneic (donor blood transfusion 21 days pre-transplant) recipients. Allograft pathology and donor-specific antibody levels (DSA) were assessed 6 months post-transplant. Renal tubular epithelial cell (RTEC) and glomerular endothelial cell (GEnC) BAFF gene expression was determined, *in vitro*.

**Results:** Allogeneic and sensitized allogeneic recipients had chronic-active AMR and elevated renal BAFF levels compared to syngeneic recipients (Figure 1A). Renal BAFF correlated with glomerulitis ( $R^2=0.39$ ,  $P=0.01$ ), peritubular capillaritis ( $R^2=0.60$ ,  $P=0.0007$ ), microvascular inflammation ( $R^2=0.64$ ,  $P=0.0003$ ), C4d ( $R^2=0.43$ ,  $P=0.008$ ), intragraft macrophages ( $R^2=0.48$ ,  $P=0.004$ ), vimentin ( $R^2=0.46$ ,  $P=0.006$ ), and IgG DSA ( $R^2=0.69$ ,  $P=0.0001$ ). RTEC and GEnC generated BAFF transcript in response to IFN $\gamma$  stimulation, *in vitro* (Figure 1B).

**Conclusions:** Renal BAFF levels were elevated in chronic-active AMR and correlated with allograft inflammation (microvascular inflammation, intragraft macrophages, and C4d) and epithelial de-differentiation (vimentin). Thus, renal BAFF contributes to allograft inflammation and resident renal cells are a source of BAFF. As anti-BAFF therapeutics are now clinically available, further studies are needed of the effects BAFF has on renal tissues and its therapeutic effectiveness in AMR.

**Funding:** NIDDK Support

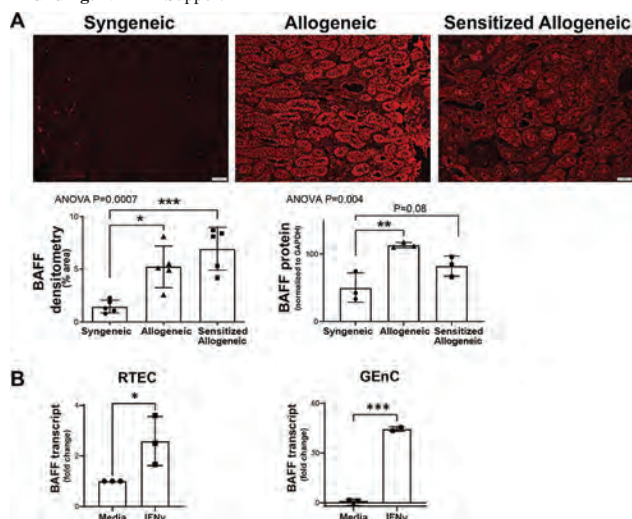

**Figure 1.** A) BAFF (red) was increased in allogeneic and sensitized allogeneic recipients compared to syngeneic recipients. B) RTEC and GEnC stimulated with IFN $\gamma$  generated BAFF transcript.

**TH-PO637**

**Normothermic Ex Vivo Kidney Perfusion Preserves ATP Generation and Graft Function After Warm Ischemia, Which Is Further Enhanced With Pharmacologic Mitochondrial Protection**

Masataka Kawamura,<sup>1,2</sup> Catherine Parmentier,<sup>1,3</sup> Samrat Ray,<sup>1,3</sup> Sergi Clotet Freixas,<sup>1,3</sup> Emmanuel Nogueira,<sup>1,3</sup> Yuki Noguchi,<sup>1,3</sup> Bhranavi Arulratnam,<sup>1,3</sup> Sujani Ganesh,<sup>1,3</sup> Ana Konvalinka,<sup>1,3</sup> Markus Selzner,<sup>1,3</sup> Lisa Robinson,<sup>2,4</sup> <sup>1</sup>Toronto General Hospital, Toronto, ON, Canada; <sup>2</sup>The Hospital for Sick Children, Toronto, ON, Canada; <sup>3</sup>University Health Network, Toronto, ON, Canada; <sup>4</sup>University of Toronto, Toronto, ON, Canada.

**Background:** Normothermic Ex-vivo kidney machine perfusion (NEVKP) is a novel preservation technique. We recently determined that NEVKP preserves the expression of proteins involved in mitochondrial biogenesis in kidneys. We hypothesize that ex vivo machine perfusion will replenish energy levels in mitochondria, thereby restoring mitochondrial function and reducing injury in kidney grafts. AP39, a mitochondria-

targeted hydrogen sulfide donor, has been shown to stimulate mitochondrial electron transport and improve cellular bioenergetic function. Here, we investigated whether administering AP39 during NEVKP protects mitochondrial function and protects renal grafts from ischemia reperfusion injury.

**Methods:** Porcine kidneys were subjected to either 0 or 60 minutes of warm ischemia (WI) followed by 5 hours of static cold storage (SCS) or NEVKP. The warm ischemia grafts were subsequently divided into three groups: SCS group, NEVKP group, and a group in which AP39 was additionally administered during NEVKP (NEVKP + AP39) (Fig. 2.). After contralateral nephrectomy, grafts were auto-transplanted and animals were followed for 3 days. Renal function and ATP levels were assessed.

**Results:** All animals (n=5-6 in each group) survived the follow-up period. Grafts preserved with NEVKP had lower serum creatinine (SrCr) on postoperative day 3 compared to the SCS group (Fig. 1). Treatment with NEVKP + AP39 further reduced SrCr when compared to the NEVKP group (HB vs SCS vs NEVKP vs NEVKP + AP39: 1.7±0.3 vs 12.7±1.1 vs 7.6±2.8 vs 3.5±1.1 mg/dl, mean±SD). We measured ATP in biopsy-derived cell suspensions from grafts stored using SCS, NEVKP, and NEVKP + AP39. ATP levels were increased in the NEVKP group compared with SCS group at the time of pre-implantation and this level was further increased when AP39 was administered. (SCS vs NEVKP vs NEVKP + AP39: 21.9±11.4 vs 73.6±9.3 vs 121.6±36.3 nM/1000cells).

**Conclusions:** For grafts subjected to warm ischemia, NEVKP has the potential to preserve ATP generation and graft function, which is further enhanced with mitochondria-targeted hydrogen sulfide donor, AP39.

**TH-PO638**

**HIF1 $\alpha$  and Succinate Pathway: Role in Deceased Kidney Donors Inflammation**

Jordi Vilardell. *Fundacio Puigvert, Barcelona, Spain.*

**Background:** The type of donor has an impact on the renal prognosis of the recipient. It has been observed that the decline of renal function is higher in deceased donor (DD). These could be related with the pre-implantation inflammation state of the donor and the development of fibrotic processes. Own data indicate that complex succinate dehydrogenase (SDH) has a lower gene expression in DD kidneys and is associated with inflammatory markers, macrophages, and purinergic receptors and a worse renal function graft. The aim of this study is to determine that in renal DD, ischemia/hypoxia can increase renal succinate levels, inducing infiltration of inflammatory cells.

**Methods:** Pre-implantational kidneys biopsies from 47 DD and 19 LD, were collected. 159 genes from these samples were analysed by qRT-PCR. Relative quantification of gene expression was performed with 3 internal controls. Genes with high positive correlation with HIF1 $\alpha$  have been grouped in clusters using STRING database. Succinate levels were measured in serum from 27 renal DD and in 10 healthy volunteers with the EnzyChrom™ Succinate Assay Kit. All statistical data was analyzed using GraphPad Prism 5.

**Results:** To determine the hypoxia status of kidney donors, transcription levels of HIF1 $\alpha$  and HIF2 $\alpha$  were determined from renal tissue samples. A significant increase in HIF1 $\alpha$  gene expression is observed in DD compared to LD ( $p<0.001$ ). From the expression of the 159 genes analyzed, 24 of them are expressed exclusively in DD samples and have a high correlation with HIF1 $\alpha$  ( $Rho > 0.5$ ). These genes have been grouped in 3 different clusters: Transcription factors and metalloproteinases, ECM proteins and integrins and Inflammatory and Macrophages Markers. We also found reduced mRNA expression of all the SDH subunits ( $p<0.001$ ) in DD samples. As a consequence, succinate cannot be converted to fumarate in concordance with the greater succinate levels ( $p=0.002$ ) observed in sera of DD.

**Conclusions:** These results indicate that kidneys from DD undergo a greater hypoxia compared with LD, demonstrated by the increased transcription rate of HIF1 $\alpha$ . Hypoxia not only increases HIF1 $\alpha$  but also may affect the energetic metabolism of the cell, reducing the expression of SDH. As a consequence extracellular levels of succinate increase, maintaining HIF1 $\alpha$  levels, that could take part in a sustained inflammatory/anti-inflammatory process in kidney from DD.

**Funding:** Private Foundation Support, Government Support - Non-U.S.

**TH-PO639**

**Changes in Urinary Proteome in Living Kidney Donors After Kidney Donation**

Sachin M. Naik, Kajal Kamboj, Jaskiran Kaur, Joyita Bharati, Ashok K. Yadav, Vivek Kumar. *Post Graduate Institute of Medical Education and Research, Chandigarh, India.*

**Background:** Recent concerns about long term effects of living kidney donation have generated interest in adaptive mechanisms post kidney donation. We present initial data on changes in urinary proteome over 6 months after living kidney donation.

**Methods:** Prospective living kidney donors, scheduled for living donor kidney transplantation, were enrolled. Participants were followed up at 6 months after surgery. Urine samples for proteomics were collected before surgery and at 6 months after surgery. Urinary proteomic profiling was done by liquid chromatography and mass spectrometry (LC-MS/MS) using Thermo Scientific™ Orbitrap Fusion™ Tribrid™ mass spectrometer.

**Results:** 25 participants have been enrolled till date. We present data of 15 participants who have completed follow up. The mean age was 43.2±7.62 years. Serum creatinine increased while hemoglobin and serum inorganic phosphorus decreased at 6 months after living kidney donation. Proteomic analyses showed 257 differentially expressed proteins (DEPs) (115 downregulated, 142 upregulated, figure 1). Gene ontology enrichment analysis suggest upregulation of insulin like growth factor pathway, growth factor activity, cell junction organization and cell activation, and downregulation of generation of precursor metabolites and energy, various solute transporters, cell cycle, cell adhesion

molecule binding, MAPK family signaling pathway. The protein-protein interactions and pathway relatedness suggest linkage to Erb1 downstream pathway, Rho GTPase effectors, PDGFRB pathway etc.

**Conclusions:** This study provides clues to possible biological processes and pathways involved in kidney adaptation. However, these need more evaluation and validation.

**Funding:** Government Support - Non-U.S.

UPREGULATED PROTEINS		
Accession No	Protein name	Function
P01344	Insulin-like growth factor II	positive regulation of organ growth
P98172	Ephrin-B1	Angiogenesis, cell adhesion; cell-cell signaling
P55285	Cadherin-6	Wnt signaling, adherens junction organization, proximal tubular development
P05413	Fatty acid-binding protein, heart	positive regulation of lipid metabolism
P02760	Protein AMBP	cell adhesion, heme catabolic process
P25311	Zinc-alpha-2-glycoprotein	Cell adhesion, negative regulation of cell population proliferation
Q9GZ9	Twisted gastrulation protein homolog 1	upregulation of BMP signaling, TGF beta receptor signaling pathway
Q6P986	MTOR-associated protein MEAK7	mTOR pathway, regulation of cell population proliferation
P13987	CD59 glycoprotein	negative regulation of activation of MAC and complement activation, complement-dependent cytotoxicity
P41222	Prostaglandin-H2 D-isomerase (PGD2 synthase)	prostaglandin biosynthetic process
DOWNREGULATED PROTEINS		
Q9Y696	Chloride intracellular channel protein 4	angiogenesis; branching morphogenesis of an epithelial tube; cell differentiation, chloride transport
P13866	Sodium/glucose cotransporter 1	Sodium and glucose transport
P04085	Platelet-derived growth factor subunit A	actin cytoskeleton organization; angiogenesis; signaling
A0PJK1	Sodium/glucose cotransporter 5	hexose transmembrane transport; sodium ion transport
P55017	Solute carrier family 12 member 3 (Na-Cl cotransporter)	Chloride, sodium and potassium ion homeostasis
Q15109	Advanced glycosylation end product-specific receptor	positive regulation of ERK1 and ERK2, MAPK, NFkB signaling
Q69577	Sodium-dependent neutral amino acid transporter B	Sodium and amino acid transport
Q13214	Semaphorin 3B	cell-cell signaling, positive regulation of cell migration

Selected upregulated and downregulated proteins

**TH-PO640**

**Metabolic Profiling of Kidney Grafts: A Novel Approach for Allograft Monitoring in Transplantation**

Sergi Clotet Freixas,<sup>1,2</sup> Cairtriona M. McEvoy,<sup>1,2</sup> Masataka Kawamura,<sup>3,4</sup> Max Kotlyar,<sup>5,6</sup> Alexander Boshart,<sup>1,2</sup> Aninda D. Saha,<sup>1,2</sup> Joseph Kim,<sup>1,7</sup> Rohan John,<sup>1,8</sup> Lisa Robinson,<sup>3,9</sup> Ana Konvalinka.<sup>1,2</sup> <sup>1</sup>Toronto General Hospital Research Institute, University Health Network, Toronto, ON, Canada; <sup>2</sup>Soham and Shaila Ajmera Family Transplant Centre, University Health Network, Toronto, ON, Canada; <sup>3</sup>Division of Nephrology, The Hospital for Sick Children, Toronto, ON, Canada; <sup>4</sup>Division of General Surgery, University Health Network, Toronto, ON, Canada; <sup>5</sup>Osteoarthritis Research Program, Division of Orthopedic Surgery, Schroeder Arthritis Institute, University Health Network, Toronto, ON, Canada; <sup>6</sup>Krembil Research Institute, University Health Network, Toronto, ON, Canada; <sup>7</sup>Division of Nephrology, Department of Medicine, University Health Network, Toronto, ON, Canada; <sup>8</sup>Department of Laboratory Medicine and Pathobiology, University of Toronto, Toronto, ON, Canada; <sup>9</sup>Program in Cell Biology, The Hospital for Sick Children Research Institute, Toronto, ON, Canada.

**Background:** Kidney transplantation is the optimal treatment for end-stage kidney disease, but kidney grafts are often lost prematurely. In transplanted organs, ischemia reperfusion injury (IRI) predisposes to inferior graft outcomes. Delayed graft function (DGF) is the manifestation of severe IRI in kidney transplantation. DGF is manifested as acute tubular necrosis (ATN), and injury to the peritubular and glomerular vasculature, features of acute kidney injury (AKI). Increasing evidence suggests that altered metabolism in the graft mediates AKI and is the major cause of DGF. Deciphering the metabolic underpinnings of IRI will improve our capacity to diagnose, prevent, and treat AKI.

**Methods:** We studied the tubulointerstitial and glomerular proteome of kidney transplant patients that developed ATN (n=12) and compared them to cases with antibody-mediated rejection (n=7) or acute cellular rejection (n=11). In addition to kidney graft proteome, we studied metabolic function of biopsy-derived kidney cell suspensions, and the urinary excretion of lactate, in a pig kidney auto-transplantation model.

**Results:** Patients with ATN showed increased expression of 8 glycolytic enzymes in the tubulointerstitium (ALDOA, ALDOC, GPI, LDHA, PFKF, PGM2, PKM, and TALDO1) and 5 in the glomeruli (ALDOA, G6PD, HK1, LDHA, and TALDO1), at the time of rejection. ATN was also linked to altered levels of mitochondrial proteins (P<0.05). In our pig model, ischemia followed by cold storage led to significantly reduced mitochondrial respiration in cells derived from the kidney graft, in comparison to the 'healthy' contralateral kidney. Functional changes after cold storage were linked to significantly reduced levels of kidney mitochondrial proteins (e.g., CPT2, ETFB; n=10; P<0.05), and significantly increased lactate levels in urine (n=10; P<0.05).

**Conclusions:** Our work shows that increased glycolysis and reduced mitochondrial function may contribute to post-transplant AKI and solidifies the importance of monitoring metabolism in kidney transplantation. Our next goal is to delineate a glycolytic signature that identifies 'high risk allografts', facilitating early diagnosis of DGF in kidney transplantation. Such signature could facilitate future clinical interventions targeting the highest risk grafts.

**TH-PO641**

**Cellular and Molecular Landscape of AKI Post-Renal Transplant**

Jennifer M. McDaniels,<sup>1</sup> Amol C. Shetty,<sup>1</sup> Thomas Rousselle,<sup>1</sup> Elissa Bardhi,<sup>1</sup> Daniel G. Maluf,<sup>1</sup> Enver Akalin,<sup>2</sup> Valeria R. Mas.<sup>1</sup> <sup>1</sup>University of Maryland Baltimore, Baltimore, MD; <sup>2</sup>Albert Einstein College of Medicine, Bronx, NY.

**Background:** Acute kidney injury (AKI) is a risk factor for chronic kidney disease. Delayed graft function (DGF) post kidney transplantation (KT) is common due to ischemia/reperfusion injury and acute tubular necrosis (ATN). The pathophysiology of AKI post-KT and acute-to-chronic transition is unknown.

**Methods:** Kidney grafts with DGF <6 weeks post-KT (AKI graft with ATN (n=4); no evidence of acute/chronic Banff injury scores) and normal allografts (NA, n=4) (normal function/histology) were tested using single nuclei (sn)RNA-seq (10X Genomic Chromium Platform). Analysis was done with Cell Ranger. DEGs (FDR<0.05) identified enriched GO terms and pathways.

**Results:** 31,803 nuclei UMAP showed 19 main clusters (Fig 1A). AKI KT patients were divided as with (WGFr; n=2) and without graft function recovery (WoGFr; n=2). ATN WoGFr showed lower proximal tubule epithelial cells (PTEC) and increased fibroblasts (FB). Also, monocytes and T cells were increased in ATN WoGFr. FBs were higher (Fig 1B) and more transcriptionally active in AKI WoGFr compared to NA and AKI WGFr. A paired pre-implantation biopsy for an AKI WoGFr patient presented a temporal increase in FB with AKI onset (Fig 1C). PTECs showed high heterogeneity between NA and AKI grafts (Fig 1D). PTEC clusters 9-11 were mainly present in AKI grafts and enriched in myofibroblast markers (COL1A1, COL1A2, SLC26A3) (Fig 1E), marked metabolic dysfunction, and produced ECM. PTEC DEGs in AKI WoGFr were enriched in epithelial cell differentiation and tubule morphogenesis, suggesting a transitional cellular state.

**Conclusions:** Different immune and PTEC clusters were identified based on condition (NA vs ATN) and graft outcome (WGFr vs WoGFr), showing cell-type specific transcriptional profiles and pathways associated with impaired repair in AKI post-KT.

**Funding:** NIDDK Support

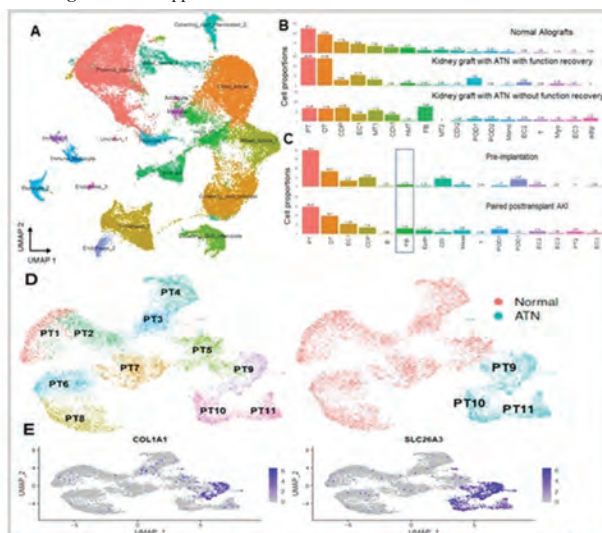

Fig 1. A. UMAP cell clusters. B. Cell proportions among different conditions. C. Cell proportions between paired biopsies at two-time points. D. UMAP showing all PTEC subclusters (left) and per condition (right). E. Expression of myofibroblast markers.

**TH-PO642**

**Discrepant Toxicity Profiles of Cyclosporine A and Tacrolimus Beyond Calcineurin Inhibition**

Duygu E. Yilmaz,<sup>1</sup> Karin M. Kirschner,<sup>1</sup> Hasan Demirci,<sup>1</sup> Nina Himmerkus,<sup>2</sup> Sebastian Bachmann,<sup>1</sup> Kerim Mutig.<sup>1</sup> <sup>1</sup>Charite Universitätsmedizin Berlin, Berlin, Germany; <sup>2</sup>Christian-Albrechts-Universität zu Kiel, Kiel, Germany.

**Background:** Calcineurin inhibitors (CNI), cyclosporine A (CsA) or tacrolimus (Tac), belong to the first-line immunosuppressive strategies after solid organ transplantation. However, both CNI exert pronounced nephrotoxicity, which is typically stronger in patients receiving CsA. Calcineurin inhibition by CsA occurs via building complexes with cyclophilins, whereas Tac recruits FKBP12 instead. We hypothesized that suppression of cyclophilin chaperone function by CsA may induce endoplasmic reticulum (ER) stress and pro-apoptotic unfolded protein response (UPR) in kidney epithelia.

**Methods:** Effects of CsA vs. Tac (10  $\mu$ M for 6 h) on the UPR signaling were compared in cultured human embryonic kidney cells (HEK293), human renal proximal tubular (PT) epithelial cells (HRPTEpC), and freshly isolated rat PTs using quantitative PCR, immunoblotting, and immunofluorescence staining. An established ER stress inducer, thapsigargin (Tg) served as a positive control.

**Results:** CsA and Tg, but not Tac, induced ER stress and pro-apoptotic UPR in HEK293 cells, as reflected by increased levels of key UPR products (BiP, CHOP, spliced XBP1, and phosphorylated IRE1 $\alpha$ ) and cleaved caspase-3 (cCas-3). Similar effects were observed in HRPTEpC cells and isolated rat PTs. Knockdown of cyclophilin A or B isoforms in HEK293 cells using siRNA aggravated CHOP and cCas-3 suggesting relevance of cyclophilin activity for intact proteostasis. Application of chemical chaperones, TUDCA or 4-PBA, alleviated the CsA-induced UPR suggesting that improved protein folding may have protective effects against CsA cytotoxicity. Along the same line, genetic suppression of UPR in HEK293 cells by CRISPR/Cas9-mediated deletion of the key ER stress sensors, PERK or ATF6, blunted the pro-apoptotic UPR in response to CsA.

**Conclusions:** In summary, these results suggest that nephrotoxic effects of CsA may be aggravated by suppression of cyclophilins, ER stress, and pro-apoptotic UPR. Pharmacological or genetic modulation of UPR bears the potential to alleviate CsA nephrotoxicity.

**Funding:** Government Support - Non-U.S.

#### TH-PO643

##### Towards the Use of Immortalized Perfusate-Isolated Human Endothelial Cells for the Screening of Non-human Leukocyte Antigen (Non-HLA) Antibodies in Kidney Transplant Recipients

Dania Altulea,<sup>1</sup> Rosa G. Lammerts,<sup>1</sup> Wendy Dam,<sup>1</sup> Jacob van den Born,<sup>1</sup> Jan-Stephan Sanders,<sup>1</sup> Constanca Figueiredo,<sup>2</sup> Stefan P. Berger.<sup>1</sup> <sup>1</sup>Universitair Medisch Centrum Groningen, Groningen, Netherlands; <sup>2</sup>Medizinische Hochschule Hannover, Hannover, Germany.

**Background:** Endothelial cells (ECs) are important target cells for both cellular and antibody mediated rejection in transplanted kidneys. Non-HLA antibodies may play an important role in immunity to the allograft, yet screening for non-HLA antibodies is not routinely performed prior to transplantation due to uncertainty about the clinical relevance and the lack of validated detection assays. Recently, cell-based crossmatching assays have been described for the screening of non-HLA antibodies using either primary ECs such as human umbilical vein endothelial cells (HUVECs), Tie-2+ endothelial precursor cells, or cell lines such as the conditionally immortalized human glomerular endothelial cells (CiGeNCs) as the target cells. However, despite the promising results of these assays, HUVECs and Tie-2+ ECs are not organ specific, and CiGeNCs, despite being kidney-specific, are derived from a single donor and thus lack heterogeneity in protein expression. Therefore, the development of an ideal EC crossmatching assay with organ and donor specificity is warranted. We aimed to establish a cell bank of kidney-derived ECs covering a broad array of HLA and non-HLA targets, upon which, an EC-based crossmatch assays will be developed using ECs isolated from the liquid of machine-perfused kidneys.

**Methods:** Human cells were collected and cultured from the perfusate after post-mortem kidney donation and perfusion, then, ECs were isolated based on the expression of CD31. Transduction of the ECs was performed utilizing a lentiviral vector encoding for the SV40 large T antigen and mCherry as reporter gene.

**Results:** To assess the success of the transduction, the expression of the reporter gene was assessed using fluorescence microscopy. The positive cells were cultured for a period of 5-8 weeks until a suitable expansion level, then checked for the expression of ECs markers including CD31, CD34, VEGFR-2, ET-1, and vWF with flow cytometry.

**Conclusions:** Our results showed that the transformed cells expressed the selected common ECs markers even after a long period of culturing, confirming their endothelial characteristics. Additional flow cytometry analysis for a broad array of EC markers, as well as single-clone expansion and HLA-silencing is planned in the near future.

**Funding:** Government Support - Non-U.S.

#### TH-PO644

##### Machine Perfusion Affects Endothelium of Porcine Kidneys Irrespective of Haematocrit of Perfusion Fluid

Cor van 't Hof, Tobias M. Huijink, Anita Meter, Jacob van den Born, Stefan P. Berger, Henri Leuvenink. *Universitair Medisch Centrum Groningen, Groningen, Netherlands.*

**Background:** In transplanted kidneys, ischemia-reperfusion injury (IRI) is a major cause of renal failure and eventual allograft loss. In the pathological mechanisms of IRI, renal endothelium plays a key role. In this project, the effects of different haematocrits during kidney machine perfusion on the endothelium were investigated by assessing phenotypic alterations in renal endothelial cells in porcine kidneys.

**Methods:** Two experimental groups of porcine kidneys (n=6 per group), obtained from a local abattoir, were subjected to 35 minutes of warm ischemia and flushed with 1L saline. Thereafter, kidneys underwent 3 hours of hypothermic and 4 hours of normothermic machine perfusion (NMP). During NMP experimental groups were perfused with either a 24% or 36% haematocrit. Post-nephrectomy and post-normothermic machine perfusion biopsies of two groups were obtained and stained for endothelial markers vascular endothelial growth factor receptor 2 (VEGFR-2) and endocan. The stained sections were scanned and quantified digitally. A p-value of <0.05 was considered significant. P-values were calculated using a paired T-test, in the case of a normal distribution, or a Wilcoxon Signed Rank test, in the case of a non-normal distribution.

**Results:** Since no significant differences were found between 24% and 36% haematocrit groups, both groups were combined. The expression of endocan and VEGFR-2 was significantly reduced from post-nephrectomy to post-normothermic machine perfusion in both groups. Endocan expression was mainly decreased in the glomerular capillaries compared to peritubular capillaries (P=0.012 and P=0.596). VEGFR-2 expression both in glomerular and peritubular capillaries was largely lost after normothermic machine perfusion, P=0.002 and P=0.003 respectively.

**Conclusions:** These data show that machine perfusion, irrespective of the haematocrit of the perfusion solution, strongly affects the endothelium of the perfused kidneys. Additional analysis will be performed to explore when this decline in expression occurs.

**Funding:** Government Support - Non-U.S.

#### TH-PO645

##### Nephrotoxic Side Effects of the Calcineurin Inhibitors Cyclosporin A and Tacrolimus Affect Glomeruli and Tubulointerstitium Differentially in Chronic Experimental Settings

Hasan Demirci,<sup>1</sup> Suncica Popovic,<sup>1</sup> Duygu E. Yilmaz,<sup>1</sup> David H. Ellison,<sup>2</sup> Kerim Mutig,<sup>1</sup> Sebastian Bachmann.<sup>1</sup> <sup>1</sup>Charite Universitätsmedizin Berlin, Berlin, Germany; <sup>2</sup>Division of Nephrology & Hypertension, Oregon Health & Science University, Portland, OR.

**Background:** Chronic calcineurin inhibitor (CNI) nephrotoxicity is a major drawback in current immunosuppressive regimens. Pathology includes vascular/glomerular and tubulointerstitial alterations. Although still commonly in use, cyclosporine A (CsA) is increasingly replaced by tacrolimus (Tac) for a more favorable clinical outcome. Data on their differential pathogenetic effects in the kidney are still scarce. We hypothesized that the major renal compartments are differentially affected by the two drugs. Histological, ultrastructural and gene expression changes were registered to achieve mechanistic perspectives in controlling CNI nephrotoxicity.

**Methods:** CsA and Tac were administered chronically in wt rats and mice with a megalin-related endocytosis defect. Clinical parameters were controlled. Animals were prepared for high-end morphological analysis, elective immunostaining, and high-throughput technology.

**Results:** In rats, CsA and Tac produced distinct alterations in glomeruli and tubulointerstitium. Both drugs caused a-SMA-positive fibrotic foci with sclerotic glomeruli and damaged tubules to similar extent. With CsA, glomerular damage was milder than with Tac. Proximal tubules showed increases in dysmorphic lysosomes along with high apoptosis rate and diminished albumin uptake. Megalin-dependent endocytosis was causally involved in the changes. Lysosomal exocytosis was stimulated at the apical cell pole. KIM1 signal was moderate. With Tac, these changes were far less pronounced, but focal tubular necrosis along with KIM-1 signal was enhanced. High throughput analysis showed differential changes between CsA and Tac with almost no overlap between the respective spectra. CsA caused upregulation of components of the unfolded protein response and apoptosis, whereas Tac showed a disproportionately sharp induction of the RAS and vascular structural deterioration.

**Conclusions:** In sum, CNI nephrotoxicity presented with fundamentally different effects caused by CsA vs. Tac. While CsA mostly affected proximal tubular integrity, Tac was primarily acting on vascular components. Results may serve to better adjust immunosuppressive treatment combinations in transplant patients.

#### TH-PO646

##### Polygenic Burden for Hypertension, Stroke, and Intracranial Aneurysm in Deceased Kidney Donors

Kane E. Collins,<sup>1</sup> Edmund H. Gilbert,<sup>1</sup> Katherine A. Benson,<sup>1</sup> Elhussein A. Elhassan,<sup>2</sup> Graham M. Lord,<sup>3</sup> Gianpiero Cavalleri,<sup>1</sup> Peter J. Conlon.<sup>2,1</sup> <sup>1</sup>Royal College of Surgeons in Ireland, Dublin, Ireland; <sup>2</sup>Beaumont Hospital, Dublin, Ireland; <sup>3</sup>King's College London, London, United Kingdom.

**Background:** Intracranial Haemorrhage (ICH) and stroke are common causes of death among kidney donors, but the genetic factors involved are poorly understood. Polygenic burden for a trait can be calculated by generating a Polygenic Risk Score (PRS) which estimates the cumulative effect of common genetic variation on an individual's disease status. Previous studies have found that PRS for ischemic stroke offer predictive performance similar to clinical risk factors. Here we investigate the role of polygenic burden in determining donor cause and age of death.

**Methods:** We utilised 2122 genotyped kidney transplant donor-recipient pairs from across the UK and Ireland. We calculated PRSs for stroke, Intracranial Aneurysm (IA) and hypertension using large published GWASs of European ancestry. We compared PRSs between the donors who died of intracranial haemorrhage (DDICH) (1,303 individuals) and controls, as well as donors who did not die of ICH. We investigated whether kidneys that came from individuals with high polygenic risk (defined as top 20% of distribution) performed differently from lower risk kidneys (bottom 80%) when transplanted into recipients.

**Results:** DDICH had significantly higher PRSs for hypertension, stroke, and IA than controls (p-values 1.0e-13, 1.2e-11, and 0.028 respectively), but also than the donors who did not die of ICH (p-values 2.9e-9, 2.3e-4, and 0.41). The risk of death from ICH was 9% greater in individuals with high polygenic risk for hypertension (OR: 1.09, p: 0.015). Similarly, for donor age of death, polygenic risk for hypertension had an Odds Ratio (OR) of 12.2 (p-value 0.002). Polygenic risk for each trait in donor kidneys did not have a statistically significant impact on graft survival.



**Conclusions:** These observations support the hypothesis that DDICH carry an increased burden for traits related to stroke. This results in a greater risk of death from ICH and a younger age of death. These PRSs are similarly predictive to established clinical risk factors. Kidneys that come from donors with high polygenic risk for all traits do not have different graft function or survival from low risk kidneys. PRSs can distinguish DDICH from the general population. These findings could have utility in testing relatives of DDICH to determine if they share the same risk for ICH.

**Funding:** Government Support - Non-U.S.

**TH-PO647**

**Recipient Polygenic Burden as a Predictor of Kidney Transplant Outcome**

Kane E. Collins,<sup>1</sup> Edmund H. Gilbert,<sup>1</sup> Katherine A. Benson,<sup>1</sup> Elhoussein A. Elhassan,<sup>2</sup> Graham M. Lord,<sup>3</sup> Peter J. Conlon,<sup>2,1</sup> Gianpiero Cavalleri.<sup>1</sup>  
<sup>1</sup>Royal College of Surgeons in Ireland, Dublin, Ireland; <sup>2</sup>Beaumont Hospital, Dublin, Ireland; <sup>3</sup>King's College London, London, United Kingdom.

**Background:** The clinical predictors of transplant outcome have been well established and include HLA mismatch, donor age, era of transplantation, immunosuppressive regimen, and recipient blood pressure. Polygenic burden can be quantified using a Polygenic Risk Score (PRS), which estimates the cumulative effect of common genetic variation on an individual's disease status. Polygenic burden has been demonstrated to have an impact on kidney function, but the impact of polygenic burden on kidney graft function is less clear. It has also been shown that polygenic burden can predict certain transplant outcomes including the development of Non Melanoma Skin Cancer. Here, we investigate the role of polygenic burden in kidney transplant recipients on transplant outcome.

**Methods:** We utilised 2,122 genotyped donor-recipient pairs from across the UK and Ireland and 5,519 ancestry matched controls. We calculated PRSs for eGFR, albuminuria, and hypertension from large, publicly available summary statistics from populations of European ancestry. We compared PRSs between recipients and the healthy controls. We also investigated the differences in transplant outcome between the individuals with high polygenic burden (defined as top 20% of distribution) for each trait and those with low polygenic burden (bottom 80%).

**Results:** Recipients had lower polygenic burden for reduced eGFR (p-value: 7.9e-4) than healthy controls. There was no statistically significant difference in graft survival or graft function at 1-year post-transplant between individuals with high and low polygenic burden. However, there was a significant difference in graft function at 5 years' post-transplant between the high and low polygenic burden individuals (Odds Ratio: 16.2, p-value: 0.048).

**Conclusions:** Polygenic burden for eGFR has an impact on graft function at 5 years' post-transplant, but other traits do not appear to have a significant effect. This is in line with what previous studies have found.

**Funding:** Government Support - Non-U.S.

**TH-PO648**

**Comparison Between Nuclear Medicine Studies, Creatinine Clearance, and Estimated Glomerular Filtration Rate**

Ana C. Acosta Peña, Mario Alamilla Sanchez. Instituto de Seguridad y Servicios Sociales de los Trabajadores del Estado, Mexico City, Mexico.

**Background:** Measurement and estimation of glomerular filtration rate (GFR) are associated with systematic error, leading to differences in measured GFR, estimated GFR, and creatinine clearance. eGFR or CrCl within 30% of a mGFR is appropriate.

**Methods:** Comparative study between mGFR DTPA by renal scintigraphy, CrCl in 24-hour urine, and eGFR CKD-EPI/MDRD. Means were compared, with a 95% CI calculation. Bias and precision are assessed, providing a standard margin of ±30% relative to mGFR DTPA.

**Results:** 40 donors were studied, 50% women, aged 42 years [20 – 67 years], weight 72.9 ± 13.2 kg, serum creatinine 0.74 ± 0.15 mg/dL. The mGFR DTPA measurement was on average 128.4 ± 23 ml/min; higher in men [136.1 vs. 120.7 ml/min; p = 0.03]. The eGFR were: CKD-EPI 107.6 ± 17.2 mL/min, MDRD 105.3 ± 20 mL/min; no differences between men and women [p= 0.84]; CrCl was 113.1 ± 32.6 mL/min; significantly higher in men [p= 0.006]. Differences were found between mGFR DTPA vs CrCl [128 vs 113 mL/min; p=0.01] vs. CKD-EPI [128 vs. 107 mL/min; p < 0.001] vs. MDRD [128 vs. 105 mL/min; p < 0.001]. No differences when comparing CrCl and CKD-EPI [113 vs 108 mL/min, diff. = 4.3ml/min; p = 0.49] or MDRD [113 vs. 107 mL/min; p = 0.39]; neither between CKD-EPI and MDRD [107 vs 105 mL/min; p = 0.13]. When estimating the precision at 30% (p=30) regarding mGFR DTPA between the methods, CrCl had less bias and GFR CKD-EPI better precision.

**Conclusions:** The use of mGFR DTPA is the best tool to establish GFR, however, among the methods used, CrCl has the least bias and GFR CKD-EPI has the best precision within 30% compared to mGFR DTPA.

**Funding:** Government Support - Non-U.S.

Comparison of measurement GFR DTPA vs estimation of GFR CKD-EPI/MDRD vs CrCl

Method	ml/min	Difference to ml/min vs mGFR DTPA [bias/precision %]	p [IC 95%]
mGFR DTPA	128.4 ± 23	Ref.	Ref.
CrCl	113.1 ± 32.6	15.6 [12 / 80]	0.01 [3.2 – 28]
eGFR CKD-EPI	107.6 ± 17.2	20.8 [16 / 85]	< 0.001 [12.9 – 28.6]
eGFR MDRD	105.3 ± 20	23 [18 / 80]	< 0.001 [14.8 – 31.3]

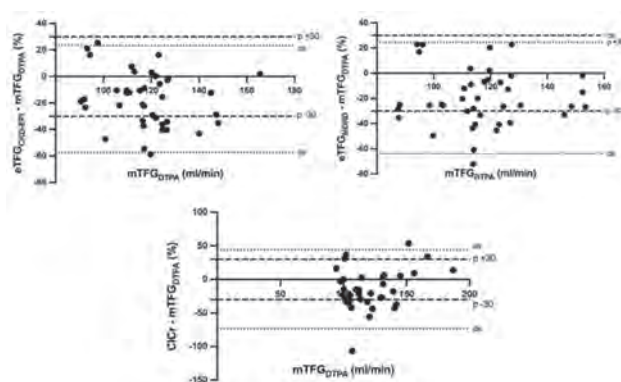

**TH-PO649**

**Blood-Brain-Barrier Biomarkers in Patients Before and After Kidney Transplantation**

Leah N. Hernandez, Liam J. Ward, Samsul Arefin, Peter F. Barany, Peter Stenvinkel, Karolina Kublickiene. Department of Clinical Science, Intervention and Technology (CLINTEC), Division of Renal Medicine Karolinska Institutet, Stockholm, Sweden.

**Background:** The uremic milieu affects the blood-brain barrier by altering the levels of brain-specific biomarkers in the peripheral circulation, which may be due to increased BBB leakage. Renal replacement therapy such as kidney transplantation in ESKD patients may improve neurologic status and may be reflected by the altered levels of circulating BBB-specific biomarkers. The aim of this study is to compare the levels of the circulating BBB-specific biomarkers such as neuron-specific enolase (NSE), neurofilament light chain (NFL), and brain-derived neurotrophic factor (BDNF) in living-donor kidney transplant patients and non-CKD controls.

**Methods:** Serum from non-CKD control (n=80) and plasma from living-donor renal transplant patients (LD-RTx, n=69) were used to measure NSE, NFL, and BDNF using commercially available enzyme-linked immunosorbent assay (ELISA). Circulating levels of the NSE, NFL, and BDNF in kidney transplant recipients were compared at baseline, and one and two years follow-up.

**Results:** LD-RTx patients showed lower levels of NSE at 1 year, 2-year post-transplantation when compared to baseline and non-CKD controls (p < 0.05). BDNF and NFL levels were higher in LD-RTx patients at 1 year and 2-year follow-up compared to baseline and non-CKD controls (p < 0.05). Sex divided analysis showed significant difference in NFL levels only at 1 year follow up, with males having higher NFL levels compared to females.

**Conclusions:** Varying levels of BBB biomarkers suggest that kidney transplantation may have a beneficial effect on the BBB integrity. This is supported by the altered circulating levels of NSE, BDNF and NFL in the peripheral circulation. Further studies are ongoing to understand implications of sex differences and associations with clinical and biochemical parameters related to the maintenance of BBB and neurological status.

**Funding:** Government Support - Non-U.S.

**TH-PO650**

**DNA of Urinary Extracellular Vesicles Reflects Kidney Allograft Injury**

Ivana Sedej,<sup>1,2</sup> Maja Stalekar,<sup>3</sup> Magda Tusek Znidaric,<sup>3</sup> Katja Goricar,<sup>2</sup> Nika Kojc,<sup>4</sup> Polona Kogovšek,<sup>3</sup> Vita Dolzan,<sup>2</sup> Metka Lenassi,<sup>2</sup> Miha Arnot.<sup>1</sup>  
<sup>1</sup>Department of Nephrology, Division of Internal Medicine, University Medical Center Ljubljana, Ljubljana, Slovenia; <sup>2</sup>Institute of Biochemistry and Molecular Genetics, Faculty of Medicine, University of Ljubljana, Ljubljana, Slovenia; <sup>3</sup>Department of Biotechnology and Systems Biology, National Institute of Biology, Ljubljana, Slovenia; <sup>4</sup>Institute of Pathology, Faculty of Medicine, University of Ljubljana, Ljubljana, Slovenia.

**Background:** When allograft injury (AI) occurs, levels of donor-derived cell-free DNA (dd-cfDNA) increase in kidney transplant (TX) recipients' body fluids, including urine. Within this are extracellular vesicles (uEVs), membranous particles released by virtually all cell types carrying biomolecules reflecting the state of the original cell. DNA is an important, unexplored uEV cargo (evDNA) that may be a relevant noninvasive biomarker for AI. The rationale of our study was to investigate the evDNA characteristics of kidney TX recipients to reveal possible association with AI and finally to evaluate the biomarker potential of dd-evDNA.

**Methods:** We isolated uEVs, ev-, and cfDNA from 2nd morning spot urine of 41 kidney TX recipients undergoing protocol or for-cause biopsy. We used Nanoparticle Tracking Analysis to determine the size and concentration of uEVs. We measured DNA yield, copy number, integrity index, and dd-fraction using fluorometry, donor-recipient genotyping and digital droplet PCR, respectively. We associated DNA characteristics to histological phenotype, by comparing data from normal histology (NH), rejection injury (RI; combination of antibody- (ABMR) and T-cell mediated rejection (TCMR)) and non-rejection injury (NRI) group.

**Results:** The uEVs concentration was similar in all patient groups, whereas uEVs were significantly larger in the RI and NRI groups (mean  $P=0.045$ ; median  $P=0.031$ ). We detected higher evDNA yields and higher evDNA copy number in the RI and NRI groups than in the NH group ( $P=0.018$  and  $P=0.007$ , respectively). In particular, the number of dd-evDNA copies was significantly increased in ABMR patients (Figure 1). In addition, we report significantly lesser fragmentation of dd-evDNA vs. dd-cfDNA ( $P<0.001$ ). evDNA characteristics were related to the degree of interstitial inflammation, microvascular inflammation, and inflammation in the areas of fibrosis (all  $P<0.050$ ).

**Conclusions:** evDNA reflects AI, particularly allograft rejection and could be used as a biomarker for monitoring kidney allograft injury status.

**Funding:** Government Support - Non-U.S.

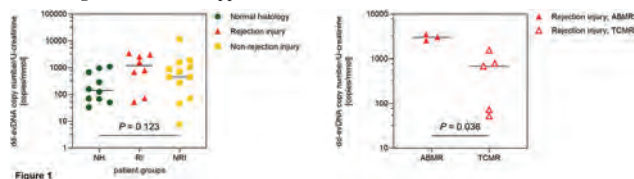

## TH-PO651

### Roles of Endothelial and Mesangial Cells in the Progression of Transplant Glomerulopathy

**Pongpratch Puapatanakul, Samir Husami, Jeffrey H. Miner, Sanjay Jain, Tarek Alhamad, Hani Sulaiman.** Washington University in St Louis School of Medicine, St Louis, MO.

**Background:** Transplant glomerulopathy (TG) is a morphologic diagnosis characterized by reduplication of the glomerular basement membrane (GBM) on kidney allografts. Changes to the GBM and adjacent structures as TG develops and progresses have not been studied extensively at a molecular level.

**Methods:** Archived paraffin-embedded kidney biopsies from 9 TG patients (2 and 7 patients with Banff score cg1a and cg1b or higher [1b+], respectively), and 10 nephrectomy controls were imaged by Airyscan confocal microscopy. Immunofluorescence staining was performed using antibodies against collagen  $\alpha1\alpha2(IV)$ , collagen  $\alpha3\alpha4\alpha5(IV)$ , laminin  $\alpha5$  (LG domain), and agrin as markers of GBM; CD34 as a marker of endothelial cells; vimentin as a marker of endothelial activation; and integrin  $\alpha8$  and  $\alpha$ -smooth muscle actin ( $\alpha$ -SMA) as markers of mesangial cells.

**Results:** There were significant increases in thickness and intensity of most GBM proteins, namely collagen  $\alpha1\alpha2(IV)$ , laminin  $\alpha5$ , and agrin at all stages of TG. Collagen  $\alpha3\alpha4\alpha5(IV)$  was unchanged, suggesting that podocytes did not contribute much to GBM thickening. Laminin  $\alpha5$  appeared as two leaflets correlating with visible GBM reduplication by light microscopy in Banff cg1b+ TG. CD34 staining extending from capillary lumina into the thickened GBM, suggesting protrusions of endothelial cells, was observed more prominently in Banff cg1b+ TG. TG endothelial cells expressed vimentin consistently at all stages, whereas controls did not. We also observed integrin  $\alpha8$  and  $\alpha$ -SMA in the reduplicated GBM in Banff cg1b+ TG, which could represent mesangial interposition as the GBM thickened at later stages.

**Conclusions:** We demonstrate that endothelial activation occurs early, followed by endothelial protrusion into the GBM and expansion of collagen  $\alpha1\alpha2(IV)$ , highlighting the importance of endothelial injury in TG. The presence of mesangial markers in the thickened GBM later in the course of disease suggests a role for mesangial cells in TG progression. Whether these successive changes yield prognostic values requires future prospective studies.

## TH-PO652

### Identification of Complement Regulatory Proteins in ABO-Incompatible and HLA-Incompatible Kidney Transplantation

**Kavita Jintanapramote,<sup>1</sup> Thansita Bhunyakarnjanarat,<sup>2</sup> Jeerath Phannajit,<sup>1</sup> Jerasit Surintrspanont,<sup>3</sup> Asada Leelahavanichkul,<sup>1,2</sup> Yingyos Avihingsanon,<sup>1</sup> Somchai Eiam-Ong,<sup>1</sup> Natavudh Townamchai.<sup>1</sup>** <sup>1</sup>Chulalongkorn University Faculty of Medicine, Bangkok, Thailand; <sup>2</sup>Chulalongkorn University Department of Microbiology, Bangkok, Thailand; <sup>3</sup>Chulalongkorn University, Bangkok, Thailand.

**Background:** ABO incompatible kidney transplantation (ABOi KT) provides better allograft outcomes compared to HLA incompatible KT (HLAi KT), especially a lower incidence of antibody-mediated rejection (ABMR). The findings in ABMR generally consist of the presence of serum anti-donor antibody, C4d staining, and inflammation in the allograft. Despite the positivity of C4d, there is no evidence of inflammation found in ABOi KT, indicating that there must be some mechanisms preventing the allograft from complement mediated injury. We hypothesize that the complement regulatory proteins may play roles in this process.

**Methods:** This observational, retrospective study was conducted at King Chulalongkorn Memorial Hospital. All living donor KT patients were divided into 4 groups according to pre-transplant antibody: 1) ABOi, 2) HLAi, 3) combined ABOi and HLAi, which considered as high-immunologic risk groups and 4) compatible KT, which served as the control group. The expression of complement regulatory proteins including CD59, CD55, CD46, and CD35 was measured from allograft tissue within 1 year after KT using RNA isolation and quantitative reverse transcription-PCR (qRT-PCR).

**Results:** There were 87 patients enrolled of which 12 were ABOi KT, 22 were HLAi KT, 6 were combined ABOi and HLAi KT and 47 were compatible KT group. There was no differences in CD59, CD55, CD46, and CD35 expression between all groups. However, CD46 expression was significantly higher in ABOi KT patients with C4d positive (accommodation) who have a high ABO titer ( $\geq 1:32$ ) compared to a low ABO titer ( $<1:32$ ) ( $p = 0.006$ ). In addition, CD 59 was upregulated in high-immunologic risk patients compared with the control group ( $p = 0.018$ ).

**Conclusions:** This study found no evidence of increased CD59, CD55, CD46, or CD35 expression in ABOi KT compared with other types of transplantation. However, CD46 expression increased in association with the ABO titer. All types of incompatible KT revealed higher CD59 expression, which may play roles protection of the allograft against preformed antibodies.

**Funding:** Private Foundation Support

## TH-PO653

### Universal Antigen Specific CD8 Treg to Suppress Alloreactive T Cells

**Anis J. Saad,<sup>1,3</sup> John Y. Choi,<sup>1,3</sup> Hye-jung Kim,<sup>2,3</sup> Nour K. Younis,<sup>1,3</sup> Hengcheng Zhang,<sup>1,3</sup> Christa A. Deban,<sup>1,3</sup> Zhabiz Solhjoui,<sup>1,3</sup> Ahmad Halawi,<sup>1,3</sup> Harvey Cantor,<sup>2,3</sup> Jamil R. Azzi.<sup>1,3</sup>** Brigham and Women's Hospital Department of Medicine, Boston, MA; <sup>2</sup>Dana Farber Cancer Institute, Boston, MA; <sup>3</sup>Harvard Medical School, Boston, MA.

**Background:** We have previously shown that alloreactive T cells upregulate their expression of Qa-1(HLA-E in human)-FL9 peptide complex, making them susceptible to killing by Qa1 restricted CD8 Treg. Mobilization and activation of CD8 Treg in vivo by immunization with an engineered FL9 peptide superagonist, dampens TH-dependent Ab mediated injury and prolongs allograft survival. Therefore, we hypothesized that adoptively transferred FL9-antigen specific CD8 Treg may preferentially suppress the alloimmune response, and delay allograft rejection, opening new horizons for the use of CD8 Treg in cellular therapies.

**Methods:** We generated FL9-Qa1 TCR Transgenic mice (FL9-Tg). We then transplanted B6 hosts with BALB/c skin allografts with or without vaccinating with FL9 superagonist AND with or without adoptively transferring CD8 T cells isolated from FL9 TCR Tg mice. One group of skin allograft recipient was subsequently transplanted with BALB/c hearts. Allograft survival was monitored and CD8 Treg migration was tracked in allograft and lymphoid organs. Mechanistic analysis was performed in the spleen, LN and allograft.

**Results:** FL9 specific CD8 Tregs significantly suppressed Tfh, GC B cell differentiation and DSA production, prolonging skin and heart allograft survivals compared to FL-9 superagonist alone or untreated recipients ( $p<0.05$ ). Furthermore, the superagonist vaccine and CD8 Treg adoptive transfer group showed a synergistic effect( $p<0.05$ ), prolonging mean survival time of heart allografts from 4 to up to 15 days in a stringent sensitized transplant model.

**Conclusions:** Implementation of Tg CD8 Treg in cellular therapies has provided proof of concept data for the role of CD8 Treg in allo-immune response with high translational potential.

**Funding:** Other NIH Support - NIAID, Private Foundation Support

## TH-PO654

### Single Cell RNAseq Analysis of Kidney Transplant Biopsies Demonstrates a Role for Endothelial Cell CCL23 in Antibody Mediated Rejection

**Andrew F. Malone, Aidan Leckie-Harre.** Washington University in St Louis, St Louis, MO.

**Background:** Antibody mediated rejection (AMR) remains one of the major causes of allograft failure and our understanding of this disease process is poor. Macrophages are thought to play an important role in the alloimmune reaction including AMR. We performed single cell RNAseq on biopsies from transplant patients to examine the effects of endothelial cell ligand expression on macrophages in AMR.

**Methods:** The 10X Genomics platform was used to make libraries which were sequenced to a depth of ~50k reads/cell. Gene-cell matrices were obtained from Cell Ranger and the downstream analysis were done using R and Seurat. The effect of ligand expression on target cells was analyzed using nichenetr. nichenetr predicts ligand-receptor interaction based on known target cell gene activity in response to ligand activity. This study had IRB approval.

**Results:** 15375 cells in total from 5 kidney transplant biopsy samples (3 AMR and 2 non-AMR) were included in the final integrated analysis using UMAP. All major kidney cell types were identified including macrophages. Endothelial cells (EC) were subclustered into 4 subgroups, IFNg\_EC, PTC\_EC, GEC\_EC, and angiogenic\_EC. The ligand with the greatest prediction score (0.958) for target cell (macrophage) gene activity in the rejection niche was CCL23 acting through CCR1 receptor. CCL23 was differentially expressed in IFNg\_EC cells in AMR (compared to other ECs and non-rejecting ECs).

**Conclusions:** A target gene activity approach to ligand-receptor analysis using single cell RNAseq of human kidney transplant biopsies suggests CCL23 expression from endothelial cells interacts with macrophages in AMR. Therefore, CCL23 may mediate macrophage recruitment to the kidney allograft in AMR.

**Funding:** NIDDK Support

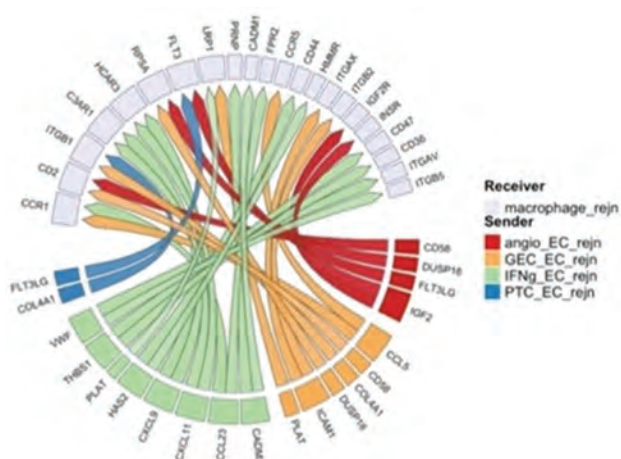

### TH-PO655

#### Immune-epithelial Niches Are Dose-Dependent in Calcineurin Inhibitor Nephrotoxicity

Seth Winfree,<sup>1</sup> Kyle Mcandrews,<sup>1</sup> Krysten Vance,<sup>1</sup> Gregory S. Kubik,<sup>1</sup> Anna A. Zmijewska,<sup>2</sup> James Eudy,<sup>1</sup> Roslyn B. Mannon.<sup>1,1</sup> <sup>1</sup>University of Nebraska Medical Center, Omaha, NE; <sup>2</sup>University of Alabama, Birmingham, AL.

**Background:** While mainstay immunosuppressive agents in kidney transplantation, calcineurin inhibitors (CNIs) are limited by their intrinsic nephrotoxicity. Understanding the mechanisms of injury following chronic CNI exposure is critical to developing strategies to ameliorate this toxicity. There is growing evidence the interplay between the renal tubular epithelium and immune cells plays a critical role in renal injury and disease. We used spatial transcriptomics (ST) to elucidate this interaction and the role immune-epithelial niches may play in CNI nephrotoxicity.

**Methods:** 8-10 week old mice on a low-salt diet were treated with 90 or 120 mg/ Kg Cyclosporine A (CsA) daily for two weeks and kidneys were harvested and frozen. Frozen kidneys were embedded in optimal cutting temperature media prior to sectioning. High quality tissue sections (RIN 6-8) were processed for use on the 10x Visium platform including imaging and library generation followed by next-generation sequencing. FASTQ and TIFF file processing were performed with Cell Ranger. Expression matrices and images were imported into Seurat (v4.0) for analysis. Cell-type distributions within Visium spots were determined by deconvolution with SPOTLight (v0.1.7) using a scRNASeq reference library generated from mouse kidneys.

**Results:** Cortical and medullary markers of the murine kidney were identified by ST and spatially correlated with histologically defined regions of the kidney. Following treatment with CsA, kidney injury markers, *Havcr1* and *Len2*, increased. At the higher dose of CsA, there was a differential upregulation of immune markers, cytokine/chemokines and profibrotic genes. After Visium spot deconvolution, epithelial cell signatures were identified and localized to expected regions of the kidney. Further, signatures of immune cells were associated with specific tubular subsegments (cortical vs. medullary-thick ascending limb) in a CsA dose dependent manner.

**Conclusions:** Our data demonstrates ST can uncover molecular profiles and cellular niches of CNI nephrotoxicity. Furthermore, our data provide initial observations of a shift in the transcriptional state of the kidney and the cellular niches of toxicity with increasing doses of CsA. This suggests multiple mechanisms of injury in nephrotoxicity may be at play as a function of CNI dose.

**Funding:** Veterans Affairs Support

### TH-PO656

#### Paracrine FGF23 Signaling Suppresses Erythropoiesis in Iron Deficiency Anemia

Guillaume Courbon, Jadeah J. Spindler, John C. Von Drasek, Aline Martin, Valentin David. Northwestern University Feinberg School of Medicine, Chicago, IL.

**Background:** Iron deficiency anemia (IDA) stimulates fibroblast growth factor 23 (FGF23) production in osteocytes and erythroid cells, leading to excess circulating FGF23 derived fragments but only slightly elevated intact (iFGF23). Recent studies have suggested that rising iFGF23 in IDA negatively regulates erythropoiesis. However, the contribution of osteocytic and/or erythroid iFGF23 production to anemia remains to be determined.

**Methods:** We generated conditional *Fgf23* knockout mice by deleting *Fgf23* under the control of dentin matrix protein 1 (*Dmp1*) in osteocytes (*Fgf23*<sup>Dmp1-cKO</sup>) or hemoglobin Beta (*HbB*) in erythroid cells (*Fgf23*<sup>HbB-cKO</sup>). Next, we induced IDA in mutant and wild-type (WT) mice, by feeding animals a control (Ctr) or a low-iron diet (ID) from 3 to 6 weeks of age. In all mice, we analyzed serum biochemical parameters of iron metabolism, hematological parameters and bone marrow erythroid differentiation by flow cytometry and PCR. In parallel, we investigated the effects of FGF23 signaling in erythroid cell cultures, in presence of recombinant FGF23 and FGF receptors inhibitors.

**Results:** Compared to WT-Ctr mice, WT-ID mice developed IDA, marked by decreased serum iron, Hb content, increased erythroid progenitors, and a reduction in erythroblasts and reticulocytes number ( $p < 0.05$ ). WT-ID mice also showed a mild but significant increase in serum iFGF23 levels. Deletion of *Fgf23* in osteocytes completely rescued iFGF23 levels in *Fgf23*<sup>Dmp1-cKO</sup>-ID mice. In sharp contrast, deletion of *Fgf23* in erythroid cells only minimally decreased circulating iFGF23 levels. Intriguingly, suppression of *Fgf23* in erythroid cells corrected the reductions in Hb in ID mice, whereas suppression of *Fgf23* in bone did not. In addition, *Fgf23*<sup>HbB-cKO</sup>-ID mice showed a ~30% increase in erythroblasts and reticulocytes number compared to WT-ID mice. In line with these findings, erythroid progenitors treated with escalating doses of iFGF23 dose dependently blocked erythroid differentiation at precursor stage and reduced reticulocyte number. These effects were fully suppressed by co-treatment with FGFR1 inhibitor.

**Conclusions:** In aggregate, our results show that erythroid-produced iFGF23, but not circulating iFGF23, is a negative regulator of erythropoiesis and contributes to anemia via FGFR1 activation in erythroid precursors.

**Funding:** NIDDK Support

### TH-PO657

#### Inflammation-Induced Alterations in Erythropoiesis at the Single Cell Level

Jane J. Thomas, Guillaume Courbon, Aline Martin, Valentin David. Northwestern University Feinberg School of Medicine, Chicago, IL.

**Background:** Inflammation is a common determinant of anemia in patients with chronic kidney disease (CKD). Inflammation restricts bone marrow (BM) erythropoiesis, due to hepcidin-mediated hypoferremia, and increases erythrophagocytosis. In addition, pro-inflammatory cytokines act on erythroid cells to suppress erythroid differentiation. Splenic hematopoiesis helps maintain erythroid homeostasis in inflammation, but the exact mechanisms are poorly understood.

**Methods:** To investigate the immediate effects of inflammation on BM and on the spleen (SP), we injected 6 week-old mice with a single dose of saline (Ctr) or 250 ng/g IL-1 $\beta$  (IF) and performed single cell RNA sequencing on BM and SP cells from Ctr and IF mice collected 4 hours post-injection. We examined the hematopoietic progenitors and terminally differentiated cells response to IF using differentiation-specific molecular markers.

**Results:** Compared to Ctr, IF rapidly led to an increased recruitment of precursors to myeloid progenitors in BM. In addition, IF increased the number of lymphoid and megakaryocytic progenitors at the expense of the erythroid lineage in BM. In contrast, IF increased the number of terminally differentiated cells detected in SP. Indeed, while the number of lymphoid progenitors and precursors increased in BM, the number of terminally differentiated B, T and NK cells increased in SP in response to IF. A similar effect was seen in the megakaryocytic lineage resulting in an increased number of megakaryocytes in SP during IF. Interestingly, we further found that SP-differentiated erythroid cells were identical to BM erythroblasts, suggesting that trafficking of BM erythroid progenitors to the SP, rather than de novo recruitment of splenic precursors, maintains extramedullary erythropoiesis. However, in addition to mature reticulocytes, we found an alternate cluster of cells differentiating from orthochromatic erythroblasts in SP that was quasi-absent in BM. This cluster increased in response to IF, and shows a reduction in apoptotic markers and an increase in mature reticulocyte markers compared to steady state reticulocytes.

**Conclusions:** In aggregate, our results suggest that IF leads to increased trafficking of erythroid progenitors from the BM to the SP. Further maturing of erythroid progenitors in the SP results in reticulocytes that might be functionally distinct from BM cells.

**Funding:** NIDDK Support

### TH-PO658

#### Rates of Major Events in Untreated Patients Diagnosed With Anemia of CKD in France

Gema Requena,<sup>1</sup> Benedicte Stengel,<sup>2</sup> Oriane Lambert,<sup>2</sup> Ziad Massy,<sup>2,3</sup> Anne-Charlotte M. De Gouville,<sup>4</sup> Sally Wetten,<sup>1</sup> Marianne Cunningham.<sup>1</sup> <sup>1</sup>GlaxoSmithKline, Brentford, United Kingdom; <sup>2</sup>CKD REIN, Paris, France; <sup>3</sup>Hôpital Ambroise Paré, AP-HP, Paris, France; <sup>4</sup>GlaxoSmithKline, Paris, France.

**Background:** New treatments for anemia of chronic kidney disease (CKD) within the hypoxia-inducible factor prolyl hydroxylase inhibitors (HIF-PHI) class have recently been approved or are in development. Evidence of background rates of major events of interest in the eligible population will improve the understanding of the benefit/risk of these new products. We describe rates of events of interest among eligible non-dialysis dependent (NDD) patients with anemia of CKD not receiving an erythropoiesis-stimulating agent (ESA).

**Methods:** CKD-REIN is a prospective cohort study that collected demographic and clinical information from 3033 NDD patients with CKD (stage 3-5 at enrollment) in France. All participants were assessed annually between July 2013-Dec 2019, and outcomes data were limited to fatal and hospitalization events. Anemia was defined by hemoglobin level ( $< 13$  g/dl for men,  $< 12$  g/dl for women). Patients were followed from the study entry (index date) until the event of interest or censoring for end of the study period, ESA use, dialysis, kidney transplant or death.

**Results:** 1,118 patients had anemia and were ESA-naïve at entry into CKD-REIN. Mean age was 68 yrs and 67% were men. The most common comorbidities were hypertension (97%), hyperlipidemia (67%) and diabetes (50%). The highest event rates of interest were all-cause mortality, heart failure, septicemia and malignancies (Table).

Key: TH - Thursday; FR - Friday; SA - Saturday; OR - Oral; PO - Poster; PUB - Publication Only

Underline represents presenting author.

**Conclusions:** Results indicate that septicemia, heart failure and malignancies were common among these anemic CKD patients. The major complications observed will help physicians to better understand and manage these patients.

Patients untreated N=1,118	Events (n, %)	Event rate per 100py [95%CI]
Death (all cause)	335 (30%)	9.5 [8.5-10.5]
Myocardial Infarction	33 (3%)	1 [0.6-1.3]
Stroke	38 (3%)	1.1 [0.8-1.5]
Heart Failure	121 (11%)	3.6 [3-4.3]
Thromboembolic Event	19 (2%)	0.5 [0.3-0.8]
Pulmonary Arterial Hypertension	1 (0.1%)	0.03 [0-0.1]
Oesophageal and Gastric Ulcers	12 (1%)	0.3 [0.1-0.5]
Duodenum ulcer and unspecified peptic ulcer	9 (1%)	0.3 [0.1-0.4]
Malignancy	98 (9%)	2.9 [2.3-3.4]
Seizures	5 (0.4%)	0.1 [0-0.3]
Septicemia, Septic Shock, Other Infection	240 (21%)	7.3 [6.4-8.3]
Fractures	58 (5%)	1.7 [1.3-2.1]

**TH-PO659**

**Anemia and Dementia Risk in US Veterans With New-Onset CKD**

Alain Koyama,<sup>1</sup> Wei Yu,<sup>2</sup> Nilka Rios Burrows,<sup>1</sup> Devasmita Choudhury,<sup>2,3</sup> Robert Nee,<sup>4</sup> Alfred K. Cheung,<sup>5,6</sup> Keith C. Norris,<sup>7</sup> Monique E. Cho,<sup>5</sup> Guofen Yan.<sup>2</sup> <sup>1</sup>Centers for Disease Control and Prevention, Atlanta, GA; <sup>2</sup>University of Virginia, Charlottesville, VA; <sup>3</sup>VA Medical Center Salem, Salem, VA; <sup>4</sup>Walter Reed National Military Medical Center, Bethesda, MD; <sup>5</sup>University of Utah Health, Salt Lake City, UT; <sup>6</sup>VA Salt Lake City Health Care System, Salt Lake City, UT; <sup>7</sup>University of California Los Angeles, Los Angeles, CA.

**Background:** Current evidence suggests anemia is a risk factor for dementia. Older adults with chronic kidney disease CKD are at increased risk of both anemia and dementia; however, it is unclear how CKD influences the association between these two conditions. We examined the association between anemia and risk of dementia in US veterans with new-onset CKD.

**Methods:** The cohort included 444,474 veterans, aged ≥65 years, with new-onset CKD (estimated GFR <60 mL/min/1.73 m<sup>2</sup> for >3 months) in 2005-2016 in the Veterans Health Administration (VHA), followed for 2-14 years. At baseline, veterans were free of dementia and end-stage kidney disease. The severity of anemia was determined using baseline hemoglobin with pre-defined thresholds (g/dL): moderate or severe, <11.0; mild, 11.0-11.9; and none ≥12.0 for women; and <11.0, 11.0-12.9, and ≥13.0 for men, respectively. The outcome was incident dementia over follow-up identified using ICD-9/10 codes in claims from the VHA and Centers for Medicare & Medicaid Services. We estimated unadjusted and adjusted risks of dementia using cause-specific hazard ratios to account for the competing risk of death.

**Results:** The cohort had a mean±SD age of 76.3±7.2 years, and 98% were men. At baseline, 22,329 (5%), 114,314 (26%), and 307,831 (69%) veterans had moderate or severe anemia, mild anemia, and no anemia, respectively. Dementia incidence per 1,000 person-years was 52.7, 46.1, and 35.9 cases for patients with moderate or severe, mild, and no anemia, respectively. After multivariable adjustment, compared to patients without anemia, those with moderate or severe anemia had a 23% significant increased risk of dementia, while those with mild anemia had a 12% significant increased risk (Table).

**Conclusions:** Among patients with incident CKD, anemia was independently associated with an increased risk of dementia.

**Dementia risk by anemia status among veterans with incident CKD**

	Incidence of dementia (per 1000 patient-years)	Unadjusted hazard ratio (95% CI)	Adjusted hazard ratio (95% CI)*
No anemia	35.9	1.00 (reference)	1.00 (reference)
Mild anemia	46.1	1.35 (1.32-1.37)	1.12 (1.10-1.14)
Moderate or severe anemia	52.7	1.60 (1.55-1.65)	1.23 (1.19-1.27)

\*adjusted for demographics and baseline clinical characteristics (eGFR, erythropoietin-stimulating agent use, body mass index, systolic and diastolic blood pressure, smoking status, and a wide range of prevalent comorbidities)

**TH-PO660**

**Psychometric Properties of the SF-36 Vitality Scale in Patients With Anemia of CKD**

Tom J. Keeley,<sup>1</sup> Wen-Hung Chen,<sup>2</sup> Rodrigo Refoios Camejo,<sup>1</sup> Tony Okoro,<sup>2</sup> Margaret Vernon,<sup>3</sup> Ray Hsieh,<sup>4</sup> Sonja M. Stringer,<sup>4</sup> Kirsten L. Johansen.<sup>5</sup> <sup>1</sup>GlaxoSmithKline, Brentford, United Kingdom; <sup>2</sup>GlaxoSmithKline, Collegeville, PA; <sup>3</sup>Evidera, London, United Kingdom; <sup>4</sup>Evidera, Bethesda, MD; <sup>5</sup>Hennepin Healthcare, University of Minnesota, Minneapolis, MN.

**Background:** The Short-Form 36 is a widely used generic health-related quality of life (HRQoL) measure. The Vitality domain of the SF-36 (SF-36VT) offers a 4-item assessment of fatigue and energy levels. We evaluate the psychometric properties and score interpretation of SF-36VT in patients with anemia of chronic kidney disease (CKD).

**Methods:** A sample of 450 patients with anemia of CKD not currently receiving dialysis and patients initiating dialysis was used in these analyses. Assessments included reliability, construct validity and responsiveness. Thresholds for within-patient meaningful change were estimated by anchor-based (*a priori* anchors: Patient Global Impression of Severity [PGI-S] and PGI-Change [PGI-C]) and distribution-based methods.

**Results:** Internal-consistency reliability was good (Cronbach's alpha 0.83), and test-retest reliability was acceptable (intraclass correlation coefficient 0.68). Convergent validity was strong based on correlations (≥0.5) with the Chronic Kidney Disease-Anemia Questionnaire (CKD-AQ) and the Work Productivity and Activity Impairment Questionnaire: Anemic Symptoms Clinical Practice Version (WPAI-ANS-CPV). Greater impairment based on SF-36VT score was associated with more severe ratings on PGI-S, supporting known-groups validity. SF-36VT scores were responsive to change, with consistent patterns of increase observed with improvements in other measures (eg PGI-S, SF-36 Physical Functioning, SF-36 General Health, Euroqol 5-dimension). Anchor-based methods yielded a within-patient meaningful change from Day 1 to Week 28 of 11.9 and 6.1 points on the SF-36VT based on 2-point and 1-point improvements in PGI-S, respectively. Within-patient meaningful change based on PGI-C ratings were 6.8 (very much improved) and 4.5 (moderately improved). Distribution-based estimates of within-patient meaningful change thresholds were 6.78 (0.3 SD), 11.31 (0.5 SD) and 9.56 (delta 0.50 SD).

**Conclusions:** SF-36VT is a reliable, construct-valid and responsive measure for assessing fatigue/energy in patients with anemia of CKD. SF-36VT within-patient meaningful change estimates help interpret the benefit of a medical intervention.

**Funding:** Commercial Support - GlaxoSmithKline

**TH-PO661**

**CKD and Anemia Questionnaire (CKD-AQ): A Reliable and Sound Patient-Reported Outcome Measure for Use in Patients With Anemia of CKD**

Tom J. Keeley,<sup>1</sup> Wen-Hung Chen,<sup>2</sup> Rodrigo Refoios Camejo,<sup>1</sup> Tony Okoro,<sup>2</sup> Purav R. Bhatt,<sup>2</sup> Margaret Vernon,<sup>3</sup> Ray Hsieh,<sup>4</sup> Sonja M. Stringer,<sup>4</sup> Kirsten L. Johansen.<sup>5</sup> <sup>1</sup>GlaxoSmithKline, Brentford, United Kingdom; <sup>2</sup>GlaxoSmithKline, Collegeville, PA; <sup>3</sup>Evidera, London, United Kingdom; <sup>4</sup>Evidera, Bethesda, MD; <sup>5</sup>Hennepin Healthcare, University of Minnesota, Minneapolis, MN.

**Background:** CKD-AQ is the first patient-reported outcome (PRO) measure designed specifically to assess the symptom burden of anemia of CKD. It includes 21 items that give three domain scores (Tired/Low Energy/Weak, 10 items; Chest Pain/Shortness of Breath, 4 items; Cognitive, 3 items) and four individual item scores (difficulty sleeping, difficulty standing for long periods of time, severity-shortness of breath while sitting/resting, time with shortness of breath while not doing activity). We report on the measurement properties of CKD-AQ in patients with anemia of CKD.

**Methods:** Two separate samples (n=399, n=450) of combined data from patients with anemia of CKD not currently receiving dialysis and patients initiating dialysis were used. Factor structure was identified and tested using exploratory and confirmatory factor analyses (EFA/CFA). Other assessments: internal-consistency and test-retest reliability; construct validity; responsiveness; differential item functioning (DIF) analysis between patients on and not on dialysis.

**Results:** The three multi-item domain structure identified through EFA was confirmed with CFA, with factor analytic fit statistics above or just slightly below the recommended standard. Internal-consistency reliability was good (Cronbach's alpha 0.734-0.955) and test-retest reliability was adequate (intraclass correlation coefficient 0.555-0.701) for all scales. Convergent validity analysis showed hypothesized associations with Short-Form (SF)-36, Euroqol 5-dimension, and Work Productivity and Activity Impairment scores. CKD-AQ scores were significantly different among Patient Global Impression of Severity groups, supporting known-groups validity. Supporting responsiveness, improvements in CKD-AQ scale scores were consistently associated (p>0.3) with improvements in multiple external validation anchors (including SF-36 domains and component scores). There was no systematic difference in the way that dialysis and non-dialysis patients answered the CKD-AQ items.

**Conclusions:** CKD-AQ is a valid, fit-for-purpose and psychometrically sound PRO tool suitable for use in patients with anemia of CKD. The measure is licensable and ready for future use.

**Funding:** Commercial Support - GlaxoSmithKline

TH-PO662

**Patient and Physician Preferences for Treatments of Anemia in CKD: Insights From the Qualitative Pilot of a Choice Experiment**

Anna Richards,<sup>1</sup> Jaemin Seo,<sup>2</sup> Sarah Mulnick,<sup>2</sup> Ember Lu,<sup>3</sup> Tony Okoro,<sup>3</sup> Sebastian Heidenreich,<sup>4</sup> Rodrigo Refoios Camejo.<sup>1</sup> <sup>1</sup>GlaxoSmithKline, Brentford, United Kingdom; <sup>2</sup>Evidera, Bethesda, MD; <sup>3</sup>GlaxoSmithKline, Collegeville, PA; <sup>4</sup>Evidera, London, United Kingdom.

**Background:** A choice experiment (CE) was developed following literature review and qualitative interviews to understand patient/physician preferences for treatments of anemia of CKD. This pilot phase asked CE participants to make trade-offs between five treatment attributes.

**Methods:** The CE was pilot tested in virtual interviews with non-dialysis (ND; CKD stages 3–5) and peritoneal dialysis (PD) patients and nephrologists in US, Germany and Japan. Interviews explored if CE was understandable; the attributes relevant; and participants willing and able to make trade-offs. A think-aloud method from cognitive psychology was used to observe participants' understanding of the CE. Interviewers completed structured notes templates with their observations. Participants were asked if attributes of treatment profiles were more and less important to them when making choices.

**Results:** 18 patients (ND=13; PD=5) and 12 nephrologists participated. Attributes and levels were considered relevant and meaningful; relative importance within treatment profiles differed (Table). Patients focused more on route and frequency of administration (n=11, 61%) and reducing fatigue (n=10, 56%); physicians prioritized keeping Hb levels within target range (n=9, 75%) and 1-year risk of major cardiovascular events (n=6, 50%). Dosing restriction requirement (required time interval between taking phosphorous or iron supplements and anemia of CKD treatment) was less important for some patients and physicians (n=5, 28%; n=4, 33%), but more important to other patients (n=4, 22%).

**Conclusions:** Pilot testing met objectives for attribute comprehension, relevance, and tradability. Differences in importance of attributes presented in treatment profiles suggest divergent treatment priorities and presence of preference heterogeneity.

Table: Directly Stated More or Less Important Attributes in Pilot Interviews

Treatment Attributes within Profiles	Patients (n=18)		Physicians (n=12)	
	More Important*	Less Important*	More Important*	Less Important*
Route and frequency of administration	11 (61%)	1 (6%)	1 (8%)	0 (0%)
Keeping Hb in the target range	8 (44%)	1 (6%)	9 (75%)	0 (0%)
1-yr risk of major cardiovascular events*	3 (17%)	4 (22%)	6 (50%)	3 (25%)
Reducing fatigue	10 (56%)	2 (11%)	3 (25%)	2 (17%)
Dosing restriction requirement	4 (22%)	5 (28%)	1 (8%)	4 (33%)

\*Not mutually exclusive

TH-PO663

**Artificial Intelligence (AI) Tool Decreases Epoetin Beta (Mircera) Drug Exposure and Maintains Hemoglobin at Desired Levels**

Michael E. Brier,<sup>1,2</sup> Adam E. Gaweda,<sup>1</sup> George R. Aronoff,<sup>3</sup> <sup>1</sup>University of Louisville, Louisville, KY; <sup>2</sup>VA Robley Rex Medical Center, Louisville, KY; <sup>3</sup>Dosis Inc, San Francisco, CA.

**Background:** We innovated a clinical decision support tool for anemia management with epoetin alfa. This tool uses AI methods to classify patients into multiple dose-response categories combined with predictive control to achieve target hemoglobin over time. The tool was modified for use with long acting epoetin isoforms. We report clinical results with epoetin beta.

**Methods:** Data were abstracted from commercially available software Strategic Anemia Advisor (SAA, Dosis Inc, San Francisco, CA) between Dec 2018 and Mar 2022 and include dose and hemoglobin information on 2116 patients in 19 dialysis facilities receiving epoetin beta. Data were aggregated by month SAA use. Not every patient provided prior initiation data. Comparisons were the 12 month control period prior to SAA use, a 1 month washout period and a 12 month treatment period by linear regression and ANOVA using the factors Time (1-12) and SAA use. Epoetin beta is reported as the total monthly dose and hemoglobin as the mean monthly concentration.

**Results:** Statistical analysis demonstrated a mean monthly use of epoetin beta of 140 mcg/patient/month in the control period and an initial 40 mcg decrease with the use of SAA (p<0.001) that decreased over time (p=0.009) achieving a final dose of 84 mcg/patient/month. Achieved hemoglobin was 10.7 g/dL and not different in the control periods and in SAA months 5-12. Mean Hb was 10.5 g/dL in SAA months 1-4 (p=0.05). These results are shown in Figure 1.

**Conclusions:** An AI-powered anemia management program developed using epoetin alfa response data was adapted for use with epoetin beta. Treatment of patients in a real-world setting confirm previous observations where efficacy is maintained over a 12 month period while decreasing epoetin beta dose 29% initially ending with a mean dose of 84 mcg/month (Months 9-12). Further, the tool achieves the stated goal for ESA therapy using the least amount of ESA to avoid transfusion.

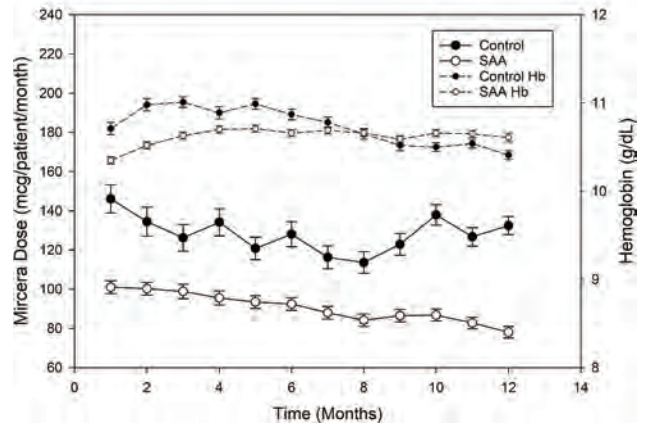

TH-PO664

**Discontinuation of Artificial Intelligence (AI) Tool for Anemia Management Results in Higher Drug Exposure, Lower Hemoglobin (Hb)**

Michael E. Brier,<sup>1,2</sup> Adam E. Gaweda,<sup>1</sup> George R. Aronoff,<sup>3</sup> <sup>1</sup>University of Louisville, Louisville, KY; <sup>2</sup>VA Robley Rex Medical Center, Louisville, KY; <sup>3</sup>Dosis Inc, San Francisco, CA.

**Background:** We innovated a clinical decision support tool for anemia management. This tool uses AI methods to classify patients into multiple dose-response categories combined with predictive control to achieve target Hb over time. The tool was modified for use with long acting epoetin isoforms (epoetin beta, Mircera®). We tested the hypothesis that dropping anemia management guidance will decrease quality.

**Methods:** Data were abstracted from a commercially available software Strategic Anemia Advisor (SAA, Dosis Inc, San Francisco, CA) between Dec 2018 and Mar 2022 on 855 patients in 5 dialysis facilities receiving epoetin beta located in the same geographic area. SAA use was left at the discretion of the facility medical director. Two facilities used SAA over the duration of the data capture (Facility 1 and 2), one facility never used SAA (Facility 3) and two facilities discontinued SAA at month 53 and 54 (Facility 4 and 5). Data were aggregated by month and an indicator of SAA recommendations.

**Results:** Facilities that used SAA guidance had higher Hb and lower monthly dose of epoetin beta/patient than the facility that did not use SAA (p<0.001). Discontinuation of SAA caused Hb to fall by about 0.6 g/dL and dose increased 30-39 mcg/patient/month. Mean Hb and dose are shown in Table 1. SAA use is shown as a solid line and no SAA use is shown as a dashed line in Figure 1.

**Conclusions:** Discontinuing AI management results in an immediate, detrimental effect on Hb and ESA dose. Those facilities that never used SAA or discontinued use observed an increased dose of epoetin beta and a decrease in Hb obtained. This is likely due to increased manipulation of the dose in resulting in over control the Hb concentration.

Facility	1	2	3	4	5
SAA	Yes	Yes	No	Yes	No
Hb (g/dL)	11.1	10.6	10.3	10.5	9.8
Dose (mcg/patient/month)	47	70	139	65	102

Statistical Analysis Oneway SNK

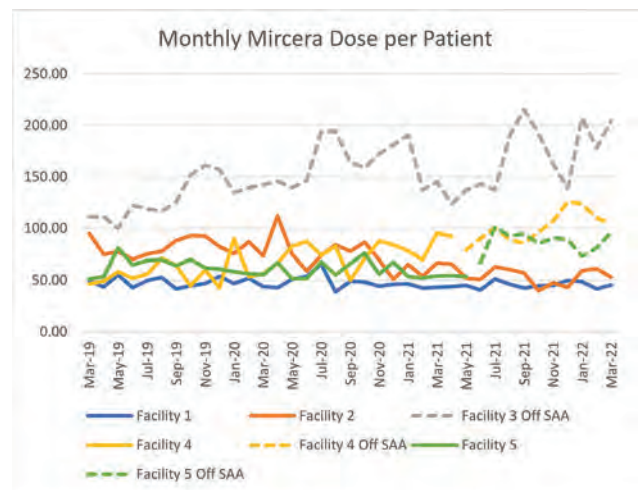

TH-PO665

An Explainable Model of ESA Prescription in the Hemodialysis Population

Yi-Wen Chiu,<sup>1,3</sup> Ming-Yen Lin,<sup>1</sup> Chan-Tung Ku,<sup>2</sup> Hong-Ren Yen,<sup>2</sup> Chan Hsu,<sup>2</sup> Yihuang Kang,<sup>2</sup> *Kaohsiung Medical University Chung Ho Memorial Hospital, Kaohsiung, Taiwan;* <sup>2</sup>*National Sun Yat-sen University, Kaohsiung, Taiwan;* <sup>3</sup>*Kaohsiung Medical University, Kaohsiung, Taiwan.*

**Background:** Our RCT (NCT04185519) has demonstrated the AI-assisted ESA prescription can maintain the Hb therapeutic target in HD patients, not inferior to physicians, and ESA dose-saving. However, the mechanism is untransparent.

**Methods:** A Generalized Linear Mixed-Effects Model (GLMM) was trained by ESA doses, iron supplement, Hb levels, and demographic and biochemical data of HD patients between 2014 and 2020. Except for mean absolute error (MAE), the traditional ESA dose prescription algorithm (TEA) was compared for the model efficiency. An index named "Confidence" was calculated as the percentage of optimal ESA dose predicted by a model. The optimal ESA dose was defined as within one syringe dose different from the ones maintaining the Hb within 10.8-11.2 gm/dL.

**Results:** 25,979 records of 316 ESKD patients were included, with 71.9% of Hb between 10-12mg/dL. The MAE were 0.4534 and 0.4964 gm/dl in training and testing data, respectively. Increasing the tree number and the depth of tree may further lower the MAE at the cost of model interpretability. The determinants of Hb changing by ESA dose included Hb, Hb changes, ESA dose, ESA dose changes, and iron supplement. There were 13 branches in our model to classify all records and demonstrate the ESA prescription algorithms. Compared with the TEA, our model showed similar efficiency in optimal ESA dose prediction. (Table)

**Conclusions:** A simple mixed-effect tree model with 13 leaf nodes can predict and explain the relationship between ESA dose and Hb changes. The "Confidence" used in our study helps evaluate the model. A further RCT (NCT05032651) is ongoing to confirm its clinical application.

**Funding:** Clinical Revenue Support

	Records size	GLMM	GLMM	TEA
	N (%)	MAE, gm/dL	ESA Confidence, %	ESA Confidence, %
node 1	1809 (7.0)	0.49	86.2	95.7
node 2	261 (1.0)	0.46	94.6	96.6
node 3	1347 (5.2)	0.48	92.4	97.4
node 4	217 (0.8)	0.45	89.3	95.7
node 5	789 (3.0)	0.49	92.6	91.9
node 6	3805 (14.7)	0.45	78.8	89.1
node 7	1128 (4.3)	0.48	83.5	87.7
node 8	2560 (9.9)	0.43	85.9	86.9
node 9	8224 (31.7)	0.45	80.2	88.9
node 10	2625 (10.1)	0.45	86.5	73.5
node 11	1059 (4.1)	0.47	75.9	83.1
node 12	1642 (6.3)	0.51	96.6	100
node 13	513 (2.0)	0.50	100	99.4

TH-PO666

Prevalence of Hyporesponse to Erythropoiesis-Stimulating Agents Among Medicare Patients With CKD-Related Anemia According to Absolute or Weight-Based Definitions

Todd Berner,<sup>1</sup> Christine Ferro,<sup>2</sup> Gabriela Dieguez,<sup>2</sup> Steve Metz,<sup>2</sup> Darrin W. Benjumea,<sup>3</sup> Kirsten L. Johansen.<sup>4,5</sup> <sup>1</sup>*Akebia Therapeutics Inc, Cambridge, MA;* <sup>2</sup>*Milliman USA, New York, NY;* <sup>3</sup>*Genesis Research LLC, Hoboken, NJ;* <sup>4</sup>*Hennepin Healthcare, Minneapolis, MN;* <sup>5</sup>*University of Minnesota, Minneapolis, MN.*

**Background:** Erythropoiesis-stimulating agents (ESAs) are widely used to treat anemia of chronic kidney disease (CKD). ESA hyporesponsiveness is associated with adverse events, leading to higher healthcare resource utilization. Hyporesponse (HR) has been defined vaguely as need for high doses of ESAs with or without achieving target hemoglobin levels. No standard definition of HR exists, and terms offered in literature vary widely. Using data representing 100% of Medicare fee-for-service beneficiaries, we examined the prevalence of hyporesponsiveness using different definitions in a dialysis-dependent (DD)-CKD patient population in the US.

**Methods:** We identified patients with DD-CKD receiving 3+ months of outpatient dialysis (in-center or at home) with concurrent ESA use in 2019. For each patient, we defined months of HR as those where the hemoglobin level for the prior month was <10 g/dL and the current month's average ESA weekly dose surpassed weight dependent and weight agnostic thresholds: 300 epoetin alfa (epo) units (U)/kg of body weight, 375U/kg, 450U/kg, and 18,000U. We assessed the number and percent of patients at least one month of HR or with at least 60% of months of HR.

**Results:** We identified 247,992 patients with DD-CKD and 3+ months of ESA use. Table 1 presents the number of patients and prevalence of HR by average weekly ESA dose threshold.

**Conclusions:** Different definitions of ESA hyporesponse among people with CKD-related anemia produced a range of prevalence rates. In our study, between 7.0% and 31.2% of patients experienced at least one month of HR; however, only a fraction of these (0.4% to 3.0%) were hyporesponsive for at least 60% of the time, reflective of the transient nature of the condition. Further research is needed to understand the clinical trajectories of episodically hyporesponsive patients.

**Funding:** Commercial Support - Akebia Therapeutics, Inc.

Table 1: Prevalence of hyporesponse to ESA therapy (2019 Medicare FFS)

Patient Counts (% Prevalence)	ESA Threshold (epoetin alfa U per week)			
	300/kg	375/kg	450/kg	18,000
With ≥1 Months HR	48,966 (19.7%)	29,332 (11.8%)	17,376 (7.0%)	77,380 (31.2%)
With ≥60% Months HR	3,663 (1.5%)	1,882 (0.8%)	1,005 (0.4%)	7,556 (3.0%)

ESA, erythropoiesis-stimulating agent; FFS, fee-for-service; HR, hyporesponse.

TH-PO667

Variation in Hemoglobin Distribution in Patients With CKD: The International Network of CKD Cohorts (iNET-CKD)

Mark Canney,<sup>1</sup> Dilshani Induruwage,<sup>2</sup> Mila Tang,<sup>2</sup> Lee Er,<sup>2</sup> Yinshan Zhao,<sup>3</sup> Natalia Alencar de Pinho,<sup>4</sup> Benedicte Stengel,<sup>4</sup> Maarten W. Taal,<sup>5</sup> Janis M. Dionne,<sup>6</sup> Harold I. Feldman,<sup>7</sup> Thomas Hiemstra,<sup>8</sup> Anna Richards,<sup>8</sup> Ognjenka Djurdjev,<sup>2</sup> Adeera Levin,<sup>3</sup> iNET-CKD Investigators <sup>1</sup>*Ottawa Hospital Research Institute Clinical Epidemiology Program, Ottawa, ON, Canada;* <sup>2</sup>*BC Provincial Renal Agency, Vancouver, BC, Canada;* <sup>3</sup>*The University of British Columbia, Vancouver, BC, Canada;* <sup>4</sup>*Centre de Recherche en Epidemiologie et Sante des Populations, Villejuif, France;* <sup>5</sup>*Royal Derby Hospital, Derby, United Kingdom;* <sup>6</sup>*BC Children's Hospital, Vancouver, BC, Canada;* <sup>7</sup>*University of Pennsylvania, Philadelphia, PA;* <sup>8</sup>*GlaxoSmithKline Plc, Brentford, United Kingdom.*

**Background:** Hemoglobin (Hb) has a narrow target range in patients with CKD but little is known about geographical differences in Hb distribution. The aims of this global collaborative study were to compare the distribution of Hb across international CKD populations and evaluate predictors of Hb.

**Methods:** Two-stage individual participant data meta-analysis of cross-sectional data from participating iNET-CKD cohorts. Included participants were >18 years with non-dialysis CKD (eGFR <60 mL/min). Using a standardized protocol with harmonized variable definitions, the relationships between candidate predictors and Hb were evaluated in linear regression models and estimates were subsequently pooled in a random effects model.

**Results:** A total of 54,368 participants from 19 cohorts (median eGFR 17 to 49 mL/min) were included with broad geographic representation. Hb values varied substantially among the cohorts even within strata of eGFR and sex (Figure). Across the eGFR range, women had a lower Hb compared to men; however, these differences were smaller at lower eGFR (mean difference 13.2 g/L (95% CI 10.8-15.6) at eGFR of 60 mL/min versus 5.2 g/L (95% CI 3.5-7.0) at eGFR of 15 mL/min, p<0.001 for interaction). In a multivariable model, lower eGFR, female sex, older age, lower body mass index and diabetic kidney disease were independent predictors of a lower Hb value, but this only explained a minority of variance in Hb (median R<sup>2</sup> of 21% [range 7 to 44%] across the cohorts).

**Conclusions:** There are substantial regional differences in Hb distribution among individuals with CKD. The majority of variance in Hb is unexplained by demographics, GFR or comorbidities. A better understanding of international variation in Hb, and the factors that contribute to it, could change the way Hb values are interpreted in CKD.

**Funding:** Commercial Support - GSK

Figure: Hemoglobin distribution among international CKD cohorts by eGFR category and sex.

All cohorts are represented in the violin plots. The shaded bars represent the median and interquartile range. Wider sections of the plot represent a higher probability that members of the population take on a given value.

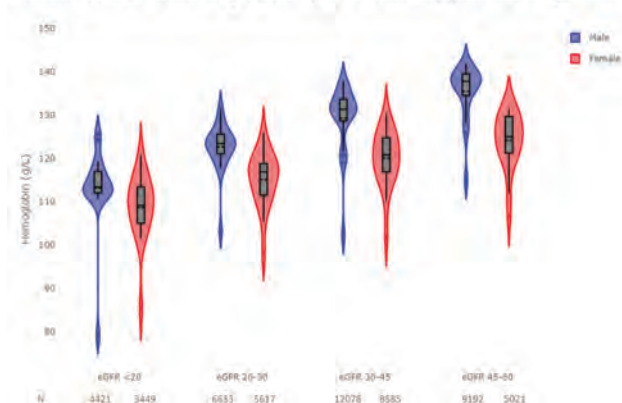

TH-PO668

Variation of Hemoglobin and Hematocrit by Timing of Blood Sampling in Hemodialysis Patients

Pichaya Tantiyavarong, Jakkraphip Weeravittayasate. *Thammasat University Faculty of Medicine, Khlong Nueng, Thailand.*

**Background:** Hemoglobin (Hb) and hematocrit (Hct) have been used to monitor anemia treatment and their values depending on plasma volume. In long hemodialysis interval, patients usually incur higher weight gain, which may lower Hb and Hct levels. This study aimed to compare Hb and Hct regarding blood sampling times.

**Methods:** The prospective observational study was conducted in 103 patients receiving three hemodialysis sessions per week. Hb, automated and centrifuged Hct were collected pre- and post-dialysis in three consecutive sessions. Primary outcome

was to compare these measures between blood sampling periods (one long and two short intervals). Secondary outcomes were correlation with body weight loss, correlation between Hb and Hct, and agreement of automated and centrifuged Hct.

**Results:** There was no difference in the mean pre-dialysis Hb ( $10.1 \pm 1.2$  vs  $10.3 \pm 1.3$  vs  $10.3 \pm 1.3$  g/dL in long and two short intervals respectively;  $p = 0.320$ ), automated Hct ( $31.0 \pm 4.0$  vs  $31.7 \pm 4.4$  vs  $31.8 \pm 4.2\%$ ;  $p = 0.372$ ) and centrifuged Hct ( $34.0 \pm 4.6$  vs  $35.8 \pm 6.1$  vs  $35.2 \pm 4.8\%$ ;  $p = 0.054$ ). Weight losses were correlated with all incremental measures. Hb were strongly correlated with automated Hct ( $r = 0.98$ ,  $p < 0.001$ ) and centrifuged Hct ( $r = 0.86$ ,  $p < 0.001$ ). Centrifuged Hct was higher than automated Hct (mean difference of 3.65%).

**Conclusions:** Timing of pre-dialysis blood samplings did not impact the level of Hb, automated or centrifuged Hct. Either Hb or Hct can be used to monitor renal anemia.

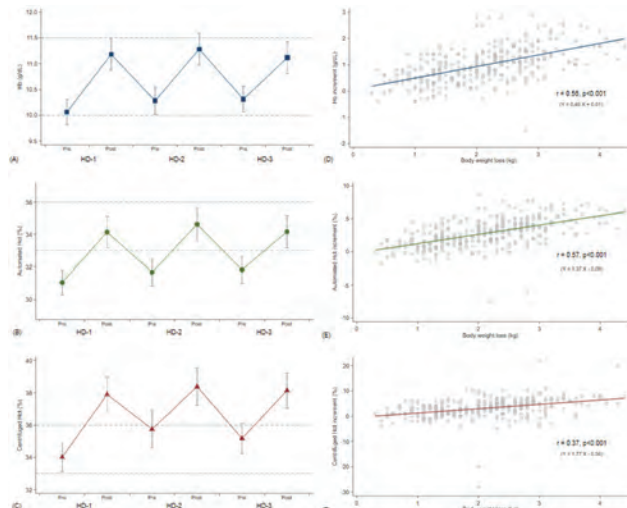

**Effects of hydration status on hemoglobin, automated and centrifuged hematocrit: A – C) Comparison between pre and post-dialysis among three dialysis sessions; D – F) Incremental changes and body weight losses.**

Abbreviation: HD-1, the first hemodialysis session (long interval); HD-2, the second hemodialysis session (short interval); HD-3, the third hemodialysis session (short interval).

**TH-PO669**

**Maintenance Intravenous Iron in Hemodialysis Patients to Minimize Erythropoietin Doses: A Double-Blinded, Randomized Controlled Trial**  
 Pichaya Tantiyavarong,<sup>1,3</sup> Suthiya A. Anumas,<sup>2,3</sup> Aphichat Chatkraitel.<sup>3</sup>  
<sup>1</sup>Thammasat University Faculty of Medicine, Khlong Nueng, Thailand; <sup>2</sup>Thammasat University, Pathum Thani, Thailand; <sup>3</sup>Thammasat University Hospital, Khlong Nueng, Thailand.

**Background:** There is no standard regimen for maintenance iron supplementation in chronic hemodialysis patients. We investigated fixed-appropriate doses of intravenous (IV) iron protocols for maintaining hemoglobin levels and minimizing erythropoietic-stimulating agents (ESA).

**Methods:** A double-blinded, randomized controlled trial was conducted in hemodialysis patients who had ferritin levels of 200-700 ng/dl and transferrin saturation (TSAT) 20-40%. Patients were randomized to receive either 100-mg or 200-mg monthly IV iron. ESA was adjusted monthly to maintain Hb of 10-12 g/dl. The primary endpoint was ESA dose at 12 months. Key secondary endpoints were all-cause mortality, cardiovascular events, absolute iron deficiency anemia (IDA), blood transfusion, adverse events, and iron withholding rate.

**Results:** Of 79 eligible patients, 40 were in the 100-mg IV iron group and 39 in the 200-mg. Mean monthly ESA dose at month 12 was  $35,706 \pm 21,637$  IU in the 100-mg IV iron group versus  $26,382 \pm 14,983$  IU in the 200-mg group ( $P = 0.03$ ). Twelve patients (30%) in 100-mg group and four patients (10.5%) in 200-mg one had IDA ( $P = 0.05$ ). Three patients in each group died ( $P = 0.9$ ). There were no significant differences in hospitalization, venous access thrombosis, and infection rate in both groups, but these were slightly higher in the 200-mg cohort. The withholding rate was 25% and 64.1% ( $P = 0.03$ ).

**Conclusions:** Monthly 200-mg IV iron doses were effective at minimizing ESA doses in hemodialysis patients but with a higher withholding rate. In high-ferritin patients, we suggest starting with 100-mg IV iron.

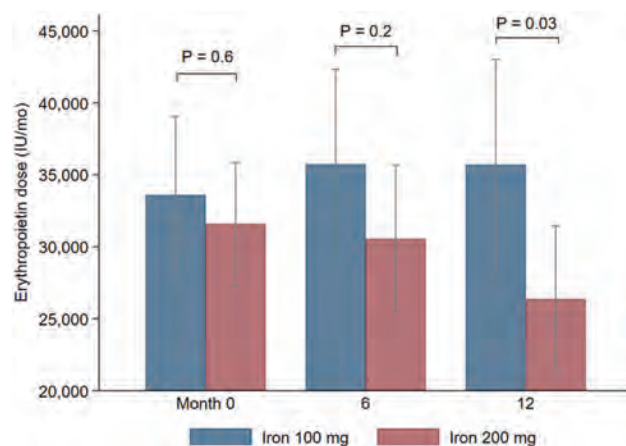

Mean monthly dosages of erythropoietin at month 0 (baseline), month 6, and month 12 (primary endpoint) between 100-mg and 200-mg intravenous iron groups

**TH-PO670**

**Impact of Angiotensin Converting Enzyme Inhibitors and Angiotensin II Receptor Blockers on Erythropoiesis-Stimulating Agents in the CKD Population in Singapore**

Karmen Quek. Changi General Hospital, Singapore, Singapore.

**Background:** The hypothesis that angiotensin converting enzyme inhibitors (ACEi) and angiotensin II receptor blockers (ARB) affect erythropoiesis stimulating agent (ESA) dosing requirement remains controversial. To test this hypothesis in the local population, a retrospective observational cohort study was conducted in a group of chronic kidney disease patients with renal anaemia.

**Methods:** The effect of ACEi and ARBs were evaluated by tracing the ESA dosing requirement and haemoglobin concentration achieved within 6 months of newly initiating an ACEi or ARB. Results from 200 patients were compared between patients receiving ESA alone (control arm, N=100) and patients receiving both ESA and ACEi or ARB (intervention arm, N=100). Patients were further divided into 3 groups: ESA alone (N=100), ESA and ACEi (N=50), ESA and ARB (N=50) for stratified analysis. The outcomes evaluated after a 6-month follow-up include ESA dose, haemoglobin concentration and erythropoietin resistance index (ERI). Multiple linear regression analysis with adjustment was performed to eliminate the influence of confounding factors in the heterogeneous patient groups.

**Results:** The ACEi studied were enalapril (N=33), lisinopril (N=15) and perindopril (N=2). The ARBs studied were losartan (N=23), irbesartan (N=13), telmisartan (N=12) and valsartan (N=2). The addition of ACEi and ARB did not have an effect on ESA dosing requirement ( $84.1 \pm 50.6$  vs  $91.1 \pm 58.1$  U/kg/week,  $P=0.37$ ) and haemoglobin concentration ( $10.7 \pm 1.3$  vs  $10.6 \pm 1.2$  g/dL,  $P=0.67$ ) in both direct comparison and multiple linear regression analysis. For the stratified analysis, two parameters in the multiple linear regression model, baseline haemoglobin concentration and ESA dose had an effect on ESA dose ( $P=0.033$  and  $P=0.001$ , respectively) and ERI ( $P<0.001$  for both) at the end of the 6-month follow-up period.

**Conclusions:** The findings of this study suggest that ACE inhibitors and ARBs do not contribute to ESA resistance and may be used as indicated in the local CKD population. Nevertheless, given the wide divide in current opinion, it may be prudent to trial dose reduction or cessation of ACEi or ARB in patients if there is no other clearly definable cause for ESA hyporesponsiveness and if the anticipated benefits exceed the anticipated risks.

**TH-PO671**

**Don't Forget About Trace Minerals: A Rare Case of Erythropoietin-Resistant Anemia**

Andrew Yanik, Josephine Abraham, Tooran Lavasani. University of Utah Health, Salt Lake City, UT.

**Introduction:** Erythropoietin (EPO) resistant anemia is a problem often encountered in patients with end stage renal disease (ESRD), and a rare cause of this is copper deficiency. We report the case of a patient with EPO resistant anemia attributable to zinc induced copper deficiency.

**Case Description:** A 69-year-old male with ESRD due to type I diabetes mellitus on intermittent hemodialysis and darbepoetin for anemia was referred to hematology for EPO resistant anemia as well as pancytopenia. Notably, he also followed with ophthalmology for a history of acute angle closure glaucoma. His hemoglobin had ranged from 9.0-12 g/dL for a period of about three years. Six months prior to referral, he was admitted for a hip fracture complicated by severe anemia with a hemoglobin to 6.2 g/dL. There was no evidence of blood loss and anemia was attributed to ESRD. His hemoglobin had remained at 6.5-8 g/dL despite an escalating dosing of erythropoietin and pancytopenia was noted, prompting referral to hematology. Labs were pertinent for hyperzincemia to 124 ug/dL (ref 60-120) with hypocupremia to 20.6 ug/dL (ref 70-140). On further investigation, he was noted to have been taking a multivitamin regimen prescribed by ophthalmology that

contained 160 mg of daily zinc. This was held and copper supplementation was initiated. Repeat studies later revealed zinc and copper to be normal at 90.9 ug/dL and 88.8ug/dL respectively. His hemoglobin has remained 10-12.1 g/dL since.

**Discussion:** EPO resistant anemia is not uncommon for patients with ESRD on dialysis, and hypocupremia is an underreported etiology. Zinc deficiency is reported in up to 80% of patients with ESRD and is therefore often supplemented. Zinc competes with other metals at the metallothionein protein receptor in the small intestine. In the setting of hyperzincemia, this receptor upregulates as a homeostatic mechanism and copper's higher affinity for the receptor promotes its binding and ultimate loss in the stool, causing hypocupremia. As illustrated in the case presented here, zinc induced copper deficiency is a clinically relevant cause of EPO resistant anemia in ESRD.

#### TH-PO672

##### The Direct Effect of the Vitamin D Receptor Activation in Hemoglobin: Opening a New Treatment Approach in Renal Anaemia

Miguel Uriol Rivera,<sup>1,2</sup> Gemma Arrufat Goterris,<sup>1</sup> Aina Obrador,<sup>1</sup> Angel Garcia-Alvarez,<sup>3</sup> Sonia Jimenez.<sup>1</sup> <sup>1</sup>Hospital Universitari Son Espases, Palma de Mallorca, Spain; <sup>2</sup>Fundacio Institut d'Investigacio Sanitaria Illes Balears, Palma de Mallorca, Spain; <sup>3</sup>Hospital Comarcal d'Inca, Inca, Spain.

**Background:** Renal anemia (RA) is a major problem in chronic kidney disease (CKD). Correcting the relatively low plasma erythropoietin levels as a treatment strategy has safety concerns. The supraphysiological erythropoiesis stimulus increases the number of reticulocytes that could be associated with detrimental effects especially increasing anisocytosis which is easily determined by the changes in red blood cell distribution width (RDW) values. The benefit of the selective vitamin D receptor activation improving hemoglobin levels has been described; however, whether the effect of the paricalcitol in RA is independent of the secondary hyperparathyroidism (SHPT), renal function and its effect on RDW is unknown.

**Methods:** This is a retrospective study. Patients were treated with paricalcitol and followed up for 6 months. Patients were stratified according to the presence of SHPT (plasma parathyroid hormone < 72 pg/ml) and chronic kidney disease (CKD, plasma creatinine < 1.3 mg/dl) and renal anemia (hemoglobin < 12 g/dl for female and < 13 g/dl for male. Neither recombinant erythropoietin nor iron supplements were administered. Exclusion criteria were bleeding or recent blood transfusion history.

**Results:** 40 patients were included. Sex (M/F): 26/14. Mean age: 57 (18) years. Overall, the mean (95%CI) was 0.8 (0.4 to 1.2) g/dL, P<0.001. Hemoglobin increased in patients with and without SHPT [0.9 (0.2 to 1.6) and 0.7 (0.2 to 1.1) g/dL, P<0.014 and P=0.004, respectively], in patients with or without CKD [0.9 (0.3 to 1.6) g/dl and 0.6 (0.1 to 1.1), P<0.013, P=0=0.004, respectively] and in anemic versus non-anemic patients [0.9 (0.2to1.7)g/dl and 0.6 (0.2 to 1.0)g/dL, P=0.01 and P=0.004, respectively]. Interestingly red blood cells count (RBC) increased in all groups, but no changes in mean corpuscular volume (MCV), mean corpuscular hemoglobin (MCH) and RDW were observed.

**Conclusions:** Paricalcitol therapy increased significantly hemoglobin levels independently of SHPT and chronic kidney disease. Paricalcitol increased the RBC number maintaining the degree of anisocytosis in the physiological range. These results represent a real opportunity for exploring the use of paricalcitol as a safe and effective therapy for renal anemia

#### TH-PO673

##### ESAs in Hemodialysis Patients With Malignancy: A Multicenter, Retrospective Cohort Study

Junkyu Park, Sungjin Chung, Eun Sil Koh, Wonji Jo. Catholic University of Korea School of Medicine, Seoul, Republic of Korea.

**Background:** Anemia is a common complication in both chronic kidney disease (CKD) and malignancy, associated with mortality and decreased quality of life. Erythropoiesis-stimulating agents (ESAs) is commonly used to treat anemia in CKD patients. However, the risk of cancer progression of ESAs use has been constantly implicated. KDIGO guideline recommends to use ESAs with great caution for anemia in CKD patients combined with malignancy due to the risk of cancer progression. Recently, Several studies showed that it might be irrelevant. In this study, the impact of ESAs use on the risk of cancer progression and mortality has been explored.

**Methods:** A retrospective, multi-centered cohort was established using electronic medical records from 5 different medical institutes. Patients who were 18 years old or older, had been newly diagnosed end-stage renal disease and begun hemodialysis were considered as eligible participants. A total of 894 patients were enrolled from March 1, 2010 to December 31, 2017. The patients were classified into three groups based on ESAs prescription patterns: never users, dynamic users, and always users. The association between ESAs use and the occurrence of newly diagnosed malignancy, recurrence of pre-existing cancer, and mortality were investigated.

**Results:** The mean age of the patients was 62 years and 58% were male. Diabetes consisted of 61.0% of the patients and 81.5% were hypertensive. The mean hemodialysis vintage was 6.9 years. Primary incidence of malignancy recurrence, newly diagnosed malignancy and mortality was 9 (1.9%), 52 (5.8%), 133 (14.9%), respectively. Multivariable cox regression analysis revealed that ESAs use is not significantly associated with mortality (Hazard ratio (HR), 0.55; Confidential index (CI), 0.19-1.52; P=0.246). The risk for newly diagnosed cancer decreased in always users compared with never users (HR, 0.12; CI, 0.02-0.67; P=0.016). The risk of newly diagnosed cancer for dynamic users were statistically insignificant compared with never users (HR, 0.23; CI, 0.05-1.08; P=0.063).

**Conclusions:** This study showed that there is no statistically significant difference in mortality risk among ESAs use patterns, and partially decreased risk for cancer progression. A careful, individualized administration of ESAs to patients with ESRD and malignancy can be considered for anemia treatment.

#### TH-PO674

##### The Effect of Intravenous Iron on Exercise Capacity in Iron-Deficient but Not Anaemic Patients With CKD: A Multicentre Prospective Double-Blind Randomised Controlled Trial

Sharlene A. Greenwood,<sup>1,2</sup> Benjamin A. Oliveira,<sup>2</sup> Elham Asgari,<sup>4</sup> Salma Ayis,<sup>2</sup> Luke A. Baker,<sup>3</sup> Debasish Banerjee,<sup>5</sup> Sunil Bhandari,<sup>6</sup> Joseph Chilcot,<sup>2</sup> James Burton,<sup>3</sup> Philip A. Kalra,<sup>7</sup> Courtney J. Lightfoot,<sup>3</sup> Iain C. Macdougall,<sup>1</sup> Anastasios Mangelis,<sup>2</sup> Kieran Mccafferty,<sup>8</sup> Darlington Okonko,<sup>2</sup> Fiona Reid,<sup>2</sup> Alice C. Smith,<sup>3</sup> Pauline A. Swift,<sup>9</sup> Emma L. Watson,<sup>3</sup> David C. Wheeler,<sup>10</sup> Thomas J. Wilkinson,<sup>3</sup> Kate Bramham.<sup>2</sup> <sup>1</sup>King's College Hospital NHS Foundation Trust, London, United Kingdom; <sup>2</sup>King's College London, London, United Kingdom; <sup>3</sup>University of Leicester, Leicester, United Kingdom; <sup>4</sup>Guy's and St Thomas' NHS Foundation Trust, London, United Kingdom; <sup>5</sup>St George's and St Thomas' NHS Foundation Trust, London, United Kingdom; <sup>6</sup>Hull University Teaching Hospitals NHS Trust, Hull, United Kingdom; <sup>7</sup>Salford Royal Hospital, Salford, United Kingdom; <sup>8</sup>Royal London Hospital Cardiovascular Services, London, United Kingdom; <sup>9</sup>Epsom and Saint Helier University Hospitals NHS Trust, Carshalton, United Kingdom; <sup>10</sup>University College London, London, United Kingdom.

**Background:** Many people living with chronic kidney disease (CKD) are iron deficient, even though they may not be anaemic. The Iron and Muscle study aimed to evaluate whether iron supplementation leads to enhanced exercise capacity and physical function.

**Methods:** Prospective, double-blind multicentre randomised controlled trial (RCT) with non-dialysis CKD patients with iron deficiency but without anaemia. Patients were randomly assigned (1:1) to either: i) intravenous (IV) iron therapy, or ii) placebo. Primary outcome was difference in six-minute walk test (6MWT) between groups at 4 weeks. Secondary outcomes included: fatigue, physical function, muscle strength, quality of life, clinical chemistry, safety and harms at baseline, 4, and 12 weeks. Difference in means for all outcomes between groups was analysed using an ANCOVA model.

**Results:** We randomly assigned 75 patients with mean (SD) age for iron therapy [(n=38) 54(16) yrs vs placebo (n=37) 61(12) yrs], mean (SD) eGFR [34(12) vs. 35(11) ml/min/1.73m<sup>2</sup>], mean (SD) transferrin saturation (TSAT) [23 (12) vs. 21 (6)%], mean (SD) serum ferritin (SF) [57 (64) vs. 62 (33) µg/L] and mean (SD) 6MWT [384 (195) vs. 469 (142) metres] at baseline, respectively. Adjusting for baseline measures, 6MWT showed no statistically significant difference between arms at 4 weeks (p=0.263), or 12 weeks (p=0.321). There were non-significant increases in 6MWT from baseline to 12 weeks in the IViron arm. There were statistically significant increases in SF and TSAT at 4 and 12 weeks (p<0.001) and haemoglobin at 12 weeks (p=0.0135). There were no adverse events attributable to IV iron.

**Conclusions:** This study did not demonstrate any significant beneficial effect of IV iron on exercise capacity despite improvements in parameters of iron status and Hb concentration, and numerical increases in functional capacity scores. A larger study is required to confirm if IV iron is beneficial in non-dialysis patients with CKD who are iron-deficient but not anaemic to improve exercise capacity.

**Funding:** Private Foundation Support

#### TH-PO675

##### Urinary Iron and Death in Kidney Transplant Recipients

Daan Kremer,<sup>1</sup> Tim J. Knobbe,<sup>1</sup> Joanna Sophia J. Vinke,<sup>1</sup> Kai Luersen,<sup>2</sup> David E. Leaf,<sup>3</sup> Martin H. De Borst,<sup>1</sup> Gerald Rimbach,<sup>2</sup> Stephan J. Bakker,<sup>1</sup> Michele F. Eisenga.<sup>1</sup> <sup>1</sup>University Medical Center Groningen, Groningen, Netherlands; <sup>2</sup>Christian-Albrechts-Universität zu Kiel Agrar- und Ernährungswissenschaftliche Fakultät, Kiel, Germany; <sup>3</sup>Brigham and Women's Hospital, Boston, MA.

**Background:** Circulating markers of iron status are associated with adverse outcomes among kidney transplant recipients (KTRs), but limited data are available on urinary iron. Increased urinary iron can result from (i) increased iron delivery to the kidneys, (ii) increased glomerular passage, or (iii) decreased tubular reuptake. We studied associations of urinary iron with these pathways and with clinical outcomes in KTRs.

**Methods:** We used data from the prospective TxL FN cohort study, which included prevalent KTRs ≥1y after transplantation. Urinary iron concentrations were measured using mass-spectrometry.

**Results:** We included 693 KTRs (age 53±13y, 43% female, eGFR 45±19 ml/min/1.73m<sup>2</sup>). Urinary iron concentrations were assessed at a median of 5.4 years post-transplant [IQR, 2.0 to 12.0]. In linear regression, higher urinary iron was associated with lower eGFR (St. β -0.20; P<0.001), and more tubular injury as assessed using urinary and circulating markers (**Figure**). In contrast, urinary iron was not associated with transferrin saturation, ferritin, and iron after adjustment for age, sex, and eGFR (P>0.05 for all). Prospectively, higher urinary iron was associated with graft failure, but the association was eliminated after adjustment for proteinuria (**Table**). Higher urinary iron was independently associated with increased mortality (**Table**).



**Conclusions:** Higher urinary iron was associated with worse kidney function, more proteinuria, and increased markers of tubular injury, but not with systemic iron status. In addition, higher urinary iron was independently associated with higher mortality risk in KTRs, which warrants further investigation into the potential of urinary iron as a biomarker in KTRs and other populations.

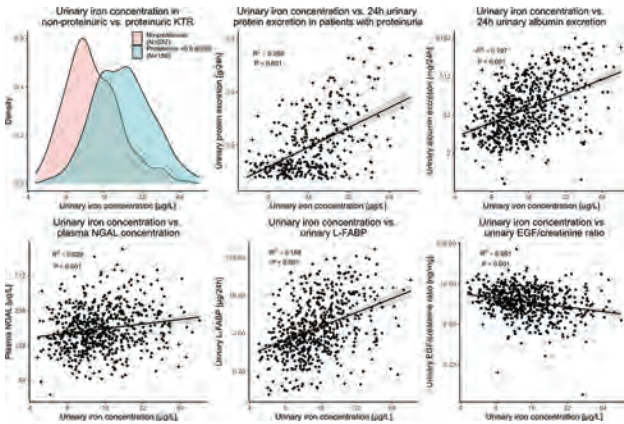

**Table 1** Univariable and adjusted Cox proportional hazards analyses for the association of urinary iron concentration with graft failure and mortality

Model	Graft Failure (N=83, 12%)		Mortality (N=150, 22%)	
	HR per doubling (95% CI)	P-value	HR per doubling (95% CI)	P-value
Crude	1.65 (1.38 to 1.97)	<0.001	1.30 (1.11 to 1.51)	<0.001
Model 1	1.63 (1.11 to 1.63)	<0.001	1.45 (1.24 to 1.70)	<0.001
Model 2	1.34 (1.11 to 1.63)	0.003	1.38 (1.18 to 1.62)	<0.001
Model 3	1.08 (0.86 to 1.37)	0.5	1.28 (1.07 to 1.52)	0.006
Model 4	1.14 (0.89 to 1.47)	0.3	1.26 (1.05 to 1.50)	0.014
Model 5	1.11 (0.85 to 1.44)	0.4	1.28 (1.07 to 1.54)	0.007

**Model 1**, adjustment for age, sex, time after transplantation. **Model 2**, adjusted for variables in model 1 + eGFR; **Model 3**, adjusted for variables in model 2 + log<sub>10</sub> 24h urinary protein excretion; **Model 4**, adjusted for variables in model 3 + urinary epidermal growth factor to creatinine ratio, plasma NGAL, liver-type fatty acid-binding protein. **Model 5**, adjusted for variables in model 4 + circulating iron and ferritin, transferrin saturation, and use of iron supplementation.

**TH-PO676**

**Iron Status and Cause-Specific Mortality in Kidney Transplant Recipients**

Joanna Sophia J. Vinke, Daan Kremer, Tim J. Knobbe, Stefan P. Berger, Stephan J. Bakker, Martin H. De Borst, Michele F. Eisenga. *Department of Nephrology, University Medical Center Groningen, Groningen, Netherlands.*

**Background:** Iron deficiency (ID) is highly prevalent after kidney transplantation. Previously, we showed that ID, independent of anemia, is associated with an increased risk of all-cause mortality in kidney transplant recipients (KTRs). Iron is involved in myriad processes, ranging from cardiomyocyte metabolism to being fuel for bacteria. We further explored the associations of iron status parameters with different cause-specific mortality reasons in KTRs.

**Methods:** We used data from the prospective Transplantlines Food and Nutrition Study, for which baseline measurements were performed in KTRs that were ≥1 year post-transplantation. Cox regression analyses of recently updated follow-up data were used to assess associations of ferritin, reflecting iron storage, and transferrin saturation (TSAT), reflecting functional iron status, with cause-specific mortality. Analyses were adjusted for age, sex, eGFR, 24-hour urinary protein excretion, time since transplantation, hs-CRP, systolic blood pressure, smoking status and presence of anemia. Anemia was defined as Hb <13 g/dL (M) or <12 g/dL (F).

**Results:** We included 695 KTRs (age 53±13 years, 57% males, eGFR 52±20 mL/min/1.73 m<sup>2</sup>, ferritin 118 µg/L [IQR 54–222], and TSAT 25±11%). 292 (41%) KTRs had anemia. During 5.9 [IQR 5.3–6.6] years of follow-up, 148 (21%) died: 59 (9%) from cardiovascular causes, 41 (6%) from infections and 25 (4%) from cancer. Tertiles of ferritin were not associated with all-cause mortality or with any of the cause-specific mortality endpoints. A lower TSAT was associated with a higher risk of all-cause mortality [HR 1.26 (95% CI: 1.06–1.50) per 10% decrease, P=0.01] after adjustment for potential confounders. Upon cause-specific analysis, a lower TSAT was not independently associated with a higher risk of death from infection [HR 0.96 (95% CI 0.71–1.29), P=0.77] or cancer [HR 1.10 (95% CI 0.73–1.66), P=0.64], but was associated with a higher risk of cardiovascular mortality [HR 1.39 (95% CI 1.04–1.85), P=0.03].

**Conclusions:** Lower TSAT was associated with an increased risk of cardiovascular mortality in KTRs, independent of anemia and potential confounders, but not with a higher risk of mortality from other causes. These findings set the stage for prospective studies addressing cardiovascular effects of iron supplementation after kidney transplantation.

**TH-PO677**

**Iron Deficiency Is More Common in Incident Peritoneal Dialysis Patients Without Anemia**

Brianna Hartley,<sup>1</sup> Vladimir Rigodon,<sup>1,2</sup> John W. Larkin,<sup>2</sup> Yue Jiao,<sup>2</sup> Len A. Usvyat,<sup>2</sup> Franklin W. Maddux,<sup>3</sup> Peter Kotanko,<sup>4</sup> Roberto Pecoito-Filho,<sup>1</sup> Thyago P. Moraes,<sup>1</sup> Murilo H. Guedes.<sup>1</sup> <sup>1</sup>Pontificia Universidade Catolica do Parana, Curitiba, Brazil; <sup>2</sup>Fresenius Medical Care, Global Medical Office, Waltham, MA; <sup>3</sup>Fresenius Medical Care AG & Co KGaA, Bad Homburg, Germany; <sup>4</sup>Renal Research Institute, New York, NY.

**Background:** Iron deficiency (ID) and anemia often coexist. Recent findings showed ID associates with mortality in chronic kidney disease (CKD), irrespective of anemia (Guedes, et al JASN 2021). Functional ID appears to confer higher risks for negative outcomes versus absolute ID in CKD. ID states and associated outcomes are uncertain in dialysis, particularly in peritoneal dialysis (PD). We aimed to characterize ID states and all-cause mortality rates in incident PD.

**Methods:** We used data from BRAZPD, an adult PD cohort across 122 clinics in Brazil (2004-2011) and included incident PD patients who had ≥1 transferrin saturation (TSAT), ferritin, and hemoglobin (hgb) lab during baseline (≤6 months after PD start). We defined prevalence of ID (i.e. TSAT <20%), patient characteristics, and crude mortality rates per 1000 patient years (p1000py) by ID states: 1. functional ID: (hgb ≥10 g/dL, TSAT <20%, ferritin ≥200 ng/mL), 2. functional ID with anemia: (hgb <10 g/dL, TSAT <20%, ferritin ≥200 ng/mL), 3. absolute ID (hgb ≥10 g/dL, TSAT <20%, ferritin <200 ng/mL), and 4. absolute ID with anemia (hgb <10 g/dL, TSAT <20%, ferritin <200 ng/mL).

**Results:** Among a cohort of 1,365 incident PD patients (mean age 59.7 years, 46.4% male, 49.1% diabetes), the prevalence of ID was 14.9% (n=203). Prevalence of ID states was 5.2% for functional ID, 1.5% for functional ID with anemia, 6.3% for absolute ID, and 1.8% for absolute ID with anemia (Figure 1). The mortality rate was observed to be the highest for functional ID at 195.6 deaths p1000py, as compared to other ID states.

**Conclusions:** In incident PD, we found a 14.9% prevalence of ID; most patients had ID without anemia. This finding may be of importance given screening for ID is recommended with low hgb. Anemic patients were infrequently iron deficient, which may suggest more active iron replacement triggered by low hgb. Incident PD patients with functional ID without anemia appeared to exhibit a higher all-cause mortality rate than other ID states. Further studies are needed to confirm these findings.

**Funding:** Commercial Support - Pontificia Universidade Catolica do Parana, Fresenius Medical Care, Baxter Healthcare

**Figure 1:** Prevalence, characteristics, and crude mortality of iron deficiency (ID) states in patient's incident to peritoneal dialysis (PD)

Parameter	Overall	Functional ID		Absolute ID	
		without anemia	with anemia	without anemia	with anemia
Patients	1365	71	24	59	17
Age (years)	59.8	61.5	58.7	57.3	58.8
Male (%)	46.4	53.5	47.6	37.2	24.0
Race white (%)	63.1	56.3	61.9	73.8	48.0
BMI (kg/m <sup>2</sup> )	24.8	24.6	24.1	25.9	24.9
Diabetes (%)	49.1	54.9	63.8	50.0	44.0
Previous HD (%)	41.2	35.2	28.8	29.1	32.0
Albumin (g/dL)	3.5	3.4	3.6	3.5	3.4
Hgb (g/dL)	11.3	13.6	9.1	11.8	9.1
TSAT (%)	44.1	15.9	16.2	35.5	14.6
Ferritin (ng/mL)	424.2	489.5	582.5	31.6	100.2
Mortality (%)	17.6	23.1	19.1	14.9	20.0
Mortality rate (p1000py)	141.0	195.6	142.4	115.4	142.8

**TH-PO678**

**Iron Deficiency and Incident Heart Failure in Community Dwelling Individuals**

Shilpa Sharma,<sup>1,2</sup> Ronit Katz,<sup>3</sup> Paulo H. Chaves,<sup>4</sup> Andrew N. Hoofnagle,<sup>3</sup> Jorge R. Kizer,<sup>5</sup> Michael Shlipak,<sup>5</sup> Nisha Bansal,<sup>3</sup> Tomas Ganz,<sup>1</sup> Joachim H. Ix.<sup>6,7</sup> <sup>1</sup>University of California Los Angeles, Los Angeles, CA; <sup>2</sup>VA Greater Los Angeles Healthcare System, Los Angeles, CA; <sup>3</sup>University of Washington, Seattle, WA; <sup>4</sup>Florida International University, Miami, FL; <sup>5</sup>University of California San Francisco, San Francisco, CA; <sup>6</sup>University of California San Diego, La Jolla, CA; <sup>7</sup>Veterans Medical Research Foundation, San Diego, CA.

**Background:** Iron deficiency has been linked to heart failure (HF) admissions in persons with prevalent HF and clinical trials demonstrate IV iron improves outcomes in prevalent HF. We examined the relationship of iron status with incident HF in community dwelling older adults and evaluated separately in those with and without CKD.

**Methods:** In 980 Cardiovascular Health Study participants aged > 65 years without HF (41% with CKD), we used a case-cohort design and weighted Cox models to evaluate associations of iron status with incident HF. Participants were categorized based on quartiles of transferrin saturation and ferritin as “Iron Replete” (13.9 % of participants; referent group), “Functional Iron Deficiency” (7.7%), “Iron Deficiency” (11.6%), “Mixed Iron Deficiency” (iron indices between the Iron Deficiency and Functional Iron Deficiency groups; 5.6%), “High Iron” (9.7%) and “Non-classified” (51.3%), consistent with prior studies. As c-terminal (but not intact) fibroblast growth factor-23 (FGF23) marks iron deficiency, we explored whether adjustment attenuated associations. We tested for interaction by CKD status (eGFR ≥60 vs. less).

**Results:** Compared to those deemed iron replete, iron deficiency independently associated with incident HF (HR 1.47; 1.03-2.11) whereas other iron categories did not, in models adjusted for traditional risk factors and kidney function (Table). Further adjustment for C-terminal FGF23 attenuated the association (HR 1.21; 0.83-1.76) whereas intact FGF23 did not (HR 1.48; 1.04-2.11). The relationship of iron deficiency with incident HF was similar irrespective of CKD status (P interaction = 0.4).

**Conclusions:** Among older community-living persons, iron deficiency is independently associated with incident HF, an association that was similar irrespective of CKD status. Our findings support conduct of clinical trials of iron replacement for prevention of HF in older adults with iron deficiency.

**Funding:** NIDDK Support, Veterans Affairs Support

**Table: Association of Categories of Iron status with Incident Heart Failure**

	#HF events/ #Participants	Univariate Model HR (95% CI)	Multivariate Model <sup>a</sup> HR (95% CI)
High Iron	41/98	1.14 (0.68, 1.91)	1.11 (0.71, 1.76)
Iron Replete	57/140	1.00 (ref)	1.00 (ref)
Mixed	27/67	1.31 (0.72, 2.41)	0.74 (0.43, 1.28)
Functional Iron Deficiency	38/78	1.31 (0.76, 2.27)	1.10 (0.73, 1.65)
Iron Deficiency	60/117	1.56 (0.96, 2.54)	<b>1.47 (1.03, 2.11)</b>

<sup>a</sup>Multivariate is adjusted for age, gender, race, site, education, SBP, BP medication use, BMI, diabetes, prevalent CHD, total cholesterol, smoking, alcohol consumption, CRP, eGFR and UACR

**TH-PO679**

**Role of Reticulocyte-Hemoglobin in Predicting Hemoglobin Changes in Patients With Anemia Undergoing Maintenance Hemodialysis**

**Beong Woo Kim,** Taehee Kim, Yeong Hoon Kim, Yunmi Kim, Hyuk Huh. *Inje University College of Medicine, Busan, Republic of Korea.*

**Background:** It has been suggested that reticulocyte-hemoglobin (Ret-Hb) may be useful as a tool for managing iron deficiency anemia in hemodialysis (HD) patients on erythropoiesis-stimulating agents (ESA). The purpose of this study was to determine the correlation between Ret-Hb and traditional predictors of iron deficiency anemia, and to compare their function as predictors of anemia.

**Methods:** From July 2021 to October 2022, hemoglobin changes for 3 months ( $\Delta$ Hb), Ret-Hb, Transferrin saturation (TSAT), and ferritin were measured every quarter in patients receiving regular HD for more than 90 days. The correlation between Ret-Hb, TSAT, and ferritin was confirmed through linear regression analysis. Subsequently, Ret-Hb, TSAT and ferritin were analyzed for correlation with  $\Delta$ Hb to compare their potential as predictors of anemia. Patients with ESA hyporesponsiveness, bleeding, infection, hematologic disease and malignancy were excluded from the study.

**Results:** A total of 72 patients were included in the study, the mean age was 63.40  $\pm$  7.79 years, 33 men (54.15%), and 61 patients (84.7%) receiving iron therapy. Ret-Hb showed a clear positive correlation with TSAT ( $r = 0.397, p < 0.001$ ), but not with ferritin ( $r = 0.039, p = 0.746$ ). Regarding the association with  $\Delta$ Hb, only Ret-Hb had a statistically significant negative correlation ( $r = -0.274, p = 0.021$ ), and TSAT ( $r = 0.015, p = 0.904$ ) and ferritin ( $r = -0.184, p = 0.125$ ) did not show significant correlation.

**Conclusions:** Ret-Hb showed a significant correlation with TSAT, it was shown that it can be used as an auxiliary indicator to evaluate iron deficiency. In addition, since it showed a significant correlation with hemoglobin changes, Ret-Hb may have an additional role in evaluating the response to anemia treatment in patients undergoing hemodialysis in the future.

**TH-PO680**

**Iron Deficiency Impairs Skeletal Muscle Mitochondrial Function and Exercise Performance in CKD**

**Benjamin A. Oliveira,<sup>1</sup> Emmanuel Mangahis,<sup>3</sup> Fiona Reid,<sup>1</sup> James Burton,<sup>2</sup> Kieran Mccafferty,<sup>4</sup> Thomas J. Wilkinson,<sup>2</sup> Elham Asgari,<sup>6</sup> Nick Beckley-Hoelscher,<sup>1</sup> Debashish Banerjee,<sup>5</sup> Emma L. Watson,<sup>2</sup> Pauline A. Swift,<sup>7</sup> Courtney J. Lightfoot,<sup>2</sup> Luke A. Baker,<sup>2</sup> Chante Reid,<sup>3</sup> David C. Wheeler,<sup>10</sup> Alice C. Smith,<sup>2</sup> Sharlene A. Greenwood,<sup>3</sup> Kate Bramham,<sup>1</sup> Salma Ayis,<sup>1</sup> Philip A. Kalra,<sup>8</sup> Sunil Bhandari,<sup>9</sup> Iain C. Macdougall,<sup>3</sup> Darlington Okonko.<sup>1</sup>**  
<sup>1</sup>King's College London, London, United Kingdom; <sup>2</sup>University of Leicester, Leicester, United Kingdom; <sup>3</sup>King's College Hospital NHS Foundation Trust, London, United Kingdom; <sup>4</sup>The Royal London Hospital, London, United Kingdom; <sup>5</sup>St George's University Hospitals NHS Foundation Trust, London, United Kingdom; <sup>6</sup>Guy's and St Thomas' NHS Foundation Trust, London, United Kingdom; <sup>7</sup>Epsom and Saint Helier University Hospitals NHS Trust, Carshalton, United Kingdom; <sup>8</sup>Salford Royal NHS Foundation Trust, Salford, United Kingdom; <sup>9</sup>Hull University Teaching Hospitals NHS Trust, Hull, United Kingdom; <sup>10</sup>University College London, London, United Kingdom.

**Background:** Skeletal muscle (SM) mitochondrial oxidative phosphorylation (OXPHOS) is impaired in patients with CKD and could be worsened by iron deficiency (ID).

**Methods:** We quantified SM OXPHOS and exercise capacity in CKD pts with a Hb  $> 110$  g/dL (n=38, **Table 1**), and in healthy volunteers (n=6). SM OXPHOS was measured using high resolution respirometry (HRR) of quadriceps biopsies and using 31-phosphorus magnetic resonance spectroscopy (31P-MRS).

**Results:** On HRR, carbohydrate (**Fig A**) but not fatty-acid (**Fig B**) driven maximal coupled OXPHOS capacity was lowest in pts with ID, but was a higher % of maximal uncoupled ETC capacity in these pts (**Fig C**) implying that mitochondria were operating at their maxima. Pts with ID also had longer phosphocreatinine recovery halftime on 31P-MRS (33 vs. 25 vs. 17 s,  $P < 0.01$ ) and lower exercise capacity (**Fig D, E**). Adjustment for Hb did not alter results.

**Conclusions:** ID intrinsically correlates with worse SM OXPHOS in CKD.  
**Funding:** Private Foundation Support

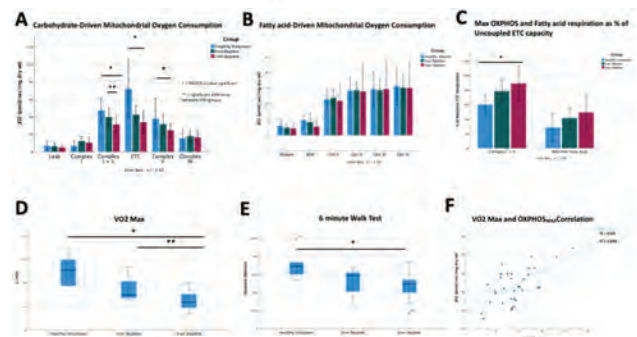

**TH-PO681**

**Association of Iron Therapy With Incidence of CKD**

**Prabin Shrestha,<sup>1</sup> Shejuti Paul,<sup>1</sup> Keiichi Sumida,<sup>1</sup> Fridtjof Thomas,<sup>1</sup> Satya.Surbhi,<sup>1</sup> Abu Mohd Naser,<sup>2</sup> Elani Streja,<sup>3</sup> Connie Rhee,<sup>3</sup> Kamyar Kalantar-Zadeh,<sup>3</sup> Csaba P. Kovesdy.<sup>1,4</sup>** <sup>1</sup>The University of Tennessee Health Science Center, Memphis, TN; <sup>2</sup>The University of Memphis, Memphis, TN; <sup>3</sup>University of California Irvine, Irvine, CA; <sup>4</sup>VA Memphis Medical Center, Memphis, TN.

**Background:** Iron replacement therapy (IRT) is effective in treating iron deficiency, but there are concerns about its effects on kidney function due to the impact of oral iron on the gut microbiome and to the oxidative stress caused by intravenous iron. We aimed to investigate the association of IRT with the incidence of new onset chronic kidney disease.

**Methods:** We identified 210,209 patients with normal eGFR and no albuminuria (N=51,448 on IRT and N=158,761 not on IRT) from 2004-2018 in a large national cohort of US Veterans. Of the patients receiving IRT, 48,946 (95%) received oral iron only, 63 (0.1%) received intravenous iron only, and 2,439 (4.7%) received both modalities. We used clinical trial emulation methods including propensity score (PS) matching to examine the association of IRT with the incidence of eGFR  $< 60$  ml/min/1.73m<sup>2</sup> and with incident urine albumin creatinine ratio (UACR)  $> 30$  mg/gm (both defined as two values at least 90 days apart) using competing risk regression.

**Results:** In the PS matched cohort of 64,446 patients (32,223 on IRT and 32,223 not on IRT) characteristics were well matched. The overall mean (SD) age was 66 $\pm$ 13 years, 92% were male, 74% were white, and the baseline eGFR, hemoglobin and ferritin levels were 86 $\pm$ 16 ml/min/1.73m<sup>2</sup>, 12 $\pm$ 1.6 g/dL and 76 (25<sup>th</sup>-75<sup>th</sup> pctl 26-188)  $\mu$ g/L, respectively. There were 10,078 cases of incident eGFR  $< 60$  (event rate 37/1000PY; 95% CI 37-38) and 7,632 cases of incident albuminuria (28/1000PY; 95% CI 27-28) over a median follow up of 3.0 years. IRT was associated with a higher risk of incident eGFR  $< 60$  (subhazard ratio, 1.23; 95% CI 1.19-1.28) and a higher risk of albuminuria (1.12; 1.07-1.18). (Table)

**Conclusions:** In this large national cohort of patients with normal kidney function, IRT was associated with modestly higher risks of incident CKD and albuminuria.

**Funding:** Veterans Affairs Support

**Association of Iron Replacement Therapy with Incidence of CKD**

	Incident eGFR $< 60$ ml/min/1.73m <sup>2</sup>			Incident UACR $> 30$ mg/gm		
	Event rate per 1000PY (95%CI)	Subhazard ratio (95%CI)	P value	Event rate per 1000PY (95%CI)	Hazard ratio (95%CI)	P value
No Iron therapy (N=32,223)	34 (33,35)	Reference		26 (25, 27)	Reference	
Iron therapy (N=32,223)	41 (40,42)	1.23 (1.19, 1.28)	$< 0.001$	29 (28, 30)	1.12 (1.07, 1.18)	$< 0.001$

**TH-PO682**

**Association of Parenteral vs. Oral Iron Therapy With Incident CKD**

**Prabin Shrestha,<sup>1</sup> Shejuti Paul,<sup>1</sup> Keiichi Sumida,<sup>1</sup> Fridtjof Thomas,<sup>1</sup> Satya.Surbhi,<sup>1</sup> Abu Mohd Naser,<sup>2</sup> Elani Streja,<sup>3</sup> Connie Rhee,<sup>3</sup> Kamyar Kalantar-Zadeh,<sup>3</sup> Csaba P. Kovesdy.<sup>1,4</sup>** <sup>1</sup>The University of Tennessee Health Science Center, Memphis, TN; <sup>2</sup>The University of Memphis, Memphis, TN; <sup>3</sup>University of California Irvine, Irvine, CA; <sup>4</sup>VA Memphis Medical Center, Memphis, TN.

**Background:** Parenteral (IV) iron is effective in treating iron deficiency, but there are concerns about its potential nephrotoxicity. However, little is known about the long-term comparative renal safety of oral vs IV iron in patients with normal kidney function. We aimed to investigate the association of oral vs IV iron with the incidence of new onset chronic kidney disease (CKD).

**Methods:** We identified 94,931 incident new users of iron replacement therapy (N=91,945 on oral and 2,986 on IV iron) from 2004-2018 in a large national cohort of US Veterans. We used clinical trial emulation methods including propensity score (PS) matching to account for differences in key baseline characteristics and limited the cohort to patients with eGFR  $> 60$  ml/min/1.73m<sup>2</sup> and urine albumin creatinine ratio (UACR)  $< 30$  mg/g. We examined the association of oral vs IV iron with the incidence of eGFR  $< 60$  ml/min/1.73m<sup>2</sup> and UACR  $> 30$  mg/g (both defined as two values at least 90 days apart) using competing risk regression.

Results: In the PS matched cohort there were 1,029 patients on oral and 1,043 on IV iron with eGFR ≥60 ml/min/1.73m² and UACR <30 mg/g at baseline. Their characteristics were well balanced, with an overall mean (SD) age of 66±12 years, 92% male, 75% white, and baseline eGFR, hemoglobin and ferritin levels of 90±18 ml/min/1.73m², 9.7±1.8 g/dL and 34 (25<sup>th</sup>-75<sup>th</sup> pctl: 11-190) µg/L, respectively. There were 370 cases of incident GFR <60 (event rate 58/1000PY; 95% CI 53-65) and 251 cases of incident albuminuria (39/1000PY; 95% CI 34-44) over a median follow-up of 1.8 years. IV (vs oral) iron therapy was associated with similar risk of incident eGFR <60 (subhazard ratio (95%CI): 1.12 (0.91-1.37), p=0.27) and incident albuminuria (1.01 (0.79-1.29), p=0.9) (Table).

Conclusions: In this large national cohort of patients with baseline normal kidney function and no proteinuria, IV iron therapy was not associated with higher risk of incident CKD when compared to oral iron.

Funding: Veterans Affairs Support

Association of Parenteral vs. Oral Iron Therapy with Risk of Incident Chronic Kidney Disease

Table with 6 columns: Incident eGFR <60 ml/min/1.73m² (Event rate per 1000PY, Subhazard ratio (95%CI), P value), Incident UACR >30 mg/gm (Event rate per 1000PY, Subhazard ratio (95%CI), P value). Rows for Oral iron (N=1,029) and Parenteral iron (N=1,043).

TH-PO683

Association of Iron Replacement Therapy With Kidney Failure and Mortality in Patients With CKD

Shejuti Paul, Prabin Shrestha, Keiichi Sumida, Fridtjof Thomas, Satya Surbhi, Abu Mohd Naser, Elani Streja, Connie Rhee, Kamyar Kalantar-Zadeh, Csaba P. Kovacs. The University of Tennessee Health Science Center, Memphis, TN; The University of Memphis, Memphis, TN; University of California Irvine, Irvine, CA; VA Memphis Medical Center, Memphis, TN.

Background: The long term safety of iron replacement therapy (IRT) in patients with chronic kidney disease (CKD) remains unclear. We investigated the association of IRT with the incidence of end stage kidney disease (ESKD) and all-cause mortality in patients with pre-existing CKD.

Methods: In a national cohort of US Veterans we identified 26,315 incident new users of IRT with eGFR <60 ml/min/1.73m² and a comparable group of 43,783 patients who did not receive IRT. We used clinical trial emulation methods including propensity score (PS) matching to examine the association of IRT vs no IRT with ESKD and mortality in competing risk regressions and in Cox models, respectively.

Results: In the PS matched cohort 14,429 patients received IRT (95% exclusively oral iron) and 14,429 received no IRT. Baseline characteristics were well matched between the two groups; the overall mean (SD) age was 74±10 years, 97% were male, 77% were white, and the baseline eGFR, hemoglobin, and ferritin levels were 45±12 ml/min/1.73m², 11.5±1.6 g/dL, and 97 (25<sup>th</sup>-75<sup>th</sup> pctl: 39-223) µg/L. There were 1,163 cases of incident ESKD (event rate 15/1000PY; 95%CI 14-16) and 18,191 deaths (188/1000PY; 95% CI 185-191) over a median follow-up of 1.7 and 2.4 years, respectively. IRT was not associated with higher risk of ESKD (subhazard ratio and 95% CI: 1.00, 0.89-1.12, p=0.97) or incident death (hazard ratio and 95% CI 0.98, 0.95-1.01, p=0.22) (Table).

Conclusions: In this large national cohort of patients with CKD, IRT (consisting mainly of oral iron replacement) was not associated with higher risk of ESKD or mortality. Notwithstanding these findings, the long term safety of IRT should be tested in clinical trials.

Funding: Veterans Affairs Support

Association of Iron Replacement Therapy with ESKD and All-Cause Mortality

Table with 6 columns: ESKD (Event rate per 1000PY, Subhazard ratio (95%CI), P value), All-cause death (Event rate per 1000PY, Hazard ratio (95%CI), P value). Rows for No iron treatment (N=14,429) and Iron treatment (N=14,429).

TH-PO684

Effects of Hypoxia-Inducible Factor-Prolyl Hydroxylase Inhibitors vs. Erythropoiesis-Stimulating Agents on Iron Metabolism in Non-Dialysis-Dependent Anemic Patients With CKD: A Network Meta-Analysis

Junlan Yang. Institute of Nephrology / Southeast University School of Medicine / Zhong Da Hospital Institute of Nephrology / Southeast University School of Medicine / Zhong Da Hospital, Nanjing, China.

Background: Hypoxia-inducible factor-prolyl hydroxylase inhibitors (HIF-PHIs) are an emerging drug for the treatment of renal anemia, which has not yet been used in clinical practice. Although many clinical studies have proved that the ability of HIF-PHIs to treat anemia is equivalent to erythropoiesis-stimulating agents (ESAs), the mechanisms of hemoglobin production of the two drugs are different. We performed this network meta-analysis to compare the effects of HIF-PHIs, ESA, and placebo on iron regulation in patients with renal anemia who do not receive dialysis.

Methods: The Cochrane Library, PubMed, Web of Science, CNKI, WANGFANG DATA were used for search in documents and journals ranging from January 1946 to December 2021. The literatures with respect to the randomized controlled clinical trial comparing HIF-PHIs, ESAs, and placebo in non-dialysis-dependent anemic patients with chronic kidney disease were selected. The main outcomes were the change in hepcidin and hemoglobin (Hb) levels.

Results: Of 1589 original titles screened, data was extracted from 15 studies included a total of 3238 patients (Fig. 1). The league table shows pairwise comparisons of the effectiveness of hepcidin-lowering and hemoglobin-raising among the eight interventions (Fig. 2). Compared with placebo, Enarodustat (SMD = -1.52, 95% CI: -3.01 to -0.03), and Roxadustat (SMD = -1.29, 95% CI: -2.23 to -0.35) could significantly reduce the level of hepcidin. All HIF-PHIs and ESAs showed greater ability to increase Hb levels than placebo, and there was no significant difference between HIF-PHIs and ESAs.

Conclusions: HIF-PHIs and ESAs have different effects on iron regulation in non-dialysis-dependent anemic patients with CKD, indicating that HIF-PHIs may increase Hb levels by promoting iron mobilization.

Funding: Clinical Revenue Support

Table with 12 columns: Study, Sample size, CKD1, CKD2, CKD3, CKD4, CKD5, CKD6, CKD7, CKD8, CKD9, CKD10, CKD11. Rows for various studies like Jiang et al (2021), Alkawasbi et al (2021), etc.

Fig. 1. Characteristics of included studies

League table with columns: Hepcidin, Comparisons, Hb. Rows for Enarodustat, Roxadustat, Daprodustat, Vadadustat, Desidustat, Placebo, Epoetin, Darbepoetin.

Fig. 2. The league table

TH-PO685

Causes of Death in Patients With Anemia of CKD (With/Without Diabetes Mellitus) in the ASCEND-ND Trial

Ajay K. Singh, Michael Aarup, Brian Claggett, Alexander R. Cobitz, Vladimir A. Dobronravov, Colin A. Hutchison, Laurent Juillard, Bart D. Maes, Stephen Mallett, Antonello Pani, Mai Ots-Rosenberg, Bonnie Shadlinger, Frank M. Strutz, Marc G. Vervloet, Christoph Wanner, Andrzej Wiecek, John McMurray. Brigham and Women's Hospital and Harvard Medical School, Boston, MA; Department of Nephrology, Odense University Hospital, Odense, Denmark; GSK, Collegeville, PA; Research Institute of Nephrology, Pavlov University, Saint-Petersburg, Russian Federation; Department of Medicine, Hawke's Bay District Health Board, Hastings, New Zealand; Université de Lyon, CarMeN, INSERM UI060, INSA de Lyon, Université Claude Bernard Lyon 1, Villeurbanne, France; Hospices Civils de Lyon, Service de Néphrologie, Hôpital E. Herriot, Lyon, France; Department of Nephrology, AZ Delta Hospital, Roeselare, Belgium; GSK, Brentford, United Kingdom; Divisione di Nefrologia e Dialisi, Azienda Ospedaliera G. Brotzu, Cagliari, Italy; Tartu University Hospital, Tartu, Estonia; DKD Helios Klinik Wiesbaden, KfH und Nierenzentrum-Rheumatologie Wiesbaden, Wiesbaden, Germany; Department of Nephrology, Amsterdam University Medical Center, Amsterdam, Netherlands; University of Würzburg, Würzburg, Germany; Department of Nephrology, Transplantation and Internal Medicine, Medical University of Silesia in Katowice, Katowice, Poland; Glasgow University, Glasgow, United Kingdom.

Background: Cardiovascular (CV) etiologies, including diabetes mellitus (DM), are the most common cause of death among chronic kidney disease (CKD) patients. This post-hoc analysis of adjudicated causes of death in patients with anemia of CKD with/without DM in the ASCEND-ND trial investigated the safety of daprodustat (Dapro), a hypoxia-inducible factor prolyl hydroxylase inhibitor, for treatment of anemia of CKD in non-dialysis patients.

Methods: ASCEND-ND (NCT02876835) was a global, randomized, open-label, phase 3 CV outcome trial. Patients received daily oral Dapro or subcutaneous darbepoetin alfa (Darbe). Outcomes were centrally adjudicated. Survival data for the intent-to-treat population was analyzed using Kaplan-Meier methods (DM vs non-DM).

**Results:** Of 3872 randomized patients (DM N=2194, non-DM N=1678), baseline characteristics were broadly balanced across treatment arms, although DM patients were older, had greater body mass index and systolic blood pressure, and more CV disease/CV medication use than non-DM patients. All-cause mortality was significantly higher in DM vs non-DM patients (hazard ratio [HR]=1.87, 95% confidence interval [CI]: 1.57–2.23; Figure 1A); this association did not differ by treatment (HR=1.87 [Dapro] vs 1.86 [Darbe]; p=0.96). Infection and CV mortality each accounted for approximately 30% of deaths independent of DM status (Figure 1B).

**Conclusions:** In patients with anemia of CKD not on dialysis, the overall death rate was higher in DM patients, but cause of death was similar regardless of DM status; infection in patients with or without DM was the most frequent cause of death.

**Funding:** Commercial Support - This study was funded by GSK.

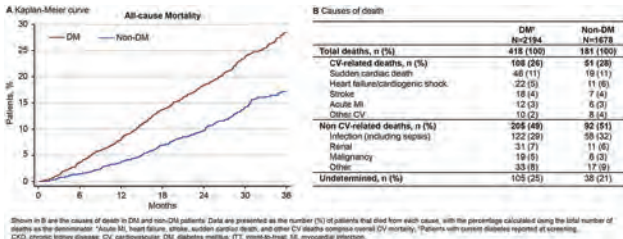

**Figure 1.** All-cause mortality\* (A) and causes of death (B) in patients with anemia of CKD not on dialysis with/without DM (ITT population)

**TH-PO686**

**Erythropoiesis-Stimulating Agent Hyporesponsiveness and Anemia Management in the ASCEND-D Trial**

**Sushrut S. Waikar,<sup>1</sup> Daniel W. Coyne,<sup>2</sup> Finnian R. McCausland,<sup>3</sup> Kirsten L. Johansen,<sup>4</sup> Vivekanand Jha,<sup>5</sup> Gregorio T. Obrador,<sup>6</sup> Purav R. Bhatt,<sup>7</sup> Stephen Mallett,<sup>8</sup> Amy M. Meadowcroft,<sup>7</sup> Ajay K. Singh.<sup>1</sup>** <sup>1</sup>Boston University School of Medicine and Boston Medical Center, Boston, MA; <sup>2</sup>Washington University School of Medicine, St. Louis, MO; <sup>3</sup>Brigham and Women's Hospital and Harvard Medical School, Boston, MA; <sup>4</sup>Hennepin Healthcare, University of Minnesota, Minneapolis, MN; <sup>5</sup>George Institute for Global Health, New Delhi, India; <sup>6</sup>Universidad Panamericana School of Medicine, Mexico City, Mexico; <sup>7</sup>GSK, Collegeville, PA; <sup>8</sup>GSK, Brentford, United Kingdom.

**Background:** Erythropoiesis-stimulating agent (ESA) hyporesponsiveness is characterized by high dose ESA and greater use of intravenous (IV) iron. Hypoxia-inducible factor prolyl hydroxylase inhibitors (HIF-PHIs) may be beneficial for iron homeostasis/utilization. Data comparing HIF-PHIs vs ESA in hyporesponders are limited.

**Methods:** ASCEND-D (NCT02879305) was a phase 3 randomized trial of daprodustat (Dapro) vs ESA in dialysis patients (pts; N=2964). ESA hyporesponsiveness was defined as baseline ESA-resistance index  $\geq 2.0$  or epoetin dose  $\geq 450U/kg/week$ . Both treatment groups used protocolized dosing of study drug and iron to achieve/maintain hemoglobin (Hb) 10.0–11.0g/dL. A rescue algorithm for anemia management allowed use of IV iron and/or red blood cell (RBC) transfusion, with discontinuation of study drug for persistent Hb <9g/dL or >2units RBC transfusion. Statistical analyses included analysis of covariance with treatment x subgroup interactions.

**Results:** At baseline, 12% of pts were ESA-hyporesponsive (ESA-HR) (Table). During the trial, higher Dapro and ESA doses were required in the ESA-HR vs non-ESA-HR group. Mean change in Hb from baseline to weeks 28–52 for Dapro vs ESA: ESA-HR group, 0.01g/dL; non-ESA-HR group, 0.21g/dL (p-interaction=0.04). Mean IV iron use was lower with Dapro vs ESA in the ESA-HR group (-31.7mg) but similar in those not ESA-HR (-6.9mg; p-interaction=0.09). A greater number of RBC transfusions and discontinuations due to rescue therapy was seen in Dapro vs ESA in ESA-HR pts; the opposite was observed in non-ESA-HR pts.

**Conclusions:** Baseline responsiveness to ESA led to different patterns of anemia management for Dapro vs ESA, with evidence of lower IV iron utilization with Dapro in those who were ESA hyporesponsive at baseline.

**Funding:** Commercial Support - This study was funded by GSK.

	Hyporesponsive at baseline		Not hyporesponsive at baseline	
	Daprodustat	ESA	Daprodustat	ESA
Number, n(%)	183(147) (12)	180(147) (12)	1285(1487) (98)	1276(1477) (97)
Baseline Hb, g/dL	8.69	9.99	10.45	10.44
Median dose of study drug, wk 48				
Daprodustat, mg	10.0	—	6.0	—
Epoetin units, U	—	15000	—	6000
Daprodustat, mg	—	250	—	150
ESR transfusions, units/100 RBC	87.8	79.9	31.8	41.7
No. requiring rescue therapy (to discontinuation), n(%)	4(18) (7.7)	5(15) (2.4)	36(104) (13.6)	48(77) (9.8)
Change in Hb from baseline to wk 28–52				
No. with deleterious and resolution period Hb <sup>a</sup>	183	180	1284	1276
Adjusted mean change from baseline (SE) <sup>b</sup>	0.11 (0.06)	0.11 (0.06)	0.31 (0.02)	0.11 (0.02)
Adjusted mean treatment difference (two-sided CI) <sup>c</sup>	0.01 (0.07, 0.10)		0.21 (0.14, 0.27)	
p-value <sup>d</sup>	0.04			
On-treatment average monthly IV iron dose during day 1 to wk 52				
No. on randomized treatment, n(%)	183(147) (100)	179(142) (96)	1279(1284) (99)	1276(1279) (99)
Adjusted mean IV iron dose, mg (SE) <sup>e</sup>	111.4 (9.09)	145.1 (9.72)	38.1 (3.09)	95.0 (5.62)
Adjusted mean treatment difference (two-sided 95% CI) <sup>f</sup>	-31.7 (-38.2, -25.2)		6.6 (-16.8, 3.1)	
p-value <sup>g</sup>	0.03			

**Figure.** Summary of Dapro and ESA hyporesponsiveness and anemia management in the ASCEND-D Trial

**TH-PO687**

**Erythropoiesis-Stimulating Agent (ESA) Hyporesponsiveness and Major Adverse Cardiovascular Events: Results From ASCEND-D**

**Finnian R. McCausland,<sup>1</sup> Sushrut S. Waikar,<sup>2</sup> Brian Claggett,<sup>1</sup> Gearoid M. McMahon,<sup>1</sup> Osvaldo M. Vieira Neto,<sup>8</sup> Anjay Rastogi,<sup>3</sup> Kearkiat Praditpornsilpa,<sup>4</sup> Ricardo Correa-Rotter,<sup>5</sup> Vijay K. Kher,<sup>6</sup> Lucia Del Vecchio,<sup>7</sup> Ajay K. Singh.<sup>1</sup>** <sup>1</sup>Brigham and Women's Hospital, Boston, MA; <sup>2</sup>Boston University School of Medicine, Boston, MA; <sup>3</sup>University of California Los Angeles David Geffen School of Medicine, Los Angeles, CA; <sup>4</sup>Chulalongkorn University, Bangkok, Thailand; <sup>5</sup>Instituto Nacional de Ciencias Médicas y Nutrición Salvador Zubirán, Mexico, Mexico; <sup>6</sup>Medanta The Medicity Medanta Institute of Kidney and Urology, Gurugram, India; <sup>7</sup>Sant'Anna Hospital, Como, Italy; <sup>8</sup>Serviço de Nefrologia de Ribeirao Preto, São Paulo, Brazil.

**Background:** Hyporesponsiveness to ESAs is associated with adverse cardiovascular (CV) outcomes. Although several definitions exist, data examining associations with CV outcomes in clinical trials are limited.

**Methods:** ASCEND-D (NCT02879305) randomized 2,964 patients on chronic dialysis to daprodustat or conventional ESAs. All received an ESA for at least 6 weeks prior to randomization and were managed with dosing algorithms for iron and randomized treatment. Three definitions of hyporesponsiveness were prespecified: 1) erythropoietin resistance index (ERI)  $\geq 2U/kg/wk/g/L$  or prior ESA dose/estimated dry weight  $\geq 450U/kg/wk$ ; 2) ERI  $\geq 1.5U/kg/wk/g/L$ ; 3) baseline ESA dose (U/week) in top 20th %ile. Cox models examined associations of each definition with the CV composite (death, myocardial infarction, stroke), adjusted for dialysis modality, region, age, sex, race, dialysis vintage, CV disease, diabetes, serum albumin, SBP, hemoglobin, and C-reactive protein. Interaction terms were included to assess for effect modification by randomized treatment.

**Results:** Baseline ESA hyporesponsiveness was present in 12%, 20%, and 20% of patients for definitions HypoR1, HypoR2, and HypoR3, respectively. Compared to no hyporesponsiveness, all definitions had quantitatively similar associations with the CV outcome: hazard ratio [HR] 1.54 (95%CI 1.24-1.91) for HypoR1 (Figure); HR 1.46; 95%CI 1.22-1.76) for HypoR2; HR 1.45 (95%CI 1.21-1.74) for HypoR3. There was no evidence for effect modification by treatment (P-interaction >0.40 for all).

**Conclusions:** Baseline ESA hyporesponsiveness is a potent predictor of CV outcomes in ASCEND-D. All pre-specified definitions provided similar predictive abilities.

**Funding:** Commercial Support - GSK

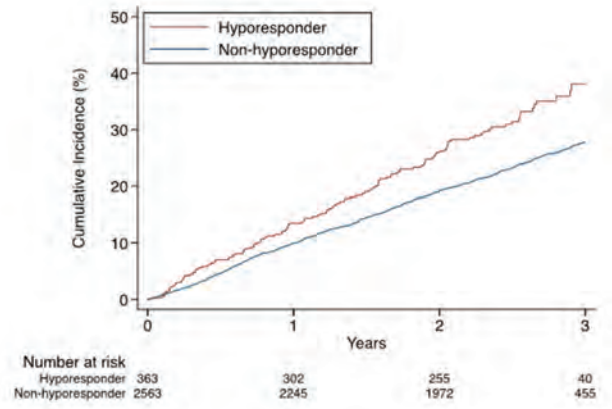

TH-PO688

Efficacy and Cardiovascular Safety of Daprodustat for the Management of Renal Anemia in Peritoneal Dialysis Patients: A Prespecified Analysis of the ASCEND-D Trial

Indranil Dasgupta, Stephen Mallett, Purav R. Bhatt, Anjali Acharya, Michael Aarup, Ricardo Correa-Rotter, Shruti Gupta, Vijay K. Kher, Osvaldo M. Vieira Neto, Anjay Rastogi, Mai Ots-Rosenberg, Brian Rayner, Muh Geot Wong, Ajay K. Singh. University Hospitals of Birmingham NHS Foundation Trust, Birmingham, United Kingdom; Warwick Medical School, University of Warwick, West Midlands, United Kingdom; GSK, Brentford, United Kingdom; GSK, Collegeville, PA; Albert Einstein College of Medicine, Bronx, NY; Odense University Hospital, Odense, Denmark; Instituto Nacional de Ciencias Médicas y Nutrición Salvador Zubirán, Mexico City, Mexico; Brigham and Women's Hospital, Boston, MA; Medanta Kidney and Urology Institute, Medanta Hospital, South Delhi, India; Sociedade Brasileira de Nefrologia, São Paulo, Brazil; David Geffen School of Medicine UCLA, Los Angeles, CA; Tartu University Hospital, Tartu, Estonia; Groote Schuur Hospital and University of Cape Town, Cape Town, South Africa; University of Sydney, Sydney, NSW, Australia; Brigham and Women's Hospital and Harvard Medical School, Boston, MA.

Background: Daprodustat (Dapro), an oral investigational hypoxia-inducible factor prolyl hydroxylase inhibitor, has been shown to be noninferior to conventional erythropoietin stimulating agents in renal anemia treatment of dialysis and non-dialysis patients (pts). This pre-specified subgroup analysis of the ASCEND-D trial examined the efficacy and cardiovascular (CV) safety of Dapro vs darbepoetin-alfa (Darbe) in end-stage kidney disease (ESKD) pts receiving peritoneal dialysis (PD).

Methods: ASCEND-D (NCT02879305) was an open-label, phase 3 trial in ESKD pts on dialysis with screening hemoglobin (Hb) 8.0–11.5g/dL, randomized to Dapro or Darbe. Primary outcomes were mean Hb change from baseline to wks 28 through 52 (noninferiority [NI] margin -0.75g/dL) and first occurrence of a major adverse CV event (MACE: a composite of death from any cause, nonfatal myocardial infarction [MI], or nonfatal stroke [NI margin 1.25]). Mean Hb change was analyzed via an analysis of covariance model adjusting for baseline Hb, treatment, dialysis modality, and geographic region. MACE was analyzed via a Cox proportional-hazards model adjusting for treatment, dialysis modality, and geographic region.

Results: Overall, 340 PD pts (Dapro n=171; Darbe n=169) were randomized (baseline [Dapro/Darbe]: mean age, years [54/53]; % male [56/54]; % dialysis vintage >5 years [18/22]; Hb, g/dL [10.25/10.23]; % stroke [5/5]; and % MI [8/7]). For Dapro and Darbe respectively, the mean change in Hb was 0.38 and 0.23g/dL (adjusted mean difference 0.15 95% confidence interval [CI] -0.04-0.34); a first occurrence of adjudicated MACE occurred in 40 (23.4%) and 46 (27.2%) pts (hazard ratio 0.84 95% CI 0.55–1.28) and the mean average monthly iron dose was 59.6g and 62.9g (adjusted mean difference -3.3 95% CI -30.7–24.0). There was no heterogeneity between PD and hemodialysis pts for these endpoints. Peritonitis rates were 26% (Dapro) and 22% (Darbe).

Conclusions: This pre-specified sub-group analysis of the ASCEND-D trial demonstrates comparable efficacy and CV safety of Dapro vs Darbe in PD pts, supporting use of this novel oral agent in anemic PD pts.

Funding: Commercial Support - This study was funded by GSK.

TH-PO689

Efficacy and Safety of Daprodustat for Treatment of Anemia in CKD: A Meta-Analysis

Si Yuan Khor, Sara Alattal, Amira S. Kamboj, Abdullah Al-Abcha, Issa R. Haddad, Michael Turk, Nora H. Hernandez Garcilazo, Yeshwanter Radhakrishnan, Mohamed Hassanein. Michigan State University College of Human Medicine, East Lansing, MI; University of Mississippi Medical Center, Jackson, MS; Mayo Clinic, Rochester, MN; Allegheny General Hospital, Pittsburgh, PA.

Background: Anemia is a well-known complication in chronic kidney disease (CKD). Current treatments for anemia in CKD include recombinant human erythropoietin (rhEPO) or its analogs. Daprodustat, a hypoxia-inducible factor prolyl hydroxylase inhibitor is a novel drug for treatment of anemia in CKD. We sought to review the efficacy and safety of daprodustat for treatment of anemia in non-dialysis dependent (NDD) and dialysis-dependent (DD) CKD patients.

Methods: We performed a systematic search using PubMed, Embase and Scopus until May 2022. Inclusion criteria included randomized controlled trials that reported the efficacy and safety of daprodustat compared to placebo or rhEPO in treating anemia patients with NDD or DD-CKD. Primary and secondary outcomes include change in hemoglobin (Hb) levels and associated adverse events (AEs), respectively. A random-effect model was utilized to calculate the mean difference and risk ratio with a 95% confidence interval.

Results: Eleven studies were included with a total of 8354 patients. The change in Hb levels were significantly higher in the daprodustat group compared to placebo for both DD (p=0.01) and NDD (p=0.002) patients with no significant difference in the incidence of AEs between the 2 groups (16.5% vs 7.4%, p=0.43; 19.1% vs 15.9%, p=0.73). There was no significant difference in change in Hb levels between daprodustat and rhEPO. The incidence of AEs was slightly higher in daprodustat group compared to rhEPO for NDD patients (p=0.02) with no significant difference in DD patients (p=0.78).

Conclusions: Our meta-analysis demonstrates that daprodustat was superior to placebo and non-inferior to rhEPO in treating anemia in CKD. The risk of AEs with daprodustat was slightly higher compared to rhEPO but was not observed when compared to placebo. Further clinical trials are required to validate the long-term efficacy and safety of daprodustat.

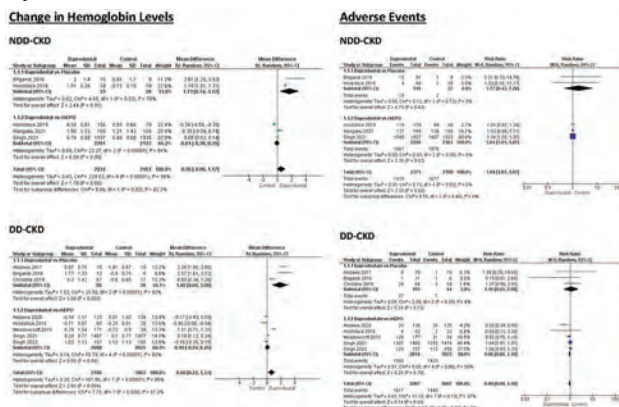

TH-PO690

Maximal Change in Erythropoietin in Hemodialysis Patients Receiving Daprodustat or Epoetin Alfa in the ASCEND-TD Trial

Daniel W. Coyne, Christoph Wanner, Renato D. Lopes, Christine K. Bailey, Kelly M. Mahar, Jennifer Shannon, Ajay K. Singh. Washington University School of Medicine, St. Louis, MO; University of Würzburg, Würzburg, Germany; Duke University Medical Center, Durham, NC; GSK, Collegeville, PA; Brigham and Women's Hospital and Harvard Medical School, Boston, MA.

Background: Higher erythropoiesis-stimulating agent (ESA) doses correlate with morbidity in patients treated for anemia of chronic kidney disease. Daprodustat, a hypoxia-inducible factor prolyl hydroxylase inhibitor, corrects anemia by inducing endogenous erythropoietin (EPO). Changes in EPO and vascular endothelial growth factor (VEGF) were examined in a double-blind trial of daprodustat vs epoetin alfa (epoetin) in hemodialysis patients.

Methods: 407 patients on ESA (baseline hemoglobin [Hb] 8–11.5 g/dL) were randomized 2:1 to daprodustat 3-times-weekly (TIW) or epoetin once-weekly or TIW for 52 weeks (ASCEND-TD, NCT03400033). The primary endpoint (change in Hb) was met and safety profiles were similar. Plasma EPO and VEGF were measured pre-dose on day 1 and once during weeks 28–52, pre-dose and 2, 4, 6, or 8h post-dose. Major adverse cardiovascular events (MACE) were adjudicated.

Results: Mean ± standard deviation (SD) baseline EPO levels (IU/L) were low (22 ± 45 daprodustat vs 18 ± 22 epoetin). Maximal (max) mean EPO increases across all doses were lower with daprodustat (161 ± 362) vs epoetin (12313 ± 814). Higher daprodustat and epoetin doses mostly correlated with max EPO (Figure); max post-baseline and change from baseline EPO with higher daprodustat doses (20–48mg) were similar to or lower than for the lowest epoetin dose (1500U). VEGF levels declined from baseline for daprodustat and epoetin, unrelated to dose. Daprodustat dose was not related to occurrence of first MACE; mean ± SD dose at first MACE (14.6 ± 9.5mg) was similar to final dose without MACE (17.2 ± 13.7mg).

Conclusions: Daprodustat-induced changes in EPO were dose-dependent. Despite high daprodustat doses, the EPO levels produced were similar to levels seen at the lowest epoetin doses.

Funding: Commercial Support - This study was funded by GSK.

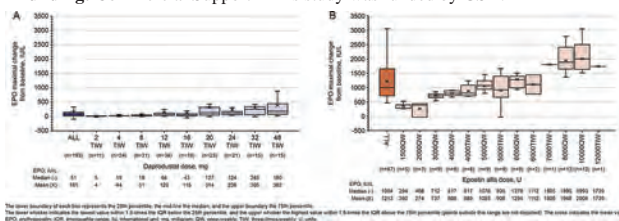

Figure. Summary of EPO, IU/L, maximal change from baseline for daprodustat (A) and epoetin alfa (B)

TH-PO691

Effects of Daprodustat on Hemoglobin and Quality of Life in Non-Dialysis CKD Patients: Expanded Results of the ASCEND-NHQ Trial

Kirsten L. Johansen,<sup>1</sup> Fredric O. Finkelstein,<sup>2</sup> Csaba P. Kovacs,<sup>3</sup> Purav R. Bhatt,<sup>4</sup> Ruben K. Israni,<sup>4</sup> Rodrigo Refoios Camejo,<sup>5</sup> Tom J. Keeley,<sup>5</sup> Stephen Mallett,<sup>6</sup> Ajay K. Singh.<sup>6</sup> <sup>1</sup>Hennepin Healthcare, University of Minnesota, Minneapolis, MN; <sup>2</sup>Yale University, New Haven, CT; <sup>3</sup>University of Tennessee Health Science Center, Memphis, TN; <sup>4</sup>GSK, Collegeville, PA; <sup>5</sup>GSK, Brentford, United Kingdom; <sup>6</sup>Brigham and Women's Hospital and Harvard Medical School, Boston, MA.

**Background:** ASCEND-NHQ (a randomized, double-blind, placebo-controlled trial; NCT03409107) investigated the effects of daprodustat on hemoglobin (Hb) and quality of life in non-dialysis patients with chronic kidney disease (CKD). Daprodustat met primary and secondary endpoints, increasing Hb and improving Short Form-36 Vitality score vs placebo. We report data for the CKD Anemia Questionnaire (CKD-AQ), a new patient-reported outcome measure developed from qualitative patient interviews to specifically capture symptoms related to anemia of CKD.

**Methods:** The CKD-AQ is a 21-item questionnaire with 3 domains: tired/low energy/weak (10 items), chest pain/shortness of breath (4 items), and cognitive (3 items); and 4 individual items. Items are scored on a scale of 0–100 (worst–best). Patients in ASCEND-NHQ were randomized 1:1 (daprodustat:placebo), to achieve and maintain target Hb (11–12g/dL) over 28 weeks. Changes in scores from baseline to Week 28 were compared between treatments via a linear mixed effect repeated measures model (missing data were not imputed) (Table).

**Results:** Of 614 patients, 405 (212 daprodustat, 193 placebo) had baseline and on-treatment Week 28 CKD-AQ data. Daprodustat increased Hb vs placebo (1.58 vs 0.19g/dL; mean difference 1.40, 95% confidence interval 1.23–1.56). Patients on daprodustat had significantly greater improvement in all CKD-AQ domains and 1 of 4 individual items vs placebo (Table). Incidence of fatigue and anemia adverse events was higher for placebo vs daprodustat.

**Conclusions:** Anemia of CKD treatment with daprodustat improved tiredness, chest pain/shortness of breath, and cognition difficulties, often associated with potential productivity loss in patients with anemia of CKD.

**Funding:** Commercial Support - This study was funded by GSK

	Mean (SD) baseline		Mean (SD) Week 28		Adjusted mean (SE) change from baseline to Week 28		One-sided P-value*	
	Daprodustat (n=207)	Placebo (n=198)	Daprodustat (n=207)	Placebo (n=198)	Daprodustat (n=207)	Placebo (n=198)		
<b>Domains<sup>1</sup></b>								
Tiredness/energy/weak	62.7 (22.0)	63.2 (21.29)	72.4 (19.28)	67.5 (19.65)	9.72 (1.08)	2.81 (1.15)	5.91 (2.85, 9.00)	<0.0001
Chest pain/shortness of breath	81.2 (17.35)	81.8 (16.86)	86.2 (15.34)	83.6 (16.07)	3.65 (0.93)	0.62 (0.97)	3.03 (1.08, 5.07)	0.015
Cognitive	78.0 (20.43)	77.3 (21.26)	82.0 (18.06)	78.0 (19.14)	4.07 (1.00)	0.48 (1.04)	3.59 (0.99, 6.63)	0.006
<b>Individual items<sup>2</sup></b>								
Time with shortness of breath while not doing an activity	90.1 (18.33)	92.4 (17.97)	93.8 (16.27)	91.8 (18.13)	2.30 (1.94)	0.29 (1.08)	2.01 (-0.88, 4.86)	0.091
Severity of shortness of breath when exercising	89.9 (20.19)	89.7 (19.10)	93.7 (14.07)	91.1 (16.63)	3.71 (0.99)	0.43 (1.00)	2.68 (-0.04, 5.39)	0.027
Difficulty standing for long periods of time	58.7 (29.78)	59.4 (28.46)	65.4 (27.23)	61.1 (27.87)	6.76 (1.86)	1.58 (1.80)	4.84 (2.08, 6.90)	0.002
Ability to walk	70.8 (29.36)	68.9 (29.07)	73.8 (23.44)	72.8 (27.34)	3.22 (1.84)	2.43 (1.44)	2.61 (-0.87, 6.09)	0.137

Table. Summary of on-treatment change from baseline in CKD-AQ<sup>1</sup> domains and individual items in ASCEND-NHQ

TH-PO692

Hemoglobin Stability in the ASCEND-D and -ND Trials

Vivekanand Jha,<sup>1</sup> Kirsten L. Johansen,<sup>2</sup> Pablo E. Pergola,<sup>3</sup> Daniel W. Coyne,<sup>4</sup> Katie St. Ledger,<sup>5</sup> Stephen Mallett,<sup>6</sup> Purav R. Bhatt,<sup>5</sup> Maria E. Duarte,<sup>5</sup> Ajay K. Singh.<sup>7</sup> <sup>1</sup>George Institute for Global Health, New Delhi, India; <sup>2</sup>Hennepin Healthcare, Minneapolis, MN; <sup>3</sup>Renal Associates, San Antonio, TX; <sup>4</sup>Washington University School of Medicine, St. Louis, MO; <sup>5</sup>GSK, Collegeville, PA; <sup>6</sup>GSK, Brentford, United Kingdom; <sup>7</sup>Brigham and Women's Hospital and Harvard Medical School, Boston, MA.

**Background:** Maintaining hemoglobin (Hb) levels in target ranges per clinical care guidelines for patients (pts) with chronic kidney disease (CKD) is complex. We examined Hb stability in pts with CKD on dialysis (ASCEND-D, NCT02879305) or not on dialysis (ASCEND-ND, NCT02876835) treated with daprodustat (Dapro) or erythropoiesis-stimulating agents (ESAs).

**Methods:** ASCEND-D and -ND were global, open-label, event-driven cardiovascular outcome trials. Our analyses examined the percentage of pts who achieved a mean Hb within the analysis target range (10.0–11.5g/dL); the percentage of time within range in the evaluation period (EP: weeks 28–52) and maintenance period (MP: week 28–end of treatment); Hb excursions ( $\geq 12g/dL$  or  $< 7.5g/dL$ ); Hb increases and decreases  $> 2g/dL$  during EP. Separate analyses were performed for Dapro and ESA per study.

**Results:** Of enrolled pts, 2485/2964 (83.8%; ASCEND-D) and 3011/3872 (77.8%; ASCEND-ND) had evaluable Hb during the EP. Hb was within the target range in 903/1238 (73%) Dapro pts and 866/1247 (69%) ESA pts (p=0.0367; ASCEND-D), and 1167/1491 (78%) Dapro pts and 1063/1520 (70%) ESA pts (p<0.0001; ASCEND-ND). In both studies, for Dapro vs ESA, respectively, Hb stayed within the target range for a greater proportion of time (61% vs 59%, p=0.0805 [ASCEND-D]; 71% vs 63%, p<0.0001 [ASCEND-ND]) and a greater proportion of pts exhibited an Hb increase  $> 2g/dL$  (15% vs 10%, [ASCEND-D]; 10% vs 7% [ASCEND-ND]) (Table). The proportions of Dapro pts achieving target Hb and time in the target Hb range were higher in ASCEND-ND than -D.

**Conclusions:** In ASCEND-D and -ND, more pts treated with Dapro achieved target Hb and spent more time in the target Hb range than pts treated with ESAs. This suggests that Dapro may provide increased Hb stability vs conventional ESA.

**Funding:** Commercial Support - This study was funded by GSK

	ASCEND-D (N=2964)		ASCEND-ND (N=3872)	
	Dapro (n=1487)	ESA (n=1477)	Dapro (n=1937)	ESA (n=1935)
Pts with evaluable Hb during EP, n (%)	1238 (84.0)	1247 (84.6)	1491 (77.2)	1520 (78.5)
Pts with evaluable Hb during MP, n (%)	1254 (84.3)	1247 (84.6)	1491 (77.2)	1520 (78.5)
Proportions with Hb within target range, n (%)	903 (73.0)	866 (73.0)	1167 (78.1)	1063 (70.0)
EP	903 (73.0)	866 (73.0)	1167 (78.1)	1063 (70.0)
MP	903 (73.0)	866 (73.0)	1167 (78.1)	1063 (70.0)
Mean % of time with Hb within target range	61%	59%	71%	63%
EP	61%	59%	71%	63%
MP	61%	59%	71%	63%
<b>Hb excursions during EP</b>				
<7.5g/dL	430 (35.0)	320 (27.5)	341 (29.5)	340 (22.3)
Mean ± SD % of time	7.6 ± 17.8	5.4 ± 14.4	4.3 ± 14.6	3.7 ± 14.7
>12g/dL	38 (3.2)	30 (2.7)	17 (1.5)	18 (1.2)
Pts with Hb increases and decreases $> 2g/dL$ in any 4 wk period for wk 28, n (%)	242 (19.6)	107 (9.2)	177 (15.0)	181 (11.9)
EP	242 (19.6)	107 (9.2)	177 (15.0)	181 (11.9)
MP	242 (19.6)	107 (9.2)	177 (15.0)	181 (11.9)

Table. Hb increases and decreases in pts with CKD on dialysis (ASCEND-D) and not on dialysis (ASCEND-ND)

TH-PO693

Suppression of Thyroid Profile During Roxadustat Treatment in CKD Patients

Yuan Cheng, Qiong Xiang, Tao Cao, Fei Tang, Qijun Wan. <sup>1</sup>Department of Nephrology, Shenzhen Second People's Hospital, the First Affiliated Hospital of Shenzhen University, Shenzhen, Guangdong, P.R. China, Shenzhen, China.

**Background:** Roxadustat has been used for renal anemia. To date, roxadustat induced suppression of thyrotropin secretion have been only described in two cases reports, but more data from a larger cohort are needed.

**Methods:** A total of 151 patients with renal anemia were collected in this retrospective cohort study. Changes in thyroid hormone and TSH were evaluated before and during the use of roxadustat or erythropoietin.

**Results:** FT3, FT4, T3, T4 and TSH level were lower during the use of roxadustat compared to baseline compared to erythropoietin group. 48.68% of patients had TSH levels dropped by more than 50%. By multivariate analysis, treatment of roxadustat was independently associated with the lower of TSH level by 41.30% (P<0.001).

**Conclusions:** This cohort study first finds that the suppression of thyroid profile is commonly related in CKD patients used roxadustat.

**Funding:** Government Support - Non-U.S.

Multivariate regression

	Unadjusted		Model 1		Model 2	
	$\beta$ (95% CI)	P	$\beta$ (95% CI)	P	$\beta$ (95% CI)	P
Erythropoietin	reference		reference		reference	
Roxadustat						
Percent change of FT3, %	-22.62 (-35.58, -9.66)	0.001	-21.85 (-35.48, -8.22)	0.003	-14.92 (-31.61, -1.77)	0.086
Percent change of FT4, %	-30.94 (-43.77, -18.12)	<0.001	-27.05 (-39.87, -14.22)	<0.001	-21.87 (-38.15, -5.59)	<0.001
Percent change of FT3, %	-19.19 (-28.81, -9.58)	<0.001	-20.13 (-29.85, -10.40)	<0.001	-18.75 (-30.77, -6.73)	<0.001
Percent change of FT4, %	-9.48 (-14.24, -4.73)	<0.001	-9.93 (-14.74, -5.13)	<0.001	-9.32 (-15.26, -3.39)	<0.001
Percent change of TSH, %	-35.77 (-50.95, -20.58)	<0.001	-34.32 (-49.69, -18.95)	<0.001	-41.30 (-59.76, -22.83)	<0.001

Model 1 is adjusted for sex, age, BMI, DM and hypertension. Model 2 is adjusted for variables in Model 1 and, CRP, serum albumin, uric acid, total cholesterol and transferrin saturation.

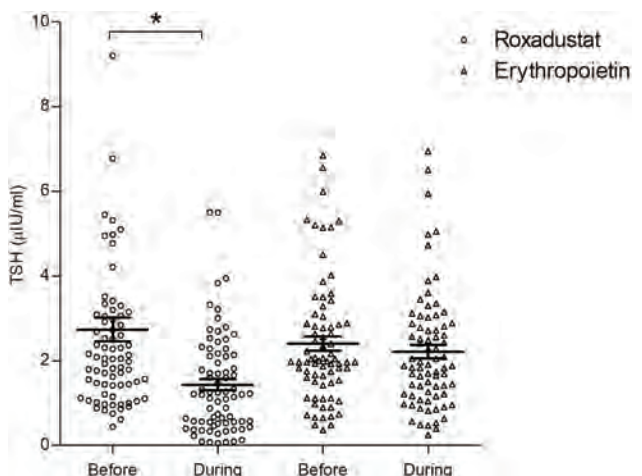

TSH change

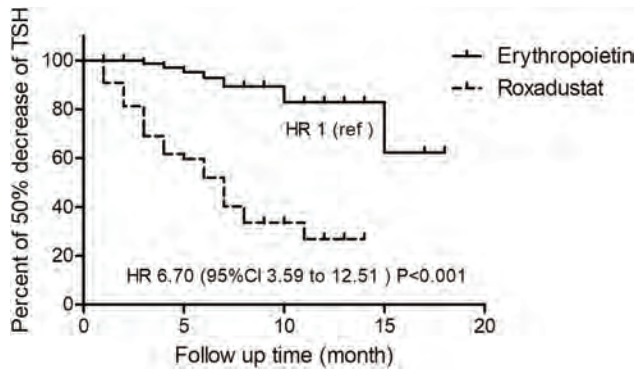

TSH decline >50%

TH-PO694

Real-World Use of Roxadustat, an HIF-PH Inhibitor, in the China Dialysis and Practice Patterns Study (DOPPS, 2019-2021)

Xinju Zhao,<sup>1</sup> Brian Bieber,<sup>2</sup> Liangying Gan,<sup>1</sup> Fan Fan Hou,<sup>3</sup> Xinling Liang,<sup>5</sup> Xiaonong Chen,<sup>6</sup> Zhaohui Ni,<sup>4</sup> Yuqing Chen,<sup>7</sup> Roberto Pecoits-Filho,<sup>2</sup> Bruce M. Robinson,<sup>2</sup> Li Zuo.<sup>1</sup> <sup>1</sup>Peking University People's Hospital, Beijing, China; <sup>2</sup>Arbor Research Collaborative for Health, Ann Arbor, MI; <sup>3</sup>Southern Medical University Nanfang Hospital, Guangzhou, China; <sup>4</sup>Shanghai Jiao Tong University, Shanghai, China; <sup>5</sup>Guangdong Provincial People's Hospital, Guangzhou, China; <sup>6</sup>Shanghai Jiao Tong University Medical School Affiliated Ruijin Hospital, Shanghai, China; <sup>7</sup>Peking University First Hospital, Beijing, China.

**Background:** Erythropoiesis stimulating agents (ESA) have been the mainstay to treat anemia in hemodialysis (HD) patients for decades but have been associated with adverse outcomes. The Hypoxia-inducible factor prolyl hydroxylase (HIF-PH) inhibitor roxadustat (roxa), is an oral anemia correction agent commercially available in China since 2018. However, little is known about its use in real-world settings. The aim of this study was to explore roxa uptake in Chinese in-center HD patients.

**Methods:** China DOPPS participants initiating roxa were identified and compared to the overall China DOPPS in-center HD population (2019-21).

**Results:** Among 1763 participants roxa prescription increased from 0 (Jan 2019) to 9.1% (Nov 2021, Figure). Compared to overall, patients starting roxa during follow-up (n=116) were older (65 v 61 years); on dialysis longer (5.0 v 3.1 years); more likely diabetic (50 v 36%) or female (51 v 40%); and had lower Hgb (9.3 v 10.8 g/dL), higher CRP (0.57 v 0.35 mg/dL), and higher ferritin (300 v 212 ng/mL) levels. Compared to values at roxa initiation, Hgb increased (10.2 g/dL), ferritin decreased (204 ng/mL), CRP and s. potassium were stable, and ESA use decreased from 93 to 70% two months after roxa initiation (v 91% overall ESA use). IV iron (~30%) and oral iron (~20%) use were similar from before to after roxa initiation, and to the overall cohort.

**Conclusions:** Per DOPPS China data, approximately 10% of HD patients in major Chinese cities are now prescribed a HIF-PH inhibitor. Impressions based on preliminary data include: roxa is prescribed to both prevalent and incident HD patients, appears to correct renal anemia, may improve iron metabolism, has no effect on potassium, and is often prescribed concurrently with an ESA. Longitudinal evaluation to assess dosing patterns, effectiveness, safety, and subgroup effects of HIF-PH inhibitors in the real-world is warranted in future studies.

**Funding:** Commercial Support - Global support for the ongoing DOPPS Programs is provided without restriction on publications by a variety of funders. For details see <https://www.dopps.org/AboutUs/Support.aspx>

Figure: Roxadustat prescription trend in China DOPPS (in-center HD, 2019-2021)

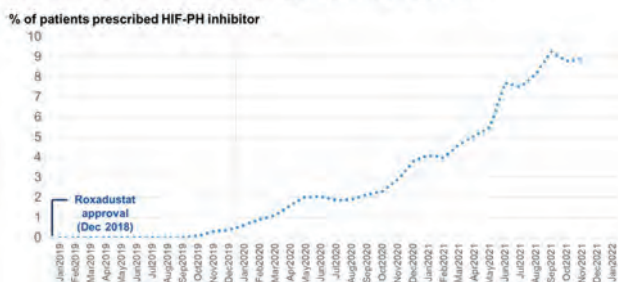

TH-PO695

Roxadustat vs. Erythropoiesis-Stimulating Agents and the Effect on Lipid Profile in Dialysis-Dependent Patients With Anemia of Renal Disease: A Meta-Analysis of Phase 3 Randomized Controlled Trials

Poemlarp Mekraksakit,<sup>1</sup> Naticha Leelavivat,<sup>2</sup> Siroj Dejhansathit,<sup>2</sup> Gaspar Del Rio-Pertuz,<sup>2</sup> Wisit Cheungpasitporn,<sup>1</sup> Juthipong Benjanuwatra,<sup>2</sup> Samapon Duangkham.<sup>2</sup> <sup>1</sup>Mayo Clinic Minnesota, Rochester, MN; <sup>2</sup>Texas Tech University Health Sciences Center School of Medicine, Lubbock, TX.

**Background:** Multiple recent studies have shown that roxadustat was non-inferior to erythropoiesis-stimulating agents (ESAs) in treatment of anemia of renal disease. However, the effects of roxadustat on lipid levels have not been well explored.

**Methods:** We searched the databases of MEDLINE and Embase from inception to April 2022. We included phase 3 randomized controlled trials (RCTs) that evaluated the efficacy of roxadustat versus ESAs in dialysis-dependent (DD) patients. Data were combined using the random-effects model and the inverse-variance method.

**Results:** Seven RCTs involving 5,391 DD patients from July 2019 to April 2022 were included. When compared to ESAs, roxadustat significantly decreased total cholesterol (mean difference [MD] -23.22 mg/dL; 95% -27.88, -18.56; I<sup>2</sup>=72%), LDL (MD -15.04 mg/dL; 95% CI -17.16, -12.91; I<sup>2</sup>=55%), and triglyceride levels (MD -9.61 mg/dL; 95% CI -15.29, -3.92; I<sup>2</sup>=0%). Although HDL cholesterol levels decreased significantly (MD -3.48 mg/dL; 95% CI -4.37, -2.59; I<sup>2</sup>=31%), an improvement in the LDL:HDL ratio was observed (MD -0.21; 95% CI -0.27, -0.15; I<sup>2</sup>=0%). Roxadustat was non-inferior to ESAs in hemoglobin response (MD 0.21 g/dL; 95% CI 0.10, 0.33; I<sup>2</sup>=87%) and decrease of hepcidin level (MD -17.56 ng/mL; 95% CI -31.97, -3.15; I<sup>2</sup>=81%). There is no difference of patients having a first blood transfusion between the two groups (pooled HR 0.86; 95% CI 0.63, 1.16; I<sup>2</sup>=55%).

**Conclusions:** Our meta-analysis indicated that roxadustat significantly decreased total cholesterol, LDL, LDL:HDL ratio, HDL, and triglyceride levels compared to ESAs. Further studies are needed to clarify this association.

A.) Total cholesterol (mg/dL)

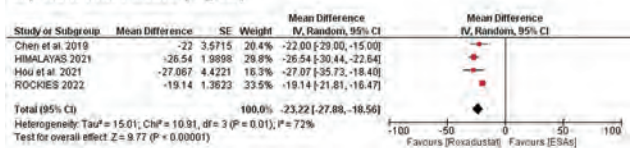

B.) Triglycerides (mg/dL)

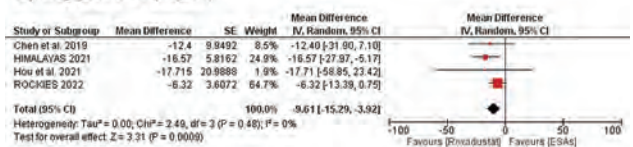

C.) LDL (mg/dL)

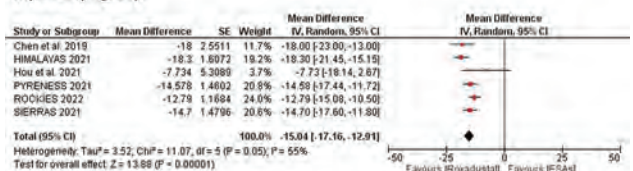

D.) HDL (mg/dL)

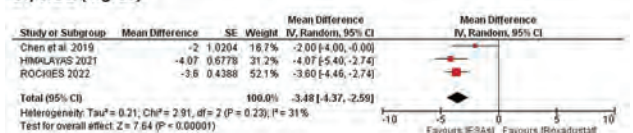

E.) LDL/HDL ratio

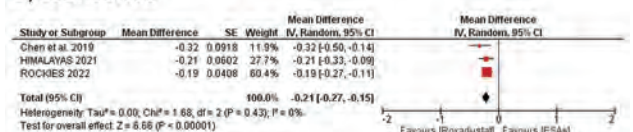

TH-PO696

**Potential Long-Term Economic Benefits of Switching From Epoetin Alfa to Hypoxia-Inducible Factor Prolyl Hydroxylase (HIF-PH) Inhibitors for the Management of Anemia in Hemodialysis (HD) Patients**

Satoshi Funakoshi,<sup>1</sup> Kosei Yamaguchi,<sup>1</sup> Mineaki Kitamura,<sup>1</sup> Tomoya Nishino,<sup>2</sup> <sup>1</sup>Nagasaki Kidney Center, Nagasaki, Japan; <sup>2</sup>Nagasaki Daigaku Igakubu Daigakuin Ishiyakugaku Sogo Kenkyuka, Nagasaki, Japan.

**Background:** HIF-PH inhibitors, which have recently become clinically available for treating renal anemia, are attracting attention for their novel mechanisms of action. However, the cost of the starting dose of HIF-PH inhibitors is considerably higher than EPO, and it may limit the use of them. Since HIF-PH inhibitors potentially lead to the activation of numerous HIF-regulated genes, we expected savings in drug use due to improvements in physical condition (i.e. cardiovascular protection) other than direct hematopoietic effects when used over the long term.

**Methods:** Sixty-four HD patients treated with 9000 U/week of EPO were converted to roxadustat (Rox) three times a week at a dose of 100 mg, then dose of Rox was titrated to achieve Hb level between 10 to 12 g/dL. In a similar way sixty-one HD patients treated with 9000 U/week of EPO were converted to daprodustat (Dap) at daily dose of 6 mg, then dose of Dap was titrated to achieve Hb level between 10 to 12 g/dL.

**Results:** The starting amounts of Rox and Dap were approx. 4,100 and 3,000 JPY / week, respectively, while EPO was approx. 2,600 JPY / week. AS shown in Figure, while spending on EPO naturally remained unchanged, but the respective drug use of Rox and Dap slowly decreased and the costs became almost equivalent to the cost of EPO in one year.

**Conclusions:** We have shown that administering Rox and Dap, HIF-PH inhibitors, had led to a reduction in cost in long-term use. Given the cost sparing advantages HIF-PH inhibitors as has been reported, they appear to be an effective alternative to ESA in the long-term management of anemia in HD patients.

**Funding:** Private Foundation Support

**Changes in weekly costs for HIF-PH inhibitors and EPO over time**

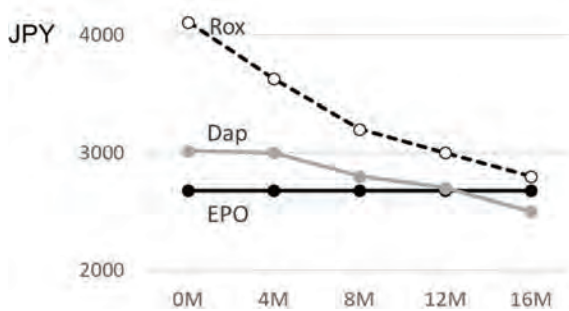

TH-PO697

**Four Cases of Serum Copper Excess in Patients With Renal Anemia Receiving a Hypoxia-Inducible Factor-Prolyl Hydroxylase Inhibitor: A Possible Safety Concern**

Hironori Nakamura, Anayama Mariko, Michiko Ueda, Masaki Nagasawa, Yasushi Makino. Department of Nephrology, Shinonoi General Hospital, Nagano, Japan.

**Introduction:** Copper is an indispensable trace metal element and is mainly absorbed in the stomach and small intestine and excreted into the bile. Hypoxia-inducible factor-prolyl hydroxylase inhibitors (HIF-PHIs) have emerged as a novel approach for renal anemia management. Many intestinal genes, including *divalent metal transporter 1* (DMT1), *duodenal cytochrome B* (DCYTB), and copper transporter ATPase7A (ATP7A), related to iron or copper metabolism are transactivated by HIF- $\alpha$ , during iron deficiency.

**Case Description:** We first report four cases of patients with renal anemia who showed excess in serum copper level during roxadustat or daprodustat treatment, which were decreased to the normal level after discontinuing HIF-PHIs and changing the drug to darbepoetin alfa, suggesting that HIF-PHI is associated with serum copper excess shown in Fig 1.

**Discussion:** In a rat model, roxadustat significantly increased expression of *DMT1* and *DCYTB* mRNA and stabilized HIF-1 $\alpha$  and HIF-2 $\alpha$  in vitro. HIF- $\alpha$  protein levels rapidly declined after washout of roxadustat from cell cultures. Just as HIF-PHI modulates iron metabolism, such as absorption, sequestration and mobilization, HIF-PHI may also influence serum copper levels by mechanisms through copper absorption and/or redistribution via DMT1, ATP7A and copper transporter 1 in tissues. Therefore, it is urgent to examine the correlation between HIF-PHI use and serum copper levels because copper excess might be involved in several acute or chronic adverse events.

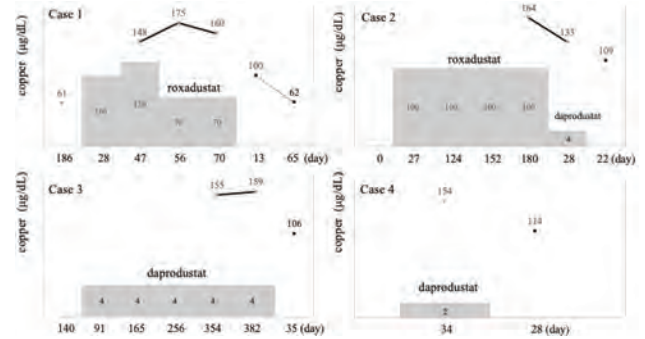

Changes of serum copper and days before, during, and after the HIF-PHI treatment. Half-tone dot meshing shows the term of HIF-PHI treatment and its dose.

TH-PO698

**Iron Deficiency, Anemia, and Health-Related Quality of Life in Kidney Transplant Recipients**

Tim J. Knobbe,<sup>1</sup> Daan Kremer,<sup>1</sup> Joanna Sophia J. Vinke,<sup>1</sup> Coby Annema,<sup>2</sup> Martin H. De Borst,<sup>1</sup> Stefan P. Berger,<sup>1</sup> Stephan J. Bakker,<sup>1</sup> Michele F. Eisenga,<sup>1</sup> TransplantLines Investigators <sup>1</sup>University Medical Center Groningen, department of Internal Medicine, Division of Nephrology, Groningen, Netherlands; <sup>2</sup>University Medical Center Groningen, Department of Health Sciences, Section of Nursing Research, Groningen, Netherlands.

**Background:** Current guidelines focus on treatment of anemia to improve health-related quality of life (HRQoL) among kidney transplant recipients (KTRs), with limited effects. Iron fulfills a myriad of functions besides stimulating erythropoiesis, and there is increasing consensus that iron deficiency, rather than anemia alone, may be a promising target to improve HRQoL. However, epidemiological support for this notion is sparse. We therefore investigated the association of iron deficiency with HRQoL in KTRs, adjusting for co-existing anemia.

**Methods:** Data of KTRs ( $\geq 1$  year after transplantation) from the TransplantLines Biobank and Cohort Study were used. Iron deficiency was defined as serum transferrin saturation  $< 20\%$  and ferritin  $< 100 \mu\text{g/L}$ . Anemia was defined as Hb  $< 13 \text{ g/dL}$  (M) or  $< 12 \text{ g/dL}$  (F). HRQoL was assessed using the validated Short Form-36 questionnaire.

**Results:** A total of 814 KTRs (62% male, mean age  $56 \pm 13$  years) were included at a median of 3 [1-10] years after transplantation. In total, 229 (28%) KTRs suffered from iron deficiency and 237 (29%) were anemic. In linear regression analyses, both iron deficiency and anemia were associated with physical (B -4.82, 95% CI -8.06 to -1.59,  $p=0.004$  and B -3.45, 95% CI -6.77 to -0.13,  $p=0.042$ , respectively) and mental (B -3.63, 95% CI -6.42 to -0.84,  $p=0.011$  and B -1.22, 95% CI -4.09 to 1.64,  $p=0.4$ , respectively) HRQoL, independent of age, sex, eGFR, time since transplantation, diabetes mellitus, pre-emptive transplantation, living donor, calcineurin inhibitor use, angiotensin receptor blocker use and ACE inhibitor use. In addition, the associations between iron deficiency and HRQoL remained materially unchanged after additional adjustment for anemia (physical: -4.43, 95% CI -7.69 to -1.16,  $p=0.008$ ; mental: B -3.53, 95% CI -6.35 to -0.71,  $p=0.014$ ).

**Conclusions:** Iron deficiency, independent of anemia, is associated with lower physical and mental HRQoL among KTRs. These data highlight the need for interventional studies investigating whether correction of iron deficiency improves HRQoL among KTRs, even in the absence of anemia.

**Funding:** Commercial Support - The TransplantLines Biobank and Cohort study was supported by a grant from Astellas BV and Chiesi Pharmaceuticals BV, and co-financed by the Dutch Ministry of Economic Affairs and Climate Policy by means of the PPP-allowance made available by the Top Sector Life Sciences & Health to stimulate public-private partnerships.

TH-PO699

**Burden of Anemia in Patients With CKD Stages 3-5 Managed in Primary Care**

Marie Evans,<sup>1</sup> Yang Xu,<sup>1,3</sup> Faizan Mazhar,<sup>1</sup> Johan Arnlov,<sup>1</sup> Elinor Cockburn,<sup>4</sup> Peter F. Barany,<sup>2,1</sup> Juan J. Carrero,<sup>1</sup> <sup>1</sup>Karolinska Institutet, Stockholm, Sweden; <sup>2</sup>Karolinska Universitetssjukhuset, Stockholm, Sweden; <sup>3</sup>Peking University, Beijing, China; <sup>4</sup>Astellas Pharma A/S, Kastrup, Denmark.

**Background:** General practitioners (GPs) are the first point of contact for patients with chronic kidney disease (CKD), who often remain in the care of their GP until advanced stages of disease. Anemia is a common complication of CKD, but there are limited studies quantifying the burden of CKD-associated anemia in primary care. In this study, we explored anemia incidence, treatment selection, and adverse clinical outcomes in primary care patients with CKD.

**Methods:** We evaluated patients  $\geq 18$  years with CKD stages 3-5 managed in primary care in Stockholm, Sweden, from 2012 to 2018, who did not have anemia and had no history of nephrology referral. Incident anemia was defined as persistently low hemoglobin (Hb) values ( $< 12.0 \text{ g/dL}$  in women and  $< 13.0 \text{ g/dL}$  in men,  $> 3$  months apart), anemia international classification of disease diagnosis, or a single low Hb measurement



with treatment initiation within 90 days. We evaluated baseline factors associated with anemia incidence and treatment selection, and the association between incident anemia and major adverse cardiovascular events (MACE) or death.

**Results:** The study included 45,637 adults with CKD stages 3-5 (mean age 78 years, 64% female, 79% CKD stage 3a) managed in primary care; 11,987 (26%) developed anemia during follow-up (median 2.4 years, interquartile range 1.0-4.7). Anemia incidence increased with CKD severity: 78 cases/1000 person-years in CKD stage 3a, to 185 cases/1000 person-years in stages 4-5. The main factors associated with anemia occurrence were older age, male sex, diabetes, and lower estimated glomerular filtration rate. In the six months following incident anemia, treatment was initiated in 2272 (19%) patients, including oral iron (9.9%), blood transfusion (6.6%), and erythropoiesis-stimulating agent (0.2%). Treatment initiation increased with anemia severity. Developing anemia was associated with a higher risk of death (adjusted hazard ratio [HR] 1.33 [95% CI: 1.25-1.42]) and MACE (HR 1.91 [95% CI: 1.77-2.06]).

**Conclusions:** One in four patients with CKD stages 3-5 developed anemia while managed in primary care. Developing anemia was associated with low treatment rates and poor outcomes, highlighting an opportunity to improve management of CKD-associated complications in primary care.

**Funding:** Commercial Support - Commercial Support (Astellas Pharma A/S Denmark)

**TH-PO700**

**Examining the Magnitude of Erythropoiesis-Stimulating Agent Hyporesponsiveness in Hemodialysis Patients**

Eric D. Weinhandl,<sup>1,2</sup> Yunji Hwang,<sup>3</sup> David T. Gilbertson,<sup>1,2</sup> Jeffrey Petersen.<sup>3</sup>  
<sup>1</sup>Chronic Disease Research Group, Minneapolis, MN; <sup>2</sup>University of Minnesota Twin Cities, Minneapolis, MN; <sup>3</sup>Amgen Inc, Thousand Oaks, CA.

**Background:** Anemia is common in patients undergoing maintenance hemodialysis (HD) and is treated with erythropoiesis-stimulating agents (ESAs) and intravenous iron. ESA hyporesponsiveness is an oft-cited unmet medical need, but the scope of the problem is obscured by complex statistical quantities, including the erythropoietin resistance index (ERI). We analyzed a contemporary, nationally representative cohort to describe anemia-related parameters of HD patients with high ERI and/or chronically low hemoglobin (Hb).

**Methods:** We analyzed CROWNWeb records of HD patients in 2016-2019. The study cohort included 6-month patient-intervals characterized by treatment with either epoetin alfa (EPO) or darbepoetin alfa (DPO), monthly measurements of Hb, and at least one measurement of transferrin saturation (TSAT). We stratified patient-intervals by the cross-classification of normal vs high ERI (definition:  $\geq 20$  EPO-equivalent IU/wk/kg/g/dL, where 1 mcg DPO = 250 IU EPO) and transiently vs chronically low Hb (definition: Hb <10 g/dL in every month of the interval). In each stratum, we estimated median values of weekly ESA dose, Hb, ERI, and TSAT.

**Results:** We identified 7,824,640 patient-intervals. Prevalence of high ERI was 17.2% in single patient-months and 15.6% during 6-month patient-intervals. In both cases, ERI was strongly correlated with weekly ESA dose ( $R^2 = 0.87$ ). In contrast, prevalence of Hb <10 g/dL was 23.0% in single patient-months, whereas prevalence of chronically low Hb was 2.5% during 6-month patient-intervals (table). Among 15.6% of patients with high ERI, 13.8% experienced only transiently low Hb, with median Hb of 10.1 g/dL and median TSAT of 25.0%. Among 2.5% of patients with chronically low Hb, 1.8% experienced high ERI, with median TSAT of 23.0%.

**Conclusions:** Prevalence of high ERI in HD patients exceeds 15%, mostly due to the scale of ESA dosing, but this overstates the prevalence of chronic anemia hyporesponsive to treatment. Lower TSAT is common in patients with high ERI and/or chronically low Hb, suggesting potential iron deficiency.

**Funding:** Commercial Support - Amgen Inc.

	Normal ERI		High ERI	
	Transiently low Hb	Chronically low Hb	Transiently low Hb	Chronically low Hb
Patient-intervals (row %)	85.7%	0.7%	13.8%	1.8%
ESA dose (EPO-equivalent IU/wk)	5136	8624	19,809	25,106
Hb (g/dL)	10.7	8.9	10.1	8.5
ERI (IU/wk/kg/g/dL)	3.9	3.5	25.0	33.3
TSAT (%)	30.0	26.0	25.0	23.0

**TH-PO701**

**Adverse Additive Effect of Iron Deficiency on Cardiac Death in Incident Hemodialysis Patients With Left Ventricular Systolic Dysfunction**

Mai Hitaka,<sup>1</sup> Kenji Nakata,<sup>1</sup> Toshihide Hayashi,<sup>1</sup> Minako Harada,<sup>1</sup> Ayaka Yamamura,<sup>1</sup> Yasushi Ohashi,<sup>2</sup> Yuri Tanaka,<sup>1</sup> Nobuhiko Joki.<sup>1</sup>  
<sup>1</sup>Department of Nephrology, Toho University Ohashi Medical Center, Tokyo, Japan; <sup>2</sup>Department of Nephrology, Toho University Sakura Medical Center, Chiba, Japan.

**Background:** Iron deficiency (ID), especially low transferrin saturation (TSAT), has a great impact on cardiac events in patients with heart failure (HF) reduced ejection fraction. Our previous study has shown low TSAT is closely associated with an enlarged heart, independent of hemoglobin level in incident hemodialysis (HD) patients. The purpose of this study is to examine the adverse effect of ID depending on the cardiac functional status.

**Methods:** 705 patients with iron data were included in this study, out of 809 consecutive end-stage kidney disease(ESKD) patients who started maintenance HD therapy during January 1993 and December 2021. The primary endpoint was defined

as cardiac death including death of myocardial infarction, HF and sudden death. ID was defined as TSAT<20% regardless of the ferritin level. 5-year cumulative survival rate was calculated by Kaplan Meier curve in 4 ESKD patient groups with/without ID and with/without ejection fraction (EF) <50%. Hazard ratios (HR) and 95% confidence intervals (CI) were estimated by Cox proportional hazard model.

**Results:** Mean age was 68 years, 30% female. During the mean follow-up period of 3.0 ± 1.9 years, 188 deaths occurred, 46 of which were cardiac deaths. About 16% and 40% of patients suffered from ID and EF<50% respectively at the initiation of HD. 5-year survival rate was 93.9% in non-ID group, which is significantly higher than that of ID group of 83.4%. Lower survival rate of 74.3% was found in ID with EF<50% group compared to 86.5% of non-ID with EF<50% group. As shown in the table, Cox regression analysis revealed that in patients with low-EF, HR is showing abrupt increment from 2.3 to 7.4 when combined with ID.

**Conclusions:** The additive adverse effect of ID on cardiac death was indicated in incident HD patients with left ventricular systolic dysfunction. Further study is needed to confirm the effect of iron supplementation for better prognosis in maintenance HD patients with cardiac dysfunction.

	HR	95% CI	p
Non-ID/EF≥50%	1		
Non-ID/EF<50%	2.3	0.72-7.39	0.1585
ID/EF≥50%	3.1	1.44-6.74	0.0037
ID/EF<50%	7.4	2.97-18.44	<0.0001

Adjusted by age, gender, diabetes mellitus, and hemoglobin.

**TH-PO702**

**Pegmolestatide for the Treatment of Anemia in NDD-CKD Patients: A Multicenter Randomized Active-Controlled Phase 3 Trial**

Ting Lin,<sup>1</sup> Aicheng Yang,<sup>2</sup> Hongyu Qiu,<sup>3</sup> Xiaomei Peng,<sup>4</sup> Wanhong Lu,<sup>5</sup> Shuifu Tang,<sup>9</sup> Qinkai Chen,<sup>6</sup> Xiangyang Huang,<sup>7</sup> Aimin Zhong,<sup>8</sup> Xueqing Yu.<sup>1</sup>  
<sup>1</sup>Guangdong General Hospital, Guangzhou, China; <sup>2</sup>Jiangmen Wuyi Traditional Chinese Medicine Hospital, Jiangmen, China; <sup>3</sup>Sichuan University West China Hospital, Chengdu, China; <sup>4</sup>The people hospital of Guangxi Zhuang Autonomous Region, Nanning, China; <sup>5</sup>The First Affiliated Hospital of Xi'an Jiaotong University, Xi'an, China; <sup>6</sup>The First Affiliated Hospital of Nanchang University, Nanchang, China; <sup>7</sup>Liu Zhou worker's hospital, Liuzhou, China; <sup>8</sup>Jiangxi Provincial People's Hospital, Nanchang, China; <sup>9</sup>The First Affiliated Hospital of Guangzhou University of Chinese Medicine, Guangzhou, China.

**Background:** Pegmolestatide, a synthetic peptide-based erythropoiesis-stimulating agent (ESA), is a potential long-acting drug for the treatment of anemia in chronic kidney disease (CKD) patients. Efficacy and safety of Pegmolestatide would be evaluated in non-dialysis-dependent(NDD)-CKD populations.

**Methods:** A multicenter, randomized, open-label, active-controlled, non-inferiority phase 3 trial was conducted at 38 centers in China. Eligible NDD-CKD patients who were not receiving ESAs were randomly assigned (2:1) to receive Pegmolestatide once in every four weeks (at a starting dose of 0.04 mg/kg) or Epoetin alfa weekly or biweekly (at a starting dose of 6000 IU per week). During the 52-week study, dosages were adjusted as needed to achieve and maintain hemoglobin(Hb) level between 10.0 and 12.0 g/dL. The primary endpoint was the change in Hb level from baseline to the evaluation period (week 17 through 24). Non-inferiority would be established if the lower boundary of 95% confidence interval for the Hb change difference (Pegmolestatide-Epoetin alfa) was greater than -1.0 g/dL. Safety profile was assessed. Cardiovascular safety was evaluated on the basis of composite safety endpoints (death, stroke and myocardial infarction).

**Results:** A total of 175 patients were randomized, and 135 patients (86 in the Pegmolestatide group and 49 in the Epoetin alfa group) completed a 24-week treatment. The median duration of exposure was 36.63 and 37.95 weeks respectively in the Pegmolestatide and Epoetin alfa group. The demographics and baseline characteristics were balanced between two groups. The non-inferiority was reached in Full-Analysis Set and Per-Protocol Set. Of the 173 patients who received at least one dose, the incidences of adverse events (AEs) and serious AEs (SAEs) were similar in both groups, and hypertension was the most common AE related to the study drug (5.2% in the Pegmolestatide group and 13.8% in the Epoetin alfa group). The composite safety endpoints were occurred in 1 patient (0.9%) who received Pegmolestatide and in 2 patients (3.4%) who received Epoetin alfa.

**Conclusions:** Long-acting Pegmolestatide was similar to Epoetin alfa in efficacy and safety, which could be used for treatment of anemia in NDD-CKD patients.

**Funding:** Commercial Support - Shanghai Hansoh Biomedical Co., Ltd

**TH-PO703**

**Long-Term P-Selectin Deficiency Does Not Prevent Progressive Renal Disease in Humanized Sickle Cell Mice**

Malgorzata Kasztan,<sup>1</sup> Erica Sparkenbaugh,<sup>2</sup> Elizabeth Binning,<sup>3</sup> Fatima Trebak,<sup>2</sup> Rafal Pawlinski.<sup>2</sup> <sup>1</sup>The University of Alabama at Birmingham Department of Pediatrics, Birmingham, AL; <sup>2</sup>The University of North Carolina at Chapel Hill Department of Medicine, Chapel Hill, NC; <sup>3</sup>The University of Alabama at Birmingham Department of Medicine, Birmingham, AL.

**Background:** Sickle cell disease (SCD) is a hemoglobinopathy characterized by chronic hemolysis, endothelial activation, and vaso-occlusion, ultimately leading to multiple organ damage. P-selectin is an adhesion molecule that mediates vascular stasis in SCD, and monoclonal antibody against P-selectin reduces the frequency of acute

vaso-occlusive crisis in SCD patients. Sickle cell nephropathy is largely determined by renal vasculopathy, thus, we aimed to assess the effect of chronic P-selectin deficiency on kidney disease in murine model of SCD.

**Methods:** We evaluated kidney structure and function in 11-12 months old, male and female, humanized sickle cell (HbSS, n=14-17) and non-sickle control (HbAA, n=16-27) mice with or without P-selectin expression.

**Results:** The absence of P-selectin did not prevent progressive renal disease in HbSS mice as evidenced by hyposthenuria, proteinuria and loss of kidney function, determined by reduced GFR. We also determined if chronic P-selectin deficiency contributes to the development of glomerulopathy by measuring structural and functional markers of glomerular injury. Even though we observed a significant reduction in glomerular congestion score (0.16±0.05 vs. 0.37±0.06, p<0.05), P-selectin deficiency did not prevent albuminuria, glomerular sclerosis, hypertrophy, and podocyte loss in HbSS mice. Interestingly, significant hypercellularity, extensive mesangial expansion (2.3±0.1 vs. 1.3±0.1, p<0.05) and mesangiolysis were observed in P-selectin<sup>-/-</sup> HbSS when compared to P-selectin<sup>+/+</sup> HbSS mice. We also examined the effect of P-selectin deficiency on tubular injury. Regardless of P-selectin genotype, HbSS mice had greater urinary KIM-1 excretion and tubular simplification with brush border loss than non-sickle control mice. Also, despite a reduction in inflammatory cell recruitment in the kidney, P-selectin<sup>-/-</sup> HbSS mice presented with the same degree of renal fibrosis as P-selectin<sup>+/+</sup> HbSS mice. Secondary to reduced macrophage renal recruitment P-selectin deficient HbSS mice had significantly elevated renal iron accumulation when compared to HbSS mice with normal P-selectin expression (12.2±1.1 vs. 8.8±0.6, p<0.05).

**Conclusions:** These results suggest that despite reducing vaso-occlusion chronic P-selectin deficiency does not prevent progressive kidney disease in murine model of SCD.

**Funding:** Other NIH Support - NHLBI R01HL144817 and UAB KUH GAIN to M.K., R01HL155193 to E.M.S., T32 HL007149 to F.T., R01HL142604 and R01HL157441 to R.P.

**TH-PO704**

**3-Carboxy-4-Methyl-5-Propyl-2-Furanpropionate (CMPF), a Protein-Bound Uremic Solute, Augments RBC Osmotic Fragility**

**Beatriz Akemi K. Van Spitzbergen,<sup>1</sup> Gabriela Ferreira Dias,<sup>2</sup> Nadja Grobe,<sup>2</sup> Peter Kotanko,<sup>2,3</sup> Andrea N. Moreno-Amaral.<sup>1</sup>** <sup>1</sup>Pontificia Universidade Catolica do Parana, Curitiba, Brazil; <sup>2</sup>Renal Research Institute, New York, NY; <sup>3</sup>Icahn School of Medicine at Mount Sinai, New York, NY.

**Background:** While contributing to renal anemia, shortened red blood cell (RBC) life span in end-stage kidney disease (ESKD) is poorly understood. Recently, the interaction between the protein-bound uremic solute 3-Carboxy-4-methyl-5-propyl-2-furanpropionate (CMPF) and the RBC Piezo1 mechanoreceptor has been hypothesized to shorten the RBC life span (Kotanko *et al.*, FASEB J BioAdvances, 2022). In the present study, we evaluated the effect of CMPF on RBC osmotic resistance.

**Methods:** RBC were isolated from healthy subjects (n=6). CMPF (8 μM, 17 μM, 87 μM, 170 μM) dissolved in DMSO was added to cell suspensions. Buffer plus DMSO served as a negative control. From these suspensions, 10μL were added to increasing NaCl solutions, from 3 to 9 g/L. After centrifugation (1500 rpm; 10 min), Hg (540 nM) was measured in the supernatant. Data were fitted to a 4-parameter logistic regression curve. The osmotic fragility index (IC50) was defined as a NaCl concentration that exerted 50% hemolysis.

**Results:** CMPF increased osmotic fragility in a dose-dependent manner. IC50 at 17 μM, 87 μM, and 170 μM, respectively, exceeded controls (4.47±0.15 vs. 4.19±0.07, 4.66±0.10 vs. 4.12±0.11, 4.82±1.34 vs. 4.65±1.88), indicating increased hemolysis in the presence of CMPF (Table 1).

**Conclusions:** Our results indicate that CMPF increases RBC osmotic fragility in a dose-dependent manner. If and to what extent an interaction between CMPF and Piezo1 is the causal pathway warrants further studies.

Table 1 - Dose-dependent increase of RBC osmotic fragility induced by CMPF

	IC50 DMSO Neg Ctrl (A)	IC50 CMPF (B)	Mean of differences (B - A)	p value
8 μM	4.18±0.09	4.23±0.36	0.05	0.843
17 μM	4.19±0.07	4.47±0.15	0.28*	0.022
87 μM	4.12±0.11	4.66±0.10	0.54**	0.003
170 μM	4.65±1.88	4.82±1.34	0.17*	0.015

Data expressed as mean±SD.

**TH-PO705**

**Iron Therapy Mitigates Kidney Fibrosis by Regulating Intracellular Iron Status of Kidney Macrophages**

**Edwin Patino,<sup>1</sup> Divya Bhatia,<sup>1</sup> Shahd Jaouni,<sup>1</sup> Rie Uni,<sup>1</sup> Carlo G. Castillo,<sup>1,4</sup> Francesca Vinchi,<sup>2,1</sup> Mary E. Choi,<sup>1,3</sup> Oleh M. Akchurin.<sup>1,3</sup>** <sup>1</sup>Weill Cornell Medicine, New York, NY; <sup>2</sup>New York Blood Center, New York, NY; <sup>3</sup>NewYork-Presbyterian Hospital/Weill Cornell Medical Center, New York, NY; <sup>4</sup>Cornell University, Ithaca, NY.

**Background:** Systemic iron metabolism is disrupted in CKD. However, little is known about local kidney iron homeostasis and its role in kidney fibrosis. Kidney-specific effects of iron therapy in CKD also remain elusive. Here, we assess the role of macrophage iron status in kidney fibrosis and report preclinical data suggesting that it can be used as a therapeutic target.

**Methods:** We used two mouse models of kidney fibrosis: adenine diet and unilateral urethral obstruction (UUO), applied to wild type mice and to ferritin heavy chain (*Fth1*) myloid-specific (LysM-cre) knockout mice. A subset of mice received weekly intraperitoneal injections of iron dextran (0.5 g/kg body weight) or adoptive transfer of iron-loaded macrophages. Mice were euthanized after 8 weeks of adenine diet or 7 days after UUO. Kidney macrophages were analyzed by flow cytometry using single cell suspensions of homogenized and digested kidney tissues. Effects of iron on macrophage phenotype were also assessed *in vitro* with and without concurrent TGF-β stimulation.

**Results:** In both models of kidney fibrosis, kidney macrophages exhibited depletion of labile iron pool (LIP) and induction of transferrin receptor 1, indicating intracellular iron deficiency. Low LIP in kidney macrophages was associated with their defective antioxidant response and pro-inflammatory polarization. Repletion of LIP in kidney macrophages through knockout of *Fth1* reduced oxidative stress and mitigated fibrosis. Iron significantly decreased TGF-β expression and suppressed TGF-β-driven fibrotic response of macrophages. Similar to *Fth1* knockout, iron dextran therapy, through replenishing macrophage LIP, reduced oxidative stress, decreased production of pro-inflammatory cytokines, and alleviated kidney fibrosis. Iron dextran therapy and Fth1 suppression had additive protective effect against fibrosis. Adoptive transfer of iron-loaded macrophages also alleviated kidney fibrosis, confirming the protective effect of iron-replete macrophages in CKD.

**Conclusions:** Depletion of LIP in kidney macrophages paradoxically drives their pro-oxidative, pro-inflammatory, and pro-fibrotic qualities in CKD. Repletion of intracellular LIP in macrophages attenuates kidney fibrosis. Thus, intracellular iron status of kidney macrophages appears to be a promising therapeutic target in CKD.

**Funding:** NIDDK Support, Private Foundation Support

**TH-PO706**

**Documentation of Social, Environmental, and Behavioral Determinants of Health in Administrative Claims Data in US Medicare and Commercially Insured Populations**

**Yun Han,<sup>1</sup> Diane Steffick,<sup>1</sup> Yiting Li,<sup>1</sup> Jennifer L. Bragg-Gresham,<sup>1</sup> Tiffany C. Veint,<sup>1</sup> Brenda W. Gillespie,<sup>1</sup> Vahakn Shahinian,<sup>1</sup> Kai M. Bullard,<sup>2</sup> Meda E. Pavkov,<sup>2</sup> Rajiv Saran.<sup>1</sup>** <sup>1</sup>University of Michigan, Ann Arbor, MI; <sup>2</sup>Centers for Disease Control and Prevention, Atlanta, GA.

**Background:** Attention to social, environmental, and behavioral determinants of health (SEBDOH) is important for addressing health disparities, especially for conditions like chronic kidney disease (CKD). SEBDOH documentation practices may vary by patient factors. We investigate SEBDOH documentation in US claims data in outpatient settings and patient factors associated with such documentation.

**Methods:** We examined ICD-10 SEBDOH-Z codes in the Medicare 5% sample (Medicare Fee-for-Services plans, FFS, 2015-2019) and the Optum data (Medicare Advantage plans and commercial plans, 2015- 2020). Patient demographics, CKD, and other conditions predicting SEBDOH were assessed using logistic regression.

**Results:** SEBDOH documentation in claims was consistently low among people with different insurance: Medicare FFS (3%), Medicare Advantage (4%), and commercial plans (2%). Across insurance groups, tobacco use was the most commonly recorded behavior(33%-59% of the SEBDOH claims); younger age, non-Hispanic Black race, male sex, CKD, hypertension, cardiovascular diseases, and anemia were less likely to have SEBDOH documentation, after adjusting for patient factors (Table). Diabetes is related with more documentation in Medicare FFS (adjusted OR: 1.10, 95% CI 1.08-1.13, p<0.0001) and Medicare Advantage (adjusted OR: 1.13, 1.13-1.14, p<0.0001) but related with less documentation in commercial plans (adjusted OR: 0.97, 0.96-0.98, p<0.0001).

**Conclusions:** We observed a uniformly low-level uptake of SEBDOH-Z codes in both Medicare and Optum data. The negative association of CKD and other conditions with SEBDOH documentation suggests missed opportunities in health care delivery. Increased SEBDOH documentation can identify vulnerable CKD patients who may benefit from supplemental services.

**Funding:** Other U.S. Government Support

Table. Documentation of Social, Environmental, and Behavioral Determinants of Health in Administrative Claims Data in US Medicare and Commercially Insured Populations

Parameter	Medicare Fee-for-Services Plans			Medicare Advantage Plans			Commercial Plans		
	Adjusted OR	95% CI	P > ChiSq	Adjusted OR	95% CI	P > ChiSq	Adjusted OR	95% CI	P > ChiSq
Age group									
age below 20	0.57	0.30 1.07	0.8707	0.22	0.03 1.90	0.2903	1.31	1.29 1.33	<.0001
age 20-45	0.17	0.16 0.18	<.0001	0.24	0.24 0.25	0.0032	0.66	0.65 0.67	<.0001
age 45-65	0.27	0.26 0.27	<.0001	0.29	0.29 0.29	0.0147	0.60	0.60 0.61	<.0001
age 65-85	ref	ref	ref	ref	ref	ref	ref	ref	ref
age above 85	2.82	2.66 3.00	<.0001	2.10	2.07 2.13	<.0001	2.19	2.03 2.34	<.0001
Race/Ethnicity									
Non-Hispanic									
White	ref	ref	ref	ref	ref	ref	ref	ref	ref
Non-Hispanic-Black	0.85	0.82 0.87	<.0001	0.66	0.66 0.67	<.0001	0.95	0.94 0.95	<.0001
Asian	1.86	1.66 2.10	<.0001	1.63	1.57 1.64	<.0001	1.89	1.86 1.91	<.0001
Hispanic	1.59	1.41 1.78	<.0001	1.32	1.30 1.34	<.0001	1.45	1.43 1.46	<.0001
American Indian and Alaska Native	1.30	1.21 1.39	0.0005						
Other	0.99	0.45 0.53	<.0001	NA*			NA		
Unknown	1.88	1.50 1.88	<.0001	NA			NA		
Male	0.79	0.77 0.80	<.0001	0.90	0.89 0.90	<.0001	0.85	0.84 0.85	0.6862
Comorbidities									
Chronic Kidney Disease	0.97	0.95 1.00	0.0386	0.87	0.86 0.87	<.0001	0.84	0.83 0.85	<.0001
Diabetes	1.00	1.06 1.13	<.0001	1.13	1.13 1.14	<.0001	0.97	0.96 0.98	<.0001
Hypertension	0.84	0.82 0.86	<.0001	0.69	0.68 0.69	<.0001	0.48	0.48 0.49	<.0001
Cardiovascular Disease	0.66	0.64 0.67	<.0001	0.51	0.51 0.52	<.0001	0.44	0.44 0.44	<.0001
Anemia	1.02	0.99 1.05	0.1975	0.75	0.75 0.76	<.0001	0.75	0.75 0.76	<.0001

# Data of Medicare Fee-for-Services plans was obtained from the Medicare 5% sample; Data of Medicare Advantage plans and Commercial Insurance was obtained from the Optum Clinformatics data.  
\* NA refers information of subgroups is not available in the Optum Clinformatics data

TH-PO707

**Comparison of Actual vs. ZIP Code-Predicted Highest Educational Attainment in ESKD and Non-ESKD Participants**

Yang Dai, Huei Hsun Wen, Girish N. Nadkarni, Lili Chan. *Icahn School of Medicine at Mount Sinai, New York, NY.*

**Background:** Research on the association of social determinants of health (SDOH) and clinical outcomes in participants with kidney disease often use SDOH measures identified using participants' zip code and census data. However, in urban neighborhoods, zip code and census derived SDOH measures may be inaccurate.

**Methods:** We utilized data from participants ≥25 years old enrolled in the BioMe Biobank and from the Mount Sinai Kidney Center hemodialysis (HD) unit. All participants completed a questionnaire regarding the highest education obtained, age, gender, and race/ethnicity. The participants' zip code was obtained from the EHR and those with a New York City zip code were kept. We then used data from the American Community Survey data from the year the participant completed the survey to predict the highest level of education given participants' zip code, gender, and race/ethnicity. ESKD participants were identified by ICD9/10 codes or by enrollment in a HD unit. Non-ESKD participants were age, gender, and race/ethnicity matched to the ESKD participants.

**Results:** 732 participants with ESKD and 732 matched non-ESKD participants were identified. Patient demographics are presented in Figure 1A. Average age was 58±13 years in both ESKD and non-ESKD cohorts, and the number of unique zip codes was 130 and 137 respectively. Correct prediction of education was significantly different between participants with and without ESKD, correctly identified in 32% of participants with ESKD and 27% of non-ESKD participants (Figure 1B & C), P=0.02. Lower prediction means that the predicted education level is lower than the participant's actual education level. Higher prediction means predicted education was higher than the real degree. Results were similar across genders. Blacks and Hispanics had the highest concordance in ESKD participants and non-ESKD participants. Concordance between survey results and zip code predicted results was poor for both ESKD and non-ESKD participants, K0.05 and K 0.02 respectively.

**Conclusions:** In an urban city, zip code predicted educational attainment using census data is inaccurate in two thirds of participants with and without ESKD. Smaller geographic areas may result in improved concordance.

**Funding:** NIDDK Support

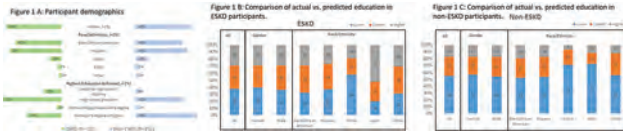

TH-PO708

**Association Between Renal Disease Management and Hospital Care Utilization**

Rahul Dhawan, Ashley Crossman, Gregory Wysocky, Karen Moran, Grace Keers, Kevin Plosser, Jiang Tao, Elizabeth Benusa. *Optum KRS nurses and product team and the OHS Medical Office Team Optum Inc, Eden Prairie, MN.*

**Background:** Evidence about impacts of disease management programs among patients with advanced stages of chronic kidney disease (CKD) is still limited. The study objectives were to evaluate the association between a renal disease management program which focuses on permanent access placement, home based dialysis initiation and patient education and hospital care utilization among patients with advanced CKD.

**Methods:** A case-control study was performed. The treatment group contained CKD 4-5 and ESRD health plan members in Utah with access to the renal care management program (N =25,332 member months). The control group contain CKD 4-5 and ESRD health plan members in Nevada without access to the renal care management program (N = 36,225 member months). Data sources included medical claims and lab result data. Inverse propensity score weighting (IPSW), based on confounding factors such as age, gender, prevalent comorbidities and CKD stages, was employed to reduce selection bias. Changes in hospital admissions and length of hospital stay (LOS) were compared to evaluate the impacts of the program.

**Results:** Generalized linear models with IPSW showed hospital admissions among the treatment group with ESRD declined by 32 per 1,000 patients per month from 2017-2018 while hospital admissions in the control group with ESRD increased by 36 per 1,000 patients per month during the same period (P<0.01). Changes in LOS between the treatment and control groups with ESRD showed the same pattern but were not statistically significant (P=0.09). Among members with CKD 4/5, hospital admissions among the treatment group increased by 4 admissions per 1,000 patients per month while hospital admissions in the control group increased by 6 admissions per 1,000 patients per month during the same period, but this difference was not significant (P=0.71). Changes in LOS between the treatment and control groups with CKD showed the same pattern but were also not statistically significant (P=0.93).

**Conclusions:** A disease specific renal care management program significantly reduces hospital admissions within 1 year after the program implementation among patients with ESRD. Impacts of renal care management in a longer period need to be further studied.

TH-PO709

**Race and the Risk of Heart Failure in CKD**

Sydney E. Hartsell,<sup>1,2</sup> Xiangyang Ye,<sup>1,2</sup> Robert E. Boucher,<sup>1,2</sup> Amara Sarwal,<sup>1,2</sup> Guo Wei,<sup>1,2</sup> Srinivasan Beddhu,<sup>1,2</sup> *The University of Utah School of Medicine, Salt Lake City, UT; <sup>2</sup>VA Salt Lake City Health Care System, Salt Lake City, UT.*

**Background:** Minority populations are disproportionately affected by poor outcomes in CKD. It is unknown whether there are racial disparities in HF incidence in CKD.

**Methods:** We created a national VA cohort (N = 801,572) extracted using the VA Informatics and Computing Infrastructure (VINCI) platform. We included patients with CKD stage 3A, 3B or 4 by outpatient CKD-EPI 2021 eGFR values collected 2010-2015, and excluded those with baseline HF by ICD9/10 codes. Incident HF through August 2018 were defined by ICD codes. We related race to incident HF with multivariable cox regression models, adjusting for demographics, comorbidities, and baseline BP.

**Results:** 74.8% were white, 18.4% black and 6.8% other races. Median age was 74.2 yrs, 96.4% male, and skewed to early-stage CKD (70.7%, 23.9%, 5.4% with stages 3A, 3B, 4). HTN was slightly more common in black patients (93.1% vs 92.3% in other races vs 91.3% in whites). There were 125,965 HF events over 3.5 million patient-years of follow up. In the entire cohort, compared to whites, blacks (HR 1.02, 95% CI 1.01-1.04) and other races (HR 1.01, 95% CI 0.99-1.04) did not have appreciably higher risk of HF. However, within CKD stages, compared to whites, black veterans with CKD stage 3B and 4 had a higher hazard of HF (Figure).

**Conclusions:** Black patients with more advanced CKD have a higher risk of incident HF than white patients. Interventions to reduce HF risk in black patients with advanced CKD are needed.

**Funding:** NIDDK Support, Other NIH Support - NHLBI, NIA, Veterans Affairs Support

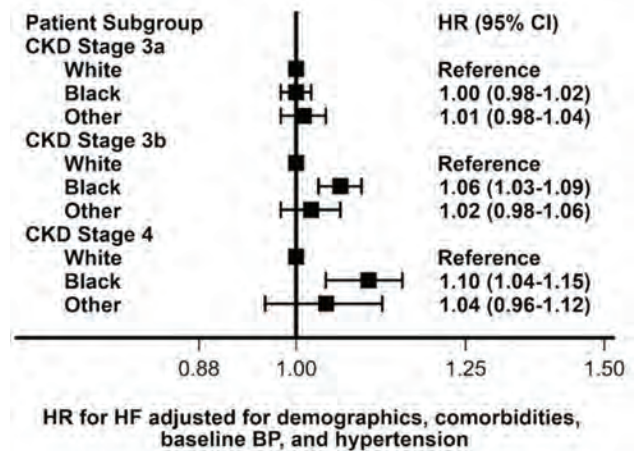

HF by race and CKD stage

TH-PO710

**Incidence of Heart Failure in CKD Patients Is Not Affected by Rurality**

Stephen R. Sammons, Xiangyang Ye, Guo Wei, Sydney E. Hartsell, Robert E. Boucher, Srinivasan Beddhu. *University of Utah Health, Salt Lake City, UT.*

**Background:** While there is a well-known interplay between Chronic Kidney Disease (CKD) and Heart Failure (HF), little is known about how social determinants of health such as rurality affect this relationship.

**Methods:** We analyzed a national cohort (n = 740,233) of veterans with CKD and without HF at baseline. Veterans with eGFR < 60 on two consecutive outpatient serum creatinine measurements that were at least 60 days apart from 1/1/2010 to 12/31/2015 were included. The index date was defined as the date of the second eGFR <60. Metropolitan, micropolitan, or small town/rural residences were defined by Rural-Urban Commuting Area (RUCA) codes. HF incidence was defined as the number of new HF diagnoses from index date until 6/30/2018. Cox regression models adjusted for age, gender, and comorbidities were used to relate rurality and CKD categories to the risk of HF.

**Results:** The distribution of metropolitan, micropolitan, or small town/rural residences were 74.8%, 13.2% and 12.0%, respectively; for CKD 3A, 3B and 4 70.9%, 23.8% and 5.3%, respectively. There were 116,298 HF events over 3.3 million person-years of follow-up. Compared to metropolitan residence, small/town rural residence was associated with statistically significant but clinically negligible higher risk of HF in the entire cohort (Table 1). There was no evidence that these associations were modified by the stage of CKD (Table 1).

**Conclusions:** Rurality does not appear to have a clear impact on incidence of heart failure in veterans with CKD. Further studies are needed to examine whether death as a competing risk might explain this finding as rural veterans with advanced CKD and HF might be at higher risk of death.

**Funding:** NIDDK Support, Other NIH Support - NIA R01 AG074592, Veterans Affairs Support

Table 1

RUCA Category	CKD3a	CKD3b	CKD4	Entire cohort
Metropolitan	1.00	1.00	1.00	1.00
Metropolitan	0.99 (0.97-1.02)	0.99 (0.96-1.02)	0.97 (0.91-1.04)	0.99 (0.97-1.01)
Small Town/Rural	1.02 (1.00-1.04)	1.04 (1.00-1.07)*	0.97 (0.91-1.04)	1.02 (1.00-1.04)

Hazard ratios with confidence intervals for incidence of HF in CKD patients stratified by RUCA category, with metropolitan category as a reference. Asterisk indicates hazard ratio is significant at  $p < 0.05$ .

TH-PO711

Racial Disparity in Anemia of CKD in the Adult US Population: Results From NHANES 1999-2018

Ajay K. Singh,<sup>1</sup> Youssef M. Farag,<sup>2</sup> <sup>1</sup>Harvard Medical School, Boston, MA; <sup>2</sup>Johns Hopkins Bloomberg School of Public Health, Baltimore, MD.

**Background:** Racial disparities have been reported in the U.S for many aspects of clinical care, including in CKD. Evaluation of anemia in CKD patients in a representative population in the United States has not been examined.

**Methods:** We analyzed data from NHANES 1999 to 2018 which included 101,316 participants. eGFR was calculated using the race-free CKD-EPI 2021 equation. CKD was defined and staged based on KDIGO guidelines. Anemia was defined using WHO criteria. Appropriate sample weights were used to account for the complex survey design. To test the association between race and anemia, we used multiple logistic regression adjusting for demographics and clinical variables.

**Results:** The weighted period prevalence of CKD in adult US population was 14.1%, of whom 14.6% were anemic, 1.35% and 0.55% had hemoglobin <10g/dL and 9g/dL, respectively, and increased over the 20-year period. Non-Hispanic Blacks had consistently higher prevalence of anemia of CKD compared to other races, and such prevalence increased over time. Fig 1 shows prevalence of anemia by race and CKD stage. Marked disparity was observed among non-Hispanic Blacks, with significantly higher prevalence of anemia compared to non-Hispanic Whites at each stage of CKD ( $p < 0.001$ ). Non-Hispanic Blacks had 3.6-fold higher odds of being anemic compared to non-Hispanic Whites (adjusted OR 3.6, 95% CI, 3.0, 4.3,  $p < 0.001$ ).

**Conclusions:** A racial disparity exists with CKD anemia in non-Hispanic Blacks in the US population. While NHANES data may have some limitations, these findings raise public health concerns that suggest gaps in CKD care disadvantaging Black's with CKD in the US.

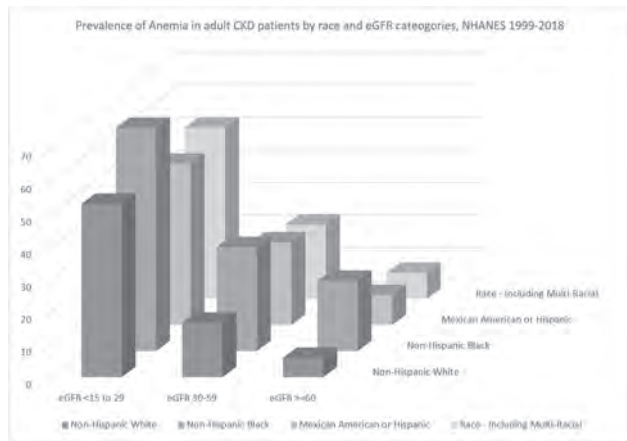

TH-PO712

Analysis of Racial and Socioeconomic Disparities in African American Patients Older Than 40 Years With CKD in the United States

Raghav K. Ranga, Georgetown University Medical Center, Washington, DC.

**Background:** Chronic kidney disease and end-stage renal disease are rapidly growing conditions across the world. Due to the ever-increasing burden of the predominant causes of these conditions, hypertension and type 2 diabetes mellitus, it is critical that everyone who develops chronic kidney disease has equal access to care. African Americans in the United States often face an uphill battle due to age-old unwritten policies of systemic discrimination, racism, and barriers that prevent their access to healthcare.

**Methods:** Articles that were written after 2000 were analyzed looking for quantifiable differences in outcomes of African Americans vs. non-Hispanic white people in chronic kidney disease, as well as confounders within the data that could explain the strong correlation between being African American and having a higher probability of death from chronic kidney disease. Articles were obtained from databases such as PubMed, Google Scholar, SciHub, ClinicalKey, eJournals, and MEDLINE. Once this was done, two potential interventions were suggested that could help to address these disparities. The PRISMA Database was used to evaluate study quality.

**Results:** The articles showed that there was a hazard ratio between 1.30 and 3.00 for African Americans getting all manifestations of kidney disease compared to non-Hispanic White Americans and it showed that one of the main confounding variables

affecting racial disparities in kidney care was socioeconomic status. The mean African American household in the United States made more than \$30,000 less than non-Hispanic Americans in the year 2019, and this could lead to other barriers.

**Conclusions:** Race and socioeconomic status both affect kidney disease by a factor of approximately 1.50 times for African Americans as compared to non-Hispanic people. The interventions that were chosen that could impact outcomes increased screenings for variations of polymorphisms of apolipoprotein L1 and sensitivity training for primary care physicians making them aware of the barriers that their African American patients may face in order to provide the most culturally competent care.

TH-PO713

The Association Between Household Income, Food Security, and Prevalence of CKD in Older Patients

Jinsuk Bae,<sup>1,2</sup> Hyuk Huh,<sup>3,5</sup> Jehun Song,<sup>1,2</sup> Jong Soo Lee,<sup>1,2</sup> Ho seok Koo,<sup>4,5</sup> Kyung Don Yoo,<sup>1,2</sup> <sup>1</sup>University of Ulsan College of Medicine, Songpa-gu, Seoul, Republic of Korea; <sup>2</sup>Ulsan University Hospital, Ulsan, Dong-gu, Republic of Korea; <sup>3</sup>Inje University Busan Paik Hospital, Busan, Republic of Korea; <sup>4</sup>Inje University Seoul Paik Hospital, Jung-gu, Seoul, Republic of Korea; <sup>5</sup>Inje University College of Medicine, Busan, Republic of Korea.

**Background:** This study aimed to clarify the association between food security and the prevalence of chronic kidney disease in Korean older patients.

**Methods:** We analyzed the variables of The Korea National Health and Nutrition Examination Survey V (2010–2012), and VI (2013–2015) while merging data from the food security questionnaire for four years. We included 15,945 participants, performed propensity score-matched analysis by quartile of household income (i.e., low, low-mid, high-mid, high) and sex, and presented the results by age group (Figure 1).

**Results:** Systolic blood pressure and proportion of current smokers were significantly higher in the elderly group, compared with the middle-aged group. The prevalence of hypertension, diabetes mellitus (DM), metabolic syndrome, and chronic kidney disease (CKD) did not differ significantly by income level in the elderly group. The food security questionnaire revealed that food security insurance was significantly lower in the low-income level (1<sup>st</sup> quartile), compared with that in the high-income level (4<sup>th</sup> quartile). The logistic regression analysis for the association between the prevalence of chronic disease and food insecurity confirmed no significant association between hypertension and DM.

**Conclusions:** There might be a correlation between self-reported food insecurity and the incidence of chronic kidney disease (CKD), particularly in the elderly populations older than 65 years.

Figure 1.

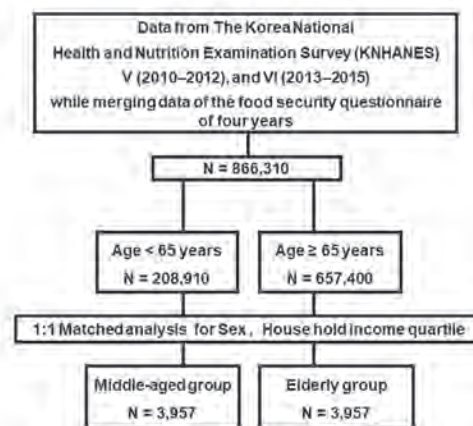

TH-PO714

Social Determinants and Health Care Utilization Among a CKD Population in North Philadelphia: An Exploratory, Mixed Methods Approach

Nicole M. Sifontis,<sup>1</sup> Jean Lee,<sup>2</sup> Avrum Gillespie,<sup>2</sup> Colleen Rabbitt,<sup>2</sup> Serban Constantinescu,<sup>2</sup> <sup>1</sup>Temple University School of Pharmacy, Philadelphia, PA; <sup>2</sup>Lewis Katz School of Medicine at Temple University, Philadelphia, PA.

**Background:** Patients with CKD exhibit multiple comorbidities, resulting in increased health care utilization and costs. Health disparities are common across the kidney disease spectrum resulting in poorer management of chronic illnesses. The starkest contrast in these disparities are seen based on social determinants like race and socioeconomic status. This project aims to better understand health disparities that drive health care utilization in patients with CKD who receive care at our institution.

**Methods:** This sequential mixed methods study identified the social determinants of health (SDoH) needs of patients with CKD at our institution. It explored available resources to address these determinants and barriers that limit access to services. Quantitative data were collected utilizing the Center for Medicare & Medicaid Services (CMS) Health-Related Social Needs (HRSN) screening tool to interview patients.

Qualitative data were collected via a focus group session with community health workers (CHWs) employed by the institution, to identify facilitators and barriers to the social needs established by the quantitative analysis.

**Results:** 34 patients with CKD were interviewed. Food insecurity (29.4%), reliable transportation (26.5%) and utility needs (23.5%) were the most common social determinants noted. Bivariate analyses revealed a statistically significant relationship between living situation and food insecurity;  $p=0.0031$ , living situation and utility needs;  $p=0.0094$ , and transportation and food insecurity,  $p=0.0227$ . CHWs expressed the importance of building trust with their patients, engaging community-based partners to assist with social needs, and robust patient engagement as important facilitators of SDoH. Reported barriers to connecting patients to supportive services included: inability to contact patients readily, provider burn out, time constraints, and the challenges of addressing overlapping social needs simultaneously.

**Conclusions:** These data highlight the need for better screening tools and more efficient care models that would allow the time and resources necessary to complete these tasks. These pilot data will help inform a systems-based approach to improving health equity among the CKD population who receive care at our center.

**TH-PO715**

**Individual and Community-Level Risk Factors for Food Insecurity Among Patients on Hemodialysis**

**Kathryn Taylor,<sup>1</sup> Sydney Santos,<sup>3</sup> Nancy A. Perrin,<sup>1</sup> Deidra C. Crews.<sup>2,1</sup> Johns Hopkins School of Nursing, Baltimore, MD; <sup>2</sup>Johns Hopkins Medicine, Baltimore, MD; <sup>3</sup>Johns Hopkins University, Baltimore, MD.**

**Background:** Patients experiencing food insecurity are at increased risk to progress from chronic kidney disease to end-stage kidney disease (ESKD). However, sociodemographic risk factors and rates of food insecurity among patients on hemodialysis are largely unknown.

**Methods:** We analyzed food security data from an ongoing prospective cohort study of patients on hemodialysis at Maryland facilities of a large dialysis organization. We enrolled participants from February through November 2021. At baseline they completed a demographic survey and the US Adult Food Security Survey Module. We cross referenced participant zip codes with area-level indicators of socioeconomic status from the 2020 American Community Survey and Rand State Statistics. We conducted logistic regression to test associations between individual-level demographic variables and low or very low food security. For area-level predictors we used a mixed effects model to account for clustering by zip code.

**Results:** Food security was assessed for 293 participants. 12.6% of the sample had low food security and 9.9% had very low food security (e.g. went hungry because there was not enough money for food). A one-year decrease in age increased odds of low or very low food security by 3%. Table 1 displays rates of low or very low food security among participants by other individual- and community-level demographics. Rates of low or very low food security were over 2 times higher in the sample compared to the broader Maryland population according to 2020 census data.

**Conclusions:** Younger age and community-level poverty were associated with low or very low food security among patients on hemodialysis. Additional research is needed to estimate food security and its implications for patient outcomes among patients on hemodialysis.

**Funding:** Other NIH Support - National Institute of Nursing Research; National Heart, Lung, and Blood Institute

**Table 1. Individual- and Community-level Demographic Risk Factors for Low or Very Low Food Security**

	High or Marginal	Low or Very Low	OR, 95% CI
<b>Gender</b>			
Male	127 (76.5%)	39 (23.5%)	(ref)
Female	97 (78.86%)	26 (21.14%)	0.87 (0.49 – 1.53)
<b>Race</b>			
Black	159 (77.56%)	46 (22.4%)	(ref)
White	41 (75.93%)	13 (24.07%)	1.1 (0.54 – 2.22)
Asian	12 (75%)	4 (25%)	1.15 (0.35 – 3.74)
Other	6 (100%)	0 (0%)	n/a
<b>Ethnicity</b>			
Non-Hispanic	211 (77.86%)	60 (22.14%)	(ref)
Hispanic	9 (60%)	5 (40%)	2.34 (0.8 – 6.85)
<b>Education</b>			
High school	99 (76.76%)	30 (23.26%)	(ref)
Post-high school	92 (84.4%)	17 (15.6%)	0.61 (0.32 – 1.18)
Less than high school	36 (65.45%)	19 (34.55%)	1.74 (0.87 – 3.47)
<b>Marital Status</b>			
Married or cohabitating	84 (82.35%)	18 (17.65%)	(ref)
Separated, divorced, or widowed	72 (75%)	24 (25%)	1.56 (0.78 – 3.09)
Never married	64 (75.29%)	21 (24.71%)	1.53 (0.75 – 3.11)
<b>Community-level Racial Composition</b>			
0 – 25% Black	73 (74.49%)	25 (25.51%)	(ref)
26 – 69% Black	72 (80%)	18 (20%)	0.74 (0.36 – 1.51)
72 – 91% Black	74 (80.43%)	18 (19.57%)	0.7 (0.34 – 1.45)
<b>Community-level Poverty Rate</b>			
0 – 7.4%	82 (86.32%)	13 (13.68%)	(ref)
7.8 – 15.6%	78 (78%)	22 (22%)	1.78 (0.83 – 3.78)
17 – 36.3%	59 (69.41%)	26 (20.59%)	2.78 (1.32 – 5.86)
<b>Community-level Income Inequality</b>			
Relative income equality	90 (84.91%)	16 (15.09%)	(ref)
High income disparity	61 (73.49%)	22 (26.51%)	2.02 (0.99 – 4.17)
Severe income disparity	69 (75%)	23 (25%)	1.88 (0.92 – 3.82)

**TH-PO716**

**Comparing Methods of Food Insecurity Screening in a Pediatric ESKD Population**

**Victoria H. Besser,<sup>1</sup> Donna J. Claes.<sup>1,2</sup> Cincinnati Children's Hospital Medical Center, Cincinnati, OH; <sup>2</sup>University of Cincinnati, Cincinnati, OH.**

**Background:** Food insecurity (FI) has been reported to affect 65% of pediatric dialysis patients. Our center noted FI prevalence of 6% during initial screening in our kidney transplant (KTx) population. We aimed to identify characteristics of FI & compare different screening methods (verbal vs paper questionnaire) within our single-center, pediatric ESKD (HD, PD & KTx) population.

**Methods:** We assessed ESKD pts for FI using the Hunger Vital Sign® by a verbal screen and later by paper questionnaire. Patients were considered FI if they answered positive on either screen. Relevant patient data [i.e. gender assigned at birth, age, race, etiology of kidney disease, BMI, weight status, eGFR, KRT modality & presence of hypertension] were obtained at the time of initial screening.

**Results:** 139 pts (19 HD, 11 PD, 109 KTx; 52.5% male; mean age 11.6 yr) completed 225 screens (113 verbal screen, 112 paper questionnaire) with a mean of 5.4 months between screens. 16 pts (11.5%; 5 HD, 1 PD, 10 KTx) were found to be FI. There was a trend of a higher rate of FI in pts of black race (44% vs 20%;  $p=0.076$ ) & HD pts (31% vs 11.4%;  $p=0.094$ ) when compared to food secure (FS) pts. There was no difference in other relevant variables between FI & FS pts (table 1). 86 pts completed both the verbal screen & paper questionnaire. Concordance of verbal & written screening was 92% ( $n=79$ ). 5 pts (6%) were found to be FI on written screen but FS on verbal screen; 2 pts (2%) were FI on verbal screen but FS on written screen.

**Conclusions:** We report FI prevalence of 11.5% in our pediatric ESKD population. We were able to demonstrate concordance of FI screening by comparing verbal & written screening methods. Further multicenter studies are needed to understand the prevalence, associated relevant outcomes, & potential risk factors of FI in the pediatric ESKD population.

**Table 1 - Baseline Characteristics**

	Food Insecure (n = 16)	Food Secure (n = 123)	
Male, n (%)	9 (56.3 %)	64 (52.0%)	p = 0.96
Age Group, mean (SD)	12.2 (7.3)	11.9 ( 5.8)	p = 0.86
< 5yo, n (%)	4 (25%)	21 (17.1%)	
5-17yo, n (%)	7 (43.8%)	80 (65.0%)	p 0.24
> 18yo, n (%)	5 (31.3%)	22 (17.9%)	
<b>Race</b>			
White, n (%)	6 (37.5%)	82 (66.7%)	
Black, n (%)	7 (43.8)	25 (20.3%)	p = 0.076
Asian, n (%)	0	4 (3.3%)	
Other, n (%)	3 (18.8%)	12 (9.8%)	
<b>Etiology of Kidney Disease</b>			
Glomerular, n (%)	5 (31.3%)	32 (26.0%)	
Non-Glomerular, n (%)	7 (43.8%)	68 (55.3%)	p = 0.84
Secondary, n (%)	1 (6.3%)	5 (4.1%)	
Other, n (%)	3 (18.8%)	18 (14.6%)	
BMI, mean (SD)	21.8 (7.8)	21.3 ( 6.2)	p = 0.818
Overweight/obese*, n (%)	5 (31.3%)	48 (39.0%)	p = 0.74
eGFR#, mean (SD)	65 (20.4) [n = 10]	66.5 (18.0) [n = 99]	p = 0.827
<b>KRT Modality</b>			
HD, n (%)	5 (31.3%)	14 (11.4%)	
PD, n (%)	1 (6.3%)	10 (8.1%)	p = 0.094
Transplant, n (%)	10 (62.5%)	99 (80.4%)	
Hypertension^, n (%)	8 (50%)	69 (56.1%)	p = 0.84
Interval time b/w screens in months, mean (SD)	5.5 (1.4) (n = 10)	5.4 (1.5) (n = 99)	p = 0.73

\* BMI 85-95%ile (overweight) or >95%ile (obese) in patients 2-18yo; BMI 25-29.9 (overweight) or > 30 (obese) in patients > 18yo  
 # calculated using Creatinine-Cystatin C-based CKiD equation (2012)  
 ^ on antihypertensive medication(s) and/or hypertension on most recent ABPM

TH-PO717

Abstract Withdrawn

TH-PO718

**Social Determinants of Health Predict Annual CKD Screening and Disease Development Among Newly Diagnosed Hypertensive and Type 2 Diabetic Patients in a Large Midwestern Health System**

Marybeth Ingle,<sup>1</sup> Sarang Baman,<sup>1</sup> Yuxian Du,<sup>2</sup> Vesta Valuckaite,<sup>2</sup> Rakesh Singh,<sup>2</sup> Sheldon X. Kong,<sup>2</sup> Todd E. Williamson,<sup>2</sup> Rasha Khatib.<sup>1</sup>  
<sup>1</sup>Advocate Health Care Inc, Downers Grove, IL; <sup>2</sup>Bayer AG, Leverkusen, Germany.

**Background:** Clinical guidelines suggest regular chronic kidney disease (CKD) screening after diagnosis of hypertension (HTN) or type 2 diabetes (T2DM), as both are risk factors. Monitoring of kidney function allows for early detection of CKD & can improve quality of life. However, social determinants of health (SDOH) can impact access to routine care, including CKD screening. We explore how SDOH factors from electronic health records (EHR) predict CKD screening & CKD development among newly diagnosed HTN and/or T2DM patients.

**Methods:** EHR of patients (n=235,208) with a new HTN and/or T2DM diagnosis between 2015-2018 were abstracted. Patients were followed for 3 years to assess annual CKD screening (1 estimated glomerular filtration rate & 1 urinary albumin-to-creatinine ratio) and CKD development (CKD or end stage renal disease). Multivariable logistic regression models evaluated SDOH factors with CKD screening & CKD development.

**Results:** Most patients were White (57%) females (55%) with HTN (65%). Few had only T2DM (9%) & 26% had both. Screening was highest for patients who developed HTN & T2DM during the study (44%) compared to T2DM (38%) or HTN (4%). CKD developed for 9% of patients. Public health insurance patients were 66% more likely to not be screened for CKD compared to patients with private insurance (Odds Ratio (OR)=1.66, 95% Confidence interval (CI):1.60,1.73). Retired patients were less likely to not be screened (OR=0.77, 95%CI:0.72,0.82). Black (OR=0.54, 95%CI:0.52,0.56), Hispanic (OR=0.55, 95%CI:0.53,0.58), & Asians (OR=0.64, 95%CI:0.60,0.68) were less likely to not be screened compared to Whites. Figure 1 depicts SDOH factors & CKD development. Blacks were over twice as likely to develop CKD (OR=2.11, 95%CI:1.95,2.29).

**Conclusions:** The increase in CKD incidence among Black and retired patients could be due to frequent screenings. However, employment and single status were not a predictor of screening, yet a predictor of CKD. It's possible lifestyle factors unique to this population contribute to CKD development.

**Funding:** Commercial Support - Bayer



TH-PO719

**Association Between Social Support and Hospitalization Risk Among Adults With CKD**

Flor Alvarado,<sup>1</sup> Siyi Geng,<sup>2</sup> Jing Chen,<sup>1,2</sup> Hua He,<sup>2</sup> Eleanor Rivera,<sup>3</sup> Milda R. Saunders,<sup>4</sup> Vallabh O. Shah,<sup>5</sup> Robert G. Nelson,<sup>6</sup> Bernard G. Jaar,<sup>7</sup> Mark L. Unruh,<sup>5</sup> Ana C. Ricardo,<sup>3</sup> Deidra C. Crews,<sup>7</sup> Amanda H. Anderson,<sup>2</sup> Jiang He.<sup>1,2</sup>  
<sup>1</sup>Tulane University School of Medicine, New Orleans, LA; <sup>2</sup>Tulane University School of Public Health and Tropical Medicine, New Orleans, LA; <sup>3</sup>University of Illinois Chicago UI Health, Chicago, IL; <sup>4</sup>The University of Chicago Medicine, Chicago, IL; <sup>5</sup>University of New Mexico School of Medicine, Albuquerque, NM; <sup>6</sup>National Institute of Diabetes and Digestive and Kidney Diseases, Phoenix, AZ; <sup>7</sup>Johns Hopkins Medicine, Baltimore, MD.

**Background:** Adults with chronic kidney disease (CKD) have a higher risk of hospitalization than the general population. We evaluated the association of social support, a potentially modifiable factor, with hospitalization risk among adults with CKD.

**Methods:** This was a prospective cohort study of adults with mild to moderate CKD enrolled in the Chronic Renal Insufficiency Cohort (CRIC) Study. Social support was assessed using the six-item Lubben Social Network Scale (LSNS-6). The summary score ranged from 0-30. A score  $\leq 12$  was considered "at-risk" for social isolation, reflecting low social support. The LSNS-6 was administered between 2013 to 2018, which was considered the baseline for the present study; and follow-up occurred until death, study withdrawal, or May 2020. Hospitalizations were ascertained based on participant self-report and review of medical records and were recorded as the number of hospitalizations. Number of hospitalizations per 1000 person-years was calculated. Counts of hospitalization by isolation risk status were assessed using a Poisson regression model controlled for the duration of follow-up.

**Results:** Among a subset of 1155 CRIC participants with baseline LSNS-6 assessments available, mean age was 69, 39% were female, 16% were Hispanic, 41% non-Hispanic Black, 41% non-Hispanic White, mean eGFR was 55 mL/min/1.73m<sup>2</sup>, and 30% were considered at-risk for social isolation. There were 4015 hospitalizations, and the maximum follow-up period was 6.7 years. In unadjusted analyses, an increased risk of all-cause hospitalization was found among those at-risk for social isolation in the whole cohort and in all racial/ethnic subsets (Table). After multivariable adjustment for other sociodemographic variables, the risk remained for Hispanic participants (Incidence Rate Ratio 2.09; 95% CI 1.62-2.68).

**Conclusions:** Low social support was associated with increased all-cause hospitalization risk among Hispanic individuals with CKD.

**Funding:** NIDDK Support

Incidence Rate Ratios for All-Cause Hospitalizations by the Status of Social Isolation using Poisson Regression					
Social Isolation	Total Hospitalizations (N)	Total follow-up time (years)	Hospitalizations per 1000 person-years	Model	
				Model 1 (95% CI)	Model 2 (95% CI)
<b>Total</b>				N=1128*	N=1127
Not at-risk for social isolation	2646	2681.3	719	1.00 (reference)	1.00 (reference)
At-risk for social isolation	1369	1429.6	958	1.33 (1.25, 1.42)	1.18 (1.10, 1.26)
<b>Non-Hispanic White</b>				N=474	N=474
Not at-risk for social isolation	1125	1772.7	635	1.00 (reference)	1.00 (reference)
At-risk for social isolation	494	569.7	867	1.37 (1.23, 1.52)	1.18 (1.05, 1.32)
<b>Non-Hispanic Black</b>				N=473	N=472
Not at-risk for social isolation	1406	1666.8	844	1.00 (reference)	1.00 (reference)
At-risk for social isolation	648	660.1	982	1.16 (1.06, 1.28)	1.02 (0.93, 1.13)
<b>Hispanic</b>				N=181	N=181
Not at-risk for social isolation	115	241.8	476	1.00 (reference)	1.00 (reference)
At-risk for social isolation	227	199.8	1136	2.39 (1.91, 2.99)	2.09 (1.62, 2.68)

\* Excluded 27 participants that completed "Other" under race/ethnicity. IRR: Incidence Rate Ratio; CI: Confidence Interval  
 Other could include American Indian/Alaska Native, Asian, Native Hawaiian or Other Pacific Islander, More than One Race, and Unknown/Not Reported  
 Model 1: Univariate model (unadjusted)  
 Model 2: Adjusted for age, sex, clinical center, education, income and race and ethnicity (if total), otherwise stratified by race and ethnicity

TH-PO720

**Electronic Health Literacy: A Key Determinant in Televisit Acceptance in Inner-City Patients With CKD**

Nicholas Baglieri,<sup>1</sup> Rohan Goyal,<sup>1</sup> Mariana S. Markell,<sup>1</sup> Montefiore Medical Center, Bronx, NY; <sup>2</sup>SUNY Downstate Health Sciences University, Brooklyn, NY.

**Background:** Televisits have become a more widely used since the COVID pandemic in 2020. However, pts in underserved populations may not be as knowledgeable about electronic health resources and may not be able to access this type of health care visit, worsening health care disparities. We examined the relationship between electronic health literacy and acceptance of televisits in an underserved inner-city population of pts with CKD.

**Methods:** 38 randomly selected CKD pts were surveyed in a face to face fashion including a demographics section, the eHEALS electronic health literacy assessment (scored from 8 to 40), and additional sections on televisit history. eHEALS is a validated 8 question survey that characterizes the subjective ability to find and use electronic health resources.

**Results:** Mean age of the pts. was 67±15 yrs. 66% were female, 74% did not attend any college, 60% make less than \$25,000 per year. 21% did not have any Internet access, 5.3% did not own a cell phone, and 5.3% of cell phone owners did not own a smart phone. 61% need help using the internet. The mean eHEALS of those who need help using the internet is 21.1±6.0 vs 27.5±8.6 (p<0.05) for those who do not need help. 76% of pts. had a televisit before the survey, of which 76% were telephone only and 24% had visits by both telephone and video. No participant had only used video.

Those who had televisits did not differ based on age, education, gender and income from those who did not. Of the 24% of participants who did not have televisits, 100% need help using the internet vs 48% who had televisits (p=0.006). Mean eHEALS score of those who had a televisit was 25.1±7.9 vs 18.9±4.9 for those who did not (p=0.01).

**Conclusions:** In our population of older inner-city CKD patients, 1. Almost one quarter had no home internet access, and over half needed help using it 2. Pts who needed help had lower eHealth literacy and were less likely to have televisits. 3. Televisit use related to eHealth literacy rather than age, education or income. 4. Administering eHEALS may identify people who would benefit most from in person visits, directed educational materials to help with televisits or for whom support should be provided 5. The rise in use of telehealth may further health resource inequities if eHealth literacy is not recognized as a potential negative social determinant in vulnerable populations.

**TH-PO721**

**Frequency of Text Messaging as a Screening Tool for Assessing Electronic Health (eHealth) Literacy in Patients With CKD/ESKD and Low Health App Usage**

Rohan Goyal,<sup>1</sup> Nicholas Baglieri,<sup>1</sup> Mariana S. Markell,<sup>2</sup> *Monte iore Medical Center, Bronx, NY; <sup>2</sup>SUNY Downstate Health Sciences University, Brooklyn, NY.*

**Background:** There are many mobile health apps available for pts with kidney disease but pts may be unable to use them due to low eHealth literacy. We assessed eHealth literacy and potential barriers to app use in an underserved inner-City population of CKD and HD pts.

**Methods:** 38 CKD pts and 31 HD pts were questioned face to face using the eHEALS electronic health literacy assessment (scored from 8 to 40), and questions regarding text messaging/app usage. eHEALS is an 8 question survey that characterizes subjective ability to find and use electronic health resources. Independent t-tests, Pearson correlation coefficient calculations, and generalized linear models were performed when appropriate.

**Results:** CKD pts were older (67.5±15.1 vs. 60.6 ±13.0m for HD, p=0.045). 61% of HD pts are male vs 34% of CKD pts (p=0.025). 51% of HD pts have attended some college or more vs 74% of CKD pts (p=0.034). Income was similar with 51% making < \$25,000 per year. Mean eHEALS score for CKD pts was 23.6 (SD = 7.7) vs 27.6 (SD = 8.2) for HD with no difference controlling for age and education. 97% of pts owned a cell phone, 91% owned a smartphone. 26% of pts reported never sending text messages, 22% reported sending a few times per week, 12% reported sending once or twice daily, and 41% reported sending more than twice daily. 45% of pts reported needing help downloading apps; 64% of pts did not report using any mobile health apps with no difference by clinic setting. Per a generalized linear model, frequency of text messaging was associated with eHEALS score with a p = 0.001 after controlling for age, education, and clinic setting.

**Conclusions:** In our population of inner city pts with kidney disease, 1. The vast majority of pts own a smart phone but do not use any mobile health apps. 2. Almost half of all pts need help downloading apps. 3. Almost half of patients surveyed do not send text messages or send them less than 1-2x per week. 4. Frequency of text messaging is significantly associated with eHealth literacy suggesting that this parameter can be used to quickly assess this potential social determinant in kidney pts. 5. Inability to utilize health apps may further accentuate health disparities and this simple question may help identify pts who need education or support in order to fully utilize available healthcare resources.

**TH-PO722**

**A Demographic and Community Characteristic Comparison of Advanced CKD Patients Seeing vs. Not Seeing a Nephrologist**

Susan M. Devaraj,<sup>1</sup> Jonathan Yabes,<sup>1</sup> Manqi Cai,<sup>1</sup> Linda-Marie U. Lavenburg,<sup>3</sup> Khaled Abdel-Kader,<sup>2</sup> Manisha Jhamb,<sup>1</sup> *<sup>1</sup>University of Pittsburgh Department of Medicine, Pittsburgh, PA; <sup>2</sup>Vanderbilt University Medical Center, Nashville, TN; <sup>3</sup>University of Pennsylvania Department of Medicine, Philadelphia, PA.*

**Background:** Despite the health benefits of receiving specialized care from a nephrologist, the majority of chronic kidney disease (CKD) patients are managed by primary care providers (PCPs). We explored potential individual and neighborhood level demographic differences among patients with high-risk CKD seeing versus not seeing a nephrologist.

**Methods:** Adult patients (age >18 years) in Western PA with advanced CKD (eGFR<30) who were managed by a PCP and not seeing a nephrologist were identified from an ongoing population health management study called Kidney CHAMP (enrolled years 2018-22). Their baseline characteristics were compared to a cohort of patients seeing a nephrologist at the kidney clinic at an academic center in Western PA between 2010-2012. Differences in individual patient (age, race, gender) and zip-code level characteristics [Social Deprivation Index (SDI) and Rural Urban Commuting Area] between those seeing vs not seeing a nephrologist were compared using chi-square

and t-tests. Multivariable logistic regression models including patient demographics and serum creatinine were used to determine the odds of having seen a nephrologist. Additional analyses are planned to explore other drivers of care.

**Results:** A total of 1,594 patients were not seeing a nephrologist, and 577 were seeing a nephrologist. Compared to patients seeing a nephrologist, patients not seeing a nephrologist were older (age 74 vs. 67 years, p<0.01), more likely to be women (58% vs. 49%, p<0.01), white (91% vs. 75%, p<0.01), were living in rural areas (11% vs. 2%, p<0.01), and had lower SDI scores meaning less social deprivation (score 40 vs. 43, p=0.01). Multivariable models showed a significantly lower odds of seeing a nephrologist with each year of age (OR: 0.97, p<0.01), white vs. black race (OR: 0.56, p<0.01), micropolitan vs metropolitan (OR: 0.37, p<0.01), and rural vs. metropolitan home address (OR: 0.13, p<0.01), and higher odds with each unit increase in creatinine (OR: 3.18, p<0.01).

**Conclusions:** Older age, white race, and living in a non-metropolitan area were independently associated with less engagement in nephrology care. Understanding factors associated with receiving specialty care may help to inform interventions to improve access for those most in need.

**Funding:** NIDDK Support

**TH-PO723**

**Addressing Disparities in Kidney Health Outcomes for First Nations Peoples of the United States, Canada, Australia, and New Zealand: A Systematic Review**

Michael D. Riceman,<sup>1,2</sup> Samantha Bateman,<sup>1,2</sup> David J. Tunnicliffe,<sup>3,4</sup> Rhane Lester,<sup>1</sup> Nari Sinclair,<sup>1</sup> Kelli Owen,<sup>1</sup> Martin Howell,<sup>3,4</sup> Odette R. Pearson,<sup>1,5</sup> Stephen P. McDonald,<sup>1,2</sup> Shilpa Jesudason.<sup>1,2</sup> *<sup>1</sup>The University of Adelaide, Adelaide, SA, Australia; <sup>2</sup>Central Adelaide Local Health Network, Adelaide, SA, Australia; <sup>3</sup>University of Sydney, Sydney, NSW, Australia; <sup>4</sup>Centre for Kidney Research, The Children's Hospital at Westmead, Sydney, NSW, Australia; <sup>5</sup>South Australian Health and Medical Research Institute Limited, Adelaide, SA, Australia.*

**Background:** First Nations Peoples of colonised counties are disproportionately burdened with kidney failure. Current systems of kidney care are failing to meet their needs, despite strong advocacy from community. We aimed to identify how disparities in health outcomes for First Nations Peoples of colonial countries living with kidney failure are addressed through different models of care.

**Methods:** We conducted a systematic review according to the PRISMA Checklist, governed by a First Nations reference group. Included studies involved First Nations Peoples of the USA, Canada, New Zealand and Australia and interventions to address the management or complications of kidney failure. The certainty of the evidence was assessed using GRADE.

**Results:** We identified 31 studies across 5 domains: dialysis care, dialysis access (vascular/peritoneal), transplantation, kidney failure complications, nutrition, and cultural safety. Few First Nations-specific randomised trials were identified. The largest body of evidence came from Australia and related to community-based dialysis care. From the Americas there is a moderate level of evidence for co-created, community-based living kidney donor transplant education and awareness campaigns.

**Conclusions:** Within the limited literature, there is evidence that purposeful, First Nations-led interventions can have positive impacts. However, considering the inequities faced by First Nations Peoples of colonial countries there is an unacceptable paucity of intervention studies evaluating First Nations specific models of kidney care.

**Funding:** Government Support - Non-U.S.

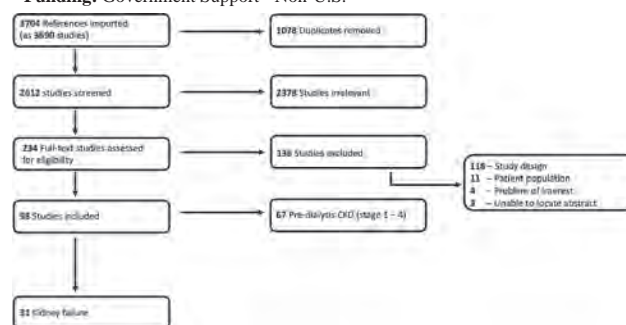

Figure 1: Adapted PRISMA diagram of study selection

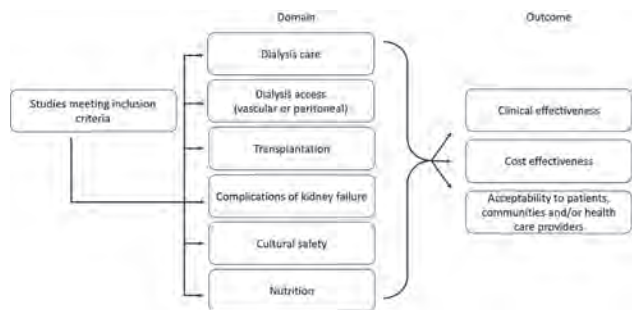

Figure 2: Data analysis schema

TH-PO724

Investigating Disparities in Telehealth Among CKD Patients in a US Integrated Healthcare System

Hui Zhou,<sup>1,2</sup> Matt M. Zhou,<sup>1</sup> Donald P. McCarthy,<sup>1</sup> Margo A. Sidell,<sup>1</sup> Benjamin Broder,<sup>1,3</sup> Emma L. Dolan,<sup>3</sup> Anthony Morena,<sup>3</sup> John J. Sim.<sup>2,3</sup> / *KPSC Research and Evaluation, Pasadena, CA; <sup>2</sup>Kaiser Permanente Bernard J Tyson School of Medicine, Pasadena, CA; <sup>3</sup>Southern California Permanente Medical Group, Pasadena, CA.*

**Background:** Telehealth utilization, including the use of telephone appointments (TAV) and video appointment visits (VAV), are a valuable alternative to in-person visits and were a crucial form of health delivery during the COVID-19 national emergency. Among chronic kidney disease (CKD) patients within an integrated healthcare system, we evaluated the rate of successfully completed telehealth visits and assess differences in adoption using an equity lens.

**Methods:** A retrospective cohort study was conducted among individuals (age ≥ 18 yrs) with CKD stage 3 and 4 receiving care at Kaiser Permanente Southern California (KPSC). We limited our sample to patients with at least one in-person visit within 12 months prior to Mar 1, 2020 and followed them for 1 year. A successfully completed telehealth visit was defined as a ≥ 20 min completed appointment via TAV/VAV. Poisson regression with robust variance error was conducted to estimate the rate ratio for a successful telehealth visit.

**Results:** Of 161,088 patients, 74% (N=118,456) had ≥ 1 successfully completed telehealth visit, 34% of which were VAVs. Younger age, female gender, white race, and English as spoken language were associated with the successful completion of a telehealth visit. Senior persons (85+) were less likely to have a successfully TAV/VAV compared to young adults (18-34 yrs) (RR:0.82; 95% CI:0.79-0.86) (Figure). Those having a KPSC online account were more likely to have successful TAV/VAV (RR:1.11; 95% CI:1.10-1.12). Medicaid patients had more successful telehealth visits while patients living in neighborhoods with less internet access were marginally less likely to have successful TAV/VAV (p=0.05).

**Conclusions:** We observed disparities in adoption of telehealth care among CKD patients within an integrated health system. Our findings suggest that further studies and management strategies are needed to facilitate and improve equitable patient-centered care.

**Funding:** Private Foundation Support

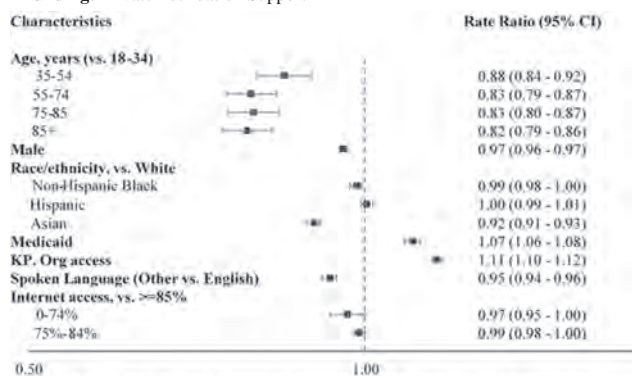

Figure. Rate Ratio of successful completion of telehealth among CKD patients

TH-PO725

Black, Non-Hispanic Individuals Are More Likely to Have Slower eGFR Decline Before Dialysis

Michael A. Kraus,<sup>1</sup> Yuedong Wang,<sup>2</sup> Catherine Y. Wang,<sup>5</sup> Len A. Usvyat,<sup>1</sup> Carly Hahn Contino,<sup>1</sup> Peter Kotanko,<sup>3,4</sup> Robert J. Kossmann,<sup>1</sup> Harvey W. Kaufman.<sup>6</sup> / *Fresenius Medical Care North America, Waltham, MA; <sup>2</sup>University of California System, Oakland, CA; <sup>3</sup>Renal Research Institute, New York, NY; <sup>4</sup>Icahn School of Medicine at Mount Sinai, New York, NY; <sup>5</sup>Carnegie Mellon University, Pittsburgh, PA; <sup>6</sup>Quest Diagnostics Inc, Secaucus, NJ.*

**Background:** Race/ethnic inequities exist in ESRD care with regard to preemptive transplantation, ESRD primary access, and home therapies. Further, Blacks are >3x as likely and Hispanics and 1.3x more likely to have kidney failure versus Whites. Understanding pre-dialysis GFR decline may provide insights into the race disparity and aid in developing population-based tools. We report pre-dialysis eGFR decline using CKD-EPI 2021 equation without a race coefficient.

**Methods:** Patients initiated on dialysis at Fresenius Medical Care with matched clinical testing from Quest Diagnostics, 1/1/2015 - 9/30/2020 were included and deidentified. Inclusion criteria: a) 2 yrs of lab data prior to dialysis; b) ≥10 serum creatinine (Scr) measurements; c) ≥1 Scr within 45 days of initiation; d) ≥2 Scr distributed over 2 quarters. Exclusion criteria were sudden eGFR increase > 20 mL/min/1.73 m<sup>2</sup> or mean eGFR >30 mL/min/1.73 m<sup>2</sup> within 45 days of dialysis. The revised CKD-EPI 2021 eGFR calculation was applied. A cubic spline was fitted to eGFRs from each patient followed by functional data clustering methods to categorize eGFR trajectories. Both K-mean and functional principal component analysis were used. One-way ANOVA and χ<sup>2</sup> tests were used to compare the trajectory groups for continuous and categorical variables.

**Results:** 2341 patients: 42% female, age 64.9 +/-12.3 years, 62.7% White non-Hispanic, 15.7% Black non-Hispanic, and 15.0% Hispanic. Patients grouped into 4 clusters of eGFR progression velocity: 1076 stable low cluster (slc); 920 slow decay cluster (sdc); 285 fast decay cluster(fdc), and 60 in the very fast decay cluster (vfdc). eGFR decreases were steepest for the vfdc, followed sequentially by fdc, sdc, slc. Mean time from eGFR of 20 to dialysis was 669.5 days (94.8) for slc, 271.2 days (155.5) for sdc, 121.4 days (93.1) for fdc, and 75.2 days (61.8) for vfdc. Faster decay groups were younger\*, male\*, and Hispanic\*. Black non-Hispanics were more likely to be in sdc than other clusters\*. Whites, non-Hispanics were equally distributed through all 4 clusters. (\* P<.001) (# P<.05)

**Conclusions:** AAs as a group, Black, non-Hispanics were 1.3x more likely to display a slower pre-dialysis eGFR decline. This suggests that there is more time to allow for improved CKD care and education and potentially better outcomes in this group.

**Funding:** Commercial Support - Fresenius Medical Care

TH-PO726

Economic and Humanistic Burden Among Individuals With CKD in the United States: A Systematic Literature Review

Katherine M. Osenenko,<sup>1</sup> Satabdi Chatterjee,<sup>2</sup> Saurabh Ray,<sup>2</sup> Tina Li,<sup>1</sup> Bonnie M. Donato.<sup>2</sup> / *Broadstreet HEOR, Vancouver, BC, Canada; <sup>2</sup>Boehringer Ingelheim Pharmaceuticals Inc, Ridgefield, CT.*

**Background:** Chronic kidney disease (CKD) is associated with substantial economic, humanistic, and clinical burden. While the clinical burden and direct medical costs are well characterized, less is known about the humanistic and economic burden, including lost productivity. The objective of this review was to synthesize contemporary estimates of economic and humanistic impact among individuals with CKD in the United States (US).

**Methods:** A systematic review was conducted using MEDLINE and Embase to identify studies reporting estimates of CKD economic or humanistic patient burden in the US, published between 2016-2021. Study selection and data extraction were performed in duplicate, in accordance with PRISMA guidelines. A grey literature search was conducted for the past 5 years. Characteristics of patients with CKD, and estimates of economic and humanistic burden, were summarized.

**Results:** From 4,880 abstracts, 38 eligible studies were included. Mean patient age ranged from 46.3-63.7 years; proportion of males ranged from 41.70-63.0%. Reported comorbidities included diabetes (23.0-55.8%), cardiovascular disease (20.5-63.0%), and hypertension (45.5-97.0%). Two studies reported out-of-pocket (OOP) expenditures for patients with CKD, estimated at \$1,599 (mean) and \$1,807 (median) annually (2022 USD), with more than 16% of patients reported to face high OOP burden. One study reported that 46.9% of non-elderly patients with CKD experienced financial hardship within the past year due to medical bills, with lack of health insurance being the strongest determinant; impacts included non-adherence and delayed/foregone medical care. Health-related quality of life (HRQoL) was assessed in 32 studies using a variety of instruments; high burden to patients with CKD was consistently demonstrated, with higher CKD stage associated with greater burden. Limited data were available on lost productivity.

**Conclusions:** The findings of this review demonstrate the high economic and humanistic burden to individuals with CKD, although HRQoL data were heterogeneous and economic data were limited. Further research is needed to better characterize the burden to individuals with CKD, in particular the economic impact and lost productivity, as well as drivers of burden.



TH-PO727

**Predictors of Evidence-Based Medication Use Among Black Patients With Hypertension and CKD**

Mona Abraham,<sup>1</sup> Kathryn A. Carson,<sup>2</sup> Mary Ann C. Stephens,<sup>1</sup> Edgar R. Miller,<sup>1</sup> Deidra C. Crews,<sup>1</sup> Five Plus Nuts and Beans for Kidneys Study Investigators <sup>1</sup>*Johns Hopkins University School of Medicine, Baltimore, MD;* <sup>2</sup>*Johns Hopkins University Bloomberg School of Public Health, Baltimore, MD.*

**Background:** Black individuals may experience therapeutic inertia on the part of their clinicians which can result in poor control of CKD risk factors, including hypertension, and can contribute to racial disparities in CKD. Among a sample of Black adults with hypertension and CKD (with albuminuria), we examined predictors of evidence-based medication use. We hypothesized that lower socioeconomic status would be associated with less use of evidence-based medications.

**Methods:** We examined baseline self-reported medication use of 142 participants of a clinical trial for Black Americans with hypertension and CKD (urinary albumin-to-creatinine ratio (ACR)  $\geq 30$  mg/g and eGFR  $\geq 30$  ml/min/1.73m<sup>2</sup>). Participant enrollment was from 2018-2021, and all were actively under the care of a primary care clinician and/or a nephrologist. Primary medication classes of interest were (1) angiotensin-converting enzyme inhibitors (ACEi) or angiotensin receptor blockers (ARBs); and (2) sodium-glucose cotransporter 2 inhibitors (SGLT2i). Examined predictors of evidence-based medication use included: age, sex, income category, insurance type, employment status, systolic blood pressure, diabetes, hemoglobin A1C, obesity, eGFR, urine ACR. Statistical analyses included descriptive statistics and multivariable logistic regression.

**Results:** Participants' mean age was 61.1 years; 36.6% were male; 44.4% had diabetes; mean eGFR was 75 ml/min/1.73m<sup>2</sup>; mean ACR was 173 mg/g and 18.3% had urine ACR  $>=300$  mg/g. A total of 91 (64%) participants were taking an ACEi or ARB. Socioeconomic status (assessed by income category, insurance type and employment status) was not statistically significantly associated with ACEi or ARB use in univariate analyses. In logistic regression models inclusive of age, sex, diabetes and obesity status, each 5 years of older age was associated with a 15% lower odds of taking an ACEi or ARB [Odds Ratio (OR) 0.85, 95% Confidence Interval (CI) 0.73-0.99]. Diabetes was associated with greater odds of taking an ACEi or ARB (OR 3.52, 95% CI 1.59-7.79). Only 4 (2.8%) participants were taking an SGLT2i, and all had diabetes.

**Conclusions:** Among a population of Black adults with hypertension and albuminuria, older age was associated with lesser ACEi or ARB use, and few were taking an SGLT2i. These findings may have implications for pharmacoequity in kidney care.

**Funding:** Other NIH Support - National Institute on Minority Health and Health Disparities, Commercial Support - Baxter

TH-PO728

**CKD Care: Perspectives From Providers and Administrators About African American and Latinx Patients**

Sadia Anjum Ashrafi, Laura Quintero Silva, Alice A. Oloo, Andiana Schwingel. *University of Illinois Urbana-Champaign, Urbana, IL.*

**Background:** African Americans (AA) and Latinx are the most vulnerable populations concerning chronic kidney disease (CKD) progression and adverse health outcomes. The formal healthcare system often lacks equal access and quality of care for all patients, driving disparities in CKD. This qualitative study explored the challenges associated with caring for AA and Latinx patients from the perspectives of healthcare providers and administrators in the nephrology field.

**Methods:** We interviewed 27 healthcare providers and administrators from 10 states and 22 different organizations. Interviews were conducted virtually from January 31, 2022, to May 16, 2022, and transcribed verbatim. Trained researchers coded the transcriptions and identified emerging themes.

**Results:** Three emerging themes described perceptions of healthcare providers and administrators about AA and Latinx CKD patients, as follow: (1) **Unattainable treatment regimens**—reflecting challenges patients have in following dietary guidelines and fluid adherence due to limited access to healthy foods and low health literacy, medication managements due to having little support, limited access to care and missing dialysis due to maintaining employment, lack of awareness about treatment options and home support for home dialysis. These issues are worsened when patients are un/under-insured and lack transportation. (2) **Difficulties in meeting patients' needs** - reflecting communication barriers such as language, implicit bias regarding disease progression, and overall mistrust patients have towards the healthcare system. Patients' emotional needs are tremendous, and providers experience difficulties when trying to be a listening ear or someone that brings them hope. (3) **Need for cultural humility in the multidisciplinary care model** – a multidisciplinary health team is needed to provide more effective treatment that understands these patients as a whole. The team needs people able to provide personalized care within their experiences with oppression and discrimination and socio-economic, language, and cultural struggle. However, the current healthcare system mostly lacks such an environment.

**Conclusions:** The study findings underscore essential areas of improvement in AA and Latinx CKD patients' care, including increasing culturally sensitive support and programs for them.

TH-PO729

**2021 CKD-EPI: Unintended Consequences in Living Kidney Donation**

Vineeta Kumar, Babak J. Orandi, Rhiannon D. Reed, Paul A. MacLennan, Brittany A. Shelton, Marshall C. Mcleod, Jayme E. Locke. *University of Alabama at Birmingham, Comprehensive Transplant Institute University of Alabama at Birmingham Bone Marrow Transplant Program, Birmingham, AL.*

**Background:** Chronic Kidney Disease (CKD) Epidemiology Collaboration eGFR formula (2021 CKD-EPI) removed Black race from the 2009 equation, with the goal of not disproportionately affecting one racial group. Unintended consequences may lead to reclassifying potential Black living kidney donors (LKD) as having more advanced CKD, potentially exacerbating living donation disparities

**Methods:** Using national data, we identified LKD with pre-donation eGFR  $\geq 60$  ml/min/1.73m<sup>2</sup> consistent with living donor screening guidelines to quantify the CKD stage reclassification based on eGFR for Black LKD

**Results:** Among 63,246 LKD, 11.2% (n=6,365) were Black with a mean creatinine of 0.88 mg/dl. Black LKD eGFR was 109.7 ml/min/1.73m<sup>2</sup> using the 2009 formula and 97.7 ml/min/1.73m<sup>2</sup> using the 2021 formula. **Overall, 17.7% of Black LKD were reclassified as having a higher CKD stage pre-donation with the 2021 formula.** (Fig. 1) Among 44,525 LKD with  $\geq 2$  creatinine measurements post-donation, 9.3% (n=4,149) were Black with a mean creatinine of 1.24 mg/dl. Black LKD mean eGFR was 73.2 ml/min using the 2009 formula and 65.6 ml/min/1.73m<sup>2</sup> using the 2021 formula. **Overall, 25.5% of Black LKD were reclassified as having a higher CKD stage post-donation with the 2021 formula.** (Fig.1)

**Conclusions:** While eGFR formulas were not developed for use in LKD, many centers use eGFR in screening and most use eGFR in post donation follow up. Exclusion of race in the formula may inappropriately label potential LKD with CKD thus exacerbate existing racial disparities. Post donation label of CKD may cause undue distress to LKD and health care consequences. These data highlight the need for a validated eGFR formula for LKD, use of measured and not eGFR & education of non-transplant care teams regarding interpretation of CKD staging in LKD.

**Funding:** NIDDK Support

Table 1. Demographics and CKD stage for Black and non-Black kidney donors pre- and post-donation.

	Pre-donation				Post-donation			
	Black donors (n=6,365)	Non-Black donors (n=56,881)	P-value	Black donors (n=4,149)	Non-Black donors (n=40,376)	P-value		
Mean age (SD)	38.6 (11.3)	43.3 (12.1)	<0.001	40.5 (11.4)	45.2 (12.1)	<0.001		
Female (%)	3,859 (60.6%)	36,022 (63.3%)	<0.001	2,610 (62.9%)	26,053 (64.5%)	0.04		
Mean systolic blood pressure (SD)	—	—	—	12.8 (7.1)	12.7 (7.1)	0.6		
Mean serum creatinine (mg/dl)	0.88 (0.19)	0.81 (0.16)	<0.001	1.24 (0.37)	1.15 (0.23)	<0.001		
eGFR formula	2009	2021	2009	2021	2009	2021		
Mean eGFR (ml/min/1.73m <sup>2</sup> ) (SD)	109.69 (20.39)	97.69 (17.12)	97.90 (16.32)	101.17 (15.52)	73.22 (16.78)	65.64 (14.32)	66.60 (15.04)	69.40 (15.02)
CKD Stage (%)								
1	5,217 (82.0%)	4,147 (65.2%)	36,378 (67.5%)	42,443 (74.6%)	590 (14.2%)	235 (5.7%)	2,050 (7.3%)	3,772 (9.3%)
2	1,148 (18.0%)	2,161 (34.0%)	16,503 (29.2%)	14,438 (25.4%)	2,663 (64.2%)	2,313 (55.7%)	22,609 (56.0%)	25,078 (63.1%)
3	0 (0.0%)	0 (0.0%)	0 (0.0%)	0 (0.0%)	396 (9.5%)	1,660 (39.9%)	14,808 (36.7%)	11,324 (28.5%)
4	0 (0.0%)	0 (0.0%)	0 (0.0%)	0 (0.0%)	0 (0.0%)	0 (0.0%)	0 (0.0%)	0 (0.0%)
5	0 (0.0%)	0 (0.0%)	0 (0.0%)	0 (0.0%)	0 (0.0%)	0 (0.0%)	0 (0.0%)	0 (0.0%)
Cohen's kappa coefficient (95% CI)	0.56 (0.54-0.58)	0.83 (0.82-0.83)			0.54 (0.51-0.56)	0.82 (0.81-0.82)		

SD - standard deviation, CI - confidence interval  
\* The Cohen's kappa coefficient is used to assess inter-rater (or in this case, inter-formula) agreement. Generally, coefficient values 0.40-0.59 suggest weak agreement and values 0.80-0.90 suggest strong agreement (McHugh ML. Interrater reliability: the kappa statistic. *Biochem Med (Zagreb)*. 2012;22(3):276-82).

TH-PO730

**Patients' Perspectives on Race and the Use of Race-Based Algorithms in Clinical Decision-Making: A Qualitative Study**

Insa M. Schmidt,<sup>1</sup> Merav Shohet,<sup>2</sup> Mariana Serrano,<sup>4</sup> Pranav Yadati,<sup>1</sup> Hanni Menn-Josephy,<sup>1</sup> Nwamaka D. Eneanya,<sup>3</sup> Emily C. C. Cleveland Manchanda,<sup>1</sup> Sushrut S. Waikar.<sup>1</sup> *<sup>1</sup>Boston University School of Medicine, Boston, MA; <sup>2</sup>Boston University College of Arts and Sciences, Boston, MA; <sup>3</sup>University of Pennsylvania Perelman School of Medicine, Philadelphia, PA; <sup>4</sup>Massachusetts Department of Public Health, Boston, MA.*

**Background:** Clinical algorithms that incorporate race as a modifying factor to guide clinical decision-making have recently been criticized for propagating racial bias in medicine. The calculation of kidney function is an example of a clinical equation that has different diagnostic parameters depending on an individual's race (Black vs. non-Black). While this clinical measure has multiple implications for clinical care, patients' awareness of and their perspectives on the application of such algorithms is not known.

**Methods:** This qualitative study included 23 adult participants who were recruited from Nephrology clinics at a safety-net hospital in Boston, Massachusetts. We conducted individual semi-structured interviews to examine patients' perspectives on race and the

use of race-based algorithms in clinical decision-making. Interviews were audiotaped, transcribed, and analyzed using thematic content analysis and modified grounded theory.

**Results:** Among the 23 study participants, 11 (48%) were women and 15 (65%) self-identified as Black or African American. Three categories of themes emerged: The first theme described definitions and the individual meanings participants ascribed to the term race. The second theme described perspectives on the role and consideration of race in clinical decision-making. Most study participants were unaware that race has been used as a modifying factor in clinical equations and rejected the incorporation of race in these equations. The third theme related to exposure to and experience of racism in healthcare settings. Experiences described by non-white participants ranged from microaggressions to overt acts of racism, including perceived racist encounters with healthcare providers. In addition, patients alluded to a deep mistrust in the healthcare system as a major barrier to equitable care.

**Conclusions:** Findings from this study suggest that most patients are unaware of how race has been used to make risk assessments and guide clinical care. Further research on patients' perspectives is needed to inform the development of anti-racist policies and regulatory agendas as we move forward to combat systemic racism in medicine.

**TH-PO731**

**Race Independent eGFR Equations in Assessing Renal Function in Patients With Liver Disease**

Jeff W. Meeusen,<sup>1</sup> Surendra Dasari,<sup>1</sup> John C. Lieske,<sup>1,2</sup> Sandrine Lemoine,<sup>3</sup> Laurence Dubourg,<sup>3</sup> Frank Stämmler,<sup>4</sup> Eric Schiffer.<sup>4</sup> <sup>1</sup>Mayo Clinic Department of Laboratory Medicine and Pathology, Rochester, MN; <sup>2</sup>Mayo Clinic Division of Nephrology and Hypertension, Rochester, MN; <sup>3</sup>Department Néphrologie, Dialyse, Hypertension et Exploration Fonctionnelle Rénale, Groupement Hospitalier Edouard Herriot, Hospices Civils de Lyon, Université Claude Bernard, Lyon, France; <sup>4</sup>Numares AG, Regensburg, Germany.

**Background:** Renal impairment is commonly associated with liver disease, and the degree of renal dysfunction impacts decisions regarding drug dosing, therapeutic interventions, and suitability for liver transplantation. Altered hemodynamics in liver disease often result in overestimation of glomerular filtration rate (GFR) by creatinine based GFR estimating equations. Recently, we have analytically and clinically validated a novel GFR estimation equation based on serum myoinositol, valine, and creatinine quantified by nuclear magnetic resonance spectroscopy in combination with cystatin-C, age and sex (AXINON® GFR(NMR)). We hypothesized that AXINON® GFR(NMR) (GFR<sub>NMR</sub>) could improve CKD classification in the setting of liver disease.

**Methods:** We compared GFR estimation equations in a multicenter retrospective study of patients (n=203) with liver disease and renal tracer clearance measured GFR (mGFR). Stored serum was analyzed and used to estimate GFR based on GFR<sub>NMR</sub>, CKD-EPI 2021 eGFRcr-cys, and CKD-EPI 2021 eGFRcr.

**Results:** eGFRcr overestimated mGFR with a mean bias of 7.5 [4.9 - 9.8] mL/min/1.73m<sup>2</sup> compared to a smaller bias of -2.9 [-4.8 - -1.3] for eGFRcr-cys and -1.64 [-3.43 - 0.16] for GFR<sub>NMR</sub> (both p<0.001). P<sub>30</sub> was similar in GFR<sub>NMR</sub> and eGFRcr-cys (83% [79 - 89] and 86% [81 - 90]) but lower for eGFRcr (74% [68 - 80]). P<sub>15</sub> was highest for GFR<sub>NMR</sub> at 59% [53 - 65] compared to 47% [40 - 53] for eGFRcr and 54% [47 - 61] for eGFRcr-cys. Concordant classification by mGFR CKD stage was 104 (51%), 109 (54%), and 120 (59%), for eGFRcr, eGFRcr-cys, and GFR<sub>NMR</sub> respectively (GFR<sub>NMR</sub> vs. eGFRcr: p = 0.074; GFR<sub>NMR</sub> vs. eGFRcr-cys: p = 0.138; eGFRcr vs. eGFRcr-cys: p = 0.588).

**Conclusions:** Our findings confirm that the new 2021 eGFRcr equation overestimates GFR among patients with liver disease, presumably due to reduced muscle mass. Addition of myoinositol and valine improved correlation of GFR<sub>NMR</sub> with mGFR and accurately stratified liver disease patients into CKD stages.

**TH-PO732**

**Performance of a Novel Race-Independent GFR Estimating Equation in Kidney Transplant Recipients Based on NMR-Measured Metabolites**

Jeff W. Meeusen,<sup>1</sup> Surendra Dasari,<sup>1,2</sup> John C. Lieske,<sup>1,2</sup> Marcello Grassi,<sup>3</sup> Frank Stämmler,<sup>3</sup> Eric Schiffer.<sup>3</sup> <sup>1</sup>Mayo Clinic Department of Laboratory Medicine and Pathology, Rochester, MN; <sup>2</sup>Mayo Clinic Division of Nephrology and Hypertension, Rochester, MN; <sup>3</sup>numares AG, Regensburg, Germany.

**Background:** Close monitoring of GFR is essential for the management of patient's post kidney transplantation. The gold-standard tracer determined measured GFR (mGFR) is not readily accessible in most centers. Furthermore, the performance of new estimated GFR (eGFR) equations based upon creatinine and cystatin C have not been validated in kidney transplant patients. We have recently developed a novel eGFR equation that uses creatinine, cystatin C, myoinositol and valine.

**Methods:** Here we evaluate this new equation (eGFR<sub>NMR</sub>) along with the 2021 CKD EPI equations using creatinine alone (eGFRcr), and in combination with cystatin C (eGFRcr-cys) in a cohort of kidney transplant patients with protocol iohalamate renal clearance mGFR (n=220).

**Results:** Compared to mGFR, there was no significant bias for eGFRcr or eGFR<sub>NMR</sub>, while eGFRcr-cys underestimated mGFR. P30 values were similar for all eGFR, while P15 was higher for eGFR<sub>NMR</sub> compared to eGFRcr. (Table 1) Agreement with mGFR CKD stages of <15, 30, 45, 60 and 90 mL/min/1.73m<sup>2</sup> was identical for eGFRcr and eGFRcr-cys while eGFR<sub>NMR</sub> was significantly higher. eGFRcr concordantly classified 86% of patients below and 78% above 60mL/min/1.73m<sup>2</sup>. Applying the eGFRcr-cys method would reclassify 8.2% of patients as <60mL/min/1.73m<sup>2</sup> and incorrectly reclassify

5.1% as >60 mL/min/1.73m<sup>2</sup> for a net reclassification improvement (NRI) of 3.1%. The eGFR<sub>NMR</sub> method correctly reclassified 3.3% lower and 4.1% higher for a net NRI of 7.1% (Table 1).

**Conclusions:** The 2021 CKD-EPI eGFRcr and eGFRcr-cys have similar bias, P15, and agreement while eGFR<sub>NMR</sub> more closely matched mGFR among kidney transplant recipients.

Table 1

	eGFRcr	eGFRcr-cys	p-value*	eGFRNMR	p-value*
Median Difference, mL/min/1.73m <sup>2</sup> (95CI)	-0.05 (-1.67 to 1.36)	-3.84 (-4.83 to -2.51)	<0.01	0.412 (-1.39 to 1.68)	0.82
P15: % (95CI)	57.3 (50.7 to 63.8)	60.9 (54.5 to 67.4)	0.43	67.3 (61.1 to 73.5)	0.03
P30: % (95CI)	85.0 (80.3 to 89.7)	90.0 (86.0 to 94.0)	0.11	90.9 (87.1 to 94.7)	0.06
Agreement: % (95CI)	61.8 (55.4 to 68.2)	61.8 (55.4 to 68.2)	1.00	66.4 (60.1 to 72.6)	0.04
Net Reclassification Improvement: % (95CI)	NA	3.1% (0.8 to 5.4)	0.05	7.4% (3.9 to 10.8)	<0.01

\*p-values compared to eGFRcr

**TH-PO733**

**The Effect of CKD-EPI Race Adjustment on CKD Lab Monitoring Guidelines**

Harrison C. Gottlich, Rachel Giblon, Maria Astudillo Potes, LaTonya J. Hickson, Robert C. Albright, Suzanne M. Norby, Bjoerg Thorsteinsdottir. Mayo Clinic Minnesota, Rochester, MN.

**Background:** Chronic kidney disease (CKD) affects 1 in 7 Americans with 90% of adults unaware of their disease. Routine lab monitoring is crucial for optimal CKD disease management and to avoid "crashing into dialysis". Historically, eGFR estimation has used a race adjustment for Black patients, contributing to inequity in CKD care. In this study, we investigated the impact of the race adjustment and other predictors on guideline concordance in a cohort of primary care patients.

**Methods:** We compiled a dataset of 1,167,056 lab results of 125,415 adults receiving care at 75 mid-west primary care practices in an integrated health system, with at least one creatinine level measured between 2014-2016. Relevant covariates were extracted from the medical chart. We characterized using descriptive statistics and recalculated GFR for self-identified Black patients without race adjustment to observe any changes in CKD stage and lab monitoring. Guideline concordant care was modeled as a binary outcome, and considered positive if patients had the recommended number of labs. Predictors of guideline concordance were examined using generalized additive models with random effects for repeat labs over time.

**Results:** Without race adjustment, 458 (33%) of Black patients would be reclassified to a higher CKD stage based on GFR alone. We found a significant gap in baseline albuminuria, with only 10% of Black and 29.1% of non-Black patients having albuminuria measures (p<0.001). This prevented proper risk stratification of many Black patients in CKD stage 3-5 (22% without race correction vs. 13% with race correction), representing a gap care for proper management. For predictors of guideline concordance assuming patients without baseline albuminuria had a status of A1, patients identifying as Black (OR: 1.35, 95% CI: 1.21-1.43) or who were diagnosed with Hypertension (OR: 3.29, 95% CI: 3.22-3.54), Diabetes (OR: 1.55, 95% CI: 1.50-1.60), or AKI (OR: 1.96, 95% CI: 1.91-2.00) were more likely to be concordant.

**Conclusions:** In addition to considering the appropriateness of the race adjustment in the CKD-EPI eGFR calculation, we found disparities exist in routine albuminuria labs, particularly for Black patients. This finding underscores the importance of screening as patients are more likely to reach lab compliance when risk factors are identified.

**TH-PO734**

**Prognostic Risk Score for Kidney Disease Progression in African Americans Without Type 2 Diabetes**

Girish N. Nadkarni,<sup>1</sup> Dipti Takale,<sup>2</sup> Sharon Stapleton,<sup>3</sup> Fergus Fleming,<sup>3</sup> Steven G. Coca,<sup>1</sup> <sup>1</sup>Icahn School of Medicine at Mount Sinai, New York, NY; <sup>2</sup>Persistent Systems Ltd, Pune, India; <sup>3</sup>Renalytix, New York, NY.

**Background:** African Americans (AAs), even without type 2 diabetes have a higher incidence of adverse kidney outcomes, compared to other populations. This is driven in part by genetic (APOL1 risk genotype) and multiple non-genetic factors. We sought to develop a composite prognostic risk score combining clinical data elements and biomarkers using machine learning for identification of AAs with non-diabetic CKD at highest risk of progression.

**Methods:** We conducted an observational study in a biobank that linked banked plasma samples and genetic information to longitudinal electronic health record (EHR) data in AAs with impaired kidney function. We measured plasma levels of soluble tumor necrosis factor receptor (sTNFR)1, sTNFR2, and kidney injury molecule-1 (KIM1) using previously validated assays. We then trained a random forest model using a 75:25 split for predicting a composite outcome of eGFR decline of ≥5 ml/min per year, ≥40% sustained decline in eGFR, or kidney failure within 5 years.

**Results:** In 472 AAs with non-diabetic CKD, the median age was 62 years, 62% were female, the baseline eGFR was 66 ml/min/1.73 m<sup>2</sup>, and 14% had the APOL1 risk genotype. Over 5 years, 7% experienced the composite endpoint. The composite risk score had an AUC of 0.78 (95% CI 0.72, 0.86). On applying a risk cutoff that considered 10% of the population as high-risk, the positive predictive value (PPV) for the outcome was 51%, and the NPV was 91% in the bottom 90% of the population. In a sub-analysis

of AAs with the *APOL1* risk genotype, the PPV and NPVs were also 50% and 91%, respectively. The hazard ratio (HR) was 31 (95% CI 15 to 68) for the top decile of risk score vs. the rest of the population.

**Conclusions:** A composite risk score accurately risk-stratified AAs with and without *APOL1* risk genotype for kidney outcomes. With further validation, this is a valuable tool for population health management, clinical trial enrichment, and ensuring health equity.

**Funding:** Commercial Support - Renalytix

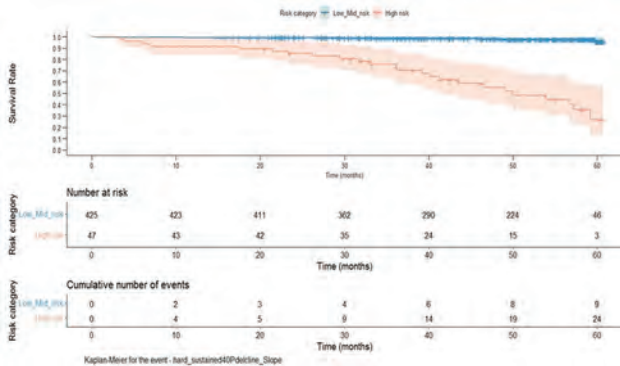

**TH-PO735**

**National Fundholding and Support Policies for Kidney Disease Management**  
 Jiwon M. Lee. *Korea Disease Control and Prevention Agency, Cheongju, Chungcheongbuk-do, Republic of Korea.*

**Background:** Chronic kidney disease (CKD) imposes a large socioeconomic burden for a country due to its lifelong medical expenses. In addition, rare genetic kidney diseases often progress to CKD and the burden is inherited in the family, which impacts national health through generations.

**Methods:** We reviewed the records of national fundholding system to support patients with chronic kidney disease and rare kidney diseases in the Republic of Korea, over the past 20 years.

**Results:** Since the year 2001, South Korea has been running a special fundholding program which exempts medical expenses for low-income individuals with rare and/or intractable diseases, including chronic kidney disease and rare genetic kidney disease. The disease list is designated by the government and, to date, there are 1,123 rare and 24 intractable diseases supported by this fundholding system. Over the past 20 years, chronic kidney disease had the largest number of applicants. In the year 2021, there were 8,518 patients with CKD who received full-governmental coverage for their medical expenses, which approximated 200,000,000 US dollars. In addition, South Korea also supports the expenses for dialysate fluids for patients receiving peritoneal dialysis. Through this national fundholding system, the recipients are maintaining their household finance maintenance rate (which is calculated by the income and property standards) of 97% after their diagnosis of rare and/or intractable diseases including CKD.

**Conclusions:** The Republic of Korea exerts diverse national efforts and runs policies to achieve kidney health equity for individuals in the real-world social system. We hope to continue with this effort through more improved and effective strategies in the future.

**TH-PO736**

**Examining the Role of KidneyIntelX in Addressing Health Inequity in CKD**

Barry I. Freedman, Rebekah A. Paige, Mitzie H. Spainhour, Benjamin M. Bagwell, Jennifer Houlihan, Richard W. Lord. *Wake Forest Baptist Medical Center, Winston-Salem, NC.*

**Background:** Compared to European Americans (EAs), African Americans (AAs) have a significantly higher burden of chronic kidney disease (CKD) and end-stage kidney disease (ESKD). This finding results from biologic differences and environmental factors. Failure to identify patients with early stage CKD and the limited availability of prognostic tools predicting disease progression contribute to these health disparities.

**Methods:** KidneyIntelX is a novel bioprognostic™ test that combines results from blood biomarkers with electronic health record (EHR) data using a machine learning algorithm to assess near-term risk of progressive kidney function decline in patients with type 2 diabetes (T2D) and CKD. To assess the impact and effectiveness of KidneyIntelX on outcomes, 2000 patients with T2D and estimated glomerular filtration rate (eGFR) 30-59 ml/min/1.73 m<sup>2</sup> [G3a, G3b]\* or eGFR ≥ 60 with urine albumin:creatinine ratio (UACR) ≥ 30 mg/g [A2, A3] are being enrolled into a prospective study at Atrium Health Wake Forest Baptist/Atrium Health primary care provider (PCP) clinics in North Carolina. We examined ancestry-based differences in KidneyIntelX test results and assessed their impact on medication prescription, blood pressure control, and engagement with consult services in an attempt to optimize care and address inequities in CKD among AAs.

**Results:** Of the initial 185 patients recruited from 46 unique PCPs, 43% (79) self-identified as AA and 57% (106) as non-AA (predominantly EA). As observed, despite similar degrees of kidney function (median eGFR 58 vs. 53 ml/min/1.73 m<sup>2</sup> and median UACR 78 vs. 51 mg/g in AAs vs. non-AAs, respectively), the proportion of AAs scored as “high risk” by KidneyIntelX was 3.5-fold higher (18% in AA vs. 5% in non-AA). Of the 14 AA high-risk patients, 6 (43%) had adjustments in clinical care.

**Conclusions:** The KidneyIntelX risk score is being assessed for its ability to predict progressive decline in kidney function in patients with T2D and early-stage CKD. It is hoped results will allow PCPs and healthcare systems to optimize allocation of treatments and clinical resources to those at highest risk, beyond traditional clinical metrics. Early data suggests that AA patients exhibit higher risk levels that may trigger more timely and effective interventions at earlier stages.

**Funding:** Commercial Support - Renalytix

**TH-PO737**

**Impact of Advancing American Kidney Health on Access to Kidney Transplant**

Luis Ng Sueng,<sup>1</sup> Nawal Peracha,<sup>2</sup> Andrew Wu,<sup>1</sup> Nadeen J. Khoury,<sup>1</sup> Milagros D. Samaniego-Picota,<sup>1</sup> Michelle Jesse,<sup>1</sup> Pritika Shrivastava,<sup>1</sup> <sup>1</sup>Henry Ford Health System, Detroit, MI; <sup>2</sup>Wayne State University School of Medicine, Detroit, MI.

**Background:** In July 2019, the US Federal Government launched the executive order (EO) Advancing American Kidney Health (AAKH). The focus of this EO was to reduce kidney failure rates and increase rates of kidney transplant. Herein, we explore the impact of the EO on referral (REF), evaluation (EVAL), waitlist (WL), and kidney transplants (T) across racial groups before and after the signing of AAKH.

**Methods:** Retrospective chart review of all patients referred for kidney transplant evaluation at a large, urban healthcare system in Detroit, MI. To ensure equal pre-post timeframes, data collected from all patients referred within 30 months pre- (1/1/2017-6/30/2019) and post-EO (10/1/2019-3/31/2022). Patients referred in the three months immediate post-EO (7/1/2019-9/30/2019) were excluded to account for system-level adjustment to the EO. Data extracted via existing internal systems included patient race/ethnicity, gender, frequency and dates of events (i.e., REF, EVAL, WL, and T). An event was coded each time a patient was referred for possible evaluation and categorized as the furthest step achieved (i.e., REF, EVAL, WL, T).

**Results:** A total of 4949 unique patients were identified, though 673 patients had more than one event. Patients were predominantly male (60.4%) and Black (50.8%), followed by White (37.4%) and Other (11.7%). There were significantly greater increases in referrals and evaluations for Black patients compared to White and Other racial categories. Since local average wait time for kidney transplant is >30 months, EO impact on transplant may be too early to assess. WL and T was equitable across groups. Table 1 reports on frequency of events across racial groups pre- to post-EO.

**Conclusions:** Since the passage of EO, minority populations may have better access to kidney transplant, as noted by increase in referrals and evaluation.

**Table 1. Frequency of Events by Race Pre- and Post-EO**

	Pre-EO	Post-EO	p-value
<b>Referrals</b>			
Black	705 (50.1%)	1138 (55.6%)	<b>0.002</b>
White	497 (35.3%)	688 (33.6%)	0.286
Other/Unknown	204 (14.5%)	222 (10.8%)	<b>0.001</b>
<b>Evaluations</b>			
Black	404 (49.4%)	570 (55.1%)	<b>0.015</b>
White	324 (39.7%)	378 (36.6%)	0.172
Other/Unknown	89 (10.9%)	86 (8.3%)	0.060
<b>Waitlist</b>			
Black	50 (48.1%)	104 (45.4%)	0.652
White	42 (40.4%)	102 (45.4%)	0.391
Other/Unknown	12 (11.5%)	21 (9.2%)	0.503
<b>Transplanted</b>			
Black	17 (36.2%)	10 (25.0%)	0.262
White	22 (46.8%)	22 (55.0%)	0.446
Other/Unknown	8 (17.0%)	8 (20.0%)	0.721

\*Significance reported across racial groups

**TH-PO738**

**Impact of Insurance Type on Kidney Transplant Wait-List Status and Post-Transplant Outcomes in the United States**

Anna M. Morenz,<sup>1</sup> James D. Perkins,<sup>2,3</sup> Andre Dick,<sup>5</sup> Yue-Harn Ng,<sup>4,2</sup> <sup>1</sup>University of Washington Department of Medicine, Seattle, WA; <sup>2</sup>Clinical and Bio-Analytics Transplant Laboratory, University of Washington, Seattle, WA; <sup>3</sup>University of Washington Department of Surgery, Seattle, WA; <sup>4</sup>University of Washington Division of Nephrology, Seattle, WA; <sup>5</sup>Seattle Children's Hospital, Seattle, WA.

**Background:** Insurance type has been associated with lower access to kidney transplant (KT) and worse KT outcomes. In this study, we assessed if insurance type remains a risk marker for worse KT outcomes post Affordable Care Act and Kidney Allocation System.

**Methods:** We conducted a retrospective analysis of the Organ Procurement and Transplantation Network data from 12/14 to 6/21. We used competing risk analyses to study the association of private versus public (Medicare, Medicaid,

or government-sponsored) insurance on wait-list status and post-transplant outcomes, controlling for candidate, donor and transplant variables.

**Results:** Table 1 depicts baseline characteristics and wait-list status by insurance type. KT candidates with public insurance were significantly more likely to die/become too sick for KT or receive a DDKT, but less likely to receive a living donor KT (LDKT). As shown in Figure 1, after KT, recipients with public insurance had higher mortality but comparable allograft survival.

**Conclusions:** Publicly insured KT candidates are at higher risk wait-list removal, have lower probability of LDKT, and higher probability of dying post-KT. Factors contributing to these disparities need to be addressed in future studies to achieve equity in KT.

**Funding:** Clinical Revenue Support

Table 1. Baseline characteristics and outcomes of wait-list candidates stratified by insurance status

Characteristic	Overall N = 247,335	Private N = 105,360	Public N = 141,975	p-value
Age, years	55 (45, 63)	53 (44, 60)	56 (45, 65)	<0.001
Female	94,963 (38%)	40,061 (38%)	54,902 (39%)	0.001
<b>Race/Ethnicity</b>				<0.001
White	97,752 (40%)	49,021 (47%)	48,731 (34%)	
Black	76,488 (31%)	27,173 (26%)	49,315 (35%)	
Hispanic	47,515 (19%)	17,123 (16%)	30,392 (21%)	
Asian	19,370 (7.8%)	9,632 (9.1%)	9,738 (6.9%)	
Other	6,210 (2.5%)	2,411 (2.3%)	3,799 (2.7%)	
<b>College education</b>				<0.001
Yes	127,232 (51%)	64,131 (61%)	63,101 (44%)	
None	111,952 (45%)	38,288 (36%)	73,664 (52%)	
Unknown	8,151 (3.3%)	2,941 (2.8%)	5,210 (3.7%)	
<b>Employment</b>				<0.001
Yes	82,947 (34%)	60,379 (57%)	22,568 (16%)	
No	157,171 (64%)	42,193 (40%)	114,978 (81%)	
Unknown	7,217 (2.9%)	2,785 (2.6%)	4,429 (3.1%)	
<b>BMI*</b>				<0.001
<18.5	2,744 (1.1%)	1,166 (1.1%)	1,578 (1.1%)	
18.5 to 24.9	54,232 (22%)	22,617 (21%)	31,615 (22%)	
25 to 29.9	80,949 (33%)	33,731 (32%)	47,218 (33%)	
30 to 39.9	102,366 (41%)	44,655 (42%)	57,711 (41%)	
≥40	7,044 (2.8%)	3,191 (3.0%)	3,853 (2.7%)	
<b>Kidney disease diagnosis</b>				<0.001
Diabetes Mellitus	96,681 (39%)	36,588 (35%)	60,093 (42%)	
HTN	55,526 (22%)	20,404 (19%)	35,122 (25%)	
GN	41,065 (17%)	21,594 (20%)	19,471 (14%)	
PKD	18,010 (7.3%)	11,146 (11%)	6,864 (4.8%)	
Congenital/Hereditary	3,801 (1.5%)	2,109 (2.0%)	1,692 (1.2%)	
Other	32,252 (13%)	13,519 (13%)	18,733 (13%)	
Diabetes Mellitus	115,647 (47%)	44,028 (42%)	71,619 (50%)	<0.001
<b>Years on dialysis</b>				<0.001
Not on dialysis	57,531 (23%)	35,037 (33%)	22,494 (16%)	
≥0 to 1 year	12,909 (5.2%)	7,540 (7.2%)	5,369 (3.8%)	
1 to 3 years	103,025 (42%)	41,855 (40%)	61,170 (43%)	
>5 years	73,870 (30%)	20,928 (20%)	52,942 (37%)	
CPRA	0 (0, 17)	0 (0, 11)	0 (0, 19)	<0.001
<b>Outcome</b>				<0.001
<b>Removal reason</b>				<0.001
Active	71,233 (29%)	32,226 (31%)	39,007 (27%)	
Died/too sick	44,984 (18%)	16,115 (15%)	28,869 (20%)	
DDKT	74,447 (30%)	27,173 (26%)	47,274 (33%)	
LDKT	32,016 (13%)	20,992 (20%)	11,024 (7.8%)	
Other	24,655 (10.0%)	8,854 (8.4%)	15,801 (11%)	

\*Abbreviations in order shown: BMI (body mass index), HTN (hypertension), GN (glomerulonephritis), PKD (polycystic kidney disease), CPRA (calculated panel reactive antibodies), DDKT (deceased donor kidney transplant), LDKT (living donor kidney transplant)

Figure 1. Kidney Transplant Outcomes by Insurance Type

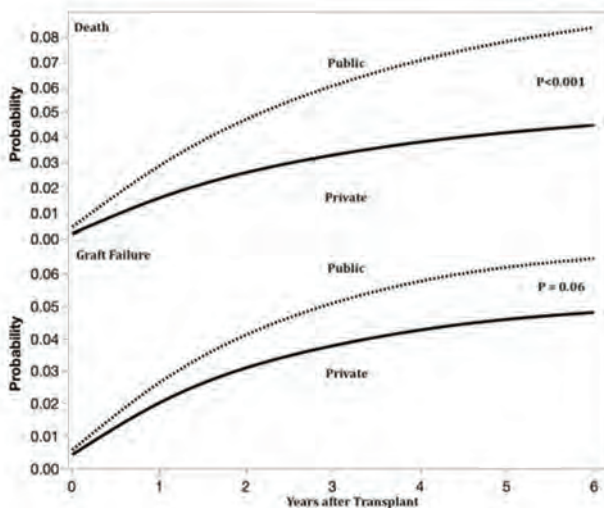

TH-PO739

Racial and Ethnic Minorities Are Poorly Represented in High-Impact Nephrology Trials

Qandeel H. Soomro,<sup>1,2</sup> Angela L. Mccarthy,<sup>2</sup> Dalila Varela,<sup>2</sup> Colin J. Keane,<sup>2</sup> Javanaugh M. Ways,<sup>2</sup> Amalya M. Charytan,<sup>2</sup> Giana Kristy C. Ramos,<sup>1</sup> Joey Nicholson,<sup>2</sup> David M. Charytan.<sup>1</sup> <sup>1</sup>NYU Langone Health, New York, NY; <sup>2</sup>NYU School of Medicine, New York, NY.

**Background:** Kidney disease disproportionately impacts underrepresented racial and ethnic minorities (URM), but only limited data are available on their representation in kidney disease randomized clinical trials

**Methods:** We analyzed how frequently race and ethnicity of trial participants were reported as well as trends in enrollment of URM in nephrology RCTs. We systematically identified RCTs between 2000 and 2021 published in 10 high impact journals and extracted data from manuscripts, supplementary material and clinical trials.gov. Race and ethnicity were classified using standard NIH PHS inclusion enrollment form categories. Enrollment of URM and reporting on race and ethnicity were analyzed according to trial type, enrollment site, and publication date

**Results:** We screened 4494 and identified 370 RCTs meeting inclusion criteria with a total enrollment of 339,047. Participant race was reported in 55% whereas ethnicity was reported in only 12% of RCTs. Among trials reporting race, White participants accounted for 87% of subjects in AKI, 75% of CKD, 62% of dialysis, 42% of glomerulonephritis and 81% of kidney transplant trials whereas Black individuals accounted for <10% of trial subjects with the exception of dialysis trials (26%). Asians accounted for 39% of GN trials-mainly IgA trials. Similarly, in trials reporting race, the majority of participants were White regardless of site but the proportion was lower in US only trials: International 79%, US only 59%, Outside US 76%, Europe only 89.5%. The enrollment trend from 2000-2021 for White participants remained between 75-83%

**Conclusions:** Despite kidney diseases disproportionately affecting URM, reporting on participant race is infrequent and URM are underrepresented in nephrology clinical trials. This impacts clinical practice and generalizability of findings from trials.

Racial Category	Trial Category (Total N = 245,269)				
	Acute Kidney Injury	Chronic Kidney Disease	Glomerulonephritis	Hemodialysis or Peritoneal Dialysis	Kidney Transplant
White N (%)	49824 (87%)	83512 (75%)	916 (42%)	23387 (62%)	30129 (81%)
Black or African American N (%)	3186 (6%)	8237 (7%)	200 (9%)	9551 (26%)	3653 (10%)
Asian N (%)	1612 (3%)	14126 (13%)	851 (39%)	1518 (4%)	1259 (3%)
American Indians and Alaska Natives N (%)	0 (0%)	694 (1%)	10 (0.4%)	207 (1%)	15 (0%)
Native Hawaiian or Other Pacific Islander N (%)	181 (0.3%)	93 (0%)	9 (0%)	59 (0%)	8 (0%)
Other Race N (%)	2310 (4%)	4481 (4%)	197 (9%)	2650 (7%)	2361 (6%)
Total N = 345,269	57113	111143	2176	37412	37425

Racial Categories based on trial category

Ethnicity	Trial Category (Total N = 39750)				
	Acute Kidney Injury	Chronic Kidney Disease	Glomerulonephritis	Hemodialysis or Peritoneal Dialysis	Kidney Transplant
Hispanic N (%)	959 (12%)	4249 (15%)	215 (24%)	3740 (22%)	687 (12%)
Non-Hispanic or Latino N (%)	6777 (88%)	23869 (85%)	680 (76%)	13351 (78%)	5143 (88%)
Total = 59,750	7836	28118	895	17077	5830

Ethnicity based on trial category

TH-PO740

Racism, Discrimination, and Kidney Transplant Success in the Southern United States

Prince M. Anand,<sup>1</sup> Teri Browne.<sup>2</sup> <sup>1</sup>Medical University of South Carolina, Charleston, SC; <sup>2</sup>University of South Carolina System, Columbia, SC.

**Background:** Kidney transplant racial disparities are prevalent in the United States. African Americans are almost half as likely as White patients to receive a kidney transplant. No previous research in the Southern U.S. (with the greatest transplant disparities) has focused on African American patients' lived experiences with racism, racial prejudice, and discrimination and their impact on kidney transplant parity. This study examines these phenomena and can inform future research and interventions to increase kidney transplant parity.

**Methods:** This community-engaged and interdisciplinary project uses qualitative content analyses of in-depth interviews with 100 African Americans who are on dialysis or have chronic kidney disease in a southern US state. We used a combination of deductive and inductive approaches for analyses, establishing a preliminary codebook of provisional codes guided by our interview prompts. We then added emergent codes to the provisional codebook, iteratively refining the codebook. Data are analyzed qualitatively using MAXQDA software.

**Results:** The most prominent themes that emerged from the analyses included the impact of racism and discrimination on 1. access to kidney transplants, 2. gaps in education, understanding, and awareness of kidney transplant, and 3. the quality of life of people living with kidney disease. Most respondents desire a kidney transplant (80%), few express concerns about transplantation (18%), but < 1/3 (29%) were referred for transplant evaluation. Few patients report receiving information from their kidney health providers on how to obtain a kidney. Most patients demonstrated limited knowledge and awareness regarding the kidney transplantation process. Many respondents also report that White patients are treated better than them, often attributing these patterns of

differential treatment to differences in class (e.g., income, poverty), race, or residential context (e.g., rural, suburb, urban).

**Conclusions:** Racial disparities have long existed in kidney transplantation, yet the impact of racism and discrimination on these health inequities is under-studied. This study can offer insight into new interventions and research to help improve kidney transplant parity, and findings can also help inform interdisciplinary practice in dialysis and transplant centers.

**TH-PO741**

**The Disparities Map: It's Gone South!**

Fatima Ayub, Andrea K. Easom, Manisha Singh. *University of Arkansas for Medical Sciences, Little Rock, AR.*

**Background:** Over 300,000 Arkansans have chronic kidney disease (CKD) but are unaware they have it. Many live in rural, underserved areas. The Arkansas State CKD Advisory Council (ARCKDAC), was established in 2019 to promote CKD awareness and raise regional stakeholder engagement by identifying systemic barriers to equity. This initiative launched a model for early recognition and treatment of CKD, targeting the slowing of CKD progression and preparation for end-stage renal disease (ESRD), if needed. ARCKDAC identified gaps in CKD awareness and patient care through regional comparative data analysis and devised remedies that could be used by local stakeholders. This statewide collaborative approach to addressing CKD may be the nation's first.

**Methods:** ARCKDAC obtained regional data from ESRD Network 13 and compared incident data for 2016 and 2017 to better understand the differences. The analyses were distributed to stakeholders statewide to compare and contrast their outcomes and develop action plans for areas of concern in their region. ARCKDAC devised measures to support these plans and increase CKD awareness by developing a "Ten Point Checklist for Managing CKD" toolkit for primary care providers and a "Know Your Kidney Number (eGFR)" poster campaign to generate public awareness and identifying other available resources.

**Results:** Approximately 1,200 Arkansans start ESRD therapies yearly. More minorities were in the two southern regions (54 to 65%) compared to 36% statewide. Medical coverage was not an issue, with 98% having insurance. Yet clinical outcomes were lowest in the south. Fewer patients (<3%) started on home dialysis in 2017 compared to 12% statewide and 19% in the central region where early CKD patient education is more accessible. Access to renal dietitians was low statewide (7%) but lower in the southern regions (1% and 3%). Pre-ESRD nephrology care was lowest in the southeast (45%) with 98% of patients starting hemodialysis and 93% using a catheter for access.

**Conclusions:** The ARCKDAC data reveals significant gaps, leading to poorer outcomes especially in rural areas. Having regional data analyzed and used by local stakeholders is the key to engagement and changes to address inequities. Public, provider and patient awareness and education campaigns may help mitigate this discordance. This approach could be a model that can be used to improve CKD outcomes nationally.

**Funding:** Private Foundation Support

**TH-PO742**

**Multi-Ancestry Proteo-Genomic Association Study of eGFR**

Matthew B. Lanktree,<sup>1,2</sup> Nicolas Perrot,<sup>2</sup> Andrew Smyth,<sup>2,3</sup> Sukrit Narula,<sup>2</sup> Marie Pigeyre,<sup>2</sup> Joan C. Krepinsky,<sup>1</sup> Salim Yusuf,<sup>2,1</sup> Guillaume Pare,<sup>2,1</sup> <sup>1</sup>McMaster University Faculty of Health Sciences, Hamilton, ON, Canada; <sup>2</sup>Population Health Research Institute, Hamilton, ON, Canada; <sup>3</sup>HRB Clinical Research Facility, Galway, Ireland.

**Background:** Reduced eGFR impacts the concentration of proteins circulating in the plasma. Biomarkers may be released during injury without being harmful themselves. Thus, biomarker studies of CKD are prone to confounding by reverse causation. The concentration of plasma protein biomarkers is also influenced by genetic variation. As genotypes are static from birth, life-long differences in genetically predicted protein concentration can be used to identify potentially causal pathogenic or protective proteins while minimizing confounding and reverse causality. Jointly considering the impact of multiple variants on life-long protein concentration can discover novel associations in addition to variants identified in genome-wide association studies (GWAS). In a proteo-genomic association study, we sought to test the impact of genetically predicted variation in 1,161 plasma proteins on eGFR.

**Methods:** We searched for *cis* protein quantitative trait loci (pQTL) genetic variants associated with the concentration of 1,161 plasma proteins in a multi-ancestry sample of 10,753 participants from the Prospective Urban and Rural Epidemiological (PURE) study. Using two-sample Mendelian randomization, we tested if pQTL variants were also associated with eGFR and kidney traits in >1 million participants of published GWAS. We also examined colocalization of pQTL signals and eGFR GWAS results and the phenome-wide impact of genetically altered concentration of the identified proteins.

**Results:** 419 pQTL instruments were constructed in PURE including 4665 genetic variants. In GWAS data, genetically altered concentration of 27 protein biomarkers was associated with eGFR ( $P < 9.5 \times 10^{-5}$ ). *UMOD* was the strongest signal, a positive control of the analysis. Six of the significant biomarkers were previously identified in GWAS; 12 were in identified loci but the causal gene under the GWAS peak was unknown; and 9 loci were unidentified in GWAS. Novel biomarker associations with eGFR include interesting biological candidates such as inhibin beta chain C, a subunit of activins, and proteinase-3, the antigen in PR3-ANCA vasculitis.

**Conclusions:** Using a proteo-genomic association study, 27 biomarkers whose genetically predicted concentration were causally associated with changes in kidney function and risk of kidney disease including interesting biological candidates.

**Funding:** Commercial Support - Bayer

**TH-PO743**

**The Impact of the New Creatinine-Based GFR Estimating Equation Without Race in Korean and US Asian Populations**

Jimin Hwang, Josef Coresh, Morgan Grams, Lesley A. Inker, Jung-Im Shin. *Johns Hopkins University Center for Teaching and Learning, Baltimore, MD.*

**Background:** Guidelines recommend the replacement of the 2009 CKD-EPI creatinine equation using age, sex, and race with the 2021 CKD-EPI creatinine equation without race to calculate estimated glomerular filtration rate (eGFR). This study aimed to examine the impact of the new 2021 CKD-EPI creatinine equation on chronic kidney disease (CKD) prevalence estimates in two distinct Asian populations in Korea and the US.

**Methods:** We conducted a cross-sectional analysis of 5,735 participants from the 2019 cycle of the Korea National Health and Nutrition Survey (KNHANES), and 928 participants who self-reported as Asian from the 2017-2020 pre-pandemic cycle of the United States National Health and Nutrition Survey (NHANES). We compared the prevalence of CKD (eGFR <60 ml/min/1.73 m<sup>2</sup> or urine albumin-to-creatinine ratio ≥30 mg/g) and CKD GFR Stages 3 and higher (eGFR <30, 45, 60 ml/min/1.73 m<sup>2</sup>) using the 2009 CKD-EPI creatinine equation and the 2021 equation.

**Results:** In our study, the prevalence of CKD and eGFR <60 ml/min/1.73 m<sup>2</sup> were higher in US Asians (mean age 46 years, 55% female, 47.3% hypertension, and 17.5% diabetes) than Koreans (mean age 48 years, 49% female, 49.2% hypertension, and 12.2% diabetes). The CKD prevalence estimates by the 2021 CKD-EPI creatinine equation were slightly lower compared with the estimates by the 2009 equation (-0.63 ± 0.10% for Koreans and -0.56 ± 0.23% for US Asians; **Table 1**).

**Conclusions:** The 2021 CKD-EPI creatinine GFR estimating equation without race led to a small decrease in CKD prevalence of similar magnitude in both Korean and US Asian populations.

Prevalence of CKD and eGFR in Korean and US Asian populations, using three eGFR equations

	Equation	Korean population (KNHANES 2019)			US Asian population (NHANES 2017-2020 pre-pandemic)		
		Number in millions	Weighted percent	Change from eGFRcr(ASR)	Number in millions	Weighted percent	Change from eGFRcr(ASR)
Chronic kidney disease	eGFRcr(ASR), 2009	4.66 ± 0.24	10.38 ± 0.53	Ref.	2.00 ± 0.18	14.14 ± 1.29	Ref.
	eGFR(AS), 2021	4.38 ± 0.22	9.75 ± 0.51	-0.63 ± 0.10	1.92 ± 0.19	13.58 ± 1.32	-0.56 ± 0.23
eGFR <60 ml/min/1.73 m <sup>2</sup>	eGFRcr(ASR), 2009	1.13 ± 0.11	2.87 ± 0.25	Ref.	0.53 ± 0.10	3.71 ± 0.74	Ref.
	eGFR(AS), 2021	0.87 ± 0.09	1.93 ± 0.19	-0.94 ± 0.14	0.38 ± 0.10	2.70 ± 0.70	-1.01 ± 0.34
eGFR <45 ml/min/1.73 m <sup>2</sup>	eGFRcr(ASR), 2009	0.36 ± 0.05	0.80 ± 0.11	Ref.	0.16 ± 0.09	1.11 ± 0.60	Ref.
	eGFR(AS), 2021	0.28 ± 0.04	0.62 ± 0.10	-0.18 ± 0.05	0.14 ± 0.09	0.96 ± 0.60	-0.16 ± 0.09
eGFR <30 ml/min/1.73 m <sup>2</sup>	eGFRcr(ASR), 2009	0.09 ± 0.03	0.21 ± 0.07	Ref.	0.08 ± 0.07	0.58 ± 0.49	Ref.
	eGFR(AS), 2021	0.08 ± 0.03	0.19 ± 0.07	-0.02 ± 0.02	0.07 ± 0.07	0.52 ± 0.49	-0.06 ± 0.06

eGFRcr(ASR), 2009: eGFR estimated by the 2009 CKD-EPI equation using age, sex, and race; eGFRcr(AS), 2021: eGFR estimated by the 2021 CKD-EPI equation using age and sex. All weighted values were proportion ± SE.

**TH-PO744**

**Contraception Use Among a Cohort of Reproductive Aged Women With CKD**

Audrey V. Carr,<sup>1</sup> Ian A. Strohbehn,<sup>2</sup> Danielle L. Saly,<sup>2</sup> Jessica S. Tangren.<sup>2</sup> <sup>1</sup>Massachusetts General Hospital Department of Medicine, Boston, MA; <sup>2</sup>Massachusetts General Hospital Division of Nephrology, Boston, MA.

**Background:** Pregnancy in women with chronic kidney disease (CKD) carries an elevated risk of preeclampsia, premature birth, low birth weight, and cesarean section. However, studies also suggest that family planning occurs infrequently in nephrology practices. Little is known about contraception practices in patients with CKD. Here we present data on contraception use in a cohort of reproductive-aged women receiving nephrology care in an academic medical network.

**Methods:** We conducted a retrospective analysis of women ages 18-40 years receiving ambulatory nephrology care in an academic hospital network between 2016-2020. Patients with documented tubal ligation, hysterectomy, or without two eGFR measurements >3 months apart were excluded. We analyzed contraception use patterns by age, CKD stage and teratogenic medication usage.

**Results:** 593 patients met the inclusion criteria. Mean age in the cohort was 29 years. 77% (n=459) of patients had stage 1 or 2 CKD, 12% (n=70) had stage 3 CKD, 4% (n=24) had stage 4 CKD, and 7% (n=40) had stage 5 CKD. 54% of all patients had no documented method of contraception. Contraception use decreased with increasing CKD stage (p for trend <0.01, Figure 1). 52% patients treated with an ACEi or ARB had no documented form of contraception. Of those with a documented method of contraception, 22% used long-acting reversible contraception (intrauterine device or implant), 22% used combined oral contraceptives or other estrogen containing method, and 18% used progesterone-only methods.

**Conclusions:** In this analysis of reproductive aged women with kidney disease, more than half had no documented method of contraception despite high rates of teratogenic medication use. Rates of contraceptive use were lowest in women with advanced CKD. More efforts are needed to increase use of contraception in women with kidney disease, especially in groups at high risk for adverse outcomes with unplanned pregnancies.

**Funding:** NIDDK Support

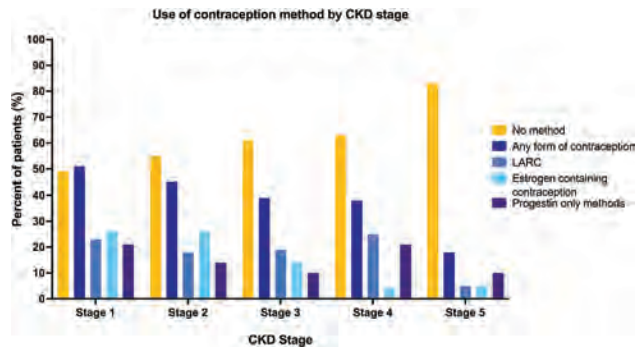

Use of contraception method by CKD stage. Contraception use decreased with increasing CKD stage (p for trend <0.01).

#### TH-PO745

##### Menstruation and Contraception in Females With CKD: A Global Mixed-Methods Study

Danica H. Chang,<sup>1,2</sup> Sandi M. Dumanski,<sup>1,2</sup> Erin A. Brennand,<sup>1</sup> Shannon M. Ruzycki,<sup>1</sup> Kaylee Ramage,<sup>1</sup> Taryn Gantar,<sup>3</sup> Sofia B. Ahmed,<sup>1,2</sup> <sup>1</sup>University of Calgary, Calgary, AB, Canada; <sup>2</sup>Libin Cardiovascular Institute of Alberta, Calgary, AB, Canada; <sup>3</sup>University of Alberta, Edmonton, AB, Canada.

**Background:** Chronic kidney disease (CKD) in reproductive-aged females is accompanied by menstrual disorders and low contraceptive use. However, most data are limited to the dialysis and transplant populations and in-depth experiences describing this within the scope of CKD have not been studied. Therefore, this mixed-methods study aimed to describe self-assessed menstruation and contraceptive use among females across all stages of CKD.

**Methods:** People aged 18-50 years, with a uterus, and diagnosed with CKD were invited to participate in an online survey followed by an optional telephone interview. The survey was disseminated globally through 112 kidney organizations, patient groups, and social media.

**Results:** Of 152 respondents, 98 satisfied the inclusion criteria [n=20 dialysis (age 35±1 years), n=59 non-dialysis (age 32±1 years), n=19 transplant (age 35±2 years)], representing 3 continents and predominantly self-identifying as white cisgender women. The most common causes of CKD were congenital anomalies of the kidney and urinary tract (30%), acute kidney injury and glomerulonephritis (15% each), and IgA nephropathy (21%) among the dialysis, non-dialysis, and transplant groups, respectively. One participant each in the dialysis and non-dialysis groups experienced primary amenorrhea, though more reported secondary amenorrhea (25% dialysis, 15% non-dialysis, 26% transplant). Of participants with current menses, 86%, 94%, and 100% of the dialysis, non-dialysis, and transplant groups reported heavy menstrual bleeding; however, only 50%, 69%, and 43% were always able to afford period products. Regarding, contraception, 50%, 63%, and 37% of dialysis, non-dialysis, and transplant participants reported no use, though among users, male condoms were notably popular in the dialysis (33%) and non-dialysis (48%) groups. Further, the interviews revealed a need for greater multidisciplinary care in the management of reproductive health in the context of CKD.

**Conclusions:** Abnormal menstruation and period poverty are common, and contraception use is low among females with CKD, highlighting an important gap in the sex-specific care of this population.

**Funding:** Government Support - Non-U.S.

#### TH-PO746

##### Effect of Hormonal Contraception on Kidney Outcomes in Females: A Systematic Review and Meta-Analysis

Danica H. Chang,<sup>1,2</sup> Victoria J. Riehl-Tonn,<sup>1,2</sup> Paul E. Ronksley,<sup>1</sup> Sofia B. Ahmed,<sup>1,2</sup> Heather Ganshorn,<sup>1</sup> Erin A. Brennand,<sup>1</sup> Sandi M. Dumanski,<sup>1,2</sup> <sup>1</sup>University of Calgary, Calgary, AB, Canada; <sup>2</sup>Libin Cardiovascular Institute of Alberta, Calgary, AB, Canada.

**Background:** Over 70% of reproductive-aged females in Canada use contraception. Previous literature demonstrates that hormonal contraception has important implications for cardiovascular health, but its effect on kidney health outcomes is poorly understood. Therefore, this systematic review and meta-analysis aimed to determine the effect of hormonal contraception on kidney outcomes in females.

**Methods:** A literature search of MEDLINE, Embase, and CENTRAL (from database inception-November 2021) was developed and reviewed by a health librarian, to identify original studies that reported kidney health outcomes (e.g., kidney function, proteinuria, progression or development of chronic kidney disease or kidney failure) in female hormonal contraception users. Two independent reviewers evaluated articles, extracted data, and assessed study quality in duplicate using the National Institutes of Health Study Quality Assessment Tools. Outcome measures were reported as weighted mean differences and meta-analyzed using a random effects model. Heterogeneity was assessed with the I<sup>2</sup> statistic. A stratified meta-analysis by type of hormonal contraception (oral vs other) was conducted for the outcome of change in serum creatinine.

**Results:** Of the 10,350 references identified within the search strategy, 18 observational studies were included, and 14 were eligible for meta-analysis. Most studies reported on oral contraceptives (N=14). Meta-analyses revealed no difference in mean serum creatinine [0.00 mg/dL (95% CI: -0.05, 0.05); I<sup>2</sup>=68.5%], creatinine clearance [10.01 mL/min (95% CI: -1.48, 21.50); I<sup>2</sup>=90.6%], and estimated glomerular filtration rate [0.37 mL/min/1.73m<sup>2</sup> (95% CI: -8.77, 9.51); I<sup>2</sup>=37.1%] between hormonal contraception users and non-users. When stratified by type of hormonal contraception, the overall pooled estimate also showed no difference in serum creatinine between groups. Overall study quality was fair.

**Conclusions:** This systematic review and meta-analysis found no association between hormonal contraception and various kidney outcomes. While the included studies had significant limitations and heterogeneity, this highlights the need for rigorous prospective studies examining the effect of hormonal contraception on kidney outcomes in females.

**Funding:** Government Support - Non-U.S.

#### TH-PO747

##### Abnormal Menstruation and Female Reproductive Hormones in Kidney Failure

Danica H. Chang,<sup>1,2</sup> Sofia B. Ahmed,<sup>1,2</sup> Erin A. Brennand,<sup>1</sup> Shannon M. Ruzycki,<sup>1</sup> Sandi M. Dumanski,<sup>1,2</sup> <sup>1</sup>University of Calgary, Calgary, AB, Canada; <sup>2</sup>Libin Cardiovascular Institute of Alberta, Calgary, AB, Canada.

**Background:** Kidney failure disrupts the hypothalamic-pituitary-ovarian axis, resulting in reproductive hormone abnormalities. It is not fully understood if these disturbances impact menstruation in females living with kidney failure treated with dialysis. Therefore, this study aimed to (1) describe menstruation and changes in menstrual patterns with chronic kidney disease (CKD) progression, and (2) assess associations between reproductive hormones and menstrual patterns among females with kidney failure.

**Methods:** Females aged 18-50 years were recruited from dialysis clinics around Calgary, Alberta, Canada. Using a self-administered survey, demographic, kidney health, and menstrual health histories were recorded. Blood samples were collected to measure follicle-stimulating hormone, luteinizing hormone, estradiol, progesterone, testosterone, prolactin, sex hormone binding globulin, and anti-Müllerian hormone levels. Descriptive and bivariate analyses were performed as appropriate.

**Results:** Twenty-seven females [n=23 hemodialysis (age 36 (IQR: 31,44) years), n=4 peritoneal dialysis (age 38 (IQR: 30,45) years)], largely identifying as white cisgender women were included. In the hemodialysis group, 52% reported absent menstrual bleeding during dialysis, though only 17% reported this during CKD and 9% before CKD diagnosis (P=0.01); however, there was no difference in proportions across timepoints in the peritoneal dialysis group (25% each) (P=0.92). In the hemodialysis group, 48% described heavy menstrual bleeding during dialysis; this proportion did not differ during CKD (65%) and before CKD diagnosis (70%) (P=0.20). Among participants on peritoneal dialysis, 25% described heavy menstrual bleeding during dialysis, which did not significantly differ during CKD (25%) and before CKD diagnosis (50%) (P=0.91). All the hormone levels did not differ between those with absent and present menstrual bleeding during dialysis, nor did it differ between those with heavy and normal menstrual bleeding.

**Conclusions:** Among females with dialysis-dependent kidney failure, proportions of absent and heavy menstrual bleeding were high. No associations between reproductive hormone levels and menstrual status were observed, underscoring the uncertainty around how kidney disease affects female reproductive health.

**Funding:** Government Support - Non-U.S.

#### TH-PO748

##### A Qualitative Study to Understand Contraceptive Use in Women With Kidney Disease

Silvi Shah,<sup>1</sup> Priyanka Gudsoorkar,<sup>1</sup> Prema D. Vyas,<sup>2</sup> Meredith J. Pensak,<sup>1</sup> <sup>1</sup>University of Cincinnati, Cincinnati, OH; <sup>2</sup>Texas Christian University, Fort Worth, TX.

**Background:** Pregnancy in women with kidney disease is not uncommon and is associated with adverse maternal and fetal outcomes. The use of contraception in women with kidney disease remains low. Little is known about patients' experiences regarding contraceptive use with kidney disease.

**Methods:** The qualitative approach included five focus group discussions (n=13) among women of reproductive age between 18-44 years from a large academic center with a history of kidney disease. Participants shared their experiences and perceptions of contraceptive use, including barriers and facilitators. Interviews were audio-recorded, transcribed, analyzed by two independent reviewers, and coded using a thematic analysis approach.

**Results:** Five major themes emerged in the analyses emerged. 'Knowledge gap' reflected variability ranging from low to considerable understanding regarding reproductive health including knowledge about impaired fertility with kidney disease, use of teratogenic medications that may lead to birth defects, and risk of adverse pregnancy outcomes. 'Lack of counseling' was attributed to time constraints and inadequate counseling by physicians regarding contraceptive use. Women stressed the importance of needing to advocate for one's own reproductive health, and family and spousal support. 'Lack of interdisciplinary approach' involved a lack of coordination of care between nephrologists and gynecologists regarding contraceptive use. Interestingly, a few transplant recipients were better informed about contraceptive use due to follow-up by multidisciplinary transplant teams. 'Insufficient educational resources' referred to the unavailability of educational materials to guide contraception discussion, resulting in a lack of trust in the medical system, and an increase in the utilization of the internet

Key: TH - Thursday; FR - Friday; SA - Saturday; OR - Oral; PO - Poster; PUB - Publication Only

Underline represents presenting author.

for health information. The final theme, 'need for research' highlighted that not enough importance is placed on family planning. Women expressed the fear of unintended pregnancy and frequent decisional conflicts between their own and their baby's health.

**Conclusions:** Participants with kidney disease reported emotional challenges with reproductive health care and a lack of counseling for contraceptive use. A critical need exists to bridge the knowledge gap for women with kidney disease and the interdisciplinary care approach.

**Funding:** Other NIH Support - NHLBI K23 career development award, under Award Number 1K23HL151816-01A1

#### TH-PO749

### Preeclampsia or Lupus Nephritis in Pregnancy: The Role of Renal Biopsy

Angelle Santos, Tripti Singh. *University of Wisconsin-Madison, Madison, WI.*

**Introduction:** Lupus nephritis (LN) in pregnancy is a significant risk factor for adverse obstetric outcomes, including preeclampsia and fetal demise. Preeclampsia and LN have similar manifestations, but treatment is different. Renal biopsy is indicated but there is limited knowledge on its role in pregnancy as it has its own risk. We present a challenging case of a pregnant woman with clinical features suggesting new-onset LN and manifested as preeclampsia at 25 weeks age of gestation (AOG).

**Case Description:** A 34-year-old female with history of benign ethnic neutropenia and thrombocytopenia, was found to have transaminitis, worsening thrombocytopenia and proteinuria of 5 grams at 19th week AOG. Labs also revealed positive antinuclear antibodies, positive anti-Ro, and negative double-stranded DNA. She was treated with steroids for 4 days which led to normalization of her platelet counts. She presented with acute kidney injury (AKI) with serum creatinine (SCr) increasing from 0.4 to 0.7 mg/dL and hypertension (HTN) at 24 weeks AOG. Work up revealed severe intrauterine fetal growth restriction (IUGR). She underwent kidney biopsy at 25 weeks AOG and was empirically started on LN treatment with steroids and hydroxychloroquine. Her course rapidly worsened with AKI (SCr 1.05 mg/dL), increasing proteinuria and hypoalbuminemia, HTN and symptoms of volume overload including ascites, pleural and pericardial effusions. Kidney biopsy revealed immune complex deposition consistent with lupus nephritis and endothelial cell injury consistent with preeclampsia. Emergent induction was planned, as expectant management becomes a contraindication. After induction and delivery to a demised fetus, AKI and HTN improved to baseline and proteinuria decreased to 4.5 grams/24 hours in 48 hours post-partum.

**Discussion:** The patient presented with AKI, HTN and nephrotic syndrome that can be seen in LN as well as preeclampsia. LN can be treated empirically with steroids, but establishing the diagnosis was essential, especially at 25 weeks AOG, as inducing delivery for preeclampsia would be fatal for the fetus due to IUGR. In conclusion, distinguishing LN and preeclampsia is challenging, but rapid diagnosis is essential as complications can be fatal for both the mother and the fetus. Kidney biopsy is high risk in advanced pregnancies but is essential in management if there is diagnostic dilemma.

#### TH-PO750

### Preeclampsia and Long-Term Kidney Outcomes

Nityasree Srialluri,<sup>1</sup> Aditya L. Surapaneni,<sup>1</sup> Alex R. Chang,<sup>2</sup> Morgan Grams,<sup>1,3</sup> <sup>1</sup>Johns Hopkins University, Baltimore, MD; <sup>2</sup>Geisinger Health, Danville, PA; <sup>3</sup>New York University Grossman School of Medicine, New York, NY.

**Background:** Preeclampsia is a complication of pregnancy characterized by acute hypertension and end-organ dysfunction. We aimed to evaluate the long-term association between preeclampsia and the risk of developing chronic hypertension and kidney disease.

**Methods:** We identified adult women without pre-existing hypertension or kidney disease who underwent deliveries in the Geisinger Health System between 1996-2019 over a median follow up of 21 years. We used propensity-score matching to compare women who developed preeclampsia during pregnancy with women who did not. Cox proportional hazards models were used to evaluate the association between preeclampsia and incident hypertension, reduced estimated glomerular filtration rate (eGFR; <60 ml/min/1.73 m<sup>2</sup>), and albuminuria > 300mg/g.

**Results:** Of the 27800 women with pregnancies during the study period (mean [SD] age, 28[5.6] years; 3% black race), 2340 (8.4%) had at least one pregnancy complicated by preeclampsia. Women with preeclampsia had higher risk of developing chronic hypertension (HR, 1.72; 95% CI 1.41 - 2.11), eGFR < 60ml/min/1.73 m<sup>2</sup> (HR 2.27; 1.26 - 4.09), and albuminuria (HR, 3.85; 95% CI 2.52 - 5.88), compared to matched controls without preeclampsia (Fig. 1). Additionally, the risk of a subsequent episode of preeclampsia was higher in women with preeclampsia compared to the matched controls (HR, 12.03; 95% CI 7.31 - 19.81).

**Conclusions:** Women with a pregnancy complicated by preeclampsia have a higher risk of hypertension, reduced eGFR, and albuminuria later in life compared to women without preeclampsia. Preeclampsia should be considered an important risk factor for hypertension and kidney disease. Further focus should be placed on implementing appropriate preventive strategies and vigilant post-partum follow-up in this population.

**Funding:** NIDDK Support

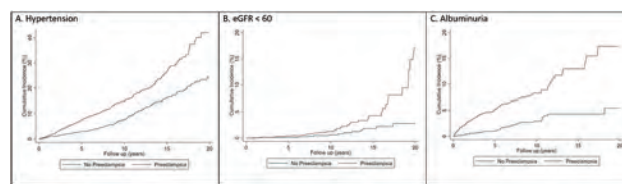

Kaplan Meier estimates of cumulative incidence of Hypertension, eGFR <60, and albuminuria among women with and without preeclampsia

#### TH-PO751

### Preeclampsia Is Associated With Complement Activation in Maternal and Fetal Circulation and Placental Tissue

Hannah Blakey,<sup>1,2</sup> Nadia Sarween,<sup>1</sup> Edwin K. Wong,<sup>4</sup> Neil S. Sheerin,<sup>4</sup> Kate Bramham,<sup>5</sup> Claire L. Harris,<sup>4</sup> Ellen Knox,<sup>3</sup> Mark T. Drayson,<sup>2</sup> Graham Lipkin,<sup>1</sup> <sup>1</sup>Queen Elizabeth Hospital Birmingham, Birmingham, United Kingdom; <sup>2</sup>University of Birmingham, Birmingham, United Kingdom; <sup>3</sup>Birmingham Women's and Children's NHS Foundation Trust, Birmingham, United Kingdom; <sup>4</sup>Newcastle University, Newcastle upon Tyne, United Kingdom; <sup>5</sup>King's College London, London, United Kingdom.

**Background:** Pre-eclampsia (PE) is a leading cause of obstetric morbidity. There remains no definitive therapy other than delivery. Long-term sequelae include an increased lifetime risk of chronic kidney disease. Complement dysregulation has been implicated in the pathogenesis of PE, although the current evidence base is limited. Our aim was to compare patterns of placental and maternal and fetal circulatory complement activity in healthy pregnant women and those with PE, to gain insight into complement activation and guide potential complement-modifying therapies.

**Methods:** Women with PE and healthy pregnant controls were recruited from a tertiary obstetric centre. Samples of maternal and umbilical cord blood were tested for iC3b, C3, C4, properdin, Ba and C5b-9, and placental tissue stained for C3d, C4d, C9 and C1q, from women with PE (n=34) and healthy pregnant controls (n=33). Properdin and Ba concentrations were validated in maternal plasma samples (PE n=35; controls n=35) from a separate tertiary centre cohort.

**Results:** Women with PE had significantly lower blood concentrations of properdin (mean 4828 vs 6877 ng/ml, p<0.001) and C4 (mean 0.20 vs 0.31 g/l, p<0.001), and higher Ba (median 150 vs 113 ng/ml, p=0.012), compared to controls. Properdin findings were replicated in the validation cohort (mean 5282 in PE vs 7021 ng/ml in controls, p<0.001). Combined cohort average properdin concentrations were 1945 ng/ml lower in PE vs controls (p<0.001), AUROC 0.87. Umbilical cord Ba was higher in PE vs controls (mean 380.7 vs 210.5 ng/ml, p=0.015). There was increased placental C4d deposition at the syncytiotrophoblast membrane in PE vs controls (median immunoreactivity score 3 vs 0, p<0.001). Maternal plasma properdin and C4 were strongly negatively correlated with placental C4d deposition.

**Conclusions:** Our data confirm excessive complement activation products in maternal and fetal circulation, strongly associated with placental complement deposition in women with PE. Classical or lectin pathway activity drives placental C4d deposition, which is amplified by the alternative pathway amplification loop, leading to significant changes in plasma complement biomarkers. Inhibition of complement activation is a potential therapeutic target in the treatment of PE.

#### TH-PO752

### Fetal APOL1 Risk Variants Association With Adverse Maternal Outcomes of Early Onset Preeclampsia

Desiree Fiorentino,<sup>1</sup> Rebecca C. Hjorten,<sup>5</sup> Jeffrey B. Kopp,<sup>3</sup> Joseph T. Myrie,<sup>4</sup> Sandra E. Reznik,<sup>1</sup> Tao Wang,<sup>1</sup> Cheryl A. Winkler,<sup>2</sup> Kimberly J. Reidy,<sup>1</sup> <sup>1</sup>Montefiore Medical Center, Bronx, NY; <sup>2</sup>National Cancer Institute, Bethesda, MD; <sup>3</sup>National Institutes of Health, Bethesda, MD; <sup>4</sup>Stanford University, Stanford, CA; <sup>5</sup>University of Washington, Seattle, WA.

**Background:** Preeclampsia, a hypertensive disorder unique to pregnancy, has a higher incidence in women of African descent. Fetal APOL1 gene variants have been associated with increased risk of preeclampsia, but their association with maternal outcomes of preeclampsia has not been examined. We hypothesized fetal APOL1 high risk gene variants are associated with increased risk of maternal complications of preeclampsia.

**Methods:** Fetal APOL1 genotypes were performed in 56 mother-infant dyads affected by early onset preeclampsia diagnosed at less than 34 weeks of gestation. Births were eligible for inclusion if preeclampsia was mentioned in the placental pathology report and if the EMR identified the mother as "black or African American". Diagnosis of preeclampsia was confirmed using ACOG criteria. Clinical data on complications was obtained from the medical record. Fisher's exact test was performed comparing the incidence of complications in mothers with fetal APOL1 high risk variants (APOL1 G1,G1; G1,G2; or G2,G2) vs. those with fetal APOL1 low risk variants (G1,G0 or G2,G0 or G0,G0).

**Results:** There were no statistically significant differences in the occurrence of maternal mortality, transaminitis, coagulopathy, hepatic hematoma, Glasgow coma score <13, stroke, visual disturbances, dialysis, postpartum hemorrhage, placental abruption, thrombocytopenia, blood transfusion, myocardial ischemia, eclampsia, pulmonary edema, intubation or oxygen supplementation for more than one hour amongst the two

groups. There was a significant increase in the rate of acute kidney injury in mothers with preeclampsia with fetal *APOL1* HR variants ( $p=0.035$ ). While there was no difference in the risk of having at least one complication, the composite score obtained as the sum of all complications experienced showed a trend towards greater complications for the fetal *APOL1* HR group with a mean number of complications of 2.7 vs 1.4. This difference did not reach statistical significance ( $p$ -value 0.16). (OR 1.45, 95% CI -0.6-3.2).

**Conclusions:** Rate of AKI in patients diagnosed with early onset preeclampsia was higher in women with fetal *APOL1* high risk alleles. The overall number of complications trended higher in this group, although it did not reach statistical significance.

**Funding:** Other NIH Support - National center for advancing translational sciences, Private Foundation Support

#### TH-PO753

##### The Influence of Normal and Preeclamptic Syncytiotrophoblast Extracellular Vesicles on Human Podocytes

Shuhan Jiang,<sup>1</sup> Toluwalase Awoyemi,<sup>1</sup> Maryam Rahbar,<sup>1</sup> Prassana V. Logenthiran,<sup>1</sup> Wei Zhang,<sup>1</sup> Jack P. Tuffin,<sup>2</sup> Moin Saleem,<sup>2</sup> Manu Vathish,<sup>1</sup>  
<sup>1</sup>University of Oxford, Oxford, United Kingdom; <sup>2</sup>University of Bristol, Bristol, United Kingdom.

**Background:** Circulating levels of syncytiotrophoblast extracellular vesicles (sSTBEVs) increase throughout gestation in normal pregnant (NP) women, and their levels are higher in preeclampsia (PE). In NP, glomerular filtration rates (GFR) increase by 50%, while in PE GFR can reduce by up to 32% which implicates the impaired glomerular filtration barrier (GFB) function. Podocytes are specialised renal cells which are involved in GFB maintenance. We aimed to evaluate whether small sSTBEVs (sSTBEVs) from NP and PE can be internalized by podocytes and influence function.

**Methods:** NP (n=3) and PE (n = 3) sSTBEVs were isolated by dual-lobe placental perfusion and differential centrifugation. sSTBEVs were phenotyped by immunoblotting, nanoparticle tracking analysis and transmission electron microscopy. sSTBEVs internalization by podocytes was assessed by flow cytometry and confocal microscopy. qPCR was used to analyze if sSTBEVs could transfer placental specific C19 miRNA into podocytes. Podocyte nephrin expression, migration ability, actin cytoskeleton and adhesion ability were assessed after treatment with sSTBEVs.

**Results:** The internalization of sSTBEVs by podocytes could be observed from 30mins and was time and dose dependent. There was no significant difference in number of sSTBEVs from NP and PE internalised by podocytes. We were able to detect placental specific C19 miRNA in podocytes treated with these sSTBEVs. Podocyte nephrin expression was increased by 1.9-fold ( $p<0.05$ ) and podocyte migration ability was upregulated by 1.2-fold ( $p<0.05$ ). F-actin staining was enhanced across the podocytes after NP sSTBEVs treatment ( $p<0.05$ ). In contrast, PE sSTBEVs treatment showed no change in nephrin expression or podocyte migration ability. Additionally, podocyte adhesion ability was impaired and F-actin appeared stressed (cortical ring formation).

**Conclusions:** NP and PE sSTBEVs can be taken up by podocytes. NP sSTBEVs enhanced podocyte function via elevated nephrin expression and migration ability. In contrast, PE sSTBEVs impaired podocyte via reduced adhesion ability and nephrin expression was unchanged. We speculate the enhanced functions of podocytes after NP sSTBEVs treatment may contribute GFB maintenance while sSTBEVs from PE may contribute to GFB damage.

#### TH-PO754

##### Preeclamptic Phenotype in Transgenic Mice With Fetuses Carrying APOL1 Risk Variants

Teruhiko Yoshida,<sup>1</sup> Khun Zaw Latt,<sup>1</sup> Huiyan Lu,<sup>1</sup> Kimberly J. Reidy,<sup>2</sup> Jennifer R. Charlton,<sup>3</sup> Yongmei Zhao,<sup>4</sup> Shashi Shrivastav,<sup>1</sup> Sandra E. Reznik,<sup>2</sup> Avi Z. Rosenberg,<sup>3</sup> Cheryl A. Winkler,<sup>4</sup> Jeffrey B. Kopp.<sup>1</sup> <sup>1</sup>National Institute of Diabetes and Digestive and Kidney Diseases, Bethesda, MD; <sup>2</sup>Children's Hospital at Montefiore, Bronx, NY; <sup>3</sup>University of Virginia, Charlottesville, VA; <sup>4</sup>Frederick National Laboratory for Cancer Research, Frederick, MD; <sup>5</sup>Johns Hopkins University, Baltimore, MD.

**Background:** African Americans experience more pregnancy complications, including preeclampsia, compared to others. African-origin genetic variants in apolipoprotein L1 (*APOL1*), promote various renal disorders. Recent clinical studies showed that fetuses with two *APOL1* risk variants predispose the mother to preeclampsia. The mechanisms of *APOL1*-associated preeclampsia remain poorly understood. Here we made use of a transgenic mouse model to investigate these mechanisms.

**Methods:** We in-vitro-fertilized CD-1 female mice using sperm from human *APOL1* gene locus transgenic mice carrying a bacterial artificial chromosome bearing either the *APOL1*-G0 allele (common variant) or the *APOL1*-G1 allele (risk variant). We measured systolic blood pressure with a tail cuff. We euthanized mice at E18.5 and collected fetuses, placenta and maternal plasma. We evaluated the phenotype of the dam by plasma chemistry and assessed weight of fetuses and placenta. We characterized placental transcriptomic profiles by single-nuclear RNA-seq.

**Results:** Compared with a dam with *APOL1*-G0 fetuses, a dam with *APOL1*-G1 fetuses had higher systolic blood pressure, 158 [141-163] vs 116 [115-131] mmHg; median [IQR],  $P=0.01$ ) and had lower plasma placental growth factor-2 levels (32 [20-82] vs 126 [98-260] pg/mL;  $P=0.047$ ). *APOL1*-G1 fetuses had lower relative weights, (0.95 [0.90-0.98] vs 1.0 [0.96-1.04];  $P=0.03$ ) when compared with WT fetuses. By contrast, *APOL1*-G0 fetuses had relative weights similar to wild-type (WT) fetuses (0.99 [0.95-1.08];  $P=1.0$ ). Single-nucleus RNA-seq demonstrated increased expression of

inflammation-related genes (e.g. *Spp1*, encoding osteopontin; *Lyz2*, encoding lysozyme2) in *APOL1*-expressing endothelial cells and trophoblasts in placentas of *APOL1*-G1 fetuses compared with placentas of *APOL1*-G0 and WT fetuses.

**Conclusions:** This *APOL1* mouse preeclampsia model suggests that the *APOL1*-G1 allele promotes endothelial and trophoblastic inflammation and thus contributes to placental dysfunction and preeclamptic phenotypes, similar to human disease.

**Funding:** NIDDK Support

#### TH-PO755

##### The Role of miR-143-3p in Podocyte Damage in Preeclampsia

Sonja Suvakov, Tamara Gojkovic, Vesna D. Garovic. Mayo Clinic Division of Nephrology and Hypertension, Rochester, MN.

**Background:** Preeclampsia (PE) is a pregnancy-specific disease characterized by hypertension accompanied by either proteinuria and/or end-organ damage. Previous research has shown that PE is associated with podocytopathy and an increased number of podocyte-derived urinary extracellular vesicles (EV), but underlying the mechanism is not well understood. We aimed to elucidate the potential role of miR-143-3p in podocyte injury in PE.

**Methods:** XRNA Exosome RNA-Seq Library Kit and qPCR were used to identify miRNA candidate(s) to study. Micro RNA 143-3p was identified and its expression was studied in an immortalized human podocyte cell line treated with either PE sera or TNF- $\alpha$ . We also investigated miR143-3p roles in inflammation, VEGF secretion, podocyte migration, both in the absence and presence of its inhibitor.

**Results:** Upon assessing differential miRNA expressions in urinary EV and validating candidates relevant for kidney injury, we identified miR143-3p as significantly increased in PE. Treatment of an immortalized podocyte cell line with either pooled PE sera or TNF- $\alpha$ . Treatment with pooled sera showed increase in miR143-3p expression in dose-dependent manner. In conditioned media, TGF- $\beta$  was increased while VEGF was decreased, both reversed by treatment with mi-143-3p inhibitor. Podocytes incubated with TNF- $\alpha$  showed higher gene expressions of miR143-3p and pro-inflammatory cytokines, IL-6, IL-8 and MCP-1, which were attenuated by a miRNA-143-3p inhibitor. No significant changes in p16 and p21 gene expressions were observed with either treatment. Beta-gal staining for senescence indicated increased senescent phenotype in podocytes treated with PE sera. Wound healing assay showed that both treatments decreased migration of podocytes, whereas the miRNA inhibitor improved migration. Finally, the total number of both podocin and nephrin positive EVs was increased in cultured media upon podocyte treatment with PE sera.

**Conclusions:** Micro RNA 143-3p is abundant in urinary EVs of preeclamptic women. It mediates expressions of pro-inflammatory cytokines in podocytes and affects their migration. These results indicate that miR-143-3p may contribute to the pathophysiology of podocyte injury in preeclampsia.

#### TH-PO756

##### Podocyte Loss and Progression of CKD in Pregnancy

Dilara Eren,<sup>1</sup> Carolyn Gill,<sup>1,3</sup> Jennifer R. Joslin,<sup>1,2</sup> Kate Bramham,<sup>1,2</sup> Priscilla Smith.<sup>1,2</sup> <sup>1</sup>King's College London, London, United Kingdom; <sup>2</sup>King's College Hospital NHS Foundation Trust, London, United Kingdom; <sup>3</sup>Guy's and St Thomas' NHS Foundation Trust, London, United Kingdom.

**Background:** Chronic kidney disease (CKD) in pregnancy is associated with deterioration in kidney function, but there are no biomarkers to predict or detect progression. Urinary podocyte loss is recognised in progressive glomerular diseases outside of pregnancy and preeclampsia but has not been explored in CKD pregnancy.

**Methods:** Urine pellets collected in two prospective studies of pregnant women with CKD were analysed for podocyte proteins (Nephrin, Podocalyxin and Podocin) using validated sandwich enzyme-linked immunosorbent assays. Participants included 20 with pregnancy associated progression of CKD (PrCKD), 10 with stable CKD (StCKD), and 10 without CKD (Controls).

**Results:** Serum creatinine increased in women with PrCKD throughout pregnancy and post-partum. Placental growth factor concentrations were normal in all women, but podocin concentrations in controls were significantly higher in women with PrCKD and StCKD than Controls (see figure 1); there were no differences between women with PrCKD and StCKD. There were no significant differences between groups for Nephrin and Podocalyxin. Demographic data are shown in Figure 2.

**Conclusions:** Nephrin, Podocin and Podocalyxin can be identified in the urine pellet in pregnancy, with increased podocin concentrations in CKD pregnancy suggesting increased podocyte cell loss, which requires confirmation in a larger prospective cohort.



Figure 1, Podocin Concentrations

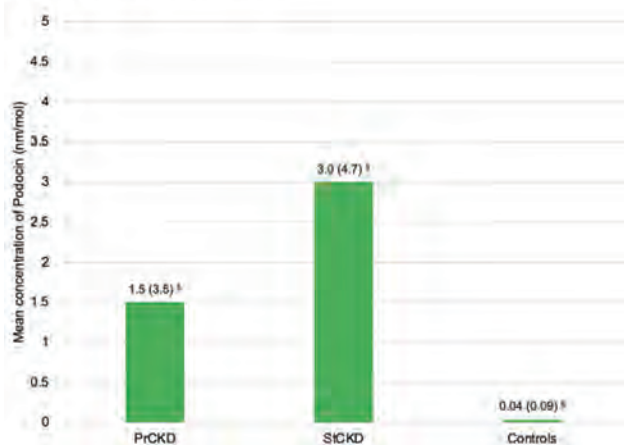

§ Podocin Concentration Mean (±SD)

Figure 2, Baseline Demographics

	Progressing CKD (P-CKD) Group N=20	Stable CKD (S-CKD) Group N=10	No CKD (Control) Group N=10
Maternal Age (Years) Mean (±SD)	34.8 (5.4)	33.0 (5.2)	33.3 (4.2)
Gestation at time of sample (Week,Day) Mean (±SD)	28.1 (7.8)	28.3 (6.3)	29.0 (6.9)
<b>Ethnicity Number (%)</b>			
White	12 (60)	6 (60)	8 (80)
Black	5 (25)	1 (10)	2 (20)
Asian	3 (15)	1 (10)	2 (20)
Other	0 (0)	2 (20)	0 (0)
<b>Blood Pressure</b>			
Booking Systolic (mmHg) Mean (±SD)	127 (17)	120 (11)	100 (12)
Booking Diastolic (mmHg) Mean (±SD)	78 (15)	76 (8)	67 (10)
Systolic at time of sample (mmHg) Mean (±SD)	130 (15)	123 (10)	105 (8)
Diastolic at time of sample (mmHg) Mean (±SD)	83 (12)	79 (7)	68 (5)
Pre-pregnancy eGFR Mean (±SD)	60 (27)	69 (22)	N/A
Post-pregnancy eGFR Mean (±SD)	40 (25)	74 (24)	N/A
<b>Stage of CKD (pre-pregnancy) Number (%)</b>			
G1-2	8 (40)	7 (70)	N/A
G3	10 (50)	2 (20)	N/A
G4-5	2 (10)	1 (10)	N/A
<b>Underlying Renal Disease Number (%)</b>			
Immunoglobulin A nephropathy	6 (30)	1 (10)	0 (0)
Lupus nephritis	4 (20)	6 (60)	0 (0)
Diabetic nephropathy	2 (10)	1 (10)	0 (0)
Focal segmental glomerulosclerosis	2 (10)	0 (0)	0 (0)
Other	6 (30)	2 (20)	0 (0)
<b>Medical history Number (%)</b>			
Chronic hypertension	8 (40)	4 (40)	0 (0)
Type 1 Diabetes Mellitus	2 (10)	1 (10)	0 (0)
<b>Final diagnosis Number (%)</b>			
Normal pregnancy	0 (0)	0 (0)	10 (100)
Pre-eclampsia superimposed on CKD	12 (60)	4 (40)	0 (0)
Gestational proteinuria with CKD	5 (25)	1 (10)	0 (0)
Normal pregnancy with CKD	1 (5)	4 (40)	0 (0)
Other	2 (10)	1 (10)	0 (0)

TH-PO757

**An Intriguing Case of Hypertension and Hypokalemia in a Third Trimester Pregnancy: Early-Onset Autosomal Dominant With Severe Exacerbation in Pregnancy**

Boonyanuth N, Maturostrakul, Abhishek Nimkar, Mala Sachdeva, Kenar D. Jhaveri. Northwell Health, New Hyde Park, NY.

**Introduction:** Geller et al described a familial syndrome of hypertension (HTN) and hypokalemia, exacerbated by pregnancy, caused by an activating mutation of the mineralocorticoid receptor (MR). Here we describe a case of hypokalemia and hypertension with pregnancy that is consistent with the diagnosis of Geller syndrome.

**Case Description:** A 35 yo woman (G1P0) was admitted at 37 weeks gestation for HTN and hypokalemia. She had no prior history of HTN prior to this and had normal K values during most of her pregnancy. She had a family history of both mother and father with HTN since their 30s. She was noted to have a low serum K of 2.9mmol/L and BP in 145/90mmHG range, highest blood pressure recorded of 156/88 mmHG, and was persistent for 2 weeks prior to admission. She denied nausea, vomiting, or diarrhea. Physical examination showed 1+ bilateral lower extremity edema. There was no

proteinuria. Urine K was 19 mmol/L, urine Cr 55 mg/dl, plasma Aldosterone <3.0 ng/dL, and plasma renin activity 1.10 g/ml/hr. The urine K/crt ratio was 36.3 meq/g. Her serum cortisol was not low or too high. She was started on potassium supplements with prompt delivery. She delivered a healthy baby girl and 3 weeks post-delivery; her BP is in 90-100mmHg SBP and 50-60mmHg DBP range. She is off her K supplements as repeat K after 3 weeks post delivery was 5.1mmol/L. Her repeat aldosterone level 4 weeks post delivery was 32.3ng/dL. Genetic testing for Liddle's syndrome and Geller's syndrome was performed and pending results.

**Discussion:** Normally the MR is activated by aldosterone but inhibited by progesterone. The novel MR S810L, described by Geller et al, is activated by both aldosterone and progesterone. In the initial description, two MR L810 carriers had a pregnancy-induced exacerbation of HTN and hypokalemia in 5 pregnancies, with low aldosterone levels. High progesterone in pregnancy was implicated. Our patient experienced new HTN and new hypokalemia in pregnancy, with renal potassium wasting and low renin and aldosterone levels, consistent with autosomal dominant early onset HTN with hypokalemia exacerbated during pregnancy. This resolved few weeks post delivery as noted with labs above. Classically in pregnancy, aldosterone and renin levels are higher than baseline. Genetic testing will confirm the diagnosis.

TH-PO758

**Involvement of Tubulo-Interstitial Impairment in the Renal Disorders Associated With Hypertensive Disorder in Pregnancy (HDP)**

Mariko Sato, Kaori Takayanagi, Koki Ogawa, Erika Sawada, Atsuko Yasui, Takatsugu Iwashita, Tomonari Ogawa, Akito Maeshima, Hajime Hasegawa. Saitama Medical Center, Saitama Medical University, Kawagoe, Japan.

**Background:** Renal involvement is frequently complicated in the Hypertensive Disorder in Pregnancy (HDP). Since enlargement of glomerular endothelial cells (endotheliosis) is observed in HDP, glomerular disorder has been considered as the principal locus of renal involvement in HDP. In the meantime, the vasospasm in the HDP is believed to be observed not only in the placenta but also systemically, and the involvement of the vasoconstriction-related tubulo-interstitial disorder (TID) is also speculated in the kidney, but the report is limited. In this study, we aim to investigate time-differential changes in multiple parameters with TID to examine its participation in HDP.

**Methods:** Twenty patients diagnosed with HDP at obstetrics department were prospectively studied. Three blood and urine samples around 30 weeks of gestation (P1), around 38 weeks of gestation (P2) and 1 month postpartum (P3) were used for the analysis. Mean home-measured morning blood pressure (BP) during the 3 days before sample collection was used as BP value.

**Results:** The mean age was 35.5 years, and half were taking methyldopa orally (mean 825 mg/day). Mean systolic BP was P1: 121.1, P2: 128.8, and P3: 122.3 mmHg. The median urine Alb was P1: 12.9, P2: 24.2, P3 30.2 mg/gCr, and there were few cases with overt albuminuria or proteinuria in this population. Among TID-related parameters, urine MCP-1, in urine NAG, urine activin and urine alpha1-MG, differences were observed in P1, P2 and P3. When stratified into high BP group (BPH) and low BP group (BPL) at systolic BP level of P1, there was a difference in the median value between BPH and BPL in urine MCP-1 (BPH P1: 1076.3, P2: 1098.1, P3: 358.0; BPL P1: 644.4, P2: 582.5, P3: 333.9) and urine NAG.

**Conclusions:** The changes of multiple TID parameters during the course of gestation, and the relevance of TID parameters with the degree of blood pressure at P1 phase might suggest an association between the severity of HDP and TID. In conclusion, it was suggested that the renal TID might be involved in HDP regardless of the existence of proteinuria.

TH-PO759

**Investigating the Psychological and Clinical Correlates of Pregnancy Risk and Pregnancy Intention in Women With CKD**

Elizabeth R. Ralston,<sup>1</sup> Joseph Chilcot,<sup>3</sup> Katherine R. Clark,<sup>1,2</sup> Priscilla Smith,<sup>1,2</sup> Kate Bramham,<sup>1,2</sup> <sup>1</sup>King's College London Faculty of Life Sciences and Medicine, London, United Kingdom; <sup>2</sup>King's College Hospital, London, United Kingdom; <sup>3</sup>King's College London Institute of Psychiatry Psychology and Neuroscience, London, United Kingdom.

**Background:** Women with Chronic Kidney Disease (CKD) are at increased risk of adverse pregnancy and renal outcomes. Risk perception is recognised to impact behaviour. This study aimed to understand how women with CKD perceive their pregnancy risk and understand what clinical and psychological factors are associated with perceived pregnancy risk and pregnancy intention.

**Methods:** Women aged between 18 and 50 years with CKD Stages 1-5 were recruited from nine renal units in the United Kingdom and asked to complete an online survey (October 2020 to December 2021). Demographic, pregnancy preference information, and psychological attributes (with validated tools) were measured. Clinical data were extracted from local databases. Multivariable linear regressions were performed.

**Results:** 315 women participated, mean age 35 (7.1) with mean estimated glomerular filtration rate (eGFR) 62.2 ml/min/1.73m<sup>2</sup> (SD 34.7). 108 (34.4%) women had previously attended pre-pregnancy counselling and 234 (74%) reported pregnancy being important to very important. Women with CKD appear to have greater perceived pregnancy risk (46.0, SD 23) than previously reported in lower risk groups (24.0, SD 14.5). After adjustment no associations were reported between clinical characteristics including eGFR and women's perceived pregnancy risk, but attendance to pre-pregnancy counselling ( $b = 6.5$ , 95% CI 1.5 to 11.4,  $p = 0.011$ ) and women's perceived kidney disease severity ( $b = 0.15$ , 95% CI 0.04 to 0.26,  $p = 0.010$ ) were associated with perceived pregnancy risk. No correlation

was reported between perceived pregnancy risk and pregnancy intention ( $r = -0.002$ , 95% CI -0.12 to 0.11,  $p = 0.97$ ), there was also no association with clinical risk factors and pregnancy intention. Importance of pregnancy was the strongest associated factor with pregnancy intention ( $b = 0.4$ , 95% CI 0.2 to 0.5,  $p < 0.001$ ).

**Conclusions:** Women with CKD appear to perceive their pregnancy risk to be greater compared to pregnancies uncomplicated by CKD. The importance of pregnancy for women with CKD is high, but clinical status is not associated with their future pregnancy intention or perceived pregnancy risk.

#### TH-PO760

##### Pregnancy History and Disease Progression Among Women Enrolled in Cure Glomerulopathy (CureGN)

Monica L. Reynolds,<sup>1</sup> Andrea L. Oliverio,<sup>2</sup> Jarcy Zee,<sup>3</sup> Isabelle Ayoub,<sup>4</sup> Salem Almaani,<sup>4</sup> Dana Rizk,<sup>5</sup> Michelle M. O'Shaughnessy,<sup>6</sup> Elizabeth M. Hendren,<sup>7</sup> Tetyana L. Vasylyeva,<sup>8</sup> Shikha Wadhvani,<sup>9</sup> Julia M. Steinke,<sup>10</sup> Meryl A. Waldman,<sup>11</sup> Margaret Helmuth,<sup>12</sup> Carla M. Nester,<sup>13</sup> Nada Alachkar,<sup>15</sup> Carmen Avila-Casado,<sup>16</sup> Michelle A. Hladunewich,<sup>14</sup> Laura H. Mariani.<sup>2</sup> <sup>1</sup>University of North Carolina System, Chapel Hill, NC; <sup>2</sup>University of Michigan, Ann Arbor, MI; <sup>3</sup>University of Pennsylvania, Philadelphia, PA; <sup>4</sup>The Ohio State University, Columbus, OH; <sup>5</sup>The University of Alabama at Birmingham College of Arts and Sciences, Birmingham, AL; <sup>6</sup>University College Cork, Cork, Ireland; <sup>7</sup>Columbia University, New York, NY; <sup>8</sup>Texas Tech University System, Amarillo, TX; <sup>9</sup>Northwestern University, Evanston, IL; <sup>10</sup>Spectrum Health Helen DeVos Children's Hospital, Grand Rapids, MI; <sup>11</sup>National Institute of Diabetes and Digestive and Kidney Diseases, Bethesda, MD; <sup>12</sup>Arbor Research Collaborative for Health, Ann Arbor, MI; <sup>13</sup>University of Iowa, Iowa City, IA; <sup>14</sup>Sunnybrook Health Sciences Centre, Toronto, ON, Canada; <sup>15</sup>Johns Hopkins University, Baltimore, MD; <sup>16</sup>University of Toronto, Toronto, ON, Canada.

**Background:** Preeclampsia increases risk for future CKD, possibly through sustained endothelial and podocyte dysfunction. Utilizing CureGN, a longitudinal glomerular disease cohort study, we assessed if complicated pregnancy history was associated with disease progression.

**Methods:** Adult women were classified based on self-reported history of complicated pregnancy (worsening blood pressure, worsening kidney function, increased proteinuria, preeclampsia, eclampsia, or HELLP), pregnancy without these complications, or no pregnancy prior to CureGN enrollment. Linear mixed models assessed associations between complicated pregnancy history and eGFR trajectory as well as UPCR from enrollment.

**Results:** Of 780 women with median follow-up of 32 months, the adjusted eGFR decline [95% CI] was faster in women with a history of complicated pregnancy compared to those without complications or no pregnancy (-2.1 [-2.9, -1.4] vs -0.9 [-1.4, -0.5] and -0.7 [-1.3, -0.1] mL/min/1.73m<sup>2</sup> per year,  $p = 0.01$ ) (Figure). Proteinuria trend did not differ significantly by pregnancy history. Among women with complicated pregnancy ( $n=124$ ), eGFR slope did not differ significantly by timing of first complicated pregnancy relative to GN diagnosis.

**Conclusions:** A history of complicated pregnancy, occurring at any length of time from GN diagnosis, was associated with faster eGFR decline following CureGN enrollment. A detailed obstetric history may inform counseling regarding disease progression in women with GN. Continued research is warranted to identify biological pathways between complicated pregnancy and progressive glomerular disease.

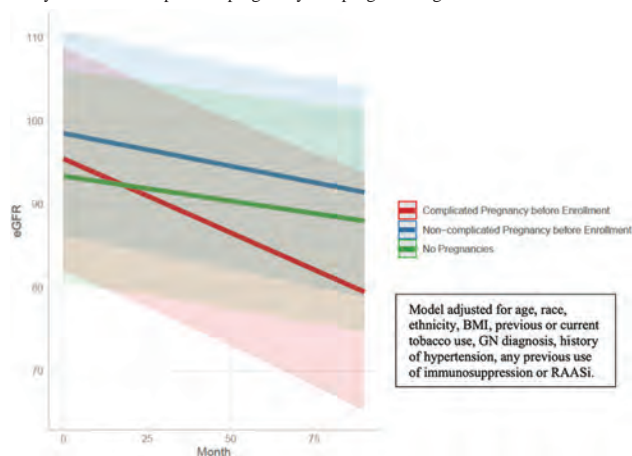

Predicted values of eGFR (95% CI) by pregnancy history from adjusted linear mixed model

#### TH-PO761

##### International Pregnancy Outcomes in Alport Syndrome (COL4A3-5 Related Disease) vs. CKD in General

Margriet Gosselink,<sup>1</sup> Rozemarijn Snoek,<sup>1</sup> Sofia P. van Bakel,<sup>1</sup> Agne Cerkauskaite,<sup>6</sup> Rimante Cerkauskiene,<sup>6</sup> Marius Miglinas,<sup>6</sup> Kalman Tory,<sup>9</sup> Kathleen Claes,<sup>5</sup> Kristel Van Calsteren,<sup>5</sup> Aude Servais,<sup>3</sup> Margriet de Jong,<sup>8</sup> Valentine Gillion,<sup>7</sup> Liffert Vogt,<sup>2</sup> Monica Furlano,<sup>4</sup> Roser Torra,<sup>4</sup> Antonio Mastrangelo,<sup>10</sup> Titia Lely,<sup>1</sup> Albertine M. van Eerde.<sup>1</sup> ALPART working group <sup>1</sup>Universitair Medisch Centrum Utrecht - Locatie Wilhelmina Kinderziekenhuis, Utrecht, Netherlands; <sup>2</sup>Amsterdam UMC Locatie AMC, Amsterdam, Netherlands; <sup>3</sup>Hopital universitaire Necker-Enfants malades, Paris, France; <sup>4</sup>Fundacio Puigvert, Barcelona, Spain; <sup>5</sup>Katholieke Universiteit Leuven Universitaire Ziekenhuizen Leuven Campus Gasthuisberg, Leuven, Belgium; <sup>6</sup>Vilniaus universiteto ligonine Santaros klinikos, Vilnius, Lithuania; <sup>7</sup>Universite catholique de Louvain, Louvain-la-Neuve, Belgium; <sup>8</sup>Universitair Medisch Centrum Groningen, Groningen, Netherlands; <sup>9</sup>Semmelweis Egyetem Klinikai Központ, Budapest, Hungary; <sup>10</sup>Fondazione IRCCS Ca' Granda Ospedale Maggiore Policlinico, Milan, Italy.

**Background:** Women with chronic kidney disease (CKD) have high risks of adverse pregnancy outcomes such as preeclampsia, preterm birth, small for gestational age (SGA). Pregnancy outcomes in CKD patients are often presented per CKD-stage without considering etiology of kidney disease. On pregnancy in COL4A3-5 related disease (Alport Syndrome, AS), a prevalent monogenic kidney disease, merely case reports are published. This study investigates pregnancy outcomes in women with AS on a large scale and compare these with pregnancies in general CKD.

**Methods:** The ALPART-network (mAternaL and fetal PregnAncy outcomes of women with Alport syndrome) was established by 15 centers in Europe and aims to include ~200 pregnancies. Women with AS and  $\geq 1$  pregnancy  $> 20$  weeks are included. Data is collected retrospectively from medical records. For these intermediary analyses, a combined adverse pregnancy outcome (cAPO) was established consisting of preterm birth  $< 34$  weeks, SGA and NICU admission. Pregnancy outcomes were compared with similar CKD stage 1-2 pregnancies of diverse etiology from the UMC Utrecht outpatient clinic.

**Results:** Data on 149 AS-pregnancies in 88 women were compared to 104 pregnancies in CKD of various causes. Prepregnancy hypertension was lower (22 vs 53%) and proteinuria levels ( $> 1$ g/day) were higher (50 vs 33%). AS pregnancy outcomes were significantly better: mean birth weight 3215 gram (SD 678) vs 2735 (913), mean gestational age 38.6 weeks (SD 2.3) vs 37.0 weeks (4.3) and cAPO occurred less frequently (24% vs 40%,  $p < 0.004$ ). Though new-onset/doubling of proteinuria did not differ significantly, missing values hinder interpretation. Mean eGFR was lower after pregnancy vs before (96.1 vs 105.5,  $p = 0.001$ ), but eGFR-slope did not differ significantly after pregnancy (eGFR decline -0.69 mL/min/1.73m<sup>2</sup> per year, mean follow up 5.6 years postpartum,  $p = 0.746$ ).

**Conclusions:** This is the largest cohort of pregnancies in women with AS. Preliminary analyses show favourable outcomes compared to CKD in general. This emphasizes the need for more data on pregnancy outcomes stratified per etiology of CKD, to improve preconception counselling and care.

#### TH-PO762

##### Association of Marijuana, Tobacco, and Alcohol Use With Estimated Glomerular Filtration Rate in Women Living With HIV and Women Without HIV

Molly Fisher,<sup>1</sup> Donald Hoover,<sup>2</sup> Qihu Shi,<sup>3</sup> Anjali Sharma,<sup>1</sup> Michelle M. Estrella,<sup>4</sup> Maria L. Alcaide,<sup>5</sup> Lauren F. Collins,<sup>6</sup> Jodie Dionne,<sup>7</sup> Audrey French,<sup>8</sup> Samy I. McFarlane,<sup>9</sup> Heather S. Mckay,<sup>11</sup> Frank J. Palella,<sup>10</sup> Sudipa Sarkar,<sup>11</sup> Amanda B. Spence,<sup>12</sup> Mallory D. Witt,<sup>13</sup> Michael J. Ross.<sup>1</sup> <sup>1</sup>Albert Einstein College of Medicine, Bronx, NY; <sup>2</sup>Rutgers The State University of New Jersey, New Brunswick, NJ; <sup>3</sup>New York Medical College, Valhalla, NY; <sup>4</sup>University of California San Francisco, San Francisco, CA; <sup>5</sup>University of Miami School of Medicine, Miami, FL; <sup>6</sup>Emory University School of Medicine, Atlanta, GA; <sup>7</sup>University of Alabama at Birmingham, Birmingham, AL; <sup>8</sup>John H Stroger Jr Hospital of Cook County, Chicago, IL; <sup>9</sup>SUNY Downstate Health Sciences University, New York City, NY; <sup>10</sup>Northwestern University Feinberg School of Medicine, Chicago, IL; <sup>11</sup>Johns Hopkins University, Baltimore, MD; <sup>12</sup>Georgetown University, Washington, DC; <sup>13</sup>The Lundquist Institute, Torrance, CA.

**Background:** Marijuana, tobacco and alcohol use are behavioral risk factors for impaired kidney function, which have not been thoroughly evaluated in persons living with HIV (PLWH). We evaluated associations between use of these substances with estimated glomerular filtration rate (eGFR) among women living with HIV (WLWH) and women without HIV.

**Methods:** We undertook a repeated measures cross-sectional study of WLWH and women without HIV nested within the Women's Interagency HIV Study, a multicenter, prospective women's cohort in the United States. Substance use was ascertained using semi-annual questionnaires. Multivariable linear regression adjusting for sociodemographic, chronic kidney disease risk factors and HIV-related factors were used to assess associations of current and cumulative marijuana, tobacco and alcohol exposures with eGFR between 2009 and 2019.

**Results:** Among 1512 participants, 1043 were WLWH with 14,481 study visits and 469 were women without HIV with 6,660 study visits. At baseline, WLWH had a lower median eGFR (99.8 mL/min/1.73m<sup>2</sup> (IQR 80.9-114) vs 102.7 mL/min/1.73m<sup>2</sup> (IQR 88.4-116.2), p=0.003), lower prevalence of current marijuana use (14% vs 22%, p<0.0001), lower current alcohol use (39% vs 50%, p<0.0001) and trend toward lower current tobacco use (40% vs 46%, p=0.06) compared to women without HIV. Alcohol use of >7 drinks/week compared with no use was associated with a 3.95 mL/min/1.73m<sup>2</sup> (95% confidence interval 1.03, 6.86; p=0.008) higher eGFR. Neither current marijuana use versus no use nor 10-year cumulative use of >1.6 versus 0-0.02 marijuana-years were associated with eGFR. Current tobacco use compared to never use and lifetime tobacco use of >10 compared to 0 pack-years were also not associated with eGFR.

**Conclusions:** In a large cohort of WLWH and women without HIV, heavy alcohol use was associated with a higher eGFR and there was no association of marijuana or tobacco use with eGFR. Despite lack of evidence of harmful effects on kidney function from marijuana and tobacco use, clinical care of PLWH should include substance use screening and counseling on other known health risks associated with substance use.

## TH-PO763

### Early Pregnancy-Associated Atypical Hemolytic Uremic Syndrome (aHUS)

Michael Che,<sup>1</sup> Sarah M. Moran,<sup>2</sup> Richard J. Smith,<sup>3</sup> Miriam Galbusera,<sup>4</sup> Sara Gastoldi,<sup>4</sup> Jocelyn S. Garland.<sup>1</sup> <sup>1</sup>Queen's University, Kingston, ON, Canada; <sup>2</sup>Department of Nephrology, Cork University, Cork, Ireland; <sup>3</sup>Molecular Otolaryngology and Renal Research Laboratories, Carver College of Medicine, University of Iowa, Iowa City, IA; <sup>4</sup>Istituto di Ricerche Farmacologiche Mario Negri-IRCCS; Clinical Research Center for Rare Diseases Aldo e Cele Daccò Ranica, Bergamo, Italy.

**Introduction:** aHUS in pregnancy is typically reported to occur in the third trimester. Here we report a case of aHUS presenting in the first trimester of pregnancy.

**Case Description:** A 30 year old G2P0A1 diabetic biracial woman presented at 9 weeks gestation with new hypertension. By 18 weeks, she developed acute kidney injury and macular edema. Investigations revealed hemoglobin 68 g/L, platelets 120 x 10<sup>9</sup>/L, LDH 588 U/L, undetectable haptoglobin and schistocytes. Creatinine increased from 50 to 88 umol/L, and microscopic hematuria and proteinuria >1 g/day were detected. ASA 162 mg, low molecular weight heparin, and anti-hypertensives were prescribed. Pre-eclampsia (PET) was ruled out as her symptoms began within the first trimester, and normal uterine artery doppler results were obtained. Placental growth factor levels at 24 and 28 weeks were >100 pg/mL. HELLP syndrome was excluded given the timing in pregnancy (<20 weeks) and normal liver transaminases. TTP was excluded by normal ADAMTS13. Complement Factor H autoantibody was negative. Complement studies revealed elevated plasma C5b-9 level of 1.05 (normal <0.3 mg/L). aHUS was diagnosed and eculizumab (ECU) was prescribed. Ex-vivo serum C5b-9 deposition on human microvascular endothelial cells (Noris, Blood, 2014) was abnormal pre-treatment with ECU (activated 223%, normal <150%), and normalized with ECU therapy (activated 123%, normal <150%). Genetic testing revealed a Complement Factor I mutation, NM\_000204.3:c.550G/A, p. Val184Met reported as pathogenic, confirming primary aHUS. Due to worsening renal function, she delivered a healthy baby at 30 weeks gestation by Caesarean section. A renal biopsy performed 3 weeks postpartum demonstrated features of TMA, mainly chronic (i.e. treated) and advanced diabetic nephropathy. Six months postpartum, she required dialysis. aHUS is in clinical remission on ECU, and she awaits kidney transplantation.

**Discussion:** aHUS is classically described to occur late in pregnancy or postpartum. Here, this patient presented uniquely during the first trimester with complement function testing aiding the diagnosis. Thus, TMA in pregnancy is not always PET or HELLP and aHUS should be considered as the diagnosis particularly for presentations occurring prior to 20 weeks gestation. Episodes of severe PET/HELLP should trigger TMA workup for underlying complement disorder.

## TH-PO764

### Severe Postpartum HELLP Syndrome: Is This Atypical Hemolytic Uremic Syndrome?

Michael Che,<sup>1</sup> Sarah M. Moran,<sup>2</sup> Richard J. Smith,<sup>3</sup> Sara Gastoldi,<sup>4</sup> Jocelyn S. Garland.<sup>1</sup> <sup>1</sup>Division on Nephrology, Department of Medicine, Queen's University, Kingston, ON, Canada; <sup>2</sup>Department of Nephrology, Cork University, Cork, Ireland; <sup>3</sup>University of Iowa Molecular Otolaryngology and Renal Research Laboratories, Iowa City, IA; <sup>4</sup>Istituto di Ricerche Farmacologiche Mario Negri-IRCCS; Clinical Research Center for Rare Diseases Aldo e Cele Daccò Ranica, Bergamo, Italy.

**Introduction:** Complement dysregulation is implicated in the pathogenesis of atypical hemolytic uremic syndrome (aHUS) and there is growing evidence to support its role in HELLP (hemolysis, elevated liver enzymes, low platelets) syndrome. Here we present a case of post-partum thrombotic microangiopathy (TMA) in the setting of HELLP syndrome.

**Case Description:** A 22 year old G1P0 Caucasian woman presents at 37 weeks gestation with abdominal pain and severe hypertension. Labs demonstrated hemoglobin 95, platelets 30, LDH 2597, schistocytes, severe transaminitis (AST 1845, ALT 830), and proteinuric acute kidney injury. She was diagnosed with HELLP syndrome and treated with anti-hypertensives and emergency Caesarean section. Unfortunately, the infant did not survive; there was no placental abruption. Platelets recovered by day 5 postpartum, LDH by day 7. However, renal function worsened and by day 6 postpartum, she required

hemodialysis when creatinine peaked at 812. A renal biopsy revealed acute and chronic TMA. She did not have cortical necrosis. Further workup revealed normal C3, C4 and ADAMTS13 levels. Dialysis was stopped after two weeks. By 6 months, her renal function and proteinuria returned to normal. Complement function testing revealed negative complement factor H autoantibody, but elevated plasma C5b-9 level (0.42 mg/L, normal <0.3). Ex-vivo serum C5b-9 deposition on human microvascular endothelial cells was assessed both on resting (182%, normal <150%) and on ADP-activated endothelial cells (273%, normal <150%). This test was repeated 6 months postpartum when renal function had normalized, and results were persistently abnormal both on resting (215%, normal <150%) and on ADP-activated endothelial cells (282%, normal <150%). aHUS genetic testing was negative.

**Discussion:** The severity of HELLP syndrome associated organ dysfunction prompted the assessment for aHUS. Identifiable aHUS genetic mutations only occur in 50% of aHUS patients; however, the persistence of increased C5b-9 deposition mimics the findings of patients who have aHUS (Noris, Blood, 2014). Complement function testing is not routinely assessed for postpartum HELLP, and these unique results suggest the patient may be at risk for recurrent TMA/aHUS, particularly if another pregnancy is being considered. Future research should explore which pregnancy associated TMA patients may benefit from anti-complement therapy.

## TH-PO765

### Cell Sex and Sex Hormones Modulate Kidney Glucose and Glutamine Metabolism in Health and Diabetes

Sergi Clotet Freixas,<sup>1,2</sup> Max Kotlyar,<sup>3,4</sup> Caitríona M. McEvoy,<sup>1,2</sup> Aninda D. Saha,<sup>1,2</sup> Alexander Boshart,<sup>1,2</sup> Allison Dart,<sup>5,6</sup> Brandy A. Wicklow,<sup>5,6</sup> Jonathan Mcgavock,<sup>5,6</sup> Tom D. Blydt-Hansen,<sup>7</sup> Minna Woo,<sup>1,8</sup> James W. Scholey,<sup>9,10</sup> Hannes L. Rost,<sup>11,12</sup> Ana Konvalinka.<sup>1,2</sup> <sup>1</sup>Toronto General Hospital Research Institute, University Health Network, Toronto, ON, Canada; <sup>2</sup>Soham and Shaila Ajmera Family Transplant Centre, University Health Network, Toronto, ON, Canada; <sup>3</sup>Osteoarthritis Research Program, Division of Orthopedic Surgery, Schroeder Arthritis Institute, University Health Network, Toronto, ON, Canada; <sup>4</sup>Krembil Research Institute, University Health Network, Toronto, ON, Canada; <sup>5</sup>Department of Pediatrics and Child Health, University of Manitoba, Winnipeg, MB, Canada; <sup>6</sup>Diabetes Research Envisioned and Accomplished in Manitoba Research Team, Children's Hospital Research Institute of Manitoba, Winnipeg, MB, Canada; <sup>7</sup>Department of Pediatrics, The University of British Columbia, Vancouver, BC, Canada; <sup>8</sup>Department of Medicine, Division of Endocrinology, University Health Network, University of Toronto, Toronto, ON, Canada; <sup>9</sup>Department of Medicine, Division of Nephrology, University Health Network, Toronto, ON, Canada; <sup>10</sup>Institute of Medical Science, University of Toronto, Toronto, ON, Canada; <sup>11</sup>The Donnelly Centre, University of Toronto, Toronto, ON, Canada; <sup>12</sup>Department of Molecular Genetics, University of Toronto, Toronto, ON, Canada.

**Background:** Diabetic Kidney Disease (DKD) is recognized as the leading cause of Chronic Kidney Disease (CKD). Male sex is a risk factor for CKD, and is generally associated with a more severe DKD. However, female sex renoprotection is often lost in the setting of diabetes. The molecular reasons behind the sex-specific progression of DKD, and their link to sex chromosomes and sex hormones, are unknown. Here, we identify a sex dimorphism in glucose and glutamine metabolism that is conserved in healthy and diabetic mice and humans.

**Methods:** We employed primary human proximal tubular epithelial cells (PTECs) from male and female donors (n=3/sex), and exposed them to sex hormones, under normal or under high glucose conditions (n=6/group). We studied male and female mice with and without gonads, as well as male and female type 1 diabetic mice (n=5-8/group). We also interrogated the serum metabolome of male and female adolescents with type 2 diabetes and their controls (n=180).

**Results:** Female PTECs displayed decreased glycolysis, mitochondrial respiration, oxidative stress, apoptosis, and high glucose-induced injury, compared to male PTECs. The more oxidative phenotype of male PTECs was enhanced by dihydrotestosterone (DHT) and linked to increased mitochondrial utilization of glucose and glutamine. Studies *in vivo* pointed towards decreased glutamine anaplerosis in diabetic female kidneys. Female PTECs displayed increased levels of pyruvate, glutamyl-cysteine, cysteinylglycine, and a higher GSH/GSSG ratio than male PTECs, indicative of enhanced redox homeostasis. Conversely, male sex was linked to increased levels of glutamate, TCA cycle, and glutathione cycle metabolites, in PTECs and in the blood metabolome of healthy youth and youth with type 2 diabetes. Finally, we identified transcriptional mechanisms that control kidney metabolism in a sex-specific fashion. While X-linked demethylase KDM6A facilitated metabolic homeostasis in female PTECs, transcription factor HNF4A mediated the deleterious effects of DHT in male PTECs.

**Conclusions:** This work uncovers the role of sex in renal glucose and glutamine metabolism, that may explain the roots of sex dimorphism in kidney health and DKD, and inspires new paradigms based on patient sex.

TH-PO766

**Sexual Dimorphism in AKI Outcomes: Does Menopause Tie the Match?**

María Isabel Acosta-Ochoa, Armando Coca, Arturo Lorenzo. *Hospital Clínico Universitario de Valladolid, Valladolid, Spain.*

**Background:** Many studies focus on gender differences when suffering AKI, some reporting that female sex could be protective against AKI adverse outcomes, this “protection” could be lost in menopause due to the absence of estrogen among other female hormones. We studied a cohort of individuals suffering from AKI and compared hard outcomes between female and masculine patients older than 55 years.

**Methods:** Retrospective cohorts’ study, of nephrology ward and consultation, AKI severity was categorized by KDIGO-2012 criteria; we included all patients ≥55 y, analyzed clinical variables and compared the rates of occurrence of the hard outcomes length of hospital stay (LOS), need for dialysis (HD), dialysis dependence at discharge (DDD), and in-hospital mortality (IHM) between groups.

**Results:** We included 1135 individuals. 70% were male, these patients were older and had a higher Charlson’s Index because they suffered more frequently of COPD, cancer, and peripheral arterial disease among other; women were hospitalized more frequently in medical wards. Table 1A summarizes our findings. We found no statistically significant differences in LOS, HD, DDD and IHM. In Table 1B we summarize the results between groups.

**Conclusions:** In our study we found that males were older and had a worst Charlson’s Index, and we found no statistically significant differences in the studied hard outcomes between males and females. In conclusion, women in the range of age of menopause (≥55 y) that suffer an episode of AKI do not differ significantly from males in the occurrence of hard clinical and renal outcomes, but males have worst clinical characteristics.

	Women 336 (30)	Men 799 (70)	P value
<b>A. Features</b>			
Age - ys	78 (70-86)	75 (66-84)	0,04
Charlson’s Index	4,1 (±2,2)	4,9 (±2,4)	<0,001
Hypertension	312 (93)	724 (91)	0,51
DM	148 (44)	358 (45)	0,86
CKD	218 (65)	510 (64)	0,79
CAD	96 (29)	269 (34)	0,10
CHF	154 (46)	321 (40)	0,09
PAD	58 (17)	321 (40)	<0,001
Cerebrovasc Dis	55 (16)	154 (19)	0,28
Dementia	30 (9)	40 (5)	0,02
COPD	69 (21)	316 (40)	<0,001
Hepatic Dis	4 (1)	15 (2)	0,75
Autoimm Dis	42 (13)	76 (10)	0,14
CA ± Mtx	101 (30)	310 (39)	0,05
AIDS	2 (1)	0 (0)	0,05
Medical Service	230 (69)	463 (58)	0,01
ICU	60 (18)	152 (19)	0,68
Comm Acq AKI	235 (70)	533 (67)	0,30
<b>KDIGO Stage</b>			
1	122 (36)	317 (40)	0,32
2	54 (16)	94 (12)	0,07
3	160 (48)	387 (48)	0,85
<b>B. Results</b>			
Acute HD	44 (13)	103 (13)	0,92
Mortality	81 (24)	186 (23)	0,76
Hospital Stay	16 (3-30)	18 (3-33)	0,19
HD Dependence	7 (2)	33 (4)	0,11

TH-PO767

**Sex and Gender Considerations in Randomized Controlled Trials in Adults Receiving Chronic Dialysis: A Meta-Epidemiologic Study**

David T. Collister,<sup>1</sup> Lonnie Pyne,<sup>5</sup> Arrti A. Bhasin,<sup>5</sup> Sofia B. Ahmed,<sup>2</sup> Brendan Smyth,<sup>4</sup> William G. Herrington,<sup>3</sup> Meg Jardine,<sup>4</sup> Michael Walsh.<sup>5</sup>  
<sup>1</sup>University of Alberta Faculty of Medicine & Dentistry, Edmonton, AB, Canada; <sup>2</sup>University of Calgary Cumming School of Medicine, Calgary, AB, Canada; <sup>3</sup>University of Oxford, Oxford, United Kingdom; <sup>4</sup>The University of Sydney Faculty of Medicine and Health, Sydney, NSW, Australia; <sup>5</sup>McMaster University, Hamilton, ON, Canada.

**Background:** How sex and gender concepts are incorporated in randomized controlled trials (RCTs) in adults with kidney failure receiving chronic dialysis is unknown.

**Methods:** Meta-epidemiologic study of RCTs in chronic dialysis from the highest impact journals from 2000 to 2020. Meta-regression was performed to identify trial characteristics independently associated with the proportion of female/women participants.

**Results:** Of 561 included RCTs, 69.7% were parallel and 28.0% were crossover in design. 80.6% were in the hemodialysis population. 1/4 were placebo controlled, 1/4 were compared to usual care and 1/2 were compared to an active therapy. 37.6% of RCTs were blinded. The median (IQR) size was 60 participants (26, 151) and the median (IQR) follow-up was 154 days (42, 365). The mean (SD) proportion of female/women participants was 0.40 (0.13). 39.0% of trials reported sex and 26.6% reported gender of participants. 56.2% referred to participants as females, 25.3% referred to participants as women and 15.5% referred to both females and women. No trial characteristic other than region (Asia, B 0.062 95% CI 0.007-0.117) was associated with the proportion of female/women participants. Considering trial design and conduct, 2.7% used male/female sex and/or man/woman gender as an inclusion criteria, 26.6% as exclusion criteria (e.g. related to pregnancy, contraception, lactation), 4.5% for randomization, 4.8% for subgroup analyses and 15.7% for covariate adjustment.

**Conclusions:** RCTs in dialysis are representative of the general dialysis population with regards to sex/gender but rarely report both sex and gender separately and often do not include either in their reporting or analysis.

TH-PO768

**Purple Urine Bag Syndrome in an Elderly Female With Constipation and Urinary Tract Infection**

Allison A. Bauman,<sup>1</sup> Lakshmi Kannan,<sup>2</sup> Brandon Nelson.<sup>2</sup> <sup>1</sup>University of Pikeville Kentucky College of Osteopathic Medicine, Pikeville, KY; <sup>2</sup>Pikeville Medical Center, Pikeville, KY.

**Introduction:** Purple Urine Bag Syndrome (PUBS) is an uncommon event that causes the urine of those affected to turn various shades of purple. Risk factors for PUBS include female gender, chronic catheterization, advanced age, constipation, chronic kidney disease (CKD), and urinary tract infections (UTI’s).<sup>(1)</sup> The purple urine is caused by elevated levels of the pigments indigo and indirubin.<sup>(1)</sup> In this article, we present a case in which an elderly female with a history of long-dwelling catheterization and CKD develops purple urine in the setting of a UTI and constipation.

**Case Description:** A 76-year-old female with a history of stage III CKD who was chronically catheterized presented to the hospital with shortness of breath from CHF exacerbation. After experiencing constipation for four days, her urine was noted to be purple (Figure 1). Urinalysis showed alkaline urine (pH of 8.5) with a large amount of blood, nitrites, leukocyte esterase, and proteins, and urine culture revealed more than 100,000 CFU/mL of *Proteus mirabilis*. In the setting of her discolored urine, these findings are consistent with PUBS. She was started on empiric ceftriaxone for UTI and miralax/senna twice daily for constipation. Her constipation resolved, and a 5-day course of antibiotics was completed.

**Discussion:** PUBS tends to occur primarily in constipated women with sulphatase/phosphatase-producing bacteria in their urinary tracts.<sup>(2)</sup> These bacteria convert indoxyl sulfate into indoxyl which, when metabolized in an alkaline environment, gives rise to indirubin and indigo.<sup>(1)</sup> PUBS is generally considered benign; however, if the infection underlying PUBS becomes too severe, serious disease (i.e. Fournier’s gangrene) can result.<sup>(3)</sup>



**Figure 1.** Dark purple urine in a Foley catheter bag. Patient’s urine turned dark purple after four days of constipation.

TH-PO769

**Albuminuria in Older Adults: Data on Prevalence and Trends Over 8 Years in the Berlin Initiative Study (BIS)**

Tim Bothe,<sup>1,3</sup> Elke Schaeffner,<sup>1</sup> Nina Mielke,<sup>1</sup> Alice Schneider,<sup>1</sup> Muhammad Barghouth,<sup>1</sup> Markus van der Giet,<sup>1</sup> Martin K. Kuhlmann,<sup>2</sup> Natalie Ebert,<sup>1</sup> <sup>1</sup>Charite Universitätsmedizin Berlin, Berlin, Germany; <sup>2</sup>Vivantes Klinikum im Friedrichshain, Berlin, Germany; <sup>3</sup>InGef - Institut für angewandte Gesundheitsforschung Berlin GmbH, Berlin, Germany.

**Background:** Data on the course of albumin-creatinine ratio (ACR) in the elderly are scarce. Identifying patterns of ACR progression is important for a better understanding of albuminuria in old age.

**Methods:** We used data of the BIS, a community-dwelling cohort of 2,069 persons aged 70 or older. Baseline visit was conducted between 2010 and 2011, followed by four biennial follow-up visits. Prevalence of albuminuria (no: ACR<30 mg/g; micro: ACR 30-299 mg/g; macro: ACR≥300 mg/g) was assessed from spot urine at all study visits. In a sub-analysis, we included only non-deceased participants with complete attendance and valid ACR measures at all study visits.

**Results:** At baseline, mean age was 80.4 years (range: 70-100) and 52.6% were females. Median ACR increased from 10.7 at baseline to 13.3 mg/g after 8 years. Prevalence of micro- and macroalbuminuria remained nearly stable over time (21.6-25.3% and 3.3-4.1%, respectively). In the subgroup with complete attendance, median ACR raised from 7.3 to 13.2 mg/g, whereas prevalence of micro- and macroalbuminuria increased from 14.9 to 25.6% and 1.7 to 3.3% after 8 years, respectively.

**Conclusions:** We found that over the observation period of 8 years, ACR increased longitudinally in the subgroup with complete attendance only slightly by about 6 mg/g and prevalence of microalbuminuria by 11%. Cross-sectionally, ACR increased in the total population by only 3 mg/g and prevalence of micro- and macroalbuminuria remained nearly stable over 8 years at approximately 25% and 4%, respectively. The coefficient of variation for ACR measurement is known to be relatively high, therefore values should be considered as rough estimates only.

Figure: Boxplots and flat violin plots of ACR distribution.

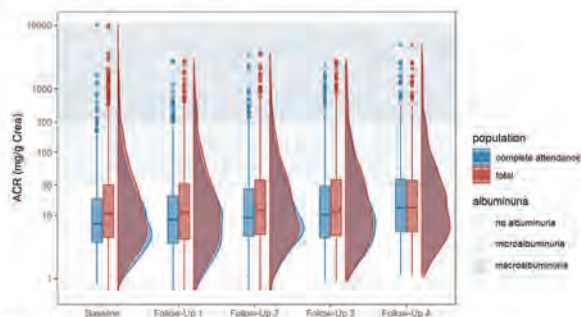

Table: Sociodemographic variables and albuminuria prevalence for both study populations.

Population	Outcome	Baseline	Follow-Up 4
Total	N <sup>1</sup>	2,055	845
	Age, mean (SD)	80.4 (6.7)	85.6 (5.2)
	Females, N (%)	1,081 (52.6)	470 (55.6)
	Deceased <sup>2,3</sup> , N (%)	125 (6.1)	94 (11.1)
	ACR, median (q25; q75)	10.7 (4.5; 30.6)	13.3 (5.4; 35.9)
	Albuminuria, N (%)		
	no (ACR < 30)	1,523 (74.1)	599 (70.9)
	micro (ACR 30-299)	458 (22.3)	218 (25.8)
	macro (ACR ≥ 300)	74 (3.6)	28 (3.3)
Complete attendance <sup>3</sup>	N	784	784
	Age, mean (SD)	77.3 (5.2)	85.5 (5.2)
	Females, N (%)	422 (53.8)	422 (53.8)
	ACR, median (q25; q75)	7.3 (3.7; 18.1)	13.2 (5.5; 37.0)
	Albuminuria, N (%)		
	no (ACR < 30)	654 (83.4)	557 (71.0)
	micro (ACR 30-299)	117 (14.9)	201 (25.6)
	macro (ACR ≥ 300)	13 (1.7)	26 (3.3)

<sup>1</sup> Complete attendance population refers to non-deceased individuals who participated in all study visits and had valid ACR values for all measurements. <sup>2</sup> N refers to persons with valid ACR measurements at each study visit. N = 1,667, 1,411, and 1,086 for Follow-Up 1 - 3. Excluded due to missing lab values were: N = 14, 32, 29, 80, and 99 (Baseline - Follow-Up 4). <sup>3</sup> Deceased<sup>2,3</sup> was calculated as number of persons who died within 2 years after their respective study visit date. Abbreviations: SD: standard deviation; q25: 25<sup>th</sup> percentile; q75: 75<sup>th</sup> percentile.

TH-PO770

**Mortality Risk According to eGFR and Proteinuria in Persons Older Than 65 Years: Results From a Nationwide Study in Iceland**

Arnar J. Jonsson,<sup>1,2</sup> Sigrún H. Lund,<sup>3</sup> Bjorn O. Eriksen,<sup>4</sup> Runolfur Pálsson,<sup>1,2</sup> Olafur S. Indridason.<sup>1</sup> <sup>1</sup>Landsþítali-The National University Hospital of Iceland, Reykjavik, Iceland; <sup>2</sup>Haskóli Íslands, Reykjavik, Iceland; <sup>3</sup>deCODE Genetics Inc, Reykjavik, Iceland; <sup>4</sup>University Hospital of North Norway, Tromsø, Norway.

**Background:** Kidney function is known to decline with age, nevertheless, a uniform definition of glomerular filtration rate (GFR) has been applied to define chronic kidney disease irrespective of age. This has mostly been based on cross-sectional studies using single assessment of estimated glomerular filtration rate (eGFR), that have indicated worse outcome at eGFR <60 mL/min/1.73 m<sup>2</sup>. The aim of this study was to examine the risk of all-cause mortality according to eGFR and proteinuria in persons aged >65 years in the general population.

**Methods:** We obtained all serum creatinine (SCr) and urine protein measurements from all clinical laboratories in Iceland in the years 2008-2016. Clinical data were obtained from nationwide electronic medical records. eGFR was calculated using the CKD-EPI equation and classified into categories; 0-29, 30-44, 45-59, 60-74, 75-89, 90-104 and >104 mL/min/1.73 m<sup>2</sup> eGFR category and proteinuria had to be persistent for >3 months. A multiple imputation method was used to account for missing urine protein measurement data. A joint model using repeated measurements was used to assess mortality and simultaneously account for decline in eGFR over time, adjusting for age as a continuous variable, sex and multiple comorbid conditions.

**Results:** We obtained 782,995 SCr values for 37,937 individuals aged over 65 years, of whom 23,344 (62%) had information on proteinuria. The median age was 75 (range, 66-106) years and 46% were men. Adjusted hazard ratios for all-cause mortality are demonstrated in the table.

**Conclusions:** Among elderly individuals, eGFR >104 mL/min/1.73 m<sup>2</sup> carries a high mortality risk, whereas eGFR of 45-74 without proteinuria is associated with the lowest mortality.

**Funding:** Government Support - Non-U.S.

Adjusted hazard ratio (95% CI) for death according to eGFR and proteinuria

eGFR (mL/min/1.73 m <sup>2</sup> )	No proteinuria	Proteinuria
> 104	4.28 (2.88-6.36)	4.47 (2.15-9.31)
90-104	1.55 (1.40-1.73)	2.23 (1.92-2.60)
75-89	1.08 (1.02-1.15)	1.62 (1.50-1.75)
60-74	Reference	1.42 (1.32-1.54)
45-59	1.05 (0.99-1.12)	1.46 (1.35-1.57)
30-44	1.33 (1.23-1.44)	1.41 (1.28-1.55)
0-29	1.97 (1.75-2.21)	2.09 (1.84-2.37)

TH-PO771

**Predialysis Care Pathways and Early Morbidity and Mortality After Transition to Dialysis in French Elderly**

Aghiles Hamroun,<sup>1,2</sup> Estelle Aymes,<sup>1</sup> Cécile Couchoud,<sup>3</sup> Luc Dauchet,<sup>1</sup> Victoria Gauthier,<sup>1</sup> Philippe Amouyel,<sup>1</sup> François Glowacki,<sup>1</sup> Benedicte Stengel.<sup>2</sup> <sup>1</sup>Centre Hospitalier Universitaire de Lille, Lille, France; <sup>2</sup>Centre de Recherche en Epidemiologie et Sante des Populations, Villejuif, France; <sup>3</sup>Agence de la biomedecine, La Plaine Saint-Denis, France.

**Background:** The ageing of the population with advanced chronic kidney disease (CKD) increases the complexity of care pathways. Our aim was to identify subgroups of elderly patients according to predialysis care pathways and describe their association with early death and hospitalization after transition to dialysis.

**Methods:** We included 22,128 incident patients aged 75 or over (median age 82 years, 63% men) from the national ESKD REIN registry, 2010-2016, linked with the National Health Claim Data System. Predialysis care pathways were identified by multiple correspondence analyzes and ascending hierarchical classification, based on healthcare use. Their associations with death or hospitalization ≥ 50% of the time off dialysis within the first year of dialysis were studied by multivariate logistic regressions.

**Results:** Five care pathway profiles were identified characterized by nephrology ambulatory follow-up (37% of the patients), limited healthcare use (28%), non-nephrology ambulatory care (17%), and a high level of non-nephrology (9%) or nephrology hospitalizations (9%). Profile subgroups did not significantly differ according to demographic and clinical characteristics, and early mortality after dialysis initiation. Compared to the nephrology ambulatory follow-up profile, all other care pathway profiles were at higher risk of prolonged hospitalization after dialysis initiation (Figure 1, n = 1,195 patients).

**Conclusions:** Elderly patients with advanced CKD experienced very heterogeneous predialysis care pathways, which do not seem to be explained by their clinical profile. Improving nephrology outpatient follow-up may help reduce the burden of hospitalizations after the transition of dialysis in this population.

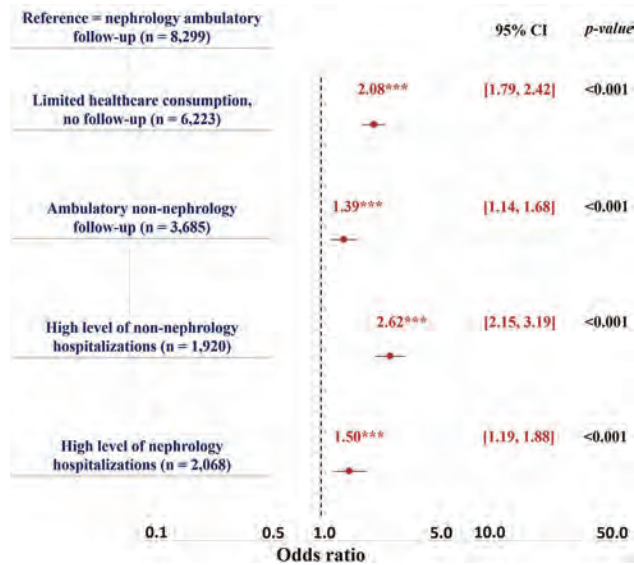

Predialysis care profile and risk of prolonged hospitalization

TH-PO772

**Informed Kidney Therapy Decision Making for Patients With ESKD Receiving Maintenance Dialysis: What Do Patients Say?**

Spencer Dahl, Fahad Saeed. University of Rochester Medical Center, Rochester, NY.

**Background:** Informed decision making has legal and ethical implications for the kidney therapy (KT) decision-making process. However, previous small scale studies suggest significant lapses in informed decision making for people receiving dialysis. To advance the field, we undertook the current study examining patient’s recall of various aspects of informed decision making during KT decisions.

**Methods:** We surveyed 223 hospitalized patients (223/578, 59% response rate) receiving maintenance dialysis at an academic tertiary care hospital in upstate New York. We assessed informed KT decision making using a previously published informed KT decision making questionnaire<sup>1</sup>. We present descriptive analyses of our findings.

**Results:** The mean age of the respondents was 68 years (SD ±15.4), 50% had attained a high school level education or lower, 39% were Black, 24% White non-Hispanic, and 21% of Hispanic or Latino origin. Patients had been receiving dialysis treatment for an average of 3.1 years (SD ±2.4). Patient’s responses are grouped into three categories: (1) dialysis knowledge and (2) decision making, and (3) prognosis. In response to questions about disease knowledge, 41% of patients responded “No” to whether they had been informed about the condition that led to kidney failure, 40% were not informed of dialysis options such as peritoneal and hemodialysis, and 57% were not aware of the potential benefits and burdens of each option. Regarding decision making, nearly 71% reported that conservative kidney management was never presented as an option, and 78% did not recall being informed of the option to withdraw from dialysis. In response to questions about prognostic awareness, 53% did not report being informed about life expectancy with and without dialysis, and 38% did not recall an explanation for how their daily life might change after initiating dialysis.

**Conclusions:** An assessment of informed decision making among hospitalized patients receiving maintenance dialysis revealed significant lapses in the informed decision making process. Interventions to improve informed decision making in people with CKD are urgently needed. Citations: 1: Song MK, Lin FC, Gilet CA, Arnold RM, Bridgman JC, Ward SE. Patient perspectives on informed decision-making surrounding dialysis initiation. *Nephrology Dialysis Transplantation*. 2013;28(11):2815-2823.

TH-PO773

**Dialysis Regret Among Patients Receiving Dialysis: A Qualitative Study**

Spencer Dahl,<sup>1</sup> Cameron E. Comrie,<sup>3</sup> Areeba Jawed,<sup>2</sup> Basil S. Kazi,<sup>1</sup> Fahad Saeed.<sup>1</sup> <sup>1</sup>University of Rochester Medical Center, Rochester, NY; <sup>2</sup>University of Michigan Michigan Medicine, Ann Arbor, MI; <sup>3</sup>Harvard Medical School, Boston, MA.

**Background:** Dialysis regret is common among people receiving maintenance dialysis; however, there is a lack in depth patient perspectives explaining the underlying reasons.

**Methods:** We conducted semi-structured interviews with 32 patients receiving maintenance dialysis, 22 hospitalized and 10 outpatients. To initiate discussion on regret, we asked “do you have any regrets about starting dialysis.” Transcripts were analyzed with MaxQDA software using thematic analysis and assessed for concordance among the research team until thematic saturation was achieved. Among transcripts classified as “high regret,” we studied other potential explanations for dissatisfaction with dialysis within the same transcript.

**Results:** In this sample, the mean age of patients was 61.5 (SD ±15), years, 40% had attained less than a high school level education, and 60% earned annual income <\$20,000 a year. Three prominent themes related to decisional regret emerged: 1) *Poor Dialysis Education:* We found that patients expressing dialysis regret reported lack of understanding of their disease and dialysis treatment. Patients described feeling frustrated, embarrassed and apathetic due to their lack of understanding of their condition. 2) *Medical paternalism:* Medical paternalism appears to also be a key factor in decisional regret – patients frequently expressed that they felt that dialysis initiation was a choice made for them rather than by them with no sense of agency during this process. 3) *Expression of Feelings of Regret:* The majority of patients had not communicated their feeling of regret to their physician and did not feel they could.

**Conclusions:** The majority of patients experiencing dialysis regret reported a lack of education on dialysis care and a presence of medical paternalism. Few patients were willing to discuss their regret with their physician. Future shared decision making interventions are needed to examine their effect on regret.

TH-PO774

**Cognitive Impairment and Trajectories in CKD: The REGARDS Study**

Katharine L. Cheung,<sup>1</sup> Miguel Arce Renteria,<sup>5</sup> Peter W. Callas,<sup>1</sup> Manjula Tamura,<sup>2,3</sup> Orlando M. Gutierrez,<sup>4</sup> Mary Cushman.<sup>1</sup> <sup>1</sup>University of Vermont College of Medicine, Burlington, VT; <sup>2</sup>Stanford University School of Medicine, Stanford, CA; <sup>3</sup>VA Palo Alto Health Care System, Palo Alto, CA; <sup>4</sup>The University of Alabama at Birmingham School of Medicine, Birmingham, AL; <sup>5</sup>Columbia University, New York, NY.

**Background:** CKD is associated with incident cognitive impairment (ICI) but it is unknown if longitudinal cognitive function has a different trajectory in CKD, or if age or race differences exist.

**Methods:** We studied 22,435 participants from the REGARDS study without baseline cognitive impairment. Participants completed the six-item screener (SIS) of global cognition every 6 months and 3 cognitive domain tests every 2 years for 10 years. ICI was defined as a SIS score ≤4. Multivariable logistic regression was used to calculate odds ratios of ICI as a function of eGFR. Latent growth curve models were used to determine the relationship of eGFR<60 ml/min/1.73m<sup>2</sup> to intercept and slope of each cognitive domain test (episodic memory, semantic and letter F fluencies) over time. Up to five cognitive examinations were analyzed.

**Results:** 13% (n=2,959) developed ICI over 10 years. As compared to eGFR ≥90 ml/min/1.73m<sup>2</sup> (reference), eGFR 60-<90, 45-<60, and <45 had unadjusted ORs (95%CI) of 1.8 (1.6, 1.9), 2.7 (2.3, 3.1) and 2.7 (2.2, 3.3). Accounting for other risk factors, there was a significant interaction of eGFR and age (p<0.001); compared to eGFR>90, the OR for ICI at eGFR <45 was 1.9 (1.2, 3.0) for age <65, whereas OR for eGFR<45 v eGFR>90 was 0.9 (0.7, 1.1) for age≥65 (Table 1). Compared to those with eGFR≥60, eGFR<60 was associated with lower baseline scores across all 3 cognitive domains, but the slope did not differ (Table 2). Baseline scores were lower in mid-life compared to late-life, whereas no differences by race were observed.

**Conclusions:** CKD is associated with increased risk of ICI and lower cognitive domain testing in mid-life compared to late-life. Strategies to reduce cognitive impairment should focus on mid-life.

**Funding:** Other NIH Support - NIGMS P20GM135007

Table 1: Odds Ratios (95% CI) of Incident Cognitive Impairment across clinical categories of eGFR in the REGARDS Study

eGFR	n	≥90	<90≥60	<60≥45	<45	Linear Trend P values
Model A	22,435	1	1.9 (1.7-2.0)	2.8 (2.4-3.2)	3.1 (2.6-3.7)	<0.001
B	22,425	1	1.0 (1.0-1.2)	1.0 (0.9-1.2)	1.0 (0.9-1.3)	0.54
C	21,462	1	1.0 (0.9-1.2)	1.0 (0.9-1.2)	1.0 (0.8-1.2)	0.87
C2	21,462	1	1.2 (1.1-1.3)	1.4 (1.2-1.6)	1.4 (1.1-1.7)	<0.001
Model C stratified by age						
<65	11,501	1	0.9 (0.8-1.1)	0.8 (0.5-1.3)	1.9 (1.2-3.0)	0.41
65+	9,961	1	1.1 (0.9-1.2)	1.1 (0.9-1.3)	0.9 (0.7-1.1)	0.64

Models: A- unadjusted; B- age, sex, race, region, income, education; C- B+ Hypertension, Diabetes, Cardiovascular disease, Hyperlipidemia, Depressive symptoms (CES-D), smoking, log ACR; C2- C+ dichotomized age variable. Interaction eGFR \* age (dichotomized) p= 0.004.

Table 1

Table 2: eGFR and trajectory of three cognitive function domains (estimates (SE) for intercept and slope)

Cognitive domain	Model A		Model B		Model C	
	Intercept	Slope	Intercept	Slope	Intercept	Slope
Episodic Memory	-0.49 (0.023)*	-0.013(0.001)*	-0.19 (0.02)*	0.003 (0.004)	-0.13 (0.02)*	0.003 (0.004)
Letter F fluency	-0.32 (0.03)*	-0.004 (0.004)	-0.15 (0.03)*	0.00 (0.004)	-0.10 (0.03)	0.001 (0.004)
Animal fluency	-0.46 (0.02)*	-0.007 (0.003)*	-0.10 (0.02)*	0.00 (0.003)	-0.05 (0.02)*	0.002 (0.004)

\*p<0.05; Model A- unadjusted; Model B- adjusted for age, sex, race, region, income and education; Model C- B + hypertension, diabetes, hyperlipidemia, coronary heart disease, depressive symptoms, smoking, and albuminuria.

Table 2

**TH-PO775**

**A Population-Based Assessment of Kidney Function and the Risk of Heart Failure Among Older Adults**

Antonios Douros,<sup>1</sup> Alice Schneider,<sup>2</sup> Nina Mielke,<sup>2</sup> Martin K. Kuhlmann,<sup>3</sup> Markus van der Giet,<sup>2</sup> Natalie Ebert,<sup>2</sup> Elke Schaeffner.<sup>2</sup> <sup>1</sup>McGill University, Montreal, QC, Canada; <sup>2</sup>Charite Universitätsmedizin Berlin, Berlin, Germany; <sup>3</sup>Vivantes Netzwerk für Gesundheit GmbH, Berlin, Germany.

**Background:** Decreased kidney function (KF) increases the risk of heart failure (HF) and other adverse cardiovascular (CV) outcomes and death. However, the role of KF in this regard among old and very old adults is poorly understood. This is an important knowledge gap since the decline of KF in advanced age can affect both healthy and multimorbid individuals. Thus, our population-based study assessed whether decreased KF is associated with an increased risk of HF, CV and all-cause mortality in a prospective cohort of community-dwelling older adults.

**Methods:** Participants of the Berlin Initiative Study (BIS), all aged ≥70 years, with baseline estimated glomerular filtration rate (eGFR<sub>BIS2</sub>) and no prior HF were followed from baseline (2009-2011) until the occurrence of a study outcome (hospitalization for HF [HHF], CV death, all-cause mortality) or 12/2020. HHF was defined via inpatient diagnostic codes, and mortality outcomes were defined via claims data, death certificates, and hospital discharge notes. Potential confounders included demographics, body mass index, alcohol consumption, smoking, physical exercise, education, income, comedication and comorbidities, measured at baseline using face-to-face interviews and claims data. Time-dependent Cox models estimated hazard ratios (HRs) with 95% confidence intervals (CIs) of the outcomes associated with decreased KF (eGFR<sub>BIS2</sub> <60mL/min/1.73m<sup>2</sup>) compared with retained KF (eGFR<sub>BIS2</sub> ≥60mL/min/1.73m<sup>2</sup>). eGFR values were updated biennially.

**Results:** Our cohort included 1466 HF free older adults (mean age 79 years; 55% female). Compared with retained KF, decreased KF was not associated with an increased risk of HHF (HR, 1.17; CI, 0.92-1.49), but was associated with increased risks of CV death (HR, 1.59; CI, 1.01-2.50), and all-cause mortality (HR, 1.33; CI, 1.02-1.72) (Figure).

**Conclusions:** Our population-based study showed that decreased KF is associated with an increased risk of CV and all-cause death among older adults. The role of HF in this association seems to be limited.

**Funding:** Private Foundation Support

	N Events	N PY	IR per 100 PY	Crude HR (95% CI)	Adjusted HR (95% CI)
<b>HHF</b>					
Decreased KF	393	5805	6.8	2.13 (1.76-2.59)	1.17 (0.92-1.49)
Retained KF	140	4412	3.2	Ref	Ref
<b>CV death</b>					
Decreased KF	198	7037	2.8	4.05 (2.73-5.99)	1.59 (1.01-2.50)
Retained KF	29	4742	0.6	Ref	Ref
<b>All-cause mortality</b>					
Decreased KF	475	7253	6.6	2.51 (2.04-3.09)	1.33 (1.02-1.72)
Retained KF	113	4816	2.3	Ref	Ref

Risk of outcomes with decreased KF among older adults

**TH-PO776**

**Perspectives of Pakistani Dialysis Patients on the Financial and Psychological Impact of Dialysis, Dialysis Decision Making, Prognostic Understanding, Use of Alternative Medicine, and End-of-Life Care**

Sheza Malik,<sup>1</sup> Ayesha Anwar,<sup>4</sup> Rebecca J. Allen,<sup>3</sup> Abdullah Zaki,<sup>5</sup> Fahad Saeed.<sup>2</sup> <sup>1</sup>Rochester General Health System, Rochester, NY; <sup>2</sup>University of Rochester, Rochester, NY; <sup>3</sup>Mount St. Joseph University, Cincinnati, OH; <sup>4</sup>Allam Iqbal Medical College, Lahore, Pakistan; <sup>5</sup>Shifa International Hospitals Ltd, Islamabad, Pakistan.

**Background:** With the increasing prevalence and mortality of end-stage kidney disease (ESKD) in developing countries, it is imperative to examine these patients' experiences with dialysis care and their attitudes toward end-of-life decisions.

**Methods:** Using convenience sampling methodology, we surveyed 221 patients (221/245, 90% response rate) receiving dialysis at five different dialysis facilities in Pakistan. The survey comprised 52 questions in Urdu to seek patients' perspectives on the impact of financial difficulties on the receipt of regular dialysis, the psychological impact of chronic dialysis, dialysis decision making, prognostic understanding, use of alternative medicine, and preparation for end-of-life care. Survey questions were administered orally to all participants.

**Results:** The mean age of the participants was 46.3±9.1 years, and 97.7% were Muslims. About 72% were married. Fifty-eight percent reported difficulty managing their finances due to the cost of dialysis. In addition, nearly 57% suggested establishing free dialysis facilities. A majority (77%) expressed a lack of understanding and knowledge about chronic kidney disease (CKD) and the available treatment options for end-stage kidney disease. Some (12%) used alternative medicine to treat their CKD. Nearly two-thirds (75%) cited faith as their greatest motivation for continuing with dialysis despite the adverse psychological effects of dialysis (29%) and feelings of social isolation (29%). The majority (81%) felt their prognosis was >10 years. Patients reported feeling almost evenly split on choosing between a comfort-based only (39%) and a life-prolonging

approach (41%), while the remaining 20% have not thought about it. Most patients did not talk to anyone about their end-of-life care (91%) and did not have a living will (96.4%).

**Conclusions:** Our study highlights major lapses in the care of Pakistani patients receiving maintenance dialysis and calls for greater awareness of kidney disease among the general population and more financial and psychosocial support for dialysis patients. Amidst major financial challenges that these patients face, honest yet compassionate prognostic conversations are still needed to facilitate end-of-life planning.

**TH-PO777**

**The Effectiveness of SPIRIT in Preparing Patients on Dialysis and Their Surrogates for End-of-Life Decision Making: A Pragmatic Trial**

Mi-Kyung Song,<sup>1</sup> Maureen J. Metzger,<sup>2</sup> Amita Manatunga,<sup>1</sup> Emily Wu,<sup>1</sup> Jacob R. Englert,<sup>1</sup> Abhijit V. Kshirsagar,<sup>3</sup> Janice P. Lea,<sup>1</sup> Laura Plantinga,<sup>1</sup> Emaad M. Abdel-Rahman,<sup>2</sup> Sandra E. Ward,<sup>4</sup> Manisha Jhamb,<sup>5</sup> Mary C. Laszlo,<sup>1</sup> Souad Benloukil,<sup>2</sup> Linda Turberville-Trujillo.<sup>1</sup> SPIRIT Trial Investigators <sup>1</sup>Emory University, Atlanta, GA; <sup>2</sup>University of Virginia, Charlottesville, VA; <sup>3</sup>University of North Carolina System, Chapel Hill, NC; <sup>4</sup>University of Wisconsin-Madison, Madison, WI; <sup>5</sup>University of Pittsburgh, Pittsburgh, PA.

**Background:** SPIRIT (Sharing Patient's Illness Representations to Increase Trust), a patient and family-centered advance care planning intervention with established efficacy in preparing patients on dialysis and their surrogates (dyads) for difficult end-of-life decision making, was tested for its real-world effectiveness when implemented as part of routine dialysis care.

**Methods:** In this cluster randomized trial, 39 outpatient dialysis clinics across 5 states (GA, NC, VA, PA, NM) were randomized by state and clinic size (22 intervention and 17 usual care). Each clinic selected at least one SPIRIT Champion (SWs, RNs, or APRNs) to identify potential patients and, in the intervention clinics, to conduct SPIRIT sessions with the dyads. SPIRIT included a 45- to 60-min. counseling session to help the patient articulate his/her values and to help the dyad understand likely end-of-life decision-making situations. A brief follow-up session was provided as needed. The preparedness outcomes (dyad congruence, patient decisional conflict, surrogate decision-making confidence, and a composite of congruence and surrogate confidence) were assessed at baseline and 2 weeks postintervention by phone.

**Results:** 426 patients and their chosen surrogates (231 dyads from intervention and 195 from usual care clinics) completed the baseline measures and were included in ITT analyses using GEEs. The sample included 72% dyads from minority groups, 51.2% women; patients were 61.9 years old (SD=12.7) and on dialysis for 4.6 years (SD=5.2) and 16% had an advance directive. Changes in dyad congruence (OR=1.6, p=.01), patient decisional conflict (b=-.1, p<.001), and the composite outcome (OR=1.6, p=.03) were better in SPIRIT than usual care, and these treatment effects were greater in non-white dyads

**Conclusions:** SPIRIT was associated with improvements in dyad preparation for end-of-life decision making in a real-world dialysis care setting, with treatment effects comparable to those seen in previous efficacy trials of SPIRIT.

**Funding:** Other NIH Support - NINR

**TH-PO778**

**Informal Caregiving Networks of Older Adults With Dementia Superimposed on ESRD: A Social Network Study**

Mi-Kyung Song,<sup>1</sup> Sudeshna Paul,<sup>1</sup> Mary Beth Happ,<sup>2</sup> Janice P. Lea,<sup>1</sup> Linda Turberville-Trujillo,<sup>1</sup> James L. Pirkle.<sup>3</sup> <sup>1</sup>Emory University, Atlanta, GA; <sup>2</sup>The Ohio State University, Columbus, OH; <sup>3</sup>Wake Forest University School of Medicine, Winston-Salem, NC.

**Background:** It is common for older adults with ESRD to have multiple caregivers to provide instrumental help and care-related decision making. Yet, most caregiving research has been focused on the primary caregivers. This study was to characterize informal/unpaid caregiving networks of older adults with moderate to severe cognitive impairment superimposed on ESRD and their associations with caregiver and older adult health outcomes.

**Methods:** We conducted an egocentric social network study to obtain caregiving information of 46 older adults on hemodialysis with cognitive impairment. Starting with the primary family caregiver (FCG), up to 2 additional FCGs were recruited for each patient, totaling 76 FCGs (46 primary, 30 non-primary). FCGs completed a social network survey and measures of caregiving burden and reward, financial hardship, and depressive symptoms. We abstracted information about patient's ED visits and hospital admissions during the past 12 months from the medical records.

**Results:** Most patients were Black (n=35, 77.8%), 22 (47.8%) were male. The mean age was 73.9 years. Most FCGs were a child of the patient (n=39, 51.3%) and female (n=57, 75%), and had a mean age of 54.2 years. Of the 46 networks, 16 (35%) included only one FCG (singletons). Multimember networks (n=30, 65%) provided longer caregiving than singletons (7.7 vs 3.8 years, p=0.008). The average network size was 3.8. The density (overall member connection) was 0.9, and mean degree and maximum degree (number of ties per member to other network members) were 2.5 and 2.8, respectively. Among the caregiver outcomes, the primary FCG's financial hardship decreased as the network density increased but at the expense of increased non-primary FCGs' financial hardship (p<0.001). For every one unit increase in mean and maximum degrees, the odds of no hospital admission increased by 3.7 (p=0.03) and 3.6 folds (p=0.04), respectively.

**Conclusions:** Our study using a social network approach revealed the scope and potential impact of informal caregiving networks of older adults with ESRD and dementia. Our findings may have significant implications for future intervention development and implementation strategies targeting ESRD population and caregivers but need to be confirmed in a larger, longitudinal study.

**Funding:** Other NIH Support - NINR

**TH-PO779**

**Prevalence, Overlap, and Prognostic Impact of Multiple Frailty Domains in Older Patients on Hemodialysis**

**Keigo Imamura,<sup>1,2</sup> Shohei Yamamoto,<sup>3</sup> Yuta Suzuki,<sup>4</sup> Shun Yoshikoshi,<sup>1</sup> Juri Uchida,<sup>1</sup> Takuya Nakajima,<sup>1</sup> Narumi Fukuzaki,<sup>1</sup> Manae Harada,<sup>5</sup> Atsuhiko Matsunaga.<sup>1</sup>** <sup>1</sup>Kitasato University Graduate School of Medical Sciences, Sagami, Japan; <sup>2</sup>Tokyo Metropolitan Institute of Gerontology, Itabashi, Japan; <sup>3</sup>Center for Clinical Sciences, National Center for Global Health and Medicine, Shinjuku, Japan; <sup>4</sup>National Institute of Public Health, Wako, Japan; <sup>5</sup>Sagami Circulatory Organ Clinic, Sagami, Japan.

**Background:** Frailty is a state of increased vulnerability due to adverse health outcomes and is recognized as a multidimensional construct comprising physical, psychological, and social domains. There is limited evidence, however, on the association between multiple domains of frailty and risks of adverse events in patients undergoing hemodialysis (HD). Here we report the prevalence, degree of overlap, and prognostic impact of multiple frailty domains in older patients with HD.

**Methods:** Outpatients (aged ≥60 years) who underwent HD between 2017 and 2020 were retrospectively enrolled. Outcomes were all-cause mortality and hospitalization. We used the Cox proportional hazard model for examine the associations.

**Results:** Among 344 older patients (mean age, 72 years; 61% were male), the prevalence of physical, psychological, and social domains of frailty was 56.7%, 26.7%, and 57.3%, respectively. In addition, 15.4% of patients had overlap in all three domains. In the Cox model, the greater number of frailty domains was associated with higher risks of all-cause mortality (P for trend=0.001, Figure 1) and hospitalization (P for trend<0.001, Figure 2).

**Conclusions:** Older patients with HD had overlapping frailty domains, which were associated with poor prognosis. These results suggest that multidimensional assessment of frailty is important for disease management in patients requiring HD.

**Funding:** Government Support - Non-U.S.

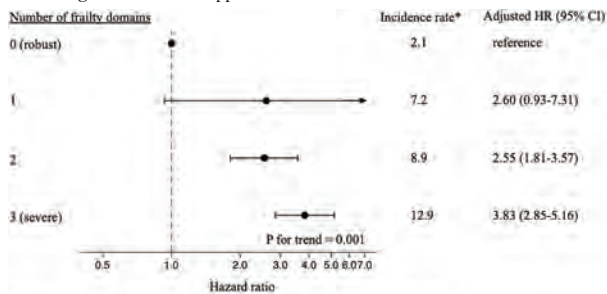

Figure 1. Associations between number of frailty domains and all-cause mortality. CI: confidence interval, HR: hazard ratio. Incidence rate\* = Incidence rate per 100 person-years. Adjusted for age, sex, body mass index, hemodialysis vintage, comorbidity score, serum albumin, C-reactive protein. 0 to 3 indicates the number of frailty domains. Higher number indicates more severe frailty.

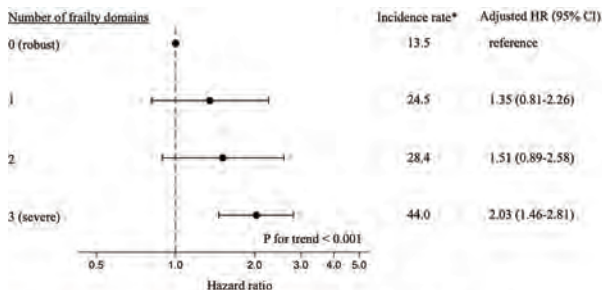

Figure 2. Associations between number of frailty domains and all-cause hospitalization. CI: confidence interval, HR: hazard ratio. Incidence rate\* = Incidence rate per 100 person-years. Adjusted for age, sex, body mass index, hemodialysis vintage, comorbidity score, serum albumin, C-reactive protein. 0 to 3 indicates the number of frailty domains. Higher number indicates more severe frailty.

**TH-PO780**

**Validation of the Novel “Race Free” CKD-EPI Equation in Persons Aged 70 and Older: The Berlin Initiative Study**

**Natalie Ebert,<sup>1</sup> Hans Pottel,<sup>2</sup> Pierre Delanaye,<sup>3</sup> Markus van der Giet,<sup>1</sup> Martin K. Kuhlmann,<sup>4</sup> Elke Schaeffner.<sup>1</sup>** <sup>1</sup>Charite Universitätsmedizin Berlin, Berlin, Germany; <sup>2</sup>KULeuven University, Kortrijk, Belgium; <sup>3</sup>Sart Tilman University, Liège, Belgium; <sup>4</sup>Vivantes Klinikum im Friedrichshain, Berlin, Germany.

**Background:** The creatinine-based CKD-EPI (ASR) equation from 2009 (ASR: age, sex, and race) has been replaced by the CKD-EPI (AS) equation using the same mathematical form without the race variable because the former has been considered a source of discrimination. NKF recently recommended using the “race free” CKD-EPI (AS) equation for patients in the US. It is unclear whether this is favorable for older patients. Our study compares the performance of CKD-EPI (AS), CKD-EPI (ASR), and the European Kidney Function Consortium (EKFC) equation.

**Methods:** We analyzed data from 570 participants of the “Berlin Initiative Study” (BIS), a community-dwelling cohort of white older adults. We measured GFR (mGFR) with iohexol plasma clearance as gold standard. We calculated bias as estimated GFR (eGFR) minus mGFR, precision (interquartile range, IQR), and accuracy (P30: percentage of eGFR values within +/- 30% mGFR). CKD-EPI (ASR), CKD-EPI (AS) and EKFC equations were validated using mGFR.

**Results:** Mean age was 78.5 yrs, 57% were male, and mean mGFR was 60.3 ml/min/1.73m<sup>2</sup>. Mean Bias for CKD-EPI (AS) was highest with 13.0 compared to 8.4 and 1.6 ml/min/1.73m<sup>2</sup> for CKD-EPI (ASR) and EKFC (Tbl. 1). P30 value was lowest for CKD-EPI (AS) (67%) compared to CKD-EPI (ASR, 81%) and EKFC (92%). Stratified by age (≥80 yrs) and mGFR (mGFR <60), we found even worse P30 results for CKD-EPI (AS) with 58% and 52% (Fig. 1).

**Conclusions:** In the US, the novel “race-free” CKD-EPI (AS) equation is recommended for diagnosing CKD. Our results suggest that CKD-EPI (AS) leads to a considerable systematic overestimation and worse prediction of eGFR in older patients. In pts. with GFR <60, P30 was even worse with only 52%, enhancing the risk of drug overdosing and delayed CKD diagnosis.

**Funding:** Private Foundation Support

**Table 1.** Bias, precision and accuracy

All n = 570	Bias [95%CI]	IQR [Pct25; Pct75]	P30 [%]
CKD-EPI (ASR)	8.40 [7.0; 9.0]	12.8 [1.7; 14.4]	81.4 [78.2; 84.6]
CKD-EPI (AS)	13.0 [12.1; 14.0]	13.8 [6.0; 19.8]	66.5 [62.6; 70.4]
EKFC	1.6 [0.7; 2.7]	11.3 [-4.0; 7.3]	91.9 [89.7; 94.2]
Age <80y n = 362			
CKD-EPI (ASR)	8.5 [6.7; 9.8]	13.9 [1.2; 15.0]	84.0 [80.2; 87.8]
CKD-EPI (AS)	13.0 [11.6; 14.5]	14.6 [5.7; 20.3]	71.5 [66.9; 76.2]
EKFC	1.3 [0.6; 2.8]	11.9 [-4.1; 7.8]	93.1 [90.5; 95.7]
Age ≥80y n = 208			
CKD-EPI (ASR)	8.3 [6.7; 9.1]	11.9 [1.8; 13.6]	76.9 [71.1; 82.7]
CKD-EPI (AS)	13.1 [11.4; 14.2]	12.4 [6.5; 18.9]	57.7 [50.9; 64.5]
EKFC	2.0 [-0.3; 3.4]	10.4 [-4.0; 6.4]	89.9 [85.8; 94.0]
mGFR <60 n = 273			
CKD-EPI (ASR)	8.8 [7.0; 10.0]	13.6 [1.7; 15.3]	67.8 [62.2; 73.3]
CKD-EPI (AS)	12.9 [11.5; 14.4]	14.7 [5.5; 20.2]	52.4 [46.4; 58.3]
EKFC	3.7 [2.7; 5.1]	11.5 [-2.3; 9.2]	85.0 [80.7; 89.2]
mGFR ≥60 n = 297			
CKD-EPI (ASR)	7.6 [6.3; 9.1]	12.6 [1.3; 13.9]	93.9 [91.2; 96.7]
CKD-EPI (AS)	13.1 [11.6; 14.5]	12.4 [6.7; 19.1]	79.5 [74.8; 84.1]
EKFC	-0.5 [-1.4; 0.8]	11.9 [-6.0; 5.8]	98.3 [96.8; 99.8]

Figure 1. P30(%) accuracy by age for CKD-EPI (ASR), CKD-EPI (AS) und EKFC in BIS data. Gray shaded area denotes area where the P30 value is above 75%.

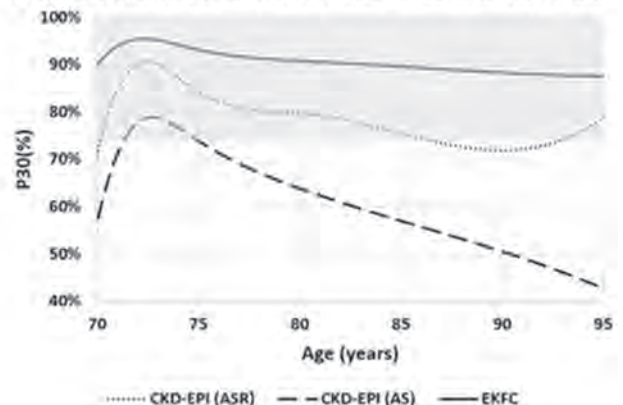



TH-PO781

**Potassium Diet Restriction in Elderly Patients With CKD: Is It Needed?**  
 Mariana L. Innecci,<sup>1</sup> Carla M. Avesani,<sup>2</sup> Venceslau A. Coelho,<sup>1</sup> Julia Lauer,<sup>1</sup> Tiago E. Costa,<sup>1</sup> Rosa M. Moyses,<sup>1</sup> Rosilene M. Elias.<sup>1</sup> <sup>1</sup>Universidade de Sao Paulo Instituto de Ciencias Biomedicas, Sao Paulo, Brazil; <sup>2</sup>Karolinska Institutet, Stockholm, Sweden.

**Background:** Most guidelines in chronic kidney disease (CKD) advise that potassium (K+) intake is to be restricted if hyperkalemia is present. For older patients with CKD, this dietary recommendation which decreases the intake of vegetables, legumes, fruits, and whole cereals may lead to poor diet and predispose the development of malnutrition and sarcopenia. Since observational studies have challenged the association between K intake and hyperkalemia, we aimed to investigate in a group of older patients with CKD the association between K+ intake and serum K+.

**Methods:** This is a cross-sectional analysis of patients > 70 yrs. with stage 4/5 CKD on conservative management. We assessed dietary K+ intake by 24-hour dietary recall. Hyperkalemia was defined as K > 5.0mmol/L.

**Results:** We included 54 patients (81 ± 7 yr, 59.3% men, body mass index 25.5 ± 4.4 kg/m<sup>2</sup>, 61.1% diabetic, eGFR 20.1 ± 6.9 ml/min, 20.4% below recommended weight). Hyperkalemia was found in 19 patients (35.2%), being more frequent among diabetics (80% vs 20% of non-diabetics, p=0.014). Serum K+ did not correlate with eGFR, albumin, sex, age, or urea. K+ dietary intake and serum K+ were 1,375 mg/day (870-1,812) and 4.8 ± 0.6 mEq/L, respectively, without a significant correlation between them (r=0.210, p=0.160). Also, K+ intake was similar between patients with and without hyperkalemia [1,581 (863-2,000) and 1,375 (878-1,543), p=0.363].

**Conclusions:** Older patients with moderate/advanced CKD did not have a high K+ intake and it was not associated with serum K+. Considering that these patients may be at risk for malnutrition, a K+ dietary restriction must be individually evaluated considering the patients clinical and nutritional condition.

TH-PO782

**Restriction of Protein: Leveraging the Risk of Sarcopenia and the Progression of CKD in Older Patients**  
 Mariana L. Innecci,<sup>1</sup> Carla M. Avesani,<sup>2</sup> Venceslau A. Coelho,<sup>1</sup> Julia Lauer,<sup>1</sup> Tiago E. Costa,<sup>1</sup> Rosa M. Moyses,<sup>1</sup> Rosilene M. Elias.<sup>1</sup> <sup>1</sup>Universidade de Sao Paulo Instituto de Ciencias Biomedicas, Sao Paulo, Brazil; <sup>2</sup>Karolinska Institutet, Stockholm, Sweden.

**Background:** Most guidelines recommend a restriction in protein intake to slow the progression of CKD. However, older patients are at high risk for sarcopenia which can be worsened with low energy and protein intake. Since older patients are often excluded from clinical trials, there is a scarcity of data to support this recommendation in this population. We aimed to evaluate nutritional status and sarcopenia in older patients with CKD.

**Methods:** This is a cross-sectional analysis of older patients (>70 yr) with stage 4 and 5 CKD on conservative management. We assessed biochemical data, 24-hour dietary recall, skinfold thicknesses, and other anthropometric measurements. Sarcopenia was assessed by the SARC-F and SARCF-Calf circumference (SARCF-CC) questionnaires (higher scores indicate higher risk for sarcopenia).

**Results:** We included 54 patients (81 ± 7 yr, 59.3% men, body mass index 25.5 ± 4.4 kg/m<sup>2</sup>, 61.1% diabetes, eGFR 20.1 ± 6.9 ml/min, 20.4% below recommended weight). Patients were divided in 3 groups: 70-80, 81-90 and > 90 yr. (Table 1). Body mass index, CC and percentage of body fat were lower in those >90yr, for similar renal function. SARCF was similar among groups (p=0.348) and SARCF-CC was higher among patients >90 yr (p=0.031). Adherence to ingesting protein intake 0.6-0.8g/Kg was followed by 26.9%, 21.1% and 11.1 % of patients in groups 70-80, 80-90 and > 90yr, respectively (p=0.065).

**Conclusions:** This analysis suggests that the older patients, particularly those > 90yr, are more susceptible to malnutrition and sarcopenia. Therefore, protein-restricted diets must be considered with caution according to the patients clinical and nutritional condition to avoid further worsening in the nutritional status.

	70-80 yr	81-90 yr	> 90 yr
N (all 54)	26	19	9
Age *	74.73 ± 2.92	85.37 ± 2.96	92.89 ± 2.03
eGFR CKD-EPI (mL/min/1.73 <sup>2</sup> )	18.68 ± 6.68	23.17 ± 7.01	17.92 ± 5.33
Creatinine (mg/dL)	3.18 ± 3.18	2.49 ± 2.94	2.76 ± 0.85
Urea (mg/dL)	108.56 ± 44.35	96.68 ± 33.98	121.00 ± 59.51
Body weight (kg) *	76.40 ± 13.80	59.73 ± 11.01	60.10 ± 7.80
BMI (kg/m <sup>2</sup> ) *	27.96 ± 4.16	22.84 ± 3.54	24.04 ± 2.40
Calf circumference (cm) *	35.69 ± 4.21	31.70 ± 2.55	29.81 ± 6.44
Body fat (%) *	33.97 ± 5.07	29.41 ± 5.98	31.90 ± 5.41
Energy intake (Kcal/kg/day) *	19.49 ± 10.14	24.46 ± 7.94	18.12 ± 6.90
Protein intake (g/kg/day) *	19.49 ± 10.14	1.08 ± 0.54	0.58 ± 0.22
Female sex (%)	38.5	36.8	55.6

\* p<0.05

TH-PO783

**Older Patients' and Caregivers' Perspectives on Kidney Therapy Decision-Making**  
 Ramya Sampath,<sup>1</sup> Sandhya Seshadri,<sup>1</sup> Tramanh Phan,<sup>1</sup> Paul Duberstein,<sup>2</sup> Ronald M. Epstein,<sup>1</sup> Fahad Saeed.<sup>1</sup> <sup>1</sup>University of Rochester Medical Center, Rochester, NY; <sup>2</sup>Rutgers School of Public Health, Piscataway, NJ.

**Background:** Growing evidence suggests that dialysis may not significantly improve survival or quality of life (QOL) for some older, frail patients with significant comorbidities. Studies also suggest that decisions to initiate dialysis are not always concordant with patients' expressed treatment preferences. Thus, it is critical to gain knowledge of patients' and their caregivers' perspectives on kidney therapy (KT) decision-making. Our study describes the perceptions and preferences of older adults and their caregivers during KT decision-making.

**Methods:** We designed a survey and administered it orally to ascertain patients' and caregivers' perceptions and preferences regarding KT decisions. Our sample included 26 patients and 15 caregivers enrolled in the intervention arm of the CKD-EDU Study, a palliative care intervention to help older adults and their caregivers with KT decision-making. Using qualitative content analysis, four study team members individually coded the data and met regularly to review the coded data. Consistent with qualitative research methods, differences were resolved through discussion and consensus to enhance rigor.

**Results:** The average ages of patients and caregivers were 82.7 ± 5.7 years and 66.4 ± 13.7 years respectively. Thirteen patients and eleven caregivers were women; twenty patients and twelve caregivers were White. Four overarching themes of patient and caregiver perceptions and preferences regarding KT decision-making emerged: 1) It is important for patients to both prolong life and have good a quality of life; 2) Some patients' desires for longevity conflicted with their preferred treatment choices; 3) Thoughts of CKD progression and consequences of treatment options on QOL were worrisome; 4) "Deciding not to decide" was a common way to cope with stressors of decision-making and to maintain a sense of control.

**Conclusions:** Patients' and caregivers' preferences for KT options are multifaceted and affect-laden. Improved communication and shared decision-making to improve KT decision-making are necessary to ensure goal-concordant care for older adults.

**Funding:** Other NIH Support - KL2 Grant funded by the NIH Renal Research Institute (NCT03465449)

TH-PO784

**Outcomes of Palliative Care Consultation in Patients With CKD Hospitalized With Acute Stroke**  
 Areeba Jawed,<sup>1</sup> Fahad Saeed,<sup>2</sup> James Slaven,<sup>3</sup> Amber Comer.<sup>3</sup> <sup>1</sup>University of Michigan Michigan Medicine, Ann Arbor, MI; <sup>2</sup>University of Rochester School of Medicine and Dentistry, Rochester, NY; <sup>3</sup>Indiana University School of Medicine, Indianapolis, IN.

**Background:** There is a heightened mortality risk for patients with Chronic Kidney Disease (CKD) hospitalized with acute stroke. Both American Heart Association and American Stroke Association endorse involvement of palliative care in these patients.

**Methods:** We report a secondary analysis of a retrospective observational study performed in adult patients with CKD discharged with a diagnosis of acute ischemic stroke from four large, urban hospitals in the mid-west between January 2016 to December 2018. We obtained data on demographics, co-morbid conditions, code status on admission and discharge, involvement of ethics and spiritual care and palliative care services. We compared outcomes between acute stroke patients with CKD who received a palliative care consultation versus those who did not. Outcome measures included: in-hospital mortality, mechanical ventilation, tracheostomy, artificial Nutrition/gastrostomy tube, thrombolytic therapy (tPA), thrombectomy, ICU Admission, dialysis, cardiopulmonary resuscitation, and end-of-life quality measures including completion of advanced care directives and documentation of goals of care conversations.

**Results:** Among the 1480 patients (mean age = 73.1 ± 14.4, 57.3% female, and 75.2% white) admitted with acute stroke, 206 had CKD stages 3-5D, and 26.2% (n=54) were seen by palliative care. Those who received palliative care consultation were older (mean age 81.1 vs. 70.2, p<0.0001), had do-not-resuscitate code status at discharge (77.8% vs. 24.3%, OR=10.88 (5.19, 22.82) p<0.0001), and were more likely to receive spiritual care (81.5% vs. 57.9%, OR=3.20 (1.50, 6.83), p<0.0001). A higher proportion of patients seen by palliative care died during the same hospitalization (32.1% vs. 10.6%, OR=3.98 (1.84, 8.65), p=0.003), enrolled in hospice (24.5% vs. 4.0%, OR=7.91 (2.83, 22.11), p<0.0001), transitioned to comfort care (51.9% vs. 11.9%, OR=7.96 (3.85, 16.45), p<0.0001), discontinued artificial nutrition (25.9% vs. 4.6%, OR=7.20 (2.72, 19.04), p<0.0001), and had vent withdrawn: 16.7% vs. 6.6%, OR=2.82 (1.08, 7.37); p=.0289 at discharge.

**Conclusions:** Palliative Care consultation is associated with improved end of life quality outcomes and an increase in hospice enrollment in patients with acute stroke and CKD.

## TH-PO785

**Older Patients Are Less Prone to Fast Decline of Renal Function: A Propensity-Matched Study**

Paula M. Pina, Luis C. Arcon, Roberto Zatz, Rosa M. Moyses, Rosilene M. Elias. *Universidade de Sao Paulo Hospital das Clinicas, Sao Paulo, Brazil.*

**Background:** Although Chronic Kidney Disease (CKD) is common among aging patients, and although factors associated with its progression have been studied over decades, little is known about the rate of renal functional decay in this population.

**Methods:** Between January 2012 and December 2017, we included 1071 adult CKD patients on conservative treatment in a 1:1 propensity-score matched study of older (O, >65yr) and younger (Y, ≤65yr) individuals. Factors associated with the slope of the decline of eGFR (S), such as proteinuria, initial eGFR, diabetes, sex, and use of angiotensin-converting enzyme inhibitors/angiotensin receptor blockers (ACEI/ARB) were analyzed. Inclusion criteria were at least two consultations in the service, and an initial eGFR lower than 45 mL/min/m<sup>2</sup>. Patients were classified as fast progressors when S exceeded 5 mL/min/1.73 m<sup>2</sup>/yr.

**Results:** Crude analysis of eGFR decline showed slower progression of O when compared to Y, both in terms of absolute change [-2.0 (-4.5, -1.0) vs. -3.0 (-7.0, -1.0) mL/min/1.73m<sup>2</sup>, p<0.001] and of S [-2.2 (-4.4, -1.0) vs. -3.1 (-6.7, -1.2)] mL/min/1.73m<sup>2</sup>, p<0.001. Patients considered fast progressors were less likely to be older (35.2% younger vs. 22.0% older, p<0.001). Accordingly, adjusted logistic multivariate regression revealed that the odds ratio of fast eGFR decline was lower in O than in Y (p=0.0001), independently of proteinuria (p=0.063), diabetes (p=0.017), ACEI/ARB use (p=0.0001), sex (p=0.0001), or baseline values for eGFR (p=0.001), phosphate (p=0.0001) and 25(OH) vitamin D (p=0.0001). The reasons for these differences between O and Y are unclear.

**Conclusions:** In patients over 65 years of age, CKD progression was slower than in younger patients even after multiple adjustments. This finding should be taken into consideration during both conservative management and preparation for dialysis.

**Funding:** Government Support - Non-U.S.

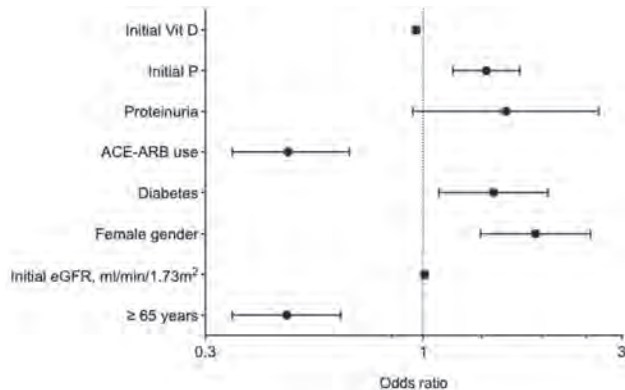

Odds ratio of fast progressor of renal function decline, defined as a reduction above 5 mL/min/1.73m<sup>2</sup>/year

## TH-PO786

**Risks Associated With Low eGFRcr, eGFRcys, and eGFRcr-cys at Older Age**

Edouard Fu,<sup>1,2</sup> Juan J. Carrero,<sup>3</sup> Yingying Sang,<sup>4</sup> Marie Evans,<sup>3</sup> Shoshana Ballew,<sup>4</sup> Lesley A. Inker,<sup>5</sup> Morgan Grams,<sup>4</sup> Andrew S. Levey,<sup>5</sup> Josef Coresh,<sup>4</sup> <sup>1</sup>Brigham and Women's Hospital, Boston, MA; <sup>2</sup>Harvard Medical School, Boston, MA; <sup>3</sup>Karolinska Institutet, Stockholm, Sweden; <sup>4</sup>Johns Hopkins University, Baltimore, MD; <sup>5</sup>Tufts Medical Center, Boston, MA.

**Background:** Understanding the risk consequences of CKD at older age has often been limited to kidney failure replacement therapy (KFRT) and all-cause mortality (ACM), and to GFR estimated using serum creatinine (eGFRcr). However, eGFRcr may be falsely elevated in the elderly due to low muscle mass. We sought to compare the risks of several clinically relevant outcomes associated with both eGFR<sub>cr</sub> and cystatin C-based eGFR (unrelated to muscle mass), in elderly patients in routine health care.

**Methods:** We included all 79,995 patients (mean age 77 years, 50% female) in Stockholm region, Sweden (SCREAM) age 65+ years who undertook routine outpatient tests of IDMS calibrated creatinine and cystatin C on the same day during 2011-2018. We modeled CKD-EPI eGFR using creatinine (eGFRcr), cystatin C (eGFRcys) or both (eGFRcr-cys) as a spline in adjusted negative binomial and Cox regressions of subsequent risk for 7 clinical outcomes: acute kidney injury, KFRT, any hospitalization, heart failure hospitalization, major adverse cardiovascular events, cardiovascular and all-cause mortality.

**Results:** 22% of older adults with creatinine testing also had routine cystatin C measurements. **Figure 1** shows the HRs for each outcome at eGFR 30 or 60 vs. 80 mL/min/1.73m<sup>2</sup> by age group. Overall, eGFRcr was not as consistently associated across the range of outcomes as eGFRcys or eGFRcr-cys, especially at greater age. A

U-shaped relationship was observed for all-cause mortality, cardiovascular mortality and hospitalization for eGFRcr, but not for eGFRcys or eGFRcr-cys (**Figure 2**).

**Conclusions:** eGFRcys and eGFRcr-cys reveal risk associations which are missed by eGFRcr. The U-shaped relationship with eGFRcr, not seen for eGFRcys, suggests the increased risk at high eGFRcr is associated with low creatinine generation, not true high GFR. Looking at outcomes beyond KFRT and mortality and using cystatin C allows for a better understanding of risks in CKD.

## TH-PO787

**Rates and Predictors of Mortality in Different Age Groups of Elderly With Maintenance Hemodialysis: A Large Observational Cohort Study in 17,354 Patients**

Kajohnsak Noppakun,<sup>1,2</sup> Chidchanok Ruengorn,<sup>2,3</sup> Apichat Tantraworasin,<sup>2,4</sup> Jiraporn Khorana,<sup>4</sup> <sup>1</sup>Division of Nephrology, Department of Internal Medicine, Faculty of Medicine, Chiang Mai University, Chiang Mai, Thailand; <sup>2</sup>Pharmacoeconomics and Statistics Research Center (PESRC), Faculty of Pharmacy, Chiang Mai University, Chiang Mai, Thailand; <sup>3</sup>Department of Pharmaceutical Care, Faculty of Pharmacy, Chiang Mai University, Chiang Mai, Thailand; <sup>4</sup>Clinical Epidemiology and Clinical Statistic Center, Faculty of Medicine, Chiang Mai University, Chiang Mai, Thailand.

**Background:** Maintenance hemodialysis (MHD) is a life-saving procedure for end-stage kidney disease (ESKD) patients. Although there is no age limit for an initiation of MHD, survival benefits of HD in very elderly patients are questionable. We aimed to identify the groups of elderly patients who have high mortality rates after an initiation of MHD.

**Methods:** Elderly (≥70 years) patients initiated MHD between Jan 2005 and Dec 2020 were recruited. All data were retrieved from Thailand Renal Replacement Therapy Registry data. Patients were divided into 3 groups according the age at dialysis initiation: 70 to <85 (n=15955), 85 to <90 (n=1151), and ≥90 years (n=248).

**Results:** 17,354 patients were recruited, 46.46% were male with mean age of 76.9±5.1 years. The total mortality rate was 36.35% with the median (IQR) follow-up time of 40.45 (0.03-192.1) months and the total time-at-risk of 76,624 years. Comparing with the group aged 70 to <85 years, the group aged 85 to <90 and ≥90 years had increased risk of death with hazard ratio (HR) 1.93 (95%CI 1.76-2.13; p<0.001) and 3.06 (95%CI 2.51-3.74; p<0.001), respectively. About 82.2% (95%CI 81.6-82.8) of the patients aged between 70 and <85 years died during 7-8 years after dialysis initiation, while 81.4% (95%CI 79.3-83.4) of patients ≥85 years of age died during 4-5 years after dialysis initiation. From multivariable analyses, predictors for mortality in the group ≥85 years of age were Karnofsky Performance Status Scale (KPSS) ≤50 (vs ≥60) with HR 4.56 (95%CI 1.57-13.29; p=0.005), eGFR at dialysis initiation ≥7 mL/min/1.73m<sup>2</sup> (vs <7) with HR 2.26 (95%CI 1.11-4.60; p=0.024), and serum albumin <3.5 g/dL (vs ≥3.5) with HR 2.22 (95%CI 1.19-4.15; p=0.012). The HR for death in patients ≥85 years of age with combination of the three potential predictors; KPSS ≤50 and eGFR ≥7 mL/min/1.73m<sup>2</sup> and serum albumin at dialysis initiation <3.5 g/dL, was 5.02 (95%CI 2.12-11.88; p<0.001) compared to patients in the same age group without those characteristics.

**Conclusions:** In elderly with ESKD, MHD is justified in patients aged between 70 and 85 years as most of them had reasonable survival rates. However, in patients who were older than 85 years, mortality rate was high in those with KPSS ≤50, eGFR ≥7 mL/min/1.73m<sup>2</sup> and serum albumin at dialysis initiation <3.5 g/dL.

## TH-PO788

**Protein Biomarkers Associated With Cardiovascular Events in Older People With Advanced CKD: Results From the EQUAL Study**

Samantha J. Hayward,<sup>1,2</sup> Nicholas C. Chesnaye,<sup>3</sup> Barnaby D. Hole,<sup>4,2</sup> Ryan E. Aylward,<sup>4</sup> Yvette Meuleman,<sup>5</sup> Claudia Torino,<sup>6</sup> Gaetana Porto,<sup>7</sup> Maciej Szymczak,<sup>8</sup> Christiane Drechsler,<sup>9</sup> Friedo W. Dekker,<sup>5</sup> Marie Evans,<sup>10</sup> Kitty J. Jager,<sup>3</sup> Christoph Wanner,<sup>9</sup> Fergus Caskey,<sup>4,2</sup> <sup>1</sup>University of Bristol Translational Health Sciences, Bristol, United Kingdom; <sup>2</sup>Southmead Hospital, Bristol, United Kingdom; <sup>3</sup>ERA-EDTA Registry, Amsterdam, Netherlands; <sup>4</sup>Population health sciences, Bristol Medical School, Bristol, United Kingdom; <sup>5</sup>Leiden Universitair Medisch Centrum Afdeling Klinische Epidemiologie, Leiden, Netherlands; <sup>6</sup>Istituto di Fisiologia Clinica Consiglio Nazionale delle Ricerche Sezione di Reggio Calabria, Reggio Calabria, Italy; <sup>7</sup>GOM Bianchi Melacrino Morelli, Reggio Calabria, Reggio Calabria, Italy; <sup>8</sup>Uniwersytet Medyczny im Piastow Slaskich we Wroclawiu Katedra i Klinika Nefrologii i Medycyny Transplantacyjnej, Wroclaw, Poland; <sup>9</sup>Division of Nephrology, University Hospital of Wurzburg, Wurzburg, Germany; <sup>10</sup>Karolinska Institutet, Stockholm, Sweden.

**Background:** Cardiovascular disease is the leading cause of morbidity and mortality in people with chronic kidney disease (CKD). We investigated a panel of proteins associated with inflammatory and cardiovascular disease to determine their potential as biomarkers for major cardiovascular events (MACE) amongst individuals with CKD.

**Methods:** The EQUAL study enrolled people aged ≥65 years with eGFR ≤20. EQUAL recruits were split into Discovery (n=611) and Replication cohorts (n=292). Baseline blood samples were tested for 184 proteins using OLINK proximity extension assay technology. Cox proportional hazard models adjusted for age, sex, eGFR and country were used to determine the risk of MACE. Proteins with false discovery rate

Key: TH - Thursday; FR - Friday; SA - Saturday; OR - Oral; PO - Poster; PUB - Publication Only

Underline represents presenting author.

(FDR) values <0.05 in the Discovery cohort were considered significant and were tested in the Replication cohort. Sensitivity analyses, adjusting for traditional (hypertension, diabetes, previous myocardial infarction, cholesterol, smoking and body mass index) and CKD-specific (calcium, phosphate and PTH) risk factors for MACE, were performed.

**Results:** During a median follow-up of 2.9 years 325 people (36%) had MACE. 63 proteins were associated with MACE in the Discovery cohort (FDR p values <0.05); 12 of these proteins had similar effect sizes in the Replication cohort (Figure 1). Tenascin, Vascular cell adhesion protein 1 (VCAM1), V-set and Immunoglobulin Domain containing protein 2 (VSIG2) and Fibroblast growth factor 23 (FGF23) maintained their association with MACE after adjustment for traditional and CKD-specific risk factors.

**Conclusions:** Increased levels of Tenascin, VCAM1, VSIG2 and FGF23 were associated with an increased risk of MACE in older people with advanced CKD. Our findings highlight VSIG2 as a new potential cardiovascular biomarker and corroborate those of previous studies linking Tenascin, VCAM1 and FGF23 with MACE in people with CKD.

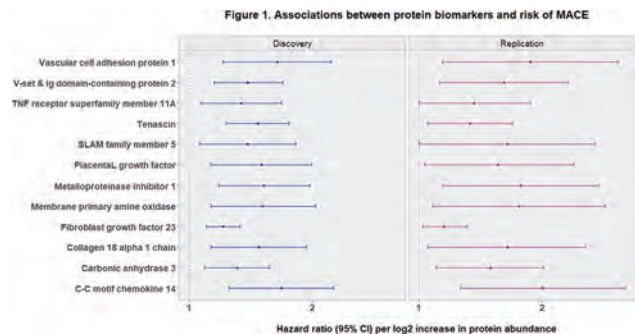

	Univariates (95%CI)	p value	Multivariates (95%CI)	p value
Age	3.136(1.221-8.058)	0.005	6.728(1.418-31.33)	0.016
irisin	0.747(0.454-1.228)	0.175		
Indoxyl sulfate	3.485(1.372-8.852)	0.01	8.525(1.807-40.207)	0.007
Interleukin 6	0.732(0.541-0.990)	0.049	1.313(0.303-5.694)	0.716
Myostatin	2.167(1.213-3,781)	0.002	0.484(0.071-3.110)	0.46
DM	0.725(0.424-1.344)	0.25		
Hypertension	0.744(0.546-1.098)	0.135		
Coronary artery disease		0.547		
Congestive heart failure	1.494(1.058-2.109)	0.009		

Table 1. Univariate and Multivariate analysis for the factors associated with lower handgrip strength in total population.

TH-PO789

**Indoxyl Sulfate Mediated Lower Handgrip Strength, in Comparison With Sarcopenia, Was Predictive of Higher Hospitalization in ESRD Patients**

Yi-Chou Hou,<sup>1</sup> Kuo-Cheng Lu,<sup>2</sup> <sup>1</sup>Cardinal Tien Hospital, New Taipei City, Taiwan; <sup>2</sup>Taipei Tzu Chi Hospital, New Taipei City, Taiwan.

**Background:** Sarcopenia is common in patients with chronic kidney disease (CKD)/end stage kidney disease (ESRD) than in normal patients. Lower handgrip strength, in comparison with sarcopenia, is associated with clinical outcome including cardiovascular mortality and hospitalization in CKD subjects. The study is to elucidate if uremic toxin contributes to the lower handgrip strength in CKD/ESRD patients.

**Methods:** The participants of the study were divided into three groups: control group (estimated glomerular filtration rate [eGFR] ≥ 60 mL/min), advanced CKD (eGFR = 15–60 mL/min), and ESRD(under maintenance renal replacement therapy). All participants received handgrip strength measurement, dual-energy X-ray absorptiometry, blood sampling for myokine and indoxyl sulfate. Sarcopenia was with lower appendicular skeletal muscle index (appendicular skeletal muscle/height<sup>2</sup>) of <7.0 kg/m<sup>2</sup> in men and <5.4 kg/m<sup>2</sup> in women) and lower handgrip strength (handgrip strength of <28 kg in men and <18 kg in women).

**Results:** The ESRD group had the highest number of participants with lower handgrip strength (41.6% vs 25% and 5.85% in the control and CKD groups, respectively, p < 0.05). The percentage of sarcopenia was similar between group (p=0.864). Lower handgrip strength was associated with higher hospitalization within total population (p=0.02) during 600 days of following up. The serum concentration of indoxyl sulfate was higher in the ESRD group(227.29±92.65uM, vs 41.97 ±43.96uM for CKD group and 6.54±3.45uM for control group, p<0.05). Indoxyl sulfate was associative to lower handgrip strength in univariate (OR: 3.485, 95%CI:1.372-8.852, p=0.001) and multivariable logistic regression (OR: 8.525, 95% CI:1.807-40.207, p=0.007).

**Conclusions:** Handgrip strength was lower in the ESRD patients. The lower handgrip strength was predictive to the hospitalization in the total population. Indoxyl sulfate contributed to lower handgrip strength associated with lower handgrip strength and counteract the effect of myokine in CKD patients.

TH-PO790

**The Prevalence of Sarcopenia and Its Impact on CV Events and Mortality Among ESKD Patients on Dialysis: A Systematic Review and Meta-Analysis**

Wannasit Wathanavasin,<sup>1</sup> Athiphat Banjongjit,<sup>2</sup> Yingyos Avihingsanon,<sup>2</sup> Kearkiat Praditpornsilpa,<sup>2</sup> Somchai Eiam-Ong,<sup>2</sup> Paweena Susantitaphong,<sup>2</sup> <sup>1</sup>Charoenkrung Pracharuk Hospital, Bangkok, Thailand; <sup>2</sup>King Chulalongkorn Memorial Hospital, Bangkok, Thailand.

**Background:** Sarcopenia in end stage kidney disease (ESKD) patients requiring dialysis is a frequent complication but remains under-recognized problem. This meta-analysis was conducted to determine the global prevalence of sarcopenia and explore whether it impacts on the clinical outcomes especially cardiovascular events and mortality in dialysis patients.

**Methods:** The eligible studies were searched from PubMed, Scopus and Cochrane Central Register of Controlled trials up to 31 March 2022. We included cross-sectional and cohort studies that reported the prevalence of sarcopenia including low muscle mass and low muscle strength and adverse effects such as cardiovascular events and mortality. The random-effects model was used to calculate pooled prevalence rate. Associations between sarcopenia and clinical outcomes were expressed as odd ratio (OR) and 95% confidence interval (CI). Cochran’s Q statistic and I<sup>2</sup> test were used to measure the presence of heterogeneity. Publication bias were also tested by Funnel plot and Egger’s test.

**Results:** This meta-analysis included 41 studies with 7,576 patients. The pooled prevalence of sarcopenia in dialysis patients was 25.6% (95% CI 22.1 to 29.4%). Among various diagnostic criteria, the highest prevalence was found in Asian Working Group for Sarcopenia (AWGS) 2019 criteria [36.9%, 95% CI 30.4 to 44.2%]. Sarcopenia was significantly associated with higher mortality risk [adjusted OR 1.83 (95% CI 1.40 to 2.39)] and cardiovascular events [adjusted OR 3.80 (95% CI 1.79 to 8.09)]. Additionally, both low muscle mass and low muscle strength were independently related to increased mortality risk in dialysis patients [OR 1.71; 95% CI (1.20 to 2.44), OR 2.15 (95% CI 1.51 to 3.07), respectively].

**Conclusions:** This meta-analysis revealed that sarcopenia was highly prevalent among dialysis patients and shown to be an important predictor of cardiovascular events and mortality. Future intervention research to alleviate this burden of disease in dialysis patients is needed.

TH-PO791

**Palliative Care for Patients With Failing Kidney Allograft: A Mixed Methods Study**

Amanda J. Reich,<sup>1</sup> Naoka Murakami,<sup>1</sup> Joshua R. Lakin,<sup>9</sup> Katherine He,<sup>1</sup> Samantha L. Gelfand,<sup>1</sup> Richard E. Leiter,<sup>9</sup> Joel T. Adler,<sup>10</sup> Emily Lu,<sup>6</sup> Song C. Ong,<sup>8</sup> Beatrice P. Concepcion,<sup>2</sup> Neeraj Singh,<sup>3</sup> Haris F. Murad,<sup>5</sup> Prince M. Anand,<sup>7</sup> Sarah Ramer,<sup>11</sup> Darshana M. Dadhania,<sup>12</sup> Krista L. Lentene,<sup>4</sup> Tarek Alhamad,<sup>5</sup> KRAFT workgroup <sup>1</sup>Brigham and Women's Hospital, Boston, MA; <sup>2</sup>Vanderbilt University, Nashville, TN; <sup>3</sup>Willis-Knighton Health System, Shreveport, LA; <sup>4</sup>Saint Louis University, Saint Louis, MO; <sup>5</sup>Washington University in St Louis, St Louis, MO; <sup>6</sup>Icahn School of Medicine at Mount Sinai, New York, NY; <sup>7</sup>Medical University of South Carolina, Charleston, SC; <sup>8</sup>The University of Alabama at Birmingham Montgomery, Montgomery, AL; <sup>9</sup>Dana-Farber Cancer Institute, Boston, MA; <sup>10</sup>The University of Texas at Austin, Austin, TX; <sup>11</sup>James J Peters VA Medical Center, New York, NY; <sup>12</sup>Weill Cornell Medicine, New York, NY.

**Background:** Patients with failing kidney allografts suffer from multiple comorbidities and experience significant symptom burden. Palliative care (PC) in transplant recipients is underutilized and the underlying barriers to PC delivery to renal transplant patients are poorly characterized.

**Methods:** We conducted an explanatory sequential mixed methods study with an online survey followed by semi-structured interviews targeting US transplant clinicians.

**Results:** A total of 149 participants (83 nephrologists, 31 nurses, 15 advanced practice providers, 10 surgeons, 6 social workers, 4 others) from 80 transplant centers completed the survey, of which 19 completed an interview. Most transplant clinicians (68%) have never or rarely referred transplant patients to PC. Participants reported poor patient functional status (86%), cancer diagnosis (76%) and frailty (74%) as the most influential factors for PC referral. Regarding timing of PC referral, most providers disagreed with PC involvement in pre-transplant (68%) or early post-transplant (74%) phases. Some (41%) thought that the goals of transplantation and PC are contradictory, others (60%) agreed with consulting PC only near end-of-life, but 62% also thought that early PC intervention may be beneficial in persistent allograft dysfunction. Barriers to engaging PC included patient/caregivers' unrealistic prognostic expectations (69%) and competing demands for clinicians' time (43%). Interviews revealed institution-level (e.g. narrow PC service scope, overburdened PC services) and clinician-level factors (e.g. lack of relationship between PC and transplant teams, limited understanding of patients' racial, ethnic or cultural background) that lead to the patterns observed in our survey. Additionally, interviews suggested several facilitators to PC care referral: improving awareness of PC services and educations to clinicians and patients/caregivers.

**Conclusions:** This mixed methods study highlights opportunities to improve the engagement of PC for transplant recipients. More attention is needed to optimize the timing, clinical setting and collaborative model to best deliver PC, especially for the diverse populations served by renal transplant teams.

**Funding:** Private Foundation Support

TH-PO792

**Bioelectrical Impedance Analysis Derived-Phase Angle as an Earlier Predictor of Frailty in Hemodialysis Patients**

Ismael A. Gómez Ruiz, Oscar Hernández Apolinar, Samantha Hernandez Espinoza, Geovana Martin-Alemañy, Juan M. Ardavin Ituarte. *Medica Santa Carmen, Ciudad de México, Mexico.*

**Background:** Frailty is highly prevalent in the hemodialysis (HD) patient population (28-60%) and is associated with higher morbidity and mortality. Early frailty identification will allow earlier treatment interventions. The aim of the present study was to study phase angle (PA) measured by bioelectrical impedance analysis (BIA) as a predictor of frailty risk. Secondary aims were: a) evaluate the association between frailty and different factors, b) determine the prevalence of frailty among adult patients on hemodialysis.

**Methods:** prospective cohort study performed between July 2021 and April 2022 in two Mexican HD centers. The Clinical Frailty Scale (CFS) was used to diagnose frailty. Using ROC curves, we determined the best cut-off for PA to predict frailty (Figure A). Pearson's correlation coefficient between PA and CFS score were calculated and univariate logistic regression analysis was performed (Figure B)

**Results:** 78 patients were enrolled in this study. Participants were an average of 63.7 ± 14.3 years old with more male gender (62.8%) than female. 60.2% of participants were categorized as frailty. As expected, patients with frailty were older, had lower PA value and higher CFS score. Frailty was more prevalent in males and smokers. The AUC of PA to predict frailty was 0.87 (p<0.0001). Moderate-to-strong negative correlation was found between PA and CFS score (r=-0.58, p<0.0001). A univariate logistic regression analysis revealed that the factors independently associated with frailty were the following: male (odds ratio [OR] = 3.01, 95% confidence interval [CI] 1.09-8.35), age (OR = 1.04, 95% CI 1.00-1.08) and phase angle (OR = 0.51, 95% CI 0.34-0.75).

**Conclusions:** A simple PA determination (<5.3) by BIA can predict risk of frailty (sensitive 85% and specificity 84%) in HD patients. The use of PA as a screening tool at no extra cost would allow early identification of frailty and referral for geriatric evaluation.

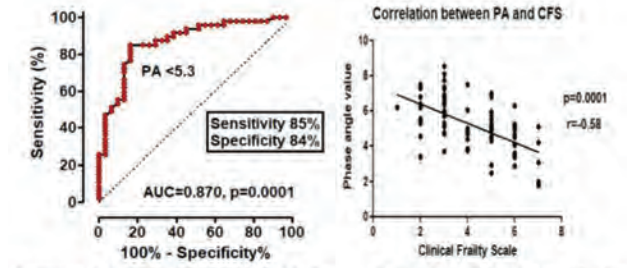

Figure A. ROC curves to predict Frailty.

Figure B. Relationship between PA value and CFS score

TH-PO793

**Prediction Model for 6-Month Mortality in Incident Older Hemodialysis Patients: Data From the Korean Society of Geriatric Nephrology**

Woo Yeong Park,<sup>1</sup> Jang-Hee Cho,<sup>2</sup> Byung chul Yu,<sup>3</sup> Miyeun Han,<sup>4</sup> Sang Heon Song,<sup>5</sup> Gang-Jee Ko,<sup>6</sup> Jae Won Yang,<sup>7</sup> Sungjin Chung,<sup>8</sup> Yu Ah Hong,<sup>9</sup> Young Youl Hyun,<sup>10</sup> Eunjin Bae,<sup>11</sup> In O Sun,<sup>12</sup> Hyunsuk Kim,<sup>13</sup> Won Min Hwang,<sup>14</sup> Sung Joon Shin,<sup>15</sup> Soon hyo Kwon,<sup>16</sup> Kyung Don Yoo.<sup>17</sup> Korean Society of Geriatric Nephrology <sup>1</sup>Keimyung University School of Medicine, Daegu, Republic of Korea; <sup>2</sup>Kyungpook National University School of Medicine, Daegu, Republic of Korea; <sup>3</sup>Soonchunhyang University Hospital Bucheon, Bucheon, Gyeonggi-do, Republic of Korea; <sup>4</sup>National Medical Center, Seoul, Republic of Korea; <sup>5</sup>Pusan National University School of Medicine, Busan, Republic of Korea; <sup>6</sup>Korea University College of Medicine and School of Medicine, Seoul, Republic of Korea; <sup>7</sup>Yonsei University Wonju College of Medicine, Wonju, Gyeonggi-do, Republic of Korea; <sup>8</sup>The Catholic University of Korea, Seoul, Republic of Korea; <sup>9</sup>The Catholic University of Korea, Daejeon, Republic of Korea; <sup>10</sup>Sungkyunkwan University School of Medicine, Seoul, Republic of Korea; <sup>11</sup>Gyeongsang National University Graduate School of Medicine, Changwon, Gyeongsangnam-do, Republic of Korea; <sup>12</sup>Presbyterian Medical Center, Jeonju, Jeollabuk-do, Republic of Korea; <sup>13</sup>Hallym University College of Medicine, Chuncheon, Gangwon, Republic of Korea; <sup>14</sup>Konyang University Hospital, Daejeon, Republic of Korea; <sup>15</sup>Dongguk University School of Medicine, Goyang, Gyeonggi-do, Republic of Korea; <sup>16</sup>Soonchunhyang University Hospital, Seoul, Republic of Korea; <sup>17</sup>University of Ulsan College of Medicine, Ulsan, Republic of Korea.

**Background:** Early mortality following hemodialysis initiation is a barrier to improving patient survival. We aimed to develop a clinical risk model to predict the early mortality of older hemodialysis patients.

**Methods:** Hemodialysis patients aged >70 years were recruited from a retrospective cohort from the Korean Society of Geriatric Nephrology (KSGN). A prognostic score for 6-month mortality risk after dialysis initiation was developed, named the KSGN score. Multivariate Cox regression analysis was used to select risk factors from 20 clinical variables.  $\beta$ -coefficients were converted to natural logarithms for the final risk score model.

**Results:** Among the 1,967 incident hemodialysis patients, the crude 6-month mortality rate was 15.7% (n=309). In the multivariate Cox analysis, independent risk factors for 6-month mortality and each score were as follows: the body mass index (<18.5 kg/m<sup>2</sup> (0), 18.5 ≤, <23 kg/m<sup>2</sup> (0)), age at dialysis initiation (<80 years (0), ≥85 years (1)), status of malignancy (curative state (0), palliative treatment (1)), hypertension (0), nursing hospital care at dialysis initiation (0), vascular access at dialysis initiation (arteriovenous graft (-1)), vascular access on maintenance dialysis (arteriovenous fistula (-1), arteriovenous graft (-1)), and serum albumin (0)). According to the KSGN score, mortality rate was 4.8%, 8.6%, 32.0%, 60.3%, and 66.7% for -2, -1, 0, 1, and 2 points, respectively. The area under the curve of the KSGN score was significantly higher than that of either the Alberta or United States Renal Data System scores.

**Conclusions:** The KSGN score is a simple tool to predict early mortality after dialysis initiation in older patients with end-stage kidney disease and may be useful to support decision-making and management in older adults starting dialysis.

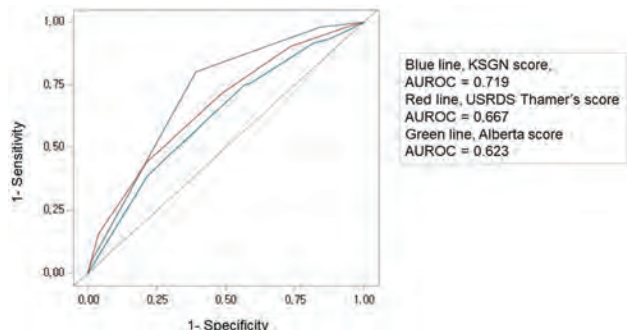

Comparison of ROC curve between the prognostic models

## TH-PO794

**Dialysis vs. Conservative Management for Patients 65 Years and Older With ESKD: A Propensity-Matched Cohort Study**

Bjoerg Thorsteinsdottir,<sup>1</sup> Kavya Sindhu Swarna,<sup>1</sup> Andrew D. Rule,<sup>1</sup> Runolfur Palsson,<sup>2</sup> Robert C. Albright,<sup>1</sup> Kianoush Kashani,<sup>1</sup> Ann M. O'Hare,<sup>4</sup> LaTonya J. Hickson,<sup>3</sup> <sup>1</sup>Mayo Clinic Minnesota, Rochester, MN; <sup>2</sup>Landspítali, Reykjavik, Iceland; <sup>3</sup>Mayo, Jacksonville, FL; <sup>4</sup>VA Puget Sound Health Care System Seattle Division, Seattle, WA.

**Background:** Several cohort studies have compared survival for older individuals with ESKD who pursue dialysis vs. conservative care. Results have been variable and methodologically challenged by systematic differences in age and comorbidity by treatment. We sought to account for differences in patient characteristics by using propensity score matching among members of a large claims-based database.

**Methods:** All patients in the OptumLabs Data Warehouse over 65 years old with at least one creatinine measure, and six months of coverage were identified. The median eGFR at dialysis start was 9 ml/min/1.73 m<sup>2</sup>. All patients who started dialysis within 3 days of reaching this eGFR threshold were propensity matched with patients with an eGFR in the same range who did not start dialysis. Overall survival was compared for the two groups with Cox regression and the subgroup age >80 years. Sensitivity analysis was performed using eGFR thresholds of 11 and 7 ml/min/1.73 m<sup>2</sup>, (representing the 25<sup>th</sup> and 75<sup>th</sup> percentiles), and excluding patients with an AKI diagnosis.

**Results:** We identified 6017 patients who initiated dialysis during the observation period and 5814 who did not start dialysis. Those who started dialysis were younger (mean age 74.9 vs. 77.3 years), more likely to be men, more likely to be identified as Black or Hispanic and had a higher comorbid burden, especially CKD complications (i.e. anemia), cardiac and pulmonary disease, and less likely to have dementia, cancer and other neurological conditions. In survival comparison before propensity matching, dialysis carried a hazard ratio (HR) of 0.67(CI 0.64-0.71) compared to no dialysis. After propensity matching of 2,566 patients from each group, the overall survival advantage was attenuated (HR 0.77; CI 0.71-0.83) but persisted even for those over 80 years old (HR 0.65; CI 0.57-0.73).

**Conclusions:** Patients who do not receive dialysis are more likely to be older, white and have disabling or life limiting comorbidities. Even after propensity score matching, patients who started dialysis survived longer than those who did not, and this was true even for those aged 80 years or older. However, sicker patients who start dialysis more acutely at higher GFR levels may be underrepresented in our cohort.

**Funding:** NIDDK Support, Other NIH Support - NIAK23AG051679

## TH-PO795

**Validity and Practice Patterns of Mortality Risk Prediction Tools in Dialysis Patients**

Jennifer Bergeron,<sup>1</sup> Christina Damon,<sup>2,1</sup> Sean Meagher,<sup>1</sup> Katharine L. Cheung,<sup>1</sup> <sup>1</sup>University of Vermont, Burlington, VT; <sup>2</sup>Tufts University School of Medicine, Boston, MA.

**Background:** Mortality rates are high among dialysis patients, but much heterogeneity exists, making it difficult to predict patients' outcomes, particularly in older adults. Accurately predicting mortality is essential for prognostication and advance care planning. Although several risk assessment tools have been developed, few have been externally validated. Furthermore, there are no studies assessing nephrologists' ideas and use of these tools.

**Methods:** All 279 of Vermont's dialysis patients' data were input into 3 mortality risk prediction tools: Cohen, Charlson Comorbidity Index, and Couchoud. 6 months later, chart review determined which patients had died, and the c statistic for each tool was calculated via logistic regression and subsequent ROC curve. 80% of nephrology dialysis providers in Vermont underwent a semi-structured interview regarding their experience, use, and ideas of the utility of mortality risk prediction tools. The interviews were transcribed, and common themes were identified independently by 2 reviewers.

**Results:** Couchoud had the best discrimination in Vermont's dialysis patients with a c statistic of 0.77 compared to Cohen and Charlson (both 0.68). Providers were only aware of 2 tools to predict mortality, 100% knew Cohen's surprise question and 25% knew Charlson. No nephrologists used these tools in their practice. The main barrier to use identified was concern that the tool would not be accurate in their individual patients and providers trusted their own clinical judgement over that of a tool. Most providers were open to using these tools in their prognostication if further evidence for the validity and education about the use of these tools was provided. Providers noted that if a tool with strong discrimination predicted a high mortality, it would change management of the patient- make them more likely to encourage supportive care over dialysis.

**Conclusions:** Our study shows that nephrologists do not routinely use mortality risk prediction tools in practice due to concerns about their external validity and lack of knowledge about how to use them. We also showed that Couchoud had strong discrimination, particularly in Vermont's older population, and could be used for advanced care planning. We are currently conducting further interviews to see if this data specific to their patients changes their ideas and use of prediction tools.

## TH-PO796

**Association of ACR Trajectories With Frailty Worsening or Death in Community-Dwelling Older Adults**

Nina Mielke,<sup>1</sup> Alice Schneider,<sup>1</sup> Natalie Ebert,<sup>1</sup> Markus van der Giet,<sup>1</sup> Doerte Huscher,<sup>1</sup> Martin K. Kuhlmann,<sup>2</sup> Elke Schaeffner,<sup>1</sup> <sup>1</sup>Charité Universitätsmedizin Berlin, Berlin, Germany; <sup>2</sup>Vivantes Klinikum im Friedrichshain, Berlin, Germany.

**Background:** Elevated Albumin-creatinine-ratio (ACR) has been associated with prevalent and incident frailty. We analyzed the association of ACR trajectories over 6 years and frailty status worsening or death in the successive 2-year follow up window in data of the Berlin Initiative Study (BIS).

**Methods:** Prospective population-based cohort of old adults interviewed biennially with a standardized questionnaire incl. geriatric and physical examination. 6-year ACR trajectories were constructed using either "no albuminuria (A0)" or "albuminuria (A1) (30 – 300 mg/g)" or "A2 (>300 mg/g)" over four study visits. Trajectories were distinguished into "stable A0" or "all other" trajectories of albuminuria incl. incident albuminuria. Frailty was assessed at the 3<sup>rd</sup> (frailty baseline) and 4<sup>th</sup> follow-up. Frailty worsening was defined as the transition from robust to prefrail or frail, or from prefrail to frail within the 2-year period. Association between ACR trajectories and the ordinal outcome of no worsening, frailty worsening, or death was analyzed using partial proportional odds regression.

**Results:** At frailty baseline, mean age was 84 yrs, 46% were male, and 48% were prefrail and 31% frail. Participants with trajectories of albuminuria during the previous 6 years (N=342) were older (86 vs. 84 yrs), were less physically active, had higher prevalence of diabetes (39% vs. 24%) or CVD (83% vs. 66%) and had a lower mean eGFR of 45 compared to 53 mL/min/1.73 m<sup>2</sup> in participants with stable A0 trajectories (N=729). After 2.1 (2.0-2.3) years, 960 (90%) participants had valid information on frailty transition: 187 (17.5%) worsened and 111 (10.3%) died. In the multivariable model<sup>1</sup> the odds of frailty worsening for participants with albuminuria trajectories during the 6 yrs preceding initial frailty assessment were 1.5-fold higher compared to participants with stable A0 trajectories. The odds for death were even higher with albuminuria trajectories.

**Conclusions:** In older adults, albuminuria trajectories are associated with 1.5-fold higher odds for frailty worsening independent of death.

**Funding:** Private Foundation Support

Table: Association of ACR trajectory over 6 years with subsequent frailty worsening or death within 2 years, OR (95%CI)

	Outcome	ACR trajectory	
		stable A0 (N=656)	albuminuria (N=304)
No. of events (%)	frailty worsening	130 (19.8)	57 (18.8)
	death	43 (6.6)	88 (22.4)
crude model	frailty worsening	Reference	1.95 (1.46-2.60)
	death	Reference	4.11 (2.73-6.19)
adjusted model <sup>1</sup>	frailty worsening	Reference	1.53 (1.11-2.10)
	death	Reference	3.17 (2.07-4.86)

ACR – albumin creatinine ratio in mg/g; OR – odds ratio; CI – confidence interval.  
<sup>1</sup>adjusted for age, sex, hypertension, diabetes mellitus, physical activity, calve circumference, smoking, body mass index, CRP and any cardiovascular disease

## TH-PO797

**Effect of Structured Exercise on Biomarkers of Kidney Health in Sedentary Older Adults in the LIFE Study: A Randomized Clinical Trial**

Anoop Sheshadri,<sup>1,2</sup> Mason Lai,<sup>1</sup> Fang-Chi Hsu,<sup>3</sup> Scott R. Bauer,<sup>1,2</sup> Shyh-Huei Chen,<sup>3</sup> Vasantha Jotwani,<sup>1,2</sup> Gregory J. Tranah,<sup>4</sup> Roger A. Fielding,<sup>5</sup> Christine Liu,<sup>6</sup> Joachim H. Ix,<sup>7</sup> Steven G. Coca,<sup>8</sup> Michael Shlipak,<sup>1,2</sup> LIFE-Kidney Investigators <sup>1</sup>University of California San Francisco, San Francisco, CA; <sup>2</sup>San Francisco VA Health Care System, San Francisco, CA; <sup>3</sup>Wake Forest University School of Medicine, Winston-Salem, NC; <sup>4</sup>California Pacific Medical Center, San Francisco, CA; <sup>5</sup>Tufts Medical Center, Boston, MA; <sup>6</sup>Stanford University School of Medicine, Stanford, CA; <sup>7</sup>University of California San Diego, La Jolla, CA; <sup>8</sup>Icahn School of Medicine at Mount Sinai, New York, NY.

**Background:** We previously demonstrated among older adults that a structured exercise intervention slowed kidney function decline over two years, *independently of changes in blood pressures and weight*. In an ancillary study to the Lifestyle Interventions and Independence For Elders (LIFE) study, we sought to evaluate mechanisms by which physical activity and exercise might slow kidney decline using biomarkers of kidney health.

**Methods:** Participants in LIFE were 1381 sedentary adults aged 70-89 years who were randomized to a structured exercise intervention or health education (HE). Physical activity was measured by step count (Actigraph wGT3X-B). Blood and urine samples were collected at baseline, year 1 and year 2 of follow-up. We estimated the association of step count and biomarkers of kidney health using mixed effects models. Primary outcomes were changes in 14 blood and urine biomarkers of kidney health categorized by quartiles to allow for comparisons across biomarkers.

**Results:** Participants assigned to the intervention walked a mean 291 more steps/day compared to HE. The intervention was not significantly associated with changes in any biomarkers. However, persons in the highest versus lowest quartile of steps (≥3470 vs. <1568 steps) had statistically significant improvement in biomarkers assessing for glomerular injury, tubular function and repair, tubular injury, generalized inflammation, and tubulointerstitial fibrosis. (Figure).

**Conclusions:** While randomization to a structured exercise program did not result in improvements in biomarkers at a group level, larger increases in step count were associated with improvements in several biomarkers of kidney health.

**Funding:** NIDDK Support, Other NIH Support - National Institute on Aging, FDA, Other U.S. Government Support

Key: TH - Thursday; FR - Friday; SA - Saturday; OR - Oral; PO - Poster; PUB - Publication Only

Underline represents presenting author.

**Figure: Associations of physical activity (high vs. low quartile) with changes in 14 biomarkers of kidney health (scaled/SD) using mixed effects models in the LIFE trial**

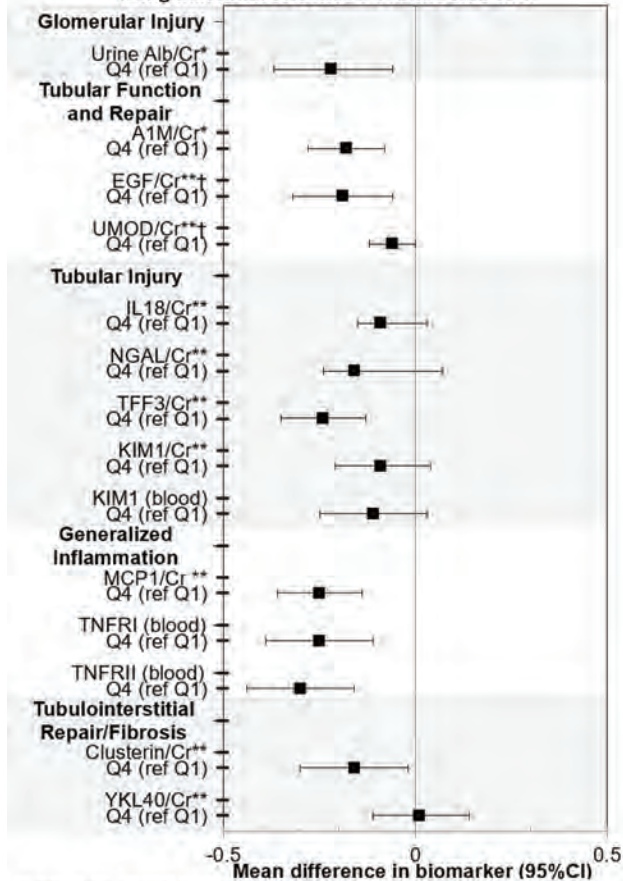

All models are adjusted for intervention, sex, clinical sites, age, BMI, time-varying SBP, race, education, diabetes, CVD, hypertension, visit, and intervention by visit interaction. \*Changes in UMOD and EGF are reversed for clarity, higher levels reflect improved kidney health. Lower levels of all other biomarkers reflect better kidney health or systemic inflammation. All urine biomarkers are indexed to urine Cr. \*Biomarker units are mg/L per mg/dL of UCr. \*\*Biomarker units are pg/mL per mg/dL of UCr.

TH-PO798

**The Effect of Long-Term High-Intensity Interval Training on CKD Prevention in the Elderly: A Substudy of the Generation-100 Randomized Controlled Trial**

Stein I. Hallan,<sup>1,2</sup> Marius A. Øvrehus,<sup>2</sup> Michael Shlipak,<sup>3,4</sup> Joachim H. Ix,<sup>5,6</sup> Dorthe Stensvold,<sup>1</sup> Knut Asbjørn R. Langlo.<sup>1,2</sup> <sup>1</sup>Norges teknisk-naturvitenskapelige universitet, Trondheim, Norway; <sup>2</sup>St Olavs Hospital Universitetssykehuset i Trondheim, Trondheim, Norway; <sup>3</sup>University of California San Francisco, San Francisco, CA; <sup>4</sup>San Francisco VA Health Care System, San Francisco, CA; <sup>5</sup>University of California San Diego, La Jolla, CA; <sup>6</sup>Veterans Affairs San Diego Healthcare, San Diego, CA.

**Background:** Recent trials suggest moderate-intensity exercise may lower CKD incidence in older adults. Whether or not there is a dose response relationship regarding intensity of exercise and CKD risk is unknown. High-intensity interval training (HIIT) has shown very encouraging results on cardiorespiratory capacity, endothelial function and other key aspects of cardiovascular as well as kidney health.

**Methods:** All inhabitants of Trondheim, Norway, aged 70-77 years were invited to participate in the Generation 100 study. Main exclusion criteria were uncontrolled hypertension, unstable angina, heart failure or symptomatic valvular disease, dementia, cancer or other diseases or disabilities that precluded exercise. Participants were randomized to supervised physical training consisting of 10-minute warm-up followed by 4x4-minute high-intensity interval training (HIIT) at ~90% of peak heart rate or 50 minutes of moderate-intensity continuous training (MICT) at ~70% of peak heart rate twice/week for five years. Peak oxygen uptake (VO<sub>2</sub> peak) and blood samples were obtained at baseline and at one, three, and five years. Incident CKD was defined as a >25% eGFR decline to a new level <60ml/min/1.73m<sup>2</sup> based on the CKD-EPI Cystatin C equation.

**Results:** The 787 participants had mean (1 SD) age 72 (2) years, 51% were males, and 6% had diabetes. Baseline blood pressure was 134 (18) / 75 (9) mmHg, and eGFR was 91 (16) ml/min/1.73m<sup>2</sup>. In total, 400 subjects were randomized to the HIIT group and 387 to the MICT groups. After one year, mean VO<sub>2</sub> peak had increased from 28.9 (6.4) to 32.2 (6.7) ml/kg/min in the HIIT group and from 28.6 (6.6) to 30.9 (6.8) ml/kg/min in the MICT group. During the five-year training period, there were 13 new CKD cases in the HIIT group (3.4%) and 25 cases in the MICT group (6.7%) for a relative risk reduction of 0.47 (95% CI 0.24, 0.93, p=0.030). There was no interaction between the HIIT treatment effect and baseline levels of VO<sub>2</sub> peak or eGFR.

**Conclusions:** Among older persons, compared to moderate-intensity continuous training, high-intensity interval training reduced the risk of incident CKD.

**Funding:** Government Support - Non-U.S.

TH-PO799

**Lower Functional Status and Perceived Health Status Are Associated With Poorer Quality of Life in Older People With ESKD**

Amarpreet K. Thind,<sup>1,2</sup> Michelle Willicombe,<sup>1,2</sup> Edwina A. Brown.<sup>2,1</sup> KTOP Study Investigator Group <sup>1</sup>Imperial College London, London, United Kingdom; <sup>2</sup>Hammersmith Hospital, London, United Kingdom.

**Background:** Frailty is under-recognised in end-stage kidney disease (ESKD) including in those eligible for transplantation. Understanding which frailty components are associated with quality of life outcomes (QoL) allows for focused intervention and counselling of older people with ESKD.

**Methods:** The Kidney Transplantation in Older People: impact of frailty on outcomes (KTOP) study explores frailty, cognition, and QoL changes in older people (≥60) whilst waiting for and after a transplant. Frailty was assessed using the Edmonton Frailty Scale which gives total scores and scores for different frailty components. We present QoL scores from 5 measures at recruitment, their variation by frailty status, and their association with frailty components.

**Results:** 210 patients have been recruited; 118(63.4%) were identified as not frail, 38(20.4%) were vulnerable, and 30(16.2%) were frail. Frailty and QoL scores were available for 164-167 patients. Progressively lower QoL scores in all measures were observed in the vulnerable and frail groups (figure 1, p<0.0001). Table 1 shows the association between frailty components and QOL scores (p<0.05 on adjusted linear regression). Poor functional status and general health status were associated with lower QoL scores across all measures.

**Conclusions:** Frailty and vulnerability to frailty is not uncommon in older people considered eligible for transplantation and is associated with worsening reported QoL. Functional dependence and general health status were associated with poorer QoL scores throughout all questionnaires. This is invaluable for giving a holistic depiction of ESKD in older people and allows for more targeted management.

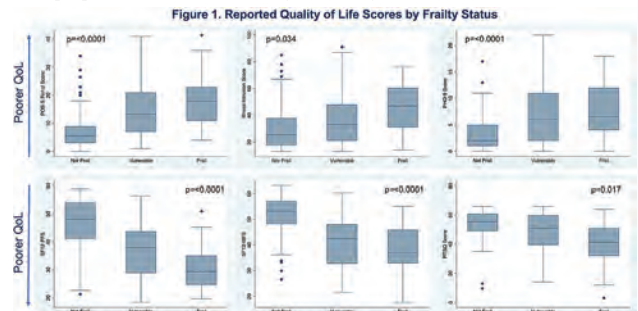

Distribution of quality of life (QoL) scores by frailty status across study questionnaires. POS-S Renal – Palliative Outcome Scale Symptoms Renal, PHQ-9 – Patient Health Questionnaire 9, SF12-PFS – Short Form 12 Physical Function Score, SF12-MFS – Mental Function Score, RTSQ – Renal Treatment Satisfaction Questionnaire.

**Table 1. Frailty Components Associated With Poorer Reported Quality of Life Scores**

Frailty Domain	Component*	SF-12 (Q2)			
		POS-S Renal n=184	PHQ-9 Rating Scale n=163	PHQ-9 n=167	PHQ-9 n=167
Cognition	Minor errors				
	Major errors				✓
General Health –					
Reported Satisfaction	1-3				✓
	3-5				✓
General Health – Status	Fair	✓	✓	✓	✓
	Poor	✓	✓	✓	✓
Functional Independence**	2-4	✓	✓	✓	✓
	5-8	✓	✓	✓	✓
Social Support	Satisfactory				
	Never				
Medication Burden	3†	✓	✓	✓	✓
Medication Adherence	Non-adherence				
Restriction – weight loss	Restrictable				
Mixed	1-6	✓	✓	✓	✓
Isotonic exercise					
Time up and go	11-30 s				
	30+ seconds, needs assistance				

Illustration of the components of frailty significantly associated with lower reported quality of life scores across each questionnaire, based on the coefficients having a p value of <0.05 in an adjusted linear regression. \*Severity category is compared with the least severe category for each component. \*\*Determined by the number of activities of daily living that require support. POS-S Renal – Palliative Care Outcome Scale – Renal, PHQ-9 – Patient Health Questionnaire, SF-12 (Q2) – Short-Form 12 (version 2), n – seconds.

## TH-PO800

## Association of Plant-Based Protein Intake With Cognitive Function in Adults With CKD

Luis M. Perez, Zhiying You, Jessica B. Kendrick. *University of Colorado Denver School of Medicine, Aurora, CO.*

**Background:** Patients with chronic kidney disease (CKD) have accelerated cognitive aging and cognitive function worsens as kidney function declines. Diets higher in plant-based proteins are associated with better survival in patients with CKD. Whether diets high in plant-based proteins are associated with cognitive function in adults with CKD is unclear.

**Methods:** Using NHANES 2011-2012 data, we included participants aged 60 years and older with cognitive and dietary data available. We calculated plant-based protein intake from dietary records by linking food database codes with standard references. CKD was defined as urine albumin:creatinine  $\geq 30$ mg/g and/or eGFR  $< 60$  mL/min. Plant protein intake was examined categorically with high vs. low intake defined by median levels. Primary cognitive outcomes included: 1) Consortium to Establish a Registry for Alzheimer's disease (CERAD); 2) the Animal Fluency test (AFT); and 3) the Digit Symbol Substitution test (DSST). Regression analysis models were used to examine the association between plant-based protein intake and cognition.

**Results:** We included 322 participants with CKD. The mean age and eGFR were  $72 \pm 7$  years and  $60.5 \pm 22.4$  mL/min/1.73m<sup>2</sup>, respectively. Over half of the participants were male (52%) and the majority were Non-Hispanic White (47%). Median (IQR) plant protein intake was 19 (13-27)g. Higher plant-based protein intake was significantly associated with higher cognitive scores on CERAD and AFT in the fully adjusted model (Table). Higher plant-based protein intake was not associated with DSST in the fully adjusted model.

**Conclusions:** Plant-based protein appears to be a significant predictor of cognitive score measures in adults with CKD. It is possible that plant-based protein intake represents lower dietary acid load or other healthy habits that may improve cognitive performance or be associated with increased cognitive function.

**Funding:** NIDDK Support

## Association of Plant-Based Protein Intake with Cognition in CKD

High plant protein vs. low, g	CERAD Total Score		AFT Score		DSST Score	
	$\beta$ -estimate (95% CI)	p-value	$\beta$ -estimate (95% CI)	p-value	$\beta$ -estimate (95% CI)	p-value
Unadjusted	1.96 (-0.03 to 3.94)	0.05	1.58 (-0.34 to 3.50)	0.10	5.75 (-0.98 to 12.47)	0.09
Model 1	1.94 (0.22 to 3.65)	0.03	1.51 (0.43 to 2.57)	<0.01	5.29 (1.94 to 8.63)	<0.01
Model 2	1.54 (0.08 to 3.00)	0.04	1.21 (0.33 to 2.08)	0.01	2.01 (-0.63 to 4.65)	0.12

Model 1: age, sex, race/ethnicity and BMI

Model 2: Model 1 + dietary animal protein, diabetes, hypertension, education

## TH-PO801

## Phosphorus Content and Phosphorus-to-Protein Ratio Among Plant-Based Protein Products

Kendal M. Burstad,<sup>1</sup> Alexandria Fons,<sup>1</sup> Kathleen M. Hill Gallant.<sup>1,2</sup> *University of Minnesota Twin Cities, Minneapolis, MN; <sup>2</sup>Indiana University School of Medicine, Indianapolis, IN.*

**Background:** Plant-based eating is of growing interest in management of CKD due to several reasons, including the proposed lower P bioavailability from plant sources. However, few data are available on the P content of emerging plant-based products. In this study, we aimed to quantify P in several popular food categories of plant-based foods (soy or other pulse-based) and compared to their animal protein counterparts. Our results for plant-based dairy and ground beef alternatives were presented at the National Kidney Foundation Spring Clinical Meeting 2022 and overall showed that P content and P-to-protein ratio were lower in soy- compared to pulse-based products, and soy products were comparable to their animal protein counterparts.

**Methods:** Here, we present results for plant-based chicken/turkey, sausage/bacon, yogurt/cheese, and other popular soy/pulse products. Products were prepared according to package directions, freeze-dried, ashed and analyzed for P content using MP-AES.

**Results:** Analyzed P content ranged from 116-196 mg P/100g, 80-293 mg P/100g, and 5-346 mg P/100g for plant-based chicken/turkey, bacon/sausage, and yogurt/cheese products, respectively. For comparison, P content from animal sources in the categories of chicken/turkey, bacon/sausage, and yogurt/cheese ranged from 125-273 mg P/100g, 122-237 mg P/100g, and 105-1223 mg P/100g. Analyzed P content of other soy products (i.e., tofu, tempeh, etc.) ranged from 145-571 mg P/100g and of other pulse products (i.e., chickpea, green lentils, etc.) ranged from 52-166 mg P/100g. Nine of the 40 products analyzed had at least one inorganic phosphate additive listed on the label. Total P content of plant-based chicken/turkey alternatives was lowest in pulse-based products, but the P-to-protein ratio was lowest in a soy-based chicken product (3.8 mg/g). Total P content of soy-based cheese products was lower than pulse- or animal-based. However, these soy-based cheeses contained no protein, and animal- and pulse-based cheese products had the highest P-to-protein ratios of all food studied, 85.6 mg/g and 103.6 mg/g.

**Conclusions:** These data show the wide variation in P content and P-to-protein ratio of both plant-based products and their animal-based counterparts. Further quantification and reporting of P content in emerging plant-based products is needed for appropriate recommendations for patients with CKD.

**Funding:** NIDDK Support, Other U.S. Government Support

## TH-PO802

## Therapeutic Strategies for Reversing the Negative Health Effects of a High Phosphate Diet in Mice

Uma D. Alappan,<sup>1</sup> Jamie Arnst,<sup>1</sup> Manjula Viggswarapu,<sup>2</sup> George R. Beck.<sup>1,2</sup> *<sup>1</sup>Emory University School of Medicine, Atlanta, GA; <sup>2</sup>VA Medical Center Atlanta, Decatur, GA.*

**Background:** Dietary inorganic phosphorus (Pi) regulation is crucial for treating CKD patients as excess serum Pi can lead to comorbidities. Studies show high +Pi may negatively impact those with clinically normal renal function via partly understood mechanisms like increased Pi-responsive factors (PTH, osteopontin [OPN], FGF23), kidney damage, and decreased bone volume. Clinicians commonly administer Lanthanum Carbonate (LaC) Pi-binder to reduce serum Pi, Vitamin D (VitD) to increase bone strength, Cinacalcet (CNC) to suppress PTH, and Zoledronate (Zol) to prevent bone loss. Our study investigates these pharmacologic strategies compared to a low Pi diet to reduce excess Pi's negative health consequences.

**Methods:** Healthy 10-Week-old, female C57BL/6J mice were fed diets with Normal Pi (NPD, 0.6% Pi) or High Pi (HPD, 1.8% Pi). All diets contained 0.6% Calcium, 2.2IU VitD, similar protein, Kcals, and fat%. Strategies to control systemic effects of high Pi included: low Pi diet (LPD, 0.2%), HPD + LaC (3%), VitD (10IU) or CNC (100mg/kg) incorporated into the feed, and Zol (100µg/kg ip). Serum FGF23, OPN, PTH were measured by ELISA, bone volume by micro-computed tomography, and kidney gene expression by quantitative real-time (qRT) PCR.

**Results:** Therapeutic strategies to control Pi-responsive factors were generally as expected with LaC reducing HPD-induced increase in FGF23 and CNC lowering PTH in response to HPD. VitD did not produce an effect and surprisingly Zol somewhat exacerbated response to HPD. Though some strategies controlled systemic, high Pi-related effects, all were generally ineffective at blunting bone loss—except Zol. Changes in kidney-related gene expression—i.e. Klotho, Pi transporters, Lipocalin-2—were influenced by dietary Pi and at least partially corrected with Pi-normalizing strategies. Reducing Pi consumption (LPD) lowered systemic Pi factors and improved bone volume over NPD.

**Conclusions:** Though individually existing, clinically used therapies are generally effective at correcting some aspects of systemic phosphate dysbiosis in mice, they generally do not correct negative consequences on bone volume. This suggests that the negative health consequences of dysregulated phosphate homeostasis, even in the context of normal renal function, are multifactorial and cannot be fully alleviated with existing clinically used therapies.

**Funding:** Veterans Affairs Support

## TH-PO803

## Low Sodium Intake, Low Protein Intake, and Excess Mortality: Findings in the Lifelines-MINUTHE Study

Niek Hessels,<sup>1</sup> Yinjie Zhu,<sup>1</sup> Martin H. De Borst,<sup>1</sup> Stephan J. Bakker,<sup>1</sup> Gerjan Navis,<sup>1</sup> Ineke J. Riphagen.<sup>1,2</sup> *<sup>1</sup>Universitair Medisch Centrum Groningen, Groningen, Netherlands; <sup>2</sup>Certe Medical Diagnostics and Advice, Leeuwarden, Netherlands.*

**Background:** Several observational studies reported on a U-shaped association between sodium intake and mortality, which raises questions about the safety of low sodium intake and hampers widespread acceptance of public health campaigns and dietary guidelines. We investigated whether concomitant low protein intake explained the lower part of this U-shaped association between sodium intake and all-cause mortality.

**Methods:** We investigated the associations between sodium intake (24 h sodium excretion) and all-cause mortality, including the interaction with protein intake (Maroni formula), using multivariable Cox regression in a gender and socioeconomic status balanced Lifelines cohort.

**Results:** A total of 1603 individuals aged between 60 and 75 years was included. After a median follow-up of 8.9 years, 125 (7.8%) deaths occurred. Both the highest (Q4,  $> 4.7$  g/day; HR 1.74 [95%CI 1.03-2.95]) and the lowest quartile of sodium intake (Q1, 0.7-2.8 g/day; 2.05 [1.16-3.62];  $p=0.01$ ) were associated with increased risk of all-cause mortality compared with the third quartile of sodium intake (Q3, 3.6-4.7 g/day), independent of potential confounders. A significant interaction with protein intake (P-interaction=0.006) was found, with the increased risk of low sodium intake being reversed to reduced risk by concomitant high protein intake, while the increased risk was magnified by concomitant low protein intake (see figure 1).

**Conclusions:** We found that both high and low levels of sodium intake were associated with increased all-cause mortality. However, higher protein intake annihilated the excess mortality observed in subjects on low sodium intake. A joint low intake of sodium and protein is associated with a particularly high mortality risk, allegedly due to a poor nutritional status. This backs up guidelines advocating to lower sodium intake while also highlighting the importance of recognizing overall nutritional status.

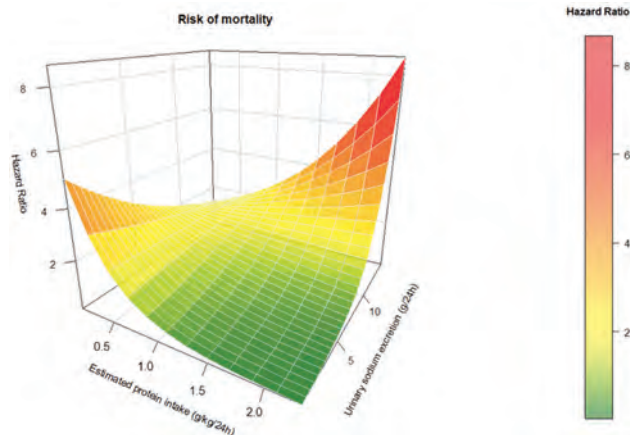

TH-PO804

**Effectiveness of Short-Term, Home-Delivered, Low Sodium Meals to Sustain Long-Term Changes in Dietary Behavior in Hemodialysis Patient**

Shu H. Kwan,<sup>1</sup> Alexis King,<sup>2</sup> Hsin-Yu Fang,<sup>2</sup> Kenneth R. Wilund.<sup>2</sup> <sup>1</sup>University of Illinois Urbana-Champaign College of Agricultural Consumer and Environmental Sciences, Urbana, IL; <sup>2</sup>University of Illinois Urbana-Champaign, Urbana, IL.

**Background:** Reducing dietary sodium intake (SI) in hemodialysis (HD) patients can reduce volume overload and risk of cardiovascular complications. However, previous studies indicated that dietary education alone is ineffective in reducing SI in HD patients. A 4-week-study in our lab found that short-term low-sodium home-delivered meals provision could reduce SI, interdialytic weight gain (IDWG), and blood pressure (BP) of HD patients. However, it is not known if changes from short-term meal feeding can be sustained long-term. The purpose of this study is to determine if short-term feeding of low-sodium meals can “prime” changes in long-term dietary behavior and lead to sustained reductions in IDWG and BP in HD patients.

**Methods:** To date, we have recruited 11 subjects (61±11 years, BMI 35.6±11.9 kg/m<sup>2</sup>) from a HD clinic in central IL. Subjects were randomized into a control (CON) or intervention group (INT). CON subjects received standard care for the first 5 months, followed by 2 months of low-sodium meals (2 meals/day in Month 6 and 1 meal/day in Month 7) and dietary education. INT subjects received low-sodium meals (2 meals/day in Month 1 and 1 meal/day in Month 2) and dietary education for the first 2 months, followed by 3-month continued dietary education. We collected monthly IDWG, BP, and 3 days of dietary recalls at baseline (0M), 1 month (1M), 2 month (2M), and 5 month (5M).

**Results:** SI, IDWG, systolic blood pressure (SBP), and diastolic blood pressure (DBP) were significantly reduced after 1 month of low-sodium meal feeding (p < 0.05), but these changes were not sustained long-term (Table). SI, IDWG, and DBP increased starting 2M.

**Conclusions:** Short-term low-sodium home-meal delivery can reduce SI, IDWG, and BP in HD patients. However, these changes are not sustained after patients’ resumption of meal responsibility. This suggests that extended meal feeding and/or more intensive low-sodium counseling strategies may be needed to sustain long-term behavior change.

**Funding:** Commercial Support - Renal Research Institute

Changes in Outcomes

Variable	0M (Baseline)		1M		2M		5M		P-value
	CON	INT	CON	INT	CON	INT	CON	INT	
Dietary sodium, mg	2663 ± 2148	2338 ± 1245	2738 ± 1411	1570 ± 632*	2578 ± 1281	1800 ± 736	2634 ± 1428	2125 ± 833	* p < 0.05
IDWG, kg	2.6 ± 1.4	2.5 ± 1.2	2.7 ± 1.3	2.3 ± 1.1*	3.0 ± 1.3	2.5 ± 1.4	3.3 ± 1.4	2.6 ± 1.3	* p < 0.05
SBP, mmHg	155.0 ± 28.6	154.0 ± 17.8	164.1 ± 25.0	149.7 ± 24.3*	162.8 ± 23.7	145.3 ± 24.1	157.6 ± 24.4	142.8 ± 24.4*	* p < 0.05
DBP, mmHg	82.8 ± 12.7	81.3 ± 16.2	87.7 ± 12.4	78.5 ± 17.0*	85.8 ± 16.2	77.6 ± 22.3	87.9 ± 16.4	78.3 ± 15.9	* p < 0.05

TH-PO805

**Urinary Sodium, Potassium, and Kidney Function in West Africans**

Titilayo O. Ilori,<sup>1</sup> Temitayo M. Adebile,<sup>1</sup> Adaobi Solarin,<sup>2</sup> Mamak Mamven,<sup>3</sup> Bolanle A. Omotoso,<sup>4</sup> Yemi R. Raji,<sup>5</sup> Ifeoma I. Ulasi,<sup>6</sup> Runqi Zhao,<sup>1</sup> Rasheed A. Gbadegesin,<sup>7</sup> Rulan S. Parekh,<sup>8</sup> Babatunde L. Salako,<sup>9</sup> Dwomoa Adu,<sup>10</sup> Cheryl A. Anderson,<sup>11</sup> Akinlolu Ojo,<sup>12</sup> Christiana O. Amira,<sup>13</sup> Sushrut S. Waikar.<sup>1</sup> <sup>1</sup>Boston University School of Medicine, Boston, MA; <sup>2</sup>Lagos State University Teaching Hospital, Lagos, Nigeria; <sup>3</sup>University of Abuja, Abuja, Nigeria; <sup>4</sup>Obafemi Awolowo University Teaching Hospital Complex, Ile-Ife, Nigeria; <sup>5</sup>University College Hospital Ibadan, Ibadan, Nigeria; <sup>6</sup>University of Nigeria, Nsukka, Nigeria; <sup>7</sup>Duke University School of Medicine, Durham, NC; <sup>8</sup>Women’s College Hospital, Toronto, ON, Canada; <sup>9</sup>University of Ibadan, Ibadan, Nigeria; <sup>10</sup>University of Ghana Medical Centre, Accra, Ghana; <sup>11</sup>University of California San Diego, La Jolla, CA; <sup>12</sup>University of Kansas School of Medicine, Kansas City, KS; <sup>13</sup>Lagos University Teaching Hospital, Surulere, Nigeria.

**Background:** Dietary intake of sodium (Na) and potassium (K) may impact kidney function and outcomes, but data are conflicting. Our goal was to examine associations of 24hr urine K and Na (as proxies for dietary intake) with kidney function in Africans with CKD and compare our findings to a U.S.-based CKD cohort, the Chronic Renal Insufficiency (CRIC) study.

**Methods:** We included participants in the Diet, CKD and ApolipoproteinL1 study (DCA, n=619) ancillary to the Human Hereditary and Health in Africa Kidney Disease study. The exposures were calibrated, log transformed 24hr -UNa, UK and Na/K ratio. Outcomes were calculated eGFR and 24hr-urine protein (Uprotein). We utilized generalized linear regression with a random intercept for clinical center to estimate crude and adjusted beta coefficients and 95% CI. We performed similar analyses in 3,459 participants in CRIC.

**Results:** Median UNa excretion was lower in DCA than in CRIC [134 (104-175) vs. 160 (118-215) mmol/24hr, p < 0.001]. Median UK excretion was lower in DCA than in CRIC [36 (28-48) vs 55 (40-74) mmol/24hr (p < 0.001)]. Findings on the associations of UNa and UK with eGFR and Uprotein were directionally consistent. Higher UK was associated with higher eGFR in DCA and CRIC participants. Higher 24hr-UNa was associated with higher Uprotein excretion but not eGFR in both cohorts. The UNa/UK<sub>ratio</sub> was associated with lower eGFR and higher Uprotein in both cohorts (see figure).

**Conclusions:** Cross-sectional associations with eGFR and proteinuria were similar in West Africans and Americans, with evidence for associations of higher UK with higher eGFR, and higher UNa with higher proteinuria.

**Funding:** NIDDK Support

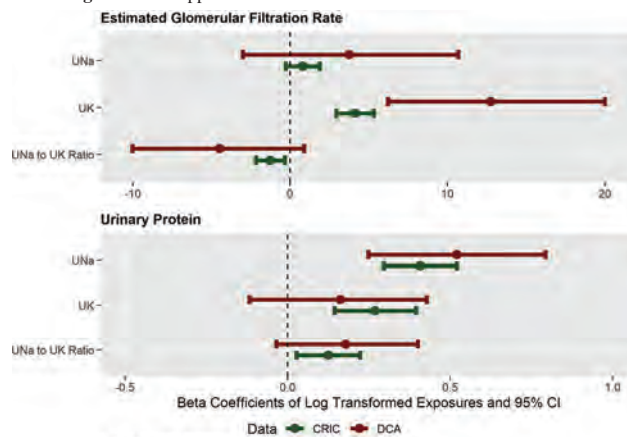

UNa, UK, EGFR and Proteinuria



**TH-PO806**

**Urinary Sodium and Potassium and Blood Pressure in African and US Cohorts With CKD**

Titilayo O. Ilori,<sup>1</sup> Manmak Mamven,<sup>2</sup> Adaobi Solarin,<sup>3</sup> Temitayo M. Adebile,<sup>1</sup> Yemi R. Raji,<sup>4</sup> Bolanle A. Omotoso,<sup>5</sup> Ifeoma I. Ulasi,<sup>6</sup> Rulan S. Parekh,<sup>7</sup> Rasheed A. Gbadegesin,<sup>8</sup> Runqi Zhao,<sup>1</sup> Christiana O. Amira,<sup>9</sup> Dwomoa Adu,<sup>10</sup> Cheryl A. Anderson,<sup>11</sup> Akinlolu Ojo,<sup>12</sup> Sushrut S. Waikar.<sup>1</sup> <sup>1</sup>Boston University School of Medicine, Boston, MA; <sup>2</sup>University of Abuja, Abuja, Nigeria; <sup>3</sup>Lagos State University College of Medicine, Ojo, Nigeria; <sup>4</sup>University College Hospital Ibadan, Ibadan, Nigeria; <sup>5</sup>Obafemi Awolowo University College of Health Sciences, Ile-Ife, Nigeria; <sup>6</sup>University of Nigeria, Nsukka, Nigeria; <sup>7</sup>Women's College Hospital, Toronto, ON, Canada; <sup>8</sup>Duke University School of Medicine, Durham, NC; <sup>9</sup>Lagos University Teaching Hospital, Surulere, Nigeria; <sup>10</sup>University of Ghana Medical Centre, Accra, Ghana; <sup>11</sup>University of California San Diego, La Jolla, CA; <sup>12</sup>The University of Kansas Medical Center, Kansas City, KS.

**Background:** Higher dietary sodium (Na) and lower potassium (K) are associated with increased blood pressure and cardiovascular disease risk. In individuals with CKD, there are conflicting results on the associations of dietary Na and K with kidney function. We examined associations of 24hr-urine Na and K, with systolic and diastolic blood pressure (SBP and DBP) and pulse pressure (PP) in Africans and Americans with CKD.

**Methods:** We analyzed 619 participants enrolled in an ancillary study to the Human Hereditary and Health in Africa Kidney Disease Network. Calibrated log transformed 24-hr urinary sodium (UNa), potassium (UK) and sodium/potassium ratio (UNa/UK) were analyzed centrally. Using generalized linear regression with a random intercept for clinical center, we calculated crude and adjusted (adjusting for covariates)  $\beta$  coefficients and 95% CI with each blood pressure parameter. Similar cross-sectional analyses were performed in the Chronic Renal Insufficiency Cohort (n=3459).

**Results:** Median UNa excretion was lower in West Africans vs Americans [134 (104-175) vs. 160 (118-215) mmol/24hr, p <0.001]. Median UK excretion was lower in West Africans vs Americans [36 (28-48) vs 55 (40-74) mmol/24hr (p <0.001)]. Higher UNa excretion was associated with higher SBP in both cohorts (**Fig 1**). Higher UK was associated with lower SBP, and significantly associated with lower DBP in both cohorts.

**Conclusions:** Cross-sectionally, higher urinary Na excretion, lower urinary K excretion and higher Na/K ratio are associated with higher blood pressure and is consistent among West Africans and Americans with CKD.

**Funding:** NIDDK Support

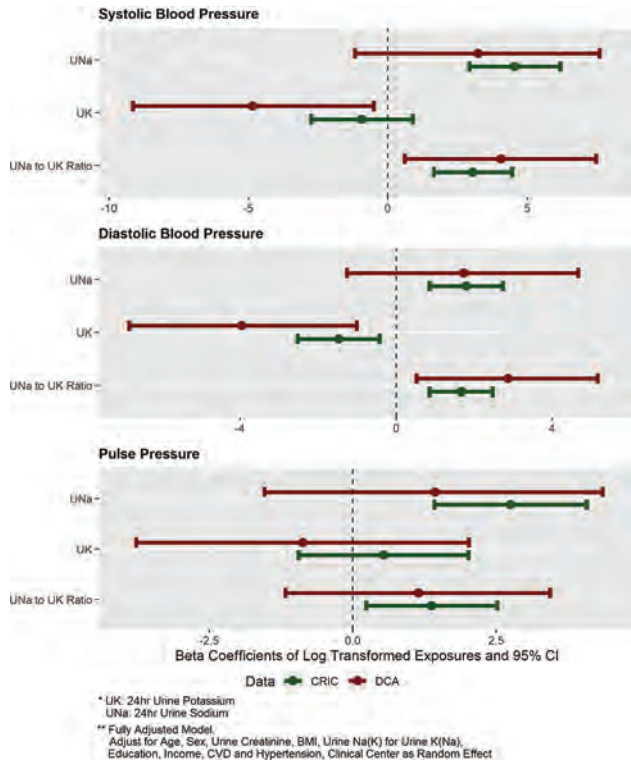

$\beta$  Coefficients and 95% CI of UNa and K and Blood pressure

**TH-PO807**

**Estimated 24-Hour Urinary Sodium Excretion and the Risk of ESKD**  
Xiaoyan Huang, Peking University Shenzhen Hospital, Shenzhen, China.

**Background:** Sodium reduction lowers blood pressure and albuminuria, but the association between sodium intake and long-term kidney hard endpoints is debated and yet to be proven. We investigated linear and nonlinear associations of estimated 24-h urinary sodium excretion, reflecting daily sodium intake, with the incidence of ESKD.

**Methods:** This was a population-based cohort study including 444,375 community-dwelling volunteers (mean age, 56.2 years; 54% females) from the UK Biobank. The participants were followed for a median of 12.7 years. Estimated 24-h urinary sodium excretion was calculated based on spot urinary biomarkers at baseline. A repeated measurement after an average of 4.3 years in a subsample of 17,205 participants was used to correct for regression dilution bias. The outcome of interest was incident ESKD, ascertained by linking to electronic health records. We constructed Cox proportional hazards models and restricted cubic splines to assess both linear and nonlinear relationships.

**Results:** The mean estimated 24-h urinary sodium excretion was 3.3 g. During follow-up, 865 (0.2%) ESKD events occurred. For every 1 g increment in estimated 24-h urinary sodium excretion, multivariable-adjusted HRs (95% CIs) for incident ESKD were 1.07 (0.95 - 1.21) and 1.09 (0.94 - 1.26) before and after regression dilution adjustment, respectively. Similar null results were observed when estimated 24-h urinary sodium excretion was treated as binary (<2 g vs.  $\geq$ 2 g) or multicategorical. Nonlinear associations were not detected with restricted cubic splines. The null findings were confirmed by a series of sensitivity analyses, which attenuated potential bias from measurement errors of the exposure, reverse causality, and competing risks.

**Conclusions:** In individuals at low- or intermediate-risk, estimated 24-h urinary sodium excretion is neither linearly nor nonlinearly associated with the incidence of ESKD.

**Funding:** Government Support - Non-U.S.

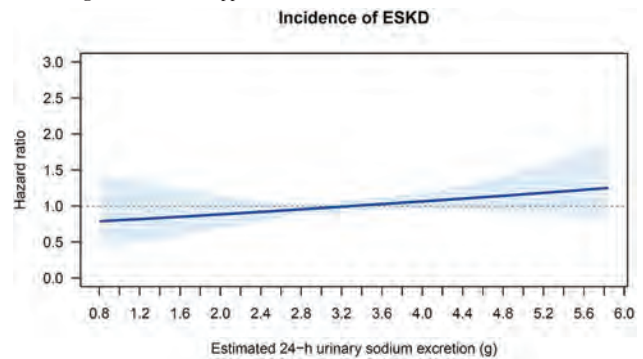

Restricted cubic splines for the incidence of ESKD.

The analyses were adjusted for potential confounders. Each point of the curve is the pointwise average HR. Shaded areas represent 95% CIs.

**TH-PO808**

**Investigating the Kidney-Gut-Brain Axis in CKD: Effects of High Amino Acids Diet With/Without Antibiotic Therapy**

Yitong Zhao, Han Liu, Tiffany Tran, Mark Fisher, Wei Ling Lau. University of California Irvine, Irvine, CA.

**Background:** Chronic kidney disease (CKD) has been associated with increased brain microhemorrhages in humans and in animal models. The altered gut microbiome in CKD contributes to the accumulation of uremic toxins such as p-cresyl sulfate (pCS), indoxyl sulfate (IS) and trimethylamine N-oxide (TMAO), which are derived from amino acid catabolism. We hypothesize that these vascular toxins increase brain microhemorrhages, and that suppression of the gut microbiome with broad-spectrum antibiotics in drinking water (Abx) will modify this outcome.

**Methods:** Male C57Bl/6J mice were randomized to control or CKD groups. CKD was induced with 0.2% adenine diet. Subgroups of mice were fed a high amino acids diet (HAA: 1.26% tryptophan, 2.88% phenylalanine & 0.6% choline) with/without Abx (ampicillin 1g/L, vancomycin 500 mg/L, neomycin sulfate 1g/L & metronidazole 1g/L). Levels of creatinine, cystatin C and uremic toxins were measured in serum samples. Microhemorrhage quantification was done via brain histology with Prussian blue staining, and stool was analyzed for microbial diversity. Data were analyzed using ANOVA.

**Results:** Levels of creatinine and cystatin C were significantly increased in CKD vs control animals and were decreased with Abx water consumption in CKD mice. Consumption of Abx changed the composition of microbiota in the stool samples. More Lactobacillus was observed in CKD and CKD+HAA mice compared to controls. There was an increased abundance of Akkermansia on the HAA diet, and Abx treatment markedly increased gut Enterobacter while suppressing other bacterial taxa. Levels of the uremic toxins pCS, IS and TMAO were significantly increased in CKD groups compared to controls, and TMAO was further increased on the HAA diet. Consumption of Abx in drinking water significantly reduced levels of all 3 toxins and the number of brain microhemorrhages (see table).

**Conclusions:** Broad-spectrum oral antibiotics treatment altered the gut microbiome, suppressed serum uremic toxins, and reduced brain microhemorrhage development in CKD mice.

**Funding:** Other NIH Support - NINDS

Table 1. Serum metabolites and cerebral microhemorrhage counts in control (CTL) and chronic kidney disease (CKD) groups. HAA: high amino acid diet; Abx: antibiotics in drinking water.

	CTL n=8	CKD n=16	CKD+HAA n=16	CKD+HAA+Abx n=16
Creatinine (mg/dL)	0.046 ± 0.001	0.243 ± 0.011*	0.160 ± 0.003 <sup>††</sup>	0.141 ± 0.008 <sup>††</sup>
Cystatin C (mg/L)	0.366 ± 0.106	2.983 ± 0.324*	1.377 ± 0.176 <sup>†</sup>	1.338 ± 0.195 <sup>†</sup>
p-cresyl sulfate (ng/mL)	579 ± 221	6329 ± 1002*	6119 ± 911 <sup>†</sup>	not detected
Indoxyl sulfate (ng/mL)	311 ± 44	3692 ± 413*	1887 ± 239 <sup>††</sup>	not detected
Trimethylamine N-oxide (ng/mL)	6 ± 0.5	132 ± 28	414 ± 81 <sup>††</sup>	6 ± 0.2 <sup>10</sup>
Brain microhemorrhage counts per cm	0.955 ± 0.328	1.287 ± 0.278	1.032 ± 0.195	0.431 ± 0.159 <sup>†</sup>

\*p<0.05 compared to CTL, † p<0.05 compared to CKD, †† p<0.05 compared to CKD+HAA

## TH-PO809

### Association Between Dietary Protein Sources and Gut-Derived Uremic Toxins in Patients on Long-Term Hemodialysis

Yoko Narasaki, Connie Rhee, Yitong Zhao, Kamyar Kalantar-Zadeh, Wei Ling Lau. *University of California Irvine, Irvine, CA.*

**Background:** Gut-derived uremic toxins derived from bacterial catabolism of amino acids include indoxyl sulfate (IS), p-cresyl sulfate (PCS) and trimethylamine N-oxide (TMAO). These vascular toxins have been associated with increased risk of cardiovascular events and mortality in chronic kidney disease (CKD). In this study, we examined the association between dietary protein sources and gut-derived uremic toxins in chronic hemodialysis patients using an existing biorepository from the "Malnutrition, Diet and Racial Disparities in CKD" (MADRAD) study.

**Methods:** Dietary intake was assessed using the Block Food Frequency Questionnaire (FFQ). Serum samples collected within 1 year of FFQ survey date were analyzed for uremic toxins using mass spectrometry. Cross-sectional associations were examined using linear regression models.

**Results:** Participant age was 54±15 years (mean±SD) and 54% were male, n=154. Dialysis vintage was 4.1±3.3 years, and serum was analyzed 2.7±5.8 months from time of FFQ survey. Caloric intake averaged 985 kcal/day [interquartile range (IQR) 569, 1400] and total protein intake was 42 g/day [IQR 24, 64] with 70% from animal sources [IQR 60, 76]. Average serum toxin levels for IS, PCS and TMAO were 10.6±7.1, 79.5±74.9 and 6.6±4.3 ug/mL respectively, as compared to 0, 1.4 and 1 ug/mL in healthy controls. On unadjusted linear regression analysis, there was a positive association between %plant-based protein intake and higher IS levels (beta coefficient, B = 0.074 with 95% confidence interval [CI] 0.005, 0.143; P=0.03) as well as dietary fiber intake from vegetables/fruits and IS levels (B = 0.677 with 95% CI: 0.215, 1.138; P<0.01). There was a negative association between dairy intake and TMAO (B = -1.473 with 95% CI: -2.620, 0.326; P=0.01) and between total animal protein intake and TMAO (B = -0.022 with 95% CI: -0.043, -0.002; P=0.04). Percent plant vs animal protein intake was not associated with PCS levels.

**Conclusions:** This hemodialysis cohort study revealed unexpected associations between higher plant-based protein intake and higher levels of circulating uremic toxins. More work is needed to elucidate the dietary sources of gut-derived toxins in the dialysis population.

## TH-PO810

### The Dietary Fiber Inulin Beneficially Alters the Gut Microbiota and Microbially-Derived Metabolites in a Rat Model of Progressive CKD

Annabel Biruete,<sup>1,2</sup> Shruithi Srinivasan,<sup>2</sup> Kalisha O'Neill,<sup>2</sup> Henriette De Ioor,<sup>3</sup> Pieter Evenepoel,<sup>3</sup> Kelly Swanson,<sup>4</sup> Neal X. Chen,<sup>2</sup> Sharon M. Moe.<sup>2</sup> <sup>1</sup>Indiana University Purdue University Indianapolis, Indianapolis, IN; <sup>2</sup>Indiana University School of Medicine, Indianapolis, IN; <sup>3</sup>Katholieke Universiteit Leuven, Leuven, Belgium; <sup>4</sup>University of Illinois Urbana-Champaign, Urbana, IL.

**Background:** Inulin is a fermentable dietary fiber that may be able to improve uremic dysbiosis. Our objective was to evaluate if inulin impacts the gut microbiota and derived metabolites in a rat model of CKD-MBD.

**Methods:** The Cy/+ rats, a model of progressive CKD, were fed a grain-based diet until 22 weeks of age and then changed to a casein-based diet with either inulin (CKD+IN) or cellulose (non-fermentable fiber; CKD+CE) for 10 weeks (until the CKD animals had a GFR ~ 15% or normal) to test the hypothesis that fiber type affects the cecal microbiota and derived metabolites, including uremic toxins. NL littermates were treated with a casein-based diet with cellulose (NL). Cecal microbiota, cecal and serum butyrate, and microbially-derived serum uremic toxins were analyzed.

**Results:** There was no difference in CKD progression in the CKD animals with the two types of fiber. The a-diversity, or diversity within a sample, was lower with CKD+IN treatment across different metrics (p<0.03) than CKD+CE and NL. B-diversity, or diversity between samples, was also different in CKD+IN vs. CKD+CE or NL (PERMANOVA q=0.03). At the genera-level, CKD+IN (vs. CKD+CE or NL) had a higher

relative abundance of *Allobaculum*, *Bacteroides*, *Parabacteroides*, *Bifidobacterium*, and *Sutterella*, and lower *Clostridium*, unclassified *Peptostreptococcaceae*, *U. Desulfovibrionaceae*, *U. Ruminococcaceae*, and *Oscillospira* (p<0.05). Fecal and serum butyrate, a short-chain fatty acid produced by the microbiota, were increased in the CKD+IN by 3- and 7-fold, respectively, vs. NL and CKD+CE (p<0.03). CKD+IN lowered the elevated levels of indoxyl sulfate and p-cresyl sulfate found in the CKD+CE group (p<0.0008) to concentrations similar to the NL rats despite no difference in kidney function between CKD+CE and CKD+IN.

**Conclusions:** In our rat model of CKD-MBD, the fermentable fiber inulin, compared to non-fermentable fiber cellulose, improved the gut microbiota composition and the microbially-derived metabolites, including butyrate and uremic toxins. This suggests that adequate dietary fiber substrates can improve uremic dysbiosis and reduce toxin production.

**Funding:** NIDDK Support

## TH-PO811

### Plasma Metabolites and Physical Function in Patients Undergoing Dialysis

Keith G. Avin,<sup>1,2</sup> Ranjani N. Moorthi,<sup>2</sup> Sharon M. Moe,<sup>2</sup> Thomas Oconnell,<sup>2</sup> Stephanie Dickinson,<sup>3</sup> Sahir Kalim,<sup>4</sup> Clary B. Clish,<sup>5</sup> Tariq Shafi,<sup>6</sup> Eugene P. Rhee,<sup>4</sup> <sup>1</sup>Indiana University Purdue University Indianapolis, Indianapolis, IN; <sup>2</sup>Indiana University School of Medicine, Indianapolis, IN; <sup>3</sup>Indiana University Bloomington, Bloomington, IN; <sup>4</sup>Massachusetts General Hospital, Boston, MA; <sup>5</sup>Broad Institute, Cambridge, MA; <sup>6</sup>University of Mississippi School of Medicine, Jackson, MS.

**Background:** Impaired physical function contributes to falls, fractures, and mortality among patients undergoing dialysis. Using a metabolomic approach, we identified metabolite alterations and composite scores associated with measures of impaired physical function (gait speed and grip strength).

**Methods:** In 108 subjects incident to dialysis, targeted plasma metabolomics via liquid chromatography-mass spectrometry and physical function (i.e., 4m walk, handgrip strength) were measured. Gait speed and grip strength were categorized as above/ below median, with grip utilizing sex-based medians. Metabolites significant between gait speed and grip strength groups (Wilcoxon p<0.05) and effect sizes >0.40 were used to develop composite scores. Receiver operating characteristic analyses tested whether scores differentiated between high and low function groups.

**Results:** Participants were 54% male, 77.4% Black and 53.4 ± 13.9 y. Median (IQR) grip strength was 35.5 (11.1) kg (males) and 20 (8.4) kg (females); median gait speed was 0.82 (0.34) m/s. Of 246 measured metabolites, 30 and 20 metabolites were different between grip strength and gait speed groups respectively with three common metabolites (C7 carnitine, phosphocholine isomer, valine). Composite scores were composed of 22 and 12 metabolites that differentiated grip strength and gait speed, respectively. Area under the curve for metabolite composite was 0.88 (gait) and 0.911 (grip).

**Conclusions:** n this study, we developed a composite score that represents physical function with metabolites unique for each measure of gait speed and grip strength in patients who are incident to dialysis. We included 22 key metabolites for grip strength and 12 metabolites for gait speed in the composite score, with alterations in fatty acid oxidation and protein synthesis observed in both measures. Given the complexity of the systems involved in physical function, the use of panels of metabolites associated with physical function offers a fresh opportunity to both predict changes over time and offer insight into pathophysiology for those with CKD.

**Funding:** NIDDK Support, Other NIH Support - National Institute of Nursing Research, National Institute of Arthritis and Musculoskeletal and Skin Diseases, Veterans Affairs Support

## TH-PO812

### Selenium Concentration and Kidney Function: A Mendelian Randomization Study

Schoon Park, Yong Chul Kim, Seung Seok Han, Hajeong Lee, Yon Su Kim, Dong Ki Kim. *Seoul National University Hospital, Jongno-gu, Seoul, Republic of Korea.*

**Background:** Selenium is one of the trace minerals that is commonly included in micronutrient supplements, although the supplementation is associated with some adverse side effects. The effect of selenium on kidney function remains unclear. A genetically predicted micronutrient and its' association between eGFR can be used to assess the causal estimates towards kidney function by Mendelian randomization (MR).

**Methods:** In this MR study, we instrumented 11 genetic variants associated with blood or toenail selenium level with genome-wide significance from a previous large-scale genome-wide association study (GWAS). The association between genetically predicted selenium concentration and eGFR was first assessed by summary-level MR in the CKDGen GWAS meta-analysis summary statistics including 567,460 European samples. Replication analysis was performed with individual-level UK Biobank data including 337,318 white British ancestry individuals.

**Results:** Summary-level MR analysis by inverse variance weighted method indicated that a genetically predicted one standard deviation increase in selenium concentration was significantly associated with low eGFR [-1.05 (-1.28, -0.82) %]. The results were similarly reproduced by pleiotropy-robust MR analysis including MR-Egger and weighted median method. In the UK Biobank data, genetically predicted high selenium concentration was also significantly associated with low eGFR [-0.36 (-0.52, -0.20) %],

Key: TH - Thursday; FR - Friday; SA - Saturday; OR - Oral; PO - Poster; PUB - Publication Only

Underline represents presenting author.

and the results were similar when body mass index, hypertension, and diabetes mellitus covariates were adjusted [-0.33 (-0.50, -0.17) %].

**Conclusions:** This MR study suggests higher concentration of selenium may possibly decrease eGFR for a small degree. Selenium should be carefully supplemented for those at risk of kidney function impairment.

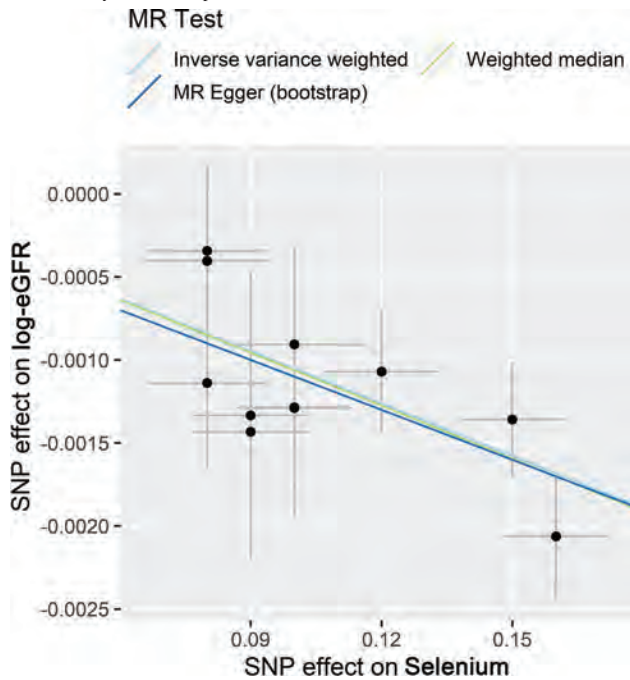

**TH-PO813**

**Underweight Status and Development of ESKD: A Nationwide Population-Based Study**

Chang Seong Kim,<sup>1,2</sup> Tae ryom Oh,<sup>2</sup> Sang Heon Suh,<sup>2</sup> Hong sang Choi,<sup>1,2</sup> Eun Hui Bae,<sup>1,2</sup> Seong Kwon Ma,<sup>1,2</sup> Soo Wan Kim.<sup>1,2</sup> <sup>1</sup>Chonnam National University Medical School, Gwangju, Republic of Korea; <sup>2</sup>Chonnam National University Hospital, Gwangju, Republic of Korea.

**Background:** An underweight status increases the risk of cardiovascular disease and mortality in the general population. However, whether an underweight status is associated with an increased risk of developing end-stage kidney disease (ESKD) is unknown.

**Methods:** A total of 9,845,420 participants aged ≥ 20 years who underwent health checkups were identified from the Korean National Health Insurance Service database and were analyzed in this study. Individuals with underweight (body mass index [BMI] < 18.5 kg/m<sup>2</sup>) and obesity (BMI ≥ 25 kg/m<sup>2</sup>) were categorized according to the World Health Organization recommendations for Asian populations.

**Results:** During a mean follow-up period of 9.2 ± 1.1 years, 26,406 participants were diagnosed with ESKD. After fully adjusting for other potential predictors of ESKD, the severe underweight group (BMI < 16.5 kg/m<sup>2</sup>) had a significantly higher risk of ESKD than the reference (normal) weight group (adjusted hazard ratio [HR], 1.531; 95% confidence interval [CI], 1.243–1.884), whereas the obesity group had a lower risk of ESKD (adjusted HR, 0.661; 95% CI, 0.642–0.681). Compared with the reference BMI group (BMI 24–25 kg/m<sup>2</sup>), the adjusted HRs for ESKD increased as BMI decreased by 1 kg/m<sup>2</sup>. In the sensitivity analysis, sustained underweight or progression to an underweight status over two repeated health checkups had a higher HR for ESKD, even after fully adjusting for other potential predictors.

**Conclusions:** An underweight status is associated with an increased risk of ESKD, and this association gradually becomes stronger as BMI decreases.

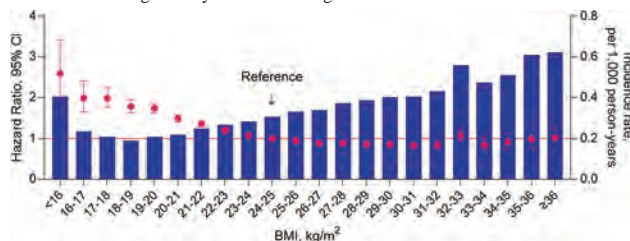

**TH-PO814**

**Strategies to Improve Self-Management in CKD From the Patient Perspective**

Sarah J. Schrauben,<sup>1</sup> Eleanor Rivera,<sup>3</sup> Diane Park,<sup>1</sup> Sandra Amaral,<sup>2</sup> Harold I. Feldman,<sup>1</sup> Laura M. Dember,<sup>1</sup> Frances K. Barg.<sup>1</sup> <sup>1</sup>University of Pennsylvania Perelman School of Medicine, Philadelphia, PA; <sup>2</sup>The Children's Hospital of Philadelphia, Philadelphia, PA; <sup>3</sup>University of Illinois Chicago, Chicago, IL.

**Background:** Self-management is integral for the treatment of chronic kidney disease (CKD). Despite low adherence to self-management behaviors, few studies provide insight into ways to improve self-management. This current study aimed to describe factors needed to self-manage CKD and suggestions to improve self-management from the patient perspective.

**Methods:** Semi-structured interviews were conducted with 30 participants who were purposively recruited for representation by CKD stage (3 or 4), age (<65, ≥65 yrs), race (white, non-white), and sex. Interviews focused on patient experiences with CKD and its management, and to identify resources necessary to manage CKD. They were recorded, transcribed, and entered into NVivo 12.0 for coding and analysis. Transcripts were coded inductively and analyzed thematically.

**Results:** Two themes described components necessary for self-management from the patient perspective. The first was “getting in the right mindset”, which included acceptance of the CKD diagnosis, being open-minded, and expecting lifestyle changes. The second theme was “supports of self-management”, which included educational resources, social/peer support, and a good patient-provider relationship. Almost all participants shared they wanted to be educated “on their level” about CKD. Participants shared that “having people who are in the same situation is very valuable”, especially for emotional support. Another shared that “you have to have open lines of communication with your doctor”. Participants also provided actionable suggestions for enhancing the supports of self-management, which included 1) creating a repository of trustworthy educational resources in laymen’s terms, 2) establishing peer support groups, and 3) encouraging shared-decision making by providing example questions to patients that are important to ask doctors.

**Conclusions:** Participants with CKD in this study endorsed several key themes to promote their self-management, across different levels of the healthcare model. At an individual level, they endorsed the need to accept their disease and be ready to change, at a community-level, they emphasized benefits of social or peer support and at an institutional level, they stressed the need for education to be at the patient’s level of health literacy and for shared-decision making in disease management.

**Funding:** NIDDK Support

**TH-PO815**

**Using Formative Research to Develop a Healthy Lifestyle Program for Recent Kidney Transplant Recipients**

Cheryl Gibson,<sup>1</sup> Aditi Gupta,<sup>1</sup> Abhijit S. Naik,<sup>2</sup> Debra K. Sullivan,<sup>6</sup> Mona D. Doshi,<sup>2</sup> Jaehoon Lee,<sup>4</sup> James M. Backes,<sup>5</sup> Susan P. Harvey,<sup>3</sup> Kelly Shaffer,<sup>2</sup> Rebecca Mount,<sup>1</sup> Heather Valentine.<sup>1</sup> <sup>1</sup>University of Kansas Medical Center Department of Internal Medicine, Kansas City, KS; <sup>2</sup>University of Michigan Medical School, Ann Arbor, MI; <sup>3</sup>University of Kansas, Lawrence, KS; <sup>4</sup>Texas Tech University, Lubbock, TX; <sup>5</sup>University of Kansas School of Pharmacy, Lawrence, KS; <sup>6</sup>University of Kansas Medical Center Department of Nutrition and Dietetics, Kansas City, KS.

**Background:** A significant number of kidney transplant recipients experience weight gain in the first year after transplantation. Post-transplantation weight gain is associated with higher rates of cardiovascular disease, new-onset diabetes, metabolic syndrome and loss of graft function. The objective of this formative research project was to gather data to inform intervention design and implementation of a healthy lifestyle program to counter unnecessary weight gain.

**Methods:** Recent kidney transplant recipients at the University of Kansas Health System and the University of Michigan Transplant Center were invited to participate in an online survey. Survey items included sociodemographic information, current medications, health conditions, weight change post-transplant, diet behaviors, physical activity participation, and desired features of a healthy lifestyle program.

**Results:** Fifty-three (38 KS; 15 MI) participants, average age 58 ± 12 years, primarily male, completed surveys. Forty percent gained weight post-transplantation with 19% gaining 10+ pounds. Most indicated struggling with their diet after transplantation, with ratings of current eating habits fair to poor (e.g., too few fruits and vegetables, too much sodium, fat and added sugars). Physical activity (PA) stayed the same (17%) or decreased (40%) post-transplantation with most not regularly participating in PA or resistance training. Many participants (41.5%) indicated they would very likely or definitely participate in a healthy lifestyle program of 6 to 12 months in length. Most wanted online PA and nutrition sessions to meet once or twice weekly with several suggestions about what kinds of information and activities to make part of the program, including healthy eating strategies (e.g., how to eat healthfully at restaurants, grocery shopping tips, recipes), resources for at-home physical activities, access to healthy cooking classes and apps to track both physical activity and food intake.

**Conclusions:** Gathered information will be used to inform and tailor the healthy lifestyle program for recent kidney transplant recipients. Identifying features of a program for the prevention of unnecessary weight gain with patients’ input is essential for promoting healthy behaviors.

## TH-PO816

### Occupational Prolonged Sitting Increased the Risk Across the Spectrum of Kidney Disease: Results From a Cohort of a Half-Million Asian Adults

Min Kuang Tsai, Chi pang Wen. *National Health Research Institutes, Zhunan, Taiwan.*

**Background:** Kidney diseases were viewed as continuously progressing from microalbuminuria, chronic kidney disease (CKD), end-stage renal disease (ESRD), and deaths. The report of the association between prolonged sitting and kidney diseases is limited.

**Methods:** We examined a cohort of 455,506 participants in a screening program in Taiwan conducted between 1996 and 2017. Data on occupational sedentary behavior and physical activity were collected with a standardized questionnaire. The outcomes of ESRD and death were identified by linking with the Registry of Dialysis and Cause of Death Data. The association between prolonged sitting and CKD, the incident of ESRD, and death were assessed using a logistic regression model to compute odds ratios (ORs) and Cox proportional hazards model for hazard ratios (HRs).

**Results:** More than half of the participants, 265,948 (58.4%), were categorized as “prolonged sitting” during their work. During the median 13 years of follow-up, we identified 2,227 individuals undergoing dialysis and 25,671 deaths. Occupational prolonged sitting was significantly associated with a higher risk of CKD (OR: 1.26, 95% confidence interval: 1.21, 1.31), ESRD (HR: 1.19, 95% CI: 1.03, 1.38), and kidney-specific mortality (HR: 1.43, 95% CI: 1.07, 1.91) compared to mostly standing participants after controlling for physical activity and other risk factors. Inactive prolonged sitting carries a significantly higher risk of ESRD than physically active, mostly standing participants (HR: 1.34, 1.04, 1.73). However, active prolonged sitting decreased ESRD risk (HR: 1.03, 95% CI: 0.79, 1.34) compared to inactive prolonged sitting.

**Conclusions:** The results suggest that prolonged sitting is associated with a greater risk of kidney diseases, independent of physical activity. Given the pervasive nature of prolonged sitting, especially during the COVID-19 pandemic, decreasing the amount of time spent sitting can be a modifiable behavior to lower the risk of kidney diseases.

## TH-PO817

### Prehabilitative Virtual Reality Mindfulness and Personalized Physical Activity for Hemodialysis Patients With Depressive Symptoms: A Feasibility Study

Brett Burrows, Alexis King, Ashley Morgan, Kenneth R. Wilund. *University of Illinois Urbana-Champaign, Urbana, IL.*

**Background:** Historically, exercise-related trials in hemodialysis (HD) patients have suffered from low exercise adherence, possibly due to a lack of personalization and/or high rates of depression in HD patients. Therefore, our aim was to assess the feasibility and initial efficacy of applying a novel virtual reality (VR) mindfulness program as a prehabilitation to a personalized activity prescription (PARx) in HD patients with elevated depressive symptoms

**Methods:** HD patients (n=10) with elevated depressive symptoms were randomized into a treatment (VR mindfulness + PARx) or control (PARx only) group. The intervention began with 2 weeks of prehabilitation, in which the treatment group was exposed to our VR-based mindfulness program and the control group received usual care. Directly following, both groups participated in 8 weeks of our PARx program. Feasibility was assessed through recruitment, retention, adherence, acceptability, and adaptation (assessed by the Modified Health Care Climate Questionnaire). Initial efficacy was measured using metrics of depression, mindfulness, fatigue, and physical activity (PA) energy expenditure.

**Results:** Recruitment rate was 25%, with a 90% retention rate. Mean age was 59.60 ( $\pm$  13.66) years; 70% female; and 60% Black. 100% and 90% of the participants liked or strongly liked our VR mindfulness program and PARx, respectively. PARx demonstrated high levels of perceived autonomy support ( $M = 27.6 \pm 2.1$ ). Following the prehabilitation, the treatment group showed significant between-group improvement in mindfulness ( $p = 0.02$ ) and trended towards significance in depressive symptoms ( $p = 0.07$ ). Both groups saw an increase in PA energy expenditure from week 1 to week 8 of PARx (treatment: 824 to 2835 kcal/wk and control 792 to 1740 kcal/wk), though no between-group difference was evident. The treatment group did, however, have a significant within-group increase in PA energy expenditure ( $p < 0.01$ ).

**Conclusions:** The current pilot study demonstrated that our novel VR-based mindfulness program and PARx program are both feasible and potentially efficacious for in-center HD patients. Future trials should examine a larger sample size and expand the intervention duration to validate these findings.

**Funding:** Private Foundation Support

## TH-PO818

### A Novel Exercise Intervention, Home-Based and Video-Supervised, Improved Cardiorespiratory Fitness and Physical Performance in CKD

Gwenaelle Begue,<sup>1</sup> Alina Nicorici,<sup>2</sup> Nargies Ghafar,<sup>2</sup> Radhika Batra,<sup>2</sup> Harshanna Badhessa,<sup>2</sup> Chenoa R. Vargas,<sup>2</sup> Tae Youn Kim,<sup>2</sup> Hiba Hamdan,<sup>2</sup> Thomas Jue,<sup>2</sup> Jorge Gamboa,<sup>3</sup> Baback Roshanravan.<sup>2</sup> <sup>1</sup>*California State University Sacramento, Sacramento, CA;* <sup>2</sup>*University of California Davis, Davis, CA;* <sup>3</sup>*Vanderbilt University Medical Center, Nashville, TN.*

**Background:** Sarcopenia is a prevalent complication in chronic kidney disease (CKD) and a central component of the frailty phenotype associated with adverse clinical outcomes. In the era of COVID, there is a critical need for practical, safe, interactive, and personalized home-based exercise targeting improvements in physical function in vulnerable patients living with CKD.

**Methods:** The ESTEEM-VIDA CKD pilot randomized clinical trial tests the efficacy of a home-based, video-supervised, and personalized exercise program on cardiorespiratory fitness (CRF) and physical performance in patients with moderate-severe CKD. Exercise (EX, n=12) consisted of 30-40min exercise sessions, thrice a week for 12 weeks: high-intensity interval training, strength training, and moderate intensity walking. One week of video-supervised exercise alternates with one week of self-directed exercise. Each one-week video-supervised session was conducted by exercise trainers using a videoconference tool, while self-directed exercise weeks used pre-recorded exercise videos. Controls (CTL, n=5) received diet and exercise counseling at baseline. Pre- and post-intervention CRF (VO2peak) and total work were measured using a graded cycle ergometer test and physical performance was assessed by the 6-minutes walking distance (6MWT) test. The effect of exercise on change in CRF and 6MWT using linear mixed effects models was tested.

**Results:** Mean age was 62  $\pm$  10y with 47% females and 53% with diabetes. Mean eGFR was 34.4 $\pm$ 11.8 ml/min per 1.73m<sup>2</sup>. Mean total work and 6MWT at baseline were 31.7  $\pm$  17kJ and 494  $\pm$  51m, respectively. EX was associated with a 6.9kJ increase in total work (95% CI 2, 12; p=0.008) compared to CTL independent of change in VO2peak, suggesting improved muscular efficiency following training. EX was associated with a 43m increase in 6MWT (95% CI 11, 75; p=0.008) compared to CTL. VO2peak did not differ between groups (p=0.99).

**Conclusions:** Preliminary findings suggest a home-based, video supervised, personalized exercise program is feasible and efficacious in improving muscular and physical performance in CKD. It provides a tool for studying metabolic and molecular health and may shed new light on the pathophysiology of sarcopenia in CKD.

**Funding:** NIDDK Support, Private Foundation Support

## TH-PO819

### Relationship Between Serum Klotho Levels and Physical Function in a Community-Based Cohort

Elliott Arroyo,<sup>1</sup> Gayatri Narayanan,<sup>1</sup> Andrew R. Coggan,<sup>2</sup> Sharon M. Moe,<sup>1</sup> Kenneth Lim.<sup>1</sup> <sup>1</sup>*Indiana University School of Medicine, Indianapolis, IN;* <sup>2</sup>*Indiana University Purdue University Indianapolis, Indianapolis, IN.*

**Background:** Sarcopenia is a degenerative skeletal muscle disease involving the loss of muscle mass and function that can progress into decreased physical function. Beyond exercise and physical activity interventions, there are limited options for the treatment of sarcopenia. Therefore, identifying potential modifiable targets for the treatment of sarcopenia is critically important. Emerging data indicates that the anti-aging protein Klotho may play a key role in regulating sarcopenia and physical function. Herein, we sought to examine the relationship between serum Klotho levels and physical function in a well-validated community-based cohort.

**Methods:** We conducted an exploratory analysis utilizing data from the “Musculoskeletal Function, Imaging and Tissue Resource Core (FIT Core) study” cohort that enrolled ambulatory men and women in Central Indiana aged 5 years and over. All patients underwent comprehensive physical performance assessment and self-reported physical activity questionnaire.

**Results:** A total of 80 healthy participants (age=49 [18] years) were stratified into four age groups (n=20, 10 [50%] men per group): 20-35 years, 35-50 years, 50-65 years, and  $\geq$ 65 years. Subjects were further grouped into Low and High performers based on the z-scores for grip strength and number of chair stands completed in 30 seconds. Klotho levels were significantly lower in the  $\geq$ 65 years group (703.0 $\pm$ 189.3 pg/mL) compared to 20-35 years group (916.1 $\pm$ 284.8 pg/mL; p=0.03). Despite significantly higher grip strength, number of chair stands completed in 30 seconds, gait speed, distance walked in 6 minutes, and self-reported physical function (SF-36 and PROMIS PF CAT), no significant differences were observed in Klotho levels between the Low and High performers in any age group.

**Conclusions:** Our findings suggest that Klotho levels decline with increasing age but are not associated with declines in physical function in a healthy community-based cohort. Studies evaluating the relationship between impaired physical function and Klotho levels in patients with chronic kidney disease (CKD), a known state of Klotho deficiency, are warranted.

**Funding:** Other NIH Support - National Institute of Arthritis and Musculoskeletal and Skin Diseases (NIAMS)

## TH-PO820

### Objective Physical Activity Is Associated With Glycemic Variability in Patients With CKD

John Mowrey, Zaneb Mehmood, Harshanna Badhessa, Radhika Batra, Hiba Hamdan, Tae Youn Kim, Baback Roshanravan. *University of California Davis, Sacramento, CA.*

**Background:** Sedentary behavior is highly prevalent in patients with Chronic Kidney Disease (CKD) and strongly associated with adverse metabolic and clinical outcomes across populations. However, associations of objective and self-reported physical activity with clinically relevant measures of glycemic variability in patients with CKD remain unknown.

**Methods:** We performed a cross-sectional study in 25 patients with moderate-severe CKD simultaneously wearing an ActivPAL 4 accelerometer and Abbott Freestyle Libre Pro continuous glucose monitor (CGM) for 2 weeks. Self-reported physical activity was evaluated using the Human Activities Profile (HAP), divided into maximal and adjusted activity scores. Linear regression was used to test associations of measures of physical activity and CGM.

Key: TH - Thursday; FR - Friday; SA - Saturday; OR - Oral; PO - Poster; PUB - Publication Only

Underline represents presenting author.

**Results:** Mean eGFR of our sample was  $35.72 \pm 11.54$  ml/min with 48% female, and 56% with diabetes. Average sitting time in the cohort was  $527 \pm 168$  min/day. We observed that greater sitting time correlates with worsening glucose control including higher average glucose ( $P=0.04$ ), decreased time in target ( $p=0.04$ ), and increased time above target ( $p=0.007$ ). Each 1-SD increase in sitting time was associated with a 0.77SD lower (95% CI 0.65SD, 2.11SD lower;  $p=0.001$ ) time in target range (70-140mg/dL) independent of diabetes status, sex, and BMI. We did not see any meaningful or significant association of impact on self-reported physical activity on CGM readings.

**Conclusions:** Objective measurement of sitting time is strongly associated with worse glycemic control in patients with CKD. Future intervention studies are needed to determine if physical activity interventions improve glycemic control in CKD patients with, and without diabetes.

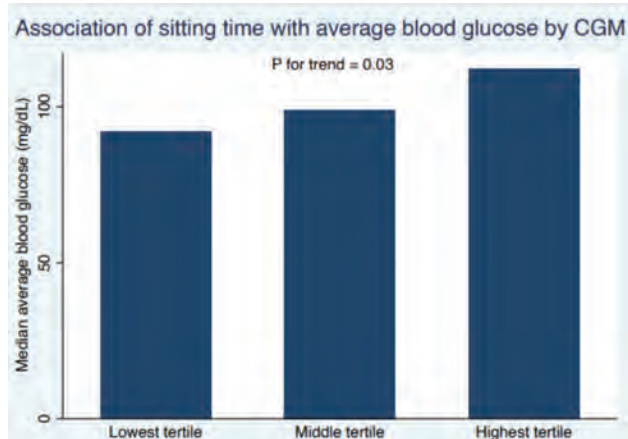

#### TH-PO821

##### The Impact of Home-Based Exercise on Skeletal Muscle Mitochondria in CKD

Jennifer E. Norman,<sup>1</sup> Jesse Gipe,<sup>1</sup> Béatrice Chabi,<sup>2</sup> Radhika Batra,<sup>1</sup> Harshanna Badhesha,<sup>1</sup> Chenoa R. Vargas,<sup>1</sup> Armin Ahmadi,<sup>1</sup> Tae Youn Kim,<sup>1</sup> Thomas Jue,<sup>1</sup> Jorge Gamboa,<sup>3</sup> Gwenaëlle Begue,<sup>4</sup> Baback Roshanravan.<sup>1</sup> <sup>1</sup>University of California Davis, Davis, CA; <sup>2</sup>DMEM, Université de Montpellier, INRAE, Montpellier, France; <sup>3</sup>Vanderbilt University Medical Center, Nashville, TN; <sup>4</sup>California State University Sacramento, Sacramento, CA.

**Background:** Mitochondrial dysfunction in patients with chronic kidney disease (CKD) contributes to the development of sarcopenia, central to the frailty phenotype. The impact of exercise on muscle mitochondrial energetics in patients with CKD is unknown.

**Methods:** We performed an interim analysis of the ESTEEM-VIDA CKD study, a pilot randomized trial of a 12 week, home-based, video-supervised exercise intervention in CKD patients. Vastus lateralis biopsy samples were analyzed by high resolution respirometry (Oroboros O2k) pre and post intervention. Two protocols were run: 1) muscle tissue was homogenized using the PBI Shredder and the O<sub>2</sub> consumption and hydrogen peroxide production were measured simultaneously (using Amplex UltraRed) and 2) O<sub>2</sub> consumption was measured on permeabilized muscle fibers in a more comprehensive protocol, including measurements with sub-saturating ADP concentrations. We used paired t-tests to test for differences in mitochondrial respiration rates pre and post exercise intervention.

**Results:** Respirometry rates were compared pre and post exercise intervention for 11 participants. Protocol 1 demonstrated an increase in succinate supported leak (53% increase,  $p=0.005$ ) and pyruvate and succinate supported OXPHOS (57% increase,  $p=0.0114$ ). There was a decrease in hydrogen peroxide production relative to O<sub>2</sub> consumption in the succinate supported leak state (20% decrease,  $p=0.0326$ ). In protocol 2, pyruvate and malate supported OXPHOS with  $31.25 \mu\text{M}$  ADP (44% increase,  $p=0.0435$ ) and  $62.5 \mu\text{M}$  ADP (55% increase,  $p=0.0485$ ) were significantly increased after exercise, while no statistical differences were observed between pre and post exercise intervention for OXPHOS with saturating ADP.

**Conclusions:** Exercise increased leak and OXPHOS respiratory rates measured on skeletal muscle homogenate (protocol 1), but changes in respiratory rates measured on permeabilized fibers with saturating ADP were not evident. The lack of agreement between the protocols may be attributed to greater sample variability between permeabilized fiber bundles, requiring a greater number of samples to detect a change in respiration rates. Further, our data may indicate increased sensitivity to changes in respiration with sub-saturating levels of ADP.

**Funding:** NIDDK Support, Private Foundation Support

#### TH-PO822

##### Exercise in CKD Patients Reduces Collagen Crosslinking but Not Total Collagen in Quadriceps Muscle

Sarah E. Brashear,<sup>1</sup> Armin Ahmadi,<sup>1</sup> Tae Youn Kim,<sup>1</sup> Jorge Gamboa,<sup>2</sup> Baback Roshanravan,<sup>1</sup> Lucas R. Smith.<sup>1</sup> <sup>1</sup>University of California Davis, Davis, CA; <sup>2</sup>Vanderbilt University, Nashville, TN.

**Background:** Muscles in CKD become fibrotic, containing excess extracellular matrix (ECM), particularly collagen, that contribute to muscle dysfunction. Collagen is crosslinked in the ECM with crosslinking associated with fibrosis, stiffness, and reduced ECM remodeling. However, it is not known how exercise in CKD may impact the extent of collagen crosslinking or fibrosis.

**Methods:** We studied 12 patients with non-dialysis CKD (eGFR < 60 ml/min per  $1.73 \text{m}^2$ ) enrolled in the ESTEEM-VIDA CKD pilot randomized clinical trial who underwent muscle biopsy. Participants were randomized to home-based exercise ( $n=9$ ) or no exercise ( $n=3$ ). Exercise consisted of 30-40 min sessions, thrice weekly for 12 weeks. Vastus lateralis biopsies were obtained pre and post 12 weeks. Biochemical analysis used tissue powdered and separated into a pepsin and acidic acid soluble and insoluble fraction before applying a hydroxyproline assay. The insoluble fraction represents the more crosslinked collagen. For histology tissue frozen in liquid nitrogen cooled isopentane was cut in  $10 \mu\text{m}$  thick sections and stained with Picrosirius Red.

**Results:** The overall amount of collagen was not altered in either group (Fig. 1A). However, the amount of heavily crosslinked collagen associated with fibrosis was significantly decreased in the exercise cohort (Fig. 1B). Picrosirius red stained sections did not reveal a change in ECM area with exercise (Fig. 1C/D).

**Conclusions:** This study shows that while overall collagen was not influenced by exercise, the extent of crosslinked collagen was decreased with exercise in CKD patients. This is indicative of improved muscle health as collagen crosslinking is associated with fibrosis, increased muscle stiffness, and decreased ECM remodeling.

**Funding:** NIDDK Support, Private Foundation Support

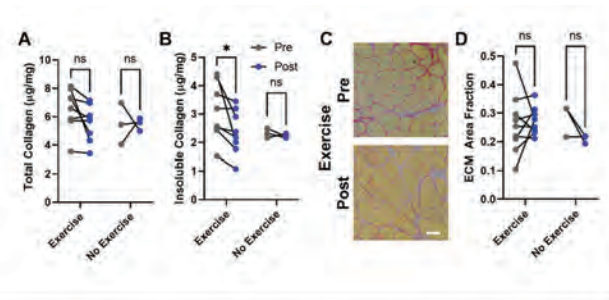

**Figure 1:** Skeletal muscle collagen. A) Total collagen content and B) crosslinked collagen measured biochemically pre- and post- exercise intervention. C) Representative sirius red stained sections labeling ECM in red from a CKD subject pre- and post- exercise intervention. D) Quantification of ECM area fraction. Scale bar = 50  $\mu\text{m}$ .

#### TH-PO823

##### Exercise Training Reduces Maximal Peripheral Blood Mononuclear Cell Mitochondrial Respiration While Increasing Anti-Inflammatory IL-10 in Patients With CKD

Armin Ahmadi,<sup>1</sup> Jennifer E. Norman,<sup>1</sup> Radhika Batra,<sup>1</sup> Harshanna Badhesha,<sup>1</sup> Jesse Gipe,<sup>1</sup> Chenoa R. Vargas,<sup>1</sup> Béatrice Chabi,<sup>2</sup> Tae Youn Kim,<sup>1</sup> Thomas Jue,<sup>1</sup> Gwenaëlle Begue,<sup>3</sup> Jorge Gamboa,<sup>4</sup> Baback Roshanravan.<sup>1</sup> <sup>1</sup>University of California Davis, Davis, CA; <sup>2</sup>Université de Montpellier, Montpellier, France; <sup>3</sup>California State University Sacramento, Sacramento, CA; <sup>4</sup>Vanderbilt University, Nashville, TN.

**Background:** Patients with CKD suffer from impaired physical performance. Exercise has been shown to improve physical performance in CKD, but its impact on immune cell mitochondrial function is unknown. We tested the impact of exercise on peripheral blood mononuclear cell (PBMC) mitochondrial function and their link with inflammatory biomarkers.

**Methods:** We performed an interim analysis of pilot randomized trial of 12 weeks of home-based, video supervised exercise intervention in CKD. Intact PBMC bioenergetics were measured using the high resolution respirometry (Oroboros O2k). We estimated basal, maximal respiration (MR) and reserve capacity (RC). Plasma IL-10 concentrations were measured using ELISA. Two-way ANOVA was used to evaluate the impact of exercise on PBMC bioenergetics. Spearman correlation was calculated for changes in log-transformed MR and IL-10 concentrations in exercise responders defined with >5% improvement in total work measured by cycle ergometry testing.

**Results:** Twelve participants (60.6 ± 11.1 yrs) were randomized to the exercise (EX) group and 5 (64.5 ± 8.1 yrs) were randomized to the non-exercise control (CTL) group. The mean EX eGFR was  $33.3 \pm 14.1$  compared to eGFR of  $37 \pm 3.1$  of CTL. The mean MR was 10.9 (3.8) and mean RC was 8.57 (2.8). EX was associated with a marked reduction in MR and RC compared to CTL ( $p=0.03$  and  $p=0.02$ , respectively) (Figure 1A). The change in PBMC MR inversely correlated with changes in plasma IL-10 concentration among EX responders ( $n=9$ ,  $r=-0.83$ ,  $p=0.008$ ) (Figure 1B).

**Conclusions:** A decrease in PBMC MR is associated with an increase in anti-inflammatory IL-10 levels which suggest that exercise alters PBMC mitochondrial energetics in CKD. Future studies will focus on the impact of exercise on immune cell metabolic health and its immunomodulatory effects in CKD

**Funding:** NIDDK Support, Private Foundation Support

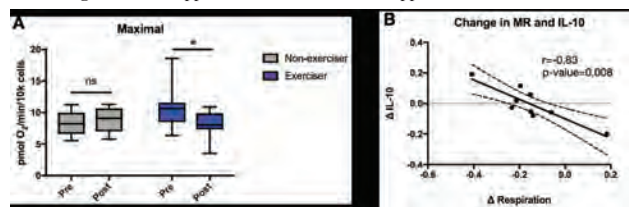

**Figure 1.** The impact of exercise intervention on PBMC respiration in CKD (A). The correlation between changes in log-transformed PBMC MR and IL-10 among exercise responders (B).

#### TH-PO824

##### Association of Mitochondrial Respiration in Peripheral Blood Mononuclear Cells With Fatigue in Persons With CKD

Tae Youn Kim,<sup>1</sup> Harshanna Badhessa,<sup>1</sup> Radhika Batra,<sup>1</sup> Jesse Gipe,<sup>1</sup> Armin Ahmadi,<sup>1</sup> Chenoa R. Vargas,<sup>1</sup> Jennifer E. Norman,<sup>1</sup> Thomas Jue,<sup>1</sup> Gwenaelle Begue,<sup>3</sup> Jorge Gamboa,<sup>2</sup> Baback Roshanravan.<sup>1</sup> <sup>1</sup>University of California Davis, Sacramento, CA; <sup>2</sup>Vanderbilt University, Nashville, TN; <sup>3</sup>California State University Sacramento, Sacramento, CA.

**Background:** Increased physical frailty and fatigue are prevalent in persons with chronic kidney disease (CKD), contributing to poor quality of life and increased morbidity and mortality risk. Impaired mitochondrial function adversely impacts energy metabolism and may contribute to increased fatigue. While patient-reported fatigue is a complex syndrome involving physiological and psychological mechanisms, little is known about the relevance of PBMC mitochondrial bioenergetics to fatigue in CKD.

**Methods:** We performed a cross-sectional analysis of the association of PBMC mitochondrial energetics and patient reported fatigue in 27 persons. PBMC basal respiration (BR) and maximal uncoupled respiration (MR) were measured using the high resolution respirometry (Oroboros O2k). Fatigue and depression were measured using the 8-item PROMIS® Fatigue and Depression scales respectively. A higher PROMIS score indicates having more fatigue or depressive mood. Linear regression with robust standard errors was used to test associations adjusting for sex, age, and depression.

**Results:** Fifty-two percent of the sample were male and diabetes with a mean age of 63±10 years and mean eGFR of 37±12ml/min per 1.73m<sup>2</sup>. The mean depression and fatigue scores were 47±8.3 and 50±8.5 respectively. The mean PBMC BR and MR were 2.2±0.8 and 9.3±3.3 pmol O<sub>2</sub>/min/10K cells respectively. Spearman's correlation coefficient was -.43 (p =.025) between BR and fatigue and -.46 (p =.015) between MR and fatigue. The elevated BR was associated with less fatigability after adjustment of sex and age. Each 1 standard deviation greater BR was associated with a 8.7-point (95%CI [-16.0, -1.3], p=.023) reduction in fatigue. Further adjustment for depression minimally attenuated the estimated association (8.5 points, 95%CI [-14.6, -2.4], p=.0008), suggesting a potential role of PBMC mitochondrial energetics in explaining the variation in fatigability.

**Conclusions:** In a cross-sectional analysis, greater PBMC mitochondrial respiration was associated with improved patient-reported outcomes. Further research is needed to examine longitudinal impact of improving PBMC mitochondrial function on patient outcomes such as fatigue and quality of life in a larger cohort of CKD.

**Funding:** NIDDK Support, Private Foundation Support

#### TH-PO825

##### Association Between Cardiorespiratory Fitness and Muscle Strength in Maintenance Hemodialysis Patients

Kun Zhang, Zhang-Yi Zhu, Xin Li, Chen Yu. Tongji University, Shanghai, China.

**Background:** Cardiovascular disease (CVD) is one of the most common complications in patients with maintenance hemodialysis (MHD). Cardiopulmonary fitness (CRF) was strongly associated with the incidence of CVD and the risk of all-cause death. MHD patients always have muscle wasting because of chronic inflammation, oxidative stress, dietary restrictions and other factors, but there is still a lack of relevant research between CRF and muscle strength in MHD patients. We aimed to investigate the association between cardiorespiratory fitness and muscle strength in maintenance hemodialysis (MHD) patients.

**Methods:** In this Cross-Sectional Study, patients who were ≥18 years old and were treated with regular MHD ≥3 months in MHD center from September 2020 to December 2020 were recruited. Cardiopulmonary exercise test (CPET) was used to test cardiorespiratory fitness (CRF) of MHD patients. Baseline data including body circumference, exercise capacity, upper and lower extremity muscle strength as well as clinical and biochemical data were collected. Correlation and hierarchical regression analysis was performed on the corresponding indicators to explore the influencing factors of CRF and the relationship between CRF and muscle strength.

**Results:** A total of 48 patients were enrolled in our study, of whom 34 were male (70.8%), the age was (60.31±10.44) years old, and the median dialysis vintage was 48(15,84) months. Furthermore, CRF was positively correlated with lower extremity muscle strength (r = 0.322, P = 0.026) and 6MWT (r = 0.307, P = 0.034), was negatively correlated with age (r = -.300, P = 0.038). Multivariate linear regression analysis demonstrated that age (β=-0.235) and lower extremity muscle strength(β=0.241) were the influencing factor for peak VO<sub>2</sub>/kg.

**Conclusions:** Cardiorespiratory fitness were at an extremely low level, which is closely related to the lower extremity muscle strength in MHD patients.

#### TH-PO826

##### Mitochondrial Quality Control Mechanisms and Fatty Acid Metabolism in Renal Cortex During the Normoalbuminuric Stage of Diabetes Mellitus

Naohito Ishii,<sup>1</sup> Pamela K. Carmines,<sup>2</sup> Yoshifumi Kurosaki,<sup>1</sup> Akemi Imoto,<sup>1</sup> Taro Sugase,<sup>4</sup> Hiroyuki Takahashi,<sup>1</sup> Masanori Yokoba,<sup>1</sup> Takafumi Ichikawa,<sup>1</sup> Tsuneo Takenaka,<sup>3</sup> Masato Katagiri.<sup>1</sup> <sup>1</sup>Kitasato University, Sgamihara, Japan; <sup>2</sup>University of Nebraska Medical Center, Omaha, NE; <sup>3</sup>International University of Health & Welfare, Minato-ku, Japan; <sup>4</sup>Seikai Medica Clinic, Tochigi, Japan.

**Background:** Oxidative stress during the normoalbuminuric stage of type 1 diabetes mellitus (DM) damages renal cortical mitochondria; hence, we aimed to determine if oxidative stress in DM triggers 1) mitochondrial fission or fusion, 2) mitophagy, and/or 3) increased fatty acid (FA) metabolism.

**Methods:** Rats receiving streptozotocin (STZ, 65 mg/kg i.p.) or vehicle (Sham) were left untreated or treated with telmisartan (TLM, an angiotensin receptor blocker; 10 mg/kg/d). Two weeks later, blood glucose (BG), blood pressure (BP), glomerular filtration rate (GFR), and urinary excretion of albumin (U<sub>alb</sub>V) and N-acetyl-β-D-glucosaminidase (U<sub>NAG</sub>V) were measured, and the renal cortex was harvested for the following assays: HPLC was used to detect 3-NT (oxidative stress marker). Fission-, fusion-, and mitophagy-related proteins were quantified by Western blot. Levels of acylcarnitine (transports FA into mitochondria for β-oxidation) were calculated as total-minus-free carnitine levels measured by the enzymatic cycling method. GC was used to quantify ω3 FAs (α-linolenic acid, EPA & DHA) and ω6 FAs (linoleic acid & AA).

**Results:** BP, U<sub>alb</sub>V, and U<sub>NAG</sub>V did not differ among groups. STZ rats displayed elevated BP and GFR that were unaffected by TLM. Renal cortical samples yielded the following: The ω3/ω6 FA ratio (corrected for FA intake) and 3-NT levels were increased in STZ rats (both P<0.05 vs Sham), effects that were prevented by TLM. Acylcarnitine levels in STZ rats were higher than in Sham and were further elevated in STZ+TLM (P<0.05 vs STZ alone). STZ rats displayed TLM-sensitive increases in the mitophagy-related proteins LC3-II and PINK1 (all P<0.05), but not BNIP3 dimer or p62. Drp1 (fission marker) was 3-fold higher in STZ than in Sham, with intermediate values in STZ+TLM. Mfn2 (fusion marker) did not differ among groups.

**Conclusions:** During the normoalbuminuric stage of DM, renal cortical mitochondria undergo enhanced fission and mitophagy, as well as increased FA metabolism with a shift toward ω3 FAs (antioxidant & vasoprotective) relative to ω6 FAs. As these effects are blunted by TLM jointly with its antioxidant effect, they are likely quality control mechanisms triggered by oxidative damage.

#### TH-PO827

##### Appropriate Evaluation of Sarcopenia Among Hemodialysis Patients: Impact of Different Indices of Muscle Mass and Myokines

Donghwan Oh,<sup>1</sup> Hae Yeul Park,<sup>1</sup> Jong Hyun Jhee,<sup>1</sup> Jung eun Lee,<sup>2</sup> Hoon Young Choi,<sup>1</sup> Hyeong cheon Park.<sup>1</sup> <sup>1</sup>Gangnam Severance Hospital, Seoul, Republic of Korea; <sup>2</sup>Yongin Severance Hospital, Yongin, Republic of Korea.

**Background:** No consensus exists for appropriate adjustment methods and cutoff values for the diagnosis of sarcopenia in hemodialysis (HD) patients. The aim of study was to investigate proper method for normalizing skeletal muscle mass to define low muscle mass (LMM) and assess myokines as potential biomarkers for sarcopenia.

**Methods:** We conducted a cross-sectional observational study in a cohort of 139 Korean HD patients. All patients underwent bioelectrical impedance analysis (BIA) to measure muscle mass after HD session. Appendicular skeletal muscle mass (ASM) was indexed to height-squared (HT<sup>2</sup>), body surface area (BSA), body mass index (BMI), and body weight (BW). Handgrip strength (HGS) and muscle function were evaluated using a handgrip dynamometer and a gait speed test, respectively. Serum myostatin was measured by enzyme-linked immunosorbent assay kit.

**Results:** The mean age of participants was 63.9±13.1 years, and 49.6% was male. Depending on the equation used to standardize ASM, the prevalence of LMM ranged from 17.3 to 29.5% and the prevalence of sarcopenia ranged from 11.5 to 20.9%. The prevalence of LMM adjusted for HT<sup>2</sup> and BW was not constant, in contrast no significant difference in LMM indexed to BSA and BMI was observed among the different BMI groups (normal: BMI<23kg/m<sup>2</sup>, overweight: 23kg/m<sup>2</sup>≤BMI<25kg/m<sup>2</sup>, obese: BMI>25 kg/m<sup>2</sup>). Muscle strength was positively correlated with muscle mass normalized by HT<sup>2</sup>, BSA, and BMI (r=0.63, 0.62 and 0.60, P<0.001, respectively), but the association was less robust in muscle mass indexed to BW (r=0.49, P<0.001). In term of the correlation between muscle mass and performance, there were significant direct correlations with all muscle mass indices, although the correlation was less robust. Patients with LMM by all definitions, especially BSA, were more likely to have muscle weakness compared to those

with normal muscle mass (OR 3.07, 95% CI 1.19-7.91,  $P=0.021$ ). Serum myostatin level was proportional to muscle mass ( $r=0.417$ ,  $P<0.001$ ) and was positively correlated with muscle strength ( $r=0.527$ ,  $P<0.001$ ) and performance ( $r=0.343$ ,  $P<0.001$ ).

**Conclusions:** Muscle mass index adjusted to BSA and BMI is superior to height or weight alone in terms of diagnosis of sarcopenia in HD patients. Moreover, serum myostatin may act as an adjunct biomarker for sarcopenia in HD patients.

**TH-PO828**

**Molecular Mechanisms Underpinning Muscle Atrophy in CKD**

Limy Wong,<sup>1,2</sup> Rachel Kenny,<sup>1</sup> Jennifer L. Howard,<sup>2</sup> Lawrence P. McMahon,<sup>1,2</sup>  
<sup>1</sup>Monash University Eastern Health Clinical School, Box Hill, VIC, Australia;  
<sup>2</sup>Eastern Health Foundation, Box Hill, VIC, Australia.

**Background:** Sarcopenia is prevalent in patients with chronic kidney disease (CKD). Emerging evidence reports the association of sarcopenia with poor outcomes. The underlying molecular pathogenesis has yet to be fully elucidated. The aim of this systematic review is to summarise the current evidence on molecular mechanisms underpinning muscle atrophy in CKD and to assess the strength of such evidence.

**Methods:** The PubMed and EMBASE databases were searched using 3 main themes: mRNA/protein/microRNA expression, skeletal muscle and CKD. This study was conducted in accordance with the PRISMA standards (Figure 1) and was registered with PROSPERO (CRD42021257292).

**Results:** Ninety-eight studies were included in the systematic review, comprising 26 prospective human clinical studies, 4 human and rodent studies, and 68 rodent-only studies (32 mouse and 36 rat models respectively). The sample sizes of human studies were predominantly small (40% of studies had  $\leq 20$  participants). Qualitative polymerase chain reaction (qPCR) was the most commonly used method for gene expression. None of the studies fulfilled the Minimum Information for Publication of qPCR Experiments (MIQE) criteria for quality assessment. Most studies investigated only a few genes or a specific signalling pathway. *FBXO32*, *TRIM63*, *MSTN*, *IL6*, *TNF* and *IGF1* were the most studied genes. The identified differentially expressed genes and proteins belonged to 8 major pathways, including apoptosis, autophagy, inflammation, insulin/insulin-like growth factor 1 signalling, lipid metabolism, mitochondrial function, muscle cell growth and differentiation, and protein degradation, similar to other chronic disease states.

**Conclusions:** The current evidence for molecular mechanisms of muscle atrophy in CKD is largely derived from small and heterogeneous studies. Nonetheless, comparable modifications in the major biological pathways between CKD and other chronic diseases supports shared deleterious molecular mechanisms producing muscle atrophy, irrespective of the underlying chronic disease.

**Funding:** Private Foundation Support

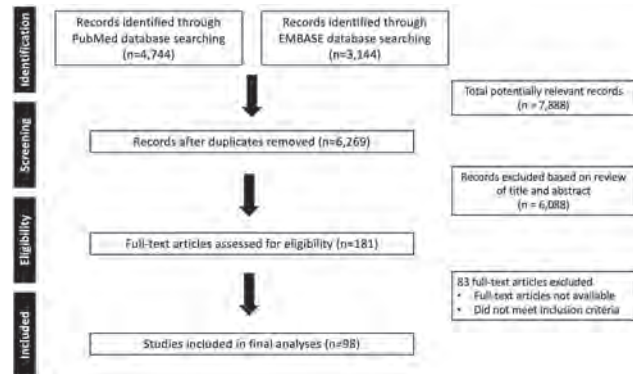

**TH-PO829**

**RNA Sequencing Analysis of Skeletal Muscle in Moderate to Advanced CKD**

Jorge Gamboa,<sup>1</sup> Javier Jaramillo Morales,<sup>1</sup> Armin Ahmadi,<sup>2</sup> Gwenaëlle Begue,<sup>3</sup> Tae Youn Kim,<sup>2</sup> Lucas R. Smith,<sup>2</sup> Baback Roshanravan,<sup>2</sup> Talat Alp Ikizler,<sup>1</sup>  
<sup>1</sup>Vanderbilt University Medical Center, Nashville, TN; <sup>2</sup>University of California Davis, Davis, CA; <sup>3</sup>California State University Sacramento, Sacramento, CA.

**Background:** Patients with moderate to advanced kidney disease suffer a higher prevalence of sarcopenia and frailty. We hypothesized that the RNA expression profiling in skeletal muscle from patients with CKD will provide mechanistic insight into these abnormalities.

**Methods:** In a cross-sectional study, we performed RNA sequencing analysis and pathway analysis in skeletal muscle biopsies from three groups (matched for gender, body mass index, and history of diabetes); controls (n=13), patients with CKD 3-5 not yet on hemodialysis (n=13), and patients on maintenance hemodialysis (MHD, n=10). Total RNA was extracted and used to construct libraries for small and total RNA sequencing using Illumina NovaSeq 6000 system. Differentially expressed genes (DEGs) were identified with a false discovery rate (FDR)  $<0.05$  and fold change  $> 2$ . Gene Set Enrichment Analysis (GSEA) was performed using WebGestaltR v0.4.4 to analyze RNA sequencing results and to identify the overrepresentation of cellular components and biological pathways.

**Results:** We identified 256 DEGs between controls and MHD groups, and 261 DEGs between CKD 3-5 and MHD groups (Figure 1). Notably, there were only 3 DEGs between controls and patients with CKD 3-5. GSEA showed that there is an enrichment of cellular components related to the extracellular matrix [18 DEGs (with enrichment ratio (ER) of 8.1,  $FDR < 1 \times 10^{-7}$ ) in control vs MHD; and 24 DEGs (ER 10.1,  $FDR < 1 \times 10^{-7}$ ) in CKD 3-5 vs. MHD] and collagen-containing extracellular matrix [14 DEGs (ER 8.5,  $FDR = 4 \times 10^{-7}$ ) in control vs MHD; and 22 DEGs (ER 12.6,  $FDR < 1 \times 10^{-7}$ ) in CKD 3-5 vs. MHD].

**Conclusions:** Our results suggest that there is altered remodeling of the extracellular matrix in moderate to advanced CKD. This may be associated with the progressive loss of muscle mass in CKD, which is replaced by adipose and/or fibrotic tissue through the differentiation of fibroadipogenic progenitors. Further studies should identify specific molecular and cellular pathways to prevent sarcopenia and frailty in CKD.

**Funding:** NIDDK Support

**Figure 1. Volcano plot for all the comparisons**

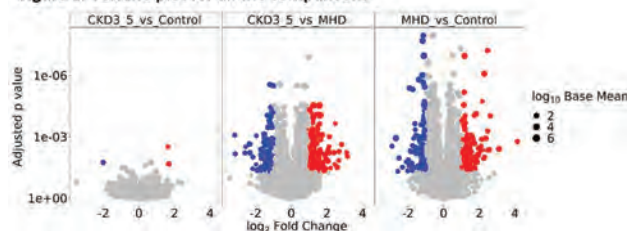

**TH-PO830**

**Effect of IV-Iron on Markers of Skeletal Muscle Health in Iron Deficient CKD Patients: Initial Findings From the Iron and Muscle Study**

Luke A. Baker,<sup>1,2</sup> Benjamin A. Oliveira,<sup>3</sup> Nicola Parker,<sup>1</sup> Kate Bramham,<sup>4</sup> Sharlene A. Greenwood,<sup>4</sup> Iain C. Macdougall,<sup>4</sup> Darlington Okonko,<sup>3</sup> Alice C. Smith,<sup>1,2</sup> Emma L. Watson,<sup>1,2</sup> <sup>1</sup>University of Leicester College of Life Sciences, Leicester, United Kingdom; <sup>2</sup>NIHR Leicester Biomedical Research Centre, Leicester, United Kingdom; <sup>3</sup>King's College London, London, United Kingdom; <sup>4</sup>King's College Hospital NHS Foundation Trust, London, United Kingdom.

**Background:** Many people with chronic kidney disease (CKD) present with non-anaemic iron deficiency but are not routinely offered intravenous iron (IV) supplementation. With this population known to present with impaired muscle health, and previous studies showing a cardiovascular benefit of IV-iron usage, the Iron & Muscle study investigated the effect of 4-weeks IV iron on skeletal muscle function and health; we now report initial results from a mechanistic muscle biopsy sub-study.

**Methods:** This was a prospective, double-blind multicentre randomised controlled trial in 75 non-dialysis CKD patients with non-anaemic iron deficiency, of which 29 provided samples for the sub-study. Patients were randomly assigned to either: IV-Iron or placebo. and muscle biopsy samples were taken pre and 4 weeks post-intervention. This initial analysis involved mRNA expression analysis of indicators of mitochondrial biogenesis, protein turnover and inflammation. Baseline samples were also collected from healthy volunteers (HV, n=6) and non-iron deficient CKD controls (CKD, n=8) to allow for cohort comparisons.

**Results:** At baseline, significantly higher mRNA expression of several markers was seen in ID-CKD compared to CKD and HV cohorts: SOD2 (vs. HV  $p=0.021$ ; vs. CKD  $p=0.016$ ); Parkin (vs. HV  $p<0.001$ ; vs. CKD  $p<0.001$ ); TNFa (vs. HV  $p=0.032$ ; vs. CKD  $p=0.012$ ). A significant reduction in Murf-1 was noted in the CKD cohort in relation to both the ID-CKD cohort ( $p=0.001$ ) as well as the HV cohort ( $p=0.011$ ). No further differences were noted in relation to other markers of mitochondrial biogenesis, oxidative stress, or inflammation. Initial analysis of the effect of 4-weeks of IV-iron in our ID-CKD cohort showed no significant change in any of our panel of markers related to mitochondrial biogenesis, inflammation, or oxidative stress.

**Conclusions:** This preliminary analysis suggests that skeletal muscle in those with ID-CKD have elevated levels of oxidative stress, mitophagy and inflammation in comparison to those without ID and HV. The use of 4-week IV-Iron does not influence any of these markers at the transcriptional level. Subsequent analysis will seek to examine whether IV-Iron produces beneficial effects on the translational & structural, components of skeletal muscle.

**TH-PO831**

**Intradialytic Oral Nutrition on Clinical Outcomes in Malnourished ESRD on Hemodialysis Patients: A Randomized Controlled Trial**

Tanin Apiyangkool, Paramat Thimachai, Pamila Tasanavipit, Narongrit Siri Wattanasit, Pitchamon Inkong, Narittaya Varothai, Amnart Chairprasert, Naowanit Nata, Theerasak Tangwonglert, Wisit Kaewput, Ouppatham Supasyndh, Bancha Satirapoj. *Phramongkutklao College of Medicine, Bangkok, Thailand.*

**Background:** Oral nutritional supplementation (ONS) is recommended for malnourished hemodialysis patients when nutritional intake remains inadequate to meet energy and protein requirements. Hemodialysis induces a negative nitrogen balance, hence oral intradialytic supplements might be an option for well-nourished patients, compensating for the loss of proteins during hemodialysis sessions. The study aimed to

evaluate intradialytic ONS supplements (INTRA-ONS) compared with interdialytic ONS supplements (INTER-ONS) on nutritional status in patients on hemodialysis.

**Methods:** Patients were randomized in two groups; INTRA-ONS group (N=16) received specific renal formula 370 kcal/day three times per week during each hemodialysis session and INTER-ONS group (N=16) received same ONS three times per week on day without hemodialysis for 12 weeks. All patients were counseled by the same registered dietitian during the study. The nutritional status was evaluated using malnutrition inflammation score (MIS) assessment, serum albumin, and anthropometric measurements at baseline and 12 weeks.

**Results:** Total MIS decreased significantly among patients in the INTRA-ONS (-6.12, 95%CI -8.26 to -3.96) and INTER-ONS group (-3.50, 95%CI - 5.65 to -1.35), while a significant difference in changes of MIS was found among the two groups (-3.06%, 95% -5.94 to -0.17, P=0.038). Additionally, serum albumin (0.31 g/dL, 95%CI 0.14 to 0.47) and body weight (1.05 kg, 95%CI 0.36 to 1.74) increased significantly in the INTRA-ONS group, whereas no significant change was found in the INTER-ONS group. No significant change was observed between groups by treatment effects regarding anthropometric measurements, body weight or physical function. No serious adverse effects were reported in any group.

**Conclusions:** Dietary advice combined with oral nutritional supplementation given during hemodialysis improves malnutrition inflammation score among malnourished ESRD patients undergoing maintenance hemodialysis.

**TH-PO832**

**The Effects of Brazilian Green Propolis Extract on Inflammation in CKD on Peritoneal Dialysis (PD): A Randomized Double-Blind Controlled Clinical Trial**

Denise Mafra,<sup>1,2</sup> Beatriz G. Baptista,<sup>1</sup> Ludmila F. Cardozo,<sup>1</sup> Marcelo Ribeiro-Alves,<sup>3</sup> Marcia M. Ribeiro,<sup>2</sup> Susane Fanton,<sup>1</sup> Livia D. Alvarenga,<sup>1</sup> Bruna R. de Paiva,<sup>1</sup> Paul G. Shiels,<sup>5</sup> Andresa Berretta,<sup>4</sup> Renal Nutrition - UFF <sup>1</sup>Universidade Federal Fluminense, Niteroi, Brazil; <sup>2</sup>Universidade Federal do Rio de Janeiro Centro de Ciencias da Saude, Rio de Janeiro, Brazil; <sup>3</sup>Fundacao Oswaldo Cruz, Rio de Janeiro, Brazil; <sup>4</sup>Apis Flora, São Paulo, Brazil; <sup>5</sup>University of Glasgow, Glasgow, United Kingdom.

**Background:** Chronic kidney disease (CKD) patients on dialysis display a low-grade systemic inflammatory burden. Nutritional interventions designed to activate the cytoprotective nuclear factor Nrf2, and inhibit nuclear NF-κB have been proposed to mitigate this burden. Several bioactive compounds have been investigated to achieve this, including propolis, a resin produced by *Apis mellifera* bees. The aim of the study was to evaluate the effects of propolis supplementation on inflammatory markers in patients with CKD on PD.

**Methods:** CKD patients were randomized into two groups: propolis (4 capsules of 100 mg/day containing concentrated and standardized dry EPP-AF® Brazilian green propolis extract) or placebo for two months. The plasma levels of TNF-α and IL-6 were evaluated by ELISA. Quantitative real-time PCR analyses were performed to evaluate the expression of Nrf2 and NF-κB in peripheral blood mononuclear cells. Plasma malondialdehyde (MDA) levels and routine biochemical markers were analyzed. Carotid Intima-Media Thickness (CIMT) was measured with a doppler ultrasonography device.

**Results:** A total of 19 patients completed the study, ten patients in the propolis group (54 ± 1.0 years, five men, 7.2 ± 5.1 months on PD) and nine in the placebo group (47.5 ± 15.2 years, three men, 10.8 ± 24.3 months on PD). There were no differences in baseline values in both groups (Table 1). The plasma levels of TNF-α reduced significantly (p=0.02), and mRNA expression of Nrf2 showed a trend to increase (p=0.07) after propolis supplementation.

**Conclusions:** EPP-AF® Green Propolis extract (400 mg/day) supplementation for two months mitigated inflammation by reducing TNF-α levels in CKD patients on PD.

**Funding:** Government Support - Non-U.S.

Inflammation markers, biochemical parameters, and CIMT values in placebo and propolis groups at the baseline.

Inflammation markers	Overall	Placebo Group	Propolis Group	p-values
Ultrasonal (mm)	0.7 (0.2)	0.6 (0.2)	0.7 (0.1)	0.892
MDA (nmol/mL)	0.80 (0.6)	0.87 (1.6)	0.64 (0.5)	0.131
TNF-α (pg/mL)	48.1 (15.9)	53.7 (17.5)	47.5 (11.8)	0.820
CRP (mg/mL)	7.9 (9.7)	5.8 (10)	8.3 (9.3)	0.594
NF-κB (a.u.)	0.87 (0.6)	0.95 (0.5)	0.79 (0.6)	0.518
Nrf2 (a.u.)	1.04 (0.6)	1.05 (0.3)	0.85 (0.5)	0.351

**TH-PO833**

**Effects of Curcumin Supplementation on mRNA Expression of NLRP3 Inflammasome, IL-1β, and NF-κB in Hemodialysis Patients**

Denise Mafra,<sup>1</sup> Livia D. Alvarenga,<sup>1</sup> Marcelo Ribeiro-Alves,<sup>2</sup> Ludmila F. Cardozo,<sup>1</sup> <sup>1</sup>Universidade Federal Fluminense, Niteroi, Brazil; <sup>2</sup>Fundacao Oswaldo Cruz, Rio de Janeiro, Brazil.

**Background:** Chronic Kidney Disease (CKD) patients have many complications associated with inflammation and oxidative stress. Inflammasomes are multimeric protein complexes that can be activated by the nuclear factor kappa-B (NF-κB). When the NLRP3 is activated, pro-Interleukin 1β (IL-1β) is cleaved to IL-1β, inducing the inflammatory response. Curcumin may mitigate the inflammatory process.

**Methods:** Thirty-one patients with CKD on HD were randomized into two groups: "Curcumin" and "Control." The curcumin group received 100 mL of orange juice with

12 g of carrots and 2.5 g of turmeric three times a week for three months. The control group received the juice with the same composition (without curcumin). The mRNA expression of NF-κB, NLRP3, and IL-1β was measured by real-time polymerase chain reaction (RT-qPCR) on PBMC.

**Results:** Twenty-eight patients concluded the study, 14 patients in the control group [50% men, 51.5 (IQR=15.5) years, HD time 36 (IQR=38.75) months], and 14 patients in the curcumin group [50% men, 56.5 (IQR=20) years, HD time 45 (IQR=85) months]. After three months of supplementation with curcumin, the patients showed a significant reduction in mRNA expression of IL-1β (p=0.05) (Figure 1).

**Conclusions:** Curcumin supplementation showed to mitigate inflammation in CKD patients on HD by decreasing mRNA IL-1β expression.

**Funding:** Government Support - Non-U.S.

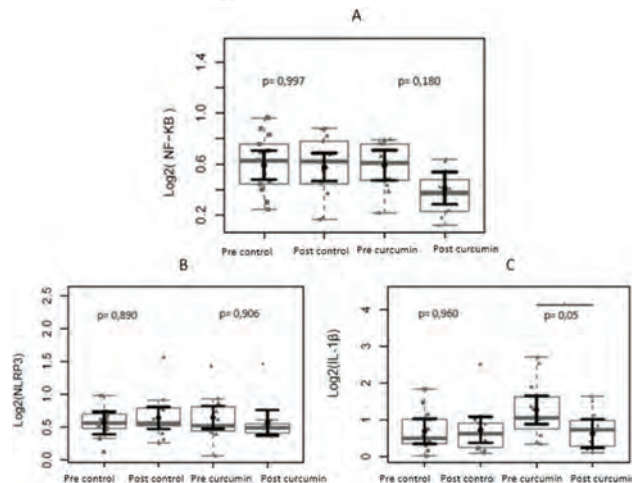

Figure 1. Comparison of mRNA of the factors of evolution of the inflammatory pathway before and after three months of intervention

**TH-PO834**

**Curcumin: A Nutritional Strategy to Control Oxidative Stress in Patients Undergoing Peritoneal Dialysis**

Denise Mafra,<sup>1</sup> Drielly Cristhiny M. Reis,<sup>1</sup> Beatriz G. Baptista,<sup>1</sup> Ludmila F. Cardozo,<sup>1</sup> Marcelo Ribeiro-Alves,<sup>2</sup> Bruna R. de Paiva,<sup>1</sup> Livia D. Alvarenga,<sup>1</sup> Denis Fouque,<sup>3</sup> Maurilo Leite,<sup>4</sup> <sup>1</sup>Universidade Federal Fluminense, Niteroi, Brazil; <sup>2</sup>Fundacao Oswaldo Cruz, Rio de Janeiro, Brazil; <sup>3</sup>Universite Claude Bernard Lyon 1, Villeurbanne, France; <sup>4</sup>Universidade Federal do Rio de Janeiro, Rio de Janeiro, Brazil.

**Background:** Patients with chronic kidney disease (CKD) on peritoneal dialysis (PD) present a high production of reactive oxygen species (ROS) that lead to oxidative stress and inflammation. Bioactive compounds such as curcumin (from turmeric) have been tested as nutritional strategies to mitigate both complications. The aim of this study was to evaluate the effect of curcumin supplementation on lipid peroxidation and inflammatory markers in patients with CKD on PD.

**Methods:** In this longitudinal, randomized, single-blind, placebo-controlled trial, 42 patients were randomized into two groups: curcumin (1.5g/d with 98.42% of curcuminoids) or placebo for 3 months. The malondialdehyde (MDA) plasma levels (lipid peroxidation marker) and TNF-α and IL-6 were measured before and after the intervention.

**Results:** Twenty-four patients completed the study, 10 in the curcumin group (54 yr, 3 men) and 14 in the placebo group (52 yr, 5 men). MDA plasma levels were significantly reduced after three months of curcumin supplementation (Figure 1), whereas remained unchanged in the placebo group. The inflammation markers did not change after intervention in both groups.

**Conclusions:** Curcumin supplementation may be a good strategy to reduce oxidative stress in patients undergoing PD.

**Funding:** Government Support - Non-U.S.



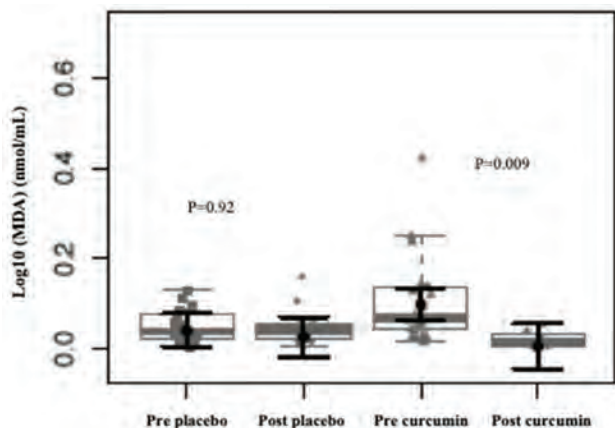

TH-PO835

Use of Parenteral Vitamins and Trace Elements for Critically Ill Patients: A Survey of Practice in the United Kingdom

Lynda K. Cameron,<sup>1,3</sup> Nuttha Lumlertgul,<sup>1,2</sup> Marlies Ostermann,<sup>1,3</sup> <sup>1</sup>Guy's and St Thomas' NHS Foundation Trust, London, United Kingdom; <sup>2</sup>King Chulalongkorn Memorial Hospital, Bangkok, Thailand; <sup>3</sup>King's College London, London, United Kingdom.

**Background:** Micronutrient products, including parenteral vitamins and trace elements, are prescribed commonly to critically ill patients in the UK for different reasons. Our aim was to explore clinical practice of prescribing micronutrients in the absence of clear evidence or consensus practice guidelines. We were particularly interested in prescribing practice in patients receiving renal replacement therapy (RRT) for acute kidney injury (AKI).

**Methods:** A 12-question survey was designed and distributed through professional networks of clinicians (physicians, nurses, pharmacists and dietitians) working in UK intensive care in late 2019 – early 2020.

**Results:** A total of 217 responses to the survey were received from physicians (58%), nurses (16%), pharmacists (15%) and dietitians (11%). Table 1 shows the proportion of respondents who stated they would prescribe/recommend micronutrient products for renal indications in the ICU. The reasons underpinning prescribing decisions for patients receiving RRT were variable: to replace water soluble vitamins lost via the filter circuit (20%), to treat concurrent disease states (8%), to both replace losses and treat an underlying condition (24%), unsure (18%), for another reason (6%) and declined to answer (24%).

**Conclusions:** These results show heterogeneity in reported prescribing practice. Only 1 in 5 respondents considered AKI in critical illness (whether receiving RRT or not) to be an indication for parenteral micronutrient administration, despite altered micronutrient status being reported in this cohort. A decision to prescribe micronutrients to patients on RRT may be based on the loss of water soluble substances in RRT effluent (which has been demonstrated for some micronutrients), a potential treatment effect of micronutrients, or a combination of both. As the evidence base and cost-benefit ratio in this population is uncertain, further research is needed to better define their place in therapy.

Renal indications for prescribing micronutrients in ICU

Primary indication	Would prescribe/recommend parenteral vitamins	Would prescribe/recommend parenteral trace elements
RRT for any indication	43 (19.8%)	27 (12.4%)
AKI requiring RRT	41 (18.9%)	33 (15.2%)
AKI not requiring RRT	4 (1.8%)	4 (1.8%)
Known ESRD	7 (3.2%)	9 (4.1%)

AKI = acute kidney injury; ESRD = end stage renal disease; RRT = renal replacement therapy

TH-PO836

Severe Hyperparathyroidism Is Associated With Nutritional Impairment in Maintenance Hemodialysis Patients

Sinee Disthabanchong, Mahidol University Faculty of Medicine Ramathibodi Hospital Department of Medicine, Bangkok, Thailand.

**Background:** Severe hyperparathyroidism predicts poor outcomes and parathyroidectomy is associated with improved survival in patients with kidney failure. Mechanisms underlying these observations have not been clearly elucidated. The issues regarding nutritional impairment in severe hyperparathyroidism have rarely been addressed. The present study examined nutritional status among maintenance hemodialysis (MHD) patients with different degree of hyperparathyroidism.

**Methods:** Seven hundred forty-five patients were categorized into four groups according to PTH levels: group 0, PTH<200; group 1, PTH=200-599; group 2, PTH=600-1499; and group 3, PTH≥1500 pg/mL. Group 0 was excluded because low PTH level was linked to

older age and malnutrition. Patients in groups 1 and 2 were matched to group 3 by propensity score yielding 410 patients in the final analysis. Nutritional parameters at baseline (Year 0) and the preceding 1 and 2 years (Year -1 and Year -2) were analyzed.

**Results:** At baseline, lower serum albumin (P<0.001), creatinine (P<0.001), height in female (P=0.001), creatinine/body surface area (Cr/BSA) (P=0.001) and higher number of patients with serum albumin <38 g/L (P<0.001) were observed in group 3 compared to groups 1 and 2. Higher PTH level was independently associated with serum albumin <38 g/L (P<0.001) and serum Cr/BSA <380 μmol/L/m<sup>2</sup> (P=0.001). Lower serum albumin, creatinine and Cr/BSA and higher number of patients with serum albumin <38 g/L were observed at Year 0 compared to Year -1 and Year -2 among patients in group 3. Between group comparisons confirmed a significant difference in serum albumin, the number of patients with serum albumin <38 g/L, serum creatinine and Cr/BSA between baseline and the preceding 1 and 2 years in group 3 compared to groups 1 and 2. The number of patients with Cr/BSA <380 μmol/L/m<sup>2</sup> was also significantly different between baseline and the preceding 1 and 2 years in group 3 compared to group 1. Weight loss was more substantial in group 3 compared to group 2 (P=0.03) and the number of patients with ≥5% weight loss was higher in group 3 compared to groups 1 (P=0.005) and 2 (P=0.03).

**Conclusions:** MHD patients with severe hyperparathyroidism had deterioration of nutritional status compared to patients with moderate hyperparathyroidism and patients with PTH level within the recommended range.

TH-PO837

Higher 25-Hydroxyvitamin D Associates With Gastrointestinal Bleeding Events

John W. Larkin,<sup>1</sup> Yue Jiao,<sup>1</sup> Suman K. Lama,<sup>1</sup> Sheetal Chaudhuri,<sup>1</sup> Joanna Willetts,<sup>1</sup> Anke Winter,<sup>2</sup> Manuela Stauss-Grabo,<sup>2</sup> Len A. Usvyat,<sup>1</sup> Jeffrey L. Hymes,<sup>1</sup> Franklin W. Maddux,<sup>4</sup> Peter Stenvinkel,<sup>5</sup> Jürgen Floege.<sup>3</sup> on behalf of the INSPIRE Core Group <sup>1</sup>Fresenius Medical Care, Global Medical Office, Waltham, MA; <sup>2</sup>Fresenius Medical Care, Global Medical Office, Bad Homburg, Germany; <sup>3</sup>University Hospital Aachen, Division of Nephrology and Clinical Immunology, Aachen, Germany; <sup>4</sup>Fresenius Medical Care AG & Co KGaA, Bad Homburg, Germany; <sup>5</sup>Karolinska Institutet, Stockholm, Sweden.

**Background:** In an effort within the INSPIRE collaboration, we built a gastrointestinal (GI) bleed hospitalization risk model and unexpectedly found higher serum 25 hydroxyvitamin D concentration (25OH Vit D) was one of the most predictive factors in hemodialysis (HD). To investigate this signal, we assessed all-cause and GI bleed hospitalization rates by 25OH Vit D levels.

**Methods:** We used data from adult HD patients in the United States with ≥1 25OH Vit D lab during Jan 2016-Dec 2020. We calculated % patients with ≥1 all-cause or GI bleed admission within 180 days after a 25OH Vit D lab by groups (<15, ≥15 to <30, ≥30 to <50, ≥50 to <60, ≥60 ng/mL).

**Results:** Among 225,459 patients (mean age 63.1 years, 57.4% male, 56.2% white race & HD vintage 3.3 years), those with 25OH Vit D <15 ng/mL had the highest all-cause, yet the lowest GI bleed, admission rates (Figure 1). Patients with 25OH Vit D ≥30 to <50 and ≥50 to <60 ng/mL had the lowest all-cause and highest GI bleed admission rates. Patients with 25OH Vit D >60 ng/mL had a higher all-cause admission rate than the ≥30 to <50 and ≥50 to <60 ng/mL groups, and a GI bleed admission rate slightly lower than the ≥30 to <50 ng/mL group.

**Conclusions:** We found an inverse association between all-cause and GI bleed admission rates based on 25OH Vit D levels. It appears 25OH Vit D >30 ng/mL may associate with GI bleeding events in HD patients, with the highest event rates at ≥50 to <60 ng/mL, which is consistent with findings at in warfarin users without kidney failure (Keskin U, 2019). Albeit hypothetical, extremely high 25OH Vit D >60 ng/mL might be representative of specific comorbidities that explain the all-cause admission rates in this group. Given the higher recommendations for 25OH Vit D in kidney disease (≥30 ng/mL) versus general population (≥20 to <30 ng/mL), further adjusted analysis accounting for competing risks are needed.

**Funding:** Commercial Support - Fresenius Medical Care

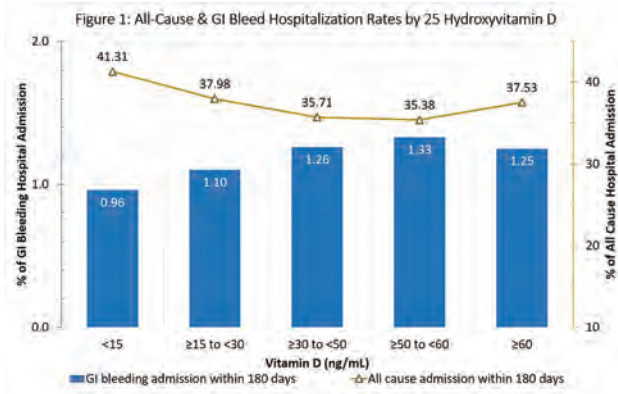

TH-PO838

**Subjective Global Assessment Scores and Survival in a Multi-Center Prospective Hemodialysis Cohort**

Ji Hoon Yoon,<sup>1</sup> Yoko Narasaki,<sup>1</sup> Amy S. You,<sup>1</sup> Silvina Torres Rivera,<sup>1</sup> Lisa Le,<sup>1</sup> Anyssa K. Dang,<sup>1</sup> Matthew D. Nguyen,<sup>1</sup> Arjun Marwaha,<sup>2</sup> Danh V. Nguyen,<sup>1</sup> Kamyar Kalantar-Zadeh,<sup>1</sup> Connie Rhee.<sup>1</sup> <sup>1</sup>University of California Irvine, Irvine, CA; <sup>2</sup>University of Pennsylvania, Philadelphia, PA.

**Background:** Protein-energy wasting (PEW) is highly prevalent in end-stage kidney disease (ESKD) patients receiving hemodialysis (HD), and is a potent predictor of survival in this population. We sought to conduct Subjective Global Assessment (SGA) surveys, a simple yet validated nutritional assessment instrument, in a prospective cohort of HD patients in order to assess the relationship between PEW and survival in this population.

**Methods:** In a multi-center prospective cohort of 1018 HD patients from the NIH “Malnutrition, Diet, and Racial Disparities in Kidney Disease (MADRAD)” Study recruited from 18 dialysis clinics who underwent protocolized SGA surveys every 6 months, we examined the relationship between baseline and time-dependent SGA scores with all-cause mortality using multivariable Cox models.

**Results:** The median (IQR) and min-max of baseline SGA scores were 1 (0, 2) and 0-13, respectively (Fig A). In analyses of baseline SGA scores categorized as quartiles, we observed that incrementally higher SGA quartiles were associated with increasingly higher mortality risk: HRs (95%CI) 1.37 (1.01, 1.86), 1.65 (1.17, 2.33), and 2.02 (1.55, 2.64) for the second lowest, second highest, and highest quartiles of SGA scores, respectively, in expanded case-mix+laboratory models (Fig B). Analyses of time-dependent SGA scores showed a similar pattern of findings: HRs (95%CI) 1.27 (0.92, 1.76), 1.53 (1.08, 2.16), and 2.58 (1.98, 3.36) for the second lowest, second highest, and highest quartiles of SGA scores, respectively, in expanded case-mix+laboratory models (Fig C).

**Conclusions:** In a prospective multi-center cohort of HD patients, increasing severity of PEW ascertained by SGA surveys were associated with incrementally higher death risk. These findings underscore the importance of using the SGA as a practical nutritional assessment tool that can be conveniently applied at the bedside in order to identify HD patients with inadequate dietary intake who may benefit from earlier implementation of nutrition interventions.

**Funding:** NIDDK Support

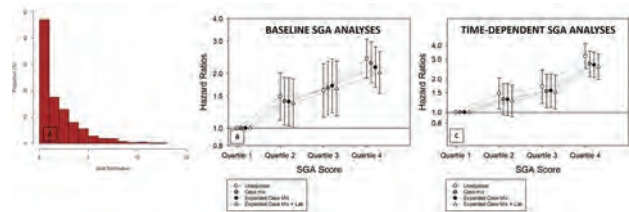

TH-PO839

**Case Studies of Intradialytic Total Parenteral Nutrition in Nocturnal Home Hemodialysis**

Sachin V. Pasricha,<sup>1,2</sup> Khaled A. Alqarni,<sup>1,2</sup> Michael Davis,<sup>1,2</sup> Christopher T. Chan.<sup>1,2</sup> <sup>1</sup>University of Toronto, Toronto, ON, Canada; <sup>2</sup>University Health Network, Toronto, ON, Canada.

**Introduction:** Malnutrition occurs in 30-50% of dialysis patients. If unable to meet caloric intake requirements, intradialytic parenteral nutrition (IDPN) may be considered. Standard IDPN occurs thrice weekly with intermittent hemodialysis (IHD), but has yielded heterogeneous clinical results. Nocturnal home hemodialysis (NHD) occurs at a median of 5 nights/week with 8 hours/session. Through longer duration and increased frequency, prescribing IDPN with NHD augments IDPN dose. We present a series of four NHD patients who required intradialytic total parenteral nutrition (IDTPN) as their primary source of caloric intake.

**Case Description:** 1. A 25-year old woman with ANCA-vasculitis on Peritoneal Dialysis (PD) developed encapsulating peritoneal sclerosis (EPS) and a small bowel obstruction (SBO). 2. A 60-year old woman with amyloidosis on NHD had weight loss from amyloidosis. 3. A 46-year old man with cryoglobulinemic vasculitis on NHD needed IDTPN twice for GI symptoms and suboptimal intake. 4. A 59-year old man with IgA-nephropathy on PD developed an EPS-related SBO. **Outcomes:** Our patients received 1200-1590 kcal with each IDTPN session and achieved a significant increase in weight, albumin, and BMI (Table 1) (p<0.05 using a Wilcoxon signed rank test). Metabolic complications resembled those with TPN (cramping, hypertriglyceridemia, transaminitis, and fluid overload), and other complications resembled those of the dialysis population (three hospitalizations and one line infection).

**Discussion:** IDTPN significantly improved nutrition without significant side effects. Our cases are the first example of IDPN being used as the primary source of caloric intake (i.e. IDTPN), which was enabled by longer (≤8 hours) and more frequent (≤7/week) sessions. Our study is novel in its focus on NHD, whereas prior IDPN studies have focused on IHD. We highlight this because NHD enables diet liberalization and enhances quality of life, both relevant to malnourished patients. Finally, NHD with IDTPN may be particularly useful for PD patients with EPS, as they need to switch dialysis modality and start parenteral nutrition, but presumably prefer to dialyze at home.

Table 1: Summary of IDTPN outcomes

Patient	Pre-IDTPN			On IDTPN		
	Albumin (mmol/L)	Weight	BMI	Albumin (mmol/L)	Weight	BMI
1	26	47.2 kg	18.4	41	50.5 kg	19.7
2	32	44.0 kg	15.3	29 (note worsening liver amyloid)	53.9 kg	18.7
3 (Time 1)	26	58.5 kg	19.5	36	66.6 kg	22.3
3 (Time 2)	23	57.0 kg	19	36	69.7 kg	23.3
4	28	67.1 kg	22.4	39	74.2 kg	24.5

TH-PO840

**DASH Diet Mechanism Dissected by Urinary Extracellular Vesicles**

Dana Bielopolski,<sup>1</sup> Luca Musante,<sup>2</sup> Douglas Barrows,<sup>1</sup> Tom S. Carroll,<sup>1</sup> Jonathan N. Tobin,<sup>1,4</sup> Uta Erdbruegger.<sup>3</sup> <sup>1</sup>The Rockefeller University, New York, NY; <sup>2</sup>The Pennsylvania State University - University Park Campus, University Park, PA; <sup>3</sup>University of Virginia, Charlottesville, VA; <sup>4</sup>Clinical Directors Network Inc, New York, NY.

**Background:** The DASH (Dietary Approach to Stop Hypertension) diet is a proven intervention in lowering blood pressure, yet its mechanism has never been elucidated. We sought to characterize changes in urine exosome protein abundance pattern shifting from Western style diet to DASH diet.

**Methods:** 9 volunteers were admitted for 14 days to the Rockefeller hospitalization unit, during which they transitioned from American style diet to DASH diet. blood and urine for electrolytes were collected daily and aldosterone was sampled four times. Urine was centrifuged to discard cell debris at low speed and than the supernatant was centrifuged at 21,000g, the pellet was termed P20. P20 was treated with TCEP to discard of Uromodulin. The supernatant was further centrifuged at 164,000g, and the pellet termed P100. P100 was fractionated with size exclusion chromatography to discard of Uromodulin, and the first two fractions that were positive for TSG101 and negative for Uromodulin were used for further analysis.

**Results:** A total of 1,593 proteins were identified in P20+P100. 240 were uniquely expressed in P100 and 759 were uniquely expressed in P20. According to DAVID annotation tool both fractions were enriched for exosomes (P20 with 95% and P100 with 97.4% of proteins involved P-value of 7.0E-51). Due to this differential expression we chose to unite the two fractions of P100 and P20 for mass spectrometry analysis of the DASH samples. 1800 proteins were identified and 226 crossed the significance threshold of change between trial days. 22 proteins were with upregulated and 25 were down regulated from day 0 to days 5 and 11. Both groups were enriched for extracellular Exosomes pathway p-value= 3.8E-14 including SLC12A3 (NCC) in the upregulated and Aquaporin 2 (AQP2) in the downregulated.

**Conclusions:** Following DASH diet implementation, the prevalence of NCC symporter increases and the prevalence of AQP2 decreases in uEV's. This leads to increased urine output and salt wasting similar to Gittelman syndrome. prolonged thiazide treatment increases NCC abundance in urinary extracellular vesicles of essential hypertensive patients, as well as in uEVs isolated from mice fed a high potassium diet. The increased abundance following the two stimuli may be a compensatory effect to counteract reduced NCC activity as a result of inhibition.

**Funding:** Private Foundation Support

TH-PO841

Abstract Withdrawn

TH-PO842

**Enteric Hyperoxaluria With Recurrent Oxalate Nephropathy**

Himesh Sheth, Tammy Yu, Jie Tang. Brown University Warren Alpert Medical School, Providence, RI.

**Introduction:** Enteric hyperoxaluria (EH) can lead to acute kidney injury (AKI), end-stage renal disease (ESRD) and represents therapeutic challenge. Here we present a case of recurrent oxalate nephropathy in a kidney transplant recipient, illustrating the potential aggressive nature of EH and the challenges in treating this condition

**Case Description:** 77-year-old Caucasian lady with hypertension, diabetes, and obesity, developed AKI three years after her Roux-en-Y gastric bypass, with serum creatinine (sCr) rose to of 7 mg/dl from a baseline of 0.7 mg/dl. Kidney biopsy at the time showed extensive tubular injury with numerous calcium oxalate (CaO) inclusions superimposed on moderate interstitial fibrosis and tubular atrophy. Patient ultimately started on hemodialysis four months later and underwent living unrelated kidney transplant 12 months after the onset of AKI, with sCr improved to 0.7 mg/dl. However, six months later, patient developed AKI again following a bout of diarrhea, sCr rose to 3 mg/dl with urine sediment showing features of tubular injury. Due to concern for graft rejection, patient underwent allograft biopsy which again showed intratubular CaO inclusions without signs of rejection. 24-hour urine collection revealed an elevated oxalate level (62 mg), low citric acid (<20mg) pH of 5.1, urine calcium of 70 mg. Her diarrhea resolved after the adjustment of her immunosuppressive regimen. But AKI persisted with 24hr urine oxalate unexpectedly worsened to 92 mg. Patient was then started on potassium citrate (KC) to alkalinize urine and to prevent CaO crystallization, Calcium carbonate with meals to reduce oxalate absorption from the gastrointestinal tract in addition to dietary oxalate restriction. She responded well initially, sCr improved to 1.37 mg/dl, along with a reduction in 24-hour urine oxalate and rises in urine citric acid and pH (7.1). Unfortunately, sCr worsened again to 1.7 mg/dl 6 weeks later. Iatrogenic

Key: TH - Thursday; FR - Friday; SA - Saturday; OR - Oral; PO - Poster; PUB - Publication Only

Underline represents presenting author.

milk alkali syndrome was suspected. Calcium carbonate was stopped, and patient continued dietary oxalate restriction and KC supplementation. Her sCr improved again to 1.3 mg/dl 4 months later and repeat 24-hour urine showed oxalate 55 mg, citric acid 102 mg, Ca <20 mg, pH 5.55.

**Discussion:** Enteric oxalate nephropathy is often under recognized, and, if left untreated, can lead to ESRD and allograft injury. Current treatment options are limited although several promising medications are on the horizon.

TH-PO843

**Adenine Phosphoribosyl Transferase Deficiency Caused Obstructive Nephropathy: A Case Report**

Jonathan Sung, Lili Tong, Tiane Dai. Harbor-UCLA Medical Center, Torrance, CA.

**Introduction:** Adenine phosphoribosyl transferase deficiency (APRTD) is a rare autosomal recessive metabolic disorder. It causes excessive production and renal excretion of 2,8 dihydroxyadenine (DHA), which leads to nephrolithiasis. Characterized by radiolucency, which is similar to uric acid stones, they are often misdiagnosed or missed, which can often lead to progressive renal failure, even in transplanted patients. We report a case of APRTD in a woman with an incidental finding of unilateral hydronephrosis from ureteral stone.

**Case Description:** A 57 year-old Mexican female, with known medical history of hypertension and extensive peripheral arterial disease requiring multiple interventions including aortobifemoral bypasses, was referred to urology for incidentally noted persistent right-sided severe hydronephrosis from an obstructive right mid ureteral stone. Patient underwent ureteroscopy with stone extraction and laser lithotripsy of the right ureteral stone. Stone analysis revealed a 2,8-dihydroxyadenine stone. She was subsequently referred to nephrology for management and Human Genetics for genetic testing/counseling. Patient was asymptomatic. Patient was started on allopurinol 300mg daily, which inhibits xanthine oxidoreductase and results in adenine urinary excretion instead of 2,8-dihydroxyadenine, and hydration. She has continued to have relatively stable renal function without known recurrence of nephrolithiasis. She had APRT gene sequencing, and the results revealed homozygous pathogenic variant in APRT gene, c.294G>A (p. Trp98Ter).

**Discussion:** APRTD is characterized by a mutation on chromosome 16q24, affecting the gene for adenine phosphoribosyltransferase resulting in accumulation of the insoluble purine 2,8-dihydroxyadenine in the kidneys. This can result in crystalluria and nephrolithiasis, which can lead to hydronephrosis and chronic, progressive renal disease. Generally, two different types of mutations have been described. Type I APRT deficiency has virtually absent enzyme activity whereas Type II deficiency has functionally decreased activity. 2, 8-dihydroxyadenine stones are similar to uric stones as they are both radiolucent and have identical chemical reactivity. The treatment is allopurinol and hydration. Stone retrieval and stone analysis play pivotal roles in the diagnosis of APRTD induced nephrolithiasis and guide further management.

TH-PO844

**Marginal Structural Model (MSM) Analysis to Investigate the Causal Relationship of XOR Inhibitors With Outcomes in Hemodialysis**

Takeo Ishii,<sup>1,2</sup> Masataka Taguri,<sup>3</sup> Hiromichi Wakui,<sup>2</sup> Kouichi Tamura,<sup>2</sup> Department of Medical Science and Cardiorenal Medicine, Yokohama City University School of Medicine <sup>1</sup>Yokohama Daiichi Hospital, Yokohama, Japan; <sup>2</sup>Department of Medical Science and Cardiorenal Medicine, Yokohama City University School of Medicine, Yokohama, Japan; <sup>3</sup>Department of Health Data Science, Tokyo Medical University, Shinjuku, Japan.

**Background:** Randomized trial of allopurinol and febuxostat has been performed in hyperuricemic patients to inhibit XOR and reduce uric acid levels. Nonetheless, the protective effect for CVD events and mortality is insufficient in dialysis patients. Furthermore, febuxostat(FEB) is also known to be a potent ATP binding cassette transporter subfamily G member2 (ABCG2) inhibitor that promotes the accumulation of uremic toxins by reduced excretion from the gut. We investigated the preventative effect of XOR inhibitors on outcomes under observation.

**Methods:** We observed 6791 maintenance dialysis patients from April 2016 to March 2019. Outcomes were all-cause mortality and CVD events, using longitudinal data. Baseline uric acid and outcome was examined using Cox Hazard analysis. Causal associations for outcomes of allopurinol (ALLO) or FEB were analyzed using 3 years of longitudinal data, including concomitant drugs, using MSM, which is weighted analysis that examined the causal effect of ALLO or FEB versus control at each visit.

**Results:** MSM indicated that ALLO estimated HR 0.35 for all-cause mortality versus un treatment (p<0.001), also indicated that FEB estimated HR 0.42 (p<0.001). In CVD events, ALLO demonstrated a preventative effect of HR 0.81 versus control (p<0.001). However, FEB did not show a preventative effect of HR 0.98 (95% CI: 0.91–1.04). ALLO versus FEB for CVD events was HR 0.83(95% CI 0.75–0.92).

**Conclusions:** FEB failed to demonstrate a preventative effect for CVD events compared with ALLO and the control but did not increase the risk of all-cause mortality or CVD events. Attenuated effect of FEB was considered to be the result of uremic toxin accumulation evoked by ABCG2 dysfunction.

Treatment Effect for CVD Events

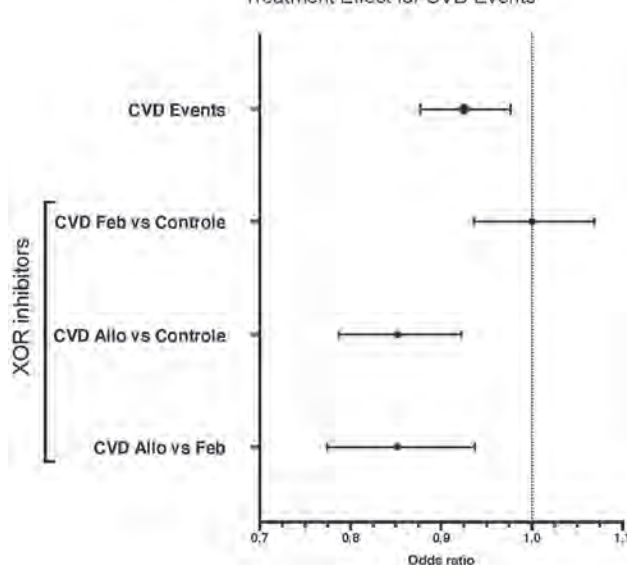

CKD events

TH-PO845

**Associations of Reduced Rank Regression (RRR)-Based Dietary Patterns With Kidney Health**

Giulia Barbieri,<sup>1,2</sup> Vanessa Garcia-Larsen,<sup>4</sup> Ryosuke Fujii,<sup>1,3</sup> Roberto Melotti,<sup>1</sup> Lucia Cazzoletti,<sup>2</sup> Peter Paul Pramstaller,<sup>1</sup> Maria E. Zanolin,<sup>2</sup> Cristian Pattaro,<sup>1</sup> Essi Hantikainen,<sup>1</sup> <sup>1</sup>Accademia Europea, Bolzano, Italy; <sup>2</sup>Università degli Studi di Verona, Verona, Italy; <sup>3</sup>Fujita Ika Daigaku Daigakuin Igaku Kenkyu-ka Seikei Geka, Toyoko, Japan; <sup>4</sup>Johns Hopkins University, Baltimore, MD.

**Background:** A healthy diet is key to chronic kidney disease (CKD) prevention; however, which specific dietary components are more beneficial is still unclear. We identified dietary patterns (DPs) analytically through selected risk factors of CKD.

**Methods:** We included 6215 Cooperative Health Research In South Tyrol (CHRIS) study participants without known kidney disease, hypertension or diabetes. We obtained serum creatinine-based estimated glomerular filtration rate (eGFR) with the 2021 CKD-EPI equation and defined CKD as eGFR<60 ml/min/1.73m<sup>2</sup>. Dietary intake was estimated based on the self-administered internationally validated GA2LEN food frequency questionnaire (FFQ). We estimated DPs using RRR, selecting two groups of mediators (Figure 1): the FFQ-derived nutrients (DPN) and selected biomarkers (DPB). Factor loading-based scores, either as continuous or stratified into tertiles (T1-T2-T3), were included in multiply-adjusted regression models for eGFR and CKD. Sex-specific DPs and models were also implemented.

**Results:** We identified 3 DPN and 2 DPB scores (Figure 1). DPN1 was characterized by high intake of all nutrients and associated with lower eGFR (linear p<0.001, T3vsT2 p=0.042). The T3 of DPN3 (low intakes of potassium and sodium; high intakes of proteins and phosphorus) was protective against CKD risk (T3vsT2 p=0.017). DPB1 reflected the impact of higher levels of all risk biomarkers and was associated with lower eGFR (linear p=0.027). Other DPs showed no evidence of association with eGFR or CKD. Sex-stratified analyses led to similar DPs, and effects on eGFR and CKD differed to some extent between males and females.

**Conclusions:** In addition to confirming known relationships between nutrient-based DPs and kidney health, biomarker-based DPs highlighted additional food groups related with specific CKD risk factors. Integrating both nutrients and biomarkers risk factors as mediators adds value to the investigation of diet effects on kidney function.

**Funding:** Private Foundation Support, Government Support - Non-U.S.

Figure 1: Description of Dietary Patterns derived by Reduced Rank Regression

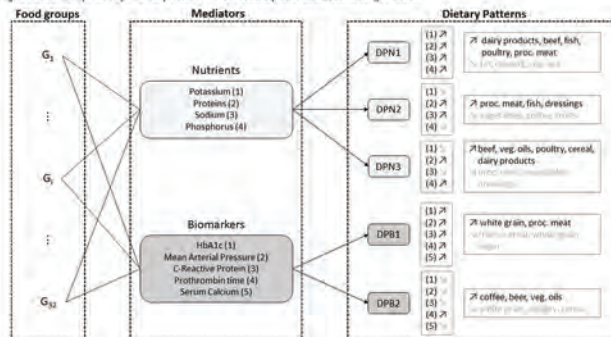

## TH-PO846

## Coffee Consumption and Risk of Kidney Function Decline in a Dutch Population-Based Cohort

Qingqing Cai,<sup>1,2</sup> Annik V. Westing,<sup>3</sup> Stephan J. Bakker,<sup>1</sup> Gerjan Navis,<sup>1</sup> Johanna M. Geleijnse,<sup>3</sup> Martin H. De Borst.<sup>1</sup> <sup>1</sup>Universiteit Groningen Faculteit Medische Wetenschappen, Groningen, Netherlands; <sup>2</sup>Southern Medical University Nanfang Hospital, Guangzhou, China; <sup>3</sup>Wageningen University, Wageningen, Netherlands.

**Background:** Coffee consumption has been associated with beneficial outcomes in various disease domains, including chronic kidney disease (CKD). Whether coffee consumption is associated with kidney function decline in the general population is unclear. We investigated the association of coffee consumption with kidney function decline or incident chronic kidney disease (CKD) in the Dutch population.

**Methods:** This study was performed in 78,346 participants free of CKD in the prospective population-based Lifelines cohort from Northern Netherlands. Coffee consumption (daily cups) was assessed at baseline using food frequency questionnaires. Incident CKD was defined as eGFR <60 mL/min/1.73 m<sup>2</sup> (CKD-EPI equation). Multivariable logistic regression analyses were used to evaluate the associations of daily coffee consumption with annual change in estimated glomerular filtration rate (eGFR) or a composite kidney outcome (incident CKD and/or >20% eGFR decline).

**Results:** Participants with higher daily coffee intakes were more often men, older, lower-educated, and current smoker. They were less physically active and had higher BMI, higher alcohol intake, and lower tea intake. They also had less often diabetes and cardiovascular disease and more often gastrointestinal disease. During a mean (SD) follow-up of 3.6±0.9 years, 8 735 events (11.1%) of the composite kidney outcome occurred. The median (IQR) annual change in eGFR was -2.23 (-3.69, -0.80) mL/min/1.73 m<sup>2</sup>. Coffee intake was inversely associated with annual eGFR decline ( $\beta$  [95%CI] for 1-2 cups, 0.13 [0.06-0.21]; 3-4 cups, 0.15 [0.08, 0.23]; 5-6 cups, 0.19 [0.11, 0.27]; and >6 cups, 0.23 [0.14, 0.33]), vs non-coffee drinkers,  $P_{\text{trend}} < 0.001$ ). Similar dose-response relationships were observed for composite kidney outcome. Coffee intake (continuously, per cup/d) was related to a lower risk of the composite kidney outcome (OR [95%CI], 0.98 [0.97,0.99],  $P=0.02$ ).

**Conclusions:** Daily coffee consumption was inversely associated with kidney function decline and CKD risk in a dose-response manner in Dutch population-based cohort. Intervention studies are needed to address whether increasing coffee consumption protects against kidney function loss.

**Funding:** Government Support - Non-U.S.

## TH-PO847

## Measured GFR Adjusted Metabolic Changes Following Bariatric Surgery

Benjamin J. Apple,<sup>1</sup> Jingsha Chen,<sup>2</sup> Tooraj Mirshahi,<sup>3</sup> Andrew S. Levey,<sup>4</sup> Lesley A. Inker,<sup>4</sup> Morgan Grams,<sup>5</sup> Josef Coresh,<sup>2</sup> Alex R. Chang.<sup>3</sup> <sup>1</sup>Geisinger Commonwealth School of Medicine, Scranton, PA; <sup>2</sup>Johns Hopkins University Welch Center for Prevention Epidemiology and Clinical Research, Baltimore, MD; <sup>3</sup>Geisinger Medical Center, Danville, PA; <sup>4</sup>Tufts Medical Center, Boston, MA; <sup>5</sup>New York University Grossman School of Medicine, New York, NY.

**Background:** Bariatric surgery reduces glomerular hyperfiltration in the short term and is associated with a reduced risk of end-stage kidney disease during long-term follow-up. Assessing surgery-induced changes in serum metabolites may be useful to understand the salutary metabolic changes that occur after bariatric surgery.

**Methods:** In a prospective, single-center research cohort of 27 adults with severe obesity who underwent bariatric surgery, we measured serum metabolites using untargeted ultrahigh-performance liquid chromatography-tandem mass spectrometry and measured glomerular filtration rate (mGFR) by iohexol clearance approximately 1-3 months prior and 6 months after bariatric surgery. Generalized estimated equations (GEE) were used to examine changes in serum metabolites after surgery.

**Results:** Bariatric surgery was significantly associated with 223 serum metabolites after adjustment for age, sex, and log(mGFR) at a Bonferroni-corrected p-value <4.85E-05. Following bariatric surgery, the levels of many metabolites associated with insulin resistance and inflammation decreased, such as branch-chain amino acids (tiglyl carnitine, isovalerylcarnitine, alpha-hydroxyisovalerate), kynurenine pathway (kynurenine, xanthurenate, 8-methoxykynurenate, quinolinate), sphingomyelin metabolites (behenoil dihydrospingomyelin, sphingomyelin, tricosanoyl sphingomyelin). Additionally, creatinine decreased following surgery independent of mGFR. Increases in metabolite levels occurred for insulin sensitivity-promoting primary bile acid metabolites (cholic acid glucuronide, cholate, glycol-beta-muricholate), antioxidant plasmalogen metabolites (1-2-oleoyl-GPC, 1-2-palmitoleoyl-GPC), and microbiome-derived acetylated peptide metabolites (phenylacetylglutamate, phenylacetylglutamine).

**Conclusions:** After adjustment for mGFR, we confirm several metabolic changes after bariatric surgery, which could have favorable renal benefits.

**Funding:** NIDDK Support

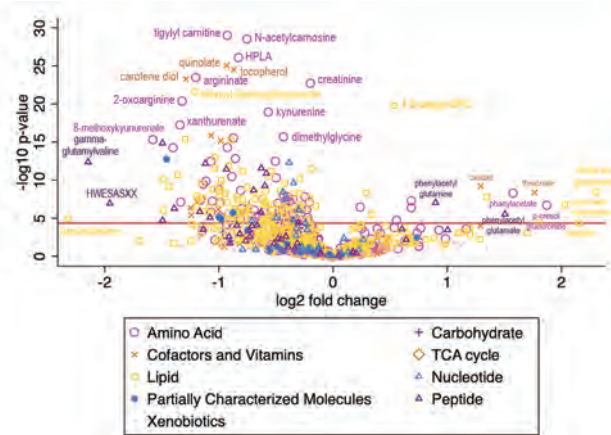

Volcano Plot

## TH-PO848

## High-Fat Diet Increases Gadolinium Retention in Mice

Brent Wagner,<sup>1,2</sup> G. P. Escobar,<sup>2,1</sup> Joshua Deaguero,<sup>2,1</sup> Abdul Mehdi S. Ali,<sup>3</sup> Karol Dokladny,<sup>2,1</sup> Kidney Institute of New Mexico <sup>1</sup>New Mexico VA Health Care System, Albuquerque, NM; <sup>2</sup>University of New Mexico Health Sciences Center, Albuquerque, NM; <sup>3</sup>University of New Mexico Department of Earth & Planetary Sciences, Albuquerque, NM.

**Background:** Gadolinium is a heavy/rare earth (lanthanoid) metal extensively used in modern diagnostic medicine as an enhancer of magnetic resonance imaging (MRI) procedures. Exposure to gadolinium-based contrast agents can cause 'nephrogenic' systemic fibrosis (NSF), a medical condition characterized by skin fibrosis associated with severe pain, burning, and itching leading to inhibition or loss of joint flexibility and movement. Our team has shown that gadolinium is detectable in symptomatic and asymptomatic patients in the urine, hair, and nails after MRI contrast exposure. We have also pioneered mechanistic studies showing that C-C chemokine receptor 2-dependent activated myeloid cells and fibroblasts mediates NSF. It has been shown that the kidney is a reservoir for gadolinium-based contrast even days after a single dose. However, relative gadolinium retention in obese animals has not been examined.

**Methods:** Mice were randomized to a 60 kcal% fat diet (n=14) ad libitum (20 kcal% protein and 20 kcal% carbohydrates; Research Diets, Inc; D12492i) or control chow (19% protein, carbohydrates 47%, and fat 6.5 %; Tekland Diets; 2020x; n=8) for 18-20 weeks. Then, the groups were sub-divided into untreated (n=8) and gadolinium-based contrast agent-treated (Omniscan 2.5 mM) (n=14) subgroups 5 days a week for 4 weeks. Tissues were excised and snap-frozen in liquid nitrogen. On average, 15 mg of tissue were digested and gadolinium concentrations were quantified using PerkinElmer NexION 300D Inductively Coupled Plasma Mass Spectrometry (ICP/MS) with a detection limit of 0.01 ppb.

**Results:** We observed gadolinium retention in the kidney and liver of animals exposed to Omniscan. Interestingly, HFD increased gadolinium accumulation in tested organs in males and females. Similarly, tungsten retention was increased in animals (regardless of sex) treated with gadolinium. HFD exacerbated gadolinium retention. In the kidneys of males, Ca and P retention was augmented by HFD regardless of Omniscan treatment. Zn accumulation was not influenced by either Omniscan or HFD treatment.

**Conclusions:** Our data indicate that obesity promotes gadolinium retention in the kidney and liver. Future studies are needed to delineate the cellular mechanisms leading to augmented gadolinium accumulation in obese animals and demonstrate associated pathological consequences.

**Funding:** NIDDK Support, Other NIH Support - UL1TR001449, Veterans Affairs Support, Other U.S. Government Support, Private Foundation Support

## TH-PO849

## The 10-Year Effects of Lifestyle Modifications on Kidney Outcomes

Linda-Marie U. Lavenburg, Jordana B. Cohen, Douglas E. Schaubel, Peter P. Reese, Renal-Electrolyte and Hypertension, University of Pennsylvania University of Pennsylvania, Philadelphia, PA.

**Background:** Obesity is a global epidemic associated with risk factors for chronic kidney disease (CKD). The Action for Health in Diabetes (Look AHEAD) trial showed greater weight loss after exposure to intensive lifestyle intervention compared to diabetes support and education (i.e., usual care). Weight loss interventions can improve short-term kidney outcomes, but larger longitudinal studies on non-surgical obesity treatments are needed. We investigated the effects of weight loss from lifestyle modifications on kidney function over ten years.

**Methods:** We performed a retrospective cohort study of 4,901 individuals with type 2 diabetes and BMI  $\geq 25$ kg/m<sup>2</sup> using the Look AHEAD dataset which was collected between 2001-2015. We used linear mixed effect models to evaluate for within-individual changes of mean values and slope of estimated glomerular filtration rate (eGFR) (primary

outcome) and urine albumin to creatinine ratio (UACR) (secondary outcome) between randomization arms. We evaluated for effect modification by baseline kidney function and visit year using the Wald test and a two-sided significance level of 0.05.

**Results:** At baseline, mean eGFR in both randomization arms was 89ml/min/1.73m<sup>2</sup> and 83% of participants had normal albuminuria. Over 10 years, the intervention arm had a slightly higher mean eGFR compared to the usual care arm (beta-coefficient (B): 0.5, p=0.04). The intervention improved loss of eGFR after year two (B: 0.78, p<sub>interaction</sub>=0.001). The magnitude of the intervention's effect differed by year with the slowest decline in eGFR by 1.20ml/min/1.73m<sup>2</sup> (p=0.002) at year 3. Among individuals with a baseline eGFR <80ml/min/1.73m<sup>2</sup>, the mean eGFR in the intervention arm was 1.25ml/min/1.73m<sup>2</sup> (p=0.02) higher than the usual care arm. However, there was no difference in mean UACR (B: -0.001, p=0.94) or slope of UACR (B: 0.0002, p=0.80) between arms.

**Conclusions:** Among individuals at high risk for CKD, exposure to intensive lifestyle intervention resulted in slower eGFR loss by year 2 and slightly higher kidney function over 10 years compared to usual care. Individuals with lower kidney function had greater benefit from the intervention than those with higher kidney function. Participation in a lifestyle modification program is recommended for individuals with excess body weight and can slow progression to CKD in at risk populations.

**Funding:** Other NIH Support - T32

**TH-PO850**

**Individualized and Technology-Assisted Ketogenic Diet on Metabolic and Kidney Health in Overweight or Obese Adults**

Christiane L. Meireles,<sup>1</sup> Yan Du,<sup>1</sup> Shiyu Li,<sup>1</sup> Brittany Dennis,<sup>1</sup> Nicholas S. Niazi,<sup>2</sup> Darpan I. Patel,<sup>1</sup> Jonathan A. Gelfond,<sup>4</sup> Chengdong Li,<sup>3</sup> Hongping Ye,<sup>2</sup> Richard Montellano,<sup>2</sup> Anthony J. Franzone,<sup>2</sup> Jing Wang,<sup>3</sup> Kumar Sharma,<sup>2,1</sup> *School of Nursing, UT Health San Antonio, San Antonio, TX; <sup>2</sup>Center for Precision Medicine, School of Medicine, UT Health San Antonio, San Antonio, TX; <sup>3</sup>Florida State University College of Nursing, Tallahassee, FL; <sup>4</sup>Department of Population Health Sciences, School of Medicine, UT Health San Antonio, San Antonio, TX.*

**Background:** Obesity is a major public health concern, as it is associated with a variety of chronic conditions, including kidney and cardiovascular dysfunction. The ketogenic diet has drawn much scientific and public attention to improve health however implementation is challenging. We therefore designed a study to assess the effects of a technology-assisted ketogenic diet on metabolic and kidney health, and report the results of the 3-month data collection point of the overall 6-month study.

**Methods:** Sixty overweight/obese adults (20 without type 2 diabetes and chronic kidney disease (CKD), 20 with type 2 diabetes and without CKD, and 20 with CKD) were randomized to a ketogenic diet (n=30) or a low-fat diet (n=30) group. Both groups received individual in-person educational sessions, digital educational sessions, and devices for self-monitoring lifestyle behaviors and health indicators (e.g., physical activity, diet, ketone levels). The data of 34 participants who finished the 3-month data collection by May 2022 were analyzed (n=17 in the ketogenic diet group, mean age 55.5 ± 12.4, 47% without diabetes and/or CKD; n=17 in the low-fat diet group, mean age 50.2 ± 11.3, 47% without diabetes and/or CKD). An intention to treat analysis was used. Paired t-tests and independent t-tests were conducted to assess within and between group differences in kidney and metabolic health from baseline to 3 months, respectively.

**Results:** Body weight, body mass index (BMI), and triglycerides were found to be significantly reduced in both the ketogenic diet and the low-fat diet groups; BMI reduction in the ketogenic diet group was significantly greater compared to the low-fat group. Reductions in hemoglobin A1c (HbA1c) (p=0.006), and systolic (p=0.010) and mean arterial pressure (MAP, p=0.003) were only found in the ketogenic diet group. No significant changes in urine albumin to creatinine ratio and estimated glomerular filtration rate were found in either group at 3 months compared to baseline.

**Conclusions:** At three months, a ketogenic diet-based lifestyle intervention has favorable effects on weight control, HbA1c, triglycerides, and systolic and mean arterial pressure in overweight/obese adults with or without diabetes and/or CKD.

**Funding:** Private Foundation Support

**TH-PO851**

**Need to Think Outside the Box: Clinical Presentation and Outcome of Tuberculosis in Patients With CKD**

Mohan P. Patel,<sup>1</sup> Jitendra Goswami,<sup>2,1</sup> *Apollo Specialty Hospitals Pvt Ltd, Nashik, India; <sup>2</sup>Manipal Hospitals, Jaipur, India.*

**Background:** Tuberculosis (TB) is still an important public health problem in Indian subcontinent and limited literature on TB among chronic kidney disease (CKD) population. Additionally, the diagnosis of TB in CKD patients is challenging because of suboptimal performance of screening and diagnostic tests. The present study aimed to investigate the clinical profile and outcome of TB in CKD patients and further assisting the complications during the treatment and recovery of the patients.

**Methods:** A prospective observational study was conducted in patients with CKD stage III - V, diagnosed with TB between January 2014 and December 2021. Demographic characteristics and clinical findings were recorded. Treatment with anti-TB drugs, adverse events and the outcome of patients were also noted.

**Results:** A total of 63 CKD patients with mean (SD) age 49.2 (18.3) years, clinically diagnosed with TB were enrolled in the study. About 72% of patients were male and 76.2% of patients (n=48) with TB had advanced CKD stage V. At the time of diagnosis of TB, 39 (81.25%) and 9 (18.75%) patients were on hemodialysis and peritoneal dialysis, respectively with mean (SD) dialysis duration was 9.2 (7.4) months. At the time of TB

diagnosis, twenty-nine patients (46%) were already diagnosed to have Diabetes Mellitus. The diagnosis of TB in 58.73% patients was on the basis of microbiological/histological reports and only on clinical grounds in rest of the 41.27% patients. The majority of the patients (n=41, 65%) had extrapulmonary TB. Pleuro-pulmonary (38.09%), lymph node (26.6%), peritoneum (17.46%) and genitourinary tract (6%) were common sites for TB. About 7.9% patients had joint TB and one patient (2%) had disseminated TB. Twenty-four patients (39.68%) had adverse events related to anti-TB drugs like rifampicin induced hypertension (n=11), isoniazid induced rash (n=2) isoniazid induced cerebellitis (n=3) and hepatitis (n=9). About 69.8% of the patients in the study were survived and 30.2% died.

**Conclusions:** As the clinical presentations of TB in CKD patients are mostly nonspecific, leading to delay in diagnosis and treatment along with poor patient outcomes. Hence, we need to think outside the box in patients with CKD as extrapulmonary presentations are more common. Adverse events related to anti-TB drugs frequently complicate the treatment, therefore vigilance is needed.

**TH-PO852**

**Association of Bicarbonate Therapy With Incident CKD**

Hanwen Wang,<sup>1</sup> Elani Streja,<sup>2</sup> Keiichi Sumida,<sup>3</sup> Fridtjof Thomas,<sup>3</sup> Csaba P. Kovcsdy,<sup>3</sup> Kamyar Kalantar-Zadeh,<sup>2</sup> *University of California Los Angeles, Los Angeles, CA; <sup>2</sup>University of California Irvine Medical Center, Orange, CA; <sup>3</sup>The University of Tennessee Health Science Center, Memphis, TN.*

**Background:** Sodium bicarbonate is used to treat metabolic acidosis and may delay deterioration of kidney function in patients with chronic kidney disease (CKD), but its effects on end-stage kidney disease (ESKD), incident CKD, and death in patients with normal kidney function are unclear.

**Methods:** We examined a national cohort of 238,313 US veterans with normal baseline kidney function (eGFR ≥60 ml/min/1.73m<sup>2</sup> and UACR <30 mg/g). We examined the association of de novo prescription of bicarbonate with ESKD, incident CKD (defined as two eGFR values <60 ml/min/1.73m<sup>2</sup> at least 90 days apart), and all-cause mortality, over a follow-up of up to 14 years. Associations were examined in Cox models and competing risk analyses adjusted for demographics, major comorbidities, baseline eGFR, and serum bicarbonate level. We also analyzed associations in a propensity score (PS)-matched cohort.

**Results:** We identified 2,992 Veterans who were incident bicarbonate users. Overall, patients had a mean age of 58 ± 12 years, with 7% female, 18% Black, and 7.7% Hispanic. Bicarbonate users (vs non-users) had a 1.7-fold higher risk of ESKD (SHR: 1.71, 95%CI: 0.69, 4.21), a 2-fold higher risk of incident CKD (SHR: 2.04, 95%CI: 1.87, 2.23), and a 3.3-fold higher risk of death (HR: 3.33, 95%CI: 3.15, 3.51) (Table). Results were consistent in a PS-matched cohort.

**Conclusions:** In this cohort of veterans with normal baseline kidney function, sodium bicarbonate use was associated with higher risks of ESKD, incident CKD, and mortality. Additional research is needed to determine if bicarbonate treatment is a surrogate of disease conditions associated with a higher risk of CKD, or if it causes deleterious outcomes directly.

**Funding:** NIDDK Support, Veterans Affairs Support

Table. Association of bicarbonate therapy with A) ESKD, B) Incident CKD and C) Death across models in 238,313 US veterans with normal baseline kidney function.

Event	Overall cohort (n=238,313)				PS matched cohort (n=5,968)	
	Crude (un-adjusted) model		Adjusted model		HR (95%CI)	P-value
	HR/SHR (95%CI)	P-value	HR/SHR (95%CI)	P-value		
ESKD	1.51 (0.62, 3.66)	0.3624	1.71 (0.69, 4.21)	0.2450	1.71 (0.80, 58.46)	0.0797
Incident CKD	1.96 (1.81, 2.13)	<0.0001	2.04 (1.87, 2.23)	<0.0001	2.04 (2.48, 3.20)	<0.0001
Death	5.22 (4.95, 5.51)	<0.0001	3.33 (3.15, 3.51)	<0.0001	3.31 (2.12, 2.53)	<0.0001

PS, propensity score; HR, hazard ratio; SHR, subhazard ratio; eGFR, estimated glomerular filtration rate; ESKD, end-stage kidney disease.

**TH-PO853**

**Association of Fibrate Therapy and Incident CKD**

Diana Tran,<sup>1</sup> Csaba P. Kovcsdy,<sup>2</sup> Shaun M. Whitecavage,<sup>1</sup> Keiichi Sumida,<sup>2</sup> Fridtjof Thomas,<sup>2</sup> Kamyar Kalantar-Zadeh,<sup>1</sup> Elani Streja,<sup>1</sup> *University of California Irvine Medical Center, Orange, CA; <sup>2</sup>The University of Tennessee Health Science Center, Memphis, TN.*

**Background:** Fibrate therapy can result in an acute increase in serum creatinine, which makes the assessment of kidney outcomes associated with fibrates difficult in studies with short follow-up times. We aimed to examine the association of fibrate therapy with incident CKD in a large national cohort of US Veterans with long follow-up.

**Methods:** In a nationwide cohort of 688,382 US Veterans with an eGFR ≥60 mL/min/1.73m<sup>2</sup> and available data on albuminuria in 2004-2006, we examined the association of de novo prescription of fibrate medications during the baseline period with incident CKD (defined as an eGFR <60 mL/min/1.73m<sup>2</sup> measured at least twice and separated by at least 90 days) over 14 years. Associations were examined in hazard models adjusted for demographics, major comorbidities, labs, baseline eGFR, and albuminuria.

**Results:** We identified 58,773 incident new fibrate users. Overall mean (SD) age was 59 (13) years, with 6.6% female, 17.9% Black, and 7.0% Hispanic. Fibrate users were more likely to be male, White, current smokers, and had higher frequencies of comorbidities. There were 139,360 cases of incident CKD (event rate 2.64/100PY, 95% CI: 2.63-2.66) with median follow-up of 8.5 years. Fibrate use (vs. non-use) was associated with higher

risk of incident CKD in crude (HR: 1.52, 95% CI: 1.50-1.55, model 1; Figure) and multivariable adjusted models (HR: 1.33, 95% CI: 1.31-1.36, model 5).

**Conclusions:** In this large national cohort of US Veterans with long follow-up time, fibrate therapy was associated with a higher risk of incident CKD. Further studies are needed to corroborate these findings by examining alternative kidney end points.

**Funding:** NIDDK Support, Veterans Affairs Support

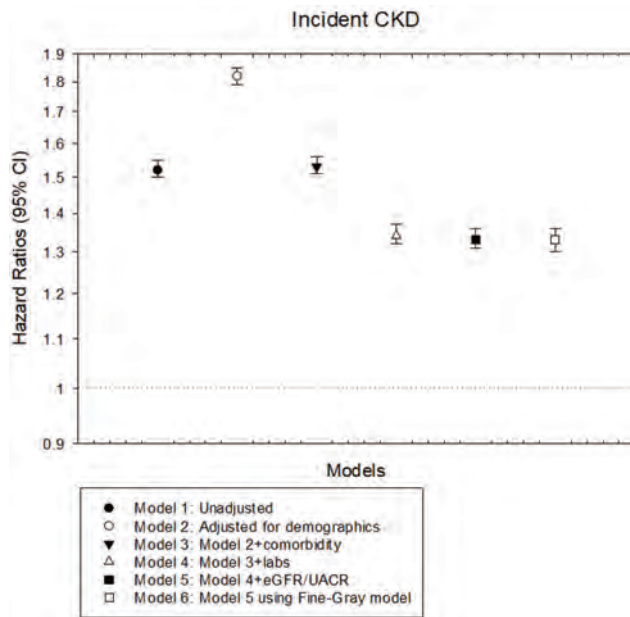

TH-PO854

**Changing Patterns of Antihypertensive Treatment Among CKD Patients: The CKD-REIN Cohort Study**

Margaux Costes-Albrespic,<sup>1</sup> Solene M. Laville,<sup>4</sup> Sophie Liabeuf,<sup>4</sup> Christian Jacquelinet,<sup>5</sup> Christian Combe,<sup>6</sup> Denis Fouque,<sup>7</sup> Maurice Laville,<sup>8</sup> Carole Ayav,<sup>3</sup> Ziad Massy,<sup>1</sup> Roberto Pecoits-Filho,<sup>9</sup> Benedicte Stengel,<sup>1</sup> Benedicte Sautenet,<sup>2</sup> Natalia Alencar de Pinho,<sup>1</sup> <sup>1</sup>Centre de Recherche en Epidemiologie et Sante des Populations, Villejuif, France; <sup>2</sup>Centre Hospitalier Regional Universitaire de Tours, Tours, France; <sup>3</sup>Centre hospitalier regional universitaire de Nancy, Nancy, France; <sup>4</sup>Centre Hospitalier Universitaire Amiens-Picardie, Amiens, France; <sup>5</sup>Agence de la biomedecine, La Plaine Saint-Denis, France; <sup>6</sup>Centre Hospitalier Universitaire de Bordeaux Groupe hospitalier Pellegrin, Bordeaux, France; <sup>7</sup>Hospices Civils de Lyon, Lyon, France; <sup>8</sup>Universite Claude Bernard Lyon 1, Lyon, France; <sup>9</sup>Arbor Research Collaborative for Health, Ann Arbor, MI.

**Background:** Blood pressure (BP) control is one of the cornerstones for preventing cardiovascular complications in chronic kidney disease (CKD). Yet, despite a wide range of treatments, a majority of patients remain off-target. We aimed at describing changes in antihypertensive treatment regimens in this population.

**Methods:** We collected drug prescriptions over 5 years among 2,755 hypertensive patients with CKD stages 3 and 4 recruited from a nationally representative sample of 40 nephrology clinics in France. Using the international Anatomic Therapeutic and Chemical codes, we classified antihypertensive drugs into 14 mutually exclusive classes, and assessed time-dependent prescription status until death, kidney replacement therapy, or censoring.

**Results:** At baseline, 81% of the patients (mean age, 67; 66% men; mean eGFR 33 mL/min/1.73 m<sup>2</sup>) had BP ≥130/80 mmHg. We identified 257 distinct antihypertensive drug class regimens. The most prescribed class were RAS inhibitors (78%), and the most frequent combination, RAS inhibitors with diuretics (9%). BP level did not significantly differ according to the number of antihypertensive drugs. Over a median of 5 years of follow-up (IQR 4.5; 5.1), half of the patients changed their treatment regimen. These changes included adding-on, withdrawing or changing a drug class in 22%, 19%, and 10% of cases, respectively, and resulted in virtually no progression in the number of prescribed drug classes per patient at the end of follow-up (Figure). Analyses by drug classes revealed highest rates of regimen increments for β-blockers (46%) and for diuretics in addition with drug classes other than RAS inhibitors (35%).

**Conclusions:** This study highlights substantial heterogeneity of antihypertensive drug prescriptions among CKD patients under nephrology care. Greater knowledge of the evolving patterns of antihypertensive treatment regimens is a first, but key step in the understanding of the determinants of BP control in CKD.

**Funding:** Government Support - Non-U.S.

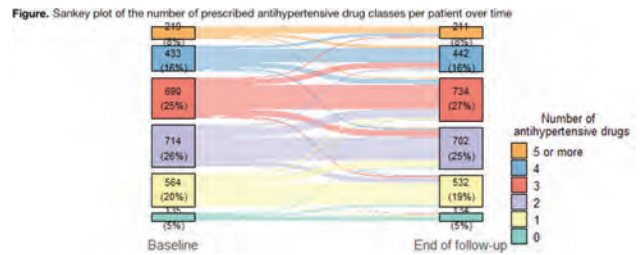

TH-PO855

**Early Dapagliflozin Utilization for CKD Treatment in the United States**

Eric T. Wittbrodt,<sup>1</sup> Jason M. Wright,<sup>3</sup> Juan Jose Garcia Sanchez,<sup>4</sup> Matthew Arnold,<sup>4</sup> Cassandra Nan,<sup>2</sup> <sup>1</sup>AstraZeneca R&D Gaithersburg, Gaithersburg, MD; <sup>2</sup>AstraZeneca AB, Mölndal, Sweden; <sup>3</sup>AstraZeneca Pharmaceuticals LP, Wilmington, DE; <sup>4</sup>AstraZeneca UK Ltd, Cambridge, United Kingdom.

**Background:** In 2021, dapagliflozin was approved for the treatment of adults with chronic kidney disease (CKD) in the United States (US). OPTIMISE-CKD is a multinational, observational, secondary data study program describing dapagliflozin treatment for CKD in routine clinical practice, contextualized by contemporary CKD management. This first observational analysis aims to describe early dapagliflozin utilization under the approved CKD indication in the US.

**Methods:** Adult patients with CKD in administrative claims data linked with electronic medical records in the OPTUM Market Clarity database from 30 March 2020 - 30 June 2021 were included. Criteria for CKD included any of the following: ≥1 UACR ≥30 mg/g, 2 eGFR ≥90 days apart of which the second was ≤75 mL/min/1.73m<sup>2</sup>, or a CKD diagnosis code. Patients with type 1 diabetes, gestational diabetes or <365 days continuous enrolment were excluded. Patients were dapagliflozin eligible if they met the CKD indication after 30 April 2021 and did not have a previous prescription for dapagliflozin 10 mg. Dapagliflozin CKD initiators had a recorded prescription for dapagliflozin 10 mg within 90 days of dapagliflozin eligibility.

**Results:** A total of 583 patients met the study criteria and had initiated dapagliflozin during the first 2 months since approval. The median age was 69 years (interquartile range; IQR 59-77) and 46% were female. For the 316 initiators with known CKD stage, the distribution was as follows: 4% stage 1, 16% stage 2, 28% stage 3a, 38% stage 3b, 13% stage 4 and 1% stage 5 (non-dialysis). The most common comorbidities were hypertension (91%), heart failure (44%) and type 2 diabetes (82%). Lipid lowering drugs (61%), diuretics (58%), renin-angiotensin-aldosterone system inhibitors (57%) and angiotensin receptor/nephrilysin inhibitor (9%) were commonly prescribed. Similar patterns were found among patients who were not treated with dapagliflozin.

**Conclusions:** Early use of dapagliflozin in the US was observed in a broad range of patients with CKD with respect to baseline characteristics and was representative of treatment-eligible patients overall. Further analyses across more patients and countries in the OPTIMISE-CKD program will provide additional insight into the real-world experience of novel treatments for CKD and facilitate optimized CKD management.

**Funding:** Commercial Support - AstraZeneca

TH-PO856

**Fracture Risk in Association With Use of Anticoagulants for Atrial Fibrillation in Patients With CKD**

Nazleen Khan, Seoyoung C. Kim, Su Been Lee, Katsiaryna Bykov, Julie M. Paik. Brigham and Women's Hospital Department of Medicine, Boston, MA.

**Background:** Direct oral anticoagulant (DOAC) use has been associated with better safety outcomes relative to warfarin in patients with atrial fibrillation. However, little is known about the safety and effectiveness of anticoagulant therapy in patients with chronic kidney disease (CKD), who are predisposed to fractures and other adverse outcomes.

**Methods:** We conducted a new user, active comparator cohort study in a large US commercial insurance database (2013-2020). Individuals were required to have at least 365 days of continuous enrollment prior to anticoagulant initiation and at least one International Classification of Diseases (ICD) diagnosis code for CKD, stages 3-5, and atrial fibrillation during the baseline period. The primary outcome was non-vertebral fracture defined using a previously validated algorithm of ICD diagnosis and procedure codes. Primary analyses quantified fracture risk in patients initiating DOACs (apixaban or rivaroxaban) or warfarin using a 1:1 propensity score-matched design with adjustment for 82 covariates. Cox proportional hazards regression and modified generalized linear models were used to obtain adjusted hazard ratios (HRs) and rate differences and 95% confidence intervals (CIs) of fracture in the 365 days following anticoagulant initiation. Secondary analyses evaluated comparative risks of all-cause mortality and hip fracture.

**Results:** The matched population included 14,394 initiators of DOACs and warfarin, respectively. The mean age was 77 years (standard deviation 8), and 45% were female. The rate of fracture events per 1,000 person-years was 32.53 for DOAC users and 29.89 for warfarin users. The adjusted HR of fracture comparing DOACs to warfarin was 1.09 (95% CI 0.92 to 1.29), and the rate difference was 2.64 events per 1,000 person-years

(95% CI -2.56 to 7.83). In secondary analyses, the adjusted HR comparing DOACs to warfarin was 0.87 (95% CI 0.81 to 0.93) for all-cause mortality and 1.23 (95% CI 0.91 to 1.65) for hip fracture.

**Conclusions:** In our study of CKD patients with atrial fibrillation, we did not observe a difference in the rates of fracture between DOACs and warfarin initiators; however, the use of DOACs was associated with a lower risk of all-cause mortality.

#### TH-PO857

##### Leukotriene Antagonist Use Is Associated With Less Albuminuria and Lower Systolic Blood Pressure in Adults

Jennifer M. Lai,<sup>1</sup> Seth B. Furgeson,<sup>1</sup> Petter Bjornstad,<sup>1,2</sup> Zhiying You,<sup>1</sup> Kalie L. Tommerdahl,<sup>1,2</sup> Jessica B. Kendrick.<sup>1</sup> <sup>1</sup>University of Colorado Denver School of Medicine, Aurora, CO; <sup>2</sup>Children's Hospital Colorado, Aurora, CO.

**Background:** Proinflammatory mediators known as leukotrienes have been implicated in the development of both chronic kidney disease (CKD) and cardiovascular disease (CVD). Leukotrienes cause endothelial dysfunction which increases glomerular permeability to albumin and causes vascular dysfunction leading to CVD. We hypothesized that the use of montelukast in adults would associate with less albuminuria and lower systolic blood pressure (SBP).

**Methods:** Participant data from a total of 51,111 adults was extracted from NHANES 1999-2018 and stratified by montelukast prescription status. We evaluated baseline urine albumin to creatinine ratio (ACR) (mg/g), estimated glomerular filtration rate (eGFR) (mL/min/1.73m<sup>2</sup>), CKD (defined as urine ACR >30 mg/g or eGFR <60 mL/min/1.73m<sup>2</sup>), and SBP (mmHg) in participants taking montelukast vs. participants not taking montelukast. Urine ACR was log transformed prior to analysis due to positive skew. Regression analyses were used to examine the association between montelukast use and outcomes.

**Results:** We identified participants taking montelukast (N=434) and compared them to participants not taking montelukast (N=50,677). The mean age and eGFR were 47.2 ± 19 years and 96.6 ± 23.2 mL/min/1.73m<sup>2</sup>, respectively. Participants taking montelukast were older, had a higher prevalence of diabetes and hypertension, and had a lower eGFR. After adjustment for demographics, diabetes status, hypertension, body mass index (BMI), eGFR, and use of an ACE inhibitor or angiotensin receptor blocker, montelukast use associated with lower urine ACR (Table). Montelukast use did not associate with eGFR or CKD. After adjustment for demographics, diabetes status, BMI, hypertension, eGFR, urine ACR and use of anti-hypertensive medications, montelukast use associated with lower SBP.

**Conclusions:** Participants taking montelukast had significantly lower albuminuria and SBP compared to participants not taking montelukast. Leukotriene inhibition may represent a promising avenue for future treatment of CKD and CVD.

**Funding:** NIDDK Support

Montelukast Use vs. No Use	β-estimate (95% CI)	P-value
Urine ACR	-0.13 (-0.22 to -0.04)	0.005
eGFR	-0.50 (-2.1 to 1.05)	0.51
SBP	-1.98 (-3.82 to -0.11)	0.038
	Odds Ratio (95% CI)	P-value
CKD	0.89 (0.66 to 1.21)	0.45

#### TH-PO858

##### Nephrologists Survey to Learn Prescribing Patterns of Sodium-Glucose Cotransporter 2 Inhibitors (SGLT2i)

Tripti Singh,<sup>1</sup> Tingting Li,<sup>2</sup> Didier A. Mandelbrot,<sup>1</sup> Ali Poyan-Mehr.<sup>3</sup> <sup>1</sup>University of Wisconsin-Madison, Madison, WI; <sup>2</sup>Washington University in St Louis, St Louis, MO; <sup>3</sup>Kaiser Permanente, Oakland, CA.

**Background:** SGLT2i decrease proteinuria and slow the progression of CKD. KDIGO recommends using SGLT2i in all diabetic CKD patients (1A recommendation). However, only 10% of diabetic CKD patients are prescribed SGLT2i. Here we surveyed SGLT2i prescribing patterns among nephrologists globally and identify barriers to SGLT2i prescribing.

**Methods:** We developed a nine-item online questionnaire to understand the causes of SGLT2i underutilization. We collected the responses of the anonymous survey via Qualtrics from nephrologists through the Glomerular Disease Study and Trial Consortium's (GlomCon) email distribution list, and via Twitter, Facebook, and Instagram.

**Results:** We received responses from 153 survey participants. Forty-nine percent of responders were nephrology fellows or recent graduates of past five years and 51% had been practicing for more than five years. 42% of respondents were from the US, and 58% were outside the US. 52% of respondents worked at a university hospital, and 48% were in private practice. 86% of respondents said they spend >50% of their time in clinical practice. 64% of total respondents and 68% of trainees or recent graduates said that they knew the indications for SGLT2i very well. 53% of respondents from the US vs. 80% of respondents outside the US responded that they knew indications of SGLT2i very well (P 0.001). 33.6% of respondents said that they prescribe SGLT2i to >50% of their patients meeting requirements for SGLT2i. There was no difference based on recent graduates vs. practicing nephrologists >5 years or US nephrologists vs. non-US nephrologists. The most common barriers to prescribing SGLT2i were the cost of the medication or high co-pay (34%), lack of experience or comfort in prescribing SGLT2i (29%), and lack of time and personnel to manage the side effects (11%). Professional guidelines (29%), readily available medical knowledge through social media (26%), and participation in professional conferences (18%) were identified as the mechanisms that have helped the most in prescribing SGLT2i

**Conclusions:** SGLT2i prescribing remains low among nephrologists. Major barriers to prescribing SGLT2i include unfamiliarity with drug indication among nephrologists and cost of medication.

#### TH-PO859

##### Novel Phosphate Binder Lanthanum Dioxycarbonate Does Not Demonstrate Clastogenic or Mutagenic Potential

Pramod Gupta, Atul Khare. *Unicyclic Therapeutics, Inc, Los Altos, CA.*

**Background:** Lanthanum dioxycarbonate, RENAZORB (LDC), is a novel nanotechnology product that combines lanthanum, which has the highest binding capacity vs. other P binders, with a potentially smaller pill size that is swallowed with water rather than chewed. We present studies assessing the clastogenic and mutagenic potential of LDC.

**Methods:** The clastogenic and mutagenic potential of LDC was tested using chromosome aberration assays and bacterial reverse mutation assays, respectively. For the chromosome aberration assays, Chinese hamster ovary cells were harvested 20 hours after treatment initiation. Cell growth and mitotic inhibition relative to control were evaluated. Statistical analysis was performed using the Fisher's Exact test. Bacterial reverse mutation assays (Ames Test) consisted of two phases (initial toxicity mutation and confirmatory mutagenicity) and used *Salmonella typhimurium* and *Escherichia coli* tester strains with and without Aroclor-induced rat liver S9. Dose levels tested were 1.5, 5.0, 15, 50, 150, 500, 1500, and 5000 µg for the first phase and 50, 150, 500, 1500, and 5000 µg for the second phase.

**Results:** In the non-activated 4-hour exposure group, there was no increase in the proportion of cells with structural or numerical aberrations relative to control at any dose level (p>0.05). In the non-activated 20-hour exposure group, increases in the proportion of cells with numerical aberrations were not significant at any dose level (p>0.05). In the initial toxicity-mutation assay, precipitate was observed beginning at 500 µg per plate, and no background lawn toxicity was observed. No positive mutagenic responses were observed with any of the tester strains with or without S9 activation. In the confirmatory mutagenicity assay, no appreciable toxicity or positive mutagenic responses were observed.

**Conclusions:** Lanthanum dioxycarbonate did not induce structural and numerical chromosome aberrations. LDC was negative in bacterial reverse mutation assay. These data support that LDC is safe and should be tested in the target population of patients with ESKD on dialysis with hyperphosphatemia. If approved, LDC would offer a small, swallowable phosphate binder option that could improve patient quality of life and potentially adherence.

#### TH-PO860

##### Simulated Impact of SGLT2 Inhibitors on US Dialysis Census

Alhaji Cherif,<sup>1</sup> Peter Kotanko,<sup>1,2</sup> Nina L. Muellers,<sup>4</sup> Zdenek Cerman,<sup>4</sup> Julian Dreismeier,<sup>4</sup> Robert J. Kossmann,<sup>3</sup> Franklin W. Maddux.<sup>3</sup> <sup>1</sup>Renal Research Institute, New York, NY; <sup>2</sup>Icahn School of Medicine at Mount Sinai, New York, NY; <sup>3</sup>Fresenius Medical Care North America, Waltham, MA; <sup>4</sup>Fresenius Medical Care AG & Co KGaA, Bad Homburg, Germany.

**Background:** Diabetes (DM) is common in CKD patients and associated with excess cardiovascular (CV) mortality. Sodium-glucose cotransporter 2 inhibitors (SGLT2i) have beneficial effects on morbidity and mortality of patients with DM, CV, and CKD. This study aims to predict the impact of SGLT2i use on dialysis census.

**Methods:** The patient population was divided into 5 groups: (1) non-CKD (nCKDi) and (2) CKD patients with indications for SGLT2i use (CKDi); (3) CKD patients without SGLT2i indication (CKDo); (4) incident and (5) prevalent dialysis patients. The model describes the transitions between different groups with the respective influx/efflux rates, e.g., mortality and CKD-to-dialysis progression (Fig. 1a). The model was validated using Fresenius Kidney Care data from 1/2018 to 1/2020.

**Results:** The model predicted dialysis census between 1/2019 and 1/2020 (Fig. 1b). Sensitivity analysis identified 4 SGLT2i-related parameters that affect dialysis census: mortality rate of CKD patients and CKD-to-dialysis progression exert a significant effect, while nCKDi mortality rates and progression to CKD have marginal impacts. Figs. 1c-d show the forecasted dialysis census over 40 months when CKDi mortality and CKD-to-dialysis progression rates are reduced by 30%. Table 1 shows that a 20% SGLT2i take-on rate among CKDi reduces the dialysis census from 1.280 to 1.269 -fold change at year 5. Within ≤9 years, SGLT2i reduces the dialysis census based on the drug take-on rate. But, this trend is reversed after 10 years, resulting in a rising dialysis census.

**Conclusions:** SGLT2i use affects dialysis census dynamically. In the first 9 years, the dialysis census is reduced; then followed by an increase. Further research is needed to understand the effect of time-varying SGLT2i take-on rates on dialysis census.

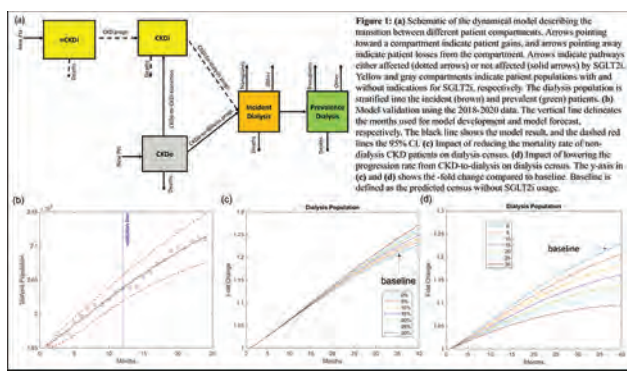

Figure 1: (a) Schematic of the dynamical model describing the transition between different patient compartments. Arrows pointing toward a compartment indicate patient gains, and arrows pointing away indicate patient losses from the compartment. Arrows indicate pathways either affected (dotted arrows) or not affected (solid arrows) by SGLT2i. Yellow and grey compartments indicate patient populations with and without indications for SGLT2i, respectively. The dialysis population is stratified into the incident (brown) and prevalent (green) patients. (b) Model validation using the 2016-2020 data. The vertical line indicates the months used for model development and model forecast. (c) Impact of reducing the mortality rate of non-dialysis CKD patients on dialysis census. (d) Impact of lowering the progression rate from CKD-to-dialysis on dialysis census. The y-axis in (c) and (d) shows the -fold change compared to baseline. Baseline is defined as the projected census without SGLT2i usage.

Table 1: Shows the -fold change of the dialysis census for four different SGLT2i take-on rates, with the corresponding combined effects on mortality rate in CKD and CKD-to-dialysis progression rate. E.g., a 20% take-on rate corresponds to a 6.6% reduction in CKD mortality rate and a 4.58% reduction in CKD-to-dialysis progression. Note that after 10 years, the dialysis census rises with SGLT2i take-on.

	SGLT2i Take-on rate [%]			
	0	5	20	100
Mortality rate reduction factor [%]	0	1.65	6.6	33
Progression rate into dialysis factor [%]	0	1.15	4.58	22.9
Time [years]	-fold change in dialysis census relative to time 0.			
0	1	1	1	1
1	1.074	1.073	1.07	1.052
2	1.151	1.149	1.142	1.106
5	1.280	1.277	1.269	1.215
10	1.291	1.292	1.294	1.294

TH-PO861

Association Between Urine Uromodulin and Interstitial Fibrosis

Alexander L. Bullen,<sup>1,2</sup> Joachim H. Ix,<sup>1,2</sup> Dena E. Rifkin,<sup>1,2</sup> Pranav S. Garimella,<sup>1</sup> <sup>1</sup>University of California San Diego, La Jolla, CA; <sup>2</sup>VA San Diego Healthcare System, San Diego, CA.

**Background:** Tubular atrophy and interstitial fibrosis are common findings in virtually all forms of chronic kidney disease. The severity of tubular atrophy and fibrosis on kidney biopsy is strongly predictive of progression to kidney failure; however, this damage is poorly correlated with either eGFR or albuminuria. The only form to identify interstitial fibrosis is with a kidney biopsy. Identifying interstitial fibrosis in a noninvasive manner would be of extreme value. Urine uromodulin (uMOD) is a marker of the renal reserve, and low concentrations of uMOD have been associated with chronic kidney disease progression. The association between uMOD and tubulointerstitial fibrosis is uncertain.

**Methods:** Among 52 individuals who underwent kidney biopsy for clinical reasons, we measured uMOD. The percentage of fibrosis was determined by morphometry technique. Due to skewed distribution, we log-transformed uMOD. We used linear regression to evaluate the association between uMOD and fibrosis, adjusting for age, sex, urine creatinine, obesity, diabetes, hypertension, baseline eGFR, and albuminuria.

**Results:** Among the 52 study participants, the mean age was 42 years, 48% were women, 23% had diabetes, and the mean eGFR was 64 ml/min/1.73m<sup>2</sup>. The mean uMOD was 5.1 mcg/mL. Participants in the lowest tertile of uMOD had more hypertension and diabetes mellitus and lower eGFR. Each doubling of urine uromodulin was associated with 1.88% decrease in fibrosis greater or equal to 25% (moderate or severe) after adjusting for all the covariates, including baseline eGFR and albuminuria.

**Conclusions:** Assessment of tubule function by measurement of uMOD provides information on interstitial fibrosis, independent of eGFR and albuminuria.

**Funding:** Veterans Affairs Support

TH-PO862

Circulating Proteins Improve Prediction of Short-Term Kidney Disease Progression

Carolina Lopez-Silva,<sup>1</sup> Aditya L. Surapaneni,<sup>2</sup> Josef Coresh,<sup>1</sup> Teresa K. Chen,<sup>1</sup> Morgan Grams,<sup>2</sup> <sup>1</sup>Johns Hopkins University School of Medicine, Baltimore, MD; <sup>2</sup>New York University Grossman School of Medicine, New York, NY.

**Background:** Chronic kidney disease (CKD) progression may be preventable with early medical intervention, but few tools reliably identify high-risk patients in early disease. The proteins KIM-1, TNFRSF1A, and TNFRSF1B have been proposed as promising early markers of CKD progression.

**Methods:** Using participants from ARIC visit 2 (mean age 57 years, 56% women, mean eGFR 98 mL/min/1.73m<sup>2</sup>), ARIC visit 5 (mean 76 years, 76% women, mean eGFR 69 mL/min/1.73m<sup>2</sup>) and AASK (mean age 55 years, 39% women, mean mGFR 46 mL/min/1.73m<sup>2</sup>) studies, we compared the performance of three clinical models: model 1 (age, sex, GFR, race and center/randomized group), model 2 (model 1 + albuminuria),

model 3 (model 2 + diabetes, systolic BP, hypertension medication, smoking status) with those incorporating KIM-1, TNFRSF1A and TNFRSF1B. Individuals were stratified by diabetes status and eGFR level.

**Results:** The baseline clinical models had strong risk discrimination for 3-year 40% eGFR decline (C-statistic range for model 3: 0.73-0.89). Baseline levels of KIM-1, TNFRSF1A and TNFRSF1B improved risk prediction among 9,605 ARIC visit 2 participants (where albuminuria was not obtained). Among 2,935 ARIC visit 5 participants, the biomarkers enhanced risk prediction over model 1, except in patients without diabetes. Finally, among 557 AASK participants, the biomarkers added discrimination to model 1 but not to models 2 or 3 (Table 1).

**Conclusions:** Inclusion of KIM-1, TNFRSF1A and TNFRSF1B in clinical models resulted in small but significant improvements in risk prediction for short-term 40% eGFR decline in subgroups of patients at various levels of risk. Model improvement for 40% eGFR decline was more consistent among patients with diabetes and eGFR<60 ml/min/1.73 m<sup>2</sup>, and before inclusion of albuminuria.

**Funding:** Other NIH Support - R01 DK124399, K24 HL155861

Cohort	N	# of events	Model	Base Model C	Protein Model C	C Difference	P
<b>ARIC Visit 2</b>							
Overall	9,605	94	1	0.79 (0.74-0.85)	0.85 (0.81-0.90)	0.06 (0.03-0.09)	<0.001
			3	0.85 (0.81-0.90)	0.88 (0.84-0.92)	0.03 (0.01-0.04)	0.01
Diabetes	1,325	54	1	0.82 (0.76-0.89)	0.89 (0.85-0.93)	0.07 (0.03-0.11)	0.002
			3	0.84 (0.78-0.90)	0.89 (0.85-0.94)	0.06 (0.02-0.10)	0.004
No Diabetes	8,262	40	1	0.73 (0.63-0.82)	0.79 (0.72-0.87)	0.07 (0.01-0.12)	0.02
			3	0.78 (0.69-0.86)	0.83 (0.76-0.90)	0.05 (0.01-0.10)	0.03
eGFR < 60	206	31	1	0.82 (0.75-0.90)	0.90 (0.84-0.95)	0.07 (0.00-0.15)	0.04
			3	0.89 (0.84-0.94)	0.92 (0.87-0.97)	0.03 (0.00-0.07)	0.08
eGFR > 60	9,399	63	1	0.71 (0.64-0.79)	0.79 (0.73-0.85)	0.08 (0.03-0.12)	0.001
			3	0.80 (0.74-0.87)	0.84 (0.78-0.89)	0.04 (0.01-0.07)	0.02
<b>ARIC Visit 5</b>							
Overall	2,935	126	1	0.69 (0.64-0.74)	0.77 (0.72-0.81)	0.08 (0.04-0.12)	<0.001
			2	0.77 (0.73-0.82)	0.80 (0.76-0.84)	0.03 (0.01-0.06)	0.02
			3	0.82 (0.78-0.86)	0.83 (0.80-0.87)	0.01 (-0.01-0.04)	0.18
Diabetes	837	66	1	0.59 (0.52-0.66)	0.74 (0.67-0.80)	0.15 (0.07-0.22)	<0.001
			2	0.73 (0.66-0.80)	0.76 (0.70-0.82)	0.03 (-0.01-0.07)	0.13
			3	0.73 (0.66-0.80)	0.79 (0.73-0.84)	0.05 (0.011-0.09)	0.01
No Diabetes	2,057	57	1	0.77 (0.70-0.84)	0.79 (0.72-0.85)	0.02 (-0.02-0.05)	0.41
			2	0.82 (0.76-0.88)	0.83 (0.77-0.89)	0.01 (-0.01-0.03)	0.42
			3	0.85 (0.80-0.90)	0.85 (0.80-0.91)	0.00 (-0.02-0.02)	0.97
eGFR<60	768	65	1	0.67 (0.58-0.75)	0.77 (0.70-0.84)	0.10 (0.04-0.17)	0.002
			2	0.80 (0.74-0.87)	0.83 (0.78-0.89)	0.03 (0.00-0.06)	0.08
			3	0.81 (0.75-0.88)	0.84 (0.79-0.89)	0.03 (-0.01-0.07)	0.15
eGFR>60	2,167	61	1	0.62 (0.56-0.69)	0.73 (0.67-0.79)	0.11 (0.03-0.18)	0.004
			2	0.71 (0.65-0.78)	0.75 (0.69-0.81)	0.04 (-0.01-0.09)	0.12
			3	0.80 (0.75-0.85)	0.81 (0.76-0.86)	0.01 (-0.02-0.03)	0.57
<b>AASK</b>							
Overall	557	139	1	0.78 (0.74-0.83)	0.82 (0.78-0.86)	0.04 (0.02-0.07)	0.001
			2	0.83 (0.79-0.87)	0.84 (0.80-0.88)	0.01 (0.00-0.06)	0.10
			3	0.84 (0.80-0.88)	0.85 (0.81-0.88)	0.01 (0.00-0.02)	0.20

Table 1. 40% GFR decline within 3 years. C-statistic improvement after inclusion of KIM-1, TNFRSF1A, TNFRSF1B in model. Model 1= Age, sex, GFR, race and center/randomized treatment group. Model 2 = Model 1 + urine albumin-to-creatinine ratio (ACR)°. Model 3 = Model 2 + diabetes, systolic BP, hypertension medication, current and former smoking, °ACR not available for ARIC visit 2; measured GFR and urine protein-to-creatinine ratio (UPCR) used in AASK.

TH-PO863

Lifestyle, Work, Clinical Parameters, and Kidney Function Decline in a Prospective Cohort With CKD of Uncertain Etiology in Sri Lanka

Edison Lee,<sup>1</sup> Pasan M. Hewavitharane,<sup>2</sup> Sai Liu,<sup>1</sup> Kaitlin E. Harold,<sup>1</sup> Santhushya Hewapathirane,<sup>3</sup> Shuchi Anand,<sup>1</sup> Maria E. Montez-Rath,<sup>1</sup> Stephen L. Schensul,<sup>4</sup> Penny Vlahos,<sup>5</sup> Nishantha Nanayakkara.<sup>2</sup> <sup>1</sup>Stanford University, Stanford, CA; <sup>2</sup>Kandy Teaching Hospital, Kandy, Sri Lanka; <sup>3</sup>University of Peradeniya, Peradeniya, Sri Lanka; <sup>4</sup>University of Connecticut School of Medicine, Farmington, CT; <sup>5</sup>University of Connecticut College of Liberal Arts and Sciences, Storrs, CT.

**Background:** Chronic kidney disease of unknown origin is a leading cause of death for adults living in the dry region of Sri Lanka and in other hotspots throughout the world.

**Methods:** In 2018, we initiated the Kidney Progression Project to prospectively follow 292 persons with CKDu and with CKD-EPI eGFR 20-60ml/min. Using data from 3 years of follow-up, we assessed the rate of kidney function decline by sex, and the association of rapid kidney function decline (>3ml/min annual decline) with baseline lifestyle, residence and clinical parameters.

**Results:** Median eGFR at enrollment was 28ml/min/1.73m<sup>2</sup> among 71 women and 30ml/min/1.73m<sup>2</sup> among 221 men; 91-99% had trace or no proteinuria during follow up. Among women, median serum Na was 143meq/L, uric acid was 6.3mg/dL, and K was 4.5meq/L. Among men, median serum Na was 143, uric acid was 6.9, and K was 4.3. Overall slope of decline was -0.5 [SD 4.9] ml/min/year; 30% of women and 17% of men experienced >3ml/min annual decline. Figure 1 depicts Kaplan-Meier curves for the composite outcome of 30% reduction in eGFR, eGFR<15% and death, stratified by sex. Self-reported hypertension was associated with rapid kidney function decline among men (OR 4.03 (1.81-8.95)); no other variables, e.g., family CKD history, tobacco use, farm work hours, agrochemical application, or serum sodium, were consistently associated with rapid kidney function decline.

**Conclusions:** Overall rate of kidney function decline was slow in this CKDu cohort, similar to other non albuminuric CKD (e.g., in CRIC cohort). Men and women had similar event rates, highlighting the need to re-examine the current understanding of CKDu as disproportionately affecting men. Many exposures were ubiquitous, and thus we could not identify distinct correlates of rapid kidney function loss, implying the need for control populations.

**Funding:** NIDDK Support, Other NIH Support - NIH RO1 DK127138



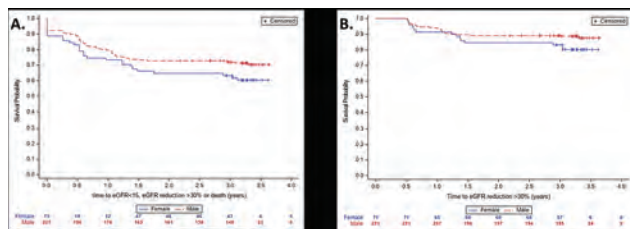

Kaplan-Meier curve showing the probability of (A) the composite outcome of death, eGFR < 15, or eGFR reduction greater than 30%, (B). eGFR reduction by greater than 30%

TH-PO864

Metabolic Biomarkers and Risk of CKD: A Prospective Cohort Study

Tingting Geng, Junxiang Chen, Yan-Feng Zhou, Gang Liu, An Pan. *Huazhong University of Science and Technology Tongji Medical College, Wuhan, China.*

**Background:** The prospective associations between nuclear magnetic resonance (NMR)-based metabolic biomarkers and chronic kidney disease (CKD) have not been scrutinized, which is crucial for understanding the etiological pathways and paving the way toward novel prevention and treatment strategies of CKD. We aimed to examine the associations of NMR-based metabolic biomarkers with risk of CKD using data from the UK Biobank study.

**Methods:** A total of 91,534 participants (mean age 55.3 years, 42.8% men) without CKD and lipid-lowering therapy were followed for a median of 11.5 years. NMR spectroscopy was used to quantify 249 metabolic biomarkers, including routine lipids, lipid concentrations and composition within 14 lipoprotein subclasses, as well as other metabolites. Multivariable-adjusted Cox regression models were used to compute the hazard ratios. We also estimated the predictive performance for the 10-year CKD risk using the selected metabolites by the least absolute shrinkage and selection operator (LASSO) regression.

**Results:** A total of 1846 incident CKD were identified. In general, very-low-density lipoprotein (VLDL) particles were associated with a higher risk of CKD whereas high-density lipoprotein (HDL) particles were associated with a lower risk of CKD. Similar patterns of cholesterol, lipids, and phospholipids in VLDL and HDL with risk of CKD were observed. Triglycerides within all lipoproteins, including all HDL particles were associated with a higher risk of CKD. However, we did not observe significant associations of LDL particles or lipids measures, except for triglycerides and free cholesterol in LDL, with risk of CKD. Adding metabolic biomarkers selected by LASSO, including histidine, isoleucine, albumin, glucose, omega-3 fatty acids to total fatty acids percentage, docosahexaenoic acid to total fatty acids percentage, glycoprotein acetyls, phospholipids to total lipids in very small VLDL percentage, and triglycerides to total lipids in large LDL percentage to the clinical variable-based model improved discrimination (C-statistic from 0.820 to 0.831, P<0.001) for prediction of 10-year CKD incidence.

**Conclusions:** Circulating lipids, lipoprotein and metabolites were associated with risk of CKD, suggesting that these metabolites may be involved in the pathogenesis of CKD. Selected NMR-based biomarkers could enhance the prediction of CKD.

**Funding:** Government Support - Non-U.S.

TH-PO865

Mitochondrial DNA Haplotypes and Risk of CKD and AKI

Vasanth Jotwani,<sup>1</sup> Mark J. Sarnak,<sup>3</sup> Heather Thiessen Philbrook,<sup>2</sup> Ronit Katz,<sup>4</sup> Joachim H. Ix,<sup>5</sup> Sushrut S. Waikar,<sup>6</sup> Chirag R. Parikh,<sup>2</sup> Gregory J. Tranah,<sup>8</sup> Samir M. Parikh,<sup>7</sup> Michael Shlipak,<sup>1</sup> Dan Arking.<sup>2</sup> <sup>1</sup>University of California San Francisco, San Francisco, CA; <sup>2</sup>Johns Hopkins University, Baltimore, MD; <sup>3</sup>Tufts University, Medford, MA; <sup>4</sup>University of Washington, Seattle, WA; <sup>5</sup>University of California San Diego, La Jolla, CA; <sup>6</sup>Boston University, Boston, MA; <sup>7</sup>The University of Texas Southwestern Medical Center, Dallas, TX; <sup>8</sup>California Pacific Medical Center, San Francisco, CA.

**Background:** Experimental models suggest an important role for mitochondrial dysfunction in the pathogenesis of chronic kidney disease (CKD) and acute kidney injury (AKI), but little is known regarding the impact of mitochondrial genetic variation on kidney health. We evaluated associations of inherited mitochondrial DNA (mtDNA) haplotypes with risk of CKD and AKI in a large population-based cohort.

**Methods:** Among UK Biobank participants who self-identified as white, we tested eight distinct mtDNA haplotypes (N=379,432) with minor allele frequency >0.5% that were previously identified based on associations with traits associated with mtDNA copy number. Individuals with prevalent end-stage kidney disease were excluded. We used linear and logistic regression models to evaluate associations of these mtDNA haplotypes with estimated glomerular filtration rate by serum creatinine and cystatin C (eGFR, N=362,802), AKI defined by diagnostic codes (N=14,170 cases), and urine albumin/creatinine ratio (ACR, N=114,662).

**Results:** The mean age was 57±8 years and the mean eGFR was 90±14 ml/min/1.73m<sup>2</sup>. MtDNA haplotype was significantly associated with eGFR (p= 2.84E-12), but not with risk of AKI (p=0.256) or urine ACR (p=0.538). The association of mtDNA haplotype with eGFR remained significant after adjustment for diabetes mellitus and hypertension (p=1.20E-10). When compared to the reference haplotype, mtDNA haplotypes I, IV, and V were each associated with higher eGFR (Table).

**Conclusions:** Among self-identified white UK Biobank participants, mtDNA haplotype was associated with eGFR, but not with AKI risk or albuminuria.

**Funding:** NIDDK Support, Other NIH Support - NIA 2R01AG027002

Table: Associations of mitochondrial DNA haplotypes with eGFR (ml/min/1.73m<sup>2</sup>) among UK Biobank participants

mtDNA haplotype	N (%)	β Coefficient	P-Value
Reference	150790 (40)	—	—
I	13467 (4)	0.402	2.74E-4
II	8892 (2)	0.122	0.418
III	34453 (9)	-0.144	0.0503
IV	34801 (9)	0.430	4.22E-8
V	104630 (28)	0.233	2.69E-6
VI	14450 (4)	0.172	0.109
VII	19849 (5)	0.162	0.0807
<b>P-Value for model</b>			<b>2.84E-12</b>

Model adjusts for age, sex, center, principal components, and genotyping array. Beta coefficients compare each displayed mtDNA haplotype to the reference mtDNA haplotype. Abbreviations: CKD, chronic kidney disease; CI confidence interval; eGFR, estimated glomerular filtration rate by combined CKD-EPI equation for serum creatinine and cystatin C.

TH-PO866

MR Imaging-Based Kidney Parameters in the Population-Based German National Cohort Study

Peggy Sekula, Jan Lipovsek, Elias Kellner, Anna Kottgen. on behalf of the Project Team Medical Center - University of Freiburg, Freiburg, Germany.

**Background:** Chronic kidney disease (CKD) affects around 10% of adults worldwide. Imaging is an emerging and complementary approach to derive markers of kidney function, CKD and CKD progression. The goal of our project was to derive novel imaging markers of the kidneys through automated kidney segmentation from whole-body MR images of a subgroup of participants of the large, population-based German National Cohort (NAKO/GNC) study, and to examine their distributions and associations with other characteristics.

**Methods:** Using MR images of 11207 GNC participants and functionalities of the imaging platform NORA (www.nora-imaging.org), a workflow to train a convolutional neural network was developed to automatically segment different kidney compartments (cortex, hilus, medulla). Volumetric parameters (mL) for compartments and total kidney volume (TKV) were normalised to body-surface-area (BSA, m<sup>2</sup>) and related to demographic variables and estimated glomerular filtration rate (eGFR) based on serum creatinine and cystatin C.

**Results:** Quality control left data of 9955 participants for analysis. The mean (SD) TKV was 339 (+/-56) mL for men and 276 (+/-46) mL for women. On average, right kidneys were 5% smaller than left kidneys. The compartment volumes showed different patterns across age, with medullary volume decreasing and hilus increasing. In multivariable linear regression analyses (Table), BSA-corrected TKV was positively associated with age, sex, height and body mass index (BMI). The inclusion of eGFR strongly improved the proportion of explained variance in BSA-corrected TKV and compartments (R<sup>2</sup>=33-36%). For example, per 1 mL/min/1.73m<sup>2</sup> higher eGFR, the BSA-corrected TKV was higher by 0.99 mL/m<sup>2</sup>.

**Conclusions:** The developed framework allows for robust segmentation of kidneys from MR images of a large cohort study. TKV and compartment volumes of the kidney show correlations with various participants' characteristics that are consistent with prior knowledge and with eGFR.

**Funding:** Government Support - Non-U.S.

BSA-corrected marker:	TKV (R <sup>2</sup> =33%)	Cortex (R <sup>2</sup> =35%)	Medulla (R <sup>2</sup> =36%)	Hilus (R <sup>2</sup> =30%)				
Variable:	Effect estimate	P-value	Effect estimate	P-value	Effect estimate	P-value	Effect estimate	P-value
Age, years	0.47	8.4E-45	0.47	2.1E-78	0.00	8.4E-01	0.31	4.8E-176
Sex, male	8.50	1.4E-25	11.4	4.1E-71	-2.53	4.5E-14	3.74	2.5E-45
Height, cm	0.16	4.7E-04	0.11	8.8E-04	0.05	1.2E-02	0.10	6.9E-13
BMI (kg/m <sup>2</sup> )	0.17	1.0E-02	0.61	4.8E-36	-0.45	7.3E-64	0.25	1.1E-33
eGFR (ml/min/1.73m <sup>2</sup> )	0.99	8.5E-300	0.66	1.3E-250	0.32	4.3E-206	0.11	6.4E-45

Bold P-values <0.05

TH-PO867

New Surrogate Marker of CKD Progression and Mortality in Medical Word Virtual Space: Prospective Cohort Study

Eiichiro Kanda,<sup>1</sup> Bogdan I. Epureanu,<sup>2</sup> Taiji Adachi,<sup>3</sup> Naoki Kashihara.<sup>1</sup> <sup>1</sup>Kawasaki Ika Daigaku, Kurashiki, Japan; <sup>2</sup>University of Michigan, Ann Arbor, MI; <sup>3</sup>Kyoto Daigaku, Kyoto, Japan.

**Background:** Chronic kidney disease (CKD) leads to end-stage renal disease (ESRD) or death. A new surrogate marker reflecting its pathophysiology has been needed for CKD therapy.

**Methods:** In this study, we developed a virtual space unifying data in the medical literature and that of actual CKD patients and created a surrogate marker of CKD progression and mortality using natural language processing.

**Results:** A virtual space of medical words was constructed from the CKD-related literature (n=165,271) using natural language processing, in which CKD-related words (n=106,612) composed a network (Figure 1). The data of CKD patients of a prospective cohort study for three years (n=26,433) were transformed into the space and linked with the network on the basis of information-geometry theory. We let the relationship between a patient and the outcome (ESRD or death) in the network be a surrogate marker of the outcome. The network satisfied the definitions of vector keeping their medical meanings. Riemannian metrics highly accurately predicted the primary outcomes; C-statistics, 0.911. Cox proportional hazards models with spline showed that the high Riemannian metrics were associated with high hazard ratio of the primary outcomes (p<0.0001). Moreover, the risk of the primary outcome in high-Riemannian-metric group was 21.92 (95% CI: 14.77, 32.51) times higher than that in the low-Riemannian-metric group.

**Conclusions:** The medical-word virtual space reflects the real-world patient data. And the Riemannian metrics between a patient and the outcome is a new surrogate marker for CKD therapy.

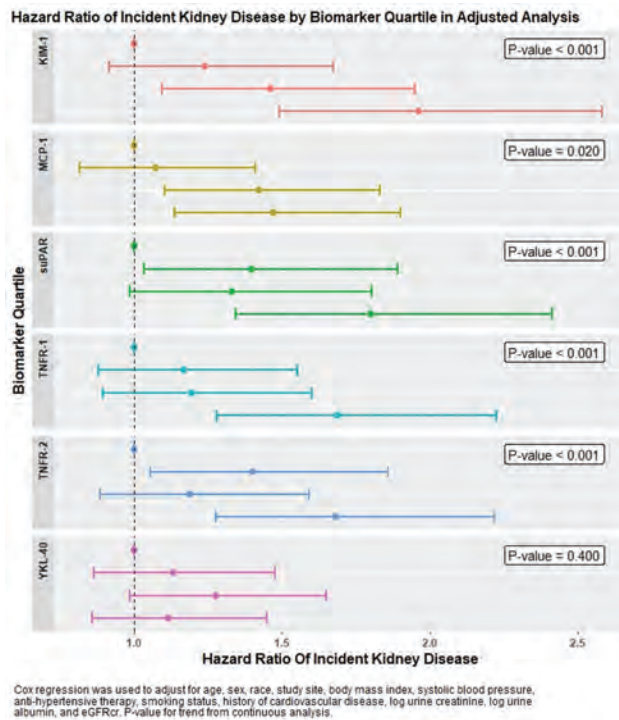
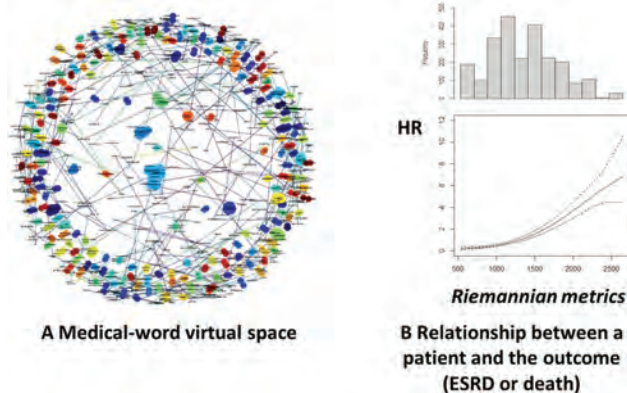

TH-PO868

**Plasma KIM-1, MCP-1, suPAR, TNFR1, and TNFR2 Are Associated With Incident CKD in Individuals Without Diabetes**  
 Dustin Le. Chronic Kidney Disease Biomarkers Consortium Johns Hopkins Medicine, Baltimore, MD.

**Background:** Numerous kidney biomarkers related to tubular injury, inflammation, and repair have been associated with kidney disease progression in patients with diabetes and underlying chronic kidney disease (CKD). Whether these markers are associated with incident CKD in a general population without diabetes is not well established.

**Methods:** In a nested case-cohort study within the Atherosclerosis Risk in Communities (ARIC) study, we evaluated the association of plasma biomarkers related to tubular injury (kidney injury molecule-1 [KIM-1]), inflammation (monocyte chemoattractant protein-1[MCP-1], soluble urokinase plasminogen activator receptor [suPAR]), tumor necrosis factor receptor 1 [TNFR-1], tumor necrosis factor receptor 2 [TNFR-2]), and repair (human cartilage glycoprotein-39 [YKL-40]) and risk of incident CKD among individuals with baseline eGFR  $\geq$  60 mL/min and no diabetes. Biomarkers were measured at visit 4 (1996-1998). Incident CKD was defined as eGFR <60 mL/min per 1.73 m<sup>2</sup> and  $\geq$  40% eGFR decline at visit 5 (2011- 2013) or end stage kidney disease through linkage with the USRDS registry.

**Results:** There were 523 incident CKD cases (38 being ESRD) and 425 non-cases. Mean age was 62 years, 59% were women, and 20% were black. Mean baseline eGFR was 88 (5<sup>th</sup>- 95<sup>th</sup> percentile: 66 - 108). In multivariable analyses, there was a higher risk of incident CKD per two-fold higher concentration of KIM-1 (HR 1.35, 95% CI: 1.22 - 1.50), MCP-1 (HR 1.36, 95% CI: 1.12 - 1.65), suPAR (HR 1.69, 95% CI: 1.37 - 2.08), TNFR-1 (HR 1.54, 95% CI: 1.32 - 1.80), and TNFR-2 (HR 1.69, 95% CI: 1.35 - 2.11). See Figure for results by biomarker quartile. YKL-40 was not significant.

**Conclusions:** Higher plasma levels of KIM-1, MCP-1, suPAR, TNFR-1, and TNFR-2 were associated with increased risk of incident CKD in a general population study.

**Funding:** NIDDK Support, Other NIH Support - NHLBI, NIA

TH-PO869

**The Associations of Kidney Functional Magnetic Resonance Imaging Biomarkers of Oxygenation and Fibrosis With Inflammatory Biomarkers in Individuals With Advanced CKD**

Jacquelyn Trujillo,<sup>1</sup> Manal Alotaibi,<sup>1</sup> Nay Seif,<sup>1</sup> Xuan Cai,<sup>1</sup> Brett Larive,<sup>2</sup> Jennifer J. Gassman,<sup>2</sup> Kalani L. Raphael,<sup>3</sup> Dominic S. Raj,<sup>4</sup> Linda F. Fried,<sup>5</sup> Stuart M. Sprague,<sup>6</sup> Geoffrey A. Block,<sup>10</sup> Michel Chonchol,<sup>7</sup> John P. Middleton,<sup>8</sup> Myles Wolf,<sup>8</sup> Joachim H. Ix,<sup>9</sup> Pottumarthi V. Prasad,<sup>6</sup> Tamara Isakova,<sup>1</sup> Anand Srivastava.<sup>1</sup> <sup>1</sup>Northwestern University Feinberg School of Medicine, Chicago, IL; <sup>2</sup>Cleveland Clinic, Cleveland, OH; <sup>3</sup>Oregon Health & Science University, Portland, OR; <sup>4</sup>The George Washington University School of Medicine and Health Sciences, Washington, DC; <sup>5</sup>University of Pittsburgh School of Medicine, Pittsburgh, PA; <sup>6</sup>NorthShore University HealthSystem, Evanston, IL; <sup>7</sup>University of Colorado Denver School of Medicine, Aurora, CO; <sup>8</sup>Duke University School of Medicine, Durham, NC; <sup>9</sup>University of California San Diego School of Medicine, La Jolla, CA; <sup>10</sup>US Renal Care, Dallas, TX.

**Background:** Chronic kidney hypoxia and tubulointerstitial fibrosis promote chronic inflammation, which may lead to worsening CKD progression. There is limited data on the associations between non-invasive markers of kidney oxygenation and fibrosis with inflammation.

**Methods:** We evaluated the association of baseline kidney functional magnetic resonance imaging (fMRI) biomarkers of oxygenation and fibrosis with interleukin-6 (IL-6) and C-reactive protein (CRP) in 127 participants from the COMBINE trial, which was a randomized, 12-month study of nicotinamide and lanthanum carbonate vs. placebo in individuals with CKD stages 3-4. Higher cortical relaxation rate (R2\*) on BOLD MRI may represent decreased oxygenation. Lower cortical apparent diffusion coefficient (ADC) on diffusion-weighted MRI may indicate greater fibrosis. Multivariable linear regression models tested the associations between kidney fMRI and inflammatory biomarkers at baseline. Linear mixed effects models tested the association of baseline kidney fMRI biomarkers with change in inflammatory biomarkers over time.

**Results:** At baseline, mean $\pm$ SD eGFR, R2\*, and ADC was 32.2 $\pm$ 8.7 mL/min/1.73m<sup>2</sup>, 20.3 $\pm$ 3.1 s<sup>-1</sup>, 1.46 $\pm$ 0.17 mm<sup>2</sup>/s, respectively. Median [IQR] IL-6 and CRP was 3.7 [2.4-4.9] pg/mL and 2.8 [1.2-6.3] mg/L. At baseline, cortical R2\* did not have a significant association with IL-6 or CRP, but higher ADC was associated with lower IL-6 and CRP (Figure 1A). Mean annual IL-6 and CRP slope were 0.98 (95% CI 0.85-1.12) pg/mL per year and 0.91 (95% CI 0.79-1.06) mg/L per year, respectively. Cortical ADC and R2\* did not have significant associations with change in IL-6 or CRP over time (Figure 1B).

**Conclusions:** In individuals with advanced CKD, higher cortical ADC, suggestive of less cortical fibrosis, was associated with lower inflammation, as assessed by IL-6 and CRP. Kidney fMRI biomarkers did not associate with change in inflammatory biomarkers over time.

**Funding:** NIDDK Support

**Figure 1A.** Associations of baseline kidney MRI biomarkers with serum IL-6 and CRP.

Corical ADC	% difference (95% CI)	P
IL-6	-13.1 (-23.8 - -1.17)	0.03
CRP	-27.3 (-41.8 - -9.25)	0.003

Adjusted for age, sex, race, diabetes status, baseline log transformed UACR, and baseline eGFR. The percent difference in the inflammatory biomarker of interest is per 1 SD increase in the MRI biomarker of interest. Percent differences in each inflammatory biomarker were calculated by raising 2 to the power of the beta-coefficient, subtracting 1, and multiplying by 100 [(2<sup>β</sup> - 1) \* 100] for each respective from the linear regression model.

**Figure 1B.** Associations of baseline kidney MRI biomarkers with change in serum IL-6 and CRP over time.

IL-6	β	95% CI	P
IL-6	-0.001	(-0.001, 0.000)	0.000
CRP	-0.001	(-0.001, 0.000)	0.000

Each model is adjusted for age, sex, race, diabetes status, treatment group, study center, baseline log transformed UACR, baseline eGFR, and respective log transformed inflammation biomarker. The β estimate is the difference in each respective mean annual inflammation biomarker slope per 1 SD increase in the MRI biomarker of interest from the respective MRI biomarker x time interaction term.

**TH-PO870**

**Characteristics and Patient-Reported Outcomes of Advanced CKD Patients Treated With Conservative Management vs. Dialysis: Findings From the Prospective NIH OPTIMAL Cohort**

Connie Rhee,<sup>1</sup> Ji Hoon Yoon,<sup>1</sup> Yuhei Otobe,<sup>1</sup> Susan T. Crowley,<sup>2</sup> Csaba P. Kovacs,<sup>3</sup> Dana B. Mukamel,<sup>1</sup> Yoko Narasaki,<sup>1</sup> Alejandra Novoa-Vargas,<sup>1</sup> Silvana Torres Rivera,<sup>1</sup> Amy S. You,<sup>1</sup> Danh V. Nguyen,<sup>1</sup> Kamyar Kalantar-Zadeh.<sup>1</sup> <sup>1</sup>University of California Irvine, Irvine, CA; <sup>2</sup>Yale University, New Haven, CT; <sup>3</sup>The University of Tennessee Health Science Center VolShop Memphis, Memphis, TN.

**Background:** Dialysis is linked with high early mortality, frequent hospitalizations, and high withdrawal in certain groups, catalyzing interest in conservative management (CM) as an alternative treatment option for advanced CKD. We conducted an interim analysis of the prospective NIH OPTIMAL cohort examining patient-centered outcomes in advanced CKD patients treated with CM vs. dialysis.

**Methods:** We conducted an interim analysis of the prospective NIH OPTIMAL cohort comparing CM vs. dialysis preparation on the longitudinal trajectory of HRQOL, physical function, symptom burden, and nutrition in advanced CKD patients. We examined clinical characteristics and patient-reported outcomes (PROs) among the 1<sup>st</sup> 18 enrolled patients undergoing comprehensive, holistic CM vs. dialysis preparation encompassing commensurate education, nutrition guidance, symptom management, and social support.

**Results:** Baseline Short Form 36 HRQOL assessments showed low (worse) physical/mental component summary scores, as well as lower subscale scores (Table 1). Human Activity Profile surveys showed high prevalence of low/moderate self-reported activity levels, and Short Physical Performance Battery assessments showed relatively low physical performance. While the Dialysis Symptom Index showed high symptom burden in the cohort, Malnutrition Inflammation Score surveys showed preserved nutritional status.

**Conclusions:** The next phases in the OPTIMAL study will compare hard and patient-centered outcomes among patients receiving CM vs. dialysis preparation, and will identify which patients will most benefit from these advanced CKD management strategies.

**Funding:** NIDDK Support

Age, mean ± SD (yrs)	67.1 ± 13.6
Sex, %	
Male	56%
Female	44%
Race/Ethnicity, %	
Hispanic White	28%
Non-Hispanic White	39%
Asian	33%
Comorbidities*, %	
Diabetes	39%
Hypertension	100%
Coronary artery disease	11%
Congestive heart failure	22%
Atrial fibrillation	6%
Peripheral vascular disease	6%
Malignancy	28%
Medications, %	
RAAS inhibitors	33%
Potassium binders	17%
SGLT2 inhibitors	11%
Diuretics	44%
Sodium bicarbonate	17%
Laboratory values, median (IQR)	
eGFR (ml/min/1.73m <sup>2</sup> )	22 (22, 24)
Patient-Centered Outcomes: Median (IQR) or %	
Short Form 36 HRQOL score	
-Physical Component Score	55 (49, 64)
-Mental Component Score	59 (47, 60)
-Subscales	
*Physical Functioning	60 (40, 85)
*Role Limitations due to Physical Health	50 (40, 85)
*Role Limitations due to Emotional Problems	100 (0, 100)
*Energy/Fatigue	55 (35, 65)
*Emotional Well-Being	92 (68, 96)
*Social Functioning	87.5 (75, 100)
*Pain	100 (70, 100)
*General Health	55 (25, 60)
Human Activity Profile score	
-High Activity (AAS >73)	18%
-Moderate Activity (AAS 54-73)	45%
-Low Activity (AAS <54)	36%
Short Physical Performance Battery Score	
-Total score	10 (6, 12)
Dialysis Symptom Index	
-Overall median (IQR) score	123 (104, 132)
Malnutrition Inflammation Score	
-Total score	2.6 (1.1, 4.5)

\*May have multiple co-existing values.

Abbrev.: AAS, Adjusted Activity Score; HRQOL, health related quality of life; RAAS, renin angiotensin aldosterone system; SGLT2, sodium glucose cotransporter-2

**TH-PO871**

**Comorbidity Trends in US Veterans With Advanced CKD Patients Treated With Conservative Management vs. Dialysis**

Yoko Narasaki,<sup>1</sup> Connie Rhee,<sup>1</sup> Susan T. Crowley,<sup>2</sup> Csaba P. Kovacs,<sup>3</sup> Dana B. Mukamel,<sup>1</sup> Amy S. You,<sup>1</sup> Ji Hoon Yoon,<sup>1</sup> Danh V. Nguyen,<sup>1</sup> Kamyar Kalantar-Zadeh.<sup>1</sup> <sup>1</sup>University of California Irvine, Irvine, CA; <sup>2</sup>Yale University, New Haven, CT; <sup>3</sup>The University of Tennessee Health Science Center, Memphis, TN.

**Background:** While dialysis has been the dominant treatment paradigm for ESKD, this approach may not offer survival benefit nor improved quality of life in certain subgroups (comorbid, elderly). We examined comorbidity trends in a contemporary cohort of US Veterans with advanced CKD treated with dialysis vs. conservative management (CM).

**Methods:** In a national cohort of US Veterans, we examined patients with advanced CKD (≥2 eGFRs <25ml/min/1.73m<sup>2</sup> separated by ≥90 days from 10/2010-9/2019). Using linked USRDS and Medicare (CMS) data, we compared comorbidity trends among patients categorized according to receipt of CM, defined as those who did not receive dialysis within 2-years of the index eGFR (1<sup>st</sup> eGFR <25), vs. receipt of dialysis within 2-years of the index eGFR.

**Results:** Among 106,089 advanced CKD patients who met eligibility, 25% and 75% were treated with dialysis vs. CM, respectively. Compared to the dialysis group, CM patients tended to be younger; were more likely to be White; and less likely to be Black or Hispanic. Median (IQR) Charlson Comorbidity Index (CCI) scores in the dialysis vs. CM groups were 7 (6, 9) and 7 (5, 9), respectively (Fig A). Using CMS Chronic Conditions Data Warehouse algorithms, the most prevalent comorbidities in the dialysis group were diabetes (77%), CHF (65%), PVD (50%), CVD (36%), and history of MI (35%) (Fig B). Among the CM group, the most common comorbidities were diabetes (65%), CHF (58%), COPD (50%), PVD (46%), and CVD (37%).

**Conclusions:** Among US Veterans with advanced CKD, while there were socio-demographic differences among the dialysis vs. CM groups, comorbidity burden defined by CCI score and types of comorbidities were similar. Further studies are needed to identify the clinical phenotype of patients who will most benefit from dialysis vs. CM.

**Funding:** NIDDK Support

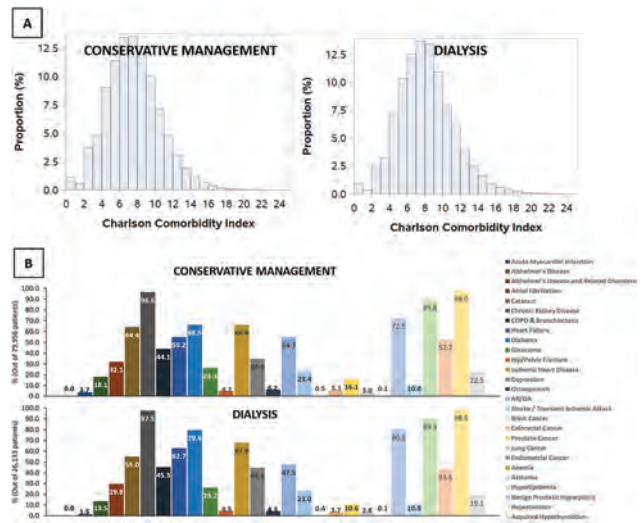

**TH-PO872**

**Lower Glomerular Filtration Rate and Higher Albuminuria Are Associated With Incident Atrial Fibrillation: A Systematic Review and Meta-Analysis**

Jeffrey Ha,<sup>1,2</sup> Ben Freedman,<sup>3</sup> Dearbhla M. Kelly,<sup>4</sup> Brendon L. Neuen,<sup>1,2</sup> Vlado Perkovic,<sup>2</sup> Min Jun,<sup>1,2</sup> Sunil Badve.<sup>1,2</sup> <sup>1</sup>The George Institute for Global Health, Newtown, NSW, Australia; <sup>2</sup>University of New South Wales, Sydney, NSW, Australia; <sup>3</sup>Heart Research Institute Ltd, Newtown, NSW, Australia; <sup>4</sup>Massachusetts General Hospital, Boston, MA.

**Background:** In patients with atrial fibrillation (AF), the risk of stroke and mortality increases with worsening estimated glomerular filtration rate (eGFR). The purpose of this systematic review was to study the independent associations of eGFR and albuminuria with incident AF.

**Methods:** MEDLINE, EMBASE and CENTRAL databases were searched for cohort studies and randomized controlled trials that reported incident AF in adults according to baseline measurements of eGFR or albuminuria. From cohort studies, multivariable-adjusted risk ratios (RR) were extracted. For each trial, RRs and 95% CIs for eGFR and albuminuria categories were derived from meta-analysis using reported event data. The outcome of incident AF was analyzed separately among patients with decreased eGFR and increased albuminuria using random effects meta-analysis. If studies reported more than one estimate of the association for different eGFR and albuminuria categories, a

within-study summary risk estimate was obtained. Subgroup analyses according to eGFR and albuminuria categories were conducted to explore sources of heterogeneity.

**Results:** Thirty-five studies involving 26,840,893 participants with 436,304 incident AF cases were included. Compared to participants with eGFR  $\geq 60$  and  $\geq 90$  mL/min/1.73 m<sup>2</sup>, the risk of incident AF was increased among participants with eGFR  $\leq 59$  mL/min/1.73m<sup>2</sup> (16 studies, RR 1.56, 95% CI 1.34 – 1.81, I<sup>2</sup>= 70%), and eGFR  $\leq 89$  mL/min/1.73m<sup>2</sup> (11 studies, RR 1.49, 95% CI 1.28 – 1.74, I<sup>2</sup>=67%), respectively. Compared to participants with no albuminuria, the risk of incident AF was greater among participants with albuminuria (3 studies, RR 1.37, 95% CI 1.18 – 1.60, I<sup>2</sup>=0%). Compared to those with normal to mildly increased albuminuria, risk of incident AF was greater for participants with moderately- to severely-increased albuminuria (6 studies, RR 1.67, 95% CI 1.28 – 2.17, I<sup>2</sup>=75%). Subgroup analyses showed that incident AF risk increased progressively at lower eGFR and higher albuminuria categories.

**Conclusions:** Lower eGFR and higher albuminuria are independent risk factors for incident AF. Additional studies are required to evaluate whether systematic screening for AF leads to improved outcomes in patients with chronic kidney disease.

**TH-PO873**

**Association Between Dietary Magnesium Intake and Incident CKD**

Hee Byung Koh, Ga Young Heo, Hyo Jeong Kim, Ye Eun Ko, Shin-Wook Kang, Jung Tak Park. *Yonsei University College of Medicine, Seodaemun-gu, Seoul, Republic of Korea.*

**Background:** Recent studies suggest a close association between low serum magnesium levels and kidney injury. However, whether dietary magnesium intake relates with kidney function is not well known. In this study, the relationship of dietary magnesium intake with the development of chronic kidney disease (CKD) was evaluated.

**Methods:** This observational study screened 210,984 European adults aged 40-70 who underwent dietary questionnaires from April 2009 to June 2012 in the UK Biobank cohort. Participants with underlying CKD (baseline eGFR < 60 mL/min/1.73 m<sup>2</sup> or urine albumin-to-creatinine ratio >30mg/g/Cr) or dietary energy intake <500 kcal or >6000 kcal were excluded. Dietary magnesium intake was assessed through online 24-hour recall dietary questionnaire and adjusted for energy intake using residual method. The participants were categorized into quartiles according to energy-adjusted dietary magnesium intake. Primary outcome was incident CKD diagnosed through ICD-10 and OPCS-4 codes. Sensitivity analysis was performed with outcome of CKD defined as eGFR <60 mL/min/1.73 m<sup>2</sup>.

**Results:** A total of 144,408 participants were included in the final analysis. The mean age was 55.8 ± 8.0 years and 51.8 % were female. Average magnesium intake amount per person was 352.0 ± 118.7 mg/day. During a 1431716.4 person-year follow-up, CKD outcome occurred in 4,438 patients. Incidence of CKD was progressively lower in patients with higher magnesium intake (3.5%, 3.1%, 2.9%, and 2.7% in Q1-4, respectively). Cox regression analysis revealed that the hazard ratios (HRs) for incident CKD decreased in a stepwise manner towards higher magnesium intake quartiles (1Q: HR, 0.90; 95% CI, 0.83-0.97; 2Q: HR, 0.83; 95% CI, 0.77-0.90; 3Q: HR, 0.80; 95% CI, 0.74-0.87) relative to 4Q (P for trend <0.001). This association was maintained even after adjustments were made for confounding factors. Similar results were observed with eGFR-defined CKD outcome (1Q: adjusted HR [AHR], 0.93; 95% CI, 0.84-1.04; 2Q: AHR, 0.86; 95% CI, 0.76-0.96; 3Q: AHR, 0.83; 95% CI, 0.74-0.94) relative to 4Q (P for trend =0.002).

**Conclusions:** Higher intake of dietary magnesium may relate with lower risk of kidney function decline in adults with normal kidney function.

**TH-PO874**

**Patterns of Gut Microbiota and Metabolites in CKD: The CRIC Study**

Amanda H. Anderson,<sup>1,2</sup> Robin L. Baudier,<sup>1</sup> Scott G. Daniel,<sup>4</sup> Lillian Chau,<sup>2</sup> Lisa C. Nessel,<sup>2</sup> James P. Lash,<sup>3</sup> Anne Frydrych,<sup>3</sup> Harold I. Feldman,<sup>2</sup> Kyle Bittinger,<sup>4</sup> Tanika Kelly,<sup>1</sup> Jiang He,<sup>1</sup> Gary Wu.<sup>2</sup> *The CRIC Study* <sup>1</sup>Tulane University, New Orleans, LA; <sup>2</sup>University of Pennsylvania Perelman School of Medicine, Philadelphia, PA; <sup>3</sup>University of Illinois Chicago, Chicago, IL; <sup>4</sup>The Children's Hospital of Philadelphia, Philadelphia, PA.

**Background:** The gut microbiome is altered in numerous disease conditions but its importance in the setting of moderate chronic kidney disease (CKD) remains to be elucidated.

**Methods:** Among 291 men and women with CKD (58% with diabetes; mean estimated glomerular filtration rate (eGFR): 56 mL/min/1.73m<sup>2</sup>; 56 repeat stool collections) enrolled in the Chronic Renal Insufficiency Cohort (CRIC) Study, shotgun metagenomic sequencing and targeted fecal metabolite assays were performed. For genera associations, 148 genera present in  $\geq 5\%$  of samples that comprised  $\geq 0.01\%$  of total reads were included.

**Results:** Beta diversity (Euclidean distance, Bray Curtis dissimilarity and unweighted Jaccard similarity index) was related to eGFR and its change over time using the Optimal Microbiome Regression-based Kernel Association Test (Figure 1; each P $\leq 0.001$ ). Nearly all fecal measures of amino acids, bile acids, short-chain fatty acids and urea were significantly associated with beta diversity at a false discovery rate (FDR) <0.05. eGFR was inversely correlated with alpha diversity (ACE: each P<0.001). Five genera including *Lawsonella* (phylum: Actinobacteria), *Hymenobacter* (Bacteroidetes), *Neisseria* and *Halomonas* (phylum: Proteobacteria), and *Methanosphaera* (phylum: Euryarchaeota), as well as caproic acid levels were associated with eGFR by linear regression independent of age, sex, race, diabetes, and systolic blood pressure at an FDR <0.05. Twenty-six genera were independently associated with eGFR change prior to FDR adjustment. Various genera were independently associated with amino (Figure 2) and bile acids (not shown) at an FDR threshold of <0.05 by tobit regression.

**Key: TH - Thursday; FR - Friday; SA - Saturday; OR - Oral; PO - Poster; PUB - Publication Only**  
**Underline represents presenting author.**

**Conclusions:** These findings suggest possible pathways through which CKD may influence health.

**Funding:** NIDDK Support

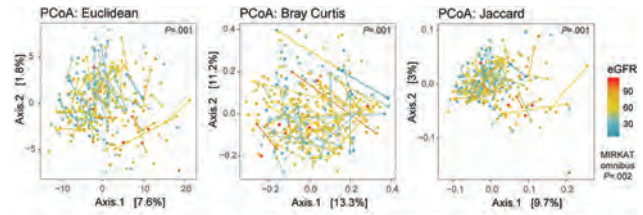

**Figure 1. Strength of association between Beta Diversity and eGFR among those with chronic kidney disease with inclusion of multiple time points. Lines denote repeat stool collections 1-3 were apart among the same participant**

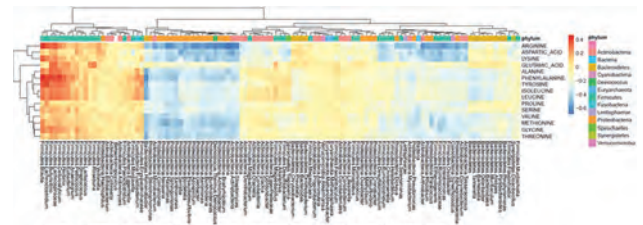

**Figure 2. Heatmap of genera independently associated with amino acids related to Beta Diversity.**

**TH-PO875**

**Peri and Para-Renal Fat Tissue and Risk of CKD in Morbid Obese Patients**

Natasha Smiliansky, Sofia San Román, Gabriela Ottati, Gustavo Bruno, Mariela Garau, Oscar A. Noboa, Veronica Etchegoimberly. *UDELAR, Hospital de Clinicas, Montevideo, Uruguay.*

**Background:** Obesity is known as a global pandemic. Multiple studies had determined obesity as an independent risk factor to the initiation and progression of CKD. The measurement of peri and para-renal fat thickness could reflect the visceral fat accumulation associated with kidney function impairment. The aim of this study is to determine the association of para and peri-renal ultrasonographic fat thickness (PUFT) with some cardiovascular and kidney damage markers in morbid obese patients.

**Methods:** This study was performed with morbid obese patients in bariatric surgery preoperative evaluation. The sonograms were performed by a single technician, to decrease the inter operator variability. It was measured the perirenal fat thickness from the inner side of the abdominal wall to the external edge of each kidney with a convex transducer (3-5 MHz), this measurement was taken twice to insure results. The average of the sonographic measurements to both sides was defined as PUFT

**Results:** 44 patients were analyzed, 86.4% of the population studied were women, with a mean age of 45 (±11.2) years. 65.9% of the patients were hypertensive and 36.4% diabetic. The average BMI was 50.4 (± 8.1) in a range between 35 and 71.6 kilogram square meter. The PUFT was correlated with BMI (p=0.007) and with visceral fat thickness (p<0.001) with a significance level of 0.05. Albuminuria and PUFT were correlated (p=0.006) even in non-diabetic patients (p=0.018). Estimated glomerular filtration rate (eGFR) was not correlated with PUFT (p=0.735), but when categorizing individuals according to eGFR (< 60 ml/min, between 60-120 ml/min, >120 ml/min), there was a correlation between hyperfiltration patients and PUFT (p=0.0039). Spearman correlation was performed. When correlating uricemia and PUFT through Pearson's r coefficient, the value was 0.316, (p=0.047), indicating that there is a weak association. The PUFT did not show association with TC, LDL, HDL or TG.

**Conclusions:** The sonographic perirenal fat thickness (PUFT) measurements could be considered as an accessible and least invasive method to predict kidney damage in morbid obese patients. It has an equivalence to BMI and other traditional anthropometric indexes as an accurate parameter of visceral fat thickness

**Funding:** Other NIH Support - Fondo de investigación en nefrología, Hospital de Clinicas, UDELAR

**TH-PO876**

**Association Between Family History of CKD and Incidence and Progression of CKD: A Nationwide Family Cohort Study in South Korea**

Jae Young Kim,<sup>1,2</sup> Tae ik Chang.<sup>1</sup> *<sup>1</sup>National Health Insurance Service Ilsan Hospital, Goyang, Gyeonggi-do, Republic of Korea; <sup>2</sup>Yonsei University College of Medicine, Seodaemun-gu, Seoul, Republic of Korea.*

**Background:** It is suggested that family clustering plays a crucial role in the development of kidney diseases with the effect of both genetic factor and shared environment. However, it is not well documented that if chronic kidney disease (CKD) aggregates in Asian families.

**Methods:** We aimed to estimate the familial aggregation of kidney diseases using a national database of Korean population with detailed longitudinal data. A total of 881,453 patients with incident CKD diagnosed between 2004-2017 were matched to control by age and sex on a 1:1 basis. Primary outcome of interest was the risk for incident CKD in the general population and the disease progression to kidney failure among CKD patients having first-degree relatives affected with end stage renal disease (ESRD).

**Results:** Multivariable logistic regression analysis showed that individuals with an affected first-degree relative with CKD were found to have 46% higher risks for incident CKD than that in the general population, which was independent of age, sex, residential area, income levels, and comorbid conditions including hypertension and diabetes (adjusted OR 1.46; 95% CI, 1.43-1.49). Furthermore, during 3,207,497 person-years of follow-up (mean 3.9 years), multivariable-adjusted Cox proportional hazards models revealed that having an affected first-degree relative with ESRD was associated with an increased risk for the development of ESRD (adjusted HR 1.22; 95% CI, 1.17-1.26). Not only in related kinship, higher risks were observed in those with an unrelated affected spouse.

**Conclusions:** In this large national study of Korean population, individuals having first-degree relatives affected with kidney diseases had higher risks for incident CKD and the disease progression to kidney failure.

**TH-PO877**

**Association of Low-Grade Albuminuria With CKD Progression in Individuals With CKD**

Ashish Verma,<sup>1</sup> Insa M. Schmidt,<sup>1</sup> Ragnar Palsson,<sup>2</sup> Sushrut S. Waikar,<sup>1</sup> Anand Srivastava,<sup>3</sup> <sup>1</sup>Boston University School of Medicine, Boston, MA; <sup>2</sup>Massachusetts General Hospital, Boston, MA; <sup>3</sup>Northwestern University Feinberg School of Medicine, Chicago, IL.

**Background:** By convention, albuminuria, a major risk factor for CKD progression, is classified as moderately (30-300 mg/g) or severely (>300 mg/g) increased. However, the relationship of low-grade albuminuria (<30 mg/g) with CKD progression has not been well-studied among individuals with CKD.

**Methods:** We examined the association of urine albumin to creatinine ratio (UACR) with CKD progression (defined as eGFR decline ≥50% or incident ESKD) in 1629 participants with UACR <30 mg/g enrolled in the Chronic Renal Insufficiency Cohort (CRIC) Study. Multivariable-adjusted Cox-proportional hazard models tested the association of CKD progression with UACR modeled as a continuous variable (log base 2) and in tertiles.

**Results:** Mean ± SD age was 60.2 ± 9.6 years, 847 (52%) participants were women, mean eGFR was 49.6 ± 14.7 mL/min/1.73m<sup>2</sup>, and median [IQR] UACR was 6.9 [4.0, 14.2] mg/g. Over a median follow-up of 9.8 years, 182 participants developed CKD progression. In fully adjusted models, UACR had a linear association with CKD progression (Figure 1A). Each doubling of UACR was associated with 56% increased risk of CKD progression (HR 1.56, 95% CI 1.33-1.83) (Figure 1B). Individuals in the highest tertile of UACR had a 2.64-fold increased risk of CKD progression (HR 2.64, 95% CI 1.72-4.05) compared to individuals in the lowest tertile (Figure 1B).

**Conclusions:** Low levels of urine albumin excretion, well below the threshold set in the current CKD staging system, were independently associated with CKD progression. Future studies are needed to determine the optimal threshold for initiation of treatment with anti-proteinuric agents and whether the further reduction in albuminuria may improve adverse clinical outcomes in individuals with CKD.

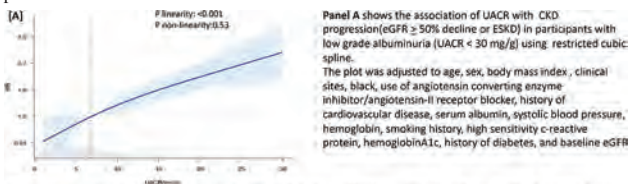

FIGURE 1: Association of UACR with CKD progression using cox-proportional hazard and cubic restricted spline models.

**TH-PO878**

**Association of Race-Based vs. Race-Free eGFR With Nutritional Status, Mortality, and ESKD in African Americans With CKD**

Sahar Amin,<sup>1</sup> Atif Ibrahim,<sup>1</sup> Barry M. Wall,<sup>1,2</sup> Csaba P. Kovcsy,<sup>1,2</sup> <sup>1</sup>The University of Tennessee Health Science Center College of Medicine, Memphis, TN; <sup>2</sup>VA Memphis Medical Center, Memphis, TN.

**Background:** Severity of CKD is associated with malnutrition and higher risk of death and kidney failure. As a result of the elimination of race from equations estimating GFR (eGFR), the eGFR value of African American patients was revised downward to variable extent, depending on the equation used. It is unclear if the different levels of eGFR and the resultant differences in CKD stages affects the association of kidney function with clinical outcomes such as nutritional status, mortality and ESKD.

**Methods:** We examined a cohort of 461 African American US veterans with stage 3-5 CKD followed at a single institution. We used the original CKD-EPI equation with and without the inclusion of the race correction factor and the revised 2021 race-free CKD EPI formula to estimate GFR and to determine CKD stages. We examined the association of

the different eGFR values and CKD stages with dietary protein intake (g/day, estimated from spot urine urea nitrogen/creatinine) in linear regression models and with all-cause mortality and ESKD incidence in Cox models.

**Results:** Patients were 66±11 years old, 96% were male, and 60% were diabetic. The race-free equations yielded lower eGFR values and a higher proportion of patients with more advanced stages of CKD, with the lowest eGFR values seen with the race-free old CKD-EPI equation (Table). There were 154 ESKD events (event rate, 82.3/1000 PY; 95%CI, 70.3-96.3) and 250 deaths (133.6/1000PY, 95%CI: 118.0-151.2) over a median follow-up of 4.0 years. Lower eGFR was associated with lower protein intake and higher risk of death and ESKD irrespective of the eGFR formula (Table).

**Conclusions:** Elimination of race from the GFR estimation formulas results in lower estimated GFR values and a higher proportion of African American patients categorized into more advanced stages of CKD. While subjective decisions using eGFR cutoffs may be influenced by such differences, the association of eGFR with objective clinical outcomes was similar across the different formulas used to estimate GFR.

**Funding:** Veterans Affairs Support

	Mean (SD) eGFR value: (ml/min/1.73m2)	CKD stages 2, 3a, 3b, 4 and 5 (%)	Dietary protein intake per 10 ml/min/1.73m2 lower eGFR in g/day (95%CI)	Hazard ratio (95%CI) of death (per 10 ml/min/1.73m2 lower eGFR)	Hazard ratio (95%CI) of ESKD (per 10 ml/min/1.73m2 lower eGFR)
CKD-EPI 2012 with race	34 (15)	5/19/31/53/10	-1.019 (-1.715, -0.324)	1.42 (1.29, 1.57)	2.16 (1.86, 2.51)
CKD-EPI 2012 without race	29 (13)	0/13/29/44/14	-1.182 (-1.988, -0.375)	1.50 (1.54, 1.69)	2.44 (2.05, 2.91)
CKD-EPI 2021	31 (13)	2/15/32/39/11	-1.138 (-1.900, -0.376)	1.46 (1.31, 1.63)	2.33 (1.98, 2.75)

**TH-PO879**

**Changes in CKD Prevalence With and Without eGFR Indexing to the Median Body Surface Area in the United States**

Elani Streja,<sup>1</sup> Maria Clarissa Tio,<sup>2</sup> Aliba Syed,<sup>1</sup> Yoshitsugu Obi,<sup>2</sup> Michael Hall,<sup>2</sup> Kamyar Kalantar-Zadeh,<sup>1</sup> Tariq Shafi,<sup>2</sup> <sup>1</sup>University of California Irvine, Irvine, CA; <sup>2</sup>University of Mississippi Medical Center, Jackson, MS.

**Background:** The eGFR is reported indexed to a body surface area (BSA) of 1.73m<sup>2</sup>, the estimated BSA of 25-year-olds in 1912. However, the contemporary median BSA of the US population is higher than 1.73 and arbitrarily indexing eGFR to a lower BSA may systematically overcalculate CKD prevalence, particularly Stage G3a A1. We assessed the changes in the U.S. CKD prevalence using eGFR indexed to the median BSA of the U.S. population (ml/min/medianBSA), with particular emphasis on CKD G3a.

**Methods:** We analyzed the 2017-2020 National Health and Nutrition Examination Survey (NHANES; N=8,016). eGFR was calculated using the CKD-EPI 2021 race-free equation while individual BSA was calculated from the DuBois & DuBois formula. We used reclassification tables to determine the changes in CKD prevalence when eGFR is indexed to 1.73m<sup>2</sup> (eGFR/1.73) vs. indexed to median BSA in the US (eGFR/Median). We defined CKD as eGFR <60 or ACR ≥30 mg/g.

**Results:** The median US BSA was 1.91m<sup>2</sup> (2.0m<sup>2</sup> in males and 1.78m<sup>2</sup> in females). The BSA of 1.73 corresponded to the 26th percentile for the US population (6.4<sup>th</sup> percentile in males and 39.6<sup>th</sup> percentile in females). The median eGFRs of the US population was 108 ml/min/1.73m<sup>2</sup> and 109.2 ml/min/1.91m<sup>2</sup>. Using eGFR/Median instead of eGFR/1.73, 3.7 million (12%) US adults with CKD (eGFR <60 mL/min/1.73m<sup>2</sup> or ACR ≥30 mg/g) were no longer classified as CKD (Table 1). All of those reclassified as no CKD were in CKD 3a A1 (ACR <30) and comprised 54% of the US population with CKD 3a A1.

**Conclusions:** Our data suggest overdiagnosis of CKD using only eGFR with arbitrary selection of BSA-indexing to 1.73m<sup>2</sup> and that using the outdated BSA for eGFR indexing leads to an 11.8% higher CKD prevalence in the US.

**Funding:** Other NIH Support - NIGMS

		eGFR/1.91m <sup>2</sup>		TOTAL
		Not CKD	CKD	
eGFR/1.73m <sup>2</sup>	Not CKD	196.4 million (100.0%)		196.4 million
	CKD	3.7 million (11.8%)	27.5 million (88.2%)	31.1 million
	TOTAL	200.0 million	27.5 million	227.5 million

TH-PO880

**Cognitive Patterns in Patients With CKD: The CKD-REIN Cohort Study**

Hélène Levassort,<sup>1,3</sup> Ziad Massy,<sup>2,3</sup> Oriane Lambert,<sup>3</sup> Christian Combe,<sup>4,3</sup> Denis Fouque,<sup>5,3</sup> Maurice Laville,<sup>6,3</sup> Carole Ayav,<sup>7,3</sup> Christian Jacquelinet,<sup>8,3</sup> Benedicte Stengel,<sup>3</sup> Marion Pépin.<sup>1,3</sup> Center for research in Epidemiology and Population Health (CESP), Clinical Epidemiology Team, Paris-Saclay University, Versailles Saint-Quentin-en-Yvelines University, National Institute of Health and Medical Research, Villejuif, France <sup>1</sup>Clinique Ambroise Pare Service de Court Séjour Geriatrique, Boulogne-Billancourt, France; <sup>2</sup>Hopital Ambroise-Pare Service de Nephrologie Dialyse, Boulogne-Billancourt, France; <sup>3</sup>Centre de Recherche en Epidemiologie et Sante des Populations, Villejuif, France; <sup>4</sup>Centre Hospitalier Universitaire de Bordeaux, Bordeaux, France; <sup>5</sup>Universite Claude Bernard Lyon 1, Villeurbanne, France; <sup>6</sup>Universite de Lyon, Lyon, France; <sup>7</sup>Centre hospitalier regional universitaire de Nancy, Nancy, France; <sup>8</sup>Agence de la biomedecine, La Plaine Saint-Denis, France.

**Background:** Chronic kidney disease (CKD) is associated with an increased risk of neurocognitive disorders (NCD). The global Mini Mental State Examination (MMSE) is often used to screen for cognitive impairment in patients with CKD, but the relative impact of CKD on the different cognitive domains of MMSE remains unexplored

**Methods:** We used the MMSE to assess orientation, memory, attention and calculation, language and praxis, scores among 3033 patients (mean age, 66.82±12.87; 65.3% men) with all types of CKD and an estimated glomerular filtration rate (eGFR) < 60 mL/min/1.73 m<sup>2</sup> included in the CKD-Renal Epidemiology and Information Network (CKD-REIN) cohort. Adjusted associations of patient characteristics with the global and domain-specific MMSE scores were estimated using linear regression models.

**Results:** The mean global MMSE score was 26.8/30 and the median score was 28/30. Two cognitive domains were significantly lower at lower eGFR level: orientation and praxis. After adjusting for age, sex, education, depressive symptoms, polymedication, psychoactive drug use, cerebrovascular disease, heart failure, history of depression and urinary albumin/creatinine ratio, low eGFR (expressed as 10 mL/min/1.73 m<sup>2</sup>), the orientation score was significantly lower, by 0.03 points [0.003, 0.05] for every 10 mL/min/1.73 m<sup>2</sup> drop in eGFR (p=0.03), and praxis, by 0.01 points [0.002, 0.02] (p=0.01).

**Conclusions:** This study shows that orientation and praxis domains may be affected before the occurrence of clinically evident NCD, in patients with nondialysis CKD. This highlights the importance of screening individual cognitive domains in this population.

**Funding:** Other NIH Support - CKD-REIN

TH-PO881

**Comparison Between the Profile of Patients Defined by Age-Adapted and Fixed-Threshold CKD Criteria: A National-Wide, Cross-Sectional Study**  
Yixin Ma, Jianfeng Lin, Peng Xia, Hua Zheng, Peili Ji, Guangjin Zhu, Ling Qiu, Limeng Chen. Peking Union Medical College Hospital, Dongcheng-qu, China.

**Background:** Kidney function declines with advancing age, an age-adapted eGFR threshold has been proposed instead of the fixed cutoff for CKD definition. The study aims to describe and compare the profile of CKD patients defined by these two criteria in a Chinese population.

**Methods:** We recruited the adult participants with selected biochemical tests from the Chinese Physiological Constant and Health Condition (CPCHC) survey conducted from 2007 to 2011, with the GFR estimated by the Chronic Kidney Disease Epidemiology Collaboration (CKD-EPI) formula. The age-adapted threshold of eGFR was 75, 60, and 45 mL/min/1.73 m<sup>2</sup> for the population under 40 years old, 40 to 64 years old, and above 64 years, respectively. The fixed threshold is 60 mL/min/1.73 m<sup>2</sup> for all ages.

**Results:** Among the recruited 23,438 participants, 480 participants were diagnosed with CKD by fixed-threshold criteria, 391 participants by age-adapted criteria. We found that the CKD patients defined by age-adapted criteria matched well with the 2.5th percentile of eGFR in the Chinese individuals. When compared with their age- and gender-matched controls, patients included by age-adapted criteria but excluded by fixed-threshold criteria had a significantly higher prevalence of hypertension (23.2% vs. 7.7%, p<0.001) and hyperuricemia (25.0% vs. 5.5%, p<0.001), while patients included only by the fixed-threshold criteria were not significantly different in CVD risk factors and CKD related disturbance except for hyperuricemia (41.2% vs. 14.0%, p<0.001).

**Conclusions:** An age-adapted criterion is more closely associated with CVD risk factors and CKD-related disturbance compared to fixed-threshold criteria.

**Funding:** Government Support - Non-U.S.

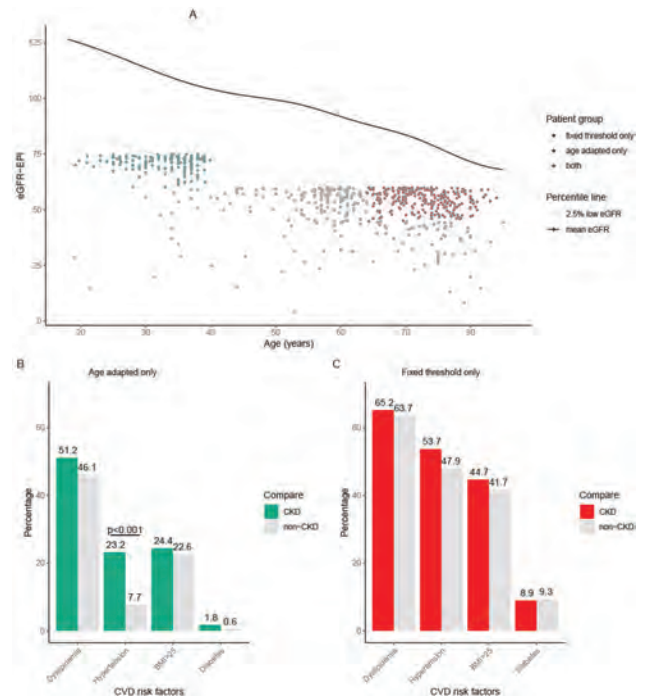

Figure 1. Illustration of age and eGFR distribution and the CVD risk profile of patients

TH-PO882

**Diagnostic Validity of Claims Data Diagnoses for CKD With Data From the Berlin Initiative Study (BIS)**

Tim Bothe,<sup>1,2</sup> Elke Schaeffner,<sup>1</sup> Nina Mielke,<sup>1</sup> Alice Schneider,<sup>1</sup> Antonios Douras,<sup>3</sup> Muhammad Barghouth,<sup>1</sup> Markus van der Giet,<sup>1</sup> Martin K. Kuhlmann,<sup>4</sup> Natalie Ebert.<sup>1</sup> <sup>1</sup>Charite Universitätsmedizin Berlin, Berlin, Germany; <sup>2</sup>InGef - Institut für angewandte Gesundheitsforschung Berlin GmbH, Berlin, Germany; <sup>3</sup>McGill University, Montreal, QC, Canada; <sup>4</sup>Vivantes Klinikum im Friedrichshain, Berlin, Germany.

**Background:** Information on diagnostic validity of kidney disease within claims data is scarce. Thus, we aimed to estimate the validity of diagnostic codes of chronic kidney disease (CKD) in German claims data using estimated glomerular filtration rate (eGFR) as the gold standard.

**Methods:** We used data of the Berlin Initiative Study (BIS), a community-dwelling cohort of 2,069 persons aged 70 or older, for whom primary clinical data linked with claims data are available. After baseline assessment (2010–2011), 4 follow-up visits were conducted biennially over a total observation period of 8 years. Correspondence of overall and stage-specific CKD ICD-10 diagnoses in claims data with CKD stages assessed by the creatinine-based CKD-EPI equation (eGFR<sub>CKD-EPI-Crea</sub>) was evaluated over time (cross-sectionally and longitudinally) and for each stage, respectively.

**Results:** The sensitivity of claims data diagnoses increases with CKD stages (Figure). For stages 3 and 4, stage-specific sensitivity increases from baseline to follow-up 4 (0.29/0.42 vs. 0.55/0.68 for stage 3/4) as well as longitudinally through ±1 year (Δ<sub>95%</sub> = +3.6 - +12.5 / +3.6 - +17.4 for stage 3/4). Still, false-negative rates are high, as many patients do not receive diagnoses corresponding with the respective CKD stage (e.g., 1-sensitivity<sub>total</sub> = 0.91/0.83 for stage 1/2). Over all measures and stages, sensitivity is low (0.38 for overall and 0.22 for stage-specific diagnoses).

**Conclusions:** Correspondence of claims data diagnoses with eGFR measurements can be interpreted as acceptable for CKD stages 5 and 4, limited for stage 3, and low for stages 2 and 1. Stage-specific sensitivity is lower than overall. Over time (cross-sectionally as well as longitudinally), correspondence seems to increase. Over all measures and stages, diagnostic validity of CKD diagnoses in claims data should be interpreted as restricted.

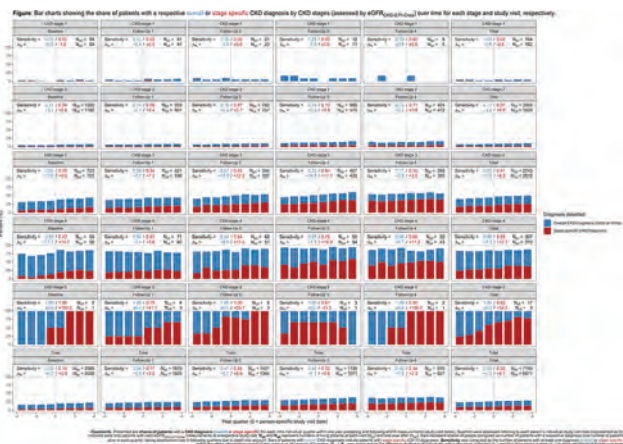

TH-PO883

**Impact of Urinary Protein Examination on Early Diagnosis of CKD: A Nationwide Hospital-Based Observational Study in Japan, REAL-CKD**  
 Shoichi Maruyama,<sup>1</sup> Tetsuhiro Tanaka,<sup>2</sup> Masayoshi Takeda,<sup>3</sup> Naru Morita,<sup>3</sup> Toshitaka Yajima.<sup>3</sup> <sup>1</sup>Dep. of Neph, Nagoya Univ., Aichi, Japan; <sup>2</sup>Dep. of Neph, Tohoku Univ., Miyagi, Japan; <sup>3</sup>AstraZeneca K.K., Osaka, Japan.

**Background:** Early diagnosis and active management can slow disease progression of CKD. However, diagnosis rate of CKD in stage 3a (G3a) based on eGFR is reported to be very low (around 10%) in a real-world setting. This study assessed the impact of urinary protein examination in combination with eGFR on the improvement of early diagnosis of CKD patients.

**Methods:** REAL-CKD is a hospital-based observational study using RWD database (Real World Data Co., Ltd., Kyoto, Japan) between 2004-2021. Patients aged ≥18 years with two or more eGFR results of <90 mL/min/1.73m<sup>2</sup> between 90-360 days apart were included. Patients with CKD diagnosis were defined as having an associated CKD diagnosis code any time in 12 months before or 3 months after the second eGFR measurement. Qualitative proteinuria such as urine albumin-to-creatinine ratio (UACR) and urine protein-to-creatinine ratio (UPCR) were utilized for KDIGO risk classification.

**Results:** Of 788,059 eligible patients, qualitative urinary protein records necessary for KDIGO risk classification were available in 54,073 (6.9%) patients. There was no gender difference in the overall CKD population while in A3 category, male rate was high (60.2%). The most frequent comorbidities were diabetes (63.7%), hypertension (51.1%) and heart failure (22.3%) in KDIGO risk classified population. The CKD diagnosis rate increased from A1 towards A3, notably in G2 (A1: 14.5, A2: 24.9, A3: 47.5%) and G3a (A1: 26.2, A2: 36.2, A3: 56.5%) with the total diagnosis rate of 20.2% and 35.4%, respectively (Figure1).

**Conclusions:** While urinary protein examination in combination with eGFR increased early diagnosis rate of CKD, the examination rate was very low and a high proportion of the patients were still not diagnosed properly in the real-world clinical setting. Given recent development of CKD treatment strategies, there is a clear need to increase the early diagnosis rate to improve the clinical outcomes by proactively detecting progressive CKD patients.

**Funding:** Commercial Support - AstraZeneca K.K.

Figure 1 CKD diagnosis rate

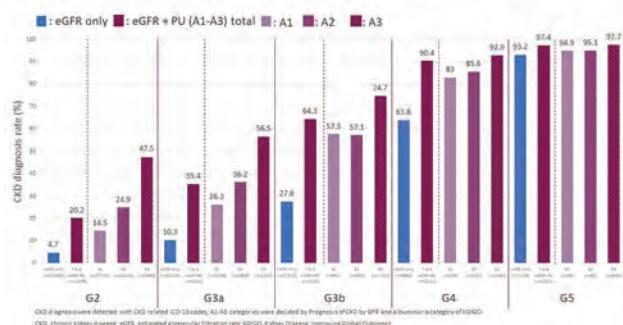

TH-PO884

**Performance of Machine Learning Compared With Regression Analysis in Predicting Albuminuria**

Ali Haider Arsiwala,<sup>1</sup> Marcella Mathew,<sup>2</sup> Johannes B. Scheppach.<sup>2</sup> <sup>1</sup>Dr. Vasantrao Pawar Medical College, Hospital & Research Centre, Nashik, India; <sup>2</sup>Charite Universitätsmedizin Berlin, Berlin, Germany.

**Background:** Albuminuria is a marker of kidney disease and an independent risk factor for cardiovascular events, cognitive decline, and all-cause mortality. Machine learning (ML) algorithms are increasingly used for risk prediction in medical science, given their proficiency in identifying patterns in large datasets and modeling non-linear interactions, surpassing the capacity of traditional statistical approaches. We compared the predictive performance of three ML models with a regression model in correctly classifying participants as with or without albuminuria.

**Methods:** We studied 18,117 participants aged 20 to 80 years from the National Health and Nutrition Examination Survey (NHANES) between 2005 and 2018. Synthetic minority oversampling technique was used to correct the class imbalances in the data resulting from the oversampling recruitment strategy applied by NHANES. Self-reported variables like age, sex, ethnicity, education status, blood pressure, diabetes status, and modified frailty phenotype were used to predict albuminuria, defined as a Urine Albumin-Creatinine Ratio > 30 mg/g. Participants were randomly grouped into a training dataset (n=13,587) and a testing dataset (n=4,530). A logistic regression model, a gradient boosting classifier model, a k-nearest neighbor model, and an artificial neural network (ANN) were used for classification. To compare classification results, accuracy, sensitivity, and specificity were computed.

**Results:** Out of all prediction models, the ANN had the highest accuracy (0.89; 95% Confidence Interval: [0.88, 0.90]) and highest sensitivity (0.99 [0.97, 1.00]). For comparison, the logistic regression model showed an accuracy of (0.86 [0.85, 0.87]) and a sensitivity of (0.90 [0.89, 0.92]). However, the specificity of the ANN (0.77 [0.75, 0.80]) was lower than that of the logistic regression model (0.83 [0.81, 0.85]).

**Conclusions:** Using ML algorithms for the prediction of albuminuria showed an advantage in performance with higher accuracy and sensitivity over traditional regression analysis. Artificial intelligence-based screening tools for albuminuria developed from self-reported data could offer diagnostic and economic advantages in the early detection and prevention of chronic kidney disease.

TH-PO885

**Predictors of CKD Awareness in Middle-Aged and Older Community-Dwelling Japanese Adults**

Keiko Kabasawa, Yumi Ito, Kazutoshi Nakamura, Junta Tanaka, Ichiei Narita. Niigata University, Niigata, Japan.

**Background:** Despite global efforts in public health campaigns on chronic kidney disease (CKD), CKD awareness, which is a key to improving health outcomes through patient engagement, remains low. Predictors of CKD awareness may help identify effective ways to raise awareness but are not yet clear. In this study, we aimed to determine clinical and socio-demographic characteristics associated with CKD awareness.

**Methods:** Using the 5-year longitudinal framework of the Unonuma cohort study, we analyzed data of 5,932 Japanese adults (median age at baseline, 61 years; range, 40-92 years; 50.7% women) who participated in the baseline (2012-2014) and 5-year surveys and in a health checkup at the study's 5-year follow-up. CKD awareness was defined as answering the question "Have you ever been told by a doctor that you have chronic kidney disease (abnormal urinalysis or kidney dysfunction)?" with "Yes, I was told within the past 5 years." A self-administered questionnaire collected clinical history, socio-demographic characteristics, and family history of CKD. At the 5-year health checkup, CKD was diagnosed based on eGFR <60 mL/min/1.73 m<sup>2</sup> or ≥1+ dipstick urine protein.

**Results:** At the 5-year follow-up, there were 1,232 participants (20.8%) who had CKD, with mean eGFR of 73.6 (standard deviation 15.0) mL/min/1.73 m<sup>2</sup>. The sensitivity and specificity of the CKD awareness question were respectively 15.4% and 97.7% in men and 9.3% and 99.1% in women. In demographic-adjusted logistic regression analysis, family history of CKD and history of heart disease, stroke, hypertension, diabetes, and hyperuricemia were significantly associated with CKD awareness, but these associations were not significant in multivariable logistic regression analysis with further adjustment for eGFR. In the multivariable logistic regression model, independent predictors of CKD awareness were history of urinary tract stone (adjusted odds ratio [95% confidence interval], 2.08 [1.33-3.25]), female sex (0.47 [0.35-0.64]), and married status (0.62 [0.45-0.87]).

**Conclusions:** The results of this study suggest that known risk factors for CKD did not predict CKD awareness independently of kidney function and that a sex-dependent approach may help to improve CKD awareness.

**Funding:** Government Support - Non-U.S.

TH-PO886

**Luetic Nephropathy: An Underrecognized Etiology of Nephropathy**

Umair Khan,<sup>1</sup> Divya Mounisha R. Thimmareddygar,<sup>1</sup> Fatima Z. Warraich,<sup>2</sup> Ujjwala Murari,<sup>1</sup> Heather R. Lefkowitz.<sup>1</sup> <sup>1</sup>Newark Beth Israel Medical Center, Newark, NJ; <sup>2</sup>Baystate Medical Center, Springfield, MA.

**Introduction:** Syphilis is an underrecognized cause of nephropathy. Most cases of syphilis are diagnosed in individuals with HIV, Hepatitis B and/or C and hence nephropathy may wrongly be attributed to them. Here we present an unusual case of luetic nephropathy presenting as crescentic glomerulonephritis.

**Case Description:** A 80-year-old female with a history of hypertension and Parkinson's disease was evaluated for lower extremity swelling, facial edema, and elevated serum creatinine. Workup revealed creatinine of 1.5 mg/dL (baseline of 1.01 mg/dL), proteinuria with a urine protein-creatinine ratio of 507 mg/g, mild hematuria without any casts or sediments. Serological panel was positive for antiproteinase 3 (PR-3-ANCA) however was negative for cytoplasmic (C-ANCA), perinuclear (P-ANCA), HIV, HBV, HCV, with normal complements (C3/C4). Lupus, scleroderma, GBM, Sjogren's, Group A strep and primary membranous nephropathy workup was negative. Drug-associated glomerulonephritis was excluded clinically. Infectious work-up revealed a Rapid Plasma Reagin level of 1:1 and positive Treponemal antibody. A diagnostic kidney biopsy showed fibrous crescents consistent with crescentic glomerulonephritis and chronic interstitial inflammation with eosinophils without features of necrotizing arteritis. In our case, biopsy findings of crescentic glomerulonephritis with positive syphilis serologies highly suggested luetic nephropathy and hence was then started on penicillin therapy.

**Discussion:** Syphilis-associated renal disease (luetic nephropathy), is an uncommon disease with a wide variety of manifestations. It presents as a nephrotic syndrome with varying degrees of proteinuria [1,2]. It is now known that deposition of IgG against treponema pallidum in the renal mesangium incites the onset of nephropathy [2]. Walker et al reported a case of secondary syphilis associated with crescentic glomerulonephritis [3]. Syphilis-associated glomerulonephritis is part of the infection-related glomerulonephritis whose main treatment is infection resolution. The implementation of steroid in such cases is unclear but may aid in reducing irreversible glomerular scarring. KDIGO guidelines do not advise to screen for syphilis however given its increased prevalence, luetic nephropathy should be kept in mind to while evaluating patients with renal dysfunction.

**TH-PO887**

**Prevalence of CKD: Comparison of Real-World Data (RWD) Sources to the US National Health and Nutrition Examination Survey (NHANES)**  
Joseph Stavas,<sup>1</sup> Emily L. Butler,<sup>1</sup> Debra E. Irwin,<sup>2</sup> Rohan J. Shah,<sup>2</sup> Helen Latimer,<sup>2</sup> Alberto Sepulveda,<sup>5</sup> Sandy D. Balkin,<sup>5</sup> Katherine R. Tuttle.<sup>3,4</sup>  
<sup>1</sup>ProKidney, Raleigh, NC; <sup>2</sup>Aetion, New York, NY; <sup>3</sup>Providence Health System, Spokane, WA; <sup>4</sup>University of Washington, Seattle, WA; <sup>5</sup>Royalty Pharma, New York, NY.

**Background:** NHANES is a common source of CKD prevalence data in the USA, where CKD stage is based on one eGFR estimate using the KDIGO categories. We estimated the prevalence of CKD stage ≥3 using RWD and compared it to NHANES estimates.

**Methods:** RWD was extracted from HealthVerity PrivateSource20 closed claims and linked to Veradigm Health Insights Electronic Health Record (EHR). Adults, ≥20 years old, continuously enrolled in the claims data and active in the EHR were evaluated during 2018. eGFR values were used to determine the CKD stage. The prevalence of CKD stage ≥3 was projected to the USA population (standardized on age, gender, and geographic region using USA census data) and compared to the NHANES 2015-2018 report.

**Results:** The prevalence of all CKD stage ≥3 estimated in RWD was significantly lower than NHANES reports (see table). This finding translates into 22.5 million individuals estimated from NHANES and 5.2 million from RWD. The absolute differences between the two groups were less for higher categories.

**Conclusions:** Prevalence estimates from our RWD sources included those who have continuous health insurance, sought healthcare, and were diagnosed with CKD. In contrast, NHANES sampled a more diverse population likely to be covered by various forms of insurance including the uninsured. This work supports the unmet need for early identification of CKD and demonstrates necessity for methodological clarity when reporting prevalence estimates.

**Funding:** Commercial Support - ProKidney, LLC

Prevalence of CKD stages

SOURCE	Stage 3-5	Stage 3	Stage 4	Stage 5
NHANES	7%	6.4%	0.4%	0.1%
Real World Data	2%*	1.8%*	0.1%*	0.05%*

\*p < 0.05

**TH-PO888**

**REVEAL CKD: Estimated Glomerular Filtration Rate (eGFR) Decline Before and After a CKD Diagnosis Among Patients With CKD Stage 3**  
Navdeep Tangri,<sup>1</sup> Stefan Franzén,<sup>2</sup> Emily J. Peach,<sup>3</sup> Salvatore Barone,<sup>5</sup> Pam R. Kushner.<sup>4</sup>  
<sup>1</sup>University of Manitoba Department of Internal Medicine, Winnipeg, MB, Canada; <sup>2</sup>Medical/Payer Evidence Statistics, BioPharmaceuticals Medical, AstraZeneca, Gothenburg, Sweden; <sup>3</sup>Cardiovascular, Renal and Metabolism Epidemiology, BioPharmaceuticals Medical, AstraZeneca, Cambridge, United Kingdom; <sup>4</sup>Department of Family Medicine, University of California Irvine, Irvine, CA; <sup>5</sup>Global Medical Affairs, BioPharmaceuticals Medical, AstraZeneca, Gaithersburg, MD.

**Background:** Studies have shown considerably high rates of undiagnosed early-stage CKD despite guidelines recommending that CKD should be diagnosed and managed as soon as possible to slow progression and prevent complications. However, the benefit of an early diagnosis is not yet fully understood. The aim of this analysis was to describe the potential change in slope of eGFR before and after a CKD diagnosis using data from the REVEAL-CKD study program.

**Methods:** Data were extracted from the US TriNetX database for patients aged ≥18 years with two consecutive eGFR records ≥30 and <60 mL/min/1.73m<sup>2</sup> recorded 91-730 days apart from 2015-2020 with an ICD-9/ICD-10 code for CKD after ≥6 months of follow-up. The eGFR decline was estimated before and after CKD diagnosis by fitting an individual linear regression model with time to diagnosis as the only independent variable for the 2-year period before, and up to 2-year period after CKD diagnosis. Estimated slopes were summarized using medians and compared before and after diagnosis using the Wilcoxon rank sum test. The eGFR trajectories over time were estimated by applying a generalized additive model (GAM).

**Results:** The study cohort included 26,851 patients with diagnosed CKD stage 3. In the 2-year period before CKD diagnosis, the median eGFR decline was -4.12 (95% CI: -4.23, -4.02), and median eGFR decline was -0.30 (95% CI: -0.44, -0.14) in the 2-year period after diagnosis (p<0.001). The decline in eGFR slope before and after CKD diagnosis is shown in Figure 1.

**Conclusions:** A significant slowing in eGFR decline was observed after a CKD stage 3 diagnosis. This finding may be partially explained by the natural course of renal function decline, and also improved care post-diagnosis given the marked difference around the time of diagnosis. Future analyses will explore initiation of targeted monitoring and treatment in response to a formal diagnosis.

**Funding:** Commercial Support - AstraZeneca

Figure 1. eGFR trajectory before and after CKD diagnosis in US patient with CKD stage 3 (GAM with 95% confidence interval)

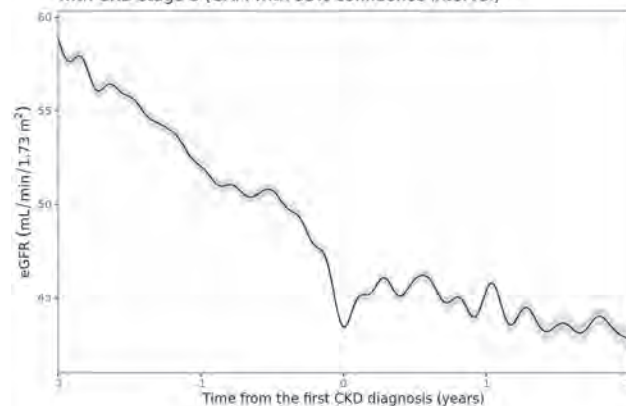

**TH-PO889**

**REVEAL-CKD: Management and Monitoring of Patients With CKD Stage 3 in France, Germany, Italy, Japan, and the United States**  
Navdeep Tangri,<sup>1</sup> Toshiki Moriyama,<sup>9</sup> Markus P. Schneider,<sup>6</sup> Jean Blaise J. Virgitti,<sup>8</sup> Luca De Nicola,<sup>7</sup> Emily J. Peach,<sup>3</sup> Salvatore Barone,<sup>11</sup> Matthew Arnold,<sup>10</sup> Hungta (tony) Chen,<sup>4</sup> Kristler Järbrink,<sup>5</sup> Pam R. Kushner.<sup>2</sup>  
<sup>1</sup>University of Manitoba Department of Internal Medicine, Winnipeg, MB, Canada; <sup>2</sup>University of California Irvine, Irvine, CA; <sup>3</sup>Cardiovascular, Renal and Metabolism Epidemiology, BioPharmaceuticals Medical, AstraZeneca, Cambridge, United Kingdom; <sup>4</sup>Medical/Payer Evidence Statistics, BioPharmaceuticals Medical, AstraZeneca, Gaithersburg, MD; <sup>5</sup>Cardiovascular, Renal and Metabolism Evidence, BioPharmaceuticals Medical, AstraZeneca, Gothenburg, Sweden; <sup>6</sup>Department of Nephrology and Hypertension, University Hospital Erlangen, Friedrich-Alexander-Universität Erlangen-Nürnberg, Erlangen, Germany; <sup>7</sup>Department of Advanced Medical and Surgical Sciences, Nephrology and Dialysis Unit, Naples, Italy; <sup>8</sup>Cabinet Medical, Orry-La-Ville, France; <sup>9</sup>Osaka Daigaku, Suita, Japan; <sup>10</sup>Real World Evidence Data & Analytics, BioPharmaceuticals Medical, AstraZeneca, Cambridge, United Kingdom; <sup>11</sup>Global Medical Affairs, BioPharmaceuticals Medical, AstraZeneca, Gaithersburg, MD.

**Background:** Chronic kidney disease (CKD) is vastly under-recognised yet affects 11.1% of the global population. Early diagnosis and active management can slow disease progression. This study assessed CKD management and monitoring in patients with CKD stage 3.

**Methods:** REVEAL-CKD is a multi-national, observational study, using medical record and claims data from the general population. Data were extracted from six databases from France, Germany, Italy, Japan, and the USA. Included patients were aged ≥18 years with 2 consecutive eGFR values ≥30 and <60 mL/min/1.73m<sup>2</sup> recorded 91-730 days apart between 2015-2020. The date of the second qualifying eGFR was the index date. Patients with no CKD diagnosis code before and up to 6 months after index were considered undiagnosed. Data on selected quality indicators were extracted from 6-months post-index and the proportion of diagnosed and undiagnosed patients meeting these indicators was calculated.

**Results:** Across the six databases cohort sizes were 20,012-250,879 patients with mean ages of 71-80 years; 41.9-52.9% were male, and median index eGFR was 49-52 mL/min/1.73m<sup>2</sup>. Prevalence of undiagnosed CKD ranged from 61.6 to 95.5%. UACR monitoring and treatment with SGLT2i was low across databases; UACR was notably 3-fold higher for patients with diagnosed CKD in Japan. Across all countries,



blood pressure monitoring, and treatment with ACEi/ARB and statins was greater in patients with diagnosed CKD (Image 1).

**Conclusions:** In five countries, a large proportion of patients with CKD stage 3 are undiagnosed and do not receive timely CKD management and monitoring, however, a greater proportion of patients meet care quality indicators when they have a CKD diagnosis. There is a clear need to proactively diagnose early-stage CKD so that patients can receive guideline-directed monitoring and treatments to improve outcomes.

**Funding:** Commercial Support - AstraZeneca

Image 1: CKD monitoring and management in patients with CKD stage 3 by diagnosed status

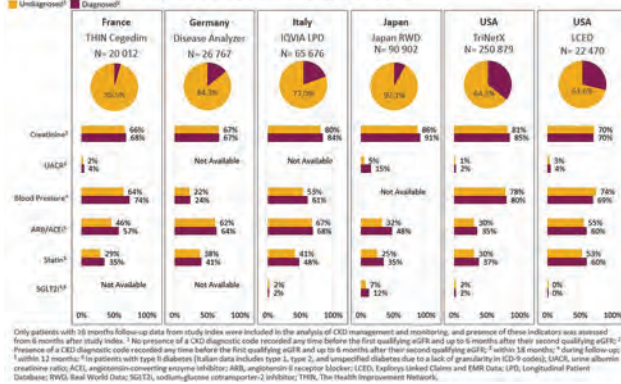

TH-PO890

Risk Prediction: CKD Staging Is the Beginning, Not the End

Morgan Grams,<sup>1,2</sup> Yingying Sang,<sup>1</sup> Shoshana Ballew,<sup>1</sup> Kunihiro Matsushita,<sup>1</sup> Andrew S. Levey,<sup>3</sup> Josef Coresh.<sup>1</sup> <sup>1</sup>Johns Hopkins University Bloomberg School of Public Health, Baltimore, MD; <sup>2</sup>NYU Langone Health, New York, NY; <sup>3</sup>Tufts Medical Center, Boston, MA.

**Background:** The stages of chronic kidney disease reflect risk of subsequent adverse kidney outcomes. The heterogeneity of risk within each GFR and ACR stage is yet uncertain.

**Methods:** Using deidentified electronic health record data from Optum Labs Data Warehouse on patients with eGFR and albuminuria (urine ACR, PCR, or dipstick protein) within a two-year window. Albuminuria was harmonized to ACR levels for A-staging (ckdpcrisk.org/pcr2acr). We used the kidney-failure risk equation (ckdpcrisk.org/kidneyfailure-risk) to estimate the 2-year risk of kidney failure in 350,232 patients with eGFR <60 ml/min/1.73m<sup>2</sup>. We used the 40% eGFR decline calculator (ckdpcrisk.org/gfrdecline40) to estimate the 3-year risk of 40% decline in eGFR in 1,365,272 patients with eGFR ≥15 ml/min/1.73m<sup>2</sup>. We plotted the distribution of predicted risk within each G- and A-stage.

**Results:** The patients in the kidney failure risk population had a mean age 73 (SD 11) years; 39% were men; and there were 13,623 kidney failure events over mean follow-up of 3.4 years. The 40% decline population had a mean age of 58 (SD 15) years; 42% were men; and there were 33,257 events over a mean follow-up of 3 years. Risk of adverse outcomes increased with higher G- and A-stage. Within each stage; however, there was heterogeneity in predicted risk of adverse outcomes. Some stages contained risk distributions that spanned risk thresholds for action. For example, G5A1, G5A2, and G4A3 all contained patients with 2-year kidney failure risk above and below 20%, the suggested threshold for referral for vascular access/transplant evaluation. Risk overlap between stages was even greater when using the 40% decline calculator, with nearly all CKD stages spanning multiple risk categories.

**Conclusions:** CKD staging is useful as an initial tool for estimating risk of adverse outcomes but can be enhanced with use of appropriate risk prediction tools for a more nuanced estimate of future kidney failure and eGFR decline. Some strategies for risk-guided care have been developed and the potential for others should be tested using modeling and outcomes studies.

**Funding:** NIDDK Support, Private Foundation Support

Figure. Predicted risk of kidney failure (panel A) and ≥40% decline in eGFR (panel B) by CKD eGFR (G1 to G5) and ACR (A1 to A3) stage in OLDW. Lines show potential risk thresholds for clinical decisions.

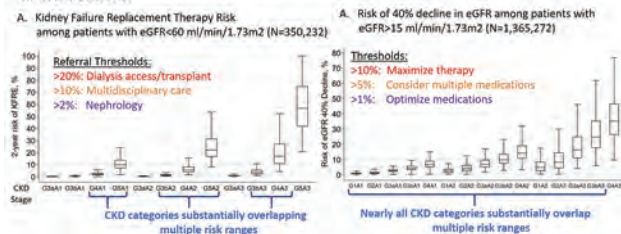

TH-PO891

TWEAK-Fn14 Signalling in Mesangial Cells Drives Intrarenal Inflammation During CKD Progression

Asha Seth,<sup>1</sup> Barbara Musial,<sup>1</sup> Timo N. Haschler,<sup>1</sup> Hong Wang,<sup>1</sup> Pernille B. Laerkegaard Hansen,<sup>2</sup> <sup>1</sup>AstraZeneca PLC, Cambridge, United Kingdom; <sup>2</sup>AstraZeneca, Gothenburg, Sweden.

**Background:** It is increasingly recognised that inflammation evokes renal injury and promotes chronic kidney disease (CKD) progression. Tumor necrosis factor (TNF)-like weak inducer of apoptosis (TWEAK), a member of the TNF superfamily, is a pleiotropic cytokine, which binds to fibroblast growth factor-inducible-14 (Fn14). TWEAK-Fn14 signalling has been linked with pathogenic processes in the kidney that may contribute to the progression of CKD. However, whether this pathway is a key driver of human disease has yet to be established.

**Methods:** To further explore the relevance of TWEAK-Fn14 signalling in CKD we have used human transcriptomic data sets and IHC to interrogate the expression of both ligand and receptor in kidney disease. We have then used human primary mesangial cells to identify regulators of Fn14 expression and explore the mechanisms regulated by the TWEAK-Fn14 pathway in renal cells. Finally, we have used a neutralising TWEAK antibody in vitro and in vivo to explore the therapeutic potential of intervening in this pathway.

**Results:** Fn14 expression was found to be upregulated in biopsies collected from CKD patients as compared to healthy living donors and was also highly correlated with increased kidney damage. IHC showed in patients with DKD, or in pre-clinical models of CKD, Fn14 was localised to the glomerulus, in a pattern consistent with mesangial expression, and in tubule cells. In primary human mesangial cells, PDGF-BB treatment increased cell surface Fn14 expression 9.6-fold. TWEAK application to mesangial cells dose-dependently induced increases in cell proliferation and the release of IL-8 and MCP-1. These effects were blocked by treatment with a neutralising TWEAK antibody. We further tested the beneficial effects of TWEAK neutralization in a murine model of rapid progressive glomerulonephritis induced by administration of nephrotoxic serum. We found that anti-TWEAK treatment significantly decreased MCP-1 transcript expression in the kidney and reduced the level of urinary MCP-1 indicating a reduction in intrarenal inflammation.

**Conclusions:** Fn14 is regulated in human CKD and is highly correlated with disease severity in CKD. In human primary mesangial cells Fn14 activation leads chemokines release. In vivo, TWEAK neutralisation translates into a decrease in the level of kidney MCP-1.

**Funding:** Commercial Support - AstraZeneca

TH-PO892

Factors Associated With Influenza Non-Vaccination Among Patients With CKD Under Nephrology Care

Junichi Ishigami,<sup>1</sup> Bernard G. Jaar,<sup>1</sup> James P. Lash,<sup>2</sup> Julia Brown,<sup>2</sup> Jing Chen,<sup>3</sup> Katherine T. Mills,<sup>3</sup> Jonathan J. Taliercio,<sup>4</sup> Jeanne Charleston,<sup>1</sup> Sheru Kansal,<sup>5</sup> Deidra C. Crews,<sup>1</sup> Kristin Rieker,<sup>1</sup> David W. Dowdy,<sup>1</sup> Lawrence J. Appel,<sup>1</sup> Kunihiro Matsushita.<sup>1</sup> <sup>1</sup>Johns Hopkins University, Baltimore, MD; <sup>2</sup>University of Illinois Chicago, Chicago, IL; <sup>3</sup>Tulane University, New Orleans, LA; <sup>4</sup>Cleveland Clinic, Cleveland, OH; <sup>5</sup>University Hospitals, Cleveland, OH.

**Background:** Influenza vaccines are strongly recommended in patients with CKD due to their high risk of poor outcomes. Identifying risk factors for not receiving an influenza vaccine ("non-vaccination") could inform strategies for improving vaccine uptake in this population.

**Methods:** We explored factors associated with influenza non-vaccination in 3522 CRIC participants (mean age 66 years, 43% female, 44% Black). Receipt of influenza vaccine was asked during annual clinic visits in 2008-2020 (median, 4 times per person) if participants were seen by a nephrologist, and assessed along with age, sex, race, diabetes, COPD, eGFR, urine protein-to-creatinine ratio, education, household income, marital status, employment status. We used mixed-effects Poisson models to estimate adjusted prevalence ratios (aPRs) for association with non-vaccination.

**Results:** The overall vaccine uptake was 72%. Factors significantly associated with influenza non-vaccination were younger age (aPR, 2.18 [95%CI, 1.85-2.56] for <50 vs. 75+ years), Black race (1.57 [1.41-1.74] vs. White), lower education, lower annual household income, formerly married status, and non-employed status (Figure). Participants with diabetes (0.80 [0.72-0.88]) and COPD (0.80 [0.70-0.93]) were more likely to receive vaccination than those without. Those with ESKD were more likely to receive vaccination (0.66 [0.56-0.79] vs. eGFR 60+ ml/min/1.73m<sup>2</sup>).

**Conclusions:** Despite nephrology care, influenza vaccines were underutilized for CKD patients, particularly younger adults, Black individuals, and those with low socioeconomic status. Strategies to improve vaccine uptake through nephrology care should be explored in future studies.

**Funding:** NIDDK Support

**Figure: Prevalence ratios (PRs) of not receiving an influenza vaccine: CRIC Study.** PRs (95%CI) for not receiving an influenza vaccine were estimated using mixed-effects Poisson models with robust variance to account for multiple records per person all estimates are adjusted for age, sex, race, enrollment phase, study center, diabetes, hypertension, history of CVD, COPD, cancer eGFR, and uPCR.

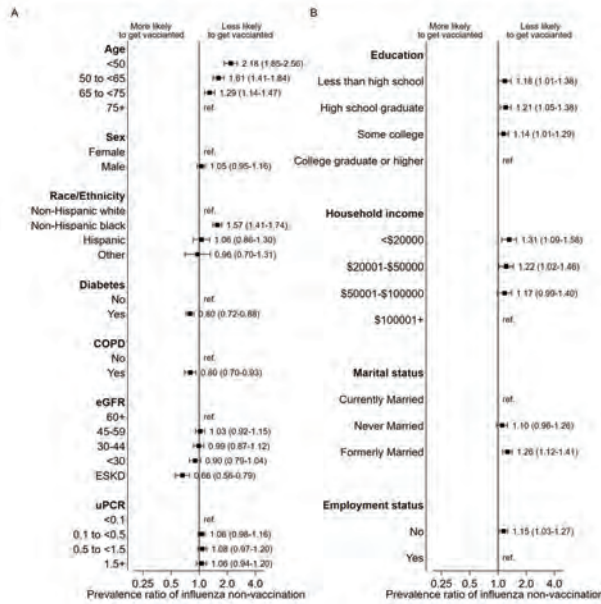

TH-PO893

**Impact of Caring for Individuals With CKD in the United States: A Systematic Literature Review**

Katherine M. Osenenko,<sup>1</sup> Satabdi Chatterjee,<sup>2</sup> Saurabh Ray,<sup>2</sup> Tina Li,<sup>1</sup> Bonnie M. Donato.<sup>2</sup> <sup>1</sup>Broadstreet HEOR, Vancouver, BC, Canada; <sup>2</sup>Boehringer Ingelheim Pharmaceuticals Inc, Ridgefield, CT.

**Background:** Individuals with chronic kidney disease (CKD) often rely upon the support of unpaid caregivers (CGs) who play a critical role in assisting with disease management activities. While the importance of CGs' roles is widely recognized, the impact to CGs is not well characterized, including time required for care duties and negative impacts to CG health and well-being. The objective of this review was to synthesize contemporary estimates of economic, clinical, and humanistic impact among CGs of patients with CKD in the United States (US).

**Methods:** A systematic review was conducted using MEDLINE and Embase to identify studies reporting estimates of CG impact in the US, published between 2016-2021. Study selection and data extraction were performed in duplicate, in accordance with PRISMA guidelines. A grey literature search was conducted for the past 5 years. Characteristics of patients with CKD and their CGs were summarized, as well as estimates of the economic, clinical, and humanistic impact to CGs.

**Results:** From 2,990 abstracts, 8 studies reporting CG burden estimates were included. Mean CG age ranged from 61-63 years; CGs were primarily female (57.9-78.4%) and the patient's spouse/partner (42.1-45.3%). Time spent caregiving ranged from 27-38 hours/week (2 studies) and caregiving duration from 3.7-5.0 years (2 studies). In one study, 69.1% of CGs for those with CKD and anemia made at least one job-related decision due to caregiving, including retiring early, reducing work hours, or quitting their job. Depression was identified in 31.6-36.4% CGs (2 studies), while 31.6- 43.6% had anxiety (2 studies). Although a variety of instruments were used to measure humanistic burden, studies consistently documented the high impact of caregiving for patients with CKD.

**Conclusions:** This review demonstrates the considerable burden of caring for individuals with CKD; however, estimates of CG impact were sparse and heterogeneous. Despite limited data, notable findings include the large amount of time spent caregiving and frequent identification of depression and anxiety among CGs. Future research is needed to better characterize the impact to those caring for individuals with CKD, including economic burden and healthcare resource use, as well as the evaluation of drivers of burden.

TH-PO894

**Nationwide Implementation of Integrated Renal Palliative Care: A Model for Middle-Income Countries**

Rafidah Abdullah. Hospital Putrajaya Malaysia, Putrajaya, Malaysia.

**Background:** Malaysia is an upper-middle-income country and is categorized as having isolated provisions for palliative care services (Stage 3A). End-stage kidney disease (ESKD) patients have reported palliative care symptoms and their needs are largely unmet. Integration of palliative care into nephrology services will increase access to renal patients.

**Methods:** Comparisons between Malaysia, a middle-income country with a high-income country, United Kingdom were made using Checkland's CATWOE and needs assessment (comparative and corporate approaches). Analysis of current renal services was performed using SWOT analysis.

**Results:** A model of healthcare delivery using four components was designed - structure, process, output, and outcome (Image 1) based on SWOT analysis. The emphasis was put on engagement, capacity, and environmental aspects; in accordance with the findings of the comparative needs assessment. National Palliative Care policy and strategic plan 2019-2030 for Malaysia strongly supported the integration of services. Following this, the integration of renal palliative care into nephrology services was identified as key for nephrology services, a forefront for the 12th National Strategic Plan for Malaysia 2021-2025. A framework for nationwide implementation was designed in four phases. In phase I, the foundation was laid in terms of training, questionnaire, planning, and multi-sectoral engagement. Phase II involved the development of shared decision-making including pre-dialysis education program and training. Phase III includes national implementation, training, audit, and quality improvements. In phase IV, there will be integration with primary care delivering community renal palliative care.

**Conclusions:** A standardized comprehensive ESKD care program will provide holistic healthcare delivery and access to achieve universal health coverage. This framework can be replicated and may be applicable to other middle-income countries. This implementation will achieve advanced integration of palliative care within nephrology services.

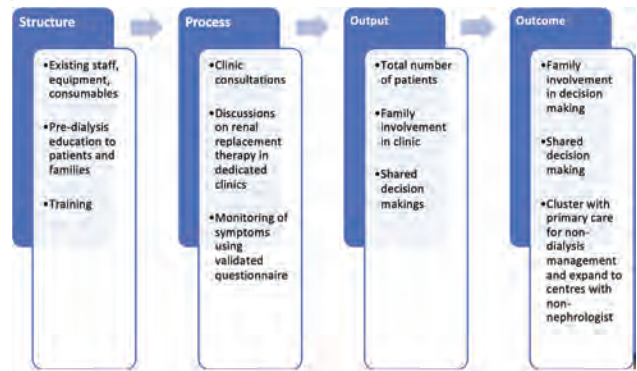

TH-PO895

**HIF-Stabilization Drives Expression of MUC1 Pathogenic Variants in Human Renal Tubular Cells**

Stephanie Naas,<sup>1</sup> René Krüger,<sup>1</sup> Karl X. Knaup,<sup>1</sup> Julia Naas,<sup>2</sup> Steffen Grampp,<sup>1</sup> Mario Schiffer,<sup>1</sup> Michael S. Wiesener,<sup>1</sup> Johannes Schödel.<sup>1,1</sup> <sup>1</sup>Universitätsklinikum Erlangen Medizinische Klinik 4 Nephrologie und Hypertensiologie, Erlangen, Germany; <sup>2</sup>Center for Integrative Bioinformatics Vienna (CIBIV), Max Perutz Labs, University of Vienna and Medical University of Vienna, Vienna, Austria.

**Background:** Various genetic alterations in the Mucin1 (MUC1) gene predispose to the development of chronic kidney disease. These variations comprise both the frequent GWAS-identified polymorphism rs4072037 that alters splicing of MUC1 mRNA but also ultra-rare autosomal-dominant inherited mutations which lead to expression of a deleterious frameshift (fs) protein causing autosomal dominant tubulointerstitial kidney disease (ADTKD-MUC1). Furthermore, the length of a region with a variable number of tandem repeats (VNTR) within the second exon of the MUC1 gene is associated with markers of kidney function. Hence, MUC1 presents a bona fide kidney disease gene. However, regulatory mechanisms influencing expression of MUC1 in the kidney are still poorly defined.

**Methods:** Primary renal tubular cells were isolated from kidneys of a large cohort of patients undergoing tumor nephrectomy or from the urine of ADTKD-MUC1 patients. Different pharmacological compounds causing stabilization of hypoxia-inducible transcription factors (HIFs) or hypoxia were used to investigate the effect of HIF on the expression of MUC1 and MUC1 pathogenic variants. Expression of MUC1 mRNA including splice variants was analysed by qPCR or RNA-sequencing. Wild-type MUC1 and fs-protein were detected by Immunoblotting.

**Results:** Using the Assay for Transposase-Accessible Chromatin with high-throughput sequencing and Chromatin Immunoprecipitation DNA-sequencing, we identified a regulatory, hypoxia-responsive element in the promoter-proximal region of MUC1, which drives MUC1 expression upon stabilization of HIF. HIF induces mRNA expression of wild-type MUC1 but also of the harmful splice-, VNTR-, and frameshift variants when tubular cells were exposed to hypoxia or novel prolyl-hydroxylase inhibitors to stabilize HIF.

**Conclusions:** In this study, we demonstrate a functional link between the regulation of MUC1 expression and the hypoxia-inducible transcription factor pathway in human renal tubular cells. In the context of the recent introduction of HIF-stabilizing substances for the treatment of renal anemia and the evidence for MUC1 pathogenic variants in causing kidney disease, our results should be considered when selecting patients for the treatment with novel HIF-stabilizing agents.

TH-PO896

**Comparative Safety and Effectiveness of Apixaban Dosing in Patients With Atrial Fibrillation and Severe CKD**

Yunwen Xu,<sup>1</sup> Alex R. Chang,<sup>2</sup> Lesley A. Inker,<sup>3</sup> Mara McAdams-DeMarco,<sup>4</sup> Morgan Grams,<sup>4,1</sup> Jung-Im Shin.<sup>1</sup> <sup>1</sup>Johns Hopkins University Bloomberg School of Public Health, Baltimore, MD; <sup>2</sup>Geisinger Health, Danville, PA; <sup>3</sup>Tufts Medical Center, Boston, MA; <sup>4</sup>New York University Grossman School of Medicine and Langone Health, New York, NY.

**Background:** The United States Food and Drug Administration (FDA) recommends reduced dose of apixaban in atrial fibrillation (AF) patients with  $\geq 2$  of the following characteristics: age  $\geq 80$  years, weight  $\leq 60$  kg, or serum creatinine  $\geq 1.5$  mg/dL. Thus, the FDA-recommended dose for some patients with severe chronic kidney disease (CKD G4+; eGFR  $< 30$  ml/min/1.73 m<sup>2</sup>) is the standard dose (5 mg twice daily) and for others is the reduced dose (2.5 mg twice daily). On the other hand, the European Medicines Agency (EMA) recommends the reduced dose of apixaban for all patients with severe CKD (creatinine clearance 15-30 ml/min).

**Methods:** Using de-identified electronic health record data from the Optum Labs Data Warehouse, we identified patients with AF and non-dialysis dependent CKD G4+ initiating apixaban in 2013-2021. We compared the risks of bleeding (harm) and ischemic stroke (benefit) by apixaban dose (5 mg vs. 2.5 mg), adjusting for baseline characteristics by inverse probability of treatment weighting (IPTW). We used Fine-Grey subdistribution hazard models to account for the competing risk of death. We also examined the risk of death by apixaban dose using Cox regression.

**Results:** Among 4313 apixaban new users, 1705 (40%) received 5 mg and 2608 (60%) received 2.5 mg. Patients given 5 mg were younger (mean age 72 vs. 80 years), with greater weight (95 vs. 80 kg) and higher serum creatinine level (2.69 vs. 2.47 mg/dL). Mean eGFR was similar between the groups (24 vs. 24 ml/min/1.73 m<sup>2</sup>). In IPTW analyses, apixaban 5 mg (vs. 2.5 mg) was associated with a higher risk of bleeding (incidence rate difference [95% CI], 1.24 [0.19-2.29] per 100 person-years; subdistribution hazard ratio [95% CI], 1.47 [1.01-2.14]) (Figure). The risks for ischemic stroke and death did not differ by apixaban dose.

**Conclusions:** Use of 5 mg apixaban was associated with a higher risk of bleeding in patients with AF and CKD G4+, with a similar risk for ischemic stroke, supporting the current apixaban renal dosing recommendation by EMA.

**Funding:** NIDDK Support

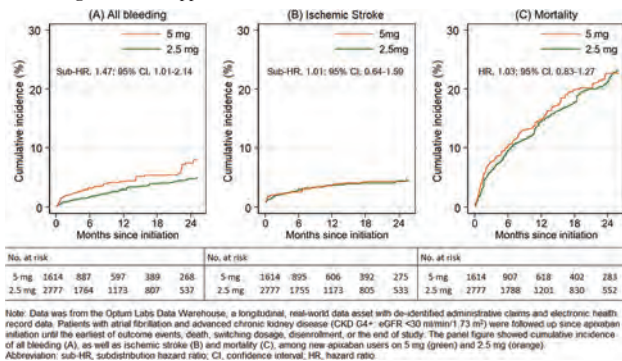

TH-PO897

**Estimating Time to Kidney Failure: Comparison of KFRE and eGFR Thresholds**

Chi D. Chu,<sup>1</sup> Charles E. McCulloch,<sup>1</sup> Raymond K. Hsu,<sup>1</sup> Neil R. Powe,<sup>1</sup> Brian Bieber,<sup>2</sup> Bruce M. Robinson,<sup>2</sup> Roberto Pecoito-Filho,<sup>2</sup> Rupesh Raina,<sup>3</sup> Delphine S. Tuot.<sup>1</sup> <sup>1</sup>University of California San Francisco, San Francisco, CA; <sup>2</sup>Arbor Research Collaborative for Health, Ann Arbor, MI; <sup>3</sup>Akron Children's Hospital, Akron, OH.

**Background:** The Kidney Failure Risk Equation (KFRE) is a widely validated model for predicting the risk of ESKD at 2 years among persons with CKD. We examined correspondences between KFRE-predicted risk and time to ESKD and compared them to eGFR thresholds.

**Methods:** In the CKDopps cohort study of patients with CKD G3-G5 recruited from 34 US nephrology practices 2013-2021, the KFRE-predicted 2-year risk of ESKD was computed using age, sex, UACR, and eGFR (2021 CKD-EPI equation without race) and analyzed. For persons missing UACR, we substituted UPCr or urinalysis protein as available, converting to UACR using validated equations. Each participant could contribute multiple risk periods based on updated KFRE predictions calculated at follow up visits. We used accelerated failure time (Weibull) models to estimate median, 25<sup>th</sup>, and 75<sup>th</sup> percentile times to reaching ESKD starting from KFRE values of 10%, 20%, 40% and from eGFR values of 30, 20, and 15 ml/min/1.73m<sup>2</sup>. We additionally examined time to ESKD in subgroups by age, sex, race, diabetes status, and albuminuria. Robust standard errors were used to account for clustering by participant.

**Results:** 1,634 participants (mean age 68±13 years; 48.7% female; mean eGFR 29±12 ml/min/1.73m<sup>2</sup>; median UACR 104 [IQR 25, 803] mg/g) were included, contributing 9,886 risk periods. Over a median follow up of 1.6 years (IQR 1.0, 2.5), 266 participants developed ESKD and 178 died. Median time to ESKD was highly

variable across subgroups from eGFR thresholds of 30 and 20 ml/min/1.73m<sup>2</sup> (Figure) and was shorter for Black (versus non-Black), diabetic (versus non-diabetic), younger age, and higher albuminuria subgroups. There was less subgroup variability from an eGFR of 15 ml/min/1.73m<sup>2</sup> and from KFRE thresholds.

**Conclusions:** Compared with eGFR, KFRE thresholds demonstrated less variability across subgroups in time to ESKD and may be advantageous for informing clinical decisions about kidney replacement therapy.

**Funding:** Private Foundation Support

Figure. Median (IQR) time to ESKD from eGFR or 2-year KFRE threshold values

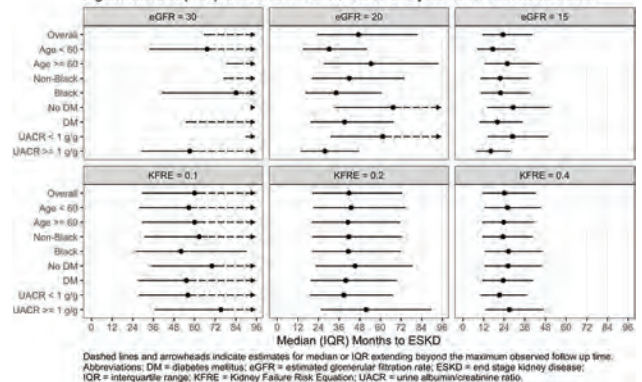

TH-PO898

**Discordances Between Creatinine and Cystatin C-Based eGFR and Adverse Clinical Outcomes in Routine Clinical Practice**

Edouard Fu,<sup>1,2</sup> Juan J. Carrero,<sup>3</sup> Yingying Sang,<sup>5</sup> Marie Evans,<sup>3</sup> Lesley A. Inker,<sup>4</sup> Andrew S. Levey,<sup>4</sup> Josef Coresh,<sup>5</sup> Morgan Grams.<sup>5</sup> <sup>1</sup>Brigham and Women's Hospital, Boston, MA; <sup>2</sup>Harvard Medical School, Boston, MA; <sup>3</sup>Karolinska Institutet, Stockholm, Sweden; <sup>4</sup>Tufts Medical Center, Boston, MA; <sup>5</sup>Johns Hopkins University, Baltimore, MD.

**Background:** The 2021 NKF-ASN Task Force recommended increased use of cystatin C-based eGFR equations. Discordances can occur between eGFR<sub>Cr</sub> and eGFR<sub>Cys</sub>, since creatinine and cystatin C have different non-GFR determinants. Currently, it is unknown how common and large these discordances are in routine clinical practice, and whether discordances predict adverse clinical outcomes. In Sweden, routine cystatin C testing has been available for over a decade.

**Methods:** We used data from the SCREAM project, which covers the healthcare of Stockholm region. We identified adults who, during 2011-2018, undertook outpatient tests of IDMS calibrated creatinine and cystatin C on the same day. eGFR<sub>Cr</sub> and eGFR<sub>Cys</sub> were calculated with the 2021 and 2012 CKD-EPI equations. Multivariable Cox proportional hazards regression was used to calculate hazard ratios for quartiles of discordance between eGFR<sub>Cys</sub> and eGFR<sub>Cr</sub>, and the outcomes AKI, kidney failure with replacement therapy (KFRT), major adverse cardiovascular events (MACE) and death.

**Results:** Of 1,570,592 people with eGFR<sub>Cr</sub>, 13% also had routine eGFR<sub>Cys</sub>. We included 158,663 participants (mean age 62 years, 48% women, mean eGFR<sub>Cr</sub> 80 and eGFR<sub>Cys</sub> 73 ml/min/1.73m<sup>2</sup>) with both tests on the same day. Discordances were common, with eGFR<sub>Cys</sub> in most cases being lower than eGFR<sub>Cr</sub>. Patients with lower eGFR<sub>Cys</sub> than eGFR<sub>Cr</sub> were older, and more often female, with hypertension, diabetes or cardiovascular disease. Larger discordances were observed among patients with higher eGFR<sub>Cr</sub> and UACR. Patients whose eGFR<sub>Cys</sub> was lower than eGFR<sub>Cr</sub> were at higher risk of all study outcomes. Conversely, patients whose eGFR<sub>Cys</sub> was higher than their eGFR<sub>Cr</sub> were at lower risks (Table). Similar findings were observed within subgroups of eGFR categories, age, sex, and comorbidities.

**Conclusions:** Integration of cystatin C testing into routine clinical practice in the Stockholm region showed many patients with a discordance between eGFR<sub>Cys</sub> and eGFR<sub>Cr</sub>. Lower eGFR<sub>Cys</sub> than eGFR<sub>Cr</sub> consistently identified patients at higher risk of multiple outcomes.

Table. Adjusted hazard ratios for adverse outcomes associated with quartiles of distribution in discordances between eGFR<sub>Cys</sub> and eGFR<sub>Cr</sub>.

	Quartile 1 (-99% to -27%) eGFR <sub>Cys</sub> < eGFR <sub>Cr</sub>	Quartile 2 (-27 to -10%) eGFR <sub>Cys</sub> ≈ eGFR <sub>Cr</sub>	Quartile 3 (-10% to +6%) eGFR <sub>Cys</sub> ≈ eGFR <sub>Cr</sub>	Quartile 4 (+6% to +880%) eGFR <sub>Cys</sub> > eGFR <sub>Cr</sub>
AKI	2.39 (2.11, 2.70)	1.44 (1.27, 1.64)	Reference	0.63 (0.54, 0.75)
KFRT	1.33 (1.14, 1.54)	1.12 (0.97, 1.28)	Reference	0.81 (0.70, 0.94)
MACE	1.67 (1.57, 1.76)	1.25 (1.18, 1.32)	Reference	0.82 (0.76, 0.88)
All-cause death	2.64 (2.55, 2.73)	1.47 (1.41, 1.52)	Reference	0.81 (0.77, 0.85)

Lower quartiles depict situations in which eGFR<sub>Cys</sub> was lower than eGFR<sub>Cr</sub>. Adjusted for age, sex, hypertension, diabetes and history of CVD, eGFR<sub>Cr</sub> splines with knots at 60 and 90, missing indicator of urine albuminuria and logACR (converted from PCR or dipstick if ACR is not available).

TH-PO899

**Association of Longitudinal B-Type Natriuretic Peptide Monitoring With Kidney Replacement Therapy and Heart Failure in Patients With CKD**  
 Tatsufumi Oka,<sup>1,2</sup> Yusuke Sakaguchi,<sup>3</sup> Koki Hattori,<sup>2</sup> Yuta Asahina,<sup>2</sup> Sachio Kajimoto,<sup>2</sup> Wendy I. McCallum,<sup>1</sup> Hocine Tighiouart,<sup>4,5</sup> Mark J. Sarnak,<sup>1</sup> Jun-Ya Kaimori,<sup>3</sup> Yoshitaka Isaka.<sup>2</sup> <sup>1</sup>Division of Nephrology, Tufts Medical Center, Boston, MA; <sup>2</sup>Department of Nephrology, Osaka University Graduate School of Medicine, Suita, Japan; <sup>3</sup>Department of Inter-Organ Communication Research in Kidney Diseases, Osaka University Graduate School of Medicine, Suita, Japan; <sup>4</sup>Institute for Clinical Research and Health Policy Studies, Tufts Medical Center, Boston, MA; <sup>5</sup>Tufts Clinical and Translational Science Institute, Tufts University, Boston, MA.

**Background:** Existing evidence suggests that B-type natriuretic peptide (BNP) reflects volume status in patients with chronic kidney disease (CKD). Although longitudinal monitoring of BNP may result in optimal fluid management, including the avoidance of volume overload, potentially leading to better renal prognosis, its clinical benefit remains uncertain.

**Methods:** In this retrospective cohort study, adult CKD outpatients with stages 3–5 not on dialysis referred to an academic hospital between 2005 and 2018 were analyzed. The exposure variable was monitoring of plasma BNP. Study outcomes included kidney replacement therapy (KRT) and heart failure (HF) hospitalization. Applying marginal structural models using inverse probability of weighting (IPW), which created a balanced pseudo-population at each time point, the associations between longitudinal BNP monitoring and outcomes were examined. IPW-weighted pooled logistic regression models were employed to estimate the hazard ratios (HRs). Patient demographics, comorbidities, laboratory data, and medications were considered as potential time-dependent confounders.

**Results:** Among 2998 outpatients, median age and eGFR were 66 years and 38.4 mL/min/1.73 m<sup>2</sup>, respectively. During follow-up (median, 5.9 years), 449 patients required KRT and 236 were hospitalized for HF. After adjustment for time-dependent confounders, longitudinal BNP monitoring was associated with lower risks of KRT (HR, 0.45; 95% confidence interval [CI], 0.21–0.93) and HF hospitalization (HR, 0.37; 95% CI, 0.15–0.94). The association between longitudinal BNP monitoring and KRT was attenuated after additional adjustment for HF hospitalization as a time-dependent covariate.

**Conclusions:** Among patients with CKD not on dialysis, longitudinal BNP monitoring was associated with a lower risk of requirement for KRT, potentially mediated by a reduced risk of HF hospitalization.

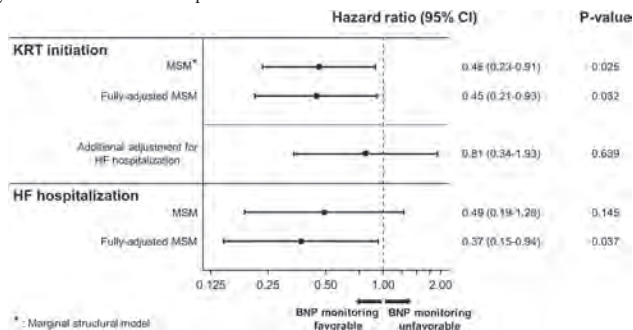

TH-PO900

**An Early Look at the ESRD Treatment Choices (ETC) Payment Model's Impact on Organ Procurement and Transplant Network (OPTN) Medicare Kidney Transplant Waitlist Additions**  
 Andrew Placona, Brittany R. Shean. *United Network for Organ Sharing, Richmond, VA.*

**Background:** Beginning on January 1st, 2021, CMS randomly assigned 30% of Health Referral Regions (HRR) to the ETC payment model. This payment model links dialysis reimbursements to two metrics, home dialysis and the transplant rate. The definition of transplant rate includes the proportion of a dialysis provider's attributed patients on the kidney transplant waitlist. Our objective was to determine if the ESRD Treatment Choices (ETC) payment model was associated with an increased number of Medicare kidney registrations.

**Methods:** We obtained the data for all kidney waitlist additions between 2016 and 2021 from the OPTN database, the participating ETC sites data from CMS, and the zip code to HRR crosswalk from the Dartmouth Atlas. We utilized the archival transplant program-specific report data from the SRTR. We utilized the candidate's reported zip code and the Dartmouth Atlas' zip code to HRR crosswalk to create a panel dataset where the unit of analysis was a HRR for each year from the OPTN registration data. The dependent variable was the logarithmic transformation of the number of Medicare waitlist additions. The dependent variable was regressed on lagged waitlist additions, lagged size of the waitlist, one-year graft survival performance for the dominant transplant center the year prior, and percent Medicare in the HRR utilizing a difference-in-difference design via the first difference estimator.

**Results:** Our sample included 237,850 total additions (106,626 Medicare) between 2016 and 2021. The ETC program was associated with a 6.60% increase in the change of (95 CI: 1.16% to 12.0%, p=.018) Medicare kidney transplant registrations.

**Key: TH - Thursday; FR - Friday; SA - Saturday; OR - Oral; PO - Poster; PUB - Publication Only**  
**Underline represents presenting author.**

**Conclusions:** The first year of ETC program resulted in faster growth in Medicare kidney transplant registrations in areas affected by the new payment policy  
**Funding:** Other U.S. Government Support

TH-PO901

**Long-Term Effect of COVID-19 Infection on Kidney Function Among COVID-19 Patients Followed in a Post-COVID-19 Recovery Clinic in British Columbia, Canada**  
 Jordyn R. Thompson,<sup>1</sup> Mohammad Atiquzzaman,<sup>2</sup> Selena Shao,<sup>2</sup> Ognjenka Djurdjev,<sup>2</sup> Adeera Levin,<sup>1</sup> Peter C. Birks.<sup>1</sup> <sup>1</sup>The University of British Columbia, Vancouver, BC, Canada; <sup>2</sup>BC Provincial Renal Agency, Vancouver, BC, Canada.

**Background:** Recent research suggests that COVID-19 is associated with acute kidney dysfunction. Effect of COVID-19 infection on downstream kidney function is unknown. We investigated this using the BC Interdisciplinary COVID-19 Care Network data.

**Methods:** This retrospective cohort study analyzed a 2,212 COVID-19 patient cohort, aged ≥18 years, referred to the Post COVID Recovery Clinic (PCRC) in BC, Canada between July 9, 2020 & April 21, 2022. COVID-19 diagnosis date was the index date. Patients with history of kidney transplantation or dialysis before index date were excluded. Patients who deceased within 3 months of cohort entry were excluded. eGFR values were retrieved from the Provincial Laboratory Information System. We examined change in eGFR at 3-, 6-, 12-months after COVID-19 infection among the same study individuals using linear mixed model. Subgroup analysis included comparison between hospitalized vs. non-hospitalized, & diabetics vs. non-diabetics.

**Results:** Analytic cohort included 457 patients (median age 59 years, 50% male) for whom eGFR was recorded at 3-, 6-, 12-months from index date. Prevalence of reduced eGFR (≤59ml/min/1.73m<sup>2</sup>) was 16%, 16%, 17% at 3-, 6- and 12- months post-index date, respectively. Median (IQR) eGFR at baseline was 90 (73, 102) that was reduced to 85 (70, 101) at 6-months & remained stable or <previous value at 12 months post-index date, 86 (69, 101). Results from linear mixed model indicated a 0.23 mL/min decrease in eGFR in each month after COVID-19 infection (intercept 85.51, slope -0.23, p-value=0.0003). In subgroup analyses, similar trends of decreasing eGFR over time were observed among diabetic (n=188, intercept 83.08, slope -0.42, p-value=0.0001) & non-diabetic patients (n=269, intercept 87.33, slope -0.12, p-value=0.13). Interestingly, eGFR appeared to improve over time in non-hospitalized patients (n=133, intercept 88.34, slope 0.24, p-value=0.03) compared to a decreasing trend among hospitalized patients (n=324, intercept 83.94, slope -0.41, p-value<0.001).

**Conclusions:** One in 6 COVID-19 patients who were referred to PCRC had reduced eGFR. COVID-19 was associated with a statistically significant decrease in eGFR, particularly in diabetic & hospitalized patients that warrants ongoing monitoring following COVID-19 infection.

TH-PO902

**COVID-19 Infection Is a Risk Factor for CKD and Glomerulonephritis**  
 Maria-Eleni Roumelioti, Hamza Mir, Christos Argyropoulos. *University of New Mexico Health Sciences Center, Albuquerque, NM.*

**Background:** The ongoing COVID19 pandemic continues to challenge healthcare systems. While COVID19 disease is associated with Acute Kidney Injury and collapsing glomerulonephritis, little is known about the potential kidney manifestations of PASC (Post-Acute Sequelae of COVID19). In this study we used TrinetX, a large health research network that aggregates data from multiple centers in the United States to analyze the effects of COVID19 on chronic kidney disease (CKD) manifestations of PASC.

**Methods:** We searched TrinetX for patients > 18 years old with a documented SARS-COV-2 PCR test and classified them into 2 cohorts: C19+ve (with a [+] molecular test for SARS-COV-2 or a clinical diagnosis of COVID19 disease) and C19-ve (absence of such findings). We excluded patients who had received any COVID19 vaccine. We collected demographics, comorbidities, diagnoses for up to two years after any COVID19 PCR test (index event). A 1:1 propensity score matching (PSM) using the nearest neighbor method was used to balance the 2 cohorts on age, gender, Hispanic ethnicity, black race, hypertension, diabetes, heart failure and atherosclerosis. Patients with a kidney specific diagnosis prior to their COVID19 PCR test were excluded.

**Results:** We identified 2,780,780 C19+ve and 6,757,849 C19-ve patients. After PSM each group contained 2,775,418 subjects. Mean age was 40.2±23.1, females were 54.7%, blacks were 15.8% & 12.3% were Hispanic or Latinos. COVID19 diagnosis was a strong risk factor for CKD (Relative Risk, RR 2.474, p<0.001), nephritic, nephrotic syndrome and glomerular disorders.

**Conclusions:** COVID19 disease is a major risk factor for incident CKD, nephrotic and nephritic syndrome. These findings should be confirmed in prospective studies. Whether these sequelae represent persistence of the kidney tropic SARS-COV-2 virus, vascular damage from the acute infection or a manifestation of autoimmunity can only be established through targeted mechanistic studies.

Incident Kidney Specific Diagnosis

Diagnosis (ICD10)	C19+ve	C19-ve	RR	95%CI
CKD (N18)	74,229/2,531,455	31,065/2,620,854	2.474	(2.442, 2.507)
Unspecified kidney failure (N19)	12,286/2,748,570	3,684/2,759,576	3.348	(3.227, 3.474)
Nephritic syndrome (N05)	1,701/2,767,692	1,227/2,767,250	1.386	(1.288, 1.492)
Nephrotic Syndrome (N04)	984/2,771,095	816/2,771,093	1.206	(1.099, 1.323)
Glomerular disease (N00-N06)	3,336/2,757,954	2,879/2,755,818	1.158	(1.102, 1.217)

TH-PO903

**Vaccination Reduces Risk of CKD Associated With COVID-19 Disease**

Hanza Mir, Maria-Eleni Roumelioti, Christos Argyropoulos. *University of New Mexico Health Sciences Center, Albuquerque, NM.*

**Background:** COVID19 disease has emerged as a major risk factor of chronic health conditions, i.e. PostAcute Sequelae of COVID19 (PASC). With the emergence of more transmissible variants, the global human population will eventually be exposed to the spike protein of SARS-COV-2 either through natural infection or vaccination. It remains unknown whether vaccination may affect the kidney manifestations of PASC.

**Methods:** We searched TrinetX, a large health research network that aggregates data from multiple centers in the United States to analyze the effects of vaccination on CKD manifestations of PASC. We classified patients as C19+ve (with a [+] molecular test for SARS-COV-2 or a clinical diagnosis of COVID19 disease) and Vax7+ve if they had at least one dose of any COVID19 vaccine and did not have a breakthrough infection. We collected demographics, comorbidities, diagnoses for up to 2 years after any COVID19 PCR test (index event). A 1:1 propensity score matching (PSM) using the nearest neighbor method was used to balance the two cohorts on age, gender, Hispanic ethnicity, black race, hypertension, diabetes, heart failure and atherosclerosis. Patients with a kidney specific diagnosis prior to their COVID19 PCR test were excluded.

**Results:** We identified 2,780,576 C19+ve and 735,966 Vax+ve patients. After PSM each group contained 736,034 subjects. Mean age was 51.5±21.4, females were 58.8%, blacks were 14.9% & 9.9% were Hispanic or Latinos. COVID19 vaccination was associated with reduced risk of incident CKD, unspecified kidney failure and the nephritic syndrome, but did not reduce the risk of the nephrotic syndrome or glomerulonephritis relative to COVID19 disease.

**Conclusions:** Vaccination may reduce the risk of CKD associated with PASC. If confirmed in a prospective study, our findings can expand the known benefits of vaccination on the acute disease to PASC manifestations, potentially improving the uptake of the COVID19 vaccines by the population.

Incident Kidney Specific Diagnosis

Diagnosis (ICD10)	Vax+ve	C19+ve	RR	95%CI
CKD (N18)	16,456/670,266	29,158/632,683	0.933	(0.523, 0.543)
Unspecified kidney failure (N19)	1,409/730,150	5,268/724,675	0.265	(0.250, 0.282)
Nephritic syndrome (N05)	573/732,497	673/733,019	0.852	(0.782, 0.952)
Nephrotic Syndrome (N04)	403/734,394	351/734,500	1.148	(0.995, 1.325)
Glomerular disease (N00-N08)	1,354/727,917	1,296/729,078	1.045	(0.968, 1.127)

TH-PO904

**The Emergence of CKD After COVID-19 Related AKI**

Thiago Terzian Ganadjan,<sup>1</sup> Vinicius Pereira Leite Nakamura,<sup>1</sup> Beatriz M. Silva,<sup>1</sup> Otavio H. Clemente,<sup>1</sup> Bárbara F. Domingues,<sup>1</sup> Jessica L. Andrade,<sup>1</sup> Adelson Rodrigues,<sup>1</sup> Miguel Angelo Goes.<sup>1,2</sup> <sup>1</sup>Universidade Federal de Sao Paulo, Sao Paulo, Brazil; <sup>2</sup>Universidade Federal de Sao Paulo Hospital do Rim e Hipertensao, Sao Paulo, Brazil.

**Background:** Acute kidney injury (AKI) can eventually progress into chronic kidney disease (CKD) and end-stage kidney disease (ESKD). COVID-19 is a multisystemic disorder that often causes AKI. The purpose of this study is to assess the frequency and association of clinical variables in patients who developed CKD and ESKD after COVID-19-related AKI.

**Methods:** We performed a one-year follow-up study with 182 survivor patients admitted to the ward and intensive care unit (ICU) with COVID-19 between April 2020 and March 2021 at Hospital São Paulo, Brazil. Patients aged ≥ 18 years with COVID-19 confirmed on RT-PCR were included. Patients with ESKD before hospitalization were excluded. AKI and CKD were defined according to the KDIGO criteria. We evaluated the frequency of AKI. After it, we compared some clinical variables and outcomes in two subgroups: CKD after CoV-AKI, and non-CKD after COVID-19. Univariate and multivariate analyses were performed.

**Results:** 137 (75.3%) patients developed AKI. Of these, 56 (30.8%) needed kidney replacement therapy (KRT) in-hospital. There were higher frequencies of diabetes and hypertension with lower eGFR (84.2±24.9, 94.4±29.9 ml/min; p=0.08) and mean arterial pressure (74.9±9.6, 79.1±7.7 mmHg; p=0.03) at baseline in CKD after CoV-AKI group. Hypertension was independently associated with CKD in binary logistic regression [OR: 4.472, 95% CI:1356-13886; p=0.001]. We further observed that all patients who progressed to ESKD (n=7; 3.9%) had non-dialytic CKD exacerbated by COVID-19 requiring KRT.

**Conclusions:** Hypertension was the independent clinical factor associated with progression to CKD after COVID-19-related AKI. All patients who progressed to ESKD had CKD exacerbated by COVID-19 requiring KRT.

TH-PO905

**Is COVID-19 Infection Associated With the Progression of Kidney Disease? Findings From a Population Based Observational Study From British Columbia, Canada**

Mohammad Atiquzzaman,<sup>1</sup> Ognjenka Djurdjev,<sup>1</sup> Yuyan Zheng,<sup>1</sup> Lee Er,<sup>1</sup> Peter C. Birks,<sup>3</sup> Micheli U. Bevilacqua,<sup>3</sup> Matthew J. Oliver,<sup>2</sup> Adeera Levin.<sup>3</sup> <sup>1</sup>BC Provincial Renal Agency, Vancouver, BC, Canada; <sup>2</sup>Sunnybrook Health Sciences Centre, Toronto, ON, Canada; <sup>3</sup>The University of British Columbia, Vancouver, BC, Canada.

**Background:** Recent research suggests that COVID-19 infection is associated with acute kidney injury (AKI). Together the inflammation caused by the virus in the kidneys and the episodes of AKIs are risk factors for progression of kidney diseases. We investigated the risk of progression to kidney failure among chronic kidney disease (CKD) patients from BC, Canada who were infected with COVID-19.

**Methods:** In this retrospective cohort study, we analyzed a cohort of 22,188 non-dialysis CKD patients aged ≥18 years, with no prior history of ESKD and COVID-19 infection before the cohort entry date between January 27, 2020 & December 15, 2021. The cohort was derived from Patient Records and Outcome Management Information System (PROMIS), a population based integrated registry database for CKD patients under the nephrologist care in BC. Incident COVID-19 cases were iteratively matched without replacement to non-COVID-19 controls (1:3 ratio) based on age, sex, region of residency, diabetes status, eGFR and urine ACR, CKD vintage and COVID-19 vaccination status as of COVID-19 diagnosis date. The primary outcome was a composite of initiation of maintenance dialysis defined by dialysis performed for ≥4 weeks, a sustained decline in eGFR defined by ≥40% decline from baseline that sustained over ≥4 weeks or incident kidney transplantation. Estimated HR and 95% CI using Fine and Gray subdistribution hazard model to account for death as a competing risk.

**Results:** The analytic data included 1,708 patients, 475 (28%) COVID-19 cases and 1,233 (72%) non-COVID-19 controls. Median age was 71 years, 53% was male. Median follow-up was 8.3 months, 70 (4.10%) patients progressed to kidney failure. Among the non-dialysis CKD patients, the risk of developing kidney failure in COVID-19 infected cases was 24% higher compared to matched, non-COVID-19 infected controls. The HR (95% CI) was 1.24 (0.75, 2.06) (p-value: 0.39).

**Conclusions:** COVID-19 infection in non-dialysis CKD patients appeared to be associated with higher risk of progression to kidney failure. Although not statistically significant, the substantial increase in risk estimate warrants close monitoring of kidney function among CKD patients after COVID-19 infection.

**Funding:** Government Support - Non-U.S.

TH-PO906

**Effect of the COVID-19 Pandemic on Incidence of Glomerular Disease: A Single Centre Report**

Philippa G. Boothroyd, Katie Chu, Sharad C. Sinha, Kazi M. Fardeen, Bhriгу Raj Sood, David Makanjuola. *Epsom and Saint Helier University Hospitals NHS Trust, Carshalton, United Kingdom.*

**Background:** Glomerular disease carries a significant burden of morbidity and mortality. There is emerging evidence of the impact of the COVID-19 pandemic and COVID-19 vaccination on glomerular disease. The aim of the study was to retrospectively analyse our experience of the incidence of glomerular disease between 2018 and 2021.

**Methods:** Native renal biopsy results were reviewed to compare the incidence of glomerular disease prior to the COVID-19 pandemic (2018/19); prior to development of COVID-19 vaccination (2020); and after the introduction of COVID-19 vaccines (2021). Biopsy data from January 2018 to October 2021 were collated from pathology records for all glomerular disease patients in our unit. We focused on the incidence of IgA nephropathy, lupus nephritis, minimal change disease, membranous nephropathy and pauci-immune glomerulonephritis.

**Results:** 263 native biopsies were performed; 45 biopsies in 2018, 75 in 2019, 65 in 2020 and 78 in the first ten months of 2021. The proportional incidence of each disease is shown in figure 1. The incidence of membranous nephropathy was noted to be higher in 2021, coinciding with the introduction of the COVID-19 vaccine programme in the UK, from an average of 23% of cases between 2018-2020, to 31% in the first ten months of 2021. The overall incidence of glomerular disease, excluding vasculitis, seemed to have fallen during 2020.

**Conclusions:** The emergence of COVID-19 does not appear to have caused a significant increase in the overall incidence of glomerular disease in our population. We noted an increase in the incidence of membranous nephropathy following the introduction of the COVID-19 vaccination programme in 2021. The relatively lower incidence in 2020 could be related to limited access to primary health care practitioners and consequent reduction in referrals to secondary care at the time.

**Incidence of Glomerular Disease**

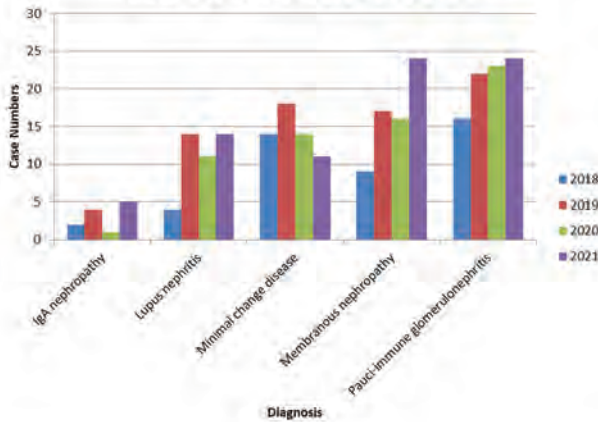

**TH-PO907**

**Kidney Function After SARS-CoV-2 Infection in Patients With and Without AKI During Hospital Admission in Western Mexico**

Alejandro Garcia Rivera, Omar H. Sanchez Vazquez, Ríos C. Katia yuritzi, Carlos A. Villavicencio López, Jesus A. Vega Lopez de Nava, Jorge fernando Topete reyes. *Hospital General Regional No 46, Guadalajara, Mexico.*

**Background:** Kidney damage in COVID-19 patients has been of special concern. Kidney function after COVID-19 has not been comprehensively studied, and there is scarce information comparing kidney function among patients with or without AKI during hospital admission.

**Methods:** Retrospective cohort study in a secondary level center in Guadalajara, Mexico. Patients who were admitted due to COVID-19 from April-December 2020 and who survived at discharge and who had at least one follow-up visit in the outpatient clinic 6 months after initial symptoms were included. Information was obtained from outpatient electronic medical files.

**Results:** From a total of 1085 patients, 733 survived at discharge. 113 had AKI during admission and only 33 (29.2%) had any kind of outpatient follow-up. Their mean age was 60.6 years, 63.6% were men, 48.4% had DM and 66.6% had HTN. Mean baseline SCr was 0.82 mg/dL with a mean eGFR of 90.82 ml/min. On follow-up mean stable SCr increased to 1.49 mg/dL, with a mean eGFR of 65.71 ml/min, a mean decrease of 25.11 ml/min. 15 patients (45.45%) developed CKD and 1 patient (3.03%) started RRT. Mean follow-up time was 451 days. 34 patients with no AKI during admission had a follow-up visit; mean age was 58.1 years, 58.8% were men, 47.1% had DM and 70.6% had HTN. Mean baseline SCr was 0.78 mg/dL and mean eGFR was 92.33 ml/min. On follow-up mean stable SCr increased to 0.86 mg/dL, with a mean eGFR of 86.64 ml/min, a mean decrease of 5.69 ml/min. 1 patient (2.94%) developed CKD and none required to start RRT. Mean follow-up time was 468 days.

**Conclusions:** AKI during COVID-19 was associated to a significant decrease in eGFR on follow-up. Those with COVID19 without AKI during admission also had a small decrease in eGFR on follow-up. Timely and more intense follow-up strategies after COVID19 and AKI are needed.

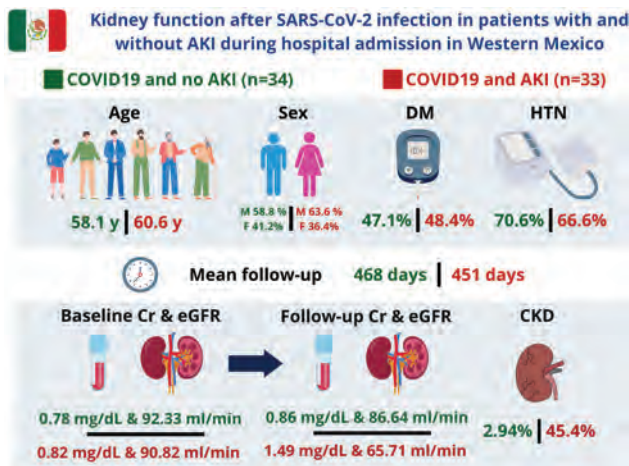

**TH-PO908**

**No Evidence for Persisting or Progressive Kidney Disease After Non-Severe COVID-19**

Christian Schmidt-Lauber,<sup>1</sup> Ammar Alabdo,<sup>1</sup> Elina L. Petersen,<sup>1</sup> Danilo Fliser,<sup>2</sup> Maja Lindenmeyer,<sup>1</sup> Raphael Twerenbold,<sup>3</sup> Thomas Renné,<sup>1</sup> Tobias B. Huber.<sup>1</sup>  
<sup>1</sup>Universitätsklinikum Hamburg-Eppendorf, Hamburg, Germany;  
<sup>2</sup>Universitätsklinikum des Saarlandes und Medizinische Fakultät der Universität des Saarlandes, Homburg, Germany;  
<sup>3</sup>University Heart and Vascular Center, Hamburg, Germany.

**Background:** Diverse abnormal findings have been described after non-severe coronavirus disease 2019 (COVID-19) but kidney outcomes remain largely unknown. Here we analyze various kidney parameters after non-severe COVID-19 to test the hypothesis of a relevant kidney sequela.

**Methods:** This cross-sectional study investigates patients after non-severe COVID-19 and matched control subjects without prior COVID-19. Patients were recruited by the population-based Hamburg City Health Study (HCHS) as well as its associated COVID program. The HCHS is a prospective population-based cohort study on randomly selected residents of the city of Hamburg, Germany. During the COVID-19 pandemic the study also invited patients at least 4 months after a PCR proven severe acute respiratory syndrome coronavirus type 2 (SARS-CoV-2) infection via newspaper announcements and an official COVID-19 test center. All patients had to be between 45 and 74 years of age. Matching was performed by age, sex, and education. Main outcomes were eGFR, albuminuria, Dickkopf3, hematuria, and pyuria. Descriptive analysis and mixed regression models were performed with adjustment for Bonferroni corrections.

**Results:** The non-COVID cohort consisted of 1328 subjects, the post-COVID cohort of 443 patients in median 9 months after SARS-CoV-2 infection. Most patients had mild COVID-19. Only 31 patients were hospitalized with COVID-19 and no patient was treated on an intensive care unit. The risk for chronic kidney disease (CKD), defined by an eGFR < 60 ml/min/1.73m<sup>2</sup>, (OR 0.9, adjusted p=1.000) or severely increased albuminuria (OR 0.79, adj. p=0.893) was not increased in the post-COVID compared to the non-COVID cohort. This also applied for early CKD stages. However, mean eGFR was mildly lower in post-COVID subjects, even after adjusting for known risk factors (beta -1.84, adj. p=0.032). We found no elevation of hematuria, pyuria, and proteinuria for the post-COVID cohort suggesting no systematic ongoing kidney involvement. Urinary Dickkopf3 even tended to be lower in post-COVID patients indicating no risk for ongoing GFR decline in this cohort (beta -72.19, adj. p=0.072).

**Conclusions:** While there is a subclinical eGFR drop after non-severe COVID-19, we found no evidence for a relevant kidney sequela nor ongoing renal involvement.

**Funding:** Government Support - Non-U.S.

**TH-PO909**

**Post COVID-19 Sequelae in Kidney Transplant Recipients (KTR): A Single Center Report**

Rosy Priya L. Kodiyapalakkal, Gabriel J. Stryniak, Perola Lamba, Thalia Salinas, John R. Lee, Deirdre L. Sawinski, Thangamani Muthukumar, Manikkam Suthanthiran, Darshana M. Dadhania. *Weill Cornell Medicine, New York, NY.*

**Background:** The impact of severe acute respiratory syndrome coronavirus 2 (SARS-CoV-2), the virus that causes COVID-19, on KTR remains unknown. We aimed to determine the impact of COVID-19 illness on kidney graft function including graft loss and characterize Long COVID (LC) symptoms in KTR.

**Methods:** Clinical data were extracted from an established registry of KTR diagnosed with COVID-19 between February 2020 to April 2022. A LC symptom questionnaire was developed and distributed. KTR that self-reported COVID-19 associated symptoms ≥2 months were considered to have Long COVID (LC).

**Results:** Of the 121 post COVID-19 KTR, 15 (12%) developed graft dysfunction defined as an increase in serum creatinine >0.3 mg/dL. Characteristics of KTR stratified as with and without graft dysfunction are shown in Table 1. Urine albumin/creatinine ratio was higher in the group with dysfunction and 2 (1.6%) KTR lost their allografts as well. Four (18%) reported LC symptoms and the frequency of LC symptoms among the first 22 questionnaire respondents are shown in Figure 1.

**Conclusions:** Both allograft injury and LC symptoms are frequent among KTR. Identification of risk factors for long-term complications post COVID-19 and development of mechanism-based interventions may mitigate post COVID-19 sequelae in KTR.

**Funding:** Other NIH Support - NIAID

Table 1: Characteristics of Kidney Transplant Recipients with and without Allograft Dysfunction\* after COVID-19 Illness

Patient Characteristics	Total (N=121)	No Graft Dysfunction (N=106)	Graft Dysfunction* (N=15)	P value
Age at COVID-19 Diagnosis (years), median (IQR)	57 (47-60)	58 (49-65)	56 (42-64)	p=0.09
Sex (male), n (%)	69 (57)	60 (57)	9 (60)	P=0.8
Race, n (%)				P=0.5
Caucasian/White	49 (41)	42 (40)	7 (47)	
Black or African American	53 (44)	29 (27)	4 (27)	
Asian	7 (6)	7 (7)	0	
Other	34 (28)	32 (30)	2 (13)	
Time from Transplant to COVID-19 Diagnosis (months), mean ± standard deviation	64 ± 163.2	77 ± 239.0		P=0.09
Creatinine at baseline, mean ± standard deviation	1.4 ± 0.70	1.49 ± 0.708	2.10 ± 0.80	p=0.001
Creatinine at last clinic visit, mean ± standard deviation	1.4 ± 0.53	1.39 ± 0.60	4.02 ± 5.00	p=0.001
Microalbumin/creatinine ratio at last visit, mean ± standard deviation	284 ± 115.5	1084 ± 367.3		p<0.001
Graft loss	2 (1.6%)	0	2 (13%)	P=0.01

Figure 1: Patient Reported Long COVID Symptoms (N=22)

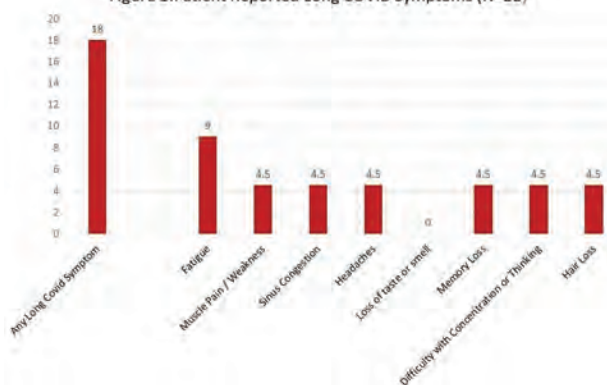

## TH-PO910

## Characteristics and Outcomes of Community and Hospital Acquired AKI in Patients With COVID-19

Rolando Claire-Del Granado,<sup>1,2</sup> Leydi M. Oliva-Cadima,<sup>1</sup> Etienne Macedo,<sup>3</sup> Ravindra L. Mehta,<sup>3</sup> <sup>1</sup>Hospital Obrero No 2 - CNS, Cochabamba, Bolivia, Plurinational State of; <sup>2</sup>Universidad Mayor de San Simon, Cochabamba, Bolivia, Plurinational State of; <sup>3</sup>University of California San Diego, La Jolla, CA.

**Background:** Acute kidney injury (AKI) is common in coronavirus disease 2019 (COVID-19). It is unknown if hospital-acquired AKI (HA-AKI) and community-acquired AKI (CA-AKI) convey a distinct prognosis. The study aim was to evaluate the incidence and risk factors associated with both CA-AKI and HA-AKI.

**Methods:** Consecutive patients (>18 years) hospitalized with a positive antigen or RT-PCR result for COVID-19 who meet the criteria for AKI, have known CKD or with kidney transplant were included in this prospective cohort study. Patient information was recorded from the time of diagnosis and renal function was followed up at 48 hours, 7 days, 14 days, at discharge, and at 6 months.

**Results:** From July 1st to May 30th 2021, we included 100 hospitalized patients with AKI, 68% were male and mean age was 68±11. Seventy-two (72%) corresponded to CA-AKI, and 28% to HA-AKI. Compared to patients with HA-AKI, subjects with CA-AKI have higher baseline sCr (1.15±0.46 vs. 1.06±0.26, p<0.001); had more diabetes (14 [19.4%] vs. 1 [3.6%], p=0.035); and presented to the emergency department with more severe disease. However the presence of ≥2 comorbidities were higher in HA-AKI (27.7% vs. 32.1%, p=0.014). Mortality rates were not different between CA-AKI and HA-AKI (14 [19%] vs. 5 [18%], p=0.856). Complete renal recovery was more frequent in CA-AKI (16 [22%] vs. 5 [18%], p<0.001) with lower incidence of *de novo* CKD (13 [29%] vs. 13 [65%], p=0.033) or CKD progression (8 [18%] vs. 0 [0%], p=0.033).

**Conclusions:** CA-AKI and HA-AKI portend an adverse prognosis in COVID-19 patients. Nevertheless, CA-AKI was associated with a higher rate of renal recovery and lower incidence of long term adverse outcomes like *de novo* CKD or CKD progression. HA-AKI is likely part of the multiorgan failure, has a more severe course than CA-AKI, and that kidney injury contributes to worse outcomes.

## TH-PO911

## COVID-19 Pandemic and Its Impact on CKD Patient Care and Clinical Parameters

Fumika Taki, Nozomi Kadota, Kasumi Konishi, Kotaro Shimoyama, Yugo Ito, Takuya Fujimaru, Masahiko Nagahama, Masaaki Nakayama. *St. Luke's International Hospital, Division of Nephrology, Tokyo, Japan.*

**Background:** In CKD management, periodic visit of nephrologist and multiple professions are known to be important. However, with the COVID-19 pandemic from the end of 2019, due to the tightening of medical care resources and intermittent lockdowns, these patients seem to be could not receive the full of nephrology care. We assessed changes of CKD patients care during the COVID-19 Pandemic and evaluated its impact on clinical parameters.

**Methods:** Patients with CKD over stage 4 and who had regularly attended CKD out-patients clinic in St. Luke's International Hospital, Tokyo, Japan, were included. We definite the pre post pandemic periods as: pre-pandemic: Pre-C, from January 2018 to December 2019, and post-pandemic; Post-C, January 2020 to December 2021. The following data was compared between the 2 periods: 1. number of nephrology visits per patient; 2. rate of using telemedicine; 3. rate of receiving multidisciplinary educational support; 4. rate of drop-out patients; 5. Decline rate of GFR and 6. number of initiating renal replacement therapy, newly.

**Results:** 289 individual patients were eligible for the analysis. The baseline data were as follows: mean age 67.9±14 years, 63.5% male, mean eGFR 22.2±5.9 ml/min and 40.2% comorbid DM. The number of nephrology visits and receiving multidisciplinary support was decreased in Post-C periods: Nephrology visits; Pre-C: 9.8±5.1 visits/year, Post-C 7.7±5.2 visits/year, p<0.01, Multidisciplinary support; Pre-C: 78%, Post-C 32%, p<0.01. Multiprofessional educational support was provided mainly for CKD stage 5 patients during the Post-C. More, the rate of using telemedicine and dropout increased in

Post-C. Especially, the dropout rate of elderly patients over 70 years old was significant: 8% in Pre-C and 17% in Post-C, p<0.05. On the other hand, clinical indicators such as delta GFR and RRT initiation rate remained unchanged.

**Conclusions:** Although the frequency of nephrology visits and multidisciplinary educational care has been decreased with COVID-19, there was no difference in the short-term prognosis of CKD patients, from our study. This may be an effect of a kind of triage function, which focused on the more severely ill patients with CKD. On the other hand, the drop out rate in the elderly was increased, the prognosis of these patients needs to be followed up and verified.

## TH-PO912

## Impact of the Risk Perception of COVID-19 Pandemic on Physical Activity and Body Weight in CKD Patients

Yaerim Kim,<sup>1</sup> Jeonghwan Lee,<sup>2</sup> Jae Yoon Park,<sup>3</sup> Jung Nam An,<sup>4</sup> Kyung Don Yoo,<sup>5</sup> Yong Chul Kim,<sup>6</sup> Jin hyuk Paek,<sup>1</sup> Woo Yeong Park,<sup>1</sup> Kyubok Jin,<sup>1</sup> Seungyeup Han,<sup>1</sup> Dong Ki Kim,<sup>6</sup> Jung Pyo Lee.<sup>2</sup> <sup>1</sup>Keimyung University School of Medicine, Daegu, Republic of Korea; <sup>2</sup>Seoul National University Seoul Metropolitan Government Boramae Medical Center, Dongjak-gu, Seoul, Republic of Korea; <sup>3</sup>Dongguk University Ilsan Hospital, Goyang, Gyeonggi-do, Republic of Korea; <sup>4</sup>Hallym University Sacred Heart Hospital, Anyang, Gyeonggi-do, Republic of Korea; <sup>5</sup>Ulsan University Hospital, Ulsan, Republic of Korea; <sup>6</sup>Seoul National University Hospital, Jongno-gu, Seoul, Republic of Korea.

**Background:** The recent novel coronavirus disease (COVID-19) pandemic has led to restrictions in physical activity. We evaluated the impact of risk perception on physical activity, and its impact on kidney function in chronic kidney disease (CKD) patients during the pandemic.

**Methods:** A population of CKD patients registered in a SKETCH (Study on Kidney disease and Environment/Tal Chemicals, Clinical Trial No. NCT04679168) cohort recruited from June 2020 to October 2020 was included in the study. Patients were followed-up every 3 months for a year. We obtained risk perception and physical activity information by a questionnaire survey. Physical exercise, 3-times/week, was categorized into three groups according to the frequency of positive response during 5 visits: group 1, 0-2; group 2, 3-4; group 3, 5. We used Logistic regression analysis to identify the significance of risk perception to physical activity. The Cox-proportional hazard model was used to identify the significance of physical activity for kidney function.

**Results:** A total of 262 patients were included, and the mean age was 60.5±12.8 years old. Mean eGFR was 43.4±20.9 mL/min/1.73 m<sup>2</sup>, and there were 220 (84.0%) with eGFR <60 mL/min/1.73 m<sup>2</sup>. There were 122 (46.6%) of patients who showed higher risk perception for COVID-19 infection. After adjustment with age, sex, comorbidities, and laboratory results, higher risk perception was significantly associated with decreased physical activity (adjusted OR 0.44, 95% CI, 0.23, 0.84). During 364.8±38.6 days, 52 (19.8%) patients showed decreased kidney function with decreasing eGFR ≥30%. Group 1 showed a significantly increased risk for kidney dysfunction (adjusted HR 3.36, 95% CI 1.23, 9.20). This result was prominent in age over 60, male sex, patients with hypertension.

**Conclusions:** Decreased physical activity related to higher risk-perception, and that was significantly increased risk for kidney dysfunction. Healthcare provider needs to consider a new strategy to encourage physical activity irrespective of risk perception.

## TH-PO913

## Outcomes in CKD Patients With COVID-19

Lucas Wang, Victor A. Canela, Manavjot Sidhu. *Methodist Dallas Medical Center, Dallas, TX.*

**Background:** Chronic kidney disease (CKD) and End-stage renal disease patients are at increased risk of severe disease and worse outcomes in coronavirus disease 2019 (COVID-19). In this study, we compared outcomes, including rates of hospital mortality, major adverse cardiovascular events (MACE) and respiratory failure requiring mechanical ventilation in unvaccinated COVID-19 patients with established CKD/ESRD to COVID-19 patients with baseline normal kidney function.

**Methods:** Using an observational database, we analyzed 3183 unvaccinated hospitalized COVID-19 PCR-positive patients at Methodist Health System (Dallas, TX) from March 2020 to December 2020. The primary endpoint was all-cause in-hospital mortality. Severe disease was identified as any patient with a major adverse cardiovascular event (MACE) or respiratory failure requiring mechanical ventilation. A MACE was defined as congestive heart failure (CHF) exacerbation, myocardial infarction, stroke, pulmonary embolism, deep venous thrombosis, or shock. Chi-square ( $\chi^2$ ), Fischer's exact test, and odds ratio tests were used to analyze observed variables.

**Results:** Of the 3183 COVID-19 patients, 476 (15%) had pre-existing kidney disease (either CKD or ESRD), 170 (5.4%) were dialysis-dependent and 279 (8.79%) were CKD KDIGO stages 1-5. Compared to the non-CKD group, the CKD/ESRD group had an increased risk of all-cause in-hospital mortality (OR = 1.41, 95% CI = 1.04-1.83, p<0.04). CKD/ESRD patients also had increased risk of MACE (OR = 1.24, 95% CI = 1.03-1.48, p<0.02), specifically, higher risk of CHF exacerbation (OR = 3.28, 95% CI = 2.16-4.97, p<0.001) and shock (OR = 1.36, 95% CI 1.01-1.84, p<0.04). The risk of respiratory failure requiring mechanical ventilation was comparable between the CKD/ESRD and non-CKD cohorts (OR = 1.06, 95% CI 0.78-1.44, p = 0.70).

Key: TH - Thursday; FR - Friday; SA - Saturday; OR - Oral; PO - Poster; PUB - Publication Only

Underline represents presenting author.

**Conclusions:** The COVID-19 pandemic had worldwide devastating outcomes for vulnerable groups such as CKD patients. In our study, we demonstrated that CKD and ESRD is associated with a higher incidence of mortality and MACE in COVID-19. By understanding the clinical course of these patients, clinicians may better anticipate and attempt to improve outcomes during inpatient visits.

**TH-PO914**

**Efficacy of COVID-19 Vaccination in Dialysis Patients: A Prospective Multicenter Study**

Claudia Ostermaier, Sahana R. Kamalanabhai, Christian S. Haas, Christian Keller, Joachim Hoyer. *Philipps-Universität Marburg Fachbereich Medizin, Marburg, Germany.*

**Background:** Dialysis patients are considered to be at increased risk for SARS-CoV-2 infections. Thus, they were prioritized for early vaccination. However, early data suggested that seroconversion rates may be lower in this population, consistent with the reduced response rate to vaccination against hepatitis B, pneumococcus or influenza. The objective of this study was to evaluate the efficacy of COVID-19 vaccines in this cohort with respect to seroconversion, and to identify potential risk factors for nonresponding.

**Methods:** We conducted a prospective, multicenter study in chronic hemodialysis patients at 4 dialysis facilities in central Germany, starting April 2021. Blood samples were taken prior to 1<sup>st</sup> vaccination, before 2<sup>nd</sup> vaccination, 7-14 days after 2<sup>nd</sup> vaccination, as well as 60 and 120 days after full vaccination for long-term follow-up. At any study time point, results of COVID-19 antigen tests and clinical symptoms were assessed. Similarly, data was obtained for 1<sup>st</sup> or 2<sup>nd</sup> booster vaccination. Blood samples for antibody titers were drawn – if applicable – at day 30, 90, 150 and 210 following booster vaccination. To identify potential risk factors, data including underlying condition, comorbidities, lab results, seroresponse to hepatitis B vaccination, immunosuppression and other medication was assessed. Antibody response was defined above a value of 7.1 BAU/l.

**Results:** After 2 vaccinations, 288 individuals were evaluated; of these, 270 (=93%) developed an adequate antibody response. Although the majority of patients had received a mRNA vaccine, there was no significant difference in the alloster response rates compared to vector based vaccines. Age and immunosuppressive medication were found to be significant risk factors for nonresponsiveness to COVID-19 vaccination (p<0.05). Infections dropped following immunization. Of note, 6 months after full vaccination, antibody titers significantly declined. Both, 1<sup>st</sup> and 2<sup>nd</sup> booster doses resulted in an increase of antibody titers: during the omicron wave, no COVID-19 associated hospital admissions were observed.

**Conclusions:** COVID-19 vaccination is effective in hemodialysis patients. Like in the general population, only age and immunosuppression are risk factors for not responding to vaccination, thereby having a potential impact on outcome, especially for the wave to come.

**TH-PO915**

**Humoral Responses in the Omicron Era Following a Three-Dose SARS-CoV-2 Vaccine Series in Kidney Transplant Recipients**

Caitriona M. McEvoy,<sup>1</sup> Queenie Hu,<sup>4</sup> Kento T. Abe,<sup>4</sup> Kevin Yau,<sup>2</sup> Matthew J. Oliver,<sup>2</sup> Adeera Levin,<sup>3</sup> Anne-Claude Gingras,<sup>4</sup> Michelle A. Hladunewich,<sup>2</sup> Darren A. Yuen.<sup>1</sup> *<sup>1</sup>St. Michael's Hospital Keenan Research Centre for Biomedical Science, Unity Health Toronto, Toronto, ON, Canada; <sup>2</sup>Division of Nephrology, Department of Medicine, Sunnybrook Health Sciences Centre, Toronto, ON, Canada; <sup>3</sup>UBC Division of Nephrology, St. Paul's Hospital, Vancouver, BC, Canada; <sup>4</sup>Lunenfeld-Tanenbaum Research Institute, Toronto, ON, Canada.*

**Background:** Kidney transplant recipients (KTR) have a diminished response to SARS-CoV-2 vaccination in comparison to immunocompetent individuals. Deeper understanding of the antibody response in KTRs following third-dose vaccination would enable identification of those who remain unprotected against Omicron and require additional treatment strategies.

**Methods:** We profiled antibody responses in KTRs pre- and at one and three months post-third-dose SARS-CoV2 mRNA-based vaccine. Anti-spike and anti-RBD IgG levels were determined by ELISA. Neutralization against wild-type, Beta, Delta and Omicron (BA.1) variants was determined using a SARS-CoV-2 spike pseudotyped lentivirus assay.

**Results:** 44 KTRs were analysed at 1 and 3 months (n=26) post-third-dose. At one month, the proportion of participants with a robust antibody response had increased significantly from baseline, but Omicron-specific neutralizing antibodies were detected in just 45% of KTRs. Median anti-spike and anti-RBD antibody levels declined at 3 months, but the proportion of KTRs with a robust antibody response was unchanged. 38.5% KTRs maintained Omicron-specific neutralization at 3 months. No clinical variables were significantly associated with detectable Omicron neutralizing antibodies, but anti-RBD titres appeared to identify those with Omicron-specific neutralizing capacity.

**Conclusions:** Over 50% of KTRs lack an Omicron-specific neutralization response 1 month following a third mRNA-vaccine dose. Among responders, binding and neutralizing antibody responses were well preserved at 3 months. Anti-RBD antibody titres may be a useful identifier of patients with detectable Omicron neutralizing antibody response.

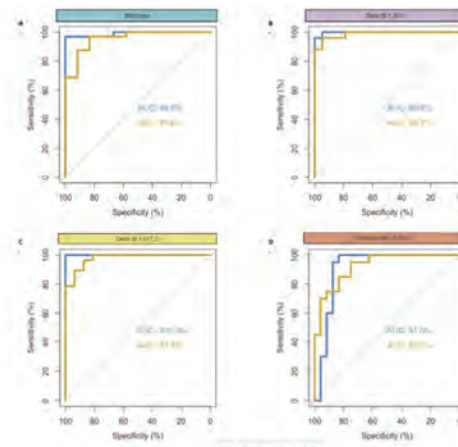

Variant	Antibody	AUC	95% CI	Threshold	Specificity	Sensitivity	TN	TP	FN	FP
Wild Type	Anti-RBD	0.99	96.74-100%	0.317	100	98.88	32	31	3	0
	Anti-Spike	0.965	89.56-100%	1.319	91.66	87.5	11	28	4	1
Beta (B.1.351)	Anti-RBD	0.998	99.21-100%	0.992	100	96	19	24	3	0
	Anti-Spike	0.987	96.56-100%	1.481	94.74	96	18	24	1	1
Delta (B.1.617.2)	Anti-RBD	1	NA	0.627	100	100	16	28	0	0
	Anti-Spike	0.978	94.39-100%	1.391	93.75	89.29	13	25	3	1
Omicron (B.1.1.529)	Anti-RBD	0.91	80.82-100%	1.098	87.5	95	22	19	1	3
	Anti-Spike	0.925	85.22-99.28%	1.475	83.33	85	20	17	3	4

Abbreviations: AUC: area under the curve; CI: confidence interval; FN: false negative; FP: false positive; NA: not applicable; RBD: receptor binding domain; Anti-Spike: Anti-spike; TN: true negative; TP: true positive.

**Figure 1:** Threshold levels of binding antibody response associated with detectable neutralizing antibody. Receiver operating characteristic (ROC) analysis of anti-RBD and anti-spike antibody levels across A) Wild-type, B) Beta, C) Delta and D) Omicron variants, for classification of the presence or absence of detectable neutralizing antibody (Log10OD50>0). Areas under the curve (AUC) for anti-spike (yellow) and anti-RBD (blue) are marked. Specific threshold values (expressed as relative ratios to a synthetic mean) are shown in the table.

**TH-PO916**

**Factors Associated With Reduced Anti-SARS-CoV-2 Antibody Responses After mRNA Vaccination in Kidney Transplant Recipients on Belatacept**  
Ayman Al Jurdi,<sup>1</sup> Leela Morena,<sup>1</sup> Jamil R. Azzi,<sup>2</sup> Jay A. Fishman,<sup>1</sup> Leonardo V. Riella.<sup>1</sup> *<sup>1</sup>Massachusetts General Hospital, Boston, MA; <sup>2</sup>Brigham and Women's Hospital, Boston, MA.*

**Background:** Antiviral antibody responses to SARS-CoV-2 vaccines are reduced in kidney transplant recipients (KTRs) on belatacept compared to those not on belatacept. However, factors associated with lower odds of developing antibody responses in KTRs on belatacept are not known.

**Methods:** We conducted a retrospective multicenter cohort study of all KTRs on belatacept who received three mRNA vaccine doses at our institutions, where all KTRs on belatacept had anti-SARS-CoV-2 receptor-binding domain (RBD) antibodies measured by the Roche Elecsys immunoassay. The primary outcome was development of anti-RBD antibodies after the third vaccination.

**Results:** 58 KTRs on belatacept were included. Median age was 62 and 69% were female. 78% were on prednisone, 60% on mycophenolate, 11% on mTOR inhibitors and 9% on azathioprine. After the third vaccine, 32/58 KTRs (55%) developed anti-RBD antibodies (Fig. 1A) with a median level of 3.3U/mL (Fig. 1B). Using univariate logistic regression, we found that age≥60, eGFR<45ml/min/1.73m<sup>2</sup>, prednisone use, and no prior SARS-CoV-2 infection were associated with significantly lower odds of developing anti-RBD responses after vaccination (Fig. 1C). These associations remained significant in the adjusted multivariable model (Fig. 1D). We also evaluated correlation between anti-RBD antibody levels and the number of days between vaccination and the most recent belatacept infusion for each vaccination but did not find an association between the two (Fig. 1E-G).

**Conclusions:** Prednisone use, age≥60, eGFR<45ml/min/1.73m<sup>2</sup>, and no history of SARS-CoV-2 infection are associated with lower odds of anti-RBD antibody responses after vaccination in KTRs on belatacept.



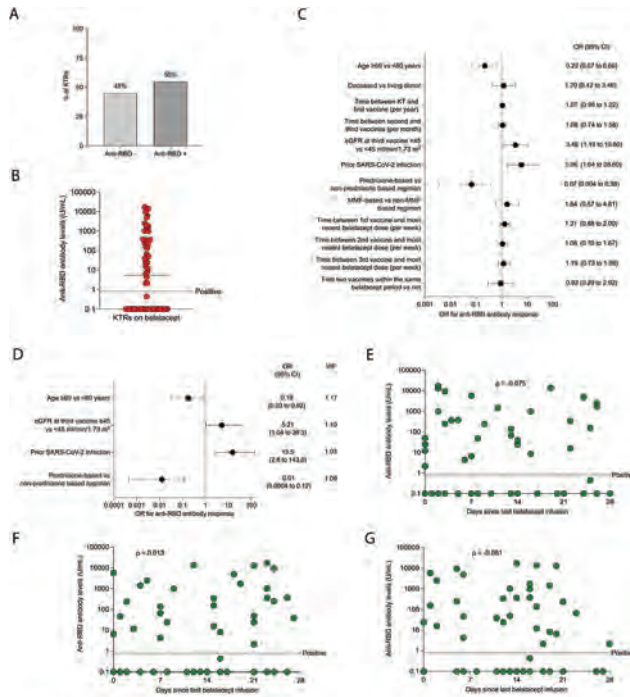

**Figure 1. Anti-receptor binding domain (RBD) antibody responses in kidney transplant recipients on belatacept after three doses of SARS-CoV-2 mRNA vaccination. (A)** Percentage of KTRs on belatacept with and without anti-RBD antibody responses after three doses of SARS-CoV-2 of mRNA vaccines (n=58). **(B)** Total (IgG + IgM + IgA) anti-RBD antibody levels measured by the Roche Elecsys immunoassay. Horizontal line indicates positivity threshold of  $\geq 0.80$  U/mL. **(C)** Univariate and **(D)** multivariate logistic regression analysis of factors associated with the odds of developing an anti-RBD antibody response (n=58). **(E)** Association between anti-RBD antibody levels and days between the most recent belatacept infusion and the first, **(F)** second and **(G)** third vaccines (n=57). (E-G) Statistic by Spearman's correlation. KT: kidney transplantation. MMF: mycophenolate mofetil. OR: odds ratio. VIF: variance inflation factor.

**TH-PO917**

**Humoral Response 3 Months After the Booster Dose in Patients on Dialysis: The SENCOVAC Study**

María Jose Soler,<sup>1</sup> Borja Quiroga,<sup>2</sup> Alberto Ortiz,<sup>3</sup> Patricia de Sequera,<sup>4</sup> SENCOVAC <sup>1</sup>Hospital Universitari Vall d'Hebron, Barcelona, Spain; <sup>2</sup>IIS-La Princesa, Nephrology Department, Hospital Universitario de la Princesa, Madrid, Spain; <sup>3</sup>Hospital Universitario Fundación Jimenez Diaz Servicio de Neurorradiología Intervencionista, Madrid, Spain; <sup>4</sup>Hospital Infanta Leonor, Madrid, Spain.

**Background:** Patients on hemodialysis are at high-risk for complications derived from coronavirus disease-19 (COVID-19). The present study aims to evaluate the impact of a booster vaccine dose and breakthrough SARS-CoV-2 infections on humoral immunity three months after the booster dose.

**Methods:** This is a multicentric and prospective study assessing anti-Spike antibodies 6 and 9 months after initial SARS-CoV-2 vaccination in patients on hemodialysis that had also received a booster dose before the 6-month assessment (early booster) or between the 6- and 9-month assessments (late booster). The impact of breakthrough infections, type of vaccine, time from the booster and clinical variables were assessed.

**Results:** 711 patients (67% male, 67 [20-89] years) were included. Of them, 545 (77%) patients had received an early booster and 166 (23%) a late booster. At 6 months, 64 (9%) patients had negative humoral response (3% of early booster and 29% of late booster participants, p=0.001) and 58 (91%) of them had seroconverted at 9 months, when, 5/545 (0.9%) patients in the early booster cohort and 1/166 (0.6%) in the late booster cohort remained antibody negative (p=NS). During follow-up, 35 patients (5%) developed COVID-19. Antibody titers at 9 months were independently associated to lower time from booster (B -0.12, p=0.043), COVID-19 (B 2.29, p<0.001) and mRNA-1273 booster (B 1.17, p=0.001).

**Conclusions:** In hemodialysis patients, higher rates of anti-Spike antibody development were associated to mRNA-1273 booster, lower time from booster and breakthrough SARS-CoV-2 infection.

**Funding:** Commercial Support - Fresenius Medical Care, Diaverum, Vifor Pharma, Private Foundation Support

**TH-PO918**

**Phenotype of SARS-CoV-2 Specific T and B Cells in Lymph Nodes of Patients With ESRD**

Sophie C. Frölke, Danisha Sri Pathmarajah, Ester B. Remmerswaal, Frederike J. Bemelman. *Amsterdam UMC Locatie AMC, Amsterdam, Netherlands.*

**Background:** In patients with end-stage renal disease (ESRD), mean antibody concentrations following SARS-CoV-2 vaccination are lower than in the general population, which correlates with the risk of COVID-19 disease. For a high-affinity antibody response, germinal centre responses in lymph nodes (LN) are critical. However, current knowledge on SARS-CoV-2 specific B and T cell responses is almost exclusively based on peripheral blood (PB) mononuclear cells (MNC). Previous studies have shown that LN MNC differ substantially from their PB counterparts. We aim to study the functional and phenotypical differences between PB- and LN-derived SARS-CoV-2 specific B and T cells after vaccination in ESRD patients and compare these with their counterparts after infection.

**Methods:** MNC were isolated from PB and paired non-draining LN of ESRD patients, retrieved during kidney transplantation. Ten patients who received SARS-CoV-2 vaccination and five who suffered COVID-19 disease were included. SARS-CoV-2 spike specific T cells were phenotyped using HLA class I dextramers and for SARS-CoV-2 spike specific B cells spike-tetramers were used. Also, antibody levels and functions like neutralization of infectivity, phagocytosis, antibody-dependent cellular cytotoxicity and complement-mediated lysis of pathogens of infected cells were measured.

**Results:** An example of the SARS-CoV-2 specific T and B cell phenotyping in PB MNC of healthy controls is shown. Whether these cells are detectable in the non-draining LN of ESRD patients after SARS-CoV-2 vaccination or infection and if they functionally and phenotypically correlate with paired PB MNC is yet to be determined.

**Conclusions:** We aim to gain an invaluable insight into the underlying T- and B-cell-centred immunological processes in LN of ESRD patients in order to understand and optimize vaccine response.

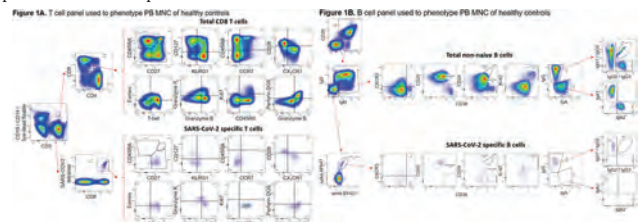

SARS-CoV-2 specific T and B cell phenotyping in PB MNC of healthy controls

**TH-PO919**

**Adherence to Preventive Measures Before and After Vaccination Against SARS-CoV-2 in Kidney Transplant Recipients**

Sophie C. Frölke,<sup>1</sup> Pim Bouwmans,<sup>2</sup> A. L. Messchendorp,<sup>3</sup> Marc H. Hemmelder,<sup>2</sup> Frederike J. Bemelman,<sup>1</sup> Pythia T. Nieuwkerk,<sup>1</sup> Suzanne E. Geerlings,<sup>1</sup> RECOVAC consortium <sup>1</sup>Amsterdam UMC Locatie AMC, Amsterdam, Netherlands; <sup>2</sup>Maastricht Universitair Medisch Centrum+, Maastricht, Netherlands; <sup>3</sup>Universitair Medisch Centrum Groningen, Groningen, Netherlands.

**Background:** At the start of the COVID-19 pandemic, kidney transplant recipients (KTR) were warned for a high risk of complications in case of infection. After SARS-CoV-2 vaccination, KTR appeared to still be at risk of fatal COVID-19 disease, especially when they had limited or no antibody formation. The aim of this study was to describe the self-reported change in behavior of KTR before and after SARS-CoV-2 vaccination in groups with different antibody responses.

**Methods:** Questionnaires were sent to 2793 KTR, asking for adherence to preventive measures before vaccination, after vaccination and after receiving their level of antibody response. Adherence was reported on a 5-point Likert scale. From April till June 2021 blood samples were collected measuring anti-spike IgG by ELISA 28 days after full SARS-CoV-2 vaccination. Participants were categorized based on antibody response to vaccination as non-responder ( $\leq 50$  BAU/mL), low-responder ( $>50 \leq 300$  BAU/mL) or responder ( $>300$  BAU/mL), which was shared with the participant as a correlate of protection. Adherence to preventive measures before vaccination was compared with the two time points after vaccination by the Wilcoxon signed rank sum test. The impact of category on adherence was measured by ordinal logistic regression, taking non-responder as reference.

**Results:** The median antibody titer was 7 BAU/mL in the non-(N=1109), 122 BAU/mL in the low-(N=564) and 1751 BAU/mL in the responder cohort (N=1120). Of all preventive measures, adherence to 'keep 1.5 m distance', 'avoid supermarket or shops' and 'rules for visitors or visits' was significantly higher (p<0.001) before than after vaccination within all cohorts. Adherence was decreased among participants, with a dose response effect, who were informed of being a (low-) responder compared to KTR with no antibody response.

**Conclusions:** SARS-CoV-2 vaccination in KTR leads to decreased adherence to some, but not all preventive measures, even when the antibody response was absent or low. A greater decrease in adherence was seen in (low-)responders to vaccination.

Figure 1. Non-adherence to preventive measures after being informed of level of antibody response by cohort

Preventive measures	Non-responder cohort (N=1109)	Low-responder cohort OR (95% CI) (N=564)	p-value	Responder cohort OR (95% CI) (N=1120)	p-value
Keep 1.5m distance	ref.	1.50 [1.22, 1.85]	<0.001	2.83 [2.21, 3.14]	<0.001
Wear a face mask	ref.	1.31 [1.01, 1.69]	0.04	1.66 [1.34, 2.05]	<0.001
Hand washing	ref.	1.07 [0.87, 1.32]	0.53	1.65 [1.39, 1.96]	<0.001
Avoid supermarket or shops	ref.	1.44 [1.18, 1.75]	<0.001	2.38 [2.02, 2.81]	<0.001
Avoid public transport	ref.	1.31 [0.99, 1.73]	0.05	1.81 [1.44, 2.27]	<0.001
Avoid crowded places	ref.	1.40 [1.08, 1.81]	<0.05	2.73 [2.23, 3.36]	<0.001
Rules for visitors or visits	ref.	1.23 [1.01, 1.50]	<0.05	1.46 [1.24, 1.73]	<0.001
Work from home	ref.	1.13 [0.82, 1.57]	0.45	1.67 [1.29, 2.17]	<0.001
Avoid travel abroad	ref.	1.16 [0.87, 1.54]	0.30	1.70 [1.42, 2.24]	<0.001

TH-PO920

Neutralization of the SARS-CoV-2 Delta and Omicron Variants in Previous Non-Responder Kidney Transplant Recipients After Short-Term Withdrawal of Mycophenolic Acid

Louise Benning,<sup>1</sup> Christian Morath,<sup>1</sup> Tessa Kühn,<sup>1</sup> Marie Bartenschlager,<sup>2</sup> Heeyoung Kim,<sup>2</sup> Christian Nussbag,<sup>1</sup> Florian Kälble,<sup>1</sup> Marvin Reineke,<sup>1</sup> Maximilian Töllner,<sup>1</sup> Matthias Schaefer,<sup>1</sup> Katrin Klein,<sup>1</sup> Antje Blank,<sup>3,5</sup> Martin G. Zeier,<sup>1</sup> Caner Süsal,<sup>6</sup> Ralf Bartenschlager,<sup>2,3</sup> Thuong H. Tran,<sup>4</sup> Claudius Speer,<sup>1</sup> <sup>1</sup>Department of Nephrology, University Hospital Heidelberg, Heidelberg, Germany, Heidelberg, Germany; <sup>2</sup>Department of Infectious Diseases, Molecular Virology, University Hospital Heidelberg, Heidelberg, Germany, Heidelberg, Germany; <sup>3</sup>German Center for Infection Research, Partner Site Heidelberg, Heidelberg, Germany, Heidelberg, Germany; <sup>4</sup>Transplantation Immunology, Heidelberg Institute of Immunology, University Hospital Heidelberg, Heidelberg, Germany, Heidelberg, Germany; <sup>5</sup>Department of Clinical Pharmacology and Pharmacoepidemiology, University Hospital Heidelberg, Heidelberg, Germany, Heidelberg, Germany; <sup>6</sup>Transplant Immunology Research Center of Excellence, Koç University Hospital, Istanbul, Turkey, Istanbul, Turkey.

**Background:** Response to COVID-19 vaccination is significantly impaired in kidney transplant recipients (KTR) even after three doses of an mRNA vaccine. Adaptive immunization strategies are urgently needed to ultimately protect these patients from COVID-19.

**Methods:** We determined the effect of an additional mRNA-1273 vaccine dose in 76 non-responder KTR with at least 3 previous vaccine doses. In 43 KTR with triple immunosuppressive therapy including a calcineurin inhibitor (CNI), mycophenolic acid (MPA), and corticosteroids (CS), MPA was withdrawn to investigate the effect of short-term MPA withdrawal on COVID-19 vaccine immunogenicity. Seroconversion was determined four weeks after vaccination. In addition, neutralization of the delta and omicron variants was determined using a live-virus assay. In patients with temporary MPA withdrawal, donor-specific antibodies (DSA) and donor-derived cell-free DNA (dd-cfDNA) were monitored before MPA withdrawal and at follow-up.

**Results:** After vaccination, 24/69 (35%) KTR showed anti-spike S1 IgG antibodies above the predefined cut-off, excluding 7 breakthrough infections that occurred during follow-up. SARS-CoV-2 specific antibodies were significantly higher in patients where MPA was withdrawn (Figure 1A). Neutralization of the delta variant was significantly better compared to neutralization of the omicron variant (Figure 1B). Higher SARS-CoV-2-specific antibodies were associated with better in-vitro neutralization of the delta and omicron variants (Figure 1C). In KTR with MPA withdrawal, no significant changes in S-creatinine, proteinuria or dd-cfDNA were observed. No acute rejection episode occurred during short-term follow-up. However, resurgence of pre-existing DSA was observed in 7 patients and the development of de novo DSA in one patient.

**Conclusions:** MPA withdrawal seems reasonable to increase immunogenicity of SARS-CoV-2 vaccination. For safety reasons, this may only be offered to patients without current or previous DSA.

**Funding:** Commercial Support - CareDX, Private Foundation Support

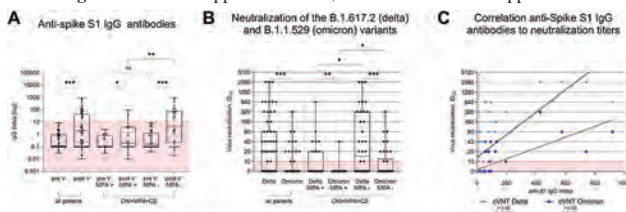

Figure 1: SARS-CoV-2 specific antibodies in 69 previous non-responder kidney transplant recipients after an additional mRNA-1273 vaccine dose (A) Anti-spike S1 IgG antibodies in 69 KTR before and after vaccination, stratified for short-term withdrawal of MPA (B) Neutralization of the SARS-CoV-2 B.1.617.2 (delta) and the B.1.1.529 (omicron) variants by antibodies in sera of 69 KTR, stratified for short-term withdrawal of MPA (C) Correlation analysis of anti-S1 IgG results to cross-neutralization titers of the B.1.617.2 (delta) and the B.1.1.529 (omicron) variants CNI, calcineurin inhibitor; CS, corticosteroids; cVNT, conventional virus neutralization test; KTR, kidney transplant recipients; ID50, inhibitory dilution 50; MFI, mean fluorescence intensity; MPA, mycophenolic acid; V, vaccination; r, Spearman's rho; \*\*\* P<0.001; \*\* P<0.01; \* P<0.05.

TH-PO921

SARS-CoV-2 Anti-Spike IgG Antibody Binding Units and Associated Outcomes in Maintenance Dialysis Patients

Harold J. Manley,<sup>1</sup> Antonia Harford,<sup>1,3</sup> Jill M. Frament,<sup>1</sup> Margaret Mcnamara,<sup>1</sup> Nien Chen Li,<sup>1</sup> Karen M. Majchrzak,<sup>1</sup> Caroline M. Hsu,<sup>2</sup> Daniel E. Weiner,<sup>2</sup> Dana Miskulin,<sup>2</sup> Doug Johnson,<sup>1</sup> Eduardo K. Lacson.<sup>1,2</sup> <sup>1</sup>Dialysis Clinic Inc, Nashville, TN; <sup>2</sup>Tufts Medical Center, Boston, MA; <sup>3</sup>University of New Mexico Health Sciences Center, Albuquerque, NM.

**Background:** Maintenance dialysis patients' SARS-CoV-2 receptor binding spike antibody (RBD s-Ab) levels decline rapidly in the months following initial vaccination. We describe the association of RBD s-Ab levels with subsequent diagnosis of COVID-19 and COVID-related hospitalization or death.

**Methods:** We identified all vaccinated adult maintenance dialysis patients at Dialysis Clinic, Inc. who were diagnosed with COVID-19 between June 20, 2021 and May 8, 2022. Descriptive analyses illustrate the association of RBD s-Ab levels assessed 7-45 days prior to COVID-19 diagnosis with COVID-related hospitalization or death.

**Results:** There were 340 maintenance dialysis patients with RBD s-Ab levels assessed at a median 23 [16,40] days prior to COVID diagnosis, with mean age 65±13 years, 51% female, 51% White, 91% HD and vintage 4.3±4.3 years. While COVID-19 diagnosis and COVID-related hospitalization or death events occurred across RBD s-Ab levels (Figure), 74 of 93 (80%) COVID-related hospitalizations and 24 of 25 deaths (96%) occurred at RBD s-Ab level <500 BAU/mL

**Conclusions:** Maintenance dialysis patients are at risk for serious COVID events when RBD s-Ab < 500 BAU/mL. Routine RBD s-Ab measurement informing personalized vaccination strategies to keep titers above 500 BAU/mL may benefit this high-risk population.

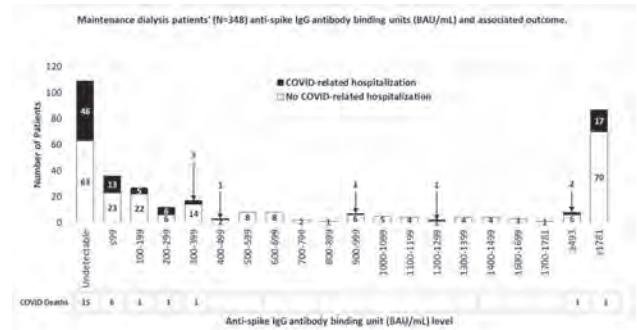

RBD s-Ab levels were converted to WHO standard antibody binding units (BAU) per mL (Freeman J and Conklin J. J Virological Methods 2022)

TH-PO922

SARS-CoV-2 Infections and Mortality in Dialysis Patients: A Multicenter Prospective Trial

Sahana R. Kamalanabhaiah, Claudia Ostermaier, Lotte L. Dahmen, Christian S. Haas, Joachim Hoyer, Christian Keller. *Philipps-Universität Marburg Fachbereich Medizin, Marburg, Germany.*

**Background:** Dialysis patients are at great risk for contracting COVID-19 during the pandemic. In need to appear at their dialysis centers on a regular basis they have limited options to self-isolate. They are forced to be in close contact with ambulance or taxi drivers, co-patients and health care workers, setting them at risk of acquiring COVID-19. Disease severity and mortality in dialysis patients seem to be higher than in the general population. The objective of this study was to assess incidence and mortality of SARS-CoV-2 infections in this cohort.

**Methods:** Repetitive PCR testing and antibody blood sampling was performed in a prospective, multicenter study in chronic hemodialysis patients in 12 dialysis centers in central Germany, starting April 2020. Basic data was assessed, means of transportation and kind of residence were evaluated, specifically with regard to risk for infection. COVID-19 associated symptoms were logged, fatalities were counted during the ongoing pandemic with its particular waves of virus variants.

**Results:** 874 patients at a medium age of 69.8±14.2 yrs (62.1% ♂) participated in the study. Taxi or ambulance were the means of transportation in 86.5%, 7.6% lived in a nursing home; 8.8% acquired COVID-19. Demographic data did not differ between diseased and healthy patients except for residency. The odds ratio to get COVID-19 was significantly higher in dialysis patients living in nursing homes compared to those in home care (OR 3.76, 95%CI 2.05-6.87). Like in the general population, the highest infection rate was observed with the alpha variant, whereas the delta variant did not affect the dialysis centers. Omicron on the other hand was highly present. Mortality was highest during the alpha variant wave (29.1%), but was lower in delta (14.2%) and lowest in omicron infections (0.3%). Overall infections and mortality in dialysis patients decreased with immunization status, either through prior infection or vaccination in nursing homes. Of note, mortality in this cohort was barely impacted by COVID-19 associated death.

**Conclusions:** COVID-19 immunization in hemodialysis patients is very effective preventing spreading the virus from nursing homes to dialysis centers. General morbidity status in dialysis patients seems to be more relevant to outcome than intercurrent infections with COVID-19.

TH-PO923

**Comparing Mortality and Morbidity of COVID-19 Omicron Variant vs. Other Variants in a Hemodialysis Population in Qatar**

Musab Elgaali, Mohamed Y. Ali, Mohamad M. Alkadi, Rania A. Ibrahim, Karima Boubaker, Hany E. Ismail, Muftah Othman, Hassan A. Al-Malki, Abdullah I. Hamad. *Hamad Medical Corporation, Doha, Qatar.*

**Background:** Patients on dialysis are more susceptible to COVID-19 infection, with higher mortality and morbidity. In December 2021 the state of Qatar witnessed a surge in COVID 19 cases solely due to omicron variant. We compare the effect of omicron Vs pre-omicron variants COVID infection on hemodialysis patients in terms of incidence, severity and mortality.

**Methods:** This is an observational, analytical, retrospective, nationwide study. COVID-19 PCR was the method of diagnosis. During the Omicron wave, Rapid Antigen Test was accepted by Ministry of Health in Qatar as a diagnostic test. Our study followed patients for duration from 3/2020 to 1/2022. All positive results from 1<sup>st</sup> of December 2021 were assigned to the omicron group as per national genomic surveillance. Cases before that were assigned to the pre-omicron group. Primary outcome was to compare the incidence of omicron infections in haemodialysis patient compared to pre-omicron era. Secondary outcomes were to assess the mortality, ICU admissions, length of stay in ICU and need for ventilatory support in omicron vs pre-omicron phase. Patient demographics and clinical features were collected from a national electronic medical record.

**Results:** 274 haemodialysis patients were diagnosed with COVID-19 during the omicron wave (2 months period) vs174 patients in the pre-omicron period (21 months). The incidence in omicron wave was 30.3%, which is significantly higher than pre-omicron waves of 18.7% (p <0.001). Omicron variant has lower mortality rate 2.4%, compared to other variants grouped together 15.5% (p <0.001). ICU admissions rate during the omicron wave was significantly less than pre-omicron waves (4.9% Vs 26.4% (p <0.001)), and there was less need for ventilatory support (0.01% Vs 0.16% (p <0.001)). ICU length of stay was not significantly different (16.7+/-8 days Vs 14.2 +/- 17.5 days (p = 0.34)).

**Conclusions:** This is the 1<sup>st</sup> national study to compare the outcome of omicron vs non-omicron COVID-19 variants infection among hemodialysis patients. The incidence of omicron variant was higher than pre-omicron variants, while mortality and ICU admission were significantly lower in the omicron era compared to pre-omicron era. ICU length of stay was not significantly different.

TH-PO924

**ChAdOx1 nCoV-19 Immunogenicity and Immunological Response Following COVID-19 Infection in Patients Receiving Maintenance Hemodialysis**

Krit Pongpirul,<sup>1,2</sup> Wisit Prasithsirikul,<sup>3</sup> Tanawin Nopsopon,<sup>1</sup> Phanupong Phutrakool,<sup>1</sup> Piyawat Kantagowit,<sup>1</sup> Anan Jongkaewwattana.<sup>4</sup> <sup>1</sup>Chulalongkorn University Faculty of Medicine, Bangkok, Thailand; <sup>2</sup>Johns Hopkins University Bloomberg School of Public Health, Baltimore, MD; <sup>3</sup>Bamrasnaradura Infectious Disease Institute, Nonthaburi, Thailand; <sup>4</sup>National Center of Genetic Engineering and Biotechnology, Pathum Thani, Thailand.

**Background:** This study aimed to evaluate the immunogenicity of two doses of ChAdOx1 nCoV-19 and the immune response post-COVID-19 infection in ESRD with HD patients.

**Methods:** The blood samples were obtained at baseline, 1-month, and 3-month follow-up after each shot or recovery. All participants were measured for anti-spike IgG by the ELISA method using Euroimmun.

**Results:** This study found a significant increase in anti-spike IgG after 1 month of two-shot ChAdOx1 nCoV-19 vaccination, followed by a significant decrease after 3 months. On the other hand, the anti-spike IgG was maintained in the post-recovery group. There was no significant difference in the change of anti-spike IgG between one-shot ChAdOx1 nCoV-19 vaccinated and post-recovery groups for both 1-month and 3-month follow-ups. The seroconversion rate for the vaccinated group was 60.32% at one-month after one-shot vaccination and slightly dropped to 58.73% at 3-month follow-up, then was 92.06% at one-month after two-shot vaccination and reduced to 82.26% at 3-month follow-up. For the recovered group, the seroconversion rate was 95.65% at one-month post-recovery and 92.50% at 3-month follow-up.

**Conclusions:** This study established the immunogenicity of two-shot ChAdOx1 nCoV-19 in ESRD patients with HD for humoral immunity. After COVID-19 infection, the humoral immune response was strong and could be maintained for at least three months.

**Funding:** Government Support - Non-U.S.

Demographic Data of Participants

Characteristics	Total	Vaccinated	Recovered
Participants	109	63	46
Age, year (mean ± SD)	54.93 ± 15.28	57.63 ± 14.83	51.22 ± 15.26
Hypertension	89 (81.65%)	56 (88.89%)	33 (71.74%)
Diabetes mellitus	49 (44.95%)	33 (52.38%)	16 (34.78%)
Coronary artery disease	4 (3.67%)	3 (4.76%)	1 (2.17%)

Data were presented as counts and percentages if not otherwise specified. SD: standard deviation.

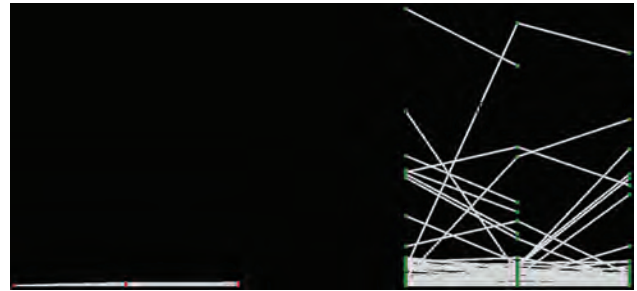

Changes in anti-spike IgG in HD patients who received a single dose of ChAdOx1 and who recovered from COVID-19.

TH-PO925

**The Safety and Humoral Response to COVID-19 Vaccination in Peritoneal Dialysis Patients**

Cheng-Hsu Chen,<sup>1,2</sup> Chia-Yu Shih.<sup>1</sup> <sup>1</sup>Division of Nephrology, Department of Internal Medicine, Taichung Veterans General Hospital, Taichung, Taiwan; <sup>2</sup>Department of Post-Baccalaureate Medicine, College of Medicine, National Chung Hsing University, Taichung, Taiwan.

**Background:** The battle between human and COVID-19 since 2019, it is highly contagious and fatal disease with poor outcome in dialysis patients. The viral vector AZD1222 is a replication deficient simian adenovirus-vectored vaccine encoding the full length SARS-CoV-2 spike protein. The efficacy and safety of AZD1222 in patients treated with peritoneal dialysis (PD) is still not knowing. We focused their seroresponse of nAb titers against SARS-CoV-2 and their local and systemic adverse effects.

**Methods:** We conducted this study to elucidate the immune response directed against SARS-CoV-2 spike (S) protein antigen and adverse effect to vaccination with AZD1222 in PD patients after their 1st and 2nd shots. There were 205 out of 263 PD patients received the first shot of AZD1222, and 192 of them had the second shot between June 2021 to Oct. 2021.

**Results:** The first and second doses of AZD1222 vaccine 13 (9.1%) and 93 (65.0%) of 143 PD patients seroconverted with anti-SARS-CoV-2 S antibody titers (≥ 50 U/mL), and titers presented with 188.54 U/mL (mean; IQR 54.7-739.6) and significantly increased to 1545.3 U/mL (mean ; IQR 52.0-38460), respectively. Pain was the most common local adverse event (AE) (75%). Systemic AEs occurring after the first dose were mostly fatigue (41%) and headache (31%). One severe AE were reported as hearing loss and stroke after the first injection. After the second dose, the most common systemic AEs were fatigue (40.5%), headache (22.5%), joint pain (20%), myalgia (17.5%) and fever (16%), but no severe AE reported. Patients with higher antibody titers after the first dose tended to have higher antibody titers after the second dose (p=1.23x10<sup>-4</sup>).

**Conclusions:** Our study concludes that significantly increasing humoral responses to AZD1222 vaccination in PD patients are from 9.1% after 1<sup>st</sup> shot and 65% after 2<sup>nd</sup> shot. While acceptable local and systemic adverse events, viral vector AZD1222 is still safe and effective vaccination for PD patients.

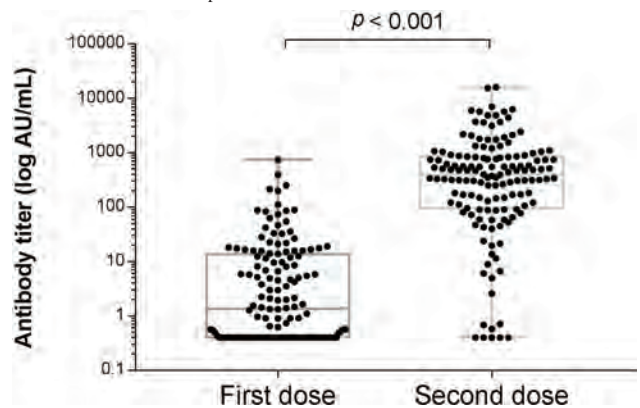

TH-PO926

**Immunogenicity and Safety Outcome of Homologous and Heterologous Prime-Boost of Inactivated Vaccine and Replication-Defective Viral Vectors Vaccine Against SARS-CoV-2 Among Hemodialysis Patients**

Phoom Narongkiatikhun, Vuddhidej Ophascharoensuk, Kajohnsak Noppakun. *Maharaj Nakorn Chiang Mai Hospital, Chiang Mai, Thailand.*

**Background:** Vaccines to prevent SARS-CoV-2 infection are considered as the most promising approach for modulating the pandemic. It is unknown that those vaccines are effectual in maintenance hemodialysis (MHD) patients as demonstrated in healthy people.

**Methods:** We conducted an observational prospective trial involving all MHD patients at Chiang Mai University hospital, Chiang Mai, Thailand. The participants were received homologous Sinovac (SV-SV), homologous AZD1222 (AZ-AZ), or the heterologous prime-boost of SV-AZ. The immunogenicity was assessed by antibodies against the S1 receptor-binding domain (anti-RBD), and SARS-CoV-2 surrogate virus neutralization test (sVNT) at specific timepoints. The primary outcome was the seroconversion rate of sVNT at day 28 after complete vaccination. The secondary outcomes were the seroconversion rate of sVNT after the first dose, the level of sVNT and anti-RBD at specific timepoints, factor associated with seroconversion, and the adverse events of each vaccine regimen.

**Results:** A total of 130 MHD participants were recruited. Among those, 16 (12.31%), 89 (68.46%), and 25 (19.23%) patients were received the SV-SV, AZ-AZ, and SV-AZ regimen, respectively. The seroconversion rate of sVNT at day 28 after the second dose were 68.75%, 78.65%, and 88.0% for SV-SV, AZ-AZ, and SV-AZ, respectively (P=0.289). The level of sVNT and anti-RBD was highest among SV-AZ (Figure 1a, b). Age and percent of plasma lymphocyte were associated with seroconversion. There were no serious adverse events reported in any vaccine groups.

**Conclusions:** Immunization with SV-SV, AZ-AZ, and SV-AZ could generate humoral immunity without any serious adverse events among MHD patients. Using the heterologous vaccine prime boost seemed to be more efficacious in term of inducing immunogenicity and further studies should be warranted.

**Funding:** Other NIH Support - Faculty of Medicine, Chiang Mai University, Chiang Mai, Thailand, and the kidney foundation of Thailand

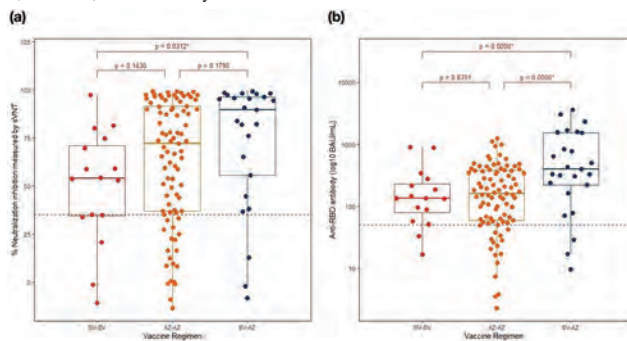

**Figure 1** Percentage of sVNT (a) and the level of anti-RBD (b) at day 28 after the second dose of each vaccine regimen.

**TH-PO927**

**Frailty and Immunogenicity Following COVID-19 Vaccination Among Patients Undergoing Hemodialysis**

Ting-yun Lin. Taipei Tzu Chi Hospital, New Taipei City, Taiwan.

**Background:** Patients with end-stage kidney disease who are undergoing dialysis have reduced immune responses to COVID-19 vaccination. Frailty is extremely common among dialysis patients and may contribute to the impaired immune responses. However, little is known about its effects on the immunogenicity following COVID-19 vaccination in the dialysis population.

**Methods:** Adult hemodialysis patients without prior SARS-CoV-2 infection who received one dose of the ChAdOx1 nCoV-19 vaccine were assessed for eligibility. Participants were categorized as robust, pre-frail, or frail using the Fried frailty criteria. Humoral responses were assessed at 28 days after vaccination by measuring titers of IgG antibody to the receptor-binding domain of SARS-CoV-2 spike protein. Seroconversion was defined as antibody levels  $\geq 50$  AU/mL. Multivariate logistic regression analyses compared humoral responses of frail or pre-frail participants with robust participants.

**Results:** A total of 206 participants were included in the study, of whom 50 (24.3%) were considered frail, 86 (41.7%) pre-frail, and 70 (34.0%) robust. Compared with robust patients, a significantly smaller proportion of pre-frail and frail patients developed anti-spike antibody seroconversion (87.1%, 66.3%, and 40.0%, respectively;  $P < 0.001$ ). Frailty was associated with the absence of humoral responses after adjustment for confounders including age, sex, body mass index, diabetes, coronary artery disease, serum albumin, and lymphocyte count (odds ratio, 0.25; 95% CI, 0.08–0.80;  $P$  for trend = 0.025).

**Conclusions:** Frailty is independently associated with impaired humoral responses following COVID-19 vaccination in hemodialysis patients. Whether repeated booster vaccination may improve the immunogenicity in frail hemodialysis patients needs further research.

Association of frailty phenotype with humoral responses to COVID-19 vaccination

	Unadjusted OR (95% CI)	Model 1 OR (95% CI)	Model 2 OR (95% CI)	Model 3 OR (95% CI)
Anti-spike antibody seroconversion ( $\geq 50$ AU/mL)				
	Reference	Reference	Reference	Reference
Robust	Reference	Reference	Reference	Reference
Pre-frail	0.29 (0.13–0.67)	0.35 (0.15–0.86)	0.44 (0.18–1.09)	0.61 (0.24–1.60)
Frail	0.10 (0.04–0.24)	0.15 (0.05–0.41)	0.21 (0.07–0.62)	0.25 (0.08–0.80)
P for trend	<0.001	<0.001	0.005	0.025

CI, confidence interval; OR, odds ratio.

Model 1 is adjusted for age, sex, and body mass index.

Model 2 is adjusted for Model 1 variables, diabetes, and coronary artery disease.

Model 3 is adjusted for Model 2 variables, albumin, and lymphocyte count.

**TH-PO928**

**Second SARS-CoV-2 Booster Vaccination Significantly Reduces Haemodialysis Patients' Susceptibility to Infection With Omicron Variant**

Nadezhda Wall,<sup>1,2</sup> Gemma D. Banham,<sup>1,2</sup> Anna L. Casey,<sup>2</sup> Alex Richter,<sup>1,2</sup> Adam F. Cunningham,<sup>1</sup> Lorraine Harper.<sup>1,2</sup> COVID HD consortium <sup>1</sup>University of Birmingham, Birmingham, United Kingdom; <sup>2</sup>University Hospitals Birmingham NHS Foundation Trust, Birmingham, United Kingdom.

**Background:** Patients requiring haemodialysis (HD) have disproportionately poorer outcomes from SARS-CoV-2 infection and vaccines afford an opportunity to improve this. However, the efficacy of booster doses on infection with emerging variants remains unclear in this population.

**Methods:** We report the real-world impact of SARS-CoV-2 booster vaccinations in an ethnically diverse urban cohort of 1172 patients receiving in-centre HD who were routinely screened for SARS-CoV-2 infection by weekly nasopharyngeal PCR between 1st December 2021 and 31st March 2022, during dominant UK prevalence of B.1.1.529 variant ("Omicron"). Where possible, genomic sequencing was performed as standard of care.

**Results:** At the start of the observation period, 896 (76.5%) had received 3 doses of SARS-CoV-2 vaccine and only 87 (7.4%) were unvaccinated. By end of study 664 (59.5%) had received 4 vaccine doses. 305 patients had PCR positive SARS-CoV-2 infection, with Omicron variant confirmed in all but one of samples successfully tested. Clinical course of infection was mild: around half of patients asymptomatic, only 1 in 20 hospitalised, case fatality 3%. Three or more vaccine doses significantly associated with reduced risk of SARS-CoV-2 PCR positivity compared to unvaccinated status, together with White ethnicity and lower deprivation index (Cox regression  $p < 0.03$ ). However, 2 booster doses further reduced the risk of infection by around a third compared to 1 boost, independent of age, gender and comorbidity.

**Conclusions:** A second SARS-CoV-2 booster vaccine further reduces the risk of Omicron infection in haemodialysis patients. As such, a double-boost policy could significantly reduce the burden and associated spread of SARS-CoV-2 infection in this vulnerable population.

**Funding:** Private Foundation Support

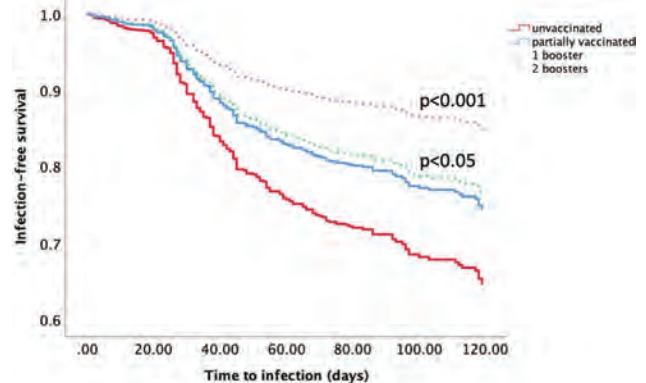

Adjusted proportional hazards model of SARS-CoV-2 infection-free survival in HD patients. Partially vaccinated: 1-2 doses. \*\*\* $p < 0.001$ , \* $p < 0.05$  (compared to unvaccinated status).

**TH-PO929**

**Antibody Response After COVID-19 Vaccination in CKD and Kidney Transplant Patients**

Thananya Trakarnvanich. Faculty of Medicine Vajira Hospital, Bangkok, Thailand.

**Background:** Vaccination of patients with chronic kidney disease (CKD) and kidney transplants (KTs) may achieve a less robust immune response. Understanding such immune responses is crucial for guiding current and future vaccine dosing strategies.

**Methods:** This prospective, observational study estimated the immunogenicity of humoral and cellular responses of two SARS-CoV-2 vaccines in different patient groups with CKD compared to controls. Secondary outcomes were adverse events after vaccination and the incidence of COVID-19 breakthrough infection, including illness severity.

**Results:** In total, 212 patients received ChAdOx1 nCoV-19 (89.62%) or inactivated vaccines (10.38%). The antibody response against the S protein was analyzed at T0 (before the first injection), T1 (before the second injection), and T2 (12 weeks after the second injection). Seroconversion occurred in 92.31% of controls at T2 and in 100% of CKD, 42.86% of KT, 80.18% of hemodialysis (HD), and 0% of continuous ambulatory peritoneal dialysis (CAPD) patients at T2 of ChAdOx1 nCoV-19 vaccine. Neutralizing antibody levels were above the protective level at T2 in each group. The KT group had the lowest neutralizing antibody and IFN $\gamma$ . Blood groups O and vaccine type were associated with good immunological responses. After the first dose, 14 individuals (6.6%) out of the total population experienced breakthrough COVID-19 infection.

**Conclusions:** Immunity in patients with CKD and HD after vaccination was strong and comparable to that of healthy controls. Our study suggests that a single dose of the vaccine is not efficacious and delays may result in breakthrough infection. Some blood group and type of vaccine can affect the immune response.

**Funding:** Government Support - Non-U.S.

**TH-PO930**

**COVID-19 Infection in Dialysis Patients: Efficacy of Vaccination**

Jose E. Navarrete, Jason Cobb, Ibronne W. Apata, Tahsin Masud, Janice P. Lea. Emory University, Atlanta, GA.

**Background:** End stage kidney disease (ESKD) patients are particularly susceptible to poor outcomes from Covid-19 infection (C19). Vaccination has been the cornerstone of mortality prevention. We examine the efficacy of C19 vaccine in ESKD patients.

**Methods:** All patients dialyzed at Emory dialysis centers from December 1, 2020 until February 2022 represent the study population. Date of completed vaccines series was recorded. Confirmed C19 cases were also registered. Time from vaccination to C19 and from C19 to death was recorded. Mortality risk was compared between vaccinated and unvaccinated patients. Patients that received vaccination after an episode of C19 were excluded from the analysis (n=89).

**Results:** 935 patients received maintenance dialysis during the study period. 68% completed 2 doses of C19 vaccine. 46% of vaccinated patients received a booster dose after 294 days (IQR: 251-273) of completing the primary vaccination series. Non-vaccinated patients were younger (55 vs 60y/o), with shorter dialysis vintage (1.0 vs 2.8 years). The proportion of home and in-center dialysis was similar among vaccinated and unvaccinated patients. The prevalence of diabetes, CHF, PVD, COPD, atrial fibrillation, and previous transplants was also similar. 71 vaccinated patients died during follow up (11%) after 196 days (IQR 122-290), compared to 70 in the non-vaccinated group (24%) after 86 days (IQR 39-166), p<0.001. Adjusting for age, dialysis vintage, diabetes and CHF, ESKD vaccinated patients had a 78% reduction in mortality risk (A). 73 vaccinated patients (11%) acquired C19 after 250 days (IQR 150-288) compared to 48 unvaccinated patients (16%) who acquired C19 after 64 days (IQR 30-215), p<0.001. The mortality odds ratio after C19 infection was 3.9 [CI: 1.3-11.9] for unvaccinated patients 30 days post infection, 4.7 [CI: 1.7-14.2] at 60 days and 4.1 [CI: 1.6-11.5] at 90 days (B).

**Conclusions:** Vaccination against C-19 infection resulted in a 78% reduction of mortality risk in patients receiving dialysis. Non-vaccinated patients diagnosed with C19 had higher mortality rates than vaccinated patients (OR 4.1 at 90 days post infection).

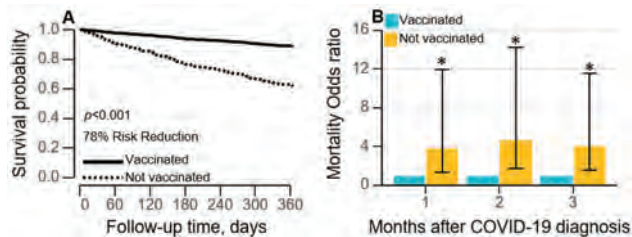

**TH-PO931**

**The Effect of SARS-CoV-2 Vaccination in a Hemodialysis Population in the Region of Southern Denmark**

Anne D. Thuesen,<sup>1</sup> Erik B. Pedersen,<sup>2</sup> Annie R. Knudsen,<sup>1</sup> Rikke Juul-Sandberg,<sup>1</sup> Majbritt Knudsen,<sup>3</sup> Christine Nilsson,<sup>2</sup> Per B. Jensen,<sup>2</sup> Claus Bistrup.<sup>2,4</sup> <sup>1</sup>Sygehus Lillebalt Kolding Sygehus, Kolding, Denmark; <sup>2</sup>Odense Universitetshospital, Odense, Denmark; <sup>3</sup>Sydvestjysk Sygehus, Esbjerg, Denmark; <sup>4</sup>Syddansk Universitet, Odense, Denmark.

**Background:** Hemodialysis patients are a high-risk, immunocompromised population. Therefore, it is expected that vaccination against SARS Cov-2 will have a reduced efficacy in these patients, who have a high mortality from SARS-CoV-2 infection.

**Methods:** Prospective observational study performed on three dialysis facilities in the Region of Southern Denmark (Kolding Hospital, Odense University Hospital and Sydvestjysk Hospital Esbjerg) in the period March 2021 through March 2023. SARS CoV-2 anti-S RBD IgG are measured in blood samples collected one, two, five, seventeen and twenty-three month after the second vaccination and furthermore before and one month after the third vaccination see. Anti-S RBD IgG was determined using the SARS-CoV-2 IgG II Quant assay (Abbott Laboratories). Non-responders are defined with anti-S-RBD IgG < 7.1 BAU/ml. All hemodialysis patients received the mRNA vaccine Comirnaty/Pfizer-BioNTech. We have included 249 hemodialysis patients.

**Results:** Below one percent of the hemodialysis population were infected with the Wild type and Delta COVID-19 variant. Significant reduction in the anti-S-RBD level from 4 weeks after the second vaccination (mean = 544 BAU/ml SEM ±82) to 20 weeks after (mean = 102.3 BAU/ml SEM±49.1). There was a significant increase in the anti-S RBD level after the third booster vaccination with a large variation (mean = 2403 BAU/ml SEM ±148.3) compared to four weeks after the second (mean = 544 BAU/ml SEM ±82). The fraction of non-responders were markedly reduced after the third vaccination from 26% to 3%. We will present the latest data on the anti-S-RBD level that we continuously measures until March 2023.

**Conclusions:** Hemodialysis patients seem to loose humoral immunity rapidly after the initial COVID-vaccinations, but gain a significant rise in anti-S RBD antibody levels after the third vaccination. The fraction of non-responders after 3<sup>rd</sup> dose decreased to 3%.

**TH-PO932**

**mRNA Vaccines Increase SARS-CoV-2 Antibody Levels Among Dialysis Patients Initially Vaccinated With Adenovirus Vector-Based SARS-CoV-2 Vaccine (Ad26.COV2.S)**

Joanna Willetts,<sup>1</sup> Linda Ficociello,<sup>1</sup> Curtis D. Johnson,<sup>2</sup> Sandra E. Alexander,<sup>3</sup> Claudy Mullan,<sup>1</sup> Jeffrey L. Hymes.<sup>1</sup> <sup>1</sup>Fresenius Medical Care, Waltham, MA; <sup>2</sup>Spectra Laboratories, Milpitas, CA; <sup>3</sup>Fresenius Medical Care North America, Waltham, MA.

**Background:** Antibody (AB) response to Ad26.COV2.S vaccine (AdV) was observed to be lower than with mRNA vaccines in dialysis patients and additional vaccine doses were recommended. We conducted a quality improvement project in Fresenius Kidney Care clinics to track AB response in dialysis patients initially administered AdV who later received or did not receive additional vaccine doses.

**Methods:** AB response was measured in remnant blood with semiquantitative chemiluminescent assay detecting IgG AB directed against receptor binding domain of S1 subunit of SARS-CoV-2 spike antigen (Siemens); AB index >1 was considered reactive, >7 as adequate, and > 750 was maximum detected. All patients who received an AdV, had 2 AB measures after vaccination, and were not Covid-19 positive/suspected cases were included in the analysis. Patients were classified into 4 groups based on vaccine doses received: AdV single dose (n=103); AdV+AdV (n=8); AdV+mRNA (n=329); AdV+mRNA+mRNA (n=14). First AB measurement occurred after initial AdV dose and Last AB measurements occurred after additional vaccine doses.

**Results:** AB was measured, on average, 97 (sd 12) days and 325 (sd 14) days after first AdV dose for First AB and Last AB measurements, respectively. Distribution of AB responses are shown in Figure. At Last AB measurement, AB index ≤ 7 was common for AdV and AdV + AdV groups (43% and 51%, respectively). However, it was rare in AdV+mRNA and AdV+mRNA+mRNA groups (7% and 0%, respectively).

**Conclusions:** Patients who were initially vaccinated with AdV, had improved AB response after one or two mRNA vaccine doses. This response was more pronounced than when patients were administered an additional AdV dose.

**Funding:** Commercial Support - Fresenius Medical Care

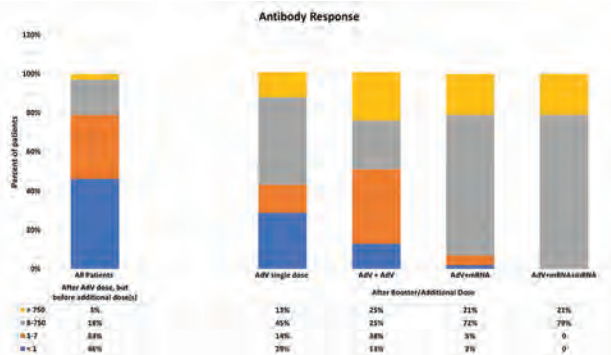

**TH-PO933**

**SARS-CoV-2 Booster Effect and Waning Immunity in Hemodialysis Patients**

Eibhlin S. Goggins,<sup>1</sup> Binu Sharma,<sup>1</sup> Jennie Z. Ma,<sup>1,2</sup> Jitendra K. Gautam,<sup>1</sup> Brendan T. Bowman.<sup>1</sup> <sup>1</sup>University of Virginia School of Medicine, Charlottesville, VA; <sup>2</sup>University of Virginia School of Medicine, Public Health Sciences, Charlottesville, VA.

**Background:** Patients with End Stage Kidney Disease (ESKD) on dialysis are extremely vulnerable to SARS-CoV-2 infection. Antibody levels decline in the months following the standard two-dose vaccination series with Pfizer BioNTech (BNT162b2) mRNA SARS-CoV-2 vaccine in hemodialysis patients. Current guidelines recommend boosters of SARS-CoV-2 mRNA-based vaccines. The aim of this study was to determine the humoral response of hemodialysis patients to a third dose of the BNT162b2 vaccine.

**Methods:** Prospective cohort study measuring the serologic response of hemodialysis patients to a booster dose of BNT162b2 vaccine at an average of 2, 6 and 11 weeks post vaccination. The Anti-SARS-CoV-2 QuantiVac ELISA (IgG) from Euroimmun (EUROIMMUN US, Inc.) was used in all assessments. Differences in antibody levels over time were compared non-parametrically using the Friedman test, then tested pairwise with Bonferroni correction at alpha < 0.05. A linear mixed model was used to estimate the decline in slope after vaccination.

**Results:** Of 35 hemodialysis patients in the original cohort, 27 (77.1%) received a third dose of BNT162b2. Antibody level significantly increased from pre-booster to 2 weeks post-booster (median (25th, 75th percentile) from 59.94 (29.69, 177.8) to 6216 (3806, 11730)), an average increase of 112 fold. Antibody levels dropped an average of 36.3% to a median of 2654 BAU/mL (1650, 8340) at 6 weeks post-booster. From weeks 6 to 11 post-booster, antibody levels dropped to a median of 1444 BAU/mL (1102, 2020), corresponding to a 52.4% average decrease. Overall, antibody levels declined 47% month to month post-booster. Still, antibody levels at 11 weeks remained an average of 40 fold higher than pre-booster levels. Nine (33%) patients had negative or borderline detectable antibody levels pre-booster and 8 of 9 developed positive (>35.2 BAU/mL) antibody levels post-booster. Those with prior infection had a lower proportional increase

in antibody level (51 fold) compared with the median change in COVID naïve patients (144 fold) from pre-booster to 2 weeks post-booster.

**Conclusions:** Following a third dose of the BNT162b2 vaccine, hemodialysis patients obtain a robust humoral response although antibody levels wane over time.

#### TH-PO934

##### Long-Term Humoral Immunity Decline in Hemodialysis Patients Following SARS-CoV-2 Vaccination

Eibhlin S. Goggins,<sup>1</sup> Binu Sharma,<sup>1</sup> Jennie Z. Ma,<sup>1,2</sup> Jitendra K. Gautam,<sup>1</sup> Brendan T. Bowman.<sup>1,1</sup> <sup>1</sup>University of Virginia School of Medicine, Charlottesville, VA; <sup>2</sup>University of Virginia School of Medicine, Public Health Sciences, Charlottesville, VA.

**Background:** Vaccines against SARS-CoV-2 are effective in the general population. Dialysis patients are vulnerable to SARS-CoV-2 infection with high morbidity and mortality. Beginning in January of 2021, the University of Virginia Dialysis Program initiated a program wide vaccination campaign administering Pfizer BioNTech mRNA SARS-CoV-2 (BNT162b2) vaccine. The aim of this study was to characterize the long term time-dependent decline in humoral immunity in hemodialysis patients.

**Methods:** 35 adult hemodialysis patients were recruited to receive two doses of the BNT162b2 vaccine. From 2 to 6 months post vaccination, monthly semi quantitative IgG antibody levels to the SARS-CoV-2 spike protein receptor binding domain were obtained. To analyze the change in antibody levels over time, a linear mixed model with random slope and random intercept was used for longitudinal antibody levels. A multivariable model was used to estimate the slope of antibody levels by adjusting for selected patient characteristics. Based on the estimated intercepts and slopes for each subject from the unadjusted model, 10-month antibody levels were projected.

**Results:** The mean baseline antibody level was 647.59 BAU/mL and 87.88% (29/33) of patients were considered qualitatively positive. Two patients were negative at baseline and an additional two had borderline results. Patient antibody levels declined at an adjusted average rate of 31% per month. At 6 months post vaccination, 40% of patients remaining in the cohort possessed either negative or borderline IgG antibody levels. Immune suppressed patients, on average, had a 65% lower antibody level compared to patients without immune suppression and patients with prior COVID-19 infection had 5 times higher antibody levels than infection naïve patients. Projecting future antibody levels based on the slopes of antibody level decay suggests 65% of the cohort will progress to borderline or negative antibody levels at 10 months post full vaccination if additional doses are not administered.

**Conclusions:** The long term vaccine response of hemodialysis patients vaccinated with the BNT162b2 mRNA vaccine was characterized. Our data demonstrates the decline in humoral immunity over time and emphasizes the crucial need for vaccine boosters in this population.

#### TH-PO935

##### A Single Center Study of SARS-CoV-2 Spike Antibody Response to Vaccination in Renal Transplant Recipients

Debargha Basuli, Bonnie Ross, Kimberly Briley, Hassam Ali, Lorita Rebellato. East Carolina University, Greenville, NC.

**Background:** Kidney transplant recipients are at high risk of mortality and complications related to COVID-19. Vaccination remains the most important strategy to prevent severe disease in this vulnerable population. The goal of this study was to evaluate the antibody response to mRNA vaccines in kidney transplant recipients.

**Methods:** We studied anti-spike IgG response to mRNA vaccines (BNT162b2 and mRNA-1273) against SARS-CoV-2 in adult kidney transplant recipients in a single center. Preserved blood samples of kidney transplant patients undergoing routine monitoring were used. The LABScreen COVID Plus Assay (One Lambda) was used to detect SARS-CoV-2 antibody response. Categorical variables were compared using the Fisher's exact test, and continuous variables were compared using a t-test.

**Results:** Among 120 subjects receiving two doses of vaccines, only 74 (61.7%) elicited a positive response with anti-Spike antibody. After a third dose/first booster vaccine, 35 out of 43 (81.4%) kidney subjects had a positive response. There was no statistically significant difference between the responders and non-responders in terms of age, gender, race, blood group, time since transplant, vaccine type. A third dose vaccine produced statistically significant increase in antibody response compared to 2 doses only. A third dose induced a serological response in 7 out of 8 subjects (87.5%) who did not respond after 2 doses of vaccine. None of the patients developed donor specific HLA antibody in response to COVID-19 infection or the vaccine.

**Conclusions:** In this single center retrospective study, we demonstrated that the antibody response to SARS-CoV-2 mRNA vaccine was most prevalent after 4 months since the second dose. In addition, a third dose induced an antibody response in a larger number of kidney transplant recipients (81.3% vs 61.67%, p value 0.018), suggesting that this patient population may benefit from receiving multiple doses of mRNA vaccines.

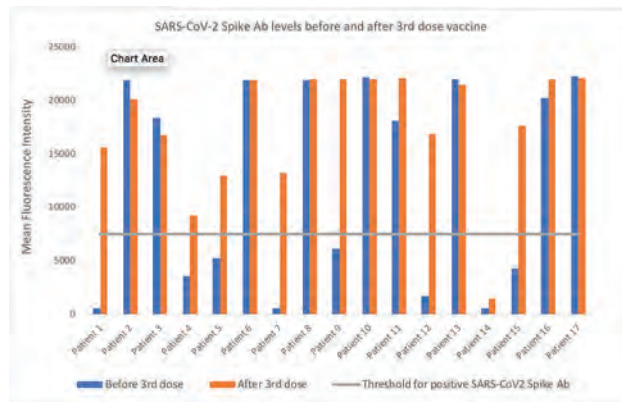

#### TH-PO936

##### Undercounting of COVID-19 Vaccinations in Fee-for-Service Medicare Claims

Nicholas S. Roetker,<sup>1</sup> Wendy L. St. Peter,<sup>2</sup> Madison Hoover,<sup>1</sup> James B. Wetmore,<sup>1,3</sup> Kirsten L. Johansen.<sup>1,3</sup> <sup>1</sup>Hennepin Healthcare Research Institute, Minneapolis, MN; <sup>2</sup>University of Minnesota Twin Cities, Minneapolis, MN; <sup>3</sup>Hennepin Healthcare, Minneapolis, MN.

**Background:** Older individuals and those with certain underlying conditions were among the earliest groups offered COVID-19 vaccinations. While patients with ESKD did not initially receive priority, a federal program permitted vaccinations to be administered in dialysis clinics starting in March 2021. We studied early uptake of COVID-19 vaccinations in Medicare fee-for-service beneficiaries with ESKD.

**Methods:** We included beneficiaries aged  $\geq 18$  years with ESKD on December 1, 2020 from the US Renal Data System. Vaccinations covered by Medicare were identified using CPT codes. The cumulative monthly incidence of first vaccination dose through June 2021 was compared by modality (HD, PD, transplant) and stratified by age and race/ethnicity. Death was treated as a competing risk.

**Results:** By June 30, 2021, the cumulative incidence of receiving a Medicare-covered first vaccination dose was  $<40\%$  in patients receiving HD (Figure A), well under the estimate reported by dialysis facilities to the CDC by this date (72%). Although caution is required, some interpretation of the Medicare vaccination data may still be permitted. After the allocation of vaccines to dialysis clinics, Medicare-covered vaccinations surged in patients receiving HD relative to the other modalities. In patients receiving HD, uptake of Medicare-covered vaccinations was initially highest among those aged  $\geq 65$  years and then surged in younger patients following the federal vaccine allocation (Figure B).

**Conclusions:** COVID-19 vaccination rates are severely underestimated using Medicare administrative data. It is unclear whether missingness of vaccination data is differential by demographic groups, such as race/ethnicity. Inferences based on these data should be made with caution.

**Funding:** NIDDK Support

**A. Cumulative incidence of first dose COVID-19 vaccinations covered by Medicare, by ESKD modality, December 2020 – June 2021**

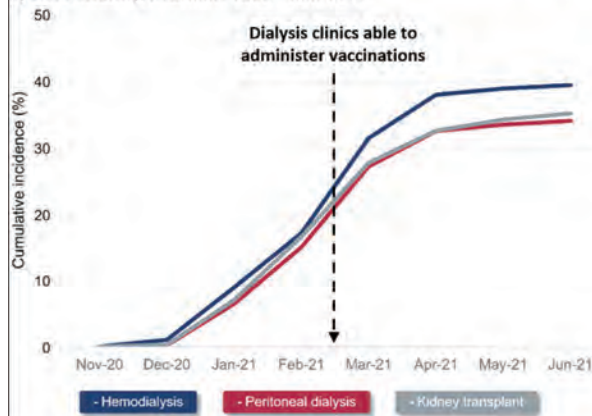

**B. Cumulative incidence of first dose COVID-19 vaccinations covered by Medicare in patients receiving hemodialysis, by age category, December 2020 – June 2021**

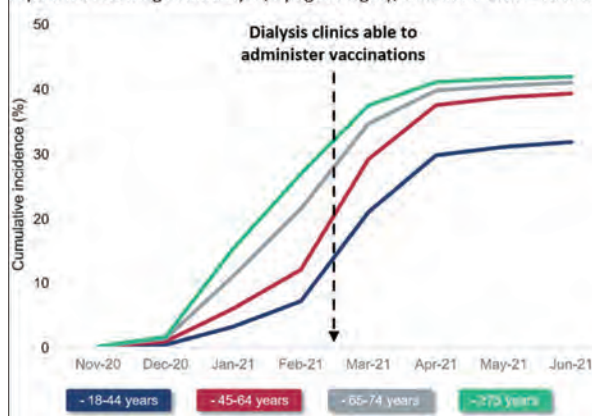

**TH-PO937**

**Humoral Response After Three Doses of SARS-CoV-2 Vaccines in Hemodialysis Patients**

Filipa Trigo, Rui A. Duarte, Karina Lopes, Ivan A. Luz, Paulo A. Santos. Centro Hospitalar do Medio Tejo EPE, Torres Novas, Portugal.

**Background:** Hemodialysis patients (HDP) are at higher risk of exposing and developing severe coronavirus disease 2019 (COVID-19). To protect this population, the Portuguese government implemented an early vaccination of these patients in the national COVID-19 immunization plan. Nevertheless, the humoral response to the two doses of BNT162b2 on HDP was lower than the one expected in the general population, leading us to believe that a third dose is of high importance at this group of patients. This study aims to determine the humoral response to the third dose of SARS-CoV-2 mRNA vaccine.

**Methods:** A single-center observational prospective study was conducted following HDP receiving SARS-CoV-2 mRNA vaccines in a Portuguese center. Specific anti-Spike IgG quantification 3 weeks after first and second doses, and 3 months after the third dose, was used to determine absolute values and non-responders (NR).

**Results:** A total of 59 patients were enrolled in this study, 33.4% of them were female and the median age was 71.3 years old. About 44% of the patients had COVID-19, all of them after the immunization with two doses of BNT162b2 vaccine. All of them suffered from mild to moderate disease. The median IgG anti-Spike S1 level after the second dose was 43.71AU/mL, with an IQR of 53, whereas 3 months after the third dose was of 473.5AU/mL, with an IQR of 1403.8 (Figure 1). The rate of NR (IgG anti-Spike S1 levels <1AU/mL) also had a high variation with the number of the doses administered - 14% of the patients after the second dose versus 0% after the third dose. After the last immunization, only 20% of the patients remained weak responders (IgG anti-Spike S1 < 150AU/mL). Age, sex, hemoglobin, ferritin, parathyroid hormone (PTH), C-Reactive Protein (CPR) and albumin did not impact on the response to the vaccine.

**Conclusions:** Most of HDP responded strongly to the third dose of SARS-CoV-2 vaccine, even though the IgG anti-Spike levels were only measured 3 months after the administration. There is no analytical feature that can predict the response to the vaccine. Therefore, every hemodialysis patient would benefit from the administration of a third vaccine dose at least six months after receiving the second one.

**TH-PO938**

**Seroresponse to Additional Doses of SARS-CoV-2 Vaccine Among Maintenance Dialysis Patients Over 6 Months**

Caroline M. Hsu,<sup>1</sup> Eduardo K. Lacson,<sup>1,2</sup> Harold J. Manley,<sup>2</sup> Gideon N. Aweh,<sup>2</sup> Doug Johnson,<sup>2</sup> Daniel E. Weiner.<sup>1</sup> <sup>1</sup>Tufts Medical Center, Boston, MA; <sup>2</sup>Dialysis Clinic Inc, Nashville, TN.

**Background:** Among patients receiving maintenance dialysis, seroresponse to an initial vaccine series wanes over time. Previously, we showed that additional doses elicit a substantial short-term increase in seroresponse. Here, we assess seroresponse over time in a national sample of maintenance dialysis patients.

**Methods:** Using retrospective clinical data, we assessed seroresponse to additional SARS-CoV-2 vaccine doses over time among maintenance dialysis patients cared for at Dialysis Clinic, Inc (DCI) facilities. Via a clinical protocol available to dialysis providers, antibodies against SARS-CoV-2 spike antigen were assessed monthly alongside routine labwork. Patients with history of COVID-19 prior to additional dose and patients who received Janssen vaccine as an additional dose were excluded. Titers after a second additional dose (i.e., for most, a fourth dose) or after COVID-19 diagnosis were excluded from analysis.

**Results:** Among 1707 patients who had received an additional vaccine dose and had at least one titer level measured after the additional dose, more than 75% had a titer level at the upper limit of the assay in the first month after the additional dose. Titer levels then waned across vaccine types. By Month 6, median [IQR] titer was 68.37 [22.30, ≥100] among Moderna recipients, 59.94 [39.90, 79.97] among Moderna half-dose recipients, and 71.29 [22.46, ≥100] among Pfizer recipients.

**Conclusions:** Among patients receiving maintenance dialysis, anti-spike IgG levels after an additional SARS-CoV-2 vaccine dose wane over time across vaccine types. These results suggest a role for routine antibody monitoring to assess possible need for further re-dosing.

**Funding:** Private Foundation Support

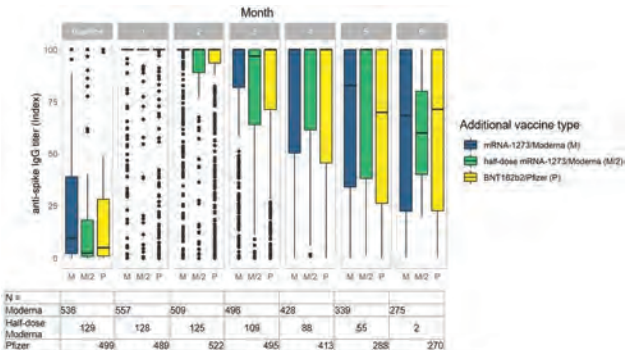

**Figure. Anti-spike IgG titers by month after receipt of additional SARS-CoV-2 vaccine, comparing by vaccine type.** The boxplots are bounded by the upper and lower limits of the assay used. For example, the median [IQR] titer in month 2 was ≥100 [88.91, ≥100] among the Moderna recipients, ≥100 [88.91, ≥100] among the half-dose Moderna recipients, and ≥100 [80.57, ≥100] among the Pfizer recipients. The dots represent outliers, defined as greater than 1.5\*IQR above the third quartile or less than 1.5\*IQR below the first quartile. Baseline is the last titer prior to the additional dose. The table of N shows the number of titers for each month, by vaccine type.

**TH-PO939**

**Persistence of Antibody Response to COVID-19 Vaccine in Peritoneal Dialysis (PD) Patients: A Single Center Study**

Shab E Gul Rahim,<sup>1</sup> Sri Lekha Tummalapalli,<sup>1</sup> Gabriel J. Stryjniak,<sup>1</sup> Supriya Gerardine,<sup>1</sup> Vesh Srivatanu.<sup>2,1</sup> <sup>1</sup>Weill Cornell Medicine, New York, NY; <sup>2</sup>Rogosin Institute, New York, NY.

**Background:** Published studies on the response to COVID-19 vaccination are primarily focused on hemodialysis. We studied the humoral response to the COVID-19 vaccine in a PD population over a 6 month follow-up period.

**Methods:** In a retrospective single-center study, we assessed response to COVID-19 vaccination in patients on PD at 4 weeks, 3 months and 6 months after completing the full vaccination series. Response was measured via semiquantitative COVID-19 spike protein total antibody (IgG) level using a chemiluminescent sandwich immunoassay. Antibody (Ab) titers <1 were categorized as no response, 1 to <20 as intermediate, and >20 as high response. Chi-squared tests for categorical variables and unadjusted linear regression for continuous variables were used to compare characteristics among responders vs non-responders.

**Results:** Of 119 patients on PD who received COVID-19 vaccine as of December 2021, 108/119 (91%) had a positive Ab response and 11/119 (9%) had no response. A total of 37% had an intermediate and 53.7% had a high response. Positive COVID-19 serology prior to vaccination (p= 0.010) as well as type of vaccine (p=0.032) were associated with higher Ab response in univariate analyses. Other factors were not statistically significantly associated with Ab response. Among the 73 participants with Ab levels at all timepoints, at 4 weeks, 11 (15%) had no Ab response, 19 (26%) intermediate, and 43 (59%) high response. At 3 months, 12 (16%) of participants had no Ab response, 27 (37%) intermediate, and 34 (47%) high response. At 6 months, 12 (16%) of participants had no Ab response, 38 (52%) intermediate, and 23 (32%) high response.

**Conclusions:** Most PD patients developed a positive Ab response to the COVID-19 vaccine. Positive COVID-19 serology prior to vaccination and the type of vaccine received were associated with higher Ab response. Our data suggests promising COVID-19 vaccine response among PD patients.

Characteristic	Total Sample (n = 119)	Never had Antibody Response (<1) to COVID-19 Vaccine (n = 11)	Intermediate Antibody Response (<1 and <20) to COVID-19 Vaccine at any timepoint (n = 44)	Ever had High Antibody Response (>20) to COVID-19 Vaccine (n = 64)	p-value
Age	65 [52 - 72]	67 [51 - 73]	65 [52 - 73]	64 [52 - 71]	0.533, 0.675
Body mass index (BMI)	26.9 [23.9 - 31]	25.4 [23.4 - 29.5]	26.2 [23.4 - 30.6]	27.2 [24 - 31.5]	0.876, 0.864
Hypertension	90.3%	100%	90.5%	88.3%	0.722
Diabetes	28.3%	27.3%	34.2%	24.6%	0.610
Coronary artery disease	19.5%	100%	33.3%	13.3%	0.011
Absolute lymphocyte count (x 10 <sup>9</sup> per mL)	1.12 [0.88 - 1.72]	0.83 [0.6 - 1.5]	1.11 [0.9 - 1.73]	1.17 [0.90 - 1.79]	0.770, 0.332
Total Kt/V	2.11 [1.79 - 2.51]	2.01 [1.93 - 2.49]	1.98 [1.74 - 2.51]	2.12 [1.83 - 2.51]	0.847, 0.925
Residual Kt/V	0.41 [0.11 - 0.86]	0.59 [0.06 - 1.39]	0.39 [0 - 0.57]	0.56 [0.18 - 1]	0.214, 0.602
COVID-19 Ab: Positive prior to Vaccine	21.4%	0.1%	7.9%	31.8%	0.010
Type of Vaccine					
Pfizer	68.6%	72.7%	62.8%	71.9%	0.032
Moderna	27.1%	9.1%	30.2%	28.1%	
Johnson & Johnson	4.2%	18.2%	7.0%	0%	
Immunosuppressed	17.5%	30%	13.5%	17.9%	

Characteristics of Patients Receiving Peritoneal Dialysis by COVID-19 Antibody Response

TH-PO940

**Antibodies Response in CKD Patients Vaccinated With CoronaVac**  
 Catarina Minczuk, Fernando L. Fonseca, Vitor Augusto Q. Mauad, Marcelo R. Bacci. *Faculdade de Medicina do ABC, Santo Andre, Brazil.*

**Background:** Chronic Kidney Disease (CKD) has emerged as one of the major risk factors to a worse outcome in COVID19 (C19) patients. Vaccination became the main prevention policy against virus spread among individuals, apart from other measures, like using face masks and social distancing; however, CKD patients are a sensitive population excluded from many trials when eGFR are below 30 mL/min. C19 pandemic as never before, became possible vaccine development in a record time. CoronaVac, a live inactivated virus vaccine, was the main immunizing agent used in Brazil in the first wave of vaccination. Apart its safety and efficacy, there was no specific dose and regimen to immunosuppressed patients and advanced CKD population. The aim of this study was evaluate the SarsCov2 antibodies response after the full dose regimen of CoronaVac immunizing agent in CKD patients.

**Methods:** It is a cross sectional study conducted in Brazil during C19 second wave. Patients with stage 4 and 5 CKD were included with matched controls. Patients that received a full dosage regimen of CoronaVac, 2 shots of 0.5 mL (600 units of inactivated virus) with a 4 week interval were included. Total Sars-Cov2 antibodies and Spike antibodies were dosed after 12 weeks of the 2 dose CoronaVac regimen received. Siemens ADVIA Centaur® essays were used to determine antibodies levels and a cut off superior to 0.05 U/mL was considered positive. Descriptive analysis were made to show data with their central tendency characteristics. Qualitative data were described with their proportions and to non-normality inference, Mann-Whitney was used. The alpha level accepted was 5%.

**Results:** The study included 41 individuals in total: 19 patients with stage 4 and 5 CKD and 21 matched controls without renal disease. The mean age in the CKD group was 71,68 years (±7,79) and 72,95 years (±9,86) in control group. Male and female individuals were equal among groups. Total SarsCov2 antibodies levels were 4,32 U/mL (±4,16) in CKD group and 6,21 U/mL (±4,51) in controls with no statistical significance (p=0.46). Spike antibodies levels were 10,47 U/mL (±32,41) in CKD group and 10,35 U/mL (±28,34) in controls with a p=0.09 between groups using Mann-Whitney non parametric test.

**Conclusions:** In conclusion, CKD patients developed adequate levels of antibodies against C19 with CoronaVac full dosage regimen in Brazil after a 3 month period.

TH-PO941

**The Effectiveness of mRNA COVID-19 Vaccine Against SARS-CoV-2 Infection in Hemodialysis Patients: A Case-Control Study**  
 Abdullah I. Hamad, Mostafa Elshirbeny, Mohamed Y. Ali, Tarek A. Ghonimi, Rania A. Ibrahim, Fadumo Y. Yasin, Poonam R. Singh, Sahar Aly, Essa Abuhelaiga, Hassan A. Al-Malki, Mohamad M. Alkadi. *Hamad Medical Corporation, Doha, Qatar.*

**Background:** Hemodialysis (HD) patients are at higher risk for SARS-CoV-2 infection and its severe complications compared to the general population. Several studies examined the effectiveness of COVID-19 vaccines in this highly vulnerable population but showed mixed results. The aim of this study was to determine the effectiveness of mRNA vaccines against confirmed SARS-CoV-2 infection in HD patients in the State of Qatar.

**Methods:** We used a test-negative case-control design to determine the effectiveness of vaccination in HD patients > 14 days after the second dose. Ninety-five patients had positive SARS-CoV-2 PCR (cases), while 884 patients had negative PCR (controls). Vaccine effectiveness was determined using the following formula [Vaccine effectiveness = 1 - Odds (T+ [vaccinated]) / Odds (T+ [non-vaccinated])].

**Results:** Thirty out of 691 vaccinated HD patients had positive SARS-CoV-2 PCR versus 65 out of 288 non-vaccinated patients (4% vs. 23%, P<0.0001). Patients were more likely to have positive PCR if they were females (P<0.0001), elderly (P=0.02), or Asians (P=0.03). The overall effectiveness of mRNA COVID-19 vaccines against confirmed SARS-CoV-2 infection was 84.5% (95% CI: 76.5-89.8; Table 1)

**Conclusions:** Our data support the importance of using the mRNA COVID-19 vaccine in HD patients to prevent SARS-CoV-2 infection in such a high-risk population.

Table 1: Vaccine Effectiveness against confirmed infection

Vaccine type	Positive SARS-CoV-2	Negative SARS-CoV-2	Adjusted vaccine effectiveness, %	(95% CI)
mRNA-1273 (Moderna)	1	68	94.9	(79.7 to 99.8)
BNT-162b2 (Pfizer)	29	593	83.3	(74.4 to 89.1)
All vaccinated	30	661	84.5	(76.5 to 89.8)
Non-vaccinated	65	223	Reference	Reference

TH-PO942

**Improvement in COVID-19 Vaccine Hesitancy Rates Between 2020-2021 in an Inner-City Dialysis Population and Associated Factors**  
 Edward Bae, Lulu Wei, Judy Lee, Ariel Gidon, Mariana S. Markell. *SUNY Downstate Health Sciences University, Brooklyn, NY.*

**Background:** Studying how vaccination hesitancy has changed since the onset of the pandemic and understanding what changed people’s opinions could help improve vaccination rate in susceptible populations with high background refusal rates.

**Methods:** Randomly selected hemodialysis patients in an inner-City Unit were surveyed in 2020 (19 by telephone) and 2021 (31 face to face) about vaccination history and attitudes towards vaccines. In 2020 participants were asked if they would receive a COVID-19 vaccine if available and in 2021 if they had received the vaccine. Respondents who planned to receive the vaccine (2020) or received one or both doses (2021) were counted as VACYES while those who were unsure or refused were classified as VACNO. Respondents were also asked their primary reasons for their choice.

**Results:** The 2021 group had a mean age of 56.1 ± 17.9 yrs., mean time on dialysis was 6.2 ± 7.2 yrs. There were 18 (58%) women and 13 (42%) men, 28 (90%) identified as black. The 2020 and 2021 groups were similar with respect to age, time on dialysis, sex, and race. In 2020, 21% were classified as VACYES compared to 84% of the 2021 sample (p < 0.001). Among VACNO pts the most commonly cited reason was “Safety” (80%). Between vaccinated and unvaccinated patients in 2021, there were no statistically significant differences with respect to age, time on dialysis, sex, race, education, insurance status and presence of diabetes. Among VACYES pts. the three most commonly cited reasons for their choice were “Recommended for people with underlying conditions” (38%), “Trust in healthcare” (45%), and “Safety of the vaccine” (44%).

**Conclusions:** In our inner-city population: 1. Although people in our catchment have a low vaccination rate the majority of the dialysis population studied received the vaccine despite initial hesitancy. 2. Recommendations related to underlying conditions, improved confidence in the safety of the vaccine and trust in healthcare were the most important reasons for acceptance. 3. With vaccine efforts still underway, education programs should continue to focus on stressing the importance in people with underlying conditions, improving patient-provider partnering, and disseminating information regarding vaccine safety in order to improve adherence in our kidney disease patients, in whom almost 20% remain unvaccinated.

TH-PO943

**Hormone Replacement Therapy and COVID-19 Outcomes in Kidney Transplant Recipients Compared With the General Population**  
 Amanda J. Vinson,<sup>1</sup> Alfred J. Anzalone,<sup>2</sup> Makayla Schissel,<sup>2</sup> Evan T. French,<sup>3</sup> Amy L. Olex,<sup>3</sup> Roslyn B. Mannon,<sup>2</sup> National Covid Cohort Collaborative (N3C) <sup>1</sup>Dalhousie University, Halifax, NS, Canada; <sup>2</sup>University of Nebraska Medical Center, Omaha, NE; <sup>3</sup>Virginia Commonwealth University, Richmond, VA.

**Background:** In the non-immunosuppressed (non-IS) population, female sex is protective against adverse COVID-19 (C19) outcomes, possibly due to estrogen-related immunity. Sex-based risk is attenuated in IS kidney transplant recipients (KTRs). Exogenous estrogen is associated with reduced C19 mortality in non-IS post-menopausal females. Here, we aimed to study the impact of estrogen or testosterone hormone replacement therapy (HRT) on C19 outcomes in KTRs compared to the general population.

**Methods:** We studied adult (>45 yrs) KTRs from across the US with C19 from 05-01-20 to 05-12-22, using EHR data from the National COVID Cohort Collaborative. Female and male patients were classified as no HRT, or HRT use in the last 6 months (exogenous systemic estrogens for females; testosterone for males). Using MV cox proportional hazards models and logistic regression, we determined the risk of developing a major adverse renal or cardiac event (MARCE), mortality, and other 90-day post-C19 outcomes. We repeated this analysis in a non-IS control group for comparison.

**Results:** Over the study period, 11,498 KTRs and >1.9M non-IS patients were diagnosed with C19. In non-IS, relative to no HRT use, HRT use in the last 6 months was associated with significantly lower risk of MARCE (Hazard Ratio [HR] 0.54, 95% Confidence Interval [CI] 0.51-0.59, for females; 0.63, 0.56-0.70, for males), mortality (HR 0.45, CI 0.40-0.51, for females; 0.55, 0.45-0.66, for males), and all secondary events for males and females (Figure 1). In KTRs, HRT was not associated with any post-C19 outcome in either males or females; there was a trend towards lower risk in males on HRT vs not on HRT, for most outcomes.

**Conclusions:** HRT was protective against adverse C19 outcomes in older non-IS males and females, but not in KTRs. The modifying effects of IS on the benefits of HRT requires further investigation.

**Funding:** Other NIH Support - AO and EF were supported by CTSA award No. UL1TR002649 from the National Center for Advancing Translational Sciences and the data use was supported by NCATS U24 TR002306 and by the National Institute of General Medical Sciences, U54 GM115458, which funds the Great Plains IdeA-CTR Network. RBM is supported by BMX003272 and the Dr. Dennis Ross Research Fund in Nephrology, University of Nebraska.



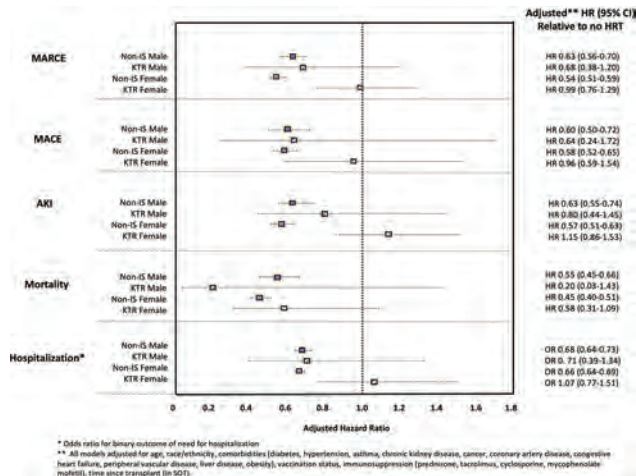

TH-PO944

Treatment With Monoclonal Antibodies Is Safe and Effective for Kidney Transplant Recipients With COVID-19

Yorg Al Azzi, Cindy T. Pynadath, Maria Ajaimy, Luz E. Liriano-Ward, Sanjana Kapoor, Enver Akalin. *Montefiore Medical Center, Bronx, NY.*

**Background:** Monoclonal antibodies have been the mainstay of treatment of COVID-19 in patients at high-risk of mortality from COVID-19. We aimed to study our experience with monoclonal antibodies (mAb) in kidney transplant recipients with COVID-19 at our center.

**Methods:** We reviewed 93 of our kidney transplant recipients who were infected with COVID-19 and received mAb treatment. The mAb infusion received was the one active against the variant that was circulating during that period (39 received either bamlanivimab or casirivimab/imdevimab, 41 received sotrovimab and 13 received bebtelovimab). All patients were on standard immunosuppression with tacrolimus and prednisone, and 88% were on mycophenolate prior to COVID-19 diagnosis, which was subsequently reduced or held for at least 2 weeks.

**Results:** Of the 93 patients, median age was 54 (IQR 44-64), 44% were male, 42% were Hispanic, 36% were African American. 76% have received deceased donor kidney transplant, 94% had history of hypertension, 47% diabetes mellitus, 18% coronary artery disease. All the patients had mild symptoms without initial hypoxia requiring supplemental O2 and only 5 patients (5.4%) were admitted to the hospital. While 33 patients (35%) were unvaccinated at the time of COVID-19 diagnosis, 60 patients (65%) have received at least 2 doses of COVID vaccination at time of diagnosis and of those 27 patients (29%) have received a third dose. There was only one death (1%) in a patient that was re-hospitalized with severe COVID-19. There was no allograft loss. The rate of re-infection after mAb treatment was 6.5%. There was no serious adverse event related to the mAb infusion.

**Conclusions:** Our experience suggests that monoclonal antibodies are a safe therapeutic to reduce the need for COVID-19 related hospitalization in this high-risk kidney transplant population, while one third of those were unvaccinated at the time of COVID-19 diagnosis.

TH-PO945

Decreased Mortality From SARS-CoV-2 in Kidney Transplant Recipients Over the Course of the Pandemic

Yorg Al Azzi, Luz E. Liriano-Ward, Sanjana Kapoor, Maria Ajaimy, Enver Akalin, Cindy T. Pynadath. *Montefiore Medical Center, Bronx, NY.*

**Background:** We aimed to investigate the variation in mortality from SARS-CoV-2 infection in kidney transplant recipients

**Methods:** Between March 16, 2020 and May 4, 2022, 537 patients were diagnosed with SARS-CoV-2 infection by RT-PCR.

**Results:** 59% were male, median age 58 (IQR: 45-67), predominantly Hispanic (51.2%) and African American (29%). 75.4% received a deceased-donor renal transplant, 55% received anti-thymocyte induction. Most patients were on triple immunosuppression (96% on calcineurin inhibitors, 87% on anti-metabolite, and 99% on prednisone). While the mortality rate was 37% (47/128) during first peak between March 16 and April 30, 2020, it has significantly decreased to 11% (7/61) from May 1, 2020 to end of December 2020 with social distancing and use of facemask. Between January 1, 2021 and November 5, 2021 with use of vaccination and monoclonal antibodies, the mortality rate further decreased to 7.7% (10/129). Between November 6, 2021 till May 4, 2022 which corresponds to the period when the Omicron variant and subvariants are prevalent, the mortality rate was 5.5% (12/219). Among those diagnosed during the period when Omicron was prevalent, 188/219 (85.8%) have received 2 doses of COVID vaccine and 82/219 (37.4%) have received a third dose. Since the beginning of use of monoclonal antibodies, 93 patients received a combination of casirivimab/imdevimab when initial SARS-CoV-2 variants were dominant and sotrovimab then bebtelovimab during the period of Omicron and its subvariants. Only one death occurred in patients who received

monoclonal antibody treatment and that patient was hospitalized for severe COVID-19. We identified 23 re-infections. Most of re-infected patients have already received at least 2 doses of COVID vaccine but only 5 received a third dose. None of the re-infected patients was hospitalized and none of them died.

**Conclusions:** In summary, mortality from SARS-CoV-2 infection in kidney transplant recipients has significantly decreased over time. This could be explained by initial exposure to higher viral load due to lack of personal protection and social distancing. However, since the judicious use of monoclonal antibodies and vaccination, in addition to social distancing protocols and use of facemask, the mortality in kidney transplant recipients has decreased over time.

TH-PO946

The Safety Profile and Impact of Remdesivir on Renal Function and Outcome in COVID-19 Infected Renal Allograft Recipients: A Retrospective Cohort Study From a Tertiary Care Hospital in Western India

Mohan P. Patel,<sup>1</sup> Jitendra Goswami,<sup>2</sup> *Apollo Specialty Hospitals Pvt Ltd, Nashik, India;* <sup>2</sup>*Manipal Hospitals, Jaipur, India.*

**Background:** Severe acute respiratory syndrome coronavirus 2 (SARS-CoV2) infection has extremely impacted the transplant population. Remdesivir (RemD) has shown some promising results in coronavirus disease (COVID-19) pandemic though with low certitude. Literature in kidney transplant recipients (KTR) were still lacking at the time of ongoing pandemic situation.

**Methods:** This was a retrospective cohort of 52 moderate to severe COVID-19 positive KTR in a single center who received RemD as a part of COVID-19 management. No dose adjustments were done. The outcomes were measured as acute kidney injury (AKI) recovery; liver function tests abnormalities, other side effects; graft loss and all-cause mortality.

**Results:** The median (inter-quartile range) age of presentation was 47 (25-56) years. The duration from onset of symptoms to RemD initiation was 5 (4-9) days. Thirty seven (71.2%) cases received RemD on the day of admission. Thirty-nine (75%) cases were on oxygen support upon initiation of RemD. Thirty-two (61.5%) cases had acute kidney injury on admission. The median baseline, admission, and 28-day follow-up serum creatinine of the cohort were 1.5 (1.1-2.0), 2.4 (1.4-3.2), and 1.6 (1.04-2.2) mg/dl, respectively. A total of 12(23%) cases died in the study with 1 (1.9%) graft loss. All those cases that died were on oxygen therapy at the time of initiation of RemD. No significant liver dysfunction or any other major adverse events with the drug were observed.

**Conclusions:** RemD therapy is safe and clinically feasible in renal allograft recipients as seen in our cohort. Larger randomized clinical trials should be conducted to further explore the efficacy in renal allograft recipients.

TH-PO947

COVID-19 Outcomes in Kidney Transplant During in the Period of Omicron Predominance

João F. Bernardo, Sara Gonçalves, Natacha Rodrigues, Noélia L. Santos, Joao A. Goncalves, Fernando Abreu, Marta R. Neves, Alice Santana, Jose A. Lopes, Iolanda Godinho. *Centro Hospitalar Universitario Lisboa Norte EPE, Lisboa, Portugal.*

**Background:** In 2022' first trimester the Omicron SARS-COV-2 variant (OV) was the most prevalent in Portugal. OV is associated to greater transmissibility and less severe disease in immunocompetent patients but less is known about the clinical characteristics of the OV in immunosuppressed patients, namely in kidney transplant recipients (KTR). The authors aim to characterize and compare the clinical characteristics of KTR infected during SARSCOV2 Omicron and Delta wave.

**Methods:** Single center retrospective cohort study of KTR (n=675) to analyze the clinical outcomes of SARS-COV-2 infection throughout the epidemic waves: June-November 2021 - Delta predominant wave (DPW); January-March 2022 - Omicron predominant Wave (OPW). Data were collected from electronic clinical records. Continuous variables were compared using t student tests and categorical variables with Chi-square tests.

**Results:** SARSCOV2 infection incidence in the KTR was significantly higher during the OPW than during the DPW (DPW 10.7% vs OPW 3.7%, p<0.001). Most patients had booster of SARSCOV2 vaccine at the time of the diagnosis of SARS-COV-2 infection (DPW 88.8% vs OPW 91.6%, pns). Patients infected during OPW had lower hospitalization rates (OPW 20.8% vs DPW 44.0%, p0.024), less need for invasive ventilation (OPW 4.1% vs DPW 24% p0.003), lower rates of admission to Intensive Care Unit (ICU) (OPW 4.1% vs DPW 24% p0.003) and lower mortality rates (OPW 5.6% vs DPW 24.0%, p0.009). In hospitalized patients, respiratory failure rates were similar between both waves (OPW 81.9% vs DPW 81.8%, pns) and there was similar percentage of lung parenchyma involvement as determined by computed tomography scan (parenchymal involvement> 50%: OPW 53.4% vs DPW 63.5%, pNS). Although not statistically different, there was a higher prevalence of acute kidney graft injury at hospital admission during the OPW (OPW 53.3% vs DPW 18.2%, pns).

**Conclusions:** OV was associated to higher infection rates but less severe respiratory disease, lower admission to the ICU and lower mortality rates than Delta SARSCOV2 in KTR. Nonetheless severe pulmonary involvement occurred in a few cases and mortality seems to be higher than in the general population. Thus, preventive strategies of OV infection in KTR should go beyond vaccination.

TH-PO948

**Senescent Lymphocyte Subsets Exhibit an Unexpected Advantageous Effect in the Response Against SARS-CoV-2 Vaccination in Dialysis Patients**

Georgios Lioulios, Asimina Fylaktou, Ioannis Tsochnikas, Panagiotis Giamalis, Aliko Xochelli, Michalis Christodoulou, Aikaterini A. Papagianni, Maria J. Stangou. *Geniko Nosokomeio Thessalonikes Ippokrateio, Thessaloniki, Greece.*

**Background:** Vaccination against SARS-CoV-2 is a potent preventive tool against Covid-19. However, response to vaccination vary depending on comorbidities. This study evaluates clinical and immunological factors affecting humoral response of End-Stage Renal Disease(ESRD) patients to BNT162b2 Vaccine.

**Methods:** Humoral immunity was evaluated in 54 ESRD patients, by serum levels of anti-receptor-binding-domain (RBD) and neutralizing antibodies (Nab), measured by CLIA, 30 (T1), 60 (T2) and 120 (T3) days, after the second vaccine dose. Results were correlated to baseline patients' T and B-lymphocyte subpopulations as determined by flow cytometry.

**Results:** Proportion of seroconverted patients based on Nab titer was diminished from 83.3%(T1) to 53.7%(T3), in three months. Age was negatively correlated to Nab at T1 and T2 (T1:R=-0.334, p=0.027, T2:R=-0.344, p=0.022). Patients on hemodiafiltration had higher Nab titers at T3. Presence of diabetes was associated with lower response rate, as 9/11 diabetics compared to 16/43 non-diabetics lost seroconversion at T3. Univariate analysis revealed a strong positive correlation of naïve CD4 T-lymphocyte population with RBD at T1(R<sup>2</sup>=0.199, p=0.015) and with Nab titer at T3(R<sup>2</sup>=0.645, p<0.001), while no association was shown with naïve CD8 T-lymphocytes. Nab titers at T3 were significantly correlated with late differentiated CD4 T-lymphocytes(R<sup>2</sup>=0.56, p<0.001) and EMRA CD8 T-lymphocytes(R<sup>2</sup>=0.156, p=0.017). Finally, RBD levels had a significant positive correlation with naïve, and negative with memory B-lymphocyte count at T3(R<sup>2</sup>=0.147, p=0.031, R<sup>2</sup>=0.159, p=0.039, respectively).

**Conclusions:** Age, diabetes mellitus and hemodialysis prescription have a strong impact to response to vaccination. T and B-lymphocytes phenotype are major determinants of humoral response potency to COVID vaccination with BNT162b2, in ESRD patients.

TH-PO949

**ESKD and Incidence and Outcomes With COVID-19: A 2-Year Review in US Veterans**

Mariana Garcia-Touza,<sup>1</sup> Vikas Singh,<sup>1</sup> Aditi Gupta,<sup>2</sup> Varun Chandra Boinpelly,<sup>1</sup> Ram Sharma,<sup>1</sup> Rishi Sharma,<sup>3</sup> Dana Hawkinson,<sup>2</sup> Virginia J. Savin,<sup>1</sup> Mukut Sharma,<sup>1</sup> Thomas Wiegmann.<sup>1</sup> VAMC <sup>1</sup>VAMC, Kansas City, MO; <sup>2</sup>KUMC, Kansas City, KS; <sup>3</sup>UMKC, Kansas City, MO.

**Background:** The COVID-19 pandemic has greatly impacted the global community. About 800,000 patients in the United States have ESKD, hence it is important to understand its interaction [WT(1) with COVID-19.

**Methods:** We used the Veterans Affairs (VA) COVID-19 resource data base to examine the incidence and outcomes of ESKD (CKF2yrs) with COVID-19 in US Veterans. The database included standard hospital data, administrative and clinical records from VA and non-VA sources from March 2020 to April 2022. We examined the effect of basic demographic and common risk factors on all-cause mortality, and other outcomes (Table). Statistical analysis, frequency distributions, ODDS Ratios (OR) used SAS (Enterprise guide 7.1).

**Results:** The total study population consisted of 1,994 533 Veterans, and 27.9% of them (n=557,208) tested positive for COVID-19 (40% Alpha, 20.4 % Delta, 39.6% Omicron). Age, hypertension, diabetes mellitus type 2, Smoking status, Gender or Race had little effect (OR 0.86 – 1.01) while body mass index had moderate effect (OR 1.27) on incidence. ESKD was also increased significantly (OR 1.2). There were 7942 ESKD patients with 7452 on dialysis tested positive for COVID-19. Common risk factors were more prevalent in the ESKD cohort (OR age 5.5, male sex 4.6, hypertension 4.9, and diabetes 7.9) while the effect of BMI was lost (OR 0.63). Propensity matching was used for these conditions to isolate the effect of ESKD on outcomes. ESKD was associated with increased mortality and morbidity (Table). Mortality was reduced by 30% with Omicron.

**Conclusions:** ESKD in Veterans is associated significantly with increased of COVID-19 and its variants, higher rates of ICU admission, ventilator use, oxygen need, ER visits, readmission and all-cause mortality.

**Funding:** Veterans Affairs Support

Variable	Outcome	Control		ESKD		ODDS	p-value
		N	%	N	%		
Death	Alive	5987	90.88	4735	71.87	3.90	<.0001
	Dead	601	9.12	1853	28.13		
Hospital	no	5344	81.12	3728	56.59	3.30	<.0001
	Admit	1244	18.88	2860	43.41		
ICU	no	6209	94.25	5496	83.42	3.26	<.0001
	Admit	379	5.75	1092	16.58		
Ventilator	no	6487	98.47	6272	95.2	3.24	<.0001
	yes	101	1.53	316	4.8		
Pneumonia	no	6580	99.88	6567	99.68	2.63	0.0157
	yes	8	0.12	21	0.32		
OxygenLowFlow	no	5648	87.73	4343	67.41	3.46	<.0001
	yes	790	12.27	2100	32.59		
OxygenHighFlow	no	6151	95.6	5810	90.7	2.23	<.0001
	yes	283	4.4	596	9.3		
Emergency Dept	no	4019	61	3166	48.06	1.69	<.0001
	yes	2569	39	3422	51.94		
Readmission	no	6289	97.7	5824	90.67	4.37	<.0001
	yes	148	2.3	599	9.33		

TH-PO950

**Outcomes of Kidney Transplant Recipients in Singapore With COVID-19 Infection With Delta and Omicron Variants**

Matthew D'Costa, Hershara K. Sran, Emmett Tsz Yeung Wong, Anantharaman Vathsala. *National University Hospital, Singapore, Singapore.*

**Background:** Kidney transplant recipients (KTR) are at higher risk for breakthrough COVID-19 infections and progression to severe disease. Herein, we compare the outcomes of KTR infected with the Delta and Omicron variants.

**Methods:** We performed a retrospective, single-centre study of all SARS-CoV-2-infected KTR confirmed by PCR from 17/09/21 to 30/04/22. At diagnosis, anti-metabolite doses were halved with further reductions of immunosuppression with increasing disease severity. Treatment for KTR not requiring supplemental oxygen (SuppO2) on admission was guided by SARS-CoV-2 spike antibody (SpAb), Roche® Cobas SARS-CoV-2-S assay. Sotrovimab 500mg IV was given if SpAb<100 U/mL. With community emergence of Omicron subvariant BA.2, sotrovimab was replaced by tixagevimab/cilgavimab (EVUSHELD™) 600mg IM in KTR with SpAb<250 U/mL or remdesivir if SpAb>250 U/mL. KTR with SuppO2 were treated with dexamethasone +/- remdesivir and immunomodulator therapy (baricitinib or tocilizumab). Characteristics and outcomes between KTR with Delta and Omicron were compared.

**Results:** Clinical characteristics and outcomes are summarized in Table 1. Baseline demographics were similar between groups. Vaccination rates increased over time in concert with government vaccine programs and communications by our team. KTR with Omicron had higher vaccination rates, higher likelihood of SpAb>250 U/mL, and were less likely to have AKI, SuppO2, ICU stay, and mortality (p<0.05 for all). Of 16 KTR with Omicron with SuppO2, 5 were unvaccinated and only 1/16 had SpAb>250 u/mL.

**Conclusions:** Severe disease was less frequent in KTR with Omicron likely due to improved vaccination rates, higher SpAb, and virus characteristics. However, KTR remain at risk for severe disease especially if unvaccinated or if SpAb is low.

**Table 1: Baseline Clinical Characteristics and Outcomes for Kidney Transplant Recipients with COVID-19 Infection**

Demographics of Study Population		
	Delta N=37	Omicron BA.1 and BA.2 N=154 (2 reinfections)
N (#) or mean +/- SD		
Male sex	25 (68%)	78 (48%)
Ethnicity		
- Chinese	24 (65%)	108 (66%)
- Malay	8 (22%)	31 (19%)
- Others	5 (14%)	25 (15%)
Age, Years	58.7 +/- 9.9	54.1 +/- 12.8
- >65 years	13 (35%)	32 (20%)
Deceased Donor Transplant	21 (57%)	66 (40%)
Interval post-Transplant, Years	10.9 +/- 7.4	10.0 +/- 7.3
COVID-19 Related Characteristics		
<b>SARS-CoV-2 Vaccination</b>		
- unvaccinated, <2 mRNA vaccines, or immunization with non-mRNA vaccines	8 (22%)*	12 (7%)*
- 2 or more mRNA vaccines	29 (78%)	152 (93%)
- 3 or more mRNA vaccines**	9 (24%)	146 (89%)
Interval from Symptom Onset to Admission, Days	3.1 +/- 2.3	3.0 +/- 2.7
- Day of illness >3	10 (24%)	43 (23%)
- Day of illness >5	4 (8%)	19 (9%)
ISARIC-4C Score at Admission	6.7 +/- 3.7	4.7 +/- 2.8
- Score >= 9	7 (19%)	10 (5%)
Spire Ab <250 U/mL***	33 (89%)	81 (58%)
<b>Monoclonal antibody treatment</b>		
Sotrovimab	27 (73%)	52 (20%)
Casirivimab/Imdevimab	2 (5%)	0
Tixagevimab/cilgavimab (EVUSHELD™)	0	32 (20%)
- Treatment		25 (15%)
- Pre-exposure prophylaxis****		5 (3%)
- Post-exposure prophylaxis****		2 (1%)
Outcomes		
Acute Kidney Injury (AKI)	14 (38%)	30 (18%)
- AKI requiring dialysis	5 (3%)	1 (0.6%)
Required Supplemental Oxygen	14 (38%)	16 (10%)
Required Intensive Care Stay	10 (27%)	10 (6%)
Mortality	8 (22%)	2 (1%)

\*5 were unvaccinated, 3 received 1 mRNA vaccine  
 \*\*5 were unvaccinated, 1 received 1 mRNA vaccine, and 6 received 22 inactivated virus vaccines  
 \*\*\*11 unknown/not obtained at time of infection or were unvaccinated  
 \*\*\*\* EVUSHELD™ 300mg IM was given as pre-exposure prophylaxis if no prior history of infection or post-exposure prophylaxis if exposed to a household contact with COVID-19.

**TH-PO951**

**Characteristics of Vaccinated Kidney Transplant Recipients Requiring Hospitalization for COVID-19 Infection**

Ali W. Rizvi, Michael Turk, Laith Alhuneifat, Naman Gupta, Aaisha Shah, Taber Rana, Ramya Gutta, Katherine Barnett, Shane Mealy, Alisha Sharma, Omar Osman, Kalathil K. Sureshkumar. *Allegheny Health Network, Pittsburgh, PA.*

**Background:** Studies have shown suboptimal immunological response to COVID-19 vaccination in kidney transplant recipients (KTRs). We aimed to describe specific characteristics of vaccinated KTRs who required hospitalization for COVID-19 infection.

**Methods:** In this descriptive study utilizing chart review, we identified KTRs who were hospitalized for COVID-19 infection between March 2020 and January 2022 within our integrated health network. Demographic characteristics were identified for KTRs who received ≥2 COVID-19 vaccine doses prior to hospitalization.

**Results:** Among 114 KTRs admitted to the hospital with COVID-19 infection, 44 (39%) had received 2 or more vaccine doses prior to hospitalization including 35 patients who received 2 vaccines and 9 who received >2 vaccines. Vaccinated patients requiring hospitalization were generally older with male predominance. Prevalent comorbidities included overweight/obesity, hypertension, and diabetes. Among these patients, 18% required dialysis and 90-day mortality was 20% (Table).

**Conclusions:** Despite receiving at least 2 doses of preventative vaccination, many KTRs developed COVID-19 infection requiring hospitalization. Our findings are consistent with studies showing reduced antibody and cell mediated response to vaccination in KTRs. Every effort should be made to educate and encourage this vulnerable population about measures to prevent infection, especially vaccination with subsequent booster doses.

Baseline Characteristics	Total (n=44)
Age (years)	61.6 ± 12.2
Body mass index	29.1 ± 5.2
Sex: Female	19 (43%)
Race: White, Black, Other	29 (66%), 12 (27%), 3 (7%)
Hypertension, Diabetes	41 (93%), 20 (46%)
CAD, CHF	15 (34%), 12 (27%)
COPD	6 (14%)
Immunosuppression: Tacrolimus, MMF, Steroids	41 (93%), 36 (82%), 25 (57%)
Donor type: Deceased	33 (75%)
Outcomes	
90-day mortality	9 (20%)
Need for new dialysis	8 (18%)
Length of Stay (days)	8.3 ± 9.7

CAD=coronary artery disease; CHF=congestive heart failure; COPD=chronic obstructive pulmonary disease

**TH-PO952**

**Management and Course of the SARS-CoV-2 Pandemic in a German Dialysis Network**

Thilo Krueger, Werner Kleophas. *DaVita Clinical Research Deutschland GmbH, Düsseldorf, Germany.*

**Background:** The global Covid-19 pandemic is a particular risk for dialysis patients, the Covid-associated mortality of dialysis patients is known to be higher than that of the general population. From the DaVita network, we present the course of SARS-CoV-2 infections from 65 German centers with around 3,300 active dialysis patients and approximately 1,500 employees.

**Methods:** To reduce the risk of infection, a triage system was introduced, regulating how dialysis patients are treated in the centers. The triage is based on items like clinical symptoms, swab results and contact with confirmed positive individuals and determines further dialysis in isolation. Point-of-care antigen tests were introduced early and routinely used as a screening measure for both dialysis patients and medical staff. Further to general hygiene measures, a traffic light system was implemented depending on the local incidence rate. This provided for further measures such as a ban on visits, cohort isolation, area care and isolated trips to dialysis. The local vaccination status was also recorded in this system.

**Results:** In general, the course of incidences among patients reflects that of the general population. We recorded the peak incidence of SARS-CoV-2 at the end of 2021. The cumulative total number of patients who tested positive is currently 1545 cases, which corresponds to a rate of around 48% of patients (officially 30.4% in Germany as of April 2022). With regard to the infection rate per center, there are marked differences within the network, ranging from 1% to 65%. The mortality rate from SARS-CoV-2 among dialysis patients who tested positive was 10.2% as of April 2022 (158/1545; currently around 0.5% across Germany). Since 2021, a significantly reduced Covid-associated mortality rate was noticed decreasing continuously from around 23% in August 2021 to 1.5% in April 2022. The infection rate of the staff was around 37.1% (587/1583) in the network. The rate of dialysis patients with at least three vaccinations is currently at 84.9%.

**Conclusions:** In summary, the measures taken were able to effectively control for the occurrence of infection within the network. The higher incidence rate of Covid infections amongst patients may be due to more frequent routine testing than in the general population. The markedly decreasing Covid-associated mortality is possibly due to vaccinations and the milder omicron variant.

**TH-PO953**

**Worn Face Mask Testing to Diagnose SARS-CoV-2 Infection in Hemodialysis Patients**

Xiaoling Wang,<sup>1</sup> Ohnmar Thwin,<sup>1</sup> Zahin S. Haq,<sup>1</sup> Zijun Dong,<sup>1</sup> Lela Tisdale,<sup>1</sup> Lemuel Rivera Fuentes,<sup>1</sup> Nadja Grobe,<sup>1</sup> Peter Kotanko,<sup>1,2</sup> *Renal Research Institute, New York, NY; <sup>2</sup>Icahn School of Medicine at Mount Sinai, New York, NY.*

**Background:** Hemodialysis (HD) patients are at increased risk for COVID-19 infection, hospitalization, and mortality. Early COVID-19 diagnosis is thus critical to mitigate SARS-CoV-2 spread and improving patients' health outcomes. Generally, nasopharyngeal (NP) specimens are considered the most sensitive biological samples to diagnose SARS-CoV-2 infections. However, NP swabbing is considered uncomfortable by most patients, and it requires health professionals, thus impacting its cost-effectiveness. In a previous proof-of-principle study, we demonstrated that face masks worn by in-center HD patients can harbor SARS-CoV-2. In this Kidney-X funded study, we determined efficiency of face mask testing by comparing results to saliva specimen collected from same individuals.

**Methods:** Disposable 3-layer masks were provided to each subject at the time of entering the dialysis center. Masks were collected 4 hours after worn. Saliva was collected using Salivette kit at the time of mask collection. RT-PCR based testing were performed using Thermo Fisher COVID-19 Combo Kit (A47814).

**Results:** We collected 179 pairs of saliva/masks, 114 from 42 dialysis staff and patients without recent COVID-19 infection (control group), and 65 from 30 HD patients with COVID-19, diagnosed by NP RT-PCR (COVID-19 group). Patients provided 1 to 7 sample pairs on average 11±8 days (0 to 36) after COVID-19 diagnosis. Thirty-one of the 65 sample pairs were SARS-CoV-2 positive either in the saliva or the mask samples (26 positive saliva; 20 positive masks). Saliva and mask testing sensitivities were 84% and 65% with a mean cycle threshold (CT) of 31.8 and 32.2, respectively. Fifteen pairs tested positive for both worn masks and saliva. Mask and saliva CT values did not differ significantly. Of note, in 5 sample pairs saliva tested negative while masks tested positive. In the control group, all 114 saliva samples tested negative; one mask tested weakly positive, resulting in saliva and mask testing specificities of 100% and 99%, respectively. S gene dropout was observed in all positive samples, indicating Omicron BA.1 infection.

**Conclusions:** While the sensitivity of mask testing is less compared to saliva testing, its operational ease, lack of patient discomfort, seamless repeatability, and lower costs make it a viable option for SARS-CoV-2 screening.

**Funding:** Commercial Support - Fresenius Medical Care, Private Foundation Support

TH-PO954

**Outcomes of COVID-19 in Peritoneal Dialysis: A Multi-Centre Observational Study**

Bhamini Gutty, Jyoti B. Baharani. *University Hospitals Birmingham NHS Foundation Trust, Birmingham, United Kingdom.*

**Background:** Patients with end stage renal failure are not only at high risk of developing Coronavirus disease 2019 (COVID-19) but there are reports of disproportionately severe impact on dialysis patients, with reported short-term mortality of 20% or higher. The aim of this study was to assess the impact of COVID-19 in patients on peritoneal dialysis (PD).

**Methods:** We conducted a retrospective observational study across four hospitals in West Midlands in United Kingdom. We identified a total of 50 patients on PD, 18 years and over, with a positive SARS-COV-2 swab from 1st of January 2020 to 31st of December 2020. Data was analysed using IBM SPSS software. We looked at mortality (7 days, 28 days, 3 months), intensive therapy unit (ITU) admission, ventilation requirement, peritonitis and conversion to haemodialysis.

**Results:** The mean age was 63 years, with higher prevalence in men (66%). 54% were of white ethnicity (46% of Black, Asian and minority ethnic groups). 10 out of the 50 patients (20%) had died within 7 days, 17 (34%) had died within 28 days and 19 (38%) were not alive at 3 months. 3 patients (6%) required ITU admission. 4 patients (8%) received non-invasive ventilation, but none required mechanical ventilation. 4 patients (8%) were converted to haemodialysis. 8 patients (16%) had peritonitis.

**Conclusions:** We found a high risk of short-term mortality in our PD patients who acquired COVID-19 infection. However, more studies are required to establish any causal link between COVID-19 infection in PD patients and high short-term mortality.

**Outcomes of patients on maintenance PD with COVID-19 infection**

<b>n</b>	50
<b>Hospitalization n (%)</b>	30 (60)
<b>Length of hospital stay, days, mean (SD)</b>	15.8 (19.3)
<b>Conversion to haemodialysis n (%)</b>	4 (8)
<b>Peritonitis n (%)</b>	8 (16)
<b>Admission to ITU n (%)</b>	3 (6)
<b>Non-Invasive Ventilation n (%)</b>	4 (8)
<b>Mechanical Ventilation n (%)</b>	0 (0)
<b>Mortality</b>	
Died within 7 days of COVID-19 n (%)	10 (20)
Died within 28 days of COVID-19 n (%)	17 (34)
Died within 3 months n (%)	19 (38)
<b>Cause of Death, n=19</b>	
COVID pneumonia n (%)	12 (63%)
Unknown n (%)	3 (15%)
Infective Endocarditis n (%)	1 (5.3)
GI haemorrhage n (%)	1 (5.3)
Sepsis n (%)	1 (5.3)
Treatment withdrawal for medical reasons n (%)	1 (5.3)

TH-PO955

**Variability in Excess ESKD Patient Mortality Among States During the Pandemic**

Eric D. Weinhandl,<sup>1,2</sup> Jiannong Liu,<sup>1</sup> David T. Gilbertson,<sup>1</sup> James B. Wetmore,<sup>1,3</sup> Kirsten L. Johansen.<sup>1,3</sup> *<sup>1</sup>Chronic Disease Research Group, Minneapolis, MN; <sup>2</sup>Satellite Healthcare, San Jose, CA; <sup>3</sup>Hennepin Healthcare, Minneapolis, MN.*

**Background:** The incidence of death among patients with ESKD in the United States has been significantly elevated during the COVID-19 pandemic, relative to recent historical levels. In the general population, individual states have exhibited markedly variable COVID-19 death rates, possibly reflecting policy decisions concerning pandemic management. However, little is known about regional variability in the excess mortality of ESKD patients. We analyzed excess mortality among both prevalent dialysis and kidney transplant (KT) patients between March 15, 2020, and June 30, 2021.

**Methods:** We analyzed national data extracted from the Centers for Medicare and Medicaid Services (CMS) End Stage Quality Reporting System (EQRS). For each epidemiologic week from week 1 of 2018 to week 26 of 2021, we identified prevalent dialysis and KT patients at the beginning of each week, and the incidence of all-cause death among them during the week. For each combination of state and kidney replacement therapy, we estimated excess mortality during the pandemic (definition: week 12 of 2020 and thereafter), using a logistic regression model of death among patient-weeks, with adjustment for age, sex, race.

**Results:** From 732,063 dialysis patients in 50 states, there were 129,095 pandemic-era deaths; and from 238,265 KT patients in 41 states, there were 11,256 pandemic-era deaths. State-level excess mortality ratios in dialysis patients ranged from 0.96 to 1.34, with 40% of states having ratios significantly greater than 1.1. State-level excess mortality ratios in KT patients ranged from 1.02 to 2.73, with 61% of states having ratios significantly greater than 1.1.

**Conclusions:** States exhibited wide variability in excess ESKD patient mortality, with roughly 3-fold wider variability in prevalent KT patients than in dialysis patients.

**Funding:** NIDDK Support

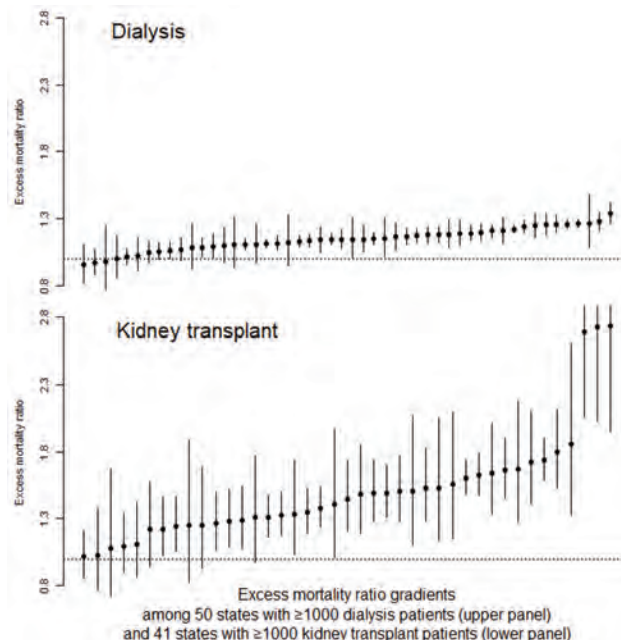

TH-PO956

**Outcomes in Kidney Transplant Recipients With COVID-19 Illness in the Era of Vaccines**

Perola Lamba, Gabriel J. Stryniak, John R. Lee, Thangamani Muthukumar, Thalia Salinas, Deirdre L. Sawinski, Darshana M. Dadhania. *Weill Cornell Medicine, New York, NY.*

**Background:** Kidney transplant recipients (KTRs) are at risk for severe complications from COVID-19 illness due to immunosuppression. Predating COVID-19 vaccines our center reported AKI in 39% & death in 13% of KTRs. Here we describe the impact of COVID-19 on allograft & patient outcomes in KTRs with & without COVID-19 vaccination. We also compare outcomes in KTRs with & without response (SARS-CoV2 spike/anti-S antibody) to COVID-19 vaccine.

**Methods:** This is a retrospective cohort analysis of 142 KTRs identified with COVID-19 illness between 7/1/21 and 2/10/22. We collected data on patient demographics, COVID-19 vaccine doses, anti-S levels & clinical outcomes including graft dysfunction, hospitalization, ICU admission & death.

**Results:** Of 142 KTRs in our cohort, 113 (80%) were fully vaccinated (+/- booster) and 29 (20%) were un or partially vaccinated. 60 of 113 vaccinated KTRs were tested for anti-S levels between COVID-19 vaccination & illness: 68% tested positive and 32% negative for anti-S Ab. Allograft dysfunction & hospitalization were less frequent in fully vaccinated vs unvaccinated KTRs (Fig.1). There was no difference between the two in terms of ICU admission and death (22 vs 18%, p=0.7). Among vaccinated KTRs, there was a trend towards less graft dysfunction in positive vs. negative anti-S (15% vs. 33% p=0.15). No differences were observed between anti-S levels and hospitalization (23% vs 26% p=0.7), ICU admission (11 vs 60% p=0.07) and death (11 vs 20% p=0.65).

**Conclusions:** In our cohort, kidney allograft dysfunction and hospitalization were less common in vaccinated vs unvaccinated KTRs with COVID-19. Additionally, there is a trend towards lower graft dysfunction in those with positive anti-S Ab. No significant differences were observed in death and ICU admissions with vaccination or positive anti-S. Vaccination to COVID-19 and maintaining positive anti-S Ab (with boosters or monoclonal Ab) are important in preventing graft dysfunction and hospitalization following COVID-19.

**Figure 1: Clinical Outcomes in Vaccinated vs. Unvaccinated KT Recipients**

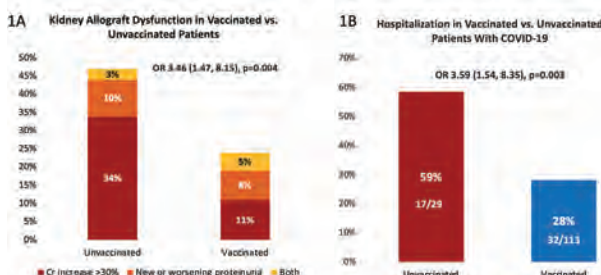

TH-PO957

**COVID-19 Infection in Patients Receiving Kidney Replacement Therapy Under Universal Health Coverage in Thailand**

Siribha Changsirikulchai,<sup>1</sup> Pornpen Sangthawan,<sup>2</sup> Thammasin Ingviya,<sup>3</sup>  
<sup>1</sup>Division of Nephrology, Department of Medicine, Srinakharinwirot University, Nakhonnayok, Thailand; <sup>2</sup>Division of Nephrology, Department of Medicine, Faculty of Medicine, Prince of Songkla University, Songkla, Thailand; <sup>3</sup>Department of Family and Preventive Medicine, Faculty of Medicine, Prince of Songkla University, Songkla, Thailand.

**Background:** The Thai nation has used public health and social health measures to control the spreading of COVID-19 pandemic infection since February 2020. The sample of these measures was identifying the index cases, tracing cases with high-risk contacts, isolating in quarantine sites, vaccination, using face masks, washing hands, and physical distancing. Patients with high mortality risk from COVID-19 would be treated in hospitals. This study aimed to evaluate the incidence and outcomes of COVID-19 infection in patients receiving kidney replacement therapy (KRT) under universal health coverage (UC).

**Methods:** Data of patients who registered with the National Health Security Office Region 4 (NHSO4) to receive peritoneal dialysis (PD), hemodialysis (HD), or kidney transplantation (KT) during January 2020-December 2021 was analyzed. The incidence and mortality rates of COVID-19 in each type of KRT were calculated. The comorbidities and complications which were recorded in the file of the electronic claim to reimburse from the NHSO4 were diagnosed following the ICD-10. The comorbidities and complications which were the risks associated with death in COVID-19 were analyzed. The cost of treatment according to the Diagnosis Related Group (DRG) which was paid back to the hospitals from the NHSO was evaluated.

**Results:** There were 1,744 patients on PD, 1,267 patients on HD, and 35 patients on KT. The incidence, mortality rate, and characteristics of patients with COVID-19 infection in each category of KRT were shown in Table 1.

**Conclusions:** The incidence of COVID-19 infection was highest in patients receiving HD followed by KT and PD respectively. The cost of treatment according to DRG in patients with PD was lower than in those with HD. The mortality was not different among these types of KRT.

Table 1: Incidence, mortality rate, and characteristics of KRT patients with COVID-19 infection

Variable	PD	HD	KT
Total of patients	1744	1267	35
Number (%) of patients with COVID-19	46 (2.6)	132 (10.4)	2 (5.7)
Number (%) of male with COVID-19	27 (58.7)	55 (41.7)	2 (100)
Number (%) of female with COVID-19	19 (41.3)	77 (58.3)	0 (0)
Median (IQR) age at COVID-19 infection	55.2 (22.4)	60.9 (21.5)	53.6 (10.0)
Median (IQR) length of admission (days)	9 (7.8)	12 (7.3)	13.5 (4.5)
Number (%) of death	21 (45.6)	59 (44.7)	1 (50.0)
Number (%) of patients with comorbid diseases			
Diabetes	21 (45.6)	57 (43.2)	1 (50.0)
Cardiovascular disease	8 (17.4)	16 (12.1)	1 (50.0)
Cerebrovascular disease	3 (6.5)	5 (3.8)	0 (0)
Malignancy	0 (0)	2 (1.5)	0 (0)
Airway disease	0 (0)	3 (2.3)	0 (0)
Liver disease	0 (0)	6 (4.5)	0 (0)
HIV infection	0	2 (1.5)	0 (0)
Obesity	0 (0)	2 (1.5)	1 (50)
Psychiatric problem	0	2 (1.5)	0 (0)
Number (%) of patients with complication			
Pneumonia	37 (80.4)	108 (81.8)	2 (100)
Respiratory failure	0	2 (1.5)	0 (0)
Sepsis	7 (15.2)	8 (6.1)	0 (0)
Heart failure	1 (2.2)	8 (6.1)	0 (0)
Fluid overload	0 (0)	4 (3.0)	0 (0)
Median (IQR) cost of treatment according to DRG (not include cost of dialysis) (baht)	13,089.12 (25,099.24)	15,000 (36,962.5)	31,500 (18,000)

TH-PO958

**Patients With ESKD Are Commonly Hospitalized Early During COVID-19 Illness: An Opportunity for Early Intervention**

Daiana R. Moreno, Ritu Seethapathy, Destiny Harden, Qiyu Wang, Nurit S. Katz, Meghan E. Sise. Massachusetts General Hospital, Boston, MA.

**Background:** Antiviral medications such as remdesivir, molnupiravir, and nirmatrelvir/ritonavir are most effective when used early in the course of COVID-19. These medications are authorized for patients with COVID-19 with mild symptoms who are at high risk for severe disease. ESKD is among the strongest risk factors for mortality from COVID-19. As the ESKD population is highly linked to care, we hypothesized that they are more likely to be admitted to the hospital within five days of symptom onset when antiviral medications are maximally effective.

**Methods:** We identified patients with ESKD on dialysis who were admitted to Massachusetts General Hospital with COVID-19 by using dialysis records and manually extracted the date of symptom onset as shown in the admission note. Primary outcome was the proportion of patients with ESKD admitted within 5 days of symptom onset; secondary outcome was the risk of respiratory failure within 90 days among the early presenters.

**Results:** After implementing the exclusion criteria shown in Figure 1, we included 99 patients with community-acquired COVID-19 admitted between March 2020 and Jan 2022. Thirty patients (30%) remained asymptomatic during their hospitalization. Among patients with symptomatic COVID-19, 56 (81%) were admitted within 5 days of symptom onset; among them, 17 developed respiratory failure within 90 days (30%) and 11 died from respiratory failure (20%). (Figure 1)

**Conclusions:** We found that most patients with ESKD on dialysis admitted for symptomatic COVID-19 presented within 5 days of symptom onset. We conjectured that because of this, inpatient antiviral therapy may be more effective in the ESKD population than in a typical inpatient population with COVID-19 that presents later in the disease course. Given the high risk of respiratory failure in ESKD population who developed COVID-19, improved treatment strategies are urgently needed.

**Funding:** Commercial Support - Gilead

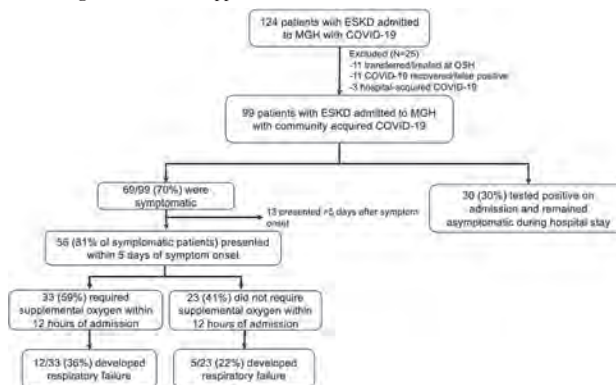

TH-PO959

**Paradoxical Protection of Keeping an In-Center Short Daily Hemodialysis Schedule During the First 2 Years of COVID-19 Pandemic**

Istenio Pascoal, Adolfo Simon, Luiza Lins, Kelia Xavier, Vilber Bello, Juliane Lauer. Centro Brasiliense de Nefrologia Dialise, Brasilia, Brazil.

**Background:** Covid-19 Pandemic imposed several restrictions to the general population, including stay at home guidance. Most dialysis patients are challenged by mandatory transportation and thrice-weekly long stays in their Units. Home dialysis and/or reduction of hemodialysis frequency have been promoted to mitigate the spread. Notwithstanding, we report the contrasting experience of keeping a long-term in-center short daily hemodialysis program while enforcing protective measures and an unique transportation arrangement.

**Methods:** From March 16, 2020 to March 15, 2022 dialysis patients who were symptomatic, hospitalized for other reasons or had contact with confirmed cases of Covid-19 were tested for Sars-Cov-2 by RT-PCR. We examined outcomes of those who tested positive. Eighty private-insured patients (48M; 62.1±14.3yrs) on in-center short daily hemodialysis (6-7x/wk; 115.4±11.2min; single-use high-flux dialyzer) were studied. Round-trip transportation was provided by a fleet of 12 dedicated minivans. Eating during dialysis was abolished and isolation room for confirmed or suspected cases was adopted. A 3-dose vaccination started in January 2021 and covered all patients and staff members.

**Results:** Forty out of 80 patients (50%) contracted Covid-19 (21M; 60.2±16.8yrs) and four were reinfectd. Thirty of the 44 infections were symptomatic (68%) and 14 asymptomatic (32%). Ten of the 40 infected patients were hospitalized (25%), 1 required mechanical ventilation and died, while 39 recovered well (5% fatality rate pre-vaccination, 0% post-vaccination). Over the 2 years dialysis mortality and transplantation rates were 5.6% (9/80 patients). Average dialysis frequency was 5.9 sessions/week. Our 100-member staff presented 33 Covid-19 infections.

**Conclusions:** During the two years of Covid-19 Pandemic we kept our in-center short daily hemodialysis schedule as usual while applied comprehensive transportation and restrictive measures. There was one death attributable to Covid-19, in sharp contrast with the death toll on dialysis population worldwide (20-30% fatality rate). This benign

course may reflect a combination of strict prophylactic discipline (limiting transmission among patients and staff) with a potential inflammatory mediators removal by high-frequency high-flux hemodialysis (perhaps preventing cytokine storm).

**TH-PO960**

**Opportunistic Infections in Post Renal Transplant Patients Treated With Dexamethasone for COVID-19**

Benjamin G. Morrison, Hasan Fattah. *University of Kentucky, Lexington, KY.*

**Background:** Dexamethasone, a common treatment regimen for COVID-19, may mitigate inflammation-mediated lung injury in immunocompromised patients who have COVID-19 with severe disease. However, it comes with the cost of further suppressing the immune system, increasing the risk for opportunistic infections. This study looked at various post renal transplant patients on immunosuppression who contracted COVID-19, their treatment with or without dexamethasone, and their subsequent development of opportunistic infections that necessitated readmission.

**Methods:** We identified index hospitalization for COVID-19 amongst kidney transplant recipients between 2020 and 2022 at our institution. Local electronic medical record review was utilized for demographics, vaccination status, readmissions for opportunistic infections, and dexamethasone treatment characteristics for COVID-19 infection.

**Results:** Of the 33 patients included in the analyses, 14 (42.4%) were readmitted at least once for opportunistic infections. Those readmissions included 5 cases of viral infection, 14 bacterial infection, and 4 fungal infection. For treatment of COVID-19, 18/33 patients (54.5%) received at least 1 dose of dexamethasone. Of the 18 patients given dexamethasone, 8 (44.4%) were found to be among the 14 readmitted patients with opportunistic infection. Of the 33 patients, 25 (75.8%) had received at least one dose of the COVID-19 vaccine at the time of COVID-19 diagnosis. Amongst the 14 readmitted patients, 8 (57.1%) had received at least one dose of COVID-19 vaccine at time of COVID diagnosis and 6 (42.9%) had not received any vaccine.

**Conclusions:** In this single cohort, readmission rate after COVID-19 hospitalization for kidney transplant recipient was 42%, higher than the average rate for all COVID-19 cases readmission rate (12% per CDC, 27% per National Veterans Affairs). Glucocorticoid use should be done with extreme caution in immunocompromised patients due to the increased risk for opportunistic infections. Opportunistic infections were associated with corticosteroids use in 44% of COVID-19 patients in this group. Another risk factor for opportunistic infection following COVID-19 in immunosuppressed patients may be vaccination status at the time of COVID-19 diagnosis.

**TH-PO961**

**Diagnostic Value of the COVID-GRAM and 4C Mortality Score in Predicting Critical Events Among ESRD Patients With COVID-19**

Kate Nicole T. Yu. *National Kidney and Transplant Institute, Quezon City, Philippines.*

**Background:** Around 800 ESRD patients from March 2021 to July 2021 were affected by COVID-19 in a tertiary specialized hospital in the Philippines, with a case fatality rate of 2.3%. These subset of patients have one of the highest morbidity and mortality among others. That is why numerous tools such as the COVID GRAM and 4C Mortality Score were formulated to predict the critical events in COVID-19 patient and may hopefully be useful for ESRD patients as well.

**Methods:** This is a retrospective cohort design to determine the diagnostic value of COVID GRAM and Mortality 4C score in predicting critical events. Participants were end stage renal disease (ESRD) patients infected with COVID19 seen at the National Kidney and Transplant Institute from March 2020 to July 2021. Chart review was done from August 2021 to October 2021. **Inclusion Criteria:** Age ≥19 years old Admitted patients for at least 24hrs COVID-19 confirmed via RT PCR or GeneXpert with nasopharyngeal or oropharyngeal swab, provided that: Testing performed in an accredited institution ESRD Filipino patients already on RRT or for RRT initiation **Exclusion Criteria:** Kidney transplant patients Acute kidney injury needing renal replacement therapy Incomplete data on 4C mortality and COVID GRAM

**Results:** This study included a total of 97 patients (41 in the critical group, 56 in non-critical group). Both COVID GRAM and 4C mortality score showed high levels of discriminative ability, accuracy, sensitivity, specificity. The discriminative ability or AUC of both COVID GRAM and 4C Mortality Score were at 0.93 and 0.95, respectively. Overall accuracy was at 93.81% and 96.91%.

**Conclusions:** Even with the advent of vaccination, COVID 19 remains to be a leading cause of morbidity and mortality in our country and has cost the Philippine government \$30.72B. Therefore, proper allocation of the budget and expenses remains to be a priority. With both COVID GRAM and 4C Mortality, these tools can aid physicians in decision making especially for those at high risk of experiencing a critical event and maybe be used to determine if patients need to be admitted or can be managed at an outpatient basis.

**Funding:** Government Support - Non-U.S.

**TH-PO962**

**Neutralising Antibodies Against SARS-CoV-2 and Variants of Concern in In-Centre Haemodialysis Patients in the United Kingdom**

Edward Carr,<sup>1</sup> Rupert Beale.<sup>1,2</sup> NAOMI Consortium, Crick COVID Immunity Consortium, Legacy Study Consortium <sup>1</sup>The Francis Crick Institute, London, United Kingdom; <sup>2</sup>Royal Free Hospital, London, United Kingdom.

**Background:** Haemodialysis patients have significant morbidity and mortality from SARS-CoV-2 infection. In-centre haemodialysis (IC-HD) patients are at particular risk at times of high community transmission as they must attend healthcare settings for life-preserving treatment sessions. In the UK, adenoviral or mRNA vaccines were used for doses 1 and 2 in IC-HD. mRNA vaccines were used for subsequent doses. IC-HD patients are not reported by the phase 3 vaccine trials. Given the coalescence of uraemia, immunosuppressive primary renal diseases and treatments, together with prior experience using other vaccines (for example influenza), we anticipated that IC-HD patients would have an attenuated response to SARS-CoV-2 vaccination.

**Methods:** As a UK-wide consortium, we have used a high-throughput live virus microneutralisation assay to determine the ability of IC-HD patient sera to neutralise ancestral SARS-CoV-2 and variants of concern (VOCs). Ancestral binding Spike antibodies were also assessed by an ancestral S1 ELISA and by a flow cytometry method with full-length trimeric Spike.

**Results:** We will report IC-HD neutralisation titres after fourth doses and to the newest VOCs, BA.4 and BA.5. Neutralising responses to the first three doses in IC-HD patients are already published by the consortium (Carr *et al.* The Lancet 2021 and 2022). We will show heterogeneity in the cross-neutralising ability of IC-HD patient sera, and explore how population-level ancestral binding antibody correlations neutralisation titres might not generalise to the individual patient.

**Conclusions:** Three doses were required for most IC-HD patients to generate neutralising titres against Delta and Omicron BA.1. Further doses are likely required to maintain high serological protection in this vulnerable group of renal patients.

**Funding:** Private Foundation Support, Government Support - Non-U.S.

**TH-PO963**

**COVID-19 Mortality in Kidney Transplant Recipients: Analysis of Risk Factors**

Michael Turk, Laith Alhuneafat, Ali W. Rizvi, Naman Gupta, Katherine Barnett, Ramya Gutta, Shane Mealy, Tabeer Rana, Aaisha Shah, Alisha Sharma, Omar Osman, Kalathil K. Sureshkumar. *Allegheny Health Network, Pittsburgh, PA.*

**Background:** Mortality rates for COVID-19 infection vary widely. Immunocompromised patients in general have worse outcomes. We aimed to evaluate kidney transplant recipients (KTRs) who were admitted for COVID-19 infection and investigate patient specific factors or comorbidities that may have influenced mortality rates.

**Methods:** In this retrospective study, we identified KTRs who developed COVID-19 infection between March 2020 and January 2022 within our integrated health network. Through chart review, patient characteristics were collected and stratified by 90-day mortality.

**Results:** Out of 114 KTRs hospitalized with COVID-19 infection, 24 (21.0%) died during admission, and another 7 died within 90 days of admission bringing total 90-day mortality to 31/114 (27.2%). Among the 114 hospitalized patients, 53 (46.5%) had received at least one prior COVID-19 vaccine dose including 35 who received two doses and 9 who received ≥3 doses. KTRs who survived following COVID-19 hospitalizations were significantly younger and were more likely to be vaccinated (Table).

**Conclusions:** Approximately 1 out of 4 KTRs admitted for COVID-19 infection died within 90-days. Older age was a mortality risk factor and vaccination conferred protection against mortality in these immunocompromised patients. Our study highlights the importance of vaccination in these patients. Relatively small sample size likely limited identification of other potential risk factors for mortality in our analysis.

Patient characteristics

Variables	Overall (n=114)	Survived (n=83)	Deceased (n=31)	p-value
Age	61.2 ± 11.6	58.7 ± 11.0	68.0 ± 10.5	<0.001
Female sex	46 (40%)	30 (36%)	16 (52%)	0.13
White race	72 (63%)	53 (64%)	19 (61%)	0.41
Black race	37 (33%)	27 (33%)	10 (32%)	0.41
Body mass index	29.9 ± 7.2	30.3 ± 6.7	28.7 ± 8.6	0.28
Hypertension	106 (93%)	76 (92%)	30 (97%)	0.33
Diabetes	58 (51%)	41 (49%)	17 (55%)	0.61
CAD	35 (31%)	23 (28%)	12 (39%)	0.26
Donor type: Deceased	83 (73%)	57 (69%)	26 (84%)	0.11
Donor type: Living	31 (27%)	26 (31%)	5 (16%)	0.11
IS regimen: MMF	84 (74%)	59 (71%)	25 (81%)	0.30
IS regimen: Steroids	59 (52%)	45 (54%)	14 (45%)	0.39
Vaccinated (at least 1 dose)	53 (46%)	43 (52%)	10 (32%)	0.06

CAD=coronary artery disease; IS= immunosuppression

FR-PO001

**Effect of the Seraph® 100 Biomimetic Pathogen Adsorbing Device on Inflammatory Biomarkers in 42 COVID-19 Patients**

Jan T. Kielstein,<sup>1</sup> Borchina Dan-Nicolae,<sup>1</sup> Julius Schmidt,<sup>2</sup> <sup>1</sup>Academic Teaching Hospital Braunschweig, Braunschweig, Germany; <sup>2</sup>Medizinische Hochschule Hannover, Hannover, Germany.

**Background:** Lack of pharmacological treatment options in severely ill hospitalized COVID-19 patients prompted explorations of extracorporeal treatments. The Seraph® 100 Microbind® Affinity filter, remove viruses, including SARS-CoV-2 from the blood. Data from an international registry, from a multicenter evaluation in the US, as well as from several case reports suggest that Seraph® 100 can not only be safely used but it may have an impact on patient centered outcome parameters. As it is unknown whether the effect of the Seraph® 100 in COVID-19 patients is solely based on the removal of the virus or, as suggest by a recent observation, by additionally modulating inflammation, we set out to perform a biomarker study.

**Methods:** We performed this prospective multicenter observational trial at three tertiary care hospitals in patients being treated with Seraph® 100 for severe COVID-19 between June 2020 and April 2021. Biomarkers were obtained before the treatment as well as 2-4 hours after the treatment, as well as 4 days after the Seraph® 100 treatment. Routine clinical chemistry parameters were performed in the respective clinical chemistry labs using certified methods. For the assessment of the inflammatory markers a Bio-Plex Pro Human Cytokine Screening Panel, 48-Plex #12007283 (Bio-Rad) was used.

**Results:** From June 1<sup>st</sup> 2020 to April 1<sup>st</sup> 2021, 42 patients with COVID-19 treated with the Seraph® 100 in our hospitals could be included in the study. Hemoperfusion treatment was initiated in median 3 days after hospital admission. At beginning of the treatment 41/42 (98%) of patients were in the ICU; 8/42 (19%) needed mechanical ventilation, 3/42 (7%) were on additional ECMO support; 27/42 (64%) needed pressors. Seraph® 100 treatment significantly reduced d-dimer comparing pre-treatment data with data obtained 2-4 hours after treatment. Four days after treatment hemoglobin, LDH, D-dimer, troponin and ferritin were significant reduced. From the interleukin assay IL-1b, IL8, IL-10, IL-13, IL-15, Eotaxin, G-CSF and IP-10 were significantly reduced 2-4 hours after treatment, but not 4 days later. The median hospital stay was 20 days. After 3 months 20/42 (48%) of patients had died.

**Conclusions:** In conclusion, our data show that Seraph® 100 leads to a significant reduction of biomarkers that are either predictive of adverse outcome or the severity COVID-19.

FR-PO002

**Hemoperfusion With Seraph-100 Is Not Associated With Improved Survival in Severe COVID-19 Patients**

María Martínez, Paula Ardura, Mercedes Artola, Arturo Lorenzo, Arinson Vasquez, Amanda Francisco, María Isabel Acosta-Ochoa, María Bustamante, Pablo Gonzalez, Elena Bustamante, Armando Coca. *Hospital Clínico Universitario de Valladolid, Valladolid, Spain.*

**Background:** Seraph-100 Blood Filter (ExThera Medical) is a hemoperfusion device designed to treat bloodstream infections. Its membrane binds pathogens, reducing bacterial and viral blood titers. The device received an authorization for emergency use in critically-ill COVID-19 patients by the FDA. We summarize the efficacy and safety profile of the device in a sample of COVID-19 ICU patients.

**Methods:** 25 consecutive COVID-19 patients admitted in the ICU between Nov 2021 and Feb 2022 were retrospectively reviewed. 11 patients received a single treatment with Seraph-100 plus standard care. Subjects in the control group received standard care only.

**Results:** We found no differences between groups regarding age, sex or comorbidities. Treatment with Seraph was well tolerated and was associated with no modifications of leukocyte count or CRP levels. No differences regarding in-hospital mortality (LR=0.37;P=0.54) or length of ICU stay were observed. Patients treated with Seraph suffered Gram-positive associated pneumonia less frequently.

**Conclusions:** Seraph hemoperfusion was not associated with better results in our sample. This may be due to small sample size and high heterogeneity present in parameters such as disease severity, other complications, length of ICU stay or hemoperfusion dosage. To improve results it is necessary to better define the most appropriate timing and dosage for each case.

	Treated with Seraph	Control Group	P value
N	11	14	
Age, years	60 (50-73)	68 (58-76)	0,584
Male sex, n (%)	8 (72,7)	11 (78,6)	0,734
Hypertension, n (%)	8 (72,7)	7 (50)	0,25
Diabetes, n (%)	4 (36,4)	4 (28,6)	0,678
Ischemic heart disease, n (%)	0 (0)	0 (0)	-
COPD, n (%)	1 (9,1)	1 (7,1)	0,859
CKD, n (%)	0 (0)	1 (7,1)	0,366
Previous solid organ transplant, n (%)	0 (0)	0 (0)	-
Cancer, n (%)	1 (9,1)	1 (7,1)	0,859
Hemoperfusion only, n (%)	7 (63,6)	-	-
Expected treatment duration >300 min, n (%)	2 (18,2)	-	-
Seraph-associated hypotension, n (%)	3 (27,3)	-	-
Blood line or circuit clotting, n (%)	2 (18,2)	-	-
Premature end of treatment, n (%)	2 (18,2)	-	-
Average change in systolic blood pressure, mmHg	0 (-10-12,5)	-	-
Average change in diastolic blood pressure, mmHg	0 (-7-5-15)	-	-
Average change in leukocytes, cells/mm <sup>3</sup>	-4990 (880-7555)	-	-
Average change in C-reactive protein, mg/L	-7,4(-44,5-14,6)	-	-
Gram positive bacterial pneumonia, n (%)	5 (45,5)	13 (92,9)	0,009
Stage 3 AKI, n (%)	1 (9,1)	1 (7,1)	0,859
ICU stay, days	19 (11-94)	16 (4-34)	0,255
In-hospital death, n (%)	6 (54,5)	6 (42,9)	0,561

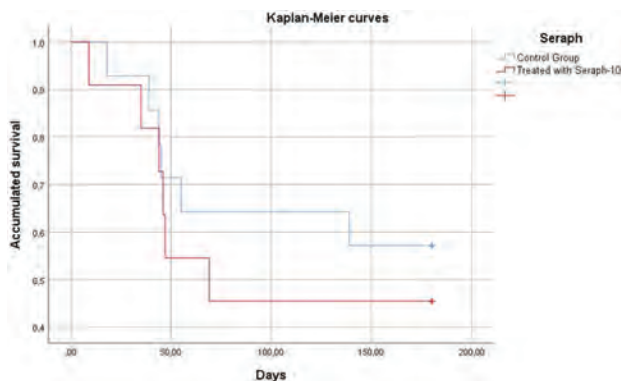

FR-PO003

**Persistently Elevated Urinary Levels of Serpin A3 Appear to Predict Kidney Recovery and Survival in Critically Ill COVID-19 Patients Who Required KRT**

Noemi Del Toro-Cisneros, Miguel A. Martínez-Rojas, Isaac González Soria, Juan Antonio Ortega-Trejo, Norma Bobadilla, Olyinka Vega. *Instituto Nacional de Ciencias Medicas y Nutricion Salvador Zubiran, Ciudad de Mexico, Mexico.*

**Background:** Numerous studies have suggested a possible role for acute kidney injury (AKI) biomarkers in predicting renal recovery after kidney replacement therapy (KRT) with poor performance. In this study, we investigated urinary SerpinA3 (USerA3) as a biomarker to predict renal recovery (RR) after AKI in critically ill COVID-19 patients with invasive mechanical ventilation (IMV).

**Methods:** Prospective cohort study of patients with critical COVID-19 in ICU with IMV and who required KRT, admitted to our Institute in Mexico City (Mar 2020 - Feb 2022). Patients with CKD stages 4 or 5 and kidney transplant were excluded. SerpinA3, KIM-1, NGAL and HSP-72 were measured in urine on day 0 (start of KRT) and days 1, 3, 7 and 14. We performed log10 transformation only for urinary USerA3 and, subsequently performed repeated sample ANOVA for each one of the biomarkers.

**Results:** Sixty patients were included, 52% died before discharge, 38% had complete RR after 90 days and 10% partial RR. Characteristics at baseline for KRT are shown in Table 1. No differences or trends were found in KIM-1 (p=0.380), NGAL (p=0.956), or HSP-72 (p=0.899). In Figure 1 appears USerA3 behavior along the study, showing a clear tendency to be different among the groups. We can observe that the patients who died presented lower amount of USerA3 compared to those who survived. On the other hand, patients with partial RR exhibited USerA3 excretion with a tendency to be lower than those with complete RR, especially in measurements 4 and 5 (day 7 and day 14, respectively).

**Conclusions:** In this study, we observed that USerA3 seems to be a predictor of RR and survival, which probably reflects a greater renal functional reserve.

Table 1: Clinical characteristics of the patients included in this study.

Characteristic	Dead (n=31)	Complete recovery (CR) (n=23)	Partial recovery (PR) (n=6)	p-value
Age (mean ± SD), years	56 ± 12	52 ± 13	47 ± 10	0.187
Male, n(%)	26 (84)	16 (70)	4 (68)	0.390
BMI (median, IQR), kg/m <sup>2</sup>	29.4 (26.8-38)	31.2 (29-38.1)	31.2 (31.1-33.4)	0.500
Charlson index (median, IQR)	2 (0-3)	1 (0-2)	2 (0-4)	0.393
Baseline SCr (median, IQR) mg/dl	1.0 (0.9-1.22)	1.0 (0.83-1.20)	0.88 (0.70-1.10)	0.583
SOFA to AKI (median, IQR)	10 (8-11)	10 (9-11)	9 (7-12)	0.732
Laboratory to AKI (median, IQR)				
-Leukocytes, x 1000m <sup>3</sup>	12 (8-17)	13 (10-17)	7 (5-9)	0.614
-Ferritin, nmol/L	1202 (613-1855)	1123 (57-1770)	443 (327-900)	0.098
-C-reactive protein, mg/dL	19 (8-29)	17 (10-30)	13 (10-18)	0.782
-PaO <sub>2</sub> /FIO <sub>2</sub> ratio	123 (86-154)	144 (107-170)	160 (113-175)	0.285
SCr at start of KRT (median, IQR), mg/dL	4.18 (3.30-4.95)	4.56 (3.30-6.95)	5.65 (5.14-6.9)	0.220
Accumulated balance (median, IQR), ml	8046 (4107-13,195)	5426 (3150-8629)	5074 (3174-7059)	0.068
Serpin A3 (median, IQR) DPI/mg, (at start of KRT)	0.34 (0.04-2.09)	0.67 (0.30-2.00)	0.05 (0.03-0.32)	0.370
KIM-1 (median, IQR), ng/mg, (at start of KRT)	1.77 (0.69-2.68)	3.66 (2.21-8.19)	2.17 (0.65-4.90)	0.052
NGAL (median, IQR), ng/mg, (at start of KRT)	0.72 (0.26-2.73)	2.06 (1.124-13)	0.39 (0.20-1.81)	0.101
HSP-72 (median, IQR), ng/mg, (at start of KRT)	1.31 (0.09-14.97)	1.62 (0.35-7.96)	0.25 (0.11-0.35)	0.325

Figure 1. Marginal means of urinary Serpin A3

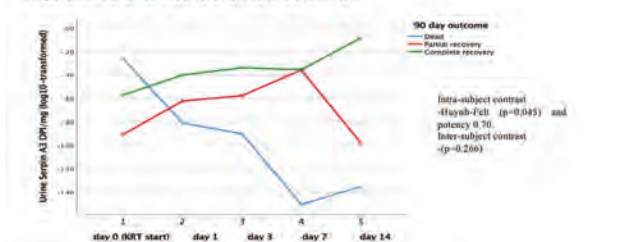

FR-PO004

Validation of a Modified Renal Angina Index (RAI) in Critically Ill Patients With COVID-19

Noemi Del Toro-Cisneros, Nathan Berman, Adela U. Pérez, John Hernandez Flores, Adrián Esteban Caballero-Islas, Ricardo Correa-Rotter, Olyinka Vega. Instituto Nacional de Ciencias Medicas y Nutricion Salvador Zubiran, Ciudad de Mexico, Mexico.

**Background:** The renal angina index (RAI) is a tool validated in multiple studies in pediatric and adult populations, to predict the development of severe AKI. The aim of this study was to evaluate the efficacy of the RAI in predicting severe AKI in critically ill patients with COVID-19 and to validate a modified model.

**Methods:** Prospective cohort analysis of all COVID-19 patients with invasive mechanical ventilation (IMV), admitted to the intensive care unit (ICU) of our Institute in Mexico City from 03/2020 to 01/2022. AKI was defined according to KDIGO guidelines. Patients with CKD stages 4 or 5 or AKI on admission were excluded. RAI was calculated using the method of *Matsuura et al* (Figure 1). Outcome was defined as the development of severe AKI (stage 2 or 3) at 24 and 72 hours after ICU admission. Since all patients had 5 points corresponding to IMV, we performed a logistic regression analysis to look other factors associated with the severe AKI and with them development a modified RAI (mRAI) and compared the efficacy of both scores.

**Results:** Of the 452 patients, 30% developed severe AKI. Fig 1 shows the performance of the RAI to predict the development of severe AKI, with an AUC of 0.67 at 24 h and AUC of 0.73 at 72 h. In a multivariate analysis, adjusted for age and sex, we obtained BMI ≥30 kg/m<sup>2</sup>, SOFA ≥6, and Charlson Index as risk factors for development of the outcome (Table 1). In the new proposed score (mRAI), the conditions were summed and multiplied by the Cr delta (Figure 1).

**Conclusions:** The original RAI in patients with critical COVID-19 with IMV is a limited tool. The modified score (mRAI) adds predictive performance and improves risk stratification in critically ill patients with IMV.

Table 1. Logistic regression analysis for severe AKI development.

	OR crude			OR Adjusted		
	OR	95% CI	p-value	OR	95% CI	p-value
Age, per year	1.015	0.999-1.030	0.062	0.998	0.975-1.021	0.854
Male, vs female	0.946	0.653-1.578	0.740	1.108	0.697-1.781	0.665
BMI ≥ 30 kg/m <sup>2</sup> , Vs not	1.508	1.007-2.259	0.046	1.666	1.087-2.553	0.019
Charlson Index, per point	1.245	1.082-1.433	0.002	1.313	1.062-1.624	0.012
SOFA ≥ 6 points at ICU admission	1.978	1.299-3.012	0.001	1.939	1.262-2.980	0.003

Abbreviations. OR, odds ratio; 95%CI, confidence interval at 95%; BMI, body mass index; SOFA, Sequential Organ Failure Assessment score; ICU, intensive care unit.

Figure 1. Area under the curve for RAI and mRAI score

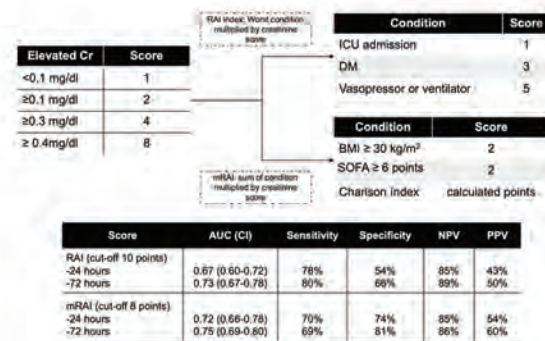

Abbreviations. Cr, creatinine; RAI, renal angina index; mRAI, modified renal angina index; ICU, intensive care unit; DM, diabetes mellitus; BMI, body mass index; SOFA, Sequential Organ Failure Assessment score; AUC, area under curve; NPV, negative predictive values; PPV positive predictive value.

FR-PO005

Prophylaxis for Vulnerable Patients at Risk of COVID-19 Infection (PROTECT-V): A Platform Trial Experience

Rona M. Smith,<sup>1,2</sup> Wendi Qian,<sup>2</sup> Davinder P. Dosanjh,<sup>3</sup> Francis Dowling,<sup>2</sup> Katrina L. Gatley,<sup>2</sup> Zehra Yilmaz,<sup>2</sup> Vivekanand Jha,<sup>4</sup> Toby J. Humphrey,<sup>2</sup> <sup>1</sup>University of Cambridge, Cambridge, United Kingdom; <sup>2</sup>Cambridge University Hospitals NHS Foundation Trust, Cambridge, United Kingdom; <sup>3</sup>Queen Elizabeth Hospital Birmingham, Birmingham, United Kingdom; <sup>4</sup>The George Institute for Global Health, New Delhi, India.

**Background:** Despite the introduction of vaccination, there remains a need for pre-exposure prophylactic agents against SARS CoV-2. Several patient groups are more vulnerable to COVID-19 infection by virtue of underlying health conditions, treatments received or suboptimal responses to vaccination.

**Methods:** PROTECT-V is a platform trial testing pre-exposure prophylactic interventions against SARS CoV-2 infection in vulnerable patient populations (organ transplant recipients; individuals with oncological/haematological diagnoses, immune deficiency, or autoimmune diseases requiring immunosuppression or on dialysis). Multiple agents can be evaluated across multiple vulnerable populations sharing placebo groups, with the option of adding additional treatments at later time points as these become available. The primary endpoint is symptomatic COVID-19 infection, and each agent will be independently evaluated in real time when the required number of events occur.

**Results:** The trial commenced with the first intervention, intranasal niclosamide (UN1911) and matched placebo (1:1 ratio) in February 2021. As of 14<sup>th</sup> May, 1175 patients from 36 UK sites and 6 Indian sites had been enrolled. A second inhaled intervention, ciclesonide with matched placebo, will be added to the platform in the UK imminently. In parallel to the repurposed drug arms, a monoclonal antibody arm, sotrovimab, will enrol vaccine non-responders in a 1:1 ratio, active: placebo in the UK.

**Conclusions:** The PROTECT-V trial platform brings greater efficiency, running multiple sub-trials within one master protocol. It is an exemplar trial demonstrating the success of collaboration in the COVID-19 pandemic. The platform is jointly funded from charitable (LifeArc, Kidney Research UK, Addenbrooke's Charitable Trust), government (NIHR), and industry (Union Therapeutics (Hellerup, Denmark) for the niclosamide arm; Vir/GSK for the sotrovimab arm) sources and focuses on patient populations often excluded from clinical trials due to complex disease, but remain vulnerable to infection despite the success of vaccination. The trial is sponsored by Cambridge University Hospitals NHS Foundation Trust and University of Cambridge in the UK, and The George Institute for Global Health in India. Clinicaltrials.gov: NCT04870333; EudraCT: 2020-004144-28.

**Funding:** Commercial Support - Vir/GSK; Union Therapeutics, Private Foundation Support



FR-PO006

**TNFR-1, TNFR-2, and KIM-1 Plasma Concentrations After COVID-19 and Association With Kidney Function**

Lili Chan,<sup>1</sup> Nanditha Anandkrishnan,<sup>1</sup> Aparna Saha,<sup>1</sup> Stefanie Defronzo,<sup>1</sup> Gohar Mosoyan,<sup>1</sup> Kristin Meliambro,<sup>1</sup> Juan Wisnivesky,<sup>1</sup> Girish N. Nadkarni,<sup>1</sup> Sharon Stapleton,<sup>2</sup> Fergus Fleming,<sup>2</sup> Steven G. Coca,<sup>1,2</sup> Evren U. Azeloglu,<sup>1</sup> <sup>1</sup>Icahn School of Medicine at Mount Sinai, New York, NY; <sup>2</sup>Renalytix, New York, NY.

**Background:** Biomarkers TNFR1, TNFR2, and KIM1 are associated with progression of kidney disease. These biomarkers have not been evaluated in patients who have recovered from COVID-19.

**Methods:** Patients who had COVID-19 and recovered were followed longitudinally at an outpatient clinic with labs and surveys as part of the Mount Sinai Post-COVID clinic. Blood was sent for creatinine at baseline and 6 month follow up visit. We measured plasma TNFR1, TNFR2, and KIM-1 from the first post-COVID visit via Renalytix' proprietary multiplex assay. eGFR was calculated using the 2021 CKD-EPI formula.

**Results:** 450 COVID survivors had serum creatinine values measured at baseline (222±89 days post-COVID) and 6 month (419±97 days post-COVID) follow up. The average age of patients was 50±14 years, 62% were female, 60% were white, and 17% were Black. 23% were hospitalized, 4% required ICU admission, and 2% of patients reported AKI. eGFR at the baseline visit was 94±21 and at 6-months was 96±22 ml/min/1.73m<sup>2</sup>. At the baseline visit, KIM-1, TNFR-1, and TNFR-2 levels were highest in patients who were hospitalized and had AKI (Figure 1a) and concentrations of all three were associated with lower eGFR 6 months later (Figure 1b).

**Conclusions:** Severity of illness during COVID is associated with higher levels of plasma TNFR1, TNFR2, and KIM1 several months after recovery. The degree of biomarker elevation post-COVID was associated with lower kidney function more than 1 year post-COVID.

**Funding:** Commercial Support - Renalytix

Figure 1A: Violin Plot of KIM-1, TNFR-1, and TNFR-2 stratified by hospitalization and AKI.

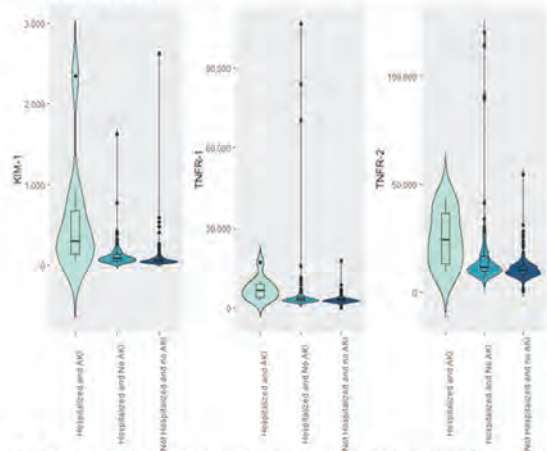
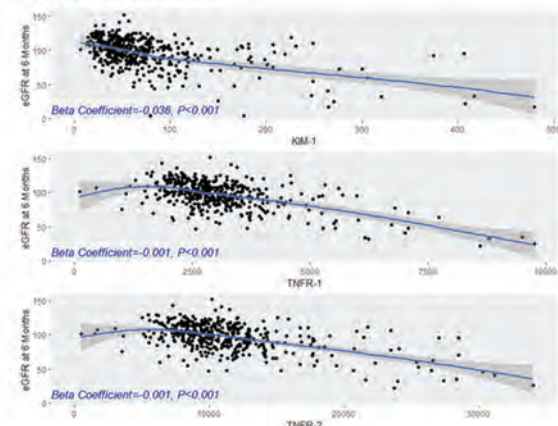

Figure 1B: Scatter plot with regression line of KIM-1, TNFR-1, and TNFR-2 and eGFR at 6 months.



FR-PO007

**SARS-CoV-2 S Protein Is a Competitive Inhibitor of Furin Mediated ENaC Activation**

German R. Magaña,<sup>1,2</sup> Kevin Garcia Avila,<sup>3,2</sup> Hector Carbajal-Contreras,<sup>1,2</sup> Consuelo Plata,<sup>2</sup> Erika Moreno,<sup>1</sup> Norma H. Vázquez,<sup>1</sup> Gerardo Gamba,<sup>1,2</sup> Maria Castañeda-Bueno,<sup>1,2</sup> Unidad de Fisiología Molecular <sup>1</sup>Universidad Nacional Autónoma de México, Ciudad de México, México; <sup>2</sup>Instituto Nacional de Ciencias Médicas y Nutrición Salvador Zubiran, Ciudad de México, México; <sup>3</sup>Instituto Tecnológico y de Estudios Superiores de Monterrey, Ciudad de México, México.

**Background:** Severe acute respiratory syndrome coronavirus 2 (SARS-CoV-2) is the causative agent of COVID-19 (Coronavirus disease 19). SARS-CoV-2 causes a multisystemic infection, which frequently presents with pulmonary oedema, endothelial damage and electrolytic abnormalities. An essential physiopathological feature of SARS-CoV-2 involves cleavage of its S protein by furin or furin-like enzymes. It has been shown by sequence-based evidence that the S protein polybasic aminoacid sequence is identical to the consensus sequence for furin cleavage present in the human alpha subunit of the epithelial sodium channel (ENaC). Furin and furin-like enzymes are also involved in the posttranslational regulation of ENaC in many tissues, including the lung, endothelium, and the kidney, where cleavage is associated with increased activity of the channel. ENaC is involved in the regulation of fluid clearance, Na<sup>+</sup>, K<sup>+</sup> and acid-base homeostasis, and endothelial function. Thus, we hypothesized that the S protein competes with ENaC for furin-mediated cleavage and activation.

**Methods:** We injected synthetic mRNA encoding WT S protein and mutant S protein lacking the furin consensus sequence (Δ-Spike) into *X. laevis* oocytes with αβγ-ENaC subunits. We then performed whole-cell voltage-clamp experiments and protein analysis by western blot.

**Results:** We observed an interdependent competitive effect on the cleavage of both the S protein and ENaC when co-expressed, which was partially prevented with the injection of Δ-Spike. We also found a decrease in the amiloride-sensitive sodium current in oocytes injected with the WT S protein but not with Δ-Spike. This suggests diminished function of ENaC in the presence of WT S protein that depends on its furin cleavage site.

**Conclusions:** These findings show evidence of a competitive interaction between the S protein and ENaC for furin-like enzymes. This suggests that SARS-CoV-2 infection may impair ENaC activity in human epithelia, which gives a plausible explanation to pulmonary oedema, endothelial damage, and electrolyte disturbances in patients with COVID-19.

**Funding:** Government Support - Non-U.S.

FR-PO008

**Use of Non-Approved and Approved Treatments for COVID-19 by CKD Status in Medicare**

Nicholas S. Roetker,<sup>1</sup> Wendy L. St. Peter,<sup>3,1</sup> Madison Hoover,<sup>1</sup> James B. Wetmore,<sup>1,2</sup> Kirsten L. Johansen,<sup>1,2</sup> <sup>1</sup>Hennepin Healthcare Research Institute, Minneapolis, MN; <sup>2</sup>Hennepin Healthcare, Minneapolis, MN; <sup>3</sup>University of Minnesota Twin Cities, Minneapolis, MN.

**Background:** Hydroxychloroquine, chloroquine, and ivermectin gained popularity for treatment of COVID-19 in 2020. Remdesivir was approved for treating hospitalized COVID-19 in late 2020. We studied the uptake of these drugs early in the pandemic in a 5% sample of Medicare fee-for-service beneficiaries with and without CKD.

**Methods:** We examined the percentage of beneficiaries receiving ≥1 Part D covered prescription for hydroxychloroquine or chloroquine and ivermectin in each month of 2020. Among first COVID-19 hospitalizations from November 2020-June 2021, we examined the percentage receiving remdesivir using ICD-10-PCS. Analyses included those aged ≥66 years without ESRD; CKD was defined by ≥1 inpatient or ≥2 outpatient diagnoses.

**Results:** Use of hydroxychloroquine and chloroquine increased in March 2020 and then subsided in the ensuing months, remaining slightly elevated though 2020 (Figure A). Receipt of these drugs was higher in patients with CKD than in those without. Ivermectin use was uncommon in both groups before spiking in December 2020 (Figure B). Among COVID-19 inpatients, 55% without CKD and 44% with CKD received remdesivir, which was used more often in men than in women, less often in Blacks than in Whites or Hispanics, and less often in those with the low-income subsidy than in those without.

**Conclusions:** In 2020, Medicare beneficiaries with and without CKD showed similar spiking patterns in use of the approval-revoked or non-approved drugs hydroxychloroquine/chloroquine (in March) and ivermectin (in December). Through June 2021, remdesivir was used less in patients with CKD than in those without for hospitalized COVID-19, likely because the FDA recommends not using remdesivir if eGFR is <30 mL/min. Lower income and Black patients were less likely to receive remdesivir than others.

**Funding:** NIDDK Support

**A. Percentage of Medicare beneficiaries receiving Part D covered hydroxychloroquine or chloroquine, by month, 2020**



**B. Percentage receiving Part D covered ivermectin among Medicare beneficiaries, by month, 2020**



**FR-PO009**

**SARS-CoV-2 Saliva Testing to Determine Viral Shedding Duration in Hemodialysis Patients**

Ohnmar Thwin,<sup>1</sup> Xiaoling Wang,<sup>1</sup> Zijun Dong,<sup>1</sup> Lela Tisdale,<sup>1</sup> Zahin S. Haq,<sup>1</sup> Sarah Ren,<sup>1</sup> Lemuel Rivera Fuentes,<sup>1</sup> Nadja Grobe,<sup>1</sup> Peter Kotanko.<sup>1,2</sup> <sup>1</sup>Renal Research Institute, New York, NY; <sup>2</sup>Icahn School of Medicine at Mount Sinai, New York, NY.

**Background:** Hemodialysis (HD) patients are vulnerable to COVID-19. Early detection of COVID-19 in dialysis clinics informs isolation and infection control policies. Saliva testing is an alternative to nasopharyngeal swab to detect SARS-CoV-2. The understanding of viral shedding in HD patients is limited. We explore viral shedding duration in HD patients and determine its correlation with immunosuppression.

**Methods:** Eligible patients diagnosed with COVID-19, confirmed by nasal swab RT-PCR within 2 weeks of COVID-19 diagnosis, were recruited. They were given Salivette Saliva Collection kits and instructed to chew a cotton swab for 60 seconds.

**Results:** 30 COVID-19 positive patients participated (Table 1). Each patient provided up to 7 saliva samples. 65 samples were collected for an average of 11±8 days (range 0-36) after diagnosis. 26 samples showed at least one COVID-19 target gene (N, ORF1ab) with cycle threshold <38 cycles. 12 patients had at least 1 positive sample, and 23 patients had at least 1 negative sample. Of the 23 patients who had at least one negative sample, median days to first negative sample is 9 days (range 0-36). For the 7 patients who only had positive samples, median days to last positive sample is 9 days (range 0-36). There is no observed difference between vaccinated (n=24) and vaccinated patients (n=6). 6 out of 30 patients took immunosuppressants such as Tacrolimus, Hydroxychloroquine, and Mycophenolate sodium. Median days to turn negative (or use last positive date if negative results never achieved) was 15 days for immunocompromised group and 8 days for non-immunocompromised group (Fig.1)

**Conclusions:** Immunocompromised HD patients shed COVID-19 virus for a significantly longer period. While our study did not explore the shedding of viable SARS-CoV-2, a longer isolation should be considered in immunosuppressed HD patients. Studies on shedding of viable SARS-CoV-2 are warranted in immunocompromised HD patients to inform policies regarding isolation and contact tracing protocols, and vaccination strategies.

**Table 1. Demographic characteristics of COVID-19 patients**

	Total (n=102) (n%)	HD patients (n=24) (n%)	Immunocompromised patients (n=4) (n%)
Age			
Mean (SD)(yrs)	60 (8.14)	63 (11.2)	69.5 (18.7)
Gender			
Female	11 (10.7%)	9 (37.5%)	2 (50.0%)
Male	20 (19.3%)	15 (62.5%)	4 (100%)
Comorbidity			
Hypertension	9 (20.0%)	4 (25.0%)	0 (0%)
Heart disease	24 (100.0%)	18 (75.0%)	6 (100%)
Diabetes Mellitus	5 (11.9%)	3 (25.0%)	0 (0%)
Ins	25 (18.3%)	19 (79.2%)	6 (100%)
Race			
White	22 (71.5%)	17 (70.8%)	4 (100%)
Non-White	8 (28.5%)	7 (29.2%)	0 (0%)

**Fig 1. Median times between immunocompromised and non-immunocompromised HD patients. Immunocompromised HD patients (n=6) had a median time of 15 days. Non-immunocompromised HD patients had a median time of 8 days (n=24).**

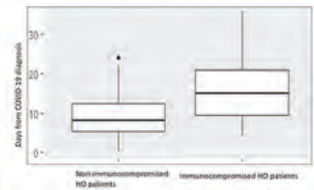

**FR-PO010**

**Treatment of AKI With Continuous Renal Replacement Therapy and CytoSorb in Critically Ill Hospitalised Patients With COVID-19**

Robert Ekart,<sup>1,2</sup> Eva Jakopin,<sup>1</sup> Masa Knehtl,<sup>1</sup> Nina Vodošek Hojs,<sup>1</sup> Nejc Piko,<sup>1</sup> Sebastjan Bevc,<sup>1,2</sup> Radovan Hojs.<sup>1,2</sup> <sup>1</sup>Univerzitetni Klinični Center Maribor, Maribor, Slovenia; <sup>2</sup>Univerza v Mariboru, Maribor, Slovenia.

**Background:** AKI is common in critically ill patients with COVID-19. The aim of this study was to evaluate the 30- and 60-day survival of patients with COVID-19 and AKI, treated in the ICU. We analysed two groups of patients: patients in the first group were treated with CRRT only, and patients in the second group were treated with CRRT plus hemoadsorption with Cytosorb cartridge.

**Methods:** This is a retrospective study of patients admitted with COVID-19 between March, 2020 and April, 2022 in all COVID ICUs of our hospital. Inflammatory and biochemical biomarkers at admission, length of ICU stay, and mortality at day 30 and day 60 after ICU admission were analysed.

**Results:** One hundred two patients (mean age 68.1±8.1 years, 74.5% male) had AKI requiring CRRT, and 44 (43.1%) out of these patients were treated concomitantly with CRRT and Cytosorb. Of the prior concomitant diseases, 39 (38.2%) patients had diabetes, 75 (73.5%) had hypertension, 22 (21.6%) had heart failure, and 26 (25.5%) had chronic kidney disease. Patients treated with CRRT and Cytosorb were younger (64.7 vs. 70.6 years; p<0.001), had lower serum creatinine levels (294 vs. 405 µmol/L; p<0.001), urea levels (29 vs. 48 mmol/L; p < 0.001), higher levels of IL-6 (1754 vs. 385 pg/mL; p<0.001) and lactate dehydrogenase (8.8 vs. 7.1; p=0.038). We found no statistically significant difference between the two groups for serum lactate, ferritin, D-dimer, C-reactive protein, and procalcitonin. Onset of treatment was earlier in patients treated with CRRT and Cytosorb than in patients treated with CRRT alone (11.4 vs. 18.2 days; p=0.005). Mean length of stay in ICU was 27.4±20.2 days, with no differences between the two groups. Mortality 30 and 60 days after ICU admission was in all patients 58.8% and 76.5%. In patients treated with CRRT alone, mortality at 30 and 60 days was 65.5% and 84.5%, and in patients treated with CRRT and Cytosorb, 50% and 65.9%. The number of patients who died 60 days after ICU admission was statistically significantly higher in the group of patients treated with CRRT alone (χ<sup>2</sup>, p=0.029). The most common causes of death were sepsis and multiple organ failure (55.1%), acute respiratory failure (24.4%), and cardiac arrest (19.2%).

**Conclusions:** CRRT and CytoSorb cartridge treatment results in improved 60-day survival in COVID-19 ICU patients with AKI.

**FR-PO011**

**Antiviral Effects of Voclosporin on SARS-CoV-2 in Immunocompromised Kidney Patients**

Eline J. Arends, Soufian Meziyerh, Dirk Jan Moes, Sylvia Kamerling, Sandra W. Van der kooij, Natacha S. Ogando, Eric J. Snijder, Martijn J. Van Hemert, Leo G. Visser, Mariet Feltkamp, Ton J. Rabelink, Cees van Kooten, Aiko P. De Vries, Yoe Kie Onno Teng. on behalf of all the VOCOVID investigators *Leids Universitair Medisch Centrum, Leiden, Netherlands.*

**Background:** Immunocompromised patients, including Kidney Transplant Recipients (KTRs) and lupus nephritis (LN) patients, are at increased risk for prolonged SARS-CoV-2 infection and developing COVID-19-related complications. Recently, we reported that voclosporin, a novel calcineurin inhibitor (CNI), demonstrated in vitro a more potent inhibitory effect on SARS-CoV-2 replication than other CNIs (tacrolimus and ciclosporin). Additionally the AURORA-2 study, where 216 LN patients were treated with voclosporin or placebo on top of standard of care, SARS-CoV-2 infection was detected in 12/100 placebo-treated patients (12%) compared to 7/116 voclosporin treated patients (6%) and more patients died due to COVID-19 in the placebo arm versus voclosporin arm (3% vs 0%). In this proof-of-concept study we assessed whether voclosporin demonstrated an added antiviral benefit in SARS-CoV-2 positive immunocompromised patients.

**Methods:** We performed a prospective, randomised, open-label, single-center, exploratory, proof of concept study in 20 KTRs with mild to moderate symptoms from a COVID-19 infection comparing time to viral clearance of SARS-CoV-2 between patients on standard immunosuppressive therapy with tacrolimus versus voclosporin (the VOCOVID study).

**Results:** In the VOCOVID study no difference in time to viral clearance or time to clinical recovery was found between both treatment arms. Pharmacokinetic analysis demonstrated that adequate trough levels of voclosporin were reached from day 4-8 after randomization. Looking at specific timepoint in a post-hoc analysis, indeed a significantly better viral clearance of SARS-CoV-2 was observed in voclosporin treated patients at day 4-8. No safety concerns were raised.

Key: TH - Thursday; FR - Friday; SA - Saturday; OR - Oral; PO - Poster; PUB - Publication Only

Underline represents presenting author.

**Conclusions:** The present study provides evidence that voclosporin has a favorable benefit-risk profile for immunocompromised kidney disease patients who contract a SARS-CoV-2 infection while requiring the continuation of their immunosuppressants.

**Funding:** Commercial Support - Aurinia Pharmaceuticals

### FR-PO012

#### Assessing Fluid Management and Its Association With AKI in COVID-19 Patients

Salman Bhutta, Rezwan F. Munshi, Joshua Fogel, Narois Nehru, James R. Pellegrini, Eric H. Lam, Sandra Gomez Paz, Sofia Rubinstein. Nassau University Medical Center, East Meadow, NY.

**Background:** Managing fluid balance in COVID-19 patients can be challenging, particularly if they develop acute kidney injury (AKI). We study the relationship between fluid net input and output (FNIO) in patients with confirmed COVID-19 infection with development of AKI, time to development of AKI, in-hospital length of stay (LOS), and in-hospital mortality.

**Methods:** This is a retrospective study of patients (n=403) with confirmed COVID-19. Data for FNIO were from day 1 through day 10 or until development of AKI were recorded, whichever occurred first. Available FNIO data was calculated as a mean due to information not available for all days. Covariates included demographics, comorbidities, treatment, and management variables.

**Results:** Mean age was 58.1 (SD=16.5) years. There were 39.5% female and 53.1% Hispanic. Mean FNIO average was 612.2 (SD=747.4) mL. For the outcome variables, AKI occurred in 22.8%, in-hospital mortality occurred in 26.3%, mean days to AKI were 7.7 (SD=6.3), and mean LOS was 11.4 (SD=13.2) days. In the multivariate logistic regression analyses, increased FNIO mean was significantly associated with slightly increased odds for mortality (OR=1.001, 95% CI: 1.00, 1.001, p=0.03) but was not significantly associated with AKI (p=0.82). In the multivariate linear regression analyses, increased FNIO mean was significantly associated with lesser days to AKI (B=-6.92\*10<sup>-5</sup>, SE=<0.001, p=0.002) while FNIO mean was not significantly associated with LOS (p=0.75).

**Conclusions:** Increased fluid balance was associated with AKI development and increased mortality. Physicians should exercise caution with administering fluid in patients with COVID-19 to prevent such adverse outcomes.

### FR-PO013

#### Renal Injury and Inflammatory Response in New Onset IgA Nephropathy After Infection With SARS-CoV-2 or COVID-19 Vaccination

Naser Hussein, Eva Vonbrunn, Kerstin U. Amann, Christoph Daniel. Friedrich-Alexander-Universitat Erlangen-Nurnberg, Erlangen, Germany.

**Background:** After infection with SARS-Cov-2 or vaccination against COVID-19, some patients develop kidney diseases, including minimal change nephrotic syndrome and IgA Nephropathy (IgAN). Here we characterized renal injury and inflammatory response in biopsies from patients with new onset IgAN diagnosed promptly after COVID-19 disease or vaccination.

**Methods:** Eleven kidney biopsies from patients who developed IgAN after SARS-Cov-2 infection and 6 from patients with new onset IgAN after vaccination against COVID-19 were diagnosed at Dep. of Nephropathology, FAU Erlangen-Nuremberg. Biopsies from patients with IgAN who had no prior COVID-19 disease (n=10) and zero-time biopsies from transplants (ZB; n=6) served as controls. Serum creatinine was assessed and kidney injury by analysis of podocyte loss, detection of Pax-8 positive parietal epithelial cells on the glomerular tuft and IF/TA. Macrophages and granulocytes were detected by triple staining of CD68, CD163 and myeloperoxidase.

**Results:** Significant podocyte loss, as assessed by nephrin staining, was observed in all three IgAN groups compared to ZB, as well as Pax8-positive parietal epithelial cells on glomerular tuft. The serum creatinine, as a marker of kidney function, was on average 1.8-3.5-fold higher in the IgAN groups compared to ZB, but did not reach significance level due to small sample numbers. IF/TA was below 20% in most investigated biopsies. No significant differences in renal function or injury were observed between different IgAN groups. While CD68+CD163+MPO+, CD68+CD163-MPO+ and CD68+CD163+MPO- (M2c-like macrophages) inflammatory cells were significantly increased in both COVID-19 IgAN groups, significant increase of CD68-CD163+MPO- cells compared to ZB control was restricted to IgAN w/o COVID-19 group (11.7±8.1 vs 0.8±0.9 cells / mm<sup>2</sup>). CD68+CD163-MPO- M1-like macrophages and CD68-CD163-MPO+ neutrophils tended to be higher in all IgAN groups but failed to reach the level of significance.

**Conclusions:** Changes in kidney function and renal damage was comparable in all three investigated IgAN groups independent on experience of COVID-19 or vaccination. Renal macrophage and neutrophil invasion tended to be higher in COVID-19 IgAN groups. However, no significant differences in inflammatory were observed in direct comparisons of IgAN groups.

**Funding:** Other NIH Support - German research foundation (DFG)

### FR-PO014

#### CKD Results in Differential Expression of SCARF Genes That Potentially Facilitate SARS-CoV-2 Cell Entry and/or Replication

Sol M. Carriazo,<sup>1,2</sup> Marta Ribagorda,<sup>2</sup> Aranzazu Pintor Chocano,<sup>2</sup> Alberto Ortiz,<sup>1,2</sup> Maria Dolores Sanchez-Nino,<sup>2</sup> Hospital Universitario Fundacion Jimenez Diaz, Madrid, Spain; <sup>2</sup>Instituto de Investigacion Sanitaria de la Fundacion Jimenez Diaz, Madrid, Spain.

**Background:** Chronic Kidney disease (CKD) is the risk factor that most increases the risk of lethal COVID-19. However, the underlying molecular mechanisms are unclear. CKD patients have an increased risk of multiple infections due to CKD-associated non-specific immunodeficiency. Whether specific defects are related to the defense against SARS-CoV-2 is unknown. SARS-CoV-2 and coronavirus-associated receptors and factors (SCARFs) regulate coronavirus cell entry and/or replication. We hypothesized that CKD may alter the expression of SCARF genes.

**Methods:** A literature search identified 32 SCARF genes of which 21 were directly related to SARS-CoV-2 or SARS-CoV infection and assessed their expression in target tissues of COVID-19 (kidneys, lungs, aorta and heart) in experimental CKD in mice fed adenine and compared them with controls.

**Results:** Out of 21 SCARF genes, 19 (90%) were differentially expressed in at least one organ in CKD. 15 genes had a differential expression that would be expected to favor SARS-CoV-2 infection and/or severity in at least one organ. Of these, 13 were differentially expressed in the kidney. Only 2 genes reported to protect from SARS-CoV-2, Ifitm3 encoding interferon induced transmembrane protein 3 (IFITM3) and Ly6e encoding lymphocyte antigen 6 family member 6 (LY6E), were downregulated in at least two non-kidney target organs (lung and heart), potentially predisposing to more severe lung/cardiovascular involvement in COVID-19 (Fig). The largest change was observed for Ifitm3.

**Conclusions:** CKD is associated with the differential expression of multiple SCARF genes in target organs of COVID-19. The decreased expression of Ifitm3 and Ly6e in heart and/or lung may contribute to increase the severity of COVID-19 in CKD. These data may allow the development of interventions that decrease the risk of severe COVID-19 in CKD patients.

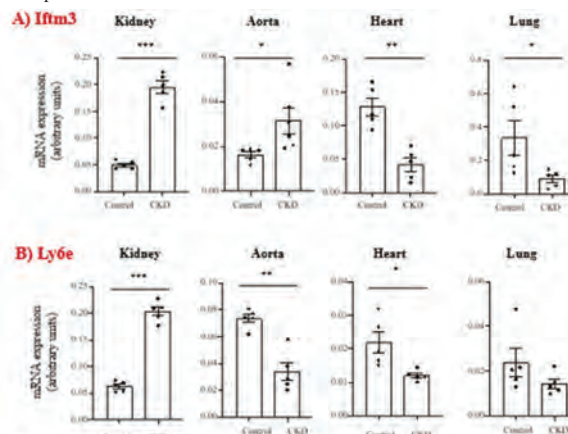

Figure 1. Differential gene expression of Ifitm3 and Ly6e in the kidney and in target organs of COVID-19 in experimental CKD.

### FR-PO015

#### Neutralization of the Omicron Variant of SARS-CoV-2 Is Effective by a Human and a Mouse Soluble ACE2 Protein

Luise Hassler,<sup>1</sup> Vlad I. Nicolaescu,<sup>2</sup> Jan Wysocki,<sup>1</sup> Glenn Randall,<sup>2</sup> Daniel Battle,<sup>1</sup> Northwestern University Feinberg School of Medicine, Chicago, IL; <sup>2</sup>The University of Chicago, Chicago, IL.

**Background:** We have previously reported that ACE2 618-DDC-ABD, a soluble ACE2 protein with extended duration of action and increased binding affinity for SARS-CoV-2, provides lung and kidney protection in a lethal mouse model of SARS-CoV-2 infection. Moreover, we showed that this protein also neutralizes the gamma and delta variant SARS-CoV-2 infection in Vero E6 cells. As omicron is most prevalent SARS-CoV-2 variant we tested whether ACE2 618-DDC-ABD can also neutralize this variant and hypothesized that it is more sensitive to mouse ACE2 as well as human ACE2.

**Methods:** The omicron BA.1 SARS-CoV-2 strain was incubated with various concentrations of ACE2 618-DDC-ABD (0-180µg/ml) for 1 hour at 37°C. Human ACE2 1-740 and mouse ACE2 1-740 were used as controls at the same concentrations. These mixtures were then used to infect Vero E6 cells. Cells were allowed to grow for 3-4 days until a noticeable cytopathic effect was observed in control wells (0µg/ml soluble ACE2 proteins). Cell numbers were assessed by staining cells with crystal violet and reading absorbance of each well at 595 nm. Values were then normalized to the 0µg/ml control and expressed as a percentage of the mock (no virus) control wells.

**Results:** ACE2 618-DDC-ABD (red) neutralized the omicron BA.1 variant at all concentrations tested and to a similar extent as native human soluble ACE2 1-740 (blue) used as control. Native mouse ACE2 1-740 (black) also neutralized infection completely at high concentrations while lower concentrations were less effective as compared to low concentrations of ACE2 618-DDC-ABD or human ACE2 1-740.

**Conclusions:** Soluble ACE2 618-DDC-ABD effectively neutralizes the omicron BA.1 variant of SARS-CoV-2 in Vero E6 cells at concentrations lower than those we have previously shown are required for gamma, delta and wildtype SARS-CoV-2. Moreover, the omicron BA.1 variant is sensitive to neutralization by soluble mouse ACE2.

**Funding:** NIDDK Support, Private Foundation Support

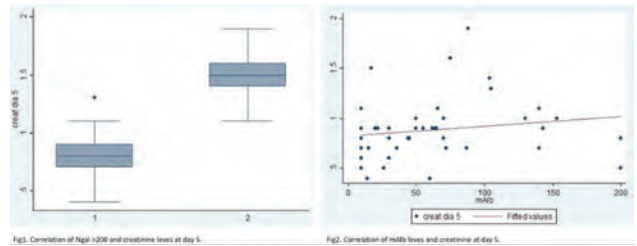
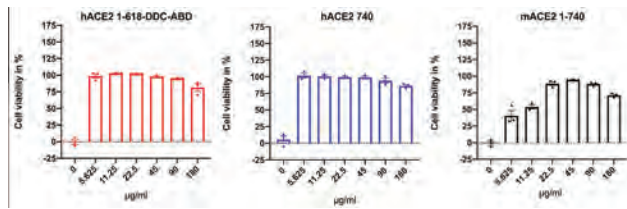

#### FR-PO016

### Efficacy of a Recombinant Humanized Anti-IL-6 Receptor Monoclonal Antibody Compared to Hemoperfusion in Severe COVID-19 Pneumonia: Ambispective Cohort Study

Kanin Thammavaranucupt,<sup>1</sup> Kulapong Jayanama,<sup>1</sup> Ittikorn Spanuchart,<sup>2</sup> <sup>1</sup>Chakri Naruebodin Medical Institute, Bang Phli, Thailand; <sup>2</sup>Mahidol University Faculty of Medicine Ramathibodi Hospital, Bangkok, Thailand.

**Background:** Coronavirus disease 2019 (COVID-19) is a newly emerging disease caused by the SARS-CoV-2 virus resulting in a global crisis. Activation of the cytokine cascades plays a crucial role in the pathophysiology of severe pneumonia caused by COVID-19. Several treatments targeting pro-inflammatory cytokines have been introduced, however, their efficacy remains controversial. We aimed to demonstrate the comparative efficacy between hemoperfusion and tocilizumab in the reduction of mortality from severe COVID-19 pneumonia.

**Methods:** A multicentered, ambispective study was conducted on adult patients who were diagnosed with COVID-19 pneumonia between January 1st, 2020, and December 31st, 2021. Clinical parameters including the specific therapy with hemoperfusion (Hemoadsorption cartridge, HA330 JACFRON) or tocilizumab were collected for analysis. Invariable and multivariable regression analyses were performed to determine the association between the specific therapy and the 28-day mortality.

**Results:** A total of 92 patients with COVID-19 pneumonia were eligible for analyses (25 patients received hemoperfusion and 67 patients received tocilizumab). The 28-day mortality in the hemoperfusion and tocilizumab groups were 64.0% and 25.4% respectively ( $p=0.001$ ). However, receiving Tocilizumab was not associated with mortality rate, compared to hemoperfusion in the multivariable analysis [OR 0.56 (95%CI 0.13 - 2.39);  $p=0.428$ ]. Receiving invasive mechanical ventilator (%), duration of hospitalization, and successful withdrawal of invasive mechanical ventilation was not different between the two groups. Inflammatory marker (CRP) was significantly reduced with hemoperfusion and tocilizumab  $-46.2$  ( $-88.37$ ,  $-24.9$ ) ( $p=0.013$ ) and  $-45.1$  ( $-54.6$ ,  $-26.15$ ) ( $p<0.001$ ).

**Conclusions:** The 28-day mortality of COVID-19 pneumonia patients receiving hemoperfusion and tocilizumab were comparable.

#### FR-PO017

### Urinary Biomarkers as Predictors of AKI in COVID-19 Hospitalized Patients With Pneumonia

Raul V. Enriquez, Lilia M. Rizo Topete. *Hospital Universitario Dr Jose Eleuterio Gonzalez, Monterrey, Mexico.*

**Background:** COVID-19 disease manifests in most cases as a lower respiratory tract infection. The most frequently reported causes of admission to the intensive care unit in patients with COVID-19 are hypoxemic respiratory failure that requires invasive mechanical ventilation or hypotension that requires support with vasoactive amines. Data on AKI are scarce since they only report on incidence in these patients. The use of microalbuminuria as a marker for AKI was shown in an animal model and correlated with other markers. NGAL has been tested in multiple studies of patients at risk of AKI due to sepsis, cardiac surgery or exposure to contrast media.

**Methods:** A prospective observational study. Patients who came to the area for COVID-19 were recruited. Upon admission, a urine sample was analyzed with Getein 1100, by quantitative immunofluorescence to determine levels of microalbuminuria and NGAL in 50 patients with creatinine  $<1.0$ . All patients had high oxygen requirements ( $>5$  liters/minute). All patients who had a positive PCR test for SARS CoV-2 were included and patients with a history of chronic kidney disease, urinary symptoms, underlying urological disease or complications of Diabetes or hypertension were excluded. Laboratories were collected at admission and 5 days after admission to compare with initial NgAl and microalbuminuria levels.

**Results:** The association of the variables was analyzed using the Spearman correlation coefficient, since they are continuous variables. It was found that an elevation of creatinine at day 5 and an initial NgAl  $>200$  and microalbuminuria  $>30$  have a moderate correlation ( $\rho = 0.46$ ) with a  $p < 0.05$ , and a low correlation ( $\rho = 0.28$ ) and a  $p < 0.05$ , respectively.

**Conclusions:** There is no ideal biomarker for acute kidney injury. With the emergence of COVID-19 disease, it is necessary to be able to prevent and treat acute kidney injury on time, in order to reduce the morbidity and mortality of these patients. In this study, it is observed that 2 biomarkers have a significant correlation to predict acute kidney injury.

#### FR-PO018

### International Multicenter Study to Investigate the Performance of Urinary L-FABP in Predicting COVID-19 Severity

Daisuke Katagiri,<sup>1</sup> Yusuke Asai,<sup>4</sup> Minami Suzuki,<sup>1</sup> Hideki Takano,<sup>1</sup> Yoshihiro Miyashita,<sup>5</sup> Takeshi Sugaya,<sup>2</sup> Eisei Noiri,<sup>3</sup> <sup>1</sup>National center for Global Health and Medicine Hospital Department of Nephrology, Tokyo, Japan; <sup>2</sup>Time Well Medical, Tokyo, Japan; <sup>3</sup>National Center for Global Health and Medicine, Central Biobank, National Center Biobank Network, Tokyo, Japan; <sup>4</sup>National Center for Global Health and Medicine, DCC, Tokyo, Japan; <sup>5</sup>Department of Respiratory Medicine, Yamanashi Prefecture Central Hospital, Tokyo, Japan.

**Background:** Early detection of the illness trajectory in SARS-CoV-2 infected patients is crucial for patients and healthcare workers. A practical, non-invasive approach, with simple measurement for decision-making, is necessary for a pandemic to discriminate between high and low-risk patients, even though both may appear mild initially.

**Methods:** To determine COVID-19 disease severity within 10-days, distinguishing severe vs. moderate+mild and severe+moderate vs. mild, urinary L-type fatty acid-binding protein (L-FABP) was assayed less than four days after receiving a diagnosis. Severity was divided into mild (without oxygen), moderate (with oxygen) and severe (IMV/ECMO), and L-FABP within four days of diagnosis were used to predict severity within 10 days after onset. For risk prediction, urinary L-FABP was compared with interleukin-6. Next, the L-FABP point-of-care test (POCT) was further examined for its utility in risk screening in the international multicenter study.

**Results:** Of the 224 participants in the study, 173 initially had a mild form. The AUC for a severe outcome was 96.3% in creatinine-adjusted L-FABP and 93.5% in net value. The AUC for a mild outcome was 85.0% and 84.9% net. The predictability of L-FABP for either a severe or mild outcome was superior to that of IL-6. Dynamics further showed better predictability of L-FABP than IL-6 during 10-days after onset. Finally, a multicenter-multicountry study confirmed the L-FABP POCT risk prediction of a severe outcome with an AUC of 88.9% and a mild outcome of 68.5%.

**Conclusions:** Urinary L-FABP can predict the patient's risk of illness severity in COVID-19. L-FABP may detect severe cases more effectively and earlier than IL-6. L-FABP POCT is implementable for patient management.

**Funding:** Government Support - Non-U.S.

#### FR-PO019

### Transforming Growth Factor- $\beta$ Regulates Angiotensin Converting Enzyme 2 by MicroRNA Mediated Mechanism

Ewelina Hejenkowska,<sup>1</sup> Nilay Mitash,<sup>2</sup> Joshua Donovan,<sup>1</sup> Carol A. Bertrand,<sup>2</sup> Agnieszka Swiatecka-Urban,<sup>1</sup> <sup>1</sup>University of Virginia School of Medicine, Charlottesville, VA; <sup>2</sup>University of Pittsburgh School of Medicine, Pittsburgh, PA.

**Background:** TGF- $\beta$  signaling plays an essential role in tissue fibrosis and mediates profibrotic programs after SARS-CoV-2 infection in the kidney and lung. SARS-CoV-2 also induces humoral immune responses controlled by cytokines, including TGF- $\beta$ . Studies have found that the incidence of SARS-CoV-2 infection and the severity of Covid-19 in cystic fibrosis (CF) patients is lower than the general population. We studied how SARS-CoV-2 regulates TGF- $\beta$ -mediated gene expression in the CF airway.

**Methods:** Small RNAseq was performed in human bronchial epithelial cells CFBE41o- from a patient homozygous for the F508del mutation in the *CFTR* gene on Illumina NextSeq 500's. Pathway analysis was done by Ingenuity Pathway Analysis (IPA) software (QIAGEN) and miRNet browser. IPA was used for analyzing coronavirus associated pathways affected by differentially regulated miRNAs. miRNAs predicted to target the coronavirus associated genes were collected from TargetScan Human release 7.2, miRmap, Diana-TarBase v.8, and miRBase bioinformatics tools. Anti-miRNA oligonucleotide miRCURY LNA™ Power Inhibitors or control (Exiqon) were used. Cells expressing F508del or wild type *CFTR* were used to compare the results in CF and non-CF models. Findings were validated in primary human bronchial epithelial (HBE) cells.

**Results:** Compared to vehicle control, TGF- $\beta$ 1 dysregulated 48 miRNAs; 38 and 19 pathways were uniquely affected by the upregulated and downregulated miRNAs, respectively. We found 43 miRNAs targeting 119 different mRNA of the proteins associated with coronavirus pathogenesis pathway and 21 miRNAs targeting 21 different mRNA of the proteins associated with coronavirus replication pathway. Two miRNAs upregulated by TGF- $\beta$ 1 target the host receptor for SARS-CoV-2 invasion, angiotensin converting enzyme 2 (ACE2). We confirmed the results by qRT-PCR that TGF- $\beta$ 1 increased expression of specific miRNAs targeting ACE2 mRNA. Upregulation of the

miRNAs was followed by inhibition of ACE2 mRNA and protein levels and the effect was blocked by specific anti-miRNA oligonucleotides. The above results differed between the CF and non-CF cells.

**Conclusions:** miRNAs may be important effectors of TGF-β modulating SARS-CoV-2 pathogenicity and replication in the CF airway. Ongoing studies focus on elucidating the mechanisms of SARS-CoV-2 invasion of kidney cells.

**Funding:** Other NIH Support - NHLBI-R01HL144539, Private Foundation Support

**FR-PO020**

**Lack of Evidence for Kidney Invasion by SARS-CoV-2 in a Lethal Mouse Model**

Mariya Syed,<sup>1</sup> Cosimo L. Cianfarini,<sup>1</sup> Luise Hassler,<sup>1</sup> Minghao Ye,<sup>1</sup> Jan Wysocki,<sup>1</sup> Yashpal S. Kanwar,<sup>1</sup> Dominique Missiakos,<sup>2</sup> Glenn Randall,<sup>2</sup> Daniel Battle.<sup>1</sup> <sup>1</sup>Northwestern University Feinberg School of Medicine, Chicago, IL; <sup>2</sup>University of Chicago Department of Microbiology, Chicago, IL.

**Background:** There is an ongoing controversy as to whether SARS CoV-2 can infect the kidney parenchyma directly. To date, the presence of SARS CoV-2 in the kidney has been described mainly post-mortem in autopsy studies of patients who died of or with COVID-19, but this has not been examined in an experimental model where the timing of SARS-CoV-2 infection can be defined. We used transgenic mice expressing human ACE2 (k18hACE2) susceptible to lethal SARS-CoV-2 infection to study this issue directly on kidney tissue taken at defined time points and using lung tissue as positive control.

**Methods:** Transgenic k18hACE2 mice were inoculated with 3x10<sup>4</sup> PFU SARS-CoV-2 in a BSL-3 facility. Kidneys and lungs were removed from the animals sacrificed on days 5 to 7 and used for histology (PAS-staining), immunofluorescence (IF) of the S1 spike protein of SARS-CoV-2 and measurement of viral load by plaque assay. Kidney samples were additionally evaluated by IF using kidney injury markers NGAL and KIM-1.

**Results:** Kidney tissue stained using an anti-S1-spike antibody showed negative results in all samples (n=15). By plaque assay, viral titers were also not detectable in any of the kidneys. By contrast, lungs from infected mice showed strong staining for the S1 spike protein in 13 of 14 cases and this was associated with positive viral titers in all lung samples. Despite severe lung disease, only mild and variable kidney damage was observed by histopathology. Positive staining for NGAL in the proximal tubules was consistently seen, while KIM-1 staining was rarely positive.

**Conclusions:** In a transgenic mouse model with lethal SARS-CoV-2 infection and severe lung but mild kidney disease there is no evidence of S1 spike protein in the kidney, which is consistent with lack of detection of replicating virus by plaque assay.

**Funding:** Other NIH Support - 1R21 AI166940-01 (Grant Number), Private Foundation Support

**FR-PO021**

**COVID-19-Associated AKI in Hospitalized Patients: Incidence, Risk Factors, and Outcomes in a Tertiary Care Center in Thailand**

Suphanan Phisalwut, Narongrit Siriwattanasit, Pitchamon Inkong, Narittaya Varothai, Paramat Thimachai, Pamila Tasanavipap, Amnart Chairprasert, Naowanit Nata, Theerasak Tangwonglert, Wisit Kaewput, Oupphatham Supasyndh, Bancha Satirapoj. *Phramongkutklao College of Medicine, Bangkok, Thailand.*

**Background:** Acute kidney injury (AKI) is a common complication of COVID-19 and related with severity and outcomes. However, relatively little is known about risk factors of AKI and outcomes among Thai hospitalized patients with COVID-19. The study described the incidence of different stages of AKI, risk factors and renal outcomes in hospitalized COVID-19-associated AKI patients.

**Methods:** The observational study involved a review of data from health records of COVID-19 pneumonia patients aged ≥18 years in the tertiary care center from June 1 to September 30, 2021. We describe the frequency of AKI, dialysis requirement, and adjusted hazard ratios (adjusted HR) with AKI.

**Results:** A total of 966 hospitalized COVID-19 pneumonia patients, AKI occurred in 170 (17.5%) and AKI stage 1, 2 and 3 was 45.2% (N=77), 25.2% (N=43) and 29.4% (n=50). 23 patients (13% of AKI) required dialysis. The independent risk factors for AKI were pre-existing CKD (aHR 1.74, 95%CI 1.03-2.93), cardiovascular disease (aHR 2.42, 95%CI 1.38-4.24), serum ferritin (aHR 1.001, 95%CI 1.001-1.002), history of diuretic use (aHR 2.68, 95%CI 1.08-6.64), respiratory support (aHR 3.33, 95%CI 1.65-6.73), and presence of septic shock (aHR 3.23, 95%CI 1.59-6.56). 44.7% had non renal recovery. In-hospital mortality in AKI patients was 54.1%. An adjustment for demographics, and laboratory values, the aOR for death was 2 (95%CI, 1.01-4.05)

**Conclusions:** AKI is common among patients hospitalized with COVID-19 and is associated with non-renal recovery and death. The predisposing factors are pre-existing CKD, cardiovascular disease, history of diuretic use and more severe COVID-19 presentation.

**FR-PO022**

**Role of the Complement System and Vascular Endothelium in COVID-19 Pathogenesis**

Niyousha Rostam Shirazi,<sup>1</sup> Christoph Licht,<sup>2</sup> <sup>1</sup>University of Toronto, Toronto, ON, Canada; <sup>2</sup>The Hospital for Sick Children, Toronto, ON, Canada.

**Background:** Coronavirus Disease 2019 (COVID-19) caused by SARS-CoV-2 infection has become a global pandemic, presenting with varying degrees of severity from respiratory distress to multi-organ damage. Kidneys are of several organs affected in COVID-19, with acute kidney injury (AKI) being a common consequence, occurring in more than 30% of patients with severe COVID-19. While the underlying mechanisms of COVID-19 pathogenesis remain poorly understood, there is evidence linking complement system overactivation and endothelial injury to organ damage that increases the risk of mortality in COVID-19. Evidence from previous coronavirus epidemics also suggest direct involvement of inflammation, complement dysregulation, and endothelial cell dysfunction. Thus, we hypothesize that vascular endothelial injury resulting from complement overactivation contributes to COVID-19-associated organ injury.

**Methods:** Clinical information and sera from SARS-CoV-2+ patients with mild (n=7) and severe COVID-19 (n=7) diseases were obtained from the Canadian COVID-19 Prospective Cohort Study (CANCOV). Complement activation on ECs was evaluated via immunofluorescence assays, measuring the deposition of complement products C3b and C5b-9 on Human Umbilical Vein Endothelial Cells exposed to control or patient sera. In addition, a permeability assay using a transwell model was used to measure the integrity of the endothelial monolayer exposed to patient sera.

**Results:** Complement was found to be overactivated on ECs treated with SARS-CoV-2+ patient sera compared to those treated with normal human serum as evidenced by significantly increased C3b and C5b-9 deposition. While ECs treated with sera from patients with mild COVID-19 seemed to have higher C3b deposition, ECs treated with sera from patients with severe COVID-19 disease were associated with higher C5b-9 deposition. In addition, increased permeability of the monolayer incubated with SARS-CoV-2+ patient sera was seen over time regardless of disease severity. However, ECs treated with severe COVID-19 patient sera had significantly increased vascular leakiness as evidenced by increased permeability of the treated monolayer.

**Conclusions:** Thus, we conclude that complement is overactivated in SARS-CoV-2+ patients and use of anti-complement therapies may be an effective strategy in treating COVID-19 associated vascular injury, hyperinflammation, and organ damage.

**FR-PO023**

**Role of Urinary IL-6 (uIL-6) and Mechanical Ventilation (MV) Parameters in the Development of AKI in Severely Ill Patients With SARS-CoV-2**

David Escamilla-Illescas,<sup>1</sup> Gustavo A. Casas-Aparicio,<sup>2</sup> <sup>1</sup>Medica Sur, Ciudad de Mexico, Mexico; <sup>2</sup>Instituto Nacional de Enfermedades Respiratorias, Mexico, Mexico.

**Background:** MV Parameters and biomarkers have been associated with the development of AKI in patients with ARDS due to SARS-COV-2. The objective was to analyze these factors in patients who required early MV (<6 hours from hospital admission).

**Methods:** Single center, prospectively study, conducted at the National Institute of Respiratory Diseases (INER) in Mexico City. We included patients with Pneumonia caused by SARS-COV-2 confirmed by rPCR who require early MV in September 2021. We recorded MV parameters and took a urine sample for measurement of IL-6 by ELISA immediately after the start of MV. Clinical and laboratories data was gathered from medical file. Patients were followed up during hospitalization to analyze outcomes. We define AKI according to KDIGO criteria using only serum creatinine. We used chi-squared and Mann Whitney-U test as appropriate, to compare variables between patients who developed AKI and those who did not. We calculated the area under the curve (AUC) for IL-6 and established a sensibility and specificity balanced cut-off point. We performed a multivariate logistic regression.

**Results:** We included 45 patients with a median age of 57 years-old, 66.7% were men. Plateau Pressure (PP), Peak Inspiratory Pressure (PIP), Driving Pressure (DP) and Static Compliance (SC) as well as uIL-6 were higher in the group with AKI. The AUC for uIL-6 was 0.819 (95% CI: 0.687-0.951; **p <0.01**), the cutoff with the best accuracy was 1.5 pg/mL. The results of univariate and multivariate logistic regression are show in table 1.

**Conclusions:** Higher levels of uIL-6 and PP in patients who require early MV were associated to development of AKI during hospitalization. Pulmonary inflammation and stiffness may play a role in the development of AKI.

**Funding:** Government Support - Non-U.S.

Univariate and multivariate analysis for AKI

Variables	Unadjusted OR (95% CI)	p	Adjusted OR (95% CI)	p
Age	1.02 (1.00-1.06)	0.16	1.03 (1.00-1.09)	0.25
Male	1.51 (0.43-5.31)	0.52	5.68 (0.57-56.10)	0.13
u-IL-6 > 1.5 pg/mL	7.27 (1.69-31.25)	0.01	9.35 (1.04-83.46)	0.04
Plateau Pressure	1.25 (1.04-1.45)	0.01	3.04 (1.004-9.2)	0.04
Driving Pressure	1.21 (1.03-1.43)	0.02	0.92 (0.55-1.53)	0.75
Static Compliance	0.93 (0.87-1.00)	0.049	0.95 (0.76-1.19)	0.95
Peak Inspiratory Pressure	1.16 (1.02-1.33)	0.01	0.50 (0.22-1.11)	0.09

CI: Confidence Interval; OR: Odds Ratio; u-IL-6: Urinary Interleukine-6

FR-PO024

**Angiotensin-Converting Enzyme 2 and Urine Amino Acid Excretion Increase in COVID-19 Patients With AKI**

Ander Vergara,<sup>1</sup> Kaiming Wang,<sup>1</sup> Daniele Colombo,<sup>4</sup> Mahmoud Gheblawi,<sup>1</sup> Jaslyn C. Rasmuson,<sup>1</sup> Rupasri Mandal,<sup>1</sup> Franca Del Nonno,<sup>4</sup> Brian Chiu,<sup>1</sup> James W. Scholey,<sup>3</sup> Maria Jose Soler,<sup>2</sup> David S. Wishart,<sup>1</sup> Gavin Oudit.<sup>1</sup>  
<sup>1</sup>University of Alberta, Edmonton, AB, Canada; <sup>2</sup>Hospital Universitari Vall d'Hebron, Barcelona, Spain; <sup>3</sup>University Health Network, Toronto, ON, Canada; <sup>4</sup>INMI Lazzaro Spallanzani IRCCS, Roma, Italy.

**Background:** Angiotensin-converting enzyme 2(ACE2), the receptor for SARS-CoV-2, is highly expressed in the kidneys. ACE2 also possess a unique function to facilitate amino acid absorption. A persistent elevation in plasma ACE2 during COVID-19 is related to increased mortality. The present study sought to explore the relationship between urine ACE2(uACE2) and renal outcomes in COVID-19 patients.

**Methods:** In 104 COVID-19 patients without acute kidney injury(AKI), 43 patients with COVID-19-mediated AKI, and 36 non-COVID-19 controls, uACE2, urine tumor necrosis factor receptors I and II(uTNF-RI and uTNF-RII), neutrophil gelatinase-associated lipocalin(uNGAL), and urine albumin-creatinine ratio were measured. We also assessed ACE2 staining in autopsy kidney samples and generated a propensity-score matched subgroup to perform a targeted urine metabolomic study to describe the characteristic urine signature of COVID-19.

**Results:** uACE2 was increased in patients with COVID-19, and further increased in those that developed AKI(Figure 1). After adjusting uACE2 levels for age, sex and previous comorbidities, increased uACE2 was independently associated with over 3-fold higher risk(OR 3.05,95%CI:1.23-7.58, p=0.017) of developing AKI. Increased uACE2 corresponded to a tubular loss of ACE2 in kidney sections and strongly correlated with uTNF-RI and uTNF-RII, suggesting that ADAM17 could be responsible for ACE2 shedding. Urine quantitative metabolome analysis revealed an increased excretion of essential amino acids in COVID-19 patients, including leucine, isoleucine, tryptophan and phenylalanine. Additionally, a strong correlation was observed between urine amino acids and uACE2(Figure 1).

**Conclusions:** Elevated uACE2 is related to AKI in patients with COVID-19. The loss of tubular ACE2 during SARS-CoV-2 infection demonstrates a potential link between aminoaciduria and proximal tubular injury.

**Funding:** Government Support - Non-U.S.

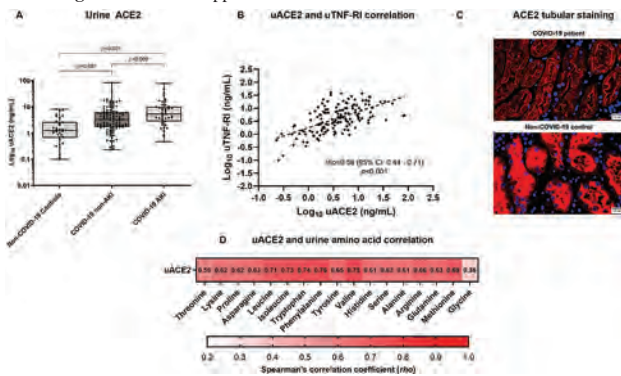

FR-PO025

**RECOVID: Renal Outcomes and Mortality in Patients With COVID-19 Infection at UCLA**

Peter Fahim, Charley Q. Jang, Tristan Grogan, Arseniy Vasilyev, Mohammad Kamgar, Niloofar Nobakht. *University of California Los Angeles, Los Angeles, CA.*

**Background:** Acute kidney injury (AKI) is a common complication in patients with COVID-19 infection with rates as high as 32% to 46% and has been associated with poor outcomes. Our study investigates the frequency, risk factors, need for kidney replacement therapy (KRT), and mortality among patients with COVID-19 infection and AKI in both vaccinated and unvaccinated populations.

**Methods:** This retrospective, observational study is a review of 2 years of data from early pandemic in March 2020 till March 2022. Data of patients aged ≥18 years with laboratory-confirmed COVID-19 admitted to UCLA Ronald Reagan Medical Center and UCLA Santa Monica Medical Center were analyzed.

**Results:** Among the 3527 hospitalized patients with COVID-19, AKI occurred in 972 (27.6%) patients. Of the 972 patients with AKI, 411 (42.3%) did not receive the COVID-19 vaccine, 94 (9.6%) were partially vaccinated (1 dose), and 465 (48.1%) were fully vaccinated patients (2 doses). Among AKI patients, in-hospital mortality was 46.2% in unvaccinated patients versus 12.4% in fully vaccinated (OR 6.1, 95% CI, 4.3 to 8.5) and 18% of unvaccinated patients remained on dialysis at discharge versus 12.2% among fully vaccinated (OR 1.6, 95% CI, 1.1 to 2.3).

**Conclusions:** Fully vaccinated patients with COVID-19 infection and AKI had less in-hospital mortality and were less dialysis-dependent at the time of discharge.

Table 1: Demographics, race/ethnicity, and comorbidities

		Not vaccinated [N(%)=411(42.28%)]	Two doses [N(%)=467(48.05%)]
Demographics	Age at diagnosis (Mean (SD))	66.98 (19.65)	67.39 (17.26)
	Female	152 (36.98%)	180 (38.54%)
	BMI (Mean (SD))	28.29 (7.11)	27.98 (7.37)
	Smoking - current or former	122 (39.87%)	175 (39.68%)
Race/Ethnicity	White	182 (44.28%)	254 (54.39%)
	Black or African American	56 (13.63%)	46 (9.85%)
	Hispanic or Latino	136 (33.09%)	153 (32.76%)
	Asian	30 (7.3%)	29 (6.21%)
	American Indian or Alaska Native	1 (0.24%)	
	Native Hawaiian or Other Pacific Islander	3 (0.73%)	1 (0.21%)
Comorbidities	CHF	126 (30.66%)	133 (28.48%)
	MI	75 (18.25%)	88 (18.84%)
	PVD	101 (24.57%)	147 (31.48%)
	CVD	90 (21.9%)	129 (27.62%)
	Dementia or chronic cognitive deficit	69 (16.79%)	51 (10.92%)
	COPD	115 (27.98%)	190 (40.69%)
	Rheumatologic disorder	27 (6.57%)	42 (8.99%)
	PUD	22 (5.35%)	28 (6%)
	Liver disease	54 (13.14%)	118 (25.27%)
	Diabetes with end-organ damage	83 (20.19%)	128 (27.41%)
	Diabetes without end-organ damage	149 (36.25%)	198 (42.4%)
	Paraplegia or hemiplegia	25 (6.08%)	24 (5.14%)
	CKD	131 (31.87%)	194 (41.54%)
	Active cancer	81 (19.71%)	130 (27.84%)
HIV	2 (0.49%)	4 (0.86%)	

Abbreviations: CHF, Congestive Heart Failure (symptomatic); CKD, Chronic Kidney Disease; COPD, Chronic Pulmonary Disease (not asthma); CVD, Cerebrovascular Disease; HIV, Human Immunodeficiency Virus; MI, Myocardial Infarction; PVD, Peripheral Vascular Disease (claudication, prior revascularization, aortic aneurysm >6 cm); PUD, Peptic Ulcer Disease

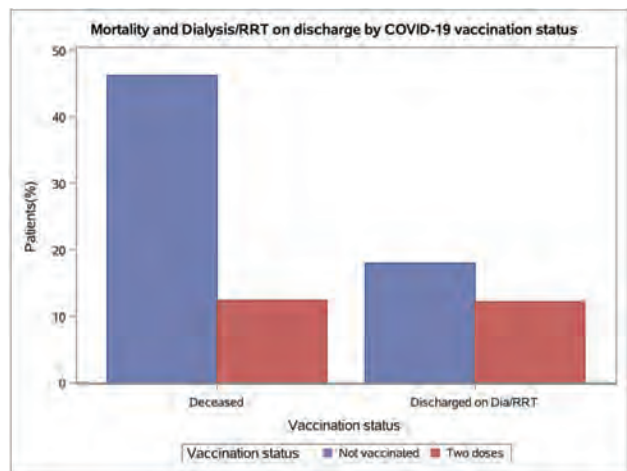

FR-PO026

**Impact of Metabolic Acidosis on All-Cause Mortality in Patients With COVID-19**

Yaerim Kim,<sup>1</sup> Soie Kwon,<sup>2</sup> Jeonghan Lee,<sup>3</sup> Jin hyuk Paek,<sup>1</sup> Woo Yeong Park,<sup>1</sup> Kyubok Jin,<sup>1</sup> Seungyeup Han,<sup>1</sup> Dong Ki Kim,<sup>2</sup> Jung Pyo Lee.<sup>3</sup> <sup>1</sup>Keimyung University School of Medicine, Daegu, Republic of Korea; <sup>2</sup>Seoul National University Hospital, Jongno-gu, Seoul, Republic of Korea; <sup>3</sup>Seoul National University Seoul Metropolitan Government Boramae Medical Center, Dongjak-gu, Seoul, Republic of Korea.

**Background:** Low total CO<sub>2</sub> (tCO<sub>2</sub>) levels are significantly associated with all-cause mortality. Lots of factors are related to the poor prognosis of COVID-19, it was a lack of data to evaluate the impact of tCO<sub>2</sub>. We evaluated the impact of metabolic acidosis on all-cause mortality in patients with COVID-19.

**Methods:** We retrospectively reviewed the data from two independent hospitals that care for admitted patients with COVID-19 between February 2020 and September 2021. We excluded subjects with underlying end-stage kidney disease, no data of tCO<sub>2</sub> value, and age under 18 years old. The primary outcome was in-hospital mortality. We evaluate the impact of tCO<sub>2</sub> as a continuous variable on mortality using the Cox-proportional hazard model. In addition, we tried to find the relative value of tCO<sub>2</sub> to increase the risk of mortality using a generalized additive model. We also evaluated the impact of such a value of tCO<sub>2</sub> and 22mEq/L of tCO<sub>2</sub> on mortality.

**Results:** A total of 4,423 patients were included, and the mean age was 54.7±18.3 years old. Mean tCO<sub>2</sub> was 26.2±3.6 mEq/L, and there were 792 (17.9%) with tCO<sub>2</sub> <22 mEq/L. Increased in 1 mEq/L of tCO<sub>2</sub> significantly decreased risk for all-cause mortality after adjustment with age, sex, history of hypertension, diabetes, and laboratory results such as serum white blood count, hemoglobin, platelet, calcium, phosphate, albumin, and eGFR (adjusted HR 0.95, 95% CI 0.91, 0.99). We found that the level of 24 mEq/L of tCO<sub>2</sub> as a cut-off value to increase risk of mortality. In the Cox-proportional hazard model, the risk of all-cause mortality was significantly increased by around 1.6 times in subjects with lower tCO<sub>2</sub> irrespective of the cut-off value of 22 or 24 mEq/L.

**Conclusions:** Decreased tCO<sub>2</sub> significantly increased the risk of all-cause mortality in patients with COVID-19. Monitoring of tCO<sub>2</sub> could be a good indicator to predict prognosis, and it needs to be considered to encourage in patients with a specific condition.

**FR-PO027**

**Outcomes Among Hospitalized Patients With COVID-19 and AKI: Role of SARS-CoV-2 Vaccine**

**Jose L. Torres Cuevas,** Froylan D. Martinez-Sanchez, Hector R. Gonzalez Sanchez, Santiago Saenz-Ancira, Yatzil Reyna Juárez, Alejandra Diaz-Jarquín, Carlos A. Romero-Reyes, Luis A. Ibarra Santoyo, Joana B. Juarez, Mauricio A. Salinas-Ramirez, Erika K. Tenorio-Aguirre. *Hospital General Dr Manuel Gea Gonzalez, Ciudad de Mexico, Mexico.*

**Background:** COVID-19 and Acute kidney injury (AKI) are associated with increased mortality and worse kidney outcomes. Although vaccines against SARS-CoV-2 have decreased the rate COVID-19 morbimortality, the role of immune protection against SARS-CoV-2 in the setting of AKI has not been fully yielded

**Methods:** Retrospective case-control study that included clinical and biochemical data of 412 (78 vaccinated and 334 non-vaccinated) patients with severe COVID-19. Cox regression analyses were used to evaluate the effect of the vaccine in mortality and AKI outcomes

**Results:** The mean age of the patients was 55±15 years, 64% were women, the mean body mass index was 28±5 kg/m<sup>2</sup>, and median in-hospital stay was 10(6-16) days. The rate of mortality and AKI 3 was 29% vs 10% and 27% vs 13%, for unvaccinated and vaccinated patients, respectively. Cox proportional hazard ratios for survival and prevention of AKI are shown in table 1

**Conclusions:** The SARS-CoV-2 vaccine was independently associated with lower mortality and AKI progression in patients with severe COVID-19

Table 1. Cox proportional hazard model of SARS-CoV-2 vaccination and the risk for mortality, development of Acute Kidney Injury (AKI), and AKI stage 3

SARS-CoV-2 Vaccine	Mortality		AKI 1-3*		AKI 3*	
	HR (95%CI)	p value	HR (95% CI)	p value	HR (95%CI)	p value
Unadjusted	0.382 (0.185-0.785)	0.009	0.629 (0.441-0.897)	0.010	0.528 (0.274-1.017)	0.056
Model 1	0.348 (0.168-0.719)	0.004	0.597 (0.418-0.853)	0.005	0.498 (0.256-0.967)	0.040
Model 2	0.440 (0.211-0.919)	0.029	0.585 (0.407-0.842)	0.004	0.464 (0.234-0.919)	0.028
Model 3	0.444 (0.213-0.927)	0.031	0.534 (0.368-0.776)	0.001	0.493 (0.246-0.985)	0.045

Model 1 was adjusted by age, sex, and Body Mass Index; model 2 included model 1 plus type 2 diabetes, blood pressure >140/90 mmHg, chronic kidney disease, renal replacement therapy, and AKI 3; and model 3 included model 2 plus serum levels of D-dimer, lactic dehydrogenase, C-reactive protein, and ferritin.

\* In model 2 variable AKI 3 was not included in the Cox regression analysis.

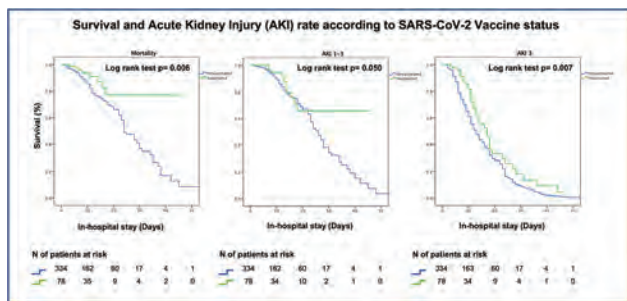

**FR-PO028**

**Assessment of Magnesium Disturbances and Clinical Characteristics in Patients With COVID-19 In São Paulo, Brazil**

**Claudia M. Helou,** Marcia Fernanda Arantes de Oliveira, Igor Smolentzov, Camila E. Rodrigues, Lucia Andrade. *GRUPO IRA do HC-FMUSP Universidade de Sao Paulo Laboratorio de Pesquisa Basica em Doencas Renais, Sao Paulo, Brazil.*

**Background:** Infection with severe acute respiratory syndrome coronavirus 2 has resulted in a global pandemic. The objective of this study was to investigate the prevalence, causes, and clinical implications of magnesium disturbances, including their possible association with treatment outcomes, among patients with COVID-19.

**Methods:** This cohort study was conducted at the Hospital das Clínicas, a tertiary care academic medical center in the city of São Paulo, Brazil. We included only patients diagnosed with COVID-19, and all clinical data were extracted from medical records.

The patients were classified as having hypomagnesemia (HypoMg, plasma Mg ≤ 1.58 mg/dL) or hypermagnesemia (HyperMg, plasma Mg ≥ 2.55 mg/dL), and the groups were compared in terms of clinical features and outcomes. We analyzed data collected at admission, ≤ 72 h after admission, or both.

**Results:** We analyzed 3,777 patients. Data regarding magnesium levels were available for 3,162 of those patients, and 344 (10.9%) were found to have HyperMg (240 men and 104 women). The mean age of the HyperMg group patients was 62.2 ± 0.8 years (range, 15-98 years). Of the HyperMg group patients, 54% died during hospitalization, 86% required mechanical ventilation, 13.4% developed AKI, 4% required dialysis, and 4.3% presented cardiac arrhythmia. Comorbidities included COPD (in 6%), diabetes (in 36.6%), hypertension (in 61.5%), and cardiovascular disease (in 17%). Seven patients presented moderately high levels of Mg (> 4.0 mg/dL), and all of those patients died. Of the 344 HyperMg group patients, 97 (28%) had hypernatremia and 27 (8%) had hyponatremia. HypoMg was found in 166 (5.2%) of the patients (84 men and 82 women). The mean age of the HypoMg group patients was 59.0 ± 1.4 years (range, 18-99 years), and 23% died during hospitalization. Of the 166 HypoMg group patients, 11 (6.6%) had hypernatremia and 11 (6.6%) had hyponatremia.

**Conclusions:** Magnesium disturbances, especially HyperMg, appear to be common in COVID 19, increasing the risk of death. Further studies are needed in order to determine the cause of the high rate of hypermagnesemia in patients with COVID-19.

**Funding:** Government Support - Non-U.S.

**FR-PO029**

**Risk Factors for AKI in Patients With COVID-19 in Two University Hospital of Colombia**

**Kateir Contreras,<sup>1,2</sup>** Oscar R. Barbosa Silva,<sup>3</sup> Ana C. Munoz,<sup>3</sup> Juan S. Suarez,<sup>2</sup> Camilo A. Gonzalez,<sup>1,3</sup> Patricia Rodriguez,<sup>3,1</sup> Martha C. Valderrama Rios,<sup>2</sup> Paola Garcia,<sup>3,1</sup> Diana C. Vargas angel,<sup>1,3</sup> Jorge A. Cortes.<sup>2</sup> *COVAKI Hospital Universitario San Ignacio, Bogota, Colombia; <sup>2</sup>Universidad Nacional de Colombia, Bogota, Colombia; <sup>3</sup>Pontificia Universidad Javeriana, Bogota, Colombia.*

**Background:** Patients with COVID-19 have a high incidence of acute kidney injury (AKI), which is associated with mortality. The objective of our study is to know the factors associated with AKI, to manage the level of care and health resources according to risk.

**Methods:** We design an observational retrospective cohort study in 2 hospitals in Bogotá, Colombia. Adults hospitalized for > 48 hours between March 2020 and March 2021, with confirmed SARS-CoV-2 infection. The main outcome was incidence of AKI during the first 28 days from admission. A descriptive analysis of the sociodemographic and clinical characteristics of the study population was performed. Univariate and bivariate analysis and multivariate logistic regression model was conducted for the outcome AKI.

**Results:** We included 1584 patients, 60.4% male, 46.8% older than 65 years. The incidence of AKI was 46.5%, stage 1 in 60.7%, Stage 2 in 15.7%, and stage 3 in 23.6%. Renal replacement therapy was performed in 11.1% of patients with AKI. Table 1 summarizes cohort characteristics and the bivariate analysis. In the multivariate analysis, sex, age, hypertension, CKD, treatment with oral antidiabetics, diuretics, statins, qSOFA, platelet count, CRP, D-dimer, treatment with vancomycin, piperacillin tazobactam, requirement of vasopressor support were related with AKI. The interactions antihypertensive /diuretics, PAFI /Requirement of invasive mechanical ventilation, Hypertension /antihypertensives, were associated with AKI (P value <0.5). Hospital crude mortality for AKI was 45.5% versus 11.7% without AKI (p<0.0001)

**Conclusions:** AKI is frequent in patients hospitalized with COVID 19, conventional risk factors are the rule, we denote other known markers of severity for COVID-19 in association with AKI. These results allowed us to manage the hospital resource

Characteristic	Total (n=1584)	Non-AKI (n=846)	AKI (n=738)	p-value
Age - median in years (IQR)	63 (21.5)	61 (23)	66 (19)	0.000
Gender (male - n (%))	956 (60.4)	436 (51.5)	520 (70.5)	0.000
Days from onset of symptoms until admission - median in days (IQR)	7 (5)	7 (6)	6 (4)	0.102
Respiratory symptoms on admission - n (%)	1309 (82.6)	701 (82.5)	608 (82.4)	0.903
Gastrointestinal symptoms on admission - n (%)	442 (28)	240 (28.4)	202 (27.5)	0.703
Overweight or obesity - n (%)	393 (24.8)	178 (21)	215 (29.1)	0.000
Smoking - n (%)	403 (25.4)	188 (22.2)	215 (29.1)	0.002
Diabetes mellitus - n (%)	325 (20.5)	152 (18)	173 (23.4)	0.007
Hypertension - n (%)	664 (41.9)	299 (35.3)	365 (49.5)	0.000
Chronic kidney disease - n (%)	103 (6.4)	22 (2.6)	79 (10.7)	0.000
Heart failure - n (%)	106 (6.7)	37 (4.4)	69 (9.4)	0.000
Charlson index - median (IQR)	0 (1)	0 (1)	0 (1)	0.000
Immunosuppression* - n (%)	9 (0.6)	4 (0.5)	5 (0.7)	0.589
Previous immunosuppressive treatment - n (%)	35 (2.2)	19 (2.3)	16 (2.2)	0.916
Prior antihypertensive treatment - n (%)	1128 (71.2%)	622 (73.5)	506 (68.6)	0.030
Previous statin treatment - n (%)	548 (34.6)	342 (40.4)	206 (28)	0.000
Previous treatment with diuretics - n (%)	182 (11.5)	517 (61.1)	305 (41.5)	0.000
Previous treatment with oral antidiabetics - n (%)	930 (58.7)	544 (64.3)	386 (52.3)	0.000
Previous treatment with NSAIDs - n (%)	74 (4.7)	26 (3.1)	48 (6.5)	0.001
Temperature at admission - median in degrees Celsius (IQR)	36.7 (0.9)	36.7 (1)	36.6 (0.7)	0.014
Diastolic blood pressure on admission - median in mmHg (IQR)	74 (15)	75 (14)	74 (17)	0.001
Oxygen saturation on admission - median in % (IQR)	88 (5)	88 (8)	88 (10)	0.408
qSOFA at admission - n (%)				0.000
qSOFA 0	634 (41.3)	389 (45.5)	249 (26.5)	
qSOFA 1	782 (49.4)	415 (49.1)	367 (49.7)	
qSOFA 2	137 (8.7)	46 (5.4)	91 (12.3)	
qSOFA 3	11 (0.7)	0 (0)	11 (1.5)	
PAFI at admission - median (IQR)	244 (133-5)	262 (106)	237 (139)	0.000

**Key: TH - Thursday; FR - Friday; SA - Saturday; OR - Oral; PO - Poster; PUB - Publication Only**

**Underline represents presenting author.**

FR-PO030

**Clinical Characteristics and Outcomes of Critically Ill COVID-19 Patients That Required Continuous Renal Replacement Therapy With and Without Adjuvant Blood Purification**

Victor M. Ortiz-Soriano,<sup>1</sup> Stuart M. Carter,<sup>1</sup> Lucas J. Liu,<sup>1</sup> Jin Chen,<sup>1</sup> Javier A. Neyra.<sup>2</sup> <sup>1</sup>University of Kentucky, Lexington, KY; <sup>2</sup>University of Birmingham at Alabama, Birmingham, AL.

**Background:** oXiris use received EUA by the FDA as a blood purification adjuvant for COVID-19 critical illness. We evaluated clinical characteristics and outcomes of patients with COVID-19 critical illness that received CRRT with vs. without oXiris.

**Methods:** Single-center, retrospective cohort study of adult ICU patients with COVID-19 critical illness requiring CRRT (3/2020 to 4/2021). oXiris exposure was defined as a minimum use of 48 h within the first 72 h of CRRT initiation and use of at least 50% of time if the patient died within the first 72 h of CRRT. Data were analyzed with and without propensity-score (PS) matching and with PS-regression.

**Results:** 114 critically ill COVID adults admitted to the ICU required CRRT during the study period. Of these, 11 patients used oXiris without meeting the definition of exposure and were excluded. Of the 103 remaining patients, 31 used oXiris and 72 did not. Mean (SD) age of the cohort was 60 (12) years, 66% were male, and 81% white. There were no differences in demographics between both groups. Similarly, there was no difference in baseline kidney function or prevalence of ESRD. Patients that received oXiris had more frequently sepsis (90% vs. 63%, p=0.004) and more frequently received IL-6 inhibitors but CRRT indications were similar in both groups, being the most common one fluid overload in about two-third of patients. Critical illness parameters including SOFA scores (median of 11 in both groups) and extracorporeal organ support (ECMO or mechanical ventilation) were also similar in both groups. Inpatient mortality was not different between both groups (74% in the oXiris group vs. 65% in the non-oXiris group, p=0.37). Further, 28-day ventilator, CRRT and ICU free-days were comparable in both groups. Similarly, kidney recovery rates were not different based on oXiris exposure. These results were consistent in all adjusted analyses. There were no circuit or filter related complications attributed to oXiris.

**Conclusions:** The use of oXiris as adjuvant treatment of blood purification during CRRT appears feasible and safe. We did not observe differences in mortality, kidney recovery, or resource utilization among patients exposed vs. non-exposed to oXiris. The clinical impact of oXiris needs to be further evaluated in interventional studies.

FR-PO031

**Kidney Outcomes in Critically Ill Patients With and Without COVID-19**

Frances Tian, Leila R. Zelnick, Mark M. Wurfel, Pavan K. Bhatraju, Bryan R. Kestenbaum. University of Washington, Seattle, WA.

**Background:** Case series have described high rates of AKI in critically ill persons with covid-19. However, no study has directly compared kidney outcomes in similarly ill persons with and without covid-19 that are contemporaneously enrolled.

**Methods:** We assessed 346 participants from a study of covid-19 in critical illness enrolled from University of Washington from April 2020 to May 2021. Patients in the ICU were recruited if symptoms of lower respiratory tract infection prompted covid testing. 2/3 of the cohort were covid positive; the remaining 1/3 had another cause of respiratory illness and served as controls. We defined major adverse kidney events (MAKE) as doubling of serum creatinine, dialysis, or death during hospitalization. Among 186 patients with available urine samples, we also assessed kidney injury molecule-1 (KIM-1), epidermal growth factor (EGF), and Cr. We used inverse probability of treatment weighting with propensity scores to increase similarity between the comparison groups.

**Results:** Mean age was 55 years; 64% were male, and mean admission serum Cr was 1.3 ± 1.0 mg/dL. Baseline characteristics, including APACHE III and SOFA scores, were similar between groups after propensity weighting. Among Covid-19 patients the incidence of MAKE was 45% and in non-covid-19 patients was 26%. Covid-19 positivity was associated with a 55% greater incidence of MAKE and each component of MAKE was numerically higher in the covid-19 positive group (figure). The covid positive group had lower urine EGF levels (indexed to urine Cr) over time. Urine KIM-1 levels were similar.

**Conclusions:** The incidences of clinical kidney outcomes are numerically higher in critically ill patients with covid-19 compared with similarly ill control patients without covid-19. Urinary concentrations of EGF are lower in covid positive patients.

Comparison of clinical outcomes and kidney markers in critically ill persons with and without covid-19

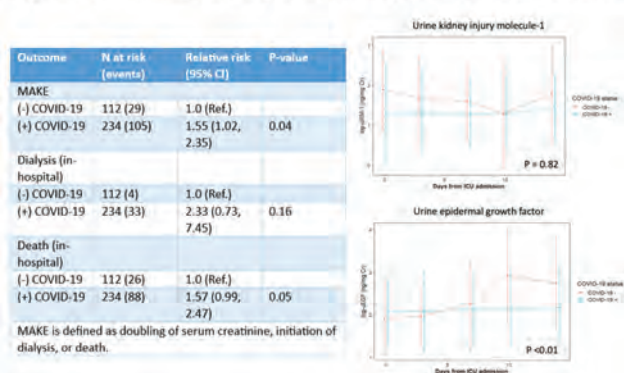

FR-PO032

**Validation of UCSD-Mayo Risk Score for Predicting Hospital-Acquired AKI in COVID-19 Patients**

Rolando Claude-Del Granado,<sup>1,2</sup> Nicholas Y. Barbosa,<sup>1,2</sup> Marina Wainstein,<sup>3</sup> Sally Shrapnel,<sup>4</sup> ISARIC Clinical Characterization Group <sup>1</sup>Hospital Obrero No 2 - CNS, Cochabamba, Bolivia, Plurinational State of; <sup>2</sup>Universidad Mayor de San Simon, Cochabamba, Bolivia, Plurinational State of; <sup>3</sup>The University of Queensland Medicine Program, Brisbane, QLD, Australia; <sup>4</sup>The University of Queensland Mathematics Discipline, Brisbane, QLD, Australia.

**Background:** Acute kidney injury (AKI) in patients hospitalized with coronavirus disease 2019 (COVID-19) is common and often associated with poor prognosis. Early prediction of AKI that may allow early and effective interventions is essential to improve clinical outcomes. In this study we aimed to validate the UCSD-Mayo risk score for AKI in a non-ICU population of patients hospitalized with COVID-19 in a Bolivian referral center.

**Methods:** One hundred and thirty-nine patients hospitalized with COVID-19 from Hospital Obrero No 2 – CNS in Cochabamba, Bolivia were enrolled in this study. Data for predictor variables was extracted from patient’s medical records and the International Severe Acute Respiratory and Emerging Infection Consortium (ISARIC - WHO) case report forms at hospital admission. The UCSD-Mayo risk score was calculated using the original equation (Nephrol Dial Transplant. 2017; 32(5): 814–822). Patient information was recorded from the time of diagnosis and renal function was followed up daily up to 7 days. AKI was defined using KDIGO serum creatinine criteria.

**Results:** A total of 77 patients (55.4%) developed AKI, 75.3% were male with a mean age of 67 years (SD 15). The patients who developed AKI had significantly higher UCSD-Mayo score (≥5 points) than those without AKI (36.4% [n=28] vs. 17.7% [n=11]; 0.015). Positive and negative predictive values for the optimal cutoff value of ≥ 5 points in the cohort were 72% and 51% respectively with an odds ratio of 2.65 (95% CI 1.19-5.89; p=0.015). The UCSD-Mayo risk score performance was regular in predicting AKI with a ROC-AUC of 0.632 (95% CI 0.540 - 0.725; p = 0.07). As expected, mortality was higher in patients who developed AKI compared to those that did not (57%, [n=44] vs. 40.3% [n=25]; 0.049). None of the patients who developed AKI required KRT.

**Conclusions:** We validated the performance of UCSD-Mayo risk score in predicting hospital-acquired AKI in COVID-19 patients, which showed regular performance. More studies will be needed in order to validate this score in COVID-19 patients. This type of risk assessment tools could help clinicians stratify patients for primary prevention, surveillance and early therapeutic interventions to improve the care and outcomes of COVID-19 patients.

FR-PO033

**Osmotic Demyelinating Syndrome and COVID-19**

William A. Vasquez Espinosa,<sup>1</sup> Aditi A. Joshi,<sup>1</sup> Megha Puri,<sup>1</sup> Christian C. Toquica Gahona,<sup>1</sup> Carla F. Vasquez Espinosa,<sup>2</sup> Shaunak A. Dwivedi.<sup>1</sup> <sup>1</sup>Saint Peter’s University Hospital, New Brunswick, NJ; <sup>2</sup>Universidad UTE, Quito, Ecuador.

**Introduction:** Osmotic demyelination syndrome (ODS) is a dreaded complication of rapid sodium correction in high-risk hyponatremic patients. Predisposing factors include chronic alcoholism, malnourishment, severe hyponatremia. SARS-Cov2 infection may also be a risk factor as it is linked with multiple patterns of brain injury, renal damage and hyponatremia.

**Case Description:** Patient is a 48-year-old female with history of alcohol use disorder who presented with malaise, vomiting, diarrhea for 3 days. On admission, the patient was stuporous and confused. She was clinically hypovolemic. Initial labs demonstrated severe hyponatremia (102 mmol/L), hypokalemia (2.2 mmol/L), HCO3 of 35mmol/L, lactic acid of 4 mmol/L, no EtOH, preserved GFR. SARS-CoV2 PCR was positive. She was not hypoxic, her chest X-ray was clear. The patient was resuscitated with 1L of isotonic saline, potassium correction was attempted. Her bloodwork 4 hours later showed Na of 113 mmol/L and K of 2.4 mmol/L. At this point patient had prominent diuresis, UNa was 13mmol/L, Uosm 175mOsm/kg and U spec gravity 1.006. Immediately DDAVP and D5W were started. She had a poor response to this therapy and her sodium continued raising



even at maximal doses. At 24h her sodium was 118 mmol/L and at 48h it was 125mmol/L with stabilization at this level. She had clinical improvement and was more responsive on day 3. On the following days, sodium gradually drifted toward 132 mmol/L. On day 5 she developing worsening mental status. She was found poorly responsive with fixed gaze, aphasia, minimally removing extremities from pain, able to blink when asked. Brain MRI revealed signal abnormalities in the central pons, bilateral thalami, caudate, basal ganglia, subinsular regions consistent with ODS. Intensive treatment was restarted with D5W and DDAVP. Na of 124mmol/L was achieved at 24h. Over the course of the following days, she had partial recovery. She was discharged to rehab, able to smile, move her head and partially move her extremities.

**Discussion:** SARS-Cov2 causes hyponatremia through several mechanisms. Poor oral intake, gastrointestinal losses, kidney injury and SIADH have been described. All of them may occur at the same time and cause hypovolemic/euvolemic states with high ADH. Volume replacement rapidly shuts off the ADH drive predisposing patients to get sodium overcorrection.

#### FR-PO034

##### COVID-19 Vaccination as a Trigger for Atypical Hemolytic Uremic Syndrome

Romy N. Bouwmeester,<sup>1</sup> Arjan D. Van Zuilen,<sup>2</sup> Jack F. Wetzels,<sup>1</sup> Nicole Van De Kar,<sup>1</sup> <sup>1</sup>Radboudumc, Nijmegen, Netherlands; <sup>2</sup>University Medical Center Utrecht, Utrecht, Netherlands.

**Introduction:** After introduction of COVID-19 vaccination, rare but severe thrombocytopenia-associated complications have been reported. Although several patients developed aHUS after COVID-19 infection, to date it is unknown if COVID-19 vaccination could trigger aHUS in pediatric and adult patients with a pathogenic complement variant.

**Case Description:** Here we present three adult and one pediatric aHUS patient (all with pathogenic C3 variants) who developed a total of 5 episodes of onset or relapse of atypical hemolytic uremic syndrome (aHUS) at a median of 7 days (range 2-26) after mRNA based (Pfizer/BioNTech's, BNT162b2) and adenoviral (AstraZeneca, ChAdOx1 nCoV-19) COVID-19 vaccination. Other aHUS triggering or explanatory events were absent in all patients. During eculizumab treatment, kidney function recovered in all but one adult. Eculizumab was discontinued after stabilization of kidney function and a median treatment duration of 12 weeks (2.5-15).

**Discussion:** We identified COVID-19 vaccination, independent of the vaccine type, as a potential trigger for aHUS onset and relapse in pediatric and adult patients. We hypothesize that the synergistic effect of a local complement-amplifying condition and a pre-existing (pathogenic) complement genetic variant might cause conversion of a "normal" pro-inflammatory state into an unrestrained overactivation of the alternative pathway. We advise clear patient instruction and routinely monitoring of serum creatinine, proteinuria, mechanical hemolytic anemia (MAHA) parameters, and blood pressure approximately 3-7 days after COVID-19 vaccination in patients with a previous episode of aHUS, and/or a proven (likely) pathogenic variant in complement protein(s), and who are not treated with complement inhibitory therapy (eculizumab/ravulizumab). In addition, aHUS should be included in the differential diagnosis of patients with vaccine-induced thrombocytopenia, especially if co-occurring with MAHA and acute kidney injury.

#### FR-PO035

##### A Rare Case of IgG4-Related Kidney Disease With a Rapid Growing Renal Tumor After COVID-19 Vaccination

Rei Nakazato, Akiko Mii, Akira Shimizu. *Nihon Ika Daigaku, Bunkyo-ku, Japan.*

**Introduction:** IgG4-related diseases (IgG4-RD) are characterized by organomegaly, high IgG4 level and marked infiltration of IgG4(+) cells in the affected organs, with renal involvement in approximately 25% of cases. The coexistence of AAV with IgG4-RD has been reported in some case, while ANCA-associated vasculitis (AAV) is often associated with autoimmune diseases. There have also been some reports of new renal lesions caused by the COVID19 vaccine, such as minimal change disease, IgA nephropathy, and vasculitis, but there are still no reports of new-onset IgG4-RD.

**Case Description:** A 61-year-old man developed fever, malaise, thirst and polydipsia the day after a second vaccination of COVID19 (mRNA-12733, Moderna). Blood test showed kidney dysfunction, high IgG4 level, and MPO-ANCA positivity. Brain MRI showed enlargement of pituitary gland. Salivary gland scintigraphy showed secretory impairment in the submandibular and parotid glands. CT scan revealed a rapid growing left renal tumor and CT-guided needle biopsy was performed. Renal specimens showed diffuse infiltrates of CD138(+) plasma cells in the interstitium. More than 40% of IgG4(+) cells were IgG4-positive, accompanied by interstitial fibrosis with a "strifrom" pattern. Focal necrotic and granulomatous lesions were detected with tubular atrophy and tubulitis. Bowman's capsules were disrupted by massive interstitial inflammation in some glomeruli, but no obvious proliferative lesions. Finally, he was diagnosed as IgG4-RD and steroid therapy was started. Desmopressin was administered for central enuresis. The systemic symptoms were improved gradually and the renal tumor was reduced.

**Discussion:** In this case, it is suggested that immunological changes caused by the vaccine or allergic reaction to the vaccine may trigger the onset of the disease. Elevated MPO-ANCA titer and tubulointerstitial nephritis with necrotic and granulomatous lesions may have been associated with AAV. However, the patient had renal tumor with characteristic pathological findings of IgG4-RD, accompanied by hypophysitis and sialadenitis. We concluded that the main condition in our case is IgG4-RD. IgG4-related kidney disease after COVID-19 vaccination is extremely rare. Careful monitoring after the COVID19 vaccine is important with immunological abnormalities.

#### FR-PO036

##### Successful Outcome of AKI in a Patient With Leptospirosis and COVID-19 Infection

Irma Tchokhoniidze, Tamar Tevdoradze. Tbilisi State Medical University Clinic Tbilisi State medical University, Tbilisi, Georgia.

**Introduction:** Severe leptospirosis manifests as pulmonary edema leading to ARDS. Superimposed Covid-19 increases the risk ARDS and AKI. Cytokine storm is the main incriminating factor in both. High-dose steroids have been used to facilitate the effects of covid-19 and leptospirosis.

**Case Description:** A 31-year-old male farmer was admitted to ER on Nov 10, 2020. According to PMH, the diseases presented on Nov 3 with chills, fever, abdominal pain, diarrhea. On admission he had decreased urine output, edema, fever, abdominal pain, diarrhea. Laboratory tests were significant for uremia, abnormal liver enzymes, thrombocytopenia, leukocytosis, elevated LDH. Leptospirosis serology test was positive. Doxycycline 200mg added. Hemodialysis was started. Oxygen saturation fell to 74% on room air. Nasopharyngeal swab tested positive for COVID-19. Methylprednisolone 500mg i/v for three consecutive days, followed by 32mg. Chest CT showed bilateral ground-glass opacities Fig.1. From Nov 23 his clinical condition improved: urine output increased, oxygen saturation became 98% on room air, bowel movements one time per day. He was discharged. In December serum creatinine dropped to basic levels (89 μmol/L). CT scan of the lungs showed almost complete resolution of the opacities Fig.2.

**Discussion:** Our case demonstrates successful resolution of the severe ARDS, AKI, with complete restoration of the kidney function under steroid therapy. Further trials are needed to elaborate recommendations on steroid therapy during co-existing covid-19 and leptospirosis.

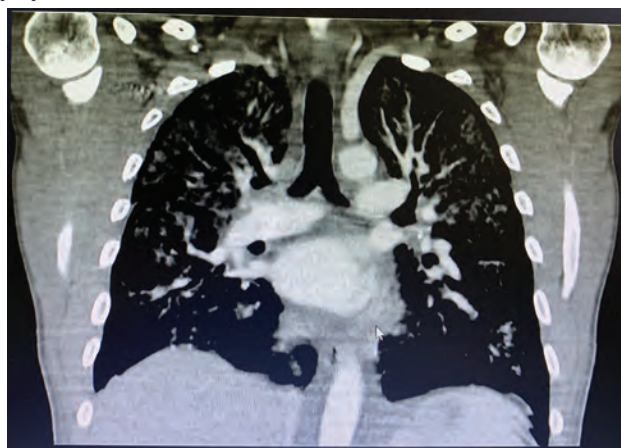

#### FR-PO037

##### A Case of Idiopathic Immune-Complex Mediated Glomerulonephritis Following Moderna COVID-19 Vaccination

Shota Obata,<sup>1</sup> Kunihiko Ishioka,<sup>1</sup> Sumi Hidaka,<sup>1</sup> Mitsuru Yanai,<sup>2</sup> Shuzo Kobayashi.<sup>1</sup> <sup>1</sup>Shonan Kamakura Sogo Byoin, Kamakura, Japan; <sup>2</sup>Sapporo Tokushukai Byoin, Sapporo, Japan.

**Introduction:** mRNA vaccines for COVID-19 have been used worldwide, and a small number of cases have been reported in which mRNA vaccines may have triggered glomerulonephritis such as IgA nephritis, ANCA-associated vasculitis, or MCNS. This is the first case of immune-complex mediated glomerulonephritis (ICGN) following mRNA vaccination, and we investigated the case including abnormalities in complement regulation.

Key: TH - Thursday; FR - Friday; SA - Saturday; OR - Oral; PO - Poster; PUB - Publication Only

Underline represents presenting author.

**Case Description:** A 71-year-old female with hypertension was referred to our nephrology department with proteinuria and microscopic hematuria. She had had microscopic hematuria and had been examined by urologists, but no apparent abnormality was found. She had received the Moderna COVID-19 vaccine a week before noticing leg swelling. At admission, her vital signs were normal except for her blood pressure of 165/116. She has pitting edema in her lower legs. Lab data revealed serum creatinine of 0.94mg/dL, urinary protein of 1.5g/day, and urine blood of 1+. There was no evidence of hypocomplementemia or various autoantibodies. On day 2, she underwent a renal biopsy showing enlarged mesangial matrix and hyperplasia of mesangial cells with endocapillary proliferation in all glomeruli. GBM duplication and subendothelial and subepithelial electron dense deposits were observed with prominent intracellular proliferation. IF showed peripheral and mesangial deposits of IgG, C3, and C1q, with IgG predominance, suggesting ICGN secondary to infection-related glomerulonephritis. However, the investigation did not detect any etiology of ICGN. She received methyl prednisone of 1000 mg IV for 3 days followed by prednisone of 40 mg daily. She responded to the treatment and was discharged with no hematuria and decreased proteinuria of 0.62 g/day.

**Discussion:** We have experienced idiopathic ICGN following the Moderna COVID-19 vaccine. Cases with MPGN pattern injury are classified as hematologic, infection-related, collagen disease, or complement dysregulation, and idiopathic cases are considered to be rare. Since this case has mild hematuria prior to vaccination, we hypothesize that the vaccine exacerbates her glomerulonephritis or may affect complement regulation. Therefore we examine the patient's complement regulation genes and also the literature on the possibility of vaccines affecting complement dysregulation.

#### FR-PO038

##### **IgA Vasculitis After COVID-19 Vaccination: A Rare but Significant Complication**

Michael W. George, Kristen Tomaszewski, Sylvester Dorobisz, John R. Sedor. Cleveland Clinic, Cleveland, OH.

**Introduction:** A 24 year old male presented with rash, gastrointestinal bleeding and nephrotic syndrome one week after first COVID vaccination. Renal biopsy revealed crescentic IgA nephritis. He was treated steroids and responded clinically but continues to have proteinuria.

**Case Description:** A 24 year old male with history of cerebral palsy presented with a vasculitic rash, hematochezia and edema. He had no prior history of renal or autoimmune disease. Symptoms developed one week after first dose of Moderna mRNA-1273 vaccine. Serum albumin was 1.6 g/dL and urine protein-creatinine ratio 8.5. Endoscopy showed esophagitis and small bowel ulcerations. Renal biopsy showed focally crescentic and necrotizing proliferative glomerulitis with IgA dominant deposits consistent with IgA vasculitis with renal involvement. He received pulse dose solumedrol followed by prednisone taper. Cyclophosphamide was initiated but then stopped due to cytopenias. After several weeks GI bleeding resolved spontaneously and proteinuria improved but remained in the nephrotic range. The course was further complicated by positive COVID testing prior to discharge- he was asymptomatic and received sotrovimab. On follow-up three months later the patient's edema resolved and serum albumin normalized. He continues to have subnephrotic range proteinuria with 2.3 grams/24 hours and active urinary sediment with dysmorphic red cells. He remains on steroid taper with plan for repeat renal biopsy to inform decisions regarding further immune suppression. He has not been rechallenged with COVID vaccine.

**Discussion:** Rare associations between COVID vaccination and both de-novo and relapsing glomerular lesions, including minimal change disease, IgA nephropathy, ANCA and anti GBM glomerulonephritis, have been reported. COVID infection itself has been associated with an FSGS type lesion termed COVID-associated nephropathy (COVAN). As highlighted by this case, unvaccinated or partially vaccinated patients are at increased risk for COVID infection. Thus even in those with known glomerular disease, vaccination should still be recommended. Studies are needed to determine if patients with off-target glomerulopathies can be safely rechallenged with COVID vaccine, whether the course of COVID vaccine-associated disease glomerular lesions mimic the primary glomerular disease and how to optimally manage these patients.

#### FR-PO039

##### **De Novo ANCA (-) Pauci-Immune Crescentic Glomerulonephritis After Injection of COVID-19 mRNA Vaccine**

Heejin Cho, Hyo jin Boo, Jin Ho Hwang. Chung Ang University Hospital, Seoul, Republic of Korea.

**Introduction:** To prevent the spread of the COVID-19 pandemic, vaccinations have been authorized for emergency use and implemented worldwide. As with the others, COVID-19 vaccines are known to cause mild and transient side effects such as fever, myalgia, and fatigue, but severe and consistent adverse events have rarely been reported. We present a case of de novo glomerulonephritis after injection of COVID-19 mRNA vaccine, BNT162b2 (BioNTech, Pfizer, NY, USA).

**Case Description:** A 48-year-old man with no past medical history was referred for suddenly and persistently worsening renal insufficiency for only a month and a half after the second dose injection of the vaccine. He presented with arthralgia and skin rash a week after the vaccination. Abdominal pain and diarrhea started two weeks later, and he was admitted to the hospital for enteritis treatment. Upon colonoscopy, multiple ulceration and petechiae suggestive of vasculitis were observed in the terminal ileum. While taking prednisolone for a few weeks the gastrointestinal symptoms improved, but the renal function continues to deteriorate. A kidney biopsy was performed for the rapid decline in renal function accompanying nephrotic-range proteinuria (urine protein to creatinine ratio 3389mg/gCr), and anti-neutrophil cytoplasmic autoantibody (ANCA)-negative

pauci-immune crescentic glomerulonephritis was diagnosed. He started treatment with high-dose steroid pulse therapy and oral cyclophosphamide, and then gradually took steroid tapering, showing improvement in proteinuria and renal function over several weeks.

**Discussion:** To date, several cases of glomerulonephritis suspected to be related to the COVID-19 vaccine have been reported. This is the first case report of ANCA-negative pauci-immune crescentic glomerulonephritis with extrarenal involvement after COVID-19 mRNA vaccine injection. It is difficult to find definite evidence to suspect or prove the causal relationship, except when there is a temporal association after vaccination or when the disease manifestations are unusual compared to well-known pathologic findings. Further in-depth studies are needed for de novo glomerulonephritis that occurs after vaccination and COVID-19 infection.

#### FR-PO040

##### **Mixed Nephrotic/Nephritic Syndrome in a Pediatric Patient With SARS-CoV-2 Infection**

Eva M. Glenn Lecca,<sup>1</sup> Marleni R. Torres Nunez,<sup>1</sup> Ana L. Paredes.<sup>2</sup> <sup>1</sup>Nicklaus Children's Hospital, Miami, FL; <sup>2</sup>Kidz Medical, Miami, FL.

**Introduction:** Glomerular diseases in children generally present as a variety of findings that include hematuria, proteinuria, edema, and hypertension. Glomerular diseases can be isolated to the kidney or present as a component of a systemic disorder. Emerging reports show that SARS-CoV-2 infection precedes the appearance of various autoimmune diseases.

**Case Description:** Twelve-year-old Hispanic female with history of migraines, obesity, hypercholesterolemia, and NAFLD, who presented with anasarca, fever, and fatigue. On exam, she had hypertension (138/89 mmHg) and anasarca with ascites. Labwork was remarkable for K+ 5.6 mmol/L, Cr 1.07 mg/dL, albumin 2.1 gm/dL, AST 48 IU/L, cholesterol 265 mg/dL, triglycerides 178 mg/dL, CRP 2.6 mg/dL and ESR 80 mm/hr. UA with >500 proteinuria, moderate blood, 100 RBCs, 49 WBCs, and negative leukocyte esterase and nitrites. A rapid strep test and Hepatitis Panel were negative. ANA <1:10, C3 complement level low at 36 mg/dL, C4 normal. Abdominal US showed hepatomegaly, echogenic bilateral kidneys, and a small pleural effusion. SARS-CoV2 antigen test was positive. She was managed with antihypertensives, albumin infusions, and furosemide. She was readmitted 2 weeks later from the Nephrology clinic since her creatinine was 1.5 mg/dL and she persisted with generalized edema. Repeat SARS-CoV2 PCR was negative. At this time, she presented ANA titer in ≥1:1280, strongly positive SSA, SSB, and SM antibodies, low C3 (43.0 mg/dL) and low C4 (7.4 mg/dL). Renal biopsy specimens showed more than 50 percent of glomeruli affected with mesangial and extracapillary hypercellularity, segmental cellular crescents, interstitial fibrosis, and marked deposition of immunoglobulins and complement, consistent with lupus nephritis Grade IV.

**Discussion:** Systemic Lupus Erythematosus (SLE) is an autoimmune condition that has been described in correlation with SARS-CoV-2 infection in adult patients. Our patient fulfills SLICC criteria for SLE and a temporal relationship exists between SARS-CoV-2 infection and the development of SLE antibodies. SARS-CoV2 has also been reported to directly cause nephritis, although with more tubular than glomerular involvement. A renal biopsy is required for accurate diagnosis.

#### FR-PO041

##### **A Rare Case of Granulomatous Interstitial Nephritis in a Patient With COVID-19-Associated Collapsing Glomerulopathy**

Manal Alotaibi, Carla L. Ellis, Shikha Wadhvani, Yonatan A. Peleg. Northwestern University Feinberg School of Medicine, Chicago, IL.

**Introduction:** AKI in patients with COVID-19 is common. Among glomerular pathologies in COVID 19, COVID 19 Associated Collapsing Glomerulopathy (COVAN) remains the most common pattern of injury. AIN is a less common finding in patients with COVID-19. Reports of a subtype of AIN, granulomatous interstitial nephritis (GIN), among COVID-19 patients, are rare and have not been reported in association with COVAN. Here, we report a case of COVAN associated with severe GIN

**Case Description:** A 52YOM who presented with fever and fatigue. The physical exam was remarkable. The patient tested positive for COVID-19 and was found to have oliguric AKI with a creatinine of 9.6 mg/dl and nephrotic range proteinuria. Therefore iHD was initiated. Serologies and infection studies were negative. Fungal serologies were negative. A kidney biopsy revealed up to 32 glomeruli, four of which were globally sclerotic. Up to four glomeruli had features of glomerular collapse. The interstitium showed severe, diffuse edematous change with inflammatory infiltrates and focal interstitial granulomas. EM showed extensive foot process effacement and multiple TRI. Additional stains were negative. After the biopsy results returned, the patient was started on high-dose steroid. He experienced side effects with the high dose and therefore was transitioned to an every other day regimen. Losartan was added and prednisone taper was started. He was doing very well clinically at the last visit with resolving AKI and proteinuria

**Discussion:** We have presented a rare case of GIN in a patient with COVAN. With negative infectious and autoimmune evaluation, it is possible the GIN was secondary to drug exposure and/or potentiated by the inflammatory milieu of COVID-19 infection. Even several years into the pandemic, we continue to find new kidney pathology among COVID-19. Kidney biopsy was absolutely necessary in this case and informed a dedicated treatment plan that allowed a remarkable recovery of kidney function

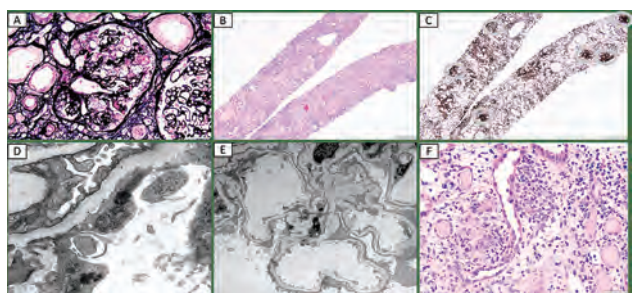

A: sliver johns stain B: H&E: C: CD163 immunohistochemical stain D and E EM. F: H&E

FR-PO042

COVID-19 Mimicking Classic Hemolytic Syndrome in a Toddler

Apoorva Jagadish, Patricia Pichilingue Reto, Radhakrishna Baliga. LSU Health Shreveport, Shreveport, LA.

**Introduction:** Coronavirus disease 2019 (COVID-19) is a heterogenous, predominantly pulmonary disease, caused by severe acute respiratory syndrome coronavirus 2 (SARS-CoV-2). Thrombotic microangiopathy (TMA), a triad of hemolytic anemia, thrombocytopenia and end organ damage, is present in severe COVID-19 and Hemolytic uremic syndrome (HUS). Classic HUS is commonly caused by Shiga toxin (ST) producing *Escherichia coli* 0157:H7 (ST-HUS). We report a toddler with features of classic HUS with positive PCR testing for SARS-CoV-2.

**Case Description:** A 2-year healthy girl presented with diarrhea of 7 days that turned bloody 2 days prior to admission. Previously, several family members with respiratory symptoms tested positive for COVID-19. On admission, she appeared jaundiced with generalized swelling, BP was 137/85 mm Hg (>99%). By day 2, her diarrhea subsided, she was oliguric, fatigued and listless. She was treated symptomatically and BP was controlled with labetalol. Pertinent laboratory data: Hemoglobin 5.1g/dL, reticulocyte 8.4%, platelets 51 K/uL lactate dehydrogenase 833 U/L and haptoglobin < 8 mg/dL. Serum creatinine (Scr) was 0.71 mg/dl with eGFR of 67 ml/min/1.73m2 and Urine showed +3 protein and blood. Random sample (RS) urine protein to Cr ratio was 5.1 (<0.2). Stool culture was negative for *E. coli* 0157:H7 and other enteropathogens. Shiga toxin 1 and 2 were negative by enzyme immune assay. Nasal swab was positive for SARS-CoV-2 by PCR. Genetic renal panel v8 for aHUS was negative. Complement, Coombs and ANA negative. ADAMSTS13 level >100%. By day 5, symptoms subsided and kidney function improved significantly with Scr at 0.55 mg/dl (eGFR 81ml/min/1.73m2). She was discharged on Lisinopril. Four months later, BP was 107/73 mm Hg and Scr 0.32 mg/dl (eGFR 127ml/min/1.73m2). Urine had trace protein with RS urine protein to Cr ratio of 0.32.

**Discussion:** Both COVID-19 and HUS cause severe endothelial dysfunction resulting in release of inflammatory cytokines, complement dysregulation, and development of TMA. COVID-19 has been reported as a potential trigger of aHUS in patients with kidney involvement wherein genetic testing revealed complement defect. Our patient had features of classic HUS, was negative for ST-HUS and ST, but positive for SARS-CoV-2. COVID-19 may be considered in children with bloody diarrhea followed by hemolytic anemia, thrombocytopenia and acute kidney injury.

FR-PO043

Twelve-Year-Old Girl With Steroid Resistant Nephrotic Syndrome With Collapsing Focal Segmental Glomerulosclerosis After COVID-19 Vaccination

Chika Masuda,<sup>1</sup> Tomoko Horinouchi,<sup>1</sup> Hideaki Kitakado,<sup>1</sup> Yuta Ichikawa,<sup>1</sup> Yu Tanaka,<sup>1</sup> Atsushi Kondo,<sup>1</sup> Nana Sakakibara,<sup>1</sup> Norishige Yoshikawa,<sup>2</sup> Kandai Nozu,<sup>1</sup> <sup>1</sup>Kobe Daigaku Daigakuin Igakukei Kenkyuka Igakubu, Kobe, Japan; <sup>2</sup>Shakai Iryo Hojin Aijinkai Takatsuki Byoin, Takatsuki, Japan.

**Introduction:** With the increase of COVID-19 vaccinations, the development of nephrotic syndrome (NS) after vaccination is one of the new concerns. Most NS cases after vaccination are accompanied by minimal change, while others include focal segmental glomerulosclerosis (FSGS). Although an association between COVID-19 infection and collapsing FSGS has been reported especially in patients with *APOL1* risk variants, no cases of childhood collapsing FSGS cases after COVID-19 vaccination have been reported up to now.

**Case Description:** Twelve-year-old Japanese girl had been administered BNT162b2 (Pfizer/BioNTech) vaccine. Soon after that, edema had gradually appeared and 15 days after the injection, she was referred to our hospital because of severe edema. She did not have any past nor family history. Blood examination showed severe hypoalbuminemia (sAlb 1.4 g/dL) without kidney disfunction (eGFR 118.0 mL/min/1.73m<sup>2</sup>) or hypocomplementemia. Urinalysis showed severe proteinuria (urine protein/Cr 12.8 g/gCr) with hematuria, indicating nephrotic syndrome. Prior to treatment, collapsing FSGS was confirmed by kidney biopsy. Prednisolone (PSL) 60 mg/day was started according to the clinical guidelines for pediatric nephrotic syndrome. She had not achieved the complete remission 28 days after administration of PSL, and cyclosporine and lisinopril treatment was started. In addition, we administered two cycles of methyl prednisolone pulse therapy. Finally, she achieved the complete remission after 2.5 months treatment. Comprehensive genetic testing revealed no variant in genes causing steroid resistant NS or asymptomatic proteinuria.

Key: TH - Thursday; FR - Friday; SA - Saturday; OR - Oral; PO - Poster; PUB - Publication Only  
Underline represents presenting author.

**Discussion:** The new onset of NS after vaccination, including COVID-19 vaccination, has been reported. The actual mechanism has not been clarified yet, but some immunological impact is reported to be associated the onset after the vaccination. Interestingly, this patient showed collapsing FSGS which is common as a secondary FSGS, especially in patients with the *APOL1* risk variants suffered viral infection. Collapsing FSGS accompanied by COVID-19 infection had been reported to be associated with interferon activation or VEGF activation. Patients with collapsing FSGS after COVID-19 vaccination may have a common etiology.

FR-PO044

Atypical Hemolytic Uremic Syndrome due to Factor H Antibodies Following COVID-19

Salman B. Mahmood, Nattawat Klomjit. University of Minnesota Twin Cities, Minneapolis, MN.

**Introduction:** Atypical hemolytic uremic syndrome (aHUS) is a form of thrombotic microangiopathy (TMA) characterized by dysregulated complement activation. Antibodies to factor H (anti-FH), a regulator of the alternative complement pathway, are a recognized cause of aHUS particularly in children. We present the case of an elderly patient who developed aHUS following COVID-19.

**Case Description:** A 74-year-old male presented with weakness, petechial rash involving extremities and diarrhea for 2 weeks. Prior history included hepatitis C infection status-post treatment 2 years ago with associated cirrhosis. Three weeks ago, the patient had been diagnosed with COVID-19. His symptoms of sore throat, cough and fever had by now resolved. Initial investigations showed leukocytosis and AKI with an active urinary sediment and nephrotic range proteinuria (Fig 1). Hemoglobin and platelets were normal and a blood smear was negative for hemolysis. Imaging revealed small bowel enteritis suggestive of an infectious or vasculitic process. Infectious workup returned negative. Autoimmune serologies revealed a borderline positive ANA, low C3 and low-normal C4. Renal biopsy revealed diffuse endothelial injury with swollen endothelial cells, focal mesangiolysis and glomerular basement membrane duplication. Hence, pulse dose steroids were started and complement function panel sent. Soon after steroid initiation, the patient's renal function, leukocytosis and rash improved. Ultimately, complement testing returned positive for anti-FH. At follow-up, renal function had returned to baseline with continued steroid taper.

**Discussion:** COVID-19 is associated with TMA likely due to endothelial toxicity or complement pathway dysregulation. Our patient had no prior history of renal or hematologic disease. Given the chronology of events, it is likely that COVID-19 triggered formation of anti-FH, in turn leading to development of aHUS in our patient.

Lab Test	Diagnosis		Hospital		Hospital		Hospital		At 2 month follow-up	
	Baseline	Admission	Day 3	Day 7	Day 10	Discharge	Day 10	Discharge	Day 10	Discharge
WBC, x10 <sup>3</sup> /µL	9.0	20.9	19.2	18.6	10.2	9.5	8.5	8.5	8.5	8.5
Hgb, mg/dL	21	160	141	90	87	46	18	18	18	18
Serum Cr, mg/dl	0.8	3.3	3.2	2.3	1.5	1.0	0.8	0.8	0.8	0.8
Serum Albumin, g/dL	4.1	1.7	1.4	1.4	1.7	1.8	3.3	3.3	3.3	3.3
UPCR, g/g Cr	—	3.9	—	—	—	—	0.65	0.65	0.65	0.65
UAcr, mg/g Cr	5.1	—	—	—	—	—	—	—	—	—
Total Bilirubin, mg/dL	0.5	3.0	4.2	2.6	1.9	1.1	0.6	0.6	0.6	0.6
Direct Bilirubin, mg/dL	—	3.2	—	1.9	1.4	—	—	—	—	—
ALP, U/L	102	179	198	255	316	347	100	100	100	100
ALT, U/L	37	22	26	37	155	156	65	65	65	65
AST, U/L	30	27	44	53	105	81	36	36	36	36
CRP, mg/L	—	81	78	31	—	—	—	—	—	—
Ca, mg/dL	—	54	—	—	—	—	93	93	93	93
CA, mg/dL	—	14	—	—	—	—	15	15	15	15
ANA	—	1:40, speckled	—	—	—	—	negative	negative	negative	negative
Urinalysis	—	RBCs >182/HPF WBCs 23/HPF Albumin 50 mg/dL	—	RBCs 2/HPF WBCs 2/HPF Albumin negative	—	—	RBCs 3/HPF WBCs 1/HPF Albumin negative	—	—	—

Fig 1. Lab trend during admission and at follow-up.

FR-PO045

IgA Vasculitis With Cryoglobulin-Like Deposits in Kidney Following COVID-19 Infection

Rajib K. Gupta,<sup>1</sup> Austine Y. Mengnjo,<sup>2</sup> <sup>1</sup>LSU Health Shreveport, Shreveport, LA; <sup>2</sup>Reading Hospital, West Reading, PA.

**Introduction:** Infection-related IgA glomerulonephritis with large paramesangial immune deposits appearing like intraluminal cryo deposits have occasionally been described in literature temporally associated with Staphylococcus infection. COVID-19 associated glomerular disease is classically known to manifest as collapsing glomerulopathy, although other types have been reported.

**Case Description:** We present a case of a 76-year old Hispanic female with a history of type 2 diabetes, hypertension and a 2-month old history of COVID-19 pneumonia who recently presented with acute kidney injury, dark urine, shortness of breath and leg edema. 2 weeks prior, she had presented with a history of purpuric rash. Urinalysis had shown hematuria and proteinuria, and a skin biopsy showed IgA vasculitis. Blood culture for Staphylococcus was negative. A kidney biopsy now showed IgA glomerulonephritis with focal crescents along with intraluminal pseudothrombi (cryo-plugs) positive for IgA on immunofluorescence. Electron microscopy showed intraluminal occlusive electron-dense

deposits. Serum cryoglobulin was negative. The patient was treated with steroids and oral cyclophosphamide, and she responded significantly to treatment.

**Discussion:** Our case shows a unique glomerular manifestation of COVID-19 infection in the form of IgA vasculitis with intraluminal cryo-like features, not previously described in literature.

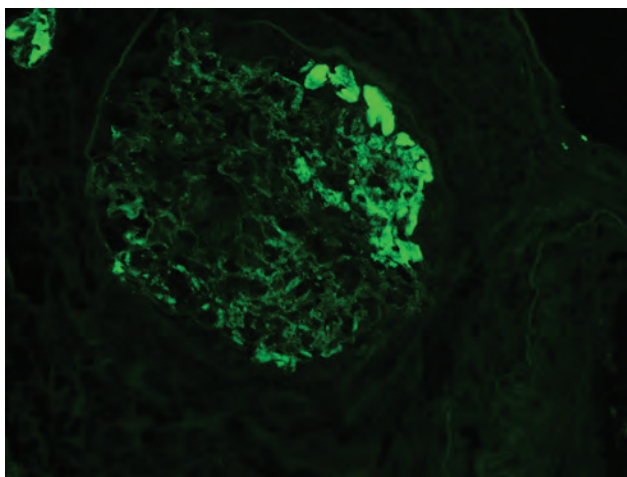
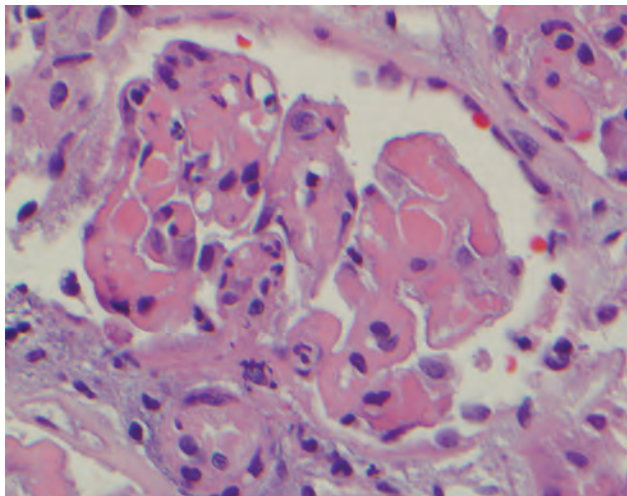

#### FR-PO046

##### An Atypical Case of DNAJB9 Negative Fibrillary Glomerulonephritis Associated With COVID-19 Infection

Pir Shehzad,<sup>1,2</sup> Sabiha M. Khan,<sup>1,2</sup> Spencer Hodgins,<sup>1,2</sup> Jonathan Freeman,<sup>1,2</sup> Gregory L. Braden,<sup>1,2</sup> <sup>1</sup>Baystate Medical Center, Springfield, MA; <sup>2</sup>University of Massachusetts Chan Medical School, Worcester, MA.

**Introduction:** FGN is a rare immune-complex mediated GN characterized by the demonstration of Congo-red negative, randomly organized nonbranching fibrils with a diameter of 15 nm - 25 nm on electron microscopy and more recently the presence of DNAJB9 protein in almost all patients. FGN has been associated with HCV infection, autoimmune disease, malignancy, and monoclonal gammopathies. We report a unique case of DNAJB9 negative FGN associated with COVID-19 Infection.

**Case Description:** 74 yo M with Afib, HTN, HFrEF, and DM presented with fatigue and dizziness. Labs revealed an elevated serum creatinine of 1.0 mg/dL above the baseline of 0.7 mg/dL. The patient was positive for COVID-19 infection without overt symptoms. The patient had been vaccinated against SARS-CoV-2. The patient developed oliguric AKI with a rapid rise in serum creatinine over 4 days. Urinalysis revealed pyuria, hematuria, and 4+ albuminuria with 14 gm of proteinuria on quantification (TP/Cr). He had hypocomplementemia, normal immunofixation, negative ANA, dsDNA, RF, ANCA, anti-GBM antibody, viral hepatitis antibodies, and cryoglobulin. MRA ruled out renal vein thrombosis. The patient was started on 1g methylprednisolone for three days. His creatinine peaked at 9.9 mg/dL and was started on hemodialysis. A kidney biopsy was done. Light microscopy showed DPGN with IF demonstrating a full house pattern most consistent with Class IV Lupus Nephritis. The Congo-red stain was negative. Electron microscopy was delayed. He was started on Euro-lupus protocol with IV Cytosin, 500 mg IV every 2 weeks for 6 weeks, and Prednisone. The patient was discharged on maintenance Euro-lupus protocol and had an excellent response to therapy with normalization of serum creatinine to his baseline of 0.7 mg/dL and a decrease in proteinuria (TP/Cr of 0.47). The electron microscopy results later showed non-branching randomly arranged fibrils with thickness ranging from 15 nm - 30 nm characteristic of FGN. Testing for DNAJB9 was negative.

**Discussion:** DNAJB9 has been identified in all but a few cases of FGN. There is currently no known association between COVID-19 infection and FGN. Our case is unique since it's DNAJB9 negative and potentially establishes a new association between FGN and COVID-19 infection which can cause AKI reversible upon IV Cytosin therapy usually reserved for crescentic FGN.

#### FR-PO047

##### ANCA-Associated Vasculitis Following Johnson & Johnson COVID-19 Vaccine in Nepal

Kamal Ranabhat,<sup>1</sup> Sangam Shah,<sup>2</sup> <sup>1</sup>Government of Nepal Ministry of Health and Population, Kathmandu, Nepal; <sup>2</sup>Tribhuvan University Institute of Medicine, Maharajgunj, Nepal.

**Introduction:** Antineutrophil cytoplasmic autoantibodies (ANCA) associated vasculitis (AAV) after influenza vaccination has been previously reported, there are a very few case reports of AAV following COVID-19 vaccination.

**Case Description:** A 52-year-old hypertensive female presented with complaints of fever, joint pain, and weakness of all limbs. She developed symptoms 12 days after getting vaccinated with Johnson and Johnson (J & J) COVID-19 vaccine in late July 2021. The fever occurred for 10 days, intermittent type, and associated with chills and rigor. The joint pain was for 3 days which was acute in onset involving small joints of hands and feet. Concurrently she also developed weakness of all four limbs with relatively more weakness in lower limb than upper limbs. She consumed alcohol occasionally. Urinalysis revealed 12 red blood cells per high-power field (HPF), 4 white blood cells/HPF, and 0.631 gm/day protein with albumin (2+). Serologic evaluation was notable for increased C-reactive protein, decreased C3 complement level, normal C4 level, positivity for p-ANCA and c-ANCA (3+). Renal ultrasound showed tiny non-obstructive calculus in both kidneys. Following this she was started on antibiotics, NSAIDs, and methylprednisolone. She was planned for kidney biopsy and was started on cyclophosphamide. Blood transfusion was done. Renal biopsy revealed necrotizing and crescentic glomerulonephritis with insignificant glomerular immune complex deposit suggesting ANCA associated glomerulonephritis in the view of history of ANCA positivity (Figure 1). She was discharged after 10 days of hospitalization.

**Discussion:** AAV following adenovirus vector vaccine has not been reported previously. There have been reports of AAV after administration of influenza vaccine. So, J&J vaccines was thought to be a potential trigger for development of AAV. The temporal causal association between autoimmune manifestations like AAV and COVID-19 vaccines can be explained by hypothesized mechanisms like molecular mimicry, defective neutrophilic apoptosis, polyclonal activation, and systemic proinflammatory cytokine response.

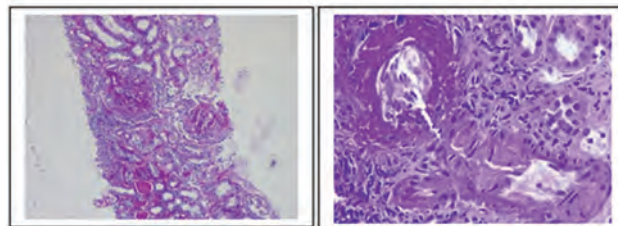

Figure 1(left & right): Immune complex deposit

#### FR-PO048

##### Tip Variant of Focal Segmental Glomerulosclerosis Post COVID-19 Vaccination

Kanza Haq,<sup>1</sup> Claire F. Schretlen,<sup>1</sup> Carmen E. Cervantes,<sup>1</sup> Mohamad A. Hanounh,<sup>1,2</sup> <sup>1</sup>Johns Hopkins University School of Medicine, Baltimore, MD; <sup>2</sup>Nephrology Center of Maryland, Baltimore, MD.

**Introduction:** Rapid and mass SARS-CoV-2 vaccination has been a pivotal strategy to curb the COVID-19 pandemic. The use of developed mRNA vaccines has provided effective protection against COVID-19 infection. However, few cases of immune-mediated reactions, such as de novo/relapsing glomerulonephritis (GN) have been reported.

**Case Description:** A 45-year-old man with no PMH presented with progressive worsening lower extremity edema 1 week after receiving the Janssen vaccine (Ad26. COV2). He was not taking any prescribed or over the counter medications. His physical exam showed BP of 160/90 mmHg and +2 lower extremity edema. Laboratory studies revealed the following: BUN 97 mg/dL, serum creatinine 6.7 mg/dL (baseline 0.8 mg/dL), serum albumin 1.8 g/dL and 24-hour urine protein of 6.5 g. Serological workup was negative. A kidney biopsy showed focal areas of segmental glomerulosclerosis (FSGS), associated with endocapillary foam cells and epithelial cell capping, predominantly involving the takeoff point of the proximal tubule (fig 1). The areas of segmental sclerosis herniated into the proximal tubule. Immunofluorescence was negative and electron microscopy revealed diffuse epithelial foot process effacement (fig 2). The patient was diagnosed with tip variant of FSGS and started on oral prednisone 80 mg daily. He required initiation of dialysis and has no evidence of renal recovery to date.

**Discussion:** New cases and relapses of GN's can present shortly after mRNA COVID-19 vaccination. IgA nephropathy, FSGS and minimal change disease have been reported. The tip variant of FSGS usually presents as a primary podocytopathy and has the best prognosis among the various forms of FSGS due to its high response to steroid therapy and low risk of progression.

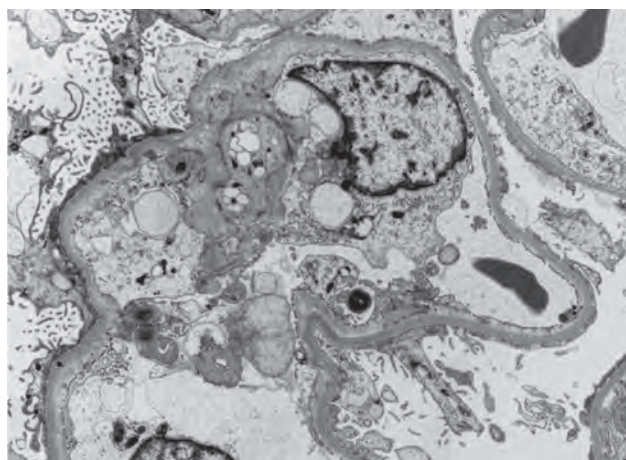
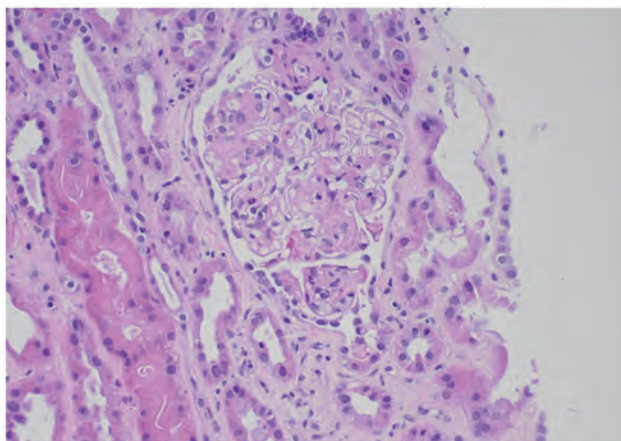

#### FR-PO049

##### A Case of Collapsing Focal Segmental Glomerulosclerosis in Post-mRNA COVID-19 Vaccination

Shabtab Khan, Sheryl C. Caberto. *Emory University School of Medicine, Atlanta, GA.*

**Introduction:** The association of collapsing Focal Segmental Glomerulosclerosis (FSGS) and mRNA COVID-19 vaccine has been reported. The APOL1 genotype is present in about 75% of African descendants with FSGS. This increases the rates of FSGS as well as HIV-associated nephropathy. We present a case of African-American male with Human Immunodeficiency Virus (HIV) who developed collapsing FSGS after mRNA covid vaccination.

**Case Description:** A 24-year-old male with history of well-controlled HIV on Biktary was referred to nephrology for acute kidney injury (AKI) with nephrotic-range proteinuria. Outpatient workup for nephrotic syndrome was unrevealing. Two months prior to AKI, patient received Moderna mRNA COVID-19 vaccine. Renal function worsened with creatinine of 1.6 mg/dL from 1.3 mg/dL with 6 grams of proteinuria. Renal biopsy was done which revealed collapsing FSGS with 10% interstitial fibrosis and tubular atrophy. This was unlikely due to HIV. Treatment was started with Methylprednisolone, Mycophenolate and Lisinopril. A booster COVID-19 vaccine was not recommended.

**Discussion:** Proteinuric renal disease is common in patients with history of HIV, but for a patient with well-controlled HIV, other causes of glomerular diseases must be ruled out. We present this case to consider mRNA COVID-19 vaccine as a potential cause of nephrotic syndrome. Glomerular diseases have been reported in temporal association with Moderna and Pfizer BioNTech vaccines. In a case series of 29 biopsy proven glomerular disease that were documented within 1 month of a covid vaccination, 27 out of 29 cases were new onset glomerular diseases. The most common glomerular disease was IgA nephropathy. This a case of collapsing glomerulopathy in relationship with COVID-19 vaccine. Collapsing FSGS has been commonly reported as a cause of AKI in COVID-19, but in our case, we have a patient with collapsing FSGS in the setting of COVID-19 mRNA vaccination. It is unclear of what mechanism attributed to FSGS, but it is possible to consider an inflammatory response against the spike protein as a 'second hit' phenomenon to susceptible individuals, such as African Americans with APOL-1 risk alleles or HIV. This is a potential adverse effect that must be considered after mRNA covid vaccination.

#### FR-PO050

##### The Mosaic of Autoimmunity

Aditi A. Joshi, William A. Vasquez Espinosa, Nida Arabi. *Saint Peter's University Hospital, New Brunswick, NJ.*

**Introduction:** Lupus nephritis (LN) is one of the most common manifestations affecting 45% of patients with systemic lupus erythematosus (SLE). Here we present a case of rapid progression of LN in the setting of recent COVID-19 infection, suggesting a possible synergistic cascade of cytokines contributing to rapid disease flare up.

**Case Description:** 52-year-old hispanic lady with past medical history of hypertension and newly diagnosed SLE presented to the clinic with chief complaint of generalized anasarca, fatigue and low back ache. She was found to have a hemoglobin of 8.8 along with severe leukopenia. Urinalysis was positive for large amount of blood, protein with a protein: creatinine ratio of 9 gm. ANA titer was positive along with low levels of C3 complement and normal levels of C4 complement. Creatinine of 2.3 which was 4 times higher than her baseline. Labs from 2 months ago showed creatinine of 0.57. Of note, the patient was diagnosed with COVID-19 a month ago. She had a renal biopsy and was diagnosed with stage IV LN and was started on dialysis.

**Discussion:** LN usually has an indolent course with people developing ESRD within 5 years of diagnosis of lupus. This case strikes out as a rapid progression of LN with progression to ESRD within less than 3 months of diagnosis of SLE. COVID-19 a few months before she was diagnosed with Lupus is a possible source of a cytokine storm. Suggested mechanisms of induction of autoimmunity include both molecular mimicry as well as bystander activation whereby the infection may lead to activation of antigen presenting cells that may in turn activate pre-primed auto-reactive T-cells, thus leading to pro-inflammatory mediators, which in turn may lead to tissue damage. Strategies to prevent rapid progression to ESRD in these patients needs to be studied and better understood. Perhaps patients with autoimmune conditions like SLE need more robust management of diseases like COVID-19 which is known to alter and activate the immunological cascade. As per recent literature exaggerated extrafollicular B cell response characteristic of active SLE also characterizes the B cell response to COVID-19. Understanding and targeting the B cell pathway could potentially help dampen a severe response and disease progression. Overlap including racial preponderance of disease severity also needs to be studied further.

#### FR-PO051

##### Paxlovid Use in COVID-19 Infection: An Ounce of Prevention Is Worth a Pound of Cure

Randa Abd algayoum, Mario A. Leone, Khaled Nashar, Reem Daloul, Kalathil K. Sureshkumar. *Allegheny Health Network, Pittsburgh, PA.*

**Introduction:** Paxlovid (nirmatrelvir+ ritonavir) is a promising new combination drug that can significantly reduce hospitalization and all-cause mortality in Covid-19 infection. Ritonavir is a potent inhibitor of cytochrome-P450 system CYP3A enzymes and concomitant use with calcineurin inhibitors (CNI) such as tacrolimus can dangerously increase CNI blood levels. We present a heart transplant recipient on tacrolimus who developed acute kidney injury (AKI) and refractory life-threatening hyperkalemia following Paxlovid use and successful treatment using P450 induction with phenytoin along with dialysis support.

**Case Description:** A 43-year-old male with CKD stage III and previous heart transplant on tacrolimus was admitted with dyspnea, malaise, and oliguria. Few days earlier, he developed Covid-19 infection and received 5-day course of Paxlovid prescribed from elsewhere. On presentation, patient was hypervolemic, with the following serum values: K+ 7.1 mMol/L (peaking to 8.3 despite medical therapy), HCO3- 17 mMol/L and creatinine 4.67 mg/dL (baseline 3.0). Patient required emergent hemodialysis. Tacrolimus trough level came back as >60 ng/mL. Patient was started on IV phenytoin 100 mg every 12 hours. Tacrolimus levels remained extremely high over next few days with subsequent improvement (fig.). Patient required 4 dialysis sessions. Subsequently urine output improved, and serum creatinine returned to baseline.

**Discussion:** Paxlovid use will likely increase with Covid-19 surge. This drug has important safety risks in organ transplant recipients and kidney disease as highlighted by our case, where supratherapeutic tacrolimus levels due to P450 inhibition resulted in AKI and hyperkalemia. Empiric dose reduction or withholding CNI agents when initiating Paxlovid with close CNI level monitoring is recommended. Risk mitigation strategies are also important such as interruptive alerts in electronic health records, educational outreach, and alerting pharmacies about Paxlovid-CNI interactions.

Key: TH - Thursday; FR - Friday; SA - Saturday; OR - Oral; PO - Poster; PUB - Publication Only

Underline represents presenting author.

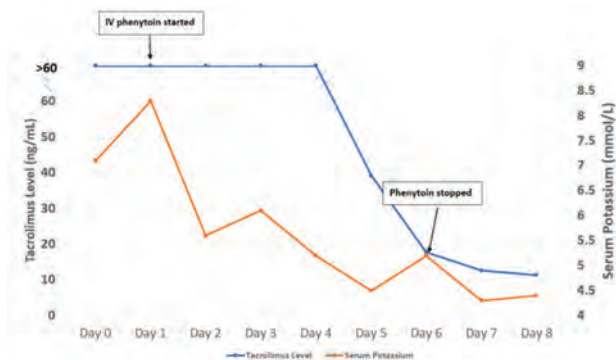

Serial K+ and Tac levels

FR-PO052

**Proceed With Caution: Drug Interaction Complicates Use of Nirmatrelvir/Ritonavir in Kidney Transplant Recipients With COVID-19**  
 Shikha Shaaily, Clifford D. Miles, Scott G. Westphal, Kathleen Borghoff, Audai Ma'ayah. *University of Nebraska Medical Center, Omaha, NE.*

**Introduction:** Kidney transplant recipients are at increased risk of severe COVID-19 infection due to poor response to vaccination and immunosuppression. Antiviral therapies are thus important to mitigate risk of severe disease. Nirmatrelvir/ritonavir, an oral antiviral, has increasingly been used in higher risk patients with COVID-19. Unique to transplant patients is the risk of calcineurin inhibitor (CNI) drug interaction and potential for severe drug toxicity.

**Case Description:** A 57-year-old male received a kidney transplant 8 months ago. Immunosuppression includes tacrolimus, mycophenolate, and prednisone, and he was fully vaccinated and boosted against SARS-CoV-2. He presented with headache, fevers, and body aches and COVID antigen test was positive. His primary care provider prescribed nirmatrelvir/ritonavir, and immunosuppression was continued. Two days later he developed nausea, vomiting, diarrhea, and fatigue prompting emergency evaluation. It was unclear if symptoms were drug-related or due to COVID-19 infection. Given the high risk of severe COVID-19, nirmatrelvir/ritonavir was continued, and tacrolimus was held. Two days later, tacrolimus level was checked and resulted at 75.6 ng/mL, complicated by acute kidney injury. He was admitted, treated with intravenous fluids and phenytoin to enhance CNI metabolism. Symptoms and graft function improved, and tacrolimus level decreased but remained high 2 days later (54 ng/mL). Tacrolimus remained on hold at discharge and was restarted when level normalized.

**Discussion:** Nirmatrelvir inhibits M<sup>pro</sup>, a protease enzyme required for SARS-CoV-2 replication. As a potent inhibitor of CYP3A, nirmatrelvir/ritonavir may interact with drugs metabolized through this pathway, including CNIs. This patient's tacrolimus level was severely elevated even after 2 days of drug cessation leading to toxicity and hospitalization. Use of nirmatrelvir/ritonavir with CNIs requires extreme caution. The antiviral benefit may be opposed by risks incurred through drug interaction. If used, we recommend holding or reducing the CNI dose and close monitoring of levels. Providers and patients should be educated about this interaction, and alternative treatments may be preferable.

FR-PO053

**Importance of Renal Biopsy in the Current COVID-19 Era: Acute Phosphate Nephropathy in a Patient With COVID-19 and New Systemic Lupus Nephritis**

Mathura Babu. *Ascension St John Hospital, Detroit, MI.*

**Introduction:** Lupus nephritis is a common manifestation of systemic lupus erythematosus. About 40-60% of patients with systemic lupus erythematosus will have renal involvement. We present a case of a young lady with SARS-CoV-2 pneumonia who additionally presented with alopecia, arthritis and acute renal injury. Initially, the consulting team presumed the diagnosis to be due to lupus nephritis. The patient was treated with IV methylprednisolone and oral prednisone. The renal biopsy revealed widespread calcium phosphate crystals within the tubular lumens, suggestive of acute phosphate nephropathy. Electron microscopy showed diffuse foot process effacement consistent with minimal change disease.

**Case Description:** A 20-year-old lady with no past medical history presented with right-sided chest pain, myalgias, fever, and vomiting for 5-6 days. She had proteinuria and serum creatinine of 5 mg/dl. She was SARS-CoV-2 positive. She also had frontal alopecia and photosensitivity over the past five months, along with swelling/tenderness in her wrists and MCPs over the past year. The patient's mother had a diagnosis of lupus which was well controlled on Hydroxychloroquine. Further lab work revealed lymphopenia, positive for smith, coombs, cryoglobulins, RF, RNP, and SSA. Other pertinent work-up was negative. The patient was started on induction therapy for possible lupus nephritis of 1 g IV solumedrol daily for three days. The patient progressively became anuric, and creatinine peaked to 8 mg/dl. Dialysis was initiated. Her urine output improved after the third dialysis session, and dialysis was stopped. Her creatinine improved to 2.4 mg/dl. After the biopsy confirmed phosphate nephropathy, a focused history failed to reveal a cause. She denied sodium phosphate bowel preparations, consuming star fruit or ethylene glycol exposure.

**Discussion:** This case shows the importance of biopsy even in a well-known condition such as lupus nephritis. The etiology of renal failure in SARS-CoV-2 is primarily acute tubular necrosis, with collapsing focal segmental glomerulosclerosis also reported. Calcium phosphate deposition is not a reported complication of COVID-19 or lupus nephritis. The tubuloreticular inclusions can be found with lupus nephritis and viral infection. The etiology of phosphate-induced nephropathy remains unclear.

FR-PO054

**AKI in COVID-19 Infection: Role of Hypercatabolic Status**

Qasim Muhammad,<sup>1</sup> Ping Li,<sup>2</sup> *<sup>1</sup>The George Washington University, Washington, DC; <sup>2</sup>Veterans Health Administration, Washington, DC.*

**Introduction:** Acute Kidney Injury (AKI) is a very common complication of patients with SARS-COV-2 virus (COVID-19) infection. COVID-19 infected patients have longer hospital length of stays and higher mortality rate. There are multiple postulated mechanisms for AKI in the setting of COVID-19. Some researchers reported that the COVID-19 virus directly binds to the ACE-2 receptors in proximal tubules and leads to tubular dysfunction. In rare cases, a hypercatabolic state can be seen that carries a significantly higher mortality rate with ensuing hyperuricemia and hyperphosphatemia.

**Case Description:** We describe a patient presenting with severe AKI with hypercatabolic state in the setting of COVID-19 infection. 40 year old male with a history of hypertension and CHF (EF 35%) presented with fatigue, diarrhea, nausea and vomiting for 10 days after COVID-19 infection. He was found to have severe AKI with blood urea nitrogen of 254 and creatinine of 21 mg/dl which was associated with hyperkalemia, gap acidosis, severe hyperuricemia (23 mg/dl) and hyperphosphatemia (17 mg/dl). Despite aggressive volume resuscitation in the ICU, the patient remained oliguric with no improvement in kidney function for two days. He was subsequently initiated on hemodialysis. After getting 2 sessions of dialysis without ultrafiltration, renal recovery was noted eventually normalizing within 10 days. Extensive work up indicated the patient had no tumor lysis syndrome and rhabdomyolysis on this admission.

**Discussion:** There are multifactorial mechanisms for AKI in patients with COVID-19 infection including direct viral invasion of the kidney proximal tubules. Our case demonstrated that a hypercatabolic state may contribute to AKI in these patients. The proposed mechanisms involve elevated serum uric acid levels causing small renal arterial constriction, glomerular auto-dysregulation and tubular crystallization due to supersaturation causing to kidney tubular injury. Thus, clearance of uric acid and phosphorus with dialysis may promote more rapid kidney function recovery.

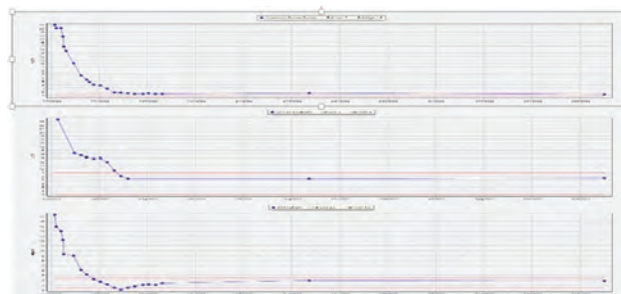

FR-PO055

**A Case of Membranous Nephropathy Post SARS-CoV-2 Vaccination**

Luis G. Osorio,<sup>1</sup> Esteban Rodriguez,<sup>1</sup> Smita Padala,<sup>1,2</sup> *<sup>1</sup>HCA Florida Citrus Hospital, Inverness, FL; <sup>2</sup>VSP Nephrology Associates, Lecanto, FL.*

**Introduction:** Emergency use authorization and mass vaccination programs worldwide have lowered the burden of the COVID-19 pandemic. Vaccine complications not previously seen in clinical studies continue to manifest. We present a case of membranous nephropathy (MN) following the SARS-CoV-2 vaccination with successful treatment.

**Case Description:** Our patient is a 58-year-old woman with past medical history of hypothyroidism seen at a nephrology clinic for evaluation of new onset symptoms of dyspnea, severe bilateral pedal edema, and proximal muscle weakness for 4 months. The patient had 3+ proteinuria and microscopic hematuria on urinalysis obtained by primary care provider. She also had a rapid decline in serum albumin to 2.2 g/dL and new onset hypercholesterolemia at 415 mg/dL. Before initial presentation, she had normal labs and no symptoms. Upon presentation to our nephrology clinic, the patient had proteinuria of 2,360 mg/day on a 24-hour urine collection, random urine protein-to-creatinine ratio (UPCR) of 5,459 mg/g and random urine albumin-to-creatinine ratio (UACR) of 3,539 mg/g. She had no risk factors for chronic kidney disease. The only recent change in the health management of the patient was the administration of two doses of the SARS-CoV-2 vaccine several weeks prior to presenting with her initial symptoms 4 months ago. The phospholipase A2 receptor (PLA<sub>2</sub>R) antibody was elevated at 287 IU/mL. Serological tests for other sources of proteinuria were negative. Renal biopsy performed was consistent with primary MN. The patient was started on rituximab infusion given 2 weeks apart based on Mentor Trial. Additional treatment included apixaban, sulfamethoxazole/trimethoprim DS, losartan, and L-carnitine. After two doses of rituximab, she had resolution of dyspnea, pedal edema and muscle weakness. Repeat labs revealed UPCR to 1000 mg/g, UACR to 629 mg/g, improvement of PLA<sub>2</sub>R to 8 IU/mL. Our patient achieved immunological remission and partial clinical remission.

Key: TH - Thursday; FR - Friday; SA - Saturday; OR - Oral; PO - Poster; PUB - Publication Only

Underline represents presenting author.

**Discussion:** This case illustrates a potential association of the SARS-CoV-2 vaccination and autoimmune mimicry leading to MN. We hope that this will help clinicians become aware of a potential complication not widely recognized and an effective management strategy. We hope further investigations of this possible association are performed as more cases are discovered.

**FR-PO056**

**Can COVID-19 Vaccination Be the Culprit for New-Onset Crescentic Glomerulonephritis? The Correlation vs. Causation Conundrum**

Akbar A. Khan,<sup>1</sup> Grant Kirby,<sup>2</sup> <sup>1</sup>Hospital Municipio de San Juan, San Juan, Puerto Rico; <sup>2</sup>Johns Hopkins University, Baltimore, MD.

**Introduction:** While the development, delivery, and implementation of the mRNA vaccines have been spectacular, consideration for potential rare side effects on organ systems was not clear. Although emergency use authorization trials of these vaccines in the USA did not demonstrate major safety concerns, unique side effects after mass-scale vaccination are now being reported more frequently. Here, we describe a case of new-onset crescentic & sclerosing GN with linear basement membrane staining for IgG, kappa, and lambda by immunofluorescence in a 30-yo healthy female three days after receiving her Tozinameran (Pfizer-BioNTech) booster vaccine.

**Case Description:** 30 y/o Caucasian female with no PMH presented with a CC of gross hematuria 3 days after receiving her booster of Tozinameran. Retrospectively reported symptoms of pedal edema, generalized athermalgia, tinnitus, and paresthesia of lower limbs. UA revealed dysmorphic RBCs and proteinuria. CT urethrogram, & cystoscopy revealed left hydronephrosis, no nephrolithiasis or urothelial lesions. Kidney biopsy revealed crescentic & sclerosing GN, with linear GBM staining for IgG, Kappa, & Lambda on IF. Several glomeruli showed segmental scars & fibrous crescents in addition to focal cellular crescents of varying ages raising the possibility of concurrent ANCA vasculitis. Her GBM antibody was 25. Additional workup of ANCA, PLA2R, PR3, ana, c3/c4 levels, dsDNA, and hepatitis studies returned negative. On admission, BP was 175/103, and HR 104. Labs were notable for hemoglobin 13.3, WBC 16.6k, & BUN/creatinine 16/1.5. The PE was unremarkable. She received pulse IV steroid therapy, cyclophosphamide, Lupron, and daily plasma exchange (PLEX) for 5 days until her GBM antibody cleared. She responded well to treatment. Her renal function improved, and she was discharged without requiring dialysis.

**Discussion:** Our case demonstrates a possible correlation & causation scenario after receiving a Tozinameran booster shot activating anti-GBM disease with concurrent ANCA-negative vasculitis demonstrated by kidney biopsy. Although the mechanism of *de novo* anti-GBM disease & ANCA-negative vasculitis post-SARS-CoV-2 vaccine remains to be explained, pharmacovigilance is vital in our efforts to ascertain answers.

**FR-PO057**

**Ravulizumab for COVID-19 Kidney Injury**

Aliza Anwar Memon,<sup>1</sup> Hasban Ahmed,<sup>2</sup> Andrew M. Siedlecki,<sup>2</sup> <sup>1</sup>Saint Louis University, Saint Louis, MO; <sup>2</sup>Brigham and Women's Hospital, Boston, MA.

**Background:** The evidence suggests that the primary events in AKI occur on the luminal surface of the endothelial cells in the microvasculature of kidney. These findings can be explained by the activation of the complement resulting in endothelial injury. Ravulizumab inhibits the cleavage of C5 into C5a and C5b thus preventing endothelial dysfunction. In this study, we report the use of ravulizumab to treat AKI in the setting of COVID-19 infection with focus on a primary follow-up period of 30 days.

**Methods:** Patients were randomized in a placebo-controlled fashion. One group received placebo and standard care (SOC) while the second group received SOC and ravulizumab. Outcomes were rigorously assessed for 30 days after enrollment.

**Results:** 13 (11.4% of screened) patients identified to have COVID-19 infection were enrolled in the study. Six patients were randomized to receive ravulizumab in addition to standard of care (SOC+R) and seven patients were randomized to SOC. Three patients randomized to the SOC group died after enrollment. Mean number of hospital free days after enrollment was 290±47 (SOC+R) vs 164±144 (SOC) respectively. Free C5 levels increased over 30 days following ravulizumab infusion and corresponded with decreasing ravulizumab blood levels over the same time interval (p=0.001). During this same time period there was a decreased number of anuric days observed in the SOC+R compared to SOC (p=0.009). There was a reduced frequency of dialysis events in the SOC+R for ten days after enrollment (p=0.001).

**Conclusions:** Due to the recurrent impact of COVID-19 infection throughout the world, targeted therapies for concomitant kidney injury merit future investigations to reduce incidence of AKI and potentially reduce future prevalence of CKD.

**Funding:** Commercial Support - Alexion Pharmaceuticals Inc

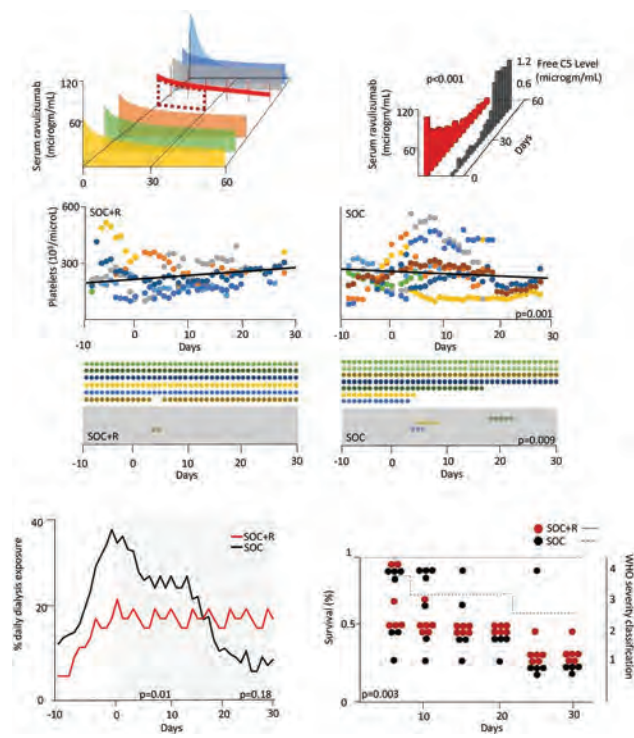

**FR-PO058**

**Incidence of COVID-19-Associated AKI: Effect of Time**

Claudine T. Jurkovitz, Richard Caplan, Kevin Ndura, Michael T. Vest. *Christiana Care Health Services Inc, Wilmington, DE.*

**Background:** Acute Kidney Injury (AKI) is a known complication of COVID-19. Recent reports have suggested a decrease in AKI incidence with time. The objective of this study was to evaluate the incidence of AKI over time and determine whether changes in patients' characteristics could explain this decrease.

**Methods:** Data were selected from the Cerner Real-World Data™, a cloud-based platform of de-identified electronic health records data from >100 health systems. Our study population was defined as hospitalized adults with COVID-19 in 2020-2021. We excluded patients with known end-stage kidney disease and those whose first interaction with the health system was the COVID-related hospitalization. AKI was defined as an increase in serum creatinine by ≥0.3 mg/dl within 48 hours or ≥1.5 times the baseline. We used logistic regression to estimate the association between time categorized in quarters and occurrence of AKI after adjusting for demographic variables and comorbidities identified from the Elixhauser ICD10-based algorithm. To determine whether the effect of demographic and comorbidities on the likelihood of AKI varied with time, we also ran separate logistic regression models for each quarter.

**Results:** Our analytical dataset included 152,296 patients. Of those 49% were female, 12% black, 71% white, 29% Hispanic, mean age was 61±19, 32% had diabetes, 55% hypertension, 14% Kidney Disease, 20% coronary artery disease, 14% congestive heart failure, 24% COPD, 10% liver disease and 21% developed AKI while hospitalized. The incidence of AKI decreased from 28% in 2020 quarter one (2020Q1) to 19% in 2021Q4 (test of trend p<0.001). The odds of developing AKI for 2020Q2 to 2021Q4 compared to 2020Q1 were Odds Ratio=0.80, 95% CI 0.72-0.89, 0.73 (0.66-0.81), 0.72 (0.66-0.80), 0.72 (0.65-0.80), 0.58 (0.53-0.65), 0.67 (0.60-0.74), 0.61 (0.52-0.71) respectively. After adjusting for covariates, the effect of time although attenuated (highest 2020Q2 OR=0.79 (0.71-0.88), lowest 2021Q4 OR=0.67 (0.58-0.79) remained significant. Time did not modify the effect of the demographic variables and comorbidities on developing AKI.

**Conclusions:** The decrease in AKI incidence with time is independent of the effect of demographic risk factors and comorbidities. This decrease is likely related to improvement in patients volume management, treatment with steroids, anticoagulation and early treatment of the virus.

**Funding:** Other NIH Support - Institutional Development Award (IDeA) from NIH-NIGMS

**FR-PO059**

**Renal Outcomes in Hospitalized Patients Receiving Hemodialysis After Infection With Acute COVID-19**

Abhishrey Raj, Alpana Raizada. *University College of Medical Sciences, Delhi, India.*

**Background:** Kidney injury in acute COVID-19 infection has been associated with decreased survival and prolonged duration of hospitalization irrespective of patient population or severity of illness. Outcomes among hospitalized patients with COVID-19

and kidney injury in terms of recovery of renal function are insufficiently assessed. A good understanding of the same is vital to plan post-discharge renal care, and to estimate the potential burden that COVID-19 confers on the nephrology community.

**Methods:** In a cohort study, we included patients who received hemodialysis (HD) during hospital stay after infection with COVID-19 at our center following kidney injury during the second wave of the pandemic in New Delhi between June and December, 2021. Participants were excluded if they received dialysis following previously existing chronic renal failure. Participants were followed-up telephonically for a period of six months to assess renal function and need for HD. Recovery of renal function was considered early if serum creatinine improved by 33% of peak value during hospital stay, or late if a 33% reduction in follow-up evaluation was noted over the discharge serum creatinine.

**Results:** A total of 62 patients (34 (54.8%) men and 28 (45.2%) women) with a mean age of 51.2 years (+16.3), and mean urea of 181 mg/dl (+95.7) and mean creatinine of 6.9 mg/dl (+3.5) at presentation were included in the cohort. Of these, 31 (50%) had presented with mild, 11 (17.7%) with moderate and 20 (32.3%) with severe disease. Ten (16.1%) succumbed to illness during hospital stay and another 12 (19.3%) patients died during the follow up period. 34 (54.8%) patients were discharged from hospital on HD, and 18 (29%) were not advised HD at discharge. While 30 (75%) of the survivors had indicated early renal recovery at discharge, none had recovered renal function at the end of follow up period. A median decline of 48% and 44% at follow up was noted from the peak and presentation values of creatinine recorded during hospital stay.

**Conclusions:** Patients undergoing hemodialysis after hospitalization with acute COVID-19 infection had poor short-term outcome and survivors continued to have renal impairment after six months. It is important to recognize recovery rates and patterns to offer early comprehensive renal care.

## FR-PO060

### Follow-Up Care of Critically Ill Patients With AKI

Rachel Jeong,<sup>1,2</sup> Alix Clarke,<sup>1</sup> Matthew T. James,<sup>1</sup> Robert R. Quinn,<sup>1</sup> Pietro Ravani,<sup>1</sup> Sean M. Bagshaw,<sup>3</sup> Henry T. Stelfox,<sup>2</sup> Neesh I. Pannu,<sup>4</sup> Ngan Lam.<sup>1</sup> <sup>1</sup>Cumming School of Medicine, Division of Nephrology, University of Calgary, Calgary, AB, Canada; <sup>2</sup>Department of Critical Care Medicine, University of Calgary, Calgary, AB, Canada; <sup>3</sup>Department of Critical Care Medicine, University of Alberta, Edmonton, AB, Canada; <sup>4</sup>Department of Medicine, Division of Nephrology, University of Alberta, Edmonton, AB, Canada.

**Background:** Acute kidney injury (AKI) occurs in more than half of critically ill patients in the intensive care unit and is associated with adverse outcomes. The 2012 Kidney Disease Improving Global Outcomes guideline recommends follow-up at 3 months post-discharge for assessment of kidney health. It remains unclear whether these recommendations are followed. Our objective was to determine processes of follow-up care for critically ill patients with AKI.

**Methods:** We conducted a retrospective cohort study in Alberta, Canada, using linked healthcare databases within the Alberta Kidney Disease Network. We included critically ill adult patients with evidence of AKI (defined as  $\geq 50\%$  or  $\geq 26.5$   $\mu\text{mol/L}$  serum creatinine increase from baseline) from 2005-2018. The primary outcome was an outpatient nephrology follow-up visit within 3 months of discharge. Secondary outcomes were an outpatient serum creatinine or urine protein measurement, and a follow-up visit by a family physician within 3 months of discharge.

**Results:** There were 29,732 critically ill adult patients with AKI. The median age was 68 years, 39% were female, and the median estimated glomerular filtration rate was 72 mL/min/1.73 m<sup>2</sup>. The cumulative incidence of receiving nephrology follow-up within 3 months before dying or requiring maintenance kidney replacement therapy was 5%. At 3 months, 64% and 28% of patients had an outpatient creatinine and urine protein measurement, respectively, and 89% received follow-up by a family physician. Factors associated with nephrology follow-up were younger age, urban residence, lower baseline estimated glomerular filtration rate, higher baseline albuminuria, previous nephrology visit, shorter hospitalization stay, higher severity of AKI, receipt of acute dialysis, inpatient nephrology consultation, kidney biopsy, and worse kidney function at the time of discharge.

**Conclusions:** Many critically ill patients with AKI do not receive the recommended follow-up care. Our findings illustrate a significant gap in the transition of care for critically ill patients with AKI. Further research is needed to determine if follow-up care is associated with improved patient outcomes.

**Funding:** Private Foundation Support

## FR-PO061

### Race-Agnostic Computable Phenotype for Kidney Health Assessment in Adult Hospitalized Patients

Tezcan Ozrazgat-Baslanti, Yuanfang Ren, Esra Adiyek, Tyler J. Loftus, Mark S. Segal, Azra Bihorac. *University of Florida, Gainesville, FL.*

**Background:** Acute kidney injury (AKI) and chronic kidney disease (CKD) are clinically used categorizations of kidney health. Standard race adjustments for estimating glomerular filtration rate (GFR) and reference creatinine can yield a lower AKI and CKD prevalence among African Americans (AA) to ones from non-adjusted estimates.

**Methods:** We developed race-agnostic computable phenotypes that assess kidney health among 139,152 subjects admitted to the University of Florida Health between 1/2012-8/2019. We removed the race modifier from the formula used by the race-adjusted algorithm to calculate the estimated GFR and creatinine (*race-agnostic algorithm 1*). In the second race-agnostic algorithm (*race-agnostic algorithm 2*), these calculations

rely on 2021 CKD-EPI refit without race formula as endorsed by the National Kidney Foundation. We validated computable phenotypes developed for preadmission CKD and AKI presence on 300 selected cases using clinical adjudication.

**Results:** Race-agnostic algorithms identified CKD and AKI in 23% and 15% of encounters, respectively. Among 86,379 AA admissions, 26,908 (31%) and 26,003 (30%) had CKD based on race-agnostic algorithm 1 and 2, respectively. Race adjustment reclassified 2,113 (8%) to no CKD and 7,901 (29%) to a less severe CKD stage compared to race-agnostic algorithm 1, while it reclassified 1,208 (5%) to no CKD and 4,606 (18%) to a less severe CKD stage compared to race-agnostic algorithm 2. Of 12,451 (15%) AKI encounters based on race-agnostic algorithm 1, the race adjustment reclassified 591 (4.7%) to no AKI and 305 (2.4%) to a less severe AKI stage. Of 12,251 (14%) AKI encounters based on race-agnostic algorithm 2, the race adjustment reclassified 382 (3.1%) to no AKI and 196 (1.6%) to a less severe AKI stage. Phenotyping algorithm based on refit without race formula performed well in identifying patients with CKD and AKI with a sensitivity of 100% (95% CI 97%-100%), 99% (95% CI 97%-100%), and a specificity of 88% (95% CI 82%-93%) and 98% (95% CI 93%-100%), respectively.

**Conclusions:** Race-agnostic algorithms identified substantial proportions of additional patients with CKD and AKI compared to race-adjusted algorithms in AA patients. The phenotyping algorithm is promising in identifying patients with kidney disease, assessing quality of care, and improving clinical decision-making.

**Funding:** NIDDK Support

## FR-PO062

### Use of a Policy Tree Algorithm to Identify Maximal Treatment Effect of Crystalloid Therapy in a Cohort of Critically Ill Patients With Sepsis

Wonsuk Oh,<sup>1</sup> Hannah Kittrell,<sup>2</sup> Girish N. Nadkarni.<sup>3</sup> <sup>1</sup>Icahn School of Medicine at Mount Sinai Department of Genetics and Genomic Sciences, New York, NY; <sup>2</sup>Icahn School of Medicine at Mount Sinai, New York, NY; <sup>3</sup>Icahn School of Medicine at Mount Sinai Department of Medicine, New York, NY.

**Background:** Sepsis-associated acute kidney injury (SA-AKI) is a significant health problem in intensive care units. As SA-AKI can progress, it is important to individualize therapy early based on patient characteristics to prevent progression. We aimed to use a machine learning causal inference method to identify groups of patients that have more than the average population treatment effect, specifically in relation to intravenous crystalloids.

**Methods:** We identified critically ill adult patients with sepsis admitted to a tertiary academic medical center. The baseline of this study is 1 hour after sepsis onset. We excluded patients (i) who were discharged within 48 hours of onset, (ii) with a history of kidney failure, (iii) without vital signs measurement during the admission, (iv) with AKI stage 1-3 present before the baseline, and (v) without serum creatinine or urine output measurements after the baseline. The study outcome was the difference between baseline serum creatinine and peak serum creatinine during the follow-up periods. We applied a policy tree algorithm, a state-of-the-art machine learning method, to learn rule-based policy (treatment strategies) through a doubly robust estimator with a form of decision trees. We gradually increased the tree's depth (accounting for more variable interactions) and evaluated average treatment effects of crystalloids on limiting the increased peak serum creatinine levels in identified patients.

**Results:** We applied the policy tree algorithm on 19,179 patients. 13,204 (68.7%) patients developed AKI stage 1 or higher. As we gradually increased the policy tree, the tree identified 832, 1188, 1999, 2425, and 3384 patients who showed maximal average treatment effects (ATE) of decreasing peak serum creatinine level, and ATE showed 0.246 (95% CI: 0.008, 0.484), 0.404 (0.191, 0.617), 0.436 (0.275, 0.597), 0.526 (0.376, 0.676), and 0.553 (0.418, 0.648), respectively. Mean ATE for the entire population was -0.076 (-0.108, 0.044).

**Conclusions:** We used the policy tree algorithm to identify subgroups of patients with sepsis with differing benefits of crystalloid therapy on SA-AKI prevention. Our results suggest that policy learning-based patient discovery can be useful for achieving personalized therapy of sepsis to prevent SA-AKI.

**Funding:** NIDDK Support, Other NIH Support - NHGRI

## FR-PO063

### Personalized Recommendations for AKI Using a Kidney Action Team (KAT-AKI): Design, Rationale, and Early Data

Abinet M. Aklilu, Kyle D. O'Connor, Francis P. Wilson. CTRA (Clinical and Translational Research Accelerator) *Yale School of Medicine, New Haven, CT.*

**Background:** AKI is common during hospitalization and is associated with high morbidity and mortality. Although studies have looked at the utility of electronic alerts in improving AKI outcomes, no prior study has evaluated real time, personalized AKI recommendations. Our study aims to assess the impact of individualized AKI-specific recommendations from a trained clinician and pharmacist delivered immediately after electronic detection of AKI in hospitalized patients.

**Methods:** KAT-AKI is a randomized-controlled trial conducted across 8 hospitals at two major hospital systems. A real-time electronic AKI alert system informs a dedicated team comprising a physician and pharmacist who independently review the chart in real-time, screen for eligibility, and provide AKI-specific recommendations, across the following domains: diagnostics, medications, volume, potassium and acid-base management. Recommendations are delivered to the primary team in the alert arm of the study and logged for future analysis in the usual care arm. The primary outcome is a composite of progression to higher AKI stage, dialysis and mortality 14days after randomization. A key secondary outcome will be percentage of recommendations implemented by the primary care team within 24hours from randomization.

Key: TH - Thursday; FR - Friday; SA - Saturday; OR - Oral; PO - Poster; PUB - Publication Only

Underline represents presenting author.



**Results:** As of May 16, 2022, there were 342 individuals enrolled out of 507 screened. Median(IQR) age was 72.2(60.0,81.5) yrs. 48.8% were female, 12.3% Hispanic and 19.6% were Black. Nearly half(49%) were on a general medical floor at the time of alert and 14.4% were admitted to an ICU. Virtually all participants (99.1%) were recommended to have at least one diagnostic intervention. 180(52.6%) individuals had recommendations to discontinue a medication or to dose-adjust a medication. Of the 90 with medication discontinuation recommendations, 23.3% were on NSAIDs. The median(IQR) time from AKI alert to recommendation was 0.52(0.18,0.90)hr.

**Conclusions:** Conducting a randomized clinical trial using an electronic AKI alert coupled with a team of clinicians is feasible and generates valuable data about early AKI management.

**Funding:** Other U.S. Government Support

Frequencies of Selected Personalized Recommendations

Recommendation	Participants with Recommendation, n (%)
DIAGNOSTIC	339 (99.1)
- Obstruction	- 222 (64.9)
- Strict I&Os	- 267 (78.1)
- Urinalysis	- 292 (85.4)
- Other	- 236 (69.0)
NEPHROLOGY CONSULT	10 (2.9)
VOLUME	275 (80.6)
- Empiric challenge	- 64 (18.7)
- Assess volume	- 255 (74.6)
MEDICATIONS	180 (52.6)
- Discontinue	- 90 (26.3)
- Dose-adjust	- 122 (35.7)

FR-PO064

Outcomes Following Community-Acquired AKI: A National Study of US Veterans

Virginia Wang,<sup>1,2</sup> Lindsay Zepel,<sup>1</sup> Matthew L. Maciejewski,<sup>2,1</sup> Erin B. Chang,<sup>1</sup> M. Alan Brookhart,<sup>1</sup> C. Barrett Bowling,<sup>2,1</sup> Clarissa J. Diamantidis,<sup>1</sup> <sup>1</sup>Duke University School of Medicine, Durham, NC; <sup>2</sup>Durham VA Medical Center, Durham, NC.

**Background:** Community-acquired acute kidney injury (CA-AKI) develops outside of the hospital and is the most common form of AKI. Due to limited availability of outpatient lab and integrated health data, CA-AKI outcomes are poorly studied. This study leveraged national data to examine associations between incident CA-AKI and subsequent hospitalization and mortality.

**Methods:** We constructed a retrospective cohort of active primary care patients in the Veterans Health Administration (VA) in 2013-2017, excluding Veterans with no recorded outpatient serum creatinine (SCr) and those with a history of severe kidney disease (≥ Stage 5 or kidney transplant). CA-AKI was defined as ≥1.5-fold relative increase in outpatient SCr or inpatient SCr (≤24 hours from admission), from a reference value defined as the preceding outpatient SCr ≤12 months prior. We compared outcomes in Medicare and VA databases from a pooled cohort of patients with CA-AKI and a 5% random sample without observed CA-AKI. Cox models estimated associations between CA-AKI and 2-year all-cause hospitalization and mortality, adjusting for patient characteristics.

**Results:** With an annual cumulative CA-AKI incidence of approximately 2% in 2013-2017, the analytic cohort consisted of all 220,777 Veterans with CA-AKI and 492,539 controls with no CA-AKI. Those with CA-AKI had a higher hazard of 2-year all-cause hospitalization (hazard ratio [HR]=1.89, 95% confidence interval [CI] 1.87, 1.90) and mortality (HR=2.72, 95% CI 2.67, 2.77) compared to those without CA-AKI. These risks increased with greater CA-AKI severity (hospitalization: Stage 1 HR=1.80, 95% CI 1.78, 1.81; Stage 2 HR=2.23, 95% CI 2.19, 2.27; Stage 3 HR=2.68, 95% CI 2.60, 2.76; mortality: Stage 1 HR=2.50, 95% CI 2.45, 2.54; Stage 2 HR=3.45, 95% CI 3.35, 3.55; Stage 3 HR=4.57, 95% CI 4.38, 4.76). Compared with no CA-AKI, CA-AKI within 24 hours of hospital admission was associated with greater hazard of mortality (HR=3.81, 95% CI 3.72, 3.90) than among those with CA-AKI in the outpatient setting (HR=2.42, 95% CI 2.37, 2.46).

**Conclusions:** In a national cohort of Veterans, CA-AKI was associated with an approximately two-fold increased risk of hospitalization and mortality. Strategies to improve identification and follow-up management is critical to mitigate adverse outcomes of CA-AKI.

**Funding:** NIDDK Support, Veterans Affairs Support

FR-PO065

AKI and ESRD Progression in Older Adult Veterans With Advanced CKD

Danira Medunjanin,<sup>1</sup> Bethany Wolf,<sup>1</sup> Roberto Pisoni,<sup>1,2</sup> David J. Taber,<sup>1,2</sup> John L. Pearce,<sup>1</sup> Kelly J. Hunt.<sup>1,2</sup> <sup>1</sup>Medical University of South Carolina, Charleston, SC; <sup>2</sup>VA Medical Center Ralph H Johnson, Charleston, SC.

**Background:** Those ≥65 years represent the largest growing age category in the US. Advanced age is a major risk factor for the development of CKD, which has high heterogeneity in disease progression. Hospitalization rates for AKI are increasing, especially amongst older adults who are at particular risk given their high comorbidity burden and susceptibility to nephrotoxins. Previous AKI epidemiologic analyses have focused on hospitalized populations which may bias results towards sicker populations; particularly when results are extrapolated to ambulatory CKD populations.

**Methods:** This was a national longitudinal cohort study which performed competing risk regression analysis on 24,133 older Veterans (≥65 years), with incident CKD stage 4 from 2011-2013 to determine the association between AKI and progression to ESRD while evaluating age as an effect modifier. The following covariates based on a priori selection were adjusted for: AKI severity and history, age, sex, race-ethnicity, service-connected disability, Elixhauser comorbidity burden, NSAIDs, ACE inhibitors, diuretics, rural residence, and driving distance to nearest primary care. Veterans were followed until December 31, 2016, or death. AKI was defined according to the modified KDIGO AKIN definition. Due to the time constraint in defining AKI (≤ 7 days), we were limited to inpatient labs. Most studies of hospitalized patients with AKI assign a baseline SCr at the time of admission which may not reflect stable levels of kidney function. Because the VA is the largest integrated health care system in the US, we can access outpatient SCr labs prior to hospitalization to determine an appropriate baseline kidney function. ESRD was defined by entry into the USRDS registry. Death was considered the competing risk.

**Results:** Adjusted modeling demonstrated AKI was independently associated with a 1.9-fold increased risk [HR: 1.91 95% CI: 1.64-2.23] of ESRD progression. Age was not an effect modifier of this relationship (p-value=0.08). Though non-significant, AKI was associated with a 6% increase [HR: 1.06 (95% CI: 0.96-1.16)] in death.

**Conclusions:** Regardless of AKI status, death was far more frequent than ESRD in this population (51.1% vs. 14.5%). Despite this, our national cohort study showed that AKI was a substantial and independent risk factor for the development of ESRD in older Veterans with advanced CKD.

**Funding:** Veterans Affairs Support

FR-PO066

The Burden of AKI in a Cohort of 5217 CKD Patients

Ulla T. Schultheiss,<sup>1,5</sup> Fruzsina K. Kotsis,<sup>1,5</sup> Charlotte Behning,<sup>4</sup> Jennifer Nadal,<sup>4</sup> Anna Kottgen,<sup>1</sup> Kai-Uwe Eckardt,<sup>2,3</sup> Markus P. Schneider.<sup>3</sup> <sup>1</sup>Institute of Genetic Epidemiology, Faculty of Medicine and Medical Center, University of Freiburg, Freiburg, Germany; <sup>2</sup>Department of Nephrology and Medical Intensive Care, Charité – Universitätsmedizin Berlin, Berlin, Germany; <sup>3</sup>Department of Nephrology and Hypertension, Friedrich-Alexander-University Erlangen-Nürnberg, Erlangen-Nürnberg, Germany; <sup>4</sup>Institute of Medical Biometry, Informatics and Epidemiology, University Hospital Bonn, Bonn, Germany; <sup>5</sup>Department of Medicine IV - Nephrology and Primary Care, Faculty of Medicine and Medical Center - University of Freiburg, Freiburg, Germany.

**Background:** Chronic Kidney Disease (CKD) is associated with an increased risk for acute kidney injury (AKI), which is a risk factor for mortality. While in-patient AKI has been studied extensively, characteristics of out-patient AKI have been less studied. We therefore characterized in- and out-patient AKI in a large German CKD (GCKD) patient cohort.

**Methods:** Over 6.5 years of follow-up, in-patient-AKI events were adjudicated from hospital discharge letters and categorized based on the GCKD study adjudication catalogue: i) increase of creatinine >0.3 mg/dl, ii) doubling to triplication of creatinine, iii) creatinine value >4 mg/dl plus an acute increase of >0.5 mg/dl, iv) initiation of temporary renal replacement therapy. Out-patient-AKI events were calculated based on an algorithm by Hapca et al. 2020, using time windows prior- and post-AKI, applying similar criteria to categorize AKI as for in-patient-AKI.

**Results:** In 5217 CKD patients, 1411 in-patient-AKI events in 636 participants (median 1, IQR: 1-6) vs. 1114 out-patient-AKI events in 624 participants (median 1, IQR: 1-10) occurred. Recurrent events were recorded more frequently for out-patient-AKI compared to in-patient-AKI. Baseline characteristics for participants without any AKI event compared to participants experiencing at least one event in either in-patient-AKI or out-patient-AKI were a mean ± standard deviation (m ± sd) age for participants without an AKI event of 59.3 ±12.2 years, of 62.2 ±10.7 for in-patient-AKI, and of 58.8 ±12.6 for out-patient-AKI. Men were more likely to experience an AKI event than women for both in- and out-patient-AKI. Mean baseline eGFR values were lowest for participants without AKI (29.5 ±5.8 ml/min/1.73m<sup>2</sup>), but similar for both in-patient and out-patient-AKI (~31.1 ± 6.3 ml/min/1.73m<sup>2</sup>). Median UACR values were >300 mg/g for those with an out-patient-AKI event compared to 52.7 mg/g for those with an in-patient-AKI event. Prevalent cardiovascular disease was similar between in-patient-AKI and out-patient-AKI groups (e.g. 30% coronary heart disease), but ~8-15% higher than for participants without AKI.

**Conclusions:** Our study emphasizes the high burden of both in- and out-patient-AKI in CKD patients. Our analysis could further demonstrate that UACR values were higher for out-AKI-patients, which may help to better target preventative measures.

FR-PO067

Platelet Factor 4 Antibodies and Severe AKI

Charlotte Thomas,<sup>1</sup> Rafia W. Ali,<sup>1</sup> Isabel Park,<sup>1</sup> Helena Kim,<sup>1</sup> Samuel Short,<sup>2,1</sup> Hanny Al-Samkari,<sup>3</sup> David E. Leaf.<sup>1</sup> <sup>1</sup>Brigham and Women's Hospital, Boston, MA; <sup>2</sup>University of Vermont College of Medicine, Burlington, VT; <sup>3</sup>Massachusetts General Hospital, Boston, MA.

**Background:** Production of platelet factor 4 (PF4) antibodies is the seminal event in the development of heparin-induced thrombocytopenia, a common and often devastating complication in hospitalized patients. PF4 antibodies can cause macrovascular arterial and venous thrombosis, however, only limited data are available on their association

with microvascular thrombosis. Since the kidney is a highly vascularized organ, and renal microvascular thrombosis has been observed in multiple kidney diseases, we hypothesized that the appearance of PF4 antibodies in the circulation is independently associated with a higher risk of development of severe acute kidney injury (AKI) among hospitalized patients.

**Methods:** We performed a retrospective cohort study of all adult inpatients who had a PF4 test during an admission to two large academic hospitals in Boston, MA, between 2015 and 2021. Data were extracted using ICD-9/10 diagnosis and procedure codes. The primary exposure was a positive PF4 antibody immunoassay test. The primary outcome was severe AKI, defined as  $\geq 200\%$  increase in serum creatinine compared to the hospital admission value or receipt of kidney replacement therapy within 7 days following the PF4 test. We used multivariable logistic regression to adjust for potential confounders.

**Results:** The cohort consisted of 4224 patients who had a PF4 test, of whom 469 (11.1%) tested positive. Among those with a positive PF4 test, 50 (10.7%) developed severe AKI compared to 235 (6.3%) with a negative test ( $P < 0.001$ ). In a multivariable model adjusted for age, sex, race, baseline eGFR, comorbidities, and severity of illness, patients with a positive PF4 test had 51% higher odds of developing severe AKI (95% CI, 1.08–2.13) compared to patients with a negative test (**Figure**). Patients with a positive PF4 test also had higher risk of developing AKI (any stage), the composite of AKI or death, and arterial and venous thrombosis, with similar magnitudes of association seen with thrombosis as with AKI (**Figure**).

**Conclusions:** PF4 positivity is independently associated with a higher risk of severe AKI in hospitalized patients.

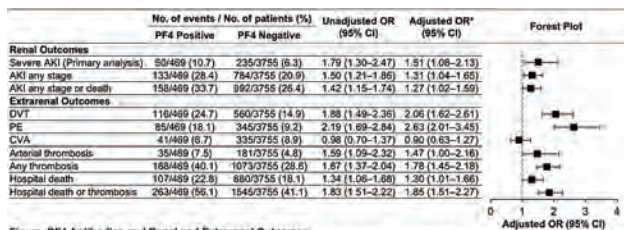

**Figure. PF4 Antibodies and Renal and Extrarenal Outcomes.**  
\*Adjusted for age, sex, race, baseline eGFR, hypertension, hyperlipidemia, chronic liver disease, active malignancy, WBC count, hemoglobin, invasive mechanical ventilation, sepsis, and shock. Abbreviations: CVA, Cerebrovascular Accident; DVT, Deep Vein Thrombosis; PE, Pulmonary Embolism.

FR-PO068

**Electronic Alert Outpatient Protocol Improves the Quality of Care for the Risk of Postcontrast AKI Following Computed Tomography**  
Seokwoo Park, Eun-Jeong Kwon, Ho Jun Chin, Ki Young Na, Sejoong Kim. Seoul National University Bundang Hospital Department of Internal Medicine, Seongnam, Gyeonggi-do, Republic of Korea.

**Background:** Prevention and diagnosis of postcontrast acute kidney injury (PCKI) after contrast-enhanced computed tomography (CECT) requires intravenous fluid administration and follow-up measurements of serum creatinine in high-risk patients, which is often burdensome in outpatient department. Here, we investigated whether an electronic alert system can promote quality improvement regarding prevention and timely diagnosis of PCKI, and long-term outcomes.

**Methods:** In March 2018, we launched an automated alert system incorporated with hospital information system in a tertiary hospital in South Korea. The system identifies patients with baseline renal dysfunction, provides with protocolized prescription of fluid regimen, and recommends follow-up serum creatinine measurement. Severe PCKI was defined as increase in serum creatinine from baseline of more than 50%. Participants were categorized according to the time period when CECT was prescribed, before and after the launch of the system. Propensity for the surveillance of PCKI with serum creatinine measurement, severity of PCKI, and admission within 6 months were compared using logistic regression. Risks of mortality and renal replacement therapy were analyzed with Cox regression.

**Results:** Historical and alert group included 289 and 309 participants, respectively. After the introduction of alert system, participants were more likely to be followed for the surveillance of PCKI (66.7% versus 29.4%; OR<sub>adj</sub>, 5.37;  $P < 0.001$ ). Within those followed-up, severe PCKI was less common in alert group (5.3% versus 10.6%; OR<sub>adj</sub>, 0.31;  $P = 0.051$ ), albeit not statistically significant. The two groups did not differ in terms of admission ( $P_{adj} = 0.597$ ), mortality ( $P_{adj} = 0.589$ ), and renal replacement therapy ( $P_{adj} = 0.434$ ).

**Conclusions:** An automated alert system can assist in appropriate prevention and reduce underdiagnosis of PCKI, concomitantly limiting clinical burdens of care providers. Whether the system may improve long-term outcomes is yet uncertain.

**Funding:** Government Support - Non-U.S.

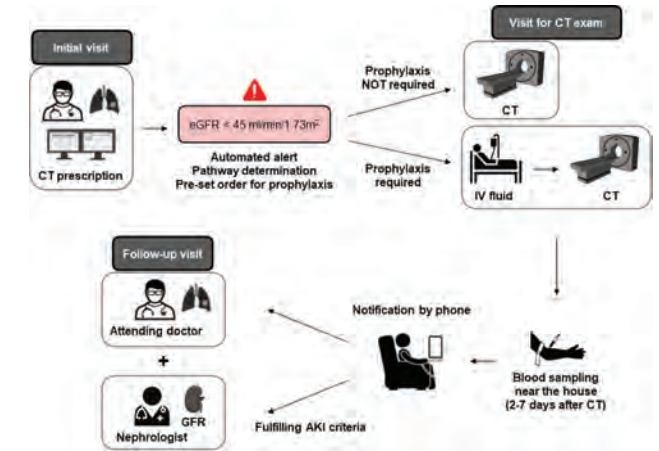

Study protocol

FR-PO069

**Risk Prediction for AKI in Patients Hospitalized With COVID-19: Withstanding Variants Over Time**  
Meredith C. McAdams, Pin Xu, Michael M. Li, Mauricio Ostrosky-Frid, Duwayne L. Willett, Christoph U. Lehmann, Susan Hedayati. The University of Texas Southwestern Medical Center, Dallas, TX.

**Background:** Acute kidney injury (AKI) is common in patients hospitalized with COVID-19, predictive models for AKI are lacking. We aimed to develop the best predictive model for AKI and assess performance over time.

**Methods:** Patients with positive SARS CoV-2 PCR hospitalized between 3/1/2020 to 1/14/2022 at 19 Texas hospitals were included. Those with AKI present on admission were excluded. Comorbidities, demographics, baseline laboratory data, and inflammatory biomarkers were obtained from the EHR and used to build nested models for AKI in an inception cohort. Models were validated in four out-of-time cohorts. Model discrimination and calibration measures were compared to assess performance.

**Results:** Of 13,468 patients, 5,676 were in the Inception Cohort and 7,792 in subsequent validation cohorts grouped based on predominance of COVID variants, with cohorts 1 and 3 containing a mix of variants, cohort 2 corresponding to Delta predominance, and cohort 4 to Omicron. Prevalence of AKI was 13.7% in inception and 12.6%, 12.4%, 13.3%, and 14.4% in the validation cohorts. Proportion of AKI stages 2 or 3 vs. 1 was lower in the Omicron-dominant cohort 4 compared to the inception cohort (28/139 vs. 257/776,  $P = 0.008$ ), but was no different for cohorts 1-3. The final model containing demographics, comorbidities and baseline WBC, hemoglobin, hsCRP, ferritin, and D-dimer, had an AUC=0.781 (95% CI, 0.763, 0.799). Compared to the inception cohort, discrimination by AUC (validation 1: 0.785 [0.760, 0.810],  $P = 0.14$ , validation 2: 0.754 [0.716, 0.795],  $P = 0.14$ , validation 3: 0.778 [0.751, 0.806],  $P = 0.14$ , and validation 4: 0.743 [0.695, 0.789],  $P = 0.14$ ) and calibration by ECI (validation 1: 0.116 [0.041, 0.281],  $P = 1.0$ , validation 2: 0.081 [0.045, 0.295],  $P = 0.64$ , validation 3: 0.055 [0.030, 0.162],  $P = 1.0$ , and validation 4: 0.120 [0.043, 0.472],  $P = 0.50$ ) showed stable performance over time.

**Conclusions:** Using demographics, comorbidities, admission laboratory values, and inflammatory biomarkers, we developed and externally validated a model to accurately predict AKI in hospitalized patients with COVID-19. A lower proportion of patients hospitalized during the Omicron-dominant period of the pandemic experienced severe AKI, but our predictive model withstood changes in practice patterns and virus variants.

**Funding:** NIDDK Support

FR-PO070

**Use of TIMP-2 and IGFBP-7 for Prediction of AKI After Cardiac Surgery**  
David Delijani,<sup>1,2</sup> Pey-Jen Yu,<sup>3,1</sup> Jamie S. Hirsch,<sup>4,1</sup> Steven Fishbane,<sup>4,1</sup> Purva D. Sharma,<sup>4,1</sup> Tylis Chang,<sup>1</sup> Alan Hartman,<sup>3,1</sup> Hugh Cassiere,<sup>3,1</sup> Kenar D. Jhaveri,<sup>4,1</sup> <sup>1</sup>Northwell Health, New Hyde Park, NY; <sup>2</sup>Donald and Barbara Zucker School of Medicine at Hofstra/Northwell, Hempstead, NY; <sup>3</sup>Dept of Cardiothoracic Surgery, Manhasset, NY; <sup>4</sup>Division of Kidney Diseases and HTN, Great Neck, NY.

**Background:** Cell cycle arrest urinary biomarkers, tissue inhibitor of metalloproteinases-2 (TIMP-2) and insulin-like growth factor-binding protein 7 (IGFBP-7) have been used for early detection of acute kidney injury (AKI) in critically ill patients. The purpose of this study was to validate the use of these urinary biomarkers in patients undergoing open heart surgery.

**Methods:** In a single center prospective observational study, urine samples were collected in 108 consecutive patients who underwent open heart surgery. Immediately after separation from cardiopulmonary bypass and on postoperative day one, and were sent for the biomarker [TIMP2]\*[IGFBP7]. Acute kidney injury was defined based on KDIGO criteria and levels of [TIMP2]\*[IGFBP7] were analyzed for the ability to predict AKI.

**Results:** Of the 108 patients, 19 (17.6%) patients developed postoperative AKI within 48 hours of surgery. At the threshold of  $>0.3$  (ng/mL)<sup>2</sup> /1000, post-cardiopulmonary bypass [TIMP-2]\*[IGFBP-7] had a sensitivity of 13% and specificity of 82% for predicting postoperative AKI. Postoperative day 1 [TIMP-2]\*[IGFBP-7] had a sensitivity of 47% and a specificity of 59% for predicting postoperative AKI. There were no differences in [TIMP-2]\*[IGFBP-7] values at either time points between patients that developed postoperative AKI as compared to those that did not. (Figure). Limitations include a single center study and small sample size.

**Conclusions:** Urinary [TIMP-2]\*[IGFBP-7] was not predictive of the risk of AKI after cardiac surgery in this study population. More studies are needed to confirm these markers for AKI after cardiac surgery.

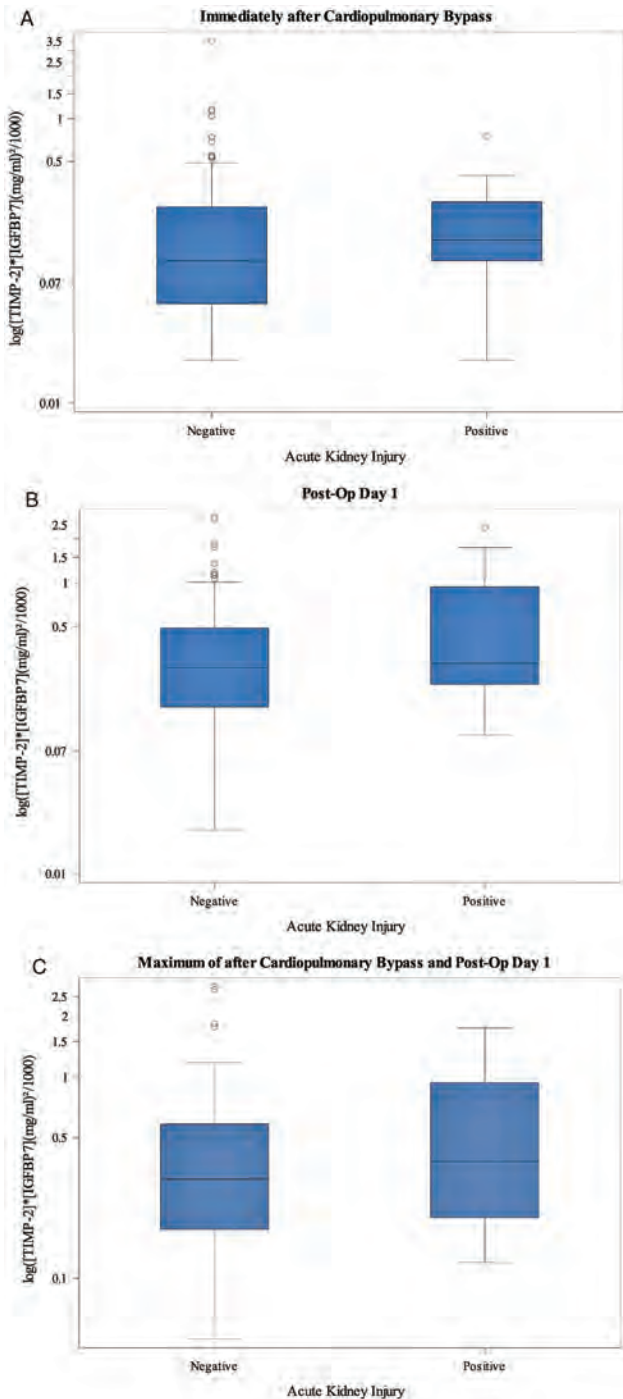

Box and whisker plots comparing median and interquartile range of urinary [TIMP-2]\*[IGFBP-7] levels between patients with and without AKI at different time points. A: Immediately after separation from cardiopulmonary bypass. B: Postoperative day one. C: Maximum value of separation from cardiopulmonary bypass and Postoperative day one.

FR-PO071

CCL14 Predicts Response to Diuretics in Patients With Moderate to Severe AKI

Sevag Demirjian,<sup>1</sup> Lakhmir S. Chawla,<sup>2</sup> Eric Hoste,<sup>3</sup> Patrick Kampf,<sup>4</sup> Jay L. Koyner,<sup>5</sup> Paul McPherson,<sup>4</sup> John A. Kellum.<sup>6</sup> <sup>1</sup>Cleveland Clinic, Cleveland, OH; <sup>2</sup>Veterans affairs, San Diego, CA; <sup>3</sup>Universiteit Gent, Gent, Belgium; <sup>4</sup>Astute Medical Inc, San Diego, CA; <sup>5</sup>University of Chicago, Chicago, IL; <sup>6</sup>University of Pittsburgh, Pittsburgh, PA.

**Background:** Non-recovery in patients with moderate to severe acute kidney injury (AKI) is associated with morbidity and mortality. Elevated CCL14 levels predict persistent AKI and might facilitate better patient management. We examined whether there is an interaction between CCL14 and diuretic use on urine output in order to guide subsequent volume management.

**Methods:** We analyzed data on 497 patients enrolled in 2 prior studies where urine output was documented the day prior, and two days following CCL14 measurement. Diuretic use was defined as any diuretic exposure from one day prior to one day following the CCL14 measurement. Urine output was compared across previously reported three categories of CCL14 ( $\leq 1.3$ ,  $>1.3-13$ ,  $>13$  ng/mL) and by diuretic status using Tukey's honestly significant difference test.

**Results:** In the overall cohort 242 (49%) patients received diuretics; 55%, 46% and 34% in patients with low, intermediate and high CCL14 levels, respectively. Urine output over 72 hours was greater with diuretics when CCL14 was low ( $\leq 1.3$  ng/mL) (difference in means (95%CI) = 2596 ml (1157 - 4034) ml,  $p < .001$ ), but not when CCL14 was elevated (Figure).

**Conclusions:** Response to diuretics was only observed in patients with low CCL14 ( $\leq 1.3$  ng/mL) corresponding to low risk for persistent AKI. Identifying patients with AKI who are unlikely to respond to diuretics may guide clinicians at the bedside to choose alternative means for volume management.

**Funding:** Commercial Support - Astute medical

	No diuretic use(n=255)	Diuretics Use (n=242)	p value
Male	150 (59%)	154 (64%)	0.311
Age (years)	64 (55 - 72)	67 (57 - 75)	0.038
Chronic kidney disease	36 (14%)	40 (17%)	0.458
Diabetes mellitus	82 (32%)	91 (38%)	0.221
Heart failure	37 (15%)	73 (30%)	<0.001
Baseline serum creatinine (mg/dL)	1.0 (0.7 - 1.2)	1.0 (0.8 - 1.3)	0.026
Non-renal APACHE III score at enrollment	56 (40 - 75)	55 (44 - 76)	0.168
Fluid balance l (mL) on Day 1	3234 (1477 - 6328)	2122 (319 - 4282)	<0.001
CCL14 concentration l (ng/mL)	2.17 (0.77 - 7.07)	1.28 (0.56 - 4.66)	0.004

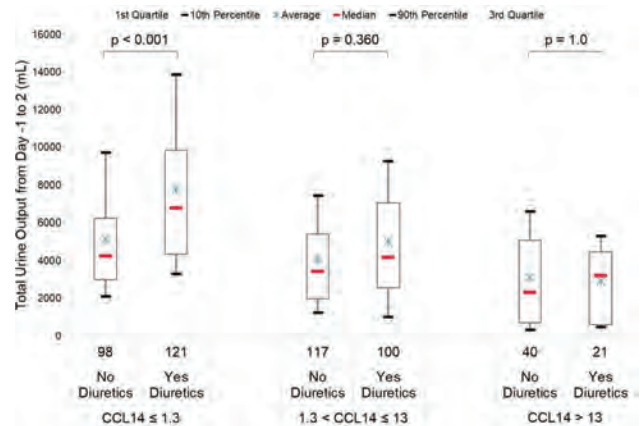

FR-PO072

**Serum Response Factor, a Novel Early Diagnostic Biomarker of AKI**

Long Zhao, Yan Xu. *The Affiliated Hospital of Qingdao University, Qingdao, China.*

**Background:** Studies have shown that serum response factor (SRF) is increased in chronic kidney injury, such as diabetic nephropathy, hyperuricemic nephropathy and renal cell carcinoma. The objective is to explore the early diagnostic value of SRF in acute kidney injury (AKI).

**Methods:** AKI-related microarray data were analyzed, and the expression and location of SRF were investigated in the early phase of AKI.

**Results:** Bioinformatics results demonstrated that SRF was dramatically elevated 2-4 h after ischemia/reperfusion (I/R) in mouse renal tissue (Figure 1). In I/R rats, SRF was mostly expressed and located in renal tubular epithelial cells (TECs) (Figure 2). SRF started to increase at 1 h, peaked at 3-9 h and started to decrease at 12 h after I/R (Figure 3-4). The areas under the ROC curve of renal SRF mRNA, renal SRF protein, urinary SRF, serum SRF and serum creatinine (Scr) were 87.9%, 83.0%, 81.3%, 78.8%, 68.8%, respectively (Figure 5).

**Conclusions:** SRF is remarkably upregulated in early (before 24 h) AKI and can replace Scr as a potential new early diagnostic biomarker of AKI.

**Funding:** Government Support - Non-U.S.

**Figure 1**

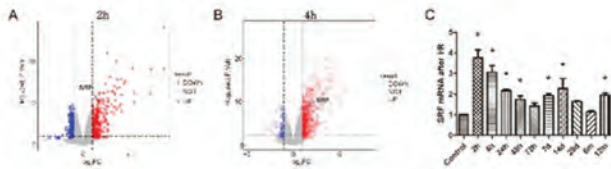

**Figure 2**

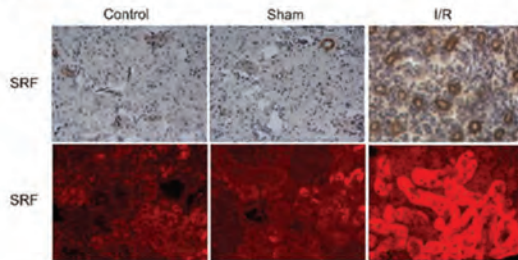

**Figure 3**

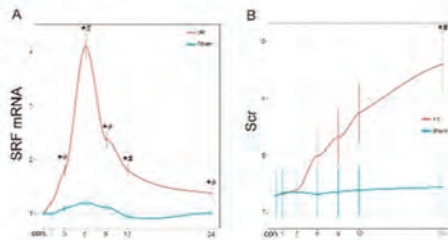

**Figure 4**

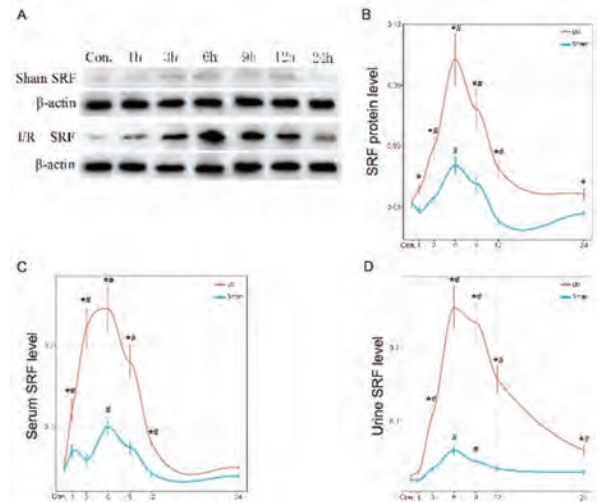

**Figure 5**

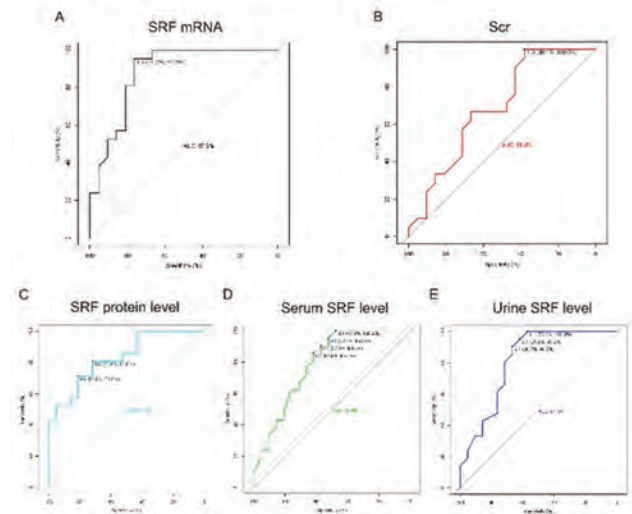

FR-PO073

**Ouabain as an Early Marker of AKI**

Lorenzo Cocchini,<sup>1</sup> Marta De Filippo,<sup>1</sup> Matteo Marcello,<sup>1</sup> Davide Raimondo,<sup>1</sup> Chiara Lanzani,<sup>2,1</sup> Elisabetta Messaggio,<sup>2</sup> Lorena Citterio,<sup>2</sup> Laura Zagato,<sup>2</sup> Giuseppe Vezzoli,<sup>2,1</sup> Paolo Manunta,<sup>2,1</sup> Marco Simonini.<sup>2</sup> <sup>1</sup>Università Vita Salute San Raffaele, Milano, Italy; <sup>2</sup>IRCCS Ospedale San Raffaele, Milano, Italy.

**Background:** Acute kidney injury (AKI) is a common post-cardiac surgery complication and its influence on morbidity and mortality makes it necessary to identify new preoperative biomarkers and solid predictive models for AKI. This study was designed to create a new powerful score for postoperative AKI risk and to validate the use of endogenous ouabain (EO) as biomarker of individual susceptibility for AKI after cardiac surgery.

**Methods:** 1174 patients undergoing elective cardiac surgery were enrolled in the study and included in the analysis. The primary outcome was AKI development, according to KDIGO 2012 guidelines. Preoperative blood samples were collected to evaluate EO basal levels. Different preoperative clinical variables were analyzed, among which classic anthropometric variables, comorbidity and surgery-connected variables.

**Results:** AKI was developed in 21.6% of patients (9% developed severe AKI, stage ≥ 2), and it is significantly correlated to postoperative death and to preoperative EO levels in plasma (p-value < 0.001). Moreover the higher was EO level, the greatest was the incidence

of AKI: the patients in the first EO tertile developed AKI with a frequency of 14.1%, 18.0% in the second tertile, and 28.8% in the third one. A significant association was also found among EO and cardiac and kidney basal function (EF and eGFR, p-value = 0.005 and p-value = 0.003, respectively). Five independent risk factors turned out to be significantly correlated to AKI and severe AKI: age, FE, NYHA class, reoperation and complex surgical intervention (p-value < 0.001 for all of them). In the light of these results, a clinical predictive model for AKI, based on the preoperative clinical values significantly associated with AKI and on the preoperative EO, was developed. The inclusion of EO in the predictive model led to a significant improvement in the prediction capacity of the score (AUC per Severe AKI = 0.82, 95% CI 0.771-0.858, p-value < 0.001).

**Conclusions:** In conclusion, AKI is correlated to high postoperative mortality. EO preoperative level in plasma is strongly associated to cardiac and kidney basal function and a prediction score that includes it results in better patient stratification and more effective pre-operative counseling.

FR-PO074

Association of Serum Ferritin and Hepcidin With Renal Recovery in Community Acquired AKI

Jasmine Sethi, Vivek Kumar, Ashok K. Yadav. Post Graduate Institute of Medical Education and Research, Chandigarh, India.

**Background:** Acute kidney injury (AKI) is an expanding overall health concern. The present study was designed to study the association of serum iron, ferritin and hepcidin with renal recovery at 4 months in patients of community acquired AKI.

**Methods:** It is a prospective observational cohort study. All admitted patients aged between 13-70 years and diagnosed to have CA-AKI were eligible for screening. Patients with pre-existing CKD, suspected glomerulonephritis, chronic liver disease, transplant recipients, previous history of blood transfusion and suspected malignancy were excluded. The subjects had scheduled follow up visits at 1 and 4 months after discharge with renal function test and spot urinary PC ratio.

**Results:** Between October 2020 to July 2021, 100 patients of community acquired acute kidney injury were enrolled in the study after taking informed consent. Out of 100, 4 patients expired and 1 patient was lost to follow up. Out of 95 patients, 76 patients had complete renal recovery whereas 19 patients progressed to chronic kidney disease at the end of 3 months. The mean age of the study sample was 43.2 years with sex ratio of 2:1. Most common aetiology of CAAKI was found to be sepsis related which accounted for 42% cases followed by tropical illness and pancreatitis contributing almost equally 17% and 16% respectively. Other rare causes include snake/ wasp bite (5%), poisoning (3%), acute gastroenteritis(10%). Around half of the cohort had stage 3 acute kidney injury at admission. Higher baseline serum Ferritin and hepcidin showed a statistically significant association with renal recovery at 4 months. On multivariate analysis Diabetes, Ferritin and Hepcidin were significantly affecting renal recovery at 4 months.

**Conclusions:** Renal non recovery was seen in a significant proportion of patients (n=19, 20%) with community-acquired AKI. Elevated baseline serum ferritin and hepcidin were associated with a favourable renal outcome in CA-AKI. Ferritin and hepcidin can be used as prognostic markers in patients with AKI for predicting renal recovery.

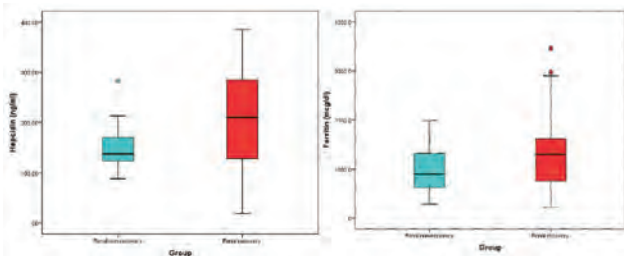

FR-PO075

Platelet Count Is a Novel Independent Predictor of Major Adverse Kidney Events

Isabel Park,<sup>1</sup> Samuel Short,<sup>2</sup> Charlotte Thomas,<sup>1</sup> Helena Kim,<sup>1</sup> Rafia W. Ali,<sup>1</sup> David E. Leaf,<sup>1</sup> <sup>1</sup>Brigham and Women's Hospital, Boston, MA; <sup>2</sup>University of Vermont College of Medicine, Burlington, VT.

**Background:** Thrombocytopenia is associated with increased mortality in patients with established acute kidney injury (AKI). We investigated whether lower platelet count is independently associated with incident AKI.

**Methods:** We performed a retrospective cohort study in two groups of patients: those admitted to the ICU (n=71,749) and those who underwent cardiac surgery (CS; n=21,981) at two academic medical centers in Boston, MA between 2005 and 2018. Patients with end-stage kidney disease and those who already had AKI at study entry were excluded. The primary exposure was platelet count, assessed on ICU admission and preoperatively in the ICU and CS cohorts, respectively. Platelet count was assessed categorically (<30, 30-49, 50-99, 100-149, 150-450, and >450 x 10<sup>9</sup>/L in the ICU cohort, and <100, 100-149, 150-450, and >450 x 10<sup>9</sup>/L in the CS cohort). In both cohorts, platelet counts of 150-450 x 10<sup>9</sup>/L served as the reference group. The primary outcome was Major Adverse Kidney Events within 7 days (MAKE7) following ICU admission or CS, defined as doubling of creatinine, dialysis, or death. We used multivariable logistic regression to adjust for confounders.

**Results:** In both the ICU and CS cohorts, we observed a monotonic increase in risk of MAKE7 with platelet counts below the reference range of 150-450 x 10<sup>9</sup>/L. In the ICU cohort, patients with a platelet count <30 vs. 150-450 x 10<sup>9</sup>/L had a 3.58-fold (95% CI, 3.05-4.19) higher risk of MAKE7 in fully adjusted models (Figure 1A). In the CS cohort, patients with a platelet count <100 vs. 150-450 x 10<sup>9</sup>/L had a 2.28-fold (95% CI, 1.62-3.22) higher risk of MAKE7 in fully adjusted models (Figure 1B).

**Conclusions:** Lower platelet count is strongly and independently associated with a higher risk of MAKE7 in patients admitted to the ICU and in those undergoing CS.

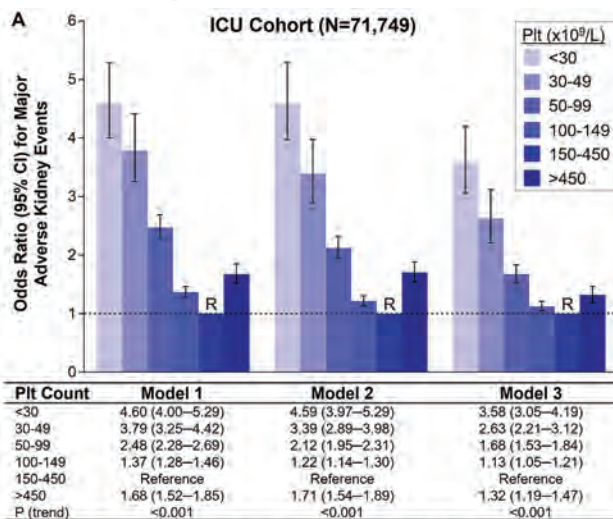

Model 1 is unadjusted. Model 2 adjusted for age, sex, race, baseline eGFR, diabetes, CHF, PAD, CAD, chronic lung disease, chronic liver disease, active malignancy, previous or current smoker, and solid organ transplantation. Model 3 is further adjusted for ICU type, hemoglobin, WBC count, INR, sepsis, shock, and mechanical ventilation.

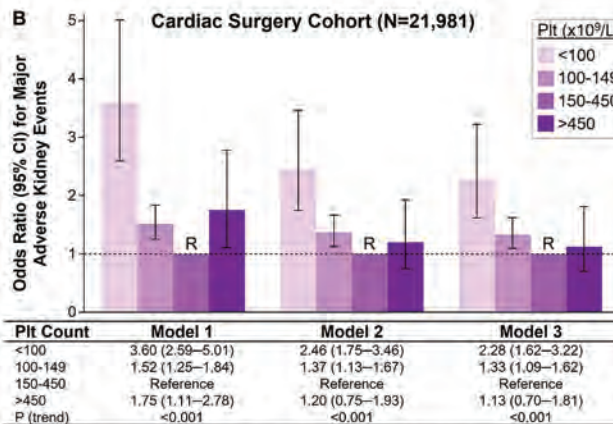

Model 1 is unadjusted. Model 2 adjusted for age, sex, race, baseline eGFR, hemoglobin, hypertension, diabetes, CHF, and PAD. Model 3 is further adjusted for combined CABG/valve procedure, and surgery status (elective vs. non-elective).

FR-PO076

Serum Uromodulin as a Marker for AKI and Chronic Nephron Loss

Eva Vonbrunn, Nadja Ebert, Kerstin U. Amann, Christoph Daniel. Friedrich-Alexander-Universität Erlangen-Nürnberg, Erlangen, Germany.

**Background:** Uromodulin (Umod) is expressed exclusively in the kidney in the thick ascending limb of the loop of Henle. It is secreted in the urine, where it is the most abundant glycoprotein. To a minor degree, Umod is also released basolaterally from cells into the serum. Actually, serum Umod-levels are an established, sensitive and robust marker for chronic kidney disease (CKD). Here, we investigate serum Umod-levels, renal Umod protein and mRNA expression in acute kidney injury (AKI) and in rat models of nephron loss.

**Methods:** Umod was first assessed in AKI using an ischemia-reperfusion (I/R) rat model. Blood and kidney samples were collected 10 min, 6h, 24h, 3d, 5d and 8w post reperfusion. To investigate the effect of nephron number on Umod levels, sera and tissue from healthy rats, uni- and 5/6-nephrectomized (Snx) rats were studied. Renal function (serum creatinine), histological changes (acute tubular injury), and renal damage markers (KIM-1) were evaluated in both models. Serum Umod levels were measured by ELISA and renal Umod mRNA expression by multiplex gene expression analysis. The amount and distribution of Umod protein in the kidney was examined by antibody-based detection methods.

**Results:** In AKI, serum creatinine increased markedly 24h after I/R. Serum Umod was also transiently increased, peaking between 6-24h and correlating with injury. Simultaneously, the amount of Umod-positive kidney cells decreased from  $12.4 \pm 7.7\%$  in healthy rats to  $1.8 \pm 1.7\%$  in kidneys 24h after I/R. In healthy kidneys Umod was detected mainly in the inner and outer strips, while it was substantially reduced and homogeneously distributed in the medulla, inner strip, and outer strip 24h after I/R. Moreover, mRNA expression of Umod decreased continuously after I/R and was lowest on day 1-5. In the models of nephron loss serum Umod correlated positively with nephron number showing highest levels in healthy rats ( $2192.2 \pm 323.8$  pg/ml), which were significantly reduced after uni-nephrectomy ( $1262.9 \pm 208.8$  pg/ml) and further reduced after Snx ( $939.8 \pm 193.5$  pg/ml).

**Conclusions:** Serum Umod appears to be a sensitive marker for AKI showing a transient increase in serum levels in parallel with loss of Umod-expressing cells. Umod serum level correlated positively with nephron number. Thus, serum Umod appears as promising marker to assess acute and chronic renal failure.

**Funding:** Other NIH Support - German research foundation (DFG)

## FR-PO077

### The Correlation Between Neutrophil-to-Lymphocyte Ratio and Contrast-Induced AKI and Establishment of New Predictive Models by Machine Learning

Yi Lu, Fangfang Zhou, Youjun Xu, Shuzhen Zhang, Qun Luo. *Ningbo Huamei Hospital University of Chinese Academy of Sciences, Ningbo, China.*

**Background:** This study intends to explore the correlation between NLR and CI-AKI, and to establish new predictive models of CI-AKI by machine learning.

**Methods:** The data of patients who underwent elective vascular intervention, coronary angiography and percutaneous coronary intervention in our hospital from January 2016 to December 2020 were retrospectively collected. The patients were divided into AKI group and non-AKI group. The analysis of linear trends was used to assess the correlation between the NLR levels and risk of AKI after the sample was divided into tertiles based on the distribution of controls. Logistic regression was used to analyze the correlation between NLR and CI-AKI, and machine learning methods were used to establish logistic regression (LR), random forest (RF), gradient boosting decision tree (GBDT), extreme gradient boosting (XGBoost) and naïve bayes (NB) models. The diagnostic value of the machine learning model was evaluated by receiver operating curve (ROC), and the proportion of feature variables was calculated.

**Results:** (1) 2230 patients were included in this study, and the incidence of CI-AKI was 5.38%. Compared with patients in non-AKI group, patients in AKI group had higher levels of NLR [ $3.38(2.60,5.35)$  vs  $2.79(1.98,4.18)$ ,  $P<0.001$ ], and further multivariate logistic regression analysis showed that NLR was an independent risk factor for CI-AKI (OR=1.054,  $P=0.048$ ). (2) After dividing patient into tertiles based on NLR, those with higher NLR had higher risk of postoperative AKI than those with lower NLR (2.69% vs 5.95% vs 7.51%, trend  $P=0.046$ ). (3) Gradient Boosting Decision Tree(GBDT) model has the best predictive performance of CI-AKI (AUC=0.738), followed by RF, NB, XGBoost and LR models respectively (The AUC values are 0.727, 0.725, 0.719, 0.711). Four indicators included in the GBDT model, which were NLR, serum creatinine, fasting plasma glucose, and the use of  $\beta$ -blocker.

**Conclusions:** There is a significant correlation between NLR and CI-AKI, and the GBDT, RF, NB, XGBoost and LR models established after incorporating this indicator have good effects in predicting and diagnosing the occurrence of CI-AKI.

**Funding:** Government Support - Non-U.S.

## FR-PO078

### Effects of Low Hemoglobin Levels on the Development of Contrast-Induced AKI

Fangfang Zhou, Yi Lu, Youjun Xu, Shuzhen Zhang, Qun Luo. *HwaMei Hospital, University Of Chinese Academy of Science, Ningbo, China.*

**Background:** The aim of this study was to evaluate the relationship between low hemoglobin levels and the development of CI-AKI in patients undergoing angiographic intervention, coronary angiography (CAG) and/or percutaneous coronary intervention (PCI).

**Methods:** Patients aged  $\geq 18$  years who underwent elective angiographic intervention and CAG and/or PCI in the Department of Cardiology and Vascular Surgery of our hospital from January 2016 to December 2020. According to KDIGO criteria of AKI, patients were divided into: (1) AKI group: AKI occurred after CM was used; (2) Non-AKI group: no AKI occurred after CM was used. The baseline characteristics of patients, preoperative use of medicines, laboratory test indicators (eGFR was calculated using EPI formula) and other parameters of each patient were collected retrospectively. SPSS 22.0 software was used for statistical analysis.

**Results:** A total of 2230 patients were included in the study. The hemoglobin (g/L) in patients with CI-AKI was  $117.50(108.00,133.00)$ , significantly lower than that in patients without CI-AKI ( $130.00(118.00,142.00)$ ) ( $P<0.001$ ). The low hemoglobin group was assigned according to hemoglobin level (male,  $<120$  g/L; female,  $<110$  g/L;  $N=40$ ) and normal hemoglobin group (male  $120-160$ g/L; female,  $110-150$ g/L;  $N=80$ ). Multivariate logistic regression analysis showed that 4.30% of patients in the normal hemoglobin group developed CI-AKI, and 10.87% of patients in the low hemoglobin group developed CI-AKI, low hemoglobin (male,  $<120$  g/L; female,  $<110$  g/L) was an independent protective factor for CI-AKI (OR=1.667, =0.001). The independent risk factors for CI-AKI in patients with low hemoglobin level were hyperlipidemia (OR=5.556,  $P=0.01$ ) and atrial fibrillation (OR=2.703,  $P=0.039$ ) and history of coronary artery disease (OR=2.833,

$P=0.006$ ), use of ACEI (OR=3.521,  $P=0.023$ ) and ARB (OR=2.732,  $P=0.011$ ), fasting glucose increased (OR=1.186,  $P=0.001$ ). For patients with normal hemoglobin level, independent risk factors for CI-AKI were increased systolic blood pressure (OR=1.015,  $P=0.008$ ) and positive urine protein (OR=2.114,  $P=0.019$ ), increased neutrophil/lymphocyte ratio (OR=1.079,  $P=0.017$ ), history of chronic kidney disease (OR=5.102,  $P<0.0001$ ), use of low molecular weight heparin (OR=2.222,  $P=0.002$ ) and spironolactone (OR=2.564,  $P=0.033$ ).

**Conclusions:** Low hemoglobin level is an independent risk factor for CI-AKI.

**Funding:** Government Support - Non-U.S.

## FR-PO079

### Epidemiology and Long-Term Outcomes of Severe AKI in Thailand: A Prospective Multicenter Study

Suri Tangchitthavorngul,<sup>1</sup> Nuttha Lumlertgul,<sup>1,14</sup> Sadudee Peerapornratana,<sup>1,14</sup> Veerapatr Nimkietkajorn,<sup>2</sup> Petchdee Oranrigsupak,<sup>4</sup> Wanjak Pongstisak,<sup>5</sup> Kamonwan Tangvoraphonkchai,<sup>6</sup> Atchara Aksornrat,<sup>7</sup> Sompoete Intarak,<sup>8</sup> Theerapon Sukmar,<sup>9</sup> Anan Chuasuwan,<sup>3</sup> Kamol Khositrangsiluk,<sup>10</sup> Watanyu Parapiboon,<sup>11</sup> Pichaya Tantiyavarong,<sup>12</sup> Karjbundit Surasit,<sup>13</sup> Somchai Eiam-Ong,<sup>1</sup> Nattachai Srisawat.<sup>1,14</sup> <sup>1</sup>Chulalongkorn University Faculty of Medicine, Bangkok, Thailand; <sup>2</sup>Buddhachinaraj Phitsanulok Hospital, Phitsanulok, Thailand; <sup>3</sup>Bhumibol Adulyadej Hospital, Bangkok, Thailand; <sup>4</sup>Nan Hospital, Nan, Thailand; <sup>5</sup>Division of Nephrology, Department of Internal Medicine, Faculty of Medicine Vajira Hospital, Navamindradhiraj University, Bangkok, Thailand; <sup>6</sup>Department of Medicine, Maharakham University Hospital, Maharakham, Thailand; <sup>7</sup>Sichon Hospital, Nakhon Si Thammarat, Thailand; <sup>8</sup>Maharakham Hospital, Maha Sarakham, Thailand; <sup>9</sup>Thungsong Hospital, Nakhon Si Thammarat, Thailand; <sup>10</sup>Maharat Nakhon Si Thammarat Hospital, Nakhon Si Thammarat, Thailand; <sup>11</sup>Maharat Nakhon Ratchasima Hospital, Nakhon Ratchasima, Thailand; <sup>12</sup>Thammasat University Hospital, Pathum Thani, Thailand; <sup>13</sup>Nakornping Hospital, Chiang Mai, Thailand; <sup>14</sup>Center of Excellence in Critical Care Nephrology, Chulalongkorn University, Bangkok, Thailand.

**Background:** Acute kidney injury (AKI) contains a high short-term morbidity and mortality. However, little is known regarding long-term outcomes, especially in the resource constrained settings. We aimed to evaluate 1-year major adverse kidney events (MAKE<sub>365</sub>) in patients with severe (stage 3) AKI by kidney recovery patterns at 28 days or hospital discharge.

**Methods:** We analyzed the data from InSEA RRT registry—a multicenter prospective cohort study conducted between January 2021 and January 2022. Critically ill patients with stage 3 AKI as defined by KDIGO were enrolled and classified by recovery status after 28 days or at hospital discharge as early, late, and nonrecovery. Primary outcome was MAKE<sub>365</sub> which is a composite of persistent kidney dysfunction, long-term dialysis, and all-cause mortality on day 365 after enrollment.

**Results:** A total of 1,534 patients from 14 hospitals across Thailand were enrolled. Among these, 755 (49%) patients died, 401 (51%) patients experienced early recovery, 188 (24%) late recovery, and 190 (24%) never reversed AKI. The incidence of MAKE<sub>365</sub> was 68.4 per 100 person-years of all patients. Nonrecovery were more likely to develop MAKE<sub>365</sub> than recovery (adjusted HR 4.24 ;95% CI, 3.20-5.61;  $P<0.001$ ). The incidence of new CKD and CKD progression were 82.8 and 42 per 100 person-years. Patients with older, cancer, mixed ICU, and no nephrologist follow-up were also at risk for MAKE<sub>365</sub>.

**Conclusions:** Nonrecovery AKI was independently associated with adverse long-term outcomes. Recognition and close follow-up of patients with non-recovered AKI is crucial. Novel intervention might improve long-term outcomes and need further study.

**Funding:** Private Foundation Support

## FR-PO080

### AKI During Pregnancy: Baseline Characteristics and Long-Term Outcomes

Mistafa Hafid, Abdel-Raouf M. Akkari, Omar K. Salameh, Muhammad Abdulbasit, Nasrollah Ghahramani. *Penn State College of Medicine, Hershey, PA.*

**Background:** Pregnancy-related acute kidney injury (AKI) is a serious public health problem and is an important cause of maternal and fetal morbidity and mortality. The incidence of pregnancy-related AKI has increased due to increase in maternal age and higher detection rates. Using a large multicenter cohort, we analyzed the differences in demographic characteristics in pregnant women who developed AKI during pregnancy with those who did not develop AKI.

**Methods:** We performed a retrospective multi-center cohort study using TriNetX Research Network database, a federated medical records network, to identify 1,537,027 pregnant women from 46 healthcare organizations (HCOs) in the United States. From this group, we then identified women who has a confirmed diagnosis of AKI during their pregnancy. We calculated the odds ratio (OR) and 95% confidence interval (CI) of diagnosis of off-end Stage Renal Disease (ESRD) and death in the first five years after pregnancy.

**Results:** 4,867 pregnant women (from 40 HCOs) had a confirmed diagnosis of AKI during pregnancy. Compared with the non-AKI group, women in the AKI group were older ( $37.9 \pm 17.5$  vs.  $31.4 \pm 8.9$ ;  $p<0.0001$ ) and more likely to: • be African American ( $p<0.001$ ) • have a Body Mass Index (BMI)  $> 30$  kg/m<sup>2</sup> ( $p<0.001$ ) • have a BMI  $< 20$  kg/m<sup>2</sup> ( $p<0.001$ ) • be nicotine dependent during pregnancy ( $p<0.001$ ) Within the first five years

after pregnancy, a total of 4798 women (434 with AKI) were diagnosed with ESRD and 5136 women (550 with AKI) died. After propensity matching, AKI was associated with higher odds of ESRD (OR: 33.6; CI:30.4 to 37.3), and mortality (OR: 41.7; CI: 38.0 to 45.8).

**Conclusions:** Among pregnant women, those who developed AKI during pregnancy were more likely to be older at time of pregnancy, African American, have a BMI above 30 kg/m<sup>2</sup> or below 20 kg/m<sup>2</sup>, and to be nicotine dependent during pregnancy. AKI during pregnancy was associated with higher likelihood of ESRD and death within five years after pregnancy.

**FR-PO081**

**Recovery of AKI After Cardiac Surgery**

Ankit Sakhuja,<sup>1</sup> Priyanka Priyanka,<sup>2</sup> John A. Kellum.<sup>2</sup> <sup>1</sup>West Virginia University, Morgantown, WV; <sup>2</sup>University of Pittsburgh, Pittsburgh, PA.

**Background:** Acute kidney injury (AKI) is a common complication after cardiac surgery. Development of this cardiac surgery associated AKI (CSA-AKI) is associated with increased mortality and healthcare costs. AKI lasting longer than 3 days (non-recovery) is associated with worse outcomes. There is, however, a lack of studies looking into epidemiology of recovery of CSA-AKI.

**Methods:** This was a retrospective observational study using data from High-Density Intensive Care -15 Database from University of Pittsburgh Medical Center. Data from 2008 – 2014 was included for this study. Patients undergoing cardiac surgery were identified using ICD-9-CM codes. AKI was identified using KDIGO criteria. Patients with continued AKI at discharge were identified as having acute kidney disease (AKD). Missing variables were imported using Multivariate Imputation by Chained Equation (MICE). We used Kruskal-Wallis and Chi-Square/Fisher Exact tests to compare continuous and categorical variables respectively. We used multivariable logistic regression models to identify risk factors for development of non-recovery of AKI and AKD after cardiac surgery.

**Results:** Among 6,440 patients, 5228 (81.9%) developed CSA-AKI. Of those who developed CSA-AKI, 98.2% developed it within 72 hours after cardiac surgery. We found that 84% of CSA-AKI was transient, resolving within 72 hours. AKI that persisted for more than 3 days (non-recovery) was about as likely to be seen with serum creatinine as with urine output, whereas transient AKI was more likely to be urine output based. Risk factors for non-recovery of AKI included thrombocytopenia, congestive heart failure, chronic obstructive pulmonary disease, CABG combined with valve surgery, black race and emergent admission. Development of AKD was seen in less than 10% patients. Risk factors for development of AKD included longer duration of surgery, congestive heart failure, use of intra-aortic balloon pump, black race and emergent admission.

**Conclusions:** AKI is very common after cardiac surgery but majority of it resolved within 3 days of onset. Transient AKI is more often associated with isolated oliguria, whereas non-recovery is about as likely to be seen with oliguria and as with azotemia.

**Funding:** Commercial Support - CytoSorbents Corporation

**FR-PO082**

**Temporal Evolution of AKI After Cardiac Surgery**

Ankit Sakhuja,<sup>1</sup> Priyanka Priyanka,<sup>2</sup> John A. Kellum.<sup>2</sup> <sup>1</sup>West Virginia University, Morgantown, WV; <sup>2</sup>University of Pittsburgh, Pittsburgh, PA.

**Background:** Acute kidney injury (AKI) is a common complication after cardiac surgery and is associated with high mortality. There is a well-defined timing of injury to the kidneys in these patients, which provides a unique opportunity for trial of novel therapeutic agents. There is, however, very little information about the temporal evolution of AKI after cardiac surgery. Understanding of the temporal evolution is important to inform trials for novel therapeutic strategies for prevention and management of CSA-AKI.

**Methods:** This was a retrospective observational study using data from High-Density Intensive Care -15 Database from University of Pittsburgh Medical Center. Data from 2008 – 2014 was included for this study. Patients undergoing cardiac surgery were identified using ICD-9-CM codes. AKI was identified using KDIGO criteria. We used Kruskal-Wallis and Chi-Square/Fisher Exact tests to compare continuous and categorical variables respectively. We used multivariable logistic regression models to identify risk factors for development of stage II/III AKI at 72 hours based on serum creatinine and urine output based criteria.

**Results:** Among 6,440 patients, 5228 (81.9%) developed CSA-AKI. Of those who developed CSA-AKI, 91% developed it within 24 hours and 98% within 72 hours after cardiac surgery. Stage I AKI within first 72 hours after cardiac surgery was the most common initial manifestation of CSA-AKI (98.7%). Majority of AKI within first 72 hours after cardiac surgery was due to isolated decrease in urine output. Additionally, the maximum AKI stages as scored by urine output exceeded those scored by serum creatinine by approximately 50% over first 10 days after cardiac surgery. The risk factors for stage II/III AKI by 72 hours after cardiac surgery differed based on whether the severity was seen due to rise in serum creatinine or decrease in urine output. Patients who developed AKI within first 24 hours were more often obese, with chronic kidney disease and diabetes. They also consistently had higher major adverse kidney events at 30d, 90d, 180d and 1 yr after surgery.

**Conclusions:** AKI is very common after cardiac surgery and is characterized by both oliguria and azotemia with former being much more frequent. Majority of CSA-AKI is notable within 24 hours after cardiac surgery with stage I being the initial manifestation. AKI manifesting as azotemia has different risk factors than that manifesting as oliguria.

**Funding:** Commercial Support - Cytosorbents Corporation

**FR-PO083**

**Association of Acute eGFR Changes With Mortality and Heart Failure Hospitalizations Among Patients Admitted for Acute Heart Failure Requiring Hemodynamic Monitoring**

Run Banlengchit,<sup>1</sup> Hocine Tighiouart,<sup>1,2</sup> Jake Gillberg,<sup>1</sup> Marcelle Tuttle,<sup>1</sup> Jeffrey M. Testani,<sup>3</sup> Tatsufumi Oka,<sup>1</sup> Michael S. Kiernan,<sup>1</sup> Mark J. Sarnak,<sup>1</sup> Wendy I. McCallum.<sup>1</sup> <sup>1</sup>Tufts Medical Center, Boston, MA; <sup>2</sup>Tufts Medical Center Institute for Clinical Research and Health Policy Studies, Boston, MA; <sup>3</sup>Yale School of Medicine, New Haven, CT.

**Background:** Acute changes in estimated glomerular filtration rate (eGFR) are frequently encountered among patients admitted for acute heart failure (AHF). However, there is wide variation in how acute eGFR change is described, and whether these acute changes are associated with clinical outcomes.

**Methods:** Records for patients admitted with a primary diagnosis of AHF requiring invasive hemodynamic monitoring were collected from 2015 to 2021 from a single quaternary academic center. Using the CKD-EPI 2021 formula, each in-hospital creatinine was used to estimate GFR, and slopes of eGFR were calculated for each individual using linear mixed modeling. Multivariable Cox regression models were used to evaluate the association between in-hospital eGFR slope with risk of mortality and a composite of mortality or HF hospitalization after discharge, treating eGFR slope both as a continuous variable and in quartile analysis. Covariates included age, sex, race, diabetes, hypertension, and baseline eGFR.

**Results:** Among 727 patients admitted for AHF with both baseline and discharge eGFR available, the mean (SD) age was 61 (14) years with mean baseline eGFR of 57 (27) ml/min/1.73m<sup>2</sup>. Overall, eGFR increased by median (IQR) 1.3 ml/min/1.73m<sup>2</sup> per week (-1.5, 4.6). Over a median 14 (maximum 35) months follow-up, in reference to the quartile with the fastest increase in eGFR (Quartile 1), the quartile with fastest decline in eGFR (Quartile 4) was associated with increased risk of mortality and composite of mortality and HF hospitalization (Table).

**Conclusions:** Among patients admitted for AHF requiring invasive hemodynamic monitoring, an acute in-hospital decrease in eGFR was associated with increased risk of mortality and heart failure hospitalization, independent of baseline eGFR.

**Funding:** Other NIH Support - NCATS

Table. Hazard ratios for mortality and composite outcome per each 5 ml/min/1.73m<sup>2</sup> faster increase in in-hospital eGFR per week and by quartiles of slope, with Quartile 1 having the fastest increase and Quartile 4 the fastest decrease

	Continuous (n=727)	Quartile 1 Increase in eGFR (n=198)	Quartile 2 (n=184)	Quartile 3 (n=178)	Quartile 4 Decrease in eGFR (n=167)
Median eGFR slope (IQR), ml/min/1.73m <sup>2</sup> per week	1.3 (-1.5, 4.6)	7.1 (5.7, 11.8)	2.6 (1.8, 3.4)	-0.2 (-0.9, 0.4)	-4.5 (-7.0, -3.1)
<b>Mortality</b>					
N of events	288	68	76	83	71
Unadjusted	0.92 (0.84, 1.01)	Ref	1.23 (0.89, 1.71)	1.48 (1.08, 2.04)	1.44 (1.03, 2.01)
Adjusted	0.84 (0.76, 0.93)	Ref	1.15 (0.83, 1.59)	1.46 (1.05, 2.03)	1.93 (1.37, 2.70)
<b>Composite of Mortality and Heart Failure Hospitalization</b>					
N of events	588	148	139	143	138
Unadjusted	0.93 (0.87, 1.00)	Ref	1.06 (0.84, 1.34)	1.10 (0.87, 1.38)	1.25 (0.99, 1.58)
Adjusted	0.90 (0.84, 0.96)	Ref	1.09 (0.86, 1.37)	1.17 (0.92, 1.47)	1.41 (1.11, 1.79)

Data presented as hazard ratios (95% CI). Model is adjusted for age, sex, race, diabetes, hypertension, and baseline eGFR. Abbreviations: eGFR, estimated glomerular filtration rate

**FR-PO084**

**Externally Validated Postoperative Long-Term Adverse Event Prediction Model for Non-Cardiac Surgery: An Extension of Simple Postoperative AKI Risk (SPARK) Model**

Sehoon Park,<sup>1</sup> Soie Kwon,<sup>1</sup> Ji Eun Kim,<sup>2</sup> Jin Ho Hwang,<sup>3</sup> Chung Hee Baek,<sup>4</sup> Jeonghwan Lee,<sup>5</sup> Yong Chul Kim,<sup>1</sup> Dong Ki Kim,<sup>1</sup> Kwon Wook Joo,<sup>1</sup> Yun Su Kim,<sup>1</sup> Hajeong Lee.<sup>1</sup> <sup>1</sup>Seoul National University Hospital, Jongno-gu, Seoul, Republic of Korea; <sup>2</sup>Korea University Guro Hospital, Seoul, Republic of Korea; <sup>3</sup>Chung Ang University Hospital, Seoul, Republic of Korea; <sup>4</sup>Asan Medical Center, Songpa-gu, Seoul, Republic of Korea; <sup>5</sup>Seoul National University Seoul Metropolitan Government Boramae Medical Center, Dongjak-gu, Seoul, Republic of Korea.

**Background:** We aimed to construct an externally validated postoperative long-term adverse event prediction model based on acute kidney (AKI) related variables. We extended our previous Simple Postoperative AKI Risk (SPARK) model to suggest a comprehensive prediction-system for postoperative adverse events related to kidney function.

**Methods:** This model development study retrospectively included 4 observational cohorts. The model development cohort included 33,636 non-cardiac surgery patients from Seoul National University. Three external validation cohorts were constructed: including external non-cardiac surgery cases from other hospitals or duration (N=33,943, 56,012, and 15,220). Primary study outcome was composite adverse event of dialysis or mortality within 1 year. Multivariable Cox regression model including the variables consist of the SPARK index, baseline malignancy, and postoperative AKI stage was used for model construction.

**Results:** The prediction model for kidney failure or mortality within one year showed acceptable performance (c-index 0.752) in the development cohort. When the model was applied to the validation cohorts, the prediction performances were also acceptable (c-index 0.735, 0.755, and 0.843). The model has been constructed as a calculator with combination of the SPARK index for comprehensive usage for nephrologists for postoperative adverse event risk assessment based on kidney related variables.

**Conclusions:** The prediction model for long-term adverse event after non-cardiac surgery provides a useful way to predict long-term risks based on kidney function related variables, along with the prediction for the risks of postoperative AKI.

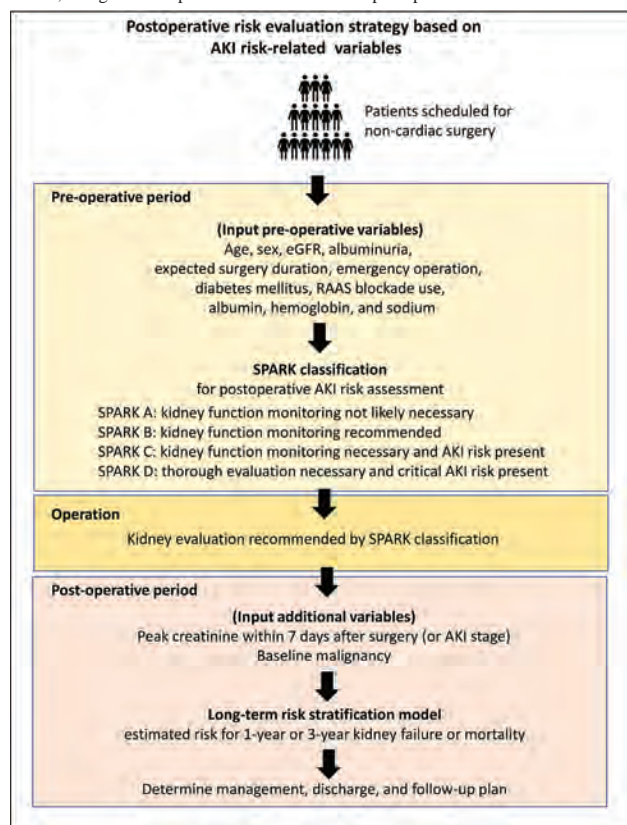

#### FR-PO085

##### Effects of Cardiovascular Outcomes of Sacubitril-Valsartan in Patients With AKI

Hoon Young Choi,<sup>1,2</sup> Donghwan Oh,<sup>1,2</sup> Eunji Yang,<sup>1,2</sup> Jong Hyun Jhee,<sup>1,2</sup> Hyeoncheon Park,<sup>1,2</sup> <sup>1</sup>Yonsei University College of Medicine, Seodaemun-gu, Seoul, Republic of Korea; <sup>2</sup>Gangnam Severance Hospital, Seoul, Republic of Korea.

**Background:** Sacubitril-valsartan reduced the risk of cardiovascular (CV) mortality among patients with heart failure with reduced ejection fraction (HFrEF). However, it is still unclear a long term protective effect on cardiac function in HFrEF patients with acute kidney injury (AKI). This study aimed to investigate the association between long term effects of CV protection and AKI treated by sacubitril-valsartan.

**Methods:** Data were retrieved from the Severance Open Big Data Portal. Patients under Sacubitril-valsartan or valsartan medication after diagnosis of heart failure between May 2015 and June 2021 (N = 782). A total of 295 patients with HFrEF treated by sacubitril-valsartan or valsartan were enrolled. The participants were divided into each group to study the effect of sacubitril-valsartan in patients taking valsartan as a control group. The ratio ( $\Delta$  Ejection Fraction(EF)/ $\Delta$  estimated glomerular filtration rate(eGFR)) was used to analyze the association between CV and renal outcomes during the study period.

**Results:** The total of 295 patients with HFrEF and the rate of patient with AKI accounted for 9.5% of the total. Baseline characteristics show that the mean age of the HFrEF patients with AKI was 76.1  $\pm$  9.4 years, and 65.5% were male. The mean level of eGFR were 41.5  $\pm$  23.4 in sacubitril-valsartan group and 64.9  $\pm$  23.1 mL/min/1.73m<sup>2</sup> in valsartan group. The mean level of EF (%) were 28.0  $\pm$  6.4 in sacubitril-valsartan group and 37.5  $\pm$  12.6 in valsartan group. When the association between renal outcome and cardiovascular outcome was analyzed by independent two sample t-test, the sacubitril-valsartan group improved cardiovascular outcomes compared to valsartan group (Difference value 11.2  $\pm$  13.1% in sacubitril-valsartan group and -0.6  $\pm$  11.1% in valsartan group, P= 0.03).

**Conclusions:** The present study demonstrated that HFrEF patients treated with sacubitril-valsartan had a significant improved cardiovascular outcome even if AKI.

#### FR-PO086

##### The Effects of Muscle Mass and Quality on Mortality of Patients With AKI Requiring Continuous Renal Replacement Therapy

Jiyun Jung,<sup>1</sup> Jangwook Lee,<sup>1</sup> Sung Joon Shin,<sup>1</sup> Hyosang Kim,<sup>2</sup> Jae Yoon Park.<sup>1</sup> <sup>1</sup>Dongguk University Ilsan Hospital, Goyang, Gyeonggi-do, Republic of Korea; <sup>2</sup>Asan Medical Center, Songpa-gu, Seoul, Republic of Korea.

**Background:** Sarcopenia which can lead to decline in physical ability has been known as risk factor on mortality and morbidity. However, little studies have found the effects of muscle mass on mortality of patients with Acute Kidney Injury (AKI) requiring Continuous Renal Replacement Therapy (CRRT).

**Methods:** We collected 2,221 AKI patients who received CRRT in 8 medical centers between 2006 and 2021. The skeletal muscle areas (SMA) with a threshold of  $-29$  to 150 Hounsfield units from CT images at the level of the 3rd lumbar vertebra was obtained through automated software at ASAN medical center. SMA was further categorized in normal attenuation muscle area (NAMA) and low attenuation muscle area (LAMA) to assess the density of muscle. We used Cox proportional hazard model to investigate the association between mortality within 1, 3, and 30 days and skeletal muscle index (SMA, NAMA, and LAMA). In addition, stratified analyses were conducted by sex, age, the acute physiology and chronic health evaluation (APACHE II) score, and the sequential organ failure assessment (SOFA) score to assess the susceptible subgroups.

**Results:** More than half of the patients (60%) were male and the mean age of patient was 66.01 years. The 30-day mortality rate was 52% (n=1,155). An IQR increase of SMA (38.2cm<sup>2</sup>) was associated with decreased mortality risk (Hazard ratio [HR]: 0.79, 95% confidence interval [CI]: 0.65–0.97). In subgroup analyses on muscle quality, we identified the 26% decreased risk of LAMA on mortality (HR: 0.74, 95% CI 0.63–0.87) while non-significant effects were found in NAMA (HR:1.05, 95% CI: 0.85–1.29). Stronger protective effects of muscle mass index on mortality were found in male, those who aged over 65 years, and high score group of APACHE II.

**Conclusions:** We found the protective effects of muscle mass on mortality of AKI patients requiring CRRT. In addition, even if the density was low, the effect of muscle mass itself was significant determinant factors on lowering mortality.

**Funding:** Government Support - Non-U.S.

#### FR-PO087

##### Circulating Endotoxin and Inflammatory Proteins Correlate With Kidney and Hospitalization Outcomes in Critically Ill Patients

Sian Piret, Fabliha Fairuz, Samaneh Gholami, Sobia N. Khan, Sandeep K. Mallipattu. *Stony Brook University, Stony Brook, NY.*

**Background:** Endotoxin, a component of gram negative bacterial cell walls, may be present in the circulation of critically ill patients with or without bacteremia, and is a potent trigger of AKI and inflammation. Our aim was to determine correlations between endotoxin levels, inflammatory proteins, and AKI and hospitalization outcomes in incident critically ill patients.

**Methods:** Patients were recruited from those aged 18 or over admitted to intensive care units (ICUs), who did not have end-stage renal failure requiring dialysis, or were on chronic immunosuppressive medication. Blood endotoxin levels were measured within 48 hours of ICU admission using the FDA-approved endotoxin activity assay (EAA). EAA results were categorized as either low/intermediate (<0.6) or high ( $\geq$ 0.6), or used as a continuous variable. Kidney parameters, vital signs, and dispositions were obtained from electronic medical records. AKI was defined as per KDIGO guidelines. Plasma proteomics was undertaken on 87 patients using the O-link Target 96 inflammation panel.

**Results:** A total of 106 patients were recruited between November 2020 and March 2022, with 4 patients testing positive for gram negative bacteria. EAA levels were <0.6 in 54 patients (51%) and  $\geq$ 0.6 in 52 patients (49%). There was a positive correlation between EAA and serum creatinine levels (p<0.05). Only 2/54 patients (3.7%) with EAA <0.6 developed AKI stage III versus 9/52 patients (17.3%) with EAA  $\geq$ 0.6 (p<0.05). Combined EAA plus SOFA score was significantly higher in patients with AKI versus no AKI (p<0.0001). Patients with EAA  $\geq$ 0.6 has a significantly longer hospital stay than patients with EAA <0.6 (p<0.05). Hierarchical clustering analysis using plasma proteomics data resulted in two clusters, with most of the patients without AKI represented in a separate cluster from those with AKI. Analysis of individual protein levels between the two clusters showed differences in levels of IL8, MCP-3, FGF23, IL-10, and CCL20. These proteins were also significantly higher when compared specifically in patients with AKI versus no AKI (p<0.01 – p<0.0001).

**Conclusions:** Endotoxin levels on admission to ICU correlated with kidney function and AKI, and patients with high EAA had longer hospital stay. Patients with AKI also had higher levels of specific circulating inflammatory proteins.

#### FR-PO088

##### Outcomes After AKI: Are We Communicating Effectively?

Ingi A. Elsayed. *University Hospitals of North Midlands NHS Trust, Stoke-on-Trent, United Kingdom.*

**Background:** Acute Kidney Injury (AKI) is widely recognised as both a prevalent and serious problem, associated with worsening of morbidity, an independent predictor of mortality & risk of development of CKD. NICE guidance (NG148) recommended improved communication between 2ry care & 1ry care, to enable appropriate follow up when needed.



**Methods:** We provide an institute wide (large teaching hospital, catchment area of 700,000) AKI service, comprised of consultant intensivist/nephrologist (lead) & two specialist nurses. We have implemented an e-Alert system, which integrates laboratory information system, using an NHS endorsed algorithm (based on biochemical criteria), with hospital admission systems to identify patients with AKI in real time. This generates a list that is forwarded daily to AKI team, where AKI specialist nurses review, all patients with AKI stages 2 & 3. We implemented an electronic communication system, using hospital discharge letters to document AKI, its stage and issue advice to Iry care requesting interval repeat of kidney functions & referral to renal services where appropriate. We analysed the efficiency of this communication system, over one month (Oct 2019) and followed them up for three months afterwards.

**Results:** Over October 2019, we reviewed a total of 190 AKI patients, 136 of which were community-acquired AKI (71.5%). 106 of them were male (55.7%) and the median age of all patients was 74ys. 126 of patients presented with an AKI stage 2 (66.3%). Average baseline creatinine was 80.4 (SD 31) micromol/L and 92 of all patients were known to have CVD (48.4%); while 31 were to have CKD3 or 4 prior to presentation (16.3%). Their LOS was 14.9 days on average. By the end of the study period, 56 patients died (29.5%); 36 of whom, died during their index admission. Electronic communication was issued for 100% of all survivors at time of discharge. Yet, 25 patients did not get repeat blood tests (13%) over 3 months after index presentation. Of those who had their bloods tested, 33 patients' creatinine levels remained above baseline (17.3%) with only One patient referred to renal services by their Iry care physician.

**Conclusions:** Improved communication to ensure better quality of care & prevent further episodes of AKI, is integral to care of AKI patients. Better systems to guarantee seamless care (including long term follow up) after AKI, are needed.

**FR-PO089**

**Building a Prediction Model for Postoperative AKI Using Machine Learning: The CMC-AKIX Model**

Ji Won Min,<sup>1</sup> Hye Eun Yoon,<sup>2</sup> *Catholic University of Korea Bucheon Saint Mary's Hospital, Bucheon, Gyeonggi-do, Republic of Korea;* <sup>2</sup>*Catholic University of Korea Incheon Saint Mary's Hospital, Incheon, Incheon, Republic of Korea.*

**Background:** Postoperative acute kidney injury (AKI) is associated with increased mortality and morbidity in patients undergoing surgeries performed under general anesthesia. There are several models that predict postoperative AKI risk, but most are single-center studies that need external validation.

**Methods:** In this retrospective cohort analysis, we included noncardiac surgeries performed between 2009 and 2019 at 7 university hospitals in South Korea. Postoperative AKI was defined as an increase of serum creatinine at least 1.5 times the baseline value or initiation of renal replacement therapy within 30 days of the postoperative period. We tested 6 machine learning prediction models: deep neural networks (DNN), logistic regression, decision tree, random forest, light gradient boosting machine (GBM), and naive Bayes, and compared model performance using the area under the curve (AUC) of the receiver-operating characteristic.

**Results:** A total of 239,267 surgeries were included, and 7,935 postoperative AKI events (3.3%) occurred. The 6 different statistical analysis methods were run on various combinations of 40 independent preoperative predictors that we had selected (Table 1). Model 1 included all variables, Model 2 included variables that had been significantly associated with postoperative AKI in previous studies, and Model 3 included variables that were found significant in multivariate analysis. Among them, Model 1 run on DNN (AUC = 0.821) and light GBM (AUC = 0.823) and Model 3 run on DNN (AUC = 0.807) demonstrated the best prediction performance.

**Conclusions:** We have developed a high-performance risk prediction system for postoperative AKI that can be easily applied using preoperative patient characteristics and laboratory data.

**Funding:** Private Foundation Support

Analysis	Model	AUC	Accuracy	Precision	Specificity	F1 score
DNN	Model 1 *	0.821	0.955	0.375	0.998	0.641
	Model 2 **	0.806	0.956	0.407	0.999	0.691
	Model 3 ***	0.807	0.955	0.380	0.999	0.633
Logistic Regression	Model 1	0.811	0.955	0.383	0.998	0.754
	Model 2	0.784	0.956	0.333	1.000	0.607
	Model 3	0.802	0.955	0.310	0.998	0.643
Decision Tree	Model 1	0.672	0.956	0	1.000	0
	Model 2	0.666	0.967	0	1.000	0
	Model 3	0.672	0.956	0	1.000	0
Random Forest	Model 1	0.803	0.956	0.571	1.000	0.607
	Model 2	0.767	0.967	0.440	1.000	0.610
	Model 3	0.778	0.956	0.455	1.000	0.609
Light GBM	Model 1	0.823	0.955	0.360	0.998	0.653
	Model 2	0.803	0.966	0.356	1.000	0.614
	Model 3	0.801	0.955	0.328	0.998	0.637
Naive Bayes	Model 1	0.780	0.851	0.145	0.881	0.318
	Model 2	0.766	0.884	0.112	0.902	0.171
	Model 3	0.782	0.895	0.162	0.921	0.318

\*Model 1: Age, Sex, SBP, DBP, BMI, CKD, DM, HF, CVD, CAD, FOPX, I.C, emergency operation, operation duration, ABO group, NSAIDs usage, serum creatinine, GFR, renal function, albumin, AST, ALT, BUN, creatinine, potassium, chloride, sodium, CPK, LDH, CRP, glucose, hemoglobin, potassium, WBC, urine-specific gravity, urine protein  
 \*\* Model 2: Age, sex, emergency operation duration, DM, ABO usage, albumin, hemoglobin, sodium, GFR, serum creatinine  
 \*\*\* Model 3: Age, Sex, SBP, DBP, operation duration, serum creatinine, GFR, albumin, sodium, potassium, chloride, glucose, LDL serum protein

Table 1. Performance metrics of postoperative AKI prediction models.

**FR-PO090**

**Continuous Prediction of Mortality During AKI Renal Replacement Therapy (RRT): A Deep Learning Approach**

Lucas J. Liu,<sup>1</sup> Victor M. Ortiz-Soriano,<sup>2</sup> Jin Chen,<sup>1</sup> Javier A. Neyra,<sup>3,1</sup> *University of Kentucky, Lexington, KY;* <sup>2</sup>*University of Kentucky Medical Center, Lexington, KY;* <sup>3</sup>*University of Alabama at Birmingham, Birmingham, AL.*

**Background:** AKI-RRT is associated with high risk of mortality. Continuous accurate prediction of mortality in these patients could assist with resource utilization and transition to palliative care when needed. Deep learning (DL) models have shown promise in risk-prediction using temporal EHR data. However, most existing methods fall short in clinical settings where the real-world EHR data are often asynchronous and irregular.

**Methods:** We developed a novel DL model based on Long Short Term Memory (LSTM) to continuously predict 24-hour mortality risk during AKI-RRT. Our model extends LSTM with two time-aware gates to handle irregular and asynchronous data, and a knowledge-aware gate that uses medical ontology to guide attention between multiple variables at each time step. We used data from 570 adult patients with AKI-RRT admitted to the ICU, excluding patients with ESRD, kidney transplant or those in whom RRT lasted <72h. We utilized 12 temporal features including vital signs and biochemical parameters and 6 static features including demographics, BMI and Charlson score. We assessed our model based on subpopulations according to static features and compared it with four existing models.

**Results:** Hospital mortality rate was 58.4%. Our model outperformed all others at almost all levels of subpopulations and all metrics for the continuous prediction of mortality during AKI-RRT (Table).

**Conclusions:** We developed a novel DL model with three additional gates for the continuous prediction of mortality during AKI-RRT. With the new gates, our model achieved better performance for the asynchronous and irregular EHR data. This model can be further enhanced and validated for augmenting bedside clinical decisions.

**Funding:** NIDDK Support

Table. Performance of mortality prediction for balanced datasets (positive (dead); negative (survived) = 1:1) on two subpopulations. Subpopulations were defined by hierarchical clustering at different levels of granularity where level 1 has the lowest and level 2 has the highest granularity based on demographics and comorbidity. The scores are shown as average and standard deviation.

	Subpopulation Level 1			Subpopulation Level 2		
	ROCAUC	ACC	F-3	ROCAUC	ACC	F-3
XGBoost	0.54(0.04)	0.55(0.07)	0.09(0.09)	0.54(0.06)	0.56(0.07)	0.09(0.13)
SVM	0.61(0.04)	0.59(0.03)	0.54(0.15)	0.61(0.16)	0.59(0.12)	0.53(0.20)
LSTM	0.63(0.15)	0.64(0.06)	0.43(0.24)	0.63(0.14)	0.64(0.06)	0.42(0.26)
Transformer	0.67(0.11)	0.59(0.01)	0.24(0.18)	0.68(0.08)	0.59(0.07)	0.23(0.18)
<b>Proposed Model</b>	<b>0.70(0.10)</b>	<b>0.64(0.08)</b>	<b>0.54(0.23)</b>	<b>0.69(0.13)</b>	<b>0.64(0.09)</b>	<b>0.53(0.23)</b>

**FR-PO091**

**Time-Trend of Postoperative AKI From a Multicenter Cohort Study**

Jeongmin Cho,<sup>1</sup> Soie Kwon,<sup>1,2</sup> Sehoon Park,<sup>1</sup> Jeonghwan Lee,<sup>3</sup> Chung Hee Baek,<sup>4</sup> Ji Eun Kim,<sup>7</sup> Jin Ho Hwang,<sup>6</sup> Ji In Park,<sup>9</sup> Jiwon Ryu,<sup>8</sup> Jina Park,<sup>5</sup> Kook-Hwan Oh,<sup>1</sup> Kwon Wook Joo,<sup>1</sup> Hajeong Lee,<sup>1</sup> *Seoul National University Hospital, Jongno-gu, Seoul, Republic of Korea;* <sup>2</sup>*Seoul National University College of Medicine, Seoul, Republic of Korea;* <sup>3</sup>*Seoul National University Seoul Metropolitan Government Boramae Medical Center, Dongjak-gu, Seoul, Republic of Korea;* <sup>4</sup>*Asan Medical Center, Songpa-gu, Seoul, Republic of Korea;* <sup>5</sup>*Biomedical Research Institute, Seoul National University Hospital, Jongno-gu, Seoul, Republic of Korea;* <sup>6</sup>*Chung Ang University Hospital, Seoul, Republic of Korea;* <sup>7</sup>*Korea University Guro Hospital, Seoul, Republic of Korea;* <sup>8</sup>*Seoul National University Bundang Hospital, Seongnam, Republic of Korea;* <sup>9</sup>*Kangwon National University Hospital, Chuncheon, Kangwon, Republic of Korea.*

**Background:** After emphasis on prevention and early recognition of acute kidney injury (AKI) from the KDIGO 2012 AKI guideline, in-hospital AKI occurrence had reduced during the past two decades. However, understanding the time trend of post-operative AKI (PO-AKI) is lacking yet.

**Methods:** A retrospective cohort study was performed from 2005 to 2020. The patients who underwent non-cardiac major surgery more than 1 hour of operation time at 5 departments were enrolled. PO-AKI was defined as KDIGO AKI criteria within 7 days after surgery. Severe PO-AKI (S-PO-AKI) was defined as stage 2 or 3 AKI. The time period was divided into 3-year intervals and evaluated by join-point regression analysis and multivariate logistic regression.

**Results:** A total of 143,219 patients were included. During the study period, 8,604 (6.0%) PO-AKI and 1,197 (0.8%) S-PO-AKI occurred. The patients were older and more women. They had more comorbidities including diabetes mellitus (5.7%→13.7%), hypertension (12.8%→28.6%), coronary artery disease (1.8%→3.6%) as times go by. Preoperative NSAID usage was decreased whereas diuretics and RAAS blockades uses were increased with time. The PO-AKI incidence had decreased from 8.9% in 2014 to 4.6% in 2020. In join-point analysis, PO-AKI incidence decreased with annual percent change (APC) of -4.2 % per year (95% confidence interval [CI] -5.5 - -2.8%, p-value <0.001). Although, S-PO-AKI was not (APC -0.3%, 95% CI -2.1 - 1.5%, p-value = 0.732, Figure 1). The multivariate analysis showed that these trends were remained similarly even after adjustment with well-known risk factors (adjusted odds ratio [95% CI], 2005-2007, reference; 2008-2010, 0.77 [0.71-0.84]; 2011-2013, 0.69 [0.63-0.75]; 2014-2016, 0.55 [0.51-0.59]; and 2018-2020, 0.57 [0.53-0.62], p-value<0.001).

**Conclusions:** In this large-scale study, we found the PO-AKI had decreased recently, although the incidence of S-PO-AKI still had not changed.

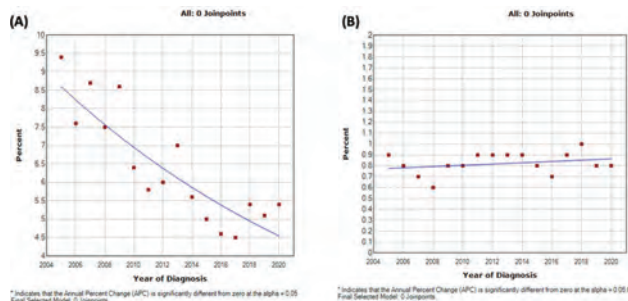

Figure 1. Joint-point regression analysis describing annual incidence trend of (A) PO-AKI and (B) S-PO-AKI.

**FR-PO092**

**The Incidence and Risk Factor of Post-Operative Acute Kidney Disease After Non-Cardiac Surgery**

Soie Kwon,<sup>1</sup> Sunah Yang,<sup>1</sup> Geumnae Nam,<sup>1</sup> Sehoon Park,<sup>1</sup> Jina Park,<sup>1</sup> Jiwon Ryu,<sup>7</sup> Jeonghwan Lee,<sup>2</sup> Chung Hee Baek,<sup>3</sup> Ji Eun Kim,<sup>4</sup> Ji In Park,<sup>6</sup> Jin Ho Hwang,<sup>5</sup> Dong Ki Kim,<sup>1</sup> Kook-Hwan Oh,<sup>1</sup> Kwon Wook Joo,<sup>1</sup> Yon Su Kim,<sup>1</sup> Hajeong Lee.<sup>1</sup> <sup>1</sup>Seoul National University Hospital, Jongno-gu, Seoul, Republic of Korea; <sup>2</sup>Seoul National University Seoul Metropolitan Government Boramae Medical Center, Dongjak-gu, Seoul, Republic of Korea; <sup>3</sup>Asan Medical Center, Songpa-gu, Seoul, Republic of Korea; <sup>4</sup>Korea University Guro Hospital, Seoul, Republic of Korea; <sup>5</sup>Chung Ang University Hospital, Seoul, Republic of Korea; <sup>6</sup>Kangwon National University Hospital, Chuncheon, Kangwon, Republic of Korea; <sup>7</sup>Seoul National University Bundang Hospital, Seongnam, Republic of Korea.

**Background:** The importance of acute kidney disease (AKD), the condition of which acute kidney disease (AKI) has not recovered, is being emphasized because it increases the risk of progression to chronic kidney disease (CKD). Although, there was a lack of large-scale cohort study on AKD after non-cardiac surgery.

**Methods:** We performed a retrospective cohort study from three tertiary referral center in South Korea. Among patients who underwent non-cardiac surgery over than 1 hour from 2014 to 2020, AKI was defined as whether the KDIGO AKI criteria were satisfied within 7 days after surgery. AKD was defined as a case of not recovering to less than 1.5 times from baseline creatinine within 7 days after peak creatinine after surgery in AKI group. The information of death event and initiation of renal replacement therapy were collected at 90 days after surgery. Logistic regression was used to investigate the risk factors that AKI progressed to AKD. In multivariate logistic regression, only variables with p-value less than 0.2 in univariate analysis were considered.

**Results:** A total of 178,565 patients were enrolled and 11,047 (6.2%) cases of AKI events were occurred. In whole population, 442(0.2%) patients newly started RRT and 2,157 patients dead (1.2%). 594 (8.2%) patients were progress to AKD and patients who progressed AKD had more risk of all-cause mortality and ESRD progression. (Figure 1) In multivariate logistic regression, surgery from urology (Odd ratio [OR] 2.13, 95% confidence interval [CI] 1.62-2.80, p<0.001 Table 1) and neurosurgery (OR 2.05, CI 1.16-4.62, p=0.014) department and leukocytosis (OR 1.04, CI 1.00-1.07, p=0.024) were associated with increased risk of progression to AKD. Patients who diagnose with malignancy before surgery (OR 0.62, CI 0.43-0.88, p=0.008) had lower risk of progression to AKD in the present study cohort.

**Conclusions:** Considering high mortality and poor renal outcome of AKD patients, physicians need pay attention to the occurrence of post-operative AKD after non-cardiac surgery.

**Funding:** Government Support - Non-U.S.

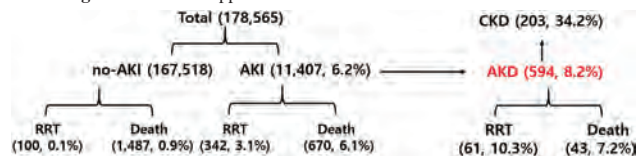

**FR-PO093**

**Sepsis and Septic AKI Sequence: The Most Important Complication of Steroid Responsive Nephrotic Syndrome**

Saptarshi Ghosh,<sup>1</sup> Debanjan D. Sinha,<sup>2</sup> Sanat K. Ghosh.<sup>2</sup> <sup>1</sup>Medical College and Hospital Kolkata, Kolkata, India; <sup>2</sup>Dr B C Roy Post Graduate Institute of Pediatric Sciences, Kolkata, India.

**Background:** Sepsis is a well recognized complication of nephrotic syndrome. Systemic inflammatory response syndrome (SIRS) insult in the nephrotic background initiates interplay between inflammation and oxidative stress, leading to septic acute

kidney injury (SAKI). Sepsis and SAKI sequence develop as a complication of nephrotic syndrome. Data on this subject is lacking. The present study is conducted to know the prevalence, clinical profile, morbidity and outcomes of this sequence in steroid responsive nephrotic syndrome.

**Methods:** This observational study is conducted at Dr B C Roy PGIPS, Kolkata, India. Consecutively hospitalised children with steroid responsive nephrotic syndrome below 12 years were included after exclusion of pre-existing chronic kidney disease. Sepsis & septic shock were identified by Sepsis-3 criteria and AKI was identified by KDIGO. AKI developing in the background of sepsis was defined as SAKI. Hospital stay, requirement of ICU care, inotropes, ventilator support and renal replacement therapy (RRT) were used as indicator of morbidity.

**Results:** Out of 235 subjects, 64 (27.23%) developed AKI. 59 (92.18%) of them were SAKI. Among the 59 subjects with SAKI, 40 (67.79%) had sepsis and 19 (32.20%) had septic shock. As per KDIGO, AKI staging of 59 patients with SAKI- 38 (64.4%), 12(20.33%) and 9 (15.25%) subjects developed stage 1, stage 2 and stage 3 AKI respectively. Severity of AKI was associated with sepsis 3 score (p value <0.0000). Clinical features included features of peritonitis, sepsis, or septic shock followed by prolongation of the oliguric phase, development of hypertension, azotemia, Edema, azotemia subsided with diuresis. Hypertension persisted for a variable period. Duration of hospital stay, requirement of ICU care and mortality were higher in this group compared to non-AKI group (p value 0.00005360, <0.0000001 and 0.02215 respectively). Prevalence of sepsis-AKI sequence in steroid responsive nephrotic syndrome was quite high. Sepsis-3 score correlated with severity of AKI staging. SAKI was associated with increased length of hospital stay, increased frequency of inotropes & ICU requirement and increased mortality.

**Conclusions:** Sepsis--AKI sequence is the most important complication of steroid responsive nephrotic syndrome. Published data on septic AKI in nephrotic syndrome is very scanty.

**FR-PO094**

**AKI in Patients With Leukemia Submitted to Allogeneic Hematopoietic Stem Cell Transplant: A Cohort Analysis**

Claudia Costa, Natacha Rodrigues, Carolina Branco, Filipe Marques, Pedro D. Vasconcelos, Carlos M. Martins, Jose A. Lopes. Centro Hospitalar Universitario Lisboa Norte EPE, Lisboa, Portugal.

**Background:** Studies on acute kidney injury (AKI) in hematopoietic stem cell transplant (HSCT) consider several hematologic diagnoses in their cohorts and heterogeneous definitions for AKI. The purpose of this study was to evaluate the incidence, severity, and risk factors of AKI in patients with leukemia submitted to allogeneic HSCT considering serum creatinine (SCr) and UO.

**Methods:** We conducted a single-center retrospective cohort study including 164 patients with leukemia admitted for allogeneic HSCT between 2005 and 2015. KDIGO classification was used for AKI diagnosis considering daily values of SCr and 6-hour UO from admission day for HSCT until hospital discharge, and weekly evaluations within the first 100 days. We used survival analysis methods considering competing events to calculate AKI cumulative incidence, to establish AKI risk factors and to evaluate AKI impact on relapse, and Cox regression for AKI impact on 5-year mortality.

**Results:** The cumulative incidence of AKI was 58.5% at 30 days post-HSCT and 63.4% at 100 days post-HSCT. AKI diagnosis was firstly made by SCr criteria in 76.9%, by UO criteria in 15.4% and by both in 7.7%. The highest stage of AKI was 1 in 61.8%, 2 in 21.6% and 3 in 16.7%. Renal replacement therapy occurred in 12.5%. Independent variables associated with higher incidence of AKI included: hematopoietic cell transplant-specific comorbidity index (HCT-CI)>2 (Hazard Ratio (HR)1.88, 95%CI 1.13-3.11,p=0.015), radiotherapy (RT) in the past (HR 2.07,95%CI 2.07-1.06,p=0.034), serum lactate dehydrogenase (LDH) at hospital admission (HR 1.51, 95%CI1.03-2.21,p=0.035), shock (HR 1.57,95%CI 1.02-2.39,p=0.039), and sepsis (HR 3.36, 95%CI 1.22-9.24,p=0.019). AKI was an independent risk factor for 5-year mortality (HR 1.67,95% CI 1.09-2.57,p=0.020).

**Conclusions:** AKI affects almost two thirds of leukemia patients submitted to allogeneic HSCT. Independent risk factors for AKI were HCT-CI >2, previous RT, higher LDH levels at hospital admission, sepsis, and shock. AKI was independently associated with 5-year mortality. To our knowledge, this is the first study considering both SCr and UO criteria for AKI classification in leukemia patients after HSCT, which contributes to a more accurate determination of AKI incidence in these patients.

**FR-PO095**

**The Risk of AKI in the Elderly With Advanced CKD**

Nadir Goulamhousen, Josee Bouchard, Karyne Pelletier, Isabelle Chapdelaine, Stephan Troyanov. Hopital du Sacre-Coeur de Montreal, Montreal, QC, Canada.

**Background:** AKI in the elderly is associated with short- and long-term mortality, increased risk of ESKD, and functional decline. Estimating the incidence of AKI in advanced CKD is challenging, given that the 0.3 mg/dl threshold might not be of clinical significance. Using the KDIGO definitions, we assessed AKI frequency and recovery time in the elderly with advanced CKD as well as its predictors.

**Methods:** We included all patients ≥ 70 years of age and followed for ≥3 months at the Sacré-Coeur kidney protection clinic from 2012 to 2020. All AKI episodes, defined by an increase of 0.3 mg/dL over 48 hours or 1.5x increase over 7 days during the follow-up period were recorded. Given the elevated baseline creatinine, we also identified subpopulations of patients who also reached 0.5 and 1.0 mg/dL elevation in creatinine. We assessed differences between age groups. AKI recovery was defined as a return to within 0.3 mg/dL from baseline, within 2 or 7 days.

Key: TH - Thursday; FR - Friday; SA - Saturday; OR - Oral; PO - Poster; PUB - Publication Only

Underline represents presenting author.

**Results:** We included 462 patients, of which 46 % were female, with an initial eGFR of  $20 \pm 8$  mL/min/1.73m<sup>2</sup>, and followed for a median of 21 [9-38] months. The rate of AKI was 36 events/100 patient-years, with 39 % experiencing at least one episode. AKI incidence was similar across age strata (Table), but recovery using the 1.5x criteria in those  $\geq 90$  years was lower (43 % vs. 79 %,  $p = 0.04$ ). CKD etiologies were not associated with the risk or recovery of AKI. Predisposing risk factors of AKI were a history of congestive heart failure (26 % vs. 13 %,  $p = 0.005$ ) and liver disease (44 % vs 15 %,  $p = 0.02$ ).

**Conclusions:** AKI frequency is elevated in the elderly with severe CKD, with an increased risk of non-recovery in the very old.

**Funding:** Private Foundation Support

Age groups at 1st assessment (n)	70-79 (182)	80-89 (239)	$\geq 90$ (41)
AKI (%)			
-No AKI	61	61	63
- $\uparrow$ creat $\geq 0.3$ mg/dL within 48h	6.0	1.1	2.4
- $\uparrow$ creat $\geq 0.3$ mg/dL within 48h, with peak $\geq 0.5$ mg/dL	10	7.5	12
- $\uparrow$ creat $\geq 0.3$ mg/dL within 48h, with peak $\geq 1$ mg/dL	7.1	4.6	4.9
- $\uparrow$ creat $\geq 1.5$ x baseline within 7 days	15	16	17
Time to recovery within $<0.3$ mg/dL ( $\bar{w}$ )			
$\leq 2$ , [2-7], $\geq 7$ days, no recovery	18, 21, 42, 18	22, 23, 36, 20	0, 27, 47, 27

**FR-PO096**

**Atorvastatin vs. Rosuvastatin for Contrast-Induced Nephropathy Prevention in Patients With Acute Coronary Syndrome Undergoing Percutaneous Coronary Intervention: A Meta-Analysis of Randomized Controlled Trials and Propensity-Score Matching**

**Naticha Leelavivat,<sup>1</sup> Poemlarp Mekraksakit,<sup>1</sup> Gaspar Del Rio-Pertuz,<sup>1</sup> Juthipong Benjanuwattra,<sup>1</sup> Angkawipa Trongtorsak,<sup>2</sup> Samapon Duangkham,<sup>1</sup> Mahmoud Abdelnabi.<sup>1</sup>** <sup>1</sup>Texas Tech University Health Sciences Center, Lubbock, TX; <sup>2</sup>AMITA Health, Chicago, IL.

**Background:** Statins have been reported to prevent contrast-induced nephropathy (CIN) via various mechanisms. However, the studies that compare the effect between atorvastatin and rosuvastatin following percutaneous coronary intervention (PCI) are still lacking. We conducted a systematic review and meta-analysis to compare atorvastatin and rosuvastatin for the prevention of CIN in patients with acute coronary syndrome (ACS) undergoing PCI.

**Methods:** Two investigators independently searched the databases of MEDLINE and EMBASE from inception to April 28, 2022. We included randomized clinical trials (RCTs) and propensity-score-matched (PSM) studies that compared atorvastatin and rosuvastatin and the effect on CIN in patients with ACS undergoing PCI. Data from each study were combined using the random-effects model and the generic inverse-variance method.

**Results:** Six studies (5 RCTs and 1 PSM study) involving 2,690 patients with ACS from October 2013 to August 2020 were included in our meta-analysis. There was no statistical difference between atorvastatin and rosuvastatin in preventing CIN (OR 1.2; 95% CI 0.89, 1.61; I<sup>2</sup> = 0%). However, the use of high-dose atorvastatin was associated with a decreased risk of CIN following PCI in ACS patients compared to low-dose atorvastatin (OR 0.5; 95% CI 0.29, 0.87; I<sup>2</sup> = 0%).

**Conclusions:** Our meta-analysis indicated that the rate of CIN in patients with ACS undergoing PCI who received atorvastatin is not statistically different from those receiving rosuvastatin. Larger studies are needed to clarify this outcome.

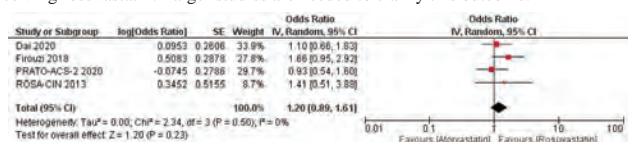

**FR-PO098**

**Clinical Characteristics of AKI in Patients With Glyphosate Surfactant Herbicide Poisoning**

**In O Sun,** A young Cho. Presbyterian Medical Center, Jeonju, Jeollabuk-do, Republic of Korea.

**Background:** In this study, we investigated the clinical characteristics of acute kidney injury (AKI) in patients with glyphosate surfactant herbicide (GSH) poisoning.

**Methods:** This study performed between 2008 and 2021 included 184 patients categorized into AKI and non-AKI groups. The incidence, clinical characteristics, and severity of AKI were compared between the AKI (n=82) and non-AKI (n=102) groups, based on the Risk, Injury, Failure, Loss of kidney function, and End-stage kidney disease classification.

**Results:** The incidence of AKI was 44.5%, of which 25.0%, 6.5%, and 13.0% patients were classified into the Risk, Injury, and Failure categories, respectively. Patients in the AKI group were older ( $63.3 \pm 16.2$  years vs.  $57.4 \pm 17.5$  years,  $P = 0.020$ ) and had  $\geq 1$  comorbidities (52.4% vs. 32.7%,  $P = 0.005$ ) than those in the non-AKI group. The length of hospitalization was longer ( $10.7 \pm 12.1$  days vs.  $6.5 \pm 8.1$  days,  $P = 0.004$ ), and hypotensive episodes occurred more frequently in the AKI group (45.1% vs. 8.8%,  $P < 0.001$ ). Electrocardiographic (ECG) abnormalities on admission were more frequently observed in the AKI than in the non-AKI group (80.5% vs. 47.1%,  $P < 0.001$ ). Patients in the AKI group had poorer renal function ( $62.2 \pm 22.9$  mL/min/1.73 m<sup>2</sup> vs.  $88.9 \pm 26.1$  mL/min/1.73 m<sup>2</sup>,  $P < 0.001$ ) on admission. The mortality rate was higher in the AKI than in the non-AKI group (18.3% vs. 1.0%,  $P < 0.001$ ). Multiple logistic regression analysis showed that hypotension and ECG abnormalities upon admission were significant predictors of AKI in patients with GSH poisoning.

**Conclusions:** Blood pressure and ECG findings on admission may be useful predictors of AKI in patients with GSH intoxication.

**FR-PO099**

**Risk of AKI During Treatment With Lithium**

**Gisli Gislason,<sup>1</sup> Olafur S. Indridason,<sup>2</sup> Engilbert Sigurdsson,<sup>3,1</sup> Runolfur Palsson.<sup>2,1</sup>** <sup>1</sup>Haskoli Islands, Reykjavik, Iceland; <sup>2</sup>Division of Nephrology, Landspítali-The National University Hospital of Iceland, Reykjavik, Iceland; <sup>3</sup>Mental Health Services, Landspítali-The National University Hospital of Iceland, Reykjavik, Iceland.

**Background:** Lithium intoxication is frequently associated with acute kidney injury (AKI), but the risk of AKI has otherwise not been well studied in persons using lithium. The aim of the study was to examine the risk of AKI in individuals on lithium treatment.

**Methods:** This was a retrospective cohort study of all persons treated with lithium in Iceland in 2003–2018. A control group comprised patients with affective disorders attending the outpatient clinic of the Mental Health Services at Landspítali-The National University Hospital in 2014–2016. Clinical and laboratory data were obtained from nationwide electronic medical records. Individuals with  $<2$  serum creatinine (SCr) values were excluded. Lithium exposure was defined as two or more measurable serum lithium levels or one or more filled lithium prescription. Individuals were censored at the time of last lithium exposure. AKI was defined using the SCr component of the KDIGO criteria. Risk assessment was performed using Cox proportional hazards with time-dependent variables.

**Results:** The lithium-treated group consisted of 2682 individuals, of whom 2017 (74.5%) were included in the study. Of those, 283 (14.0%) developed AKI. Of 1426 individuals in the control group, 1165 (81.8%) were included in the study and 48 (4.1%) of those developed AKI. Lithium use was an independent risk factor for AKI (hazard ratio [HR] 3.01, 95% confidence interval [CI], 2.25–4.23). When lithium users were analyzed separately, history of lithium toxicity (HR 2.87, 95% CI, 1.87–4.40) and higher mean lithium concentration (HR 1.15 per 0.1 mEq/L, 95% CI, 1.07–1.24) were significant risk factors for the development of AKI.

**Conclusions:** Lithium treatment is associated with a risk of AKI. History of lithium toxicity and higher blood lithium concentrations seem to contribute to AKI in lithium users. Lithium levels should be followed carefully in these patients and be maintained at lowest possible levels that meet their therapeutic needs at any given time.

**Funding:** Government Support - Non-U.S.

**FR-PO100**

**Statins and Contrast Induced-AKI: A Systematic Review and Meta-Analysis**

**Shriman Chittoor,<sup>1</sup> Kripa Kohli,<sup>1</sup> Sankar D. Navaneethan.<sup>2,3</sup>** <sup>1</sup>Fort Bend Independent School District, Sugar Land, TX; <sup>2</sup>Baylor College of Medicine, Houston, TX; <sup>3</sup>Michael E DeBakey VA Medical Center, Houston, TX.

**Background:** Several treatment options are available to reduce the incidence of contrast-induced acute kidney injury (CI-AKI). Clinical trial evidence reported conflicting data on the incidence of CIN with statins. Hence, we conducted a systematic review and meta-analysis to evaluate the effects of statins as well as compare the effects of different doses of statins on the incidence of CI-AKI.

**Methods:** We searched MEDLINE and other databases (until March 2022) for randomized control trials (RCTs) that compared the effect of statin treatment on the incidence of CI-AKI or trials that compared high-dose vs. low-dose statin treatments on the occurrence of CI-AKI. Two authors independently assessed study quality and extracted data. Statistical analyses were performed using the random-effects model and results were expressed as a risk ratio (RR) for dichotomous outcomes with 95% confidence intervals (CI). Quality assessment was conducted using Cochrane quality assessment method.

**Results:** Seven RCTs (6635 patients) comparing statins to placebo and 2 trials (1204 patients) comparing low dose to high dose statins were included. There was a 59% reduction in the incidence of CIN with statins (7 trials, 6655 patients, Pooled RR- 0.59, 95% CI 0.44- 0.79) compared to placebo with no significant heterogeneity between the included studies [Figure]. However, there was no impact on the incidence of CI-AKI warranting dialysis with statins (Pooled RR- 0.28, 95% CI 0.05-1.70). High dose statins (vs. low dose statins) did not lower the incidence of CI-AKI (Pooled RR- 0.70, 95% CI 0.39-1.26) and CI-AKI warranting dialysis. Most included studies had mild-moderate risk of bias.

**Conclusions:** Statins use reduced the incidence of CI-AKI but without an impact on the incidence of AKI warranting dialysis. Large clinical trials examining the potential beneficial effects of high dose statins are warranted.

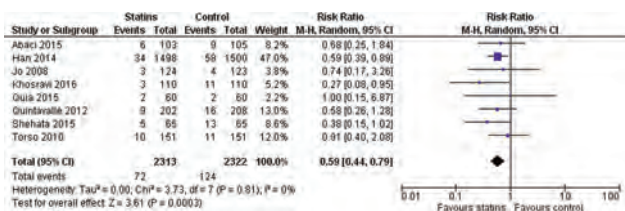

Incidence of CI-AKI with statins and placebo

FR-PO101

Patient Education to Improve AKI Outcomes and Awareness: A Scoping Review

Michael Heung,<sup>1</sup> Emily C. Capellari,<sup>1</sup> Ashita J. Tolwani,<sup>2</sup> Daniel P. Murphy,<sup>5</sup> Linda Awdishu,<sup>3</sup> Marlies Ostermann,<sup>7</sup> Jorge Cerda,<sup>4</sup> Patricia F. Kao,<sup>6</sup> AKI!Now Initiative <sup>1</sup>University of Michigan, Ann Arbor, MI; <sup>2</sup>The University of Alabama at Birmingham College of Arts and Sciences, Birmingham, AL; <sup>3</sup>University of California San Diego, La Jolla, CA; <sup>4</sup>Albany Medical College, Albany, NY; <sup>5</sup>University of Minnesota Academic Health Center, Minneapolis, MN; <sup>6</sup>Washington University in St Louis, St Louis, MO; <sup>7</sup>Guy's and St Thomas' NHS Foundation Trust, London, United Kingdom.

**Background:** Survivors of acute kidney injury (AKI) have limited knowledge of AKI and many are unaware of their diagnosis. In order to optimize outcomes, increased AKI education and awareness are needed. The goal of the AKI!Now Initiative Education Subcommittee is to increase patient awareness and establish best practices in educating patients about AKI. As part of our needs assessment, we sought to characterize the current state of AKI patient education by reviewing the available literature on this topic.

**Methods:** Ovid Medline and CINAHL were searched to identify literature on patient-focused education and awareness around AKI. The search strategy included keywords and Medical Subject Headings related to AKI, education, information, specific educational materials (e.g., pamphlet, video, etc.), and purpose for information sharing (e.g., discharge and self-care). To increase sensitivity, adjacency searching was used in lieu of phrases for the patient education and information concepts. No limits were applied to the results. After screening for relevance based on inclusion criteria of 1) AKI population and 2) patient-focused education, the characteristics of included abstracts were summarized.

**Results:** Of the 419 abstracts identified with our search criteria, 371 were excluded (145 non-AKI focus, 213 without patient education, 13 other) leaving 48. Of these, 23/48 (48%) were published since 2019; 36/48 (75%) were in biomedical journals, compared to 5/48 (10%) in nursing and 5/48 (10%) in allied health journals. 23/48 (48%) abstracts were observational (including survey) studies, while 17/48 (35%) were review or editorial-type publications; no randomized trials were identified. Of the observational studies, 16/23 (70%) reported a patient education intervention, and 14/23 (61%) specified an outcome measure (6 clinical, 7 knowledge/awareness, 1 process). Of these 14 studies, 10 reported a statistically significant improvement in post-intervention outcomes.

**Conclusions:** In recent years there has been increasing interest in patient education around AKI, as reflected in the literature by more published research and calls for action. However, there remains a paucity of high-level evidence exploring effectiveness of various approaches to AKI education, especially regarding patient-centered clinical outcomes.

FR-PO102

Can Augmented Intelligence Assist in Delivering Continuous Renal Replacement Therapy? A Scoping Review

Nada Hammouda,<sup>1</sup> Javier A. Neyra.<sup>2</sup> <sup>1</sup>The University of Texas Southwestern Medical Center, Dallas, TX; <sup>2</sup>University of Alabama at Birmingham, Birmingham, AL.

**Background:** Despite advances in renal replacement therapy (RRT) technologies, the overall mortality rate for ICU patients on RRT is over 50%. Yet, CRRT delivery is not standardized, and there are no validated quality indicators to assess structure, processes and/or outcomes of programs. Digital health and artificial intelligence (AI) technologies have transformed most aspects of health service delivery, including patient diagnostics, risk classification, clinical decision support, and even workflow optimization such as patient scheduling. The current state of literature on the applications of AI in CRRT delivery remains unknown. We aimed to characterize the state of existing literature on the use of AI in CRRT delivery, and identify current gaps and future research priorities.

**Methods:** We searched PubMed, OVID Embase, Web of Science, Cochrane, Scopus and ProQuest, from inception onwards, for original papers published or translated in English. Study summaries were tabulated and analyzed for insight on the current state of research and potential future directions.

**Results:** 12 papers were selected, 6/6 (50%) in 2021, and 7/12 (60%) focused on machine learning to augment CRRT delivery. All innovations were in the design/validation phase of development. Primary research interests focused on early indicators of CRRT initiation, clinical prognostication, and identifying risk factors for mortality. Secondary research priorities included dynamic CRRT monitoring, predicting complications, and automated data pooling for point-of-care analysis. Identified literature gaps included implementation barriers, quality indicators, bias ascertainment, and quantifying social or machine-generated healthcare disparities.

**Conclusions:** Research on AI applications in CRRT delivery grows exponentially but the field remains premature. Future studies are needed on validation, structural implementation, quality assurance, bias and equity ascertainment. The next breakthrough in the field should be smart task delegation: its utility, hazards and overall benefit for patients, clinicians, and health systems.

FR-PO103

Unusual Consequences of Dietary Supplements in a Patient Presenting With AKI

Sherif Badra, Gajapathiraju Chamarthi, Ramon Ortiz Espinal, William L. Clapp, Rupam Ruchi. *University of Florida, Gainesville, FL.*

**Introduction:** Oxalate nephropathy is a rare disorder that can lead to acute kidney injury (AKI). Hereby, we report a case of secondary oxalate nephropathy with biopsy proven oxalate crystalline deposits.

**Case Description:** A 26-year-old male was referred for hospital admission after blood work showed worsening of creatinine (cr) from baseline 1.1 to 3.2 mg/dl. Past medical history was significant for polyglandular autoimmune syndrome and pancreatic insufficiency treated with pancreatic enzyme replacement therapy. The patient reported single episode of nephrolithiasis 7 years ago. Ultrasound showed no hydronephrosis or stones. Acute interstitial nephritis was suspected based on recent use of antibiotics for skin lesions consistent with sweet syndrome. Kidney biopsy was performed and showed tubulopathy with calcium oxalate deposits (Figure 1). Upon further evaluation in our stone clinic, patient reported taking daily Vitamin C and high oxalate supplements (turmeric). Genetic testing for primary hyperoxaluria was negative, and serum oxalate was normal. Patient was advised to maintain low oxalate diet and discontinue the supplements. Subsequent 24-hour urine showed an oxalate of 51 mg/d. Although there was partial recovery of renal function on follow up, with cr improving to 1.6 mg/dl, he developed chronic kidney disease (CKD) stage 3a secondary to oxalate nephropathy.

**Discussion:** Detailed history of high oxalate supplements is crucial for diagnosis of secondary hyperoxaluria. Renal biopsy can be useful in cases of oxalate nephropathy when etiology of AKI is unclear. Physicians should be aware about that condition that can lead to kidney failure. Our case shows the importance of kidney biopsy to diagnose oxalate nephropathy.

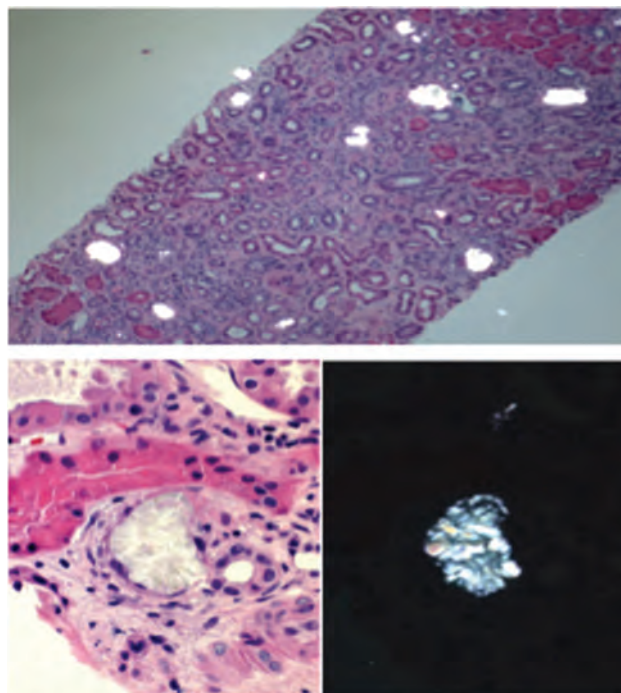

**Figure 1**  
 Top: Birefringent tubular crystals (H&E, polarized)  
 Bottom: Tubular calcium oxalate crystal (radiating or fan-like shape), (left, H&E) and (right, polarized)

## FR-PO104

**A Novel Case of Renal Mucormycosis Associated With Empagliflozin Use**  
Abdul Haseeb,<sup>1</sup> Muhammad Abu-Rmaleh,<sup>1</sup> Jeffrey G. Penfield,<sup>2</sup> Hao Liu,<sup>2</sup> Peter N. Van Buren,<sup>2</sup> Eleanor D. Lederer,<sup>2,1</sup> Swati Lederer.<sup>2,1</sup> *The University of Texas Southwestern Medical Center, Dallas, TX; <sup>2</sup>VA North Texas Health Care System, Dallas, TX.*

**Introduction:** Renal mucormycosis is a rare but often fatal disease. We describe the first case of renal mucormycosis associated with use of empagliflozin, a sodium glucose cotransporter-2 (SGLT2) inhibitor, in a diabetic patient.

**Case Description:** 63-year-old gentleman with uncontrolled diabetes, hypertension, and hepatitis C liver cirrhosis presented to the Emergency Department with left flank pain. He was on empagliflozin for diabetes mellitus. He was hemodynamically stable. Initial laboratory investigations revealed acute renal failure with a creatinine of 1.7 mg/dl (baseline 0.9 mg/dl). His HbA1c was 12.8%. Urine culture was negative. Imaging revealed left hydronephrosis with perinephric fat stranding. The presumptive diagnosis was a kidney stone but repeat imaging revealed emphysematous cystitis, left hydronephrosis with extensive pyelitis. Broad spectrum antibiotics were started, and a left percutaneous nephrostomy (PCN) tube was placed. A repeat urine culture from the left nephrostomy tube grew mold, of uncertain significance. The culture later speciated zygomycetes and posaconazole was initiated. Repeat imaging was concerning for liquefactive necrosis of the left kidney and an obliterated left ureter. New right-sided hydronephrosis developed, requiring right PCN tube. Liposomal amphotericin was started. He underwent left nephroureterectomy, partial cystectomy, with removal of both PCN tubes and placement of a right ureteral stent. Final microbiologic diagnosis was invasive mucormycosis. He was treated initially with both amphotericin and posaconazole, followed by posaconazole alone for a planned duration of 6-months.

**Discussion:** This is the first reported case of renal mucormycosis in the setting of SGLT2 inhibitor use. Patient's risk factors for infection were liver cirrhosis, uncontrolled diabetes, and SGLT2 inhibitor use. The successful outcome was due to the combination of aggressive antifungal therapy and surgery. SGLT2 inhibitors, commonly prescribed for their beneficial effects on cardiovascular and renal outcomes in diabetic patients, are well-tolerated but are associated with a risk of urinary tract infections (UTIs). Though UTIs are most frequently bacterial, rare and atypical organisms can occur, as was seen in this case. Providers should maintain a high index of suspicion when unexpected culture results are obtained.

## FR-PO105

**A Case of Rhabdomyolysis Leading to ESRD Secondary to Influenza A Infection in a 70-Year-Old Patient**

Nidal Alhosainat, Mohamed A. Mohamed Ahmed, Mahmood Mubasher, Wajid M. Choudhry. *Rochester Regional Health, Rochester, NY.*

**Introduction:** Rhabdomyolysis is a serious clinical syndrome characterized by muscle breakdown and release of damaging proteins. Influenza infection has been increasingly reported as a causative disease. We are reporting an unusual case of severe rhabdomyolysis with acute renal failure leading to ESRD due to influenza A infection

**Case Description:** A 70-year-old female with PMHx of hyperlipidemia and hypothyroidism, admitted with body aches along with flulike symptoms for 4 days duration, no history of seizure or trauma, only on levothyroxine at home. Physical exam with stable vital signs, clear lungs. Labs were pertinent for WBC  $31.0 \times 10^9$ , eosinophilia 20%, creatinine 1.4mg/dl (baseline 0.9) and AST/ALT 2590/530 mg/dl, hepatitis screen negative, urine analysis with +3 blood, 3 RBCs, +1 protein. CK 104,740 U/L, influenza A PCR positive, negative PCR for influenza B, COVID 19. Diagnosis of acute renal failure secondary to rhabdomyolysis secondary to influenza A was made, patient was started on oseltamivir and required renal replacement therapy, no recovery after 3 months and labeled ESRD

**Discussion:** Influenza A is a negative-sense RNA virus, transmitted by large droplets and small particle aerosols, complication of influenza includes but not limited to pneumonia, encephalitis, myocarditis and Myositis which can be secondary to Direct invasion of muscle tissue by the viral agent, Myotoxic cytokines release and Immunologic processes induced by the viral infection. Rhabdomyolysis is a syndrome characterized by muscle necrosis and the release of intracellular muscle constituents into the circulation. It might occur due to trauma, drugs, bacterial or viral infections or others, Creatine kinase levels are typically elevated. The risk of AKI is higher with CK levels of more than 15 to 20,000 units/L, caused mainly by Volume depletion resulting in renal ischemia, tubular obstruction due to heme pigment casts, and tubular injury from free chelatable iron. Treatment is mainly by large volume administration of isotonic fluids, renal replacement therapy may be needed for sever cases. **Conclusion:** Influenza can be a serious disease leading to serious complications, extra caution should be considered in patients who develop acute renal failure after influenza infection; rhabdomyolysis should be suspected, investigated, and treated appropriately

## FR-PO106

**Kratom Induced Acute Tubular Necrosis**

Victor A. Canela, Roberto L. Collazo-Maldonado. *Methodist Health System, Dallas, TX.*

**Introduction:** Kratom (*Mitragyna speciosa*) is part of the coffee plant family (Rubiaceae). Its use has been linked to rural workers in Indonesia and Malaysia but recently has gained popularity in the Western world. The active compounds are indole alkaloids (mitragynine) which act as partial opioid agonists. Its effects are described as a

stimulant, analgesics and muscle relaxants. The potential drug to drug interactions, cross contamination and direct kidney injury makes it important for Nephrologists to recognize. This case highlights acute kidney injury in a young patient with daily use of Kratom.

**Case Description:** A 28 y/o Caucasian man with history of DM type 1 and Psoriasis presented with one week of nausea, vomit and decreased urine output. Medication list included an insulin pump, Enbrel and Valtrex. He reported increased use of daily Kratom pills in the last week for anxiety. On physical exam, his VS were normal but was found to be hypovolemic. BUN was 44 mg/dl, Cr 9.53 mg/dl. Electrolytes, LFT's CK were normal. Serologies were negative. U/A showed pyuria, 1+ eosinophils, no granular casts, no rbc's and no crystals. A 24-hr urine had 2 gm of proteinuria. Urine toxicology was negative. Renal U/S had normal kidneys with no hydronephrosis. His kidney function became worse despite adequate intravascular volume expansion; therefore, a kidney biopsy was done and was consistent with acute tubular necrosis. His Cr peaked at 13 mg/dl and kidney function gradually improved without the need of any kidney replacement therapy.

**Discussion:** Kratom consumption in the United States is unregulated and mostly available at herbal stores. The FDA has recommended to classify as Schedule I substance. We presented a case of oliguric AKI in a patient with Kratom consumption. Drug-to-drug interaction and cross contamination are the main safety concern of this substance. Rhabdomyolysis, acute hepatic and kidney injury have been reported. It is important for the practicing Nephrologist and general clinicians to be aware of such herbal supplements and their presentations. More studies are needed to establish the exact pathogenesis and relation to causality.

## FR-PO107

**Disseminated Lomentospora Infection Presenting as AKI**

Katrina Epperson,<sup>1,2</sup> Elliot Perens,<sup>1,2</sup> Christina Ruiz,<sup>1,2</sup> Katayoon Shayan,<sup>2,1</sup> Leidy Tovar Padua,<sup>1,2</sup> Caitlin E. Carter.<sup>1,2</sup> *University of California San Diego, La Jolla, CA; <sup>2</sup>Rady Children's Hospital San Diego, San Diego, CA.*

**Introduction:** Acute kidney injury (AKI) is a common complication of childhood leukemia and its treatment. One month after induction chemotherapy, the patient developed AKI without another obvious nephrotoxic insult, and a kidney biopsy showed angioinvasive fungus. He was found to have disseminated Lomentospora prolificans and succumbed to the infection. Invasive fungal infection commonly causes multiorgan dysfunction from infection, but AKI is an uncommon initial presentation.

**Case Description:** An 18yo male with trisomy 21 developed rapidly progressive AKI approximately after initiation of induction chemotherapy (vincristine, cytarabine, methotrexate, and PEG-asparaginase) for newly diagnosed leukemia. He developed non-oliguric AKI with a rise in serum creatinine from 0.75 to 3.7 mg/dL over 72 hours without hemodynamic instability, nephrotoxic medication exposure, or other evident cause of AKI. Evaluation for underlying causes of AKI, including urine microscopy and renal and renovascular ultrasound, were not diagnostic. Kidney biopsy demonstrated acute fungal tubulointerstitial disease. Brain MRI showed multiple lesions concerning for angioinvasive fungal disease. Plasma metagenomic next-generation sequencing identified Lomentospora prolificans. Due to the extensive multiorgan involvement, it was determined that infection was not curable and family opted to withdraw care. Postmortem blood, urine, skin tissue, and spinal fluid were positive for Lomentospora.

**Discussion:** Our patient suffered severe rapidly progressive AKI as the presenting finding of Lomentospora prolificans infection, a ubiquitous multi-drug resistant environmental filamentous fungi with very high mortality. His risk factors for Lomentospora disseminated disease included leukemia and chemotherapy-induced neutropenia. Treatment for localized Lomentospora includes excision of infected tissue and antifungal therapy, however disseminated disease is often fatal, as it was in this case.

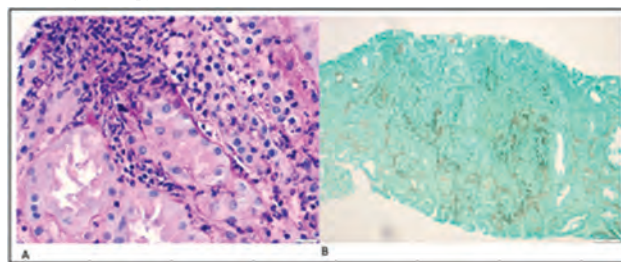

PAS (a) and GMS (b) light micrographs demonstrating acute fungal infection of the kidney with numerous fungal organisms in multiple forms.

## FR-PO108

**Kidney Volume Is a Predictor of AKI Following Cardiovascular Surgery Independent of eGFR**

Takahisa Kasugai, Miho Murashima, Tatsuya Tomonari, Minamo Ono, Masashi Mizuno, Takayuki Hamano. *Nagoya City University Nagoya Shiritsu Daigaku, Nagoya, Japan.*

**Background:** Predictors of acute kidney injury (AKI) after cardiovascular (CV) surgery have been extensively studied. However, risk prediction has been suboptimal.

**Methods:** In this retrospective cohort study, we enrolled adults who underwent CV surgery from 2014 to 2021 at our facility and computed tomography (CT) scan within 6 months before surgery. We excluded those with multiple or large cysts, single kidney, creatinine > 4 mg/dL, or undergoing kidney replacement therapy. Exposure of interest

Key: TH - Thursday; FR - Friday; SA - Saturday; OR - Oral; PO - Poster; PUB - Publication Only

Underline represents presenting author.

was height-adjusted total kidney volume (htTKV) measured by software using the three dimensional CT reconstruction. The outcome was postoperative AKI defined by the KDIGO creatinine criteria. We employed logistic regression models and the results were shown as cubic spline curves.

**Results:** Among 558 patients, 196 (35.1%) developed AKI. Those with smaller htTKV were older, less likely to be diabetic, and had lower eGFR. The association between htTKV and AKI was U-shaped after adjustment for confounders including eGFR. The odds ratio for AKI was 1.60 (1.47-1.75) and 1.06 (1.02-1.11) among those with htTKV ≤75 and >125, respectively, compared with htTKV 75-125 mL/m<sup>2</sup>. The U-shaped relationship between htTKV and AKI was observed among non-diabetics but not among diabetics (p for interaction 0.05). There were no effect modifications by age, sex, eGFR, or the use of diuretics for the association between htTKV and AKI.

**Conclusions:** The Association between htTKV and AKI after CV surgery was U-shaped. Smaller htTKV might reflect more severe atherosclerotic changes independent of eGFR. A small increase in the incidence of AKI among those with large htTKV might be due to kidney congestion often observed in patients with pre-operative heart failure. HTTKV could be a useful predictor for postoperative AKI among those undergoing CV surgery.

Table 1: Cause-specific Cox proportional hazards model for composite of all stages AKI or RRT

Underlying All stages AKI/RRT	Plasma Free Hemoglobin (mg/dL)		LDH (IU/L)		Minimum Platelets (per 100k)		Minimum Hemoglobin (g/dL)				
	HR (95% CI)	p	HR (95% CI)	p	HR (95% CI)	p	HR (95% CI)	p			
Hemolysis Markers	<50	1.78 (0.42-7.59)	0.43	<500	1.09 (0.72-1.63)	0.66	0.96 (0.62-1.09)	0.63	0.99 (0.67-1.03)	0.20	
	≥50	3.13 (1.65-6.01)	<0.001	≥500	2.07 (1.28-3.49)	0.002				0.001	
Age (yr) (<10-14 years)			0.002							0.001	
3 months - 3 years		1.64 (0.89-2.75)			1.59 (0.90-2.64)			1.70 (1.02-2.83)		1.82 (0.97-2.70)	
>3 years - 9 years		1.75 (0.89-3.02)			1.73 (0.99-3.02)			1.99 (1.12-3.54)		1.75 (0.99-3.10)	
10 years - 12 years		2.87 (1.20-6.84)			2.87 (1.55-5.31)			3.23 (1.87-6.00)		2.84 (1.52-5.28)	
>12 years - 18 years		3.80 (1.54-9.37)			4.06 (2.08-7.95)			4.60 (2.59-7.76)		3.80 (2.08-6.94)	
>18 years		4.37 (2.34-10.68)			4.63 (2.48-8.28)			4.68 (3.00-7.53)		4.04 (2.41-7.03)	
Male Sex (vs. Female)		1.09 (0.89-1.34)	0.52		1.07 (0.82-1.40)	0.63		1.04 (0.82-1.43)	0.57	1.11 (0.85-1.46)	0.44
Hypotension (systolic BP <90 mmHg)			<0.001			<0.001			<0.001	<0.001	
Diuretic Use											
None/low		0.52 (0.15-0.62)			0.57 (0.13-0.66)			0.51 (0.14-0.77)		0.59 (0.18-0.89)	
High		0.45 (0.10-0.70)			0.45 (0.10-0.70)			0.45 (0.10-0.70)		0.45 (0.10-0.70)	
Diuretic Use		1.57 (0.76-2.05)			1.50 (0.74-2.51)			1.49 (0.79-2.55)		1.49 (0.79-2.55)	
Diuretic Use		3.80 (1.27-11.77)			3.44 (1.19-9.88)			3.74 (1.19-11.96)		3.74 (1.19-11.96)	
Albumin (g/dL) <3.0		0.62 (0.44-1.12)	0.08		0.62 (0.43-1.30)	0.60		0.67 (0.43-1.26)	0.30	0.62 (0.44-1.12)	0.64
Average pH		0.11 (0.01-1.19)	0.10		0.13 (0.01-1.50)	0.10		0.11 (0.01-1.52)	0.10	0.13 (0.01-1.40)	0.10
Average Lactate		1.11 (1.07-1.17)	<0.001		1.11 (1.06-1.16)	<0.001		1.11 (1.06-1.16)	<0.001	1.11 (1.07-1.17)	<0.001
Medical AKI**		0.97 (0.58-0.01)	0.001		0.97 (0.58-0.39)	0.001		0.97 (0.58-0.39)	0.001	0.97 (0.58-0.39)	0.001
Nephrology Medication Count†		1.01 (0.84-1.12)	0.89		1.03 (0.89-1.14)	0.80		1.03 (0.84-1.24)	0.81	1.02 (0.84-1.21)	0.87

† Age- and sex-adjusted (C-statistic)  
 ‡ HR (95% CI) (p-value)  
 § Based on NMA (95% CI) of nephrologists

Table 1: Cause-specific cox proportional hazards model for composite of all stages AKI or RRT

FR-PO110

Right Heart Failure and Reduced Kidney Function in Left Ventricular Assist Device Recipients

Carl P. Walther, Sankar D. Navaneethan. Baylor College of Medicine, Houston, TX.

**Background:** Right heart failure (RHF) and kidney dysfunction are harmful complications of left ventricular assist devices (LVADs). RHF can cause kidney dysfunction through elevated renal venous pressure. We investigated the time-varying relationship of RHF with reduced kidney function in a national cohort of LVAD recipients.

**Methods:** We identified implantations of isolated continuous flow LVADs from 2016-17 in INTERMACS, a national registry. RHF was ascertained from the binary right heart failure variable in INTERMACS, an adjudicated variable based on persistent signs and symptoms of RHF. Multistate Markov models were used to analyze the relationship between time-varying RHF state and reduced kidney function (defined as eGFR <30 ml/min/1.73m<sup>2</sup> or dialysis) over 14 months following LVAD implantation (censoring for heart transplant, LVAD removal, or death). Piecewise models were used, to account for varying baseline risk of reduced kidney function during follow-up, with cut points at 1 week and 1, 3, and 6 months.

**Results:** We identified 4,616 LVAD implantations. Median age was 59 years and 21% were female. There were 313 state changes to RHF and 752 state changes to reduced kidney function over 3,043 person-years. Risk for development of reduced kidney function, and prevalences of reduced kidney function and RHF, were highest early after LVAD implantation but remained substantial throughout follow-up (Figure). RHF was associated with higher risk of development of reduced kidney function: HR 2.93 (95% CI 2.18-3.94).

**Conclusions:** We found that RHF is associated with nearly 3 fold higher risk of development of reduced kidney function among LVAD recipients in a national cohort, with highest risk early after LVAD implantation. This demonstrates the importance of right heart function and renal venous pressure to kidney function in advanced heart failure and durable mechanical circulatory support.

**Funding:** NIDDK Support

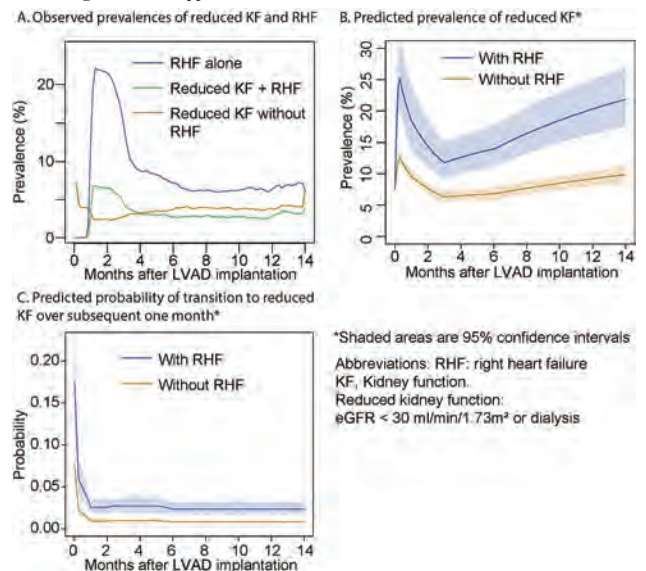

FR-PO109

Intravascular Hemolysis and AKI in Pediatric Patients Undergoing Extracorporeal Membrane Oxygenation (ECMO)

Amy Strong, Jarcy Zee, Rosanna Fulchiero, Diego Campos, Todd J. Kilbaugh, Benjamin L. Laskin, Michelle Denburg. The Children's Hospital of Philadelphia, Philadelphia, PA.

**Background:** AKI is common in ECMO patients. We sought to describe the impact of laboratory evidence of ECMO associated intravascular hemolysis on AKI.

**Methods:** This retrospective cohort study included patients treated with ECMO at a single center over ten years. The primary outcome was a composite of time to renal replacement therapy (RRT) or AKI (by creatinine based KDIGO criteria) after ECMO start. Serum creatinine closest to ECMO start time was considered the pre-ECMO baseline and used to determine abnormal kidney function at ECMO start. The patient's subsequent creatinine values were used to identify AKI on ECMO. Multivariable cause-specific cox proportional hazards models were used to assess the impact of markers of intravascular hemolysis on time to the composite outcome after controlling for confounders.

**Results:** 501 children were evaluated: median age 1.2 years, 56% male. Four models are presented in Table 1 each with a different marker of hemolysis (plasma free hemoglobin, LDH, minimum platelets and minimum hemoglobin). An elevated plasma free hemoglobin level, the most specific of these hemolysis markers, demonstrated a >3-fold higher hazard for the composite outcome (p-value 0.001). Elevated LDH was associated with an adjusted hazard ratio of 2.4. Effect estimates were more pronounced in a sensitivity analysis of stage 2+ AKI/RRT: HR 6.5 (95% CI 3.3-12.8) for plasma free hemoglobin and 3.3 (95% CI 1.7-6.5) for LDH.

**Conclusions:** Laboratory findings consistent with intravascular hemolysis on ECMO were associated with a higher hazard of AKI or RRT in children undergoing ECMO.

**Funding:** NIDDK Support, Private Foundation Support

FR-PO111

**Kidney Donors With and Without Post-Donation AKI: Comparison of Baseline Characteristics and Long-Term Outcomes**

Abdel-Rauof M. Akkari, Mistafa Hafid, Muhammad Abdulsbasit, Omar K. Salameh, Nasrollah Ghahramani. Penn State College of Medicine, Hershey, PA.

**Background:** There is an increasing demand for kidney transplantation, especially from living donors. This has necessitated better understanding of medium-term and long-term risks of kidney donation. Using a large multicenter cohort, we analyzed the differences in demographic characteristics in donors who developed acute kidney injury (AKI) within the first year after donation with those who did not develop AKI.

**Methods:** We performed a retrospective multi-center cohort study using TriNetX Research Network database, a federated medical records network, to identify 42,955 donors  $\geq$  18 years from 59 healthcare organizations (HCOs) in the United States. From this group, we then identified donors who had a confirmed diagnosis of AKI within a year of donation. We calculated the odds ratio (OR) and 95% confidence interval (CI) of diagnosis of End Stage Renal Disease (ESRD) and death in the first five years after donation.

**Results:** 3,055 donors (from 39 HCOs) had a confirmed diagnosis of AKI within the first year after donation. Patients in the AKI group were older at time of donation ( $44.2 \pm 13.5$  years vs.  $40.8 \pm 12.9$  years;  $p < 0.0001$ ), and more likely to: • be male ( $p < 0.001$ ) • have a Body Mass Index (BMI)  $> 30 \text{ kg/m}^2$  ( $p < 0.001$ ) • have a diagnosis of hypertension at time of donation ( $p < 0.001$ ) • be on a diuretic agent at time of donation ( $p < 0.001$ ) • be nicotine dependent ( $p < 0.001$ ) Within the first five years after donation, a total of 5554 donors (1874 with history of AKI) were diagnosed with ESRD and 1266 donors (501 with AKI) died. After propensity matching, AKI was associated with higher odds of ESRD (OR: 15.2; CI: 14.1 to 16.5), and mortality (OR: 9.9; CI: 8.8 to 11.2).

**Conclusions:** Among kidney donors, those who developed AKI within the first year of donation were more likely to be older at time of donation, male, have a BMI  $> 30 \text{ kg/m}^2$ , carry a diagnosis of hypertension and be on a diuretic at time of donation, and to be nicotine dependent. AKI within first year of donation was associated with higher likelihood of ESRD and death within five years after donation.

FR-PO112

**Long-Term Outcome of AKI: New-Onset Comorbidities and Survival**

Young Eun Choi,<sup>2</sup> Jihyun Yang,<sup>1,2</sup> Sungyeon Kim,<sup>2</sup> Suk Min Chung,<sup>2</sup> Ko Yoon Sook,<sup>2</sup> Lee Hee Young,<sup>2</sup> Yina Fang,<sup>2</sup> Tai yeon Koo,<sup>2</sup> Sewon Oh,<sup>2</sup> Myung-Gyu Kim,<sup>2</sup> Sang-Kyung Jo.<sup>2</sup> Kangbuk Samsung Medical Center, Jongno-gu, Seoul, Republic of Korea; <sup>2</sup>Korea University Anam Hospital, Seoul, Republic of Korea.

**Background:** Acute kidney injury (AKI) is known as a risk factor for short-term mortality and poor prognosis. In this study, we studied whether the AKI would be a risk factor for other comorbidities using the Korean national medical insurance database.

**Methods:** This study was performed using data from NHIS-NSC of Korea. The cohort was composed of 0.4% of the total eligible Korean population baseline population (n=186,512 AKI patients vs 45,000,000) between 2008 to 2013. We set that inclusion period as the index date. Patients who had been diagnosed with AKI using N17 code and dialysis requiring AKI (AKI-D) were defined as patients who were encoded with dialysis-related codes, the rest of the patients who had experienced AKI without a history of dialysis were defined as AKI-non-D. Patients with a previous history of AKI, end-stage kidney disease (ESKD), and dead before the index date were excluded.

**Results:** During a median follow-up of 1800days, newly developed comorbidities including angina, myocardial infarction, cardiac failure, cerebral hemorrhage and cerebral infarction, percutaneous coronary artery intervention, coronary artery bypass graft, fractures, and dementia were observed in AKI-D survivors. Survivors of AKI regardless of AKI severity showed higher mortality compared to the normal population. Patients with AKI-D showed worse survival compared with AKI-non-D as well as ESKD. Most of the initial mortality drop was observed within 300 days. Female, elderly with coexisting comorbidities including hypertension, angina, cardiac failure, cerebral hemorrhage and infarction, malignancy, fracture history, and dementia were significant risk factors for mortality.

**Conclusions:** AKI episode has long-term adverse effects on comorbidities and poor survival which is worst with dialysis-requiring cases. Close monitoring for renal function with comorbidity management would be important to severe AKI survivors.

FR-PO113

**Post Discharge Follow-Up Care in AKI Hospitalizations: A Health Systems Approach**

Prakash S. Gudsoorkar,<sup>1</sup> Jwalant R. Modi,<sup>1</sup> Karthikeyan Meganathan,<sup>1</sup> Charuhas V. Thakar.<sup>1,2</sup> <sup>1</sup>University of Cincinnati, Cincinnati, OH; <sup>2</sup>Cincinnati VA Medical Center, Cincinnati, OH.

**Background:** Acute kidney injury (AKI) survivors face increased risk of readmissions and fragmented post-discharge care. We operationalized and implemented a quality improvement program (QIP) to track metrics of readmissions and follow-up care after in AKI patients.

**Methods:** By automated informatics approach, from all renal consults except transplant we extracted AKI patients, reviewed by each calendar quarter (10/2015 to 09/2019). Outcome metrics were: i) 30- or 90-day readmission; ii) renal follow up in clinics or dialysis among eligible survivors.

**Results:** Of the 3,988 AKI patients (6,602 hospitalizations) 58.5% were male. Discharge disposition included 24% expired/hospice and 42% home (Fig 1). 2,591 (65%) were eligible for follow up care. The median time to readmission was 18 days (IQR=8-43); average 30- and 90-day readmission rate was 28% and 41% respectively (Fig 2). Of the eligible patients, renal follow up occurred in 38% (range 30-45%); of which clinic follow up was 33% (range 24-39%) and dialysis follow up was 5% (range 2-7%). The follow up trends were similar across quarters.

**Conclusions:** A prospective QIP of follow up care in AKI evaluates missed opportunities. This program can then help in implementation of post-discharge clinics and improve outcomes in AKI survivors.

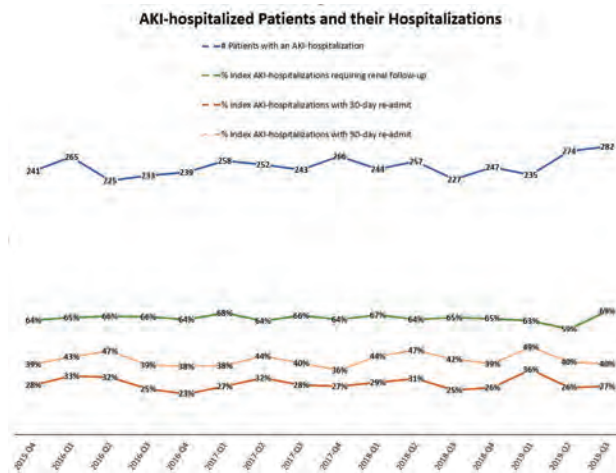

Fig 1. Quarterly trends

**Discharge disposition of index AKI-hospitalization (2015 Q4 - 2019 Q3)**

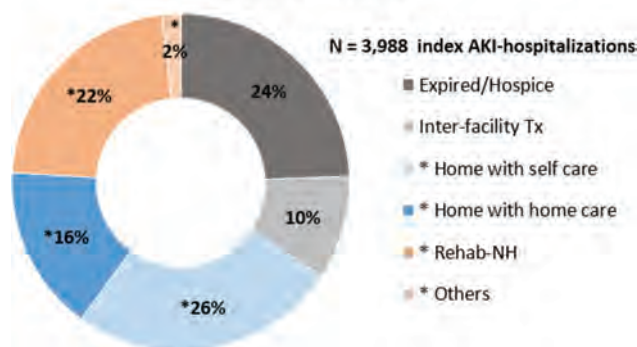

Fig 2. Discharge dispositions

FR-PO114

**Identifying Key Challenges and Opportunities in the Care of AKI Survivors Not on Dialysis: AKINow Workgroup**

Emaad M. Abdel-Rahman,<sup>1</sup> Samuel A. Silver,<sup>2</sup> Erin F. Barreto,<sup>3</sup> Jorge Cerda,<sup>4</sup> Leslie S. Gewin,<sup>5</sup> Javier A. Neyra,<sup>6</sup> Jia Hwei Ng,<sup>7</sup> Anitha Vijayan.<sup>5</sup> <sup>1</sup>UVA Health, Charlottesville, VA; <sup>2</sup>Queens University, Kingston, ON, Canada; <sup>3</sup>Mayo Clinic Minnesota, Rochester, MN; <sup>4</sup>Albany Medical College, Albany, NY; <sup>5</sup>Washington University in St Louis, St Louis, MO; <sup>6</sup>University of Kentucky, Lexington, KY; <sup>7</sup>Northwell Health, Glen Cove, NY.

**Background:** ASN recently established the AKINow initiative aiming to promote excellence in the prevention and treatment of AKI. One of the core policy, practice and research objectives of this workgroup is to identify gaps in the care of AKI survivors post hospitalization and develop quality evidence and benchmark existing strategies to care for these patients including insights from other stakeholders

**Methods:** We held a focus group with key stakeholders that included nephrologists, primary care providers, advanced practice providers (APP), intensivists, pediatric providers, community providers, patients and allied health personnel. We sought perspectives on optimal plans for hospital discharge of AKI survivors, challenges and opportunities in their care, communication strategies across diverse stakeholders, patient and care partner education and activation, and preferred interventions

**Results:** While 54% of the participants (n=57) identified integrated care delivery among providers to be the biggest barrier for care of AKI survivors, 23% thought that education and awareness among patients are the main challenge. 79% of the participants recommended RAAS blockers resumption should be after serum creatinine returns to baseline/ new baseline. They further suggested that currently 95% of the care of AKI

survivors is shouldered by nephrologists. This care is shared by Internists (51%), pharmacists (51%), RN (43%), APP (43%) and by other allied health personnel (8-22%). AKI patients' survivor testimonial about their experiences highlighted some of the gaps encountered in their care. Four breakout sessions (12-15/session) suggested specific recommendations to inform who is currently followed after AKI and by whom, different options for care delivery, and potential interventions/practices that may improve clinical and patient-centered outcomes

**Conclusions:** The stakeholder relationships formed, including those with patients, industry, and academia, will facilitate a collaborative research and practice agenda to advise the best and efficient practices after AKI. This represents an opportunity for the "recovery after AKI" workgroup of *AKINow* to provide leadership by raising awareness and promoting strategies focused on equitable and effective post-AKI care throughout the ASN and wider nephrology community

**FR-PO115**

**Incidence, Risk Factors, and Outcomes of Neonatal AKI in Very Low Birth Weight Infants: A Retrospective Cohort Study in a Single Neonatal Intensive Care Unit in Japan**

Erika Hidawa,<sup>1</sup> Naomi Hotta,<sup>2</sup> Hayato Sakurai,<sup>2</sup> Hiroko Kakei,<sup>2</sup> Masakazu Honda,<sup>2</sup> Tetsuya Kunikata,<sup>2</sup> Yuko Akioka.<sup>1</sup> <sup>1</sup>Department of Pediatrics, Saitama Medical University, Iruma, Japan; <sup>2</sup>Department of Neonatology, Saitama Medical University, Iruma, Japan.

**Background:** Premature neonates are at high risk of chronic kidney disease (CKD) due to low nephron number at birth. In very low birth weight (VLBW) infants, acute kidney injury (AKI) is common during admitted to the neonatal intensive care unit (NICU). AKI is a greater long-term risk of CKD. This study was aimed to determine the incidence, risk factors and outcomes of AKI in VLBW infants admitted to the NICU.

**Methods:** In this study, VLBW infants hospitalized between January 2014 and March 2020 in our NICU were enrolled. We examined the incidence of AKI, and analyzed the association with detailed maternal history, neonatal history, anthropometry, vitals and clinical signs of neonates. The diagnosis of AKI was defined by an increase in serum creatinine (SCR)>0.3 mg/dL or urine output <1 ml/kg per hour, the neonatal modification of Kidney Disease: Improving Global Outcomes criteria.

**Results:** In total, 234 VLBW infants were included. Incidence of AKI was 52.7% (n=125). Factors associated with a higher risk of AKI included: gestational age, birth weight, Apgar scores at 1, Apgar scores at 5, hyperbilirubinemia, pulmonary surfactant, diuretics, vasopressors, blood transfusion, steroids for fetal maturation, length of stay as shown in the table. In multiple regression analysis, compared with no-AKI, AKI was associated with higher risk of indomethacin for patent ductus arteriosus (odds ratio(OR), 145.97; 95%confidence interval (CI), 17.72-1202.20), smaller for gestational age (OR, 0.27; 95%CI, 0.092-0.81) and preeclampsia (OR, 0.040; 95%CI, 0.0017-0.98). SCR levels at discharge are not significantly different between neonates with AKI to no-AKI.

**Conclusions:** Early diagnosis and timely intervention in neonates who treated with indomethacin can prevent the progression of AKI and thus improve prognoses. We suggest that those neonates should be followed up for a long term to prevent CKD.

Characteristic	Whole cohort N=234	AKI N=125	no-AKI N=109	Pvalue
Gestational age, weeks, mean(SD)	30(3.3)	29(3.1)	32(2.5)	<0.0001*
Birth weight, grams, mean(SD)	1212(251.7)	1131(260.9)	1289(228)	0.0020*
Male sex, n(%)	124(53.0)	63 (50.4)	61 (56.0)	0.4053
Small for date, n(%)	90(37.6)	24 (19.2)	64 (58.7)	<0.0001*
Apgar Score at 5min, median(SD)	6(2.2)	5(2.0)	8(1.9)	<0.0001*
Pneumonia, n(%)	17(7.3)	3 (2.4)	14 (12.8)	0.0021*
Chorioamnionitis, n(%)	21(9.0)	17 (13.5)	4 (3.8)	0.0064*
Antenatal corticosteroids, n(%)	138(59.0)	71 (56.8)	67 (61.4)	0.4590
Indomethacin, n(%)	84(35.9)	81 (64.8%)	3 (2.8%)	<0.0001
Genamycin, n(%)	73(31.2)	52 (41.5)	21 (19.3)	0.0002
Vasopressor drugs, n(%)	118(50.4)	81 (64.8)	37 (33.9)	<0.0001
Diuretic drugs, n(%)	78(33.3)	65 (50.8)	13 (11.9)	<0.0001
Creatinine at discharge, µmol/L, mean(SD)	0.24(0.057)	0.23(0.054)	0.24(0.060)	0.6484

Demographic of VLBW infants with AKI and no-AKI

**FR-PO116**

**Integration of Human Kidney Transcriptome and Plasma Proteome Identifies Novel Biomarkers of Proximal Tubule Maladaptation to Injury**

Yumeng Wen,<sup>1</sup> Emily Su,<sup>1</sup> Leyuan Xu,<sup>2</sup> Steven Menez,<sup>1</sup> Dennis G. Moledina,<sup>2</sup> Paul M. Palevsky,<sup>3</sup> Lloyd G. Cantley,<sup>2</sup> Patrick Cahan,<sup>1</sup> Chirag R. Parikh.<sup>1</sup> <sup>1</sup>for the Kidney Precision Medicine Project (KPMP) and Translational Research in Biomarker Endpoints of Acute Kidney Injury (TRIBE-AKI) consortia <sup>1</sup>Johns Hopkins Medicine, Baltimore, MD; <sup>2</sup>Yale School of Medicine, New Haven, CT; <sup>3</sup>University of Pittsburgh School of Medicine, Pittsburgh, PA.

**Background:** There are no non-invasive approaches to identify maladaptive responses in proximal tubule (PT) after kidney injury.

**Methods:** We performed single nucleus RNA sequencing (snRNA-seq) analysis of kidney biopsy tissues from 6 participants with AKI and 7 healthy controls from the KPMP and HuBMAP consortia. We integrated differentially expressed genes in PT maladaptation with the plasma proteome (SomaScan) in cardiac surgery patients in

the TRIBE-AKI cohort. We evaluated the association between post-operative plasma proteins of maladaptive and healthy PT with KDIGO stage 2-3 AKI after surgery. We also performed reverse translational studies and confirmed these findings in a mouse model of maladaptive kidney repair following unilateral ischemia-reperfusion injury.

**Results:** SnRNA-seq analysis of kidney biopsy tissue in participants with AKI identified the subgroup of maladaptive PT cells characterized by advanced dedifferentiation and enrichment of pro-fibrotic pathways. Integrating 923 differentially expressed genes in PT maladaptation in participants from KPMP with the post-operative plasma proteome on 4040 protein aptamers in participants from TRIBE-AKI, we identified 4 proteins whose genes were specifically upregulated, and 5 proteins whose genes were specifically downregulated by PT maladaptation. The increases in COL23A1, TGFB2 and NLGN4X, and decreases in ENPP6 and PLG protein aptamers post-operatively were strongly associated with development of severe AKI during hospitalization. (Figure 1) The upregulation in *Col23a1* and *Tgfb2*, and the downregulation in *Enpp6* were associated with kidney atrophy in the mouse model of maladaptive kidney repair.

**Conclusions:** A multiomics approach of human kidney tissue interrogation discovered multiple novel protein markers to assess PT maladaptation and health with severe AKI.

**Funding:** NIDDK Support

Aptamer Odds Ratio (95% CI)	Model 1 (post-operative aptamer)	Model 2 (model 1 +age+ sex+ race+ comorbidities* + baseline eGFR)	Model 3 (model 2 + baseline ACR+ pre-operative aptamer)
FSTL3	2.22 (1.19- 3.8)	2.07 (1.01- 4.19)	1.74 (0.7- 4.18)
NLGN4X	1.87 (1.09- 3.45)	2.49 (1.36- 5.09)	6.41 (2.05- 21.7)
COL23A1	2.04 (1.01- 4.24)	2.89 (1.33- 6.59)	2.6 (1.15- 6.21)
TGFB2	2.27 (1.14- 4.66)	3.31 (1.51- 7.61)	2.38 (1.03- 5.8)
PDK2	0.37 (0.06- 1.4)	0.38 (0.06- 1.48)	2.06 (0.11- 39.7)
P4HA2	0.14 (0.03- 0.67)	0.14 (0.04- 0.73)	0.19 (0.15- 2.13)
ENPP6	0.29 (0.05- 1.09)	0.18 (0.03- 0.86)	0.03 (0.002- 0.3)
PLG	0.13 (0.04- 0.44)	0.1 (0.02- 0.38)	0.06 (0.009- 0.38)
AFM	0.43 (0.19- 1.01)	0.61 (0.25- 1.54)	0.5 (0.06- 3.95)

**Figure 1.** Associations between post-operative plasma aptamers of PT maladaptation and PT health with KDIGO stage 2-3 AKI in 322 participants after cardiac surgery in the TRIBE-AKI consortium. Among 322 participants, 47 developed stage 2-3 AKI.

\*Comorbidities included hypertension, diabetes mellitus, congestive heart failure, and myocardial infarction. All aptamers were presented by gene names, the measurements were log2-transformed so that the odds ratio represents an increase in the odds of doubling aptamer levels. Abbreviation: ACR, urine albumin-creatinine ratio.

**FR-PO117**

**Arginase 2 is a Mediator of Cisplatin-Induced AKI Through Regulation of Macrophage Inflammatory Responses**

Yushi Uchida,<sup>1,2</sup> Kumiko Torisu,<sup>2</sup> Seishi Aihara,<sup>2</sup> Hiroaki Ooboshi,<sup>1</sup> Toshiaki Nakano.<sup>2</sup> <sup>1</sup>Department of Internal Medicine, Fukuoka Dental College, Fukuoka, Japan; <sup>2</sup>Department of Medicine and Clinical Science, Graduate School of Medical Sciences, Kyushu University, Fukuoka, Japan.

**Background:** Cisplatin is a classic and effective chemotherapeutic agent, but its application is limited by its nephrotoxicity. Cisplatin induces tubular damage followed by intensive infiltration of inflammatory cells such as macrophages. Arginine metabolism has emerged as a critical regulator of inflammatory responses in macrophages. Arginase 2 (ARG2) is an enzyme that degrades arginine, but its role in the inflammatory response of macrophages remains unclear. In this study, we investigated the inflammatory role of ARG2 in macrophages in cisplatin-induced acute kidney injury.

**Methods:** Male *Arg2*<sup>-/-</sup> and WT mice were treated with cisplatin (20 mg/kg) by intraperitoneal injection. After 3 days of treatment, mice were euthanized and the kidney and blood samples were collected for analysis. Bone marrow-derived macrophages (BMDMs) isolated from *Arg2*<sup>-/-</sup> and WT mice were stimulated with 100 ng/mL LPS for 24-hour to evaluate cytokine excretion (IL-6 and IL-1β). Primary proximal tubular epithelial cells (PTECs) isolated from *Arg2*<sup>-/-</sup> and WT mice were cultured under 100 μM cisplatin for 24-hour to evaluate tubular apoptosis induced by cisplatin.

**Results:** In vivo, ARG2 deficiency mitigated cisplatin-induced renal dysfunction (SCR: *Arg2*<sup>-/-</sup> 1.01±0.11 mg/dL vs. WT 1.63±0.20 mg/dL, p<0.05). Cisplatin-induced tubular injury was also significantly attenuated in *Arg2*<sup>-/-</sup> mice as compared to WT mice based on histological analysis. The protein levels of cleaved caspase-3 and the number of TUNEL-positive cells in the kidneys of cisplatin-treated *Arg2*<sup>-/-</sup> mice were lower than those in the kidneys of WT mice. In vitro, *Arg2*<sup>-/-</sup> BMDMs had decreased secretion of proinflammatory cytokines as compared to WT BMDMs (IL-6: *Arg2*<sup>-/-</sup> 1.96±0.23 ng/mL vs. WT 4.02±0.51 ng/dL; IL-1β: *Arg2*<sup>-/-</sup> 3.38±0.44 ng/dL vs. WT 8.68±1.41 ng/mL, p<0.05), while there was no significant difference in tubular apoptosis caused by cisplatin between *Arg2*<sup>-/-</sup> and WT primary PTECs.

**Conclusions:** The deficiency of ARG2 significantly alleviated cisplatin-induced acute kidney injury. Our results suggested that ARG2 is a key mediator of macrophage inflammatory response, but is not directly involved in tubular apoptosis by cisplatin. Inhibition of ARG2 may be beneficial for the treatment of cisplatin-induced acute kidney injury by attenuating the inflammatory response of macrophages.

**Funding:** Government Support - Non-U.S.



## FR-PO118

**Mechanisms of Protection From Ischemic Injury With Renal Exosomes**

Katherine J. Kelly,<sup>1,2</sup> Jesus H. Dominguez,<sup>1</sup> <sup>1</sup>Indiana University School of Medicine, Indianapolis, IN; <sup>2</sup>Richard L Roudebush VA Medical Center, Indianapolis, IN.

**Background:** Ischemic renal injury results in tremendous acute and chronic morbidity and mortality and has no specific therapy. We have demonstrated marked improvement in posts ischemic kidney function and structure with exosomes (EV) from tubular cells given after renal failure was established. EV from skin epithelia or platelets were not effective, allowing the examination of the mechanisms of benefit with renal EV.

**Methods:** In a well established model of renal ischemia/reperfusion injury, EV or vehicle was given 24 hours after ischemia when renal failure was established. A model of anoxia/reoxygenation injury in primary renal tubular cells was used and apoptosis, inflammatory mediators, leukocyte adhesion and oxidative stress quantified in cells treated with vehicle or EV from different sources. Apoptotic cell death was quantified by TUNEL; leukocytes were fluorescently labeled to measure adhesion; expression of the inflammatory mediators C3, C5 and ICAM1 was evaluated by immunohistochemistry; generation of reactive oxygen species (ROS) was measured using dichlorodihydrofluorescein diacetate; and bax, superoxide dismutase and catalase expression analyzed by immunoblot.

**Results:** Renal EV, but not those derived from skin or platelets, significantly decreased anoxic renal cell death. A major effect of renal EV was anti-inflammatory (table). Leukocyte adhesion and expression of complement components C3 and C4 and intracellular adhesion molecule 1 were all significantly improved in the presence of renal EV as compared to either skin or platelet EV.

**Conclusions:** The benefits of renal exosomes in ischemic injury are multifaceted and include decreasing multiple pro-inflammatory mediators.

**Funding:** Other NIH Support - NIAID, Veterans Affairs Support

MEDIATORS OF INJURY (fold change vs normoxia)

	TUNEL+	WBC adhesion	ICAM	C3	C5	SOD	CAT	ROS	bax
vehicle/anoxia	8.8	51.5	7.9	6.8	8.9	0.19	0.65	2.7	9.7
renal EV/anoxia	2.0*	8.5*	2.5*	2.0*	1.5*	0.89*	2.5*	0.5*	3.8*
skin EV/anoxia	7.6	43.0	6.8*	5.2*	4.5*	0.25	1.0	0.9	7.4
platelet EV/anoxia	7.2	40.5	6.7*	5.0*	4.4*	0.26	1.1	0.9	8.0

\*p<0.01 vs vehicle/anoxia

## FR-PO119

**Protein Lactylation Promotes AKI-CKD Transition by Activating NLRP3 Inflammasome**

Kehong Chen. Army Medical Center of PLA, Chongqing, China.

**Background:** Renal interstitial inflammation contributes to the progression of AKI-CKD transition. Recent studies have shown that protein lactylation caused by lactic acid accumulation can regulate chronic organ injury. So we investigated the role and mechanism of protein lactylation in AKI-CKD transition.

**Methods:** Severe renal ischemia-reperfusion(I/R) injury (severe AKI) was constructed by bilateral renal ischemia for 35min. The lactylation enhancer rotenone and the lactylation inhibitor sodium dichloroacetate (DCA) were used to verify the effect of protein lactylation. Lactylated proteomics was used to detect the changes of lactylated proteins in renal cortex at different time points, and the lactylated proteins related to renal function were screened for verification.

**Results:** The SCR of BUN levels did not return to normal value at 14 days after I/R injury. At day 28, renal interstitial fibrosis was observed with AKI-CKD transformation. The renal injury score was significantly increased at day 7 and renal interstitial fibrosis was enhanced at day 28 after treatment with protein lactylation enhancer. IL-1b and IL-18 were found to be the most significantly enhanced inflammatory cytokines in the blood of mice, and the NLRP3 inflammasome activation was significantly enhanced in renal tissues at 7 days. Meanwhile, lactylation inhibitor had a protective effect on AKI-CKD transition. Lactylated proteins in kidney were detected by Lactylated proteomics analysis at 0, 3 and 7 days after I/R, and the enrichment of differential lactylated proteins was analyzed. GO enrichment analysis was performed on lactylated differential proteins associated with renal function trends at 0-7 days. The results showed that the seven differential proteins with significant difference mainly existed in the tricarboxylic acid cycle. One of them is citrate synthase (CS), a key rate-limiting enzyme in the tricarboxylic acid cycle. Citrate synthase lactylation level increased significantly on day 3 after AKI, recovered slightly on day 7, but still failed to return to normal level on day 28.

**Conclusions:** Renal protein lactylation promotes activation of NLRP3 inflammasome, leading to AKI-CKD transition. Citrate synthase may be the key lactoacylated protein.

## FR-PO120

**Cholinergic Signaling Increases Macrophage-Macrophage Interactions and Protects Sepsis-Induced AKI**

Yasuna Nakamura,<sup>1</sup> Tsuyoshi Inoue,<sup>1</sup> Reiko Inagi,<sup>2</sup> Masaomi Nangaku,<sup>2</sup> <sup>1</sup>Nagasaki Daigaku Igakubu Daigakuin Ishiyakugaku Sogo Kenkyuka, Nagasaki, Japan; <sup>2</sup>Tokyo Daigaku, Bunkyo-ku, Japan.

**Background:** Nicotinic acetylcholine receptor agonists have been shown to activate the cholinergic anti-inflammatory pathway (CAP) and improve systemic inflammation and acute kidney injury. This inflammatory reflex is known as a nervous system-mediated

immune response. It is considered that the CAP activation is thought to be through  $\alpha 7$  nicotinic acetylcholine receptor ( $\alpha 7$ nAChR) expressed on macrophages, but no one has been demonstrated *in vivo*.

**Methods:** To confirm the importance of  $\alpha 7$ nAChR in macrophages *in vivo*, macrophage-specific  $\alpha 7$ nAChR knockout (KO) mice (LysM-Cre: *Chrna7*<sup>fllox/fllox</sup> mice) were generated and tested whether GTS-21 ( $\alpha 7$ nAChR specific agonists) ameliorates lipopolysaccharide (LPS)-induced kidney injury. We also performed single-cell RNA sequencing (sc-RNA seq) of the spleen to identify the cells or genes that receive cholinergic signals in the spleen under LPS administration comprehensively.

**Results:** Administration of GTS-21 resulted in a decrease in systemic TNF- $\alpha$  production and kidney *Ngal* elevations by LPS in littermate wild-type (WT) mice, whereas the decreases were not observed in KO mice. This result suggested that the cholinergic signaling is mediated by  $\alpha 7$ nAChR on macrophages *in vivo*. In addition, sc-RNA seq identified that GTS-21 administration induces cell-cell interactions between macrophage-macrophages. *In vitro* transwell experiments using the macrophage cell line RAW 264 showed that GTS-21 increases macrophage-to-macrophage contacts. Furthermore, co-culture of macrophages suppressed TNF- $\alpha$  production induced by LPS as well as GTS-21 treatments. The anti-inflammatory and renal protective effects were canceled by splenectomy, suggesting that macrophage-macrophage cell interactions in the spleen are essential even *in vivo*.

**Conclusions:** Activation of cholinergic signaling via  $\alpha 7$ nAChR on macrophages increases macrophage-macrophage interactions in the spleen, resulting in anti-inflammatory and renoprotective effects in LPS-induced acute kidney injury.

**Funding:** Government Support - Non-U.S.

## FR-PO121

**Renalase Protects Renal Injury by Maintaining Mitochondrial Dynamic Homeostasis**

Xiaojia Guo,<sup>1</sup> Rongmin Chen,<sup>1</sup> Tian-Min Chen,<sup>1</sup> Gilbert W. Moeckel,<sup>1</sup> Robert L. Safirstein,<sup>1,2</sup> Elizabeth A. Jonas,<sup>1</sup> Gary V. Desir.<sup>1,2</sup> <sup>1</sup>Yale School of Medicine, New Haven, CT; <sup>2</sup>Connecticut VAMC, West Haven, CT.

**Background:** Renalase (RNLS) is a protein that participates in the salvage pathway for intracellular NADH. When secreted, it signals through the calcium ATPase ATP2b4 and activates kinases linked to survival. RNLS attenuates acute ischemic and cisplatin (CP)-induced kidney injury. We aim to elucidate the function of RNLS in renal mitochondrial homeostasis.

**Methods:** RNLS knockout (KO) and wild type (WT) mice were given CP at 15 mg/kg or vehicle control for 4 days and kidneys were collected and analyzed for structure with electron microscopy (EM), mitochondrial proteins with immunoblotting, and mitochondrial respiration assayed ex-vivo.

**Results:** CP induced severe renal damage in RNLS deficient animals as evidenced by plasma creatinine: KO 1.178  $\pm$  0.285 mg/dL, n=13 vs WT 0.151  $\pm$  0.026 mg/dL, n=14, p<0.005. EM analysis revealed that RNLS KO kidneys had 30% more mitochondria compared to control WT, while in CP treated animals, there was no difference in number of mitochondria between the strains. CP treatment induced 4-fold increase in autophagosomes in RNLS KO mice and only 2-fold increase in WT animals. Parkin protein, which plays a key role in mitophagy and mitochondrial motility and size, was not detected in WT control kidneys but was expressed in RNLS KO mouse kidneys. CP induced Parkin in WT and dramatically enhanced Parkin level in KO. AMPK $\alpha$  and AMPK $\beta$  were highly activated, and OPA-1 was reduced in RNLS KO AKI as compared to WT AKI kidneys. RNLS KO mouse kidneys exhibited reduced mitochondrial complex I and II activities as compared to WT (p<0.005 and p<0.05, respectively, n=5). Recombinant RNLS rescued the impaired mitochondrial activities of complexes I and II in RNLS KO kidneys (n=3, p<0.001).

**Conclusions:** Knockout of RNLS alters mitochondrial dynamics, and CP augmented mitophagy and autophagy during AKI as compared to WT-AKI. Recombinant RNLS attenuates mitochondrial dysfunction *in vitro*. These data suggest that renalase may be an effective therapeutic agent for mitochondrial relevant disorders, such as cisplatin-induced kidney injury and neurodegeneration.

**Funding:** Other NIH Support - NCI, 2R44CA224463-02

## FR-PO122

**Apobec-1 Limits Cisplatin and Ischemia-Reperfusion-Induced AKI**

Xiaojia Guo,<sup>1</sup> Leyuan Xu,<sup>1</sup> Heino Velazquez,<sup>1,3</sup> Tian-Min Chen,<sup>1</sup> Valerie Blanc,<sup>2</sup> Nicholas Davidson,<sup>2</sup> Gilbert W. Moeckel,<sup>1</sup> Robert L. Safirstein,<sup>1,3</sup> Gary V. Desir.<sup>1,3</sup> <sup>1</sup>Yale School of Medicine, New Haven, CT; <sup>2</sup>Washington University in St Louis, St Louis, MO; <sup>3</sup>Connecticut VA Medical Center, West Haven, CT.

**Background:** Cisplatin (CP) and Ischemia/reperfusion (I/R) injury induces AKI whereby proximal tubules undergo regulated necrosis. Repair is almost complete after a single dose of CP. We now examine the role Apolipoprotein B MRNA Editing Enzyme Catalytic Subunit 1 (Apobec1) plays in the recovery from AKI.

**Methods:** Mice were given CP 15 mg/kg or subjected to 20 min IRI with contralateral nephrectomy and renal function, histology, mRNA, protein, lipids and single cell RNA sequencing were analyzed. Bone marrow-derived macrophages (BMDM) were isolated from WT and Apobec1 KO mice and treated with LPS and IL-4 that polarize BMDM to M1 and M2, respectively, followed by cytokine profiling.

**Results:** Apobec-1 KO caused more severe AKI, plasma creatinine (pCr) 2.07 mg/dL  $\pm$  0.59 (n=13) vs 0.23 mg/dL  $\pm$  0.09 (n=8) 3d, p < 0.01 and greater mortality than in WT. The kidneys of Apobec1 KO showed increased necrosis, neutrophil invasion,

Key: TH - Thursday; FR - Friday; SA - Saturday; OR - Oral; PO - Poster; PUB - Publication Only

Underline represents presenting author.

KIM-1, NGAL, RIPK3, MLKL, TLR2, TLR4, and ASCL4 levels compared to WT kidneys ( $p < 0.01$ ). I/R injury was greater in Apobec1 KO as well ( $pCr 1.34 \pm 0.22$ ,  $n=6$  vs  $0.75 \pm 0.06$ ,  $n=5$ ,  $p < 0.05$  than WT). Apobec1 expression was restricted to invading macrophages in WT animals and single cell RNA sequencing revealed markedly increased inflammatory cytokine expression in these invading macrophages in the Apobec1 KO animals. BMDM from Apobec1 KO mice exhibited a maturation defect as they failed to polarize to M1 phenotype in response to LPS. The increase in macrophages seen in WT AKI kidneys was not observed in Apobec1 KO AKI kidney, suggesting a macrophage homing defect. The Apobec1 KO animals showed enrichment of cytokine-cytokine receptor, NF- $\kappa$ B, chemokine, and TNF signaling pathways.

**Conclusions:** We have identified Apobec1 as a crucial gene regulating the necrotic response to IR- and CP-induced nephrotoxicity. The absence of Apobec1 in macrophages prevented the transition of a cell death promoting phenotype to one supporting repair and regeneration. Apobec1 is a critical pro-survival response to renal injury and increasing Apobec-1 activity could be an effective strategy to reduce or prevent AKI.

#### FR-PO123

##### TGF $\beta$ R1 Activation in Tubular Epithelial Cell Recruits Leukocytes That Deliver Lethal Hit in a Model of AKI

Emelie Lassen, Liping Yu, Ilse S. Daehn. *Icahn School of Medicine at Mount Sinai, New York, NY.*

**Background:** Activation of the TGF $\beta$  signaling pathway plays an important role in both acute kidney injury (AKI) and chronic kidney disease pathogenesis. We have previously shown that ligand-independent activation of TGF $\beta$ R1 in proximal tubules (doxycycline inducible transgenic Pax8Tgfbf1) results in rapid epithelial cell injury and death, as well as immune cell infiltration. This study aims to determine the drivers and mechanism of epithelial cell injury in this novel model of TGF $\beta$ R1 mediated AKI.

**Methods:** To determine the mechanisms involved in AKI observed in transgenic Pax8Tgfbf1 mice, we isolated and immortalized proximal tubular epithelial cells (mPTECs) from Pax8Tgfbf1 mice with hTERT and treated with doxycycline. Characterization was done by IF for proximal tubule markers (AQP1, APN) and by RT-PCR. Splenocytes were isolated by sieving spleens from single transgenic mice of the same background (FVB). Cell viability was assessed by MTT, cell death by Annexin V/PI (FACS) and by cleaved caspase 3 (IF). Chemokines and cytokines released by mPTECs were determined by Luminex.

**Results:** We confirmed activation of TGF $\beta$ R1 and the canonical TGF $\beta$  pathway in doxycycline treated mPTECs. To our surprise, TGF $\beta$ R1 activation in these cells caused mild cell damage that did not reflect the dramatic phenotype observed in the mouse. This suggested to us that additional mechanisms could be at play in driving the severe tubular injury phenotype. We examined the secretome of mPTECs +/- doxycycline to determine whether these cells could induce infiltration of proinflammatory cells that could potentiate injury. TGF $\beta$ R1 activation induced the release of GM-CSF, LIF and MCP-1, suggesting recruitment and activation of infiltrate. Interestingly, an observed increase in VEGF by activated mPTECs could be involved in promoting vascular permeability. We next performed co-cultures with mixed allogenic leukocytes, and after 24hrs cell commitment to death was initiated by cleaved caspase 3, resulting in significant cell death of the mPTECs.

**Conclusions:** TGF $\beta$ R1 in mPTECs promotes the recruitment of leukocytes by the secretion of key chemokines and facilitating vascular permeability. Activated leukocytes subsequently contribute to an injurious interplay triggering cell death pathways in mPTECs.

#### FR-PO124

##### Transcript Isoform Switching in Sepsis-Induced AKI

Amy Zollman,<sup>1</sup> Arvin Halim,<sup>1</sup> Jered Myslinski,<sup>1</sup> Pierre C. Dagher,<sup>1</sup> Takashi Hato,<sup>1,2</sup> <sup>1</sup>Indiana University School of Medicine, Indianapolis, IN; <sup>2</sup>Richard L Roudebush VA Medical Center, Indianapolis, IN.

**Background:** In a subset of patients with sepsis-induced AKI, recovery of kidney function is observed. Understanding how such recovery unfolds will aid the development of targeted therapy. We have previously identified that translation shutdown is a hallmark of late phase sepsis. In a reversible model of endotoxemia, this late phase of sepsis is also a crucial transition period where tissue recovery begins. Notably, a set of genes are found to be highly resistant to translation shutdown. These resistant genes are enriched in pathways involved in RNA splicing. Thus, to examine the role of RNA splicing in tissue recovery, we performed long-read sequencing and analyzed temporal changes in RNA isoforms.

**Methods:** Reversible AKI was induced in mice by 5 mg/kg LPS iv. Kidneys were harvested at various time points. Full-length transcripts were prepared following the Nanopore protocol (SQK-DCS109) and sequenced on GridION.

**Results:** During the early course of endotoxemia, no significant changes were observed in the composition of RNA isoforms. In contrast, during late phases of endotoxemia (16–30 hrs), hundreds of genes exhibited distinct isoform switches. The emergence of isoform switches occurred during translation shutdown and the resultant alternative isoforms persisted throughout the recovery phase. Exon skipping and alternative exon ending were the 2 dominant modes of alternative splicing. Moreover, we found a number of very short isoforms consisting of a canonical first exon and a cryptic polyadenylated exon that originated from a first intron. Importantly, these short isoforms outnumbered their corresponding conventional protein coding isoforms. Because these

short isoforms lack sufficient lengths of open reading frame (<100 nt), they are predicted to fail in generating proteins. Thus, we surmise that the preponderance of short isoforms could serve as a novel endogenous gene downregulation mechanism. Indeed, we found that crucial stress-response genes including p53 exhibited this short isoform switch, thus effectively leading to downregulation of functional p53. Such isoform switch could permit cells to exit cell cycle arrest and promote tissue recovery in sepsis.

**Conclusions:** Transcript isoform switching is pervasive during the recovery phase of septic AKI. The genesis of the very short isoforms may have functional importance in controlling the expression of stress-response genes.

**Funding:** NIDDK Support, Veterans Affairs Support

#### FR-PO125

##### Proteomics Reveals Defective Fatty Acid Oxidation During the Progression of AKI and Repair

Jia Chen. *Army Medical Center of PLA, Chongqing, China.*

**Background:** Acute kidney injury (AKI) is characterized by a rapid decrease in renal function with high mortality and risk of progression to chronic kidney disease (CKD). Ischemia and reperfusion injury (IRI) is a major cause of AKI. However, the cellular and molecular responses of the kidney to IRI are complex and not fully understood.

**Methods:** Herein, we conducted unbiased proteomics and bioinformatics analyses in a severe bilateral IRI mouse model on days 3, 7, and 21, and validated the results using IRI, unilateral ureteral obstruction (UUO), and biopsies from patients with AKI or CKD.

**Results:** The results indicated an obvious temporal expression profile of differentially expressed proteins and highlighted impaired lipid metabolism during the progression of AKI to CKD. Acyl-coenzyme A oxidase 1 (Acox1), the first rate-limiting enzyme of fatty acid beta-oxidation, was then selected, and its disturbed expression in the two murine models validated the proteomic findings. Accordingly, Acox1 expression was significantly downregulated in renal biopsies from patients with AKI or CKD, and its expression was negatively correlated with kidney injury score. Furthermore, in contrast to the decreased Acox1 expression, lipid droplet accumulation was remarkably increased in these renal tissues, suggesting dysregulation of fatty acid oxidation.

**Conclusions:** In conclusion, our results suggest that defective fatty acid oxidation might be a common pathological feature in the transition from AKI to CKD, and that Acox1 is a promising intervention target for kidney injury and repair.

**Funding:** Clinical Revenue Support

#### FR-PO126

##### Regnase-3 in Kidney-Resident M $\phi$ Controls Severity of AKI and AKI-CKD Transition by Degrading Pre-mRNAs That Drive Their Polarization Towards a Pro-Inflammatory M1 Phenotype

Chenyu Li, Julian A. Marschner, Stefanie Steiger, Zhibo Zhao, Hans J. Anders. *Klinikum der Universität München Medizinische Klinik und Poliklinik IV - Standort Ziemssenstrasse, München, Germany.*

**Background:** Kidney resident macrophages (M $\phi$ ) are involved in regulating AKI-CKD transition (PNAS 2021). The mRNA regulatory enzyme Regnase-3 is specifically expressed in M $\phi$  and involved in the interferon- $\gamma$  signaling pathway (J Exp Med. 2019). Here we speculated that Regnase-3 would represent a kidney resident M $\phi$ -specific immune checkpoint that limits necroinflammation in AKI and AKI-CKD transition.

**Methods:** We generated transgenic mice with a conditional resident-M $\phi$ -specific Regnase-3 KO (Rank<sup>Cre</sup>/WT; Regnase3<sup>fllox</sup>/fllox, [Reg3cKO]) that bred at Mendelian ratios. 6-8 week-old mice were subjected to a unilateral ischemia-reperfusion injury (IRI) with or without nephrectomy (uNX). We measured GFR before and 1, 3, 7, 14, and 21 days after uIRI. In vitro, we stimulated Reg3cKO bone-marrow-derived M $\phi$  with H<sub>2</sub>O<sub>2</sub> and assessed cell metabolism, migration, and phagocytosis.

**Results:** After uIRI, the GFR significantly dropped in both WT and Reg3cKO mice at day 1. However, in Reg3cKO mice kidney function failed to fully recover compared with WT mice as indicated by the GFR at day 21 after uIRI. Serum creatinine as well as intrarenal Kim-1, Ngai, Timp2, and Tnf $\alpha$  mRNA levels were also higher in Reg3cKO mice together with more IFTA and interstitial F4/80+ cell infiltrates. Because uIRI is a model of persistent post-AKI ischemia, we turned to uIRI+uNX, an AKI model that restores reperfusion. Similarly, Reg3cKO mice showed delayed GFR recovery with only ~30% of baseline GFR at day 3 but ~50% for WT mice. In both Reg3cKO and WT mice the GFR fully recovered at day 14 after uIRI+uNX. However, the levels of Kim-1 and Ngai remained still higher in Reg3cKO mice with more IFTA and F4/80+ cell infiltrates. In vitro, after H<sub>2</sub>O<sub>2</sub> incubation, M0 and M1 but not M2 Reg3cKO M $\phi$  showed higher metabolic, migratory, and phagocytic capacity, as well as higher expression levels of CCR2/5, IL6, and TNF $\alpha$  T than WT, indicative of M1 M $\phi$ .

**Conclusions:** Regnase-3 might act as a negative regulator of resident M $\phi$  polarization towards an M1 phenotype, which contributes to the early injury phase of AKI and AKI-CKD transition. Mechanistically, Regnase-3 is likely to degrade certain preRNAs to limit the expression of pro-inflammatory cytokines/chemokines and chemokine receptors during kidney necroinflammation.

## FR-PO127

**Autophagy Activates EGR1 via ERK to Induce FGF2 in Renal Tubular Cells for Fibroblast Activation and Fibrosis During Maladaptive Kidney Repair**

Man J. Livingston<sup>1,2</sup>, Zheng Dong<sup>1,2</sup> <sup>1</sup>Augusta University Medical College of Georgia, Augusta, GA; <sup>2</sup>Charlie Norwood Department of Veterans Affairs Medical Center, Augusta, GA.

**Background:** Autophagy contributes to the regulation of maladaptive kidney repair including the development of tubulo-interstitial fibrosis. Our recent work reveals an autophagy-dependent tubular production and secretion of FGF2 into the interstitium where it acts as a key paracrine factor to activate fibroblasts for renal fibrosis. The mechanism by which autophagy induces FGF2 in renal tubular cells to promote maladaptive repair after AKI remains unclear.

**Methods:** Using various genetic and pharmacological approaches, this study examined the transcription factor early growth response protein 1 (EGR1) in post-ischemic mouse kidney tissues and in TGF- $\beta$ 1-treated proximal tubular cells.

**Results:** Following ischemic AKI, EGR1 was induced in the nuclei of chronically injured proximal tubules that were KIM-1-positive. Compared with wild-type mice, autophagy deficiency in *iRT-Atg7* KO (inducible, renal tubule-specific *Atg7* knockout) mice suppressed EGR1 expression in kidneys, indicating the induction of EGR1 was mediated by tubular cell autophagy. Consistently, TGF- $\beta$ 1 treatment induced EGR1 in cultured proximal tubular cells, which was also attenuated in *Atg7* KO tubular cells and by autophagy inhibitors. In TGF- $\beta$ 1-treated cells, EGR1 knockdown inhibited FGF2 mRNA and protein expressions. ChIP assay further detected an increased binding of EGR1 to *Fgf2* gene promoter region for transcriptional activation during TGF- $\beta$ 1 treatment. Interestingly, both FGF2 and EGR1 induction at mRNA levels were inhibited by FGF2 neutralizing antibody, suggesting a positive feedback between FGF2 and EGR1 that may contribute to EGR1-mediated FGF2 autoregulation. This feedback mechanism was further confirmed in *Fgf2* KO primary tubular cells and *Fgf2* KO mice. Upstream of EGR1, MAPKs (ERK, P38 and JNK) were activated in both post-ischemic kidneys and TGF- $\beta$ 1-treated tubular cells, whereas only ERK activation was attenuated by autophagy inhibition. Moreover, inhibition of ERK suppressed EGR1 induction in TGF- $\beta$ 1-treated tubular cells.

**Conclusions:** Together, these results suggest that autophagy activates ERK in tubular cells, which induces EGR1 for FGF2 transcription and autoregulation. FGF2 is then secreted into the interstitium for the activation of fibroblasts for fibrogenesis.

**Funding:** NIDDK Support, Veterans Affairs Support

## FR-PO128

**PKM2 Exacerbates Cisplatin-Induced AKI Through Regulation of STAT3**

Lu Wen<sup>1,2</sup>, Zheng Dong<sup>2,1</sup> <sup>1</sup>The Second Xiangya Hospital of Central South University, Changsha, China; <sup>2</sup>Augusta University, Augusta, GA.

**Background:** Pyruvate kinase M2 (PKM2) is an important rate-limiting enzyme catalyzing the last step of glycolysis. However, in addition to its vital role in energy metabolism in cytoplasm, PKM2 can translocate into the nucleus and interacts with signal transducer and activator of transcription 3 (STAT3) to regulate cell differentiation and inflammation. The role of nuclear PKM2 in renal pathophysiology is unknown.

**Methods:** To investigate the role of PKM2 in cisplatin-induced AKI, we generated kidney proximal tubule-specific PKM2 knock-out mice (PT-PKM2-KO) by crossing PKM2-floxed mice with PEPCK-CRE mice. PT-PKM2-KO or wild type mice of 8-10 weeks were intraperitoneally injected with 25 mg/kg of cisplatin to induce acute kidney injury (AKI). In vitro, we transfected PKM2-overexpressing plasmids into rat renal proximal tubular cells (RPTCs), followed by treatment with 20 $\mu$ M cisplatin for 24h. To determine the involvement of STAT3, we tested Stattic (inhibitor of STAT3) in PKM2 knock-out and wild type mice.

**Results:** Deficiency of proximal tubule PKM2 mitigated cisplatin-induced AKI in mice, suggesting an injurious role of PKM2. Consistently, overexpression of PKM2 aggravated cisplatin-induced apoptosis in RPTCs. Moreover, both STAT3 and phosphorylated STAT3 were increased in mice renal cortex cisplatin-induced AKI in mice. Notably, Stattic ameliorated cisplatin-induced AKI in wild type mice, but not in PKM2 knock-out mice.

**Conclusions:** These results indicate that PKM2/STAT3 signaling contributes to renal tubular injury in cisplatin-induced AKI, suggesting the PKM2/STAT3 pathway as a new therapeutic target in cisplatin nephrotoxicity.

**Funding:** NIDDK Support, Veterans Affairs Support

## FR-PO129

**Stanniocalcin-1 Ameliorates Ischemia-Reperfusion Kidney Injury via Selective Activation of AMPK- $\alpha$ 2**

Jenny S. Pan<sup>1,2</sup>, Qingtian Li<sup>1</sup>, David (Daud) Sheikh-Hamad<sup>1,2</sup> <sup>1</sup>Baylor College of Medicine, Houston, TX; <sup>2</sup>Michael E DeBakey VA Medical Center, Houston, TX.

**Background:** Acute kidney injury (AKI) is common and is associated with increased morbidity, mortality, and development/progression of chronic kidney disease. Currently, therapeutic options remain limited. AMPK activation has been found to protect from AKI. However, there are concerns about off target effects as AMPK is ubiquitously expressed and exert a multitude of regulatory effects. We previously showed that STC1 protects

from ischemia-reperfusion (I/R) kidney injury through an AMPK-dependent pathway. In STC1 Tg kidneys, we observe preferential activation (phosphorylation) of the AMPK  $\alpha$ 2 isoform relative to the  $\alpha$ 1 isoform compared to WT kidneys. We hypothesize that kidney protection by STC1 is mediated through selective activation of the AMPK $\alpha$ 2 isoform.

**Methods:** In the current experiments, we sought to determine kidney phenotype after I/R kidney injury in mice with transgenic overexpression of STC1 and inducible, kidney tubular epithelium-specific knockdown of AMPK  $\alpha$ 1 (STC1 Tg; AMPK $\alpha$ 1f/f; Pax8rtTA; LC1-Cre; referred to as AMPK $\alpha$ 1KO) or AMPK  $\alpha$ 2 (STC1 Tg; AMPK $\alpha$ 2f/f; Pax8rtTA; LC1-Cre; referred to as AMPK $\alpha$ 2KO); all on C57B/6 background. 10-12 week old mice were subjected to bilateral kidney I/R (clamping of renal pedicles for 30 min with non-traumatic vascular clamps). Mice were euthanized after 72 hours; blood and timed urine were collected for calculation of creatinine clearance, and kidneys were harvested for analyses.

**Results:** Using antibodies that recognize both  $\alpha$ 1 and  $\alpha$ 2 isoforms of the catalytic subunits of AMPK, we observed preferential phosphorylation of the  $\alpha$ 2 isoform in STC1 Tg kidneys compared with WT kidneys. Kidney tubule-specific knockdown of AMPK  $\alpha$ 2 in STC1 transgenic mice (AMPK $\alpha$ 2KO) restored the susceptibility to I/R kidney injury (demonstrated by decreased creatinine clearance and urine output, and increased histologic injury and mitochondrial ROS). In contrast, kidney tubule-specific knockdown of AMPK  $\alpha$ 1 in STC1 transgenic mice (AMPK $\alpha$ 1KO) had no significant effect on STC1-mediated kidney protection (preserved creatinine clearance, kidney morphology and urine output; less ROS production).

**Conclusions:** The data suggest that STC1 ameliorates ischemia-reperfusion kidney injury via an AMPK- $\alpha$ 2-dependent pathway. Selective activation of the AMPK  $\alpha$ 2 isoform by STC1 may protect from AKI while minimizing off target effects of AMPK activation.

**Funding:** Veterans Affairs Support, Private Foundation Support

## FR-PO130

**Renal Injury Response in an Adult Pkd2 Mouse Model**

Sreelakshmi Cherakara, Zhang Li, Courtney J. Haycraft, Mandy J. Croyle, Bradley K. Yoder. *The University of Alabama at Birmingham Department of Cell Developmental and Integrative Biology, Birmingham, AL.*

**Background:** Autosomal Dominant Polycystic Kidney Disease (ADPKD) is caused by dysfunction of the primary cilium on the renal tubule epithelium due to either loss of proteins localized on the cilium or loss of cilia structure. Mutations in *Pkd1* or *Pkd2*, which encode PC1 and PC2, respectively, result in progressive cyst formation in mouse models of ADPKD. Previous studies have shown that renal injury accelerates cyst formation in these models suggesting the cilium/PKD1/PKD2 is involved in regulating injury and repair responses. Here we evaluate the role of *Pkd2* in regulating renal injury and repair processes and how dysregulation of this process may contribute to renal cyst formation.

**Methods:** The renal injury will be induced by a single IP injection of cisplatin (9.0 mg/kg body weight), a chemotherapeutic drug with nephrotoxic side effects in adult induced CAGG-CreERT2; *Pkd2* mutant mice. We analyzed the percentage of SOX9 (an indicator of injury) expressing cells at 3-, 7-, 14-, 21-, 28-, and 35-days post cisplatin injury using immunofluorescence (IF) and FACS.

**Results:** The number of cells expressing SOX9 peaked 7 days after cisplatin injection in both *Pkd2* mutants and wildtype controls then decreased through 28 days post injury. In wild type controls, a small number of SOX9+ cells remained at 28- and 35-days post injury. However, in *Pkd2* mutants, the number of cells expressing SOX9 at 28- and 35- days were more in injured epithelial cells than in the controls. In *Pkd2* mutant kidneys, many of the epithelial cells lining the forming cysts continue to express SOX9, and this number increases during cyst expansion.

**Conclusions:** These data show that following renal injury, *Pkd2* mutant and control kidneys have a similar increase in SOX9 expression in response to cisplatin-induced injury. However, in *Pkd2* mutant mice, the number of SOX9+ cells at 28-days post-cisplatin is higher when compared to controls and begins to increase through day 35. This suggests that the *Pkd2* mutant epithelium cannot complete the repair process after injury and *Pkd2* might be required for the completion of the repair process.

**Funding:** NIDDK Support

## FR-PO131

**The Human MicroRNA-mRNA Transcriptome in AKI**

Thomas De Luca, Ricardo Melo ferreira, Michael T. Eadon, Danielle Janosevic. *Indiana University School of Medicine, Indianapolis, IN.*

**Background:** MicroRNAs (miR) regulate gene expression by base-pairing to messenger RNA (RNA) and primarily repressing protein synthesis. Here, we describe miRNA and mRNA transcriptomic profiles in acute kidney injury (AKI). Further, we hypothesized that biobanked renal tissue biopsies (IB) with the pathologic diagnosis (path) of minimal change (MCD) or thin basement membrane (TBM) disease should demonstrate similar transcriptomic profiles to reference nephrectomies (Nx) and in comparisons with AKI.

**Methods:** AKI, IB, and nephrectomy (Nx) transcriptomic data (miR, RNA) were derived from stored human kidney tissues obtained in the routine clinical care of patients. AKI specimens carried path of acute interstitial or tubular necrosis (n=39). IB specimens had path of MCD (n=11) or TBM (n=1), IFTA <5%, no AKI. RNA was extracted from tissue (Qiagen miRNeasy), libraries prepared (RNA: Takara Total RNA-Seq, miR: Qiaseq) and sequenced. Differentially expressed genes (DEGs) and miRNAs (DEMs) were identified with DESeq2 using comparisons between: AKI/IB, AKI/Nx, IB/Nx. KEGG enrichment analysis was performed for DEGs and DEMs with FDR <0.05 using pathfinder for R, Mienturnet, and miRPathDbv2.0. MiRNA-mRNA interactions were identified using miRTarBase and miRDB.

**Results:** In AKI, increased miR-150-5p was associated with downregulation of IL1A, CTSB (related to MAPK signaling, metabolism). Similarly, increased miR-155-5p was associated with decreased HIF1a, known to exacerbate AKI. Next, we determined if IB can be used as a surrogate reference, and if each is distinct from AKI. In comparing the miRNA and mRNA transcriptomes of all samples, principal component analysis revealed 3 distinct clusters corresponding to IB, Nx and AKI. Comparing IB to Nx, enriched pathways included cell cycle, cancer pathways, and reactive oxygen species. AKI/Nx and AKI/IB comparisons enriched similarly in PI3K-Akt and related structural pathways (e.g. extracellular matrix, actin cytoskeleton, focal adhesion).

**Conclusions:** The miR and RNA targetome of AKI were similar when compared to both reference sets (IB and Nx). Our data suggest that miR regulate RNA in several important AKI-related pathways. Additionally, we propose the use of IB as tissue reference data for AKI.

**Funding:** Other NIH Support - This publication was made possible with support from Grant Number, UL1TR002529 (S. Moe and S. Wiehe, co-PIs) from the National Institutes of Health, National Center for Advancing Translational Sciences, Clinical and Translational Sciences Award., Private Foundation Support

## FR-PO132

**Effects of Delayed Treatment With Poly (ADP-Ribose) Polymerase Inhibitor After Ischemia-Reperfusion on Healing Phase of Renal Injury**  
Junseok Jeon,<sup>1</sup> Hojin Jeon,<sup>1</sup> Sung Bin Yoon,<sup>1</sup> Kyungho Lee,<sup>2</sup> Hye Ryoung Jang,<sup>1</sup> Jung eun Lee,<sup>2</sup> Yoon-Goo Kim,<sup>1</sup> WooSeong Huh,<sup>1</sup> <sup>1</sup>Samsung Medical Center, Sungkyunkwan University School of Medicine, Seoul, Republic of Korea; <sup>2</sup>Johns Hopkins University School of Medicine, Baltimore, MD.

**Background:** Excessive activation of poly (ADP-Ribose) polymerase (PAPR) after DNA damage aggravates tissue injury, including postischemic kidney, through NAD<sup>+</sup> depletion. The beneficial effects of PARP inhibition on the early injury phase of renal ischemia-reperfusion injury (IRI) was demonstrated in several studies. However, the role of PARP inhibitions on the healing phase after renal IRI has not yet been determined. The effects of JPI-289, a novel PARP inhibitor, on the healing phase of ischemic AKI were investigated in murine renal IRI and hypoxic HK-2 cell models.

**Methods:** Male 9-week-old C57BL/6 mice were used for renal IRI surgery. Saline (control) or JPI-289 was injected into the peritoneum. JPI-289 100 mg/kg was administered twice at 24 and 48 hours after unilateral IRI (UIRI), and 50 or 100 mg/kg was administered once at 24 hours after UIRI or bilateral IRI (BIRI). HK-2 cells were treated with the JPI-289 after hypoxic insult.

**Results:** Renal function initially worsened and then recovered in the JPI-289 treated group compared to the control group after BIRI, but was comparable between groups after UIRI. Renal tubular necrosis and damage, inflammatory cell infiltration, and intrarenal expression of proinflammatory cytokines/chemokines were more prominent in the JPI-289 100 mg/kg twice treated group at 12 weeks after UIRI compared to the control group, although those were comparable between groups at 6 weeks after BIRI or UIRI. The extent of fibrosis was similar between the groups. JPI-289 treatment of 0.5 and 0.75 mg/mL at 3 or 6 hours after hypoxia facilitated the proliferation of hypoxic HK-2 cells, whereas further treatment after 24 hours suppressed proliferation even with lower dosages.

**Conclusions:** Our results suggest that late treatment of PARP inhibitors after renal IRI did not have a beneficial effect on the recovery of ischemic AKI, but rather could have a negative effect on healing.

**Funding:** Government Support - Non-U.S.

## FR-PO133

**Single Cell Chromatin Accessibility Atlas During Murine Kidney Injury and Repair**

Yoshiharu Muto, Eryn E. Dixon, Haojia Wu, Nicolas Ledru, Parker C. Wilson, Yuhei Kiritani, Benjamin D. Humphreys. Washington University in St Louis School of Medicine, St Louis, MO.

**Background:** Recent single cell and single nucleus RNA-seq (snRNA-seq) studies revealed cell-specific molecular alterations in acute ischemic injury (AKI). We previously identified a failed-repair proximal tubular cell (FR-PTC) state with a persistent inflammatory signature after ischemic renal injury (IRI). However, the underlying epigenetic mechanisms driving the failed repair cell state is undefined.

**Methods:** We performed single nucleus ATAC-seq (snATAC-seq) on mouse kidneys after IRI: 4 hours, 12 hours, 2 days, 14 days, 6 weeks and sham (n = 3 for each) using the 10x Genomics platform. We integrated snATAC-seq data with the snRNA-seq data obtained from the same IRI mouse kidney samples, and a comprehensive bioinformatic analysis was performed on the dataset.

**Results:** We obtained 136,469 single-nucleus chromatin accessibility libraries with 193,731 peaks. We performed label transfer from snRNA-seq data to snATAC-seq using Seurat, and all major cell types (11 clusters) were identified. The proximal tubular cell (PT) cluster was further subclustered into 8 subtypes including FR-PTC, which showed specific promoter accessibilities on inflammatory molecules including Tnf, Ccl2 and Vcam1. Transcription factor motif enrichment analysis on accessible regions identified acute activation (4 hours after IRI) of NRF2 and API in injured PT cells, although the most severely injured cells failed to activate NRF2, suggesting a potential therapeutic target. NF-κB transcription factors were activated specifically in FR-PTC to induce chronic inflammatory signatures. The most specifically accessible regions with NF-κB binding motifs in FR-PTC include potential distal enhancers for Ltbp2 and Edn1 that were up-regulated in FR-PTC. We constructed FR-PTC-specific cis-regulatory accessibility network to predict the cis interactions that shape these FR-PTC-specific gene expression signatures.

**Conclusions:** The first comprehensive snATAC-seq atlas of mouse IRI kidneys catalogued phase-specific and cell-specific activation of regulatory genomic regions and transcription factors that shape cell-specific responses to ischemic injury. Epigenetic mechanisms driving FR-PTC revealed in this study implicate potential novel therapeutic targets in AKI and its transition to chronic kidney disease.

**Funding:** NIDDK Support

## FR-PO134

**Mitochondrial-Driven Inflammation in Aged Kidneys Is Exacerbated by Nicotinamide Mononucleotide but Ameliorated by Elamipretide**

Tara A. Saleh,<sup>1</sup> Jeremy A. Whitson,<sup>2</sup> Peter S. Rabinovitch,<sup>1</sup> Mariya T. Sweetwyne,<sup>1</sup> <sup>1</sup>University of Washington, Seattle, WA; <sup>2</sup>High Point University, High Point, NC.

**Background:** Mitochondrial dysfunction is characterized by loss of structural integrity, decreased efficiency of the electron transport chain and is linked to cellular senescence and inflammation. With age, kidneys show progressive mitochondrial dysfunction, suggesting a therapeutic target to reduce aging kidney decline. Previously, systematic treatment of old mice with tetrapeptide, Elamipretide (ELAM), which interacts with the inner mitochondrial membrane to improve cristae structure and function, reduced mito-dysfunction and senescence in kidney and heart. We hypothesized that added intervention with Nicotinamide Mononucleotide (NMN), an NAD<sup>+</sup> precursor, which contributes to the efficiency of ATP generation, would enhance the mito-energetic capability, thus decreasing mito-dysfunction and senescence in aged kidneys.

**Methods:** Old male mice were treated for 8 weeks at 24 months-old (mo) with: ELAM (osmotic pump, 3mg/kg), NMN (drinking water, 300 mg/kg), or ELAM+NMN combined. Untreated control mice were 4 mo (young) and 26 mo (old). Treated kidneys were harvested at 26 mo and preserved as frozen and formalin fixed tissues. Liver was analyzed to clarify intervention responses as global vs. kidney-specific mechanisms.

**Results:** Contrary to our hypothesis, NMN was detrimental in aged kidney by increasing mRNA expression of inflammatory cytokine, IL1b, relative to aged control kidneys (23-fold vs. 9-fold normalized to young, p=0.0002). RNA in situ hybridization showed IL1b expression localized to the old NMN-treated proximal tubules. In NMN treated kidneys IL-1β downstream targets CCL2, an inflammatory chemokine, and proximal tubule injury marker, KIM-1, were significantly upregulated. This was reduced in mice treated with combined ELAM+NMN. Finally, kidney F4/80+ macrophages by immunohistochemistry were higher in NMN treated mice, relative to old control or combined treatment groups. IL1b-driven inflammation was not observed in livers of NMN treated mice, demonstrating kidney specificity.

**Conclusions:** This suggests that high doses of NMN supplementation exacerbates existing inflammation pathways in aged kidneys but that this is reduced by ELAM mitochondrial intervention. Further work seeks to track NMN metabolite levels in primary tubule cells to better understand NMN-induced injury and ELAM protection in aged kidneys.

**Funding:** Other NIH Support - NIA P01 AG001751, NIA K01 AG062757

## FR-PO135

**Integrin-Linked Kinase Depletion Prevents Fibrosis and the Decrease of Mitochondrial Complex Functionality in Folic Acid-Induced Nephropathy**

Sofia Campillo de Blas,<sup>1,3</sup> Mariano de la Serna,<sup>3,2</sup> Elena Gutierrez Calabres,<sup>1,3</sup> Natalia Canales Bueno,<sup>3,1</sup> Cristina González Valero,<sup>3,1</sup> Mercedes Griera,<sup>4,3</sup> Sergio De frutos garcia,<sup>4,5</sup> Laura Calleros,<sup>1,3</sup> Diego Rodriguez puyol.<sup>6,5</sup>

<sup>1</sup>Department of Systems Biology, Physiology Unit, Universidad de Alcalá, Alcalá de Henares (Madrid), Spain; <sup>2</sup>Biomedical Research Foundation, Hospital Universitario Príncipe de Asturias., Alcalá de Henares (Madrid), Spain; <sup>3</sup>NOVELREN, Instituto Ramón y Cajal de Investigación Sanitaria (IRYCIS), Fundación Renal Iñigo Álvarez de Toledo (FRIAT) and REDinREN, (ISCIII), Alcalá de Henares (Madrid), Spain; <sup>4</sup>Department of Systems Biology, Physiology Unit, Universidad de Alcalá. Graphenano Medical Care S.L., Alcalá de Henares (Madrid), Spain; <sup>5</sup>NOVELREN, Instituto Ramón y Cajal de Investigación Sanitaria (IRYCIS), Fundación Renal Iñigo Álvarez de Toledo (FRIAT) and REDinREN, (ISCIII). Biomedical Research Foundation, Hospital Universitario Príncipe de Asturias., Alcalá de Henares (Madrid), Spain; <sup>6</sup>Nephrology Unit, Hospital Universitario Príncipe de Asturias, Department of Medicine and Medical Specialties and Graphenano Medical Care S.L., Alcalá de Henares (Madrid), Spain.

**Background:** Integrin-linked kinase (ILK), a major scaffold protein between the extracellular matrix and intracellular signaling pathways, is involved in several pathophysiological processes during renal damage. There are few studies on the mitochondrial dysfunction that occurs after renal failure in the Folic Acid-induced nephropathy (FA). The aim of this work was to study the role of ILK in renal interstitial fibrosis associated with mitochondrial dysfunction that appears during acute kidney injury (AKI) to chronic kidney disease (CKD) transition induced by FA administration.

**Methods:** Males of the C57BL/6 WT strain and adult conditional ILK knock-down (cKD-ILK) were injected intraperitoneally with a single dose of FA (250 mg/kg) dissolved in Sodium Bicarbonate (0.3 mmol/L), with sacrifice at 15 days. We determined the expression of ILK, extracellular matrix protein (Fibronectin: FN and Collagen type I: COL1A1), the profibrotic cytokine TGF-β1 and the mitochondrial electron transport

Key: TH - Thursday; FR - Friday; SA - Saturday; OR - Oral; PO - Poster; PUB - Publication Only

Underline represents presenting author.

chain complexes (COXI: NADPH DH, COXII: Succinate DH, COXIII: Coenzyme Q, COXIV: Cytochrome C Oxidase and COXV: ATP Synthase) by Western Blot and COXIV activity by colorimetric assay kit in the mice renal cortex.

**Results:** ILK expression increases in the renal cortex of FA treated WT mice, which does not occur in the cKD-ILK FA group. Moreover, we observed an increase of fibrotic markers (FN, COL1A1) and TGF- $\beta$  in the WT FA group, which was significantly lower in FA cKD-ILK mice. Regarding the complexes of the mitochondria, we observed a notable protein decrease of these complexes in the WT FA group and the protein content of COXI and COXIV that was partly recovered after ILK deletion (as also occurs with COXIV activity). Positive correlations with ILK expression levels were obtained for all studied markers.

**Conclusions:** These data suggest that ILK plays a relevant role in the renal fibrosis development and mitochondrial dysfunction after FA-induced AKI-CKD transition, since its deletion prevents fibrosis and improves mitochondrial dysfunction. Further studies will be aimed to elucidate the underlying mechanism between ILK, mitochondrial dysfunction and fibrosis.

**Funding:** Other NIH Support - This research was supported by co-funded grants from the Instituto de Salud Carlos III (ISCIII) and FEDER funds (PI17/01513, PI17/00625, PI20/00634, PI20/00664, RICORS2040, "Kidney disease" RD21/0005/0023), Madrid Community funds (B2017/BMD-3751), and University of Alcalá and FRIAT funds., Government Support - Non-U.S.

## FR-PO136

### Helix B Surface Peptide Protects Lipopolysaccharide-Induced AKI by Inhibiting Pyroptosis and Promoting Macrophage Polarization

Lili Huang,<sup>1</sup> Wenli Sai,<sup>1</sup> Fenfen Xiong,<sup>1</sup> Guijuan Feng,<sup>1</sup> Yuanyuan Wu,<sup>2</sup> Hongsheng Zhao,<sup>1</sup> Bin Yang.<sup>1,3</sup> <sup>1</sup>Affiliated Hospital of Nantong University, Nantong, China; <sup>2</sup>Nantong University, Nantong, China; <sup>3</sup>University of Leicester, Leicester, United Kingdom.

**Background:** Sepsis is defined as life-threatening multiple organ dysfunction syndrome caused by a dysregulated host response to infection. Acute kidney injury (AKI) is one of the most common complications of sepsis. Helix B surface peptide (HBSP) is the derivative of erythropoietin (EPO) that retains the tissue protection of EPO, without erythropoiesis. Previous studies have shown that HBSP alleviated renal ischemia-reperfusion injury. In this study, we investigated the effect of HBSP on pyroptosis and underlying mechanisms in lipopolysaccharide (LPS)-induced AKI.

**Methods:** The mice were randomly divided into three groups: the control, LPS and LPS + HBSP group (n = 6-8). Serum creatinine (Scr) and blood urea nitrogen (BUN) were detected by the Fully Automatic Biochemical Analyzer, while tumor necrosis factor- $\alpha$  (TNF- $\alpha$ ), interleukin (IL)-6, IL-18 and IL-1 $\beta$  were detected by quantitative real-time PCR (qPCR). Renal histological changes were evaluated by tubular interstitial damage (TID) score in H&E stained sections. Macrophage infiltration and polarization were analyzed by immunohistochemistry and flow cytometry measures. The expression of pyroptosis-related proteins was detected by Western Blot.

**Results:** Scr, BUN and TID score were increased by LPS compared with the control group, but was decreased by HBSP (P<0.01). The level of TNF- $\alpha$ , IL-6, IL-18 and IL-1 $\beta$  mRNA, as well as HMGB1 protein, was increased by LPS, but reduced again by HBSP (P<0.05). In addition, the pyroptosis in LPS-treated kidneys was obvious compared with the control group, but HBSP treatment reduced the expression of pyroptosis-related proteins including GSDMD-N and IL-1 $\beta$  and IL-18 (P<0.05). Macrophage infiltration and inflammation in the kidney were increased by LPS, but reduced by HBSP (P<0.05). Moreover, M1 macrophage activation was induced by LPS, while the transformation of M1 to M2 phenotype was promoted by HBSP (P<0.01).

**Conclusions:** The model of LPS-induced AKI was successfully established with increased inflammatory mediators and compromised renal function and histology. HBSP effectively protected LPS-induced AKI reflected by less inflammation and pyroptosis, and improved macrophage polarization, renal function and structure. These findings provide new insights to the therapeutic strategy of LPS-induced AKI.

## FR-PO137

### Validation of Inferred MicroRNA Activity From Kidney scRNAseq

Danielle Janosevic, Thomas De Luca, Guanglong Jiang, Indiana University School of Medicine, Indianapolis, IN.

**Background:** MicroRNA (miR) regulate renal injury and recovery processes in acute kidney injury (AKI). Single-cell RNAseq (scRNAseq) datasets are broadly available, in contrast to single-cell miRNAseq (scMiRseq). Thus, pipelines that computationally derive miRNA activity (miRa) from scRNAseq are appealing. These pipelines infer a miR's activity level through enrichment of miR binding motifs on mRNA and changes in the miR targetome, proposed as a surrogate for miR expression. We hypothesize that miRa derived from kidney scRNAseq will strongly correlate with expressed miR from bulk kidney sequencing.

**Methods:** Murine kidney scRNAseq were downloaded from NCBI's GEO: GSE151658. This data is a model of sepsis-AKI at 0,1,4,16, and 27 hours after endotoxin (LPS) injection (i.v.). ScRNAseq data were normalized and miRa estimated using "miReact" R package. MiRa were averaged for all cells at each timepoint to generate the pseudobulk miRa dataset. To validate miRa, we performed a miRNAseq experiment with identical conditions to the above dataset (n=5 per timepoint) and sequenced miR from bulk kidney tissue. RNA was extracted from snap frozen kidneys (Qiagen miRNeasy), library prepared (Qiaseq) and sequenced (10-15 million read depth/sample). FASTQs aligned to mm10 transcriptome using STAR. Read counts were TMM normalized, log-transformed (counts-per-million) using EdgeR, generating the bulk miR expression

dataset. Pearson correlation was performed for each miR between pseudobulk miRa and bulk miR expression. Correlation scores with r >0.7 and p-value <0.05 were considered significantly correlated. Pathway analysis was performed with miRdb and Mienturnet.

**Results:** MiR activity analysis derived 1,588 miRa from the pseudobulk miRa data and 566 miRs identified in the bulk miR expression data, with 322 (of 566, 56%) miRs shared between pseudobulk miRa and bulk miR expression data. Of the shared miRs, 14 miRs were significantly correlated (of 322, 4%, p <0.05) with a bias towards -3p strands. Significantly correlated miRs (e.g., miR-1955-3p, r=0.99, miR-323-3p, r=0.98, miR-3069-3p, r=0.97) were related to inflammatory and immune response pathways.

**Conclusions:** In our murine kidney data, miRa was not well correlated with miR expression. The discordance of activity from expression warrants further exploration into the regulatory mechanisms of renal miR expression, which may improve computational predictions of miRa.

**Funding:** Other NIH Support - This publication was made possible with support from Grant Number, UL1TR002529 (S. Moe and S. Wiehe, co-PIs) from the National Institutes of Health, National Center for Advancing Translational Sciences, Clinical and Translational Sciences Award

## FR-PO138

### Dicarboxylic Acid Supplementation Protects Mice From AKI via Increased Renal Peroxisomal Activity

Anne C. Silva Barbosa,<sup>1,2</sup> Katherine Pfister,<sup>1,2</sup> Takuto Chiba,<sup>1,2</sup> Eric S. Goetzman,<sup>1,2</sup> Sunder Sims-Lucas,<sup>1,2</sup> <sup>1</sup>University of Pittsburgh, Pittsburgh, PA; <sup>2</sup>UPMC Children's Hospital of Pittsburgh Child Development Unit, Pittsburgh, PA.

**Background:** Lysine succinylation is a posttranslational modification associated with the control of acute kidney injury (AKI). Hypersuccinylation favors peroxisomal fatty acid oxidation (FAO) instead of mitochondrial. In addition, the medium-chain fatty acids dodecanedioic acid (DC<sub>12</sub>) and octanedioic acid (DC<sub>8</sub>), upon FAO, originate succinyl-CoA, a succinylation co-factor.

**Methods:** To test the roles of medium-chain fatty acids during AKI, mice were fed with a control, a 10% w/w DC<sub>12</sub>, or 10% w/w DC<sub>8</sub> diet, then, subjected to two models of AKI, unilateral renal ischemia-reperfusion (IRI), or an in-bolus cisplatin injection (20mg/kg). Supplementation was provided until sacrifice. Cisplatin animals were euthanized 3 days after injury, whereas IRI mice underwent contralateral nephrectomy on day 6 and were euthanized on day 7. Biochemical, histologic, genetic, and proteomic analyses were performed; the latter involving a lysine-succinylome-based mass spectrometry (LSMS).

**Results:** DC<sub>12</sub> prevented the rise of serum creatinine, blood urea nitrogen, and renal injury markers in mice during both models of AKI as well as improved morphology compared with controls. However, DC<sub>8</sub> was even more protective against AKI than DC<sub>12</sub>. Intriguingly, while DC<sub>8</sub> promotes succinylation in the kidneys only, DC<sub>12</sub> promotes it in both the liver and kidneys. Finally, LSMS evidenced that, regardless of surgical status, the kidneys of DC<sub>12</sub>- and DC<sub>8</sub>-fed mice showed, respectively, mild and extensive upregulation of a myriad of peroxisomal activity-related peptides, and a decline in mitochondrial FAO in comparison to control-fed mice.

**Conclusions:** DC<sub>8</sub> or DC<sub>12</sub> supplementation drives renal hypersuccinylation, promoting a shift from mitochondrial to peroxisomal fatty acid oxidation, and protecting against AKI. Dicarboxylic acid supplementation is convenient, inexpensive, easily administered, and efficient in preventing AKI. We believe this study could be translated in the future to the clinical setting, which would highly benefit the high-risk population.

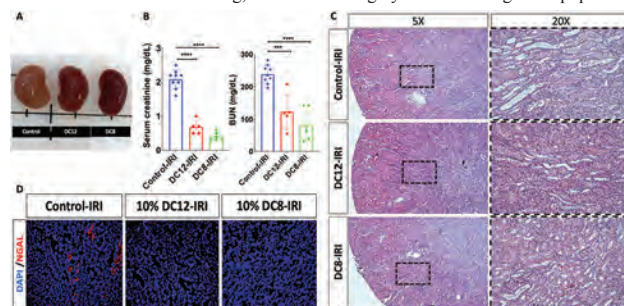

## FR-PO139

### Higher Post-COVID-19 Urinary Mitochondrial DNA Level: Serves a Biomarker of Mitochondrial Distress and Inducer of Inflammatory Cytokines Secretion in Peripheral Blood Mononuclear Cells (PBMCs)

Narayan Prasad, Brijesh Yadav, Sanjay Gandhi Post Graduate Institute of Medical Sciences, Lucknow, India.

**Background:** Severe acute respiratory corona virus-2(SARS-CoV-2) affected multiple organs including Kidney. SARS-CoV-2 open reading frame protein 3a induces necroptosis in infected cell leading release of mt-DNA, which binds to TLR9 and trigger innate immunity, which may lead to acute allograft injury.

**Methods:** Sixty-six live related renal allograft recipient previously hospitalized with SARS-CoV-2 infection were recruited after 2-3week of discharge. Patients were categorized either in non-AKI(n=47) or AKI(n=19) group, if hospitalization serum creatinine level was >30% of preCovid serum creatinine. A 50ml urine sample was collected for the mt-DNA gene NADH-ubiquinone oxidoreductase chain1(ND-1) and

Key: TH - Thursday; FR - Friday; SA - Saturday; OR - Oral; PO - Poster; PUB - Publication Only

Underline represents presenting author.

nuclear 36B4 gene quantification by RT-PCR and urine N-GAL measurement by ELISA. A 10ml blood sample from 10 healthy volunteers was collected for PBMCs isolation. A  $1 \times 10^6$  PBMCs were stimulated for 24hrs. with 1 $\mu$ g/ml of urinary DNA or CpG oligodeoxynucleotide (5'-tcgtcttttcggcgc:gcggcg-3') in duplicate. Unstimulated PBMCs served as control. The gene expression of IL-10, IL-6, MYD88 was analyzed by the RT-PCR and IL-6, IL-10 level in supernatants by the ELISA.

**Results:** The precovid creatinine in non-AKI vs AKI patient was  $1.06 \pm 0.20$  vs  $0.97 \pm 0.27$ ,  $p = .14$ ; at hospitalization  $1.27 \pm 0.18$  vs  $1.84 \pm 0.37$ ,  $p < .001$ ; at discharge  $1.09 \pm 0.20$  vs  $1.11 \pm 0.32$  mg/dl,  $p = 0.73$ . The mean ND-1 gene Ct in non-AKI vs AKI was  $21.77 \pm 3.60$  vs  $19.44 \pm 2.58$  a.u.,  $p = .013$ . The normalized ND-1 Ct in non-AKI vs AKI was  $0.89 \pm 0.14$  vs  $0.79 \pm 0.11$  a.u.,  $P = 0.007$ . The median urinary N-GAL level in non-AKI vs AKI group was  $212.78$  (range,  $219.8-383.06$ ) vs  $453.5$  (range,  $320.2-725.02$ ;  $p = 0.015$ ) ng/ml. The area under curve of ND-1 Ct gene was  $0.73$ , normalized ND-1 Ct was  $0.71$ , uNGAL was  $0.66$  and normalized uNGAL was  $0.68$  for detecting the AKI. The IL-10 gene expression was downregulated in umt-DNA treated PBMCs compared to control ( $-3.5 \pm 0.40$  vs  $1.02 \pm 0.02$ ,  $p < 0.001$ ). IL-6 and Myd88 gene expression was upregulated. The culture supernatant IL-10 and IL-6 level in umt-DNA treatment PBMCs vs control was  $10.65 \pm 0.02$  vs  $30.3 \pm 5.47$ ,  $p = 0.001$ ; and  $200.2 \pm 33.67$  vs  $47.6 \pm 12.83$ ,  $p = 0.001$  respectively.

**Conclusions:** Quantification of umt-DNA can detect the post covid19 mitochondrial distress with higher sensitivity compare to uNGAL. umt-DNA induces robust inflammatory response in PBMCs may exacerbate the post-Covid19 allograft injury.

**Funding:** Government Support - Non-U.S.

## FR-PO140

### Aldehyde Dehydrogenase 2 Alleviates Mitochondrial Dysfunction by Regulating Aerobic Glycolysis via PI3K/AKT/mTOR Pathway in AKI

Jiaying Li, Xiaoxiao Shi, Limeng Chen. *Peking Union Medical College Hospital, Dongcheng-qu, China.*

**Background:** The protective roles of mitochondrial enzyme acetaldehyde dehydrogenase 2 (ALDH2) in various diseases have been reported. In this study, we aimed to investigate the role of ALDH2 on AKI with aerobic glycolysis via the PI3K/AKT/mTOR pathway in different AKI models.

**Methods:** AKI models were established by cisplatin (cis) or maleic acid (MA) intraperitoneally (i.p.) in wild type (WT) and ALDH2 knockout (KO) mice and Alda-1 (ALDH2 agonist) was administrated for prevention experiments. We observed mitochondrial function, aerobic glycolysis, and the PI3K/AKT/mTOR pathway *in vivo* and *in vitro* with human renal proximal tubular epithelial (HK-2) cells stimulated by activation or knockdown ALDH2. Furthermore, the rescue experiment was done by LY294002 (inhibitor of PI3K) in HK-2 cells transfected with ALDH2 shRNA (shALDH2) plasmid.

**Results:** ALDH2 protein was reduced by 46% and 28% in cisplatin and MA induced AKI mice, accompanied by proximal tubular injury and mitochondrial dysfunction. ALDH2 agonist Alda-1 prevented the increase of serum creatinine (Scr) ( $38.54 \pm 4.92$  versus  $74.42 \pm 4.39$   $\mu$ mol/L,  $P < 0.0001$ ) in WT cis-AKI, while more severe ( $86.13 \pm 6.20$  versus  $62.29 \pm 3.19$   $\mu$ mol/L,  $P < 0.01$ ) in ALDH2 KO cis-AKI. In the MA-AKI mice, the renal function (Scr:  $20.09 \pm 3.65$  versus  $64.55 \pm 12.64$   $\mu$ mol/L,  $P < 0.001$ ) was recovered by Alda-1 pretreatment with reduced KIM-1 protein. In addition, decreased mitochondrial-related proteins (PGC-1 $\alpha$  and ATP5a1), mitochondrial DNA (mtDNA) and ATP content were observed in MA-AKI, but reversed by pretreatment with Alda-1. In HK-2 cells, knockdown of ALDH2 aggravated MA-induced mitochondrial dysfunction, indicated by decreased mitochondrial membrane potential and mitochondrial oxygen consumption rate (OCR) ( $54.80 \pm 7.34$  versus  $40.06 \pm 3.58$  pmol/min/ $\mu$ g.pro,  $P < 0.05$ ) with the activation of aerobic glycolysis and PI3K/AKT/mTOR pathway. Furthermore, LY294002 partially reversed the cell apoptosis percentage ( $15.50\% \pm 0.67$  versus  $19.50\% \pm 0.68$ ,  $P < 0.05$ ) of ALDH2 knockdown in MA-induced HK2 cells.

**Conclusions:** ALDH2 prevented tubular injury and apoptosis by rescuing mitochondrial dysfunction and aerobic glycolysis via the PI3K/AKT/mTOR pathway in cisplatin and MA-induced AKI.

## FR-PO141

### Primary Cilia Control Senescence Initiation in Stressed Renal Epithelial Cells

Jielu Hao, Xiaoyu Ma, Yingyi Zhang, Jinghua Hu. *Mayo Clinic Minnesota, Rochester, MN.*

**Background:** Cellular senescence is an irreversible proliferative arrest that reduces regenerative capacity of kidney after insults. Senescent cells may further exacerbate kidney injury by releasing pro-inflammatory senescent-associated-secretory phenotype (SASP). The molecular mechanism underlying stress-induced senescence remains poorly understood. Here, we discovered a direct cilium-nuclear axis in initiating senescence responses in renal tubular epithelial cells upon DNA damage.

**Methods:** Human renal cortical tubular epithelial cells (RCTE) were exposed with 5 Gy by the X-ray irradiator to induce senescence. Senescent level was determined by measuring Senescent Associated (SA)-b-Gal staining, protein and RNA levels of SASP markers. Essential cilia gene *IFT88* was knocked down to disrupt ciliogenesis in RCTE cells. Cas9 cell lines were generated to study knockout phenotypes. The expression and localization of key components were measured by western blotting, confocal imaging, and super-resolution Structure Illumination Microscopy. Immunoprecipitation assay and GST pull-down assay were performed to analyze protein-protein interaction.

**Results:** Using immunofluorescence, we observed that irradiation (IR) induces robust but transient ciliogenesis in RCTE cells during senescence, which accompanied by downregulation of ciliary GTPases ARL13B and ARL3 and upregulation of transition

fiber protein FBF1. Upon DNA damage, FBF1 translocates from primary cilia to promyelocytic leukemia nuclear bodies (PML-NBs), a nuclear structure implicated in senescence regulation, to initiate senescence in stressed cells. Mechanistically, we discovered that the ARL13B-ARL3 GTPase cascade negatively regulates UBC9-mediated SUMOylation of FBF1 at the ciliary base in normal cells, whereas irreparable stresses suppress ARL expression and thus enhance FBF1 SUMOylation in stressed cells. SUMOylated FBF1 translocates from primary cilia to PML-NBs. FBF1 depletion abolishes stress-induced PML-NB upregulation and senescence initiation, whereas FBF1 overexpression causes opposite effects.

**Conclusions:** Our findings define a paradigm in which sensory cilia communicate directly with the nucleus to control senescence initiation in stressed renal tubular epithelial cells. These results further highlight the potential of targeting cilia in future senescence-related therapeutic strategies in kidney diseases.

## FR-PO142

### FDA-Approved Drug Lasmiditan Promotes Mitochondrial Biogenesis and Accelerates Recovery of Renal Function After Ischemia/Reperfusion Injury

Kevin A. Hurtado,<sup>1</sup> Jaroslav Janda,<sup>1</sup> Rick G. Schnellmann.<sup>1,2</sup> *<sup>1</sup>The University of Arizona College of Pharmacy, Tucson, AZ; <sup>2</sup>Southern Arizona VA Health Care System, Tucson, AZ.*

**Background:** Acute kidney injury (AKI) is an abrupt loss of renal function that can result from sepsis, ischemia and toxicant induced injury. AKI incidence has become more prevalent in the last few decades and is linked with the progression into chronic kidney disease (CKD). Mitochondrial dysfunction is associated with development of AKI and mitochondrial biogenesis (MB) has been shown to recover mitochondrial homeostasis and promote recovery from AKI. We studied the effect of lasmiditan, a 5-HT<sub>1F</sub> receptor agonist that was previously shown to induce MB *in-vitro* and *in-vivo*, in a mouse model of AKI.

**Methods:** Electron microscopy was utilized to examine mitochondrial number and morphology 48 h after two daily lasmiditan treatments (0.3 mg/kg). Mice underwent ischemia/reperfusion (I/R) to induce AKI. After 24 h, serum creatinine was measured and I/R treated mice were divided into two groups and dosed with lasmiditan. Mice were treated daily for 144 h or 288 h and serum creatinine measured. KIM-1 and mitochondrial markers were measured using immunoblot analysis. Histopathology analyses were performed to measure tissue damage and fibrosis.

**Results:** Lasmiditan treatment increased mitochondrial number in murine renal cortices. Serum creatinine levels were similar between the vehicle+I/R and lasmiditan+I/R groups at 24 h. At 144 h, serum creatinine was restored to sham levels in the lasmiditan+I/R group compared to vehicle+I/R group. KIM-1 protein decreased by half in the lasmiditan+I/R group compared with vehicle+I/R at 144 and 288 h. PGC-1 $\alpha$  was restored to sham levels at 144 h and increased at 288 h in the lasmiditan+I/R group. Collagen-1 protein and interstitial fibrosis were decreased in the lasmiditan+I/R group at 288 h.

**Conclusions:** We demonstrate that the FDA approved drug lasmiditan stimulates MB and accelerates recovery of renal function after I/R and prevents interstitial fibrosis.

**Funding:** Veterans Affairs Support

## FR-PO143

### Dynamic ATP Changes and Mitochondrial Fragmentation in Podocyte During Ischemia Reperfusion Injury Determines Their Future Structure and Function

Masahiro Takahashi,<sup>1</sup> Shinya Yamamoto,<sup>1</sup> Shigenori Yamamoto,<sup>1,2</sup> Akihiro Okubo,<sup>1</sup> Masamichi Yamamoto,<sup>3</sup> Motoko Yanagita.<sup>1,2</sup> *<sup>1</sup>Department of Nephrology, Graduate School of Medicine, Kyoto University, Kyoto, Japan; <sup>2</sup>Institute for the Advanced Study of Human Biology (WPI-ASHBi), Kyoto University, Kyoto, Japan; <sup>3</sup>National Cerebral and Cardiovascular Center Research Institute, Osaka, Japan.*

**Background:** Previously, we demonstrated that ischemia reperfusion injury (IRI) results in dynamic and detrimental changes of ATP levels in proximal tubules, which are associated with kidney fibrosis in chronic phase. Although proteinuria after ischemia-related events in clinical settings, including kidney transplantation and AKI, has been documented, ATP dynamics in podocytes and the mechanisms underlying podocyte injury during IRI remains elusive.

**Methods:** GO-ATeam2 mice, which systemically express an ATP biosensor GO-ATeam2, were used for multiphoton microscopy-based intravital ATP imaging. TEM and FIB-SEM were used for microstructural analysis of podocytes. Correlations between ATP recovery in podocytes in acute phase of IRI and foot process effacement and mitochondrial fragmentation of podocytes in chronic phase were assessed. We also analyzed the efficacy of a mitochondrial fission inhibitor Mdivi-1 for structural integrity of podocytes after IRI *in vivo*, and after ATP-depletion stress *in vitro*.

**Results:** ATP levels of podocytes were decreased to the bottom level within 20 minutes during ischemia and recovered in 5 minutes after reperfusion. ATP recovery in podocytes after reperfusion became slower and insufficient after long ischemia. 3D analysis of podocyte mitochondria confirmed mitochondrial fragmentation as early as 30 minutes after reperfusion, when foot process effacement was not evident. Podocytes exhibited prominent foot process effacement and sustained mitochondrial fragmentation in chronic phase of IRI after long ischemia. There was a significant correlation between foot process width and mitochondrial roundness in chronic phase, both of which were inversely correlated with ATP recovery in acute phase. Finally, the administration of Mdivi-1 ameliorated cytoskeletal disarrangement of cultured podocytes after ATP-depletion stress, and foot process effacement in podocytes after IRI *in vivo*.

Key: TH - Thursday; FR - Friday; SA - Saturday; OR - Oral; PO - Poster; PUB - Publication Only

Underline represents presenting author.

**Conclusions:** ATP depletion and mitochondrial fragmentation in podocytes in acute phase of IRI could contribute to foot process effacement in chronic phase. Our results suggest ischemic stress could induce podocyte injury through ATP depletion and mitochondrial fragmentation, and the latter could be a therapeutic target.

**Funding:** Government Support - Non-U.S.

#### FR-PO144

##### Ceramides as Mediators of Mitochondrial Dysfunction Driving Kidney Injury

Rebekah Nicholson, Ying Li, John A. Maschek, Deborah Stuart, Nirupama Ramkumar, Scott Summers. *University of Utah Health, Salt Lake City, UT.*

**Background:** Perturbations in proximal tubule mitochondrial function and lipid metabolism potentiate kidney injury and failed repair following ischemia reperfusion or obstruction. Sphingolipids such as ceramides are recognized as lipotoxic drivers of metabolic dysfunction. We investigate mechanisms of ceramides driving proximal tubule pathology and assess the efficacy of ceramide-lowering therapeutics to combat AKI.

**Methods:** We lowered whole-body ceramides via *Degs1* inducible global knockout (*Degs1<sup>fl/fl</sup>*) in male C57BL/6J mice prior to challenge with warm bilateral IRI (22 minute ischemia) or UO and compared clinical and histopathological outcomes versus *Degs1<sup>fl/fl</sup>* littermate controls 24 hours after kidney reperfusion or 7 days after obstruction. In vitro, we examined effects of ceramide accrual on mitochondrial function in human immortalized proximal tubule epithelial cells treated with palmitate or C2-ceramide with an Agilent Seahorse Analyzer.

**Results:** *Degs1* global knockout decreased total cortex ceramide levels by 57%, preventing the 21% and 18% increase in ceramides in *Degs1<sup>fl/fl</sup>* surgery vs. sham groups following IRI or UO, respectively. *Degs1<sup>fl/fl</sup>* animals had improved blood urea nitrogen [49.82±6.34(KO) vs. 81.02±2.13(fl/fl) mg/dL], plasma creatinine [0.32±0.11(KO) vs. 1.28±0.4(fl/fl) mg/dL], and cortex *Lcn2* expression [5.31±4.61(KO) vs. 36.36±21.50(fl/fl) relative to fl/fl sham] following IRI. Following UO, *Degs1<sup>fl/fl</sup>* kidneys were less fibrotic with lower expression of fibrosis (*Col1a1*, *Col3a1*, *Fnl1*), inflammation (*Il6*), and injury (*Havcr1*) markers. Treatment of HK2 cells for 24 hours with 500mM palmitate, the primary substrate of ceramide biosynthesis, decreased basal and maximal mitochondrial respiration by 24% and 30%, respectively, vs. vehicle-treated controls. Co-treatment with 10mM myriocin, a ceramide synthesis inhibitor, prevented ceramide accumulation and rescued mitochondrial function. Treating cells with 15mM C2-ceramide, but not dihydroceramide lacking a double bond essential for lipid bioactivity, elicited similar impairments in mitochondrial oxygen consumption and acutely depleted mitochondrial ATP production.

**Conclusions:** Renal ceramides are implicated as drivers of kidney injury and mitochondrial dysfunction. Ceramide-lowering interventions may be effective strategies to prevent AKI.

**Funding:** NIDDK Support

#### FR-PO145

##### Spatially Resolved Distal Convoluted Tubule Transcriptome of AKI

Hyun Jun Jung, Sepideh Gharraie, Kyungho Lee, Emily K. Lo, Sanjeev Noel, Patrick Cahan, Hamid Rabb, Paul A. Welling. *Johns Hopkins University School of Medicine, Baltimore, MD.*

**Background:** Injury and failed repair transcriptome profiles of the renal proximal tubule and the loop of Henle have highlighted potential drivers of Acute Kidney Injury (AKI) and AKI to CKD. However, it is not clear if AKI affects gene expression profiles of other renal tubules, and whether injury is manifested focally by cell-cell communication or uniformly by autonomous mechanisms. Recent biomarker analyses raise the possibility that the distal convoluted tubule (DCT) might be especially sensitive to injury. This study aims to unravel gene expression responses of the DCT in AKI with spatial resolution at genome-wide depth.

**Methods:** Single-cell RNA sequencing (scRNA-Seq) data of human AKI patients (n=4) with healthy individuals (n=5) were obtained from the Kidney Precision Medicine Project (KPMP) and analyzed using Seurat (4.0). The 10x Genomics Visium Spatial Gene Expression platform was used to corroborate the human data in a mouse model of ischemia-reperfusion injury (IRI, ischemia for 30min followed by reperfusion for 24h), and to create an anatomical map of gene expression changes with Cell Ranger (6.0.1) and Seurat (4.0).

**Results:** Analyses of the KPMP scRNA-Seq data sets revealed that AKI is associated with remarkable alterations in the DCT transcriptome. This included increased expression of known kidney injury marker genes, Secreted Phosphoprotein 1 (Spp1), Lipocalin 2 (Lcn2) and Clusterin (Clu). A significant reduction of Epithelial growth factor (Egf) was also observed, paralleling changes in the loop of Henle. DCT-specific genes were altered, including decreased expression of Parvalbumin (Pvalb) and increased expression of Splat-like transcription factor 3 (Sall3). Spatial transcriptome profiling revealed IRI in mice has similar effects on gene expression as AKI in humans, affecting two distinct DCT cell-enriched clusters in the cortex, corresponding to early and late DCT. IRI affected the DCT transcriptome uniformly throughout the cortex.

**Conclusions:** In conclusion, the DCT transcriptome is especially sensitive to ischemic injury, exhibiting a unique injury-repair signature. The uniform change in gene expression across all DCT populations throughout the cortex suggests a cell-autonomous injury mechanism.

**Funding:** NIDDK Support

#### FR-PO146

##### scRNA-Seq Analysis of Polyploid Tubular Epithelial Cells Reveals a Specific Hypertrophy Program Triggered in Response to AKI

Letizia De Chiara, Elena Lazzeri, Paola Romagnani. *Universita degli Studi di Firenze, Firenze, Italy.*

**Background:** Acute Kidney Injury (AKI) is characterized by a rapid deterioration of kidney function. Recently, we showed that tubular epithelial cells (TC) respond to AKI by triggering polyploidization mediated hypertrophy, (i.e. increase their DNA content and dimension) which allows for a quick recovery of kidney function by providing increased functional output via cell hypertrophy. However, the processes that govern this response are currently unknown. Moreover, in the kidney polyploid TC mostly remain mononuclear, making their recognition challenging unless multiple targeted techniques are combined. Here, we explored the possibility to use single cell RNA-sequencing (scRNA-seq).

**Methods:** To identify polyploid TC, study their phenotype and dissect the mechanisms underlying polyploidization mediated hypertrophy, we applied scRNA-seq analysis *in vitro* and *in vivo* after ischemic injury combined with specific knocked-down experiments, cell sorting, pharmacological inhibition, chromatin-immunoprecipitation assay (ChIP) and *in vivo* transgenic models.

**Results:** Based on combined measurement of DNA content and cell cycle phase with the FUCCI reporter, we showed that primary proximal tubular cells (PTC) contain a fraction of polyploid TC. scRNA-seq of PTC revealed the presence of genes previously associated with different phases of polyploidization-mediated hypertrophy. A trajectory analysis suggested that PTC polyploidization starts with increased ribosome biogenesis, culminating in a YAP1 enriched signature. Sorting of polyploid PTC confirmed the YAP1 signature enrichment. scRNA-seq analysis on mouse kidneys at days 0, 2 and 30 after AKI confirmed our *in vitro* observations and suggested that polyploid TC have significantly increased transcriptome abundance, consistent with their increased DNA content. 2 days after AKI, TC specific YAP1 knock-out mice displayed less polyploid cells, smaller kidneys and TC compared to wild-type, in line with the concept that polyploid cells are hypertrophic. Finally, ChIP assays combined with targeted silencing confirmed YAP1 as the primary driver of TC polyploidization.

**Conclusions:** In conclusion: 1) scRNAseq can be successfully applied to study polyploidization if combined with the right tools and 2) scRNAseq revealed the presence of a specific hypertrophy program in polyploid TC driven by YAP1 activation.

#### FR-PO147

##### Strengths and Limitations of Integrating Single Cell and Spatial Transcriptomics to Study T Cells in Normal and AKI Kidneys

Sepideh Gharraie,<sup>1</sup> Kyungho Lee,<sup>1</sup> Kathleen Noller,<sup>1,2</sup> Emily K. Lo,<sup>1</sup> Hyun Jun Jung,<sup>1</sup> Johanna T. Kurzhagen,<sup>1</sup> Nirmish Singla,<sup>1</sup> Paul A. Welling,<sup>1</sup> Patrick Cahan,<sup>1</sup> Sanjeev Noel,<sup>1</sup> Hamid Rabb,<sup>1</sup> <sup>1</sup>Johns Hopkins Medicine, Baltimore, MD; <sup>2</sup>Duke University School of Medicine, Durham, NC.

**Background:** T cells are important in the pathogenesis of AKI but molecular mechanisms are poorly understood. We used single cell RNAseq as well as novel spatial transcriptomics to study T cells in normal and post AKI mouse kidneys. We also studied human kidneys and NIH KPMP data to assess clinical significance of our mouse data.

**Methods:** C57BL6 mice underwent bilateral ischemia reperfusion, then sacrificed at 24 hr. Kidney mononuclear cells from normal and ischemic mice isolated and sorted for CD4, CD8, and DN T cells. cDNA was synthesized and library preparation performed using 10X Chromium technology. scRNA-Seq was preprocessed on the Illumina NextSeq 500 platform. Sequencing reads were aligned to the mouse reference genome using the 10X Genomics Cell Ranger pipeline followed by downstream data analysis using Scanpy. Data was validated using qPCR. Spatial transcriptomics was performed using 10X Visium platform. "Normal" sections of human post-ischemic kidneys removed for tumor nephrectomies were evaluated. The NIH KPMP AKI data base was studied.

**Results:** scRNA-seq revealed a distinct gene profile for CD4, CD8 and DN T cells of mouse kidneys. We then identified genes that were significantly up or downregulated in each population after AKI. We selected highest expressing genes in each category, focusing on the DN T cells, and confirmed the expression of those genes including *Xcl1*, *Ly6c2*, and *Fcer1g* using qPCR. Spatial transcriptomics in normal and AKI mouse tissue showed a localized cluster of T cells in the outer medulla expressing similar genes. However, spatial transcriptomics with the current technology did not provide resolution needed to adequately study kidney T cells. Novel T cell gene signatures that we identified, were confirmed in Human kidney AKI tissue using qPCR as well as the NIH KPMP data set.

**Conclusions:** Single cell RNAseq is a useful discovery technique to study T cell gene expression in normal and AKI kidneys, and can be validated in human samples. However, spatial transcriptomics at the current technology has resolution limitations to study kidney T cells, but is useful for epithelial cell, macrophage, neutrophil, cytokine and chemokine studies.

**Funding:** NIDDK Support

## FR-PO148

**Microbiome Modulation After Severe AKI Accelerates Recovery and Decreases Fibrosis**

Sepideh Gharraie, Kyungho Lee, Jiaojiao Xu, Lois J. Arend, Jennifer L. Pluznick, Sanjeev Noel, Hamid Rabb. *Johns Hopkins Medicine, Baltimore, MD.*

**Background:** Most studies on modifying the microbiome to improve acute kidney injury (AKI) have focused on prevention. Effects on repair have not been well studied. We hypothesized that modifying gut microbiota with antibiotics (ABX) administered AFTER severe ischemic AKI in mice would accelerate kidney recovery and mitigate fibrosis.

**Methods:** C57BL/6 mice underwent 50 min unilateral ischemia reperfusion injury (UIRI). Amoxicillin, metronidazole, combination of ABX (ampicillin, metronidazole, neomycin, vancomycin) or control were started after IR. Glomerular filtration rate (GFR) was measured in conscious mice via transcutaneous detection of FITC-sinistrin. Kidneys were evaluated for fibrosis with Masson's trichrome, mRNA expression of *Colla1*, *TGFβ*, and *αSMA* by qPCR, and immunophenotyped by flow cytometry. Stool 16s rRNA sequencing was performed. Germ free (GF) and CD4 KO mice with severe AKI were studied.

**Results:** Amoxicillin started post IRI increased GFR at 1, 2, 3 and 4 weeks compared to control (900±26 vs 749±31 μL/min/100g,  $P<.01$ ; 922±28.8 vs 707±25,  $P<.01$ ; 922±21 vs 811±26,  $P=0.021$ ; and 931±23 vs 758±24,  $P<.01$ ). Amoxicillin decreased fibrosis percentage in both cortex and outer medulla compared to control (5.5±1.2 vs 12.1±2.3,  $P=.015$ ; 6.6±0.7 vs 13.9±1.2,  $P<.01$ ). Amoxicillin decreased *TGFβ* expression compared to control (0.6±0.1 vs 1.1±0.1,  $P=.013$ ). Amoxicillin decreased percentage of kidney CD4T cells (47.5±1.8 vs 61.5±2.4,  $P<.01$ ), while CD8 cells (39.4±2.2 vs 26.2±2.2,  $P<.01$ ) and PD1 expression on CD8 (21.1±2.3 vs 7.73±1.6,  $P<.01$ ) were increased. Amoxicillin did not accelerate kidney repair in GF mice, but was effective in CD4 KO mice. Amoxicillin increased stool *Alistipes*, *Anaerotruncus*, and *Lactobacillus* species and reduced *Holdemanella* and *Anaeroplasm*. GFR level was increased in metronidazole ( $P=.02$ ) at 1 week and in ABX at 1 ( $P<.01$ ), 2 ( $P=.09$ ), and 4 ( $P=.011$ ) weeks. Fibrosis percentage in cortex and outer medulla was increased by metronidazole (22.3±3.1 vs 17.4±4.3 and 13.6±1.6 vs 10.6±1.2) and combination of ABX (28.7±8.7 vs 17.4±4.3 and 14.4±1.6 vs 10.6±1.2) versus control.

**Conclusions:** Modification of gut bacteria with amoxicillin administered after induction of ischemic AKI is a promising novel therapeutic approach to accelerate recovery of kidney function and mitigate AKI to CKD progression.

**Funding:** NIDDK Support

## FR-PO149

**Detection of Myeloid Cell Pleiotropy In Situ and the Unique Niches of Immune Cells in Ischemic Kidney Injury Using CODEX Imaging**

Angela R. Sabo,<sup>1</sup> Lauren A. Maghak,<sup>1</sup> Connor J. Gulbranson,<sup>1</sup> Shehnaaz Khan,<sup>1</sup> Radmila Micanovic,<sup>1</sup> Kaice A. LaFavers,<sup>1</sup> Daria Barwinska,<sup>1</sup> James C. Williams,<sup>1</sup> Tarek M. El-Achkar,<sup>1,3</sup> Seth Winfree,<sup>2</sup> <sup>1</sup>Indiana University School of Medicine, Indianapolis, IN; <sup>2</sup>University of Nebraska Medical Center, Omaha, NE; <sup>3</sup>Richard L Roudebush VA Medical Center, Indianapolis, IN.

**Background:** Myeloid cells are involved in the pathogenesis of acute kidney injury (AKI), particularly at the early stage. Further, the renal protective protein Uromodulin (UMOD) plays a central role in modulating myeloid populations in the kidney. To understand the myeloid response during AKI *in situ* and how it is shaped by UMOD, we used CO-Detection by indEXing (CODEX) a cyclic imaging technique that allows for the imaging of more than 30 protein markers in one tissue. Such approach will preserve the spatial context and define the cellular niches that determine the pathogenesis of AKI.

**Methods:** Whole sections of murine renal tissue from wild-type and UMOD-knockout mice were harvested 6 hours after sham or 22-min ischemic injury and stained for nuclei and 33 different protein markers, targeting parenchymal, immune, and injury proteins. The collected images were processed and stitched using CODEX software and visualized in ImageJ/FIJI. Using nuclei, cells were segmented, associated markers quantitated, and cell types labeled using a semi-supervised tissue cytometry approach in the Volumetric Tissue Exploration and Analysis (VTEA) software.

**Results:** In sham and injured tissues, our marker panel labeled most cells in the kidney. VTEA cytometry and semi-supervised clustering allowed the identification and quantitation of all major epithelial, endothelial, stromal and immune cells and mapping of these various populations *in situ*. During AKI, phenotypic pleiotropy of infiltrating and resident myeloid cells was observed and spatially delineated. Using cell-centric neighborhood analysis, unique spatial niches of immune cells associated with specific epithelial and vascular cells were defined. The phenotypic pleiotropy and cells niches were altered by UMOD deficiency.

**Conclusions:** We establish a robust panel of protein markers to comprehensively capture the cellular diversity in murine kidneys and establish an analytical pipeline to uncover unique niches of immune/epithelial/vascular cells in injury. This approach will allow us to uncover the cell-cell interactions that underlie the pathogenesis of AKI and explain the protective role of Uromodulin during injury.

**Funding:** NIDDK Support, Veterans Affairs Support

## FR-PO150

**Uromodulin Deficiency Shapes AKI Severity by Enhanced Oxidative Injury and Stress Response in Proximal Tubules With Early Activation of the Inflammasome**

Kaice A. LaFavers,<sup>1</sup> Radmila Micanovic,<sup>1</sup> Angela R. Sabo,<sup>1</sup> Shehnaaz Khan,<sup>1</sup> Seth Winfree,<sup>2</sup> Tarek M. El-Achkar,<sup>1</sup> <sup>1</sup>Indiana University Purdue University Indianapolis, Indianapolis, IN; <sup>2</sup>University of Nebraska System, Lincoln, NE.

**Background:** Uromodulin (Tamm-Horsfall Protein, THP) is uniquely expressed in the kidney and its deficiency aggravates the severity of acute kidney injury (AKI). THP deficiency is a feature of chronic kidney disease (CKD) and is also induced by AKI early after injury. We have shown that loss of THP induces oxidative injury via TRPM2, a redox-regulating cationic channel. Therefore, we propose that THP deficiency observed in CKD and early AKI enhances injury severity by stimulating oxidative stress through TRPM2.

**Methods:** We used the ischemia reperfusion injury (IRI) model to induce AKI in THP<sup>+/+</sup> and THP<sup>-/-</sup> mice with a 22-minute clamp time and 6 or 24 hour recovery. Single cell RNA sequencing was used to delineate differentially expressed genes and pathways in proximal tubules. Large scale confocal imaging was done on whole kidney sections for spatial analysis. Pharmacological TRPM2 inhibition was achieved using 2-APB. Biochemical assays to measure kidney function, inflammation and gene expression were performed on tissue lysates or serum.

**Results:** Compared to THP<sup>+/+</sup>, THP<sup>-/-</sup> mice had significantly worse kidney injury at 24 hours (serum creatinine) and 6 hours post IRI (increased HAVCR1/KIM1 in S3 proximal tubules). Single cell sequencing of proximal tubules at 6 hours revealed that THP<sup>-/-</sup> mice had upregulated genes involved in oxidative stress, the integrated stress response (ISR) and regulated cell death pathways. THP<sup>-/-</sup> mice have increased expression of ATF3, a transcription factor activated by the ISR and IL-1β, a component of the inflammasome/pyroptosis pathway activated by oxidative injury. Inhibition of TRPM2 in THP<sup>-/-</sup> mice reduced renal oxidative injury 6 hours post IRI.

**Conclusions:** These results suggest that THP deficiency alters the early course of AKI towards severe injury by increasing the activation of TRPM2, thereby enhancing oxidative injury, stress response and activation of the inflammasome. These findings may have relevance to the increased risk of AKI in states of THP deficiency such as CKD. Increasing THP levels or targeting the pathways induced by its deficiency may have an important impact on improving the course and reducing the severity of AKI.

**Funding:** NIDDK Support, Veterans Affairs Support

## FR-PO151

**Proteomic and Functional Analysis of Acute Galactic Cosmic Radiation Exposure in the Kidneys**

Stephen B. Walsh, Keith Siew. *University College London, London, United Kingdom.*

**Background:** There is concern regarding the effect of galactic cosmic radiation (GCR) exposure on cancer risk, cardiovascular and neurological health posed by longer missions planned as part of the Deep Space Transport/Mars Missions. However the kidney is the dose limiting organ in abdominal radiotherapy and total body irradiation. Chronic kidney dysfunction can occur with acute low linear energy transfer (LET; e.g. γ-radiation or X-rays) radiation doses as low as <0.5Gy. An astronaut on a Mars exploration mission has an estimated absorbed dose of 0.47Gy. We hypothesise that GCR may cause acute renal failure within the timeframe and GCR dose expected for an exploratory mission to Mars, which may require renal replacement therapy and would thus be mission critical.

**Methods:** To investigate this, snap-frozen kidneys from mice either exposed to an acute 0.5Gy dose of simulated GCR or sham control (n=10 per group) at Brookhaven National Laboratory, underwent quantitative TMT mass spectrometry proteomic analysis for markers of proximal tubule damage and pathways known to be involved in radiation nephropathy. Urine and plasma were also collected from these mice 24hrs after acute GCR exposure for biochemical and electrolyte analysis to look for early signs of renal tubular and glomerular filtration dysfunction.

**Results:** Network analysis of the proteome of whole homogenised kidney of GCR exposed animals showed a biologically significant (>10%) decrease in proteins associated with mitochondrial (e.g. CYC1, COX7C) or ribosomal function, intracellular transport and cell membrane transport (e.g. SLC12A1, SLC12A3) compared to sham exposed animals. There was a >10% increase in apolipoproteins and HDL proteins (e.g. APOA4, APOA1) in GCR compared to sham exposed animals.

**Conclusions:** GCR exposed animals had proteomic and biomarker evidence of renal damage. This requires further investigation.



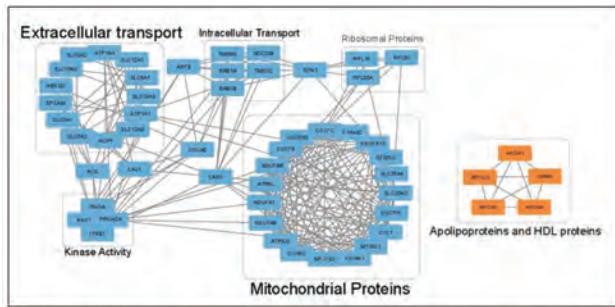

**Figure Legend:** Network analysis of proteome of homogenised renal tissue for animals exposed to GCR compared to animals exposed to sham. Blue nodes represent proteins with decreased expression (>10% decrease) after GCR, orange nodes represent proteins with increased expression (>10% increase) after GCR. Only highly connected (>10 1<sup>st</sup> degree neighbours) nodes are shown.

## FR-PO152

### Zero-Controlled Statistical Model for Single Nucleus ATAC-Seq Data Analysis and Demultiplexing

Zhen Miao, Junhyong Kim. *University of Pennsylvania, Philadelphia, PA.*

**Background:** Single nucleus ATAC sequencing (snATAC-seq) is a technique that detects open chromatin for each individual cell. While it is a key assay to augment single cell RNA-seq data, analysis methods for snATAC-seq are still in development. In particular, there is a lack of methods that explicitly incorporate probabilistic models.

**Methods:** Here, we developed a zero-controlled statistical model for snATAC-seq data that accounts for missing data and uneven sequencing coverage. Our model accounts for different sources of zero (biological vs non-biological zero); and the presence of excess zero in this highly sparse data. Our statistical model enables model-based differential feature identification, cell type classification/annotation, doublet detection, and batch effect correction.

**Results:** Our evaluations with both simulated data and real data show consistently better performance compared to existing methods that do not account for missing data. Applying our method to several snATAC-seq datasets from kidney samples showed high accuracy (over 0.9 ARI) for cell type label transfer tasks, while simultaneously detecting potential doublet cells. We applied our method to detect cell type-specific regulatory elements in each kidney cell types during injury repair process in the mouse system.

**Conclusions:** Here we present a statistical model for snATAC-seq analysis. Our evaluation suggests that accounting for missing rate disparity is important in snATAC-seq data analysis and we should adjust for different sources of zero present in the data to reduce false discovery.

**Funding:** NIDDK Support

## FR-PO153

### Embelin Attenuated Septic AKI by Inhibition of M1 Macrophage Polarization and NF- $\kappa$ B Signaling in Mice

Qiao Tang,<sup>1</sup> Yi Li.<sup>2</sup> *<sup>1</sup>North Sichuan Medical College, Nanchong, China; <sup>2</sup>Sichuan Academy of Medical Sciences and Sichuan People's Hospital, Chengdu, China.*

**Background:** Acute kidney injury (AKI) is a clinical syndrome with high morbidity and mortality. As one of the most common reasons to AKI, there is currently no effective treatment for sepsis beyond supportive care. Embelin could demonstrate hepatoprotective effect against acute liver injury and regulate hepatic macrophage activity. However, the therapeutic effect and immunomodulatory role underlying Embelin action in septic AKI is unclear.

**Methods:** Current study aimed to elucidate the role and mechanism of Embelin in lipopolysaccharide (LPS)-induced septic AKI involving macrophage activation. In the study, Embelin was once intraperitoneal injection given to the mice after LPS injection. Then harvested the serum and kidney sample after 24 h. To explore the immunomodulatory role of Embelin in macrophages, we further isolated murine bone marrow-derived macrophages (BMDMs) and stimulated murine BMDMs with LPS followed by Embelin treatment.

**Results:** We observed that Embelin attenuated renal dysfunction and renal pathological damage following LPS injection. Embelin could inhibit translocation of phosphorylated NF- $\kappa$ B p65 in LPS-induced AKI *in vivo and vitro*. Embelin also reduced the secretion of IL-1 $\beta$  and IL-6 whereas increased the secretion of IL-10 and Arg-1 both in BMDMs and murine serum after LPS induction.

**Conclusions:** It indicated that Embelin could suppress macrophage M1 activation and promote M2 polarization in LPS-induced AKI. Thus, Embelin could attenuate LPS-induced septic AKI by suppress of NF- $\kappa$ B p65 phosphorylation and regulated macrophage activation. This study suggested the potential therapeutic role of Embelin for septic AKI patients.

## FR-PO154

### Uromodulin and Injury Severity Alter Neutrophil Diversity and Signaling in AKI

Seth Winfree,<sup>1</sup> Kaice A. LaFavers,<sup>2</sup> Shehna Khan,<sup>2</sup> Radmila Micanovic,<sup>2</sup> Ricardo Melo ferreira,<sup>2</sup> Ying-Hua Cheng,<sup>2</sup> Michael T. Eadon,<sup>2</sup> Tarek M. El-Achkar.<sup>2</sup> *<sup>1</sup>University of Nebraska Medical Center, Omaha, NE; <sup>2</sup>Indiana University School of Medicine, Indianapolis, IN.*

**Background:** Neutrophils are central to the pathogenesis of acute kidney injury (AKI). Neutrophil subtypes have been described in infection, cancer, and sterile inflammation. Little is known about the role of neutrophil subtypes in AKI. The kidney is uniquely poised to affect neutrophil subtypes via Uromodulin (UMOD)-a protein made exclusively in the thick ascending limb and modulator of granulopoiesis. To explore a role for neutrophil subtypes and the impact of UMOD in AKI, we interrogated kidneys after ischemic injury in wild-type (WT) and UMOD knock-out (KO) mice with mesoscale confocal microscopy and single-cell and spatial transcriptomics.

**Methods:** Kidneys from WT or UMOD KO mice after Sham or 22- or 30-min ischemic injury were frozen in OCT for spatial transcriptomics, fixed for microscopy, or processed for single-cell RNASeq (whole kidney and CD45+ enriched cell suspensions). Sequencing results were processed with CellRanger and analyzed in Seurat (cell types), ReactomePA (pathways), Monocle (trajectories) and SPOTLight (deconvolution). Confocal microscopy was performed on whole kidney sections using the nuclear stain DAPI and markers of neutrophils, transcription factors and injury and cells were quantitated with tissue cytometry (Volumetric Tissue Exploration and Analysis).

**Results:** Neutrophil localization in the kidney in AKI was sensitive to injury severity and absence of UMOD. Transcriptionally, 7 distinct neutrophil subtypes were uncovered. Further, the proportions and pathway activation of these subtypes and neutrophil transcriptional trajectories were sensitive to the severity of ischemic injury. In severe injury there was an increase in putative immature neutrophils and CXCL3 expression in neutrophils. In injury of UMOD KO mice, neutrophils were retained in the cortex and CXCR2 ligands were uniquely upregulated in proximal tubule epithelia.

**Conclusions:** Our study uncovers an underappreciated diversity of neutrophil subtypes in AKI that is sensitive to injury severity and UMOD. We demonstrate unique subtypes of neutrophils in AKI correlated with changes in neutrophil localization and concomitant alterations in the CXCR2 signaling axis. Thus, our results suggest the neutrophil response in AKI is nuanced and modulated by injury severity and UMOD via the CXCR2 signaling axis.

**Funding:** Veterans Affairs Support

## FR-PO155

### AKI Post Allogeneic Bone Marrow Transplantation: Disease Understanding and Targeted Nanomedicines

Magdalini Panagiotakopoulou, Edgar A. Jaimes, Marcel M. Van den brink, Daniel A. Heller. *Memorial Sloan Kettering Cancer Center, New York, NY.*

**Background:** Allogeneic hematopoietic stem cell transplantation (allo-HCT) is a very effective treatment for a variety of hematologic malignancies, but also associated with serious complications, such as graft-versus-host-disease (GVHD), a severe immune condition that manifests in multiple organs including the kidneys. Kidney injury in the setting of allo-HCT has an incidence as high as 80% and leads to high patient morbidity and mortality, however, its progression and mechanisms remain poorly characterized. Moreover, no approved drugs for AKI of any etiology exist, as most experimental therapies have poor pharmacokinetic profiles and minimal efficacy in treating AKI in humans.

**Methods:** We used an MHC-disparate irradiation-conditioned murine model of GVHD to investigate the pathology, genetic and molecular signatures of GVHD-mediated AKI, via bulk RNA sequencing, immunohistochemistry and immunoassays. We have also used microfluidics to synthesize lipid nanoparticles that target overexpressed proteins in the GVHD kidneys.

**Results:** Our transcriptome analysis in kidney lysates of GVHD mice indicated significant immune and inflammatory pathway upregulation (including TNF-NF- $\kappa$ B and JAK-STAT pathways) which persisted for 14 days after transplantation. We also saw a significant increase in genes associated with renal damage and pro-fibrotic cascades. Our histological analysis demonstrated increased T-cell infiltration, apoptosis and renal damage and abnormal renal function was confirmed by elevated serum and urine biomarkers. By designing lipid nanoparticles that target overexpressed proteins in GVHD kidneys, we achieved enhanced localization of nanoparticles to the kidneys in the GVHD model.

**Conclusions:** We have investigated the histological and molecular features of AKI in an established murine model of GVHD to assess its pathophysiology and progression as well as to identify potential therapeutic targets. GVHD results in AKI characterized predominantly by T-cell infiltration, tubular gene dysregulation, renal function impairment and activation of inflammatory pathways. We have also shown that targeting specific overexpressed proteins specifically localizes nanoparticles to GVHD-AKI kidneys. We plan to use those nanoformulations to deliver small-molecule inhibitors of dysregulated pathways to the kidneys.

**Funding:** Other NIH Support - T32 Cancer Pharmacology Grant

## FR-PO156

**Immune Complex Tubulointerstitial Nephritis: An Unusual Presentation of Anti-LRP2 Nephropathy**

Fnu Fawad,<sup>1</sup> Taha Ayach,<sup>1</sup> A. Bernard Collins,<sup>2</sup> <sup>1</sup>University of Kentucky, Lexington, KY; <sup>2</sup>Massachusetts General Hospital, Boston, MA.

**Introduction:** Anti-LRP2 nephropathy/anti-brush border antibody (ABBA) disease is a recently described immune complex tubulointerstitial nephritis. It is characterized by renal failure with tubular injury, tubular basement membrane immune deposits and circulating antibodies to proximal tubular brush border. The antigen target for ABBA has recently been identified as LDL receptor-related protein 2 which is present in proximal tubular brush border. We present a case of immune complex TIN with biopsy features suggestive of anti-LRP2 nephropathy but no ABBA in the serum.

**Case Description:** A 76-year-old male with past medical history of myasthenia gravis was evaluated for unexplained worsening of renal function. His sCr had increased from 1.2 to 2.7 over 1.5 years. He had microscopic hematuria and minimal proteinuria. Serological workup showed positive ANA with a titer of 1:80 with speckled pattern, negative anti dsDNA, normal C3 and C4, negative ANCA, MPO and PR3 and normal IgG 4 level. Kidney biopsy was performed which showed chronic tubulointerstitial nephropathy with extensive IgG deposits and segmental membranous nephropathy. IF microscopy showed extensive TBM deposits of IgG, in addition to segmental membranous nephropathy. This combination of findings was felt to be suggestive of anti-LRP2 nephropathy. However, patient's serum when tested, was negative for ABBA. Patient was started on prednisone 60 mg daily which was tapered two months after initiation due to complicating nocardia infection. No further disease specific treatment was given for his ABBA disease, but on follow up his renal function has remained relatively stable with most recent sCr of 2.6.

**Discussion:** Although biopsy features in this case were suggestive of anti-LRP2 nephropathy, serum was negative for ABBA. It is noteworthy that testing for ABBA is not commercially available and was done in a research laboratory and sensitivity is not well established. Absence of serum ABBA in this case could also indicate the possible onset of spontaneous remission, which will also explain the relatively stable renal function more than one year after diagnosis. It is also possible that antibodies to antigens other than LDL receptor-related protein 2 may be playing a role in the pathophysiology of ABBA disease. Our case highlights the need for further investigation into the association of ABBA with anti-LRP2 nephropathy.

## FR-PO157

**Urinary Single-Cell Sequencing Captures Intrarenal Injury and Repair Processes in Human AKI**

Jan Klocke,<sup>1</sup> Seung J. Kim,<sup>2</sup> Christopher Skopnik,<sup>1</sup> Christian Hinze,<sup>1</sup> Leonie F. Wagner,<sup>1</sup> Luka Prskalo,<sup>1</sup> Emil Grothgar,<sup>1</sup> Nina Goerlich,<sup>1</sup> Kai M. Schmidt-Ott,<sup>1</sup> Kai-Uwe Eckardt,<sup>1</sup> Nikolaus Rajewsky,<sup>2</sup> Philipp Enghard,<sup>1</sup> <sup>1</sup>Charité Universitätsmedizin Berlin, Berlin, Germany; <sup>2</sup>Max-Delbrück-Centrum für Molekulare Medizin in der Helmholtz-Gemeinschaft, Buch, Germany.

**Background:** Acute kidney injury (AKI) is a major health issue, the outcome of which depends primarily on damage and reparative processes of tubular epithelial cells (TEC). Mechanisms underlying AKI remain incompletely understood, specific therapies are lacking and monitoring the course of AKI in clinical routine is confined to measuring urine output and plasma levels of filtration markers.

**Methods:** Here we demonstrate feasibility and potential of a novel approach to assess the cellular and molecular dynamics of AKI by establishing a robust urine-to-single cell RNA sequencing (scRNAseq) pipeline for excreted kidney cells via flow cytometry sorting. We analyzed 42,608 single cell transcriptomes of 40 urine samples from 32 AKI patients and compared our data with reference material from human AKI post-mortem biopsies and published mouse data.

**Results:** We demonstrate that urine-excreted TEC are mostly derived from distal nephron segments and are more abundant in patients with severe kidney injury. Their transcriptomes mirror intrarenal pathology and reflect distinct injury and repair processes, including oxidative stress, inflammation, and tissue rearrangement. We also describe a potentially AKI-specific abundant urinary excretion of adaptive progenitor-like cells.

**Conclusions:** In conclusion, single cell transcriptomics of kidney cells excreted in urine provides non-invasive, unprecedented insight into cellular processes underlying AKI, thereby opening novel opportunities for target identification, AKI sub-categorization and monitoring of natural disease course and interventions.

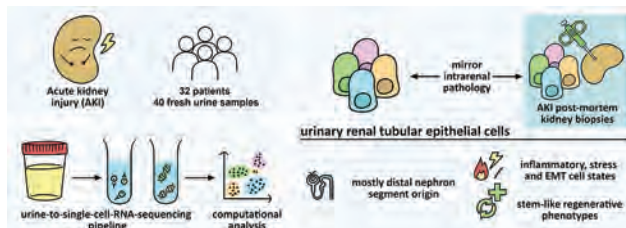

Graphical abstract

## FR-PO158

**Decreasing Kidney Injury by Maintaining Na/K-Pump Functions Using Electric Energy**

Lei Wang, University of South Florida, Tampa, FL.

**Background:** Renal ischemia-reperfusion injury is an important contributor to the development of delayed graft function, which is associated with higher rejection rates and worse long-term outcomes of the allografts. One of the earliest impairments during ischemia is insufficient ATP supply-induced Na/K pump dysfunction, which results in subsequent cellular damage. Consequently, strategies that preserve ATP levels or Na/K pump function may limit the extent of renal injury during ischemia-reperfusion.

**Methods:** In this study, we developed a novel technique that applies an oscillating electrical field to first synchronize the Na/K pump molecules, and then modulate their pumping rates. We dubbed this technique as the synchronization modulation electric field (SMEF). We present this novel technique of using electric energy to substitute ATPs in fueling and activating the pumps, thereby efficiently maintaining cellular functions under ATP insufficient conditions. We tested the effectiveness of this technique in different models of ischemic renal injury in rodents and pigs, including an *in situ* renal ischemia-reperfusion injury model (predominantly warm ischemia) and the kidney transplantation rodent and swine models (predominantly cold ischemia).

**Results:** Our results show that application of the specially designed electric field effectively delayed ATP depletion during the ischemia and preserves Na/K pump activity, thereby alleviating kidney injury by about 45% (plasma creatinine of  $1.17 \pm 0.04$  and  $1.97 \pm 0.06$  mg/dL for electric field treated and untreated groups, respectively) and improving renal allograft function by over 50% compared with the controls.

**Conclusions:** This novel technique for preserving Na/K pump function may have therapeutic potential not only for ischemic kidney injury, but also for other diseases associated with dysfunction of Na/K pumps.

**Funding:** NIDDK Support

## FR-PO159

**Identification of Hub Biomarkers and Inflammation-Related Pathways Participating in the Progression of AKI**

Qiuju Chen, Xiao Zhang, Zhenjian Xu, Anping Xu. Sun Yat-Sen Memorial Hospital, Guangzhou, China.

**Background:** Acute kidney injury (AKI) is a common, potentially devastating condition associated with markedly increased morbidity and mortality. We aim to identify key biomarkers involved in the progression of AKI and search for potential therapeutic target.

**Methods:** Microarray datasets GSE87025 and GSE192532 were integrated and batch effect was removed through ComBat. Hub markers for AKI were mined based on differential expression analysis, weighted gene co-expression network analysis (WGCNA) and lasso regression, followed by GO and KEGG term analysis. The results were further validated in GSE81741 and GSE153625.

**Results:** A total of 474 differential genes were screened. Eight co-expression modules were obtained via WGCNA; of which, blue module had the highest correlation with AKI. A total of 270 intersecting genes were acquired by combining differential genes. Six hub markers (Serpina3n, Rrad, Lgals3, Il1m, Slc34a2, Micall2) were subsequently obtained by lasso analysis as potential biomarkers for AKI. ROC curve analysis demonstrated a prime diagnostic value of the six hub markers. According to the functional enrichment analysis of the differential genes, hub markers were mainly elevated in inflammation-related pathways.

**Conclusions:** Six hub markers were identified which might be involved in the progression of AKI via inflammation-related signal pathways. Further studies are needed to validate our findings and explore effective strategies for AKI targeting these hub genes.

**Funding:** Government Support - Non-U.S.

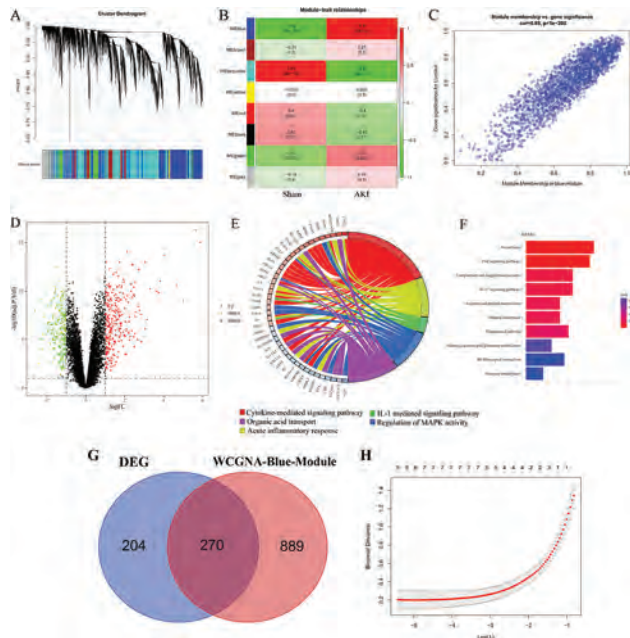

Fig 1. Identification of Hub Genes

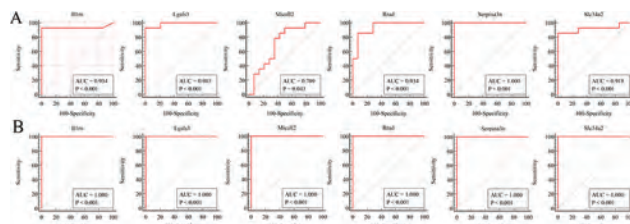

Fig 2. Validation of hub genes in the diagnostic value.

FR-PO160

**Redox Imbalance and Mitogen-Activated Protein Kinase (MAPK) Activation Mediates Pneumoperitoneum-Induced Kidney Injury**  
 Charbel Chalouhy,<sup>1,2</sup> Youakim Saliba,<sup>2</sup> Joelle Hajal,<sup>2</sup> Maria Ajaimy,<sup>1</sup> Nassim Fares.<sup>2</sup> <sup>1</sup>Montefiore Medical Center, Bronx, NY; <sup>2</sup>Universite Saint-Joseph, Beirut, Lebanon.

**Background:** Given the widespread use of laparoscopic and robotic surgeries, the effects of pneumoperitoneum (PNP) - the cornerstone of abdominal minimally invasive surgery - on kidney function become of great interest. PNP during laparoscopy causes transient renal functional impairment via various detrimental factors, such as oxidative stress. We, therefore, investigated the oxidative signaling pathways inherent to PNP-induced kidney injury.

**Methods:** PNP was established at an intraperitoneal CO2 pressure of 12 mmHg in Wistar rats (total = 45) randomly allocated into three groups: Sham (n=15), PNP1 (n=15), and PNP24 (n=15). PNP1 and PNP24 animals were sacrificed at one and 24 hours following PNP deflation, respectively. Renal histology, function, redox status, and signaling pathways were assessed.

**Results:** PNP induced kidney injury and dysfunction with altered KIM-1 profile. Both expression and activity of antioxidant (CAT, SOD1/2) and oxidant (NOS3) enzymes, lipid peroxidation, and renal RNA/DNA damage biomarkers revealed redox imbalance after PNP, with an excess H2O2 production. Moreover, the antioxidant gene regulators FoxO3a and Nrf2 were activated (p<0.05). Nevertheless, PNP had no effect on the cellular apoptotic pathways Bcl2, Bid, Caspase 3 and 8. Finally, PNP stimulated the p38 and JNK mitogen-activated protein kinase (MAPK) pathways in the kidney (p<0.05).

**Conclusions:** Our results demonstrate for the first time that PNP induces acute kidney injury due to renal redox imbalance linked to MAPK activation. These insights may open the way for further investigation into the renal therapeutic impact of managing PNP-associated oxidative stress during minimally invasive surgery requiring pneumoperitoneum.

FR-PO161

**Erythropoietin and Its Derived Peptide Helix B Surface Peptide in Ischemia-Reperfusion Induced AKI, Repair, or Fibrosis**

Cheng Han,<sup>1</sup> Yuanyuan Wu,<sup>2</sup> Fei Chen,<sup>1</sup> Wenli Sai,<sup>1</sup> Bin Yang.<sup>3,1</sup> <sup>1</sup>Affiliated Hospital of Nantong University, Nantong, China; <sup>2</sup>Nantong University, Nantong, China; <sup>3</sup>University of Leicester, Leicester, United Kingdom.

**Background:** Ischemia-reperfusion (IR)-induced acute kidney injury (AKI) often progresses to chronic kidney disease. Erythropoietin (EPO) and its derivative, helix B surface peptide (HBSP), significantly ameliorates AKI, but may lead to different outcomes at the late stage and their underlying mechanisms remain unclear. The effects and mechanisms of single and/or multiple administrations of high-dose EPO and HBSP are studies in IR induced-AKI, repair or fibrosis.

**Methods:** Mouse kidney epithelial TCMK-1 cells were stimulated by hydrogen peroxide (H<sub>2</sub>O<sub>2</sub>) for 24 h or recombinant transforming growth factor β (TGF-β) for 72 h, to mimic IR-related acute and chronic kidney injury respectively, with or without the treatment of 25-800 IU/mL EPO or 10-80 ng/mL HBSP. In addition, a mouse renal IR model was established by obstructed bilateral renal pedicles for 30 min and reperused for 2 weeks. Mice were treated with 5000 IU/kg EPO at the onset of surgery and/or every 3 days onwards, or 24 nmol/kg HBSP only once. The protein level of HMGB1 and α-SMA, renal function and histology were assessed.

**Results:** H<sub>2</sub>O<sub>2</sub> stimulation significantly increased HMGB1 expression in TCMK-1 cells at 24 h, which was decreased by 100 IU/mL EPO, but not 200-800 IU/mL EPO; and dose-dependently decreased by 20-80 ng/mL HBSP. TGF-β treatment greatly raised the level of α-SMA in TCMK-1 cells at 72 h, which was decreased by 50 IU/mL EPO, but not 100-800 IU/mL EPO, and gradually reduced by 20-80 ng/mL HBSP. In the *in vivo* model, HBSP and a single dose of EPO both markedly improved kidney function and structure, reduced HMGB1 and α-SMA protein, but increased E-cadherin protein. However, the multiple high-dose EPO did not show such impact. In addition, HBSP, but not EPO, greatly increased p-STAT5 protein in IR kidneys. Furthermore, the single dose of HBSP and multiple doses of EPO downregulated EPOR/βcr expression in IR kidneys, which was not altered by the single usage of EPO.

**Conclusions:** The low dosage of EPO and HBSP reduced inflammatory and fibrotic mediators in TCMK-1 cells, while single usage of EPO and HBSP attenuated renal injury with HBSP further reduced fibrosis. The different long-term roles of both in IR kidneys may attribute to the status of STAT5 pathway, but exact underlying mechanisms including EPOR/βcr involvement still need to be further explored.

FR-PO162

**Inhibition of EPRS Reduces Tubulointerstitial Nephritis-Induced Fibrosis via Suppression of T Cell Proliferation and γδ T Cell Activation**

Seung Seok Han,<sup>1,2</sup> Donghwan Yun,<sup>1,2</sup> Dong Ki Kim,<sup>1,2</sup> Kook-Hwan Oh,<sup>1,2</sup> Kwon Wook Joo,<sup>1,2</sup> Yon Su Kim.<sup>1,2</sup> <sup>1</sup>Seoul National University Hospital, Jongno-gu, Seoul, Republic of Korea; <sup>2</sup>Seoul National University College of Medicine, Seoul, Republic of Korea.

**Background:** Acute tubulointerstitial nephritis (ATIN), characterized by interstitial infiltration of immune cells, ultimately makes patients undergo dialysis because of irreversible fibrosis, but the agents modulating interstitial immune cells are lacking. The present study addressed whether glutamyl-prolyl-transfer RNA synthetase (EPRS), attaching glutamine and proline to transfer RNA, modulates the immune cell activity on ATIN and its pharmacological inhibition abrogates fibrotic transformation.

**Methods:** Wild-type (WT) and hetero-knockout (*Eprs*<sup>+/−</sup>) mice were treated with adenine-mixed diet to induce ATIN, and their immune and fibrotic profiles were compared. Small molecule inhibitor against EPRS was used in both *in vivo* and *in vitro* models to validate its therapeutic prospect. Human ATIN samples were used to translate the mouse results.

**Results:** The EPRS expression in certain immune cell subsets strongly increased after the ATIN induction, such as proliferating T cells and γδ T cells. The proliferation capacity of both CD4<sup>+</sup> and CD8<sup>+</sup> T cells and the interleukin-17 production of γδ T cells decreased in ATIN-induced *Eprs*<sup>+/−</sup> kidneys compared with in the counterpart WT kidneys. This different immunological milieu in *Eprs*<sup>+/−</sup> kidneys lowered fibrotic transformation compared to in WT kidneys at the chronic phase of ATIN (Figure 1). The use of inhibitor against EPRS protected the above immunopathological process on ATIN. The inhibitor also reduced proliferation of human blood-derived T cells and activity of γδ T cells similarly to the mouse results. The high expression of EPRS in human kidneys with biopsy-proven ATIN correlated with overzealous tubulointerstitial fibrosis.

**Conclusions:** The increased expression of EPRS in infiltrated proliferating T cells and γδ T cells is immunofibrotic driver of ATIN. Pharmacological inhibition of EPRS attenuates both inflammation and subsequent fibrosis on ATIN via suppression of T cell proliferation and γδ T cell activation, which will be a potential option for treatment of ATIN.

**Funding:** Commercial Support - Daewoong Pharmaceutical

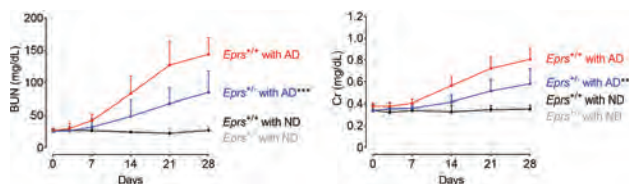

Kidney damage markers in WT and *Eprsr*<sup>-/-</sup> mice. AD, adenin-mixed diet; ND, normal diet.

### FR-PO163

#### Pirfenidone Confers Effective Prophylaxis of Renal Ischaemia Reperfusion Injury

Timothy Bowen,<sup>1</sup> Usman Khalid,<sup>2</sup> David A. Foxwell,<sup>1</sup> Robert Andrews,<sup>1</sup> Gilda Pino-Chavez,<sup>2</sup> Rafael E. Chavez,<sup>2</sup> Donald Fraser.<sup>1</sup> <sup>1</sup>Cardiff University School of Medicine, Cardiff, United Kingdom; <sup>2</sup>University Hospital of Wales, Cardiff, United Kingdom.

**Background:** Pre-clinical models show that direct or indirect ischemic preconditioning (IPC) confer protection from subsequent ischemic acute kidney injury (AKI). Nevertheless, IPC has not proved effective in clinical trials involving individuals at elevated risk of AKI. Using a drug repurposing approach, we have identified six compounds suitable for clinical testing to detect evidence of IPC-like benefit.

**Methods:** We used RNA sequencing to analyse the renal transcriptome following direct and indirect IPC in a rat bilateral IRI model. A common protective signature was identified, and Ingenuity Pathway Analysis (IPA) was performed to predict drug repurposing candidates that would confer similar changes in gene expression profiles. The effects of predicted candidates were then evaluated *in vivo*.

**Results:** Three repeated cycles of two minutes ischaemia followed by five minutes reperfusion conferred optimum benefit with either direct or indirect pulsatile IPC. Subsequent whole kidney transcriptomic profiling of sham, IRI, direct-IPC/IRI and indirect-IPC/IRI (n = 6 per group) mapped to 16,780 unique genes, of which 2,193 were differentially expressed between IRI and sham. IPA attributed these observations to an acute renal failure phenotype (p = 1.3 x 10<sup>-27</sup>) and renal proximal tubular toxicity (p = 5.1 x 10<sup>-15</sup>). Master regulators and pathways identified within inflammatory response, oxidative stress and cell cycle were diminished following both direct and indirect IPC. Based on comparison with transcriptomic information available for over 23,500 biological drugs and chemical compounds, IPA identified six repurposing candidates with potential for clinical testing for IRI prophylaxis: AG490, diphenyliodonium, pirfenidone, pyrrolidine dithiocarbamate, SP600125 and U0126, which were then evaluated further *in vivo*. All exhibited functional benefits when administered as a single prophylactic dose pre-IRI, but pirfenidone produced the most effective prophylaxis.

**Conclusions:** We have identified a protective gene expression signature common to direct and indirect IPC that provides novel mechanistic insights into the pathology of IRI injury and IPC protection. Using this dataset, computational transcriptional analysis has identified candidate drugs for repurposing for use in IRI prophylaxis, of which pirfenidone performed best.

### FR-PO164

#### IL-22 Promotes Kidney Injury Through Activation of DNA Damage Response

Kensei Taguchi,<sup>1,2</sup> Sho Sugahara,<sup>1</sup> Bertha C. Elias,<sup>1</sup> Craig R. Brooks.<sup>1</sup> <sup>1</sup>Vanderbilt University Medical Center, Nashville, TN; <sup>2</sup>Kurume Daigaku, Kurume, Japan.

**Background:** Acute kidney injury (AKI) occurs in up to 20% of hospitalized patients. Increased production of proinflammatory cytokine both predicts mortality in patients with AKI and worsens outcomes. Interleukin-22 (IL-22) is a member of IL-10 family whose receptor, (IL-22RA1), is expressed exclusively on epithelial or endothelial cells. In the kidney, IL-22RA1 expression is limited to proximal tubule cells (PTCs). Recently, IL-22 has shown to regulate the DNA damage response (DDR). The DDR is known to act as a double-edged-sword in AKI. While DNA repair is necessary for recovery from AKI, overactivation of the DDR is a major contributing factor to cell death and worsens kidney injury.

**Methods:** 1; Nephrotoxic AKI was induced by repeated doses of aristolochic acid (AA) or single dose of cisplatin in 8 to 12-week-old male wild-type (WT) and IL-22 globally knockout mice. 2; To investigate kidney specific effect of IL-22, nephrotoxic AKI was induced in IL-22RA1 flox/flox; Six2-cre (IL-22RA1<sup>ΔPT</sup>) and IL-22RA1 flox/flox. 3; S31-201, an inhibitor of STAT3, was intraperitoneally injected into cisplatin-treated WT mice.

**Results:** IL-22 is upregulated ~500 fold in the urine of cisplatin treated mice with no increase in plasma levels. IL-22RA1 is predominantly expressed in S3 segment of PTCs in basal conditions and expands to S1-S2 segments in response to AKI. Deletion of IL-22 or its receptor nearly completely ameliorates kidney injury induced by cisplatin or AA. Analysis of the kidney tissue reveals reduced apoptosis and kidney injury markers. DDR activation, as measured by phosphorylation of p53 and Ataxia telangiectasia mutated (ATM), is reduced in both IL-22 knockouts and IL-22RA1<sup>ΔPT</sup>. Mechanistically, IL-22 induces activation of STAT3 to trigger the DDR and subsequent apoptosis, which was blocked by STAT3 inhibitor S31-201 *in vitro* and *in vivo*.

**Conclusions:** Our results demonstrate that in the absence of IL-22 or its receptor, the nephrotoxic effects of cisplatin or AA are ameliorated. The engagement of IL-22 to IL-22RA1 activates STAT3 to induce DDR signaling, p53 and ATM, resulting in increased apoptotic. Thus, targeting IL-22 can reduce the negative effects of STAT3, p53, and ATM activation in AKI, without interfering with their basal homeostatic functions, providing a safe alternative to targeting these pathways directly.

### FR-PO165

#### Influenza A(H1N1)pdm09 Reaches the Kidney, Altering Immune Responses Without Causing Direct Tissue Injury

Holly Stowell-Connolly,<sup>1</sup> Abigail C. Lay,<sup>1</sup> Rachel Burt,<sup>1</sup> Elizabeth Oliver,<sup>2</sup> Anu Goenka,<sup>2</sup> Richard Coward.<sup>1</sup> Bristol Renal <sup>1</sup>University of Bristol Faculty of Health Sciences, Bristol, United Kingdom; <sup>2</sup>University of Bristol School of Cellular and Molecular Medicine, Bristol, United Kingdom.

**Background:** In 2009, a novel Influenza A(H1N1) virus caused the first pandemic of the twenty-first century. Patients commonly presented mild phenotypes, similar to seasonal influenza, however some developed complications requiring hospitalisation. Often critically ill patients exhibited major renal sequelae of acute kidney injury (AKI), leading to renal failure. Injury progression is poorly understood, with debates over development originating from direct viral infection of renal cells or pre-renal systemic inflammation.

**Methods:** Renal tissue and urine was taken from Babraham pigs (n=54) either daily (0-13 days) or weekly (0-3 weeks) following intranasal Influenza A(H1N1)pdm09 infection. IHC determined histological status of kidney tissue. Influenza A mRNA and nucleoprotein were detected by *in situ* hybridisation and IHC, respectively. Presence of H1N1 mRNA within urine was determined using qRT-PCR. Localised renal pro-/anti-inflammatory cytokine expression profiles were determined using qRT-PCR. CD4<sup>+</sup> and CD8α<sup>+</sup> T-cell infiltration and IgA deposition were detected by IF.

**Results:** Viral mRNA and protein was detected within kidney tissue at 1-6 days post-infection, similar to the timeline in respiratory tissue. Despite this, IHC revealed microscopic renal structure to be unchanged at all time points, with no evidence of necrosis/fibrosis. Consistent with this, pro-inflammatory cytokine mRNA decreased one-week post-infection (TNF-α, IFN-β, IFN-γ, and IL-4; p<0.05). Expression recovers after 7-14 days, often reaching levels greater than control (TNF-α, IFN-γ, IL-2, IL-4; p<0.05). Interstitial infiltration of CD4<sup>+</sup> and CD8α<sup>+</sup> cells, together with glomerular deposition of IgA, follows a similar trend (CD4 and IgA p<0.05). Urine samples were absent of H1N1 mRNA.

**Conclusions:** This work creates an infection timeline within the porcine renal system and highlights the ability of the influenza A(H1N1)pdm09 virus to reach the kidney without causing direct injury. Viral presence within renal tissue is cleared one-week post-infection, corresponding with a localised dampening of the immune system. This work demonstrates a direct role of Influenza A(H1N1)pdm09 in the kidney, and with current literature documenting AKI in COVID-19 patients, it is important to understand how respiratory viruses can contribute to AKI and mortality.

**Funding:** Government Support - Non-U.S.

### FR-PO166

#### Characterization of Regulatory B Cells and IL-10 in Response to Ischemic Reperfusion

Yunosuke Yokota, Kensei Taguchi, Sakuya Ito, Goh Kodama, Kei Fukami. Kurume Daigaku Igakubu Daigakuin Igaku Kenkyuka, Kurume, Japan.

**Background:** Acute kidney injury (AKI) occurs in up to 20% of hospitalized patients. Interleukin-10 (IL-10), an anti-inflammatory cytokine, modulates the progression of AKI via reducing pro-inflammatory cytokines including TNF-α and IL-6. Regulatory B cells (Breg) is considered a main source of IL-10. Breg is a subset with a CD1d<sup>hi</sup>CD5<sup>+</sup>CD19<sup>hi</sup> phenotype and comprises 1-3% of B cells in mouse spleen with smaller numbers in the blood, lymph nodes, intestine, and peritoneum under basal condition. However, the distribution of Breg in response to AKI remains unknown. Thus, we investigated Breg infiltration into ischemic reperfusion (IR) kidneys and examined the expression pattern of IL-10-producing cells.

**Methods:** Experiment 1; To study if Breg infiltrates into IR kidneys, IR was constructed by clamping left renal artery for 30 minutes in IL-10-IRES-GFP mice. The kidneys were isolated on day 1, 7, 14, 28, 42, and 70 after the surgery. Breg expression was examined by immunofluorescence staining. IL-10 expression was evaluated by real-time PCR. Experiment 2; A splenectomy was performed 7 days before ischemia IR surgery to investigate if splenectomy inhibits Breg infiltration.

**Results:** IL-10 was increased immediately after IR surgery and sustained until day 7 in parallel with an increase in tubular injury. We identified that splenectomy did not attenuate renal dysfunction and fibrosis without any change in serum IL-10. Also, the increase in renal IL-10 mRNA was not altered by splenectomy. Large scan images demonstrated that number of interstitial GFP<sup>+</sup> cells in IR kidneys was increased from day 7 when compared to sham kidneys and remained high until chronic phase. We also found that GFP signal in mesangial area of uninjured kidneys; however, the GFP expression disappeared after IR surgery. This finding indicates that mesangial cells in IR kidneys might produce IL-10 which is inhibited by IR injury.

**Conclusions:** We identified that IL-10 mRNA is upregulated in response to IR injury with an increase in number of interstitial GFP<sup>+</sup> cells. Mesangial cells might be capable of producing IL-10 which is inhibited by IR injury. Renal infiltration of IL-10-producing cells may be independent of spleen.

## FR-PO167

## NLRP3 Inflammasome Inhibition Decreases NETosis in AKI

David C. Tomaz, Asha Seth, Ricardo Parsons, Lorraine M. Irving, Lorraine Miller, Pernille B. Laerkegaard Hansen, Kevin Woollard. Biosciences Renal AstraZeneca PLC, Cambridge, United Kingdom.

**Background:** Kidney macrophages and neutrophils are inflammasome effector cells which can drive renal injury through expression of pro-inflammatory cytokines and formation of neutrophils extracellular traps (NETs). Acute kidney injury (AKI) is associated with NETs formation (NETosis), and a significant number of neutrophils infiltrate during the early injury stage, amplifying the inflammatory response. Different studies have shown an association between inflammasome activation and NETosis. Whether and how inflammasome inhibition affects NETosis-mediated injury and mechanisms of renal dysfunction remains to be fully explored.

**Methods:** We studied the role of NLRP3 inhibition and its effects on the kidney neutrophil infiltrate and kidney function in-vivo using an acute lipopolysaccharide (LPS) injury mouse model. In this model, mice were dosed with LPS (6mg/kg) or a saline solution intraperitoneally for 18 hours. Blood, urine and kidneys were collected and analysed. In vitro, we studied NETs using live cell imaging with SYTOX Green and histone staining. We further investigated mechanisms of NETs injury on renal proximal tubular endothelial cells (RPTECs) in-vitro using conditioning medium indirect co-cultures.

**Results:** In-vitro treatment with NLRP3 inhibitor (MCC950) dose-dependently reduced NET formation over 14 hours using LPS/ Nigericin and PMA inflammasome triggers. In vivo, MCC950 decreased plasma IL-1 $\beta$  and IL-18 and urinary IL-18 and protected against renal dysfunction induced by LPS, as evidenced by reduced plasma creatinine and blood urea nitrogen (BUN). Flow cytometry analysis showed a decreasing trend in myeloid infiltration and activation into the kidney. Interestingly, BUN and plasma creatinine correlated with the neutrophil infiltrate. More work is underway to characterise kidney NETs ex-vivo and PTEC injury in-vitro.

**Conclusions:** Our preliminary data suggests neutrophil infiltrate and NETs formation may accelerate tubular cell injury and death, promoting kidney dysfunction. In conclusion, we have demonstrated that NLRP3 inflammasome inhibition reduces kidney inflammation and inhibits NETosis-mediated kidney injury. The role of neutrophils as key effector cells and NLRP3 inflammasome pathway in kidney diseases warrants further investigation.

**Funding:** Commercial Support - AstraZeneca

## FR-PO168

## pNaKtide Ameliorates Systemic Inflammatory Response in Murine Model of Sepsis by Antagonism of Na,K-ATPase Signaling

Duane G. Pereira, Sneha S. Pillai, Muhammad A. Chaudhry, Joseph I. Shapiro, Komal Sodhi. Marshall University Joan C Edwards School of Medicine, Huntington, WV.

**Background:** Inflammatory processes and oxidative stress play a central role in the development and progression of sepsis, which can lead to multiple organ dysfunction. Hence, the use of strategies to limit this systemic inflammatory response, can be interesting in the development of an effective sepsis therapy. In this context, our research group recently demonstrate that the Na,K-ATPase signaling can exacerbate inflammation and oxidative stress process and that pNaKtide, an antagonist of NaK-ATPase, is able to improve pathophysiological abnormalities. The objective of this work is to demonstrate the involvement of NaK-ATPase signaling in increase inflammatory response and oxidative stress and to demonstrate the effect of pNaKtide administration in experimental model of sepsis, induced by cecal ligation and puncture (CLP), as a drug against septic shock.

**Methods:** Male C57BL/6 mice were used to induced experimental sepsis by CLP with or without, IP administration of pNaKtide (25mg/kg body wt) 24h before CLP surgery. Sham surgeries were performed and used as control for the CLP model. The severity of sepsis was assessed using the Murine Sepsis Score (MSS) at baseline, 4h, 8h and 24h after surgery for Sham and CLP. After 24h of Sham or CLP surgeries the mice were euthanized, blood was used for analysis of inflammatory markers and kidney was collected for biochemistry and morphological analysis.

**Results:** Systemic administration of pNaKtide was able to significantly improve the MSS after CLP surgery, as compared to CLP mice without pNaKtide injection. Histological analysis of kidney tissues by H&E staining showed a decrease in congestion, inflammatory infiltrate and hemorrhage in CLP mice with pNaKtide injection, as compared to CLP. As well, improved mRNA expression of inflammatory and macrophage infiltration markers, in kidney tissues of CLP mice. The pNaKtide administration also improved plasma levels of creatinine and urea, markers of kidney function.

**Conclusions:** Our study demonstrated that antagonism of Na,K-ATPase signaling by pNaKtide can attenuate the progression of CLP-induced sepsis by inhibiting the inflammatory process usually noted in this condition. Therefore, Na,K-ATPase signaling may serve as a viable clinical target for therapeutic intervention of sepsis and associated inflammatory mechanisms.

**Funding:** Other NIH Support - Supported by the National Institutes of Health Grants 1R15HL150721

## FR-PO169

## Co-Registered Spatial Proteomics and Transcriptomics Identifies Scattered Proximal Tubule Cells

Michael T. Eadon,<sup>1</sup> Ricardo Melo ferreira,<sup>1</sup> Seth Winfree,<sup>5</sup> Blue Lake,<sup>4</sup> Ying-Hua Cheng,<sup>1</sup> Carrie L. Phillips,<sup>1</sup> Samir V. Parikh,<sup>2</sup> Daria Barwinska,<sup>1</sup> Michael J. Ferkowicz,<sup>1</sup> Angela R. Sabo,<sup>1</sup> Debora L. Gisch,<sup>1</sup> Timothy A. Sutton,<sup>1</sup> Ken Dunn,<sup>1</sup> Mahla Asghari,<sup>1</sup> Brad H. Rovin,<sup>2</sup> Katherine J. Kelly,<sup>1</sup> Sanjay Jain,<sup>3</sup> Pierre C. Dagher,<sup>1</sup> Tarek M. El-Achkar.<sup>1</sup> Kidney Precision Medicine Project <sup>1</sup>Indiana University School of Medicine, Indianapolis, IN; <sup>2</sup>The Ohio State University College of Medicine, Columbus, OH; <sup>3</sup>Washington University in St Louis, St Louis, MO; <sup>4</sup>University of California San Diego, La Jolla, CA; <sup>5</sup>University of Nebraska System, Lincoln, NE.

**Background:** THY1 (CD90) is a marker of mesenchymal stem cells. THY1 is expressed in the kidney and postulated to be upregulated in regenerative scattered tubular cells (STCs) of the proximal tubule (PT). The merged KPMP/HubMAP snRNAseq atlas does not contain a specific STC cluster. Using co-registered spatial transcriptomics (ST) and CO-Detection by indEXing (CODEX) immunofluorescence, we identified this STC sub-cluster within the snRNAseq atlas.

**Methods:** On consecutive sections of human kidney tissue (10  $\mu$ m thick, N=3), CODEX (44 antibodies including THY1 and megalin) and ST (>20,000 genes detected) were performed and co-registered to spatially align protein and gene expression. Protein expression of THY1 and megalin defined regions for downstream ST comparison. Using ST, THY1+ megalin+ regions were compared to THY1- megalin+ regions. Differentially expressed ST genes (DEGs) were used to define a novel subcluster in the snRNAseq atlas.

**Results:** A novel STC subcluster was defined within the snRNAseq atlas. DEGs of STCs included *THY1*, *SLC16A9*, and *PDZK1IP1*. STC enriched pathways included Rho GTPase cycle, RAC1, growth factor signal transduction, and cell adhesion related pathways, consistent with the expected functions of this regenerative cell. Using Seurat anchor methodology, the *THY1+* sub-cluster, defined by snRNAseq, mapped back to regions of THY1 protein expression.

**Conclusions:** The integration of CODEX, ST, and snRNAseq datasets facilitated the identification of an important PT cell type which was under-represented in the KPMP snRNAseq atlas.

**Funding:** NIDDK Support

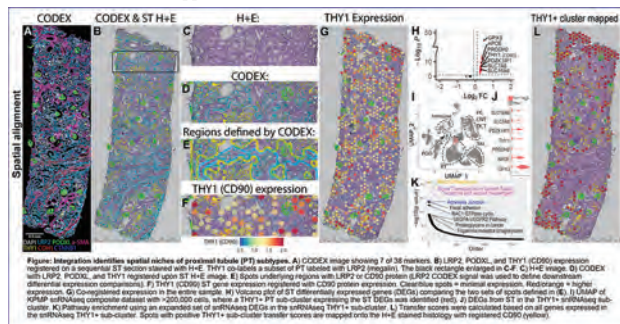

## FR-PO170

## Recombinant High-Density Lipoprotein Modulates Inflammatory Response and Renal Dysfunction in a Swine Model of Sepsis-Induced AKI

Alexandra Stasi, Rossana Franzin, Marco Fiorentino, Fabio Sallustio, Loreto Gesualdo. Universita degli Studi di Bari Aldo Moro, Bari, Italy.

**Background:** Sepsis is a severe and dysregulated inflammatory disease that often precedes the development of acute kidney injury (AKI) with consequent worsening outcome. Although clinical data demonstrate that high-density lipoprotein (HDL) levels drop in septic patients with a poor prognosis, little is known about the molecular basis of HDL's role in systemic inflammation and renal function. Here we investigate whether the use of recombinant HDL, CER-001, is effective in reducing inflammation during sepsis and preventing AKI.

**Methods:** Sepsis was induced by intravenous infusion of a saline solution containing 300  $\mu$ g/kg of LPS in a porcine model. The animals were randomized into three groups: LPS (endotoxemic pigs, n=6), CER-001(20mg/kg) (LPS pigs treated with a single dose of CER-001 20mg/kg; n=6), and CER-001(40mg/kg) (LPS pigs treated with two doses of CER001 at time 0 and 3 hours later; n=6). Animals were sacrificed after 24h from the start of experimental procedure.

**Results:** We observed an increased survival rate in both CER-001 treated groups of pigs compared to the LPS group. Furthermore, LPS injection led to a time-dependent increase of IL-6 in endotoxemic animals with respect to basal condition (T0). CER-001 treatment was able to reverse LPS effects. In particular, the second infusion of CER-001 three hours after the first dose (T3) strongly reduced IL-6 serum levels back to basal level (LPS p < 0.05). Similarly, we found high levels of TNF- $\alpha$ , MCP-1, sVCAM-1, s-ICAM-1 and ox-LDL in endotoxemic pigs that were significantly decreased in both CER-001 treatment arms. CER001 preserved liver and renal parenchyma, decreasing pathological scores of renal tubular and glomerular injury. Thus, CER-001 treatment preserved renal physiology, recovering urine output and decreasing creatine levels. Then, we evaluated the circulating LPS concentration in treated animals. We observed that LPS levels were

greatly reduced in treated animals and the effects are more evident after the second infusion of CER-001. Therefore, we also examined LPS levels in bile samples and we observed a dose-dependent increasing amount of endotoxin in the CER001 treated pigs.

**Conclusions:** The nephroprotective regimens with CER-001 may be a promising therapeutic approach for future sepsis induced-AKI treatment.

#### FR-PO171

##### GDF-15/GFRAL Axis, Survival, and Kidney Protection in Lipopolysaccharide and Folic Acid Nephropathy in Mice

Henriette Frikke-Schmidt, Rong Meng, George Ho, Krista P. Farrington, Alessandro Pocai, Shannon Mullican. Cardiovascular, Metabolism and Retina Therapeutic Area, Janssen Research & Development *Janssen Research and Development LLC, Spring House, PA.*

**Background:** GFRAL, the receptor for Growth/differentiation factor-15 (GDF-15), is expressed only in the hindbrain and while this axis regulates food intake, the role of GFRAL in described reno-protective effects of GDF-15 is not well understood. Overexpression of GDF-15 has been shown to protect against lipopolysaccharide (LPS) induced acute kidney injury and mortality in mice, but it is not confirmed if this is mediated through GFRAL. To explore this, we assessed survival and kidney injury in GDF-15 overexpressing (hNAG-1 mouse line generated by Prof. Thomas Eling) or GFRAL deleted (GFRAL<sup>-/-</sup>) mice challenged with LPS or folic acid (FA)

**Methods:** hNAG-1 mice and wild type (WT) controls were given 12 mg/kg of intraperitoneal (IP) LPS and monitored for survival. Acute kidney damage was induced in GFRAL<sup>-/-</sup> mice and WT controls by IP administration of LPS (200 ug for survival, 250 ug for kidney function) or FA (250 mg/kg) and monitored for survival, plasma creatinine (pCre), blood urea nitrogen (BUN) and proteinuria.

**Results:** Survival: 72 hours after LPS, 86% of hNAG-1 mice were alive compared to only 39% of WT (p=0.0071 Log-rank test). LPS treated GFRAL<sup>-/-</sup> mice did not show significantly different survival versus WT controls (47% vs 79%, no significant difference Log-rank test). 7 days after FA administration, only 33% of the GFRAL<sup>-/-</sup> mice survived compared to 78% of WT mice (p=0.0146 Log-rank test). **Kidney function:** 24 hours after LPS plasma pCre in the GFRAL<sup>-/-</sup> mice was increased versus WT controls (0.41±0.166 vs 0.27±0.080 mg/dl, p=0.0094 unpaired t-test) whereas BUN remained unchanged (129±12.8 vs 120±15.7 mg/dl). 7 days after FA only 33% of the GFRAL<sup>-/-</sup> mice survived compared to 78% in WT mice (p=0.0146 Log-rank test). On day 2 after FA (before any deaths occurred) GFRAL<sup>-/-</sup> mice had highly elevated proteinuria (2224±2508 vs 42.6±21.9 µg/mg urine albumin creatinine ratio, p=0.0046 unpaired t-test), whereas levels of plasma pCre (8.0±3.1 vs 5.8±4.7 mg/dl) and BUN did not change (42±24 vs 53±29mg/dl).

**Conclusions:** We confirm that GDF-15 overexpression improves survival in LPS challenged mice and show that lack of GFRAL augments LPS and FA induced kidney damage. Our data supports the involvement of GFRAL signaling in the observed reno-protective effect.

**Funding:** Commercial Support - Johnson & Johnson

#### FR-PO172

##### T Cell Metabolic Programming and Protection by Glutamine Blockade in AKI

Kyungho Lee, Elizabeth A. Thompson, Sepideh Gharraie, Chirag H. Patel, Johanna T. Kurzhagen, Andrea M. Newman-Rivera, Phillip M. Pierorazio, Lois J. Arend, Sanjeev Noel, Barbara S. Slusher, Hamid Rabb. *Johns Hopkins University School of Medicine, Baltimore, MD.*

**Background:** T cells participate in AKI pathogenesis. T cells are regulated by metabolic programming, less understood in AKI. Among metabolic pathways, glutaminolysis is particularly important for effector T cell function. We aimed to study kidney T cell metabolism during AKI and effects of glutamine blockade.

**Methods:** C57B6 mice underwent 30 min ischemia-reperfusion surgery or cisplatin injection. Germ-free (GF) mice were also studied to evaluate the effect of gut microbiota on T cell metabolism. Kidney T cells were isolated and studied by a flow cytometry-based immune-metabolic assay with interrogating artificial intelligence metabolic programs. Mice were treated with the glutamine antagonist JHU083 and effects on AKI were evaluated. Kidney sections were scored for tubular injury. In vitro studies were performed on FACS-sorted kidney T cell culture exposed to hypoxia-reoxygenation.

**Results:** T cells from postischemic kidneys showed a distinct T cell subset with low levels of mTOR and oxidative phosphorylation-related enzymes. Kidney T cells from GF mice exhibited global downregulation of multiple metabolic enzymes compared to those from wild-type mice. Blocking glutamine utilization with JHU083 improved functional and structural renal outcomes in ischemic (serum Cr at 24h, vehicle vs JHU083, 1.6±0.2 vs 1.1±0.1 mg/dL, P=.026; cortical necrosis, 6.6±0.9 vs 4.2±0.5%, P=.039) and cisplatin-induced AKI (serum Cr at 72h, 2.3±0.3 vs 1.2±0.2 mg/dL, P=.016; outer medullary necrosis, 57.1±3.7 vs 19.9±4.5%, P<.001). CD4 T cells from post-AKI kidneys in JHU083 treated group were skewed toward naive phenotypes with lower proliferation in both ischemic (CD44, 67.5±1.7 vs 56.3±1.9%, P<.001; CD62L, 29.0±1.6 vs 42.8±2.2%, P<.001; Ki67 58.7±2.9 vs 50.6±2.1%, P=.035) and nephrotoxic AKI (CD44, 50.2±3.4 vs 40.9±2.4%, P=.037; CD62L, 37.5±3.2 vs 52.5±3.0%, P=.005; Ki67, 54.4±3.6 vs 43.8±2.7%, P=.031). In vitro hypoxia-reoxygenation upregulated glycolysis-related enzymes in kidney T cells, and JHU083 inhibited CD3/CD28 stimulated proliferation.

**Conclusions:** AKI and as well the microbiome influence kidney T cell metabolic programming. Glutamine blockade with JHU083 improved ischemic and cisplatin-induced AKI outcomes, and is a promising novel therapeutic agent for AKI.

**Funding:** NIDDK Support

#### FR-PO173

##### Role of Double-Negative T Cells in Repair After Experimental Severe AKI

Kyungho Lee, Sepideh Gharraie, Johanna T. Kurzhagen, Lois J. Arend, Sanjeev Noel, Hamid Rabb. *Johns Hopkins University School of Medicine, Baltimore, MD.*

**Background:** T cells mediate organ injury and repair. A proportion of kidney αβ T cells are unconventional double-negative (DN) T cells (CD4<sup>-</sup> CD8<sup>-</sup>), which have anti-inflammatory properties previously demonstrated to protect from early injury in AKI. However, their role in repair from AKI has not been studied. We aimed to elucidate the role of DN T cells in AKI repair.

**Methods:** C57B6 mice underwent unilateral ischemia-reperfusion injury (IRI) surgery with 40 min ischemia. DN T cells, isolated from *Fas<sup>l</sup><sup>fl/d</sup>* mouse lymph nodes, were adoptively transferred AFTER IRI. Vehicle (neg. control) or Tregs (pos. control, Kidney Int 2009 PMID: 19625990) were also injected. GFR was measured by FITC-sinistrin-based method. Fibrosis was assessed with Masson trichrome staining. Profibrotic genes were measured with quantitative RT-PCR. T cells from postischemic kidneys were studied by flow cytometry.

**Results:** Percentages and the numbers of DN T cells markedly decreased in postischemic kidneys at 3 weeks from IRI compared to normal kidneys (18.7±1.1 vs 6.9±0.5% of αβ T cells, P<.001, 5.9±0.6×10<sup>4</sup> vs 0.9±0.3×10<sup>4</sup> cells/kidney, P<.001). DN T cell CD44 (95.0±0.4 vs 90.8±0.7%, P<.001) and CD69 (94.1±0.3 vs 85.8±1.1%, P<.001) were reduced, while DN T immune checkpoint TIGIT (0.6±0.2 vs 2.5±0.5%, P=.005) and NK1.1 (35.9±2.6 vs 52.4±3.5%, P=.004) were upregulated. Post-AKI transfer of DN T cells improved renal recovery, as did Treg transfer, with 3 week-GFR of 1176±27 µL/min/100g (vehicle, 1076±25, P=.001; Treg 1217±42, P=.399) and outer medullary fibrosis of 64.5±2.3% (vehicle, 82.0±1.9, P<.001; Treg 45.4±9.3%, P=.058). *Tgfb1* was lower in the DN T cell transfer group (1.0±0.1 fold) than vehicle group (vehicle, 1.3±0.1, P=.012; Treg, 0.8±0.1, P=.226). Postischemic kidneys from DN T cell transferred mice had less effector memory CD4 T cells (94.7±0.2%) compared to those from vehicle group (vehicle, 96.9±0.3, P<.001; Treg 93.7±0.3%, P=.021). DN T cell transfer enhanced tubular proliferation, with higher Ki67 expression of CD45<sup>+</sup> E-cadherin<sup>+</sup> cells (73.4±1.1; vehicle, 68.5±1.2, P=.011; Treg, 71.8±2.2%, P=.304).

**Conclusions:** Kidney DN T cells undergo quantitative and phenotypical changes long-term after severe ischemic kidney injury. Post-injury infusions of DN T cells, like T regs, can hasten repair and decrease fibrosis. A potential mechanism is by regulating kidney CD4 T cells.

**Funding:** NIDDK Support

#### FR-PO174

##### RNA-Binding Protein HuR Regulates the Progression of Septic AKI by Modulating CD147

Davey Li, Anna Tang, Nisha Sharma, Yufeng Huang. *University of Utah Health, Salt Lake City, UT.*

**Background:** Septic AKI is one of the most common complications in critically ill patients with a high risk of developing CKD and no cause-specific treatment. Hu antigen R (HuR), an RNA-binding protein governing mRNA stability and translation, has been identified as a key modulator in inflammation. We hypothesized that the enhanced HuR/pro-inflammatory actor circuit is a crucial mechanism for the transition of septic AKI to CKD and inhibition of HuR may reverse septic kidney injury.

**Methods:** Sustained administration of LPS (5mg/kg BW, i.p. every other day)-induced mice (n=5/each group) were treated without or with HuR inhibitor, KH-39 (50mg/kg BW) or niclosamide (NCS, 10mg/kg BW) i.p. daily for 7 days. Normal mice injected with saline served as controls.

**Results:** Repeated injection of LPS to mice developed chronic kidney damage, including increase plasma BUN levels and urinary albumin/creatinine ratio by 2.98 and 2.52-folds respectively. Histologically, LPS-injured kidneys showed accumulative inflammatory cells (including F4/80+ macrophages) infiltration and fibronectin (FN) & collagen (Col) deposition. Both α-SMA and FN as the markers of renal fibrosis were markedly increased by 6.1 and 9.73-folds respectively determined by Western blot. Notably, a significantly increased HuR expression was observed in diseased kidney, which was inhibited by HuR inhibitor, KH-39 or NCS. Immunofluorescent staining for HuR confirmed the Western blot measurement. In addition, CD147 expressed in tubular cells is involved in kidney disease mainly associated with increase inflammatory cell recruitment at site of injury. As expected, expression of CD147 was increased by 2.28-folds in LPS-injured kidney tubular cells determined by Western blot and IF staining. Interestingly, this increase was inhibited by KH-39 or NCS. Inhibition of HuR with KH-39 or NCS further largely reduced the elevated plasma BUN levels and albuminuria, and tubular injury, inflammation and tubulointerstitial fibrosis, compared to the untreated LPS-injured mice (P<.05).

**Conclusions:** These results suggest that HuR is increased in LPS-injured kidneys and the progression of septic AKI to CKD induced by persistent inflammation is strongly reduced by HuR inhibition, at least, through downregulating CD147 expression. This study may provide a proof-of-concept for repurposing HuR inhibitor as a new therapy for septic kidney injury.

**Funding:** NIDDK Support

Key: TH - Thursday; FR - Friday; SA - Saturday; OR - Oral; PO - Poster; PUB - Publication Only

Underline represents presenting author.

## FR-PO175

**Intu Deficiency in Renal Tubules Delays Kidney Repair yet Suppresses Renal Fibrosis After Kidney Injury**

Shixuan Wang,<sup>1,2</sup> Zheng Dong,<sup>1,2</sup> <sup>1</sup>Augusta University, Augusta, GA; <sup>2</sup>Charlie Norwood Department of Veterans Affairs Medical Center, Augusta, GA.

**Background:** Intu is an effector protein of the planar cell polarity network that is essential for embryonic development and maintenance of normal organ functions. It was recently demonstrated that Intu plays a protective role in renal ischemia/reperfusion injury via interacting partner Stat1. However, the role of Intu in kidney repair and fibrosis remains unknown.

**Methods:** We have established an inducible Intu knockout mouse model that was exposed to doxycycline to ablate Intu specifically from kidney tubules (iRT-Intu-KO). iRT-Intu-KO mice and wild-type littermates were subjected to unilateral renal ischemia/reperfusion or ureteral obstruction injury. Kidney repair/recovery was evaluated by histological, biochemical, immunohistochemical and immunofluorescence approaches. In vitro, we examined Intu-knockdown proximal tubular cells.

**Results:** We found that ablation of Intu in renal tubules delayed kidney recovery and ameliorated renal fibrosis after renal ischemia/reperfusion injury. These mice also had less renal fibrosis during unilateral ureteral obstruction. We further found that senescence was suppressed while cell proliferation was increased in Intu knockout kidneys following renal ischemia/reperfusion injury. In cultured renal tubular cells, knockdown of Intu inhibited cell migration, accompanied by the abnormality of centrosome orientation.

**Conclusions:** Knockout of Intu suppressed kidney recovery and weakened fibrosis, associated with centrosome orientation abnormality and senescence inhibition. These findings suggest that planar cell polarity may contribute to tubular repair after kidney injury, shedding light on new strategies for improving kidney repair and recovery.

**Funding:** NIDDK Support, Veterans Affairs Support

## FR-PO176

**Use of Daratumumab in a Patient With Proliferative Glomerulonephritis With Monoclonal Immunoglobulin Deposition**

Akshith Doddi,<sup>1</sup> Dalia Y. Ibrahim,<sup>2</sup> Khaled Shawwa,<sup>1</sup> <sup>1</sup>West Virginia University, Morgantown, WV; <sup>2</sup>The Ohio State University, Columbus, OH.

**Introduction:** Monoclonal gammopathy of renal significance is a pathogenic entity associated with end stage kidney disease. Proliferative glomerulonephritis with monoclonal immunoglobulin deposition (PGNMID) results from deposition of a monoclonal immunoglobulin leading to kidney damage. Until recently there was no evidence to guide treatment. We report a case of a patient with PGNMID who responded well to daratumumab.

**Case Description:** This is a 57-year-old female with diabetes of 3 years duration and hypertension. She presented with worsening swelling of a couple weeks duration and was found to have anasarca. Her serum albumin was 1.4 mg/dL, serum creatinine 1.8 mg/dL and had 3-5 red blood cells per high power field in her urine. She was started on intravenous diuretics. Her 24-hour urine protein was 7.3 grams. Her complement levels C3 and C4, ANA, ANCA, hepatitis B and C were negative or normal. The patient's kappa (5.2 mg/dL) and lambda (2.7 mg/dL) free light chains were slightly elevated. Her urine and serum protein electrophoresis did not show a monoclonal protein. A kidney biopsy was done. There was moderate focal segmental mesangial expansion with hypercellularity with no endocapillary hypercellularity. Immunofluorescence (IF) showed moderate diffuse mesangial staining for IgG and C3 with kappa light chain restriction. IF with antibodies for IgG subclasses showed a predominantly IgG1 subclass staining. Electron microscopy revealed electron dense immune-type deposits in the mesangium and a few subepithelial and intramembranous deposits. The patient was diagnosed with PGNMID. A bone marrow biopsy and skeletal survey were negative. She was given rituximab. She was then referred 3 months later for a second opinion due to a continued nephrotic syndrome and decreased kidney function. She proceeded with daratumumab based on Zand et al protocol. After completing the first 8 doses, her creatinine improved to 1.5 mg/dL from 4 mg/dL at time of initial infusion. She continued to have proteinuria until after her 10<sup>th</sup> infusion, where it improved down to 0.6 grams. This was sustained after the 15<sup>th</sup> infusion (0.27 grams). During her treatment course with daratumumab, her side effects included transient nausea and vomiting, back pain, and constipation.

**Discussion:** The patient had complete remission with proteinuria <0.5 gram and improvement in her kidney function.

## FR-PO177

**Looking Beyond the Proteinuria**

Lauren Kring,<sup>1</sup> Alia Hasan,<sup>2</sup> <sup>1</sup>Carilion Clinic, Roanoke, VA; <sup>2</sup>VA Medical Center Salem, Salem, VA.

**Introduction:** Nephrotic syndrome usually raises concern for primary renal disorders such as membranous nephropathy, focal segmental glomerulosclerosis or minimal change disease. A careful history however, must be taken to evaluate for possible malignancy, especially in a patient with normal GFR. Here we present a case of nephrotic syndrome with normal renal function in whom malignancy was initially overlooked.

**Case Description:** A 64 year old white male with history of controlled hypertension and new onset diabetes mellitus, presented with leg swelling and was diagnosed with an acute left leg DVT. The edema also prompted his physician to order a 24-hour urine which showed 18g of proteinuria. Referral was made to Nephrology. He endorsed a 16 pound weight loss, "foamy" urine, right hand and left leg neuropathy for the past 2-3 months. He attributed his neuropathy to diabetes. Labs revealed Hgb 12.1 g/dL, serum creatinine

0.7 mg/dL, albumin 2.9g/dL. Anemia noted for past 4 months. He had mild proteinuria on urinalysis for about 1 year, which worsened 2 months prior; quantification not performed. Hgb A1c was under 6.5. Hepatitis B and C, ANA, dsDNA were negative. Serum protein electrophoresis, immunofixation, and free light chain ratio of 0.67 indicated monoclonal lambda proliferation. Renal biopsy contained 11 glomeruli: 1 globally sclerotic, others normal on light microscopy. Electron microscopy showed a normal basement membrane with 70% foot process effacement. CT imaging had multiple lytic bone lesions and bone marrow biopsy showed 85% plasma cells. He was diagnosed with multiple myeloma (MM) and started on pulse dose steroids, daratumumab (anti CD38) and RVD (lenalidomide, bortezomib, dexamethasone).

**Discussion:** While this patient's nephrotic syndrome was concerning for intrinsic renal disease, he also had new anemia, weight loss, asymmetric peripheral neuropathy and new DVT over a span of 4 months, concerning for underlying malignancy. Light microscopy findings on renal biopsy were consistent with minimal change disease (MCD). MCD is usually associated with hematologic or solid malignancies, but can occasionally be seen in MM. His renal disease therefore was secondary and malignancy related. After starting MM treatment, his proteinuria, edema and neuropathy resolved. This case illustrates the need to assess the patient as a whole and not just focus on one organ or syndrome.

## FR-PO178

**Unusual Course of Paraneoplastic IgA Nephropathy Associated With Squamous Cell Lung Cancer**

Mariam Charkviani, Pingchuan Zhang, Sandra Herrmann. *Mayo Clinic Minnesota, Rochester, MN.*

**Introduction:** Immunoglobulin A nephropathy (IgAN) is a common primary glomerulonephritis, that is characterized by glomerular IgA deposits, however paraneoplastic IgAN has been rarely reported. In this case report we describe an unusual clinical course of patient with squamous cell lung carcinoma that was subsequently diagnosed with IgAN/Henoch-Schönlein purpura (HSP)

**Case Description:** 61-year-old male recently diagnosed with squamous cell carcinoma of the lung was referred for elevation of serum creatinine to 1.49 mg/dl from 0.9 mg/dl. He presented with vasculitic rash on lower extremities, and urinalysis showed acanthocytes and predicted 24-hour proteinuria of 7.8 g. Serologic and infectious workup so as monoclonal screen were negative. He underwent kidney biopsy that revealed diffuse mesangial and endocapillary hypercellularity with segmental fibrinoid necrosis and IgA dominant IF staining, consistent with crescentic IgAN/Henoch Schönlein purpura (HSP) nephritis (**FIG 1**). Immunosuppression was on hold due to active malignancy, and radiation and chemotherapy started. Follow up urinalysis showed less active sediment and decreased proteinuria. He also developed AKI thought to be pre-renal origin and improved with volume. But after cancer therapy changed to Durvalumab his creatinine peaked from 1.6 mg/dL to 2.84 mg/dL and urinalysis showed new sterile pyuria in addition of active sediment. There was concern for immune check point (ICI) induced acute interstitial nephritis (AIN) versus flare of IgA vasculitis. As patient presented with symptoms of ICI induced pneumonitis, Durvalumab was discontinued, and he was started on prednisone. His kidney function gradually improved while on steroids and after completing the course his creatinine was 1.68 mg/dl. Patient remained on remission under active surveillance by oncology for two years.

**Discussion:** Our case describes an unusual course of paraneoplastic IgA /HSP nephropathy and heightens the need for awareness of complications associated with these pathology and immunotherapy cancer agents.

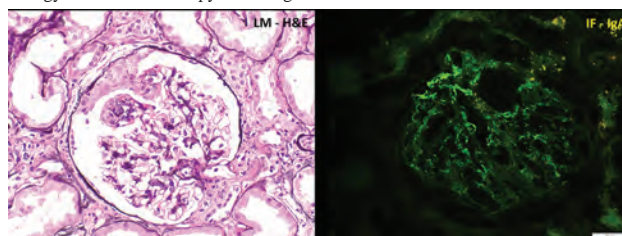

Biopsy images: Light Microscopy and Immunofluorescent staining for IgA

## FR-PO179

**Acute Interstitial Nephritis Secondary to Sarcoid-Like Reaction After Autologous Bone Marrow Transplantation**

Luciana G. Luff,<sup>1</sup> Fernando L. Strufaldi,<sup>1</sup> Livia B. Cavalcante,<sup>1</sup> Renato A. Caires,<sup>2</sup> Francisco Z. Mattedi,<sup>2</sup> Elerson Costalonga,<sup>2</sup> Roberta Scholnik Szor,<sup>2</sup> Veronica T. Costa e Silva,<sup>2</sup> <sup>1</sup>Hospital das Clinicas da Faculdade de Medicina de Sao Paulo, Sao Paulo, Brazil; <sup>2</sup>Universidade de Sao Paulo Instituto do Cancer do Estado de Sao Paulo, Sao Paulo, Brazil.

**Introduction:** Sarcoid-like (SL) disease is a systemic inflammatory granulomatous reaction triggered by a known underlying factor, such as immunosuppression. We report a case of acute interstitial nephritis (AIN) in the context of an SL systemic disease associated with humoral immunodeficiency in the post autologous stem cell transplant (ASCT) period.

**Case Description:** A 69-y-old woman diagnosed with non-Hodgkin mantle cell lymphoma was treated with Cyclophosphamide, Doxorubicin, Vincristine, and Prednisone regimen followed by consolidation with ASCT in first complete remission.

Key: TH - Thursday; FR - Friday; SA - Saturday; OR - Oral; PO - Poster; PUB - Publication Only

Underline represents presenting author.

In November 2019, she had Coombs-negative hemolytic anemia and a PET-CT revealed abnormal uptake in mediastinal and supraclavicular lymph nodes(LN). To rule out relapse, LN and bone marrow (BM) biopsies were performed, which demonstrated chronic inflammatory granuloma without necrosis. At this point, serum creatinine was 1.0 mg/dL, and combined hypogammaglobulinemia was observed. In July 2021, the patient was referred to the Nephrology clinic due to an insidious increase in Scr (1.8 > 2.3 > 2.8mg/dL in five months). Albeit discrete proteinuria, no other abnormalities were found. No urinary or systemic complaints were referred. Blood pressure was normal. No edema was detected. Percutaneous renal biopsy demonstrated AIN without granuloma and a negative immunofluorescence. Considering a diagnosis of sarcoid-like disease associated with post-SCT immunodeficiency, prednisone at 1mg/kg/day was started, with decline of Scr to 2.0 mg/dL two weeks later. After two months, methotrexate (10mg/week) was started with wean from steroids. The patient has been followed up with sustained Scr of 1.5mg/dL.

**Discussion:** Acquired immunodeficiencies may be associated with SL granulomatous disease. We postulate that a potential B-cell reconstitution deficiency and consequent hypogammaglobulinemia could create an immunologic environment for a granulomatous disease. This is the first reported acute IN case secondary to SL reaction after an SCT.

Variable	Value (reference range)
Proteinuria	0.7g/day
Hematuria	Absent
Autoimmunity evaluation <sup>1</sup>	Negative
Renal ultrasound	No abnormalities
Serum IgA	48.8 (60-382) mg/dL
Serum IgG	466 (700-1600) mg/dL
Serum protein electrophoresis	Hypogammaglobulinemia
Serum Immunofixation	Absence of abnormal proteins

<sup>1</sup>Autoimmunity evaluation: antinuclear antibody, Rheumatoid factor, complement (C3, C4).

## FR-PO180

### Anti-PR3 Positive Pauci-Immune Glomerulonephritis Associated With Immune Checkpoint Inhibitor Therapy and Responsive to Corticosteroid and Rituximab

Michelle Clinche, Jane M. Doheny, Matthew D. Griffin, Teresa Mchale, Liam O'Neill, David Gorey. *Galway University Hospitals, Galway, Ireland.*

**Introduction:** Immunotherapy with checkpoint inhibitors (CPIs) enables activation of suppressed immune responses against cancer-associated antigens. Due to this mechanism of action, CPIs can trigger immune-related adverse events – including renal impairment. The most common findings on biopsy are acute interstitial nephritis and acute tubular injury. Several cases of pauci-immune glomerulonephritis, most commonly ANCA-negative, have also been reported during CPI therapy.

**Case Description:** A 73 year old man was admitted with hemoptysis, nausea and fatigue 5 days after his first cycle of carboplatin, paclitaxel & pembrolizumab for non-squamous cell lung cancer. Baseline serum creatinine (SCr) was 0.74mg/dL (65µmol/L). AKI was apparent on admission with SCr 1.63mg/dL (144µmol/L), initially considered pre-renal. Deterioration in renal function continued with peak SCr of 4.61mg/dL (408 µmol/L) despite adequate supportive therapy. Serological testing revealed positive assays for cANCA and anti-PR3 (35.0 U/mL). CXR showed new bilateral pulmonary infiltrates. Ultrasound-guided kidney biopsy revealed necrotising and crescentic glomerulonephritis with negative immunofluorescence microscopy, in keeping with a pauci-immune glomerulonephritis. IV Methylprednisolone 2mg/kg was administered for 5 days followed by rituximab infusions (2 x 1g, 2 weeks apart) and oral prednisolone taper. During the following 24 days, hemoptysis and systemic symptoms resolved and SCr progressively improved to nadir of 1.62mg/dL (144µmol/L). CPI therapy was not re-initiated. The patient remains in oncological remission without clinical or serological evidence (currently cANCA negative) of recurrent ANCA-associated glomerulonephritis.

**Discussion:** Anti-PR3+ ANCA-associated pauci-immune glomerulonephritis is an unusual cause of AKI during CPI therapy which, in this case, responded well to corticosteroid and rituximab. This case illustrates the importance of kidney biopsy in assessing and managing renal impairment associated with combined chemotherapy/immunotherapy regimens.

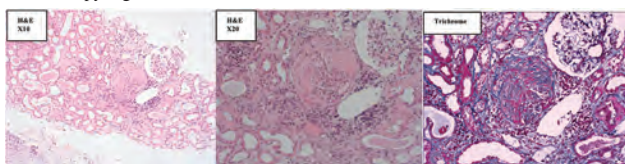

H&E and trichrome stain showing necrotising crescent.

## FR-PO181

### The Use of Rituximab in Treatment of Immune Checkpoint Inhibitor Induced Glomerulonephritis

Sai S. Achi,<sup>1</sup> Amanda Tchakarov,<sup>1</sup> Maen Abdelrahim,<sup>2</sup> Daniel Y. Wang,<sup>3</sup> Van Morris,<sup>4</sup> Ala Abudayyeh.<sup>4</sup> <sup>1</sup>The University of Texas Health Science Center at Houston John P and Katherine G McGovern Medical School, Houston, TX; <sup>2</sup>Houston Methodist Hospital, Houston, TX; <sup>3</sup>Baylor College of Medicine, Houston, TX; <sup>4</sup>The University of Texas MD Anderson Cancer Center, Houston, TX.

**Introduction:** Immune checkpoint inhibitors (ICI) have been shown to induce and exacerbate autoimmune side effects in patients with underlying autoimmune diseases. Immune adverse events of the kidney have been reported in 2-5% cases: majority of which are acute interstitial nephritis and less than 1% are glomerular diseases. Though glomerular disease is rare, it adds further complexity to cancer patients' care. We describe two cases of glomerulonephritis (GN) successfully treated with rituximab and continued ICI with cancer and renal response.

**Case Description:** A 64 year old male with mesothelioma and treated with nivolumab, developed nephrotic range proteinuria after two cycles, and biopsy confirmation of membranous nephropathy with positive antibody to PLA2R. The patient was started on rituximab course, achieved complete renal response, and continued nivolumab for 3 years. The PET/CT imaging continues to depict complete metabolic response and serum Anti-PLA2R negative. The second patient is a 71 year old female with squamous cell cancer of the anal canal who did not respond to cisplatin and 5-FU and was started on nivolumab. After the fourth cycle, she developed nephrotic range proteinuria. Biopsy confirmed minimal change disease, she was treated with a course of steroids and rituximab. She achieved complete remission of her proteinuria and had an excellent cancer response with continued ICI treatment.

**Discussion:** We present two unique cases of membranous nephropathy and minimal change disease in cancer patients after ICI exposure successfully treated and re-challenged on ICI with continued renal and tumor response. Based on a recent systematic review of ICI induced GN, the most frequent GN reported was pauci-immune and renal vasculitis (27%), podocytopathies (24%), and complement 3 GN (C3GN; 11%). There are no current guidelines on treatment of ICI induced GN. Based on our experience in vasculitis and current glomerulopathies, by targeting the B cells implicated in the autoimmune induction, rituximab offers an attractive treatment option and patients can continue ICI and improve overall survival.

## FR-PO182

### Shorter vs. Longer Corticosteroid Duration and Recurrent Immune Checkpoint Inhibitor-Associated AKI

Shruti Gupta,<sup>1</sup> Clara García-Carro,<sup>2</sup> Meghan E. Sise,<sup>3</sup> Maria Jose Soler,<sup>4</sup> David E. Leaf.<sup>1</sup> ICPi-AKI Consortium <sup>1</sup>Brigham and Women's Hospital, Boston, MA; <sup>2</sup>San Carlos Clinical Hospital, Madrid, Spain; <sup>3</sup>Massachusetts General Hospital, Boston, MA; <sup>4</sup>Vall d'Hebron University Hospital, Barcelona, Spain.

**Background:** Corticosteroids are the mainstay of treatment for immune checkpoint inhibitor-associated acute kidney injury (ICPi-AKI), but the optimal duration of therapy has not been established. Prolonged use of corticosteroids can cause numerous adverse events and possibly decreased progression-free survival among patients treated with ICPIs. We therefore sought to determine whether a shorter duration of corticosteroids was equally efficacious and safe as compared to a longer duration.

**Methods:** We used data from our previously conducted multicenter cohort study of patients diagnosed with ICPI-AKI from 29 centers across 9 countries. We examined whether a shorter duration of corticosteroids (28 days or less) versus a longer duration of corticosteroids (29-84 days) was associated with a higher rate of recurrent ICPI-AKI or death in the 30-day period following completion of corticosteroid treatment.

**Results:** Of 165 patients treated with corticosteroids, 56 (34%) received a shorter duration of treatment and 109 (66%) received a longer duration. Patients in these two groups were similar with respect to age, sex, race, malignancy type, and baseline kidney function. Five of 56 patients (8.9%) in the shorter duration group and 12 of 109 (11%) in the longer duration group developed recurrent ICPI-AKI or died (Log-rank P=0.90) (Figure A). Nadir serum creatinine in the first 14, 28, and 90 days following completion of corticosteroid treatment was similar in the shorter versus longer duration groups (P=0.40, P=0.56, and P=0.89, respectively) (Figure B).

**Conclusions:** A duration of corticosteroids of 28 days or less may be safe for patients with ICPI-AKI. However, the findings may be susceptible to unmeasured confounding and further research from randomized clinical trials is needed.



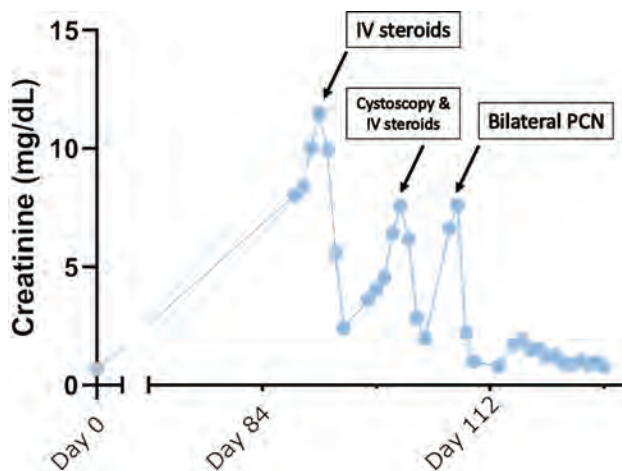
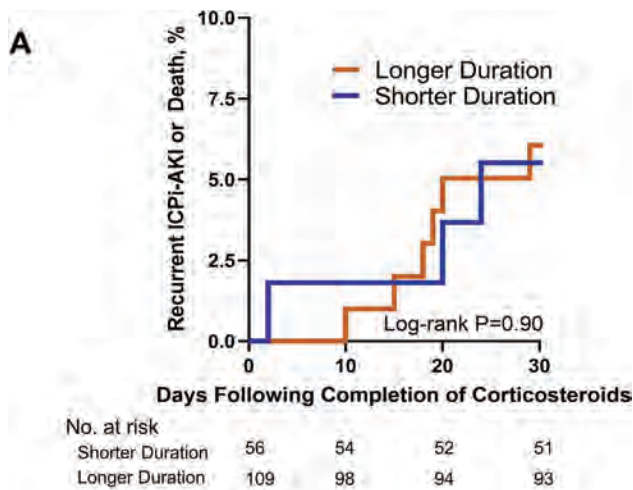

FR-PO184

Hyperphosphatemia as Initial Presentation of Multiple Myeloma

Marco A. Bonilla,<sup>1</sup> Tanazul T. Pariswala,<sup>1</sup> Mahmoud Ali,<sup>2</sup> Antonio Corona,<sup>1</sup>  
<sup>1</sup>Donald and Barbara Zucker School of Medicine at Hofstra/Northwell, Hempstead, NY; <sup>2</sup>Saint Barnabas Hospital, Bronx, NY.

**Introduction:** Hyperphosphatemia is commonly seen in patients with kidney failure. However, in patients with normal kidney function, it can be a clue to underlying dysproteinemia

**Case Description:** A 71-year-old male with a medical history of anemia presented for evaluation of abdominal pain. On presentation vital signs were unremarkable. A physical exam revealed a thin elderly male with temporal wasting. Laboratory evaluation showed hemoglobin of 7.1g/dl, sodium 133mmol/L, K 4.2mmol/L, creatinine 1.4mg/dl, Calcium 8.7mg/dl, albumin 3.3g/dl, total protein 10.3g/dl, Gamma GAP 7g/dl, phosphorus 17.7mg/dl. Further workup is in table 1.

**Discussion:** Our case describes an unusual initial presentation of MM in a patient with severe hyperphosphatemia. Bone marrow biopsy reported plasma cell myeloma with 70% CD138-positive plasma cells, confirming a diagnosis of IgG-kappa-type MM. Spurious electrolyte abnormalities present a challenge for clinicians, pseudo-hyperphosphatemia in patients with MM has been associated with laboratory artifacts. A serum sample from a patient with MM will cause an increase in serum turbidity and its optical density, leading to falsely elevated phosphate levels. After the diagnosis of MM, hyperphosphatemia was attributed to spurious etiology. He started IV corticosteroids for 4 days, with a striking improvement in the phosphorus level (Figure 1). Interventions to lower serum phosphorus in this setting should be avoided if there are normal calcium and kidney function levels. Physicians should be aware that an unexplained hyperphosphatemia might be a diagnostic clue for a paraprotein disease.

Table 1. Further laboratory data

Laboratory	Value	Reference
IFE kappa	68.56 mg/dl	0.33-1.94 mg/dl
IFE lambda	0.39 mg/dl	0.57-2.63 mg/dl
Kappa/Lambda ratio	175.79 mg/dl	0.26-1.65 mg/dl
Quantitative IgG	4175 mg/dl	700-1600 mg/dl
Serum protein Electrophoresis M-spike	3.9 g/dl	
Serum Immunofixation	IgG and Kappa bands.	

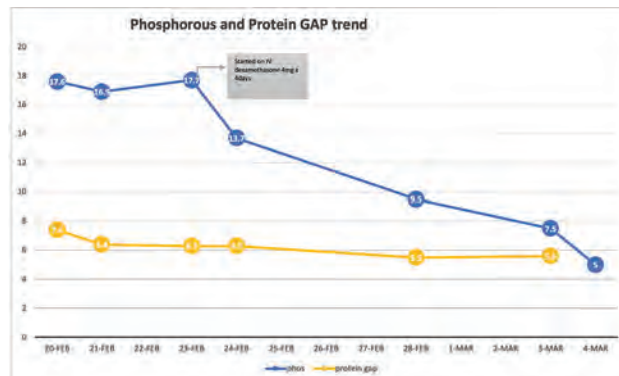

B

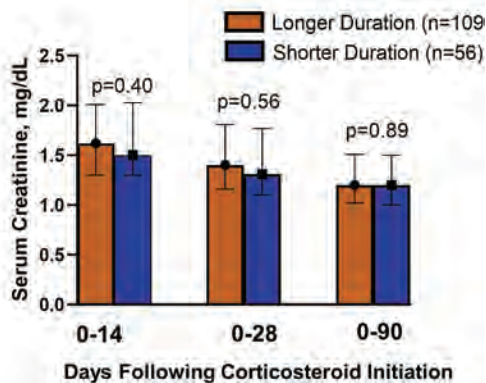

FR-PO183

It's Not What It Looks Like: Obstructive Nephropathy in a Patient With Cervical Cancer

Christine E. Reed,<sup>1</sup> Sameed K. Lodhi,<sup>2</sup> Vimal K. Derebail,<sup>2</sup> Monica L. Reynolds,<sup>2</sup> Evan Zeitler,<sup>2</sup> <sup>1</sup>The University of North Carolina at Chapel Hill School of Medicine, Chapel Hill, NC; <sup>2</sup>UNC Kidney Center, Chapel Hill, NC.

**Introduction:** Genitourinary complications may result from pelvic radiation therapy. We present a patient with history of cervical cancer with radiation-induced inflammation leading to recurrent obstructive nephropathy.

**Case Description:** A 35-year-old woman with history of stage III C1 cervical cancer treated with cisplatin, external beam radiation and brachytherapy presented with flank pain and urinary frequency with acute kidney injury (AKI). Medications included acetazolamide and ibuprofen. Exam revealed BP 150/98, and bilateral flank tenderness. Creatinine was 8.3 mg/dL from baseline 0.6 mg/dL three months prior, just after completing chemoradiation; urine protein-creatinine ratio was 8.1. Renal ultrasound revealed only mild bilateral hydronephrosis. With lack of clear etiology, she was empirically treated with intravenous steroids for suspected NSAID-related acute interstitial nephritis which improved creatinine rapidly (Figure). Kidney biopsy revealed acute tubular necrosis and steroids were discontinued. She was readmitted 3 days later for recurrent flank pain and AKI. Cystoscopy revealed bladder erythema with bullous edema obstructing the ureteral orifices. Prednisone was restarted with a taper, with initial improvement of creatinine but then recurrent AKI. Bilateral percutaneous nephrostomy tubes were placed, followed by ureteral stents with stabilization of creatinine.

**Discussion:** We report a case of severe radiation-induced ureteral and bladder inflammation leading to recurrent obstructive nephropathy three months after radiation. Unique aspects include the early onset, involvement of both ureters and bladder, lack of significant hydronephrosis on imaging and profound initial response to steroids. A high index of suspicion for radiation-related obstructive nephropathy should persist, despite an absence of overt hydronephrosis, when evaluating AKI in patients with prior pelvic radiation.

## FR-PO185

## Haplo-Storm Induced AKI

Marco A. Bonilla, Abhishkek Nimkar, Kenar D. Jhaveri, Ruthee Bayer, Steven Fishbane. *Northwell Health, New Hyde Park, NY.*

**Introduction:** Cytokine release syndrome(CRS) can occur after allogeneic blood or marrow transplantation, but is especially prevalent after HLA-haploidentical (haplo) peripheral blood transplantation (PBT). This is termed haplo-storm. Here we report a case of AKI associated with haplo-storm.

**Case Description:** A 67 year-old male with medical history of WM transformed to lymphoma was admitted for a haplo-identical peripheral blood stem cell transplant (PBST) from his son. He received an immunosuppressive/preparative regimen consisting of fludarabine, cyclophosphamide and IVIG prophylaxis. Day 1 post-transplant, he developed rigors, fever, tachycardia, nausea and shortness of breath. Clinically, there was concern for Haplo-storm. On day 2, AKI was noted. Vital signs remarkable for blood pressure of 155/95 mmHg, afebrile. Physical Exam was remarkable for encephalopathy, coarse breath sounds and sacral edema. Laboratory evaluation showed serum creatinine of 1.98mg/dl(baseline 1.0mg/dl). White blood cell count of <0.1 K/uL, hemoglobin of 7.2g/dl, Platelet count of 8 K/uL. Electrolytes were within normal limits. Alkaline phosphatase of 195 U/L, lactate dehydrogenase 369 U/L, phosphorous 4.8 mg/dl, uric acid 7.1mg/dl. Urinalysis was remarkable for trace protein, large blood with 461 RBC per high field power. A spot urine protein/creatinine ratio of 2.7g/g. No nephrotoxic agents, contrast agent or hypotension as observed. Kidney sonogram ruled out obstruction. Engraftment had not occurred ruling out engraftment syndrome. Tocilizumab 560mg IV X1 was administered. He was presumed to have Haplo-storm induced AKI. His kidney disease was managed with intravenous diuresis to a negative net fluid balance, further doses of cyclophosphamide were held. His kidney function improved within 7 days back to baseline. Dialysis was not necessary.

**Discussion:** CRS is a common complication of patients undergoing haplo-identical PBT; as high as 89% of patients. Data on Haplo-storm, a form of CRS induced AKI in HSCT is limited. Nephrologist should be aware of the risk of AKI in patients undergoing haplo-PBT, complicated by haplo-storm.

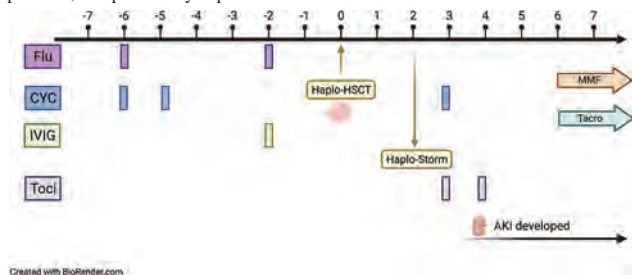

Timeline of AKI

## FR-PO186

## AKI Post SARS-CoV-2 Vaccine in Patients Treated With an Immune Checkpoint Inhibitor (ICPi): Immune Double Whammy!

Richard Baker,<sup>1</sup> Kinjal Gosalia,<sup>2</sup> Kenar D. Jhaveri,<sup>2</sup> Prakash S. Gudsoorkar.<sup>1</sup>  
<sup>1</sup>University of Cincinnati College of Medicine, Cincinnati, OH; <sup>2</sup>Donald and Barbara Zucker School of Medicine at Hofstra/Northwell, New York, NY.

**Introduction:** Immune check point inhibitors (ICPi) have become the first line treatment for most of the cancers and have shown promising results. Vaccine has mitigated the spread of COVID-19 infection, however there are no reported cases in literature of precipitation of AKI in patients treated with ICPI. We describe 3 cases of vaccine induced AIN in patients treated with ICPI. The plausible explanation is amplification of autoimmunity from SARS-CoV-2 vaccine under the influence of ICPI.

**Case Description:** **Pt 1:** 55 year old man on pembrolizumab for lung adenocarcinoma (b/1 SCr 1.1 mg/dL) came with AKI (SCr 7.65 mg/dL) after he received first dose of Pfizer SARS-CoV-2 vaccine a week prior to admission. COVID19 PCR was negative. Kidney biopsy showed AIN. ICPI was stopped and oral prednisone (1 mg/kg) was started. SCr declined sharply. Steroid was tapered over 7 months, SCr improved to 1.7 mg/dL. Rechallenge with ICPI was deferred. **Pt 2:** 68 year old female was on ipilimumab for metastatic melanoma. 10 days after her first dose of Pfizer SARS-CoV-2 vaccine she developed AKI, SCr 3.4 mg/dL (b/1 1.3 mg/dL). COVID19 PCR was negative. Kidney biopsy showed AIN. ICPI was stopped and oral prednisone (1mg/kg) was started. At 5 months her SCr was 1.6 mg/dL on prednisone 5 mg qd, however she died from sepsis and multiorgan failure. **Pt 3:** 65 year old female with h/o bladder cancer on pembrolizumab developed AKI, SCr 2.18 mg/dL (b/1 0.8 mg/dL). 3 weeks prior she got a booster dose of Pfizer SARS-CoV-2 vaccine. COVID19 PCR was negative. ICPI was discontinued. CRP was 40 mg/dL (was < 3mg/dL prior) and urine retinol binding protein to creatinine (uRBP/ Cr) ratio was 3797 mcg/g Cr (normal < 190). Patient declined kidney biopsy. Kidney function returned to baseline in 6 weeks without steroids. The cause of AKI was presumed to be AIN based on the elevated uRBP/Cr ratio.

**Discussion:** A strong immune response from SARS-CoV-2 vaccine combined with an uninhibited immune system from ICPI may have led to an amplification of autoimmunity leading to AIN. We suggest, extra surveillance in patients receiving ICPI after SARS-CoV-2 vaccination is justified, and investigation into the amplification of T-lymphocyte

response from highly immunogenic vaccines in patients receiving ICPI will throw more light on the immunopathogenesis.

## FR-PO187

## Methotrexate Deja Vu: The Solution Is in the Volume!

Fatima Ayub, Yazan A. Bashtawi, Nithin Karakala. *University of Arkansas System, Little Rock, AR.*

**Introduction:** Methotrexate (MTX) has a broad range of antitumor activity. Acute methotrexate toxicity rarely presents as a renal failure. We, hereby present a case of MTX-induced acute renal failure with evidence of MTX-induced tubular injury.

**Case Description:** 74 years old male with a past medical history of hypertension, presented to the emergency department with complaints of altered mentation and recurrent falls. He had a 3-month history of cognitive decline, unsteady gait, and mechanical falls. Over the course of 3 days prior to the presentation, his wife noticed him to be drowsier. Brain imaging showed a lesion in the right frontal lobe followed by a biopsy of the lesion that demonstrated diffuse large B cell lymphoma. He was subsequently started on a chemotherapy regimen with MTX. Following the third dose, the patient developed acute hypoxic respiratory failure with acute kidney injury. Serum creatinine of 4.7 mg/dL (Baseline: 0.9 mg/dl) and a serum MTX level of 107 uMol/L was consistent with MTX toxicity. Urine microscopy revealed MTX crystals. Chemotherapy was discontinued and he underwent emergent hemodialysis (HD) for the management of MTX toxicity. Serum MTX levels after the first dialysis treatment was 74 uMol/L which increased back to 87 uMol/L within 24 hours of the first HD session. He underwent three daily sessions of HD due to the continuous rebound of MTX levels after each session. After his fourth dialysis treatment MTX level was 2.4 uMol/L.

**Discussion:** MTX-induced renal failure is a medical emergency because methotrexate is mainly eliminated by the kidneys. Renal damage is due to the precipitation of methotrexate in the tubules leading to tubular injury. Drug precipitation can often be prevented by hydration and alkalinization of the urine. It is important to note that the volume of distribution of MTX is 1L/Kg. There is a high risk of rebound in serum levels of substances/drugs that have a large volume of distribution after short dialysis sessions. It is extremely important to understand the pharmacokinetics like volume of distribution, and protein binding to optimize the dialysis treatment.

## FR-PO188

## Identification of Pathologic Grading-Related Gene Modules Associated With Kidney Renal Clear Cell Carcinoma Based on Analysis of the Gene Expression Omnibus and The Cancer Genome Atlas

Weijian Xiong, Ying Li, Wu L. Li, Gao Xuan. *Chongqing Hospital of Traditional Chinese Medicine, Chongqing, China.*

**Background:** Renal cell carcinoma (RCC) originates from the renal epithelium and is the most common type of renal cancer with a poor prognosis. As the pathogenesis of kidney renal clear cell carcinoma (KIRC) has not been elucidated, which is necessary to be further explored.

**Methods:** An expression analysis dataset (GSE126964) was downloaded from the GEO database. Differentially expressed genes (DEGs) between KIRC and normal tissue samples were identified using edgeR and limma analysis. Based on the systematic biology approach of WGCNA, a gene co-expression network was constructed to screen potential biomarkers and therapeutic targets of this disease. Gene ontology (GO) and Kyoto Encyclopedia of Genes and Genomes (KEGG) pathway enrichment were performed in the DAVID database. Kaplan-Meier Plotter was used to identify the hub genes associated with overall survival (OS) time of KIRC patients.

**Results:** A total of 1863 DEGs were identified between the two datasets. Ten co-expressed gene modules were identified using the WGCNA method. GO and KEGG analysis findings revealed that the most enrichment pathways included Notch binding, cell migration, cell cycle, cell senescence, apoptosis, focal adhesions and autophagosomes. Twenty-seven hub genes were identified, among which FLT1, HNRNPU, ATP6V0D2, ATP6V1A, and ATP6V1H were positively correlated with the OS rate of KIRC patients.

**Conclusions:** In conclusion, DEGs present in both KIRC and normal kidney tissues, which can be considered as the KIRC biomarkers.

**Funding:** Government Support - Non-U.S.

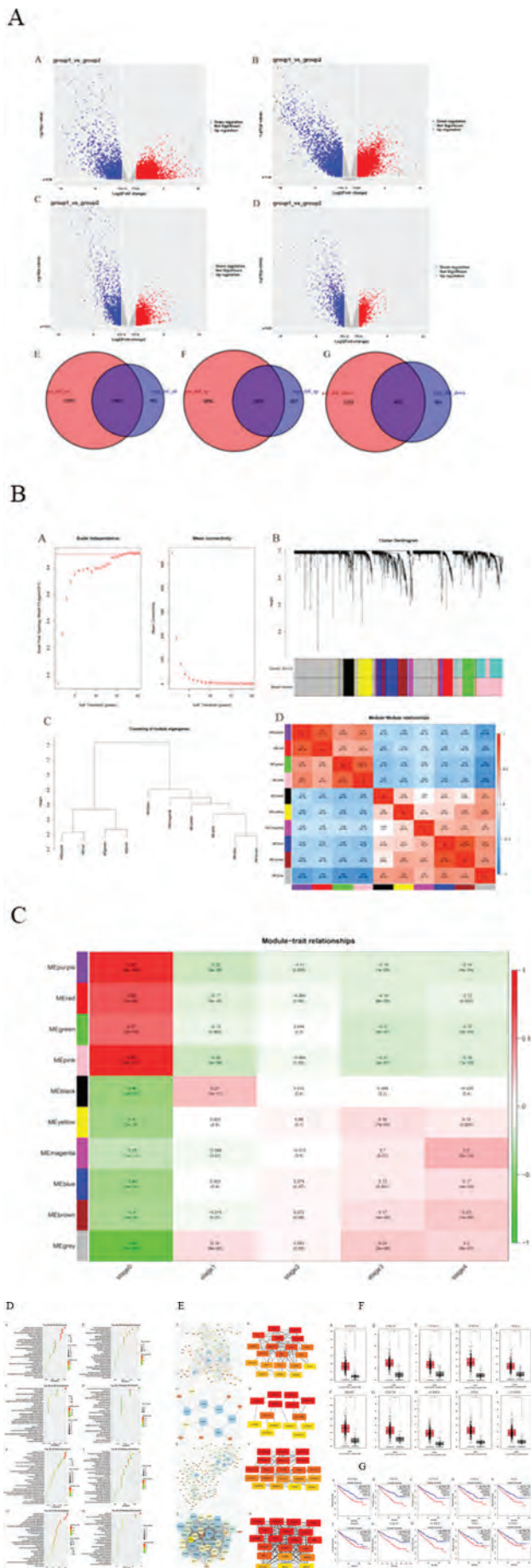

FR-PO189

Lung Cancer Induces Kidney Fibrosis and Primes the Kidney for Cisplatin-Induced Nephrotoxicity

Andrew Orwick, Sophia M. Sears, Mark A. Doll, Parag P. Shah, Levi J. Beverly, Leah J. Siskind. University of Louisville, Louisville, KY.

**Background:** Cisplatin is a common first-line treatment for many solid organ tumors. However, its effectiveness is restricted by dose-limiting nephrotoxicity. Thirty percent of cancer patients treated with cisplatin develop acute kidney injury (AKI), which requires a cessation in treatment. There are no treatment options to prevent or treat cisplatin-induced kidney injury. Historically the models used to study cisplatin-induced AKI involve a single high dose of cisplatin and do not include the co-morbidity of cancer. Our lab designed a low-dose repeated cisplatin model that results in the development of kidney fibrosis and chronic kidney disease (CKD). We hypothesized that including the comorbidity of lung cancer will potentiate the cisplatin-induced fibrosis and CKD.

**Methods:** Eight- to ten-week-old B6;129 mice were randomly assigned into four treatment groups: 1. non-cancer + vehicle, 2. non-cancer + cisplatin, 3. cancer + vehicle, 4. cancer + cisplatin. In the cancer groups, 10,000 lung adenocarcinoma cells were injected subcutaneously seven days prior to the start of cisplatin treatment. Cisplatin or saline was administered via intraperitoneal injection once a week for four weeks. Animals were euthanized 72 hours following their final cisplatin injection.

**Results:** Tumor-bearing vehicle control mice had elevated kidney injury markers, reduced markers of kidney function, and increased kidney fibrosis compared to non-tumor vehicle-treated mice. Cisplatin-induced kidney fibrosis was significantly worsened in tumor-bearing mice compared to mice without tumors.

**Conclusions:** The presence of lung tumors is sufficient to alter kidney biology, induce fibrosis, and reduce renal function, independent of cisplatin treatment, and importantly sensitized the kidneys to cisplatin-induced nephrotoxicity. Understanding the tumor-kidney crosstalk may provide mechanistic insights and uncover novel therapeutic targets for preventing and treating cisplatin-induced AKI and CKD.

**Funding:** NIDDK Support

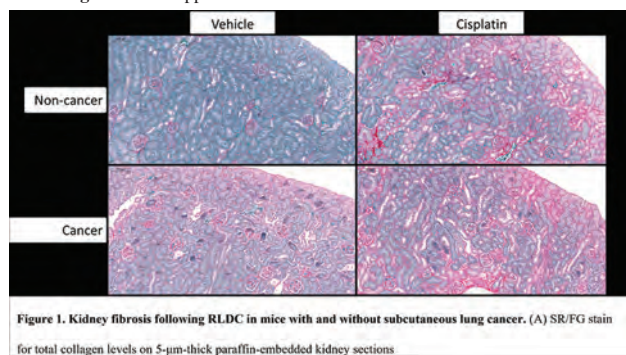

FR-PO190

Clinicopathologic and Proteomic Characteristics of Intratubular Cytoplasmic AL-Amyloidosis

Vincent Javauge,<sup>1,2</sup> Alejandro Best Rocha,<sup>3</sup> Samar M. Said,<sup>2</sup> Dominick Santoriello,<sup>4</sup> Jean Hou,<sup>5</sup> Surendra Dasari,<sup>2</sup> Jason D. Theis,<sup>2</sup> Julie A. Vrana,<sup>2</sup> Ibrahim Batal,<sup>4</sup> Christopher P. Larsen,<sup>3</sup> Glen S. Markowitz,<sup>4</sup> Vivette D. D'Agati,<sup>4</sup> Ellen D. Mcphail,<sup>2</sup> Nelson Leung,<sup>2</sup> Samih H. Nasr.<sup>2</sup> <sup>1</sup>Centre Hospitalier Universitaire de Poitiers, Poitiers, France; <sup>2</sup>Mayo Clinic Minnesota, Rochester, MN; <sup>3</sup>Arkana Laboratories, Little Rock, AR; <sup>4</sup>Columbia University, New York, NY; <sup>5</sup>Cedars-Sinai Medical Center, Los Angeles, CA.

**Background:** AL-amyloid deposits have been described in all compartments of the kidney. However, intratubular cytoplasmic AL amyloidosis (ITC-AL) is exceedingly rare and only described in few case reports.

**Methods:** We retrospectively reviewed the pathology archives at Mayo Clinic, Columbia University, Arkana Laboratories and Cedars-Sinai Medical Center from 2006-2021 for ITC-AL.

**Results:** Twenty-one patients (71% female, 58% Caucasian, median age 65 years) were included (0.003% of renal amyloidosis). Nineteen presented with AKI and 2 with CKD stage 3, without evidence of Fanconi syndrome. By light microscopy, the intracytoplasmic amyloid inclusions were black on silver stain, PAS-negative and trichrome-blue. They were identified in both proximal and distal tubular cells (n=12), in proximal tubular cells alone (n=5) or distal tubular cells alone (n=4). Ultrastructurally, these inclusions appeared membrane-bound consistent with intralysosomal localization. Concurrent cast nephropathy was present in 18 cases (amyloidogenic in 15). By immunofluorescence, amyloid deposits stained for lambda (n=18) or kappa (n=3). No patient had glomerular or interstitial amyloid deposits while 2 had vessels involvement. Extrarenal amyloid deposits were found in 3 cases. Proteomic analysis of kidney amyloid deposits identified a single light chain variable gene segment in all tested cases (IGLV1-47 in 2, IGLV1-44 in 1 and IGLV3-21 in 1). None had the glomerulopathic IGLV6-57. The underlying hematologic condition was multiple myeloma in 13/13 cases (symptomatic in 11). Patients were treated with bortezomib- (n=11) or lenalidomide-based (n=2) regimens followed by autologous stem cell transplant in 2. After a median follow-up of

14 months (range 1-51), 1 died one month after diagnosis, 4 progressed to ESKD (3 of them died) and 6 had partial recovery of kidney function.

**Conclusions:** ITC-AL occurs mostly concurrent with cast nephropathy and thus presents with AKI. Some cases are associated with extrarenal involvement by amyloidosis. Whether the amyloid fibrils are formed within the cells from reabsorbed light chains or result from phagocytosis of already formed intratubular luminal fibrils remains to be determined.

**FR-PO191**

**AA Amyloidosis Associated With Cancers**

Joyita Bharati,<sup>1,2</sup> Tanazul T. Pariswala,<sup>1</sup> Hassan Izzedine,<sup>3</sup> Kenar D. Jhaveri.<sup>1</sup>  
<sup>1</sup>Northwell Health, New Hyde Park, NY; <sup>2</sup>Post Graduate Institute of Medical Education and Research, Chandigarh, India; <sup>3</sup>Hopital des Peupliers, Paris, France.

**Background:** AA amyloidosis commonly results from chronic inflammatory conditions. Data on cancer associated AA amyloidosis is lacking.

**Methods:** We performed a descriptive systematic analysis of AA amyloidosis associated with cancers and its treatment. PubMed database was searched for English language literature using keywords- localized AA amyloidosis, systemic AA amyloidosis, cancer, solid cancer, carcinoma, malignancy, hematological malignancy, leukemia, lymphoma, tumors, cancer chemotherapy, cancer immunotherapy, and cancer drugs.

**Results:** Only case reports and case-series were identified. A total of 52 case reports and 3 case series with adequate information were included and a summary of the findings is provided. In two autopsy series evaluating AA amyloidosis, 13 and 7 cases had solid cancers. Renal cell cancer (RCC) was noted in 45.5% and 25% of these cases, the most common solid cancer associated with AA amyloidosis. In addition, 20 clinical cases of RCC were reported to be associated with AA amyloidosis. All of these were localized renal tumors, except 1 case with metastatic disease. Clear cell carcinoma was the most common histology of RCC associated with AA amyloidosis. There were case reports (1 or more) describing other solid cancers with AA amyloidosis like- lung cancer (6), gastrointestinal stromal tumors with high mitotic activity (2), sarcoma (2), uterine leiomyosarcoma (1), bladder carcinoma (2), ovarian carcinoma (1), and basal cell carcinoma of skin (3). Patients with solid cancers and AA amyloidosis frequently presented with nephrotic syndrome and kidney dysfunction rather than symptoms from the tumor directly. Among hematological malignancies, 12 cases of clonal B-cell/plasma cell dyscrasia, 5 cases of lymphoma, 1 case of chronic myeloid leukemia, and 1 case of chronic lymphocytic lymphoma were reported to be associated with AA amyloidosis. Three cases were identified to have immune checkpoint inhibitors, associated AA amyloidosis

**Conclusions:** AA amyloidosis can be associated with underlying solid cancers, hematological cancers, and immunotherapy. AA amyloidosis should be considered in the differential diagnosis for nephrotic syndrome with or without kidney dysfunction in patients with cancers.

**FR-PO192**

**Pro-Inflammatory Urinary mRNA Profile in Allogeneic Stem Cell Transplant Patients With AKI**

Victoria Gutgarts,<sup>1,2</sup> Insara Jaffer Sathick,<sup>1,2</sup> Carol Y. Li,<sup>2</sup> Annelie G. Clurmaan,<sup>1</sup> Supriya Gerardine,<sup>1,2</sup> Michael Scordo,<sup>1</sup> Justine Jorgensen,<sup>1</sup> Jessica M. Abukoush Szczerba,<sup>1</sup> Manikkam Suthanthiran,<sup>2</sup> Thangamani Muthukumar,<sup>2</sup> Edgar A. Jaimas,<sup>1,2</sup> <sup>1</sup>Memorial Sloan Kettering Cancer Center, New York, NY; <sup>2</sup>Weill Cornell Medicine, New York, NY.

**Background:** Allogeneic hematopoietic cell transplantation (allo-HCT) is an effective treatment for hematologic malignancies. However, allo-HCT has risk of acute kidney injury (AKI) in as many as 80% of patients within the first 100 days. The etiology of AKI is multifactorial but experimental studies suggest a role for immune mediated mechanisms which may have therapeutic implications. We hypothesized that the urinary cell mRNA expression of HCT recipients that develop AKI has higher levels of mRNA for genes associated with inflammation and tubular injury compared to those without AKI.

**Methods:** We prospectively studied a cohort of patients undergoing their first allo-HCT at MSKCC. Urine collections were performed at baseline, weekly while inpatient and every 3 weeks until day 100. AKI was defined as  $\geq 7$ -day elevation of  $\geq 1.5$ x baseline serum creatinine. Urine samples closest to time of AKI and matched samples from patients without AKI were analyzed. Absolute quantification of a panel of mRNAs (T cell marker CD3e, proinflammatory chemokine CXCL10/IP10, tubular markers NKCC2, E-cadherin, VIM, and TGFb1) and 18SrRNA were assessed in the urinary cells by RT-qPCR assay. We calculated the validated CTOT-04 (Suthanthiran et al, N Engl J Med 2013) urinary cell biomarker score.

**Results:** A total of 12 urine samples were analyzed, 6 patients with AKI and 6 patients without AKI. The table below shows the AKI group had a higher median absolute copy number per microgram of mRNA for all the genes tested.

**Conclusions:** Allo-HCT recipients who develop AKI have a urinary cell mRNA profile suggestive of pro-inflammatory mechanisms of injury based on higher level of expression of inflammatory and tubular genes. Ongoing analysis of additional prospectively collected samples will allow further characterization of this profile and may result in novel non-invasive tests for identification of patients at high risk for AKI and precision therapeutics.

Urinary Cell Levels of mRNAs in HCT Recipients With AKI Versus Time Matched Controls Without AKI

	18S rRNA	TGFb1	CD3e	IP10	E-cadherin	NKCC2	Vimentin	CTOT-04 - Three Gene Signature Score (Allograft Rejection Score: -1.213)
AKI Group (copies/ug total RNA; Median [IQR]; n=6)	3.32E+09 (1.41E+09 - 6.99E+09)	21100 (35900)	1220 (383.5 - 4673)	1340 (668.8 - 8393)	6530 (656.0 - 16215)	1875 (786.5 - 5303)	331000 (52805 - 980500)	-0.990 (-1.643 to 0.1123)
No AKI Group (copies/ug total RNA; Median [IQR]; n=6)	1.69E+09 (3.33E+08 - 3.40E+09)	3810 (1250 - 16475)	180.8 (12.5 - 16288)	721 (44.68 - 14280)	1580 (1031 - 3333)	1434 (209.5 - 4478)	29900 (15305 - 151500)	-2.416 (-5.819 to 0.07425)
Fold Change AKI/ No AKI	1.96E+00	5.54	6.75	1.86	4.13	1.32	11.1	2.44

**FR-PO193**

**Soluble Interleukin 2 Receptor as a Potential Biomarker for Immune Checkpoint Inhibitor Nephritis (ICI-AIN)**

Qiyu Wang,<sup>1</sup> Harish Shanthanu Seethapathy,<sup>1</sup> Rex N. Smith,<sup>1</sup> Ivy A. Rosales,<sup>1</sup> Robert B. Colvin,<sup>1</sup> Sandra Herrmann,<sup>2</sup> Jocelyn Farmer,<sup>1</sup> Meghan E. Sise.<sup>1</sup>  
<sup>1</sup>Massachusetts General Hospital, Boston, MA; <sup>2</sup>Mayo Foundation for Medical Education and Research, Rochester, MN.

**Background:** Soluble interleukin 2 receptor (sIL-2R), a marker of T-cell activation, is used to monitor disease activity for autoimmune conditions and congenital immunodeficiencies. We hypothesize that sIL-2R may be elevated in patients with ICI-AIN and potentially serve as a diagnostic biomarker.

**Methods:** Retrospective cohort study of patients diagnosed with ICI-AIN (histologic or clinical diagnosis) who had sIL-2R measured as part of work-up. We prospectively enrolled 2 control cohorts: 1) Patients receiving ICIs for cancer with normal kidney function ("healthy ICI-treated controls"); 2) Patients not receiving ICIs who were hospitalized with hemodynamic acute kidney injury (AKI). Patients were excluded if they had active infection or received immunosuppression within 2 weeks of sample collection. sIL-2R levels were standardized using the fold change of the upper limit of normal (ULN) of the CLIA-certified assay. Receiver operating curve (ROC) was generated comparing sIL-2R level between "ICI-AIN" and "hemodynamic AKI controls", and "ICI-AIN" and "healthy ICI controls". Using archived biopsy samples, we compared IL2R- $\alpha$  gene expression measured by Nanostring in patients with ICI-AIN (N=22), acute tubular injury (ATI, N=9) and healthy kidney donors (N=11).

**Results:** sIL-2R levels were significantly higher in ICI-AIN (N=21, median 2.5 fold-ULN, IQR 1.9-3.3), compared to "healthy ICI-treated controls" (N=9, median 0.7 fold-ULN, IQR 0.5-0.9) and "hemodynamic AKI controls" (N=6, median 0.9 fold-ULN, IQR 0.7-1.1). (Figure 1) ROC analysis yielded an optimal cut-point of 1.75-fold ULN of sIL-2R for differentiating ICI-AIN and hemodynamic AKI controls, with specificity of 100% (95% CI, 61%-100%) and sensitivity of 81% (95% CI, 60%-92.3%). IL2R- $\alpha$  gene expression was significantly higher in kidney tissue in patients with ICI-AIN compared to ATI and healthy kidney donors. (Figure 2)

**Conclusions:** sIL-2R is a promising biomarker for ICI-AIN that should be validated in future studies with prospective, consecutive sampling.

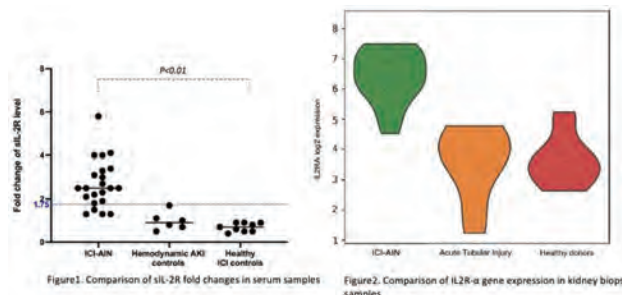

**FR-PO194**

**Cellular Senescence Is Associated With CKD Progression in Childhood Cancer Patients With Karyomegalic Interstitial Nephropathy (KIN)**

Mandy G. Keijzer-Veen,<sup>1</sup> Sebastiaan Knoppert,<sup>2</sup> Floris Valentijn,<sup>2</sup> M.M. van den Heuvel-Eibrink,<sup>3</sup> Gerrit V. Berg,<sup>1</sup> Marc Lilien,<sup>1</sup> Lianne M. Haveman,<sup>3</sup> Marijn F. Stokman,<sup>2</sup> Geert O. Janssens,<sup>2,3</sup> Roel Broekhuizen,<sup>2</sup> Roel Goldschmeding,<sup>2</sup> Tri Q. Nguyen.<sup>2</sup> <sup>1</sup>Universitair Medisch Centrum Utrecht - Locatie Wilhelmina Kinderziekenhuis, Utrecht, Netherlands; <sup>2</sup>Universitair Medisch Centrum Utrecht, Utrecht, Netherlands; <sup>3</sup>Prinses Maxima Centrum voor Kinderoncologie, Utrecht, Netherlands.

**Background:** Patients with KIN show a clinical picture of interstitial nephropathy with enlarged, irregular and hyperchromatic nuclei of tubular epithelial cells (TECs). The histologic pattern was first described in patients with FAN1 mutations with defective DNA

damage repair, but has also been infrequently reported in children treated for childhood cancers with the alkylating agent ifosfamide.

**Methods:** We included the kidney biopsies of all children treated for childhood cancer in the Princess Máxima Center for Pediatric Oncology with progressive CKD with low molecular weight proteinuria of unknown cause between 2018-2021. Features of karyomegaly and senescence were identified in TECs by automated morphometric assessment of nuclear size distribution, and immunohistochemical markers for DNA damage ( $\gamma$ H2AX), cell-cycle arrest (p21+, Ki67-), and nuclear lamina decay (loss of lamin B1).

**Results:** KIN could be diagnosed in all six children, according to the above described features. (Figure 1A-C) The number of p21 positive cells by far exceeded the typically very small numbers of truly karyomegalic cells. P21 positive TECs were found to contain significantly less lysozyme, testifying to defective resorption as an explanation of the consistent finding of LMW proteinuria. Moreover, in the 5 patients with the largest nuclei, the percentage of p21-positive TECs showed strong inverse correlation with change in eGFR from biopsy to last follow-up ( $R^2=0.93$ ,  $p<0.01$ ).

**Conclusions:** Karyomegaly and cellular senescence-associated tubular dysfunction appear to be a more prevalent cause of otherwise unexplained CKD and LMW proteinuria in children treated with ifosfamide. This finding may have important implications for future personalized treatment strategies.

**Funding:** Private Foundation Support

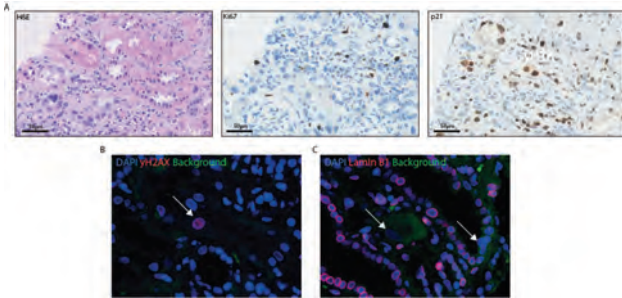

**Figure 1A.** Enlarged nuclei in KIN are Ki67 negative, p21 positive, (B-C)  $\gamma$ H2AX positive, and show less LaminB1 staining.

**FR-PO195**

**Kidney Intravascular Large B-Cell Lymphoma: A Multi-Institutional Experience**

Perna Rastogi,<sup>1</sup> Audai A. Alrwashdeh,<sup>1</sup> Mohammad Obeidat,<sup>1</sup> Tiffany Caza,<sup>2</sup> Mercury Y. Lin,<sup>3</sup> Christopher P. Larsen,<sup>2</sup> Dao-Fu Dai.<sup>1</sup> <sup>1</sup>The University of Iowa Hospitals and Clinics Department of Pathology, Iowa City, IA; <sup>2</sup>Arkana Laboratories, Little Rock, AR; <sup>3</sup>Cedars-Sinai Medical Center, Los Angeles, CA.

**Background:** Intravascular large B-cell lymphoma (IVLBCL) is an aggressive variant of large B-cell lymphoma, with growth of neoplastic cells within the blood vessels. Kidney involvement is rare. Prognostic features from a multi-institutional retrospective review are presented here.

**Methods:** Kidney biopsies with a diagnosis of kidney IVLBCL were reviewed till Dec 2021. We identified 17 cases with mean age of  $64.7 \pm 7.9$  years with 52.9% (9/17)  $\sigma$  and 53 more (total 70) from literature review with mean age  $61.1 \pm 11.4$  (50%  $\sigma$ ). Findings included fever, anemia, acute kidney injury, 88% of our 17 cases, 69% for all, proteinuria in 65% of our cases, 83.3% for all, hematuria in 35.3% of our patients, unclear in others & Nephrotic range proteinuria in 11.7% of our patients & 27.2% of all cases.

**Results:** Of 40 patients with available data, the median & interquartile range of serum creatinine was 1.75 [1.17, 3.25] mg/dL. Biopsy showed glomerular infiltration by neoplastic lymphoid cells (yellow  $\rightarrow$  Fig 1) in 84.6% cases, cells in the tubulointerstitium (56.7%) and peritubular capillaries. Arteries or veins were involved by neoplastic lymphoid cells in 13.11%. Of 58 cases with data 43.1% showed infiltration into bone marrow, liver, spleen, CNS, lungs & skin. IVLBCL expresses mature B-cell antigens, such as CD20, CD79a, PAX-5 & non-germinal center immunophenotype with CD10- and MUM1+. Follow-up data available in 48 patients showed median survival of ~20 months after diagnosis, of which 6 (12.5%) were post-mortem, with extensive extra-renal involvement. Multivariate Cox regression analysis showed extrarenal involvement is a significant predictor of mortality, with HR: 5.97 (95% CI:1.72, 20.7,  $p=0.005$ ), but not serum Cre: 1.03 (.54, 1.97,  $p=0.9$ ), after controlling for age gender.

**Conclusions:** Kidney IVLBCL is rare, presenting with fever, anemia, AKI, elevated serum creatinine & proteinuria. Median survival is 20 months & extrarenal involvement indicating extensive disease is associated with worse outcome.

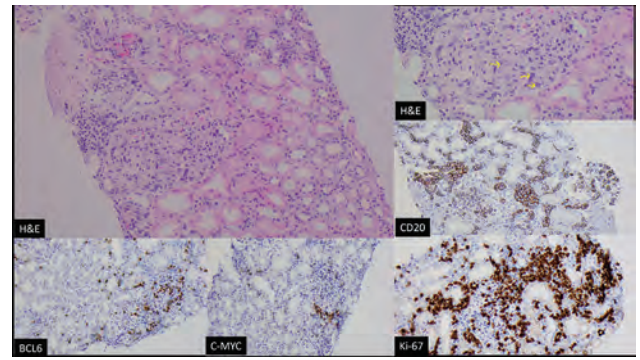

**FR-PO196**

**Pilot Study of High Dose Intravenous Magnesium in Mesothelioma Patients Receiving Surgery With Hyperthermic Intraoperative Chemotherapy With Cisplatin (HIOCC)**

Arunima Mariya Jose,<sup>1,2</sup> David E. Leaf,<sup>1</sup> Shruti Gupta.<sup>1</sup> <sup>1</sup>Brigham and Women's Hospital, Boston, MA; <sup>2</sup>Florida State University College of Medicine, Tallahassee, FL.

**Background:** HIOCC, which involves the administration of heated cisplatin solutions during surgical resection of tumors, is associated with a >50% risk of AKI postoperatively. One potential mechanism for cisplatin-associated-AKI (CP-AKI) is the reduced expression and function of magnesium (Mg) transporters in the kidneys. Mg deficiency has been shown to increase renal CP accumulation in proximal tubular cells by downregulating transporters expressed on the apical side of these cells. Administration of Mg restores the expression of these transporters, allowing cisplatin to be secreted into the tubular lumen and then excreted in the urine. We, therefore, aimed to conduct a pilot study testing whether intravenous (IV) Mg reduces the risk of AKI in mesothelioma patients receiving HIOCC.

**Methods:** We conducted a phase 1 pilot study where we administered high doses of IV Mg at 0.5 g/hour for 36 hours (18 g total) in 5 patients receiving HIOCC. The Mg infusion started the night prior to surgery and continued until the morning of postoperative day 1. Serial Mg levels were monitored throughout the infusion. AKI was defined according to the Kidney Disease Improving Global Outcomes criteria as a 1.5-fold rise in serum creatinine (SCr) in the 7 days following the surgery. Adverse events (e.g., flushing, arrhythmia) were recorded.

**Results:** All 5 patients were male, White, with a median age of 74 years (interquartile range, 67-79), and a median baseline SCr of 1.1 mg/dL (IQR, 1-1.1). Among the 5 patients who completed the study, median postoperative Mg levels were 2.4 mg/dL (IQR, 2-2.9) (Figure). None of the 5 patients developed AKI, and no adverse events were reported.

**Conclusions:** IV Mg is safe and well-tolerated, and may be associated with a decreased risk of AKI; however, these findings need to be corroborated by a larger randomized controlled trial.

**Funding:** NIDDK Support

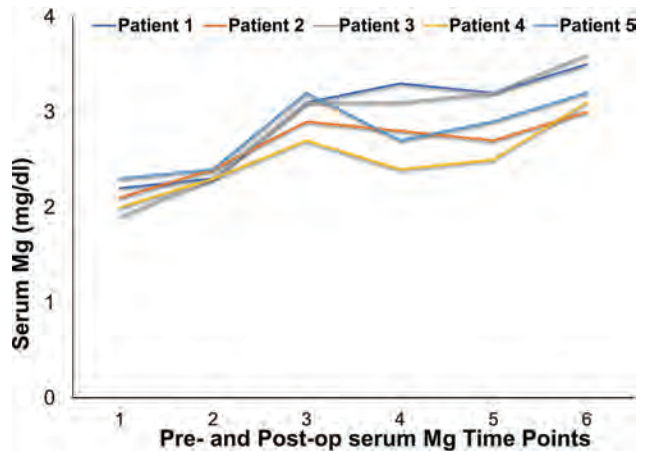

Median Pre- and Postoperative Magnesium Levels (n=5)

## FR-PO197

**High-Dose Methotrexate (HDMTX) Induced Nephrotoxicity: Glucarpidase or Dialysis?**

Abhinaya Sridhar,<sup>1,2</sup> Uzma Malik,<sup>1,2</sup> Aromma Kapoor,<sup>1,2</sup> <sup>1</sup>Westchester Medical Center, Valhalla, NY; <sup>2</sup>New York Medical College, Valhalla, NY.

**Introduction:** HDMTX induced Acute Kidney Injury (AKI) can lead to delayed renal clearance of MTX causing life threatening toxicities. Treatment options include high-flux hemodialysis (HFHD) and Glucarpidase. We report a case of MTX induced AKI which was successfully treated with Glucarpidase.

**Case Description:** 75 year old woman admitted with CNS lymphoma, planned for 6 cycles of HDMTX based chemotherapy. She received 3 cycles with no side effects. Urine pH and MTX levels were monitored with levels peaking at 2.2, 7.7 and 7.5 umol/L with no AKI. During her 4<sup>th</sup> cycle, she was found to have AKI on day 5. Blood work showed BUN 23 mg/dL and creatinine (Cr) 1.46 mg/dL. She had been normotensive with no administration of nephrotoxic medications or contrast except HDMTX. MTX level was found to be 110.5 umol/L. She was started on hydration, sodium bicarbonate and leucovorin was increased. She received one dose of Glucarpidase 50 units/kg, 52 hours after HDMTX infusion with decrease in MTX level to 21.7 umol/L. MTX levels were closely monitored and continued to downtrend. Urine pH levels were monitored to keep pH >7. Patient did not need further doses of Glucarpidase and decision was made to not initiate HD. She was discharged in renal recovery.

**Discussion:** Routine monitoring of MTX levels can lead to early recognition of AKI. Glucarpidase is an enzyme that cleaves MTX into inactive metabolites providing an alternative route for elimination. Case reports describe successful treatment of AKI with its use in addition to leucovorin rescue, hyperhydration and urine alkalization. Our patient was treated successfully with the same regimen with absence of other MTX toxicities. In the above reports, there was no rebound in MTX levels after single dose Glucarpidase as seen in our patient also. Another treatment option is HFHD, but reports show that MTX levels rebound and require repeat sessions. Recently published guidelines recommend the use of Glucarpidase for HDMTX related AKI but MTX levels not corresponding to the algorithm is a limitation to its use. Despite this, we hypothesize that its use can help avoid HD. Randomized controlled trials are warranted to assess its efficacy on clinically relevant outcomes. **Learning objectives** Routine monitoring of MTX levels can lead to early recognition of AKI. Prompt intervention with Glucarpidase can successfully treat AKI with no rebound in MTX levels and eliminate the need for HD.

## FR-PO198

**Immune Checkpoint Inhibitor Induced Multi Organ Sarcoid-Like Reaction**

Ashwin Thatti,<sup>1</sup> Amanda Tchakarov,<sup>1</sup> Maria E. Cabanillas,<sup>2</sup> Ala Abudayyeh,<sup>2</sup> <sup>1</sup>The University of Texas Health Science Center at Houston, Houston, TX; <sup>2</sup>The University of Texas MD Anderson Cancer Center, Houston, TX.

**Introduction:** With the expansive use of Immune Checkpoint Inhibitors (ICI) there has been increasing adverse events that have been recognized. Autoimmune disease induction post ICI exposure has been reported with the more common diseases such as arthritis, myositis, Sjogren's syndrome or vasculitis. A rarer entity is sarcoidosis which has been reported as granulomatous lesions in the lung, lymph nodes and skin. Here we describe two cases of multiorgan ICI induced Sarcoid-Like reactions (SLR) specifically in the kidney.

**Case Description:** Case 1: 62 year old male with history of stage IV metastatic melanoma completed 4 cycles of Ipilimumab/Nivolumab admitted for acute kidney injury (AKI) and shortness of breath (SOB). Serum Creatinine was 2.8mg/dl (baseline 1.2). UA was bland with positive urine eosinophils. A kidney biopsy showed AIN with Necrotizing granulomas. Troponins were elevated and echocardiogram showed a reduced ejection fraction. An endomyocardial biopsy showed cardiac sarcoidosis. He had a new pulmonary nodule, which was biopsied and showed necrotizing granulomatous inflammation. Steroids were started for 3 months, with AKI resolution and improved cardiac function and sarcoid remission. Case 2: 49 year old female with history of stage IV anaplastic thyroid carcinoma and was treated for 4 years prior on dabrafenib/trametinib and pembrolizumab. She developed SOB and CT of the chest showed several pulmonary nodules. A biopsy showed granulomatous inflammation concerning for sarcoidosis. Pembrolizumab was stopped and she was treated with steroids and her SOB subsequently improved. Multiple hypodense lesions over the kidney were seen incidentally on a CT scan a year after steroid treatment, with normal kidney function and bland urine. A kidney biopsy showed chronic and granulomatous interstitial inflammation. She has been in remission from her cancer and sarcoid manifestations.

**Discussion:** We have presented two unique cases of multiorgan sarcoidosis induced after ICI exposure successfully treated with steroids with continued tumor remission. Previous literature about ICI induced SLR has shown that these lesions improve upon discontinuation of ICI and/or antisarcoid treatment. Treatment might not be needed and ICI can be continued if there is no evidence of end organ damage. SLR can mimic disease progression and biopsy of new lesions seen post ICI usage should be considered.

## FR-PO199

**A Rare Case of Membranoproliferative Glomerulonephritis (MPGN) With Bevacizumab**

Prashamsa Shenoy, Li Li, JingJing Zhang, *Thomas Jefferson University, Philadelphia, PA.*

**Introduction:** Bevacizumab is an anti-VEGF target chemotherapy often associated with proteinuria, hypertension and thrombotic microangiopathy (TMA). We report a case of immune complex-mediated membranoproliferative glomerulonephritis (IC-MPGN) following bevacizumab therapy.

**Case Description:** A 58-year-old female patient diagnosed with endometrial carcinoma 4 years ago presented with a persistent rise in creatinine (Cr) to 1.4 from 0.7 baseline, while on bevacizumab 15mg/Kg/3 weeks for 10 months. She was previously treated with carboplatin, paclitaxel, docetaxel, bevacizumab and dexamethasone. Her urinalysis showed 1+ proteinuria, sterile pyuria and persistent eosinophilia. Bevacizumab was discontinued and kidney biopsy was pursued. Work up including ANA, ANCA, dsDNA, anti-Ro/ La, complements, hepatitis and HIV serologies were unremarkable. Biopsy revealed thickening of glomerular basement membrane (GBM), endocapillary and mesangial hypercellularity with lobulated pattern consistent with MPGN (Fig A). There was focal double contouring of the GBM but no evidence of fibrinoid necrosis or thrombi. Immunofluorescence (IF) showed capillary wall staining for IgG, IgA, IgM, C3, C1q, kappa and lambda in 2-3+ range. Electron microscopy demonstrated extensive subendothelial and mesangial electron-dense deposits (EDD) with mild podocytopeny (Fig B). The overall features diagnostic of IC-MPGN. She was started on prednisone 40mg, tapered in 3 months with improvement in Cr, proteinuria and remained stable despite switching to pembrolizumab and lenvatinib.

**Discussion:** Bevacizumab is often associated with TMA developing within a year and demonstrates endothelial swelling, mesangiolysis and fibrinoid necrosis. This case had classic IC-MPGN with full house IF and EDD, perplexing us if the culprit was bevacizumab or the solid tumor itself. But her kidney injury was temporally related to bevacizumab and followed discontinuation of dexamethasone suggesting potential development of antibodies to bevacizumab. Therefore, clinicians should be vigilant and practice low threshold for biopsy with patients on bevacizumab for appropriate management.

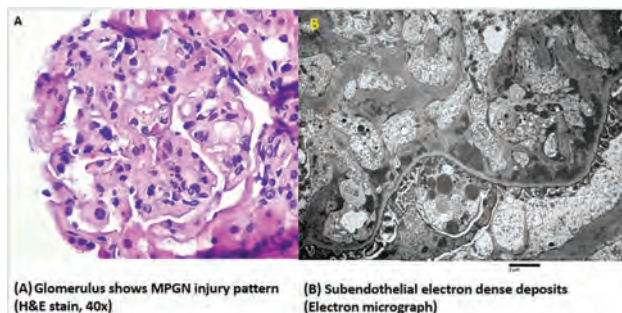

## FR-PO200

**Minimal Change Disease With Immune Checkpoint Inhibitors**

Rama Kethineni, Ritika Ohri, Marc Barry, Sarah Gilligan, Josephine Abraham. *University of Utah Health, Salt Lake City, UT.*

**Introduction:** Immune checkpoint inhibitor (ICI)-related acute kidney injury (AKI) occurs in 2-5% of patients treated with these agents. Acute interstitial nephritis is the most common finding on renal biopsy but glomerular disease accounts for approximately 10% of ICI-related AKI. We present a case of minimal change disease secondary to ICI.

**Case Description:** A 72-year-old male with history of testicular cancer s/p orchiectomy and chemoradiation in 2004, nephrolithiasis, GERD, and newly diagnosed metastatic melanoma presented with poor oral intake, cough, and shortness of breath. The patient had been taking omeprazole and was on the 2<sup>nd</sup> cycle of ipilimumab and nivolumab. Labs showed hemoglobin 10.9 mg/dl, Platelets 144, Albumin 1.9 g/dl, BUN 64 mg/dl, and creatinine 2.56 mg/dl from baseline of 1.2 mg/dl. Urinalysis showed protein and 6 RBCs, eumorphic on microscopy. UACR was 7390 mg/g with a UPCr of 9989 mg/g. Serology was negative for ANA, ANCA, HIV, hepatitis with normal C3, C4, and PLA2R 1:10. Renal ultrasound showed no obstruction. Renal biopsy showed minimal change disease with diffuse foot process effacement along with ATN and less than 10% IFTA. His creatinine worsened despite holding chemotherapy to 6.5 with BUN of 150 mg/dl with uremia requiring RRT. Prednisone was initiated at 1 mg/kg with gradual renal recovery and discontinuation of dialysis after 2 sessions. Prednisone was tapered over 4 months with resolution of albuminuria but with new baseline creatinine of 1.5-1.6 mg/dl. He was rechallenged with a Nivolumab-only regimen and developed hepatitis and worsening renal failure.

**Discussion:** Minimal change disease is a rare complication of ICI but should be considered in the differential diagnosis of ICI-related AKI. Treatment with steroids often results in at least partial renal recovery but many questions remain regarding prognosis and re-initiation of ICI.

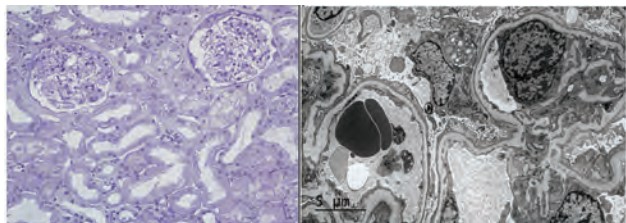

**FR-PO201**

**Immunotherapy-Induced Glomerulonephritis: Whodunit?**

Brian Benes, Kate-Lynn Muir, Kirk W. Foster, Alissa S. Marr, Ketki K. Tendulkar. *University of Nebraska Medical Center, Omaha, NE.*

**Introduction:** Kidney immune-related adverse events are well recognized side effects of immune checkpoint inhibitor therapy. We present a unique case of evolving immune related adverse events with ongoing melanoma therapy.

**Case Description:** A 72-year-old man was referred for evaluation of acute kidney injury after being treated with adjuvant nivolumab for malignant melanoma. Serum creatinine increased from 1.0 mg/dL to 3.1 mg/dL with urine protein/creatinine ratio 0.3 mgTP/mgCR, without hematuria. A presumed diagnosis of acute interstitial nephritis was made based on eosinophiluria. Nivolumab was stopped and he was started on prednisone 60 mg daily and lisinopril. After 1 month, creatinine improved to 1.2 mg/dL. Six months later he was started on talimogene laherparepvec (T-VEC) for progressive melanoma. Four months into treatment, he developed edema and proteinuria (UPCR- 10.5 mgTP/mgCR), with a rise in creatinine to 1.8 mg/dL. Kidney biopsy showed mesangio- and focal endocapillary proliferative glomerulonephritis. Immunofluorescence (IF) was positive for C3 and trace C1q. Electron microscopy had electron dense mesangial deposits. Serum complement levels were normal and functional complements were negative. T-VEC was stopped due to melanoma progression. He was treated with rituximab 1 g weekly for 4 weeks, methylprednisolone IV 1 g daily for 4 days. Proteinuria improved over 6 months to 0.4 with creatinine 1.4 mg/dl.

**Discussion:** Programmed death 1 inhibitors (PD1i) have been described to cause acute tubulointerstitial nephritis (ATIN) and glomerular injury. Improvement after stopping nivolumab and onset of proteinuria after T-VEC administration raises the possibility of T-VEC induced immune mediated effect. ATIN is the most common renal adverse event associated with PD1i (93% in a recent series). Although, C3 glomerulopathy has been reported with nivolumab. Typically, renal injury often occurs within 2-4 weeks of cessation of therapy. T-VEC is an oncolytic virus used in unresectable metastatic melanoma and immune mediated adverse events are less common. Two other case reports of GN associated with T-VEC, one of which had minimal change GN with focal mesangial immune deposition with IgM and C1q on IF have been reported. Delayed onset kidney injury from nivolumab cannot be excluded or these findings could be due to T-VEC. T-VEC should be considered a possible cause of immune adverse events.

**FR-PO202**

**Role for Calcineurin Inhibitor in Tyrosine Kinase Inhibitor-induced Focal Segmental Glomerulosclerosis**

Benjamin R. Teruel, Evelyn Bruner, Blaitin A. McMahon. *Medical University of South Carolina, Charleston, SC.*

**Introduction:** As the use and indications of anti-angiogenic therapies such as vascular endothelial growth factor (VEGF) and tyrosine kinases inhibitors (TKI's) continues to expand, clinicians will be faced with an increase in adverse kidney events associated with these therapies. Focal segmental glomerulosclerosis (FSGS) and thrombotic microangiopathies are well recognized renal pathologies identified in patients receiving anti-angiogenic therapy. Options to treat the nephrotoxicity induced by of these agents include discontinuation or dose reduction of the anti-angiogenic therapy or a trial of corticosteroids (in the case of FSGS).

**Case Description:** We describe a 74-year-old Caucasian man with metastatic papillary thyroid carcinoma who developed nephrotic syndrome, hypertension, and peripheral edema following treatment with Lenvatinib, 20mg. Renal biopsy revealed focal segmental glomerulosclerosis. Partial resolution of proteinuria (>1.0g/g) was achieved via temporary discontinuation of Lenvatinib and treatment with oral prednisone. Subsequently, tumor burden increased off Lenvatinib and a collective decision was made to resume this medication at a lower dose. Unfortunately, proteinuria increased to nephrotic range (>4.0g/g) following resumption of Lenvatinib, 14mg. Over the next three months the patient went into a complete clinical remission of his nephrotic syndrome following administration of the calcineurin-inhibitor, tacrolimus and allowed ongoing concurrent use of Lenvatinib.

**Discussion:** There are many documented cases of TKI-induced FSGS resistant to glucocorticoid treatment. Our case demonstrates that calcineurin inhibitors may have efficacy as a second-line treatment in these instances.

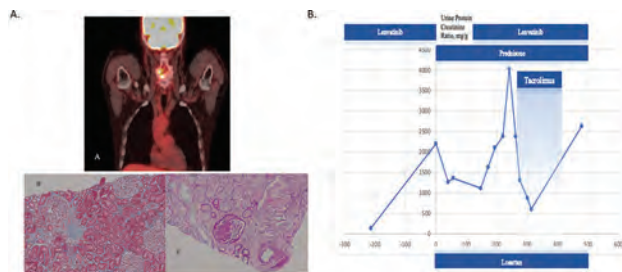

**Figure 2:** PET and CT sagittal image revealing residual metastatic papillary thyroid carcinoma in C3-C5 vertebrae following surgery and before lenvatinib treatment (A). Light microscopy of renal biopsy (left) with Periodic acid-Schiff stain at 20x (right) magnification (B) and trichrome stain at 100x magnification (C) showing FSGS.

**Figure 3:** 24-hour urine protein/creatinine ratio (UPCR) change over time from initial nephrology consultation (0) with key medications spanning the corresponding days of administration.

**FR-PO203**

**ANTI-PLA2R Positive Membranous Nephropathy Associated With Atezolizumab: A Case Report**

Diana Oleas, Irati Tapia. *Consorci Sanitari De Terrassa, Terrassa, Spain.*

**Introduction:** Immunotherapy has transformed cancer treatment in advanced malignancies. Increased survival compared with the standard of care has made immunotherapy a fundamental component of oncotherapeutics. Immune checkpoint inhibitors (ICI) trigger a potent stimulus to kill cancer cells. Immune-related adverse events (irAEs) secondary to ICI affect diverse organs. Acute interstitial nephritis is the most frequent kidney irAE. Glomerulopathies, although rare, constitute a more challenging diagnosis and treatment.

**Case Description:** A 72-year-old man with lung adenocarcinoma treated with Bevacizumab and Atezolizumab. During treatment, he developed nephrotic syndrome. A diagnosis of a phospholipase A2 receptor-positive primary membranous nephropathy associated with atezolizumab was made. After failing to respond to steroid therapy, treatment with rituximab was the preferred option. Eight months after being treated with rituximab and ten months after atezolizumab was stopped, the patient maintained preserved renal function and negativization of anti-PLA2R was achieved. Proteinuria declined to half of its initial value five months following anti-PLA2R negativization.

**Discussion:** As we have described, glomerular involvement, like membranous nephropathy, yet not frequent, could cause a high disease burden and affect the oncological and renal outcomes. We believe monitoring for proteinuria during treatment with ICI is crucial to determine an indication for a timely kidney biopsy and treatment.

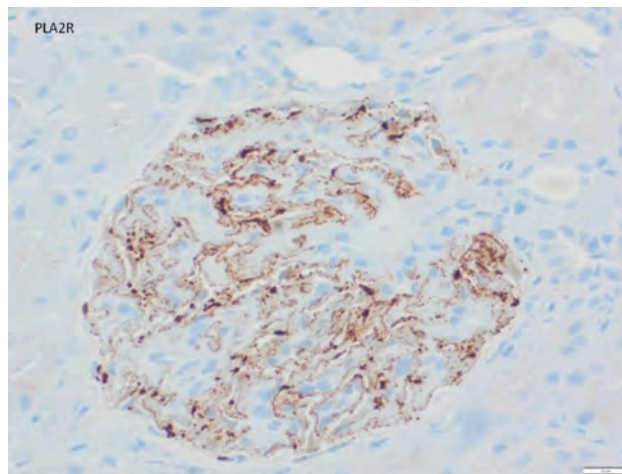

**FR-PO204**

**Panitumumab-Associated IgA Nephropathy With Membranoproliferative and Exudative Features**

Niloufarsadat Yarandi,<sup>1</sup> Mary E. Fidler,<sup>2</sup> Nelson Leung,<sup>1,3</sup> <sup>1</sup>Mayo Clinic Division of Nephrology and Hypertension, Rochester, MN; <sup>2</sup>Mayo Clinic Department of Laboratory Medicine and Pathology, Rochester, MN; <sup>3</sup>Mayo Clinic Division of Hematology, Rochester, MN.

**Introduction:** Panitumumab is a monoclonal antibody (MAB) epidermal growth factor receptor (EGFR) inhibitor approved for metastatic colon cancer. EGFR inhibitors can cause tubular, electrolyte disorders and glomerulopathies.

**Case Description:** A 62-year-old male with metastatic colon cancer to the liver developed hypomagnesemia and nephrotic range proteinuria after 2 months of panitumumab. Magnesium 0.6 mg/dL, creatinine 0.72 mg/dL, albumin 3.4 g/dL, proteinuria 16.1 g/24hr, albumin/creatinine 4991 mg/gcr. Urinalysis 51- 100 RBCs(>25% dysmorphic), 4 -10 WBCs, negative nitrite/leukocyte esterase. He required oral and IV magnesium supplements. Amiloride was attempted but resulted in hyperkalemia.

Kidney biopsy revealed IgA nephropathy with exudative membranoproliferative features. Panitumumab was discontinued and prednisone 60 mg daily was started. Proteinuria improved to 6.9 g/24hr within 2 weeks; magnesium normalized.

**Discussion:** Tubular and electrolyte disorders are more common compared to glomerular lesions and are mainly associated with EGFR MABs. The main electrolyte disorder with EGFR inhibitor MABs is hypomagnesemia via renal magnesium wasting. Proliferative IgA crescentic glomerulonephritis (GN), immune-complex GN, and pauciimmune crescentic GN have been reported with EGFR inhibitors. The exact mechanism for nephrotic/nephritic syndrome is not clear. Response to therapy varies from no response to complete response after discontinuing EGFR inhibitor +/- glucocorticoids or other immunosuppressives.

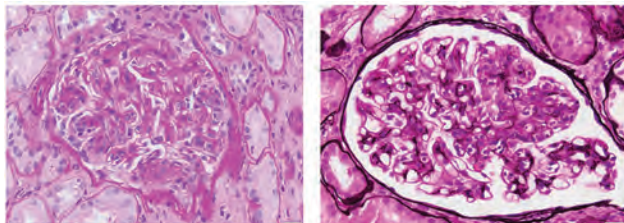

PAS-Jonesx40Endocapillary hypercellularity, segmental neutrophils, segmental glomerular basement membrane double-contouring

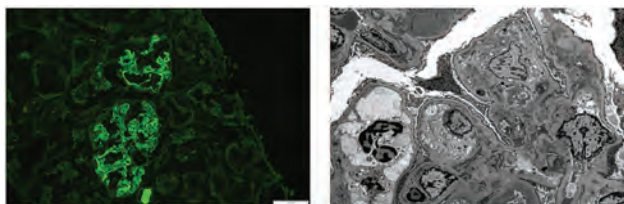

IF:IgA-dominant deposits involving mesangium and GBM EM: Endocapillary hypercellularity, mesangial/paramesangial, subendothelial deposits

**FR-PO205**

**An Uncommon Cause of Gross Hematuria With Underlying Fibrinolysis Induced by Pulmonary Artery Leiomyosarcoma**

Hiroshi D. Hikida, Fouad T. Chebib. *Mayo Foundation for Medical Education and Research, Rochester, MN.*

**Introduction:** Renal arteriovenous (AV) fistulas are an uncommon cause of gross hematuria. In our case presentation, the patient's hematuria rapidly, but temporarily, resolved with two courses of doxycycline. Ultimately, the patient's renal AV fistula was embolized with resolution of the hematuria. This case elucidates an unusual cause of gross hematuria due to renal AV fistula and exacerbated by fibrinolysis caused by a rare malignancy in the pulmonary artery.

**Case Description:** Patient presented to a local clinic with gross hematuria with clots and severe throbbing bilateral flank pain radiating to the groin. He was thought to have prostatitis and was treated with doxycycline which resolved his hematuria but recurred after few days after completion. He presented to our hospital with Hgb 7.4 g/dL and persistent gross hematuria. Abdominal renal imaging and cystoscopy was unrevealing. His workup was consistent with idiopathic fibrinolysis with normal bone marrow biopsy. CT chest revealed nodular opacities but negative comprehensive infectious work up on BAL. The patient ultimately had a renal biopsy performed after which he developed retroperitoneal bleeding that stopped after IR embolization of several bleeding pseudoaneurysms. Renal arteriogram showed evidence of arteriovenous (AV) fistula. His bleeding stopped after initiation of tranexamic acid. Three months later, he developed spontaneous hemoptysis and ipsilateral flank ecchymosis. Subsequent evaluation revealed a large right pulmonary artery mass with FDG-avidity, with ultrasound-guided endobronchial biopsy confirming high-grade pulmonary artery malignancy. He ultimately underwent surgical resection for which surgical pathology revealed high-grade pulmonary artery leiomyosarcoma. Following surgical resection, his coagulopathy improved, and he has had no recurrent bleeding events.

**Discussion:** Studies have shown that underlying malignancy is found in 10-20% of patients with gross hematuria and thus requires systemic evaluation. Diagnosis of renal AV fistulas often require a high-index of suspicion, as their symptoms can vary widely from asymptomatic to gross hematuria, flank pain, and an abdominal mass. Renal artery angiogram is diagnostic gold standard and is required for selective embolization of the fistula as was performed in our patient with a rare underlying malignancy.

**FR-PO206**

**Plasma Cell Leukemia Masquerading as Acute Myeloid Leukemia: An Unusual Clinical Presentation**

Xin Zhang, Song Liu, Kamran Mirza, Maria M. Picken, Vinod K. Bansal, Kavitha Vellanki. *Loyola University Health System, Maywood, IL.*

**Introduction:** Plasma cell leukemia (PCL) is a rare aggressive variant of plasma cell myeloma. Peripheral blood smear morphology can be misleading in the context of acute leukemia like presentation. We present one such unique experience.

**Case Description:** A 64 year old female presented with progressive weakness and fatigue. Work-up revealed acute kidney injury (serum creatinine of 6.8 mg/dl) with nephrotic range proteinuria, hypercalcemia, leucocytosis and 12% of circulating cells with blastoid features on peripheral smear (Figure 1). A preliminary diagnosis of acute myeloid leukemia (AML) was given based on circulating cell morphology, flow cytometry and bone marrow (BM) biopsy findings. Work-up for paraproteinemia subsequently revealed significantly elevated serum free lambda light chains. As co-existence of AML and myeloma is extremely unusual, kidney biopsy was done (Figure 2). While there was some phenotypic overlap with myeloid blasts, subsequent immunohistochemistry of BM biopsy with CD138 staining confirmed the diagnosis of PCL. She has since received targeted chemotherapy with recovery of renal function; currently off dialysis with serum creatinine of 2.6 mg/dl.

**Discussion:** PCL with blastoid morphology is extremely rare and can pose a diagnostic challenge by mimicking acute leukemia. This case illustrates the importance of kidney biopsy in establishing the right diagnosis when clinical features do not correlate with the initial diagnosis.

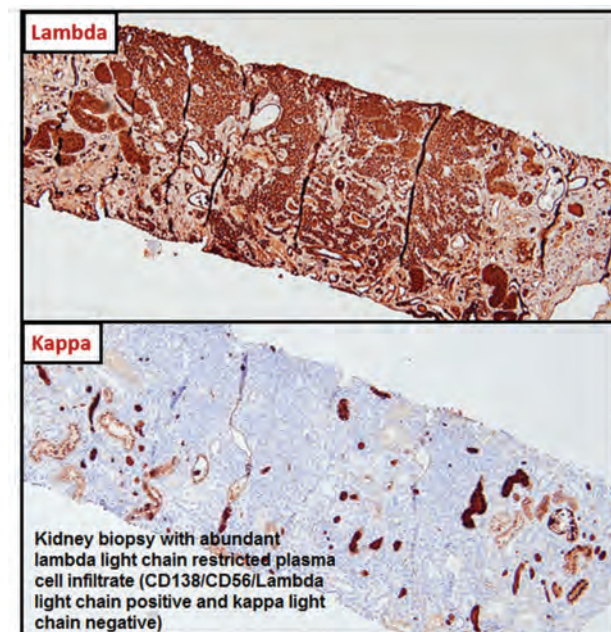
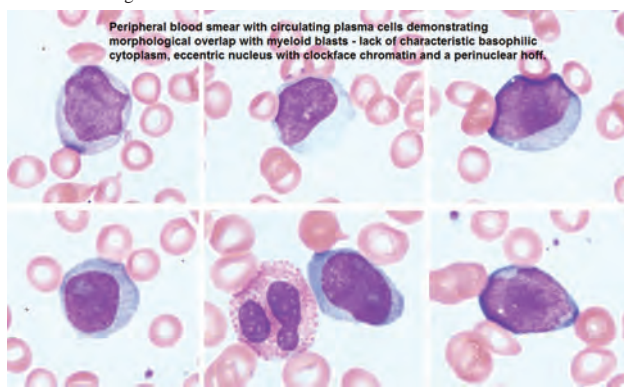



FR-PO207

**AKI and “Pseudo-Pyelonephritis” Caused by Immune Checkpoint Inhibitors**

Daniel Stalbow,<sup>1,2</sup> Ilya Glezerman,<sup>2,1</sup> Surya V. Seshan,<sup>1</sup> Steven Salvatore,<sup>1</sup> Victoria Gutgarts,<sup>2,1</sup> *Weill Cornell Medicine, New York, NY; <sup>2</sup>Memorial Sloan Kettering Cancer Center, New York, NY.*

**Introduction:** Immune checkpoint inhibitors (ICPIs) have an incidence of renal toxicity that ranges from 1 to 5%. ICPI-associated AKI (ICPI-AKI) presents as asymptomatic rise in serum creatinine. Associated symptoms of dysuria, flank pain, fever and radiologic evidence of renal inflammation are rare.

**Case Description:** Herein we describe three cases (Table below) of biopsy proven ICPI-AKI presenting with dysuria, flank pain and imaging consistent with genitourinary inflammation (Figure below). All patients were empirically treated with antibiotics for suspected infections though urine cultures were negative. Persistent symptoms and rising creatinine led to kidney biopsy which showed acute interstitial inflammation without significant neutrophil infiltration in all three cases. A course of steroids led to the resolution of symptoms and improvement in serum creatinine.

**Discussion:** These cases highlight the complexity of ICPI-AKI that is not limited to laboratory and histology abnormalities but includes symptoms and imaging consistent with inflammation of the genitourinary tract. If overlooked, patients will be mistreated for an infection causing symptoms to persist and a delay in initiation of immunosuppression.

Three cases of ICPI-AKI presenting with dysuria and imaging consistent with genitourinary inflammation

Patient	Cancer	ICPI Type	Baseline Creatinine (mg/dL)	Peak Creatinine at Time of AKI (mg/dL)	Symptoms After Start of ICPI	CT Imaging	Urine Culture	Renal Biopsy Findings	Serum Creatinine (mg/dL)
57F	Breast Cancer	PD-1	0.7	1.8	Dysuria, flank pain, fevers x 1 month	Bilateral perinephric stranding, urothelial thickening, and cystitis	Negative	Active tubulointerstitial nephritis, moderately severe.	0.9
62M	Melanoma	PD-1 and CTLA-4	1	4	Abdominal pain x 11 days	Bilateral perinephric fat stranding and urothelial thickening	Negative	Acute tubulointerstitial nephritis	1
40M	Gastric Cancer	PD-1	0.8	3.7	Bilateral flank pain x 7 days	Bilateral perinephric fat stranding and urothelial thickening	Negative	Severe active tubulointerstitial nephritis with granulomatous changes.	1.1

Figure: CT findings of bilateral perinephric stranding (yellow arrow) for pts 1-3.

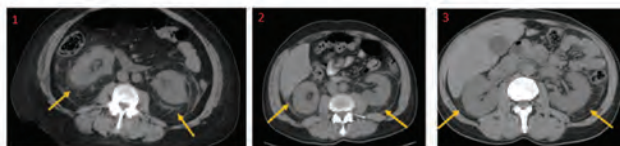

FR-PO208

**Localized Amyloidosis: The Great Masquerader**

Suryanarayanan Balakrishnan, Sushmita Prabhu, Suzanne G. Martin. *Saint Vincent Hospital, Worcester, MA.*

**Introduction:** Amyloidosis is characterized by misfolding of extracellular proteins and deposition in tissues as insoluble fibrils, causing end-organ damage. Localized amyloidosis (LA) without a plasma cell dyscrasia (AL amyloidosis) or chronic inflammation (AA amyloidosis) is rare. LA tends to involve the bladder, upper and lower respiratory tract, skin and eyes. LA presents as a tumor-like lesion, and patients may undergo extensive, and sometimes invasive, testing. LA of the bladder can present with painless hematuria, mimicking urologic malignancy.

**Case Description:** 80M with Stage IIIA CKD, BPH, and atrial fibrillation on warfarin presented with intermittent gross hematuria over many years. Two cystoscopies in the last 5 years were negative for malignancy, with inflammation on biopsy. Labs were reassuring for stable hematocrit and baseline creatinine. Urine sediment revealed nondysmorphic RBCs. Urine protein:Cr ratio was 816mg/gCr. CT abd/pelvis showed diffuse circumferential thickening of the distal right ureter and nodular thickening of the right UVJ. Repeat cystoscopy showed the right ureteral orifice to be surrounded by erythema and thickening, concerning for a ureteral or atypical bladder mass. Biopsy showed chronic inflammation and amorphous, Congo red-positive material consistent with amyloidosis, and he underwent transurethral resection. Immunofixation and serum free light chain ratio were negative for plasma cell dyscrasia. He had no manifestations of amyloidosis in other organs. Proteinuria and creatinine remain stable 8 years later, around 500mg/day and 1.1-1.3mg/dL, respectively.

**Discussion:** Localized bladder amyloidosis may masquerade as malignancy, often presenting with painless gross hematuria and/or lower urinary tract symptoms. Cystoscopy may raise concern for malignancy, and biopsy may only show nonspecific inflammation unless Congo red staining is performed. Securing the diagnosis of amyloidosis can prevent unnecessary procedures. Mass spectrometry is preferred to identify the causative misfolded protein. Primary bladder amyloidosis is rare and systemic

amyloidosis must be excluded. If left untreated, localized bladder amyloidosis can lead to symptoms of obstructive uropathy. Treatment is aimed at transurethral excision of the lesion, and surveillance for recurrence is required. The prognosis is excellent, with only 1% progressing to systemic disease.

FR-PO209

**Onconeurology, Rise of the Unknowns: Enhertu-Induced Fanconi Syndrome**

Pooja Kalantri, Koba A. Lomashvili. *Emory University, Atlanta, GA.*

**Introduction:** Kidney toxicities are associated with increasingly complex and constantly emerging cancer treatment protocols. Data clearly demonstrates that when patients with cancer develop acute or chronic kidney disease, severe fluid and electrolyte abnormalities, outcomes are inferior, and the promise of curative therapeutic regimens is lessened. Here we present a case of a new chemotherapeutic agent and the electrolyte abnormalities that it has caused.

**Case Description:** A 74-year-old woman with metastatic, recurrent ER+/PR-/HER2+ invasive ductal carcinoma of the right breast, status post bilateral mastectomies, chemo, radiation, and hormonal therapies, who, while being on Herceptin/Perjeta maintenance for a year, experienced progression. She was started on Enhertu (Herceptin+Deruxtecan), but due to worsening diarrhea, >12 episodes a day, decreased oral intake and weight loss, was admitted to the hospital. Her blood pressures were soft. Labs showed sodium 132 mmol/L, potassium 2.1 mmol/L, bicarbonate 17 mmol/L, anion gap 6, calcium 7.3 mg/dL, magnesium 1.2 mg/dL, phosphorus 1.3 mg/dL. Abnormalities persisted with improving diarrhea. Urine was positive for protein and glucose, with pH 5. Urine anion gap was negative, but eventually turned positive with improving diarrhea. Transtubular potassium gradient was 8. This was consistent with component of diarrhea causing acidosis, whereas there was also evidence of Fanconi syndrome with glucosuria, proteinuria, and renal potassium and phosphate wasting. The Fanconi syndrome was attributed to the Deruxtecan component of Enhertu, as she was previously on Herceptin. Enhertu was stopped, and her electrolyte abnormalities resolved over a course of 2 months.

**Discussion:** Deruxtecan has been associated with diarrhea (20-30%) and hypokalemia (1-12%) in phase 2 trials. But there has been no mention about Fanconi syndrome. We report a case of reversible Fanconi syndrome due to Enhertu. It is important to recognize this as future doses of this medication may cause poor outcomes in these patients, while the performance status can be improved again by recognizing this reversible cause.

FR-PO210

**Monoclonal Immunoglobulin Deposition Disease in a Young Female**

Divya Sharma Divyadarshini,<sup>1</sup> Gargi Sharma Priamvada,<sup>2</sup> Pingchuan Zhang,<sup>3</sup> Koyal Jain.<sup>2</sup> *<sup>1</sup>Sapthagiri Institute of Medical Sciences and Research Center, Bangalore, India; <sup>2</sup>University of North Carolina System, Chapel Hill, NC; <sup>3</sup>Mayo Foundation for Medical Education and Research, Rochester, MN.*

**Introduction:** Monoclonal immunoglobulin deposition disease (MIDD) is characterized by deposition of monoclonal immunoglobulin(MIg) along glomerular and tubular basement membranes (GTBM). Prevalence is higher in males with a mean age of 56 years. Light chain deposition disease (LCDD) accounts for 80% of cases with others being heavy chain(HCDD) and rarely light and heavy chain deposition disease(LHCDD). We present a case of rare pathological features of LHCDD presenting at a young age.

**Case Description:** A 34 year previously healthy female presented with hypertensive urgency, renal insufficiency and nephrotic syndrome. Urine protein creatinine ratio was 11 g/g, Urine microalbumin creatinine ratio 5.5 g/g. Serum protein electrophoresis (SPEP) revealed MIg - IgG lambda type, serum free light chain (sFLC) ratio of 0.03. Renal biopsy showed LHCDD with membranoproliferative injury and focal cellular crescents, immunofluorescence showed deposits along GTBM that were nonfibrillar by electron microscopy (Figure). Imaging did not suggest multiple myeloma. Bone marrow biopsy showed only 10% plasma cell population. She was treated with cyclophosphamide, bortezomib and dexamethasone (CyBorD) with improvement in kidney function and proteinuria.

**Discussion:** This case of MIDD, occurring in a very young female, highlights the importance of complete serologic evaluation of individuals with new onset nephrotic syndrome, including SPEP and sFLC. MIDD is associated with multiple myeloma in up to 60% of cases but can occur in absence of hematological malignancy. Kidney is the major target organ in MIDD but about 35% of cases have extrarenal manifestations. Clone-directed chemotherapy with CyBorD or bendamustine is the treatment of choice. The sensitivity of abnormal serum FLC is very high in MIDD, hence is an important marker for both suspicion of disease and remission.

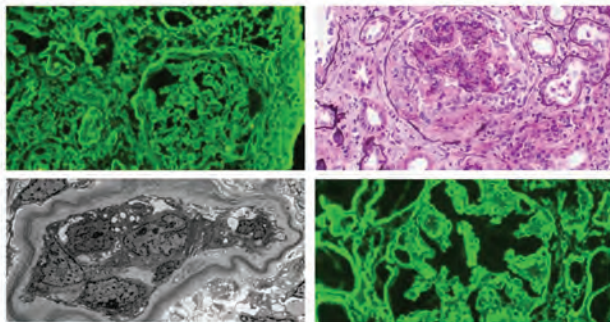

Clockwise: IF IgG, LM – Silver - Diffuse mesangial and endocapillary proliferation with lobular accentuation, IF IgG lambda, EM X4000 – Powdery deposits along TBM

#### FR-PO211

##### Hypophysitis in a Patient on Pembrolizumab

Jack Luo,<sup>1,4</sup> Kiran Suryadevara,<sup>2</sup> Warda Zaman,<sup>3,1</sup> <sup>1</sup>Alameda Health System, Oakland, CA; <sup>2</sup>St George's University School of Medicine, St George's, Grenada; <sup>3</sup>East Bay Nephrology Medical Group, Oakland, CA; <sup>4</sup>Highland Hospital Internal Medicine, Oakland, CA.

**Introduction:** Pembrolizumab is a PD-1 immune checkpoint inhibitor (ICI) used to treat advanced malignancies that may be unresectable, metastatic, or refractory to other chemotherapy regimens. We report a case of hypophysitis in a 63 year-old Asian female after receiving pembrolizumab for treatment of metastatic urothelial carcinoma.

**Case Description:** A 63 year-old post-menopausal Asian woman presented to the hospital with dizziness, loss of appetite, and generalized fatigue for three weeks. She was found to have a blood glucose level of 55mg/dL. She was on pembrolizumab for 8 months for metastatic urothelial carcinoma. She developed hypothyroidism 3 months after starting pembrolizumab. At presentation, she was hypotensive to 80/55 mmHg, euvolemic on exam, sodium level was 116mmol/L, measured serum osmolality was 246 mOsm/kg; urine osmolality was 312 mOsm/kg and urine sodium was 44 mmol/l. Liver and renal function tests were normal. Serum sodium improved to 118 mmol/L after 1 liter of lactated ringers solution. Blood glucose was 77 mg/dL on initial presentation and varied between 49-100 mg/dL throughout most of the admission. TSH was 4.06  $\mu$ IU/ml and cortisol level was <1.0 mcg/dL, ACTH level was undetectable. The patient was started on hydrocortisone 10mg in the morning and 5mg in the evening and fludrocortisone 0.05mg daily. Glucose levels remained within normal limits. All her presenting symptoms resolved. Her history of hypothyroidism and now secondary adrenal insufficiency was suspicious for hypophysitis related to Pembrolizumab. Two weeks after discharge, serum sodium was 143mmol/L and was stable on follow-up labs. In addition, FSH, LH and IGF-1 were checked and were relatively low in her, which are very elevated in post-menopausal women further confirming the hypophysitis. Currently, she is on the same doses of hydrocortisone and fludrocortisone is discontinued. There is plan to restart the Pembrolizumab.

**Discussion:** Hypophysitis is an uncommon side-effect of ICIs, especially PD-1 inhibitors. In a meta-analysis of 31 clinical trials with 7551 patients, the incidence of hypophysitis was only 0.4% with PD-1 inhibitors compared to 3.2% with CTLA-4 inhibitors and 6.4% with combination therapy. Patients may present with nonspecific symptoms such as fatigue, dizziness, and appetite loss, so it is important to have high clinical suspicion for hypophysitis and hormonal deficiencies in patients treated with pembrolizumab.

#### FR-PO212

##### Thrombotic Microangiopathy Associated With Use of Liposomal Doxorubicin

Claudia M. Brauer Ornelas,<sup>1</sup> Ciara M. Kelly,<sup>2,1</sup> Steven Salvatore,<sup>2</sup> Ilya Glezerman,<sup>2,1</sup> <sup>1</sup>Weill Cornell Medicine, New York, NY; <sup>2</sup>Memorial Sloan Kettering Cancer Center, New York, NY.

**Introduction:** TMA is rare with liposomal doxorubicin and its presentation and prognosis is not well defined in this setting. We report a patient on single agent liposomal doxorubicin who developed TMA.

**Case Description:** 72-year-old female with history of well controlled hypertension (HTN) and retroperitoneal liposarcoma referred to renal service for elevated serum creatinine (SCr) and edema. She underwent resection and left nephrectomy at the time of diagnosis of liposarcoma. Patient was started on liposomal doxorubicin at 40mg/m<sup>2</sup> per cycle (cumulative dose 1240mg/m<sup>2</sup>) 18 months prior to presentation. Her baseline SCr was 1 (0.6-1.1) mg/dL but it has been slowly rising for the past 7 months. She was taking alendronate, amlodipine and levothyroxine. Hydrochlorothiazide was added recently for worsening HTN. Patient appeared comfortable. BP was 166/86 but vital signs otherwise were stable. Exam was unremarkable except for lower extremity edema. Laboratory data revealed SCr of 2mg/dL and nephrotic range proteinuria (4g/day). Urinalysis showed five RBC/HPF. Initial work up showed normal complement level, haptoglobin and urine and serum protein electrophoresis. Hepatitis B and C serologies as well as ANA and ANCA were negative. Lactate dehydrogenase level was elevated 317 (130-250) U/L. aHUS complement panel showed no serologic evidence of complement abnormalities.

CT scan of abdomen and pelvis showed unchanged multifocal recurrent disease and well no evidence of right hydronephrosis. Patient underwent kidney biopsy which showed chronic endothelial injury suggestive of chronic thrombotic microangiopathy involving glomeruli. Liposomal doxorubicin was stopped and SCr peaked at 5.4mg/dl four months after biopsy but gradually improved to a trough of 3.4 mg/dL at last follow up. Nephrotic range proteinuria and edema resolved.

**Discussion:** Liposomal doxorubicin associated TMA is not a well-known potential side effect. There have been two cases of biopsy proven TMA in ovarian cancer patients on single agent liposomal doxorubicin after prolonged exposure. In another case report a patient with liposarcoma of kidney had a prolonged exposure to liposomal doxorubicin and developed TMA leading to hemodialysis. Our patient also had large cumulative exposure indicating that TMA may be dose dependent.

#### FR-PO213

##### Novel Anti-Cancer Agents and Capillary Leak Syndrome

Nanazul T. Pariswala, Vipulbhai Sakhiya, Rimda Wanchoo, Kenar D. Jhaveri. Northwell Health, New Hyde Park, NY.

**Background:** The term capillary leak syndrome (CLS) results clinically in the typical triad of hypotension, edema, and elevated hematocrit. The more severe cases of CLS may present with cardiovascular collapse, shock, and death. Data on CLS associated with novel anti cancer agents is insufficient.

**Methods:** We reviewed the FDA adverse event reporting system (FAERS) quarterly legacy data first quarter 2010 to 4th quarter 2021 for all recently commonly used targeted therapies and immune-checkpoint inhibitors (ICI). Well established chemotherapy agents such as gemcitabine, clofarabine, cyclophosphamide, platinum-based therapy, colony stimulating factors were excluded. CAR-T therapy is well known to cause CLS and hence was excluded. The adverse event terms queried were: capillary leak syndrome, capillary leak and cytokine storm. We reviewed the literature using pubmed, case reports, case series and the registrational studies of anti-cancer agents associated with CLS as well.

**Results:** FAERS reporting system reported 22 cases of CLS in the last 11 years with novel anti cancer agents. The most common class was anti CD20 (rituximab-9 cases), followed by ICIs (6) and then anti VEGF agents(4). Other meds (4) were mainly bortezomib and trastuzumab. The two reported ICIs were ipilimumab and nivolumab. The most common anti VEGF inhibitor was bevacizumab. The literature search revealed anti CD20 (rituximab) being the most common agent with 19 cases reported followed by bortezomib(anti plasma cell agent) with 13 cases. Trastuzumab had 11 cases reported and other rare cases with alemtuzumab(6) and blinatumomab(3). Immune checkpoint inhibitors with specifically nivolumab, there were 4 cases reported.

**Conclusions:** CLS is rare in novel anti cancer agents. Anti CD20 agents such as rituximab seem to be the most common cause of this rare side effect. Other agents such as bortezomib, anti VEGF agents, trastuzumab and ICIs(mainly nivolumab and ipilimumab) can also rarely cause CLS. Oncologist and nephrologists need to be mindful of this rare fatal side effect.

#### FR-PO214

##### Renal Adverse Events Associated With the Immune Checkpoint Inhibitor Therapy: A Systematic Review and Bayesian Network Meta-Analysis of 96 Randomised Controlled Trials

Shehjar Trisal,<sup>1</sup> Gary K. Low,<sup>1,2</sup> Faraz K. Pathan,<sup>1,2</sup> Muralikrishna Gangadharan Komala,<sup>1,2</sup> <sup>1</sup>University of Sydney - Camperdown and Darlington Campus Burkit-Ford Library, Sydney, NSW, Australia; <sup>2</sup>Nepean Blue Mountains Local Health District, Penrith, NSW, Australia.

**Background:** Immune checkpoint inhibitors (ICI) have revolutionised cancer immunotherapy, improving survival in cancer patients. However, the blockade of immune regulatory sites, CTLA-4, PD-1, and PD-L1 is associated with a range of immune related adverse events (irAE) of which renal irAE occur infrequently and are not regularly reported.

**Methods:** The PRISMA guidelines were used to search for Randomised Control Trials (RCT) reporting severe adverse renal events across five electronic databases from inception to April 2022. This was supplemented with hand searching of major medical journals and the National Clinical Trials registry. A Bayesian network meta-analysis was performed using R version 4.1.0 R for the following outcomes: acute kidney injury (AKI), hypertension (HTN), glomerulonephritis, chronic kidney disease (CKD) and the composite of all acute adverse renal events (AARE) namely AKI, HTN and glomerulonephritis. Network meta-regression was performed to adjust for inconsistencies arising from malignancy subtype.

**Results:** 96 RCTs reported severe grade adverse renal events. The risk of developing acute kidney injury is higher among patients who received PD-1 plus chemotherapy (OR 1.8 [95% CrI 1.3 to 2.4]) and PD-L1 plus chemotherapy (OR 1.90 [95% CrI 1.3 to 2.9]) when compared to standard chemotherapy and placebo (95 studies, 63, 793 participants). The risk of developing an AARE is higher among patients who received PD-1 plus chemotherapy (OR 1.7 [95% CrI 1.1 to 2.4]) and PD-L1 plus chemotherapy (OR 1.7 [95% CrI 1.1 to 2.6]) when compared to standard chemotherapy and placebo (64,409 participants).

**Conclusions:** The combined regimen of PD-1 or PDL-1 + chemotherapy is associated with higher incidence of severe grade AKI and AARE. Prescription of combined therapy will warrant closer monitoring and implementation of preventive strategies/changes to the treatment regimen could be arranged early at the onset of adverse events.

Key: TH - Thursday; FR - Friday; SA - Saturday; OR - Oral; PO - Poster; PUB - Publication Only

Underline represents presenting author.

Figure 1

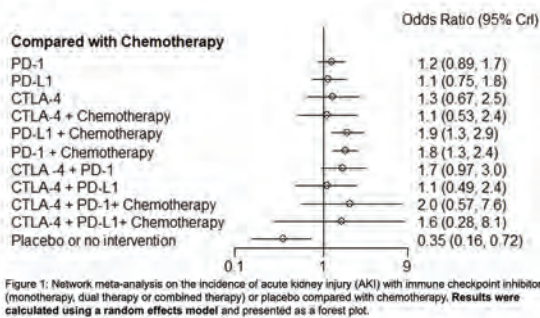

Figure 1: Network meta-analysis on the incidence of acute kidney injury (AKI) with immune checkpoint inhibitor (monotherapy, dual therapy or combined therapy) or placebo compared with chemotherapy. Results were calculated using a random effects model and presented as a forest plot.

Incidence of Acute Kidney Injury

FR-PO215

Real-World Incidence of Kidney Manifestations in Patients Treated With New Tyrosine Kinase Inhibitors

Praveen Ratanasrimetha,<sup>1</sup> Omar Mamlouk,<sup>1</sup> Sai S. Achi,<sup>2</sup> James P. Long,<sup>1</sup> Valda D. Page,<sup>1</sup> Sreedhar A. Mandayam.<sup>1</sup> <sup>1</sup>The University of Texas MD Anderson Cancer Center, Houston, TX; <sup>2</sup>The University of Texas Health Science Center at Houston, Houston, TX.

**Background:** Imatinib was the first FDA approved Tyrosine kinase inhibitor (TKI) and since then there are more than 40 new approved TKI drugs. Multiple studies reported the incidence and clinical characteristics of TKI related nephrotoxicity; however, they were limited to the first approved TKI drugs. Currently, we are relying on FDA adverse reporting system (FARES) data for the newer agents, which is subject to bias. In this study we report our cancer center incidence of acute kidney injury (AKI) and proteinuria as the kidney manifestations associated with certain newer TKI agents.

**Methods:** This is a retrospective cohort study including patients who were treated with the following six most prescribed new tyrosine kinase inhibitors; regorafenib, axitinib, cabozantinib, erlotinib, ponatinib, and ibrutinib from January 2017 to October 2019 at MDA Cancer Center. We collected data related to patient baseline characteristics, concurrent nephrotoxic medication use, serum creatinine, and urine dipstick. We defined acute kidney injury and proteinuria as a rise in serum creatinine more than 50% above the baseline and a positive urine dipstick for protein, respectively, throughout the duration of TKI therapy and up to 45 days of stopping TKI.

**Results:** We identified 2063 subjects. Median age was 63 (SD=12.7) and the overall median duration of TKI therapy was ranging 28-67 days. Around half of the patients were on Ibrutinib. Proteinuria developed in approximately half of the patients (39-61% based on the TKI) and was more prevalent with Regorafenib (61%) vs. Axitinib (39%). 1.5 % of the patients develop AKI during the first 30 days of therapy and 11.1% thereafter. The incidence of AKI was ranging between 10-28% and was highest with Ponatinib (28%) vs. Ibrutinib (10%). In univariate analysis, diabetes and proton pump inhibitors were associated with increased risk of developing proteinuria and AKI, respectively, during TKI therapy.

**Conclusions:** Our study provides a real-world data about the incidence of kidney related manifestation in patients treated with the newer generation of TKI agents. Proteinuria is the predominant kidney manifestation followed by AKI. Incidence of AKI is close to the first generation TKI with exception for ponatinib that had two to three times the risk of AKI.

FR-PO216

Glomerular Filtration Rate Equations for Drug Dosing: Discordance by BMI and Age

Beini Lyu,<sup>1</sup> Lesley A. Inker,<sup>2</sup> Alex R. Chang,<sup>3</sup> Thomas D. Nolin,<sup>4</sup> Josef Coresh,<sup>1</sup> Morgan Grams,<sup>5</sup> Jung-Im Shin.<sup>1</sup> <sup>1</sup>Johns Hopkins University, Baltimore, MD; <sup>2</sup>Tufts Medical Center, Boston, MA; <sup>3</sup>Geisinger Health, Danville, PA; <sup>4</sup>University of Pittsburgh, Pittsburgh, PA; <sup>5</sup>New York University, New York, NY.

**Background:** Historically, different methods to estimate glomerular filtration rate (GFR) have been used for drug development, labeling for drug dosing, and clinical practice. Substantial differences in GFR estimated from different equations may prevent optimal drug dosing.

**Methods:** We analyzed 29,564 patients with atrial fibrillation (AF) who had serum creatinine, weight, and height measurements in Geisinger health system between 2005-2019 (mean age 76yrs, mean body mass index [BMI] 29.5 kg/m<sup>2</sup>). We compared differences among three GFR estimates by BMI and age: Cockcroft-Gault estimated creatinine clearance (eCICr; unit: mL/min), CKD-EPI 2021 (eGFR, mL/min/1.73 m<sup>2</sup>), and non-indexed CKD-EPI 2021 (neGFR, mL/min). To quantify potential impact on drug dosing, we estimated the proportion of discordance in recommended rivaroxaban dose by different GFR estimates among patients with eGFR 30-60 mL/min/1.73 m<sup>2</sup>. The FDA label for rivaroxaban recommends a reduced dose in eCICr <50 mL/min.

**Results:** The differences among the three estimates varied by BMI and by age: for example, eCICr was higher than eGFR and neGFR among patients with BMI ≥40 kg/m<sup>2</sup> (mean: eCICr 117.8 mL/min, eGFR 65.8 mL/min/1.73 m<sup>2</sup>, and neGFR 89.4 mL/min);

eCICr was lower than eGFR and neGFR among patients ≥85 years (mean: eCICr 38.6 mL/min, eGFR 51.6 mL/min/1.73 m<sup>2</sup>, neGFR 51.9 mL/min). Rivaroxaban dosing discordance varied by BMI and age as well: for example, among patients with BMI ≥40 kg/m<sup>2</sup>, 40-60% of patients would need a reduced dose of rivaroxaban by eGFR and 15-20% would need a reduced dose by neGFR whereas standard dose would be recommended by eCICr across the age groups (Figure).

**Conclusions:** eCICr, eGFR, and neGFR values could differ substantially depending on body size and age, potentially resulting in substantial drug dosing discordance.

**Funding:** NIDDK Support

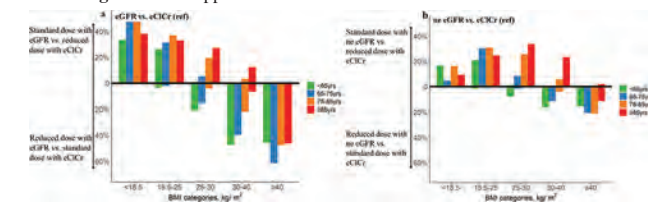

FR-PO217

Effect of Multiple Doses of Sparsentan on the Single-Dose Pharmacokinetics of Dapagliflozin: Open-Label Drug-Drug Interaction Study in Healthy Adults

Charles Chen,<sup>1</sup> Danlin Cai,<sup>1</sup> Claire E. Winnett,<sup>1</sup> Neeraj Verma,<sup>1</sup> Priscila Preciado,<sup>1</sup> Traver Therapeutics Inc, San Diego, CA.

**Background:** Sparsentan (SPAR) is a novel single molecule Dual Endothelin Angiotensin Receptor Antagonist (DEARA) being investigated for immunoglobulin A nephropathy and focal segmental glomerulosclerosis. Potential drug-drug interactions (DDI) with sodium-glucose co-transporter 2 inhibitors are not known. This phase 1 study examined the effect of multiple doses of SPAR on the pharmacokinetics (PK) of single-dose dapagliflozin (DAPA) and assessed the safety and tolerability of single-dose DAPA when co-administered after multiple doses of SPAR in healthy adults.

**Methods:** This open-label DDI study included Period 1 (Days 1-5; single dose of 10mg DAPA on Day 1, PK sampling pre-dose and up to 96 hours post-dose) and Period 2 (Days 5-14; 800mg SPAR once daily for 10 days with single 10mg dose DAPA co-administered on Day 11, DAPA PK sampling pre-dose and up to 96 hours after Day 11 dosing). To avoid hypoglycemic events, subjects received an oral 20% glucose solution in water with the DAPA dose and every ~15 minutes up to 4 hours post-dose. Plasma concentrations and PK parameters of DAPA and SPAR were summarized. Subjects with evaluable data for both periods were included in an ANOVA mixed model analysis of DAPA AUC<sub>0-t</sub>, AUC<sub>0-inf</sub>, and C<sub>max</sub> following DAPA+SPAR vs DAPA alone. Treatment-emergent adverse events (TEAEs) were summarized.

**Results:** Twenty-two healthy adults were enrolled and 20 completed both study periods. Mean peak and extent of DAPA exposure (C<sub>max</sub> and AUC) values were similar following 10mg DAPA alone and 10mg DAPA+800mg SPAR (Table). TEAEs were reported by 14 (63.6%) subjects. Most frequent were headache (6; 27.3%), nausea (5; 22.7%), and preprandial asymptomatic hypoglycemia (5; 22.7%).

**Conclusions:** Multiple dosing of SPAR did not affect single-dose DAPA PK in healthy adults. Single-dose DAPA co-administered with multiple doses of SPAR appeared to be well tolerated by healthy adults.

**Funding:** Commercial Support - Traver Therapeutics, Inc., San Diego, CA

Plasma Dapagliflozin PK Parameters Following Dapagliflozin+Sparsentan Versus Dapagliflozin Alone

	Dapagliflozin+Sparsentan	Dapagliflozin	GLSMR (%)	90% CI	Intra-subject CV%
AUC <sub>0-t</sub> (ng*hr/mL)	526.1 (n=20)	508.8 (n=20)	103.4	99.9-107.0	6.3
AUC <sub>0-inf</sub> (ng*hr/mL)	565.4 (n=16)	533.7 (n=16)	105.9	103.1-108.9	4.4
C <sub>max</sub> (ng/mL)	79.9 (n=20)	73.9 (n=20)	108.2	96.0-121.8	22.0

FR-PO218

Pharmacokinetics and Drug-Drug Interaction of KBP-5074 in Healthy Subjects

Ping Wang,<sup>1</sup> Liu Jinrong,<sup>1</sup> Judy Tan,<sup>1</sup> Jay Zhang,<sup>1</sup> Y. Fred Yang,<sup>1</sup> James C. McCabe,<sup>1</sup> Kbp Biosciences Co Ltd, Jinan, China.

**Background:** KBP-5074, a selective nonsteroidal MRA inhibitor, has a favorable safety profile and significant activity on hypertension and nephropathy in stage 3/4 CKD patients with uncontrolled hypertension. A clinical DDI study was conducted in healthy volunteers to evaluate the effect of a CYP3A4 inhibitor and inducer on the PK of KBP-5074.

**Methods:** This was a phase 1 study to investigate the effect of coadministration of a CYP3A4 inhibitor (itraconazole) and CYP3A4 inducer (rifampin) on the plasma PK of a single dose of KBP-5074 in healthy male and female subjects. 24 subjects 18 to 60 years of age with a BMI of 18.0 to 32.0 kg/m<sup>2</sup> were selected. Serial blood collections were obtained from pre-dose through 240 hours post-dose for analysis of plasma concentrations of KBP-5074.

**Results:** The strong CYP3A inhibitor itraconazole and strong CYP3A inducer rifampin had statistically significant effects on the pharmacokinetics of KBP-5074. The exposures were 1.1 fold and 1.7 fold higher when KBP-5074 was administered in combination with itraconazole based on C<sub>max</sub> and AUC<sub>last</sub>. The median t<sub>max</sub> was reduced

Key: TH - Thursday; FR - Friday; SA - Saturday; OR - Oral; PO - Poster; PUB - Publication Only

Underline represents presenting author.

(from 4 h to 2h) and geometric mean  $t_{1/2}$  was longer (60.3 h to 125 h) in the presence of itraconazole. When KBP-5074 was administered in combination with rifampin, exposures were decreased approximately 28% and 84% based on  $C_{max}$  and AUC<sub>last</sub>. Median  $t_{max}$  was similar (4 hours), but geometric mean  $t_{1/2}$  was shorter (10.9 hours).

**Conclusions:** A strong CYP3A inhibitor (itraconazole) had a weak effect (1.1 to 1.7 fold increase), whereas a strong CYP3A4 inducer (rifampin) had a strong effect (up to 84% decrease) on the clinical pharmacokinetics of KBP-5074. KBP-5074 was well tolerated when administered as a single 0.5-mg dose alone or in combination with itraconazole or rifampin.

**Funding:** Commercial Support - KBP Biosciences PTE Ltd

**FR-PO219**

**In Vitro Evaluation of Drug-Drug Interactions of Patiromer With Common Renal and Cardiovascular Drugs**

Jörg S. Schmitt,<sup>2</sup> Anna-Lena Steck,<sup>2</sup> Martin Khoeiklang,<sup>2</sup> Carol P. Moreno Quinn,<sup>2</sup> Martin Kretz,<sup>2</sup> Michael Bauer,<sup>2</sup> Lingyun Li,<sup>1</sup> Maria Wilhelm.<sup>2</sup> <sup>1</sup>Vifor Pharma Inc., Redwood City, Redwood City, CA; <sup>2</sup>Vifor Pharma Ltd, St Gallen, Switzerland, St Gallen, Switzerland.

**Background:** Patiromer (PAT) is a non-absorbed potassium binder approved for treatment of hyperkalemia (HK) and has the potential to bind off-target, positively charged molecules in the gastrointestinal tract (GIT), leading to drug-drug interactions (DDIs) with co-administered oral drugs. Generally, separation of administration by 3 hours between PAT and other oral medications is recommended. We sought to further extend the range of medications that can be administered simultaneously with PAT by evaluating drugs used to treat cardio-renal patients with hyperkalemia.

**Methods:** This study utilizes single- and gradient-pH (1.2, 4.5 and 6.8) *in vitro* models mimicking GIT passage to determine DDIs between PAT and 25 cardio-renal drugs. Resultant free test drug concentration was determined by liquid chromatography, and percentage recovery (mean [95% confidence interval]) was calculated from six replicates; <70% recovery with PAT compared with drug alone was deemed a significant DDI.

**Results:** At pH 1.2, <70% (mean [95% confidence interval]) recovery was observed with quinapril (68.0 [67.7–68.2]), telmisartan (9.9 [9.7–10.1]), losartan potassium (46.3 [45.9–46.7]), azilsartan (14.2 [12.8–15.5]), irbesartan (58.1 [57.0–59.2]), olmesartan medoxomil (58.9 [58.2–59.6]), carvedilol (1.3 [1.1–1.5]), nebivolol (5.5 [5.2–5.8]), finerenone (54.8 [54.0–55.6]) and torasemide (44.7 [44.4–45.1]). At pH 4.5, <70% recovery was observed with carvedilol, nebivolol and finerenone (5.4 [5.1–5.7], 15.8 [14.8–16.7], 69.6[69.1–70.1], respectively), and at pH 6.8 with telmisartan (10.8 [10.5–11.1]), bisoprolol fumarate (67.6 [66.5–68.6]), carvedilol (1.6 [1.5–1.7]) and nebivolol (6.9 [6.1–7.6]). Binding was associated with charge and lipophilicity. In the gradient-pH model simulating overall GIT passage, >70% recovery of quinapril, losartan potassium, irbesartan, olmesartan medoxomil, azilsartan, finerenone and torasemide was observed.

**Conclusions:** Of the 25 drugs tested, 14 showed ≥70% recovery with PAT. 11 showed <70% recovery with PAT, mostly at pH 1.2. However, 7 drugs with DDIs at pH 1.2 showed no relevant interactions with patiromer at gradient pH, suggesting DDIs at low pH could be reversed as test drugs became neutral or negatively charged in the intestine, where most drugs are absorbed.

**Funding:** Commercial Support - Vifor Pharma

**FR-PO220**

**Preclinical Pharmacokinetics of a Novel Nicorandil Prodrug**

Pramod Gupta, Atul Khare. *Unicycive Therapeutics Inc., Los Altos, CA.*

**Background:** Nicorandil, a potassium channel activator, is used to prevent or reduce angina. Limitations of nicorandil include serious gastrointestinal side effects and rapid absorption and elimination. A nicorandil prodrug may increase short half-life and improve safety profile of nicorandil. We present pharmacokinetic data in dogs for a novel nicorandil prodrug (UNI-494).

**Methods:** Groups of 3 beagle dogs were administered a single oral dose of 3, 10, or 30mg/kg UNI-494 at a volume of 5mL/kg. Clinical observations were recorded at approximately 1, 1.5, 2, 3, and 24h post-dose. Whole blood samples were collected pre-dose and 0.083, 0.25, 0.50, 1, 1.5, 2, 4, 8, and 24h post-dose to analyze systemic exposure to UNI-494 and nicorandil. Dose and concentration parameters ( $C_{max}$  and AUC) were used to generate linearity plots and calculate the coefficients of determination ( $r^2$ ) and slopes for UNI-494 and nicorandil.

**Results:** Mean  $T_{max}$ ,  $C_{max}$ , and AUC of 3, 10, and 30mg/kg dose groups are displayed in Table 1. For the linearity plots,  $r^2$  values and slopes for dose vs.  $C_{max}$  and dose vs. AUC are shown in Figures 1 and 2, respectively.

**Conclusions:** Nicorandil was rapidly formed from the prodrug UNI-494. Mean  $C_{max}$  for nicorandil was >5-fold greater than that of UNI-494, demonstrating efficient conversion of the prodrug to active drug. The conversion was consistent across dose groups. These results indicate that UNI-494 is a rationally designed drug, and future studies should evaluate this promising treatment in the target population of patients with AKI.

**$C_{max}$ ,  $T_{max}$ , and AUC by Dose Group and Analytes**

Dose Group (mg/kg)	Analyte	$C_{max}$ (ng/mL)	$T_{max}$ (Hour)	AUC (Hour*ng/mL)
3	UNI-494	43	0.3	34
	Nicorandil	1,300	0.7	3,400
10	UNI-494	178	0.3	162
	Nicorandil	3,070	1.5	11,400
30	UNI-494	1,500	0.3	1,510
	Nicorandil	7,530	1.3	38,000

Figure 1. Mean  $C_{max}$  of Nicorandil and UNI-494 by UNI-494 Dose After Single Dosing in Dogs

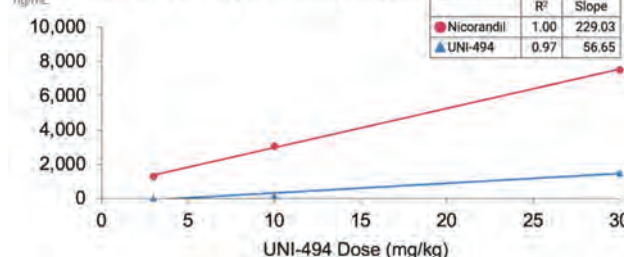
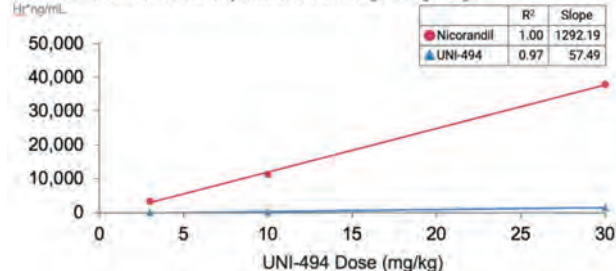

Figure 2. Mean AUC of Nicorandil and UNI-494 by UNI-494 Dose After Single Dosing in Dogs



**FR-PO221**

**Incidence, Characteristics, and Preventability of Adverse Drug Reactions in Patients With Moderate-to-Advanced CKD**

Solene M. Laville,<sup>1,2</sup> Valérie Gras,<sup>1</sup> Julien Moragny,<sup>1</sup> Christian Jacquelinet,<sup>10,6</sup> Christian Combe,<sup>3,4</sup> Denis Fouque,<sup>7,8</sup> Maurice Laville,<sup>7</sup> Carole Ayav,<sup>11</sup> Natalia Alencar de Pinho,<sup>6</sup> Brian Bieber,<sup>9</sup> Benedicte Stengel,<sup>7</sup> Ziad Massy,<sup>5,6</sup> Sophie Liabeuf,<sup>1,2</sup> CKD-REIN study Collaborators <sup>1</sup>Centre Hospitalier Universitaire Amiens-Picardie, Amiens, France; <sup>2</sup>Universite de Picardie Jules Verne, Amiens, France; <sup>3</sup>Centre Hospitalier Universitaire de Bordeaux, Bordeaux, France; <sup>4</sup>Inserm U1026, University of Bordeaux Segalen, Bordeaux, France; <sup>5</sup>Ambroise Paré University Hospital, APHP, Boulogne-Billancourt, France; <sup>6</sup>Centre de Recherche en Epidemiologie et Sante des Populations, Villejuif, France; <sup>7</sup>Claude Bernard University Lyon 1, CarMeN Inserm, Lyon, France; <sup>8</sup>Nephrology department, Lyon Sud University Hospital, Pierre-Bénite, France; <sup>9</sup>Arbor Research Collaborative for Health, Ann Arbor, MI; <sup>10</sup>Agence de la biomedecine, La Plaine Saint-Denis, France; <sup>11</sup>Clinical epidemiology, Inserm CIC-EC, Nancy University hospital, Vandoeuvre-lès-Nancy, France.

**Background:** Although adverse drug reactions (ADRs) are recognized as a major problem in the CKD population, few studies have comprehensively investigated ADRs –serious or not– in this population. Our aims were to estimate the incidence of these events according to estimated glomerular filtration rate (eGFR), describe serious ADRs and determine whether they are preventable.

**Methods:** CKD-REIN is a prospective cohort of 3033 nephrology outpatients with a confirmed diagnosis of CKD and an eGFR < 60mL/min/1.73m<sup>2</sup>. ADRs were prospectively identified from hospitalization and medical reports and participant interviews. Experts in pharmacology assessed causality and preventability using validated tools.

**Results:** At baseline, patients' median age was 69, mean eGFR was 33mL/min/1.73m<sup>2</sup>, and the median number of medications per day was 8. During a median follow-up of 4.6 years, 1672 ADRs (among which 488 were serious) occurred in 973 patients, of whom 42% had more than one ADR (incidence rate: all ADRs, 14.2[13.6-14.9] per 100 person-years (PA); serious ADRs, 4.2[3.8-4.5] per 100 PA). Among all ADRs, renal and urinary disorders (n=310), gastrointestinal disorders (n=253) and hemorrhages (n=213) were the most common. The incidence rate of serious ADRs in patients with an eGFR <30 was twice as high as in patients with an eGFR ≥ 30mL/min/1.73m<sup>2</sup> (6.0[5.2;6.7] vs 3.1[2.7;3.5] per 100 PA). This difference was mainly driven by bleeding events imputed to antithrombotics. Among 488 serious ADRs, 65% were the cause of hospitalization, 31% occurred during hospitalization and 4% were serious but did not require hospitalization. More than 27% of serious ADRs were preventable or potentially preventable (n=132). The most important preventability criterion was inappropriately

high dosage (n=28) and contraindications (n=35) according to the patient's kidney function. Patients were implicated in 22 preventable cases because of medication error (n=14), self-medication (n=6), and other (n=2).

**Conclusions:** ADRs are common in patients with CKD and are a major cause of hospitalization. Many adverse effects are preventable, suggesting the need for better dissemination of guidelines on drug management in patients with CKD.

#### FR-PO222

##### Delirium in Renal Failure, Not Always Uremia: A Case of Thiamine Deficiency With Wernicke Encephalopathy

Esra Ekiz, Marco Ramos, Prerana R. Rodrigues, Thin Thin Soe, Su M. Yee, Atin K. Shaha, Suhaib A. Andrabi, Leroy Herbert. *New York City Health and Hospitals Corporation, New York, NY.*

**Introduction:** Delirium is an acute confusional state that differs from individual's norm. Thiamine plays role in propagating nerve impulses; its deficiency can present with neurologic symptoms. We report a case of delirium, attributed to uremic encephalopathy, who was found to have thiamine deficiency.

**Case Description:** 67 year-old male with chronic kidney disease, type 2 diabetes, hypertension, polysubstance abuse including nicotine, ethanol, marijuana; admitted to hospital with a fall. Initially, vitals were within normal range, he was drowsy but oriented to three spheres. Physical exam was significant for wheezing on auscultation of lungs and tremors on outstretched hands. Investigations showed blood urea nitrogen 117 mg/dl, creatinine 8.1 mg/dl, high anion gap metabolic acidosis, hypoalbuminemia and anemia. Ethanol level and urine toxicology were negative; ammonia was elevated. Computed tomography of the head revealed no acute intracranial abnormality. Meningitis work-up was negative. Chest x-ray showed bilateral pulmonary opacities. Despite supplemental oxygen, antibiotics, lactulose; sensorium was poor and uremia was thought to be the precipitating factor. After a total of 10 hemodialysis sessions, patient continued to be lethargic and somnolent. Due to history of alcohol use disorder, he was at risk of nutritional deficiencies and high dose thiamine was started with dramatic improvement in sensorium over the course of 24 hours. He became alert, oriented and conversant.

**Discussion:** Delirium is a syndrome of disturbed consciousness or cognitive function developing over a short period of time. Chronic alcohol abuse-induced thiamine deficiency is one of the metabolic causes of altered sensorium, leading to Wernicke's encephalopathy, characterized by mental confusion, ophthalmoplegia and ataxia. All features of the classic triad are present in only one-third of patients. Diagnosis is clinical and is mainly supported by the dramatic response of neurological signs to parenteral thiamine. Azotemia is not always the cause of altered mentation in renal failure. Considering thiamine deficiency in cases with altered mental status is essential in regards to timely management of patients, prevention of complications and efficient use of resources by introduction of a safe, easily accessible medication: ie thiamine.

#### FR-PO223

##### 5-HT<sub>3</sub> Antagonist Antiemetic Drugs Alter Cisplatin Pharmacokinetics and Risk of Nephrotoxicity

Lauren E. Thompson,<sup>1</sup> Xia Wen,<sup>2</sup> Justine Jorgensen,<sup>3</sup> Jordan Palan,<sup>1</sup> Cathleen Doherty,<sup>2</sup> Brian Buckley,<sup>2</sup> Edgar A. Jaimes,<sup>3</sup> Lauren Aleksunes,<sup>2</sup> Melanie S. Joy.<sup>1</sup> <sup>1</sup>University of Colorado Health, Aurora, CO; <sup>2</sup>Rutgers The State University of New Jersey, New Brunswick, NJ; <sup>3</sup>Memorial Sloan Kettering Cancer Center, New York, NY.

**Background:** Cisplatin, a common chemotherapeutic, causes acute kidney injury (AKI) in up to one-third of patients. Previous reports have indicated that maximum plasma concentration (C<sub>max</sub>) or area under the plasma concentration vs time curve (AUC) of platinum increase risk of AKI. Ondansetron, a commonly co-prescribed 5-HT<sub>3</sub> antagonist antiemetic drug in patients receiving cisplatin-containing chemotherapy, has been associated with enhanced risk of AKI in rodents and retrospective clinical studies. However, to date, there has been no prospective evaluation of AKI risk in patients randomized to different 5-HT<sub>3</sub> antagonist drugs.

**Methods:** As part of study NCT03817970, an initial group of patients (n=23) undergoing their first or second round of cisplatin chemotherapy (≥25 mg/m<sup>2</sup>) were prospectively randomized to one of three antiemetic drugs (ondansetron 8 mg p.o., granisetron 2 mg p.o., or palonosetron 0.25 mg i.v.). Total platinum plasma concentrations were quantified using inductively coupled plasma-mass-spectrometry (ICP/MS). Pharmacokinetic analyses were performed, and parameters were compared based on 5-HT<sub>3</sub>A treatment using one-way ANOVAs with Tukey-Kramer post-hoc tests. All analyses were performed using R and Certara Phoenix™.

**Results:** Patients randomized to receive ondansetron had significantly increased total platinum plasma C<sub>max</sub> levels (normalized by cisplatin dose) compared to patients receiving granisetron (102% increase) or palonosetron (81% increase) (p=0.005). Moreover, ondansetron-treated patients had the highest AUC from 0-2 hours (normalized by cisplatin dose) (granisetron: 83% increase; palonosetron: 40% increase; p=0.147) and the largest average decrease in estimated glomerular filtration rate (eGFR) following cisplatin treatment compared to granisetron (408% decrease) and palonosetron-treated (173% decrease) patients (p=0.170).

**Conclusions:** Cisplatin-treated cancer patients prescribed ondansetron for the prevention of emesis exhibited decreased kidney function when compared to patients receiving granisetron or palonosetron. Future work will expand analyses to include additional patients, urinary excretion of cisplatin, and urinary biomarkers of kidney injury.

**Funding:** NIDDK Support, Other NIH Support - R21 DK093903, R01 GM123330, T32 ES029074 and TL1 TR002533

#### FR-PO224

##### Levofloxacin Dosing Recommendations for Home Hemodialysis (HHD)

Soo min Jang,<sup>1</sup> Susan J. Lewis,<sup>3</sup> Bruce A. Mueller.<sup>2</sup> <sup>1</sup>Loma Linda University, Loma Linda, CA; <sup>2</sup>University of Michigan College of Pharmacy, Ann Arbor, MI; <sup>3</sup>University of Findlay College of Pharmacy, Findlay, OH.

**Background:** HHD implementation is challenging due to the lack of drug dosing information for HHD. Recommendations for intermittent HD aren't applicable to HHD due to differences in dialysis frequency, duration, and dialysate volume from intermittent HD.

**Methods:** Using Monte Carlo simulation, we modelled 7-day therapy for 10 HHD settings (A: 3-h diurnal HHD 4X/week @ dialysate volumes of 30L, 40L, 50L; B: 3-h diurnal HHD 5X/week @ 20L, 30L; C: 7-h nocturnal HHD 3.5X/week @ 30L, 50L, 60L; D: 7-h nocturnal HHD 5X/week @ 30L, 60L) based on published pharmacokinetic data and internal demographic information from NxStage Medical, Inc. Many oral levofloxacin regimens were simulated to predict the probability of target attainment (PTA). Clinical breakpoints were 0.5mg/L for E. coli, 1mg/L for P. aeruginosa and 2mg/L for S. pneumoniae. The pharmacodynamic target was: AUC<sub>24h</sub>:MIC ≥125 for each 24 h for Gram-negative infections and AUC<sub>24h</sub>:MIC ≥50 for Gram-positive infections. We have aimed to predict the smallest oral levofloxacin doses that achieved PTA >90% for each HHD setting. Maximum daily dosing for oral levofloxacin approved by the U.S. Food and Drug Administration is 750mg daily, hence maximum dose was limited to 750mg daily.

**Results:** Our analyses indicates that no oral levofloxacin regimen reaches PTA of ≥90% on Day 1 for all organisms at all dialysate flows. From Day 2 until Day 7, PTA >98% was achieved for E. coli with 500mg every 24h in all 10 HHD settings at different dialysate volumes. For S. pneumoniae, 750mg every 24h was needed to achieve PD target of ≥90% whereas, 500mg every 24h achieved PTA of ≥83% on Day 2 and PTA of ≥96% from Day 3 until Day 7. For P. aeruginosa, 750mg every 24h was needed to achieve PD target of ≥90% from Day 3 until Day 7.

**Conclusions:** One levofloxacin 500 mg tablet every 24h for E. coli and S. pneumoniae, and 750mg every 24h for P. aeruginosa would reach the PD target by day 2. However, clinical caution is warranted since this levofloxacin dosing recommendation is higher than those used for intermittent hemodialysis.

**Funding:** Commercial Support - Fresenius

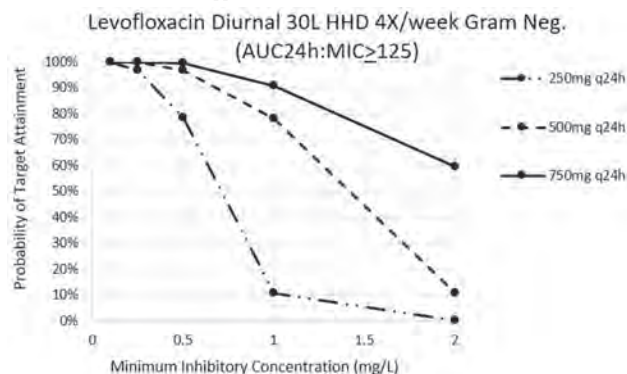

#### FR-PO225

##### Determining Vancomycin Dosing Recommendations in Patients Receiving Home Hemodialysis (HHD) Using Monte Carlo Simulations

Susan J. Lewis,<sup>1</sup> Soo min Jang,<sup>3</sup> Bruce A. Mueller.<sup>2</sup> <sup>1</sup>University of Findlay College of Pharmacy, Findlay, OH; <sup>2</sup>University of Michigan College of Pharmacy, Ann Arbor, MI; <sup>3</sup>Loma Linda University, Loma Linda, CA.

**Background:** HHD is resurging due to clinical benefits and technology advances. Vancomycin is commonly prescribed in end stage kidney disease patients receiving conventional dialysis. HHD utilizes more frequent and/or longer dialysis sessions than standard thrice-weekly hemodialysis and optimal vancomycin doses are likely different for those with HHD. This study was designed to determine optimal vancomycin dosing strategies incorporating therapeutic drug monitoring (TDM) for patients receiving common HHD settings.

**Methods:** Pharmacokinetic models were developed using internal outpatient dialysis patient demographic data and published pharmacokinetic parameters to predict vancomycin disposition in 5,000 virtual patients receiving HHD using Monte Carlo simulations. Many vancomycin doses infused post-dialysis were tested to evaluate the probability of target attainment (PTA) in 10 different HHD regimens (Table). The pharmacodynamic target was a 24-hour area under the curve/minimum inhibitor concentration (AUC<sub>24h</sub>:MIC) ≥400 mg\*h (assuming the MIC of 1 mg/L) since the upper AUC<sub>24h</sub> threshold linked with nephrotoxicity is usually of less concern in this population compared to an AKI population. The smallest vancomycin doses attaining PTA ≥90% during 1-week of therapy were considered optimal initial dosing. Therapeutic drug monitoring (TDM) using a single pre-dialysis vancomycin concentration was developed to individualize subsequent vancomycin doses.

**Results:** Vancomycin doses and TDM schedules that achieved acceptable PTA rates appear in the figure.

**Conclusions:** Optimal vancomycin dosing recommendations for HHD patients differ from those for conventional thrice-weekly hemodialysis. These vancomycin dosing recommendations warrant clinical validation.

**Funding:** Commercial Support - Fresenius

HHD Type	Duration (hours/session)	HHD Setting		Dialysate Volume (L/session)	Optimal Initial Vancomycin Doses	TDM
		Frequency (Days/week)				
Diurnal	3	4 (M-T-Th-F)	30	25-5-5-7.5 mg/kg post-HHD*	Draw pre-HHD level prior to the last HHD of the week & adjust the dose using the equation below:  New dose (mg/kg) = $\frac{\text{Previous dose} \times 24 \text{ mg/L}}{\text{Pre-HHD vancomycin conc.}}$	
			40			
			50			
Nocturnal	3	5 (M-T-W-Th-F)	20	25-0-7.5-0-7.5 mg/kg post-HHD*	*For these HHD settings, a 30% higher dose is recommended for any 3-day interdialytic period	
			30			
			30			
	7	3.5 (M-W-F-Sun)	30	25 mg/kg, 7.5 mg/kg post-HHD		
			50			
			60			
7	5 (M-T-W-Th-F)	30	25-5-5-5-7.5 mg/kg post-HHD*			
		50				
		60				

HHD: home hemodialysis; \*Dose given on M-W-F only

Optimal initial vancomycin doses and TDM strategy in ten HHD settings to attain AUC<sub>0-24h</sub> ≥400 mg\*<sub>h</sub>

**FR-PO226**

**Ceftazidime Dosing Recommendations in Patients Receiving Various Home Hemodialysis Regimens**

Susan J. Lewis,<sup>1</sup> Soo min Jang,<sup>3</sup> Bruce A. Mueller,<sup>2</sup> <sup>1</sup>University of Findlay College of Pharmacy, Findlay, OH; <sup>2</sup>University of Michigan College of Pharmacy, Ann Arbor, MI; <sup>3</sup>Loma Linda University, Loma Linda, CA.

**Background:** Home hemodialysis (HHD) regimens differ from those for typical in-center thrice-weekly hemodialysis in frequency, duration and dialysate volume. In recent years, HHD is increasingly used, but the literature for drug dosing in HHD is sparse. This study was aimed to determine optimal ceftazidime dosing regimens in end stage kidney disease patients with various HHD regimens using Monte Carlo simulation (MCS) techniques.

**Methods:** Pharmacokinetic models were constructed using internal outpatient dialysis patient demographic information and pertinent pharmacokinetic data to predict ceftazidime plasma concentrations in 5,000 virtual patients receiving HHD. MCS was performed to assess the probability of target attainment (PTA) of various ceftazidime doses in 10 different HHD settings (Table). All ceftazidime doses were simulated to be infused post-dialysis. The efficacy target was free serum ceftazidime concentrations above 4 times the minimum inhibitory concentration for at least 60% of the dosing interval (fI>4xMIC; MIC=8 mg/L for *Pseudomonas aeruginosa*). The smallest doses attaining PTA≥90% of virtual patients during 1-week of therapy were considered optimal to minimize toxicity concerns. The assumption was made that ceftazidime therapeutic drug monitoring services were unavailable.

**Results:** The lowest ceftazidime doses that met PTA goals in >90% of virtual patients for ten different HHD regimens are shown in the figure. Required ceftazidime doses differed depending on interdialytic-period (e.g. 1-3 days) and the prescribed dialysate volumes.

**Conclusions:** MCS predicted that HHD patients would require different ceftazidime doses from those recommended for typical thrice-weekly hemodialysis to ensure PTA in >90% of virtual patients. Further clinical validation of these findings is necessary.

**Funding:** Commercial Support - Fresenius

HHD Type	HHD Regimens			Optimal Ceftazidime Dose
	Duration (Hours/session)	Frequency (Days/week)	Dialysate Volume (L/session)	
Diurnal	3	4 (M-T-Th-F)	30	2g LD-2g-1.5g-2g post-HHD
			40	
			50	
Diurnal	3	5 (M-T-W-Th-F)	20	2g LD-1g-1g-1g-2g post-HHD 2g LD-1.5g-1.5g-1.5g-2g post-HD
			30	
			30	
Nocturnal	7	3.5 (M-W-F-Sun)	30	2g post-HD
			50	
			60	
Nocturnal	7	5 (M-T-W-Th-F)	30	2g LD-1.5g-1.5g-1.5g-2g post-HD 2g post-HD
			50	
			60	

\*LD: loading dose

Ceftazidime doses that met pharmacodynamic targets in 90% of virtual patients in ten HHD regimens.

**FR-PO227**

**Evaluation of Optimal Cefazolin Regimen in Hemodialysis Patients**

Maude Pichette,<sup>1,2</sup> Naoual Elftouh,<sup>1</sup> Jean-François Tessier,<sup>1</sup> Annie-Claire Nadeau-Fredette,<sup>1,2</sup> <sup>1</sup>Hopital Maisonneuve-Rosemont, Montreal, QC, Canada; <sup>2</sup>Universite de Montreal, Montreal, QC, Canada.

**Background:** Cefazolin is commonly used among patients on hemodialysis (HD) to treat gram-positive infections although equipoise persists on the optimal regimen in this specific population.

**Methods:** The primary aim of this observational prospective study was to compare free cefazolin plasmatic concentrations between 3 regimens (2-2-3g post-HD / 1g daily / 2g daily) in adult patients from a single center receiving cefazolin between Sept 2020

and Jan 2022. Our secondary aim was to determine if cefazolin levels were above the local minimum inhibitory concentration (MIC) with each regimen. The antibiotic regimen was determined by the patient's treating team (nephrologists and/or microbiologists) independent from the study. Local MIC's for methicillin-sensitive staphylococcus aureus (MSSA) were measured for patients in whom it was available, with 4 times the MIC considered as a therapeutic target according to the literature.

**Results:** 72 cefazolin dosages were obtained from 25 patients, with 15 patients receiving 2-2-3g post-HD, 6 patients treated with 1g daily and 4 patients with 2g daily. The most frequent indications for cefazolin were catheter infections (n=6), cutaneous infections (n=6) and osteitis (n=5). Of note, two patients had endocarditis and 10 patients (40%) had a MSSA bacteremia. Among patients with bacteremia, two patients were treated with 2-2-3g post-HD regimen, 4 received 1g daily and 4 patients had 2g daily. The mean free plasma concentrations of cefazolin were 23.3±13.6 mg/L, 33.2±12.7 mg/L and 67.5±21.6 mg/L for the 2-2-3g post-HD / 1g daily / 2g daily respectively. The local MICs ranged from 0.25 to 1 mg/L.

**Conclusions:** In all the three regimens, the free plasmatic levels of cefazolin were above the local MIC's. Our data show that a thrice-weekly post-HD regimen should be prioritized in MSSA infection in hemodialysis, especially in outpatient settings, to avoid the need of peripheral access and reduce the time and human resources associated to daily antibiotics.

Regimen	Thrice-weekly (n=15)	1g daily (n=6)	2g daily (n=4)	p-value
<b>Baseline characteristics</b>				
Age (years)	61.5±16.6	61.8±17.0	45.3±5.9	0.14
Male sex, n (%)	5 (33)	6 (100)	4 (100)	0.004
BMI (kg/m <sup>2</sup> )	29.3±8.1	28.8±4.2	23.8±3.5	0.57
Diabetes, n (%)	11 (73)	2 (33)	2 (50)	0.24
CAD, n (%)	9 (60)	4 (67)	0 (0)	0.53
<b>Cefazolin indication</b>				
Endocarditis, n (%)	0 (0)	0 (0)	4 (50)	
MSSA bacteremia, n (%)	2 (13)	4 (67)	4 (100)	0.002
Daily dose (mg/Kg)	14.0±4.0	11.7±1.8	30.1±10.2	0.01
<b>Dosage</b>				
Total number of dosages	32	25	15	
Free cefazolin dosages (mg)	23.3±13.6	33.2±12.7	67.5±21.6	<0.001

**FR-PO228**

**Pharmacokinetics of Remdesivir for Treatment of COVID-19 in a Child on Intermittent Hemodialysis**

Erika Allred,<sup>1,2</sup> Caitlin E. Carter,<sup>1,2</sup> <sup>1</sup>University of California San Diego, La Jolla, CA; <sup>2</sup>Rady Children's Hospital San Diego, San Diego, CA.

**Introduction:** Remdesivir is FDA approved for treatment (txt) of COVID19 in hospitalized adults and older children but is available only through an FDA EUA in pts <12 yo or <40 kg due to limited safety. Remdesivir is not recommended for use in pts with eGFR < 30 mL/min/1.73 m<sup>2</sup> due to renal excretion and limited data. Children with ESKD have increased morbidity and mortality secondary to COVID-19 and limited txt options. Determining pharmacokinetics (PK) of children on dialysis remains a priority. Here we report the PK of remdesivir and its active metabolite (GS-443902) for txt of COVID19 in a 2 yo on intermittent hemodialysis (IHD).

**Case Description:** A 2 yo male with ESKD on chronic IHD was admitted in December 2021 after developing respiratory distress and hypoxia. SARS-COV-2 PCR was positive and chest x-ray showed viral airway disease. Due to severity of illness, he was treated with 2 doses of intravenous remdesivir (5 mg/kg loading dose after IHD #1 and 2.5 mg/kg after his next IHD 44 hours later.) The plasma concentration of remdesivir quickly decreased from 112 ng/mL to undetectable between 1- and 6-hours post-infusion. GS-441524 levels rose between 1- and 6-hours post-infusion (694 ng/mL to 837 ng/mL) and remained stable at 898 ng/mL 2 days later, prior to the next IHD (fig 1), consistent with minimal clearance between IHD. GS-441524 during IHD was calculated to have an elimination rate constant of 0.154 hr<sup>-1</sup> with a half-life of 4.5 hours during IHD. HD performed prior to the second dose of remdesivir reduced GS-441524 plasma concentration by 37%. We did not observe accumulation of remdesivir, and GS-441524 accumulation was prevented by IHD. The pt was discharged after 4 days and did not have sequelae of txt with remdesivir.

**Discussion:** We report successful and safe txt of a COVID positive IHD dependent toddler with remdesivir. Given limited options for txt of COVID19 in this vulnerable population, additional exploration of remdesivir kinetics is needed to fully understand safety and efficacy.

Figure 1: Remdesivir and GS-441524 levels in a pediatric patient on IHD.

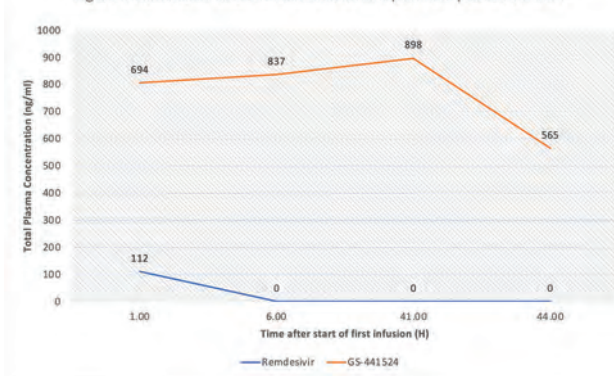

FR-PO229

**Hemodialysis Is More Effective Than Continuous Venovenous Hemodialysis for Treatment of Hypermagnesemia due to Epsom Salt Ingestion**

Yazan A. Bashtawi, Fatima Ayub, Joseph H. Holthoff. *University of Arkansas for Medical Sciences, Little Rock, AR.*

**Introduction:** A case of AKI on CKD and hypermagnesemia due to Epsom salt (MgSO<sub>4</sub>) ingestion

**Case Description:** 73 year old male with chronic kidney disease stage 3a who was in chronic use of laxatives presented to ER with generalized weakness associated with hot flushes, nausea and vomiting. He had poor oral Intake for several weeks. He takes two tablespoons of Epsom salts daily for constipation, and recently doubled the dose. On arrival vitals showed BP 128/93, P 76, RR 16, O<sub>2</sub> sat 94 %, T 97.5, BMI 15. He had diffuse hyporeflexia. Creatinine (Cr) 3.3 mg/dl; calcium (Ca) 8 mg/dl; Magnesium (Mg) 10.8 mg/dl. PH 7.12, PaCO<sub>2</sub> 28 mmHg, HCO<sub>3</sub> 9 mmol/l Table1. Urine output >2L/day. Glucose, CK, lactate, ALT, AST, TSH and troponin were normal. ECG showed sinus rhythm (SR), prolonged PR, QRS and QTC intervals. 2 L lactated Ringer's, 4 grams (g) IV Ca gluconate, Lasix 80 mg IV, 40 mEq of potassium chloride IV, and 40 mEq oral were given. 2 hours (hrs) later Mg was 10.4 mg/dl. Patient was shifted to ICU. Treatment repeated and 150 ml/hr normal saline added. 8 hrs later Mg 8.1 mg/dl. ECG showed junctional rhythm. Hemodialysis (HD) was initiated for 3 hrs (Mg 1 mEq/L, 4 k path). Post HD Mg 3.7 mg/dl. For concerns of rebound hypermagnesemia, Continuous Venovenous Hemodialysis (CVVHD) was started (4 k, Mg 1 mEq/L path, rate 25 ml/kg/hr, continuous 30 mmol potassium phosphate infusion every 12 hrs). 18 hrs later his Mg improved to 2.9 mg/dl and treatment terminated figure 1. ECG showed SR with normal PR and QTC intervals. Generalized weakness and hyporeflexia were resolved. He was discharged home 4 days later with baseline Cr and Mg 2.1 mg/dl

**Discussion:** Intermittent hemodialysis resulted in more rapid Mg removal in this patient with renal failure Figure1. CVVHD may be used as a adjunct therapy for prevention of rebound hypermagnesemia especially when prolonged GI release of ingested magnesium compounds is expected

Changes in serum Magnesium level over time

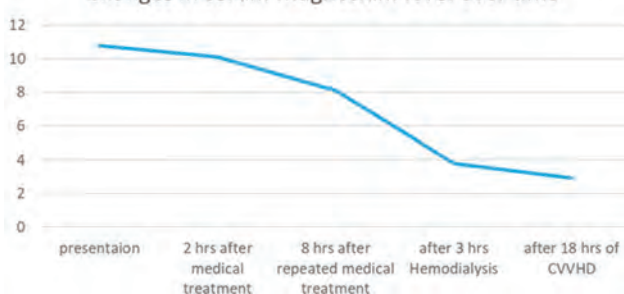

Lab results	6 months	at presentation	2 hrs	8 hrs	after HD	after CVVD
Sodium mmol/L	137	120	132	132	127	133
potassium mmol/L	3.3	2.1	2.5	2.4	3.3	3
chloride mmol/L	112	93	95	102	102	102
CO2 mmol/L	16	5	9	9	18	21
BUN mg/dl	16	41	38	35	11	7
Creatinine mg/dl	1.7	3.3	2.9	2.9	1.1	1.4
eGFR estimated 75 ml/min	48	19	22	22	NA	NA
Calcium mg/dl	NA	8	8.3	7.2	8.7	7.5
Magnesium mg/dl	NA	10.8	10.4	8.1	3.7	2.9
phosphorus mg/dl	NA	5.3	4.9	3	1	2.2

FR-PO230

**Erythrocytapheresis in the Management of Acute Sodium Nitrate Toxicity**  
Nam Ha, Parker K. Hughes, Anubhav Kumar. *UVA Health, Charlottesville, VA.*

**Introduction:** Sodium nitrate, a common food preservative, is increasingly implicated in suicide attempts. Nitrate oxidizes hemoglobin to methemoglobin, which has poor oxygen-binding capacity. At high concentrations, methemoglobinemia leads to cardiovascular collapse. We present a case of life-threatening methemoglobinemia following intentional sodium nitrate ingestion requiring erythrocytapheresis (RBC exchange) and arteriovenous extracorporeal membrane oxygenation (VA ECMO).

**Case Description:** A 27-year-old woman with a history of depression reported to emergency services that she had injected sodium nitrate into her abdomen. On arrival to the emergency department, she was unresponsive, cyanotic, hypotensive, and hypoxic to oxygen saturation of 75%. Methemoglobin level was 86%. She was given methylene blue, intubated with succinylcholine and started on vasopressor and ascorbic acid. Nephrology was consulted for RBC exchange and cardiothoracic surgery for possible serotonin syndrome after methylene blue administration. Patient underwent cannulation to begin VA ECMO. RBC exchange was begun via the ECMO circuit; 2200 mL of red cell volume was exchanged, and methemoglobin level decreased to 5.6%. The patient required no further apheresis therapy and was later decannulated from VA ECMO the next day and eventually transferred for psychiatric care.

**Discussion:** Sodium nitrate ingestion induces cardiovascular collapse via smooth muscle relaxation, compromising venous return. Methemoglobin production occurs via nitrate-mediated oxidation of hemoglobin's ferrous moiety to ferric, impairing oxygen binding and producing hypoxia. Methylene blue may be helpful to reduce ferric iron to ferrous but may be inadequate on its own in cases of extreme poisoning or cardiorespiratory symptoms. Rapid initiation of erythrocytapheresis may be life-saving in these situations, as observed in this case.

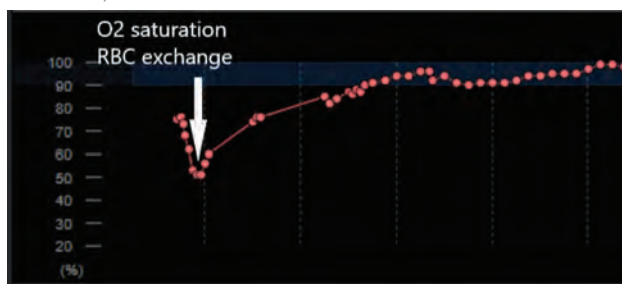

FR-PO231

**Pharmacokinetic (PK) Results From a Phase 3 Trial to Evaluate Pegunigalsidase Alfa Every 4 Weeks (Q4W) in Patients (Pts) With Fabry Disease Previously Treated With Agalsidase Beta or Agalsidase Alfa**

Camilla Tøndel,<sup>1</sup> Eric L. Wallace,<sup>2</sup> Rossana Rocco,<sup>3</sup> Einat Almon,<sup>4</sup> Sari Alon,<sup>4</sup> Liora Blinder-Haddad,<sup>4</sup> Raul Chertkoff,<sup>4</sup> David G. Warnock,<sup>2</sup> Stephen Waldek,<sup>5</sup> Antonio Pisani.<sup>6</sup> *<sup>1</sup>Haukeland Universitetssjukehus, Bergen, Norway; <sup>2</sup>University of Alabama, Birmingham, AL; <sup>3</sup>Chiesi Farmaceutici S.p.A., Parma, Italy; <sup>4</sup>Protalix Biotherapeutics, Carmiel, Israel; <sup>5</sup>University of Sunderland, Sunderland, United Kingdom; <sup>6</sup>University Federico II of Naples, Naples, Italy.*

**Background:** Fabry disease is a lysosomal storage disease caused by X-linked deficiency of alfa-galactosidase-A. Two enzyme replacement therapies (ERTs) are approved for Fabry disease (agalsidase alfa and agalsidase beta) with infusion every 2 wks. We present PK results from a phase 3 trial of pegunigalsidase alfa administered Q4W to pts with Fabry disease previously treated with ERTs.

**Methods:** In this phase 3, open-label, switch-over study, pts aged 18–60y with Fabry disease who had received ERTs for ≥3y (with stable dose for ≥6mo) and had estimated glomerular filtration rate ≥30mL/min/1.73 m<sup>2</sup> received IV infusion of pegunigalsidase alfa 2.0mg/kg Q4W for 52 wks. Blood samples for PK assessment were collected on Day 1 and at Wk 52 at 13 timepoints.

**Results:** 30 pts (24 male, 6 female) enrolled; 29 completed the study and entered the open-label extension (OLE) study. Main PK parameters are shown (Table). From baseline to week 52, pegunigalsidase alfa had a mean C<sub>max</sub> ranging from 35 876.7–46 829.6ng/mL, with t<sub>max</sub> near end of infusion time, and mean t<sub>1/2</sub> ranging from 100–134h. Detectable pegunigalsidase alfa concentrations after each 4-wk dosing interval were above the lower limit of quantitation (19.5ng/mL), ranging from 167.0–301.5ng/mL. Pts with antidrug antibodies (ADAs) at baseline (n=10) had lower AUC<sub>0-last</sub> (1 047 637h•ng/mL) and shorter t<sub>1/2</sub> (41.0h; range: 1.1–136.3h) after 1st infusion and throughout the study vs the overall population.

**Conclusions:** Mean pegunigalsidase alfa concentration at the end of each dosing interval supported Q4W dosing. Long-term clinical outcomes with Q4W dosing are being assessed in the OLE.

**Funding:** Commercial Support - This study was sponsored by Protalix. Medical writing support was provided by Chris Kirk, PhD, on behalf of Oxford PharmaGenesis Inc., Newtown, PA, and funded by Chiesi Inc. The investigators would like to acknowledge the study participants and their caregivers for participating in this study.

**Table** Summary of selected PK parameters for pegunigalsidase alfa Q4W, at baseline and at week 52

Parameter	Baseline (visit 1) <sup>a</sup>		Week 52 <sup>a</sup>	
	Mean (SD) value	Patients, n	Mean (SD) value	Patients, n
C <sub>max</sub> , ng/mL	35 876.7 (11 942.2)	30	46 829.6 (27 865.0)	28
AUC <sub>0-24h</sub> , h·ng/mL	1 757 492.0 (810 170.7)	30	1 990 784.0 (908 259.3)	28
t <sub>max</sub> , h	5.4 (2.2)	30	2.6 (2.1)	28
t <sub>1/2</sub> , h	100.1 (58.3)	30	133.7 (47.8)	26
Range	1.1–212.9	30	3.9–203.1	26
CL, mL/h	290.9 (868.6)	30	217.0 (595.1)	26
V <sub>d</sub> , mL	12 540.3 (6521.1)	30	15 103.0 (5007.9)	26

AUC<sub>0-24h</sub>, area under the concentration-time curve from time zero to last measurable concentration; CL, clearance; C<sub>max</sub>, maximum observed concentration; t<sub>1/2</sub>, terminal elimination half-life; t<sub>max</sub>, time to maximum concentration; V<sub>d</sub>, volume of distribution.  
<sup>a</sup>Infusion length was longer at baseline vs other visits (during which infusions were at steady-state).

**FR-PO232****Pharmacokinetics and Immunogenicity of Pegloticase in Patients With Kidney Transplants Receiving Pegloticase for Uncontrolled Gout**

Abdul A. Abdellatif,<sup>1</sup> Yan Xin,<sup>2</sup> Jason Chamberlain,<sup>2</sup> Lin Zhao,<sup>2</sup> Katya Cherny,<sup>2</sup> Brad A. Marder,<sup>2</sup> John D. Scandling,<sup>3</sup> Kenneth G. Saag,<sup>4</sup> <sup>1</sup>Baylor College of Medicine, Nephrology and CLS Health, Houston, TX; <sup>2</sup>Horizon Therapeutics plc, Deerfield, IL; <sup>3</sup>Stanford Medicine, Division of Nephrology, Stanford, CA; <sup>4</sup>The University of Alabama at Birmingham, Division of Clinical Immunology and Rheumatology, Birmingham, AL.

**Background:** Immunomodulator co-therapy with pegloticase markedly improves the efficacy of pegloticase by reducing its immunogenicity.<sup>1,4</sup> PROTECT (NCT04087720), an open-label, single-arm study in uncontrolled gout patients with a history of kidney transplant (KT) on stable immunosuppressants demonstrated that pegloticase was effective in reducing serum urate (SU) levels, with a high (89%) responder rate, defined as SU < 6 mg/dL for ≥80% of the time during month 6, while preserving key graft function indicators.<sup>5</sup> The objective of this study was to evaluate the pharmacokinetics (PK) and immunogenicity of pegloticase in uncontrolled gout patients with a history of KT on immunosuppression.

**Methods:** Pegloticase (8 mg infusion [IV]) was administered every two weeks (q2w) for 24 weeks. Serum samples for PK and immunogenicity analysis were collected pre- and post-dose at multiple visits.

**Results:** 20 patients received at least 1 dose of pegloticase and were included in the analysis. Measurable pegloticase concentrations were maintained in SU responders through Month 6. Following treatment initiation, the median pre- and post-dose pegloticase concentration ranged from 0.97 to 1.59 µg/mL and 1.57 to 3.60 µg/mL respectively across visits. In contrast, the 2 non-responders both had pre-dose pegloticase concentrations below the limit of quantification (BLQ), and one had a BLQ value post-pegloticase infusion, which was consistent with the immunogenicity results. Pegloticase exposures were higher than those observed with pegloticase monotherapy, which was consistent with the improved PK results observed with methotrexate co-therapy. No infusion reactions or anaphylaxis occurred during the trial.

**Conclusions:** Pegloticase 8 mg IV q2w with standard of care immunosuppressants in transplant patients resulted in a high SU responder rate and improved pegloticase exposure. **References:** 1. Keenan RT, et al. *Seminars in Arthritis and Rheumatology* 2021; 51:347-352 2. Botson J, et al. *J Rheumatol* 2021;48:767-74 3. Song Y, et al. *Arthritis Rheum* 2020;72(suppl 10) 4. Xin Y, et al. *EULAR* 2022; POS1163 5. Abdellatif A., et al. *Amer Soc Neph*; 2021, Abstract P01127.

**FR-PO233****Consumption of Uric Acid in the Gastrointestinal Tract (GI) With Engineered Escherichia coli Nissle as a Potential Treatment for Gout**

Julia Xu,<sup>1</sup> Sharee Pettiford,<sup>1</sup> Sean Cotton,<sup>1</sup> Theodore C. Moore,<sup>2</sup> Vincent Isabella,<sup>1</sup> Mylene Perreault,<sup>1</sup> David Hava.<sup>1</sup> <sup>1</sup>Synlogic, Cambridge, MA; <sup>2</sup>Ginkgo BioWorks, Boston, MA.

**Background:** Elevated circulating levels of uric acid (UA) are associated with an increased risk of developing gout and other chronic diseases such as CKD, T2D, and CVD. Despite advancements in treatment options, gout continues to be characterized by suboptimal quality of care. In healthy individuals, about 70% of circulating UA is metabolized and excreted by the kidneys, while the remaining 30% is processed through the GI tract. Emerging evidence has demonstrated a role for the gut microbiome in degrading UA. Furthermore, a remarkable gut dysbiosis in association with dysregulated host urate degradation has been reported in gout patients. In light of these findings, we engineered a Synthetic Biotic that is capable of degrading UA within the GI tract.

**Methods:** SYN-GOUT is a modified strain of *Escherichia coli* Nissle 1917 engineered to express bacterial and fungal urate oxidase enzymes, as well as to overexpress a urate transporter. The strain converts UA into 5-hydroxyisourate, which then spontaneously degrades into allantoin, a highly soluble and readily eliminated purine derivative.

**Results:** *In vitro*, SYN-GOUT effectively metabolized ~2 mM UA within 120 min, resulting in concomitant increase in its metabolite allantoin. Activity assay showed that SYN-GOUT was effective at consuming UA under hypoxic (2-7% oxygen) conditions, an environment that mimics the gastrointestinal tract. Administration of labeled UA (1,3-<sup>15</sup>N<sub>2</sub>) via intraperitoneal route in mice was associated with appearance of 1,3-<sup>15</sup>N<sub>2</sub>-UA in the small intestine, indicating the existence of an enterorecirculation loop. Finally, urinary UA output decreased more than 2-fold when non-human primates (NHPs) were given a single dose of SYN-GOUT, demonstrating that SYN-GOUT was active *in vivo*.

**Conclusions:** As a novel Synthetic Biotic, SYN-GOUT effectively consumed UA *in vitro*, and remained active under hypoxic conditions. *In vivo*, SYN-GOUT was safe and well-tolerated, and it lowered urinary UA levels in NHPs. The findings that a pool of UA circulates between systemic and GI compartments implies that SYN-GOUT, by consuming UA within the GI tract, has the potential to lower UA systemically. Therefore, SYN-GOUT could be an effective alternative for the treatment of gout, especially in individuals with compromised kidney function.

**Funding:** Commercial Support - Synlogic Therapeutics

**FR-PO234****Renally Targeted Nanoparticle Drug Therapy for Rhabdomyolysis-Induced AKI**

Jessica F. Hebert,<sup>1</sup> Yoshio Funahashi,<sup>1</sup> Adam C. Munhall,<sup>1</sup> Megan N. Nickerson,<sup>1,6</sup> Mahaba B. Eiwaz,<sup>1</sup> Jonghan Kim,<sup>5</sup> Hak soo Choi,<sup>3,4</sup> Michael Hutchens.<sup>1,2</sup> <sup>1</sup>Oregon Health & Science University, Portland, OR; <sup>2</sup>Portland VA Medical Center, Portland, OR; <sup>3</sup>Massachusetts General Hospital, Boston, MA; <sup>4</sup>Harvard University, Cambridge, MA; <sup>5</sup>University of Massachusetts Lowell, Lowell, MA; <sup>6</sup>Portland VA Research Foundation, Portland, OR.

**Background:** Rhabdomyolysis-induced acute kidney injury (RIAKI) results from excess physical training, crush, or drugs. Specific treatment is lacking. The megalin inhibitor cilastatin is effective in rodent RIAKI, however, achieving inhibition of renal megalin with systemically-administered cilastatin requires a high dose; this could cause off-target effects. To improve efficacy and specificity we tested the hypothesis that a kidney-specific nanoparticle complexed to cilastatin (Cil) and the renoprotective agent dexamethasone (Dex) would ameliorate RIAKI in mice.

**Methods:** The kidney-specific nanoparticle ("H-Dot") is comprised of a poly-ε-lysine backbone with moieties supporting targeting and therapeutic domain complexation chemistry and a fluorescent imaging domain. Cilastatin and dexamethasone were complexed to the H-Dot. Cil/Dex/H-Dot was administered to human kidney cells *in vitro*. *In vivo*, pharmacokinetic (PK) parameters were quantified in mice by HPLC. To test efficacy, Cil/Dex/H-Dot or vehicle was administered intravenously to mice subjected to RIAKI.

**Results:** Synthesized Cil/Dex/H-Dots were pure and contained 2:1:1 Cil:Dex:H-Dot ratio. *In vitro* studies demonstrated rapid drug release from the nanoparticle at late endosomal pH and endosomal delivery of Cil with nuclear delivery of Dex. Cil/Dex/H-Dots were exclusively renally filtered. PK demonstrated that kidney-specific H-Dot complexation more than doubled Cil/Dex delivery to the kidney. Efficacy studies in RIAKI-exposed mice demonstrated that loss of renal function was ameliorated 24h after induction of RIAKI in mice which received Cil/H-Dot or Cil/Dex/H-Dot treatment (mean±stdev GFR in Sham: 1111±191, Vehicle: 204±46, Cil/H-Dot 1064±453, Cil/Dex/H-Dot 1074±104, n= 3-6/group, p<0.01 by ANOVA with post-hoc Sidak test for both drugs compared to vehicle).

**Conclusions:** A kidney-specific nanoparticle formulation results in enhanced renal endosomal delivery of complexed drugs, including Cil and Dex. Complexing Cil and Dex to H-Dot nanoparticles ameliorates renal functional loss due to RIAKI in mice. Kidney-specific treatment of RIAKI with Cil/Dex/H-Dot may lead to effective, organ and mechanism-targeted therapy, with potential applications beyond RIAKI.

**Funding:** Other NIH Support - NBIB, Veterans Affairs Support, Other U.S. Government Support

**FR-PO235****GSK343 Inhibits EZH2 to Promote MST1 Expression and Confers Neuroprotection in Kidney Failure-Induced Hypercalcemia**

Yaochen Cao,<sup>1,2</sup> Xitong Li.<sup>1,2</sup> <sup>1</sup>Charite Universitätsmedizin Berlin, Berlin, Germany; <sup>2</sup>Hainan Medical University, Haikou, China.

**Background:** GSK343 is a specific inhibitor of EZH2 which has been highlighted to serve as a potential therapeutic target for kidney diseases. We sought to examine the underlying mechanism of GSK343 in the nerve damage induced by kidney failure-associated hypercalcemia.

**Methods:** We first established an *in vivo* adenine diet-induced CKD model in C57BL/6N mice. After administration of GSK343, oe-EZH2, oe-MST1 and oe-YAP1, disease activity index, serum biochemical indexes, blood calcium and nerve function of mice were evaluated, as well as the expression of M1 marker (iNOS) and M2 marker gene (Arg1). Gain function studies were all employed in renal tubular epithelial cells TCMK-1 to elucidate the mechanism of GSK343/EZH2/MST1/YAP1 in the processes of nerve damage induced by kidney failure-associated hypercalcemia.

**Results:** GSK343 polarized macrophages toward M2 phenotype and thus arrested the resultant nerve damage from kidney failure-induced hypercalcemia. GSK343 reduced the expression of EZH2 and triggered an increase in the expression of MST1. In addition, MST1 overexpression reduced the expression of YAP1, thereby promoting M2 polarization of macrophages and attenuating the nerve damage induced by hypercalcemia. Furthermore, GSK343 promoted macrophages polarized to M2 phenotype and attenuated nerve damage by regulating the EZH2/MST1/YAP1 axis.

**Conclusions:** Overall, our findings suggest that GSK343 may be a novel mechanism underlying the M2 polarization of macrophages and the resultant nerve damage from kidney failure-induced hypercalcemia.

**Funding:** Government Support - Non-U.S.

Key: TH - Thursday; FR - Friday; SA - Saturday; OR - Oral; PO - Poster; PUB - Publication Only

Underline represents presenting author.



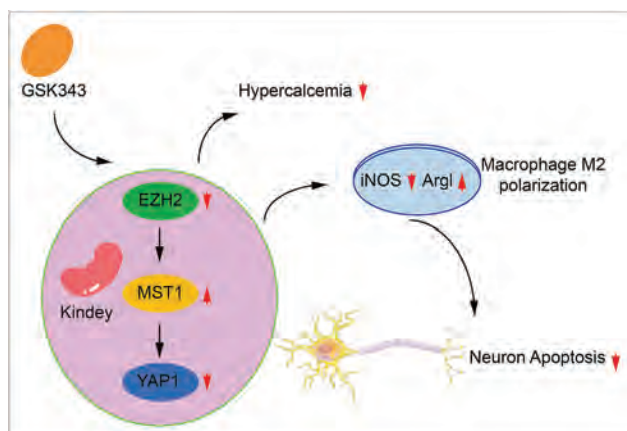

## FR-PO236

## Valacyclovir Neurotoxicity in a Patient on Peritoneal Dialysis

Taylor R. Moody, James B. Leonard, Angela H. Lam, Nicholas Husak, Joshua D. King. *University of Maryland Medical System, Baltimore, MD.*

**Introduction:** Valacyclovir is a prodrug of acyclovir often used to treat herpes zoster and herpes simplex. While acyclovir neurotoxicity is well-described in the literature, a recent systematic review identified only 35 cases of valacyclovir neurotoxicity (VAN) through 2021. Patients with advanced age and impaired kidney function are at highest risk of both acyclovir and valacyclovir neurotoxicity. In the absence of hemodialysis (HD), the half-life of valacyclovir in patients with ESKD can be up to 20 hours. Valacyclovir is removed well by HD, but continuous ambulatory peritoneal dialysis (PD) removes only approximately 10% of the drug.

**Case Description:** A 64-year-old man with ESKD on PD after a failed kidney transplant was prescribed valacyclovir 1000 mg three times daily for herpes zoster, exceeding the recommended dose of 500 mg daily. The evening of his first day of therapy, he began to experience confusion. The following day, he presented to a local hospital with hypertension, hypothermia, hallucinations, and disorientation. Serum laboratory tests and complete blood count were close to baseline; cerebrospinal fluid analysis was notable for mild leukocytosis at 11 WBC/uL. He was admitted to the ICU. The patient's mental status did not improve, and he was persistently hypertensive requiring nicardipine infusion. On hospital day 3 he began receiving PD, but his mental status deteriorated. On hospital day 5 he was started on intermittent HD in combination with his usual PD with dwells every 4 hours. Approximately 4 days after the initiation of HD, mentation substantially improved. No other medical cause of his prolonged encephalopathy was identified, and his altered sensorium was attributed to VAN.

**Discussion:** Valacyclovir is a commonly used drug that is typically well-tolerated, safe, and efficacious; however, in ESKD it may cause substantial encephalopathy. Because this drug is largely renally excreted, patients with impaired kidney function, especially those with ESKD, are at increased risk of toxicity and require substantial dose reduction. Valacyclovir is dialyzable and may require HD to rapidly remove this drug, even in patients on maintenance PD. Delaying initiation of HD, as in this case, may prolong encephalopathy and increase the risk of adverse outcomes.

## FR-PO237

## Effects of KCNN4 Blockade With Senicapoc in Kidney Cell-Based Assays and a Mouse Model of Renal Inflammation and Fibrosis

Peng Zhou,<sup>1</sup> Simon A. Hinke,<sup>2</sup> Cassandre Cavanaugh,<sup>1</sup> Li-Jun Ma,<sup>2</sup> Eugene Myshkin,<sup>1</sup> Neetu Shukla,<sup>2</sup> Thomas A. Natoli,<sup>1</sup> Jose M. Silva,<sup>2</sup> Maria chiara Magnone,<sup>1</sup> Zhiyong Yang.<sup>1</sup> <sup>1</sup>Janssen Research and Development LLC, Boston, MA; <sup>2</sup>Janssen Research and Development LLC, Spring House, PA.

**Background:** Progressive kidney fibrosis including tubulointerstitial fibroblast proliferation and mesangial matrix expansion is a common manifestation in chronic kidney disease, resulting in end-stage kidney disease. KCNN4 (KCa3.1) is an intermediate-conductance Ca<sup>2+</sup>-activated K<sup>+</sup> channel implicated in immune cell activation, cytokine production, and fibroblast proliferation. Previous studies have shown the pathophysiological relevance of KCNN4 in fibrotic disease.

**Methods:** Here, we explored the pathological role of KCNN4 in renal fibrosis. Specifically, we assessed the impact of a potent and selective KCNN4 inhibitor Senicapoc in kidney cell-based assays, and in a mouse model of renal fibrosis induced by Unilateral Ureteral Obstruction (UUO).

**Results:** *In situ* hybridization and immunohistochemistry showed KCNN4 is expressed mainly in tubular and interstitial cells in human kidney samples. *In vitro*, whole cell patch clamp confirmed the inhibition of K<sup>+</sup> current by Senicapoc (IC<sub>50</sub> ~2nM). In human renal fibroblasts, Senicapoc dose-dependently inhibited TGF-β-stimulated proliferation, but did not inhibit mRNA expression of TGF-β-stimulated fibrotic genes in human renal fibroblast or proximal tubular epithelial cells. *In vivo*, *Kcnn4* expression was upregulated ~20-fold in UUO-induced fibrotic kidney and decreased with anti-TGF-β1 antibody treatment in UUO model. Senicapoc treatment (100mpk BID, 200mpk QD or BID) at doses much higher than those commonly used in reported literature did not

improve kidney histology or decrease mRNA expression of inflammatory and fibrotic genes in a 10-day mouse UUO model. PK studies showed dramatic decrease in plasma compound exposure levels after repeat dosing when measured at day 3 and thereafter in both mice and rats, potentially indicating insufficient target coverage in the UUO study.

**Conclusions:** In summary, while KCNN4 may play a role in kidney disease, the PK profile of Senicapoc makes it not suitable for target validation studies in rodents. A compound with better exposure profile is needed in order to properly study the effects of KCNN4 blockage in a rodent disease model.

## FR-PO238

## Effect of Ibuprofen on Kynurenic Acid Production and Kynurenine Aminotransferases Activity in Rat Kidneys

Izabela Zakrocka, Wojciech T. Zaluska. *Uniwersytet Medyczny w Lublinie, Lublin, Poland.*

**Background:** Non-steroidal anti-inflammatory drugs (NSAIDs) are widely used analgesics and anti-inflammatory agents. Inhibition of cyclooxygenase, leading to decreased prostaglandin synthesis, is their main mechanism of action, also responsible for NSAIDs renal side effects. Ibuprofen, one of the most popular NSAID, is known to cause acute kidney injury, thus increasing the risk of chronic kidney disease. The metabolite of tryptophan, kynurenic acid (KYNA), is made from L-kynurenine (L-KYN) by kynurenine aminotransferases (KATs). KAT I and KAT II are the best studied KAT isoenzymes. KYNA is a non-selective antagonist of ionotropic glutamatergic receptors. Natriuretic, anti-inflammatory, chronotropic negative and hypotensive properties of KYNA were previously described. The goal of the present study was to examine the effect of ibuprofen, commonly used over-the-counter NSAID, on KYNA production and the activity of KAT I and KAT II, in rat kidney *in vitro*.

**Methods:** The effect of ibuprofen on KYNA production together with KAT I and KAT II activity was examined in rat kidney homogenates *in vitro* after 2 hours incubation in the presence of L-KYN and ibuprofen. The drug was tested at the concentration of 1 μM, 10 μM, 50 μM, 100 μM, 500 μM and 1 mM. KYNA formation during enzymatic reaction was measured with the use of high performance liquid chromatography (HPLC) with fluorometric detector. All applicable international, national and institutional guidelines for the care and use of animals were followed. All procedures performed in this study involving animals were in accordance with the ethical standards of the Local Ethics Committee for Animal Experiments.

**Results:** Ibuprofen at 500 μM and 1 mM decreased KYNA production in kidney homogenates *in vitro* to 78% (P < 0.05) and 46% (P < 0.001) of control value, respectively. At 1 mM concentration ibuprofen lowered renal KAT I activity *in vitro* to 82% (P < 0.05) of control value. Additionally, ibuprofen at 500 μM and 1 mM concentration decreased kidney KAT II activity *in vitro* to 68% (P < 0.05) and 43% (P < 0.05) of control value, respectively.

**Conclusions:** Ibuprofen decreases KYNA synthesis in rat kidney *in vitro* by inhibiting KAT I and KAT II isoenzymes. Results of our study indicate a novel mechanism of ibuprofen's action in the kidney. Its possible relationship with NSAIDs-induced nephrotoxicity needs further clarifications.

## FR-PO239

## When Normal Is Abnormal: Valproate Toxicity With Normal Valproate Serum Level

Juarez R. Braga, Manisha Singh. *University of Arkansas for Medical Sciences, Little Rock, AR.*

**Introduction:** Valproic acid (VPA) is commonly used in clinical practice for the treatment of seizures and other medical conditions. VPA is highly bound to plasma proteins with only a small fraction free in the plasma and responsible for its pharmacological action. However, in patients with hypoalbuminemia, the free fraction of VPA increases which contributes to the risk of neurotoxicity. We present a case of a patient with nephrotic syndrome and total VPA levels within the therapeutic range who developed neurological adverse symptoms.

**Case Description:** A 50-year-old male with history of CKD stage 4, nephrotic syndrome secondary to biopsy-proven diabetic nephropathy, and seizure disorder in use of VPA 1,500 mg two times daily was admitted with altered mental status. On examination, he was disoriented and had tremors and asterixis. His laboratory values were remarkable for creatinine 2.9 mg/dL, eGFR 27 mL/min/1.73 m<sup>2</sup>, BUN 81 mg/dL, and albumin 0.9 g/dL. Total VAP levels were 54 mcg/mL (50-100 mcg/mL). After admission, due to concerns for focal seizures, the dose of VPA was increased to 1,750 mg two times daily and drug monitoring of total VAP levels remained within the therapeutic range. Since symptoms persisted, uremic encephalopathy was considered but deemed unlikely due to the presence of residual kidney function. When levels of free valproate were measured, they revealed a result of 49 mcg/mL (normal 5-15 mcg/mL). Thus, VPA was held with significant improvement in mental status.

**Discussion:** This is a case of neurotoxicity resulting from increased free valproate due to hypoalbuminemia while total VPA levels were normal. Adjustment of the dose of VPA based on total levels led to neurological symptoms. Liver metabolizes VPA but in patients with hypoalbuminemia, free VPA fraction may overwhelm the metabolic pathways, thus increasing the risk for toxicity. Free VPA serum concentrations should be used for therapeutic monitoring in patients with clinically significant hypoalbuminemia. While this assay is not available in many institutions, an albumin-adjusted formula can be used to predict the levels of free VPA. An understanding of pharmacokinetics is important for nephrologists for a rational approach in the investigation and management of drug toxicities.

Key: TH - Thursday; FR - Friday; SA - Saturday; OR - Oral; PO - Poster; PUB - Publication Only

Underline represents presenting author.

## FR-PO240

**Use of Molecular Adsorbent Recirculating System for the Management of Acute Poisoning Without Liver Failure**

Victor E. Serrano-Santiago, Yi Zhao, Roberto L. Collazo-Maldonado. *Methodist Dallas Medical Center, Dallas, TX.*

**Introduction:** Molecular Adsorbent Recirculating System (MARS) is an extracorporeal liver assist device that removes endogenous substances based on the principle of albumin-based dialysis. In addition to its uses in liver failure patients, MARS can be used to remove albumin-bound toxins. We present a case of vasoplegic shock and coma caused by multiple medications that was treated successfully with MARS.

**Case Description:** A 30 y/o woman with significant psychiatric history was admitted for a suicide attempt by intentional overdose. Empty bottles of the following albumin-bound medications were found on the scene: guanfacine, hydroxyzine, lamotrigine, propranolol, sertraline, and ziprasidone. On presentation, she was hypotensive and had bradycardia, bradypnea, and a GCS of 7. The patient was intubated emergently and received activated charcoal, glucagon (2mg), and CaCl<sub>2</sub> (2g). Her blood pressure was supported with norepinephrine infusion and aggressive volume expansion. Poison control recommended seizure precautions and serial electrocardiograms (EKG). Neurological examination without sedation showed a comatose female, pupils dilated and reactive, no motor response to noxious stimulation in all four limbs, weak cough, and no gag reflex. Labs on presentation revealed normal kidney function, acid-base balance, electrolyte levels, and liver function tests. An EKG showed sinus bradycardia (QTc = 432ms) and an electroencephalogram showed moderately severe generalized cerebral dysfunction. Nephrology was consulted, and it was determined that all the ingested medications, except for lamotrigine and hydroxyzine, are highly protein-bound and not dialyzable. MARS therapy was performed for life-threatening vasoplegic shock caused by multiple toxic ingestions. Three hours later, her neurological status and blood pressure improved, and norepinephrine was discontinued. She completed 12 hours of MARS therapy with no complications. The next day, she was successfully extubated, her mental status returned to baseline, and she was hemodynamically stable. The patient was discharged to an inpatient psychiatric unit on hospital day four.

**Discussion:** This case demonstrated MARS is a feasible treatment for patients without liver failure, and that it can be a promising therapy option for those with acute poisoning from protein-bound drugs.

## FR-PO241

**Pharmacokinetics of the Novel Nonsteroidal Mineralocorticoid Receptor Antagonist KBP-5074 in Individuals With Moderate Hepatic Impairment**

James C. McCabe, Vincent Benn, Jay Zhang, Y. Fred Yang. *Kbp Biosciences Co Ltd, Jinan, China.*

**Background:** KBP-5074 is a selective nonsteroidal mineralocorticoid receptor antagonist. This study assessed the effect of moderate hepatic impairment on the pharmacokinetics, safety, and tolerability of KBP-5074.

**Methods:** This was an open, nonrandomized, multicenter, study investigating the PK, safety, and tolerability of a single oral dose of 0.5 mg KBP-5074 to male and female subjects with moderate hepatic impairment (Child-Pugh B score 7-9) compared to normal healthy subjects. Twelve subjects (6 subjects with moderate impairment and 6 matched healthy control subjects) were enrolled. All subjects received a single oral dose of 0.5 mg KBP-5074 on Day 1 after an overnight fast of ≥10 hours. Each healthy control subject was matched by age (±10 years), BMI (±20%), and sex to a moderate hepatic impairment subject. Serial blood collections were obtained through 264 hours postdose for plasma levels of KBP-5074. Plasma protein binding was analyzed and safety and tolerability were monitored.

**Results:** Following a single oral dose of 0.5 mg, KBP-5074 was steadily absorbed with median T<sub>max</sub> values of 4.00 and 3.00 hours, respectively. After reaching C<sub>max</sub>, the disposition of KBP-5074 appeared to be biphasic. The geometric mean t<sub>1/2</sub> values for the moderate hepatic impairment group and normal healthy control group were 75.6 and 65.7 hours, respectively. Systemic exposure to KBP-5074 as assessed by AUC was 23.5% to 26.6% lower in subjects with moderate hepatic impairment versus healthy subjects, whereas C<sub>max</sub> was 41.2% lower. KBP-5074 was determined to be >99.7% bound to proteins in plasma. Given the low percentage of unbound drug, it was not deemed appropriate to calculate the PK parameters for unbound drug. KBP-5074 was safe and well tolerated in all participants.

**Conclusions:** Small decreases of AUC and C<sub>max</sub> upon systemic exposure to KBP-5074 in subjects with moderate hepatic impairment demonstrate low hepatic extraction and is consistent with the observation that KBP-5074 is cleared predominantly in the gastrointestinal tract vs the kidney. Considering the long half-life and small decrease in AUC and C<sub>max</sub>, a dose adjustment does not appear to be warranted in patients with moderate hepatic impairment.

**Funding:** Commercial Support - KBP Biosciences PTE Ltd

## FR-PO242

**Uric Acid Crystal Deposition Triggers Tubule Dilation in Normal Kidneys and Cystogenesis in Polycystic Kidney Disease (PKD)**

Sebastian Strubl,<sup>1,2</sup> Nickolas J. Holznecht,<sup>1</sup> Jacob A. Torres,<sup>1</sup> Brina A. Aceves,<sup>1</sup> Margaret Schimmel,<sup>1</sup> David A. Asplund,<sup>1</sup> Bradley C. Kroes,<sup>1</sup> Sita Arjune,<sup>2</sup> Roman-Ulrich Mueller,<sup>2</sup> Peter C. Harris,<sup>3</sup> Thomas Weimbs.<sup>1</sup> <sup>1</sup>University of California Santa Barbara, Santa Barbara, CA; <sup>2</sup>Uniklinik Köln, Köln, Germany; <sup>3</sup>Mayo Clinic Minnesota, Rochester, MN.

**Background:** We have previously reported that renal CaOx crystals are commonly cleared from normal kidneys by reversible tubule dilation but can accelerate disease progression in a PKD rat model. Since ADPKD patients also have a high risk for uric acid (UA) crystal deposition we investigated the impact of UA crystals on PKD disease progression in animal models.

**Methods:** To investigate reversible tubule dilation and signaling activity in normal kidneys upon UA crystal deposition we treated wild-type Sprague Dawley rats with a diet supplemented with uric acid and the uricase inhibitor oxonic acid. To investigate the impact of UA crystal deposition on PKD disease progression we used the same dietary treatment in the HanSPRD model and in heterozygous Pkd1<sup>+/+</sup> rats.

**Results:** We report that, in normal kidneys, renal UA crystals lead to reversible tubule dilation and subsequent crystal clearance similar to CaOx crystals. We observed similar activation of the mTOR and Stat3 pathways in dilated renal tubules as described previously. UA crystal deposition accelerated ADPKD disease progression and fibrosis in the HanSPRD model. Furthermore, UA crystal deposition induced cystogenesis in a novel heterozygous Pkd1 rat model.

**Conclusions:** These results indicate that reversible tubule dilation as a renoprotective clearance mechanism applies to multiple crystal types including UA crystals. For the first time, we show that renal crystals can not only accelerate PKD disease progression but even induce de-novo cystogenesis in an orthologous, heterozygous PKD1<sup>+/+</sup> model. The latter result suggests that a second-hit somatic mutation is not necessary for cystogenesis. Rather, a heterozygous germline mutation in one PKD1 allele combined with a renal insult by tubular micro-crystals is sufficient to induce cystogenesis. These results have significant implications for the clinical management of individuals with ADPKD.

**Funding:** NIDDK Support, Private Foundation Support, Government Support - Non-U.S.

## FR-PO243

**Ferritin as an Inflammatory Molecule in Autosomal Dominant Polycystic Kidney Disease**

Johnny Dinh Phan,<sup>1</sup> Nicole Sommer,<sup>1</sup> Mackenzie Thornton,<sup>1</sup> Mercedes B. Mcgonigle,<sup>1</sup> Subhashini Bolisetty,<sup>2</sup> Darren P. Wallace,<sup>1</sup> Madhulika Sharma.<sup>1</sup> <sup>1</sup>University of Kansas Medical Center Department of Internal Medicine, Kansas City, KS; <sup>2</sup>The University of Alabama at Birmingham Department of Cell Developmental and Integrative Biology, Birmingham, AL.

**Background:** Despite approval of tolvaptan as the first drug in the treatment of autosomal dominant polycystic kidney disease (ADPKD), there is an unmet need for new drugs. We need drugs with greater efficacy and new drug targets that could enhance discovery of novel drugs. We have recently reported that ferritin is ectopically expressed in cyst lining cells and macrophages of ADPKD patients and an orthologous mouse model of PKD. Ferritin has previously been shown to activate the inflammatory NF-kappa B pathway in acute kidney injury. Since ferritin is also an acute phase reactant expressed in macrophages, we determined whether ferritin has an inflammatory role in ADPKD cells.

**Methods:** We treated primary cyst lining ADPKD and normal kidney epithelial (NHK) cells with ferritin and apoferritin to determine the effects on cell proliferation and inflammatory pathway, MAPK-NF-kappa B. We also studied the effects of ferritin deletion in collecting ducts of PKD mice. We used cell culture and Western blots to study ferritin expression in bone marrow derived macrophages in PKD mice.

**Results:** We found that cyst lining epithelial from ADPKD patients have increased capacity of extracellular ferritin uptake when compared to normal human kidney cells. Ferritin uptake was associated with increased expression of pERK and phosphorylated p65 (Nuclear factor kappa B (NF-kappa-B p65/RelA), suggesting activation of inflammatory signaling pathways. When we labeled cystic mouse PKD kidneys, we found that macrophages close to the epithelial cells expressed ferritin. We hypothesized that macrophages release ferritin which cyst epithelia cells can uptake to mediate inflammation in ADPKD kidneys. Consistent with that isolated bone marrow derived macrophages of PKD mice showed increased ferritin levels. We also show the effects of ferritin deletion in collecting ducts of a PKD mouse model. Our data suggest that ferritin may mediate a cross talk between cyst epithelial cells and macrophages.

**Conclusions:** We found that macrophages in the ADPKD kidneys express ferritin. ADPKD cyst lining cells have increased capacity for uptake of ferritin, which results in elevation of inflammatory pathway and may be responsible for aggravation of disease. Thus ferritin inhibition in cyst lining cells may constitute a therapeutic target.

**Funding:** Other NIH Support - P20GM103418 and P30GM122731, Private Foundation Support

## FR-PO244

**Divergent Injury Effects of Cisplatin Treatment on Promoting Cyst Formation in Adult *Pkd2* Mutant Mouse Model**

Zhang Li, Sreelakshmi Cherakara, Reagan S. Andersen, Bradley K. Yoder. *The University of Alabama at Birmingham School of Medicine, Birmingham, AL.*

**Background:** Cisplatin is a widely used antitumor drug with severe nephrotoxic side effects, which could result in acute or chronic kidney injury depending on the dosage. Links between cyst formation and renal injuries have been reported in multiple PKD animal models, but the effect of cisplatin-induced injury on cyst formation has not been investigated. Here we evaluate the effect of two different regimens of cisplatin treatment on renal injury and cyst formation in *Pkd2* mutant mouse models.

**Methods:** Adult-induced *Pkd2* mutant mice were treated with either a single dose (9 mg/kg) or four weekly doses (5 mg/kg each) of cisplatin by IP injection to induce acute or chronic renal injury models, respectively (Experimental Design in **Figure**). Mice were euthanized 8 weeks after initial cisplatin treatment for analysis. Renal injury (SOX9 and KIM1), proliferation (Ki67), apoptosis, fibrosis, macrophage accumulation, and cystic index were analyzed using immunofluorescence, FACS and histology approaches.

**Results:** Both cisplatin treatment regimens accelerate cyst formation in mutant mice relative to saline-treated controls. The cystic index is increased in mutant mice with acute injury model compared to chronic injury model (**Figure**). More important, kidneys from mice receiving a single cisplatin treatment had less fibrosis and macrophage accumulation but increased cell proliferation compared to the multiple cisplatin treatment group. The injury response between the two cisplatin treatment approaches is currently being investigated.

**Conclusions:** These data show that cisplatin treatment caused renal injury and enhanced cyst formation in *Pkd2* mutant kidney, and that the cisplatin protocol could be used as an alternative injury method to accelerate cyst formation in cystic kidney disease models. Additionally, these data suggest that acute and chronic injury models have distinct effects on cystic index, fibrosis, and cell proliferation.

**Funding:** NIDDK Support

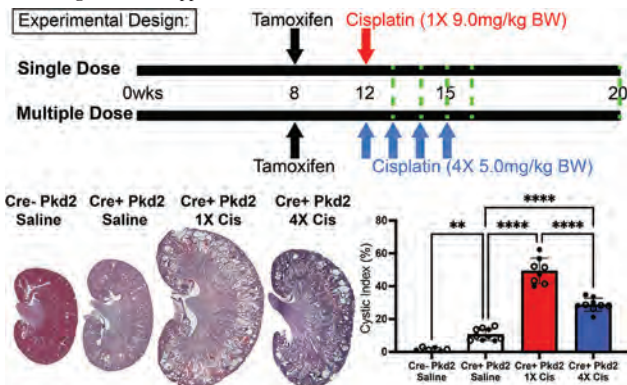

Cisplatin-induced injury accelerates cyst formation in *Pkd2* mutant kidney

## FR-PO245

**CD206+ Resident Macrophages: A Candidate Biomarker for Renal Cystic Disease Activity in Preclinical Models and Patients With Autosomal Dominant Polycystic Kidney Disease**

Zhang Li,<sup>1</sup> Kurt Zimmerman,<sup>2</sup> Sreelakshmi Cherakara,<sup>1</sup> Phillip H. Chumley,<sup>1</sup> Courtney J. Haycraft,<sup>1</sup> Reagan S. Andersen,<sup>1</sup> Mandy J. Croyle,<sup>1</sup> E.j. Aloria,<sup>1</sup> Isis Thomas,<sup>1</sup> Hanan Chweih,<sup>1</sup> Kristin L. Simanyi,<sup>1</sup> James F. George,<sup>1</sup> Michal Mrug,<sup>1</sup> Bradley K. Yoder.<sup>1</sup> <sup>1</sup>The University of Alabama at Birmingham, Birmingham, AL; <sup>2</sup>The University of Oklahoma Health Sciences Center, Oklahoma City, OK.

**Background:** Age and renal injury are drivers of renal cystogenesis in PKD mouse models. Since macrophage depletion attenuates injury-induced cystogenesis and macrophage differentiation state is age and injury-dependent, we speculated that a developmental/injury-regulated macrophage subset may influence renal cyst formation.

**Methods:** We analyzed macrophage populations during renal maturation and their associations with cystogenesis rates in conditional *Pkd2* mutant mice. We tested the relevance of these associations by depleting macrophages using the congenital *Cx3cr1* null mice. We also assessed parallels between the cystogenic activity-associated macrophage subset and disease activity in patients with ADPKD.

**Results:** CD206+ macrophages are enriched in juvenile but not adult wild type mouse kidneys. This correlates with the rapid- to slow-onset cystogenesis that occurs in *Pkd2* mutant mice with juvenile- vs adult-induction. While CD206+ macrophages are minimal in a normal adult kidney, they accumulate around the cysts in non-injured adult-induced *Pkd2* mutants. Using *Cx3cr1* null mice, we reduced macrophage number, including CD206+ macrophages, and this resulted in a significant reduction of cyst severity in non-injured adult-induced *Pkd2* mutant kidneys. The number of CD206+ resident macrophage-like cells also increased in kidneys from ADPKD patients, and their urinary content correlated with the rate of renal function loss in a small ADPKD patient cohort (**Figure**).

**Conclusions:** These data indicate that CD206+ macrophage numbers increase during periods of rapid cyst formation in *Pkd2* mutant mice. Depletion of macrophages attenuates cystogenesis in non-injured adult-induced *Pkd2* mutants. CD206+ macrophages also accumulate in human ADPKD kidneys, and their urine excretion could serve as a disease activity biomarker.

**Funding:** NIDDK Support

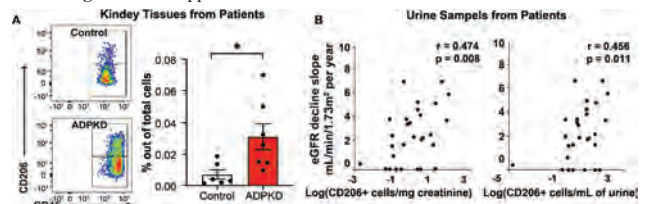

The number of CD206+ macrophages is increased in ADPKD patient kidneys, and their urinary content correlate with eGFR decline among patients.

## FR-PO246

**Automated Detection and Quantification of Individual Collagen Fibers in a Mouse Model of Polycystic Kidney Disease**

Caroline R. Sussman, Heather L. Holmes, Peter C. Harris, Michael F. Romero. *Mayo Foundation for Medical Education and Research, Rochester, MN.*

**Background:** Histological assessment of fibrosis is a standard tool for evaluating PKD. The most commonly used stains are Trichrome or Picrosirius red (PSR), which are imaged using brightfield to calculate a percent positive tissue area (cystic index). These stains are limited by variability due to specimen handling and analysis. PSR emits a red fluorescent signal, which can be used to automatically detect and analyze individual fiber characteristics and determine fiber density.

**Methods:** Four-month-old *Pkd1*RC/RC mice were compared to *Pkd1*+/+ (WT). All mice were F1 progeny from a 129/C57BL6J cross. Following euthanasia, kidneys were fixed in 4% PFA, cryosectioned, stained with PSR, and images were obtained using brightfield and fluorescent imaging. Tissue area and fibrotic index were determined using ImageJ, and individual collagen fibers were automatically detected, and metrics determined using CT-FIRE fiber detection software (LOCI; Madison, WI). Statistical measurements were obtained using PRISM (GraphPad Software, Inc.).

**Results:** Standard brightfield imaging showed a significantly higher fibrotic index in RC/RC than WT. Analysis of individual fibers by CT-FIRE indicated this was most likely due to an increase in fiber density rather than fiber width. Fiber density was significantly higher in female RC/RC vs WT ( $4275 \pm 254$  vs  $3423 \pm 102$  fibers/mm<sup>2</sup> respectively (mean  $\pm$  SEM),  $p=0.03$  by ANOVA,  $n=3-9$ ) and trended higher in males and overall ( $4328 \pm 203$  vs  $3667 \pm 230$  fibers/mm<sup>2</sup> respectively (mean  $\pm$  SEM),  $p=0.05$  by ANOVA,  $n=6-17$ ). Frequency histograms showed broader distribution of collagen fiber width in RC/RC with a significantly greater percentage of fibers in the lowest quartile. No significant differences were seen in fiber length, straightness, or angle. Overall, fiber width had a bell-shaped distribution, with almost half of fibers having intermediate width, fiber length was skewed towards shorter lengths and straightness was skewed towards being straighter. Fiber angles were more evenly distributed from 0-180 degrees with slightly greater prevalence of angles closer to 90 degrees.

**Conclusions:** These data demonstrate the potential of CT-FIRE software to provide more objective, higher resolution information about collagen during PKD. Future studies will determine whether it can provide insight into collagen dynamics preceding cysts.

**Funding:** NIDDK Support, Private Foundation Support

## FR-PO247

**High-Fat Feeding in *Pkd1* RC/RC Mice Associates With Upregulation of *Havr1* and Immune Activation**

Ioan-Andrei Iliuta,<sup>1,2</sup> Xuewen Song,<sup>2</sup> Amirreza Haghghi,<sup>3,2</sup> Ning He,<sup>2</sup> Fatemeh Nasri,<sup>1</sup> James W. Scholey,<sup>1,2</sup> York P. Pei.<sup>1,2</sup> <sup>1</sup>University Health Network, Toronto, ON, Canada; <sup>2</sup>University of Toronto Temerty Faculty of Medicine, Toronto, ON, Canada; <sup>3</sup>Brigham and Women's Hospital, Boston, MA.

**Background:** Autosomal dominant polycystic kidney disease (ADPKD) is the most common inherited nephropathy worldwide and an important cause of end-stage renal disease. The effects of overweight on ADPKD are unclear, although recent clinical research suggests increased body mass index might be an independent risk factor for disease severity. In addition, high-fat feeding aggravated cystic disease in two orthologous mouse models of ADPKD, possibly in association with impaired fatty acid oxidation in the cystic epithelium. We explored the effects of a high-fat diet (HFD) in young *Pkd1* RC/RC mice, a hypomorphic model of ADPKD characterized by slow progression of cystic disease similarly to human ADPKD.

**Methods:** Since *Pkd1* RC/RC mice exhibit sexual dimorphism, with females showing more severe cystic disease, we assigned 20 females and 20 males in a 1:1 ratio to either a HFD, with 60% of calories derived from fat, or a carbohydrate-rich "normal diet" (ND), with 10% of calories derived from fat. Mice were started on the diets at 2 months of age and sacrificed at 7 months of age. We then assessed kidney weight and volume, histology and histomorphometry, biochemistry, and gene expression. In addition to microarray analysis, we performed gene-set enrichment using Enrichr.

Key: TH - Thursday; FR - Friday; SA - Saturday; OR - Oral; PO - Poster; PUB - Publication Only

Underline represents presenting author.

**Results:** HFD compared to ND feeding associated with increased kidney volume ( $p < 0.0001$ ) and cystic index ( $p = 0.001$ ) in females, but it did not associate with reduced kidney function. In the kidneys of females fed a HFD compared to a ND, we identified: (1) upregulation of *Havcr1* (FDR  $p = 0.0009$ ), a pro-inflammatory biomarker of renal tubular injury; (2) enrichment in pathways involved in innate and adaptive immunity, with a majority of these genes upregulated in our dataset; (3) enrichment in EP300 (adjusted  $p = 8.7 \times 10^{-21}$ ), a transcriptional co-activator of cell proliferation, which was upregulated in our dataset; (4) enrichment in *PPAR $\alpha$*  (adjusted  $p = 8.5 \times 10^{-10}$ ), a major regulator of fatty acid oxidation, which was downregulated in our dataset; and (5) evidence of macrophage accumulation on immunohistochemistry ( $p = 0.07$ ).

**Conclusions:** HFD feeding in female *Pkd1* RC/RC mice aggravated the kidney cyst burden, in association with a transcriptomic profile suggesting early-stage inflammatory kidney injury and inhibited fatty acid oxidation.

**Funding:** Government Support - Non-U.S.

## FR-PO248

### Refining the Developmental Window That Determines Different Kinetics of Cystogenesis After *Pkd2* Inactivation in Mice

*Patricia Outeda*, Terry J. Watnick. *University of Maryland School of Medicine, Baltimore, MD.*

**Background:** Classic Autosomal Dominant Polycystic Kidney Disease (ADPKD) is caused by mutations in *PKD1* or *PKD2*. In mice, early inactivation of *Pkd1* results in rapid and severe cyst formation within 2 weeks. In contrast, inactivation of *Pkd1* in adult kidneys yields slow cystic progression over several months. A detailed time course of *Pkd1* inactivation revealed that the switch in the kinetics of cyst formation occurs between postnatal day (P) 13 and P14. Although it is assumed that a similar switch occurs for *Pkd2* the kinetics of cyst formation in *Pkd2* has never been described. Here we inactivate *Pkd2* at different time points to define the critical window that determines the kinetics of cyst formation after *Pkd2* depletion.

**Methods:** We used the *Pkd2<sup>fl/fl</sup>*; *Pax8<sup>Cre</sup>*; *Tet-O-Cre* mouse model and induced Cre recombinase with doxycycline at different time points (from P10 to P15). We harvested kidneys at 10 days and at 60 days after inactivation. To determine the severity of cystogenesis we analyzed kidney-to-body weight ratio (KW/BW ratio) and cystic index (CI). We performed immunofluorescence staining (IF) using segment-specific markers and performed Masson's Trichrome staining and IF and western blot (WB) to detect fibrosis.

**Results:** Gross examination and histopathological analysis revealed that kidneys inactivated at P10 and harvested at P20 were the largest and most cystic, while kidneys inactivated at and after P14 showed KW/BW ratio and CI closest to non-induced pups at the same age. In contrast, mild dilation of distal tubules was observed in kidneys induced at P14 and harvested at P24. Only a small number of cysts was detected in kidneys induced at P15 and harvested at P25, but if harvested at P60 males showed massive cyst formation in both the proximal and distal tubules while females showed few scattered distal cysts. We could not detect collagen depositions in kidneys induced at P15 and harvested at P60 but we observed an increased number of myofibroblasts around cysts and increased expression of  $\alpha$ -SMA by WB especially in males indicating that although fibrosis was not observed remodeling of extracellular matrix proteins had been initiated.

**Conclusions:** Our study revealed that the critical developmental window that determines the kinetics of cysts formation in mouse models is similar for both *Pkd1* and *Pkd2* genes. Research Supported by NIDDK-U54DK126114

**Funding:** NIDDK Support

## FR-PO249

### Raising Serum Uric Acid With a Uricase Inhibitor Worsens Polycystic Kidney Disease in Rat and Mouse Models

*Daniel Atwood*,<sup>1</sup> Ozgur A. Oto,<sup>1,3</sup> Anjana Chaudhary,<sup>1</sup> Charles L. Edelstein,<sup>1,2</sup> *Istanbul Universitesi Istanbul Tip Fakultesi, Istanbul, Turkey;* *XORTX Therapeutics Inc, Calgary, AB, Canada;* *<sup>3</sup>University of Colorado Health, Aurora, CO.*

**Background:** Humans are predisposed to gout because they lack uricase that converts uric acid to allantoin. In rodents uricase converts uric acid to allantoin and uricase inhibition raises serum uric acid. The aim of the study was to determine whether raising serum uric acid with the uricase inhibitor oxonic acid (OXO) was associated with worse PKD.

**Methods:** Orthologous models of human PKD were used. PCK rats, a *Pkd1* gene model of ARPKD and *Pkd1<sup>RC/RC</sup>* (RC) mice, a hypomorphic *Pkd1* gene model. OXO 750 mg/kg by mouth in rats from day 21-84 of age and 300 mg/kg IP in mice from day 50-120 of age was used. Uric acid and allantoin were measured by LC/MS-MS. Creatinine was measured by HPLC. Males and females were analyzed together. 12 pro-inflammatory cytokines were measured by MesoScale technology.

**Results:** On IHC staining, xanthine oxidase (that converts xanthine to uric acid) was strongly present in normal tubules in PCK rats. In pharmacokinetic studies in rats, there was a 5-fold increase in serum uric acid 2 hrs after OXO 100 mg/kg (IP or orally), that returned to normal in 8 hrs. OXO resulted in decreased allantoin in PCK rats. In PCK rats and RC mice, OXO resulted in a significant increase in serum uric acid, 2 kidney/body weight ratio (2K/BW) (%), cyst index (% of kidney that was cystic on cross sections) and creatinine (Table). OXO resulted in an increase in pro-inflammatory cytokines in the serum in RC mice.

**Conclusions:** Increasing serum uric acid by inhibiting uricase with OXO results in an increase in kidney weight, cyst index, creatinine in PCK rats and RC mice Potential mechanisms of increased cyst growth that will be investigated include crystal deposition causing tubular dilatation, increased reactive oxygen radicals and pro-inflammatory cytokines/chemokines causing tubular cell proliferation and endothelial injury.

**Funding:** Veterans Affairs Support, Commercial Support - XORTX Therapeutics Inc

	PCK VEH	PCK OXO	P Value	RC VEH	RC OXO	P Value
Uric acid ( $\mu$ M)	22	27	<0.05	20.1	30.7	<0.17
Allantoin ( $\mu$ M)	4.3	3.1	<0.05	N/A	N/A	N/A
2K/BW (%)	0.86	0.96	<0.05	1.8	2.1	<0.05
Cyst index (%)	8	14	<0.05	6	10	<0.05
Creatinine (mg/dL)	1.1	1.3	0.07	0.07	1.0	<0.05
IFN- $\gamma$ /IL-5/TNF- $\alpha$ (mg/dL)	N/A	N/A	N/A	0.11/6/2.8	0.4/5.6/4.1	0.06

## FR-PO250

### Turning the Kidney Into a Lymphoid Organ

*Daniel Atwood*,<sup>1</sup> Ozgur A. Oto,<sup>2,1</sup> Anjana Chaudhary,<sup>1</sup> Charles L. Edelstein,<sup>1</sup> *<sup>1</sup>University of Colorado Denver School of Medicine, Aurora, CO;* *<sup>2</sup>Istanbul Universitesi Istanbul Tip Fakultesi, Istanbul, Turkey.*

**Background:** *Pkd1<sup>RC/RC</sup>* mice (RC), a hypomorphic *Pkd1* mouse model of ADPKD, have suppressed kidney autophagy (Atwood, Edelstein et al. Cell Signal. 2020). We hypothesized that knocking out autophagy (ATG7) in the kidney in aged mice would induce cyst growth. The first aim of the study was to breed kidney-specific autophagy knockout (ATG7<sup>-/-</sup>) mice.

**Methods:** ATG7<sup>-/-</sup> mice were generated using a renal tubule specific cadherin Cre-Lox system. IHC was done with the VectaStain ABC kit. Staining quantitation was done using macros on the Aperio Imagescope. TLT #, size, and index was obtained from H&E sections using an NIS Element macro.

**Results:** 400d ATG7<sup>-/-</sup> mice had no cysts and normal kidney function. Surprisingly, large tertiary lymphoid tissues (TLT) (up to 9%) of the area of the kidney were seen in ATG7<sup>-/-</sup> kidneys. There was increased TLT size, number, and index in ATG7<sup>-/-</sup> vs. WT (Table). TLTs are ectopic lymphoid tissues composed of lymphocyte aggregates that develop de novo in nonlymphoid organs. TLTs form after tissue injury, infection, or chronic inflammation in various kidney diseases. The phenotype of TLTs in ATG7<sup>-/-</sup> was confirmed by the presence of T cell (CD3, 4, and 8), and B cell (CXCL13, CD21) markers and intense proliferation (PCNA) in the TLTs. There was also large amount of staining for pS6 (mTORC1), an inducer of proliferation, in the TLTs. PKD kidneys have chronic inflammation which is known to promote the formation of TLTs. There was increased number, size, and index of TLTs in kidneys from RC mice (Table). There was intense proliferation of T cells and increased pS6 (mTORC1) staining in the TLTs in RC kidneys. Treating RC mice with the mTOR inhibitor Torin2 (10 mg/kg IP) from 50-120d virtually eliminated TLTs.

**Conclusions:** The following novel findings are described: The presence of numerous, large and discrete TLTs in aged tubule-specific ATG7<sup>-/-</sup> kidneys, intense pS6 (mTORC1) in TLTs in ATG7<sup>-/-</sup> kidneys, first description of the presence of TLTs in PKD kidneys, and virtual elimination of TLTs by treatment of RC mice with an mTOR inhibitor. These data suggest a previously undescribed relationship between suppressed autophagy, activation of mTORC1 and the formation and growth of TLTs.

**Funding:** Veterans Affairs Support

	WT 120d	RC 120d	RC+Torin2 120d	WT 400d	ATG7 <sup>-/-</sup> 400d	RC 400d
TLT #	0	4.8***	0.3**	3.0	12.4**	12.8
Avg TLT size (mm <sup>2</sup> )	0	0.014***	0.002**	0.043	0.096**	0.057*
TLT Index (% of kidney)	0	0.21***	0.01**	0.36	3.09**	1.71

\* $P > 0.05$  \*\* $P > 0.01$  \*\*\* $P > 0.001$

## FR-PO251

### Unbiased RNA-Sequencing Analysis of *PKD2*<sup>-/-</sup> Proximal Tubular Epithelial Cells Reveals Stabilization of Primary Cilia by Polycystin-2

*Courtney E. Vishy*, Benjamin S. Freedman. *University of Washington, Seattle, WA.*

**Background:** Polycystic kidney disease (PKD) is commonly caused by loss of function mutations in *PKD2*, encoding the transmembrane protein polycystin-2 (PC2). PC2 is primarily an ER-resident protein, with a smaller pool localizing to the primary cilium. However, whether and how PC2 affects primary cilium structure and function remains unclear. To complement animal and organoid models of PKD, cell biology models and unbiased approaches are needed to clarify the mechanistic role of PC2 at the primary cilium and develop targeted therapeutics.

**Methods:** CRISPR-Cas9 was applied to generate 5 isogenic pairs of *PKD2*<sup>-/-</sup> and control porcine proximal tubular epithelial cells. 8 biological replicates per genotype were subjected to bulk RNA-sequencing. Gene-ontology (GO) enrichment and differential expression analyses were performed. Transcript abundance of select genes was measured by qPCR and protein abundance by immunoblot. Primary cilia morphology and cellular attachment were visualized by time-course immunofluorescence microscopy. *PKD2*<sup>-/-</sup> hPSC-derived kidney organoids were treated with the HDAC6 inhibitor tubacin across a range of doses and monitored for cyst formation, live/dead staining, and LDH release toxicity assay.

**Results:** GO term analysis yielded cilium organization as the most downregulated and mitotic cell cycle as the most upregulated. In *PKD2*<sup>-/-</sup> cells, IFT88 had decreased abundance, while the cell cycle associated  $\alpha$ -tubulin deacetylase HDAC6 had increased abundance. Upon dissociation and replating, *PKD2*<sup>-/-</sup> cells showed accelerated ciliary disassembly followed by delayed ciliary assembly. Enhanced cell cycle progression occurred only upon cellular dissociation after an initial delay in cellular attachment. Pharmacological inhibition of HDAC6 reduced the number of cysts formed and cyst area in *PKD2*<sup>-/-</sup> organoids even at low doses and without detectable toxicity.

**Conclusions:** PC2 stabilizes cilia after cell dissociation, which promotes cell attachment and inhibits cell cycle progression. These phenotypes are transient and not observed at steady state, possibly explaining why they have not been noticed previously. The isogenic cell biology model presented here thus provides new insight into the dynamics of the polycystin proteins and molecular phenotypes associated with PKD suggesting a new treatment approach to inhibit PKD cystogenesis.

**Funding:** NIDDK Support, Other NIH Support - NCATS

## FR-PO252

### Tracking Polycystin2 In Vivo Using a Novel Engineered Pkd2-HALO Allele

Courtney J. Haycraft,<sup>1</sup> Mandy J. Croyle,<sup>1</sup> Laura Lambert,<sup>1</sup> Patricia Outeda,<sup>2</sup> Hangxue Xu,<sup>1</sup> Juling Zhou,<sup>1</sup> Phillip H. Chumley,<sup>1</sup> Kelsey R. Clearman,<sup>1</sup> Feng Qian,<sup>2</sup> Michal Mrug,<sup>1</sup> Pamela V. Tran,<sup>3</sup> Stephen C. Parnell,<sup>3</sup> Terry J. Watnick,<sup>2</sup> Bradley K. Yoder.<sup>1</sup> PKD Research Resource Consortium <sup>1</sup>The University of Alabama at Birmingham School of Medicine, Birmingham, AL; <sup>2</sup>University of Maryland School of Medicine, Baltimore, MD; <sup>3</sup>University of Kansas School of Medicine, Kansas City, KS.

**Background:** ADPKD, one of the leading causes of end stage renal disease, is due to mutations in the genes *PKD1* or *PKD2*, which encode for polycystin1 or polycystin2, respectively. While the genes involved were identified several decades ago, research is ongoing to understand their functions and how disruption leads to renal cyst development. Studies focused on trafficking and localization of polycystin2 (PC2) are hindered by the difficulty in antibody generation, low-level expression of the endogenous protein, and inability to track the protein in live cells.

**Methods:** To expand the reagents available to the PKD research community and accelerate studies of PC2 function, the PKD RRC used CRISPR/Cas9 to target HALO to the C-terminus of the endogenous mouse *Pkd2* gene.

**Results:** Mice homozygous for the engineered *Pkd2*-HALO allele are viable and have no overt renal cysts at three months of age indicating that the PC2-HALO protein is functional. Initial studies using western blot from tissues harvested from heterozygous mice showed expression of the PC2-HALO protein in brain and kidney lysates. Additionally, we have begun testing the functionality of the HALO ligand *in vivo* and in primary cells cultured from the mouse line. We confirmed, using a HALO-ligand in heterozygous primary cultured cells, the presence of fluorescent labeling of the fusion protein in the primary cilium of the renal epithelium. Additional characterization of this novel mouse resource is ongoing.

**Conclusions:** This mouse will provide an invaluable resource to analyze PC2 function, trafficking, and turnover *in vivo*.

**Funding:** NIDDK Support

## FR-PO253

### Active BRAF Inhibits LKB1-AMPK Signaling and Acetyl-CoA Carboxylase Phosphorylation and Increases Renal Fibrosis in a Model of Polycystic Kidney Disease

Yan Zhang, Emily A. Daniel, Archana Raman, Gail Reif, Stephen C. Parnell, Darren P. Wallace. *University of Kansas Medical Center, Kansas City, KS.*

**Background:** Dysregulated fatty acid oxidation (FAO) in renal epithelial cells contributes to fibrosis in chronic kidney disease. Evidence has shown that reprogrammed metabolism causes reduced FAO in polycystic kidney disease (PKD), and factors that enhance FAO attenuate disease progression in PKD mice. Liver kinase B1 (LKB1) is the main kinase regulating AMP-activating protein kinase (AMPK) and its downstream target acetyl-CoA carboxylase (ACC), an essential rate-limiting enzyme for FAO. Previously, we showed that BRAF, a kinase upstream of MEK-ERK signaling, is the central intermediate for cAMP-induced proliferation of PKD cells. Collecting duct (CD) expression of active BRAF (BRAF<sup>V600E</sup>, a common activating mutation) was sufficient to induce cyst formation in wildtype mice as early as 3 weeks of age, resulting in a novel model of PKD, and accelerated cystic disease in *Pkd1<sup>RC/RC</sup>* mice. Constitutively active BRAF in melanoma cells inhibits AMPK signaling through phosphorylation of LKB1 at Ser 428, an important inhibitory site. We hypothesize that active BRAF leads to ERK-dependent inhibition of LKB1-AMPK signaling, ACC dephosphorylation, and dysregulated FAO, contributing to renal fibrosis in PKD.

**Methods:** To investigate the effect of BRAF on renal fibrosis, mice expressing a conditional BRAF<sup>V600E</sup> were bred with *Pkhd1-Cre* mice to express active BRAF in CD (BRAF<sup>CD</sup> mice). At 10 weeks, we collected BRAF<sup>CD</sup> kidneys and examined renal fibrosis, macrophage accumulation, and levels of phosphorylated LKB1 (P-LKB1) and ACC (P-ACC).

**Results:** Expression of active BRAF caused an accumulation of immune cells, determined by staining with the macrophage marker CD68, extensive interstitial fibrosis, and increased levels of blood urea nitrogen, indicating a decline in renal function. CD expression of BRAF increased ERK phosphorylation, as expected, and phosphorylation of LKB1 at Ser 428. There were also striking decreases in ACC and P-ACC levels, which have been shown to reduce FAO, leading to increased matrix production and fibrosis.

**Conclusions:** In a novel model of renal cystic disease, BRAF activation of MEK-ERK caused phosphorylation of an inhibitory site on LKB1, leading to decreased AMPK phosphorylation of ACC and increased fibrosis. We propose that ACC is a potential therapeutic target to reduce fibrosis in PKD.

**Funding:** NIDDK Support, Private Foundation Support

## FR-PO254

### Comparative Transcriptomics of PKD1 Downregulation and PKA Upregulation or Downregulation

Xiaoyan Li, Xiaofang Wang, Li Jiang, Peter C. Harris, Xiaogang Li, Vicente E. Torres. *Mayo Clinic Minnesota, Rochester, MN.*

**Background:** Constitutive activation of PKA by a kidney specific knock-out of *Prkar1a*, encoding the regulatory 1 $\alpha$  subunit, induces a cystic phenotype in wild-type mice and aggravates polycystic kidney disease (PKD) in *Pkd1<sup>RC/RC</sup>* mice (AJP Renal Physiol 313:F677, 2017) whereas constitutive inhibition of PKA by kidney specific expression of R1 $\alpha$  subunits unable to release catalytic subunits in the presence of cAMP ameliorates PKD in the same model (JASN PMID: 35236775, 2022).

**Methods:** RNA sequencing of wild-type, constitutively activated PKA (CA-PKA) wild-type, *Pkd1<sup>RC/RC</sup>*, CA-PKA *Pkd1<sup>RC/RC</sup>*, and constitutively inhibited PKA (CI-PKA) *Pkd1<sup>RC/RC</sup>* kidneys was performed to compare the effects of PKA activation and *Pkd1* downregulation on gene expression. Differential gene expressions and pathways were identified using DESeq2 and GStats package, respectively.

**Results:** 15,983 transcripts with more than 10 reads were identified. Thirty-six percent (5,710) and 22% (3,574) were differentially expressed (adjusted  $P < 0.05$ ) in CA-PKA and *Pkd1<sup>RC/RC</sup>* kidneys respectively compared to wild-type kidneys; 2,674 (47%) differentially expressed transcripts (DETs) in CA-PKA were also differentially expressed in *Pkd1<sup>RC/RC</sup>* kidneys; log<sub>2</sub> fold DET changes were highly and positively correlated (Figure 1). Fifty-six percent (9,005) and 19% (3,063) transcripts were differentially expressed in CA-PKA *Pkd1<sup>RC/RC</sup>* and CI-PKA *Pkd1<sup>RC/RC</sup>* kidneys respectively compared to *Pkd1<sup>RC/RC</sup>* controls; 2,252 (25%) DETs in CA-PKA *Pkd1<sup>RC/RC</sup>* were also differentially expressed in CI-PKA *Pkd1<sup>RC/RC</sup>* kidneys; log<sub>2</sub> fold DET changes were inversely correlated (Figure 2). DETs in CA-PKA wild-type, *Pkd1<sup>RC/RC</sup>*, CA-PKA *Pkd1<sup>RC/RC</sup>*, and CI-PKA *Pkd1<sup>RC/RC</sup>* kidneys compared to their controls included 46, 26, 66 and 25% respectively of 351 PKA-dependent out of 10,190 analyzed transcripts in mouse cortical collecting duct cells (PNAS 114:E8875, 2017)

**Conclusions:** This comparative transcriptomic analysis supports the importance of cAMP and PKA signaling in the pathogenesis of PKD and identifies additional therapeutic targets.

**Funding:** NIDDK Support

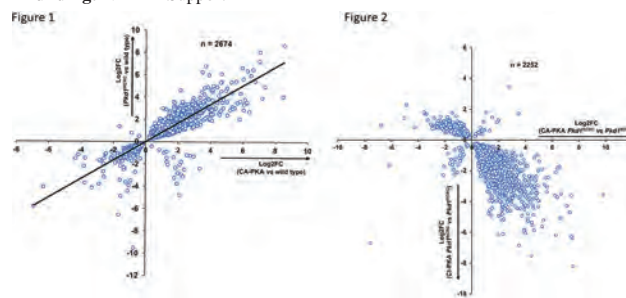

## FR-PO255

### Loss of Cross-Talk Between Polycystin 1 and LSD1 Promotes Cyst Growth Through Interaction With Ataxia Telangiectasia Mutated and Phase Separation Mechanism in Autosomal Dominant Polycystic Kidney Disease

Xiaoyan Li, Xia Zhou, Ewud Agborbesong, Xiaogang Li. *Mayo Clinic Department of Internal Medicine, Rochester, MN.*

**Background:** Autosomal dominant polycystic kidney disease (ADPKD) is caused by genetic mutations of *PKD1/PKD2*. Although diverse epigenetic regulators promote cyst growth in ADPKD through regulating cystic cell proliferation, apoptosis and ciliogenesis, and targeting dysregulated epigenetic regulators attenuates cyst growth in *Pkd1* mutant mouse models, however, a direct connection between polycystin(s) and epigenetic mechanisms and how epigenetic regulators are regulated in ADPKD kidneys remain elusive.

**Methods:** To understand the role of lysine specific demethylase (LSD1) in cyst growth *in vivo*, we treated *Pkd1<sup>Int1</sup>* and *Pkd1<sup>RC/RC</sup>* mice with LSD1 specific inhibitor ORY-1001 (400  $\mu$ g/kg) by intraperitoneally (IP) injection. To establish a direct interaction between polycystin 1 (PC1) and LSD1, and an interaction between LSD1 and ataxia telangiectasia mutated (ATM), we performed co-immunoprecipitation (Co-IP) assays in *Pkd1* wildtype and mutant renal epithelial cells.

**Results:** We found that the expression of LSD1 was upregulated in kidneys in *Pkd1* mutant mice and ADPKD patients and targeting LSD1 with its inhibitor delayed cyst growth as seen by decreased cystic index, kidney weight (KW)/body weight (BW) ratios, blood urea nitrogen (BUN) levels and cell proliferation, and increased cystic cell apoptosis in *Pkd1* mutant mice (all  $p < 0.05$ ). The molecular mechanisms of LSD1 in regulating cyst growth include: 1) the interaction with PC1, which decreases the stability and activity of LSD1 when PC1 is present, but loss of PC1 results in the upregulation of LSD1, 2) the interaction of LSD1 with its novel substrate, ATM to regulate the demethylation and activation of ATM, resulting in cyst growth in ADPKD kidneys, 3) the compositions of two intrinsic disordered regions (IDRs) in LSD1 amino acid sequence, suggesting the potential of LSD1 to form phase separation droplets, and 4) the formation of LSD1 phase separation droplets in cystic epithelial cells in kidneys from *Pkd1* mutant mice and ADPKD patients but not in wild type tissues.

**Conclusions:** This is the first study, 1) to establish a direct association of PC1 with an epigenetic regulator LSD1 in renal epithelial cells, and 2) to identify that ATM is a novel substrate of LSD1 to promote DNA damage response. In addition, LSD1 mediated phase-separation also promotes cyst growth in ADPKD.

**Funding:** NIDDK Support

#### FR-PO256

##### Single Gene Mutations in *Pkd1* or *Tsc2* Alter Extracellular Vesicles Production and Trafficking

John J. Bissler,<sup>1,2</sup> Prashant Kumar,<sup>6,2</sup> Fahad Al-Zadjali,<sup>7</sup> Ying Yao,<sup>2</sup> Alexis Hofherr,<sup>4</sup> Michael Kottgen,<sup>4,5</sup> Darshan Mehta,<sup>6</sup> Kenneth W. Gross,<sup>3</sup> <sup>1</sup>St. Jude Children's Research Hospital, Memphis, TN; <sup>2</sup>The University of Tennessee Health Science Center College of Medicine, Memphis, TN; <sup>3</sup>Roswell Park Comprehensive Cancer Center, Buffalo, NY; <sup>4</sup>Albert-Ludwigs-Universität Freiburg, Freiburg im Breisgau, Germany; <sup>5</sup>Centre for Integrative Biological Signaling Studies, Freiburg im Breisgau, Germany; <sup>6</sup>US FDA National Center for Toxicological Research, Little Rock, AR; <sup>7</sup>Sultan Qaboos University, Muscat, Oman.

**Background:** Patients with autosomal dominant polycystic kidney disease (ADPKD) and the cystic disease associated with tuberous sclerosis complex (TSC) are born with normal or near normal kidneys that later develop cysts and prematurely lose function. Both renal cystic diseases appear to be mediated, at least in part, by disease promoting extracellular vesicles (EVs) that can induce genetically intact cells to participate in the renal disease process.

**Methods:** We used centrifugation and size exclusion chromatography to isolate the EVs for study. We characterized the EVs using tunable resistive pulse sensing, dynamic light scattering, transmission electron microscopy and western blot analysis. We performed EV trafficking studies using a dye approach in both tissue culture and in vivo studies.

**Results:** We have previously reported that loss of the *Tsc2* gene significantly increased EV production and here demonstrate that the loss of the *Pkd1* gene also significantly increases EV production. Using a cell culture system, we also show that loss of either the *Tsc2* or *Pkd1* gene results in EVs that exhibit an enhanced uptake by renal epithelial cells and a prolonged half-life, possibly further accentuating the EV dose effect. Loss of the primary cilia significantly reduces EV production in renal collecting duct cells. We document that EVs from cells that have loss of polycystin-1 have greatly altered kinetics and a profound effect on the EV half-life, possibly impacting the duration of EV cargo effect on the recipient cell.

**Conclusions:** These results demonstrate the interplay between primary cilia and EVs and support a role for EVs in polycystic kidney disease pathogenesis.

**Funding:** Private Foundation Support

#### FR-PO257

##### Generation of Mice Expressing an N-Terminal SNAP-Tagged *Pkd1* Allele

Stephen C. Parnell,<sup>1</sup> Pamela V. Tran,<sup>1</sup> Heather A. Riddle,<sup>1</sup> Wei Wang,<sup>1</sup> Courtney J. Haycraft,<sup>2</sup> Patricia Outeda,<sup>3</sup> Bradley K. Yoder,<sup>2</sup> Terry J. Watnick,<sup>3</sup> Darren P. Wallace,<sup>1</sup> James P. Calvet,<sup>1</sup> PKD Research Resource Consortium <sup>1</sup>University of Kansas Medical Center Department of Internal Medicine, Kansas City, KS; <sup>2</sup>The University of Alabama at Birmingham Department of Cell Developmental and Integrative Biology, Birmingham, AL; <sup>3</sup>University of Maryland School of Medicine, Baltimore, MD.

**Background:** ADPKD missense mutations that impair intracellular trafficking of polycystin-1 (PC1) indicate that PC1 undergoes complex regulation and interacts with various proteins to mature and reach its cellular destinations. However, a lack of antibodies that reliably detect endogenous PC1 and the inability to analyze PC1 trafficking in live cells have limited our understanding of the interplay between PC1 function and localization. To facilitate the *in vivo* visualization of PC1 trafficking and co-immunoprecipitation of multiprotein complexes, we have engineered mice that express endogenous PC1 with an N-terminal SNAP tag.

**Methods:** For proof-of-concept studies, a cDNA construct expressing N- and C-terminally tagged PC1 (<sup>SNAP</sup>PC1<sup>CLIP</sup>) was transfected into HEK293T cells. <sup>SNAP</sup>PC1<sup>CLIP</sup> was detected by Western blot and localized in live cells using SNAP ligand, followed by immunostaining for the ciliary marker, ARL13B. Subsequently, a homologous repair construct encoding SNAP fused in-frame with the first exon of *Pkd1* was injected into C57BL/6J pronuclei for homology driven repair using CRISPR technology. PCR and sequencing were used to screen pups for correct insertion of SNAP into the *Pkd1* locus. RT-PCR and matings with *Pkd1*<sup>Y</sup> and *Pkd1*<sup>RC</sup> hypomorphic mutant mice were used to examine *Pkd1*<sup>N-SNAP</sup> expression and PC1<sup>N-SNAP</sup> functionality.

**Results:** <sup>SNAP</sup>PC1<sup>CLIP</sup> localized around the nucleus (likely the endoplasmic reticulum) and in the cilium of HEK293T cells, demonstrating that PC1-N-SNAP can exit the Golgi and traffic to the cilium. *Pkd1*<sup>N-SNAP</sup> mosaic founders were produced and a stable line with confirmed integration was identified. *Pkd1*<sup>N-SNAP</sup> mRNA was transcribed in multiple tissues. At 16 weeks of age, *Pkd1*<sup>N-SNAP/V</sup> and *Pkd1*<sup>N-SNAP/RC</sup> compound heterozygotes appeared normal, suggesting that the *Pkd1*<sup>N-SNAP</sup> allele is functional.

**Conclusions:** *Pkd1*<sup>N-SNAP</sup> mice express the tagged *Pkd1* allele and the tag does not appear to impair PC1 function. Future experiments will test SNAP ligands in primary cells and kidneys of live mice to visualize intracellular trafficking of PC1<sup>N-SNAP</sup>. These mice should enable novel investigation of the regulation of intracellular trafficking and the cellular functions of PC1.

**Funding:** NIDDK Support

#### FR-PO258

##### Autophagy Is Dynamically Dysregulated Along the Pathogenesis of Autosomal Dominant Polycystic Kidney Disease

Andrew M. Lavin, Ping Zhu, Peter C. Harris, Xiaolei Xu, Xueying Lin. *Mayo Clinic Research Rochester, Rochester, MN.*

**Background:** Abnormal autophagy has been noted in various models of PKD. However, a consensus is lacking and treatment targeting autophagy gives rise to contradictory results, underscoring the complexity of functions of autophagy in PKD. Here, we conducted a detailed analysis of autophagy dysregulation in a mouse model of ADPKD.

**Methods:** *Pkd1*<sup>RC/RC</sup> mouse that contains a disease variant, *PKD1* p.R3277C, was crossed into a transgenic *Tg(EGFP-Lc3)* reporter mouse. Autophagy was assessed at different time points during the disease progression via western blotting, immunofluorescence staining, and qPCR. To measure autophagic flux, BafA1, an inhibitor of autophagosome-lysosome fusion, was used.

**Results:** At 1 month of age when total kidney weight/body weight ratio (2KW/BW) in *RC/RC* mice was only doubled compared with wild-type animals, LC3-II proteins were accumulated at a steady state and failed to further accumulate in the presence of BafA1, indicating insufficient autophagic flux. GFP-LC3 puncta were mainly detected in the non-cystic PT tubules, suggesting autophagy dysregulation was more likely a primary defect to *Pkd1* mutation than secondary to cyst formation. Essential autophagy proteins such as *Becn1*, *Atg7*, and *Lamp2* were normally expressed while *Tfeb*, a transcription factor implicated in the autophagic flux regulation and oncogenic proliferation, was specifically downregulated in the PT tubules. At 6 months when 2KW/BW in the *RC/RC* mice was 5-6 times higher than wild-type controls, steady state LC3-II levels were elevated and autophagic flux was recovered. *Becn1*, *Atg7*, *Lamp2*, and *Tfeb* were all overexpressed, and *Tfeb* nuclear localization was significantly increased in both the PT and CD tubules.

**Conclusions:** We found dynamic autophagy dysregulation in the *Pkd1*<sup>RC/RC</sup> mouse model of ADPKD, i.e., impaired cargo clearance in the early phase, and adaptive/maladaptive autophagy activation in the later phase, and a spatial- and temporal-dependent dysregulation of *Tfeb*. Our study suggests a time-dependent mechanism that needs to be considered when developing an autophagy-based therapy for ADPKD.

#### FR-PO259

##### Assessing the Therapeutic Potential of Readthrough of Nonsense Mutations in Autosomal Dominant Polycystic Kidney Disease (ADPKD)

Elizabeth K. Dillinger,<sup>1</sup> Peter C. Harris,<sup>2</sup> <sup>1</sup>Mayo Clinic Graduate School of Biomedical Sciences, Rochester, MN; <sup>2</sup>Mayo Clinic Minnesota, Rochester, MN.

**Background:** ADPKD is a common cause of ESKD, and truncating mutations are associated with more severe disease. Over 25% of catalogued *PKD1* and *PKD2* mutations are nonsense type, truncating mutations. Readthrough of nonsense variants resulting in full length wildtype or missense containing proteins is a promising treatment for this type of mutation. We hypothesize that readthrough therapies may result in an increase in *PKD1* and *PKD2* protein, polycystin-1 and -2 (PC1/PC2), and hence, decrease the severity of cystic diseases.

**Methods:** Using a dual-fluorescent, short fragment, *in vitro* assay, and flow cytometry we determined the effect of various readthrough treatments on a catalogue of *PKD2* nonsense mutations. After determining which treatments have the best efficacy on the *PKD2* mutations we are further investigating the effects of these treatments on the level of readthrough, trafficking and localization of full length PC2 and the PC1/PC2 complex formation using a novel *in vitro* assay.

**Results:** We have assayed five *PKD2* nonsense variant in detail that contain the three different stop codons and different flanking sequences and have found a dramatic difference in the level readthrough depending on the sequence. We have also added 5 mM caffeine to the culture media which increases the rate of readthrough by diminishing nonsense mediated decay, although alone did not promote readthrough. For the nonsense variant p.Trp414\*, with the nonsense codon TGA C, levels of readthrough of ~28% were recorded with 1800ug/ml of gentamycin, that is promoted to ~38% with the addition of caffeine. In contrast, the nonsense variant p.Gln768\*, codon TAA G, had readthrough of only ~6%, that was not further boosted with caffeine. Analysis of treated MEFs from a mouse mimicking the Gln768\* variant showed minimal readthrough. The level of readthrough with the compounds G418 or ataluren for p.Trp414\* were not as effective as gentamycin.

**Conclusions:** Our studies indicate that readthrough may be a feasible means to increase the level of functional polycystin protein in ADPKD and so a therapy worthy of consideration. However, selecting the best drug and patients based on the specific stop codon may dramatically alter the efficacy.

**Funding:** NIDDK Support

#### FR-PO260

##### Longitudinal Characterization of Mitochondrial and Metabolic Changes in Autosomal Dominant Polycystic Kidney Disease

Jamie Zheng, Cassandra Trask, Marie C. Hogan, Vicente E. Torres, Peter C. Harris, Alfonso Eirin, Maria V. Irazabal. *Mayo Clinic, Rochester, MN.*

**Background:** Metabolic dysregulations and mitochondria abnormalities are implicated in the pathogenesis of autosomal dominant polycystic kidney disease (ADPKD), but reports differ between studies, and there are no longitudinal studies that determine the timing of these alterations through the disease. This study aimed to determine the longitudinal mitochondrial and metabolic changes in a slowly progressive *Pkd1* mouse model (*Pkd1*<sup>RC/RC</sup>) and patients with ADPKD.

Key: TH - Thursday; FR - Friday; SA - Saturday; OR - Oral; PO - Poster; PUB - Publication Only

Underline represents presenting author.

**Methods:** We analyzed the kidney metabolome of *Pkd1<sup>RC/RC</sup>* mice and WT controls (n=5 males and 5 females/group) at 1, 2, 4, 6, 8, 12, and 16 months (m, renal failure) using <sup>1</sup>H NMR and mitochondrial characteristics in kidneys and urine from the same animals at 1, 6, and 16m using electron microscopy, RNAseq, and qPCR. Disease severity and progression were evaluated by kidney weight/body weight (KW/BW), cystic index (CI), fibrotic index (FI), and BUN. We collected urine and blood from 40 well-characterized, young, early-stage (<40 years, eGFR>90 ml/min/1.73m<sup>2</sup>) patients with ADPKD and 20 age and sex-matched controls for metabolomics and mtDNA analyses. Abdominal MRIs were acquired for kidney volume.

**Results:** KW/BW and CI were higher in *Pkd1<sup>RC/RC</sup>* from 1m and FI from 4m, but BUN was similar until 8m. Metabolic changes were present throughout the disease, but the metabolic profile varied at different stages. At 1m, kidney mitochondria resembled the typical appearance of WT controls, but the mitochondria number was lower in *Pkd1<sup>RC/RC</sup>*. Changes in mitochondria area and matrix density became apparent as the disease progressed. The mitochondrial genetic profile in *Pkd1<sup>RC/RC</sup>* versus WT differed at 1, 6, and 16m. However, functional analysis revealed distinct changes at different stages of the disease. In urine, the mtDNA copy number was lower at 1m, but unexpectedly, it increased with disease progression. Analyses of human urine and plasma samples are still ongoing.

**Conclusions:** ADPKD is associated with metabolic dysregulations and mitochondria abnormalities throughout the disease. However, the abnormalities observed were different in the early, middle, and late stages of the disease. These findings have significant implications for treating patients with ADPKD and suggest that different therapeutic strategies might be beneficial throughout the disease.

**Funding:** NIDDK Support

## FR-PO261

### Loss of Intestinal Pkd1 Does Not Alter Epithelial Cell Integrity or Inflammation in Early Autosomal Dominant Polycystic Kidney Disease

Rande S. Sedaka, Shinobu Yamaguchi, Sejal Sanjay Shinde, Jung-Shan Hsu, Takamitsu Saigusa. *The University of Alabama at Birmingham, Birmingham, AL.*

**Background:** Autosomal dominant polycystic kidney disease (ADPKD) is the most common inherited progressive kidney disorder, manifested by a germline *PKD1* mutation in nearly 80% of patients. Polycystin-1 (PC-1), the protein encoded by *PKD1*, is critical to maintaining renal epithelial cell adhesion. However, its expression along the intestines and its role in intestinal epithelial cell barrier function have yet to be elucidated. Considering the gut is the largest source of inflammatory cells in the body, and macrophage infiltration precedes accelerated cyst growth in kidney-specific *Pkd1* knockout (*Pkd1KO*) mice, we hypothesized that loss of intestinal *Pkd1* would lead to decreased intestinal epithelial cell integrity and increased inflammation, potentially preceding renal inflammation.

**Methods:** Plasma, kidney, and intestines were collected from 9-12 week old male and female conditional *Pkd1KO* (CAGG-creER; tamoxifen-induced at 5-6 weeks) and flox (control) mice. Intestinal permeability was detected via a fluorescein isothiocyanate-dextran assay. Tissue was utilized for RT-PCR and immunohistochemistry, while plasma was used to measure monocyte chemoattractant protein-1 (MCP-1).

**Results:** Kidney/body weight ratio was significantly elevated in *Pkd1KO* compared to flox mice. No genotype differences were observed in colon or small intestine/body weight ratio. *Pkd1* expression was significantly decreased in the kidney, duodenum, jejunum, ileum, proximal colon, and distal colon of *Pkd1KO* compared to flox mice. Despite these deficiencies, there were no differences in kidney, ileum, or colon epithelial integrity genes (*Ocln*, *Ptk2*, *Cldn1*, *Tjp1*, *Dsg2*, *Cdh1*), inflammatory genes (*Csf1*, *Il1b*, *Ccl2*, *Il6*, *Tnfa*, *Tgfb1*, *Muc2*), intestinal damage, plasma MCP-1, or small intestinal permeability between genotypes. However, colonic endothelial integrity marker, *Plvap*, was significantly elevated in *Pkd1KO* compared to flox mice, with a trended increase in *Cdh5* and *Cgn* and decrease in colonic permeability.

**Conclusions:** Although *Pkd1* expression is downregulated along the entire intestinal tract in our ADPKD mouse model, it does not appear that intestinal epithelial integrity or inflammation are altered at this early timepoint preceding renal inflammation. Elevated endothelial integrity marker expression suggests improved colonic barrier function in *Pkd1KO* mice.

**Funding:** NIDDK Support

## FR-PO262

### CD74 Promotes Cyst Growth and Interstitial Fibrosis in Autosomal Dominant Polycystic Kidney Disease

Xia Zhou, Xiaoyan Li, Ewud Agborbesong, Xiaogang Li. *Mayo Clinic Minnesota, Rochester, MN.*

**Background:** Autosomal dominant polycystic kidney disease (ADPKD) is a genetic disorder characterized with cyst formation, inflammation and renal fibrosis. CD74 has been recognized as a transmembrane receptor for the cytokine macrophage migration inhibitory factor (MIF). Our previous study has reported that MIF is an important regulator of cyst growth in ADPKD possibly through binding with CD74 to activate ERK, PI3K-Akt, NF-kappa B and AMPK pathways to regulate the cell proliferation and survival. However, whether and how CD74 by itself regulates cyst growth and interstitial fibrosis remains elusive.

**Methods:** To understand the role of CD74 *in vivo*, we generated *Pkd1<sup>flox/flox</sup>; CD74<sup>-/-</sup>; Pkhd1-Cre* mice. To explore the mechanisms mediated by CD74 in regulating cyst growth, inflammation and renal fibrosis, we knocked down CD74 with siRNA and inhibited MIF with its inhibitor ISO-1 in renal epithelial cells and fibroblasts.

**Results:** We found that CD74 were upregulated in *Pkd1* mutant cells and kidneys, and knockout of *CD74* delayed cyst growth as seen by decreased cystic index, kidney weight/body weight ratios, blood urea nitrogen levels in *Pkd1<sup>flox/flox</sup>; Pkhd1-Cre* mice. Deletion of *CD74* decreased proliferation and increased apoptosis of cyst lining epithelia, reduced the recruitment of macrophages in pericyclic and interstitial areas, and ameliorated interstitial fibrosis. Knockout of *CD74* decreased mRNA levels of MCP-1, TNF alpha, MIF and CD44 as well as fibrotic markers, including Col I, Col III, and fibronectin. In addition, we found that knockdown of *CD74* by siRNA decreased the expression of those cytokines, CD44, and fibrotic markers in *Pkd1* mutant renal epithelial cells and renal fibroblasts. Our ChIP assay indicated that *CD74* regulated the transcription of those genes through binding on their promoters, supporting a feedback loop between MIF and *CD74*. Furthermore, we found that inhibition of MIF with its inhibitor ISO-1 decreased the phosphorylation of ERK, Akt and S6, and blocked the phosphorylation of Smad3 induced by TGF beta in renal fibroblasts.

**Conclusions:** *CD74* promotes cyst growth and renal interstitial fibrosis in ADPKD. This study identifies novel transcriptional targets of *CD74*, including cytokine and fibrotic markers, which will help in understanding of essential pathways regulating cystic cell growth and survival, the recruitment of macrophages and the activation of renal fibroblasts in ADPKD.

**Funding:** NIDDK Support

## FR-PO263

### Role of GREMLIN in Autosomal Dominant Polycystic Kidney Disease (ADPKD)

Lucia Tejedor,<sup>1,5</sup> Adrian Cordido,<sup>3,4</sup> Laura Marquez-Exposito,<sup>1,5</sup> Laura Nuñez-Gonzalez,<sup>3</sup> Vanessa Marchant,<sup>1,5</sup> Ana B. Sanz,<sup>2,5</sup> Alberto Ortiz,<sup>2,5</sup> Miguel A. Garcia-Gonzalez,<sup>3,5</sup> Marta Ruiz-Ortega.<sup>1,5</sup> <sup>1</sup>Cellular Biology in Renal Diseases Laboratory. IIS-Fundación Jiménez Díaz, Universidad Autónoma Madrid, Madrid, Spain; <sup>2</sup>Division of Nephrology and Hypertension. IIS-Fundación Jiménez Díaz-Universidad Autónoma Madrid, Madrid, Spain; <sup>3</sup>Genetics and Developmental Biology of Kidney Diseases, Health Research Institute of Santiago de Compostela (IDIS), Santiago de Compostela Clinical Hospital Complex (CHUS), Santiago de Compostela, Spain; <sup>4</sup>Department of Internal Medicine, Yale School of Medicine, New Haven, CT; <sup>5</sup>Red de Investigación Renal (REDinREN), Madrid, Spain.

**Background:** Autosomal Dominant Polycystic Kidney Disease is a genetic disease caused by *PKD1* or *PKD2* mutations, which codify for the Polycystin-1 and Polycystin-2 proteins, respectively. ADPKD prevalence is among 1:800 and 1:1000 of live births and is characterized by fluid-filled renal cysts, leading to end-stage renal disease (ESRD). During this process the production of chemokines, cytokines and growth factors by epithelial cells, interstitial fibroblasts and inflammatory cells, such as macrophages, increases. Preclinical studies have described GREMLIN as an important mediator of chronic kidney disease, which could have usefulness as urine biomarker. However, there are no studies about GREMLIN in polycystic kidney disease.

**Methods:** In an orthologous murine model of polycystic kidney disease (*Pkd1<sup>cond/cond</sup>; Tam-Cre<sup>+</sup>*) we studied the role of GREMLIN and potential downstream signaling (activation of its receptor VEGFR2 and the Notch pathway) in different stages of renal cystic progression. The polycystic phenotype was induced in lactating mice by administering tamoxifen to the mother on postnatal days 10 and 11, causing a deletion in *Pkd1* gene. Studies were performed taking into account different sacrifice points: at 18, 30 and 45 days. In urine and kidney tissue samples from ADPKD patients, GREMLIN levels were evaluated.

**Results:** In *Pkd1<sup>-/-</sup>* mutant mice, *grem-1* renal expression (the gene encoding GREMLIN protein) was increased from 18 days, with a significant upregulation at 30 days. *Grem-1* overexpression was associated with progressive cysts expansion and detriment in renal function measured by BUN. These results were confirmed at the protein level by western blot. Immunohistochemistry revealed positive GREMLIN staining since pre-cystic tubuloepithelial cells, which remained elevated in the tubules at later times. Positive GREMLIN expression was observed in biopsy samples of cysts from ADPKD patients as well as GREMLIN protein presence in urine samples. In the polycystic model, GREMLIN induction was correlated with VEGFR2 activation in the same tubular segments. Cyst formation was also associated with activation of NOTCH1 and NOTCH3.

**Conclusions:** GREMLIN expression in murine and human polycystic kidney suggests that it may be an important mediator of renal damage progression in ADPKD.

## FR-PO264

### Ouabain Treatment Increases Cyst Progression in a Slowly Progressive Autosomal Dominant Polycystic Kidney Disease Mouse Model

Jordan Trant, Gladis S. De Blanco, Jeff P. Mcdermott, Gustavo Blanco. *The University of Kansas Medical Center, Kansas City, KS.*

**Background:** Renal cyst progression in Autosomal Dominant Polycystic Kidney Disease (ADPKD) is highly dependent on agents circulating in blood. We have previously shown that one of these agents is the hormone ouabain. By binding to its cell surface receptor Na,K-ATPase (NKA), ouabain triggers a cascade of signal transduction events in the cells, which enhances ADPKD cystogenesis via two main mechanisms: increased cell proliferation and enhanced fluid secretion of the cystic renal tubular epithelial cells. These effects were obtained using *in vitro* models of ADPKD. Here, we determined the effects of ouabain *in vivo* using an ADPKD mouse model.

**Methods:** Ouabain (0.3 mg/g) or saline was injected intraperitoneally to wildtype (WT) mice and a slowly progressive ADPKD model (RC/RC mice). Ouabain was administered daily, starting at postnatal day 9 and for 1-5 months. Kidney weight to body weight ratio (KW/BW), blood urea nitrogen (BUN), percent of cystic area (% cyst area), and kidney fibrosis were then measured.

**Results:** Ouabain treatment significantly increased the % cyst area in RC/RC mice compared to saline-injected controls at all time points. The KW/BW was also augmented in RC/RC mice at 3, 4, and 5 months of treatment. There were no differences observed between male and female mice, and these effects were not seen in WT mice. BUN values were not affected by ouabain in either of the groups tested. Between 1 and 5 months, ouabain significantly increased fibrosis in the RC/RC mice compared with the saline-injected controls.

**Conclusions:** These findings demonstrate that ouabain stimulates kidney cyst progression in ADPKD not only *in vitro*, but also *in vivo*. Since the dose of ouabain that we used is within the reported normal physiological range, our results support the idea that circulating levels of this hormone could be contributing to cyst progression in ADPKD patients.

**Funding:** NIDDK Support

## FR-PO265

### Electrophysiological Characterization of Polycystin-2 Mutants With Disease-Associated Missense Mutations in the Channel's Pore Loop

Tobias Staudner, Linda Geiges, Christoph Korbmacher, Alexandr V. Ilyaskin. Friedrich-Alexander-Universität Erlangen-Nürnberg Institut für Zelluläre und Molekulare Physiologie, Erlangen, Germany.

**Background:** In ~15% of patients with autosomal dominant polycystic kidney disease (ADPKD) mutations of polycystin-2 (PC2) are causative for the disease. PC2 belongs to the family of transient receptor potential (TRP) channels characterised by six transmembrane segments (S1 - S6) and a pore loop between S5 and S6. Here we investigated the effects of three disease-associated pore loop mutations (F629S, C632R, and R638C) on PC2 ion channel properties.

**Methods:** Pore mutations F629S, C632R, or R638C were introduced into wild-type PC2 (PC2<sub>WT</sub>) or two PC2 gain-of-function (GOF) constructs (PC2<sub>F604P</sub> or PC2<sub>L677A/N681A</sub>) using site-directed mutagenesis. PC2 constructs with or without pore mutations were heterologously expressed in *Xenopus laevis* oocytes for functional analysis using the two-electrode voltage clamp technique. PC2-mediated Na<sup>+</sup> inward currents were elicited by divalent cation removal. Monovalent cation selectivity and Ca<sup>2+</sup> permeability were assessed.

**Results:** In contrast to PC2<sub>WT</sub> expression of PC2 with F629S, C632R or R638C pore mutations produced no detectable baseline Na<sup>+</sup> inward currents. These findings are consistent with a loss-of-function effect of the pore loop mutations on baseline PC2 activity. Importantly, F629S, C632R and R638C also completely abolished the ion channel function of the GOF construct PC2<sub>F604P</sub>. This finding suggests that pore loop mutations disturb the gating mechanism associated with the F604P GOF mutation. Interestingly, the R638C mutation reduced but did not abolish Na<sup>+</sup> inward currents mediated by the GOF construct PC2<sub>L677A/N681A</sub>. Importantly, the R638C mutation significantly altered monovalent cation selectivity of PC2<sub>L677A/N681A</sub> and completely abolished its Ca<sup>2+</sup> permeability. Interestingly, introducing the corresponding mutation R518C in the closely related polycystin-2L1 channel rendered it impermeable to Ca<sup>2+</sup> without affecting its Na<sup>+</sup> permeability.

**Conclusions:** PC2 pore loop mutations abolished baseline PC2 ion channel function and also the function of the GOF channel PC2<sub>F604P</sub>. This suggests that pore mutations disturb PC2 channel gating. Moreover, our findings highlight an important role of R638 in monovalent cation selectivity and Ca<sup>2+</sup> permeability of PC2. Supported by a grant from IZKF Erlangen (F8).

**Funding:** Government Support - Non-U.S.

## FR-PO266

### Lipophilic Methanethiosulfonate (MTS) Reagents Inhibit Ion Channel Function of Polycystin-2 With a Gain-of-Function Mutation (F604P)

Linda Geiges, Tobias Staudner, Christoph Korbmacher, Alexandr V. Ilyaskin. Friedrich-Alexander-Universität Erlangen-Nürnberg, Erlangen, Germany.

**Background:** Polycystin-2 (PC2) mutations account for approximately 15% of reported cases of autosomal-dominant polycystic kidney disease (ADPKD). As a member of the transient receptor potential (TRP) ion channel family, PC2 features a typical structure with 6 membrane-spanning segments (S1-S6). No specific activators or inhibitors of PC2 have been described to date. Interestingly, covalent modification of N-terminal cysteines is a known activation mechanism of another TRP channel, TRPA1. Therefore, we hypothesized that a similar regulatory mechanism may exist in PC2.

**Methods:** PC2 mutants were generated by site-directed mutagenesis and functionally expressed in *Xenopus laevis* oocytes. PC2 currents were measured using the two-electrode voltage clamp technique. For covalent cysteine modification, several structurally different methanethiosulfonate (MTS) reagents were applied in the bath. In particular, the effects of positively charged MTSET and MTSEA and lipophilic MTS reagents (methyl-, ethyl-, propyl- and benzyl-MTS) were investigated.

**Results:** Application of these MTS reagents did not result in an activation of wild-type PC2. To investigate a possible effect of MTS reagents on the channel in an open state, we used two recently discovered gain-of-function (GOF) PC2 mutants (PC2<sub>F604P</sub>

or PC2<sub>L677A/N681A</sub>). Importantly, we found that lipophilic but not positively charged MTS reagents strongly inhibited PC2<sub>F604P</sub>. The inhibitory effect could not be reproduced in the structurally related TRPML3 channel containing a corresponding GOF mutation (A419P). The GOF mutant PC2<sub>L677A/N681A</sub> was not sensitive to any of the tested MTS reagents. The inhibitory effect of methyl-MTS was preserved after mutating all four cysteines in the channel's N-terminus. Interestingly, replacing the C593 residue in the S4-S5 linker by serine or alanine resulted in a complete loss of PC2<sub>F604P</sub> function, mimicking the inhibitory effect of lipophilic MTS reagents.

**Conclusions:** We identified lipophilic MTS reagents as inhibitors of PC2<sub>F604P</sub> ion channel function. Moreover, C593 in the S4-S5 linker appears to be a crucial residue for PC2 activity. These new findings may lead to a better understanding of PC2 gating mechanisms and promote the development of pharmacological PC2 modulators. Supported by a grant from IZKF Erlangen (F8)

**Funding:** Government Support - Non-U.S.

## FR-PO267

### SMYD3 Regulates Cyst Growth and Ciliogenesis in Autosomal Dominant Polycystic Kidney Disease

Ewud Agborbesong,<sup>1</sup> Xia Zhou,<sup>1</sup> Xiaoyan Li,<sup>1</sup> Xiaogang Li,<sup>2</sup> Mayo Clinic Minnesota, Rochester, MN; <sup>2</sup>Mayo Clinic Minnesota, Rochester, MN.

**Background:** Autosomal dominant polycystic kidney disease (ADPKD) is a genetic disorder that results in renal cyst formation with the eventual loss of renal function. In addition, ADPKD is associated with abnormal primary cilia function. Yet the regulation of cystogenesis and ciliogenesis in ADPKD are not fully known. Deregulation of epigenetic modulators has emerged as a common etiological factor in ADPKD. How epigenetic modifiers regulate cystogenesis and ciliogenesis remains unclear. We investigated the role of the histone methyltransferase, SMYD3, on cyst growth and ciliogenesis in ADPKD.

**Methods:** To investigate the role and mechanism of SMYD3 on cyst growth and ciliogenesis in ADPKD, we generated double conditional knockout *Pkd1*<sup>fl/fl</sup>; *Smyd3*<sup>fl/fl</sup>; *Ksp-Cre* mice. To further define the mechanisms, we knocked down *Smyd3* with shRNA and siRNA, and performed immunostaining, western blot, qRT-PCR and chromatin immunoprecipitation analysis in renal epithelial cells and tissues.

**Results:** *Smyd3* was upregulated in *Pkd1* mutant mouse and human ADPKD kidneys, and its knockout reduced cyst growth as seen by decreased cystic index, KW/BW ratios, BUN levels, and cyst lining epithelial cell proliferation in *Pkd1* mutant mice. This decreased cyst growth correlated with shortening of cilia in *Pkd1* mutant kidney tissues. We found that *Smyd3* is located at the centrosome and its depletion disrupted centrosome integrity and decreased recruitment of basal body components such as Cep164 and Ttbk2. We further found that *Smyd3* interacted with Ttbk2 and  $\alpha$ -tubulin, and via methylation of  $\alpha$ -tubulin regulated microtubule stability which contributed to ciliogenesis. Also, *Smyd3* regulated the transcription of ciliary genes by binding to their promoters, and regulated the activation of PKD associated signaling pathways including Erk, Stat3, NF- $\kappa$ B and  $\beta$ -catenin. In addition, *Smyd3* played a crucial role in the activation of the hedgehog signaling pathway in renal epithelial cells.

**Conclusions:** *Smyd3* is a novel basal body constituent that regulates centriole assembly and ciliogenesis through its interactions with novel binding partners and transcriptional regulation of ciliary genes. The activation of *Smyd3* mediated cilia dependent hedgehog and PKD signaling pathways associated with cell proliferation promotes cystogenesis, providing a novel link between cyst growth and cilia formation and function in ADPKD.

**Funding:** NIDDK Support

## FR-PO268

### The Polycystin-1 C-Terminal Tail (CTT) Suppresses Cystic Disease: Elucidating the Underlying Mechanisms

Laura Onuchic, Valeria Padovano, Giorgia Schena, Vanathy Rajendran, Xiaojian Shi, Ke Dong, Nikolay P. Gresko, Hongying Shen, Stefan Somlo, Michael J. Caplan. Yale School of Medicine, New Haven, CT.

**Background:** Mutations in *PKD1*, which encodes polycystin-1, account for ~78% of autosomal dominant polycystic kidney disease (ADPKD) cases. We have previously shown that transgenic CTT expression in the *Pkd1*<sup>fl/fl</sup>; *Pax8*<sup>rtTA</sup>; *TetO-Cre* ADPKD mouse model suppresses cystic phenotype and preserves renal function. We have also shown that this suppression is dependent on an interaction between CTT and Nicotinamide Nucleotide Transhydrogenase (NNT). NNT is a mitochondrial enzyme that modulates NAD(P)(H) levels. In the present study, we assessed CTT-dependent changes in both redox modulation and NNT enzymatic activity. Furthermore, we expressed CTT in a non-inducible, early and rapidly progressing ADPKD mouse model.

**Methods:** Mice were generated on C57BL/6N ("N"; NNT-competent) and C57BL/6J ("J"; NNT-deficient) backgrounds. Kidney NAD(P)(H) levels were determined by targeted LC-MS. NNT enzymatic activity was measured with a spectrophotometric assay. ADPKD mice +/- CTT, in which Cre expression is driven by the *Pkd1* promoter, were generated by crossing "J"-*Pkd1*<sup>fl/fl</sup>; *Pkd1*-*Cre* with "N"- and "J"-CTT-expressing *Pkd1*<sup>fl/fl</sup>; *Pax8*<sup>rtTA</sup>; *TetO-Cre* mice.

**Results:** "N" cystic CTT-expressing mice exhibited an ~3-fold increase in NADPH/NADP<sup>+</sup> and an ~2.5-fold increase in NADH/NAD<sup>+</sup> ratios when compared to CTT-negative littermates. CTT expression on the "J" background did not affect either ratio. We detected a 20% decrease in NNT enzymatic activity in "N" cystic mice compared to "N" WT controls. Interestingly, CTT expression in "N" cystic mice rescued enzymatic activity to the same level observed in "N" WT controls. Finally, CTT expression in the



*Nnt*-heterozygous F1 progeny (*J-Pkd1<sup>fl/fl</sup>;Pkh1-Cre x N-Pkd1<sup>fl/fl</sup>;Pax8<sup>Cre</sup>;TetO-Cre+CTT*) led to a 25% decrease in kidney-to-body weight ratio. As expected, CTT expression in the “J” *Nnt*-deficient F1 progeny did not suppress cystic disease.

**Conclusions:** While the directionality of the reaction catalyzed by NNT in the context of ADPKD remains to be determined, it is likely that CTT-dependent modulation of mitochondrial redox and NNT activity contributes to disease suppression. Furthermore, we confirmed CTT-dependent disease suppression in a second *Pkd1*-KO model, which supports the idea that this small fragment may open the doors to the exploration of gene therapy approaches.

**Funding:** NIDDK Support, Private Foundation Support

## FR-PO269

### Deep Learning Allows Automated Analysis of Cystogenesis in Novel *Xenopus* Animal Models for Autosomal Polycystic Kidney Disease

Thomas Naert, Soeren S. Lienkamp. *Universitat Zurich, Zurich, Switzerland.*

**Background:** Autosomal dominant polycystic kidney disease (ADPKD) is caused by mutations in *PKD1* or *PKD2* and has an unmet need for new drugs and therapeutic targets. Ideally, these are identified in clinically relevant vertebrate disease models amenable to screening efforts. Further, genome editing simplifies the generation of new animal models for congenital disorders. However, the detailed and unbiased phenotypic assessment of altered embryonic development remains a challenge.

**Methods:** We employ targeted and unilateral CRISPR/Cas9 editing in order to inactivate *pkd1* or *pkd2* in the *Xenopus* developing vertebrate kidney. Cystogenesis is then visualized by whole-mount immunostaining, fluorescent stereomicroscopy, mesoSPIM light-sheet microscopy and advanced U-Net deep learning image processing for automated, unbiased and rapid scoring of kidney pathological states in two and three dimensions.

**Results:** CRISPR/Cas9 genome engineering in *pkd1* and *pkd2* elicited cystic malformations in developing renal tubules two-days post-fertilization ( $p < 0.001$ ). We observed cystogenesis across different developmental stages by leveraging an image processing pipeline for automated scoring of ADPKD in *Xenopus* embryos using deep learning approaches. Using a combination of segmentation and classification deep learning architectures allowed for automated size measurement of kidneys, as well as a qualitative analysis of cystic hallmarks. Our models correlated well with an independent expert on test data ( $n_{\text{test}} = 120$ ;  $r = 0.96$ ;  $P < 0.001$ ). Next, using tissue clearing and light-sheet microscopy approaches, we extended to three-dimensional analysis of cystogenesis. Here we showed that three-dimensional kidney size quantification can be achieved.

**Conclusions:** By combining light-sheet microscopy and deep learning we provide a framework for higher-throughput and in-depth characterization of novel models for autosomal polycystic kidney disease.

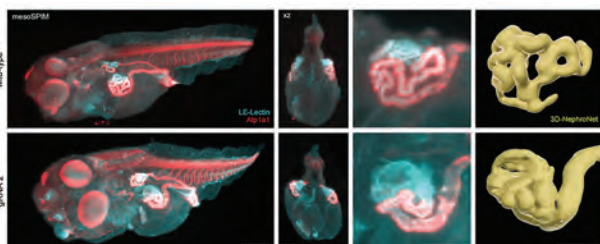

MesoSPIM light-sheet microscopy allows for whole-embryo imaging of *Xenopus tropicalis* embryos. Wild-type (top) embryos develop normal kidneys, *pkd1* mutants (bottom) reveal cystogenesis.

## FR-PO270

### The Transcriptional Regulator AP-2 $\alpha$ Maintains the Tubular Diameter of Renal Collecting Ducts in Adult Mice

Janna Leiz,<sup>1,2</sup> Shuang Cao,<sup>3,1</sup> Felix Boivin,<sup>1,2</sup> Christian Hinze,<sup>3,1</sup> Kai M. Schmidt-Ott.<sup>3,1</sup> Molecular and Translational Kidney Research <sup>1</sup>Charité Universitätsmedizin Berlin, Berlin, Germany; <sup>2</sup>Max-Delbrück-Centrum für Molekulare Medizin in der Helmholtz-Gemeinschaft, Buch, Germany; <sup>3</sup>Medizinische Hochschule Hannover, Hannover, Germany.

**Background:** The transcriptional regulator AP-2 $\alpha$ , encoded by the Tfp2a gene, is part of the AP-2 transcription factor family. Heterozygous missense mutations of TFAP2A in humans result in branchio-oculo-facial syndrome (BOFS), which is associated with renal anomalies in about 35 % of patients. Recent studies demonstrated that mice with a collecting duct-specific knockout of AP-2 $\alpha$  display a progressive tubular dilation of medullary collecting ducts. Molecular mechanisms resulting in these renal anomalies are still unknown.

**Methods:** Mice carrying a collecting duct-specific knockout of AP-2 $\alpha$  (*Hoxb7:Tfp2a<sup>fl/fl</sup>*) were generated. In addition, inner medullary collecting duct (IMCD3) cells were engineered to harbour a CRISPR/Cas9-induced knock out of AP-2 $\alpha$ . Deregulated genes were identified by bulk and single-nucleus mRNA-sequencing and validated by in situ hybridization.

**Results:** Histomorphological analyses of our mouse model confirmed a progressive tubular dilation of outer medullary collecting ducts in adult mice over a period of six month. Integrative analysis of single-nucleus and bulk RNA-sequencing for kidneys

of 3-months-old *Hoxb7:Tfp2a<sup>fl/fl</sup>* mice and littermate controls indicated deregulated expression of genes associated with cell adhesion and WNT signaling pathways. Identical pathways were deregulated in AP-2 $\alpha$ -deficient IMCD3 cells when compared to controls. Genes deregulated in AP-2 $\alpha$ -deficient collecting ducts included the tight junction component *Cldn8* and the Wnt signaling factor *Wnt9b*. Their decreased mRNA expression was confirmed by in-situ hybridization. Both genes have previously been implicated in the development of renal anomalies and defects in tubulogenesis.

**Conclusions:** Taken together our study indicates that AP-2 $\alpha$  is essential for the maintenance of tubular diameter and epithelial differentiation in collecting ducts of adult mice, providing insights into potential molecular mechanisms causing renal defects observed in BOFS.

## FR-PO271

### CDK7-CDK6-FIP5 Phosphorylation Cascade Controls Axoneme Polyglutamylation and Polycystin Signaling in Primary Cilia

Kai He, Xiaobo Sun, Jinghua Hu. *Mayo Clinic Minnesota, Rochester, MN.*

**Background:** ADPKD is mainly caused by mutations in *PKD1* or *PKD2*, which encodes Polycystin 1 (PC1) and Polycystin 2 (PC2) respectively. PC1 and PC2 co-localize to primary cilia of kidney epithelial cells and have been proposed to form a receptor/channel complex to sense environmental cues. Recently studies suggested that many PKD mutations, especially the non-truncation mutations, cause defects in ciliary localization but not the channel activity of polycystins complex. Therefore, understanding how polycystins are targeted to and maintained in primary cilia would shed light on the etiology of ADPKD. **Tubulin polyglutamylation** is a spatiotemporal post-translational modification which predominantly occurs on cilia axoneme. We recently unveiled that axoneme polyglutamylation is essential for controlling the ciliary localization and dosage of PC2. Thus, axoneme polyglutamylation could be a novel target for enhancing the ciliary function of polycystins and treatment for ADPKD. However, the regulatory mechanism underlying proper axoneme polyglutamylation remains poorly understood.

**Methods:** Kinases library screen. Biochemistry and Molecular biology approaches. Cell biology approaches. *in vitro* and *ex vivo* models of renal cystogenesis

**Results:** Here, we report that a ciliary CDK7-CDK6-FIP5 phosphorylation cascade specifically suppresses axoneme polyglutamylation by blocking the cilia import of glutamylases TLL5 and TLL6. Excitingly, pharmacologic inhibition of CDK6 by Abemaciclib effectively restores axoneme polyglutamylation and ciliary levels of PC2 in *Cep41* and *Armc9*-deficient cells, the Joubert syndrome genes whose mutations cause axoneme hypoglutamylation. Interestingly, CDK6 is abnormally upregulated in human ADPKD cells, renal tubules of ADPKD mouse model (*Pkd1<sup>RC/RC</sup>* mice), and ADPKD patients. Remarkably, pharmacologic inhibition of CDK6 significantly suppressed the cyst growth in *in vitro* and *ex vivo* models of renal cystogenesis.

**Conclusions:** Our study reveals the regulatory mechanism of axoneme polyglutamylation and ciliary polycystin signaling, and suggests CDK6 as a potential therapeutic target for ADPKD.

**Funding:** NIDDK Support, Private Foundation Support

## FR-PO272

### Role of CFTR in Autosomal Dominant Polycystic Kidney Disease

Liudmila Cebotaru, Murali K. Yanda. *Johns Hopkins University, Baltimore, MD.*

**Background:** Autosomal dominant kidney disease is the most common dominant genetic renal disorder in humans leading to significant health care costs. It is associated with the slow but relentless formation of multiple renal cysts driven by cAMP-dependent fluid secretion leading to considerable patient morbidity. CFTR is known to be involved in secreting fluid in ADPKD through its localization in the apical membrane. We showed that the CFTR corrector, VX-809 relocates CFTR to the basolateral membrane creating an absorptive phenotype. Thus, the plasma membrane is the expected site where CFTR functions. Here, we show that CFTR unexpectedly is located in primary cilia and plays a role in cilia length.

**Methods:** We used a combination of mouse models employing a conditional knockout of *pkd1* and a mouse model bearing the R3277C mutation in PC1. We labelled kidneys with anti-CFTR, PC2 and anti-acetylated  $\alpha$ -tubulin antibodies, the latter a common marker of the primary cilium. We also conducted immunoprecipitation studies.

**Results:** We showed using confocal microscopy that CFTR can be found in the cilium of normal mice and is reduced in both *pkd1* and RC/RC mice. We found the same pattern for PC2. Interestingly colocalization of CFTR, PC2 and acetylated  $\alpha$ -tubulin is restored by VX-809. We triple-labeled kidney sections to determine if CFTR and PC2 colocalize within the cilium. Surprisingly, CFTR and PC2 were co-localized to the cilia in normal and cystic kidneys treated with VX-809, but there was much less co-localization in the cystic kidneys. We asked whether CFTR and PC2 can move together within the cell via a close association. Our results showed that the two proteins are able to bind to one another. We next asked whether the absence of CFTR in a null mouse had any impact on cilia. To our surprise, the cilia length was about twice as long in the CFTR null mice compared to wt-CFTR containing controls. Finally, we determined, if PC2's location in the primary cilium is altered in CFTR-null mice and found that the colocalization is decreased in CFTR-null mice.

**Conclusions:** These data suggest that CFTR does play a role in cilia both in impacting its length and the location of PC2.

**Funding:** NIDDK Support

## FR-PO273

**A Quantitative Proteomic Study of Tolvaptan Treatment in an Orthologous Mouse Model of Autosomal Dominant Polycystic Kidney Disease: What Remains Altered?**

Laura Nuñez-Gonzalez,<sup>6</sup> Adrian Cordido,<sup>1,6</sup> Marta Vizoso,<sup>1</sup> Fernando Gómez García,<sup>1</sup> Susana Bravo,<sup>3</sup> Cándido D. Rodríguez,<sup>1,5</sup> Alberto Ortiz,<sup>2</sup> Miguel A. García-Gonzalez,<sup>1,4</sup> *Genetics and Developmental Biology of Kidney Diseases. Health Research Institute of Santiago de Compostela (IDIS), Santiago de Compostela Clinical Hospital Complex (CHUS), Santiago de Compostela, Spain;* <sup>2</sup>*Jimenez Diaz foundation. School of Medicine, Autonomous University of Madrid (UAM), Madrid, Spain;* <sup>3</sup>*Proteomic Platform. Health Research Institute of Santiago de Compostela (IDIS), Santiago de Compostela Clinical Hospital Complex (CHUS), Santiago de Compostela, Spain;* <sup>4</sup>*Galician Public Foundation of Genomic Medicine, Santiago de Compostela Clinical Hospital Complex (CHUS), Santiago de Compostela, Spain;* <sup>5</sup>*Nephrology Service, Santiago de Compostela Clinical Hospital Complex, Santiago de Compostela, Spain;* <sup>6</sup>*Department of Internal Medicine, Yale School of Medicine, New Haven, CT.*

**Background:** Autosomal Dominant Polycystic Kidney Disease (ADPKD) is a monogenic inherited disorder caused by mutations in *PKD1* and *PKD2* genes, with a prevalence of 1:800 live births. It is characterized by the presence and progressive development of fluid-filled cysts leading to end-stage renal disease. A specific antagonist of vasopressin receptor type 2 in the distal tubules of the nephron (Tolvaptan) has been approved for ADPKD treatment. Although Tolvaptan mechanism of action has been described, its underlying molecular mechanisms are not well characterized. Our study is mainly focused on the understanding of those Tolvaptan hidden molecular mechanisms, in order to also understand, the remain altered pathways.

**Methods:** Quantitative proteomics based on SWATH-MS technology were performed comparing proteomes of kidneys from polycystic kidney disease (PKD) murine model: Pkd1<sup>cond/cond</sup>;Tam-Cre<sup>-/-</sup>. Mice were subdivided in three groups: Wild Type, Mutant and Tolvaptan-treated mutant animals.

**Results:** In this study, tolvaptan showed an amelioration of renal function measured by BUN, as well as diminution in cystic index and number of cysts. Through quantitative proteomics, we identified a list of 327 proteins with an adjusted p-value below 0.05 and two-fold cut-off which were found to be modified after tolvaptan treatment in comparison to mutant animals and 433 proteins in tolvaptan-treated group in comparison with wild type animals. In both differential proteomes tolvaptan treatment has shown a differential expression in the cluster of respiratory electron transport and ATP synthesis by proteins of the inner membrane of mitochondria, which could indicate a reduction in the oxygen necessities after the treatment. This effect can reduce hypoxia in cystic environment, which in turn can be responsible for some of the beneficial effects of the drug.

**Conclusions:** This work identified novel molecular pathways modified after tolvaptan treatment such as diminution in oxygen necessities and downregulation of proteins responsible for ATP synthesis. These modifications elucidate crucial aspects of tolvaptan treatment, unmasking novel alternative or complementary treatment strategies for ADPKD.

## FR-PO274

**Protein 4.1O Binds to Polycystin-1, Activates Ubiquitination, and Inhibits Polycystin-1 Signaling**

Theresa Vienen, Eva Koenigshausen, Lars C. Rump, Lorenz Sellin. *Heinrich-Heine-Universität Düsseldorf, Düsseldorf, Germany.*

**Background:** The majority of ADPKD patients have a *PKD1* gene mutation. *PKD1* codes for Polycystin-1 (PC-1). Cyst formation is caused by altered renal tubular cell proliferation and migration. Protein 4.1 family members are actin adaptors, which link plasma membrane receptors to the actin cytoskeleton. Protein 4.1O (FRMD3) is a candidate gene for diabetic nephropathy. Furthermore, protein 4.1O has properties of a tumor suppressor. This study investigates the molecular and cellular properties of protein 4.1O as a potential ADPKD modifier and therapeutic target.

**Methods:** PC-1 full-length and truncation mutants were transiently expressed. PC-1 interaction with protein 4.1O and its truncation mutants were investigated. Truncation mutants cover the N- and C-terminal domains of protein 4.1O (Band 4.1, FERM, actin-binding domain and coiled coil domain). The modulation of the PC-1 signaling properties by protein 4.1O were investigated in luciferase assays for c-myc and TEAD. FRMD3 core promoter regions were cloned into luciferase reporter and its activation by PC-1 was investigated. Ubiquitination assays investigated the influence of protein 4.1O on ubiquitination of itself and other proteins.

**Results:** Coimmunoprecipitations show an interaction of protein 4.1O to PC-1. The C-terminus of PC-1 interacts with isoforms of protein 4.1O (201, 204, 207). The truncation mapping and isoform alignment identifies a potential leucine zipper domain in protein 4.1O as the C-terminal binding domain to PC-1. The N-terminal FERM domain and the C-terminal domain of protein 4.1O are each by themselves sufficient to mediate PC-1 interaction. Protein 4.1O silences the PC-1 mediated transactivation of c-myc and hippo signaling (TEAD). PC-1 activates the protein 4.1O promoter. Furthermore, protein 4.1O enhances ubiquitination and is polyubiquitinated.

**Conclusions:** Both, the FERM domain and C-terminal domain, containing the coiled coil domain, of protein 4.1O interact with the PC-1 C-terminus. The protein 4.1O interaction inhibits the PC-1 mediated activation of c-myc and hippo signaling.

PC-1 activates the promoter of protein 4.1O and mediates silencing of PC-1 signaling. Furthermore, protein 4.1O enhances ubiquitination and its own polyubiquitination. In summary, protein 4.1O shows features of an anti-cystogenic protein and might be an ADPKD modifier.

## FR-PO275

**Effect of Enalapril in a Novel Human Orthologous Rat Model of Autosomal Recessive Polycystic Kidney Disease With Salt-Sensitive Hypertension**

Aya Yoshimura,<sup>1</sup> Eriko Matsuyama,<sup>1</sup> Takashi Watanabe,<sup>1</sup> Miwa Sakata,<sup>1</sup> Takahiro Shirozu,<sup>1</sup> Masanori Kugita,<sup>1</sup> Kanako Kumamoto,<sup>1</sup> Akiko Takizawa,<sup>2</sup> Melinda R. Dwinell,<sup>2</sup> Masumi Hirabayashi,<sup>3</sup> Tamio Yamaguchi,<sup>4</sup> Kazuo Takahashi,<sup>1</sup> Shizuko Nagao.<sup>1</sup> *Fujita Health University, Toyoake, Japan;* <sup>2</sup>*Medical College of Wisconsin, Milwaukee, WI;* <sup>3</sup>*National Institute for Physiological Sciences, Okazaki, Japan;* <sup>4</sup>*Suzuka University of Medical Science, Suzuka, Japan.*

**Background:** One of the causes of hypertension in autosomal recessive polycystic kidney disease (ARPKD) is enhanced salt reabsorption in the collecting duct with increased expression of ENaC (Kaimori et al. 2017), which is targeted by the renin receptor in angiotensin II-induced hypertension (Peng et al. 2017). Recently, the SS-PCK novel rat model of ARPKD with salt-sensitive hypertension was established by introducing the *pkhd1* gene from the PCK rat onto the Dahl salt-sensitive (SS) background. In the current study, we investigated pathophysiological characteristics of SS-PCK rats, and the effect of ACEI treatment on hypertension and renal disease progression.

**Methods:** PCK and Sprague Dawley (SD) rats were obtained from Charles River, and SS and SS-PCK rats were from Medical College of Wisconsin. Males were given standard chow with normal salt level. Furthermore, Enalapril was administered in SS-PCK rats from 5 to 16 weeks of age. Blood pressure, serum urea nitrogen (SUN) and creatinine (Cre) were measured and kidneys were provided for histology (H&E, PAS and sirius red stains), immunohistochemistry (Ki67 and TGF-β) and immunoblotting (α-, β-, γ-ENaC subunits) analyses.

**Results:** At 18 weeks of age, blood pressure level was higher in SS-PCK rats compared to either PCK, SS or SD rats. Renal expression of ENaC subunits in SS-PCK was higher than in PCK, SS or SD rats. In SS-PCK compared with PCK, Ki67 expression, kidney weight/body weight and cyst area/section were lower, whereas severe glomerular sclerotic area was higher. Enalapril treatment in SS-PCK ameliorated hypertension, renal cyst formation and glomerulosclerosis, with reduction of Cre, SUN, fibrotic area, and expression level of renal ENaC subunits, Ki67 and TGF-β.

**Conclusions:** Current findings suggest that the novel rat model of ARPKD with salt-sensitive hypertension could be useful to determine the mechanism of disease progression. By using this strain, it is speculated that ACEI may have a therapeutic potential in ARPKD with salt-sensitive hypertension by reducing ENaC expression.

**Funding:** Government Support - Non-U.S.

## FR-PO276

**Cilk1 Deficiency Induces Cyst Formation and Abnormal Ciliary Trafficking via Klc3**

Je Yeong Ko, Gyuyeong Rah, Jong Hoon Park. *Sookmyung Women's University, Yongsan-gu, Seoul, Republic of Korea.*

**Background:** Ciliogenesis-associated kinase 1 (CILK1), also known as intestinal cell kinase (ICK), is localized in the basal bodies of cilia and regulates ciliary transport. Mutations in the CILK1 gene induces various ciliopathies, including endocrine-cerebro-osteodysplasia syndrome and juvenile myoclonic epilepsy; however, the mechanism underlying the ciliary defect in the CILK1-deficient kidney has not been elucidated.

**Methods:** We generated mice with specific deletion of Cilk1 in renal collecting duct and performed yeast-two-hybrid assay to identify a novel ciliary regulator in Cilk1-deficient model.

**Results:** CILK1 deficiency results in polycystic kidney disease (PKD) and abnormal ciliary trafficking in cyst lining cells. We identified a novel ciliary regulator, kinesin light chain 3 (KLC3), which promotes ciliary trafficking and cyst progression in CILK1 deficient PKD. KLC3 overexpression induced ciliary recruitment of IFT-B and EGFR, which contributed to the ciliary defect involved in cyst progression. Reduction in KLC3 restored abnormal ciliary trafficking and inhibited cyst progression caused by CILK1 deficiency, indicating that KLC3 is a ciliary regulator related to cyst progression in CILK1 deficient PKD.

**Conclusions:** We found that CILK1 deficiency leads to PKD accompanied by abnormal ciliary trafficking via KLC3 overexpression. These results provide new insight into the pathogenesis of CILK1 deficient PKD model.

**Funding:** Government Support - Non-U.S.

## FR-PO277

**Ion and Metabolite Composition of Cystic Fluid From a Rat Model of Autosomal Recessive Polycystic Kidney Disease (ARPKD)**

Christine A. Klemens,<sup>1</sup> Marharyta Semenikhina,<sup>2</sup> Lashodya V. Dissanayake,<sup>1</sup> Oleg Palygin,<sup>2</sup> Alexander Staruschenko.<sup>1</sup> <sup>1</sup>USF Health Morsani College of Medicine, Tampa, FL; <sup>2</sup>Medical University of South Carolina, Charleston, SC.

**Background:** Polycystic kidney disease results in fluid-filled cysts in the kidney and is responsible for ~10% of all end-stage renal disease cases. Implementation of 'omics' techniques leads to increased understanding of pathogenic changes in many diseases. While several studies have assessed kidney, plasma, and urine metabolites from both human and rodent kidneys, none have explicitly looked at the composition of cyst fluid. This study aimed to reveal ARPKD renal fluid components, which might be critical for understanding cyst formation.

**Methods:** We used the PCK rat model of ARPKD to simultaneously collect blood from the aorta, urine from the bladder, and cystic fluid directly from renal cysts of male and female rats (12-14 wks). Solute osmolality and electrolyte concentrations were measured. Cyst fluid untargeted metabolite profiling was performed using LC/MS and analyzed using MetaboAnalyst and Ingenuity Pathway Analysis.

**Results:** The cyst fluid osmolality was significantly lower than urine (430.8 ± 12.0 vs 1215 ± 99 mOsm) but above the typical plasma range (275-290 mOsm). The cyst fluid also had a distinct electrolyte composition relative to plasma and urinary values. The concentrations of Na<sup>+</sup> (23.7 ± 1.2 mM) and Cl<sup>-</sup> (65.5 ± 2.1 mM) in the cystic fluid were significantly lower than plasma or urinary levels. However, K<sup>+</sup> (95.2 ± 3.1 mM) was significantly increased compared to blood but not distinct from urinary concentrations. There were no differences observed between male and female cyst electrolytes. Omics analyses indicate that the predominant non-lipid molecule in the cyst fluid were amino acids, while fatty acids and isoprenoids were the most represented lipid chemical classes. KEGG Pathway Analysis determined the top metabolic pathways associated with cyst fluid composition included: Tryptophan, Tyrosine, and Alanine/Aspartate/Glutamate. Significant differences between male and female cyst fluid composition were observed (1,304 compounds upregulated and 1,214 compounds downregulated in males vs females).

**Conclusions:** Kidney cyst fluid has a distinct electrolyte composition. Additionally, amino acids are the most represented chemical class, and a better understanding of how their presence in cyst fluid influences cyst development may lead to potential intervention strategies.

**Funding:** NIDDK Support, Other NIH Support - NIH NHLBI, Veterans Affairs Support

## FR-PO278

**Disruption of Cystin Myristoylation Causes Autosomal Recessive Polycystic Kidney Disease (ARPKD)**

Chaozhe Yang,<sup>1</sup> Naoe Harafuji,<sup>1</sup> Ljubica Caldovic,<sup>2,3</sup> Zsuzsanna M. Bebek,<sup>4</sup> Natalie Burrill,<sup>5</sup> Erum A. Hartung,<sup>5</sup> Julie Moldenhauer,<sup>5</sup> Lisa M. Guay-Woodford.<sup>1,2</sup> <sup>1</sup>Children's National Hospital Center for Translational Research, Washington, DC; <sup>2</sup>Children's National Hospital Center for Genetic Medicine Research, Washington, DC; <sup>3</sup>The George Washington University School of Medicine and Health Sciences, Washington, DC; <sup>4</sup>The University of Alabama at Birmingham Department of Cell Developmental and Integrative Biology, Birmingham, AL; <sup>5</sup>The Children's Hospital of Philadelphia, Philadelphia, PA.

**Background:** Approximately 80% of patients with typical autosomal recessive polycystic kidney disease (ARPKD; MIM 263200) have pathogenic variants in *PKHD1*, and *DZIP1L* variants account for less than 1% of the remainder. In mice, renal disease resulting from mutations in *Cys1* (encoding cystin), but not in either *Pkhd1* or *Dzip1l*, closely phenocopies human ARPKD.

**Methods:** Identification and clinical characterization of successive fetuses from a consanguineous union with *CYS1* mutations and ARPKD phenotype. *In silico* analysis of mammalian cystin genes to identify putative functional domains. Analysis of mouse *Cys1* by mutagenesis, fluorescence staining, affinity purification/mass spectrometry, and phosphorylation/dephosphorylation assays.

**Results:** Exome sequencing of the affected siblings and parents revealed *CYS1* c.4G>A as a homozygous variant in both fetuses, which is predicted to disrupt the G2 myristoylation site within the cystin MGxxxSx N-terminal myristoylation motif. In mouse cell lines, we have confirmed that the G2 site is myristoylated and glycine-to-alanine substitution at G2 disrupts cystin ciliary localization (Tao 2009). Sequence alignment of 97 mammalian cystin protein sequences identified a conserved arginine-rich stretch of amino acids flanked by serine-8 and -17 residues. Serine-17 (S17) is a predicted phosphorylation target, suggesting that cystin membrane association is regulated by a myristoyl-electrostatic switch mechanism. Treatment with 8-bromo-cAMP attenuated the ciliary localization of endogenous cystin, but did not directly alter S17 phosphorylation, indicating a role for other cAMP-dependent kinase pathways, e.g. EPAC. In addition, we identified protein phosphatase PPM1A as a cystin-interacting protein and demonstrated that sanguinarine (a PPM1A inhibitor) regulates the phosphorylation status of cystin S17. Finally, we demonstrated that cystin interacts with  $\alpha 1$ ,  $\alpha 2$ , and  $\beta 2$  importin subunits, suggesting that the importin complex mediates cystin trafficking between the cilium and nucleus.

**Conclusions:** Our data provide further evidence that *CYS1* mutations cause ARPKD and provide new insights about the role of regulated ciliary trafficking in ARPKD pathogenesis.

**Funding:** NIDDK Support, Private Foundation Support

## FR-PO279

**Cardiac Hypertrophy in Rodents With Polycystic Kidney Disease (PKD) Before the Onset of Hypertension**

Ozgun A. Oto,<sup>1,2</sup> Daniel Atwood,<sup>2</sup> Anjana Chaudhary,<sup>2</sup> Charles L. Edelstein.<sup>2</sup> <sup>1</sup>Istanbul Universitesi Istanbul Tip Fakultesi, Istanbul, Turkey; <sup>2</sup>University of Colorado Health, Aurora, CO.

**Background:** The aim of the study was to determine whether there is cardiac hypertrophy (CH) before hypertension (HTN) in rodents and to further detail cardiac structure/ function in the heart in Pkd1<sup>RC/RC</sup> (RC) mice.

**Methods:** 12wk old PCK rats, a Pkhd1 gene model, and 120d RC mice, a hypomorphic Pkd1 gene model, were studied. A noninvasive tail-cuff system was used to measure BP. A Vevo 2100 was used for Echocardiography/ mitral Doppler measurements

**Results:** Heart weight/body weight (HW/BW) was increased in PCK rats at 12wks. HTN develops at 16wks in PCK rats. HW/BW was increased in RC mice before the onset of HTN (table). We previously described increased mTORC1/2/suppressed autophagy in the heart in 70d RC mice. mTORC1/ autophagy play a role in the CH, so we detailed cardiac structure/ function in RC mice. There was cardiac hypertrophy: increased intraventricular septum (IVS) and left ventricular wall (LVW) thickness. On echo there was increased LV mass, decreased ratio of peak velocity of early/ late filling of mitral inflow (grade 1 diastolic dysfunction) and decreased LV diastolic volume. Interestingly in 270dRC mice the cardiac dysfunction was different. There was severe Grade 4 diastolic dysfunction (increased E/A ratio) indicating restrictive filling of the LV. Normal ejection fraction fractional shortening indicated heart failure with preserved EF.

**Conclusions:** There was increased heart weight, CH, increased LV mass, grade 1 diastolic dysfunction, in RC mice before the onset of HTN. Factors other than HTN like increased mTORC1/2/ suppressed autophagy may contribute to causing CH in PKD mice.

**Funding:** NIDDK Support, Veterans Affairs Support

	+/+ PCK rat		+/+ mouse (120d)		RC mouse (120d)		+/+ mouse (270d)		RC mouse (270d)	
HW/BW (%)	0.31	0.35**	0.47	0.53***	0.53	0.53	0.53	0.66*		
E/A ratio			1.5	1.2*			1.1	1.4*		
Syst/Diast Mean BP			116/88/97	109/84/92						
IVS/LVW (mm)			1045/956	1286/1218**			49/25	58/30		
LV mass (mg/g)			1.2	1.5*						
LV Diast vol (µL)			57	71*						

\*P<0.05, \*\*P<0.01, \*\*\*P<0.001

## FR-PO280

**Metformin Worsens Kidney Function and Has No Effect on Cyst Growth in the PCK Rat Model of Autosomal Recessive Polycystic Kidney Disease (ARPKD)**

Ozgun A. Oto,<sup>1,2</sup> Daniel Atwood,<sup>2</sup> Anjana Chaudhary,<sup>2</sup> Charles L. Edelstein.<sup>2</sup> <sup>1</sup>Istanbul Universitesi Istanbul Tip Fakultesi, Istanbul, Turkey; <sup>2</sup>University of Colorado Health, Aurora, CO.

**Background:** Metformin (MET) has shown mixed results in reducing cyst growth in mouse models of PKD and in humans. Lactic acidosis has been suggested as a cause of the lack of efficacy of MET on cyst growth. The effect of MET on cyst growth in rat models of PKD is not known. The aim of this study was to determine the effects of MET on cyst growth, kidney function, mTOR signaling and lactate levels in a rat model of ARPKD

**Methods:** Male PCK rats, a Pkhd1 gene mutation model of human ARPKD were studied. PCK rats were treated with either vehicle (VEH) or metformin (300 mg/kg, IP) from 28-84 d of age. Autophagy and mTOR proteins were analyzed by quantitative immunoblot analysis (Relative densitometry units-RDU). BUN was measured with a urea assay kit (BioAssay Systems). Serum creatinine was measured by HPLC. Lactate levels were measured by an L-Lactate assay Kit (EnzymFluo). Cyst index was analyzed by a NIS Elements macro

**Results:** During the study 2 MET-treated rats died. Two kidney weight was not affected by MET (3.0 vs 3.1±0.4, p=0.6). Two kidney/body weight ratio (2K/BW) was high in MET group but there was significant weight loss. Cystic indexes were similar in both groups (3.7±1.9, 3.7±2.08, p=0.9). There was a significant increase in BUN and creatinine levels in MET group. MET is known to activate AMPK, suppress mTORC1 and induce autophagy. AMPK (pAMPK; 0.7 vs 1.3, ns), mTORC1 (pS6; 0.4 vs 0.8, ns) and mTORC2 (pAktS473) was not suppressed by MET (0.8 vs 0.5; ns) and conversion of LC3-I to LC3-II (a marker of autophagy) was not affected by MET (0.9 vs 1.6; ns). Lactate levels were significantly higher in MET group

**Conclusions:** A standard dose of MET did not slow cyst growth. MET increased lactate levels and was nephrotoxic (increased BUN and Creatinine). In conclusion, the study suggests that human studies of MET in PKD may be complicated by nephrotoxicity and that MET dosing should be carefully chosen in human PKD studies. Studies of a dose-response of MET on cyst growth, kidney function, lactate levels and mTOR/autophagy are underway in PCK rats

**Funding:** Veterans Affairs Support, Other U.S. Government Support

	Vehicle	Metformin
BW (gr)	354.5±35.13	295.8±18.4*
2K/BW (%)	0.99±0.1	1.0±0.1*
BUN (mg/dl)	23.8±4.1	31.0±3.6*
Creatinine (mg/dl)	1.7±0.1	2.8±1.1*
Lactate level (uM)	7479±1801	13168±4080*

\*P<0.05

## FR-PO281

**Cleavage of *Pkhd1* Results in a Small Fragment That Localizes and Functions Within Mitochondria**

Rebecca V. Walker, Anthony R. Maranto, Patricia Outeda, Hangxue Xu, Terry J. Watnick, Feng Qian. Qian lab *University of Maryland Baltimore, Baltimore, MD.*

**Background:** Autosomal recessive polycystic kidney disease (ARPKD) is caused by mutations in *PKHD1* encoding FPC, and is characterized by severe renal cystogenesis in neonates, yet mouse models do not fully recapitulate the human phenotype.

**Methods:** We use mouse models, biochemistry, cell models, and proteomics to reveal novel cleavage fragments of FPC and their effect on enhancing cystogenesis in *Pkd1* mutant cyst-sensitized mice.

**Results:** We describe how *Pkhd1* mutation modifies a *Pkd1* uncleavable mutant (*Pkd1<sup>V</sup>*), enhancing the cystic phenotype in kidney and pancreas, and revealing some elusive functions of FPC. FPC displays differential cleavage to produce fragments of unknown function. We identify several of these cleavage fragments and describe the mitochondrial localization of one small C-terminal fragment, induced by a newly identified mitochondria localizing signal presented in the fragments. Mitochondrial proteomics revealed that mice lacking FPC have significant changes compared to Wt. Finally, we show that deletion of just the C-terminal fragment of FPC ( $\Delta$ CT) is sufficient to enhance the renal cystic phenotype of the PC1 cleavage mutant but does not result in the pancreatic cystogenesis seen in other *Pkhd1* mutants on this background.

**Conclusions:** Our results suggest that the C-terminus of FPC plays an important role in preventing cystogenesis via a novel mitochondria specific function.

**Funding:** NIDDK Support, Private Foundation Support

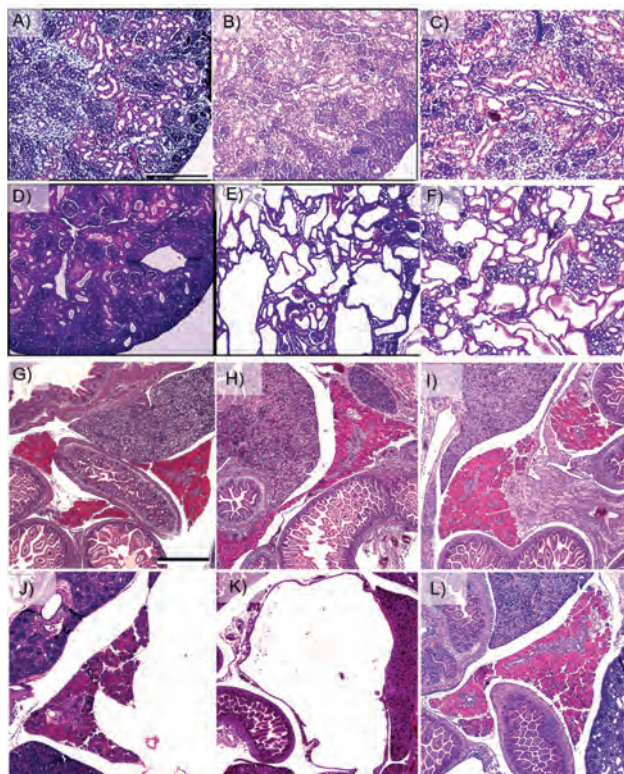
***Pkhd1* mutation effect on *Pkd1* cystic kidney and pancreas**

Haematoxylin and eosin (H&E) staining of representative kidney sections. A-F) H&E P0 kidneys, scale bar 500um. A) Wt, B) *Pkhd1*<sup>-/-</sup>, C) *Pkhd1*<sup>Δct/Δct</sup>, D) *Pkd1*<sup>V/V</sup>, E) *-V* double homozygotes, F)  $\Delta$ CT/*V* double homozygotes. G-L) H&E staining of representative pancreas sections at E17.5 mice, scale bar 500um. G) Wt, H) *-/-*, I)  $\Delta$ CT, J) *Pkd1*<sup>V/V</sup>, K) *-V* double homozygotes cystic pancreas, L)  $\Delta$ 67/*V* non-cystic pancreas.

## FR-PO282

**Mice With a Genomic Deletion of *Pkhd1* Exons 3-67 Have Minimal Renal Manifestations but Evidence of Transcriptional Network Changes by snRNA Sequencing**

Yu Ishimoto,<sup>1</sup> Luis F. Menezes,<sup>1</sup> Fang Zhou,<sup>1</sup> Teruhiko Yoshida,<sup>1</sup> Patricia Outeda,<sup>2</sup> Terry J. Watnick,<sup>2</sup> Gregory G. Germino.<sup>1</sup> <sup>1</sup>National Institute of Diabetes and Digestive and Kidney Diseases, Bethesda, MD; <sup>2</sup>University of Maryland School of Medicine, Baltimore, MD.

**Background:** Autosomal recessive polycystic kidney disease (ARPKD) is caused mostly by mutations in *PKHD1*. We previously generated a mouse with a genomic deletion of exons 3-67 of murine *Pkhd1*. While *Pkhd1*<sup>del3-67/del3-67</sup> kidneys are somewhat enlarged and show no obvious morphological or histological changes. We and others have previously reported kidney cysts in ARPKD models, suggesting that compensatory pathways might prevent cystogenesis. We therefore investigated transcriptomic changes in *Pkhd1*<sup>del3-67/del3-67</sup> kidneys and controls, using single-nuclei RNA-sequencing (snRNAseq).

**Methods:** We sampled kidneys from three male 4-weeks old *Pkhd1*<sup>del3-67/del3-67</sup> and three littermate controls. After quality control filtering, we analyzed a total of 83,322 cells, with a median number of ~4000 transcripts/cell.

**Results:** Clusters of cells representing most nephron epithelial cell types had *Pkhd1* expression. Grouping similar cell types and re-clustering, we observed no differences between mutant and control samples. Within each cell type, multiple genes distributed across the genome had significant p-value changes but most had minimal fold-change differences, and we found no evidence of significantly dysregulated pathways by gene-set enrichment analysis. Using network analysis, we inferred transcriptional networks and scored genes based on their connectivity. We found evidence that a few pathways were significantly changed in different nephron segments, including some with transcriptional regulator activity. To investigate consistent changes in all nephron segments, we derived a consensus network including only gene-gene interactions present in all segments. Within this network, we identified genes with multiple connections (hubs) that were differentially expressed and showed changes in connectivity between mutants and controls, suggestive of re-wiring. Pathway enrichment analysis of likely re-wired differentially expressed hubs identified ubiquitin-conjugation as a major change in *Pkhd1* mutants, consistent with previous results.

**Conclusions:** *Pkhd1*<sup>del3-67/del3-67</sup> kidneys showed no obvious morphological changes or compensatory transcriptional profiles. Network analyses, however, identified possible re-wiring of ubiquitin-conjugation pathway.

**Funding:** NIDDK Support

## FR-PO283

**Conserved Glycine Rich (G8) Domains in Zebrafish Fibrocystin-L (FPC-L) Paralogs Identify a Tractable Experimental System for Functional Studies of PKHD1-Encoded FPC**

Ashima Gulati,<sup>1</sup> Matthew R. Swift,<sup>2</sup> Eric Glasgow,<sup>2</sup> Lisa M. Guay-Woodford.<sup>1</sup> <sup>1</sup>Children's National Research Institute, Washington, DC; <sup>2</sup>Georgetown University, Washington, DC.

**Background:** Functional evaluation of FPC, the major protein underlying ARPKD is limited because rodent models do not recapitulate the human renal phenotype. Homology analyses and phylogenetic expression identify FPC-L encoded by *PKHD1L1* as the likely ancestral protein to *PKHD1*-encoded FPC. We compared the homology of FPC predicted domains with its ancestral protein, FPC-L. While zebrafish lack FPC, the phylogenetic conservation of specific N-terminal domains in FPC-L, suggests that zebrafish could serve as a tractable system to investigate domain-specific motifs relevant to FPC function.

**Methods:** Informatics analysis: FPC-L, FPC identity/similarity scores across evolutionary timescale. Zebrafish embryo FPC-L expression: whole mount *in situ* hybridization for *pkhd1l1.1* and *pkhd1l1.2*.

**Results:** FPC-L and FPC share two conserved glycine-rich G8 domains that are relatively unique to these protein families. The first G8 domain spanning 122 amino acids exhibits two times the identity (50% identical, 63% similar) when compared to overall human FPC-L and FPC homology (25% identity, 44% similarity). FPC-L zebrafish paralogs are widely expressed at various stages during embryonic development in a reproducible pattern (Figure). FPC-L expression mirrors that of *pkd2* and other ciliary proteins that are widely expressed at a low level in most zebrafish tissues.

**Conclusions:** The conservation of two unique G8 domains in FPC and its ancestral protein, FPC-L, over the evolutionary span of vertebrate aquatic to terrestrial transition supports the biologic relevance of these domains. Zebrafish present a tractable experimental model to interrogate the function of these highly conserved domains, and provide new insights into the functional biology of FPC-L and FPC N-termini.

**Funding:** Private Foundation Support

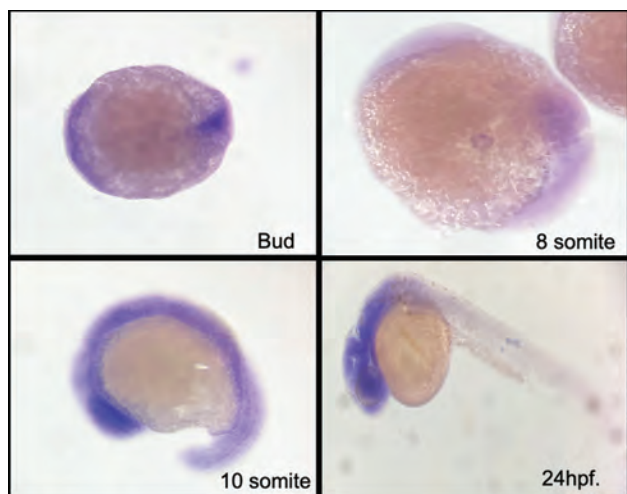

Tailbud to 24 hpf zebrafish embryos, *pkh1/2* is ubiquitous with prominent cranial staining

FR-PO284

**Pathogenic STAT3 Activation in Cystic Kidney and Bile Duct Epithelia of Murine Pkhd1-Knockout**

Wolfgang H. Ziegler, Julia Fox, Hanna Burmester, Susanne Hahnenstein, Dieter Haffner. *Medizinische Hochschule Hannover, Hannover, Germany.*

**Background:** Loss of fibrocystin function causes autosomal recessive polycystic kidney disease (ARPKD) associated with epithelial defects, cyst formation and fibrosis of kidney and liver. In the mouse model, liver defects are developing independent of gender, while kidney defects are restricted to female mice. Study of fibrocystin function in mouse kidney is hampered by mild cyst development and late onset. Here, we re-analyze the kidney and liver phenotype in *Pkhd1*-knockout mice of different age in a defined background strain and observe distinct hallmarks of disease development and fibrocystin related signaling.

**Methods:** Targeted mutation *Pkhd1*-knockout mice in BALB background were maintained within the line. Kidneys and livers of male and female animals, homozygous and heterozygous for the *Pkhd1*-knockout allele as well as wildtype, were analyzed histologically at 8 weeks and 3 to 9 months of age, with serum and urine samples taken before preparation. We compare signaling in cystic epithelia of both organs to behavior of epithelial cell lines with and without fibrocystin expression.

**Results:** At 6 and 9 months of age, relative kidney and liver weights were massively increased in homozygous female *Pkhd1*-knockout mice as compared to heterozygous and wildtype controls. In kidneys, cyst formation at the corticomedullary border led to a significantly increased cystic index in knockout mice associated with pronounced macrophage recruitment and fibrosis peaking at 9 months. In addition, proliferation markers were significantly enhanced and pronounced nuclear localization of phosphorylated STAT3 observed in cyst lining epithelia. In liver, ductal plate malformation and fibrotic remodeling were present already at 3 month of age and independent of gender. Induction of STAT3-dependent signaling was addressed in cystic mouse tissue and in stimulated *Pkhd1*-knockout cell lines with respective controls.

**Conclusions:** Maintenance in defined BALB background leads to a murine *Pkhd1*-knockout model showing progressive cyst formation in liver and kidneys associated with fibrosis and inflammation. Highly activated STAT3 signaling was observed associated with epithelial defects. The *Pkhd1*-knockout mouse allows analysis of disease related mechanisms and appears suitable for testing of pharmacological interventions.

**Funding:** Government Support - Non-U.S.

FR-PO285

**Polycystins Are Required for Renal Tubulointerstitial Fibrosis**

Yanzhe Wang, Ming Wu, Chaoyang Ye. *Shuguang Hospital, ShangHai, China.*

**Background:** Renal fibrosis is the common pathway of various chronic kidney diseases progressing to end stage renal failure. Polycystin-1 (encoded by PKD1 gene) and polycystin-2 (encoded by PKD2 gene) form a transmembrane complex and function as a stress sensor, which is located in the primary cilia. Polycystins are involved in the disease condition of different organs. Mutation of PKD genes causes autosomal dominant polycystic kidney disease and deletion of polycystin attenuates heart injury induced cardiac fibrosis. The role of polycystins in renal tubulointerstitial fibrosis is currently unclear.

**Methods:** Unilateral ureteral obstruction (UO), unilateral ischemia-reperfusion injury (UIRI), aristolochic acid or folic acid induced mouse models of renal fibrosis were established for this study.

**Results:** Here we showed that polycystin-2 is up-regulated in these three mouse models of renal fibrosis and tightly correlated with the expression of collagen-1 in a time dependent manner. Treatment with triptolide inhibited the expression of polycystin-2 and pro-fibrotic markers in UO and UIRI models. Moreover, triptolide or PKD2

siRNA inhibited the expression of polycystin-2 and pro-fibrotic markers in vitro. Using *Pkd2* conditional knockout mice, we showed that genetic deletion of *Pkd2* reduced the expression of pro-fibrotic markers in UO kidneys. Polycystin-1 was also up-regulated in renal fibrotic models and conditional deletion of *Pkd1* reduced the expression of pro-fibrotic markers in UO or folic acid induced fibrotic kidneys. Furthermore, the expression of the methyltransferase *EZH2* is positively correlated with the expression of polycystins in fibrotic kidneys. Conditional knockout of *EZH2* attenuated the anti-fibrotic responses induced by *Pkd1* deletion in UO kidneys.

**Conclusions:** In conclusion, polycystins are up-regulated in fibrotic kidneys and promote renal tubulointerstitial fibrosis through up-regulation of *EZH2*, suggesting that primary cilia are required for renal tubulointerstitial fibrosis.

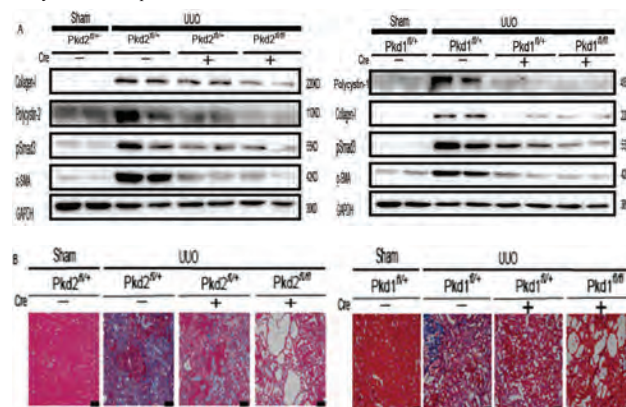

FR-PO286

**Injury-Induced Renal Fibrosis Promotes Cystogenesis and Cyst Growth in Adult Mice With Autosomal Dominant Polycystic Kidney Disease**

Yanzhe Wang, Ming Wu, Chaoyang Ye. *Shuguang Hospital, ShangHai, China.*

**Background:** Autosomal dominant polycystic kidney disease (ADPKD) is the most frequent inherited kidney disease caused by mutations in *PKD1* or *PKD2* gene. Enhanced fibrosis is correlated with the accelerated renal function decline and kidney growth in the late stage of ADPKD patients. However, the role of fibrosis in ADPKD remains unclear.

**Methods:** We established renal fibrosis by toxic (aristolochic acid I, AAI; 1,2-dichlorovinyl-cysteine, DCVC) or surgical (unilateral ischemia reperfusion injury, UIRI) injuries which was prior to *Pkd* gene inactivation in adult mice.

**Results:** Here we showed that renal cysts were induced in adult *Pkd1* or *Pkd2* mice with pre-established renal fibrosis. Recovery of renal fibrosis at three weeks after UIRI retarded cystogenesis in *Pkd1* mice. Enhanced renal fibrosis by repeated toxic injuries accelerated renal cyst growth in *Pkd1* mice. We further showed that the rate of cyst formation at the early stage of adult *Pkd1* mice was decided by the baseline level of renal fibrosis. Finally, we showed that conditional knockout of *EZH2* attenuated renal fibrosis and cyst growth in *Pkd1* mice with established renal fibrosis.

**Conclusions:** We conclude that fibrosis is a driving force for renal cyst formation and growth in adult kidneys and inhibition of renal fibrosis through targeting *EZH2* might be a new therapeutic strategy for ADPKD.

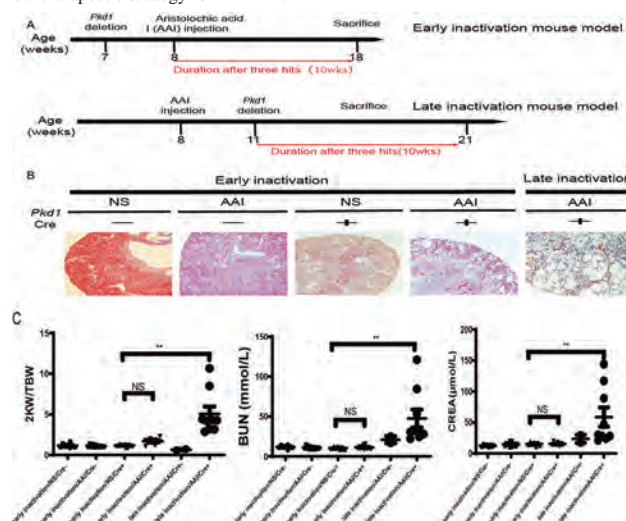

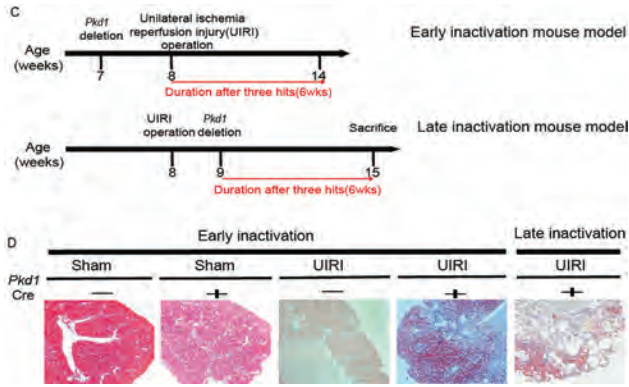

## FR-PO287

## Role of Glutamine Transporter Snat3 in Promoting Polycystic Kidney Disease

Shinobu Yamaguchi, Rande S. Sedaka, Sejal Sanjay Shinde, Jifeng Huang, Jung-Shan Hsu, Takamitsu Saigusa. *The University of Alabama at Birmingham School of Medicine, Birmingham, AL.*

**Background:** Disease severity of polycystic kidney disease (PKD) is influenced by diet. High protein (HP) diet is one of the most recognized PKD progression-accelerating factors. Dietary protein is catabolized into amino acids (AA) and delivered to the kidney, activating the mTOR pathway and renal hypertrophy. Renal hypertrophic signaling superimposed in PKD mice increases immune cell response, inflammation and accelerates cyst growth. We hypothesize that the cystogenesis-prompting effects of HP diet are caused by increased delivery of specific AA to the kidney, ultimately activating the immune cell response and accelerating cyst growth.

**Methods:** Adult tamoxifen-inducible *Pkd1<sup>fllox/lox</sup>* mice with and without Cre (CAGG-ER2) were given tamoxifen to induce gene deletion. Two weeks later, mice were fed either a high (HP; 60%), normal (NP; 18%) or low (LP; 6%) protein diet (all isocaloric 3.7kcal/g, restricted to 2.8g/day) for 1 week. Mice were then euthanized and tissues were used for histology, immunofluorescence (IF), RT-PCR and Western blot. Kidney tissue was cell sorted to isolate tubular epithelial cells for RNA sequencing.

**Results:** *Pkd1* knockout (*Pkd1KO*) mice fed a HP diet for 1 week had increased kidney weight/body weight ratio and cystic area compared to NP or LP fed counterparts. However, there were no differences in the number of renal macrophages, pro-inflammatory cytokines, or markers of proximal tubular injury at this early stage. RNA sequencing of renal tubular epithelial cells from *Pkd1KO* mice fed a HP- compared to NP- or LP diet revealed increased gene expression of sodium-glutamine transporter *Snat3* and gluconeogenesis marker *Pepck1*, confirmed by RT-PCR. *Snat3* expression by IF along cyst-lining tubular epithelial cells, as well as pS6 protein abundance, increases in HP- compared to LP diet fed *Pkd1KO* mice. Urinary ammonia, a byproduct of glutamine, was elevated in *Pkd1KO* mice fed a HP- compared to NP- or LP diet.

**Conclusions:** One-week feeding with HP- compared to NP- or LP diet increased the expression of glutamine transporter *Snat3*, gluconeogenesis, mTOR and cyst growth prior to increases in macrophage number and cytokines in *Pkd1KO* mice. Glutamine in dietary protein may accelerate cyst growth through *Snat3* during early stages of PKD.

**Funding:** NIDDK Support

## FR-PO288

## The Renal Circadian Clock Is Disrupted in Autosomal Polycystic Kidney Disease

Abeda Jamadar,<sup>1</sup> Lauren G. Douma,<sup>2</sup> Michelle L. Gumz,<sup>2</sup> Reena Rao.<sup>1</sup> <sup>1</sup>University of Kansas Medical Center Department of Internal Medicine, Kansas City, KS; <sup>2</sup>University of Florida, Gainesville, FL.

**Background:** Autosomal dominant polycystic kidney disease (ADPKD) is the most common inherited kidney disease. Based on a never-before described observation of unusually high night-time activity in the *Pkd1<sup>R3277C</sup>* (RC/RC) mouse model of ADPKD, we examined their circadian rhythms. Circadian rhythms are intrinsic cyclical ~24-hour oscillations in behavior and physiology, which at the molecular level are regulated by circadian clock proteins that regulate gene expression. The circadian clock regulates renal functions, which are disrupted in some kidney diseases. Here we examined the renal circadian rhythms in ADPKD

**Methods:** Circadian oscillation of clock proteins was examined in RC/RC and wild type (WT) mouse kidneys; and in *Pkd1* gene knockout mouse renal proximal tubular cells (PT-*Pkd1*<sup>-/-</sup>) and inner medullary collecting duct cells (IMCD3-*Pkd1*<sup>-/-</sup>) and controls (PT-*Pkd1*<sup>+/+</sup> and IMCD3-*Pkd1*<sup>+/+</sup> cells). For real-time visualization of circadian dynamics in ADPKD kidneys, bioluminescence rhythms were measured in kidney tissue explants from RC/RC and WT mice expressing *Per2<sup>Luciferase</sup>* gene. Diurnal rhythms of urine output and water intake were also measured in RC/RC and WT mice.

**Results:** PT-*Pkd1*<sup>-/-</sup> and IMCD3-*Pkd1*<sup>-/-</sup> cells showed significantly disrupted oscillations of multiple clock genes, including *BMAL1*, *CLOCK*, *CRY1* and *Per2* when compared to control cells which displayed clock gene oscillations at 20-24h intervals. We found significant differences in mRNA levels of multiple clock genes in RC/RC mouse

kidneys, compared to WT controls. In particular, both mRNA and protein levels of *Per2* showed significant difference between WT and RC/RC kidneys. While the WT-*Per2<sup>Luciferase</sup>* kidney tissue explants showed persistent bioluminescence rhythms, lower-amplitude rhythms with shorter circadian periods were found in RC/RC-*Per2<sup>Luciferase</sup>* kidney explants. We also found significant differences in diurnal rhythms of urine output and water intake in RC/RC mice compared to WT mice.

**Conclusions:** This study shows for the first time that (A) cultured renal tubular epithelial cells are good oscillators, but *Pkd1* gene deletion disrupts the circadian clock gene rhythms of tubular epithelial cells, the very cells that form cysts, and (B) circadian rhythms of clock genes as well as renal functions are disrupted in RC/RC mouse kidneys. Renal circadian rhythms are thus disrupted in ADPKD.

**Funding:** NIDDK Support

## FR-PO289

## Mechanisms of Cystogenesis by Cd79a-Driven, Conditional mTOR Activation in Mouse Developing Nephron

Linh N. Tran,<sup>1</sup> Satoshi Matsuda,<sup>1</sup> Huong Quynh Tran Thuy,<sup>1</sup> Katsuhiko Yoshizawa,<sup>2</sup> Hiroyasu Tsukaguchi,<sup>1</sup> <sup>1</sup>Kansai Ika Daigaku Fuzoku Hirakata Byoin, Hirakata, Japan; <sup>2</sup>Mukogawa Joshi Daigaku, Nishinomiya, Japan.

**Background:** Polycystic kidney diseases (PKD) are a common genetic disorder arising from developmental and/or postnatal processes. Defects of primary cilia and/or their signaling pathways, e.g., mTOR pathways, underlie the pathogenesis. However, how mTOR regulates tubular integrity remains unclear. To define the role of mTOR pathway in cyst formation, we studied phenotypes of in-house PKD mouse model (*Cd79a-Cre;Tsc1<sup>fl</sup>*, thereafter *Cd79a-Tsc1 KO*). The Cre mediated-*Tsc1* depletion driven by *Cd79a*, the known B cell receptors, allowed a unique conditional mTORC1 activation along the distal nephron after embryonic E16.

**Methods:** Paraffin kidney sections were stained with PCNA and TUNEL, a marker of proliferation and apoptosis, respectively. The activation of mTORC1 and mTORC2 was evaluated by the phosphorylation of ribosomal protein S6<sup>S240/244</sup> and Akt<sup>S473</sup>, respectively.

**Results:** *Cd79a-Tsc1 KO* kidney recapitulated human ADPKD pathology. Cysts appeared initially from the distal nephron by postnatal 2 weeks and developed global PKD by 4 weeks. Early cysts were of several cell types, either lined by cuboidal, hypertrophic cells with karyocytomegaly, or flattened, dedifferentiated epithelium with luminal cell exfoliation. In *Cd79a-Tsc1 KO* tubules, epithelial cells continued to proliferate even after physiological nephrogenesis of postnatal 2 weeks, while apoptosis was hardly seen until later tumorigenic stage after 9 weeks. Overactivation of mTORC1 was found in part but not all cyst-lining cells and occasionally regardless of *Tsc1* depletion, suggesting the non-autonomous mechanisms of the cystogenesis. Elongation of cilia and disorientation of cell intercalation as well as oriented cell division were seen in pre-cystic, developing tubules, indicating the defective cilia-related planar polarity.

**Conclusions:** Our results indicate that PKD phenotypes arising from overactivation of mTORC1 in early developing nephron closely resemble those of the primary cilia disorder ADPKD, suggesting two conditions share the common mechanisms. Cystogenesis are likely triggered at early developmental stage of tubulogenesis shaping the optimal tubule diameter through coordinated proliferation with polarity.

**Funding:** Government Support - Non-U.S.

## FR-PO290

## Combined Transcriptome and Metabolome Profiling in a Mouse Model of Tuberous Sclerosis Complex Renal Cystic Disease

Kamyar A. Zahedi,<sup>1,2</sup> Sharon L. Barone,<sup>1,2</sup> Marybeth Brooks,<sup>1,2</sup> Manoocher Soleimani.<sup>1,2</sup> <sup>1</sup>University of New Mexico Health Sciences Center, Albuquerque, NM; <sup>2</sup>New Mexico VA Health Care System, Albuquerque, NM.

**Background:** Tuberous sclerosis complex (TSC) is an autosomal recessive disorder that is caused by mutations in hamartin (*TSC1*) or tuberin (*TSC2*) and affects over a million individuals worldwide. In the kidney, TSC is associated with the development of cysts and angiomyolipomata, which damage the renal parenchyma and lead to renal failure. The cyst development and expansion in principal cell specific *Tsc1* knockout mice (*Tsc1-cKO/Aqp2 Cre; Tsc1cKO*) is dependent on the expansion of A-intercalated cells and diminution of principal cells. In order to identify the mRNA and metabolome changes associated with cystogenesis in TSC renal disease, we compared the transcriptome and metabolome of kidneys from 28 days old wildtype (Wt) and *Tsc1cKO* mice.

**Methods:** The transcriptome and metabolome of 28 days old Wt and *Tsc1cKO* were analyzed and compared.

**Results:** There were significant changes in the levels of 14 metabolites in the kidneys of *Tsc1cKO* mice compared to their Wt counterparts. These included reductions in the levels of a number of amino acids (e.g., Gly, Ile, leu, Trp and valine). We also observed significant decreases in creatine, NADH, inosine, UDP-galactose, GTP and myoinositol levels in the kidneys of *Tsc1cKO* mice. Transcriptome analysis revealed 540 mRNAs that were up regulated and 131 mRNAs that were down regulated in *Tsc1cKO* compared to Wt mice. Enrichment analysis revealed these to belong to pathways associated with collecting duct acid secretion, mTOR signaling, metabolism of amino acids as well as AMPK and AKT signaling.

**Conclusions:** Metabolome changes point to altered energy production and storage (e.g., Leloir and phosphagen pathways), signal transduction (e.g., lipid signaling) and protein synthesis pathways. The reduced amino acid levels point to their consumption in response to unregulated cell proliferation. This is supported by RNA-seq data which point to an active mTOR signaling pathway. The induction of mTOR signaling is a result of *TSC1* deletion in principal cells and a phosphor-inactivation of TSC (experimental

Key: TH - Thursday; FR - Friday; SA - Saturday; OR - Oral; PO - Poster; PUB - Publication Only

Underline represents presenting author.

data) in genotypically normal A-intercalated cells. Alterations in other metabolites and mRNAs are also indicative of changes in oxidative phosphorylation, protein synthesis, posttranslational modification, proton transport and injury to the cortex in the kidneys of *Tsc1cKO* mice.

**Funding:** Veterans Affairs Support, Private Foundation Support

#### FR-PO291

##### The Endocannabinoid System Mediates Cystogenesis in Tuberous Sclerosis Kidney Disease

Oded Volovelsky, Eden Abergel, Morris Nechama, Hadass Pri Chen. *Hadassah University Medical Center, Jerusalem, Israel.*

**Background:** Tuberous Sclerosis Complex disease (TSC) is caused by an inactivating mutations in *TSC* genes, leading to mTOR pathway hyperactivation. CKD secondary to angiomyolipoma and renal cysts is a leading cause of morbidity in TSC. The endocannabinoid (eCB) system is involved in kidney pathophysiology. Its ligands act mainly through endocannabinoid receptors, CB1R and CB2R. Here we aimed to explore eCB ligands and receptors involvement in TSC cystic kidney disease.

**Methods:** We used a TSC mouse model with *TSC1* deletion in nephron progenitor cells as well as HK2 cell line with *TSC1* deletion using *Crispr/cas9*. eCB system characterization was performed by measuring the expression of its enzymes and receptors using western blotting, immunohistochemistry, and immunofluorescence staining of kidney sections, real-time PCR for RNA expression and liquid chromatography/inline tandem mass spectrometry analysis for ligand level measurements.

**Results:** eCB ligands level in TSC kidneys changed significantly with an elevation of *N*-arachidonoyl ethanolamide and a decline in 2-arachidonoyl levels compared to control. These changes in the eCB ligands were associated with perturbations in the expression level of enzymes involved in their biosynthesis and degradation. The expression and protein level of CB1R was upregulated, and down regulated for CB2R, in *TSC1* mouse model and *TSC1* null HK2 cell. Furthermore, incubation of HK2 cells with CB1R antagonists, prevented the mTOR pathway hyperactivation and an LPS-induced increase in TNF $\alpha$  and IL-6 expression, implying attenuation in cell signaling and an anti-inflammatory mechanism responsible for the beneficial effect of CB1R antagonists.

**Conclusions:** *TSC1* deletion in the kidney modifies the eCB system, including ligands, enzymes, and receptors profile. The role of the endocannabinoid system in cystic kidney disease may be mediated by mTORC1 activity and inflammation. CB1R inhibition may ameliorate these TSC associated cell signaling with a beneficial therapeutic potential.

#### FR-PO292

##### Planar Cell Polarity Effector Fuzzy in Actin Regulation and Ciliogenesis

Rita K. Kalot,<sup>1,2</sup> Sima Babayeva,<sup>2</sup> Elena Torban.<sup>1,2</sup> *<sup>1</sup>McGill University Faculty of Medicine and Health Sciences, Montreal, QC, Canada; <sup>2</sup>Research Institute of the McGill University Health Centre, Montreal, QC, Canada.*

**Background:** Ciliopathies are disorders caused by mutations in the genes controlling cilia assembly and function. Clinical characteristics of ciliopathies include multi-organ syndromes or organ-specific anomalies, including small and/or cystic kidneys. Planar cell polarity (PCP) effector proteins are major regulators of ciliogenesis since defects in either *Fuzzy*, *Wdpcp*, or *Inturned* cause abnormal cilia formation and pleiotropic syndromes. In vertebrates, PCP effectors recruit important ciliary proteins to the ciliary base. Our recent data indicate that *Fuzzy* interacts with p190A (Arl13B), a RhoA GAP that suppresses actin polymerization at the ciliary base, and recruits it to the base of the primary cilium, indicating a potential role of *Fuzzy* and other PCP effectors in actin regulation at the base of the cilium. Therefore, we aim to understand the role of PCP effector-mediated actin regulation in ciliogenesis and ciliopathies.

**Methods:** Ciliation in mouse embryonic fibroblasts (MEF) was assessed by immunofluorescence. *Fuzzy*-p190A interaction was identified by co-immunoprecipitation. Co-localization of *Fuzzy* and p190A at the basal body was visualized by immunofluorescence in *Fuzzy*<sup>-/-</sup> and control cells. RhoA activity was assessed by Rhotekin G protein-binding domain-eGFP biosensor in mutant and control cells. Cilia rescue experiments were done using RhoA kinase inhibitors in *Fuzzy* mutant MEFs and mouse kidney explants.

**Results:** Knockout of *Fuzzy* drastically reduces cilia formation in MEFs, however, ciliogenesis in the mutant MEFs and embryonic kidney explants was rescued by ROCK inhibitors. *Fuzzy* recruits p190A to the ciliary base, where the latter likely prevents excessive actin polymerization and promotes ciliogenesis. Indeed, we detected excessive activation of RhoA (regulator of actin polymerization) at the basal body in *Fuzzy*<sup>-/-</sup> MEFs and excessive polymerization in the *Fuzzy*<sup>-/-</sup> kidney tissues.

**Conclusions:** Overall, this study has established the link between *Fuzzy* and major actin regulator p190A during ciliogenesis. This suggests that *Fuzzy* regulates actin polymerization at the basal body and thereby may control ciliary trafficking. Identifying additional actin-regulating components downstream of PCP effectors at the ciliary base may help identify novel potential drug targets for the treatment of ciliopathies.

**Funding:** Government Support - Non-U.S.

#### FR-PO293

##### The Ciliary Phosphoinositide Pathway Regulates the Level of Polycystins in Cilia

Chuan Chen, Jinghua Hu, Kun Ling. *Mayo Clinic Minnesota, Rochester, MN.*

**Background:** ADPKD is a progressive genetic disorder which is mainly caused by mutations in the *PKD1* and *PKD2*. The dosage of functional polycystins strongly correlates with the disease severity. However, molecular mechanisms underlying the trafficking and maintenance of PC1/PC2 in cilia remain unclear. Phosphoinositides (PIs) are a group of signaling phospholipids that regulate membrane trafficking. Abnormal phosphoinositide metabolism correlates with variant human diseases, including polycystic kidney. Recent studies showed that PI(4)P and PI(4,5)P<sub>2</sub> exhibit unique compartmentalization in the ciliary membrane and regulate ciliary trafficking and signaling, suggest the PI pathway may function in the trafficking of polycystins.

**Methods:** We use small molecule inhibitors and location-directed protein expression to manipulate the PI contents in the context of cilia, and then determine the ciliary level of PC1 and PC2 using IF and immunoblotting. We use the IMCD3 3D spheroid model and embryonic kidney culture to mimic cystogenesis. We use the FlpIn system to generate several patient mutations of PC1 and PC2.

**Results:** We found that approaches increasing the ciliary PI(4,5)P<sub>2</sub> significantly increase the PC2 level in cilia in normal cells and cells carrying ADPKD mutations, such as *GANAB* and *PKD1* p.R3277C. By generating more patient mutations using FlpIn system, we discovered the ciliary level of several mutated polycystins can be also restored by increasing the PI(4,5)P<sub>2</sub> level. More importantly, increasing PI(4,5)P<sub>2</sub> in cilia reduces the cystic burden in the ADPKD disease model. Cyst index analysis indicated that our specific inhibitor significantly reduced the cyst formation both *in vitro* and *ex vivo*, and moderately reduced *in vivo*. In addition, this inhibitor showed no obvious effect on phosphorylated AKT or ERK expression, suggested that the impaired cystogenesis observed in the inhibitor groups very likely resulted from the recovered ciliary level of polycystins.

**Conclusions:** ADPKD is the most prevalent inherited progressive kidney disease with potential lethality. However, the effective treatment of ADPKD is extremely limited. We found that manipulating the ciliary PI pathway as well as their products significantly increases the ciliary dosage of polycystins, and exhibits suppression effects on renal cystogenesis. These results suggest that the ciliary PI pathway could be a novel therapeutic target for ADPKD.

**Funding:** NIDDK Support, Other U.S. Government Support

#### FR-PO294

##### Early Cyst Formation Leads to the Development of an Inflammatory Microenvironment and Tissue Remodeling in Polycystic Kidney Disease

Anubhav Chakraborty, Stephen C. Parnell, Yan Zhang, Emily A. Daniel, Archana Raman, Gail Reif, Darren P. Wallace. *University of Kansas Medical Center, Kansas City, KS.*

**Background:** Polycystic kidney disease (PKD) is a genetic disorder characterized by the formation and growth of numerous fluid-filled cysts. BRAF, a kinase that activates MEK-ERK signaling, is a central intermediate for cAMP-induced cell proliferation and cyst growth in PKD. Recently, we showed that collecting duct (CD)-specific expression of active BRAF<sup>E600E</sup>, a common activating mutation (BRAF<sup>CD</sup>), was sufficient to induce renal cyst formation in an otherwise normal mouse. A key pathological feature of PKD is the development of interstitial inflammation and fibrosis, leading to a decline in renal function. Our hypothesis is that cyst formation induces an inflammatory microenvironment early in renal cystic disease.

**Methods:** To examine changes in gene expression due to cyst formation, we performed RNA sequencing on 3-week-old cystic kidneys from BRAF<sup>CD</sup> mice and *Pkd1<sup>RcRc</sup>* mice, an orthologous slowly progressive model of PKD. Kidneys from 3-week-old wildtype mice were used as controls. Pathway analysis was used to identify common pathways affected during initial cyst formation due to active BRAF-MEK-ERK signaling and mutated *Pkd1*.

**Results:** We found that 566 out of 641 differentially expressed genes (DEGs) in the BRAF<sup>CD</sup> kidneys were also changed in the *Pkd1<sup>RcRc</sup>* kidneys (out of 840). Enrichment analysis indicated that inflammation, cytokine response, tissue fibrosis, and remodeling were some of the top activated pathways and cellular functions (FDR < 0.05; Z-score > 2). 88 of the 566 common DEGs were identified as inflammatory genes (Fold Change  $\geq$  1.5; FDR < 0.05), including elevated expression of tumor necrosis factor- $\alpha$  (TNF $\alpha$ ), toll-like receptor 8, and interleukin-34. The renal tubule injury marker neutrophil gelatinase-associated lipocalin (NGAL, LCN2) and tissue remodeling factors such as MMP-7, mucins (MUC5B, MUC15), lipase family member K, glutathione peroxidase 5, and protease inhibitors (cystatin-11 and -12, serine peptidase inhibitor) were also upregulated.

**Conclusions:** Renal cyst initiation due to active BRAF or mutated *Pkd1* was associated with elevated gene expression of markers for inflammation and tissue remodeling prior to the overt cystic disease, suggesting that cystic cells contribute to early development of an inflammatory microenvironment.

**Funding:** NIDDK Support, Private Foundation Support

## FR-PO295

**Time-Restricted Feeding Outperforms Periodic Fasting Head-to-Head in Slowing and Reversing Progression of Polycystic Kidney Disease in the Han:SPRD Rat Model**

Jacob A. Torres, Nickolas J. Holznecht, David A. Asplund, Bradley C. Kroes, Sebastian Strubl, Margaret Schimmel, Thomas Weimbs. *University of California Santa Barbara, Santa Barbara, CA.*

**Background:** We previously reported that interventions that induce the state of ketosis, including caloric restriction, time-restricted feeding, ketogenic diet and extended fasting, ameliorate or reverse polycystic kidney disease progression in animal models. We had found that time-restricted feeding was highly effective in juvenile Han:SPRD rats and that a 48-hour extended fast induced apoptosis in cystic epithelia. To expand on those findings, we now compared, head-to-head, periodic 48-hour fasting against a daily 16:8 time-restricted feeding regimen in both juvenile and adult Han:SPRD rats.

**Methods:** Juvenile and adult Han:SPRD rats were fasted weekly for 48 hours and then given ad libitum access to food for 5 days before being fasted again for 48 hours. This was repeated for 5 weeks from age 3 weeks to 8 weeks in juveniles and for 4 weeks in adults from age 8 weeks to 12 weeks. For daily time-restricted feeding, rats were given ad libitum access to food for 8 hours a day and were fasted for the remaining 16 hours. This was performed in adult rats from weeks 8 weeks to 12 weeks of age.

**Results:** All treatments led to a decrease in serum creatinine and markers of cystic disease progression. The beneficial effects of daily time-restricted feeding significantly exceeded that of periodic 48-hour fasting, leading to a partial reversal of established renal cystic disease in adult rats.

**Conclusions:** These results suggest that daily time-restricted feeding is a more potent intervention than periodic fasting. This study has important implications for translation into the clinic for the dietary management of individuals with ADPKD and the design of future clinical studies to assess outcomes of such interventions.

**Funding:** Private Foundation Support

## FR-PO296

**Changes in Tubule Flow During Renal Cyst Development**

Isis Thomas, Hanan Chweih, Courtney J. Haycraft, Zhang Li, Mandy J. Croyle, Kristin L. Simanyi, Bradley K. Yoder. *The University of Alabama at Birmingham Department of Cell Developmental and Integrative Biology, Birmingham, AL.*

**Background:** Polycystic kidney disease (PKD) is an inherited disorder where cysts develop in the kidney leading to renal failure. Cyst development results from mutations in ciliary localized proteins, PC1 and PC2 (encoded by the *Pkd1* and *Pkd2* genes, respectively), or due to loss of the cilium (e.g., in *Ift88* mutants). It is currently unknown whether flow is disrupted prior to or after cyst initiation, or whether tubule flow is important in maintaining the cells' differentiation state. While the function of the cilium in the kidney remains enigmatic, one proposed role is as a mechanosensor that detects changes in flow through the tubule lumen.

**Methods:** We propose that the loss of *Pkd2* leads to changes in the nephron associated with abnormal injury responses, cyst formation, and alterations in tubule flow. In this study we evaluate tubule flow during cyst initiation and progression to determine when tubule flow is altered and whether changes in flow lead to an increase in cell injury in adult induced *Pkd2* mutant mice. *Pkd2* mutant mice were induced by IP injection of tamoxifen at 8 weeks of age. Dextran absorption was analyzed by fluorescence activated cell sorting (FACS) and immunofluorescence (IF) with LTA (proximal tubules) and additional nephron segment markers.

**Results:** At 6- and 12-weeks following tamoxifen induction, dextran absorption was still detected in proximal tubules (presence of dextran+/LTA+ cells) of mutant mice. Additionally, we observed a decrease in LTA+ cells and an increase in dextran+/LTA- cells in *Pkd2* mutants at 6 weeks post induction via FACS suggesting that at this stage flow is maintained. Decreased numbers of LTA+ cells in *Pkd2* mutant samples suggest either a loss or dedifferentiation of proximal tubule cells prior to cyst formation. Visualization of dextran flow through the tubules in live samples confirmed that tubule flow is still present. We will utilize IF staining for proximal tubule (HNF4a), injured (SOX9), and proliferating (Ki67) cells to analyze changes throughout cyst development.

**Conclusions:** Overall, our data shows that flow through the tubules is not affected in early cystogenesis, but cellular alterations, such as loss of LTA staining occur early in *Pkd2* mutant mice.

**Funding:** NIDDK Support

## FR-PO297

**Polycystin-2 Like 1 in Renal Cyst Formation**

Ario Mohammadi,<sup>1</sup> Ahmad Jaser,<sup>1</sup> Aashish Dahal,<sup>1</sup> Lydia J. Liang,<sup>1</sup> Jing Zhou.<sup>1,2</sup> <sup>1</sup>Brigham and Women's Hospital, Boston, MA; <sup>2</sup>Harvard Medical School, Boston, MA.

**Background:** Polycystin-2 (PC2), encoded by PKD2 gene is a member of the transient receptor potential (TRP) family of non-selective cation channels. Mutations in PKD2 gene cause autosomal dominant polycystic kidney disease (ADPKD). Polycystin-L (also called polycystin-2L1, Pkd2L1) is a Ca<sup>2+</sup>-activated non-selective cation channel with high sequence identity to polycystin 2 and is permeable to Ca<sup>2+</sup>, K<sup>+</sup> and Na<sup>+</sup>. We have previously shown that polycystin-L is expressed primary cilia of hippocampal

neurons in the brain. In the kidney, PCL is detected on the primary cilium of epithelial cells similar to other members of the polycystin family.

**Methods:** Genetic crossing of gene-targeted mice were used to determine the resulting phenotypes. Histology, morphometric analyses and immunostaining were used to measure cystic index and cilium length.

**Results:** To determine whether polycystin-L plays a role in the kidney, we inactivated polycystin-L by gene targeting. Disruption of polycystin-L led to increased hippocampal and thalamocortical excitability, however their kidneys are phenotypically normal, which is in striking contrast with Pkd2 knockout mice that develop severe polycystic kidney disease. To determine whether polycystin-L modulates polycystic kidney disease in orthologous model of ADPKD, we created Pkd2. Pkd1 double knockout mice. We observed a reduction in kidney/body weight ratio and cystic index in a subset of double knockout mice. Cilia length measurements showed Pkd2. Pkd1 double knockout mice have shorter cilia than Pkd2 single knockout mice.

**Conclusions:** Disruption of both PkdL and Pkd2 in mice does not worsen the PKD phenotype in Pkd2 single knockout mice. In a significant portion of mice, there is a reduction in polycystic kidney disease severity in double knockout mice when compared with that in Pkd2 single knockout mice.

**Funding:** Private Foundation Support

## FR-PO298

**A scRNAseq Approach to Define Early Events in Cyst Formation and Stepwise Transformation**

Sara Clerici, Daniel Spies, Alessandra Boletta. *IRCCS Ospedale San Raffaele, Milano, Italy.*

**Background:** We have previously generated and described a mouse model carrying kidney-specific inactivation of the *Tsc1* gene using a Cadherin16-Cre line (KspCre). The peculiarity of the *Tsc1<sup>fl/fl</sup>;KspCre* model is that it develops a slowly progressive cystic kidney disease model, triggered by mTORC1-dependent downregulation of polycystin-1 (PC-1), which progressively transform into cystadenomas and carcinomas (Pema et al, Nat Comms, 2016; Drusian et al, Cell Reports, 2018). As they transform, the renal lesions lose the expression of tubule-specific markers.

**Methods:** In order to track all KO cells within the kidney, we generated *mT/mG; Tsc1<sup>fl/fl</sup>;KspCre* mice. Indeed, only KspCre expressing cells would excise mTomato (mT) in favor of mGFP (mG), while the surrounding tissue ubiquitously expresses mTomato. Mutants were characterized through histological and immunofluorescent analyses. Single cell suspension from control and mutant kidney was obtained through mechanical and enzymatic dissociation with Miltenyi kits and validated by flow cytometry confirming viability and aggregates requirements for single-cell sequencing.

**Results:** Histological characterization of *mT/mG; Tsc1<sup>fl/fl</sup>;KspCre* confirmed the progression from cysts (at P20) to cystadenomas and carcinomas (at P50 and P80) with the previously reported frequency. Furthermore, careful characterization of the *mT/mG; Tsc1<sup>fl/fl</sup>;KspCre* revealed that cystic structure, papillae, cystadenomas and carcinomas displayed mG-positivity in all lesions of all stages of the phenotype. A dissociation protocol was set up obtaining 75% viability in both control and mutant kidneys. Flow cytometry confirmed the 25-30% mG<sup>+</sup> cells expected in controls, which expanded to 65% in mutant kidneys, in line with the robust proliferation observed in these mutants. scRNAseq analysis of control mT/mG and *mT/mG; Tsc1<sup>fl/fl</sup>;KspCre* kidneys is being set-up at different time points (P10, precystic; P20 cystic; P50 and P80 transformed).

**Conclusions:** We generated a mouse model allowing to separate and study *Tsc1* mutant cells and the surrounding healthy tissue in a mouse model of progressive cysts and renal cell carcinoma (RCC) development. Single-cell sequencing analysis will help defining early versus late events in cystogenesis and in transformation towards RCC.

**Funding:** Private Foundation Support

## FR-PO299

**Primary Cilia Respond to Nutrients Availability and Favor Glutamine Utilization During Metabolic Stress**

Maria Elena Steidl,<sup>1,2</sup> Elisa Agnese Nigro,<sup>1</sup> Anne K. Nielsen,<sup>1,2</sup> Matteo Lampis,<sup>1,3</sup> Laura Cassina,<sup>1</sup> Christine Podrini,<sup>1</sup> Roberto Pagliarini,<sup>1</sup> Marco Chiaravalli,<sup>1</sup> Valeria Mannella,<sup>1</sup> Ming Yang,<sup>4</sup> Giovanna Musco,<sup>1</sup> Christian Frezza,<sup>4</sup> Alessandra Boletta.<sup>1</sup> <sup>1</sup>IRCCS Ospedale San Raffaele, Milano, Italy; <sup>2</sup>Università Vita Salute San Raffaele, Milano, Italy; <sup>3</sup>Eidgenössische Technische Hochschule Zurich, Basel, Switzerland; <sup>4</sup>Exzellenzcluster CECAD in der Universität zu Köln, Köln, Germany.

**Background:** Autosomal Dominant Polycystic Kidney Disease (ADPKD) represents the most common renal ciliopathy. Our group demonstrated that ADPKD is characterized by a metabolic rewiring that involves increased glycolysis, glutaminolysis, fatty acid synthesis, and decreased oxidative phosphorylation (OXPHOS) and fatty acid oxidation. Given that the polycystins localize to cilia, but also to other locations, we wondered what is the contribution (if any) of cilia in regulation of the bioenergetic demand of cells.

**Methods:** Cilium-ablated *Ift88* KO MEFs and IMCD3 cells were generated by CRISPR/Cas9 technology. NMR and LC-MS analyses were used to measure extracellular and intracellular metabolites. Seahorse assays were performed to measure mitochondrial respiration parameters. Immunofluorescence analyses were performed to measure primary cilium length both *in vitro* and *in vivo* in response to various nutrients.

**Results:** We found that cilium-ablated cells do not display overt differences compared to controls in cellular growth or mitochondrial respiration under complete medium conditions. However, NMR and LC-MS metabolomics under the same culture conditions revealed subtle differences between cilium-ablated cells and controls in metabolites



involved in glucose and glutamine-related pathways and in the TCA cycle. Interestingly, we found that nutrients deprivation drives a drastic primary cilium elongation, with an effect much stronger than simple serum deprivation. Physiological levels of glutamine, but not glucose, caused re-shortening of cilia both *in vitro* and *in vivo*. Furthermore, when exposed to glutamine supplementation under nutrients deprivation, cilium-ablated cells display significant abnormalities in the intracellular levels of glutamine, aspartate, and asparagine, suggesting an altered glutamine utilization under metabolic stress. We also found that this effect was mTOR-independent, but likely mediated by glutamine fueling of the TCA cycle.

**Conclusions:** Our results reveal that the primary cilium is involved in the response to nutrients availability and the usage of glutamine. These important findings could shed light on the role of primary cilium both in physiological and pathological contexts.

#### FR-PO300

### Polycystin 1 Ciliary Localization Is Controlled by Chemo- and Mechano-sensitizing Signaling Processes That Involve the Machinery of GPCR Desensitization

Nikolay P. Gresko, Michael J. Caplan. *Yale University, New Haven, CT.*

**Background:** Most cases of autosomal dominant polycystic kidney disease (ADPKD) are caused by loss of function mutations in the PKD1 and PKD2 genes, which encode polycystin-1 (PC1) and polycystin-2 (PC2), respectively. PC1 is a 460kD multi-spanning membrane protein that undergoes several proteolytic cleavages, one of which occurs at G protein coupled receptor proteolytic site in the N terminus and at least two of which release C-terminal fragments. PC1 and PC2 proteins localize to the primary cilium and contribute to cellular mechano-sensation and, also form a cation-permeable heterotetrameric channel. Recent studies demonstrate that PC1 can function as an atypical GPCR for Wnt ligands.

**Methods:** Immunofluorescence

**Results:** Here we report that the receptor activity of PC1 controls its ciliary localization. PC1 receptor function can be induced by ligand or by mechanical stimuli. Bending of the primary cilium have been shown to induce the release of extracellular ATP. We find that extracellular ATP reduces PC1 ciliary localization and that the effects of mechanical stimuli on the ciliary localization of PC1 may be mediated at least in part by extracellular ATP. Consistent, we show that constitutively active PC1 receptor construct is absent from the primary cilia whereas a constitutively inactive PC1 construct resides stably in the primary cilia. When we block GPCRs desensitization with  $\beta$ -arrestin inhibitor barbadin, we observe active PC1 construct accumulation in the cilium. We also examined the surface localization of the full length PC1 protein co-expressed with PC2 and found that extended Wnt9b ligand treatment or mechanical stimuli both lead to reduced presence of the full length PC1 protein at the cell surface and in the primary cilium, a process that can be disrupted by inhibition of  $\beta$ -arrestin.

**Conclusions:** Taken together, our data suggest that PC1 localization is regulated by physiological stimuli, including ligand binding and mechanical stress, through a mechanism that is similar to the receptor desensitization processes that regulate GPCR localization. Furthermore, the ATP released in response to mechanical stimuli appears to contribute to these desensitization mechanisms, resulting in removal of PC1 from the primary cilium.

**Funding:** NIDDK Support

#### FR-PO301

### Selective mTORC1 Inhibitors Block Cystogenesis in a Human Kidney Organoid Model of Polycystic Kidney Disease

Ramila E. Gulieva, Benjamin S. Freedman. *University of Washington, Seattle, WA.*

**Background:** The mammalian target of rapamycin complex (mTORC) pathway is activated in kidneys with PKD, and is therefore a promising target for therapy development. There are two mTORC complexes, mTORC1 and mTORC2. Recent work has developed selective mTORC1 inhibitors (mTORC1i), which have fewer side effects than compounds that inhibit both mTORC1 and mTORC2. Whether such compounds can affect PKD cystogenesis, however, has not yet been determined. We set out to test this in human kidney organoids with mutations in *PKD1* or *PKD2*, which form cysts in a PKD-specific way.

**Methods:** *PKD1*<sup>-/-</sup> or *PKD2*<sup>-/-</sup> iPSCs were differentiated into kidney organoids, placed in suspension for 9 days until cysts formed, and transferred into 96-well plates (one cyst/well). Compounds were introduced at different concentrations (0.1 to 30  $\mu$ M), including two selective mTORC1i (ORG1, ORG2), everolimus, vehicle and untreated controls. Phase contrast images were taken of each organoid on multiple days for 14 days to measure changes in cyst size. In parallel, cultures of organoids were used to assess markers of mTOR activity (P-p70S6, P-S6RP, P-AKT). LDH activity and live/dead staining were used to measure toxicity.

**Results:** All mTORC1 inhibitors produced dose-dependent reductions in cyst growth over the course of the experiment. Everolimus and ORG1 had statistically significant effects, whereas ORG2 was less efficacious. All mTORC inhibitors significantly decreased phosphorylation of mTOR targets S6RP and p70s6. P-AKT was decreased only in everolimus treatments but not in ORG1 and ORG2 treated organoids, reflecting selectivity of mTORC1i. Live/dead assay measured on day 14 indicated that everolimus is toxic at 10  $\mu$ M and 30  $\mu$ M, ORG1 at 30  $\mu$ M, and for ORG2 no sign of toxicity was identified.

**Conclusions:** We have established a model of drug treatment in PKD organoids to predict therapeutics that can slow cyst growth. Findings in organoids demonstrated efficacy of mTORC inhibitors for PKD, which was consistent with the ability of this

class of drugs to slow cyst growth in pre-clinical models. This helps to validate the use of organoids for studying PKD and screening potential therapeutics. An exciting finding is that novel selective mTORC1i compounds show efficacy and target engagement at non-toxic doses. These data provide proof of concept for further studies in animals and eventually humans.

**Funding:** NIDDK Support, Other NIH Support - NCATS, Commercial Support - Aeovian Pharmaceuticals

#### FR-PO302

### Canonical Correlation Analysis to Identify Single Nucleotide Polymorphisms in CKD

Amy J. Osborne, Agnieszka Bierzynska, Gavin I. Welsh, Moin Saleem, Ian C. Campbell. *University of Bristol, Bristol, United Kingdom.*

**Background:** Genetic risk for chronic kidney disease (CKD) is associated with the two complementary kidney function biomarkers, estimated glomerular filtration rate (eGFR) and blood urea nitrogen (BUN). Within this context, genome-wide association studies (GWASs) have identified single nucleotide polymorphisms (SNPs) associated with each biomarker, as well as SNPs likely relevant for kidney function based on their effect size directions. However, it has not yet been investigated which SNPs show a joint statistical association with, or shared genetic basis for, both kidney function biomarkers considered together in a multivariate analysis.

**Methods:** To identify SNPs correlated with both eGFR and BUN jointly, we applied canonical correlation analysis (CCA) to two CKD genotype datasets (European ancestry NURTURE-CKD and Salford Kidney Study) and *metaCCA* to the wider context of three larger publicly available GWAS summary statistics datasets (European ancestry CKDGen, United Kingdom Household Longitudinal Study, and BioBank Japan). SNPs that showed a significant correlation with both eGFR and BUN, using Bonferroni-correction, were gene-annotated based on location (AnnoVar) and kidney tissue expression quantitative trait loci (eQTL; QTLizer). Functional enrichment and gene overlap was assessed.

**Results:** For the CKDGen European ancestry dataset, of the 122 SNPs previously reported as likely relevant for kidney function by Wuttke et al. 2019, we found that 97 SNPs (80%) showed a significant correlation with both eGFR and BUN jointly using *metaCCA*. For the *metaCCA*-identified pruned SNPs that were in exons or kidney tissue eQTL-associated, the genes showed significant functional enrichment for proximal tubule transport, low molecular weight proteinuria, abnormal renal physiology and renal tubular atrophy, and others. Between the *metaCCA*-identified genes for the CKDGen (54 genes) and BioBank Japan (7 genes) datasets, despite the genetic ancestry difference, three genes overlapped (*FGF5*, *GOSR2*, *MUC1*). For the two smaller CCA-analysed datasets, the top SNPs showed p-values < 9E-3 but none were significant based on the Bonferroni correction. Gene annotations for these top SNPs overlapped with some *metaCCA*-identified genes, including *SLC7A9* and *GATM*.

**Conclusions:** This powerful methodology identifies novel SNPs correlated with kidney function in CKD.

#### FR-PO303

### Multi-Population Meta-Analysis Highlights the Role of Immune Dysregulation in Pediatric Steroid-Sensitive Nephrotic Syndrome

Alexandra Barry,<sup>1,4</sup> Michelle McNulty,<sup>1,4</sup> Xiaoyuan Jia,<sup>11,12</sup> Hanna Debiec,<sup>2</sup> Yask Gupta,<sup>10</sup> Claire Dossier,<sup>5</sup> Yang Luo,<sup>7,4</sup> China Nagano,<sup>1,4</sup> Tomoko Horinouchi,<sup>6</sup> Kandai Nozu,<sup>6</sup> Arvind Bagga,<sup>8</sup> Marina Vivarelli,<sup>3</sup> Simone Sanna-Cherchi,<sup>10</sup> Pierre M. Ronco,<sup>2</sup> Kazumoto Iijima,<sup>6,9</sup> Matt G. Sampson.<sup>1,7</sup> <sup>1</sup>Boston Children's Hospital, Boston, MA; <sup>2</sup>Sorbonne Universite, Paris, France; <sup>3</sup>Hopital Robert Debre, Reims, France; <sup>4</sup>Broad Institute, Cambridge, MA; <sup>5</sup>Istituto di Ricovero e Cura a Carattere Scientifico Ospedale Pediatrico Bambino Gesù, Rome, Italy; <sup>6</sup>Kobe Daigaku Daigakuin Igakukei Kenkyuka Igakubu, Kobe, Japan; <sup>7</sup>Harvard Medical School, Boston, MA; <sup>8</sup>All India Institute of Medical Sciences, New Delhi, India; <sup>9</sup>Hyogo-ken, Kobe, Japan; <sup>10</sup>Columbia University College of Physicians and Surgeons, New York, NY; <sup>11</sup>Kokuritsu Kenkyu Kaihatsu Hojin Kokuritsu Kokusai Iryo Kenkyu Center, Shinjuku-ku, Japan; <sup>12</sup>Tokyo Daigaku, Bunkyo-ku, Japan.

**Background:** Steroid-sensitive nephrotic syndrome (SSNS) is the most common form of NS observed in children. Previous genome-wide association studies (GWAS) have identified associations at four loci, including HLA. Additional heritability of SSNS has remained unknown.

**Methods:** We conducted a multi-population meta-analysis of 2,486 pediatric SSNS patients of Admixed-American, African, East Asian, European and South Asian ancestries vs. 35,739 ancestry-matched controls. Significant and suggestive loci were followed-up with gene-based annotation, and colocalization with immune- and kidney-cell eQTL data. The HLA locus was fine-mapped via HLA-specific imputation using a multi-ethnic HLA reference for association at classical HLA alleles, haplotypes, and amino acid positions.

**Results:** Multi-population meta-analysis discovered 5 new significant associations near *CAPDS*, *CD28*, *AH11*, *BTC*, and *CLEC16A*. There were 12 additional suggestive risk loci. The known GWAS loci were replicated. We found three non-HLA GWAS loci with high colocalization probability across various immune cell eQTLs, including *CALHM6*, *AH11*, *TNFSF15*. Colocalization with monocytes was observed for all three loci. HLA-focused analyses discovered two independent associations within the HLA-DR/DQ region and fine-mapping identified an association at amino acid position 47 and position 52 in *HLA-DQA1*. Conditional analysis identified a secondary association at amino acid position 26 in *HLA-DQB1*. Of note, no new GWAS loci colocalized with kidney eQTLs.

Key: TH - Thursday; FR - Friday; SA - Saturday; OR - Oral; PO - Poster; PUB - Publication Only

Underline represents presenting author.

**Conclusions:** Increased cohort diversity and size empowered the discovery of novel pediatric SSNS risk loci, further implicating the key role of immune dysregulation in this disease.

**Funding:** NIDDK Support

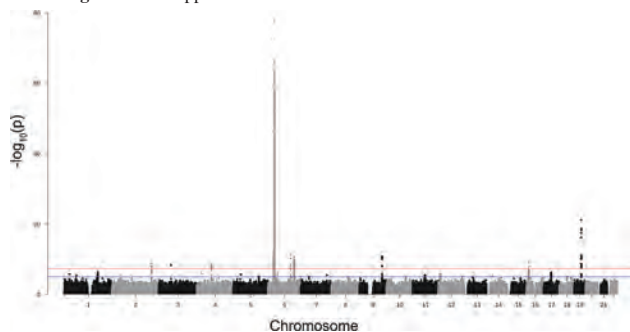

Manhattan plot of multi-population GWAS of pediatric SSNS

#### FR-PO304

##### **Polygenic Risk Score for CKD: Association Between Dyslipidemia and the Risk of Incident CKD Affected by Genetic Susceptibility**

**Boram Weon,** Jeonghwan Lee, Jung Pyo Lee, Chun Soo Lim. *Seoul National University Seoul Metropolitan Government Boramae Medical Center, Dongjak-gu, Seoul, Republic of Korea.*

**Background:** Polygenic risk score (PRS) provides information of the overall contribution of numerous genetic variants on disease outcomes. The effect of dyslipidemia on kidney disease outcome are inconsistent according to the individual's clinical characteristics including eGFR and genetic background. We aimed to investigate the genetic effect on the association between dyslipidemia and risk of CKD using PRS.

**Methods:** We constructed PRS for incident CKD using GWAS summary statistics of CKDGen Overall European Ancestry (n=480,898). UK biobank participants (aged 40 to 69) registered between 2006 and 2010 were enrolled in this study (n=389,281). Incident CKD was defined as eGFR below 60 mL/min/1.73 m<sup>2</sup> and ICD-10 code of CKD during follow-up period. The effect of lipid profile [total cholesterol (Total-C), LDL cholesterol (LDL-C), HDL cholesterol (HDL-C) and triglyceride(TG)] and PRS on incident CKD was investigated using the Cox proportional hazard model. Multivariable analysis included age, sex, comorbidities (diabetes mellitus and hypertension), body mass index, baseline kidney function, proteinuria, uric acid levels, alcohol consumption, and smoking as covariates. Interactions between lipid profile and PRS were tested in the whole participants and subgroups stratified by PRS for incident CKD.

**Results:** A total of 4,890 (1.24%) of participants developed CKD. High PRS (HR 1.117, 95% CI 1.086-1.149 as continuous variable) was associated with increased risk of CKD in univariable analysis. In multivariable analysis, high TG (HR 1.097, 95% CI 1.069-1.125), low HDL-C (HR 0.606, 95% CI 0.545-0.674), low LDL-C (HR 0.838, 95% CI 0.806-0.871), and low total-C (HR 0.866, 95% CI 0.841-0.892) were associated with incident CKD. High PRS (HR 1.173, 95% CI 1.107-1.243) was associated with CKD only in conjunction with TG. There were positive interaction between PRS and lipid profile of total-C (HR 1.030, 95% CI 1.006-1.055) and HDL-C (HR 1.138, 95% CI 1.044-1.242). When stratified by PRS tertiles, significant interaction was discovered only in high PRS group.

**Conclusions:** PRS can significantly predict the risk of incident CKD. High TG and low HDL-C are associated with increased risk of CKD. Low LDL-C and TG are also associated with high incidence of CKD, and their effect on CKD tends to increase as the genetic risk of CKD increases.

#### FR-PO305

##### **Identification of Kidney Cell-Type-Specific Regulatory Elements Reveals Genetic Variants, Genes, and Cell Types Influencing Kidney Function Heritability**

**Gabriel Loeb,**<sup>1</sup> Pooja Kathail,<sup>2</sup> Richard W. Shuai,<sup>2</sup> Kennix-Kalen Cheung,<sup>1</sup> Ryan K. Chung,<sup>2</sup> Nilah Ioannidis,<sup>2</sup> Jeremy Reiter.<sup>1</sup> <sup>1</sup>University of California San Francisco, San Francisco, CA; <sup>2</sup>University of California Berkeley, Berkeley, CA.

**Background:** Kidney disease is highly heritable. Understanding how genetic variants influence kidney function can reveal molecular pathways underlying kidney disease. Genome-wide association studies have identified hundreds of genomic loci associated with kidney function. However, due to linkage disequilibrium and localization of most risk variants within noncoding regions, the cell types and genes affected by the vast majority of these risk loci remain unclear.

**Methods:** We used single-cell ATAC-sequencing of human kidneys, partitioned LD-score regression of kidney biomarker genome-wide association studies, functionally informed fine-mapping, and deep learning models that predict chromatin accessibility from sequence to functionalize the variants, genes, and cell types associated with decreased kidney function.

**Results:** We mapped chromatin accessibility in over 40,000 human kidney cells, allowing us to identify kidney regulatory elements genome-wide. Tubule epithelial cell type-specific regulatory elements demonstrated strong enrichment for kidney function

heritability. Functionally informed fine-mapping revealed putative causal variants in both monogenic kidney disease genes and novel genes. A deep learning model trained to predict cell type-specific chromatin accessibility from sequence predicted the effect of variants on chromatin accessibility (AUROC = 0.77). We used this model and allele-specific ATAC-sequencing to identify kidney function variants that disrupt tubule epithelial chromatin accessibility, providing mechanistic insight into how these variants alter tubule gene expression to affect kidney function.

**Conclusions:** Enrichment of kidney function heritability within tubule epithelial cells suggests that perturbation of tubule gene expression is a major driver of kidney disease. Using functionally informed fine-mapping of kidney function variants, we identified regulatory elements and genes, which, when perturbed in tubule epithelial cells, affect human kidney function.

**Funding:** NIDDK Support, Other NIH Support - NICHD, NIAMS

#### FR-PO306

##### **Novel Renal Phenotype of a Rare Genetic Syndrome: Pericentri (PCNT) Gene Related Microcephalic Osteodysplastic Primordial Dwarfism Type II**

**Maria Llanos,** Xiangling Wang, Leal C. Herlitz, Fariha Shad, Fadi A. Hijazi, Mary-Beth Roberts. Cleveland Clinic foundation *Cleveland Clinic, Cleveland, OH.*

**Introduction:** Microcephalic osteodysplastic primordial dwarfism type II (MOPDII) is a rare genetic syndrome caused by biallelic mutations or deletions in the pericentri gene (PCNT), characterized by short stature and microcephaly. Aside from its classic features, its association with vasculopathy including moyamoya disease has been increasingly recognized. CKD, renal artery stenosis and aneurysm have also been reported. However, the kidney histopathological data is limited. Here we report a patient who presented with proteinuric CKD, Moya Moya disease, microcephalic short stature and was found to have distinct and novel renal phenotype with endotheliopathy, and homozygous PCNT gene deletion.

**Case Description:** 30 yr old male presented to renal genetics clinic due to CKD III, Moya Moya disease with multiple intracranial hemorrhages requiring multiple bypasses, hypertension, and family history of consanguinity and CKD in his mother and sisters. Exam was notable for short stature and microcephaly. He had estimated GFR of 36mL/min with a 1.2 UPCR. Serological work-up included negative ANA, DSDNA, ANCA, Hepatitis B, C antibody, HIV, lupus anticoagulant, monoclonals, anti-GBM, anti-MPO/PR3 antibodies and normal complements. Kidney biopsy demonstrated FSGS with endothelial abnormalities including mesangiolysis, segmental duplication of the GBMs, subendothelial widening and loss of endothelial fenestrations. Exome sequencing disclosed a pathogenic homozygous microdeletion on chromosome 21 involving multiple coding exons of the PCNT gene. This established the diagnosis of MOPDII. Familiar genetic testing was also offered. He was treated with Lisinopril with stable proteinuria and kidney function.

**Discussion:** The renal biopsy performed in this case highlighted the prominent endothelial injury in MOPDII related vasculopathy due to PCNT gene deletion. This expanded renal phenotype of MOPDII suggests that the vasculopathy observed with PCNT mutations may be related to endotheliopathy which deserves further investigation. This case also highlights the importance of genetic study in patients with systemic presentations and family history of kidney disease.

#### FR-PO307

##### **Genetically Determined Adiponectin Levels Are Associated With CKD**

**Jefferson L. Triozzi,**<sup>1</sup> Guanchao Wang,<sup>1,2</sup> Edward D. Siew,<sup>1,2</sup> Talat Alp Ikizler,<sup>1,2</sup> Otis D. Wilson,<sup>1,2</sup> Alexander Bick,<sup>1</sup> Ran Tao,<sup>1,2</sup> Cassianne Robinson-Cohen,<sup>1</sup> Adriana Hung,<sup>1,2</sup> <sup>1</sup>Vanderbilt University Medical Center, Nashville, TN; <sup>2</sup>Vanderbilt University Medical Center, Nashville, TN.

**Background:** Adiponectin is a potent insulin-sensitizing hormone with multiple anti-inflammatory, anti-oxidant and anti-atherogenic properties. Insulin resistance is associated with chronic kidney disease (CKD) incidence and progression. We investigated the causal relationship between genetically determined adiponectin levels and chronic kidney disease using a mendelian randomization experiment.

**Methods:** We performed a mendelian randomization experiment using 12 single nucleotide polymorphisms (SNPs) from a genome wide association study of adiponectin as the exposure (ADIPOGen Consortium, n = 25,513), and CKD defined as eGFR creatinine <60 mL/min/1.73 m<sup>2</sup> from a genome wide association study of European ancestry individuals with and without diabetes as the outcome (CKDGen, n = 12,385 cases, n = 104,780 controls). Mendelian randomization was performed using inverse variance weighted (IVW), weighted median, weighted mode, and MR-Egger regression analyses.

**Results:** Genetically predicted adiponectin levels demonstrated a causal relation with risk of chronic kidney disease in the IVW analysis (OR: 0.72, 95% CI: 0.58–0.89) and weighted median analysis (OR: 0.73, 95% CI: 0.55–0.96). Results were consistent in sensitivity analyses and there was no evidence of pleiotropy.

**Conclusions:** Our study finds that higher levels of adiponectin may have protective effects for CKD consistent with previous observational and pre-clinical data regarding the protective role for adiponectin in kidney disease. The mendelian randomization methodology supports a causal relationship and is less susceptible to confounding and reverse causation biases.

**Funding:** Veterans Affairs Support

Key: TH - Thursday; FR - Friday; SA - Saturday; OR - Oral; PO - Poster; PUB - Publication Only

Underline represents presenting author.

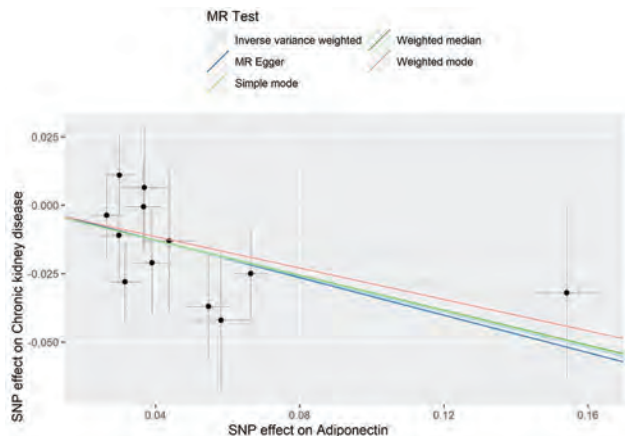

FR-PO308

**Mapping Genomic Regulation of Kidney Disease and Traits Through High-Resolution and Interpretable Expression Quantitative Trait Loci (eQTLs)**

Michelle McNulty,<sup>1</sup> Seong Kyu Han,<sup>1,2</sup> Christopher Benway,<sup>1</sup> Pei Wen,<sup>6</sup> Anya Greenberg,<sup>1</sup> Ana C. Onuchic-Whitford,<sup>1,5</sup> Parker C. Wilson,<sup>3</sup> Benjamin D. Humphreys,<sup>3</sup> Xiaquan Wen,<sup>4</sup> Zhe Han,<sup>6</sup> Dongwon Lee,<sup>1,2</sup> Matt G. Sampson.<sup>1,2</sup> NEPTUNE <sup>1</sup>Boston Children's Hospital, Boston, MA; <sup>2</sup>Harvard Medical School, Boston, MA; <sup>3</sup>Washington University in St Louis, St Louis, MO; <sup>4</sup>University of Michigan, Ann Arbor, MI; <sup>5</sup>Brigham and Women's Hospital, Boston, MA; <sup>6</sup>University of Maryland School of Medicine, Baltimore, MD.

**Background:** The genomic contributors to kidney diseases and traits extend well beyond rare, pathogenic, exonic variants that typified the initial discoveries in this area. Genome-wide association studies (GWAS) have demonstrated that heritability of diverse kidney traits and diseases are polygenic and primarily non-coding. eQTL studies illuminate genomic variants that regulate specific genes providing biological insight and fine mapping of loci discovered via GWAS. Efforts to maximize eQTL accuracy and precision are ongoing.

**Methods:** We conducted an eQTL analysis using RNA-seq from micro-dissected glomeruli (N=240) and tubulointerstitial (N=311) kidney tissue and paired whole genome sequencing (WGS) from the nephrotic syndrome cohort NEPTUNE. Single-nuclear open chromatin annotations and the distance to each gene's transcription start site were combined into an "integrative" Bayesian prior for multi-SNP fine mapping. To validate precision and accuracy of our eQTL maps, we assessed fine-mapping resolution, predicted impact on gene regulation, and heritability of estimated glomerular filtration rate (eGFR) and urine albumin-to-creatinine ratio (UACR). We highlighted the value of our eQTL maps through colocalization and transcription-wide association studies with eGFR and UACR GWAS. A subset of variants and genes were experimentally validated *in vitro* and using a *Drosophila* nephrocyte model.

**Results:** We discovered 5,371 glomerular and 9,787 tubulointerstitial eGenes. The integrative prior resulted in higher resolution eQTLs illustrated by (1) smaller credible sets with greater confidence, (2) increased enrichment of partitioned heritability for GWAS traits, (3) an increased number of variants colocalized with GWAS loci, and (4) enrichment of computationally predicted functional regulatory variants. We also functionally validated *NCOA7* and *LARP4B* eQTLs on a gene and variant level.

**Conclusions:** This study demonstrates that tissue-specific eQTL maps informed by single-nucleus open chromatin data have enhanced utility for diverse downstream analyses. Results can be explored and downloaded at [www.nephqt2.org](http://www.nephqt2.org).

**Funding:** NIDDK Support

FR-PO309

**Allele-Specific Expression in the Human Kidney: An Analysis of the NEPTUNE Cohort**

Ana C. Onuchic-Whitford,<sup>1,2</sup> Anya Greenberg,<sup>1</sup> Michelle McNulty,<sup>1</sup> Seong Kyu Han,<sup>1</sup> Jihoon Yoon,<sup>1</sup> Dongwon Lee,<sup>1</sup> Matt G. Sampson.<sup>1,2</sup> NEPTUNE <sup>1</sup>Boston Children's Hospital, Boston, MA; <sup>2</sup>Brigham and Women's Hospital, Boston, MA.

**Background:** Allele-specific expression (ASE) is a genomic phenomenon in which one copy of a gene (from one parental chromosome) is expressed more than the other, often due to cis-regulatory genetic variation. ASE has been shown to contribute to autism, heart disease and cancer. However, the extent of ASE in human kidney and its role in the pathogenesis of chronic kidney diseases is not well defined. To address this, we performed ASE analysis using whole genome sequencing data paired with kidney biopsy-derived glomerular RNA-seq data from 240 individuals in the Nephrotic Syndrome Study Network (NEPTUNE).

**Methods:** By integrating genomic and transcriptomic data from the same individual, we quantified mRNA expression originating from either of their parental chromosomes, distinguished by heterozygous loci. To do this, cohort-level genotype data was imputed

and population-phased using the Michigan Imputation Server. For each participant, gene-level ASE data for chromosome 19 (chr19) was generated by phASER (phasing and Allele Specific Expression from RNA-seq), and subsequently combined to generate cohort-level ASE data.

**Results:** 1653 genes on chr19 had sufficient glomerular expression for ASE analysis. Of these, 880 genes (53%) had ASE in  $\geq 1$  individual. We then focused on the cohort prevalence of ASE for 947 "highly expressed" genes, defined as read count  $> 100$  in  $\geq 1$  individual. The median number of highly expressed glomerular genes with ASE per person was 79. *NPHS1* – encoding nephrin, a crucial component of the glomerular slit diaphragm – was the 4th most common. Moreover, many of the individuals were outliers for *NPHS1* ASE: 13 participants had  $> 5x$  higher expression of one *NPHS1* allele compared to the other. Kallikrein related peptidase 6 (*KLK6*), the 3rd most common chr19 ASE gene, is expressed in kidney cancers and degrades the glomerular basement membrane proteins collagen and laminin.

**Conclusions:** This preliminary study of chr19 demonstrates that ASE is a pervasive phenomenon in glomerular cells, occurs in genes implicated in kidney disorders, and is found extensively across patients. This provides strong rationale to extend this ASE study genome-wide, to determine the spectrum of kidney ASE genes, the genetic variants that drive it, and their potential contribution to kidney diseases and traits.

**Funding:** NIDDK Support, Other NIH Support - Rare Diseases Clinical Research Network (RDCRN), National Center for Advancing Translational Sciences (NCATS)

FR-PO310

**Single-Cell Transcriptomics Reveals Disrupted Cell Communication in the Glomerular Niche in the Initiation of Childhood WT1 Glomerulopathy**

Jennifer C. Chandler,<sup>1</sup> Daniyal J. Jafree,<sup>1</sup> Saif N. Malik,<sup>1</sup> Gideon Pomeranz,<sup>1</sup> Maria K. Joannou,<sup>1</sup> Andrew S. Mason,<sup>2</sup> Aoife M. Waters,<sup>1</sup> David A. Long,<sup>1</sup> Long Research Group <sup>1</sup>University College London Institute of Child Health, London, United Kingdom; <sup>2</sup>University of York, York, United Kingdom.

**Background:** The glomerulus is comprised of podocytes and glomerular endothelial cells that enclose a core of mesangial cells; parietal epithelial cells enclose this specialised niche from the tubulointerstitium. Cellular communication within the glomerulus is critical for healthy filtration and its disruption is associated with adult diseases such as diabetic nephropathy. However, little is known about glomerular communication in childhood glomerulopathies.

**Methods:** Disease progression was characterised in a murine model (*Wt1*<sup>R394W/+</sup>) of childhood WT1 glomerulopathy, using biochemical and histological analyses. Single-cell RNA sequencing (scRNA-seq) and bioinformatic analyses were conducted on glomeruli isolated from wildtype (*Wt1*<sup>+/+</sup>) and mutant (*Wt1*<sup>R394W/+</sup>) mice. Validation was performed using tissue immunofluorescence and RT-qPCR.

**Results:** *Wt1*<sup>R394W/+</sup> mice have elevated urinary albumin ( $p < 0.0001$ ) from 4 weeks of age, prior to any histological features of glomerulosclerosis which occur by 8 weeks. To identify changes in cell communication that initiate glomerular damage, we performed scRNA-seq at 4 weeks, generating a dataset enriched for podocytes. Podocytes exhibited the most differentially expressed genes between *Wt1*<sup>R394W/+</sup> and *Wt1*<sup>+/+</sup> and changes in pathways associated with cell death were paralleled by a reduced WT1+ cell count ( $p < 0.0001$ ). Using ligand-receptor analysis, we identified vascular signalling to be the cellular interaction most disrupted in *Wt1*<sup>R394W/+</sup> glomeruli and CD31+ staining showed a loss of the glomerular endothelium by 8 weeks of age ( $p < 0.0001$ ). Finally, we performed a cross-disease comparison of *Wt1*<sup>R394W/+</sup> with other models of early glomerular disease (nephrotoxic nephritis, diabetes and *Cd2ap*<sup>-/-</sup>). This highlighted a common signature of podocyte transcripts that are upregulated or downregulated across early disease and others which are unique to each pathology.

**Conclusions:** This work has generated a glomerular dataset for childhood WT1 glomerulopathy. *Wt1*<sup>R394W/+</sup> podocytes have a unique transcriptional profile in early disease, driving endothelial loss. Signatures of podocyte injury exist across glomerulopathies, revealing therapeutic candidates of a disease-specific and generic nature that offer future promise in disease management.

FR-PO311

**Multi-Ethnic Polygenic Risk Modifies the Association Between APOL1 High Risk Genotypes and CKD**

Thi ha my Vy, Faris F. Gulamali, Girish N. Nadkarni. *Icahn School of Medicine at Mount Sinai, New York, NY.*

**Background:** The burden of advanced chronic kidney disease (CKD) falls disproportionately on minorities including African Americans (AAs) and Hispanic Americans (HAs) with admixed ancestry. Even though *APOL1* high-risk genotypes increase risk of kidney disease, their penetrance is incomplete i.e., only some individuals with high-risk genotypes develop kidney disease. This indicates that alongside interactions with social determinants, common single nucleotide polymorphisms (SNPs) may attenuate the effect of *APOL1*'s high risk genotypes on kidney disease via epistasis. Prior studies have only shown a small number of epistatic SNPs with small effect sizes, indicating that the modification of *APOL1* high risk may be polygenic

**Methods:** For each individual, we calculated two polygenic risk scores using summary statistics for Stage 3 CKD from two training sources: a publicly available European summary statistics generated for 118,147 individuals of European ancestry and an African summary statistics generated for 8,398 individuals of African ancestry from UK biobank. A multiethnic PRS was then derived as the linear combination of the two PRS with mixing weights  $\alpha_1$  and  $\alpha_2$  estimated from a single regression of Stage 3 CKD against each PRS. Association between PRS and risk of Stage 3 CKD was modeled using

logistic regression adjusting for age, sex, type 2 diabetes (T2D), and the first ten genetic principal components to account for population stratification.

**Results:** Using mixing weights estimated from the joint model, we computed a multi-ethnic PRS and tested for the association with CKD stage 3. As expected, we observed strong association (p=0.002) with odds ratio=1.46 (1.16-1.96) per standard deviation increment in PRS. When stratifying individuals into distinct groups by PRS quintiles: low, intermediate and high-risk groups, the intermediate-risk group had 1.49-fold (95% CI 0.89-2.56; p=0.14) and the high-risk group had 1.82-fold increased risk of CKD (95% CI 1.04-3.29; p=0.04) compared to the low-risk group.

**Conclusions:** Standardizing population screening for CKD by including *APOL1* high-risk genotypes and polygenic risk score may improve risk stratification and outcomes. PRS may serve as another feature in comprehensive models for risk prediction to power precision medicine approaches to address health disparities in kidney disease.

**Funding:** NIDDK Support

**FR-PO312**

**Sickle Cell Trait, APOL1 Renal Risk Variants, and Kidney Outcomes in the Million Veteran Program**

Trevor Thompson,<sup>1,2</sup> Zhihong Yu,<sup>1,3</sup> Hua-Chang Chen,<sup>1,3</sup> Ran Tao,<sup>1,3</sup> Jennifer E. Huffman,<sup>4,5</sup> Otis D. Wilson,<sup>1,3</sup> J. M. Gaziano,<sup>4,5</sup> Peter W. Wilson,<sup>6,7</sup> Edward D. Siew,<sup>3,1</sup> Katalin Susztak,<sup>8,9</sup> Alexander Bick,<sup>1</sup> Cassianne Robinson-Cohen,<sup>1</sup> Adriana Hung,<sup>3,1</sup> Million Veteran Program <sup>1</sup>Vanderbilt University Medical Center, Nashville, TN; <sup>2</sup>Meharry Medical College, Nashville, TN; <sup>3</sup>VA Tennessee Valley Healthcare System, Nashville, TN; <sup>4</sup>VA Boston Healthcare System, Boston, MA; <sup>5</sup>Harvard Medical School, Boston, MA; <sup>6</sup>Atlanta VA Medical Center, Atlanta, GA; <sup>7</sup>Emory University School of Medicine, Atlanta, GA; <sup>8</sup>University of Pennsylvania Perelman School of Medicine, Philadelphia, PA; <sup>9</sup>Philadelphia VA Medical Center, Philadelphia, PA.

**Background:** Individuals of African ancestry, have a 4-fold increased risk of progression to End Stage Renal Disease (ESRD). Apolipoprotein 1 high risk variants (*APOL1* HR) & Sickle Cell Trait (SCT), also denoted as the rs334 mutation, have been associated with greater ESRD risk. Both mutations arise in the same regions of West Africa due to positive evolutionary selection. Our previous GWAS in African American and Latinx populations showed that both the rs334 mutation in the *HBB* gene and *APOL1* high risk variants were associated with lower GFR. It is not known if the association described for SCT and ESRD varies by *APOL1* risk status.

**Methods:** We conducted a retrospective cohort study including 109,047 participants with African ancestry enrolled in the Million Veteran Program. We excluded patients with preexisting ESRD or Sickle Cell Disease. The primary exposure was *APOL1* high risk variants (RV) (G1 and/or G2) and/or SCT, defined by heterozygosity at the *HBB* gene for the rs334 mutation. Our primary outcome was a 40% decline in eGFR or reaching ESRD. Patients were followed to an outcome, death, or last day of follow up. Multivariable Cox regression was used for the comparison.

**Results:** Overall, the median age was 59 years [IQR 51,66], 86.2% were male, 33% had diabetes (DM) and 66% had hypertension (HTN). 5,285 (4.85%) experienced an eGFR decline of 40% and 1,796 experienced incident ESRD. Cox regression results are presented in **Table 1**.

**Conclusions:** In patients without diabetes the *APOL1* HR genotypes and SCT had the largest risk of progression. SCT did not confer increased risk of progression to ESRD for G0/G0 individuals. In diabetic patients with SCT and one high risk *APOL1* variant, there was an increased risk of renal disease progression to the clinical outcomes described above. Understanding the interaction of DM and SCT in the risk of CKD progression deserves further investigation.

**Funding:** Veterans Affairs Support

	ORV_SCT-	ORV_SCT*	1RV_SCT-	1RV_SCT*	2RV_SCT-	2RV_SCT*
<b>ALL</b>	42017	2949	47223	3192	12730	906
<b>Non-DM</b>	28223	1985	31532	2079	8461	610
Unadjusted	ref	1.00 (0.74-1.36)	1.03 (0.92-1.15)	1.28 (0.98-1.67)	1.43 (1.24-1.65)	1.76 (1.16-2.67)
10.3 10.4 10.5		p=0.989	p=0.597	p=0.071	p=0.001	p=0.008
Minimally adjusted	ref	1.00 (0.73-1.36)	1.02 (0.92-1.14)	1.28 (0.98-1.67)	1.42 (1.23-1.64)	1.83 (1.21-2.78)
Fully adjusted		p=0.985	p=0.681	p=0.074	p=0.001	p=0.004
10.3 10.4 10.5		1.00 (0.61-1.17)	1.00 (0.9-1.12)	1.19 (0.90-1.57)	1.28 (1.10-1.49)	1.63 (1.06-2.49)
		p=0.323	p=0.936	p=0.231	p=0.001	p=0.025
<b>DM</b>	13794	964	15691	1113	4269	326
Unadjusted	ref	1.06(0.86-1.30)	1.02 (0.94-1.10)	1.28 (1.07-1.53)	1.20 (1.05-1.33)	1.23(0.89-1.70)
11.3		p=0.573	p=0.645	p=0.007	p=0.001	p=0.208
Minimally adjusted	ref	1.07(0.87-1.32)	1.02(0.95-1.10)	1.28(1.07-1.53)	1.21(1.09-1.35)	1.28(0.91-1.73)
Fully adjusted		p=0.504	p=0.588	p=0.007	p=0.001	p=0.175
11.3		0.97 (0.78-1.20)	1.01 (0.93-1.08)	1.14 (0.95-1.37)	1.12 (1.00-1.24)	1.08 (0.77-1.52)
		p=0.764	p=0.888	p=0.162	p=0.047	p=0.645

SCT-, without sickle cell trait; SCT\*, without Sickle cell trait; ORV, do not carry APOL1 risk variants; 1RV, carries 1 APOL1 risk variants; 2RV, carries 2 APOL1 risk variants

**FR-PO313**

**Risk-Variant APOL1 Expression in iPSC-Derived Macrophages Increases Cellular Stress and Inflammation**

Esther Liu,<sup>1</sup> Jennie Lin,<sup>1,2</sup> <sup>1</sup>Northwestern University Feinberg School of Medicine, Chicago, IL; <sup>2</sup>Jesse Brown VA Chicago Healthcare System, Chicago, IL.

**Background:** DNA variants for the *APOL1* gene have been linked to a higher risk of developing kidney and cardiovascular disease in individuals with recent African ancestry. *APOL1* is expressed endogenously in not only kidney cells but also immune cells such as macrophages. Recent studies show that severe acute inflammatory illness such as COVID-19 increases the likelihood of individuals with the high-risk *APOL1*

genotype developing glomerulopathy, raising the question of the role of immune cells in *APOL1*-mediated disease. Therefore, we aim to understand the cellular stress and pro-inflammatory pathways increased by risk variant *APOL1* expression in iPSC-derived macrophages (iPSDM).

**Methods:** Induced pluripotent stem cell (iPSC) expressing G0 and G1 variants of *APOL1* were generated through CRISPR/Cas9. Macrophages (iPSDM) were differentiated from these iPSC lines. Expression of *APOL1* in the cultured iPSDMs, was induced with IFNγ (20 ng/mL). Cytokine expression in the cell culture supernatant was measured by ELISA. Metabolic respiration was measured by Seahorse Mito Stress Test (Agilent).

**Results:** Upon stimulation with IFNγ, we observed a 4.6-fold decrease in TGF-β secretion (n=3, p<0.001) in G1 iPSDM compared to G0. When polarized to an M1-like phenotype with IFNγ and LPS, IL-1β secretion was 1.4-fold increased (n=3, p<0.005) in G1 iPSDM compared to G0. G1 macrophages also had decreased levels of basal respiration compared to G0 (n=3, p=0.04). However, there was no observed difference in mitochondrial reactive oxygen species as measured by MitoSOX Red staining. Additionally, we observe a decrease in protein levels of LC3-II, an indicator of active autophagy, and a 4.4-fold increase of autophagy substrate P62 levels in G1 macrophages compared to G0.

**Conclusions:** The findings in our experiments show a significant increase in inflammatory cytokine expression in G1 macrophages and decreased levels of basal respiration and autophagy markers. These results suggest that *APOL1* risk variant expression modulates macrophage functions which are relevant to kidney homeostasis and disease.

**Funding:** Other NIH Support - TLIDK132769 for Chicago KUH FORWARD Training Grant, Private Foundation Support

**FR-PO314**

**Naturally Occurring Variants in APOL1: Channel Activity and Toxicity to Trypanosomes vs. Cultured Cells**

John C. Edwards, Rebecca L. Winkler, Jonathan M. Bruno, Jonathan Oliva, Saint Louis University, Saint Louis, MO.

**Background:** Wild type ApoL1 (G0) confers resistance to certain African trypanosomes. Two ApoL1 variants (G1, G2) provide resistance to a broader range of trypanosomes and contribute to risk of kidney disease. ApoL1 enters membranes at low pH where it functions as an anion permease. After titration to neutral, ApoL1 transitions to a cation channel. Compared to G0, G1 and G2 have increased cation channel activity and increased toxicity to cultured cells, supporting the hypothesis that this activity contributes to disease. Other ApoL1 variants exist that are inherited as haplotypes. Whether haplotype would impact ApoL1-associated kidney injury is unknown, but haplotype does alter toxicity of ApoL1 expressed in cultured cells.

**Methods:** Purified recombinant G0, G1, and G2 in each of the three major haplotypes were assayed for channel activity and membrane association. A subset of these were assayed for toxicity to *Trypanosoma brucei brucei* and for toxicity to cultured human podocytes using standard assays.

**Results:** K channel activity for all variants is greatest in the EIK (African) haplotype and least in the EMR (Neanderthal) haplotype. K channel activity of G1 and G2 is about double that of G0 in all haplotypes. The activity variation among haplotypes is not paralleled by differences in membrane association, but activity variation among G0, G1, and G2 is tightly correlated with membrane association. Trypanosome toxicity of G0 variant is greatest in the EIK haplotype and least in the EMR haplotype. G1 variant has no effect on trypanosome toxicity in the EIK haplotype.

**Conclusions:** Among haplotype encoded isoforms, cation channel activity correlates with toxicity to both trypanosomes and cultured cells but not with membrane association. In contrast, among the disease associated variants, cation channel activity correlates with membrane association and with cultured cell toxicity but not with trypanosome toxicity. The data suggest 1) that differences in cation channel activity among the variants is due to effects on membrane association/insertion, while differences among the haplotypes is due to differences in intrinsic activity of membrane-inserted protein; and 2) either the mechanism of ApoL1 toxicity to trypanosomes and cultured cells may be significantly different, or if identical, is not directly related to the cation channel activity of ApoL1.

**Funding:** NIDDK Support

**FR-PO315**

**A Novel Role of APOL1 Risk-Alleles in T-Cell Activation and Focal Segmental Glomerulosclerosis**

John F. Pell, Anand Reghuvaran, Soichiro Nagata, Khadija Banu, Hongmei Shi, Irene Chernova, Shuta Ishibe, Madhav C. Menon, Yale University Department of Internal Medicine, New Haven, CT.

**Background:** G1-, G2-variants in apolipoprotein-L1 (*APOL1*) increase the risk of FSGS vs. the major allele (G0). While podocyte *APOL1* expression is needed for FSGS, we recently reported a provocative role for *APOL1* within the immune system, as activated CD4<sup>+</sup> and CD8<sup>+</sup> T cells which expressed *APOL1* showed more activation in G1- or G2-genotypes by single cell transcriptomics.

**Methods:** We studied *APOL1*'s immunological role using a novel BAC-transgenic mouse (BAC-Tg) for G0-, G1- or G2-*APOL1* expression under the human *APOL1* promoter (*G0*-, *G1*-, *G2*-*pure*), and crossed each BAC-Tg line with dox-inducible interferon γ (*Ifn*g)-expressing mice (either *Rosa-Ifn*g- or *Nphs2-Ifn*g-*G0*-, *G1*-, or *G2*-), as IFNγ regulates *APOL1* expression.

**Results:** In splenocytes, *APOL1*- and dox-induced *IFN* $\gamma$ -expression were confirmed by qPCR. FACS analysis showed that adult Bac-Tg spleens had similar proportions of major immune cell types in all variants with/without dox. The proportion of CD8<sup>+</sup> T cells that were activated (CD44<sup>+</sup>CD8<sup>+</sup>) was significantly higher in *G1* and *G2* mice following dox vs. *G0* [Fig.A-B]. T cell receptor stimulated *G1*-, *G2*-CD8<sup>+</sup> T cells showed greater proliferation and marked *IFN* $\gamma$  production vs. *G0* [C-D]. In response to viral nucleic acid, *G1*-CD8<sup>+</sup> T cells showed further increases in *IFN* $\gamma$  and IL-2 intracellular staining (P<0.01 vs *G0*). To test the role of *APOL1*-variant immune cells in FSGS, we used bone marrow transfer [E]. *Rosa-lfng-G1*-, *-G2* mice that received *Rosa-lfng-G1*-marrow developed FSGS after dox feeding (positive control). Strikingly, *lfng-G1* marrow (*IFN* $\gamma$  induced only in donor cells) induced albuminuria in *G1*-, *G2*-pure recipients (without podocyte *IFN* $\gamma$  excess) while *Nphs2*-driven *IFN* $\gamma$  expression did not induce FSGS, suggesting FSGS was induced in variant-glomeruli by *G1*-marrow-derived *IFN* $\gamma$  [F-G; n=4]. *Ex vivo*, primary *G1*-podocytes treated with supernatant from TCR-stimulated *G1*-CD8<sup>+</sup> T cells showed greater apoptosis (Annexin V) vs. *G0* supernatant [n=3 each; H].

**Conclusions:** Our data suggest a novel role for activated CD8<sup>+</sup> T cells as a key source of *IFN* $\gamma$  in *G1*- and *G2* risk-genotype-Bac-Tg mice, inducing FSGS.

**Funding:** Other NIH Support - R01DK122164

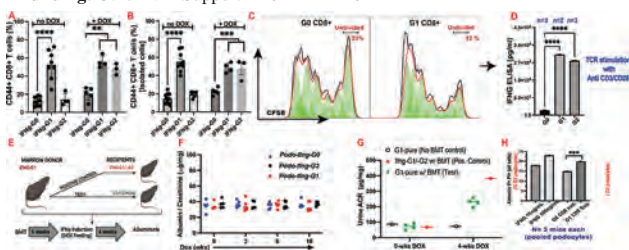

Figure 1. Association of APOL1 high-risk and p.N264K allele with end-stage kidney disease among MVP participants

FR-PO316

**Genetic Inhibition of APOL1 Pore Forming Function Prevents APOL1 Kidney Disease**

**Adriana Hung**,<sup>1,2</sup> Victoria Assimon,<sup>3</sup> Hua-Chang Chen,<sup>2,1</sup> Zhihong Yu,<sup>2,1</sup> Ran Tao,<sup>2,1</sup> Edward D. Siew,<sup>1,2</sup> Katalin Susztak,<sup>5,4</sup> Robert R. Graham,<sup>3</sup> Maarten Hoek,<sup>3</sup> Cassianne Robinson-Cohen,<sup>2</sup> Eric Green,<sup>3</sup> Alexander Bick,<sup>2</sup> Million Veteran Program <sup>1</sup>Va Tennessee Valley Healthcare System, Nashville, TN; <sup>2</sup>Vanderbilt University Medical Center, Nashville, TN; <sup>3</sup>MAZE Therapeutics, San Francisco, CA; <sup>4</sup>Philadelphia VA Medical Center, Philadelphia, PA; <sup>5</sup>University of Pennsylvania Perelman School of Medicine, Philadelphia, PA.

**Background:** African Americans are at increased risk for non-diabetic chronic kidney disease (CKD) in part due to high-risk variants in the apolipoprotein L1 (*APOL1*) gene.

**Methods:** We tested whether a different *APOL1* variant, p.N264K, modified the association between *APOL1* high-risk variants and CKD in cross-sectional analysis of 121,492 participants of African ancestry from the Million Veteran Program (MVP). We replicated our analyses in the Vanderbilt BioVU Biobank (n=14,386). The co-primary outcomes were CKD and end stage kidney disease (ESKD) among non-diabetic patients. We expressed *APOL1* high-risk mutations with and without *APOL1* p.N264K in podocytes to study mechanisms of action.

**Results:** In the MVP cohort, 15,604 (12.8%) had two *APOL1* high-risk mutations, of these 582 (0.5%) also had *APOL1* p.N264K. In the MVP cohort, 18,831 (15%) had CKD, 4,177 (3%) had ESKD and 34% had diabetes. *APOL1* high-risk variants were associated with an increased odds of CKD (odds ratio [OR] 1.72; 95% confidence interval [CI], 1.60 to 1.85) and ESKD (OR 3.94; 95% CI, 3.52 to 4.41). *APOL1* p.N264K mitigated the risk of *APOL1* high-risk variations in CKD (OR 0.70; 95% CI, 0.45 to 1.08, interaction p=0.001) and ESKD (OR 0.73; 95% CI, 0.27 to 1.96, interaction p=0.003) (Figure 1). *APOL1* p.N264K risk mitigation was replicated in BioVU. In mechanistic studies, *APOL1* p.N264K blocked *APOL1* pore-forming function and reduced toxicity of *APOL1* high-risk mutations in podocytes.

**Conclusions:** *APOL1* p.N264K is associated with reduced risk of CKD and ESKD among carriers of *APOL1* high-risk variants.

**Funding:** Veterans Affairs Support

FR-PO317

**Systems Genetics Approaches Uncover Pathway-Level Interactions in Mice Carrying APOL1 G0/G2 Transgene and Gstm1 Null Alleles**

**Josyf Mychaleckyj**,<sup>1</sup> Yves T. Wang,<sup>2</sup> Thu H. Le,<sup>2</sup> <sup>1</sup>University of Virginia Center for Public Health Genomics, Charlottesville, VA; <sup>2</sup>University of Rochester Medical Center, Rochester, NY.

**Background:** *APOL1* G1/G2 and *GSTM1* null alleles are associated with decline of kidney function but the cellular and molecular processes that effect the genetic risk remain poorly understood. We tested the interaction of an *APOL1* podocyte-specific transgene and *Gstm1* in cross-engineered mouse lines to examine the systems by which these two genes modulate kidney disease susceptibility.

**Methods:** We crossed FVB mouse lines carrying *Gstm1*(-/-) and podocyte specific *APOL1* G0 or G2 transgenes (tg) in a 2x3 factorial design with 6-8 mice per group (Figure 1). RNA was extracted from kidney cortices and subjected to RNA-seq analysis. Sequence reads were aligned using a STAR/RSEM pipeline against an *APOL1*-spiked mouse genome. Analyses included cell-type deconvolution, differential expression, and independent components analysis to identify transcriptional gene modules. Differential gene sets and gene modules were tested for pathway enrichment and modular networks inferred (Figure 2).

**Results:** There was a significant increase in %neutrophils in *Gstm1*(-/-) mice compared to wild type (WT) (p=0.004), while tgG0 and tgG2 mice showed lower %nephron/duct cells (p=0.047/0.0078). There were 39 genes with altered expression at FDR< 0.05 in tgG2 vs tgG0 and 53 in *Gstm1*(-/-) vs WT. There was strong evidence for an interaction between the *APOL1*(tg) and *Gstm1* genotypes through coordinated changes in pathways and gene sets, including cytochrome P450, glutathione, amino acid, and sphingolipid metabolism. In tgG2 vs tgG0, there were changes in oxidative phosphorylation, Th1/Th2/Th17 cell differentiation, neurodegeneration, diabetic cardiomyopathy-related, and AGE-RAGE signaling pathways. Functional cluster enrichment analysis of the modules recapitulated this through pervasive associations with immune response, innate immunity, cell adhesion, and synaptic response.

**Conclusions:** We have identified a complex of set of overlapping molecular and cellular processes that are dysregulated by these genotypic changes in *APOL1* and *Gstm1*. The risk allele (G2 and *Gstm1*(-/-) interaction suggests that additional genetic variability could be one source of the additional ‘hit’ needed to express a susceptibility phenotype within *APOL1* G1/G2 risk carriers.

**Funding:** NIDDK Support

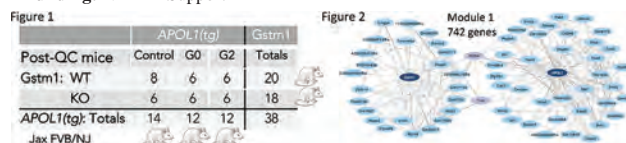

FR-PO318

**MZ-301 Is a Small Molecule Inhibitor of APOL1 Pore Function That Attenuates Albuminuria in a Mouse Model of APOL1-Mediated Kidney Disease**

**Victoria Assimon**, Sarah Bronner, Cecile Yu, Weibin Zha, Maarten Hoek, Christopher Sinz, Eric Green, David J. Morgans. *Maze Therapeutics, South San Francisco, CA.*

**Background:** *APOL1* genetic variants (G1 and G2) increase risk for a spectrum of progressive kidney diseases in people of African ancestry. To date, no *APOL1*-targeted therapies are available that address the underlying genetic driver of disease. Here we

describe the *in vitro* and *in vivo* activity of MZ-301, a small molecule APOL1 pore blocker that reduces APOL1-driven toxicity in multiple cell systems and attenuates albuminuria in a mouse model of APOL1-mediated kidney disease.

**Methods:** A parasite viability assay was used to quantify the ability of recombinant APOL1 protein to lyse trypanosomes in the presence and absence of MZ-301. MZ-301 inhibition of APOL1 pore function was determined in HEK293 cells overexpressing APOL1. Additionally, MZ-301 inhibition of APOL1 cytotoxicity was assessed in HEK293 cells and immortalized podocytes overexpressing APOL1. Finally, transgenic mice homozygous for the APOL1 G2 (G<sub>2HOM</sub>) variant were administered an IFN- $\gamma$  challenge to elevate APOL1 levels and induce albuminuria. This mouse model was used to assess the effect of MZ-301 on urine albumin-to-creatinine ratios.

**Results:** MZ-301 potently blocked the lytic activity of APOL1, preventing APOL1-mediated killing of trypanosomes. This compound also inhibited APOL1-dependent cytotoxicity in HEK293 cells and immortalized podocytes and reduced APOL1 ion conductance in APOL1-overexpressing HEK293 cells. Cellular effects were consistent across G1 and G2 variants. Finally, oral administration of MZ-301 robustly and dose-dependently attenuated IFN- $\gamma$ -induced albuminuria in APOL1 G<sub>2HOM</sub> mice to baseline levels in a preventative treatment paradigm.

**Conclusions:** MZ-301 is a potent orally bioavailable small molecule inhibitor of APOL1 pore function that blocks APOL1 lytic activity and reduces APOL1-mediated cytotoxicity in kidney cells. MZ-301 ameliorates proteinuria in a mouse model of APOL1 kidney disease. Together, these findings support inhibition of APOL1 pore function as a precision medicine approach for patients with APOL1 nephropathies and the further development of MZ-301.

**Funding:** Commercial Support - Maze Therapeutics

### FR-PO319

#### N6-Methyladenosine Methylation Regulatory Genes Modified the Effect of APOL1 Risk Genotype on Progression of CKD

Changwei Li,<sup>1</sup> Adrianna Westbrook,<sup>1</sup> Ruiyuan Zhang,<sup>1</sup> L. Lee Hamm,<sup>2</sup> Jing Chen,<sup>1,2</sup> Jiang He,<sup>1,2</sup> Tanika Kelly,<sup>1</sup> <sup>1</sup>Tulane University School of Public Health and Tropical Medicine, New Orleans, LA; <sup>2</sup>Tulane University School of Medicine, New Orleans, LA.

**Background:** The *APOL1* risk alleles is a major cause of chronic kidney disease (CKD) and its progression among Blacks. N(6)-methyladenosine (m6A) is the most abundant modification in mammalian mRNA and regulates all stages of RNA life cycle. m6A is regulated by 10 writer genes encoding m6A methyltransferase enzymes, 9 reader genes encoding m6A binding proteins to stabilize, splice and translate mRNA, and 2 eraser genes encoding m6A demethylase enzymes. We aim to evaluate whether expression quantitative trait loci (eQTLs) of the m6A regulatory genes modify the effect of *APOL1* risk alleles on CKD progression.

**Methods:** A total of 666 independent ( $r^2 \leq 0.3$ ) eQTLs of m6A regulatory genes (Writer genes: *METTL3*, *METTL14*, *WTAP*, *VIRMA*, *HAKAI*, *ZC3H13*, *RBM15*, *RBM15B*, *METTL16*, *PCIF1/CAPAM*; Reader genes: *YTHDC1*, *YTHDF1*, *YTHDF2*, *YTHDF3*, *YTHDC2*, *HNRNPA2B1*, *FMR1/FMRP*, *HNRNPC*, and *HNRNPG*; and Eraser genes: *FTO* and *ALKBH5*) were retrieved from the GTEx. The variants were tested for interactions with *APOL1* risk status on CKD progression among 1,224 Black participants of the Chronic Renal Insufficiency Cohort (CRIC) in Cox regression models. We adjusted for age, sex, study site, and the first 10 ancestry principal components (PCs) in the base model and additionally adjusted for baseline kidney function in the full model. We also performed stratified analyses to evaluate *APOL1* risk allele effects on CKD progression according to genotypes of the significant variants.

**Results:** After Bonferroni correction, a cluster of four *LAMTOR5* variants (lead SNP: rs6671673,  $P=6.58 \times 10^{-5}$ ) modified the effect of *APOL1* risk alleles on CKD progression. The *LAMTOR5* rs6671673 is an eQTL for the writer gene *RMB15*, with major T allele increasing expression of *RMB15* in the whole blood ( $P=5.4 \times 10^{-3}$ ). In stratified analyses, effects of *APOL1* risk alleles on CKD progression decreased with the number of T alleles of *LAMTOR5* rs6671673. Hazard ratios and their corresponding 95% confidence intervals associated with the *APOL1* risk alleles were 1.87 (1.18-2.97), 1.39 (1.13-1.71) and 0.85 (0.67-1.07), respectively, for participants carrying 0, 1, and 2 T alleles at the *LAMTOR5* rs6671673.

**Conclusions:** An eQTL for the m6A writer gene *RMB15* reduced the risk of *APOL1* associated CKD progression, and stabilizing *APOL1* mRNA may reduce the risk of CKD progression.

**Funding:** Other NIH Support - 1P20GM109036-01A1

### FR-PO320

#### Design and Rationale of GUARDD-US: A Pragmatic, Randomized Trial of Genetic Testing for APOL1 and Pharmacogenomic Predictors of Antihypertensive Efficacy in Patients With Hypertension

Michael T. Eadon,<sup>1</sup> Kerri L. Cavanaugh,<sup>2</sup> Girish N. Nadkarni,<sup>3</sup> Rhonda M. Cooper-DeHoff,<sup>4</sup> Carol Horowitz,<sup>3</sup> IGNITE <sup>1</sup>Indiana University School of Medicine, Indianapolis, IN; <sup>2</sup>Vanderbilt University, Nashville, TN; <sup>3</sup>Icahn School of Medicine at Mount Sinai, New York, NY; <sup>4</sup>University of Florida, Gainesville, FL.

**Background:** *APOL1* risk alleles are associated with increased cardiovascular and chronic kidney disease (CKD) risk. It is unknown whether knowledge of *APOL1* risk status motivates patients and providers to attain recommended blood pressure (BP) targets to reduce cardiovascular disease.

**Methods:** This is a multicenter, pragmatic, randomized controlled clinical trial of 6650 individuals with African ancestry and hypertension from 13 health systems. *APOL1* genotyping with clinical decision support (CDS) results are returned to participants and providers immediately (intervention) or at 6 months (control). A subset of participants are re-randomized to pharmacogenomic testing for relevant antihypertensive medications (pharmacogenomic sub-study). CDS alerts encourage appropriate CKD screening and antihypertensive agent use. Blood pressure and surveys are assessed at baseline, 3 and 6 months. The primary outcome is change in systolic BP from enrollment to 3 months in individuals with two *APOL1* risk alleles. Secondary outcomes include new diagnoses of CKD, systolic blood pressure at 6 months, diastolic BP, and survey results. The pharmacogenomic sub-study will evaluate the relationship of pharmacogenomic genotype and change in systolic BP between baseline and 3 months.

**Results:** As of January 2022, the trial had enrolled 3423 participants.

**Conclusions:** The effect of patient and provider knowledge of *APOL1* genotype on systolic blood pressure has not been well-studied. GUARDD-US addresses whether blood pressure improves when patients and providers have this information. GUARDD-US provides a CDS framework for primary care and specialty clinics to incorporate *APOL1* genetic risk and pharmacogenomic prescribing in the electronic health record.

**Funding:** Other NIH Support - NHGRI

### FR-PO321

#### Extracellular Vesicles Rescue Alport Glomerular Endothelial Lipid Dysfunction

Sargis Sedrakyan,<sup>1,2</sup> Hasmik Soloyan,<sup>1</sup> Matthew E. Thornton,<sup>2</sup> Paolo Cravedi,<sup>3</sup> Andrea Angeletti,<sup>4</sup> Laura Perin,<sup>1,2</sup> <sup>1</sup>Children's Hospital Los Angeles Department of Pediatrics, Los Angeles, CA; <sup>2</sup>University of Southern California, Los Angeles, CA; <sup>3</sup>Icahn School of Medicine at Mount Sinai, New York, NY; <sup>4</sup>IRCCS Istituto Giannina Gaslini, Genoa, Italy.

**Background:** Glomerular endothelial dysfunction plays a key role in the development of chronic kidney disease (CKD), however, its role in Alport syndrome (AS), a kidney disorder characterized by mutations in collagen IV $\alpha$ 3( $\alpha$ 5) progression has been elusive and understudied. We have previously shown that glomerular endothelial cell (GEC) injury is an early event that precedes podocyte damage in AS, manifested by enlarged fenestrations, altered glycocalyx and re-expression of GEC injury marker, plasmalemma vesicle associated protein (PLVAP). Here, we report on the link between altered lipid metabolism and GEC injury in AS, and the use of extracellular vesicles derived from amniotic fluid stem cells (AFSC-EVs) as a rescue strategy to re-establish lipid homeostasis.

**Methods:** GEC were isolated from tdTomato-reporter AS (Col4a5 mutation on C57BL/6 background) and WT mice at 4 months of age by FACS and transcriptome was analyzed and compared by bulk RNA-seq. Kidney tissue from patients affected by AS were used to confirm our findings by spatial transcriptomics and histology. In vitro, silencing experiments using human primary GEC were used to study the role of fatty acid synthase (FASN) loss in GEC dysfunction. AFSC-EVs (which contain FASN in their cargo) were applied as a rescue strategy to normalize FASN expression and restore lipid homeostasis. Data were confirmed using AFSC-EV <sup>FASN-/-</sup>.

**Results:** AS GEC were highly enriched for differentially expressed genes associated with cellular lipid metabolism. Genes associated with fatty acid transport (CD36, FATP-1, Fabp3) and synthesis (FASN) among others were downregulated, which was further associated with glomerular accumulation of lipid droplets in mice and onset of heavy proteinuria. Spatial transcriptional profiling of glomeruli from AS patients revealed strong correlation between GEC specific markers and lipid metabolism associated genes, confirming our findings in human. In vitro, AFSC-EVs were able to rescue FASN deficiency and improve GEC function, unlike AFSC-EV <sup>FASN-/-</sup>.

**Conclusions:** We report for the first time a lipid metabolic dysfunction in Alport GEC, and the ability of AFSC-EVs to rescue this phenotype. Therefore, better understanding of the functional role of GEC in AS could lead to the development of targeted new therapies for the treatment of this and other forms of CKD.

**Funding:** Private Foundation Support

### FR-PO322

#### Investigational Therapy of Alport Syndrome With ELX-02

Vasudeo Badarinarayana,<sup>1</sup> Kohei Omachi,<sup>2</sup> Megan K. Cox,<sup>1</sup> Ali Hariri,<sup>1</sup> Jeffrey H. Miner,<sup>2</sup> Vijay Modur,<sup>1</sup> <sup>1</sup>Eloxx Pharmaceuticals Inc., Watertown, MA; <sup>2</sup>Washington University in St Louis, St Louis, MO.

**Background:** Alport syndrome is a genetic disease caused by mutations in COL4A3, COL4A4 and COL4A5 genes leading to glomerular fragility, hematuria and proteinuria resulting in ESRD early in life. The most frequent form is X-linked Alport syndrome, which is caused by mutations in COL4A5. ELX-02 is an aminoglycoside analog specifically designed to readthrough premature termination (nonsense) codon mutations and produce full-length proteins instead of truncated proteins. We show here the potential for ELX-02 as an investigational therapy in Alport Syndrome.

**Methods:** A list of nonsense mutations in COL4A5 associated with Alport syndrome was compiled from ClinVar, LOVD, Ensemble and deafness variation database. The number of unique nonsense mutations and frequency of each were determined. Type of nonsense codon (UGA, UAG or UAA) was derived from sequence variant. 13 of the mutants were selected for analysis by dual reporter assay for responsiveness to ELX-02 induced readthrough. To assess expected clinical exposure in kidney for ELX-02, a Physiologically Based Pharmacokinetic (PBPK) model was built based on preclinical pharmacokinetic data from mouse, rat and dog studies using Gastroplus simulation software.

**Results:** Analysis of reported nonsense mutations compiled across different variant databases showed approximately 6% of reported pathogenic mutations in COL4A5 are of the nonsense subtype. Dual reporter assays were designed for 13 of these mutations to test for responsiveness to ELX-02. All the tested mutations had >3-fold increase in readthrough with an average of XX-Fold. PBPK modeling showed that ELX-02 levels in the kidney are >50-fold greater than plasma levels across a range of doses suggesting high exposures in the kidneys even at 0.71 mg/kg dose.

**Conclusions:** The promise of this investigational therapy in Alport syndrome is supported by several lines of evidence. 1) Nonsense mutations in COL4A5 are a significant cause of Alport Syndrome. 2) ELX-02 shows nonsense mutation readthrough across a range of nonsense mutations in Alport Syndrome. 3) PBPK modeling shows high levels of ELX-02 exposures can be achieved in the kidneys even at doses below those currently being used in clinical trials.

**Funding:** Commercial Support - Elox Pharmaceuticals, Inc

#### FR-PO323

##### Empagliflozin Reduces Renal Lipotoxicity in Alport Syndrome

Mengyuan Ge, Judith T. Molina David, Jin Ju Kim, Javier T. Varona Santos, Flavia Fontanesi, Sandra M. Merscher, Alessia Fornoni. *University of Miami School of Medicine, Miami, FL.*

**Background:** Sodium-glucose cotransporter-2 inhibitors (SGLT2i) are antidiabetic drugs that prevent glucose reabsorption in proximal tubular cells. SGLT2i improves renal outcomes in both diabetic and non-diabetic patients, indicating it may have beneficial effects beyond glycemic control. Alport Syndrome (AS) is a genetic disorder that leads to progressive kidney disease. We and others have shown that lipid accumulation in podocytes and tubular cells contributes to the pathogenesis of AS. Tubular cells preferentially use fatty acids as the main energy source, while podocytes rely on glucose. With this study, we test the hypothesis that SGLT2i affects energy metabolism in podocytes and tubular cells in experimental AS.

**Methods:** SGLT2 expression was analyzed by Western blot. Lipid droplet (LD) accumulation was determined by Nile red staining. Respiration was measured using Oroboros O2k respirometer. Blood samples were studied for BUN and creatinine levels. Albumin-to-creatinine ratios (ACR) were determined by albumin ELISA and creatinine assay. Kidney cortices were collected for lipid content analysis using Amplex Red assay and triglyceride (TG) assay.

**Results:** *In vitro*, we demonstrated a similar level of SGLT2 protein expression in cultured human and mouse podocytes when compared to tubular cells. Newly established immortalized podocytes from Col4a3KO mice (AS) accumulate LDs in association with increased apoptosis when compared to wildtype (WT) podocytes. Treatment with empagliflozin (empa, SGLT2i) reduces LD accumulation and apoptosis in AS podocytes. Empa inhibits the utilization of glucose as a metabolic substrate in AS podocytes. Interestingly, empa did not affect LD content and glucose utilization in tubular cells isolated from AS mice when compared to WT. *In vivo*, we demonstrated that empa reduces ACR and prolongs the survival of AS mice. Empa-treated AS mice showed decreased serum BUN and creatinine levels in association with reduced TGs and cholesterol esters (CE) levels in the kidney cortices when compared to AS mice. Lipid accumulation (TG, CE) in kidney cortices correlated with the decline in renal function (ACR, serum BUN and creatinine).

**Conclusions:** Empa reduces renal lipotoxicity and improves kidney function in experimental AS in association with a shift in the use of energy substrates from glucose to fatty acids in podocytes.

**Funding:** NIDDK Support

#### FR-PO324

##### High-Resolution Imaging of Inter-Organelle Interaction and Vesicle Trafficking in Live-Cells Expressing the INF2 Variants

Huong Quynh Tran Thuy,<sup>1</sup> Hiroko Ueda,<sup>1</sup> Linh N. Tran,<sup>1</sup> Naoyuki Kondo,<sup>2</sup> Hiroyasu Tsukaguchi,<sup>1</sup> <sup>1</sup>Kansai Medical University Second Department of Internal Medicine, Hirakata, Japan; <sup>2</sup>Kansai Medical University Department of Molecular Genetics, Hirakata, Japan.

**Background:** Focal segmental glomerulosclerosis (FSGS) is primarily caused by podocyte deletion. Regulation of cytoskeleton plays a key role in maintaining the slit diaphragm integrity. *INF2*, an actin regulator, is one of the most prevalent genes in monogenic FSGS. The DID domain *INF2* mutations cause two subtypes of disorders; one is FSGS alone and FSGS/CMT dual phenotypes. However, the detail mechanisms by which the DID mutations exert differential tissue effect remain unclear.

**Methods:** We characterized the cytoskeletal organization and inter-organelle interaction in HeLa/COS7 cells expressing pathogenic *INF2* variants identified in our cohort. Cellular effects are compared between FSGS only and CMT/FSGS variants. To clarify the actin dynamics and vesicle trafficking, we took advantage of the Spinning Disk Microscope DragonFly, which allows real-time imaging with 100nm resolution.

**Results:** When expressed in HeLa and COS7 cells, *INF2* variants causing FSGS alone (T161N, N202S) distributed a diffuse cytoplasmic ER pattern with Golgi enrichment similar to wild-type. In contrast, CMT/FSGS variants (G73D, V108D) exhibited a coarse granular distribution with aberrant accumulation at cell periphery. In fixed cells, actin stress fibers were more remarkably reduced in cells expressing CMT/FSGS variants than in FSGS variants. The extent of stress fiber reduction correlated with the severity of intracellular *INF2* misdistribution. Spinning Disk Microscopy with time-lapse imaging of living COS7 cells revealed that T161N variant increases the frequency of mitochondrial fragmentation as well as the number of mitochondria-ER interfaces than the wild-type. Moreover, trajectory analysis of lysotracker-labeled vesicles in living COS7 disclosed

that in T161N variant reduces the motility of cytoplasmic vesicles than the wild-type (n=100 for each group,  $P<0.0001$ ), suggesting that disorganized actin network may perturb the intracellular vesicular trafficking.

**Conclusions:** Our expression study indicates that the *INF2* variants cause severer actin network disarrangement and thus more deteriorating effects on the ER-mitochondria interaction and endosomal trafficking than wild-type. Such mechanisms may represent a common, global feature that underlies the pathogenesis of *INF2*-related disorders, affecting podocyte and/or Schwann cells.

**Funding:** Government Support - Non-U.S.

#### FR-PO325

##### Trafficking and Localization of Disease-Causing Podocin Mutants in Human Podocytes

Pei-Chen Lu,<sup>1,2</sup> Gavin I. Welsh,<sup>1</sup> Moin Saleem.<sup>1</sup> Renal group, University of Bristol <sup>1</sup>University of Bristol, Bristol, United Kingdom; <sup>2</sup>Kaohsiung Chang Gung Memorial Hospital and Chang Gung University College of Medicine, Kaohsiung, Taiwan.

**Background:** Mutations in the slit diaphragm protein podocin result in the commonest form of monogenic steroid-resistant nephrotic syndrome (SRNS). Podocin localizes to the podocyte slit diaphragm, which is crucial for the filtration process. Most disease-causing mutations of podocin cause it to be trafficked incorrectly intracellularly and this results in aberrant formation/function of the slit diaphragm complex. We have developed human podocyte cell lines expressing several disease-causing mutants of podocin to further understand the trafficking, intracellular localization and protein binding partners of this protein in both health and disease.

**Methods:** Wild type and R138Q, R238S, G92C, V180M, and R291W disease-causing mutants of podocin were tagged with Myc and stably expressed in conditionally immortalized human. Intracellular trafficking and localization of the tagged podocin constructs was determined by high resolution confocal and total internal reflection fluorescence (TIRF) microscopy. Sucrose density gradient centrifugation was used to study lipid raft localization. Proteomic analysis of podocin interacting proteins was carried out using mass spectrometry of co-immunoprecipitated proteins.

**Results:** Confocal and TIRF microscopy (Fig 1) showed that all the mutant proteins, except for the R138Q mutant, localized to the plasma membrane of podocytes. However, only the wild type and R238S protein were found to be associated with lipid raft structures. Mass spectrometry analysis of podocin binding proteins has identified several novel interactors including trafficking proteins and regulators of cell adhesion. Interestingly these protein/protein interactions are altered differentially by the podocin mutants.

**Conclusions:** Defining how disease-causing mutations alter the localization and protein binding partners of podocin will lead to a greater understanding of the pathogenesis of Nephrotic Syndrome.

**Funding:** Private Foundation Support

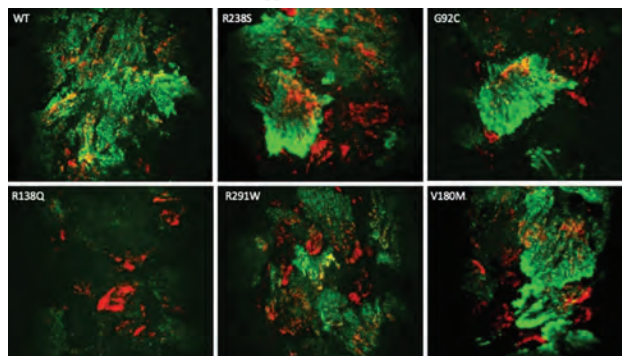

**Figure 1.** podocin in the total internal reflection fluorescence (TIRF) imaging. The wild type podocin-myc is in green and caveolin-1 is in red, and merged parts is in yellow.

#### FR-PO326

##### Phenotypic Quantification of Nphs1 Deficient Mice

Ronen Schneider,<sup>1,2</sup> Bshara Mansour,<sup>1,2</sup> Caroline M. Kolvenbach,<sup>1,2</sup> Aaron Bao,<sup>1,2</sup> Florian Buerger,<sup>1,2</sup> Shirlee Shril,<sup>1,2</sup> Friedhelm Hildebrandt.<sup>1,2</sup> <sup>1</sup>Boston Children's Hospital, Boston, MA; <sup>2</sup>Harvard Medical School, Boston, MA.

**Background:** The majority of children with steroid resistant nephrotic syndrome (SRNS) progress to end-stage renal disease (ESRD). Monogenic causes of SRNS have been detected in ~30% of pediatric cases, in one of 68 genes discovered so far, the most common being *NPHS1* and *NPHS2* (Kopp *Nat Rev Dis Primers* 6:68, 2020) affecting signaling pathways of podocytes biology (Connaughton *NDT* 35:390, 2020). Since each of these genes represents a rare cause of SRNS, tailoring therapeutic interventions to multiple molecular targets is challenging, and current treatments are limited. Therefore, gene replacement therapy (GRT) approaches have recently been considered (Zhao *JCI Insight* 22:e145936, 2021). To set the ground for GRT studies *in-vivo*, we established exact phenotypic quantification of a published *Nphs1* knockout (ko) mouse model.

Key: TH - Thursday; FR - Friday; SA - Saturday; OR - Oral; PO - Poster; PUB - Publication Only

Underline represents presenting author.

**Methods:** We have acquired a floxed nephrin mouse model (*Nphs1<sup>tm1Afrmc/J</sup>*) that was previously studied for pathways linked to pancreatic  $\beta$ -cell survival (Villarreal *J Am Soc Nephrol* 27:1029, 2016). We bred *Nphs1<sup>tm1Afrmc/J</sup>* mice with a CRE recombinase expressing mouse under the control of podocin promoter [*Tg(NPHS2-cre)<sup>205Lbb/J</sup>*] (Moeller *Genesis* 35:39, 2003), to generate podocyte specific nephrin deficient mice. We then performed survival analysis, renal light microscopic (LM) and TEM analyses, and proteinuria assessment to quantifiably phenotype these mice.

**Results:** Mice were born in Mendelian ratios. We observed median survival of 5 days in *Nphs1<sup>-/-</sup>* mice (n=27) as compared to 100% survival in *Nphs1<sup>+/+</sup>* (n=20) and *Nphs1<sup>+/-</sup>* mice (n=13) until age 50 days. Quantification by LM of the ratio of proteinaceous casts in proximal tubules to number of glomeruli in the same sequential coronal kidney sections revealed a ratio of 0.92 casts/glomeruli (545/592) in *Nphs1<sup>-/-</sup>* mice (n=3), and 0/443 in *Nphs1<sup>+/+</sup>* controls (n=2). We counted the number of foot process cross sections (FPCS) per  $\mu\text{m}$  glomerular basement membrane (GBM) length in electron microscopy images. While *Nphs1<sup>+/+</sup>* mice (n=3) showed an average of 2.9 FPCS per  $\mu\text{m}$  of GBM, ko mice (n=3) showed 0.9 /1  $\mu\text{m}$  GBM (p<0.05). Finally, *Nphs1<sup>-/-</sup>* pups had +4 albumin on urine stick (n=2), and *Nphs1<sup>+/+</sup>* mice had trace to +1 readings (n=4).

**Conclusions:** We have quantitatively phenotyped *Nphs1<sup>-/-</sup>* mice, in a model that can provide reliable phenotypic read-outs for gene-replacement therapy in *Nphs1* deficient mice.

**Funding:** NIDDK Support

**FR-PO327**

**Quantifiable Phenotyping of an Existing Nphs1 Knockout Mouse Model**  
Katharina Lemberg,<sup>1,2</sup> Kirolos Yousef,<sup>1</sup> Nils D. Mertens,<sup>1</sup> Florian Buerger,<sup>1</sup> Ronen Schneider,<sup>1</sup> Bshara Mansour,<sup>1</sup> Lea M. Merz,<sup>1</sup> Caroline M. Kolvenbach,<sup>1</sup> Ken Saida,<sup>1</sup> Camille H. Nicolas Frank,<sup>1</sup> Shirlee Shril,<sup>1</sup> Friedhelm Hildebrandt.<sup>1</sup>  
<sup>1</sup>Boston Children's Hospital, Boston, MA; <sup>2</sup>Uniklinik Köln, Köln, Germany.

**Background:** Steroid resistant nephrotic syndrome (SRNS) is the second leading cause of chronic kidney disease in the first three decades of life. The majority of children with SRNS progress to ESRD requiring dialysis or transplantation. The identification of monogenic causes of SRNS has revealed ~60 single-gene etiologies. Monogenic causes of SRNS predominantly cause glomerular podocyte dysfunction (Lovric *NDT* 31:1802-1813, 2015). Congenital nephrotic syndrome (CNS) is the most severe monogenic form of nephrotic syndrome. The second most frequent gene causing CNS when harboring biallelic mutations is *NPHS1*, which encodes the protein nephrin. Nephrin is located at the slit diaphragm and essential for the renal filtration barrier. There is no causal therapy so far. In order to enable eventual gene replacement therapy for CNS, we are developing quantifiable phenotyping in *Nphs1<sup>-/-</sup>* mouse models of CNS to provide a reproducible reference of evaluation for *in vivo* studies.

**Methods:** We developed a breeding colony for a previously published unconditional *Nphs1<sup>-/-</sup>* knockout mouse model (*Nphs1<sup>tm1Rk/J</sup>*) and performed phenotypic evaluation, comparing homozygous mice to heterozygous controls. We quantitatively evaluated them for three independent conditions: Kaplan-Meier survival curves, frequency of proteinaceous casts in proximal tubules upon light microscopy and foot process effacement upon electron microscopy.

**Results:** Mice were born in Mendelian ratios. Homozygous segregation of the *Nphs1*-KO allele led to a) a perinatally lethal phenotype with a median survival of 1.0 day (n=18), b) light microscopic changes by counting the ratio between proteinaceous casts in proximal tubules per mature glomerulus in coronal equatorial sections, with a ratio of 0.38 in homozygous mice (n=5) vs 0.0 in heterozygous mice (n=5) and c) TEM studies revealed reduced number of podocytes, which we quantified by counting foot process cross sections (fp) over a defined length of the glomerular basement membrane, with 0.49 fp/ $\mu\text{m}$  *Nphs1<sup>-/-</sup>* (n=2) and 2.5 fp/ $\mu\text{m}$  in *Nphs1<sup>+/+</sup>* (n=3).

**Conclusions:** We hereby provide a quantifiable phenotyping of *Nphs1<sup>tm1Rk/m1Rk</sup>* KO mice which can be useful for further *in vivo* studies of CNS.

**Funding:** Other NIH Support - NIH 5RC2DK122397-02

**FR-PO328**

**Phenotypic Quantification of a NPHS1 Knockout Mouse Model**  
Lea M. Merz,<sup>1</sup> Florian Buerger,<sup>2</sup> Ken Saida,<sup>2</sup> Nils D. Mertens,<sup>2</sup> Katharina Lemberg,<sup>2</sup> Kirolos Yousef,<sup>2</sup> Bshara Mansour,<sup>2</sup> Caroline M. Kolvenbach,<sup>2</sup> Shirlee Shril,<sup>2</sup> Ronen Schneider,<sup>2</sup> Friedhelm Hildebrandt.<sup>2</sup>  
<sup>1</sup>Department of Pediatrics, University Hospital Leipzig, Leipzig, Germany; <sup>2</sup>Department of Pediatric Nephrology, Boston Children's Hospital & Harvard Medical School, Boston, MA.

**Background:** Steroid-resistant nephrotic (SRNS) syndrome is the second most frequent cause of chronic kidney disease before the age of 25 years. Nephrin (*NPHS1*) is localized at the slit diaphragm of glomerular podocytes and plays a pivotal role in the filtration barrier. Biallelic mutations in *NPHS1* cause congenital nephrotic syndrome type 1 (CNS-1). To date, no causative therapy for CNS-1 is available. Recently, AAV vectors targeting the glomerular podocyte, have been assessed as a means for gene replacement therapy (Rocca. *Methods Mol Biol* 1937:227, 2019).

**Methods:** We acquired a conditional transgenic mouse model (*Nphs1tm1.1Pparg/J*) using a podocyte-specific Cre-recombinase (Verma, *Plos One* 13(6):e0198013, 2018). We phenotypically characterized the nephrin-deficient mice by analyzing the presence of proteinaceous casts by renal histology, and density of podocyte foot processes by TEM. We also performed proteinuria measurements at different time points. To quantify foot process effacement, we detected the number of foot process cross-sections per length of the glomerular basement membrane (GBM). Furthermore, we characterized median survival of the *Nphs1<sup>-/-</sup>* mice in comparison to wildtype or heterozygous controls, to determine potential time-points of postnatal treatment.

**Results:** We found the average survival rate after birth to be 17 days (range from 9-23 days, n=8). The *Nphs1<sup>-/-</sup>* mice develop proteinuria within the first week, increasing to massive proteinuria 3-4.1 mg albumin/g creatinine from day 9 until time of death. The average density of foot processes per GBM length was 1.5 fp/ $\mu\text{m}$  in the *Nphs1<sup>-/-</sup>* mice compared to 1.7 fp/ $\mu\text{m}$  in the controls at day 9. At day 14 we detected a more distinct difference with an average of 1.2 fp/ $\mu\text{m}$  in knockout mice and 2.3 fp/ $\mu\text{m}$  in the matching controls.

**Conclusions:** We quantitatively characterized the phenotype of the mouse model published by Verma *et al.* (*Plos One* 13(6):e0198013, 2018).

**Funding:** NIDDK Support

**FR-PO329**

**Characterization of the Human Podocin Short Isoform In Vivo Using a New Mouse Model**  
Linus Butt,<sup>1</sup> David Unnersjö-Jess,<sup>1,2</sup> Markus M. Rinschen,<sup>3,4</sup> Bernhard Schermer,<sup>1</sup> Thomas Benzing,<sup>1,5</sup> Martin Höhne.<sup>1,5</sup>  
<sup>1</sup>Department II of Internal Medicine and Center for Molecular Medicine Cologne, University of Cologne, Faculty of Medicine and University Hospital Cologne, Cologne, Germany; <sup>2</sup>SciLifeLab, Stockholm, Sweden; <sup>3</sup>Aarhus Universitet Institut for Biomedicin, Aarhus, Denmark; <sup>4</sup>III Department of Medicine, University Medical Center Hamburg-Eppendorf, Hamburg, Germany; <sup>5</sup>Exzellenzcluster CECAD in der Universitat zu Koln, Koln, Germany.

**Background:** To date, many mutations affecting podocyte-specific genes are known to cause steroid-resistant nephrotic syndrome, which usually progresses to end-stage renal disease due to a lack of effective therapeutic strategies. *NPHS2*, encoding the podocyte-specific protein podocin, is among the most frequently mutated genes in patients with hereditary steroid-resistant nephrotic syndromes. Previously, a short isoform of podocin lacking exon 5 was identified in human kidney tissue and characterized *in vitro*. However, its role *in vivo* remained elusive.

**Methods:** The short isoform of podocin is not found in any other organism except humans. To examine its functional relevance *in vivo* we generated a mouse line expressing the equivalent podocin isoform (podocin<sup>Δexon5</sup>) using CRISPR/Cas9 mediated genome editing. We characterized the phenotype of mice expressing podocin<sup>Δexon5</sup> resembling the human short isoform. Targeted mass spectrometry and qPCR were used to compare protein and RNA levels of podocin<sup>wildtype</sup> and podocin<sup>Δexon5</sup>. STED microscopy following immunolabeling of slit diaphragm components was applied to visualize alterations of the podocytes' foot process morphology.

**Results:** Homozygous podocin<sup>Δexon5</sup> mice born heavily albuminuric, hardly produced any urine and did not survive past the first day after birth. Targeted mass spectrometry revealed decreased protein levels of podocin<sup>Δexon5</sup> whereas RNA abundance was not different to the canonical form (podocin<sup>wildtype</sup>). STED microscopy revealed the complete absence of podocin at the podocytes' slit diaphragm and severe morphological alterations of podocyte foot processes. Mice heterozygous for podocin<sup>Δexon5</sup> were phenotypically unaffected but decreased podocin levels and altered foot process morphology could be detected.

**Conclusions:** The murine equivalent to the human short isoform of podocin is unable to stabilize the lipid-protein complex at the slit diaphragm. Reduction of podocin levels at the site of the slit diaphragm complex has a detrimental effect on podocyte morphology and decreases protein abundance of nephrin, the core protein of the extracellular slit diaphragm complex. In conclusion, our data support the hypothesis that podocin acts an orchestrator of the slit diaphragm complex, which allows for kidney ultrafiltration. The functional role of the short human isoform remains elusive.

**Funding:** Government Support - Non-U.S.

**FR-PO330**

**FVB/N-Nos1apEx3/Ex3- Mice Develop Severe Glomerular Kidney Disease, Which Is Ameliorated by Antiproteinuric Treatment**  
Florian Buerger, Lorrin Liang, Daanya Salmanullah, Vineeta Sharma, David A. Ball, Friedhelm Hildebrandt, Amar J. Majmundar.  
*Boston Children's Hospital, Harvard Medical School, Boston, MA.*

**Background:** Nephrotic syndrome (NS) is a leading cause of pediatric chronic kidney disease and frequently caused by Mendelian genetic variants. We previously discovered recessive *NOS1AP* variants as a novel cause of early onset NS in children and observed moderate glomerular disease without kidney failure in *Nos1ap<sup>Ex3-Ex3-</sup>* mice on a C57BL/6 background (Majmundar & Buerger *Sci. Adv.* 7:1386, 2021). We, next, hypothesized that the *Nos1ap<sup>Ex3-Ex3-</sup>* phenotype depends on the genetic background and that FVB/N and 129/sv mice may fully recapitulate the human disease.

**Methods:** C57BL/6-*Nos1ap<sup>Ex3-Ex3-</sup>* mice were crossed onto FVB/N and 129/sv backgrounds. Urine albumin-to-creatinine ratios (ACR) in urine, blood parameters of kidney failure, and histology by light microscopy were measured.

**Results:** FVB/N-*Nos1ap<sup>Ex3-Ex3-</sup>* mice developed significantly increased albuminuria, beginning at weaning age, relative to wildtype or heterozygote controls. ACRs in FVB/N-*Nos1ap<sup>Ex3-Ex3-</sup>* mice were one order of magnitude higher than in C57BL/6-*Nos1ap<sup>Ex3-Ex3-</sup>* and 129/sv mice-*Nos1ap<sup>Ex3-Ex3-</sup>* at 3-6 months (mean ACRs 13.47-16.04 g/g, 0.86-1.53 g/g, and 0.99-1.69 g/g, respectively). Furthermore, FVB/N-*Nos1ap<sup>Ex3-Ex3-</sup>* mice exhibited markedly reduced serum albumin, elevated serum levels of renal dysfunction marker BUN, and increased mortality compared to controls, which were all previously not observed on the C57BL/6 background. Histologic studies demonstrated increased mesangial matrix deposition, proteinaceous tubular casts, and tubular dilation in homozygous FVB/N mouse kidneys. FVB/N-*Nos1ap<sup>Ex3-Ex3-</sup>* mice with comparable baseline ACRs received



drinking water with vehicle (water), 100 mg/L lisinopril, or 200 mg/L lisinopril at 6 weeks of age. Lisinopril treatment resulted in reduced albuminuria (mean ACRs between 2-12 weeks of treatment: vehicle, 14.06-29.84 g/g; 100 mg/L lisinopril, 5.54-9.97 g/g; 200 mg/L lisinopril, 7.15-11.20 g/g). Finally, lisinopril-treated mice exhibited increased survival at 14 weeks of treatment (11/11 viable) relative to vehicle-treated FVB/N-*Noslapp<sup>Ex3-Ex3</sup>* mice (1/5 viable).

**Conclusions:** FVB/N-*Noslapp<sup>Ex3-Ex3</sup>* mice develop severe proteinuric kidney disease, consistent with human SRNS, which is ameliorated by ACE inhibition.

**Funding:** NIDDK Support, Government Support - Non-U.S.

## FR-PO331

### Recovering Impaired Cell Adhesion in Cystinosis Podocytes: A New Therapeutic Strategy?

**Sante Princiero Berlingerio,<sup>1</sup> Sarah Tassinari,<sup>2</sup> Tjessa Bondue,<sup>1</sup> Marc Fransen,<sup>1</sup> Lambertus P. Van den heuvel,<sup>1</sup> Elena N. Levchenko.<sup>1</sup> Prof. Levchenko<sup>1</sup> Katholieke Universiteit Leuven Universitaire Ziekenhuizen Leuven, Leuven, Belgium; <sup>2</sup>Universita degli Studi di Torino, Torino, Italy.**

**Background:** Cystinosis is a rare, incurable autosomal recessive storage kidney disease caused by mutations in *CTNS* gene, which encodes the cystine transporter cystinosin and leads to lysosomal cystine accumulation in all the body. In addition to proximal tubular cells, cystinosis also affects the glomerulus since podocytes are lost into urine leading to proteinuria and kidney failure. Cysteamine, the current treatment, decrease cystine accumulation but does not reverse proximal tubular injury (renal Fanconi syndrome) neither glomerular injury. These evidences suggest that different mechanisms are involved and further studies are necessary to understand the disease in order to develop new therapeutic options.

**Methods:** Immortalized patient-derived cystinosis and healthy podocytes were used and the results were validated in our newly in-house developed fluorescent *CTNS* zebrafish larvae model (*l-fabp:DBP-eGFP;CTNS*). To understand the impaired podocyte functionality, static and dynamic permeability assay, metabolomic analysis (LC-MS), flow cytometry, RT-qPCR, western blot, chemical and dynamic roGFP2 redox-sensing fluorescent probes were used.

**Results:** Cystinosis podocytes present decreased adhesion and increased permeability caused by an accumulation of mitochondrial ROS. Moreover, they show fragmented mitochondrial network with impaired TCA cycle, energy metabolism and decreased superoxide scavenging SOD2 enzyme. Interestingly, treatment with the mitochondrial superoxide scavenger mitoTEMPO can rescue the impaired adhesion and permeability *in vitro* and *in vivo*.

**Conclusions:** An impaired mitochondrial oxidative stress is a critical feature in cystinosis podocytes and the combinatory treatment of cysteamine with targeted antioxidant improves podocytes adhesion and permeability. Moreover, our developed fluorescent *CTNS* zebrafish larvae model is a useful high-throughput tool for screening new therapeutic strategies aiming at restoring the kidney functionality in cystinosis.

## FR-PO332

### Using Nanocomplexes to Deliver Therapies for Glomerular Disease

**Saif N. Malik,<sup>1</sup> Jennifer C. Chandler,<sup>1</sup> Ruhina Maeshima,<sup>1</sup> Aoife M. Waters,<sup>2</sup> Stephen L. Hart,<sup>1</sup> Tammy L. Kalber,<sup>1</sup> David A. Long.<sup>1</sup> <sup>1</sup>University College London, London, United Kingdom; <sup>2</sup>Great Ormond Street Hospital for Children NHS Foundation Trust, London, United Kingdom.**

**Background:** The onset of chronic kidney disease is often caused by damage to the kidneys' filtration unit, the glomerulus and in particular the podocyte epithelial cells lining the outer surface of glomerular capillaries. Therefore, treatment strategies that specifically target podocytes have the potential to improve glomerular disease. For glomerular disease caused by mutations, lipid nanocomplexes provide a promising strategy as they allow nucleic acid encapsulation for gene therapy and can be conjugated with peptides for targeted delivery to receptors on podocytes such as integrin  $\alpha\beta3$ . Therefore, we aimed to deliver lipid nanocomplexes directly to podocytes as a potential therapeutic strategy for glomerular disease.

**Methods:** We utilised a murine model of childhood glomerular disease with a mutation in *Wilms Tumour 1* (*WT1:c.1180C>T;p.R394W*) to compare the ability of cyclic RGD and RWrNM peptide nanocomplexes to target integrin  $\alpha\beta3$  and transfect primary healthy and diseased podocytes. We first sought transcript levels of  $\alpha\beta3$  in podocytes compared with the rest of the kidney by qPCR before transfecting podocytes with luciferase nanocomplexes (n=3/group). Transfection was quantified by luciferase assay and normalised to total protein. We then directly compared RWrNM transfection in healthy and diseased podocytes (n=5&4). *In vivo* kidney targeting was assessed following a novel ultrasound guided intra-renal artery injection in healthy mice (n=3/group).

**Results:** We found enrichment of  $\alpha\beta3$  in healthy and diseased podocytes ( $P=0.003$  &  $0.008$ ) compared with the rest of the kidney. RWrNM nanocomplexes were more effective for  $\alpha\beta3$  targeting in health and disease than cyclic RGD ( $P=0.004$  &  $0.013$ ). Furthermore, RWrNM uptake did not diminish in disease when directly compared to healthy podocytes ( $P=0.81$ ). *In vivo* experiments show high kidney localisation following ultrasound guided delivery of luciferase cyclic RGD and RWrNM nanocomplexes with 75% and 88% of the total signal accounted for by the injected kidney respectively.

**Conclusions:** This study has demonstrated that integrin  $\alpha\beta3$  can be used to target nanocomplexes directly to healthy and diseased podocytes. High kidney localisation is achieved *in vivo* by ultrasound guided renal artery injection. This forms the basis for delivery of genes that may protect podocytes using nanocomplexes in *Wt1<sup>Wt1-R394W</sup>* mice.

**Funding:** Government Support - Non-U.S.

## FR-PO333

### Methionine Restriction Prevents Cystine Urolithiasis in a Mouse Model of Cystinuria

**Mylene Perreault,<sup>1</sup> Amrik Sahota,<sup>2</sup> Min Yang,<sup>2</sup> Jay A. Tischfield,<sup>2</sup> Julia Xu,<sup>1</sup> David Hava.<sup>1</sup> <sup>1</sup>Synlogic, Cambridge, MA; <sup>2</sup>Rutgers The State University of New Jersey, New Brunswick, NJ.**

**Background:** Cystinuria is an inherited metabolic disorder caused by mutations in the *SLC3A1* and/or *SLC7A9* genes responsible for cystine reabsorption in the kidney. Defects in either of these genes is characterized by excessive excretion of cystine in the urine, which can result in the formation of crystals and/or stones in the kidney or bladder. Cystine is formed by the binding of two cysteine molecules, and strategies that aim at reducing cystine concentration in urine are recommended and include increased fluid intake, urine alkalization, and a reduction in protein intake enriched in cysteine and methionine. In mammals, the transsulfuration pathway is the only cysteine biosynthesis route and it requires the essential amino acid methionine. SYNB1353 is an engineered strain of *E. coli* Nissle that metabolizes methionine in the gastrointestinal (GI) tract and prevents its absorption. To determine whether the metabolism of methionine in the GI tract could lower cystine levels and hence prevent stone formation, we assessed the impact of dietary methionine restriction in the *Slc3a1* knockout (KO) mouse model of cystinuria.

**Methods:** Six weeks old male *Slc3a1* KO mice were provided with regular (0.62%) or low (0.12%) methionine diets for 8 weeks. Body weight and food intake were measured weekly, urine collected every 2 weeks, and bladder stone volume was determined every 2 weeks by computed tomography (CT) scan. At the end of the experiment, bladders were dissected, and stones removed and weighed.

**Results:** In *Slc3a1* KO mice, methionine restriction caused 39% body weight loss, whereas mice maintained on regular diet gained 7% of their initial body weight. Bladder stones were detected by CT scan in 7 of the 12 KO mice on regular diet, with the onset of stone detection ranging from 2 to 8 weeks of dietary treatment. However, bladder stones were not detected in mice fed the low methionine diet. Following bladder dissection, stones were identified in 2 additional mice on regular diet, with bladder and stone weights in the 9 mice ranging from 13.9-82.1 mg and 0.2-83.3 mg, respectively. Bladder weight in 12 mice maintained on low methionine diet averaged 5.7-11.0 mg.

**Conclusions:** Overall, these data indicate that methionine restriction prevents stone formation in *Slc3a1* KO mice and SYNB1353 may offer a viable approach for the treatment of cystinuria.

**Funding:** Commercial Support - Synlogic

## FR-PO334

### Preclinical Efficacy of CHK-336: A First in Class, Liver-Targeted, Small Molecule Inhibitor of Lactate Dehydrogenase for the Treatment of Primary Hyperoxalurias

**Jennifer H. Cox,<sup>1</sup> Marc-Olivier Boily,<sup>1</sup> Alex Caron,<sup>1</sup> Oliver Chong,<sup>1</sup> Jim Ding,<sup>1</sup> Samuel Gaudreault,<sup>1</sup> Robert Gomez,<sup>1</sup> John Knight,<sup>2</sup> Jeff Lester,<sup>1</sup> Xingsheng Li,<sup>2</sup> W. T. Lowther,<sup>3</sup> Renata Oballa,<sup>1</sup> David A. Powell,<sup>1</sup> Tao Sheng,<sup>1</sup> Jayakumar Surendrass,<sup>1</sup> Vincent Tong,<sup>1</sup> Joyce Wu,<sup>1</sup> Andrew J. King.<sup>1</sup> <sup>1</sup>Chinook Therapeutics Inc, Seattle, WA; <sup>2</sup>The University of Alabama at Birmingham, Birmingham, AL; <sup>3</sup>Wake Forest University School of Medicine, Winston-Salem, NC.**

**Background:** Primary hyperoxalurias (PH) 1-3 are disorders involving excess hepatic oxalate production, resulting in calcium oxalate kidney stones, progressive CKD, and potentially ESKD. There are limited therapeutic options, with only one approved agent for PH1, and no approved therapies for PH2-3. Lactate dehydrogenase (LDH) catalyzes the final step in hepatic oxalate synthesis and represents a potential therapeutic target for all forms of PH and other forms of hyperoxaluria driven by increased oxalate production. Herein we describe the preclinical efficacy profile of CHK-336, a potent and selective LDH inhibitor currently in development.

**Methods:** CHK-336 was evaluated in biochemical and cellular LDH activity assays, a <sup>13</sup>C<sub>2</sub>-glycolate stable isotope tracer pharmacodynamic model, an *Agt* knockout PH1 mouse model, and a *Ghrhr* knockout PH2 mouse model.

**Results:** CHK-336 demonstrates potent and selective inhibition of LDH in human enzyme assays and hepatocyte assays across multiple species, including hepatocytes isolated from PH1 mice. A liver-targeted tissue distribution profile was engineered into the molecule; CHK-336 demonstrates effective liver-targeting across species. In a rat pharmacodynamic model, CHK-336 inhibited the conversion of <sup>13</sup>C<sub>2</sub>-glycolate to <sup>13</sup>C<sub>2</sub>-oxalate in a dose-dependent manner. In a novel PH1 mouse model, low once-daily oral doses of CHK-336 produced robust and dose-dependent reductions in urinary oxalate to the normal range. The magnitude of effect was comparable, but with a more rapid onset than a GO-targeting siRNA. Seven days of CHK-336 treatment resulted in a statistically significant reduction in urinary oxalate in a PH2 mouse model.

**Conclusions:** By potentially blocking LDH, the final step in hepatic oxalate synthesis, along with a liver-targeted tissue distribution profile, CHK-336 is a novel oral small molecule with the potential to treat all types of primary hyperoxaluria and other disorders resulting in increased oxalate production. The human safety, pharmacokinetic and pharmacodynamic profile of CHK-336 are currently under investigation in a healthy volunteer SAD/MAD study (NCT05367661).

**Funding:** Commercial Support - Chinook Therapeutics, Inc

## FR-PO335

**Lumasiran for Patients With Primary Hyperoxaluria Type 1 and Impaired Kidney Function: 12-Month Analysis of the Phase 3 ILLUMINATE-C Trial**

Yaacov Frishberg,<sup>1</sup> Mini Michael,<sup>2,3</sup> Jaap Groothoff,<sup>4,5</sup> Hadass Shasha-Lavsky,<sup>6</sup> John C. Lieske,<sup>7</sup> Eva Simkova,<sup>8</sup> Anne-Laure A. Sellier-Leclerc,<sup>9</sup> Arnaud Devresse,<sup>10</sup> Fitsum Guebre Egziabher,<sup>11</sup> Sevcin A. Bakalolu,<sup>12</sup> Chebl Mourani,<sup>17</sup> Rola Saqan,<sup>13</sup> Richard F. Singer,<sup>14</sup> Richard G. Willey,<sup>15</sup> John M. Gansner,<sup>15</sup> Daniella Magen.<sup>16</sup> <sup>1</sup>*Shaare Zedek Medical Center, Jerusalem, Israel*; <sup>2</sup>*Texas Children's Hospital, Houston, TX*; <sup>3</sup>*Baylor College of Medicine, Houston, TX*; <sup>4</sup>*Emma's Children's Hospital, Amsterdam, Netherlands*; <sup>5</sup>*University of Amsterdam Department of Pediatric Nephrology, Amsterdam, Netherlands*; <sup>6</sup>*Galilee Medical Center, Nahariya, Israel*; <sup>7</sup>*Mayo Clinic Division of Nephrology and Hypertension, Rochester, MN*; <sup>8</sup>*Al Jalila Children's Specialty Hospital, Dubai, United Arab Emirates*; <sup>9</sup>*Hopital Femme Mere Enfant, Bron, France*; <sup>10</sup>*Cliniques universitaires Saint-Luc, Bruxelles, Belgium*; <sup>11</sup>*Edouard Herriot Hospital, Lyon, France*; <sup>12</sup>*Gazi Universitesi, Ankara, Turkey*; <sup>13</sup>*Jordan University of Science and Technology, Irbid, Jordan*; <sup>14</sup>*Camberra Health Services, Garran, ACT, Australia*; <sup>15</sup>*Anlylam Pharmaceuticals Inc, Cambridge, MA*; <sup>16</sup>*Rambam Health Care Campus, Haifa, Israel*; <sup>17</sup>*Hotel-Dieu De France, Beirut, Lebanon*.

**Background:** Primary hyperoxaluria type 1 (PH1) is a rare genetic disease characterized by hepatic oxalate overproduction leading to progressive kidney disease. In PH1, plasma oxalate (POx) increases as kidney function declines; in CKD 3b–5, POx is typically elevated and is associated with an increased risk of systemic oxalosis, making it a relevant trial endpoint. In the ILLUMINATE-C 6-month (M) primary analysis, administration of lumasiran, an RNA interference therapeutic designed to reduce hepatic oxalate production, produced substantial POx reductions and acceptable safety in PH1 patients with impaired kidney function. Here we present 12M results.

**Methods:** ILLUMINATE-C (NCT04152200) is an ongoing Phase 3, single-arm study (Cohort A: N=6, no hemodialysis [HD] at study start; Cohort B: N=15, on HD). The primary analysis period is followed by an extension period (EP) of up to 54M. Key inclusion criteria included genetically confirmed PH1, eGFR  $\leq$ 45 mL/min/1.73m<sup>2</sup>, and POx  $\geq$ 20  $\mu$ mol/L.

**Results:** All 21 patients entered the EP (median [range] exposure, 14.2 [8.3–19.7] M). As of the M12 assessments, 2 Cohort A patients (baseline eGFR, 8.6–16.0 mL/min/1.73m<sup>2</sup>) initiated HD. In Cohort B, 1 patient received a kidney transplant, discontinued HD, and continued lumasiran; 1 received a liver/kidney transplant and discontinued lumasiran. POx mean % reduction from baseline at M12 was 69.3% and 34.3% in Cohorts A and B, respectively; mean absolute reduction was 60.7 and 42.4  $\mu$ mol/L. POx AUC<sub>0-24h</sub> mean % reduction from baseline between HD sessions was 40.9% at M12 (Cohort B). Most burdensome symptoms improved or remained stable with lumasiran. The most common lumasiran-related adverse events (AEs) were mild, transient injection-site reactions. There were no deaths or lumasiran-related serious or severe AEs, discontinuations, or withdrawals.

**Conclusions:** Lumasiran showed sustained POx reductions in PH1 patients with CKD 3b–5, with an acceptable safety profile through M12. The impact on systemic oxalosis and transplant outcomes will be further monitored in the EP.

**Funding:** Commercial Support - Anlylam Pharmaceuticals

## FR-PO336

**Karyomegalic Interstitial Nephritis Is Triggered by Oxidative Stress Caused by Mitochondrial Deficiency in FAN1-Deficient Proximal Tubule Cells**

Merlin Airik,<sup>1</sup> Amy B. Huynh,<sup>1</sup> Eric S. Goetzman,<sup>2</sup> Rannar Airik.<sup>1</sup> <sup>1</sup>*University of Pittsburgh, Pittsburgh, PA*; <sup>2</sup>*Children's Hospital of Pittsburgh of UPMC, Pittsburgh, PA*.

**Background:** Karyomegalic interstitial nephritis (KIN) is a genetic form of chronic kidney disease (CKD) caused by mutations in FAN1, a DNA repair enzyme. Accordingly, accumulation of DNA damage in the kidney tubular epithelium is a hallmark of KIN. However, the source and nature of the agent(s) responsible for inducing DNA lesions that trigger KIN have remained elusive. Here, we show using *in vivo* and *in vitro* models, that mitochondrial-derived ROS is critical for inducing KIN pathogenesis.

**Methods:** KIN was induced in 12-week-old *Fan1* KO mice by employing 2 cisplatin injury models: one mimicking AKI (weekly 2 x 4 mg/kg cisplatin), and another CKD (weekly 5 x 2 mg/kg cisplatin). Coincident with cisplatin, mice were administered a novel mitochondrial ROS scavenger at a dose of 10 mg/kg. Histological analysis was performed using PAS and HE. Markers of tubular injury, DNA damage and fibrosis were assessed by IF and IHC. Human kidney proximal tubular cells (PTECs) were used to model FAN1 loss of function *in vitro*. RNA-seq analysis was performed to identify transcriptional changes in KIN. Mitochondrial OXPHOS was measured using the Oroboros Oxygraph-2k System. Metabolite measurements were performed using YSI 7100 Bioanalyzer.

**Results:** Transcriptional profiling of kidneys with KIN revealed a significant downregulation of genes involved in mitochondrial energy metabolism - OXPHOS, fatty acid oxidation (FAO) and peroxisomal function. Metabolic analysis of *FAN1* KO PTECs showed a defect in respiratory chain, increased oxidative stress and a shift to increased lactate secretion. Similarly, *Fan1* KO kidneys revealed marked increase in oxidative DNA damage (8-OHdG), lipid peroxidation (4-HNE) and tubular lipotoxicity

(OilRedO) after AKI or CKD. Treatment with mitochondrial ROS scavenger reduced the level of oxidative lesions in *Fan1* KO kidneys, mitigated tubular damage and blocked the formation of KIN.

**Conclusions:** Loss of *FAN1* causes defective mitochondrial metabolism and increased ROS generation in the kidney which give rise to oxidative DNA lesions and results in KIN. Blocking mitochondrial ROS protects *Fan1* KO kidneys from DNA damage accumulation, mitigates tubular injury and improves kidney function in mice.

**Funding:** NIDDK Support

## FR-PO337

**Using an Innovative N-of-1 Trial Approach Testing Efficacy of Salt Supplementation in Gitelman Syndrome**

Maartje F. Verploegen,<sup>1</sup> Michiel L. Wieërs,<sup>2</sup> Federica Giardina,<sup>3</sup> Francesco Trepiccione,<sup>4</sup> Stephen B. Walsh,<sup>5</sup> Ewout J. Hoorn,<sup>2</sup> Tom Nijenhuis.<sup>1</sup> <sup>1</sup>*Radboudumc Afdeling Nierziekten, Nijmegen, Netherlands*; <sup>2</sup>*Erasmus MC Afdeling Inwendige Geneeskunde, Rotterdam, Netherlands*; <sup>3</sup>*Radboudumc Department for Health Evidence, Nijmegen, Netherlands*; <sup>4</sup>*Università degli Studi della Campania Luigi Vanvitelli Dipartimento di Scienze Mediche Traslazionali, Napoli, Italy*; <sup>5</sup>*University College London Department of Renal Medicine, London, United Kingdom*.

**Background:** Gitelman syndrome is a rare hereditary salt-losing tubulopathy resulting in hypokalemic alkalosis and hypomagnesemia. Treatment practices to correct hypokalemia include high-dose potassium supplementation and potassium-sparing diuretics. Furthermore, ad libitum dietary salt intake is advised. The efficacy of supraphysiological salt supplementation has yet to be investigated. We aim to investigate this salt supplementation in an individualized manner using N-of-1 trials, which are crossover trials conducted in a single patient. This unique study design facilitates research into individual treatment effects.

**Methods:** We are currently performing multiple randomized, double-blind, placebo-controlled N-of-1 trials in patients with symptomatic, genetically-proven Gitelman syndrome. Sodium chloride (NaCl; 12 gr/day) and placebo are compared during 6 consecutive four-week treatment periods (3 periods of each treatment). Treatment periods are randomly allocated. After each treatment period, outcome parameters, among which serum potassium and symptoms, are measured. Because of the N-of-1 design, the data of each patient will be analyzed individually to draw conclusions about the effect of salt supplementation in that individual patient. Finally, all N-of-1 trials will be aggregated to draw conclusions at group level.

**Results:** Currently, five patients have completed their N-of-1 trial. Preliminary analyses demonstrate that NaCl supplementation increased serum potassium in three patients with a mean of 0.13 mmol/L, 0.17 mmol/L, and 0.35 mmol/L, respectively. In the other two patients, no increase in potassium was apparent. During Kidney Week in November 2022, we will be able to present the results of 12 patients that have completed an N-of-1 trial.

**Conclusions:** The N-of-1 trial is an inventive method producing an individualized verdict on the efficacy of an intervention and is suited for use in rare diseases. NaCl supplementation resulted in a clinically relevant increase in serum potassium in three out of five patients with Gitelman syndrome. The results of the ongoing N-of-1 trials will provide further insight into the effect of NaCl supplementation and might enable the (prior) identification of patients who benefit from NaCl supplementation.

## FR-PO338

**Modelling APRT Deficiency in Kidney Cells In Vitro**

Hildur R. Helgudottir,<sup>1</sup> Runolfur Palsson,<sup>2,1</sup> Vidar O. Edvardsson,<sup>2,1</sup> Thorarinn Gudjonsson.<sup>1,2</sup> APRT Deficiency Research Program of the Rare Kidney Stone Consortium <sup>1</sup>*Heilbrigdisvisindasvid - Haskoli Island, Reykjavik, Iceland*; <sup>2</sup>*Landspitali-The National University Hospital of Iceland, Reykjavik, Iceland*.

**Background:** Adenine phosphoribosyltransferase deficiency (APRTd) is a rare autosomal recessive disorder of adenine metabolism that results in the generation and renal excretion of large amounts of the poorly soluble 2,8-dihydroxyadenine (DHA). Affected individuals form urinary stones and crystal nephropathy characterized by inflammation and fibrosis leading to progressive chronic kidney disease. Improved understanding of the mechanisms of DHA crystal-induced kidney injury and identification of alternative therapeutic approaches remain essential unmet needs. The aim of this study was to establish a cell culture model for the characterization of inflammatory and phenotypic changes associated with DHA crystal-induced kidney injury that may be used as targets for clinical interventions.

**Methods:** Two kidney cell lines, Madin-Darby canine cell line (MDCK) and human embryonic cell line (HEK293) were used in the study. Both cell lines were treated with DHA in concentrations similar to those observed in the urine of untreated humans with APRTd, both in monolayers and 3D/transwell assays. Further, siRNA against APRT was utilized to knock down the gene in HEK293. Read-out assay included cell viability, RT-PCR, western blot and immunostaining.

**Results:** APRT knockdown was successful and confirmed with RT-qPCR. Expression of the APRT gene was significantly reduced, and the morphology of the cells changed with knockdown, cells showing more elongated protrusions than control cells. The addition of DHA did not significantly affect cell viability. Initial analysis demonstrated an increase in the expression of proinflammatory markers (interleukin (IL)-1 $\beta$  and IL-8) in HEK293 cells upon DHA treatment, indicating an inflammatory response.

**Conclusions:** We have established a cell culture model that captures APRT deficiency in MDCK and HEK293 kidney cell lines. Preliminary data suggest that DHA treatment of these cell lines in vitro induces an inflammatory response. Ongoing experiments focus on further characterizing the inflammatory response pathways and phenotypic changes in the search for disease-specific targets for clinical interventions.

**Funding:** Government Support - Non-U.S.

#### FR-PO339

##### Baseline Characteristics of Patients With Fabry Disease Enrolled in the Pegunigalsidase Alfa Expanded-Access Program

Ankit Mehta,<sup>1</sup> William Wilcox,<sup>2</sup> Khan J. Nedd,<sup>3</sup> John A. Bernat,<sup>4</sup> Jasmine Knoll,<sup>5</sup> John L. Jefferies,<sup>6</sup> Nicola Longo,<sup>7</sup> Eric L. Wallace,<sup>8</sup> Einat Almon,<sup>9</sup> Sari Alon,<sup>9</sup> Raul Chertkoff,<sup>9</sup> Dawn Sullivan,<sup>10</sup> Rossana Rocco,<sup>10</sup> Irene Koulinka,<sup>10</sup> Ozlem Goker-Alpan,<sup>11</sup> <sup>1</sup>Baylor University Medical Center at Dallas, Dallas, TX; <sup>2</sup>Emory University School of Medicine, Atlanta, GA; <sup>3</sup>Infusion Associates, Grand Rapids, MI; <sup>4</sup>University of Iowa Hospital and Clinics Iowa City, Iowa City, IA; <sup>5</sup>Phoenix Children's Hospital, Phoenix, AZ; <sup>6</sup>The University of Tennessee Health Science Center, Memphis, TN; <sup>7</sup>University of Utah, Salt Lake City, UT; <sup>8</sup>University of Alabama at Birmingham, Birmingham, AL; <sup>9</sup>Protalix Biotherapeutics, Carmiel, Israel; <sup>10</sup>Chiesi USA, Inc, Boston, MA; <sup>11</sup>Lysosomal & Rare Disorders Research & Treatment Center, Fairfax, VA.

**Background:** Fabry disease (FD) is a rare genetic disorder caused by deficiency in lysosomal enzyme, alpha-galactosidase A ( $\alpha$ -Gal A), activity. Pegunigalsidase alfa (PA) is a novel PEGylated  $\alpha$ -Gal A enzyme replacement therapy in development for FD. An expanded-access program (EAP) is offered in the US to adults with FD that cannot be adequately managed with approved drugs and who are not eligible for clinical trials. Characterizing patients in an EAP is critical to understanding unmet needs.

**Methods:** We collated baseline characteristics for patients with FD enrolled in the ongoing EAP in the US as of January 1, 2022.

**Results:** At the data cutoff date, 30 patients had enrolled in the EAP; primarily due to worsening disease symptoms and/or poor tolerability of infusions. There was a mean of 12.9 (SD 11.8) years since diagnosis and most patients had received agalsidase beta treatment (mean duration 7.1 [SD 4.7] years). Median (range) baseline eGFR was 91.4 mL/min/1.73m<sup>2</sup> (14.1–131.9) and median concentration (range) of plasma globotriaosylsphingosine was 18.1 nM (0.8–134.6)

**Conclusions:** Assessment of patients in the PA EAP demonstrated gaps in current treatment options for FD. Some patients had experienced persistent symptoms despite treatment and/or poor tolerability of infusions and may benefit from the PA EAP. Follow-up of clinical outcomes from this EAP will be monitored and presented as data become available.

**Funding:** Commercial Support - This study was sponsored by Protalix Ltd. Medical writing support was provided by Ebony Lai Hing, PhD, of Oxford PharmaGenesis, Newtown, PA, and was funded by Chiesi USA, Inc.

Table. Baseline Demographics and Characteristics

Baseline Characteristic	Overall (N=30)
Age, years, mean (SD)	41.4 (15.2)
Reason for enrollment, n (%)	
Worsening disease symptoms	14 (46.7)
Tolerability of infusions and worsening disease symptoms	6 (20.0)
Persistent symptoms	6 (20.0)
Tolerability of infusions	3 (10.0)
Worsening symptoms between infusions	1 (3.3)
<b>Medical history</b>	
At least 1 medical condition ongoing at screening, n (%)	27 (90.0)
At least 1 medical condition not ongoing at screening, n (%)	21 (70.0)
Concomitant disease, n (%)	
Cardiac	20 (66.7)
Nervous system	20 (66.7)
Psychiatric	16 (53.3)
<b>Fabry disease treatment status at enrollment</b>	
Treatment naïve, n	1
Not on therapy at enrollment but treated previously, n	
Agalsidase beta	5
Migalastat	1
Venglustat	1
Treatment at time of enrollment, n	
Agalsidase beta	22
Migalastat	1
<b>Kidney function</b>	
eGFR, mL/min/1.73m <sup>2</sup> , median (range)	91.4 (14.1–131.9)
Serum creatinine, mg/dL, median (range)	1.0 (0.6–9.2)
Urine protein:creatinine ratio, n (%)	
Normal	16 (53.3)
Abnormal, not clinically significant	11 (36.7)
Abnormal, clinically significant	0
Missing	3 (10.0)
Chronic kidney disease stage, n (%)	
Stage 1	14 (46.7)
Stage 2	5 (16.7)
Stage 3a <sup>*</sup> and 3b <sup>*</sup>	7 (23.3)
Stage 4 <sup>*</sup> or 5 <sup>*</sup>	4 (13.4)
Androgen antibody status, n (%)	
Negative	18 (60.0)
Positive	11 (36.7)
Missing	1 (3.3)

eGFR, estimated glomerular filtration rate.

\*Moderate kidney disease; †severe kidney disease; ‡kidney failure

#### FR-PO340

##### Fabry Disease Mouse Is Resistant to High-Salt Diet-Induced Hypertension Probably via Dysfunctional Sodium Transporters and Aquaporin 2

Junkyu Park, Wonji Jo, Sungjin Chung, Eun Sil Koh. *The Catholic University of Korea, Seoul, Republic of Korea.*

**Background:** Fabry disease is a rare X-linked lysosomal storage disorder resulting from an error in glycosphingolipid metabolism caused by the *GLA* gene mutation. Patients with Fabry disease often have near normal or even low systemic blood pressure although the mechanism underlying such observed finding remains unexplained. This study examined whether a high salt intake could affect transport of sodium and water and induce hypertension in mice with Fabry disease.

**Methods:** Fabry disease model mice (B6;129-Gla<sup>tm1</sup>Kul/J) and wild-type (WT) mice received 8% or normal NaCl salt diet for 2 weeks.

**Results:** A high-salt diet for 2 weeks generated higher blood pressure in WT mice but not in Fabry disease mice. Free water clearance (FWC) and electrolyte free water clearance (EFWC) in groups fed with a high salt diet were lower than those in groups fed with a normal salt diet. Both high salt-fed WT and Fabry disease mice had decreased  $\gamma$ -subunit of epithelial Na channel (ENaC) compared with normal salt-fed groups. In Fabry disease mice fed a high-salt diet, there was an decrease in renal expressions of Na<sup>+</sup>/H<sup>+</sup> exchanger isoform 3 (NHE3) and Na<sup>+</sup>-Cl<sup>-</sup> cotransporter (NCC) compared with WT mice fed a high-salt diet. Although renal expression of vasopressin V2 receptor (V2R) was upregulated in Fabry mice fed with a high salt diet, renal aquaporin 2 (AQP2) level failed to increase up to the level in WT mice fed with a high salt diet.

**Conclusions:** These findings suggest that the decreased expression of NHE3 and NCC and impaired response of AQP2 in kidneys of Fabry disease to a salt load could be one of mechanisms by which Fabry disease could have resistance to the development of hypertension.

#### FR-PO341

##### TFEB Activation by Ceria-Zirconia Antioxidant Nanoparticles Attenuates Kidney Injury in Cellular and Animal Models of Fabry Disease

Se-Hee Yoon,<sup>1</sup> Won Min Hwang,<sup>1</sup> Yohan Park,<sup>1</sup> Sung-Ro Yun,<sup>1</sup> Kuk Ro Yoon,<sup>2</sup> <sup>1</sup>Konyang University College of Medicine, Daejeon, Republic of Korea; <sup>2</sup>Hannam University, Daejeon, Republic of Korea.

**Background:** Fabry disease (FD) is a lysosome storage disease (LSD) characterized by significantly reduced intracellular autophagy function. This contributes to the progression of intracellular pathologic signaling and can lead to organ injury. Phospholipid-polyethyleneglycol-capped Ceria-Zirconia antioxidant nanoparticles (PEG-CZNP) have been reported to enhance autophagy flux. We investigated the signalling pathway of PEG-CZNP associated with autophagy flux function and analyzed whether they suppress kidney injury in both cellular and animal models of FD.

**Methods:** PEG-CZNP with size 2-3nm were synthesized using non-hydrolytic sol-gel reaction. HK-2 cells and conditionally human immortalized podocytes were transfected with shRNA targeting  $\alpha$ -GLA. FD model mice, B6;129-Glatm1Kul/J (known as  $\alpha$ -Gal A KO mice) were used for *in-vivo* study. Mice were sacrificed at 3- and 6-month age for investigation.

**Results:** PEG-CZNP treatments decreased the intracellular globotriaosylceramide (Gb3) accumulation levels in both cellular and animal models of FD by enhancing the autophagy flux. PEG-CZNP enhanced TFEB nuclear translocation by GSK3 $\beta$  inhibition. Activated TFEB by PEG-CZNP restored the blunted ATK/mTOR pathway in cellular models of FD. PEG-CZNP led to decrease of the intracellular oxidative stress, inflammatory response and fibrosis in cellular and animal models of FD.

**Conclusions:** TFEB activation by PEG-CZNP recovered the diminished autophagy flux function in cellular and animal models of FD and showed the potential as a new therapeutic medicine by alleviating the progression of kidney injury in FD.

#### FR-PO342

##### Modeling Fabry Disease in Kidney and Heart Organoids From Patient-Derived Human Induced Pluripotent Stem Cells

Sandra D. Laufer,<sup>1</sup> Anna Reinelt,<sup>1</sup> Milagros N. Wong,<sup>1</sup> Linda Blomberg,<sup>2</sup> Christine E. Kurschat,<sup>2</sup> Nicola Wanner,<sup>1</sup> Victor G. Puelles,<sup>1</sup> Tobias B. Huber,<sup>1</sup> Fabian Braun,<sup>1</sup> <sup>1</sup>Universitätsklinikum Hamburg-Eppendorf, Hamburg, Germany; <sup>2</sup>Uniklinik Köln, Köln, Germany.

**Background:** Fabry disease is an inherited lysosomal storage disorder, caused by mutations in the *GLA* gene, resulting in a multisystemic disease. Currently existing animal models fail to mirror the complexity of this clinical & molecular phenotype, specifically Fabry nephropathy and cardiomyopathy. This project aims to establish informative human *in vitro* systems for Fabry disease to advance our molecular understanding by employing the recent advances in human induced pluripotent stem cells (hiPSC) and organoid differentiation

**Methods:** We collected primary urinary cells (PUCs) of 15 Fabry patients with different mutations (classical, classical and chaperone amenable, late onset, unclear significance). 8 PUC samples were reprogrammed into hiPSC with subsequent creation of respective isogenic control lines by CRISPR Cas9 gene editing. These cell lines were differentiated into kidney and heart organoids as well as engineered heart tissue (EHTs) using published protocols.

**Results:** All patient-derived hiPSC lines and organoids retained decreased enzyme activity and Gb3 accumulation. Fabry mutations did not impair the differentiation into organoids and EHTs. Kidney organoids depicted the presence of marker proteins for different nephron segments, including glomerular structures. Heart organoids showed contractions and contained different cardiac cell types including cardiomyocytes with sarcomeres and Z-Disc formation. EHTs displayed functional abnormalities including decreased contractile force and arrhythmic beating indicative of molecular changes due to GLA deficiency.

**Conclusions:** This project underlines the advantages of novel complex human *in vitro* disease modelling to study Fabry disease. Ongoing experiments focus on the detailed structural assessment and single cell analyses of the established systems in the presence and absence of available therapies.

**Funding:** Commercial Support - Amicus Therapeutics, Government Support - Non-U.S.

### FR-PO343

#### Discovery of a Novel Autophagy Activator to Treat Autosomal Dominant Tubulointerstitial Kidney Disease

Yeawon Kim,<sup>1</sup> Chuang Li,<sup>1</sup> Chenjian Gu,<sup>1</sup> Eric Tycksen,<sup>1</sup> Sun-Ji Park,<sup>1</sup> Anuradhika Puri,<sup>1</sup> Terri A. Pietka,<sup>1</sup> Jothilingam Sivapackiam,<sup>1</sup> Kendrah O. Kidd,<sup>2</sup> Bryce G. Johnson,<sup>3</sup> Stanislav Kmoch,<sup>3</sup> Jeremy S. Duffield,<sup>6</sup> Anthony J. Bleyer,<sup>2</sup> Meredith Jackrel,<sup>1</sup> Fumihiko Urano,<sup>1</sup> Vijay Sharma,<sup>1</sup> Maria Lindahl,<sup>4</sup> Ying M. Chen.<sup>1</sup> <sup>1</sup>Washington University in St Louis, St Louis, MO; <sup>2</sup>Wake Forest University, Winston-Salem, NC; <sup>3</sup>Univerzita Karlova, Prague, Czechia; <sup>4</sup>Helsingin yliopisto, Helsinki, Finland; <sup>5</sup>Pfizer Inc, New York, NY; <sup>6</sup>Prime Medicine, Cambridge, MA.

**Background:** Autosomal dominant tubulointerstitial kidney disease due to uromodulin mutations (ADTKD-UMOD) is one of the leading hereditary kidney diseases. UMOD is largely expressed in the thick ascending limb (TAL) tubular cells, and the p.His177\_Arg185del in-frame deletion is one of the most prevalent human mutations. Currently there is no treatment for ADTKD.

**Methods:** CRISPR/Cas9 was utilized to generate an ADTKD-UMOD mouse model carrying *Umod* p.Tyr178\_Arg186del, analogous to human p.His177\_Arg185del. Inducible tubular-specific MANF transgenic and TAL-specific MANF knockout mice were also generated. Meanwhile, stable HEK cell line harboring WT or p.His177\_Arg185del was established. RNA sequencing was performed on isolated primary TAL cells. Immunoblot, q-PCR, immunofluorescence staining and electron microscopy were employed. Mitochondrial function was assessed by Oroboros high resolution respirometry and mitochondrial ROS was monitored by <sup>68</sup>Ga-Galuminex PET/CT in live animals for the first time.

**Results:** We find activated endoplasmic reticulum (ER) stress, severely impaired autophagy/mitophagy and dysfunctional mitochondria in the mutant TAL tubules, and mitochondrial DNA leaking to cytosol leads to activation of the cyclic GMP-AMP synthase-stimulator of interferon genes (cGAS-STING) inflammatory pathway and cell death in the *Umod* Y178-R186del mice. Mesencephalic astrocyte-derived neurotrophic factor (MANF), a novel ER stress-regulated secreted protein is induced in both mutant kidney and kidney biopsies with the mutation. We demonstrate that genetic ablation of MANF in TALs worsens autophagy and mitochondria failure, and exacerbates kidney fibrosis. Conversely, tubular overexpression of MANF after the onset of disease stimulates autophagy/mitophagy through activation of p-AMPK-FOXO3 axis, leading to increased autophagic clearance of mutant UMOD. Moreover, MANF induction promotes mitochondrial biogenesis and oxidative phosphorylation, as well as alleviates cGAS-STING signaling, thereby improving kidney function.

**Conclusions:** Our findings uncover a previously unknown mechanism of MANF action that can activate autophagy and protect mitochondrial function in ADTKD.

**Funding:** NIDDK Support, Other NIH Support - NIBIB and NHLBI, Other U.S. Government Support

### FR-PO344

#### Knock-Down of Uromodulin Using Antisense Oligonucleotides as a Potential Treatment for Autosomal Dominant Tubulointerstitial Kidney Disease

Kathy Y. Morgan, Nino Jungels, Ryan A. Oliver, Tushare Jinadasa, Kailash Adhikari, Nicholas L. Kern, Saad Sohail, Stephanie Garcia, Annika Malmberg, Kevin Kim. *Sarepta Therapeutics Inc, Cambridge, MA.*

**Background:** Autosomal Dominant Tubulointerstitial Kidney Disease-Uromodulin (ADTKD-UMOD) is a genetic disease caused by mutations in the uromodulin (UMOD) or Tamm-Horsfall protein. The misfolded UMOD prevents the secretion of the protein and causes intracellular UMOD to aggregate and accumulate inside the loop of Henle and distal convoluted tubule. This aggregation leads to progressive and irreversible chronic kidney disease. We hypothesized that peptide-conjugated phosphorodiamidate morpholino oligonucleotides (PPMOs) can knock down *UMOD* expression, which can potentially reduce the disease-causing UMOD aggregation inside the cells.

**Methods:** A library of PPMOs was designed to bind to the complementary sequences of the mouse *Umod* gene and induce nonsense-mediated decay. These PPMOs were screened in mIMCD-3 cells, which express endogenous *Umod*, to find the most efficacious sequence. The sequence that caused the largest *Umod* knockdown was then further characterized *in vitro* and *in vivo*.

**Results:** After screening the library of PPMOs, PPMOs that exhibited knockdown of *Umod* expression were further characterized and demonstrated robust knockdown of *Umod* expression in a dose-dependent manner in mIMCD-3 cells. In the high dose group, up to 85% knockdown of *Umod* expression was observed. PPMO was then dosed in wild-type mice where up to 70% knockdown of *Umod* was observed.

**Conclusions:** PPMOs to knockdown *Umod* and have shown their efficacy both *in vitro* and *in vivo*. These findings demonstrate that PPMOs have the potential to preserve renal function in patients with ADTKD.

**Funding:** Commercial Support - Sarepta Therapeutics, Inc.

### FR-PO345

#### Pkd2 Re-Expression Can Reverse Liver Cysts and Improve GFR in Mouse Models of Autosomal Dominant Polycystic Kidney Disease

Ke Dong,<sup>1</sup> Mingshen Tham,<sup>1</sup> Adrian Cordido,<sup>1</sup> Yiqiang Cai,<sup>1</sup> Steven Lim Cho Pei,<sup>1</sup> Rishi Bhardwaj,<sup>1</sup> Zemeng Wei,<sup>1</sup> Michael Rehman,<sup>1</sup> Kasturi Roy,<sup>1</sup> Xin Tian,<sup>1</sup> Stefan Somlo.<sup>1,2</sup> <sup>1</sup>Yale University School of Medicine Department of Internal Medicine, New Haven, CT; <sup>2</sup>Yale University School of Medicine Department of Genetics, New Haven, CT.

**Background:** We have previously shown that PKD gene re-expression reverses polycystic kidney disease in inducible, whole nephron Cre mediated mouse models of ADPKD. We now sought to investigate the potential for cyst reversal in the *Pkd2*<sup>W525</sup> mouse model in which macrocyst formation occurs by stochastic, non-Cre recombinase dependent, second hit events that better resemble the genetic mechanism of human ADPKD and allows determination of the potential to reverse both polycystic kidney and liver phenotypes.

**Methods:** *Pkd2*<sup>W525/-</sup> and tamoxifen inducible *Pkd2-BAC* re-expression (*Pkd2*<sup>FSF</sup>;*Rosa26*<sup>Flpo/ER</sup>) models previously established in the lab were intercrossed to generate *Pkd2*<sup>W525/-</sup>;*Pkd2*<sup>FSF</sup>;*Rosa26*<sup>Flpo/ER</sup> mice (*Pkd2*<sup>W525/Flpo</sup>). *Pkd2* re-expression was induced with 7 daily intraperitoneal tamoxifen injections beginning at 16 weeks. Serial kidney MRI were obtained at 16, 19 and 24 weeks and kidney and liver histology was examined at 24 weeks. In addition, we used our published *Pkd2*<sup>Cre/Flpo</sup> model with doxycycline induced *Pkd2* inactivation at 4-6 weeks and reactivation at 16 weeks to measure serial GFR at 16 and 19 weeks.

**Results:** Compared to 16-week-old *Pkd2*<sup>W525/-</sup> mice, kidney weight/body weight ratio (1.812% vs 1.333%, *P*=0.0049), liver weight/body weight ratio (5.299% vs 4.371%, *P*=0.0198) and kidney cystic index (22.18% vs 7.164%, *P*=0.0002) were significantly reduced in 24-week-old *Pkd2*<sup>W525/Flpo</sup> mice following *Pkd2* reactivation at 16 weeks. Moreover, MRI images shows progressive decrease in kidney cystic burden from 16 to 24 weeks. Kidney and liver histology at 24 weeks showed reduced cystic changes but persistent residual fibrosis and focal inflammation compared to 16-week-old *Pkd2*<sup>W525/-</sup> mice which exhibited multifocal cysts. Separately, *Pkd2*<sup>Cre/Flpo</sup> mice which showed reduced GFR at 16 weeks before *Pkd2* re-expression, had normalization of GFR at 19 weeks age, 3 weeks after *Pkd2* re-expression (0.77 ml/min/100g vs 1.45 ml/min/100g, *P*=0.0032).

**Conclusions:** *Pkd2* re-expression can reverse both kidney and liver cysts in a spontaneous, non-Cre recombinase dependent *Pkd2* model that more closely recapitulates the human ADPKD phenotype with a smaller number of larger macrocysts. Furthermore, our follow-up study to our published data shows that improved GFR accompanies improved histology following *Pkd* gene re-expression.

**Funding:** NIDDK Support, Other U.S. Government Support, Private Foundation Support

### FR-PO346

#### A Novel Organoid Model for Autosomal Dominant Polycystic Kidney Disease Based on Mouse Nephron Progenitor Cells (NPCs)

Yu Ishimoto,<sup>1</sup> Toshikazu Araoka,<sup>2</sup> Luis F. Menezes,<sup>1</sup> Tatsuya Shimizu,<sup>2</sup> Shinichi Mae,<sup>2</sup> Kenji Osafune,<sup>2</sup> Gregory G. Germino.<sup>1</sup> <sup>1</sup>National Institute of Diabetes and Digestive and Kidney Diseases, National Institutes of Health, Bethesda, MD; <sup>2</sup>Center for iPS Cell Research and Application, Kyoto University, Kyoto, Japan.

**Background:** An *in vitro* cell culture system that accurately recapitulates ADPKD cystogenesis is needed, and a human iPS cell-derived nephron organoid system is one of the options. However, the process takes >20 days, differentiation efficiency varies between cell lines, and long-term methods of induction of differentiation result in higher inter-experiment variability. Moreover, the lack of a mouse-based system means that the results of *in vitro* studies cannot be easily assessed in a whole organism. To overcome these problems, we have established a mouse nephron organoid system from primary NPCs.

**Methods:** We sorted NPCs from mouse E13.5 embryonic kidneys using antibodies that detect kidney lineage differentiation markers. Sorted NPCs were maintained in 3D expansion culture and evaluated for their nephrogenic potential. We modified conditions to assess organoid differentiation using both air-fluid and suspension culture methods. Finally, we used established differentiation protocols to evaluate cystogenesis in nephron organoids derived from NPCs of ADPKD mouse models.

**Results:** Robo2<sup>high</sup>/Pdgfrb<sup>+</sup>/Podocalyxin<sup>+</sup> cells (NPCs) sorted from E13.5 embryonic WT, *Pkd1*<sup>KO/KO</sup>, *Pkd2*<sup>KO/KO</sup>, and *Pkd1*<sup>clck/cko</sup>;tamoxifen *Cre* kidneys could be cultured for >40 passages and maintain nephrogenic potential, and they could be differentiated into nephron organoids using either air-fluid or suspension culture methods in <10 days. NPCs established from ADPKD models spontaneously formed cyst-like structures without inducers like forskolin in suspension culture but not in air-fluid culture.

**Conclusions:** Mouse primary NPCs could be maintained long term with nephrogenic potential. ADPKD mutants spontaneously make cyst-like structures when grown in suspension. This is the first mouse NPC-based organoid system that appears to make cyst-like structures spontaneously and will be a useful tool to reveal mechanisms of cystogenesis in ADPKD.

**Funding:** NIDDK Support

#### FR-PO347

### Novel Missense Mutation in SAMD9L Linked to Autosomal Dominant Cystic Kidney Disease in Mice Associated With Proteostatic Stress and Metabolic Reprogramming

Dorian Kaminski,<sup>1</sup> Yalu Zhou,<sup>1</sup> Dilip K. Deb,<sup>1</sup> Joshua S. Waitzman,<sup>2</sup> Susan E. Quaggin.<sup>1,3</sup> <sup>1</sup>Northwestern University Feinberg School of Medicine, Chicago, IL; <sup>2</sup>Beth Israel Deaconess Medical Center, Boston, MA; <sup>3</sup>Northwestern Memorial Hospital, Chicago, IL.

**Background:** Genetic cystic kidney syndromes, including polycystic kidney disease and nephronophthisis, are important causes of renal impairment. Here, we present a cystic kidney phenotype in mice carrying a novel missense mutation in *SAMD9L*, a gene that has previously been implicated in congenital autoinflammatory disorders and pediatric myelodysplastic syndrome.

**Methods:** An ENU mutagenesis library was screened for renal phenotypes and mutant mouse strains were established via backcrossing. The candidate gene was identified via mutation mapping, exome capture, high throughput sequencing on the SOLiD 4 platform (Applied Biosystems) and confirmed via whole-genome sequencing on the Illumina XTen machine. The phenotype was characterized via whole-body imaging, histology, immunoblotting, bulk RNAseq, and scRNA-seq on the 10x platform.

**Results:** A mutant with cystic kidneys was identified. While heterozygous mice exhibited a renal-restricted phenotype inherited in an autosomal dominant fashion, homozygous mutants exhibited perinatal lethality due to vascular anomalies and hypoxia. The trait was inherited in Mendelian ratios. Mutation mapping and high throughput sequencing revealed a critical region on Chr6 containing an A->T transversion in the coding region of *SAMD9L*. Kidney histology renal cysts along the entire length of the nephron and collecting system, including glomerulocysts. Bulk and scRNAseq of mutant kidneys revealed differential expression of several hundred genes, but not genes previously implicated in inherited cystic kidney disease. In homozygous mutants, there was marked differential expression of genes involved in the unfolded protein response, c-Myc signaling, and fatty acid oxidation. In heterozygous mutants, a similar but attenuated transcript signature was seen in differentiated nephron progenitors and mature epithelial clusters.

**Conclusions:** We identified a novel missense mutation in *SAMD9L* that resulted in a severe cystic kidney phenotype, with associated perturbations in proteostatic pathways and metabolism. Future experiments will include *in vivo* metabolic flux analysis and *in vitro* measurement of translation dynamics in a cell culture model.

#### FR-PO348

### Repurposing Calcium-Sensing Receptor Activator Cinacalcet for Autosomal Dominant Polycystic Kidney Disease Treatment

Pattareeya Yottasan, Qi Tiffany Chu, Onur Cil. University of California San Francisco, San Francisco, CA.

**Background:** ADPKD is characterized by progressive cyst formation and enlargement leading to renal failure. Elevated cAMP is a key mechanism of ADPKD progression by promoting cell proliferation, cystogenesis, and cyst enlargement (via Cl<sup>-</sup> and fluid secretion). V2 receptor antagonist tolvaptan is currently the only FDA-approved treatment for ADPKD; however, it can cause serious adverse effects including hepatotoxicity. There remains an unmet clinical need for effective and safe treatments for ADPKD. The extracellular Ca<sup>2+</sup>-sensing receptor (CaSR) is a major regulator of ion transport in kidney tubules and ADPKD cyst epithelia. Cinacalcet is an FDA-approved CaSR activator used for treatment of hyperparathyroidism associated with CKD and renal failure. We recently showed that cinacalcet has marked antisecretory effects in human intestinal cell and mouse models of cholera by activating phosphodiesterases (PDE) that hydrolyze cAMP (*JCI Insight* 2021, 6:e146823). Since elevated cAMP is the key shared pathophysiological mechanism for Cl<sup>-</sup> and fluid secretion in cholera and ADPKD, we hypothesize that cinacalcet can reduce cyst enlargement in ADPKD.

**Methods:** We studied the effects of cinacalcet on Cl<sup>-</sup> secretion, investigated its mechanisms of action; and tested its efficacy on cyst enlargement in MDCK cells and a mouse model of ADPKD.

**Results:** Cinacalcet (30 μM) pretreatment inhibited cAMP-induced Cl<sup>-</sup> secretion and CFTR activity in MDCK cells as suggested by ~70% lower short-circuit current (I<sub>sc</sub>) changes in response to forskolin and CFTR<sub>inh</sub>-172, respectively. Cinacalcet pretreatment inhibited forskolin-induced cAMP elevation by 60% in MDCK cells, and its effect was completely reversed by PDE inhibitor IBMX. In MDCK cells grown in collagen matrix and treated with forskolin, cinacalcet treatment (1-10 μM, Day 6 onward) concentration-dependently reduced cyst enlargement by up to 50% at Day 12 without affecting cell viability (assayed by Alamar blue). In preliminary studies, cinacalcet treatment (30 mg/kg/day for 7 days) reduced renal cyst enlargement in *Pkd1<sup>flox</sup>;KspCre* mice.

**Conclusions:** Cinacalcet reduces cyst enlargement in cell and mouse models of ADPKD by reducing cAMP via PDE activation. Considering its efficacy shown here, and favorable safety profile including extensive post-approval data, cinacalcet can be repurposed as a novel ADPKD treatment.

**Funding:** NIDDK Support

#### FR-PO349

### Proteomic Analysis of Acutely Injured Kidneys Following Treatment With Mesenchymal Stem Cells

Chris Erickson,<sup>1</sup> Danielle Soranno.<sup>2</sup> <sup>1</sup>University of Colorado, Denver, CO; <sup>2</sup>Indiana University, Bloomington, IN.

**Background:** Acute kidney injury (AKI) can result in renal fibrosis and kidney disease. Mesenchymal stem cells (MSC) have been studied as a potential treatment to mitigate renal damage from AKI. Proteomics can give insights into cell and tissue response by profiling changes to the extracellular matrix (ECM) following AKI. In this study we investigate changes to the kidney proteome following AKI and treatment with MSCs.

**Methods:** All procedures were IACUC approved. 8 week-old C57BL/6J male mice underwent bilateral ischemia-reperfusion AKI (clamp time 25 min). Animal groups were: AKI treated with: 1)MSC injected under renal capsule (subcap); 2)MSC injected IV; 3) MSC in hyaluronic acid hydrogels injected subcap; 4)No treatment; or 5)Sham AKI. After 3 months, mice were euthanized, kidneys harvested, processed for ECM extraction, and resultant renal tissue (N=5/group) were analyzed for proteomics by LC-MS/MS. Bioinformatics was performed on the resulting dataset. Statistical significance was determined by FDR corrected ANOVA p-value <0.05.

**Results:** MSC-treated mice did not cluster by proteomic analysis according to delivery method. Hierarchical clustering of the most expressed proteins showed three groups: 1)Sham AKI; 2)'Recovered' treated kidneys (RK); and 3)'Not Recovered' treated kidneys (NRK), which closely correlated with the untreated AKI group. NRKs showed high expression of fibrinogen, fibrillar collagens, and histones. The RK group showed attenuated expression of fibrinogens, collagens, and histones.

**Conclusions:** Our results showed increases in fibrinogen, fibrillar collagens, and histones in NRKs after AKI; whereas RKs showed lower levels of these proteins, indicating lower levels of fibrosis and preservation of ECM integrity. Further studies will investigate the mechanism of action of MSC therapy.

**Funding:** NIDDK Support

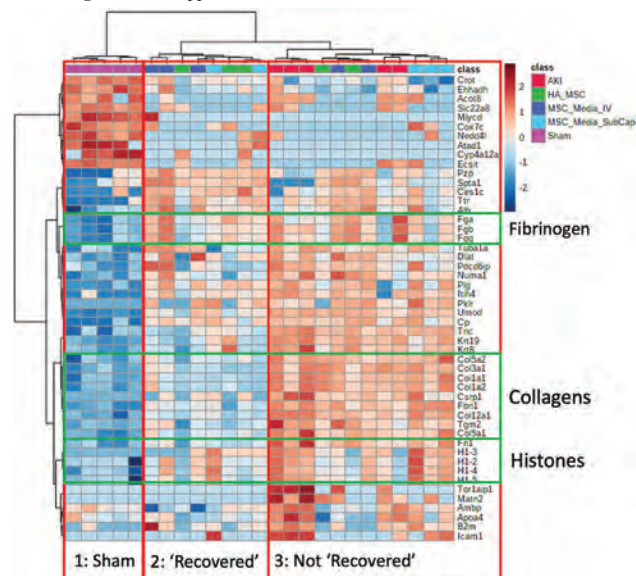

#### FR-PO350

### Uncovering the Podocyte Foot Process Proteome

Gary F. Gerlach, Lori L. O'Brien. The University of North Carolina at Chapel Hill, Chapel Hill, NC.

**Background:** Podocyte foot process integrity is vital for kidney function and health. Disruptions to podocyte architecture, or effacement, is one of the most common clinical observations in kidney disease. However, the full complement of proteins responsible for maintaining podocyte foot process integrity remains unresolved.

**Methods:** The discovery of a proximity-dependent biotin identification (BioID) moiety that utilizes a promiscuous biotin ligase has opened new avenues to discover spatially localized proteomes. Podocin (*Nphs2*), localizing to the slit diaphragm, was employed as a handle to identify the *in vivo* proteome of the podocyte foot process via knock in of the BioID moiety into the murine *Nphs2* locus (Podocin-BioID).

**Results:** We validated our Podocin-BioID model by assessing correct expression and localization of the fusion protein via western blot, immunofluorescence (IF), and localization to the slit diaphragm via electron microscopy. Subcutaneous injection of biotin into Podocin-BioID mice yields a significant enrichment of biotinylated proteins in podocytes. We isolated these biotinylated proteins and performed mass spectrometry (MS) analysis to identify proteins localized to the foot process. *In silico* analysis of the top proteins uncovered from MS identified 'cell junctions', 'actin binding', and 'cytoskeleton organization' as the top gene ontology terms. Our analyses uncovered a novel Immunoglobulin-like domain-containing receptor 2 (Ildr2) protein as highly

expressed within the podocyte foot process. We confirmed Ild2 expression in mouse podocytes by IF and *in situ* hybridization. Further, publicly available single cell RNA-seq databases detail conserved Ild2 expression in human podocytes.

**Conclusions:** Ild2 has documented expression in tricellular tight junctions and roles in immunomodulation with the ability to ameliorate autoimmune disease states in models of multiple sclerosis, type I diabetes, and rheumatoid arthritis. Yet the function of Ild2 in podocyte development, integrity, and contribution to kidney immune cell modulation remains unknown. At large the podocytes' role in immunomodulation remains a relatively unexplored niche which we aim to test through podocyte specific deletion of Ild2. In summary our innovative strategy enabled the identification of novel components of the podocyte foot process proteome leading to a new set of biomarkers and candidates for renal disease therapeutics.

**Funding:** NIDDK Support, Other NIH Support - NIH - LRP - Pediatric Research (NIDDK), Private Foundation Support

### FR-PO351

#### Trajectory Analysis of the Kidney Organoid Proteome Extends Its Modelling Potential of Disease

Moritz Lassé,<sup>1</sup> Fatih Demir,<sup>3</sup> Sean Eddy,<sup>2</sup> Jamal El Saghir,<sup>2</sup> Matthew Fischer,<sup>2</sup> Léna L. Bonin,<sup>3</sup> Arvid D. Hutzfeldt,<sup>1</sup> Bernhard Dumoulin,<sup>1</sup> Linda Reinhard,<sup>1</sup> Elion Hoxha,<sup>1</sup> Bodo B. Beck,<sup>4</sup> Matthias Kretzler,<sup>2</sup> Jennifer L. Harder,<sup>2</sup> Markus M. Rinschen,<sup>1,3</sup> <sup>1</sup>Universitätsklinikum Hamburg-Eppendorf, Hamburg, Germany; <sup>2</sup>University of Michigan, Ann Arbor, MI; <sup>3</sup>Aarhus Universitet, Aarhus, Denmark; <sup>4</sup>Uniklinik Köln, Cologne, Germany.

**Background:** Kidney organoids are a valuable and innovative model to understand genetic diseases, kidney development and transcriptomic dynamics. However, details of proteome organization during organoid development are insufficiently characterized. It is unclear how the organoid proteome changes during differentiation, and if more complex disease processes such as inflammatory tissue responses could be modelled using organoids.

**Methods:** Here, we used proteomics to compare organoids with existing model systems such as native glomeruli and cultured podocytes. We characterize the trajectory of organoid differentiation and delineate innate immune responses in organoids to expand its scope as a model system in nephrology. We also compared our proteomics with bulk and single cell transcriptomic data.

**Results:** Genes involved in Focal segmental glomerulosclerosis (FSGS) and cystic kidney disease were abundantly expressed on protein level, distinguishing organoids from almost every available cell culture model. On their pathway to terminal differentiation, organoids developed increased deposition of extracellular matrix. Single cell transcriptomic analysis suggests that most changes locate to podocytes and early podocyte progenitors. This matrix deposition of organoids during maturation was similar to the matrix deposits found in human FSGS but differed markedly from other *in vitro* and *in vivo* animal disease models. A novel signaling system discovered was the TNF $\alpha$  system, a system also available in podocytes. Incubation of organoids with high concentrations of TNF $\alpha$  led to an activation of NF- $\kappa$ B signaling, and secretion of cytokines and complement components, alongside with extracellular matrix components.

**Conclusions:** We provide a repository of human kidney organoid proteins and show their potential to model pathophysiological pathways beyond genetic diseases. Signaling systems in these organoids link inflammatory signaling, production of cytokines and complement, and production of extracellular matrix.

### FR-PO352

#### Development of Molecular Targeting Agents Enables Specific Gene Editing of Human Podocytes in Kidney Organoids

Nicole Vo, Benjamin S. Freedman. Dr. Benjamin Freedman lab *University of Washington, Seattle, WA.*

**Background:** Gene therapy offers many opportunities to treat kidney diseases. Kidney organoids are complex structures that resemble nephrons and can be used to develop gene therapy approaches. Commonly used gene transfer techniques, such as lentivirus and adeno-associated virus, are size limited, transient, or introduce DNA non-specifically into the genome. As in tissues, however, gene editing in organoids remains inefficient and non-specific. There is an unmet need for reporter systems that enable tracking of editing in different cell types. We sought to improve upon these challenges, using kidney organoids as a representative lineage.

**Methods:** To enable detection of genome editing events in different cell types, we developed a fluorescence-on (mCherry) reporter system in human iPSC cells. Intact kidney organoids were transfected with CRISPR ribonucleoprotein (RNP) complexes. To improve delivery, we tested candidate surface markers to identify molecular targeting agents (MTAs) specifically recognizing podocytes, proximal tubules, or endothelial cells in live imaging assays. An MTA labeling podocytes (PodoTracker) was tethered to Cas9. Genome editing events were detected by changes in fluorescence in specific cell types, and next generation sequencing at the target locus.

**Results:** Confocal microscopy showed that mCherry+ cells were detected in kidney organoids treated with gRNA targeting fluorescence-on reporter, but not with a scrambled guide. Co-staining of gene edited cultures with nephron markers revealed editing in both proximal tubule cells and podocytes. By imaging analysis, the fluorescence-on editing efficiency in organoids was around 5%. MTAs successfully live-labeled podocytes within kidney organoids. Tethering of Cas9 to podocyte-targeting MTA produced increased rates of podocyte genome editing (mCherry<sup>+</sup>), relative to non-tethered Cas9.

**Conclusions:** Using fluorescence-on organoids, genome editing events can be monitored using in individual cell types, showing editing rates consistent with sequencing. Coupling of Cas9 to MTAs is a promising approach to enhance delivery and edit specific cell types of interest. Because the cultures are derived from pluripotent stem cells, the platform may also be readily adapted to detect genome editing in other organ lineages. In the future, we will also test whether our tubule MTAs can selectively enable editing in tubules.

**Funding:** NIDDK Support

### FR-PO353

#### Podocyte Maturation in Human Kidney Organoids Is Accelerated With Renin-Angiotensin System Activation

Waleed Rahmani,<sup>1,2</sup> Justin Chun.<sup>1,2</sup> *Department of Medicine, Cumming School of Medicine, Calgary, AB, Canada; <sup>2</sup>Calvin, Phoebe and Joan Snyder Institute for Chronic Diseases, Calgary, AB, Canada.*

**Background:** The global prevalence of chronic kidney disease (CKD) is approximately 10% and rising. Current renal replacement modalities carry a significant socioeconomic burden and will struggle to meet rising demands. Pluripotent stem cell-derived kidney organoids have emerged as a promising alternative for providing functional nephrons to CKD patients. This technology faces many challenges including maturation as they resemble first and second-trimester fetal kidneys. The renin-angiotensin system (RAS) is critical for normal kidney morphogenesis. Indeed, prenatal exposure to RAS inhibitors is associated with kidney dysgenesis and mortality. We hypothesize that Ang II and RAS inhibitors perturb developmental programs within nephron progenitor populations and alter cell fate specification and maturation of glomerular epithelial cells within kidney organoids.

**Methods:** We performed single-cell RNA sequence analyses on human iPSC-derived kidney organoids treated acutely (24hrs) with vehicle, Ang II, losartan, or Ang II and losartan on 28th day of the Takasato protocol.

**Results:** Kidney organoids expressed all major RAS genes (*AGT*, *ACE1*, *ACE2*, *REN*, *AGTR1*, and *AGTR2*) within expected cell populations. *REN* expression was downregulated by Ang II and normalized with losartan pre-treatment suggesting a functioning RAS network. We identified 3 late podocyte (LP) clusters, 1 early podocyte (EP) cluster, 1 parietal epithelial (PEC) cluster, and 2 nephron progenitor (NPC) clusters. The EP and NPC transcriptional profiles were disproportionately sensitive to Ang II as we noted significant upregulation of podocyte differentiation genes such as *BMP7*, *FOXC2*, *PODXL*, and *NPHS2*. Moreover, Ang II depleted the immature populations (NPC and EP) and expanded mature cell states (PEC and LP). Losartan downregulated podocyte differentiation programs and increased the proportion of immature cells (EP and NPC).

**Conclusions:** Human kidney organoids developed a functioning intra-organoid RAS resembling *in vivo* intrarenal RAS. The lineage plasticity observed between NPCs, EPs, PECs, and LPs was sensitive to acute RAS perturbation. Ang II accelerated podocyte maturity while RAS inhibition held podocytes in an immature state. The next steps include testing different Ang II treatment durations, validating findings using immunocytochemistry, and reproducing this analysis on endothelial and tubule cells.

### FR-PO354

#### Deep Learning Predicts the Differentiation of Kidney Organoids Derived From Human-Induced Pluripotent Stem Cells

Jong Young Lee,<sup>1</sup> Jinwon Kim,<sup>1</sup> Yong Kyun Kim,<sup>1</sup> Jin Kim,<sup>2</sup> Sun-ah Nam.<sup>1</sup> *<sup>1</sup>Catholic University of Korea - Songjei Campus, Seoul, Republic of Korea; <sup>2</sup>Ajou University, Suwon, Gyeonggi-do, Republic of Korea.*

**Background:** Kidney organoids derived from human pluripotent stem cells (hPSCs) contain multi-lineage nephrogenic progenitor cells and can recapitulate the development of the kidney. Kidney organoids differentiated from human pluripotent stem cells can be applied in regenerative medicine as well as renal disease modeling, drug screening and nephrotoxicity testing. However, despite culturing under the same conditions, there are differences in the shape and growth level of each kidney organoid, making it difficult for clinical application. We hypothesized that an automated non-invasive method based on deep learning of bright-field images of kidney organoids can predict their differentiation status.

**Methods:** Kidney organoids were differentiated from induced pluripotent stem cells (iPSC). Bright-field images of kidney organoids were collected on day 18 after differentiation. To train the convolutional neural networks (CNNs), we utilized a transfer learning approach: CNNs were trained to predict the differentiation of kidney organoids on bright-field images, based on the mRNA expression of renal tubular epithelial cells as well as podocytes.

**Results:** The best-performing prediction model with DenseNet121 had a total Pearson correlation coefficient score of 0.783 on a test dataset. Furthermore, we focused on the classification of kidney organoids, into two categories: organoids with above-average gene expression (*Positive*) and those with below-average gene expression (*Negative*). Comparing the best-performing CNN with human-based classifiers, the CNN algorithm had a receiver operating characteristic-area under the curve (AUC) score of 0.85, while the experts had AUC score of 0.48. Time needed to classify one organoid by the experts took 1.04 seconds, but 0.014 seconds by CNN.

**Conclusions:** In this study, the CNN model predicts organoid maturity more accurately and rapidly than experts. These results show that the maturity of organoids can be predicted based on the bright-field and that the artificial intelligence algorithm can successfully recognize the differentiation status of kidney organoids.

FR-PO355

**Tuning Kidney Organoids to Generate High-Fidelity Proximal Tubule Cells**

Jack Schnell, Mary Anne A. Achieng, Nils Lindstrom. *University of Southern California Department of Stem Cell Biology and Regenerative Medicine, Los Angeles, CA.*

**Background:** The most abundant cell in the kidney, proximal tubule (PT) cells, are poorly replicated across 3D kidney organoid models. PTs perform the bulk of renal reabsorption via the work of solute carriers and transporters for nutrients, toxins, and substrates. Defects to these cells often manifest as urinary wasting of nutrients. Studies have suggested role for transcription factor Hnf4a in PT maturation by driving the expression of transporters that impart physiological function to the PT, such as *Urat1*. Yet, recapitulating PT maturation in kidney organoids remains a challenge for regenerative therapeutics.

**Methods:** We undertook a stepwise approach that mimics early proximal precursor populations. HNF4A<sup>+</sup> PTs within organoids were increased through a modified protocol for the directed differentiation of a human induced pluripotent stem cell *HNF4A* reporter line. This was done by transiently treating organoids with a small-molecule inhibitor of PI3K signaling. RNA-sequencing and immunofluorescent validation were performed to assess organoids for PT maturation genes.

**Results:** Treated organoids underwent increases in the abundance of HNF4A<sup>+</sup> PTs. RNA-sequencing of organoids suggests increases in the urate and organic ion transporter *URAT1*, the glucose transporter *SGLT6*, amino acid transporters *SLC3A1* and *EAAC1*, and others (Fig. 1). These data suggest enhanced PT maturation and better recapitulation of normal physiology compared to control samples.

**Conclusions:** These data demonstrate that organoid nephron maturation can be enhanced by modifying differentiation. Promoting proximal precursors within kidney organoids increases the abundance of HNF4A<sup>+</sup> PTs at later stages of differentiation. These organoids exhibit increased expression of vital kidney transporters, suggesting that tuning early patterning can improve organoid functional potential. As such, these studies inform *in vitro* nephrogenesis strategies building regenerative therapeutics.

**Funding:** Other NIH Support - T32 Training Grant from USC Stem Cell and NIH NICHD

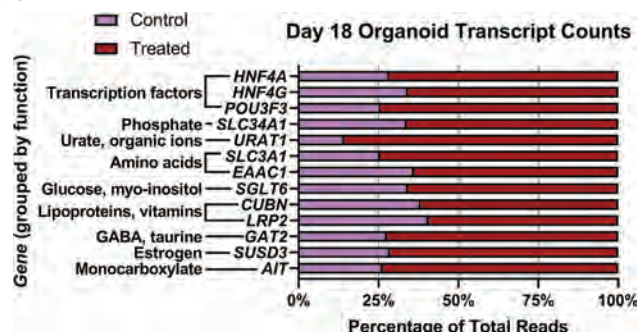

Percentage of total read counts from day 18 bulk RNA-seq of whole-organoid samples (n = 2).

FR-PO356

**Hypoxia Triggers a Signature of Maladaptive Repair in Human Kidney Organoids**

Ana B. Nunez Nescolarde,<sup>1</sup> Mehran Piran,<sup>1</sup> David J. Nikolic-Paterson,<sup>1,2</sup> Alexander N. Combes.<sup>1</sup> *Monash University, Clayton, VIC, Australia;* <sup>2</sup>*Monash Health, Clayton, VIC, Australia.*

**Background:** Reduced oxygen levels during renal ischemia can induce AKI and lead to CKD through maladaptive repair. Tubulointerstitial fibrosis is a chronic and progressive feature of CKD, for which we lack effective treatments. To facilitate therapeutic studies, we develop a human kidney organoid model of hypoxia-induced renal fibrosis.

**Methods:** Human iPSC-derived organoids were generated from 3 different cell lines and cultured for 18 days, then subjected to hypoxia (1%O<sub>2</sub>) or normoxia (21%O<sub>2</sub>) for 48h (d20) followed by 5 days recovery period in normoxia (d25). Organoids were examined by gene expression profiling, immunohistochemistry and immunofluorescence microscopy.

**Results:** Robust hypoxic response was evident on d20 by 5 and 7-fold increases in mRNA levels of hypoxia-inducible genes *VEGFA* and *HK1*, respectively (both p<0.001, Fig 1A). Tubular damage marker *KIMI/HAVCR1*, stress-response gene *JUN*, and profibrotic signal *TGFBI* were all upregulated (>2 fold p<0.001) in hypoxic organoids on d20, consistent with an AKI response (Fig 1A). Mitochondrial dysfunction was evident in hypoxic organoids on d20 with a 50% decrease (p<0.001) of *PPARGCIA* levels (Fig 1A). On d25, expression of hypoxia-responsive genes and AKI markers returned to control levels. However, proinflammatory cytokine *CCL2* (p<0.05), extracellular matrix components *COL1A1* (p<0.01) and matrix producing cells *ACTA2* were significantly upregulated in hypoxia-treated organoids (Fig 1A). Immunostaining at d25 for *COL1A1* affirmed increased collagen I deposition and reduction in tubular density (PAX8) in hypoxia-treated organoids (Fig 1B). We are currently profiling control and hypoxia-treated organoids from day 20 and 25 timepoints using bulk and single cell RNA-sequencing.

**Conclusions:** Here we show that kidney organoids transiently upregulate markers of AKI in response to hypoxia and later display signatures of maladaptive repair including elevated levels of ECM. These results suggest kidney organoids may aid in disease modelling and drug development for AKI and fibrosis.

**Funding:** Government Support - Non-U.S.

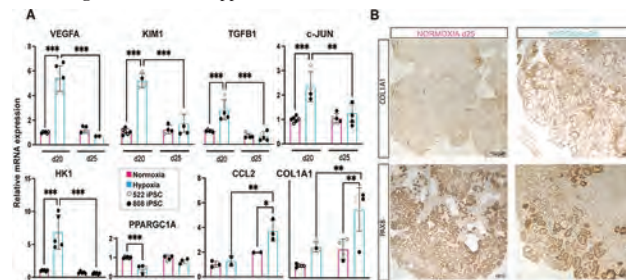

Figure 1. A) Expression levels of AKI and CKD-related markers in normoxic and hypoxic kidney organoids at day 20 and 25. One-way ANOVA to test differences (p<0.05, \* <0.01, \*\* <0.001, \*\*\*). B) Representative images of COL1A1 increase and PAX8 decrease from 3 batches of hypoxia-treated organoids at day 25. Scale bar = 100 μm.

FR-PO357

**Human Collecting Duct Tubuloids of Principal Cells Derived From Ureteric Bud Organoids as Differentiated Cell Models for Physiology and Disease Modelling**

Annarita Di Mise,<sup>1</sup> Kyle McCracken,<sup>4</sup> Ankit B. Patel,<sup>2,3</sup> Giovanna Valenti,<sup>1</sup> Takaharu Ichimura,<sup>3</sup> Joseph V. Bonventre.<sup>5</sup> *1Universita degli Studi di Bari Aldo Moro, Bari, Italy;* <sup>2</sup>*Vertex Pharmaceuticals Incorporated, Boston, MA;* <sup>3</sup>*Brigham and Women's Hospital, Boston, MA;* <sup>4</sup>*Boston Children's Hospital, Boston, MA;* <sup>5</sup>*Division of Renal Medicine, Department of Medicine, Brigham and Women's Hospital, Harvard Medical School, Boston, MA.*

**Background:** 3D kidney cellular models, organoids or tubuloids that recapitulate tissue-specific pathophysiology, including disease phenotypes after genome editing, may represent useful tools for kidney disease modeling and drug screening. We report here the first model of tubuloids originated from 3D culturing of human collecting duct (hCD) cells obtained from pluripotent stem cells-derived ureteric bud organoids. These cells generate functional epithelia characterized by amiloride-sensitive transepithelial potential and high transepithelial resistance when evaluated in two-dimensional transwells. These functional properties of hCD principal cells are unique with no other comparable cell line available in the literature.

**Methods:** To generate hCD cell tubuloids, cells were cultured as monolayer (2D) or grown in Geltrex diluted in 2% serum DMEM/F12. After 1-2 days in Geltrex, hCD cells formed aggregates which developed into more complex 3D tubular structures, which detached from the original aggregates.

**Results:** Both 2D cultures and 3D tubuloid cells expressed *AVPR2* and *AQP2* gene transcripts by qPCR. The water channel, *AQP2*, was poorly expressed in 2D cells as assessed by immunofluorescence with higher expression in tubuloids primarily in the intracellular vesicles. Activation of the V2R with dDAMP induced *AQP2* relocation from the intracellular vesicles to the apical membrane of hCD-tubuloids, but not in 2D cells. Long-term exposure of hCD-tubuloids to dDAMP induced the growth of cysts. In addition, hCD tubuloids expressed *PC2*, a protein which is mutated in ~15% of individuals with Autosomal Dominant Polycystic Kidney Disease (ADPKD).

**Conclusions:** Since the collecting system plays an important role in regulating sodium, potassium, and acid-base homeostasis as well as disease states such as polycystic kidney disease and nephrogenic diabetes insipidus, the generation of hCD-tubuloids with functional properties of hCD principal cells represents a unique model for disease modelling in human cells *in vitro*.

**Funding:** NIDDK Support, Other NIH Support - NCATS, Government Support - Non-U.S.

FR-PO359

**Vascularization of iPSC-Kidney Organoids In Vitro Is Improved by Co-Culturing With Macrophages**

Yulia Kiyan,<sup>1</sup> Ekaterina Chernobryvaia,<sup>1</sup> Nico Lachmann,<sup>1</sup> Hermann Haller.<sup>1,2</sup> *1Medizinische Hochschule Hannover, Hannover, Germany;* <sup>2</sup>*Mount Desert Island Biological Laboratory, Salsbury Cove, ME.*

**Background:** Induced pluripotent stem cells (iPSC) - derived derived kidney organoids represent an attractive model for studying kidney development, disease mechanisms and drug response *in vitro*. Despite the progress achieved in the deciphering the developmental program of the kidney and differentiating iPSC to kidney organoids *in vitro*, our knowledge of the early stages of vascularization is limited. A major limitation is the lack of proper microvascular system to study the growth and development of iPSC organoids. Secondly, during the embryonic kidney development *in vivo* macrophages play an important role in vascularization. We have investigated the role of macrophages in vascular development using iPSC and a novel angiogenesis-on-chip model.

**Methods:** We have used co-culture of organoids and human iPSC-derived macrophages in microfluidic environment. We generated reporter iPSC cell lines expressing secreted Gaussia luciferase under control of CD31-promoter to monitor endothelial differentiation, 3D confocal microscopy, RNA sequencing and biochemical assays.

**Results:** Differentiation of iPSC-derived endothelial cells and endothelial-specific function such as permeability, development of glycocalyx, and permeability are significantly improved by microfluidic conditions. In the presence of macrophages the number of endothelial cells is significantly increased. Furthermore, co-culture with macrophages induced lumen formation and capillary growth. Formed capillary show directed growth towards the glomeruli-like nephrin-positive cell clusters and tend to interconnect developing neighboring organoids. The analysis of endothelial cells transcriptome shows advanced differentiation pattern in the presence of macrophages in comparison to the organoids in monoculture.

**Conclusions:** In summary, we firstly demonstrate that co-culturing developing iPSC-kidney organoids with human iPSC-macrophages promotes endothelial differentiation and induces capillary formation. Macrophages may directly or indirectly contribute to the early vascularization in organoids and can improve organoid-derived renal tissue generation.

**Funding:** Private Foundation Support, Government Support - Non-U.S.

## FR-PO360

### Kidney Decellularized Extracellular Matrix Enhanced the Vascularization and Maturation of Human Kidney Organoids

Jinwon Kim,<sup>1</sup> Jong Young Lee,<sup>1</sup> Jin Kim,<sup>2</sup> Yong Kyun Kim,<sup>1</sup> Sun-ah Nam,<sup>1</sup>  
<sup>1</sup>Catholic University of Korea School of Medicine, Seoul, Republic of Korea;  
<sup>2</sup>Ajou University, Suwon, Gyeonggi-do, Republic of Korea.

**Background:** Kidney organoids derived from human pluripotent stem cells have extensive potential for disease modelling and regenerative medicine. However, the limited vascularization and immaturity of kidney organoids have been still remained to overcome. In kidney development, kidney ECM regulate mesenchymal condensation, nephron formation, terminal differentiation of renal tubules, and glomerular basement membrane assembly. Kidney decellularized ECM (dECM) hydrogels contain ECM proteins to provide a microenvironment similar to that of a normal kidney. Our study highlights that kidney dECM hydrogels could be used to more accurately culture kidney organoids.

**Methods:** Porcine kidneys were decellularized to prepare kidney decellularized extracellular matrix hydrogels. Kidney organoids were differentiated using kidney dECM, and VEGF for enhancing the vascular network and SB-431542 for enhancing podocyte differentiation were added.  $\alpha$ -galactosidase A (GLA) mutant iPSCs in which the GLA gene was knocked out were generated using the CRISPR/Cas9. To recapitulate of Fabry Nephropathy with Vasculopathy, GLA-mutant human iPSCs were differentiated into kidney organoids using kidney dECM. We transplanted kidney organoids derived from human iPSCs with kidney dECM beneath the kidney capsule of immunodeficient NOD-SCID mice for engraftment.

**Results:** The vascularization was extensively increased in the kidney organoids generated by using kidney dECM. Single-cell transcriptomics revealed that the vascularized kidney organoids cultured using the kidney dECM had more mature patterns of glomerular development and higher similarity to human kidney than those cultured without the kidney dECM. Differentiation of GLA knock-out hPSC generated using CRISPR/Cas9 into kidney organoids by the culture method using kidney dECM efficiently recapitulated Fabry nephropathy with vasculopathy. Transplantation of kidney organoids with kidney dECM into kidney of mouse accelerated the recruitment of endothelial cells from the host mouse kidney and maintained vascular integrity with the more organized slit diaphragm-like structures than those without kidney dECM.

**Conclusions:** Our data suggest that kidney dECM methodology for inducing extensive vascularization and maturation of kidney organoids can be applied to studies for kidney development, disease modeling, and regenerative medicine.

## FR-PO361

### Developing Methods to Improve Vascularization of Nephron Progenitor Cell Grafts Beneath the Kidney Capsule Through the Use of Pro-Angiogenic Uniformly Porous Templated Hydrogel Scaffolds

Thomas Vincent, Sophie M. Blackburn, Buddy Ratner, Benjamin S. Freedman.  
University of Washington, Seattle, WA.

**Background:** When human kidneys are acutely injured or damaged by underlying chronic conditions, the nephrons are unable to sufficiently repair themselves and will progressively deteriorate to the point of end stage kidney disease. The fairly recent development of stem cell-derived kidney organoids has raised the possibility of achieving regenerative medicine-based therapeutic to restore renal function. However, studies *in vivo* have not yet achieved clinically significant integration of implanted cells with the host kidney. Here we examine the effects of implanting nephron progenitor cells (NPCs) as well as pro-angiogenic uniform porous templated hydrogel scaffolds beneath the kidney capsule as potential methods to achieve highly vascularized grafts.

**Methods:** Human induced pluripotent stem cell-derived NPCs, differentiated kidney organoids, and hydrogel scaffolds were implanted beneath the kidney capsules of 8–10-week-old NOD-SCID mice. Cellular material was collected by manually scraping cells from adherent cultures in a 24-well plate and aggregated through centrifugation. Kidneys were excised after 3-weeks and analyzed through cryosection immunofluorescent staining to look for a variety of cell markers including those that indicate major nephron segments such as podocalyxin, lotus tetragonolobus lectin and e-cadherin.

**Results:** Our data shows that implantation of NPCs beneath the kidney capsule of NOD-SCID mice supports differentiation and leads to the development of renal structures that include podocytes, and proximal and distal tubules. The developing podocytes

interact with host vasculature to form chimeric glomerular structures lined by parietal epithelial cells. Additionally, implanted porous scaffolds allow for ubiquitous cellular infiltration and vascularization while reducing the fibrotic host response compared to similar non-porous implants.

**Conclusions:** Together, the results from these experiments have demonstrated the potential for each of these two technologies to improve kidney regeneration therapies. Next steps will be to optimize cell-seeding methodology and implant combined NPC-seeded scaffolds beneath the kidney capsule to explore potential synergistic effects.

**Funding:** NIDDK Support, Other NIH Support - NCATS, Other U.S. Government Support

## FR-PO362

### Utilizing a Patient-Specific iPSC Platform for the Study of Rare Genetic Kidney and Vascular Diseases

Daniel Diatlov,<sup>1,2</sup> Franz Leonard Melzer,<sup>2</sup> Arlette Bohorquez,<sup>2</sup> Alison L. Ma,<sup>4</sup> Christoph Licht,<sup>3,2</sup> <sup>1</sup>University of Toronto Institute of Medical Science, Toronto, ON, Canada; <sup>2</sup>The Hospital for Sick Children Research Institute Cell Biology Program, Toronto, ON, Canada; <sup>3</sup>The Hospital for Sick Children Division of Nephrology, Toronto, ON, Canada; <sup>4</sup>Hong Kong Children's Hospital Department of Paediatric Nephrology, Kowloon City, Hong Kong.

**Background:** The increasing use of induced pluripotent stem cells (iPSCs) to model human genetic diseases *in vitro* has allowed researchers to better understand the pathology of countless disorders, and subsequently develop better treatments for patients. Currently in our lab we use blood-outgrowth endothelial cells (BOECs) to study endothelial cell (EC) dysfunction in kidney diseases and thrombotic microangiopathies. However, isolating patient BOECs is often challenging, as it requires a significant sample of fresh blood which is not always readily available. As such, we are working to utilize a platform that uses patient skin fibroblasts to create patient-specific iPSCs, that can then be differentiated into ECs which capture the genetic conditions of patients.

**Methods:** Patient skin fibroblast-derived iPSCs and healthy control iPSCs were created using a commercially available Sendai virus CytoTune-iPS 2.0 reprogramming kit (Thermo Fisher). These iPSCs were then differentiated into ECs using a directed differentiation protocol in factor-defined media. Following differentiation, CD31 (PECAM1) positive cells were sorted using fluorescence-activated cell sorting (FACS), to isolate a pure population. Isolated ECs were then characterized using immunofluorescence (IF) staining for CD31 and VE-Cadherin, as well as a tubule formation assay.

**Results:** We were able to successfully create the iPSCs and differentiate them into ECs that express the appropriate markers (CD31 and VE-Cadherin) and are able to successfully form robust capillary-like tubes over a 48 hour period.

**Conclusions:** Our iPSC differentiation protocol provides a verified and valuable tool for the study of genetic kidney disorders involving endothelial cells when BOEC isolation is not possible.

**Funding:** Government Support - Non-U.S.

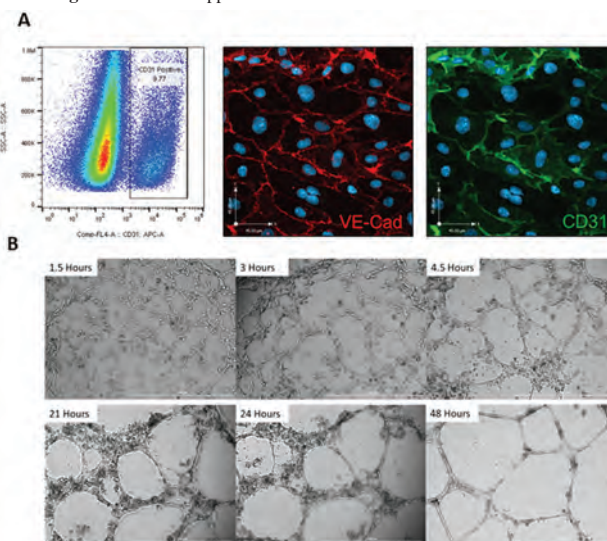

**Figure 1. (A)** Patient iPSC ECs sorted for CD31 using FACS express CD31 and VE-Cadherin (20x). **(B)** Patient iPSC ECs form robust capillary-like tubes over 48 hours (4x).



## FR-PO363

**Transcription Factor 21 Is Required for Normal Vascular Development of the Kidney**

Gal Finer,<sup>1,2</sup> Tomoko Hayashida,<sup>1,2</sup> Susan E. Quaggin,<sup>1,3</sup> Roberto Ariel Gomez,<sup>4</sup> Maria Luisa S. Sequeira Lopez,<sup>4</sup> <sup>1</sup>*Northwestern University Feinberg School of Medicine, Chicago, IL;* <sup>2</sup>*Ann and Robert H Lurie Children's Hospital of Chicago, Chicago, IL;* <sup>3</sup>*Northwestern Memorial Hospital, Chicago, IL;* <sup>4</sup>*University of Virginia, Charlottesville, VA.*

**Background:** Normal kidney development requires coordinated interactions between multiple progenitor cells. The Foxd1+ cells are a distinct progenitor cell population within the metanephric mesenchyme that gives rise to the stroma, the renal capsule, the mesangium, vascular smooth muscle cells (VSMCs), and pericytes. VSMCs surround larger vessels while pericytes envelop capillaries and establish direct contact with the endothelium. The specification and functional specialization of renal mural cells are poorly understood. We previously showed that the transcription factor 21 (Tcf21) in Foxd1+ cells promotes proliferation and differentiation of interstitial progenitors via enhancement of  $\beta$ -Catenin action on Wnt-target genes. Here, we study the role of Tcf21 in the interaction between mural cells and endothelium during nephrogenesis.

**Methods:** We examined Foxd1Cre;Tcf21f/f kidneys by immunostaining and in-situ hybridization.

**Results:** Foxd1Cre;Tcf21f/f kidneys show distorted centripetal pattern of the arterial tree with disorganized, shorter, and thinner arteries at E15.5. Additionally, Foxd1Cre;Tcf21f/f kidneys show reduced branching and aberrant ramification into the renal capsule. At E18.5, mutant kidneys have fewer vessels globally. Specifically, the mutants have smaller interlobular arteries, fewer simplified glomerular capillary loops, and disorganized peritubular capillaries in the medulla. Examination of mural cells revealed fewer layers of smooth muscle cells, fewer PDGFR $\beta$ + CD146+ mesangial cells, and fewer CD146+ pericytes in the peritubular capillaries in mutants. These findings suggest that Tcf21 expression in Foxd1+ cells is required for normal differentiation of the mural cells hence for normal development of the kidney vasculature. Renin progenitors are a subset of the Foxd1+ cells that control renal vascular development. We next examined renin expression in Foxd1Cre;Tcf21f/f kidneys. Renin mRNA and protein were significantly reduced in mutants compared to controls. Specifically, CD146+Renin+ pericytes at the afferent arteriole of the glomerulus and around the peritubular capillaries were markedly reduced.

**Conclusions:** Together, our findings suggest that Tcf21 in Foxd1+ cells directs the differentiation of kidney mural cells thereby controlling the normal development of the endothelium and the overall arterial tree of the kidney.

**Funding:** NIDDK Support

## FR-PO364

**Defining Gene Regulatory Networks in Human Kidney Organoids by Single Cell Multiomic Analysis**

Yasuhiro Yoshimura, Yoshiharu Muto, Kohei Omachi, Nicolas Ledru, Jeffrey H. Miner, Benjamin D. Humphreys. *Washington University School of Medicine, St. Louis, MO.*

**Background:** During development, changes in chromatin structure regulate gene expression dynamics. A detailed understanding of gene regulatory networks will improve our understanding of organogenesis and disease mechanisms. Kidney organoids derived from pluripotent stem cells provide unique opportunities to study kidney development *in vitro*. However, whether the epigenetic landscape during organoid differentiation is similar to that during nephrogenesis has not been elucidated.

**Methods:** We performed single nucleus RNA sequencing (snRNA-seq) and assay for transposase-accessible chromatin with sequencing (snATAC-seq) and cleavage under targets and release using nuclease (CUT&RUN) sequencing to map the epigenetic and gene expression signatures of human kidney organoids during the organoid differentiation time course.

**Results:** We identified cell type-specific chromatin accessibility and predicted cis-regulatory links between ATAC peaks and target genes. Gene body ATAC peaks correlated highly with gene expression levels. Putative enhancers were identified by examining peaks in intergenic and intronic regions through integration with genome-wide histone marks identified by CUT&RUN sequencing. Direct comparison with human adult kidney multiome datasets revealed that kidney organoids had fewer distinct cell-specific chromatin accessibility patterns in the gene regulatory elements of maturation-related genes, indicating organoid cell immaturity. Time-course analysis of organoid differentiation showed changes in transcription factor expression varied directly with enrichment of their corresponding DNA binding motifs in ATAC peaks and target gene expression. For validation, we applied CRISPR interference against the promoter and putative enhancer regions of the HNF1B gene, a critical transcription factor for proximal tubule differentiation. We observed decreased HNF1B expression in the proximal tubule cells by suppressing either promoter or distal enhancer activity, validating this gene regulatory network elucidated by multiome analysis.

**Conclusions:** We defined the cell-specific epigenetic landscape during organoid differentiation and validated select gene regulatory mechanisms in human kidney organoids. This study provides a new benchmark against which to judge the cell-specific maturation state of human kidney organoids.

**Funding:** Private Foundation Support, Government Support - Non-U.S.

## FR-PO365

**Single-Nucleus RNA Sequencing Identifies Sex-Specific Proximal Tubular Cell Differentiation Pathways**

Yuehan Lu,<sup>1,2</sup> Chia-Te Liao,<sup>3</sup> Bnar Talabani,<sup>1</sup> Tanya A. Smith,<sup>1</sup> Robert Andrews,<sup>1</sup> Sumukh Deshpande,<sup>1</sup> Timothy Bowen,<sup>1</sup> Philip Taylor,<sup>1</sup> Donald Fraser,<sup>1</sup> Wales Kidney Research Unit <sup>1</sup>*Cardiff University, Cardiff, United Kingdom;* <sup>2</sup>*Chang Gung Medical Foundation, Taipei City, Taiwan;* <sup>3</sup>*Taipei Medical University, Taipei, Taiwan.*

**Background:** Postpartum kidney growth is substantial but proliferation and differentiation pathways underpinning nephron elongation are not well defined. Here we performed sequential characterization of mouse kidney transcriptomics at the single cell level to address this.

**Methods:** Single nuclear RNA sequencing (snRNAseq) was performed on freshly harvested kidney tissue from male and female mice at age 1, 2, 4, 12 weeks of age (n=2, a total of 16 mice) using the 10x platform. Sequencing employed the Illumina NovaSeq platform and downstream analysis was conducted in R using Seurat and associated packages.

**Results:** Unbiased clustering was performed on 68,775 nuclei. All expected cell types were identified. High levels of proliferation were evident at early time points in some (eg. Tubular) but not other (eg. Podocyte) clusters. Proliferation was especially evident in Proximal Tubular Cells (PTC's) which are the most abundant cell type in the adult kidney. Uniquely when compared to other kidney cell types, PTC's demonstrated sex-specific expression profiles at 4 and 12 weeks. Mapping of PTC differentiation pathways using techniques including trajectory and RNA Velocity analyses delineated increasing PTC specialization and sex-specific phenotype specification. Ligand-receptor analysis identified key cues.

**Conclusions:** Our single-cell transcriptomics data provide a library of cellular states observed during kidney growth. We have identified PTC differentiation pathways that lead to sex-specific tubular cell phenotypes.

## FR-PO366

**Centrosome Dysfunction Disrupts Nephrogenesis and Causes Cystic Kidney Disease**

Tao Cheng,<sup>1</sup> Chidera Agwu,<sup>1</sup> Kyuwan Shim,<sup>1</sup> Baolin Wang,<sup>2</sup> Sanjay Jain,<sup>1</sup> Moe Mahjoub,<sup>1</sup> <sup>1</sup>*Washington University in St Louis, St Louis, MO;* <sup>2</sup>*Weill Cornell Medicine, New York, NY.*

**Background:** Nephrogenesis requires coordinated signaling between progenitors of the metanephric mesenchyme (MM) and ureteric bud (UB) epithelium. Many of these pathways are organized by the centrosome, the main microtubule-organizing center, and its associated structure the cilium. Mutations in centrosomal genes cause congenital renal dysplasia and cystic-fibrotic pathologies, found in patients with Nephronophthisis, Joubert and Jeune syndromes. Yet, how these mutations impact renal development and physiology is unknown. Here, we examined the consequences of centrosome dysfunction on nephron progenitor growth, fate determination and tubule formation in mice, and compared outcomes with those caused by ciliary defect.

**Methods:** Conditional deletion of Cep120, critical for centrosome duplication, was induced by crossing *Cep120<sup>fl/fl</sup>* mice with *Stx2-Cre* or *Hoxb7-Cre* strains. Loss of PKD1 (which causes ADPKD) was similarly induced in the two progenitors. Kidney morphology and function were tested at various stages. To identify pathways impacted by centrosome loss, we performed RNAseq of embryonic and adult kidneys from Cep120- and PKD1-null mice.

**Results:** Loss of Cep120 blocked centrosome biogenesis in the respective progenitor niches and led to reduced abundance of each population. This was due to delayed mitosis, activation of a mitotic surveillance pathway and apoptosis. Centrosome loss also caused premature formation of pre-tubular structures and low nephron branching morphogenesis. These defects resulted in dysplastic kidneys with low nephron endowment at birth, which mimic the human disease phenotypes. In contrast, loss of PKD1 in the MM or UB did not impact these processes, highlighting differences between centrosome and ciliary dysfunction. RNAseq of embryonic Cep120-null kidneys identified changes in signaling pathways including Wnt7-Wnt11, TGF- $\beta$  and RET-MAPK. Remarkably, a developmental switch occurred postnatally whereby centrosome-less kidneys rapidly formed cysts with fibrosis and corresponding decline in kidney function. Finally, RNAseq of adult Cep120-null kidneys identified unique pathways involved in cystogenesis and fibrosis upon centrosome dysfunction compared to ADPKD.

**Conclusions:** Our study defines the developmental defects caused by centrosome dysfunction in nephrogenesis and identifies new therapeutic targets in patients with renal "centrosomopathies".

**Funding:** NIDDK Support, Other U.S. Government Support

## FR-PO367

**Consequences of Centrosome Dysfunction in Stromal Progenitors During Kidney Development and Repair**

Ewa Langner,<sup>1</sup> Tao Cheng,<sup>1</sup> Eirini Kefalogianni,<sup>1</sup> Baolin Wang,<sup>2</sup> Moe Mahjoub,<sup>1</sup> <sup>1</sup>*Washington University in St Louis, St Louis, MO;* <sup>2</sup>*Cornell University, Ithaca, NY.*

**Background:** Reciprocal signaling between progenitor cells of the cap mesenchyme, ureteric bud epithelium and stromal mesenchyme (SM) is critical for mammalian kidney morphogenesis. Several signaling pathways involved in the growth and differentiation

of these progenitors are regulated by the centrosome, the main microtubule-organizing center, and its associated structure the cilium. Mutations in genes that disrupt centrosome biogenesis or function cause congenital renal dysplasia and cystic-fibrotic pathologies. However, it is unknown how defects in centrosome biogenesis impact renal interstitial progenitor cells. Here, we examined the consequences of defective centrosome biogenesis on SM progenitor cell growth, fate determination, formation of SM-derived lineages, and overall kidney development in mice.

**Methods:** Deletion of Cep120, the ciliopathy gene essential for centrosome duplication, was induced in the SM by crossing Cep120<sup>fl/fl</sup> mice with the FoxD1-Cre strain. Changes in kidney morphology and function upon centrosome loss were assessed at embryonic and postnatal time points and following unilateral ureteral obstruction (UUO) injury.

**Results:** Ablation of Cep120 blocked centrosome biogenesis in FoxD1-derived cells and led to reduced abundance of pericytes, peritubular fibroblasts and mesangial cells at birth. This was caused by delayed mitosis, abnormal Wnt and Hedgehog signaling leading to reduced proliferation. There was a concomitant delay in maturation of nephron tubular structures resulting in small, dysplastic kidneys by P15. Mutants differed in phenotypic severity, with survival rates between 1-5 months of age. Remarkably, mutants showed no change in kidney function nor developed spontaneous fibrosis. In contrast, loss of centrosomes caused increased proliferation of pericytes and fibroblasts following UUO injury, and led to elevated levels of profibrotic signaling factors.

**Conclusions:** Our results indicate that centrosome loss in the SM disrupts kidney morphology but not function during embryonic development. In contrast, centrosome loss sensitizes the kidneys leading to accelerated fibrosis following injury. These data highlight the contribution of defective centrosome biogenesis in the developing renal interstitium, and identify possible pathways as targets for therapy.

**Funding:** NIDDK Support

#### FR-PO368

##### **$\alpha$ -Parvin, an Integrin-Related Scaffold Protein, Regulates Actin Turnover to Facilitate Kidney Ureteric Bud Development**

Xinyu Dong,<sup>1,2</sup> Fabian Bock,<sup>2</sup> Nada M. Bulus,<sup>2</sup> Olga Viquez,<sup>2</sup> Ambra Pozzi,<sup>2</sup> Roy Zent.<sup>2,1</sup> <sup>1</sup>Vanderbilt University, Nashville, TN; <sup>2</sup>Vanderbilt University Medical Center, Nashville, TN.

**Background:** The kidney collecting duct develops by iterative branching of the ureteric bud (UB), a process that requires cell migration that is tightly regulated by actin dynamics.  $\alpha$ -Parvin is a scaffold protein associated with integrins, the major extracellular matrix (ECM) receptors. Parvin controls actin dynamics by binding to the actin filaments and by regulating the activation of the Rho family of GTPases (Rho, Rac, and Cdc42), which restructure the actin cytoskeleton during key cell activities such as cell migration. The Rho GTPases function in part by depolymerizing filamentous actin (F-actin) via the ADF/cofilin proteins. We previously showed  $\alpha$ -Parvin is critical for mouse kidney development because global  $\alpha$ -Parvin knockout led to kidney agenesis. In this study, we defined the mechanism of how  $\alpha$ -Parvin regulates UB branching.

**Methods:** We deleted  $\alpha$ -Parvin at the initiation of UB development (E10.5) by crossing the  $\alpha$ -Parvin<sup>fl/fl</sup> with a HOXB7<sup>Cre</sup> mice. To study the molecular function of  $\alpha$ -Parvin, we generated  $\alpha$ -Parvin-null collecting duct (CD) cells by deleting  $\alpha$ -Parvin using adenoviral-mediated delivery of plasmids encoding Cre recombinase from isolated CDs of the  $\alpha$ -Parvin<sup>fl/fl</sup> mice.

**Results:** The  $\alpha$ -Parvin<sup>fl/fl</sup>:HoxB7<sup>Cre</sup> mice were born with severely dysmorphic kidneys leading to death by 3 months. The kidneys showed a significant UB branching defect by E11.5. In addition to the decreased branching, the UB branches were abnormally shaped, with a larger tubular diameter and an increased number of cells around the circumference. There was excessive basal F-actin in the UB and prominent F-actin formation in  $\alpha$ -Parvin-null CD cells, suggesting a loss of actin depolymerization. Mechanistically, the  $\alpha$ -Parvin-null CD cells and kidneys had a profound increase in RhoA and Cdc42 activity. The major actin-depolymerizing factor downstream of the Rho GTPases, cofilin, was also inactivated in both the papilla of  $\alpha$ -Parvin-null kidneys and CD cells. Consequently, the  $\alpha$ -Parvin-null CD cells showed increased cell adhesion and spreading but impaired migration on ECM. Finally, inhibition of RhoA and Cdc42 was sufficient to reverse the inactivation of cofilin and rescue the  $\alpha$ -Parvin-null phenotypes.

**Conclusions:**  $\alpha$ -Parvin is required for UB development and it exerts its function by regulating the Rho/cofilin pathway that finetunes the actin dynamics.

**Funding:** NIDDK Support, Veterans Affairs Support

#### FR-PO369

##### **Rac1 Promotes Epithelial Collecting Duct Repair by Maintaining Mitotic Morphology**

Fabian Bock, Olga Viquez, Eric Sha, Xinyu Dong, Ambra Pozzi, Roy Zent. Vanderbilt University Medical Center, Nashville, TN.

**Background:** The kidney collecting duct (CD) is a major source of inflammation and fibrosis after injury but how it repairs is not known. The actin cytoskeleton is critical to restore cellular morphology and for normal cell cycle progression during epithelial repair. We have recently shown that the small Rho GTPase Rac1 is a key regulator maintaining the CD actin cytoskeleton at baseline. We thus hypothesize that Rac1 is required for CD repair after injury.

**Methods:** We crossed Rac1<sup>fl/fl</sup> with AQP2-Cre mice deleting Rac1 in the collecting system and performed reversible unilateral ureteral obstruction (rUUO). Furthermore, we performed cell cycle synchronization *in vitro* and investigated the role of Rac1 in regenerating epithelial monolayers, utilizing isolated Rac1 null CD cells.

**Results:** AQP2:Rac1<sup>fl/fl</sup> mice show impaired fibrosis regression after reversal of obstruction and were unable to normally restore epithelial and actin cytoskeletal integrity and polarity. Rac1 deletion decreased post-injury CD cell turnover with less proliferation and more apoptosis. *In vivo* cell cycle characterization by flow cytometry revealed a G2/M cell cycle defect. Upon *in vitro* cell cycle synchronization using a double thymidine block we found abnormal mitotic entry, delayed mitotic progression and mitotic cell death in the Rac1 null CD cells. High-resolution confocal microscopy *in vivo* and *in vitro* demonstrated that Rac1 is required for normal metaphase rounding, a critical mitotic morphological transformation. Furthermore, Rac1 null CD cells were unable to maintain mechanical G2/M checkpoint integrity thus allowing morphologically abnormal cells with a disrupted actin cytoskeleton to enter mitosis.

**Conclusions:** We find that Rac1 promotes kidney CD repair and Rac1 is required for both, morphological reconstitution, and post-injury cell cycle progression. Specifically, Rac1 promotes normal mitotic morphology likely by maintaining mechanical G2/M checkpoint integrity. We thus propose that Rac1 promotes repair by preventing morphologically abnormal cells from entering cell division.

**Funding:** NIDDK Support, Veterans Affairs Support, Private Foundation Support

#### FR-PO370

##### **Drosophila Nephrocytes as a Personalized Platform for Validation of Variants in TBC1D8B-Associated Focal Segmental Glomerulosclerosis**

Julian Milosavljevic,<sup>1</sup> Camille Lempicki,<sup>1</sup> Konrad Lang,<sup>1</sup> Helena Heinkle,<sup>1</sup> Minxian Wang,<sup>2,3</sup> Andrea Knob,<sup>2</sup> Martin Pollak,<sup>2,3</sup> Tobias F. Hermle,<sup>1</sup> <sup>1</sup>Renal Division, Department of Medicine, Faculty of Medicine and Medical Center - University of Freiburg, Freiburg, Germany; <sup>2</sup>Division of Nephrology, Department of Medicine, Beth Israel Deaconess Medical Center, Boston, MA; <sup>3</sup>Department of Medicine, Harvard Medical School, Boston, MA.

**Background:** Mutations in *TBC1D8B* have been discovered as a monogenic cause of nephrotic syndrome and functional studies in *Drosophila* support a role in nephrin trafficking. Nevertheless, the role of *TBC1D8B* remains incompletely understood. Frequency of *TBC1D8B* mutations among patients with hereditary FSGS is unclear while functional characterization of novel genetic variants continues to be challenging.

**Methods:** We tested evolutionary conservation of *TBC1D8B* through expression of murine *Tbc1d8b* in the background of a stable null allele of fly *Tbc1d8b*. We exploited the accessibility of slit diaphragms in podocyte-like *Drosophila* nephrocytes to assess Nephrin turnover in a *Tbc1d8b* loss-of-function. Novel *TBC1D8B* mutations were detected by whole exome sequencing within an FSGS cohort. Transgenesis of mammalian *Tbc1d8b* harboring patient mutations was used for validation in *Drosophila in vivo*.

**Results:** Fly *Tbc1d8b* was required for rapid nephrin turnover in nephrocytes and nephrin endocytosis induced by excessive function of Rab5. Accumulation of LAMP-GFP upon *Tbc1d8b* loss-of-function confirmed a role for endolysosomal degradation. Low level expression of murine *Tbc1d8b* rescued loss of the *Drosophila* gene demonstrating evolutionary conservation. We previously showed that excessive overexpression induces nephrin vesicles. To examine if this effect is linked to TBC/GAP function, we generated a transgene harboring a R537K mutation which targets the catalytic arginine finger. Expression of this transgene still entailed nephrin vesicles, but these were of a reduced size. This suggests that *TBC1D8B* function is partially GAP-independent. Finally, we discovered four novel *TBC1D8B* mutations within a cohort of 363 FSGS patients and validated a functional impact for three of these mutations in *Drosophila* studying nephrin vesicles in podocyte like nephrocytes.

**Conclusions:** The podocyte-like nephrocytes of *Drosophila melanogaster* are suitable for validation of novel variants and further functional characterization of the nephrotic syndrome gene *TBC1D8B*, establishing a personalized platform for *TBC1D8B*-associated FSGS.

**Funding:** Other NIH Support - Grant / Award Number: 'RC2-DK122397', Government Support - Non-U.S.

#### FR-PO371

##### **Genetic Studies of Paired Metabolomes Reveal Enzymatic and Transport Processes at the Interface of Plasma and Urine**

Pascal Schlosser,<sup>1,2</sup> Nora Scherer,<sup>1,3</sup> Franziska Grundner-Culemann,<sup>1</sup> Yong Li,<sup>1</sup> Anna Kottgen,<sup>1,2</sup> <sup>1</sup>Institute of Genetic Epidemiology, Faculty of Medicine and Medical Center - University of Freiburg, Freiburg, Germany; <sup>2</sup>Department of Epidemiology, Johns Hopkins Bloomberg School of Public Health, Baltimore, MD; <sup>3</sup>Spemann Graduate School of Biology and Medicine (SGBM), University of Freiburg, Freiburg, Germany.

**Background:** The kidneys operate at the interface of plasma and urine by clearing molecular waste products from the body while retaining valuable solutes. We hypothesized that a genetic study of paired plasma and urine metabolomes facilitates the identification of transport proteins and enzymes involved in this process.

**Methods:** We performed genome-wide association studies of 1,916 metabolites, of which 779 were quantified in plasma and urine from 5,023 participants of the German Chronic Kidney Disease study. Identified associations were integrated with orthogonal datasets, including colocalization with expression and protein quantitative trait loci to prioritize the underlying genes, and with complex traits and diseases to identify potential candidate genes. ATAC- and RNA-seq data from primary human kidney was used to annotate regulatory variants.

**Results:** We found 1,299 significant associations between genetic variants and metabolite levels, including examples related to the kidneys' role in metabolite handling. Of note, studying either plasma or urine alone would have missed associations with 40%

of the underlying metabolites. The major genes and metabolite pathways shaping the plasma and the urine associations were clearly distinct. Insights only enabled through the study of urine included the identification of a missense variant in *AQP7* resulting in reduced tubular glycerol reabsorption. The kidney-enriched transporter *SLC13A3* left different metabolomic footprints in plasma and urine, consistent with its function in mitochondrial energy generation. The prioritized underlying variant is predicted to specifically alter binding of major cell type-relevant transcription factors. Shared genetic determinants of 7,515 metabolite-biomarker/disease combinations provided mechanistic hypotheses for complex and monogenic diseases and allowed for the characterization of yet undescribed systemic roles of renal dipeptidase 1.

**Conclusions:** This genetic study of plasma and urine metabolomes emphasizes the role of multi-matrix studies to gain insights into *in vivo* metabolic processes, and particularly into kidney functions. The results provide a rich resource of yet unknown enzymatic and transport processes that represent a molecular link to human diseases.

**Funding:** Commercial Support - Bayer Pharma AG, Government Support - Non-U.S.

## FR-PO372

### Single-Cell RNA Sequencing Reveals Renal Endothelium Heterogeneity During Injury and Regeneration in a Murine Model of Renal Thrombotic Microangiopathy

Jan Sradnick, Anika Wirth, Hannah Kroeger, Patrick Arndt, Vladimir T. Todorov, Christian Hugo. *Division of Nephrology, Department of Internal Medicine III, University Hospital CGC, Dresden, Germany.*

**Background:** Analyses of the marker genes, pathways, and biological functions revealed that endothelial cells (EC) are highly heterogeneous showing plasticity both in normal and pathophysiological conditions. However, the heterogeneity and cellular responses of renal endothelial cells during injury and regeneration have not been well characterized.

**Methods:** Endothelial specific injury was induced in Tie2 eGFP mice (n=48) by renal arterial perfusion with ConcanavalinA (ConA) /anti-ConA. Nineteen mice served as sham operated controls. Kidneys were harvested 24h, 48h, 3 days 4 days and 7 days after injury induction. For 10x single-cell RNA sequencing, cells were isolated from glomerular and extraglomerular renal tissue. Tie2 EGFP<sup>+</sup>CD102<sup>+</sup>CD105<sup>+</sup>CD45<sup>+</sup> endothelial cells were further separated using FACS cell sorting. After 10x single cell sequencing, Seurat clustering analysis was performed to identify EC cell clusters. Endothelial cell damage was evaluated using periodic acid-Schiff staining and histology in zinc fixed paraffin embedded slices.

**Results:** Endothelial cell loss was observed 24h following injury, while the EC number already markedly increased on day 3 and was back to baseline levels after 4-7 days. 10x single-cell RNA sequencing was performed on 42,000 sorted renal cells. Following quality control measurements almost all sequenced cells expressed endothelial specific genes. In glomerular and peritubular ECs, different cluster (17 and 7, respectively) could be identified following t-distributed stochastic neighbour embedding (t-SNE). In both glomerular and peritubular EC transcriptomics, cell clusters demonstrating predominant regulation of cellular injury genes was seen 24h but also 48h after model induction. Gene clusters consistent with cell remodeling and differentiation were mostly identified on days 4-7.

**Conclusions:** In summary, our study provides a high-resolution atlas of the renal endothelium during EC specific injury and regeneration. Our data highlight the phenotypic heterogeneity and changes of endothelial subtypes which were potentially involved during EC injury and regeneration after selective renal endothelial cell injury.

## FR-PO373

### Multi-Omic Analyses of Primary Kidney Tissue Identifies Medulla-Specific Genes and Transcriptional Regulators

Stefan Haug,<sup>1</sup> Yong Li,<sup>1</sup> Selvaraj Muthusamy,<sup>3</sup> Anna Kottgen,<sup>1</sup> Shreeram Akilesh,<sup>2</sup> <sup>1</sup>*Institute of Genetic Epidemiology, Faculty of Medicine and Medical Center - University of Freiburg, Freiburg, Germany;* <sup>2</sup>*Department of Laboratory Medicine and Pathology, University of Washington, Seattle, WA;* <sup>3</sup>*Department of Pathology, Virginia Commonwealth University, Richmond, VA.*

**Background:** The kidney medulla is a key regulator of salt and water balance. Despite this vital function, it is relatively understudied, including its contribution to inherited or acquired kidney disease. To fill this gap, we generated and analyzed gene expression (RNA-seq), chromatin accessibility (ATAC-seq) and chromatin conformation (HiC) data derived from human cortex and medulla tissue in order to identify patterns of medulla-specific gene expression and regulation.

**Methods:** Macrodissected matched pairs of healthy cortex and medulla tissue were sampled from kidneys of four adult tumor nephrectomy patients. RNA-seq, ATAC-seq and HiC data were generated and analyzed to identify differentially expressed genes, differentially accessible regions and differential loops between cortex and medulla. We also analyzed our data together with publicly available single nucleus RNA-seq data and the GTEx database to calibrate and extend our findings.

**Results:** Over 2,300 genes were differentially expressed (padj < 0.01, log<sub>2</sub>-fold change > 1) between cortex and medulla. Our carefully annotated samples and gene expression analysis helped to re-assign mislabeled samples in the GTEx database. Medulla-specific genes expressed in the adult were overrepresented among kidney development pathways and included many genes relevant for kidney disease like *UMOD*, *SLC12A1* and *EGF*. By incorporating genome-wide maps of chromatin accessibility and conformation, we defined the regulatory landscape around exemplar medullary genes (*SLCO3A1*, *CLDN14*

and *WNT7B*). Next, we examined transcription factor (TF) motifs in accessible chromatin regions and predicted an important role for POU3F3 in the medulla, which we confirmed by immunohistochemistry. POU3F3 has been previously shown to be important in mouse kidney development, but here we show that it is also expressed in the adult human medulla, where it may direct expression of ~17% of medulla-specific genes.

**Conclusions:** The reference-quality functional genomic datasets generated in this study elucidate the regulatory differences between human kidney cortex and medulla. This valuable resource will help us better understand diseases and conditions originating in the medullary portion of the human kidney.

**Funding:** Government Support - Non-U.S.

## FR-PO374

### Generation of Mouse/Human Chimeric Organoids by Renal Fetal Dissociated Cell and Induced Nephron Progenitor Cells

Naoto Matsumoto, Shuichiro Yamanaka, Kenji Matsui, Yatsumu Saito, Kei Matsumoto, Eiji Kobayashi, Takashi Yokoo. *Tokyo Jikeikai Ika Daigaku Igakubu Igakuka, Minato-ku, Japan.*

**Background:** Several aspects of renal development are still unclear. Consequently, not all component cells of the kidney can be made from induced pluripotent stem cells (iPSCs). For example, human stromal progenitor cells cannot be artificially produced. Thus generating a completely functional kidney from iPSCs is still difficult. Hence attempts have been made to compensate for this limitation using xenogeneic cells. Renal progenitor cells self-organize into nephrons by aggregation. We hypothesized that taking advantage of this reaggregation mechanism, high concentration of human nephron progenitor cells (NPCs) and low of mouse dissociated single cells (DSCs) could increase cell to cell the contact chance efficiently for generating chimeric nephrons. Therefore, we examined whether higher-order chimeric structures could be obtained by mixing human NPCs with mouse renal progenitor cells to generate heterologous renal chimeric organoids.

**Methods:** NPCs were selectively induced from human iPSCs using the method reported by Taguchi and Nishinakamura et al., and spheres were created by mixing the induced NPCs with renal progenitor cells extracted from B6 mice kidneys at E13.5 and at a 1:3 ratio. The combined cells were cultured with spinal cord cells in Transwell plates. The resulting tissue was collected on day 6 and histological evaluation of differentiation was performed by immunostaining.

**Results:** On day 6, human NPCs aggregated on mouse ureteric bud (UB) tips and exhibited a chimeric CM structure. All NPCs were derived from human cells, and all UB tips were derived from mouse cells. The spinal cord cocultures revealed human-derived distal tubules (DTs), which were derived exclusively from human cells, connected to mouse collecting ducts (CDs).

**Conclusions:** Using NPCs derived from human iPSCs, we have successfully generated higher-order interspecies renal chimeric organoids with connected human CM and mouse tubular structures. This new chimeric organoid is expected to provide new insights into induced renal cells and contribute substantially to the production of kidneys for regenerative medicine.

**Funding:** Government Support - Non-U.S.

## FR-PO375

### Modeling ST2/IL-33 "Alarmin" Signaling Through Kidney Organoid-Immune Cell Co-Culture System

Vikram Sabapathy, Gabrielle Costlow, Saleh Mohammad, Rahul Sharma. *University of Virginia, Charlottesville, VA.*

**Background:** Renal diseases are a major cause of morbidity and mortality worldwide. Inflammation elicited by a variety of cytokines and chemokines is a major player in the initiation and progression of the disease. Interleukin 33 (IL-33) belongs to the IL-1 family of cytokines, which acts as an 'alarmin' that regulates the immune response during injury. Released during injury-response, cytokine IL-33 acts in an autocrine/paracrine manner through membrane receptor (ST2) aka IL33R or IL-1 receptor-like 1 (IL1RL1), triggering an inflammatory response. ST2 is widely expressed in many cells including regulatory T cells (Tregs), which constitute a major anti-inflammatory mechanism. Although, it's been demonstrated in various studies that Tregs play a crucial role in mitigating renal injury. There is no evidence determining the role of the ST2/IL33 axis in Tregs during kidney injury.

**Methods:** In this study, we attempt to delineate the role of the ST2 pathway in Tregs using murine renal injury model and kidney organoids.

**Results:** By RNA sequencing analysis it was observed that ST2-high Tregs had higher expression of regenerative factors such as amphiregulin (AREG) and Growth/differentiation factor (GDF15). The *in vivo* ischemic renal injury experimental data indicated that loss of ST2/IL33 signaling from Tregs resulted in exacerbation of renal injury leading to worsening of renal function. Co-culture of kidney organoids with ST2+ Tregs protected cellular viability under *in vitro* ischemia-reoxygenation conditions compared to ST2- Tregs. We observed that the addition of secretome from ST2+ Tregs in kidney organoid cultures improves cellular viability during *in vitro* hypoxic injury. Secretome analysis indicated elevated levels of AREG in spent media of ST2+ Tregs cultures. Our data shows that AREG treatment protected kidney organoids from cisplatin-induced apoptosis in a dose-dependent manner and mediates tubular cell plasticity.

**Conclusions:** Activation of IL-33/ST2 signaling axis in Tregs is essential for the regulation of inflammation, apoptosis, and repair in renal tissue during inflammation and injury.

**Funding:** NIDDK Support

Key: TH - Thursday; FR - Friday; SA - Saturday; OR - Oral; PO - Poster; PUB - Publication Only

Underline represents presenting author.

## FR-PO376

**Effects of Re-Expression of Renal Progenitor Genes in Mature Human Kidney Cells**

Naomi PODE SHAKKED,<sup>1,2</sup> Benjamin Dekel,<sup>4,3</sup> Oren Pleniceanu,<sup>5,6</sup> <sup>1</sup>Sheba Medical Center, Pediatric Stem Cell Research Institute and Sackler Faculty of Medicine Tel Aviv University, Tel Hashomer, Israel; <sup>2</sup>Cincinnati Children's Hospital Medical Center, Cincinnati, OH; <sup>3</sup>Tel Aviv University Sackler Faculty of Medicine, Tel Aviv, Israel; <sup>4</sup>Sheba Medical Center, Safra Children's Hospital, Division of Pediatric Nephrology, Pediatric Stem Cell Research Institute, Tel Hashomer, Israel; <sup>5</sup>Sheba Medical Center, Pediatric Stem Cell Research Institute, Tel Hashomer, Israel; <sup>6</sup>Sheba Medical Center, the Nephrology Research Lab and Sackler Faculty of Medicine Tel Aviv University, Tel Hashomer, Israel.

**Background:** During human nephrogenesis, fetal renal progenitors give rise to approximately 10<sup>6</sup> nephrons. It is currently believed that this progenitor pool is abolished postnatally due to the silencing of renal progenitor genes, depriving the mature kidney of the ability to generate new nephrons. At the same time, the incidence of end-stage renal disease is constantly growing, underscoring the need for new kidney regeneration strategies.

**Methods:** Here, we used lentiviral vectors to evaluate the effects of ectopic induction of two major renal progenitor genes (*OSR1* and *SIX2*) in primary adult kidney (AK) cells.

**Results:** OSR1 over-expression resulted in a transient change in cellular morphology into a cuboidal, mesenchymal-like phenotype, accompanied by upregulation of renal developmental transcription factors PAX2, SIX2, CITED1 and GDNF, while maintaining the expression of the GDNF protein, the major factor secreted from kidney stem cells and thus a marker of their functionality. However, no change in clonal efficiency or proliferation rate was noted in OSR1-expressing AK cells. In contrast, SIX2 over-expression led to significantly higher clonal efficiency and enhanced proliferation compared to control cells, consistent with its role as a regulator of self-renewal in renal stem cells. Surprisingly, although SIX2 induction resulted in elevated OSR1 levels, other renal progenitor genes (PAX2, SALL1 and GDNF) showed significantly lower expression levels. When injected subcutaneously into immunodeficient mice, SIX2-expressing cells demonstrated robust tubulogenic potential, giving rise mostly to CD13<sup>+</sup>EMA<sup>-</sup> proximal tubule cells, but were unable to integrate into developing renal tubules when co-cultured with embryonic mouse kidney cells. Importantly, cells over-expressing both OSR1 and SIX2 were both tubulogenic and showed distinct capacity of integrating into developing fetal renal structures.

**Conclusions:** Taken together, our results demonstrate that OSR1 induction in AK cells activates several other renal progenitor genes while SIX2 induction endows the cells with enhanced proliferation and colony formation potential, which could serve as a basis for generating an expandable *in-vitro* population of renal progenitor cells.

## FR-PO377

**CXCL12 and WNT5A Control Nephron Number in the Normal and Hypodysplastic Kidney**

Robert D'CRUZ, Nan Jiang, Norman D. Rosenblum. *The Hospital for Sick Children, Toronto, ON, Canada.*

**Background:** Renal hypodysplasia, defined by abnormally small kidneys with low nephron number and expanded stromal tissue, is the major cause of childhood renal failure. While molecular mechanisms controlling nephrogenesis have been elucidated, factors that control the number of nephrons is largely unknown and important as low nephron number is critical to kidney function in childhood and as an antecedent cause of adult-onset kidney and cardiovascular disease. Nephrons and stromal cells arise during embryonic development from *Osr1*-derived *Six2*<sup>+</sup> and *Foxd1*<sup>+</sup> progenitors, respectively. Previous work demonstrated that increased Hedgehog (Hh) signaling in *Osr1*<sup>+</sup> kidney progenitor cells disrupts normal stromal patterning (Sheybani et al., 2018). Here, we investigate the functional contribution of the embryonic renal stroma in determining nephron number.

**Methods:** Constitutive active Hh signaling in *Foxd1*<sup>+</sup> stromal cells was generated by deletion of *Ptch1*, a Hh cell surface receptor, in a *Cre*-dependent manner. Compound mutant mice with *Foxd1Cre*-dependent deficiency of *Cxcl12* or *Wnt5a* together with *Ptch1*, and mice with *Foxd1Cre*-dependent deletion of *Cxcl12*, were generated. Kidney tissue was analyzed by histology, single-cell (sc) and bulk RNA sequencing.

**Results:** Stromal *Ptch1*-deficient kidneys exhibited renal hypodysplasia characterized by a 41% reduction in nephron number (P<0.01, n=4) and expansion of *Foxd1*-derived PDGFRB<sup>+</sup> medullary stromal cells at E18.5. Complementary scRNA-seq and bulk RNA sequencing (n=3) identified increased expression of medullary stromal *Cxcl12* (P<0.001) and *Wnt5a* (P<0.01) ligands. *Foxd1Cre*-dependent deficiency of *Cxcl12* or *Wnt5a* together with *Ptch1* rescued nephron number by 32% (P<0.001, n=4) or 31% (P<0.05, n=3), respectively. Analysis of stromal *Cxcl12*-deficient kidneys demonstrated renal hypoplasia characterized by a 28% reduction in nephron number (P<0.01, n=4) at P4 due to impaired nephron epithelialization. Bulk RNA sequencing of stromal *Cxcl12*-deficient kidneys (n=3) showed dysregulation of genes associated with retinoic acid signaling, such as *Crabp1/2* (P<0.01) and *Aldh1a2* (P<0.05), and genes associated with Hippo signaling, such as *Cdc42* (P<0.05) and *Taz* (P<0.05).

**Conclusions:** Increased stromal *Cxcl12* and *Wnt5a* signal non-autonomously to drive low nephron number in renal hypodysplasia. Stromal *Cxcl12* functions physiologically to regulate nephron number.

**Funding:** Government Support - Non-U.S.

## FR-PO378

**Wilms Tumor: Insights Into the Role of Integrins Driving Cancer Stem Cells Self-Renewal vs. Differentiation**

Laura PERIN,<sup>1</sup> Astgik Petrosyan,<sup>1</sup> Valentina Villani,<sup>1</sup> Paola Aguiari,<sup>1</sup> Min Mahdi,<sup>1</sup> Matthew E. Thornton,<sup>2</sup> Brendan Grubbs,<sup>1</sup> Roger E. De Filippo,<sup>1</sup> Kevin V. Lemley,<sup>1</sup> Sargis Sedrakyan,<sup>1</sup> Gregory M. Shackleford,<sup>1</sup> Anat Erdreich-Epstein,<sup>1</sup> Stefano Da Sacco.<sup>1</sup> <sup>1</sup>Children's Hospital Los Angeles, Los Angeles, CA; <sup>2</sup>University of Southern California, Los Angeles, CA.

**Background:** Wilms Tumor (WT) is the most common pediatric renal cancer. Growing evidence links WT to aberrant nephrogenesis. While studies highlighted the genetic complexity of WT, little is known about the molecular mechanisms that regulate WT development. Here we report that uncommitted nephrogenic progenitors (NPs) expressing SIX2 and CITED1 (the master regulators of renal development) present characteristics of cancer stem cells (CSCs) and are the ones driving WT. We have also studied the role of integrins in these NPs in regulating WT development.

**Methods:** WT and human fetal kidney (hFK) samples were histologically analyzed, digested to single-cell suspension, incubated with SmartFlare-probe to isolate SIX2+CITED1<sup>+</sup> cells, and processed for RNA-seq, single-cell RNA-seq and spatial transcriptomics. Xenografts of WT-NPs and hFK-NPs were generated and tumor formation was assessed. Analyses of mechanisms that regulate self-renewal vs. differentiation were performed *in vitro* and *in vivo*. Knockdown with miRNAs against SIX2 and CITED1 was performed on WT-NPs and processed for RNA-seq.

**Results:** By comparing NPs from different WT subtypes and NPs from hFK we identified that cells expressing SIX2 and CITED1 fulfill CSC criteria, reliably recapitulating WT in transplantation studies. We showed that self-renewal vs. differentiation of SIX2+CITED1<sup>+</sup> WT CSCs is regulated by the interplay between integrins ITGB1 and ITGB4. WT transplantation studies show that blocking ITGB1 or ITGB4 leads to higher number of SIX2+CITED1<sup>+</sup> cells in the xenografts. Knockdown of SIX2 and CITED1 increased expression of kidney differentiation markers LHX1, WNT7B, PODXL, MECOM, reduced expression of nephrogenic markers MEOX1, TMEM100, EYA1, MAYFB, and increased expression of ITGB1, ITGB4, and LAMA5.

**Conclusions:** These studies define SIX2+CITED1<sup>+</sup> cells as the nephrogenic CSCs of WT, where ITGB1 and ITGB4 interplay may play a role in self-renewal vs. differentiation and serve as a potential target for new strategies to treat WT.

**Funding:** Private Foundation Support

## FR-PO379

**Indian Hedgehog Signalling in Kidney Development**

Lauren G. RUSSELL,<sup>1</sup> Christopher Rowan,<sup>2</sup> Norman D. Rosenblum,<sup>2</sup> Paul Winyard,<sup>1</sup> David A. Long.<sup>1</sup> <sup>1</sup>University College London Institute of Child Health, London, United Kingdom; <sup>2</sup>SickKids Research Institute, Toronto, ON, Canada.

**Background:** Hedgehog (Hh) signalling is critical in the development of the kidney, with genetic alterations of Hh pathway components leading to defects in nephron formation. Indian hedgehog (Ihh) is one of three ligands that activate the Hh pathway, however the cellular sources and functional role of Ihh in kidney development is not well understood.

**Methods:** We utilised a novel 3D imaging technique, combining wholemount fluorescence in situ hybridisation, immunolabelling and optical clearing to visualise *Ihh* mRNA localisation in 3D in the developing mouse embryonic kidney at cellular resolution. Furthermore, we have utilised a total *Ihh* knockout mouse model and *Cre* recombinase-based techniques to conditionally delete *Ihh* in the intermediate mesoderm, using the inducible *Osr1-Cre<sup>ERT2</sup>*, to begin to interrogate the functional role of *Ihh* in the developing kidney.

**Results:** *Ihh* mRNA was detected in the developing mouse kidney from embryonic day (E)16.5; during the maturation of tubules and glomeruli and maintained at E18.5 and the first day postnatally. Double labelling with Lotus tetragonolobus lectin revealed that *Ihh* primarily localised to the proximal tubule. As *Ihh* is detected as the mature nephron is developing, we hypothesise that *Ihh* will be important in nephrogenic development. We observed that *Ihh*<sup>-/-</sup> kidneys are smaller at E16.5 with some observed displaying highly disorganised, abnormal morphology. Additionally, *Ihh*<sup>-/-</sup> kidneys have a significantly reduced total glomerular number (p=0.0297) and a reduction in SIX2<sup>+</sup> nephron precursor cells in around 40% of *Ihh*<sup>-/-</sup> kidneys compared with wild-type littermates, overall suggesting defects in kidney development in *Ihh*<sup>-/-</sup> mice. Conditional deletion of *Ihh* in the *Osr1*<sup>+</sup> intermediate mesoderm, results in a significantly decreased kidney/bodyweight ratio at E18.5 (p=0.0089), providing initial evidence of an importance for *Ihh* in intermediate mesoderm derived cells in the development of the kidney.

**Conclusions:** In summary, using a novel imaging technique we identified the onset of *Ihh* expression in maturing proximal tubules of the mouse embryonic kidney. Further, we observed defects in the development of *Ihh* total knockout kidneys and initial data indicates a function for *Ihh* in intermediate mesoderm derived cells.

## FR-PO380

## Conditional Ablation of Nephrons in Fetal Mice

Yuka Inage, Kei Matsumoto, Shuichiro Yamanaka, Kenji Matsui, Naoto Matsumoto, Yatsumu Saito, Daishi Hirano, Kimihiko Oishi, Eiji Kobayashi, Takashi Yokoo. *Tokyo Jikeikai Ika Daigaku, Minato-ku, Japan.*

**Background:** In humans, nephron number can vary up to ten-folds and a low nephron number is associated with an increased risk of hypertension and chronic kidney disease. Although low oxygen exposure and maternal nutritional restriction are already reported as animal models of low nephron number, these methods can also affect the development of other organs. Thus far, factors to determine the number of nephrons in a fetus remain to be clarified. Here, we established a low nephron number model, using genetically modified mice, without affecting the development of other organs.

**Methods:** Six2-GFP-Cre transgenic mice were crossed with C57BL/6-Gt (ROSA) 26Sor [tm1(HBEGF)Awai]/J mice (iDTR) to obtain bigenic (Six2-GFP<sup>+/+</sup> iDTR-mice) and control offspring (Six2-GFP<sup>-/-</sup> iDTR-mice). Diphtheria toxin was injected (0.5 ng) via the intra-amniotic route at E13.5. Subsequently, at E19.5, caesarean delivery was performed and offspring were placed in foster care. We assessed body weight, blood pressure, and nephron number and also conducted blood and urine tests.

**Results:** Both bigenic and control offspring displayed adequate development. Although blood pressure was not significantly different at the 12-weeks timepoint, nephron number per area in bigenic offspring decreased by approximately 50% compared to that in control offspring. Furthermore, bigenic offspring displayed higher blood urea nitrogen levels than control offspring.

**Conclusions:** We successfully ablated nephrons in fetal mice, approximately 50% per area. While these mice grew normally, showing no-hypertension using this protocol, additional salt loading experiments are ongoing to further refine this low nephron number model.

**Funding:** Private Foundation Support

## FR-PO381

## Interplay Between Ppargc1a and Esrrγa Regulates Nephron Segmentation and Ciliogenesis

Hannah M. Wesselman, Rebecca A. Wingert. *University of Notre Dame, Notre Dame, IN.*

**Background:** Cilia, hair-like projections that facilitate mechano- and chemosensing, are nearly ubiquitous in mammalian cells. Broadly speaking, ciliopathies present phenotypes in numerous tissues, including auditory, central nervous, and renal systems. Previous research has found *ppar gamma coactivator 1a (ppargc1a)* as an essential regulator of renal and cilia formation, and we sought to identify cooperative factors that regulate these developmental pathways. *estrogen-related receptor gamma a (esrrγa)* was of interest, as it interacts with *Ppargc1a* in regulating other tissues, and has been independently linked to decreased kidney function.

**Methods:** We confirmed that *esrrγa* independently affects nephron development in the zebrafish embryonic kidney using whole mount in situ hybridization to characterize distinct cell types. Through immunofluorescence, we quantified aberrant cilia formation, cell polarity, and cell turnover in the kidney, ear, and node. Through dual heterozygosity models, we evaluated the relationship between *esrrγa* and *ppargc1a* in cilia and nephron development. Additionally, we used ELISA and qRT-PCR to evaluate potential downstream targets of this genetic cascade.

**Results:** *esrrγa* deficient animals exhibited nephron composition defects including expanded proximal and reduced distal segments. Similarly, we detected defects in cilia formation, where ciliated basal bodies and cilia length were significantly reduced. These phenotypes were not isolated to renal cilia, and aberrant cilia were also observed in the node and ear. By modelling heterozygosity, we found that *esrrγa* cooperates with *ppargc1a* in ciliogenesis. Specifically, both of these factors work upstream of PGE2 production by regulating *Cox1*.

**Conclusions:** These data position *Esrrγ* as a critical component of nephron development and cilia formation where it cooperates with *Ppargc1a* to modulate prostaglandin signaling. These novel findings may have clinical relevance for understanding the pathogenesis of ciliopathies or other renal conditions.

## FR-PO382

## The Regulatory Program of the Distalizing Mammalian Nephron

Mary Anne A. Achieng, Jack Schnell, Connor Fausto, Nils Lindstrom. *University of Southern California Keck School of Medicine, Los Angeles, CA.*

**Background:** During development, nephron progenitors differentiate into over 24 cell types that become positioned along the nephron proximal-distal axis. To improve distal cell differentiation in the *in vitro* organoid model, we are delineating the developmental programs generating distal nephrons *in vivo* by analyzing scRNAseq data capturing human nephrogenesis. Comparisons of organoid scRNAseq data to the *in vivo* benchmark highlight dissimilarities between organoids and nephron cells, notably that organoids lack mature distal nephron markers. We present a scalable platform for synchronized nephrogenesis for studying patterning programs and forming functionally competent distal-like cells.

**Methods:** To correct patterning abnormalities *in vitro*, we generated a synchronized kidney organoid system for tuning differentiation of specific nephron cell fates.  $\beta$ -catenin signaling plays a role in expanding the distal domain and is required for distal tubule formation. Thus, we pulsed small molecule WNT agonists and quantified expression of early distal transcription factors to test whether  $\beta$ -catenin signaling plays a conserved role.

**Results:** Through early modulation of  $\beta$ -catenin signaling, we increased abundance of distal precursors and partially normalized patterning. Expression of transcription factors HNF1 $\beta$  and TFAP2A, which demarcate distal precursors in the comma- and S-shaped body of the mammalian nephron, is faithfully replicated in these treated organoids, with more elongated distal domains.

**Conclusions:** The synchronicity of our organoids enables manipulation of cohorts of nephron-like structures in a narrow developmental stage. In this system,  $\beta$ -catenin signaling manipulation in early organoids alters differentiation and morphogenesis, consistent with our model of  $\beta$ -catenin regulating positional identities along the nephron proximal-distal axis.

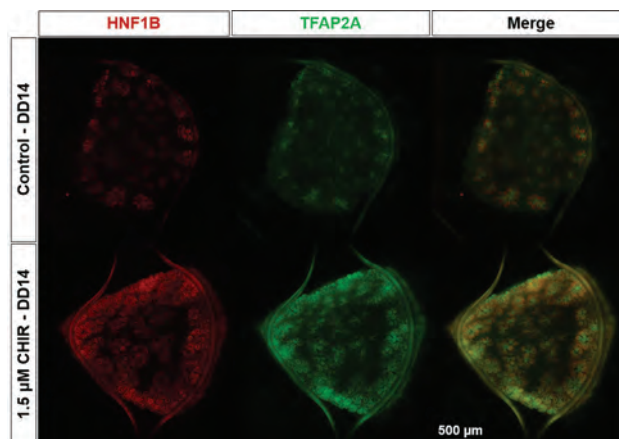

In CHIR-treated organoids, HNF1B<sup>+</sup>, TFAP2A<sup>+</sup> distal domains are significantly increased compared to control, with more elongated tubules.

## FR-PO383

Effect of Stromal Cell-Derived Factor 1 $\alpha$  Bio-Functionalization on Tissue Formation of Vascular In Situ Tissue Engineered Grafts in Rats With CKD

Merle M. Krebber,<sup>1</sup> Paul J. Besseling,<sup>1</sup> Joost O. Flederius,<sup>1</sup> Patricia Y. Dankers,<sup>2</sup> Carlijn V. Bouten,<sup>2</sup> Marianne C. Verhaar.<sup>1</sup> <sup>1</sup>Valve, Materials Driven Regeneration <sup>1</sup>Universitair Medisch Centrum Utrecht, Utrecht, Netherlands; <sup>2</sup>Techische Universiteit Eindhoven, Eindhoven, Netherlands.

**Background:** *In situ* tissue engineering (TE) offers cell-free scaffolds that transform into living grafts. However, the pro-inflammatory chronic kidney disease (CKD) environment might influence neo-tissue formation. Stromal cell-derived factor 1 $\alpha$  (SDF-1 $\alpha$ ) bio-functionalization may attract and guide host cells with anti-inflammatory and neo-tissue-stimulating properties. Therefore, we studied the role of SDF-1 $\alpha$  on initial inflammation and remodeling of vascular grafts in CKD and healthy rats.

**Methods:** CKD was induced in female rats (n=53) by 5/6<sup>th</sup> nephrectomy. Upon 50mg/24h proteinuria, CKD or sham-operated rats underwent abdominal aorta-replacement with an electrospun biodegradable supramolecular polyurethane-131-bisurea (PCU-131-BU) graft, bare or SDF-1 $\alpha$  bio-functionalized. Explantation was performed at 2 weeks (preliminary: sham + bare n=4, CKD + bare n=4, sham + SDF-1 $\alpha$  n=4, CKD + SDF-1 $\alpha$  n=7) or during remodeling (12 weeks, preliminary: sham + bare n=2 and Sham + SDF-1 $\alpha$  n=6). Explants were checked for inflammation, tissue formation and graft integrity.

**Results:** At 2 weeks, immunohistochemistry (IHC) on explants showed that CKD decreased anti-inflammatory macrophage (CD163) presence. The combined presence of CKD and SDF-1 $\alpha$  determined Elastin, pan-macrophage inflammation (CD68) and smooth muscle cell Calponin. Fibroblast marker Vimentin was similar in all conditions. Due to progressive proteinuria in n=11 animals, no 12 weeks explants were included for CKD. Vascular rupture and sudden death occurred in 4/15 sham from 3 weeks onwards (2 bare and 2 SDF-1 $\alpha$ ), possibly related to premature graft resorption. With IHC we indeed found PCU-131-BU fibers in 2-but not in 12 weeks explants. In sham at 12 weeks, SDF-1 $\alpha$  led to a non-significant increase of Elastin but no other differences. While patent, all n=9 explants at 12 weeks showed severe vascular dilatation.

**Conclusions:** *In situ* TE with PCU-131-BU led to a remodeling response, replacing the synthetic material by vascular tissue. Resorption and mechanical stability may dictate outcomes at least in equal amount to disease and bio-functionalization. SDF-1 $\alpha$  may mediate inflammation and tissue-formation in CKD at 2 weeks but during later remodeling under healthy conditions, function appears limited.

**Funding:** Government Support - Non-U.S.

## FR-PO384

**Malnutrition During Pregnancy Impairs Nephrogenesis by Modifying Epigenetic Regulation in Nephron Progenitor Cells**Oded Volovelsky, Yaniv Makayes, Morris Nechama. *Hadassah University Medical Center, Jerusalem, Israel.*

**Background:** Poor intrauterine environment, such as maternal malnutrition, impairs nephron endowment and increases the risk of chronic kidney disease in adulthood in the next generation. We have previously demonstrated that methionine metabolism has an important role in mediating the negative effects of caloric restriction during pregnancy on nephron endowment. As methionine has an important role in epigenetic control of gene expression, we examined the effects of malnutrition on gene methylation in nephron progenitor cells.

**Methods:** The caloric intake of pregnant mice was limited to 70% of daily intake. Nephron progenitor cells (NPCs) were sorted using transgenic mice with specific GFP labeling. DNA from NPCs was extracted, and the methylation pattern was characterized and analyzed using reduced representation bisulfite sequencing. The data acquired was cross-referenced with chromatin accessibility and histone modification data of nephron progenitor cells. The findings were validated using RT-qPCR. In addition, the effects of methionine on methylation patterns were evaluated using Bisulfite Amplicon Sequencing.

**Results:** Caloric restriction during pregnancy leads to a global decrease in DNA methylation in nephron progenitor cells compared to control. Specific changes in DNA methylation were localized to gene promoters, enhancers, and transcription factor binding sites. These effects were present throughout the genome, including genes involved in nephrogenesis and pivotal intracellular signaling pathways, in accordance with the changes in expression profile.

**Conclusions:** This study is the first evidence that maternal malnutrition during pregnancy impairs nephrogenesis by modifying epigenetic remodeling in NPCs, presumably mediated by methionine.

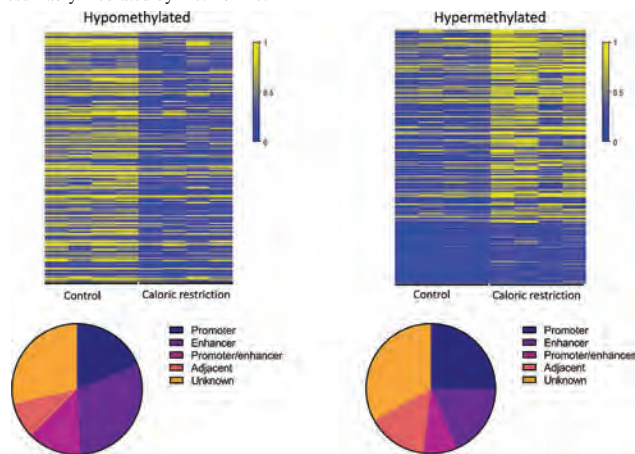

Heatmaps of differentially methylated regions in DNA of NPCs extracted from embryonic kidneys subjected to caloric restriction during pregnancy. Pie charts representing the anticipated distribution of differentially methylated regions.

## FR-PO385

**Altering Maternal Macronutrient Supply Can Extend Nephrogenesis and Rescue Nephron Endowment**

John F. Bertram,<sup>1</sup> Sarah E. Gazzard,<sup>1</sup> Julie L. Moreau,<sup>1</sup> Joel A. Eliades,<sup>3</sup> Alexander N. Combes,<sup>1</sup> Stephen J. Simpson,<sup>2</sup> Luise A. Cullen-McEwen.<sup>1</sup> <sup>1</sup>Department of Anatomy and Developmental Biology, Monash Biomedicine Discovery Institute, Monash University, Melbourne, VIC, Australia; <sup>2</sup>Charles Perkins Centre Research and Education Hub, The University of Sydney, Sydney, NSW, Australia; <sup>3</sup>Department of Biochemistry and Molecular Biology, Monash Biomedicine Discovery Institute, Monash University, Melbourne, VIC, Australia.

**Background:** Human and animal studies have linked low nephron endowment with increased risk of chronic kidney disease and hypertension in later life. Strategies to increase nephron endowment in those at risk of a nephron deficit are therefore sought. We have previously shown that feeding pregnant mice a low carbohydrate high fat diet (LCHF) boosts offspring nephron endowment. The present study investigated the mechanism behind this increased nephron endowment and whether the maternal LCHF could rescue a programmed nephron deficit.

**Methods:** To examine the mechanism behind the increased nephron endowment C57Bl6 pregnant mice were fed a normal diet (ND) or LCHF until postnatal day (PN) 0 (to assess numbers of Six2+ nephrogenic niches) or PN2-7 (to assess the timing of cessation of nephrogenesis). To examine whether the LCHF could rescue a programmed nephron deficit, a cohort of pregnant mice were fed either a ND, LCHF or a low protein diet (LPD) from mating and throughout gestation and lactation, or LPD from mating and throughout gestation and then switched to the LCHF at birth. At PN21 we estimated

nephron endowment using unbiased stereology. Food intakes were measured throughout pregnancy and lactation to assess total caloric intake.

**Results:** At birth, the number of nephrogenic niches and nephrons in LCHF offspring was similar to ND offspring indicating the augmentation of nephron number occurs postnatally during lactation. At PN3, nephron induction was complete in ND mice, however in LCHF offspring Six2+ nephron progenitor cells were still present. Similarly, at PN6 the nephrogenic zone was absent in ND offspring but remained in LCHF offspring indicating a prolonged nephrogenic period. At PN21, LPD mice contained 9770±417 nephrons per kidney while ND mice contained 13143±270 nephrons per kidney (p<0.0001). Offspring of mothers fed the LPD diet and then switched to the LCHF contained 13455±403 nephrons (p<0.0001 compared with LPD) demonstrating the diet switch at birth prevented the nephron deficit. Food intake analyses indicated the increased caloric density of the LCHF was not responsible for the augmentation of nephron number.

**Conclusions:** These findings indicate that maternal nutrition, via lactation, can rescue nephron endowment in mice destined to develop kidneys with a nephron deficit.

## FR-PO386

**SGLT2 Inhibition Promotes Intrinsic Kidney Regeneration by Cells of the Renin Lineage**

Lois van der Pluijm,<sup>1</sup> Angela Koudijs,<sup>1</sup> Wendy Stam,<sup>1</sup> Joris I. Rotmans,<sup>1</sup> Kenneth W. Gross,<sup>2</sup> Michael P. Pieper,<sup>3</sup> Anton J. Van Zonneveld,<sup>1</sup> Roel Bijkerk.<sup>1</sup> <sup>1</sup>Leids Universitair Medisch Centrum, Leiden, Netherlands; <sup>2</sup>Roswell Park Comprehensive Cancer Center, Buffalo, NY; <sup>3</sup>CardioMetabolic Diseases Research, Boehringer Ingelheim Pharma GmbH & Co KG, Biberach an der Riss, Germany.

**Background:** With chronic kidney disease (CKD) prevalence rapidly increasing, the need for novel therapies rises. Sodium glucose co-transporter-2 (SGLT2) inhibitors were initially developed to treat hyperglycemia in diabetes type 2. Clinical trials with the SGLT2 inhibitor Empagliflozin (EMPA) revealed a remarkable renal protective effect in patients with (non-) diabetic CKD, but the molecular mechanism behind this remains to be clarified. Interestingly, the cells of renin lineage (CoRL) in the juxtaglomerular apparatus have been demonstrated to harbor a progenitor potential. Upon injury or aging, CoRL are able to migrate into the glomerular tuft where they start expressing different glomerular cell markers in several CKD mouse models. Considering that EMPA treatment affects renin plasma levels and electrolyte balance in patients, we hypothesized that SGLT2 inhibition might have an effect on CoRL-induced glomerular regeneration.

**Methods:** Experiments were performed in a Ren1cre;tdTomato lineage-trace mouse strain that expresses a tomato fluorescent label in cells derived from renin lineage. Two kidney injury models were applied; bilateral ischemia reperfusion injury (bIRI) and 5/6 nephrectomy (5/6NTx). EMPA (10 mg/kg) was administered daily by oral gavage for 14 days. Subsequently, kidneys were harvested for histological analysis.

**Results:** In both the bIRI and 5/6NTx model, EMPA intake led to an increase (>2 fold) of CoRL found in intraglomerular regions compared to vehicle control. These CoRL differentiated selectively towards different glomerular cell types per model: bIRI combined with EMPA administration resulted in an increase of claudin- (10 fold) and integrin- $\alpha$ 8- (1.5 fold) tomato double positive cells, suggesting favored differentiation from CoRL to respectively a parietal epithelial or mesangial cell type. In contrast, in the EMPA treated 5/6NTx model, an increase (1.5 fold) in tomato-podocyn double positive cells was observed, implying more restocking of podocytes by CoRL in this model.

**Conclusions:** SGLT2 inhibition by EMPA treatment leads to increased CoRL-mediated intrinsic regeneration potential and provides the kidney with different replenished cell types in different kidney disease models. Our findings demonstrate a novel mechanism via which SGLT2 inhibition might protect against kidney injury.

**Funding:** Commercial Support - Boehringer Ingelheim

## FR-PO387

**A New Quantifiable View of the Renin Cell Niche in Longitudinal 3D Intravital Microscopy Reveals a Response to Glomerular Injury Feedback System**

Patrick Arndt,<sup>1</sup> Jan Sradnick,<sup>1</sup> Hannah Kroeger,<sup>1</sup> Stefan Holtzhausen,<sup>2</sup> Michael Gerlach,<sup>1</sup> Vladimir T. Todorov,<sup>1</sup> Christian Hugo.<sup>1</sup> <sup>1</sup>Universitätsklinikum Carl Gustav Carus, Dresden, Germany; <sup>2</sup>Technische Universität Dresden, Dresden, Germany.

**Background:** Renin cells (RC) reside in the juxtaglomerular apparatus and function as progenitors capable of migrating into the glomerulus after injury. While regulation of these repair processes is poorly understood, the authors propose the hypothesis that glomerular repair processes in adults underlie an individual intraglomerular-juxtaglomerular feedback mechanism. Using longitudinal intravital microscopy and a laser injury model that induces local damage in individual glomeruli, enables controlled observations of repair processes. Using virtual ray tracing, an optical object characterization technique, a new method of quantification in longitudinal 3D intravital imaging, especially a detailed characterization of the renin cell niche, was established.

**Methods:** Renin reporter mice underwent doxycycline pulse induction. Intravital microscopy was performed through an implanted body window under an upright Leica SP8 LSM for 3 hours on up to 7 days. Laser injury was induced by focusing 100% laser power for 5 seconds at 48x zoom on one Z-plane. 3D processing was performed with Bitplane Imaris 9.7 and novel 3D image quantification was realized by the Marching Cubes algorithm. The calculation of the directional thickness of RC was based on an adapted ray tracing method.

Key: TH - Thursday; FR - Friday; SA - Saturday; OR - Oral; PO - Poster; PUB - Publication Only

Underline represents presenting author.

**Results:** Targeted use of laser irradiation established an inducible, selective and reproducible intraglomerular injury model. Migrating RC extended during 3 hours towards the injury area, infiltrating this area vicinity without losing contact to the juxtaglomerular RC. During these processes the RC volume first increased outside the glomerulus and then showed an up to threefold increased area of dynamic migration with up to 344% compared to their niche of origin.

**Conclusions:** Longitudinal intravital microscopy combined with laser-induced intraglomerular injury and 3D image analysis of injury directed renin cell migration in transgenic mice was assessed in a quantifiable manner. The combination of these technologies provides a new powerful tool for studying the juxtaglomerular feedback system of renin cell recruitment/migration and transdifferentiation as a site-specific response to intraglomerular injury and may promise viable targets for further glomerular research.

#### FR-PO388

### Tet2 and Tet3 Mediated Active Cytosine Hydroxymethylation in Six2 Progenitor Cells Is Critical for Nephron Progenitor Differentiation and Nephron Endowment

Xiujie Liang, Tamas Aranyi, Jianfu Zhou, Yuting Guan, Hailong Hu, Hongbo Liu, Katalin Susztak. Susztak lab *University of Pennsylvania, Philadelphia, PA.*

**Background:** Nephron endowment is a key determinant of later life hypertension and kidney disease. Epigenetic changes are key regulators of gene expression. Here we studied whether epigenetic changes, specifically the ten–eleven translocation (*Tet*) DNA demethylase family, *Tet1*, *Tet2*, and *Tet3*-mediated active DNA hydroxymethylation is necessary for gene expression regulation and kidney differentiation.

**Methods:** We generated mice with deletion of *Tet1*, *Tet2* or *Tet3* in Six2 positive nephron progenitors (NP) and performed unbiased omics profiling, whole genome bisulfite sequencing on isolated Six positive NP and single cell RNA sequencing on newborn kidneys.

**Results:** We did not observe changes in development or kidney function in mice with nephron progenitor-specific deletion of *Tet1*, *Tet2*, *Tet3* or *Tet1/Tet2* or *Tet1/Tet3*. On the other hand, mice with combined *Tet2* and *Tet3* loss in Six2-positive NPCs failed to form nephrons leading to kidney failure and perinatal death. *Tet2* and *Tet3* loss in Six2-positive NPs resulted in defect in mesenchymal to epithelial transition and renal vesicle differentiation. Whole genome bisulfite sequencing, single cell RNA sequencing, and gene and protein expression assay identified a defect in expression in genes in the WNT- $\beta$ -catenin signaling pathway in absence of *Tet2* and *Tet3* due to a failure in demethylation of these loci.

**Conclusions:** Our results indicate the key role of *Tet2* and *Tet3*-mediated active cytosine hydroxymethylation in NPs in kidney development and nephron endowment.

**Funding:** NIDDK Support

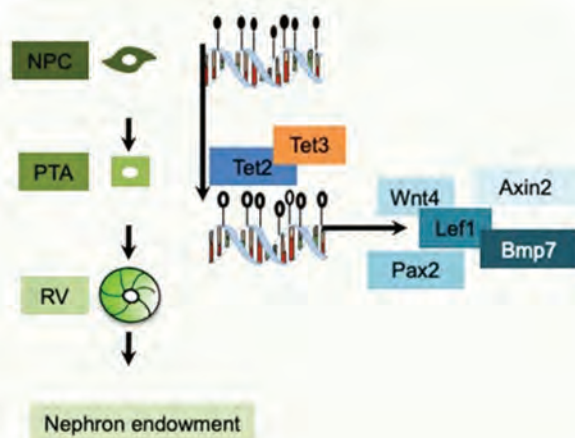

Graph abstract

#### FR-PO389

### Inducing Kidney Lymphangiogenesis in Development and Disease

Michael D. Donnan,<sup>1</sup> Dilip K. Deb,<sup>1</sup> Eric Ni,<sup>2</sup> Yalu Zhou,<sup>1</sup> Valentin David,<sup>1</sup> Susan E. Quaggin.<sup>1</sup> <sup>1</sup>Northwestern University Feinberg School of Medicine, Chicago, IL; <sup>2</sup>Lake Erie College of Osteopathic Medicine, Erie, PA.

**Background:** Expansion of the lymphatic vasculature, or lymphangiogenesis, is observed in a number of kidney pathologies including AKI, diabetes, and transplant rejection. Additionally, lymphangiogenesis in these settings appears to be protective against injury and the progression of kidney fibrosis. As lymphangiogenesis is primarily driven by the secreted ligand vascular endothelial growth factor C (VEGF-C) through the receptor VEGFR-3, this signaling pathway is a potential target for future kidney therapeutics.

**Methods:** We generated a new transgenic mouse model to investigate the role of VEGF-C induced lymphangiogenesis in kidney development and response to injury. VEGF-C was overexpressed in nephron progenitor cells and the renal tubular compartment using the Six2Cre (*Six2Vegf-C*) and Pax8-CreERT2 (*Pax8Vegf-C*) driver strains respectively. We characterized the consequences of VEGF-C overexpression during development (*Six2Vegf-C* and *Pax8Vegf-C*) as well as adult mice after 1 week of induction (*Pax8Vegf-C*). Mice underwent a detailed phenotypic evaluation. Whole kidneys were processed for micro-CT 3D imaging and histology with kidney lymphatics distinguished by co-immunofluorescence for the markers PDPN and VEGFR-3.

**Results:** Developmental overexpression of VEGF-C was detrimental to pup growth with increased mortality. Gross evaluation revealed enlarged kidneys with increased kidney-to-mouse weight ratio. Kidney histology and micro-CT imaging demonstrated large cystic lesions within the kidney hilum with marked expansion of the lymphatic capillary network throughout the kidney cortex. Inducing VEGF-C expression for 1 week in 4-week-old *Pax8Vegf-C* mice also resulted in an expansion of cortical lymphatic vessels, however without disruption of gross kidney architecture or reduced mouse viability. Single-cell RNA-seq of this model is currently pending.

**Conclusions:** Developmental and post-natal lymphangiogenesis is promoted by overexpression of VEGF-C. While developmental overexpression resulted in a more severe phenotype suggestive of cystic renal lymphangioma with increased mortality, augmenting VEGF-C expression in adult mice increased the lymphatic capillary density in the kidney without overt phenotypic consequence. This model enables further investigation into the function of lymphatic vessels during kidney injury.

**Funding:** Private Foundation Support

#### FR-PO390

### Role of P2X Receptors on Endothelial Cell Injury Mediated by Complement Activation

Arlette Bohorquez, Carolina G. Ortiz-Sandoval, Daniel Diatlov, Christoph Licht. CL Lab *The Hospital for Sick Children, Toronto, ON, Canada.*

**Background:** The complement system is critical for innate immunity. The complement system consists of over 50 proteins, provides defense against microbes, mediates inflammatory responses. The final step of complement activation is formation of the membrane attack complex (MAC, C5b-9). Complement over-activation is implicated in the pathophysiology of numerous diseases, yet the mechanisms underlying host cell damage are not fully elucidated. The P2X receptors, are transmembrane cationic channels gated by adenosine triphosphate (ATP) which are present in the plasma membrane (PM) of most excitable and non-excitable cells including all segments of the nephron, and renal cells. Recently, a link between complement system and P2X receptors has been established, showing that inhibition of P2X activation decreases complement mediated cell damage. The aim of this study is to determine the role of P2X receptors activity in complement activation on primary endothelial cells.

**Methods:** Complement was activated on blood outgrowth endothelial cells (BOECs) using an established protocol, first sensitizing the cells using a specific antibody to CD59, followed by treatment with normal human serum. Complement activity was assessed by measuring the deposition of C3b and C5b-9 on BOEC PM via immunofluorescence using specific antibodies. Intracellular Ca<sup>2+</sup> levels were measured using a fluorescent calcium indicator (Invitrogen). ATP release was measured using a commercial ATP luminescence assay (Promega).

**Results:** Complement activation caused C3b and C5b-9 deposition on the PM of BOECs, followed by Ca<sup>2+</sup> influx and ATP release. Cells treated with P2X receptor antagonists, showed a significant decrease in C5b-9 deposition compared to untreated controls. In addition, P2X antagonist treatment significantly ameliorated Ca<sup>2+</sup> influx as well as ATP release.

**Conclusions:** The finding of reduced C5b-9 deposition on BOECs in the presence of P2X receptor antagonists suggests an important functional link between the complement system and purinergic system. While more research is required to fully elucidate the interactions between these critical, ubiquitous biological systems, our results contribute to a better understanding of the consequences of complement activation on endothelial cells and suggest new therapeutic targets for disease related to dysregulated complement system.

**Funding:** Commercial Support - Paragon Ventures Inc, Vancouver, BC, Canada

#### FR-PO391

### mTORC1 Activity Promotes an Intercalated Cell State Which Is Suppressed by Hes1 to Maintain Principal Cells in a Mature State

Jennifer DeRiso,<sup>1</sup> Malini Mukherjee,<sup>1</sup> Madhusudhana R. Janga,<sup>1</sup> Morgan J. Rothschild,<sup>3</sup> Sabdi Bravo,<sup>1,4</sup> Alicia L. Simmons,<sup>3</sup> Brook W. Busselman,<sup>3</sup> Indra Chandrasekar,<sup>1,2</sup> Kameswaran Surendran.<sup>1,2</sup> <sup>1</sup>Sanford Research, Sioux Falls, SD; <sup>2</sup>University of South Dakota Sanford School of Medicine, Sioux Falls, SD; <sup>3</sup>University of South Dakota, Vermillion, SD; <sup>4</sup>Augustana University, Sioux Falls, SD.

**Background:** Notch signaling via Hes1 is required to maintain Aquaporin-2 expressing principal cell types in the distal convoluted tubule, connecting tubule and collecting duct segments of the adult mouse kidney in a non-intercalated cell state. Lineage tracing of Hes1-deficient principal cells revealed that Notch signaling suppresses intercalated programs from turning on in mature principal cells. Here we attempt to identify intercalated cell state promoting signals by using unbiased genomic approaches to determine signaling pathways suppressed by Hes1 in principal cells.

**Methods:** We identified differentially expressed genes in adult mouse kidneys from control littermates (n=9) versus mice with one week of *Hes1* inactivation within the kidney epithelial cells (n=7). RNA-sequencing of total kidney RNA was performed to identify differentially expressed genes. Also, we performed chromatin immunoprecipitation (ChIP) using anti-FLAG antibody to identify loci visited by *Hes1* in a mature principal cell line expressing *Hes1* fused with 3xFLAG. We validated direct targets of *Hes1* by ChIP-qPCR. We detected mTORC1 activity by staining for phosphorylated S6 along with principal and intercalated cell markers. We also traced the fate of wild type versus *Tsc2*-deficient mature principal cells by genetically labeling them in adult mouse kidneys.

**Results:** Our results reveal that multiple signaling pathways components, including Wnt, BMP, Hh and mTOR are upregulated soon after inactivation of *Hes1*. *Hes1* suppresses *insulin receptor substrate 1* (*irs1*), a component that mediates mTORC1 activation. Consistent with mTORC1 activity promoting intercalated cell state we observed an increase in phosphorylated S6 ribosomal protein soon after inactivation of *Hes1* in principal cells of adult mouse kidneys. Additionally, inactivation of *Tsc2*, an inhibitor of mTORC1, is sufficient to initiate conversion of principal cells towards a type A intercalated cell state in adult kidneys.

**Conclusions:** These studies reveal a role for mTORC1 activity in promoting an intercalated cell state which is suppressed by Notch signaling to maintain principal cells in a mature state.

**Funding:** NIDDK Support, Other NIH Support - Sanford Research, NSF

## FR-PO392

### Evidence for Post-Branching Nephrogenesis and Novel Ureteric Bud/Nephron Progenitor Interaction in the Postnatal Rabbit

Meredith P. Schuh, Sunitha Yarlagadda, Lyan Alkhudairy, Raphael Kopan. Cincinnati Children's Hospital Medical Center, Cincinnati, OH.

**Background:** While all vertebrates undergo branching nephrogenesis, humans proceed in two additional post-branching nephrogenesis (PBN) periods: arcading and lateral branch nephrogenesis (LBN). This process is completed at 34-36 weeks gestation, with 60% of nephrons forming in the third trimester. Infants born before 30 weeks undergo nephrogenesis for no more than 40 days postnatally, resulting in low nephron endowment and increased risk for chronic kidney disease (CKD) later in life. Identifying a model that simulates human postnatal nephrogenesis is critical in order to reduce risk of CKD in this population. The rabbit continues nephrogenesis postnatally but whether it has PBN has not been determined. Without this knowledge, its utility as a model of preterm human remains unknown.

**Methods:** To address this, we performed morphologic assessments of rabbit nephrogenesis from post conceptual day (PC) 31 (birth) to PC49 using H&E and immunofluorescence to localize *SIX1*, *SIX2*, *WT1*, *ZO-1*, and *JAG1* in the postnatal period. We performed 3D rendering of the nephrogenic niche to assess for PBN, and applied RNAScope to localize the nephrogenic niche by expression of *Six1* (nephron progenitors, NPC) and *Ret* (ureteric bud (UB) tip) transcripts.

**Results:** Using molecular markers, *SIX1* and *SIX2* were identified in the NPC throughout nephrogenesis. 3D morphologic assessments identified an elongated tubule with attached glomeruli extending below the UB tip, consistent with PBN arcades. Above these arcades, the UB tip contained a horn-like protrusion interacting with an immature *WT1*+ NPC population (fig 1). The *Ret*+ UB horns were present until PC38, while the arcades were *Cdh1*+/*Ret*-.

**Conclusions:** We conclude that the rabbit shows morphologic and molecular evidence of PBN continuing postnatally. Furthermore, we identified a novel UB/NPC interaction during the arcading period.

**Funding:** Other NIH Support - Pediatric Scientist Development Program (4K12HD000850-32), K12/ Child Health Research Career Development Award (5K12HD028827-28), Private Foundation Support

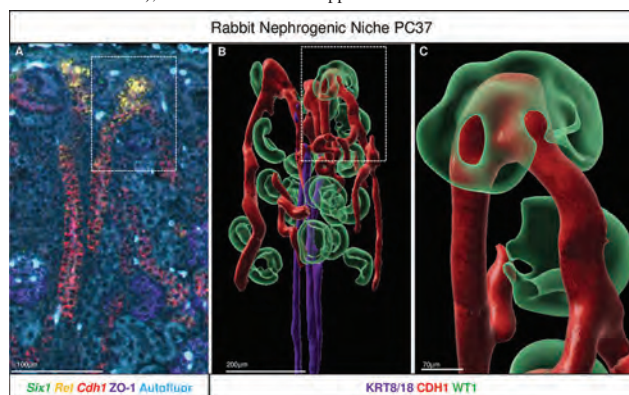

Figure 1: Arcades visualized in Postnatal Rabbit

## FR-PO393

### The Scattered Tubular Cell Phenotype Is Induced in Cultured Primary Human Tubular Cells and Correlates With Loss of HNF4A Expression

Michelle Kha,<sup>1</sup> Gülay Altıparmak,<sup>1</sup> Karl Swärd,<sup>2</sup> Martin E. Johansson.<sup>1,3</sup>  
<sup>1</sup>Goteborgs universitet Sahlgrenska Akademin, Goteborg, Sweden; <sup>2</sup>Lunds Universitet, Lund, Sweden; <sup>3</sup>Sahlgrenska universitetssjukhuset, Goteborg, Sweden.

**Background:** Scattered tubular cells (STCs) are found in the proximal tubules (PTs) of healthy human kidneys. The STCs differ from the PT cells by having less cytoplasm, fewer mitochondria and reduced brush border. Furthermore, several markers have been identified for the STCs. Shown to be involved in injury and regeneration, their phenotype is believed to be induced by injury or more controversially to represent a putative progenitor cell population. HNF4A is a transcription factor controlling the mature PT phenotype, including brush border formation and regulation of genes associated with transport and metabolism. We aimed to study if primary tubular cell cultures model induction of the STC phenotype by loss of HNF4A.

**Methods:** Primary PT cells were obtained from dissociated human kidney tissue. Histological material was collected from tissue and primary cells at consecutive passages. In parallel, we developed a method for correlative light and electron microscopy (CLEM) to seamlessly detect the STCs in light microscopy and study the ultrastructure of these cells in electron microscopy using the same tissue sample. Finally, *HNF4A* adenoviral transduction was used to reintroduce the PT phenotype in primary cells, followed by RNA sequencing.

**Results:** Colocalization of HNF4A and the STC marker VIM in human kidney tissue revealed two STC populations. A minority of VIM+ cells had complete loss of HNF4A expression. Most of the STCs were VIM+/HNF4A+, indicating an intermediate form between the PT and STC phenotype. CLEM showed reduced brush border and fewer mitochondria in most VIM+ cells, while a subset had complete loss of brush border and considerably less cytoplasm corresponding to the VIM+/HNF4A- population. Primary cells showed rapid reciprocal HNF4A loss and VIM induction following tissue dissociation. By reexpressing HNF4A using viral transduction, the PT phenotype was regained, including expression of HNF4A target genes associated with metabolism and brush border formation.

**Conclusions:** Collectively, this study suggests that HNF4A loss is a major event during development of the STC phenotype. *In vitro* culture of PT cells represents an induced STC model rather than a PT model, a process reversed by reintroduction of HNF4A. Loss of HNF4A is a gradual process possibly triggered by injurious events.

**Funding:** Government Support - Non-U.S.

## FR-PO394

### Selected Renal Cells Self-Organize to Form Neo-Nephrons and Attenuate Kidney Disease

Prakash Narayan,<sup>1</sup> Elias A. Rivera,<sup>2</sup> Deepak Jain,<sup>1</sup> Tim A. Bertram,<sup>1</sup> John W. Ludlow,<sup>1</sup> Joydeep Basu.<sup>1</sup> <sup>1</sup>ProKidney, Winston-Salem, NC; <sup>2</sup>Infinium Pathology Consultants, Oak Ridge, NC.

**Background:** Selected renal cells (SRC), a renal epithelial cell-enriched platform, is being advanced as autologous cell-based therapy for treatment of chronic kidney disease (CKD). In the present study, we tested the hypothesis that SRC forms organoids which self-organize into neo-nephrons, and its implantation into the diseased kidney induces repair and ameliorates organ dysfunction.

**Methods:** Rodent and human SRC were generated from kidney tissue using buoyant density gradient centrifugation. SRC cultures ± hydrogel were examined using light and immunofluorescence microscopy. SRC retention *in vivo* and bioactivity were examined in rodent models of CKD (ZSF1 rat and subtotal nephrectomy).

**Results:** In culture, both rodent and human SRC formed organoids (Figure 1A) that expressed renal markers including the Na-K-2Cl cotransporter, gamma-glutamyltransferase type I, megalin, and cubilin. In the presence of hydrogel, these SRC-derived organoids self-organized into tubules (Figure 1B), and other neo-nephron structures. Seeding SRC into diseased kidneys resulted in its incorporation into the renal parenchyma, evident even 4 months post-implantation, and formation of glomerular capillary loops and neo-nephrons. In subtotal nephrectomized rats, SRC implantation was associated with improvement in both survival and renal function (BUN, Scr, UPCr; p<0.05 vs. sham).

**Conclusions:** SRC forms organoids that express renal markers, and in the presence of hydrogel, self-organize into neo-nephrons. When introduced into diseased kidneys SRC exhibits reparative and restorative activity inducing neo-nephrogenesis, and improving survival and renal filtration. SRC-based Renal Autologous Cell Therapy (REACT) is in late-stage clinical trials for CKD, and has been granted Regenerative Medicine Advanced Therapy designation by Food and Drug Administration.

**Funding:** Commercial Support - ProKidney



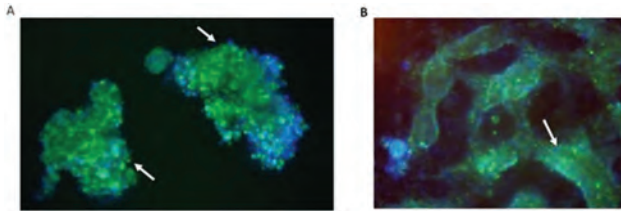

Figure 1. Organoids (A, arrows, 20X) formed from cultured SRC self-organize into tubules and neo-nephrons (B, arrow, 20X) in the presence of hydrogel.

#### FR-PO395

##### Hypoxic Mesenchymal Stem Cells-Derived Extracellular Vesicles Suppress Renal Fibrosis by Downregulating Rheb/mTOR Signaling

Wei-Cheng Tseng,<sup>1,2</sup> Der-Cherng Tarng,<sup>1,2</sup> *Division of Nephrology, Department of Medicine, Taipei Veterans General Hospital, Taipei, Taiwan; <sup>2</sup>School of Medicine; Center for Intelligent Drug Systems and Smart Bio-devices (IDS2B), National Yang Ming Chiao Tung University, Hsinchu, Taiwan.*

**Background:** Renal interstitial fibrosis, characterized by overactivated myofibroblasts and excessive deposition of extracellular matrix, is the final common pathway of all kinds of renal diseases. Recent evidence suggests that Rheb/mTOR signaling may activate renal fibroblasts and promote renal fibrosis. Till now, specific treatment targeting the pathophysiology of renal fibrosis remains an unmet medical need. Hypoxic mesenchymal stem cells (HMSC) represent novel frontiers in treating organ fibrosis. HMSCs can confer their paracrine therapeutic effects through the secreted extracellular vesicles (EVs), which are small membrane vesicles as a novel form of intercellular communication. Nevertheless, the detailed mechanisms that underlie the therapeutic effect of HMSC-EVs remain to be investigated.

**Methods:** HMSC-EVs were first isolated and characterized by transmission electron microscopy, nanoparticle tracking analysis, immunoblotting, and flow cytometry. After subjected to unilateral ureteral obstruction (UUO), 6-week-old male C57BL/6 mice were administered HMSC-EVs intravenously. In vitro, renal proximal NRK-52E epithelial cells were treated with transforming growth factor-beta 1 in the presence or absence of HMSC-EVs. The extent of renal fibrosis and the relevant pathomechanism of Rheb/mTOR signaling were investigated by histology, immunoblotting, and immunohistochemistry.

**Results:** We found the injured renal tubular cells can incorporate the HMSC-EVs, which further reduced renal fibrosis both in vivo and in vitro. HMSC-EVs not only effectively reduced UUO-induced renal interstitial fibrosis but also suppressed the expression of alpha-smooth muscle actin and fibronectin expression in vitro. Notably, HMSC-EVs decreased the expression of profibrotic Rheb in the UUO-injured renal tubular epithelial cells. Moreover, HMSC-EVs also inhibited mTOR and p70S6K expression in the obstructed kidneys.

**Conclusions:** The present study was the first to uncover the anti-fibrotic role of HMSC-EVs by suppressing Rheb-mTOR-p70S6K signaling in renal fibrosis. Our findings shed new light on the therapeutic effect of HMSC-EVs, and provide the bench evidence for applying the HMSC-EVs to treat patients with fibrotic kidney diseases.

#### FR-PO396

##### Urine-Derived Stem Cell Attenuated Renal Fibrosis via Klotho Activation in Mice

Hojoon Ko,<sup>1</sup> Dae Eun Choi,<sup>2,1</sup> Hyunsu Choi,<sup>3</sup> Yoon-Kyung Chang,<sup>3</sup> Eu Jin Lee,<sup>1</sup> Youngrok Ham,<sup>1</sup> Kiryang Na,<sup>2,1</sup> Kang Wook Lee,<sup>2,1</sup> Moo Jun Kim,<sup>1</sup> Suyeon Han,<sup>1</sup> *<sup>1</sup>Chungnam National University Hospital, Daejeon, Republic of Korea; <sup>2</sup>Chungnam National University, Daejeon, Republic of Korea; <sup>3</sup>Catholic University of Korea Daejeon St Mary's Hospital, Daejeon, Republic of Korea.*

**Background:** After renal IRI, regeneration and recovery of the renal tubular cell occurs. However, if the renal repair process is maladaptive, it progresses to renal fibrosis. The role of stem cells in kidney regeneration or fibrosis has not been fully elucidated. We evaluated the urine derived stem cells (UDSC) for renal inflammation and fibrosis after renal ischemia reperfusion (IR).

**Methods:** 10 week old balb/c nude male mice were used. sham, sham with UDSC, IR, IR with UDSC. UDSC were infused 3 times via tail vein at 6,7,8th day after renal IR. Urine NGAL/creatinine (Cr) were checked. The kidneys tissue were harvested at day 14 day. In vitro, TGF- $\beta$  treated HK2 cell were co-cultured with UDSC. Klotho siRNA silencing was performed in UDSC.

**Results:** Urinary NGAL/Cr were significantly increased in IR mice after 14 day IR, compared to sham mice. Urinary NGAL/Cr significantly decreased in UDSC treated IR mice, compared to IR mice. In H&E stain, renal tubulo-interstitial injury were significantly decreased in UDSC treated IR mice, compared to IR mice. In masson trichrom stain, renal fibrosis area were were significantly decreased in UDSC treated IR mice, compared to IR mice. The renal expression of MCP-1, osteopontine, TGF- $\beta$ ,  $\alpha$ -SMA, collagen IV, and F4/80 positive cells were significantly decreased in UDSC treated IR mice, compared to IR mice. The renal expression of Klotho were increased in UDSC treated IR mice, compared to IR mice. In vitro, UDSCs were stem cells that expressed Klotho protein more strongly than other mesenchymal stem cells (MSCs). UDSCs also suppressed fibrosis

by inhibiting transforming growth factor (TGF)- $\beta$  in HK-2 human renal proximal tubule cells in an in vitro model. Klotho siRNA silencing reduced the TGF- $\beta$ -inhibiting ability of UDSCs.

**Conclusions:** UDSC attenuate renal fibrosis after renal IR. Klotho-secretion of UDSC play a role in these anti-fibrotic effects.

**Funding:** Government Support - Non-U.S.

#### FR-PO397

##### Phenotypic Characterisation of Novel Immortalised Human Distal Convoluted Tubule Cells

Chutong Zhong, Keith Siew, Stephen B. Walsh. *University College London, London, United Kingdom.*

**Background:** The distal convoluted tubule (DCT) is responsible for fine-tuning the final excretion of sodium, potassium, calcium and magnesium in the urine. The study of rare monogenic diseases (namely Gordon and Gitelman syndromes) have highlighted the physiological importance of the DCT in blood pressure control. However, the most commonly used cellular models of this segment are either not truly kidney cells (e.g. studies have shown HEK293 are more likely of neuronal lineage) or of murine origin, and thus there is need for advanced human DCT (hDCT) models. Recently, 4 immortalised hDCT models isolated from human urine have been created by Dr Tetsuro Kusaba, but have not been biochemically or functionally characterized.

**Methods:** Western blot analysis on total cellular lysates by using NCC antibody detected three different states of NCC in all four hDCT cell lines. qPCR detected the presence of NCC mRNA at Cq 29.57-32.18 across all four samples (Human kidney positive control Cq 27, and HEK293 negative control Cq 45).

**Results:** Western blot analysis on total cellular lysates by using NCC antibody detected three different states of NCC in all four hDCT cell lines. qPCR detected the presence of NCC mRNA at Cq 29.57-32.18 across all four samples (Human kidney positive control Cq 27, and HEK293 negative control Cq 45).

**Conclusions:** The preliminary western blot and qPCR results confirmed NCC expression in all four hDCT cell lines and the position of bands agreed with previous studies (de Jong et al., 2003; DOI 10.1074/jbc.M303101200. Zhang et al., 2015. doi: 10.1093/hmg/ddv185.). Further experiments will be performed using other key markers expressed in DCT, including TRPM6 and parvalbumin, Calbindin, KS-WNK1, WNK4, human isoforms of SPAK and NCC. These cell lines could be the first validated hDCT cellular models which reflect the human DCT physiology and can be adapted to 3D cell culture system for functional experiments

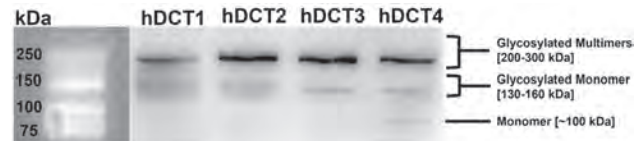

#### FR-PO398

##### Hypoxia Preconditioning Improves Angiogenic and Inflammatory Gene Profile of Adipose Derived Mesenchymal Stem Cells in Hypertensive Kidney Disease

Naba Farooqui,<sup>1</sup> Arjunmohan Mohan,<sup>1</sup> Eram Ahsan,<sup>1,2</sup> Leticia A. Sandoval,<sup>1</sup> Alfonso Eirin,<sup>1</sup> Lilach O. Lerman,<sup>1</sup> Sandra Herrmann,<sup>1</sup> *<sup>1</sup>Mayo Clinic Minnesota, Rochester, MN; <sup>2</sup>Jersey Shore University Medical Center, Neptune City, NJ.*

**Background:** Hypertensive kidney disease (HKD) in the setting of uremic milieu may alter the reparative potential of autologous adipose derived mesenchymal stem cells (AMSC) but might be improved by hypoxic preconditioning (HPC). We hypothesize that the state of HKD and not hypertension per se worsens the gene expression profile of AMSC compared to AMSC from patients with essential hypertension without CKD (HTN) as well as healthy controls (HC) and we examined if HPC attenuates that.

**Methods:** We cultured human AMSC (P3-4) isolated from healthy kidney donors (HC), HTN and HKD (n=3 each) under normoxia (20% O<sub>2</sub>) and hypoxia (1% O<sub>2</sub>). mRNA sequencing was performed on AMSC cell pellets and counts were normalized using edgeR software (v3.28.1). Genes with significant log fold change (p<0.05 and >1.4 for up- or down-regulation) were grouped based on gene sets available on Mouse Genome Informatics database.

**Results:** The baseline characteristics of the patients are shown in **Table 1**. On comparing HKD vs HC, inflammatory genes TLR3, CXCL1, CXCL2, and CXCL3 were significantly upregulated and a greater % of angiogenic genes are downregulated than upregulated (**Fig. 1A**). HPC promoted upregulation of angiogenic genes including vascular endothelial growth factor A (VEGF A), anti-inflammatory genes like Interleukin-1 receptor antagonist protein and nuclear factor kappa-B (NF- $\kappa$ B) inhibitors (**Fig. 1C**). Similarly, in HTN the inflammatory genes CXCL1, CXCL2, CXCL5, CXCL12, and TNF alpha-induced proteins were upregulated versus HC (**Fig. 1B**), and HPC abolished their upregulation. HKD showed a greater percentage downregulation of angiogenic genes compared to HTN which was reversed by HPC (**Fig. 1D**).

**Conclusions:** HKD and HTN are associated with upregulation of RNA levels of inflammatory genes in AMSC as compared to HC, with HKD showing decreased angiogenic gene profile compared to HTN. HPC may serve as a strategy to attenuate this response and enhance the angiogenic and anti-inflammatory gene expression profile of these AMSC.

**Funding:** NIDDK Support

Key: TH - Thursday; FR - Friday; SA - Saturday; OR - Oral; PO - Poster; PUB - Publication Only

Underline represents presenting author.

Table 1. Selected differentially expressed genes (included in the text)	Symbol	Accession	Expression
Aggrecan-like 1 (AGLN1)	AGLN1	NM_001101111	1.23 ± 0.12
Aggrecan-like 2 (AGLN2)	AGLN2	NM_001101112	1.15 ± 0.10
Aggrecan-like 3 (AGLN3)	AGLN3	NM_001101113	1.08 ± 0.09
Aggrecan-like 4 (AGLN4)	AGLN4	NM_001101114	1.02 ± 0.08
Aggrecan-like 5 (AGLN5)	AGLN5	NM_001101115	0.95 ± 0.07
Aggrecan-like 6 (AGLN6)	AGLN6	NM_001101116	0.88 ± 0.06
Aggrecan-like 7 (AGLN7)	AGLN7	NM_001101117	0.82 ± 0.05
Aggrecan-like 8 (AGLN8)	AGLN8	NM_001101118	0.75 ± 0.04
Aggrecan-like 9 (AGLN9)	AGLN9	NM_001101119	0.68 ± 0.03
Aggrecan-like 10 (AGLN10)	AGLN10	NM_001101120	0.62 ± 0.02
Aggrecan-like 11 (AGLN11)	AGLN11	NM_001101121	0.55 ± 0.01
Aggrecan-like 12 (AGLN12)	AGLN12	NM_001101122	0.48 ± 0.01
Aggrecan-like 13 (AGLN13)	AGLN13	NM_001101123	0.42 ± 0.01
Aggrecan-like 14 (AGLN14)	AGLN14	NM_001101124	0.35 ± 0.01
Aggrecan-like 15 (AGLN15)	AGLN15	NM_001101125	0.28 ± 0.01
Aggrecan-like 16 (AGLN16)	AGLN16	NM_001101126	0.22 ± 0.01
Aggrecan-like 17 (AGLN17)	AGLN17	NM_001101127	0.15 ± 0.01
Aggrecan-like 18 (AGLN18)	AGLN18	NM_001101128	0.08 ± 0.01
Aggrecan-like 19 (AGLN19)	AGLN19	NM_001101129	0.02 ± 0.01
Aggrecan-like 20 (AGLN20)	AGLN20	NM_001101130	0.01 ± 0.01

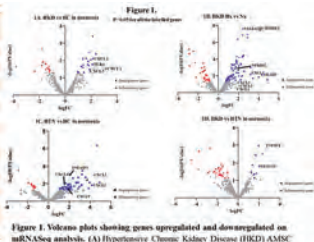

Figure 1. Volcano plots showing genes upregulated and downregulated on mRNA-seq analysis. (A) Hypertensive Chronic Kidney Disease (HCKD) AMSC compared to AMSC from patients with Essential Hypertension (EH). (B) Hypertensive Chronic Kidney Disease (HCKD) AMSC compared to HE AMSC genes in Normotensia. (C) HE AMSC genes in Normotensia. (D) HE AMSC genes in Hypotensia compared to HECKD AMSC genes in Normotensia. (E) HE AMSC compared to HE AMSC genes in Normotensia. (F) HE AMSC compared to HE AMSC genes in Normotensia.

FR-PO399

Renal Tubular Epithelial Cells From Urinary Samples of Renal Transplanted Recipients: Phenotypic Characterization, Stemness, and Immunomodulatory Properties

Valeria Pizzuti,<sup>1,2</sup> Chiara Donadei,<sup>1</sup> Elisa Gessaroli,<sup>1</sup> Giorgia Comai,<sup>1</sup> Gaetano La Manna,<sup>1</sup> Nephrology, Dialysis and Renal Transplant Unit, IRCCS-Azienda Ospedaliero-Universitaria di Bologna, Bologna, Italy; <sup>2</sup>Unit of Histology, Embryology and Applied Biology, Department of Experimental, Diagnostic and Specialty Medicine, University of Bologna, Bologna, Italy.

**Background:** The isolation of cells from urine samples represents a non-invasive approach to expand and characterize different cell populations. Renal Tubular Epithelial Cells (RTEC) are released into urines, and their amount can increase in the presence of kidney damage and transplant rejection. The aim of the present study was the isolation and phenotype characterization of RTEC in urinary samples from kidney transplant recipients, focusing on their stemness and immunomodulatory potential.

**Methods:** Urine derived RTEC, were then analyzed by cytometry for Cytokeratin, EpCAM and CD13 to confirm their epithelial features. The expression of CD90, CD73, CD44, CD105, CD24 and CD133 markers was also assayed. For the evaluation of their immunomodulatory properties, RTEC were cultured with PBMCs derived from healthy donors and the proliferation of CD4 and CD8 was analyzed with CFSE. After co-culture, T-cell subsets were quantified through flow cytometry for Th17 (CD4<sup>+</sup>, IL17<sup>+</sup>), Th1 (CD4<sup>+</sup> IFN-γ<sup>+</sup>) and Treg (CD4<sup>+</sup>CD25<sup>+</sup>, FoxP3<sup>+</sup>).

**Results:** The analysis of RTEC markers confirmed their epithelial features, with a high percentage of Cytokeratin positive cells. The expression of proximal and distal RTEC marker, CD13 and EpCam was observed (Fig. A,B). Most of the cells were positive for CD90, CD73, CD44, CD105, CD24 and CD133, which are typically associated with stem or progenitor populations. The co-culture with PBMCs activated with anti-CD3/CD28 showed a suppression in CD4<sup>+</sup> and CD8<sup>+</sup> proliferation (fig.C). Moreover, there was a reduction in Th17 and Th1 populations, while Treg subset remained stable (Fig.D).

**Conclusions:** The RTEC retain their epithelial characteristics after isolation and in vitro expansion. The expression of markers associated with stemness suggests the presence of not terminally differentiated subpopulations. The ability of RTEC to modulate the proliferation of immune cells could play an essential role in immune-mediated disorders.

**Funding:** Government Support - Non-U.S.

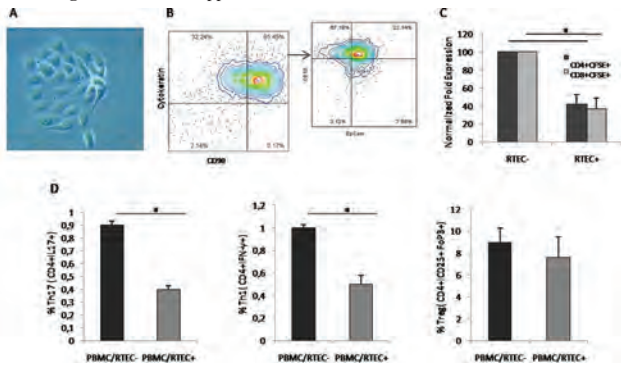

FR-PO400

Chimeric Nephrons in Neonatal Mice for Repeated-Dose Toxicity Evaluation

Kenji Matsui, Shuichiro Yamanaka, Naoto Matsumoto, Yatsumu Saito, Kei Matsumoto, Eiji Kobayashi, Takashi Yokoo. Division of Nephrology and Hypertension, Department of Internal Medicine, The Jikei University School of Medicine Tokyo Jikeikai Ika Daigaku, Minato-ku, Japan.

**Background:** The detailed molecular mechanisms of drug-induced nephrotoxicity (DIN) have not been established to date. It is difficult to examine multiple target molecules comprehensively *in vivo* because mice genetic modification requires time. Cultured kidney cells that lose polarity do not accurately reproduce toxicity. Renal organoids are

not suitable to validate the recovery process and chronic toxicity because they cannot be cultured for a long time. In this study, we have generated a new evaluation model using chimeric mice.

**Methods:** 1. Renal progenitor cells (RPCs) extracted from EGFP-labeled mouse fetuses were incubated to form spheres. The spheres were then transplanted under the renal capsules of adult C57BL/6 (B6) and NOG mice. 2. RPCs cell suspension was injected into neonatal B6 renal capsules. The mice were treated with repeated-dose cisplatin and were harvested 2 months after the injection for an evaluation with immunostaining and scRNA-seq.

**Results:** 1. The RPCs spheres in adult B6 showed a marked T-cell infiltration, suggesting an EGFP proteins rejection. Those transplanted into NOG formed nephrons, but their tubules became markedly dilated after 2 months. 2. The RPCs injected into the neonatal B6 were integrated into the host nephrogenic region without rejection. Subsequently, they formed mature chimeric nephrons from the glomeruli to the distal tubules that were retained for 4 months. Their function was confirmed by the presence of systemically administered dextran in their lumens. The repeated cisplatin administration caused them to express injury markers equivalent to the host nephrons.

**Conclusions:** We have developed a method to generate chimeric nephrons from the RPCs in neonatal mice that reproduced repeated-dose toxicity. The advantages of this model are as follows: 1, chimeric mice were generated easily; 2, chimeric nephrons showed a similar maturity and drug response to the host; 3, they survived for a longer time than the spheres in adults with connection to the host excretory tract; 4, immunocompetent neonates were tolerant to EGFP antigens, thus, traceable chimeric nephrons were formed; 5, scRNA-seq could be used to compare the nephron behavior of different origins. Furthermore, this model provided the potential to easily change tubular phenotypes by gene-editing RPCs and may be applied to elucidate the DIN mechanism.

**Funding:** Government Support - Non-U.S.

FR-PO401

Metabolomics and In Vitro Validation Study to Identify the Preventive Effect of Sodium-Glucose Cotransporter 2 Inhibitor on the Progression of Diabetic Nephropathy

Hyung Ah Jo,<sup>1</sup> Seung Hee Yang,<sup>2,1</sup> Inje University Ilsan Paik Hospital, Goyang, Republic of Korea; <sup>2</sup>Seoul National University College of Medicine, Seoul, Republic of Korea.

**Background:** We aimed to determine the metabolic profile of kidney resident cells under hyperglycemic conditions and following SGLT2 inhibitor treatment. The targeted metabolomics using the Absolute IDQ-p180 kit was applied to quantify metabolites in the kidney resident cells stimulated by high glucose (25, 50 μM) and following SGLT2 inhibitor, dapagliflozin treatment.

**Methods:** The primary cultured human tubular epithelial cells (TECs), podocytes, and glomerular endothelial cells (GECs) were used to identify metabolomic patterns according to hyperglycemic conditions following dapagliflozin treatment.

**Results:** The metabolomic pattern of kidney resident cells is distinctly depicted in the hyperglycemic stimuli compared to control (Figure 1). The levels of Asparagine, PC aa C38:4, and PC ae C34:1 were elevated in the TECs stimulated with 50 μM of glucose and significantly decreased after dapagliflozin treatment. The metabolite level of PC aa C28:1 was decreased in the TECs according to 50 μM of glucose treatment, and dapagliflozin treatment elevated its level. The level C18:1-OH was significantly decreased after 50 μM of glucose compared with control and its level was significantly increased after dapagliflozin treatment in podocytes. The level of C12 in the GECs was decreased after treatment with 50 μM of glucose, whereas dapagliflozin treatment significantly elevated its level. *In vitro* analysis showed that the treatment with glucose significantly increased the expression of fibronectin dose-dependently assessed by Western blot in the TECs, podocytes, and GECs. Dapagliflozin treatment significantly abrogated the high-glucose-induced increased expression of fibronectin (Figure 2).

**Conclusions:** The metabolic pattern of renal resident cells after SGLT2 inhibitor treatment is thought to originate from pathways associated with renal anti-fibrosis in diabetic conditions.

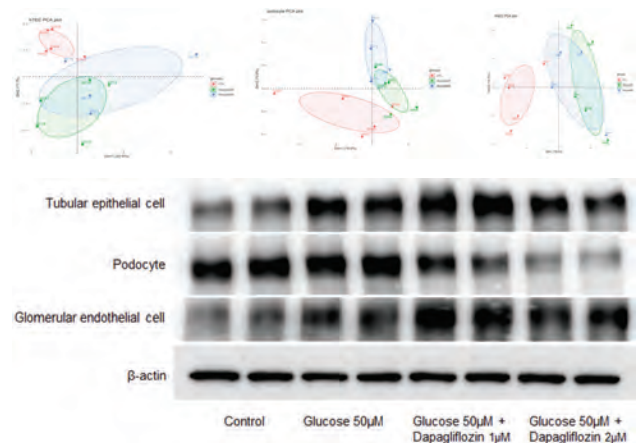

## FR-PO402

**In Utero Exposure to Maternal Diabetes Reprograms Nephron Formation and Predisposes to Hypertension and CKD**

Debora Malta C.S Santos, Takuto Chiba, Ariane Bruder do Nascimento, Andrew S. Clugston, Maliha Tayeb, Andrew J. Bodnar, Dennis Kostka, Thiago Bruder do Nascimento, Sunder Sims-Lucas, Jacqueline Ho. *University of Pittsburgh School of Medicine, Pittsburgh, PA.*

**Background:** The prevalence of diabetes has markedly increased among pregnant women worldwide and infants who are exposed to maternal diabetes *in utero* are at increased risk of congenital anomalies of the kidney and urinary tract (CAKUT). These anomalies can result in a reduction in the number of nephrons formed during kidney development, which is linked to hypertension and chronic kidney disease (CKD). However, it remains unclear how exposure to maternal diabetes *in utero* reprograms the developing kidney, predisposing to hypertension and CKD later in life.

**Methods:** We used the *Ins2<sup>+/C96Y</sup>* mouse as a genetic model of maternal type 1 diabetes. Diabetic *Ins2<sup>+/C96Y</sup>* females were bred with wildtype *C57BL/6J* males, and the wildtype offspring (DM\_Exp) were compared to wildtype offspring from *C57BL/6J* dams (=Control). Nephron numbers were estimated using the gold-standard physical dissection/fractionator method. scRNA-seq was performed on postnatal day 2 (P2) kidneys. Renal ischemia reperfusion injury was performed in male 3-month-old mice, and renal function was examined by BUN and sCr levels. Radio-telemetry was utilized to measure continuous blood pressure in male 6-month-old mice.

**Results:** Adult DM\_Exp mice exhibited a nephron deficit of approximately 20% with no associated growth restriction. The expression of the nephron progenitor markers, *Six2* and *Cited1*, was increased in DM\_Exp kidneys, while the number of developing nephrons was significantly reduced at postnatal day 2 (P2). This was accompanied by reduced levels of the *miR-200* family and increased expression of their target genes, *Zeb1/2*. Moreover, increased *DNMT3a* expression was observed in DM\_Exp kidneys. scRNA-seq indicated that the majority of significantly differentially expressed genes occur in the distal tubules and many of them encode solute transporters. Finally, adult DM\_Exp mice exhibited increased susceptibility to acute kidney injury and salt-sensitive hypertension.

**Conclusions:** Together, these data suggest that the diabetic intrauterine environment reprograms nephron formation and function via epigenetic mechanisms, predisposing to hypertension and CKD later in life.

**Funding:** NIDDK Support, Other NIH Support - DiaComp

## FR-PO403

**Development of Clinically Applicable In Vivo Tracking of Extracellular Vesicles Using Magnetic Resonance Imaging (MRI)**

Sargis Sedrakyan,<sup>1,2</sup> Johnny C. Akers,<sup>3</sup> Hasmik Soloyan,<sup>1</sup> Paola Aguiari,<sup>1</sup> Roger E. De Filippo,<sup>1,2</sup> Mya S. Thu,<sup>3</sup> Laura Perin.<sup>1,2</sup> <sup>1</sup>*Children's Hospital Los Angeles, Division of Urology, Los Angeles, CA;* <sup>2</sup>*University of Southern California Keck School of Medicine, Los Angeles, CA;* <sup>3</sup>*VisiCell Medical Inc, San Diego, CA.*

**Background:** Extracellular vesicles (EVs) derived from amniotic fluid stem cells (AFSC) hold great potential for the treatment of chronic kidney diseases (CKD). We demonstrated that AFSC-EVs are renoprotective in a mouse model of CKD, Alport syndrome. However, there is an unmet need for real-time *in vivo* monitoring of these therapeutic EVs to understand their safety, targeting, and effectiveness. While current optical imaging solutions are useful for EV tracking studies in animal models, there is limited utility in clinical applications. Here we present a novel *in vivo* tracking solution for our therapeutic EVs in Alport mice, utilizing clinically applicable MRI technology.

**Methods:** To generate trackable EVs, AFSC were labeled with a novel magnetic agent (VMI-Trac). EVs secreted by the labeled AFSC were isolated by ultracentrifugation. The viability and morphology of labeled-cells were evaluated, and the *in vitro* MR properties were analyzed by magnetometer. Purity, potency and identity was compared to non-labeled EVs. *In vivo* biodistribution of labeled EVs was evaluated in WT and Alport mice by MRI at 20 min post injection, and retro-orbital and intra-cardiac routes of delivery were compared.

**Results:** VMI-Trac did not affect the physiological characteristics of the cells and did not change identity, purity and potency of EVs. MRI phantom studies confirmed the *in vitro/ex vivo* detectability of labeled-EVs. Importantly, MRI studies showed that EV homing to the kidney injected intra-cardiacally into Alport mice was more efficient vs the retro-orbital route, and Prussian blue staining of sections confirmed EV homing to the kidney.

**Conclusions:** We have developed a clinically applicable novel magnetic nanoparticle agent that can be used to label and track the biodistribution of EVs in the kidney and other organs using non-invasive, safe, and effective MRI technology that's widely available. This technology is highly adaptable and can be deployed in both preclinical and clinical settings.

**Funding:** Private Foundation Support

## FR-PO404

**Characterization of TRIM72 Immune Modulatory Functions**

Pu Duann, Brad H. Rovin, Pei-Hui Lin. *The Ohio State University, Columbus, OH.*

**Background:** TRIM72 (MG53) is a myokine that appears to confer protection to the kidney in ischemia-reperfusion (I/R) injury and kidney fibrosis. We recently discovered the functional duality of TRIM72 as a membrane repair protein and immune system

regulator in kidney protection. We conducted experiments to identify whether TRIM72 is expressed within the immune system, and further investigated whether TRIM72 affected inflammatory cytokine profiles.

**Methods:** Spleen and bone marrow from wildtype (*mg53+/+*) or *trim72*-null (*mg53-/-*) age and gender-matched young adult mice were harvested. Thymus from pups at postnatal days 8, 18, and 24 were harvested and separated into thymic stroma and thymocytes. Tissue TRIM72 expression was analyzed by western blot and quantitative RT-PCR (qRT-PCR). Thymocyte and splenocyte immune phenotypes were further analyzed with anti-CD3, -CD4, -CD25 and -FoxP3 flow cytometry. In addition, we profiled serum from wildtype and *trim72*-null mice for pro-inflammatory cytokines using the V-PLEX Plus pro-inflammatory panel 1 (MSD company). The V-PLEX measures 10 cytokines (INF $\gamma$ , IL-1b, IL-2, IL-4, IL-5, IL-6, CXCL1, IL-10, IL-12p70 and TNF $\alpha$ ).

**Results:** We detected TRIM72 expression in thymus, spleen and bone marrow. TRIM72 is expressed in the thymic stroma, a tissue that regulates T cell tolerance early in life. Thymic expression was moderate, roughly 3% that of skeletal muscle. Wildtype pups had a higher proportion of thymocytes that were CD4+, CD25+, FoxP3+ (Tregs, 4.71%) than thymocytes from *trim72*-null pups (3.27%,  $p^* < 0.05$ ). Bone marrow and spleen expressed lower levels of TRIM72 than the thymus. Of the 10 cytokines examined from serum, CXCL1, IL-2, IL-5, IL-10 and TNF $\alpha$  were significantly elevated in *trim72*-null mice.

**Conclusions:** TRIM72 may facilitate the development of thymic Tregs, and provide basal inhibition of proinflammatory cytokines. Taken together, these findings suggest TRIM72 has anti-inflammatory and pro-tolerogenic immunomodulatory functions.

**Funding:** NIDDK Support, Other NIH Support - NIA, NIAID

## FR-PO405

**Evidence for NF- $\kappa$ B/Inflammatory Cytokine Signaling in New Nephron Formation After AKI in Adult Zebrafish**

Heiko J. Schenk,<sup>1,2</sup> Caramai N. Kamei,<sup>1</sup> Samuel M. Hughes,<sup>1</sup> Amber M. Wolf,<sup>1</sup> Iain A. Drummond,<sup>1</sup> <sup>1</sup>*Mount Desert Island Biological Laboratory, Salsbury Cove, ME;* <sup>2</sup>*Medizinische Hochschule Hannover, Hannover, Germany.*

**Background:** Adult progenitor cells in the mesonephric zebrafish kidneys are required during neo-nephrogenesis replacing injured tubules by forming new nephrons. Single-cell RNA transcriptomes of adult kidney progenitor cells point to components of NF- $\kappa$ B and inflammatory cytokine receptors that may initiate stem cell-based nephrogenesis. Here, we present evidence that gentamicin induces inflammation-associated injury, which potentially stimulates stem cell-based nephrogenesis, while the stimulatory effect on the progenitor cells to form new nephrons can be recapitulated by LPS injection.

**Methods:** Adult zebrafish were injected *i.p.* with gentamicin or LPS at day 0. NF- $\kappa$ B signaling was determined 4 days post-injection (dpi) by NF- $\kappa$ B:GFP detection of the NF- $\kappa$ B reporter line *Tg(NF- $\kappa$ B:EGFP)* and NF- $\kappa$ B-associated gene expression using qRT-PCR. The requirement of NF- $\kappa$ B signaling during regeneration was evaluated by pharmacological NF- $\kappa$ B inhibition. Bulk RNAseq from positive selected GFP+ and mcherry+ single cells by FACS was performed from kidneys 7 dpi by gentamicin injection using *Tg(lhx1a:EGFP;cdh17:mCherry)* fish.

**Results:** Gentamicin-induced kidney injury leads to increased tubular NF- $\kappa$ B reporter expression at 4 dpi and is associated with an upregulation of NF- $\kappa$ B target gene expression detected by qRT-PCR. Gentamicin also causes GH receptors mRNA upregulation at 7 dpi along with the kidney progenitor markers *osr1* and *eya4*, while the formation of new nephron aggregates as marked by *Tg(lhx1a:GFP)* expression is increased. NF- $\kappa$ B pharmacological inhibition reduces mRNA expression of kidney progenitor markers, while LPS injection induces mRNA upregulation of kidney progenitor markers. Bulk RNAseq from positive selected GFP+ Lhx1a+ cells 7 dpi with gentamicin confirmed the induction of cytokine receptors in the kidney progenitor cells.

**Conclusions:** Multiple pathways may converge on adult kidney stem cells to activate new nephron formation. We conclude that DAMP and NF- $\kappa$ B signaling is required and sufficient to induce neo-nephrogenesis. Further experiments are required to determine whether cytokine stimulation of neo-nephrogenesis is a direct or indirect effect.

**Funding:** NIDDK Support, Government Support - Non-U.S.

## FR-PO406

**Self-Complementary Adeno-Associated Viral Gene Delivery in the Metanephric Organ Culture Identifies Pvt1 as Modulator of Cystogenesis**

Karam S. Aboudehen, Kara Eckberg, Ivan D. Weisser, Daniel J. Buttram, Nikunj Somia, Peter Igarashi. *University of Minnesota Twin Cities, Minneapolis, MN.*

**Background:** Autosomal dominant polycystic kidney disease (ADPKD) is a monogenic disorder characterized by the formation of kidney cysts, which originate from the epithelial tubules of the nephron. The metanephric organ culture (MOC) is an *ex vivo* system wherein explanted embryonic kidneys undergo tubular differentiation and renal development. The MOC has been previously used to study PKD; however, difficulty in manipulating gene expression has impeded its effectiveness in identifying genes and pathways that are involved in cystogenesis.

**Methods:** We tested the ability of different viruses as a gene-delivery tool by comparing the transduction efficiency of three serotypes scAAV vectors. We then utilized scAAV serotype DJ to deliver shRNA to knockdown *Pvt1*, a long non-coding RNA (lncRNA), which was upregulated in cystic MOCs, in *Pkd1* and *Pkd2* mutant mice, and humans with ADPKD. E14.5 metanephroi from wild type CD-1 and *Pkd1*-null embryos

were incubated with scAAV-DJ/shRNA for 4 hours and cultured on a transwell dish between 24 and 96 hours. Semi quantitative qRT-PCR, western blot, and cyst index analysis were performed at 96 hours.

**Results:** scAAV/DJ displayed robust transduction efficiency of the epithelial cells of the MOC by 67%. shRNA delivery by scAAV/DJ downregulated the expression of *Pvt1* by 45% and reduced cyst index by more than 50% in explanted wild-type and *Pkd1*-mutant MOCs treated with cAMP. Mechanistically, knockdown of *Pvt1* decreased the expression of c-MYC protein by up to 60% without affecting *Myc* mRNA.

**Conclusions:** Data from this study suggest that *Pvt1* modulates cystogenesis and targeting *Pvt1* could provide therapeutic benefits for patients with ADPKD. scAAV/DJ could be utilized to rapidly and inexpensively screen and identify genes and pathways that are involved in cystogenesis.

**Funding:** NIDDK Support

## FR-PO407

### Comprehensive Characterization of 47 Adeno-Associated Virus Serotypes and Mutants for Renal Gene Transfer

Taisuke Furusho, Mia S. Galbraith-Liss, Anusha Sairavi, Hiroyuki Nakai. Oregon Health & Science University, Portland, OR.

**Background:** With the advent of the NGS-based clinical diagnostics, a number of genetic causes have been identified in CKD whose etiology was previously unknown. Such increasing knowledge about genetic etiology of CKD and the relatively high prevalence of monogenic kidney diseases in both pediatric and adult CKD patients have made CKD an attractive target for AAV vector-mediated *in vivo* gene therapy. However, gene delivery to the kidney has been challenging and there has been no study that compared renal transduction efficiencies of many AAV serotype and mutant capsid-derived vectors in a head-to-head setting. In addition, route of administration (ROA)-dependent differences in renal transduction profiles among different AAV capsids have yet to be investigated. Thus, the development of AAV vector-mediated renal gene therapy has been impeded so far.

**Methods:** We comprehensively characterized renal transduction profiles of 47 different AAV capsids (serotypes and mutants) following vector administration in mice using two ROAs (intravenous injection, IV; and renal vein injection, RV). To this end, we employed AAV DNA/RNA Barcode-Seq, an NGS-based high-throughput method. A barcoded AAV vector library was administered into C57BL/6J mice via IV or RV, kidneys were harvested 6 weeks post-injection, and transduction efficiency of each AAV capsid for each ROA was assessed by Barcode-Seq. Select AAV capsids were then individually vectorized and validated in mice.

**Results:** AAV9 showed the highest renal transduction by IV among the 47 AAV capsids but AAV9 was outperformed by a set of AAV capsids including AAVmt when administered by RV. AAVmt was found to transduce the kidney >30 times better than AAV9. AAV9 transduced only mesangial cells and interstitial cells and transduction patterns by IV and RV remained the same. In contrast, AAVmt transduced only mesangial cells by IV while cortical renal tubule epithelial cells, mostly proximal tubules, were efficiently transduced by RV.

**Conclusions:** Our high-throughput approach using Barcode-Seq identified AAV capsid - ROA combinations that can mediate renal transduction at levels that were not attainable by previous approaches. In addition, our study underscores the importance of carefully selecting AAV capsid and ROA as a combination depending on target cells of interest.

**Funding:** NIDDK Support, Other NIH Support - NIAID

## FR-PO408

### Plasma Metabolome Differences Across Time in Pediatric CKD

Arthur Lee,<sup>1</sup> Yunwen Xu,<sup>2</sup> Jian Hu,<sup>8</sup> Rui Xiao,<sup>1</sup> Stephen R. Hooper,<sup>3</sup> Erum A. Hartung,<sup>1</sup> Josef Coresh,<sup>2</sup> Eugene P. Rhee,<sup>4</sup> Vasan S. Ramachandran,<sup>7</sup> Paul L. Kimmel,<sup>6</sup> Bradley A. Warady,<sup>3</sup> Susan L. Furth,<sup>1</sup> Michelle Denburg.<sup>1</sup> CKD Biomarkers Consortium <sup>1</sup>The Children's Hospital of Philadelphia, Philadelphia, PA; <sup>2</sup>Johns Hopkins University Bloomberg School of Public Health, Baltimore, MD; <sup>3</sup>University of North Carolina at Chapel Hill School of Medicine, Chapel Hill, NC; <sup>4</sup>Massachusetts General Hospital, Boston, MA; <sup>5</sup>Children's Mercy Hospitals and Clinics, Kansas City, MO; <sup>6</sup>National Institutes of Health, Bethesda, MD; <sup>7</sup>Boston University, Boston, MA; <sup>8</sup>University of Pennsylvania Perelman School of Medicine, Philadelphia, PA.

**Background:** Studies of longitudinal metabolomics in CKD are lacking. Baseline metabolite levels have been associated with risk of future CKD progression (PMC8455058). The relations of change in metabolite levels and eGFR over time are unknown in children with CKD.

**Methods:** The Chronic Kidney Disease in Children study is a prospective multicenter cohort of children aged 0.5-16 years with eGFR 30-90ml/min/1.73m<sup>2</sup> at entry. Untargeted plasma metabolomics profiling was performed on baseline, year 2, and year 4 samples. Linear mixed effects regression (adjusted for sex and baseline age) was used to evaluate eGFR-metabolite associations and metabolite differences over time. Linear regression evaluated association of changes in metabolite level and eGFR. Significance was based on false discovery rate <0.05.

**Results:** Median (IQR) age=11.6 (8.1-15.1) years and eGFR=49.9 (36.6-64.2). 1156 person-visits (n baseline=626, follow-up=530) were included. **Figure** shows how metabolites associated with eGFR and time. Changes in 70 metabolite levels associated

with change in eGFR. 5 of those increased over time and previously associated with risk of CKD progression: n-acetyl-1-methylhistidine, hydroxyasparagine, homocitrulline, N6-carbamoylthreonyl-adenosine, and 2,3-dihydroxy-5-methylthio-4-pentenoate.

**Conclusions:** We described plasma metabolomic patterns in relation to eGFR and time in pediatric CKD. There are likely many drivers of metabolite changes over time (eGFR decline, linear growth, pubertal maturation). Longitudinal data corroborated published baseline metabolites associated with future CKD progression. N-acetyl-1-methylhistidine has been associated with risk of kidney failure and *NAT8* gene variation in adults. N6-carbamoylthreonyl-adenosine is a post-transcriptional breakdown product that is gaining interest as a potential uremic toxin.

**Funding:** NIDDK Support, Other NIH Support - NIH R38 HL143613-03

### Figure: how 622 metabolites relate to time and eGFR

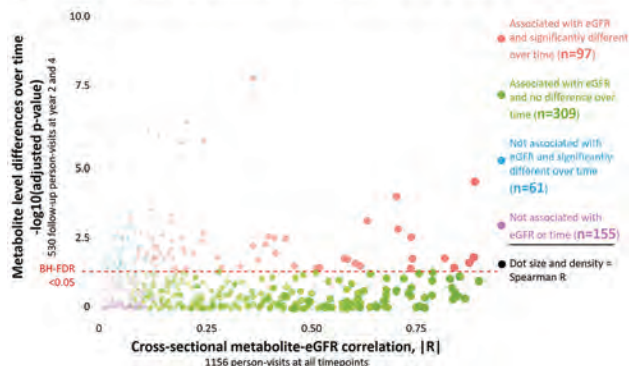

## FR-PO409

### Longitudinal Metabolite Associations With Cardiovascular Comorbidity in Pediatric CKD

Arthur Lee,<sup>1</sup> Yunwen Xu,<sup>2</sup> Mark Mitsnefes,<sup>3</sup> Jian Hu,<sup>8</sup> Rui Xiao,<sup>1</sup> Erum A. Hartung,<sup>1</sup> Josef Coresh,<sup>2</sup> Eugene P. Rhee,<sup>4</sup> Vasan S. Ramachandran,<sup>5</sup> Paul L. Kimmel,<sup>6</sup> Bradley A. Warady,<sup>7</sup> Susan L. Furth,<sup>1</sup> Michelle Denburg.<sup>1</sup> CKD Biomarkers Consortium <sup>1</sup>The Children's Hospital of Philadelphia, Philadelphia, PA; <sup>2</sup>Johns Hopkins University Bloomberg School of Public Health, Baltimore, MD; <sup>3</sup>Cincinnati Children's Hospital Medical Center, Cincinnati, OH; <sup>4</sup>Massachusetts General Hospital, Boston, MA; <sup>5</sup>Boston University, Boston, MA; <sup>6</sup>National Institutes of Health, Bethesda, MD; <sup>7</sup>Children's Mercy Hospitals and Clinics, Kansas City, MO; <sup>8</sup>University of Pennsylvania Perelman School of Medicine, Philadelphia, PA.

**Background:** Children with CKD have high prevalence of left ventricular hypertrophy (LVH) and ventricular dysfunction. We evaluated metabolite associations with cardiovascular comorbidities (CV) leveraging baseline and longitudinal follow-up samples from the Chronic Kidney Disease in Children (CKiD) study.

**Methods:** CKiD is a prospective multicenter cohort of children aged 0.5-16 years with estimated glomerular filtration rate (eGFR) 30-90ml/min/1.73m<sup>2</sup> at entry. Plasma untargeted metabolomic profiling was available at baseline and years 2 and 4, and echocardiograms at years 2, 4, and 6. LVH and ventricular dysfunction are defined the **Figure**. Logistic regression identified CV-metabolite associations at baseline. Generalized linear mixed models identified CV-metabolite associations in follow-up. Significance was defined by p<0.05 in both baseline discovery and follow-up replication analyses.

**Results:** Baseline: n=556, median [IQR] age=11.5 [8.2-15.1] years, eGFR=49.8 [36.6-64.4], LVH 10.9%, and ventricular dysfunction 16.5%. Follow-up: n=328, LVH 9.1%, and ventricular dysfunction 18.4%. **Figure** shows significant CV-metabolite associations. 4-guanidino-butanoate was the only metabolite that was not associated with eGFR, urine protein:creatinine, FGF23, or dyslipidemia. In a sensitivity analysis with 24-hour ambulatory blood pressure monitoring data: N6-carbamoylthreonyl-adenosine, 1-methyl-4-imidazoleacetate, and 3-hydroxylaurate remained significantly associated with LVH.

**Conclusions:** This is one of the first studies to utilize longitudinal metabolomics assessments to replicate cross-sectional CV-metabolite associations in CKD. 4-guanidino-butanoate has been previously associated with the *AGMAT* gene, reflecting a potential novel genetic-metabolic-CV axis in pediatric CKD. N6-carbamoylthreonyl-adenosine is interesting in that baseline levels were previously associated with risk of CKD progression.

**Funding:** NIDDK Support, Other NIH Support - NIH R38 HL143613-03



**Results:** Among 436 participants, median [IQR] age was 12.4 years [8.9, 15.2], median eGFR was 50 ml/min/1.73 m<sup>2</sup> [36, 62], and 27% had glomerular disease as etiology. The median Umod/Cr level was 0.118 mg/g [IQR 0.048, 0.225]. Each one-year older age was associated with 0.06 lower log<sub>2</sub>(Umod) (i.e., 4% lower Umod) and 0.18 lower log<sub>2</sub>(Umod/Cr) level (i.e., 12% lower Umod/Cr; **Table 1**). Each 10% lower eGFR was associated with 0.10 lower log<sub>2</sub>(Umod) (i.e., 7% lower Umod) but was not significantly associated with log<sub>2</sub>(Umod/Cr) (**Table 1**).

**Conclusions:** Among children with CKD, older age is significantly associated with lower urine uromodulin and Umod/Cr, independent of eGFR. Lower eGFR is significantly associated with lower urine uromodulin but not when it is indexed to urine creatinine. Further studies are needed to comprehensively evaluate age specific reference ranges for urine uromodulin and to evaluate the longitudinal relationship between uromodulin with both age and eGFR in children with CKD.

**Funding:** NIDDK Support, Private Foundation Support

**Table 1.** Multivariable linear regression models evaluating the relationship of age and eGFR with urine uromodulin concentration (model 1) and urine uromodulin indexed to creatinine (model 2).

Predictor	Outcome: log <sub>2</sub> (Umod)		Outcome: log <sub>2</sub> (Umod/Cr)	
	Estimate (95% CI)	p-value	Estimate (95% CI)	p-value
Age, per year	-0.06 (-0.10, -0.03)	<b>0.0004</b>	-0.18 (-0.22, -0.14)	<b>&lt;0.0001</b>
Male sex	-0.03 (-0.30, 0.24)	0.83	0.10 (-0.20, 0.40)	0.51
BMI z-score	0.05 (-0.07, 0.17)	0.44	-0.03 (-0.16, 0.10)	0.67
Afr.-Amer. race	0.02 (-0.33, 0.38)	0.89	-0.06 (-0.46, 0.34)	0.77
Hispanic ethnicity	0.16 (-0.22, 0.55)	0.41	0.17 (-0.26, 0.60)	0.43
Glomerular diagnosis	-0.11 (-0.43, 0.21)	0.49	-0.43 (-0.78, -0.08)	0.02
1/25eGFR, per 10% decrease	-0.10 (-0.13, -0.06)	<b>&lt;0.0001</b>	-0.02 (-0.06, 0.01)	0.20
Birth weight, per kg	-0.04 (-0.23, 0.16)	0.70	0.08 (-0.14, 0.29)	0.47
Hypertension	0.03 (-0.29, 0.35)	0.87	0.06 (-0.30, 0.41)	0.76
Sodium intake, per g/day	0.01 (-0.03, 0.05)	0.66	0.03 (-0.02, 0.07)	0.31

**FR-PO413**

**Relationships Between BSA-Adjusted Total Kidney Volume and Estimated Glomerular Filtration Rate in Pediatric CKD: Data From the KNOW-Ped CKD Study**

Ji hyun Kim,<sup>1</sup> Yo Han Ahn,<sup>2</sup> Eun mi Yang,<sup>3</sup> Hee Gyung Kang,<sup>2</sup> Min Hyun Cho,<sup>4</sup> Kyoung Hee Han.<sup>5</sup> <sup>1</sup>Seoul National University Bundang Hospital, Seongnam, Republic of Korea; <sup>2</sup>Seoul National University Hospital, Jongno-gu, Seoul, Republic of Korea; <sup>3</sup>Chonnam National University Medical School, Gwangju, Republic of Korea; <sup>4</sup>Kyungpook National University Hospital, Daegu, Republic of Korea; <sup>5</sup>Jeju National University Hospital, Jeju, Republic of Korea.

**Background:** The purpose of this study was to investigate the relationship between the estimated glomerular filtration rate (eGFR) and the renal volume adjusted for the body surface area through renal ultrasound in pediatric chronic kidney disease (CKD) in Korea.

**Methods:** Among the subjects enrolled in the KNOW-ped CKD cohort, 336 patients who underwent renal ultrasonography were investigated for renal lengths and widths on the longitudinal plane and the depth on the transverse plane. The formula to calculate the kidney volume was used with 0.523\*length\*width\*depth and was corrected for the body surface area (BSA). The relationship between renal volume and the eGFR at the time of ultrasound measurement was analyzed. In addition, a survival analysis between the renal volume and medical events including renal replacement therapy was performed.

**Results:** The eGFR and BSA-adjusted kidney volume showed a significant correlation (R=0.209, P=0.000) in pediatric CKD with congenital anomalies of the kidney and urinary tract (CAKUT). Kaplan-Meier analysis showed a significantly higher proportion of a 2-fold increase of serum creatinine or medical events of end-stage renal disease (ESRD) according to BSA-adjusted kidney volume (log-rank test,  $\chi^2=17.901$ , P<0.001).

**Conclusions:** The BSA-adjusted kidney volume through renal ultrasound is a marker for kidney survival in pediatric CKD, especially with CAKUT.

**Funding:** Government Support - Non-U.S.

**FR-PO414**

**APOL1 and suPAR on Time to CKD in Children With Sickle Cell Anemia**

Rima S. Zahr,<sup>1</sup> Sara R. Rashkin,<sup>2</sup> Laila Elsherif,<sup>1</sup> Kenneth I. Ataga,<sup>1</sup> Jeffrey Lebensburger.<sup>3</sup> <sup>1</sup>The University of Tennessee Health Science Center, Memphis, TN; <sup>2</sup>St Jude Children's Research Hospital, Memphis, TN; <sup>3</sup>The University of Alabama at Birmingham, Birmingham, AL.

**Background:** The incidence of CKD increases with time in patients with sickle cell anemia (SCA). Adult SCA patients with high risk APOL1 variants have an increased risk of developing CKD earlier in life, though this finding has not been explored in children. Biomarkers may further aid in predicting kidney injury and disease progression. Elevated levels of the soluble urokinase-type plasminogen activator (suPAR) is linked to the pathogenesis of CKD in APOL1 kidney disease. Elevated podocin, is found in urine of individuals with nephrosis. We aimed to identify the association of elevated suPAR, podocin, and high risk APOL1 on time to develop CKD in pediatric SCA patients.

**Methods:** Participants <18 years (y) with SCA enrolled in the Sickle Cell Clinical Research and Intervention Program (SCCRIP) participants were examined. Time to CKD (t<sup>CKD</sup>) was defined as the age at first instance of estimated glomerular filtration rate (eGFR, modified Schwartz formula) <90 ml/min/1.73m<sup>2</sup> for patients with > or = 3 consecutive instances. Controls (no instances) were censored at last eGFR. Urine podocin and plasma

suPAR were measured using Elisa kits, following manufacturer recommendations. We compared individuals with high biomarker levels (4<sup>th</sup> quartile) to those with lower levels. High risk APOL1 was defined as homozygous G1 or G2 or double heterozygous. Cox proportional hazards regression was used to test the association of APOL1, podocin, and suPAR with t<sup>CKD</sup>, adjusted for sex, hydroxyurea use, chronic transfusion use, and five principal components.

**Results:** We identified 29 cases and 220 controls; 52% of the cohort was female. The mean age at first eGFR assessment was 4.1±3.5y, mean follow-up time of 9.8±3.3y and 26% of children had high risk APOL1. APOL1 was associated with t<sup>CKD</sup> (hazard ratio (HR)=4.1; P=0.0037). High suPAR was associated with t<sup>CKD</sup> (HR=2.8; P=0.040), but high podocin was not (HR=1.5; P=0.39). In a joint model, high risk APOL1 (HR=4.4; P=0.028) and high suPAR (HR=2.9; P=0.038) were independently associated with t<sup>CKD</sup>.

**Conclusions:** High risk APOL1 and elevated suPAR were associated with earlier diagnosis of CKD in children with SCA. Larger prospective studies are needed to assess the clinical utility for APOL1 and suPAR in predicting and monitoring SCA CKD progression throughout the lifespan and if therapeutic interventions can ameliorate disease progression.

**Funding:** Other NIH Support - K23 HL157554-01A1

**FR-PO415**

**Risk Factors for Long-Term Kidney Outcomes in Childhood Cancer Survivors**

Anshika Jain,<sup>1,2</sup> Hayton Chui,<sup>1,3</sup> Sophia Nunes,<sup>1,2</sup> Simrandeep Farma,<sup>1</sup> Michael Zappitelli.<sup>1,2</sup> The first and second authors contributed equally to this work. <sup>1</sup>The Hospital for Sick Children, Toronto, ON, Canada; <sup>2</sup>University of Toronto Temerty Faculty of Medicine, Toronto, ON, Canada; <sup>3</sup>Queen's University Faculty of Health Sciences, Kingston, ON, Canada.

**Background:** Childhood cancer survivor (CCS) follow-up guidelines are unclear on how to risk-stratify for and ascertain long-term kidney outcomes (KO). We evaluated the relation of patient/treatment factors with KO in CCS up to 4 years post-therapy.

**Methods:** Prospective, national data (secondary use: Cancer in Young People in Canada database; CCS, ≤15-years-old at cancer diagnosis post Jan 1, 2001; 17 centers). Excluded: no birth date/sex; died on treatment. Outcome: KO (included hypertension, nephritis, Fanconi syndrome, CKD, AKI, fluid retention, kidney atrophy, high creatinine, low GFR, kidney stone/abscess, thrombotic microangiopathy; selection adjudicated by two authors). Univariable and multivariate logistic regression was used to evaluate independent risk factors for KO.

**Results:** 18,065 CCS included (178 with KO [1%] vs. 17,818 no KO). Age(p=0.42), sex(p=0.96), ethnicity(p=0.41), income quintile(p=0.46), main cancer diagnosis(p<0.001), abdominal radiation during therapy p=0.66, graft vs. host disease (GVHD) (p<0.004), number of hematopoietic stem cell transplants (HSCT)(p<0.001), center geography(p<0.001) and home distance from center(p=0.54) were evaluated in univariable analyses for association with KO. Adjusted analyses(Fig): More HSCT and kidney or hepatic tumor (vs. leukemia/lymphoma) were associated with higher adjusted odds of KO; East/West Canada (vs. Central) and other cancer diagnoses (shown, Fig) were associated with lower adjusted odds of KO.

**Conclusions:** Number of HSCT and cancer type are associated with KO in CCS. KO recording is suboptimal, speaking to lack of awareness and unclear CCS kidney health guidelines. We will use our data to initiate knowledge translation with child oncology stakeholders, explore barriers/facilitators to kidney health monitoring and improve current follow-up guidelines.

Risk factors included in model	Adjusted OR (95% CI)	Reference Group
GVHD	1.54 [0.59-4.01]	N/A
Number of HSCT	1.50 [1.36-1.65]***	
East	0.29 [0.19-0.46]***	Central
West	0.43 [0.29-0.64]***	
CNS/intracranial/intraspinal neoplasms	0.33 [0.20-0.55]***	
Neuroblastoma/peripheral nervous cell tumours	0.82 [0.49-1.37]	Leukemia/lymphoma
Kidney or hepatic tumors	1.61 [1.00-2.61]*	
Malignant bone/soft tissue tumors/extrasosseous sarcomas	0.66 [0.36-1.21]	
Other*	0.40 [0.18-0.86]*	

**Fig.** Multivariable analysis: factors associated with KO after childhood cancer therapy. \*retinoblastoma, germ cell/trophoblastic tumors, gonadal/malignant epithelial/unspecified malignant neoplasms, malignant melanomas; \*p<0.05, \*\*p<0.01, \*\*\*p<0.001

FR-PO416

**Body Mass Index as a Risk Factor for Kidney Health in Childhood Cancer Survivors**

Hayton Chui,<sup>1,2</sup> Anshika Jain,<sup>1,3</sup> Sophia Nunes,<sup>1,3</sup> Simrandeep Farma,<sup>1</sup> Michael Zappitelli,<sup>1</sup> The first and second authors contributed equally to this work. <sup>1</sup>The Hospital for Sick Children, Toronto, ON, Canada; <sup>2</sup>Queen's University Faculty of Health Sciences, Kingston, ON, Canada; <sup>3</sup>University of Toronto Temerty Faculty of Medicine, Toronto, ON, Canada.

**Background:** Childhood Cancer (CC) survivors are at risk for kidney outcomes(KO). High Body Mass Index (BMI) is a risk factor for kidney disease. We evaluated the relation between BMI in CC therapy with KO.

**Methods:** Secondary use of national prospective data(Cancer in Young People in Canada database: ≤15-yrs-old diagnosed with cancer at 17 Canadian centers after Jan 1, 2001; followed up to 6 yrs). Excluded: no birth date/sex; died during therapy; no BMI. Exposures: first BMI(within 6 mths of diagnosis); last BMI; last vs. first percent change BMI percentile. Outcomes: any kidney or BP outcome after CC therapy. Multivariate logistic regression used to evaluate exposure-KO relations, adjusted for location, cancer diagnosis, graft vs. host and number of hematopoietic transplants.

**Results:** 9805 children included; n=90(0.92%) had KO recorded. Patients with vs. without KO had higher first BMI, lower last BMI and BMI %change (only significant for first BMI, Fig 1). Adjusted analyses: first BMI was associated with higher adjusted odds for post-therapy KO(adjusted OR 1.01 [1.00-1.02], p<0.02, Table 1).

**Conclusions:** Higher adiposity early in CC therapy is associated with kidney and BP conditions. It is unclear if this is due to higher risk of recurrent AKI or underlying long-term risk. Children with high BMI at CC therapy start may be targeted for closer kidney health follow-up post-therapy.

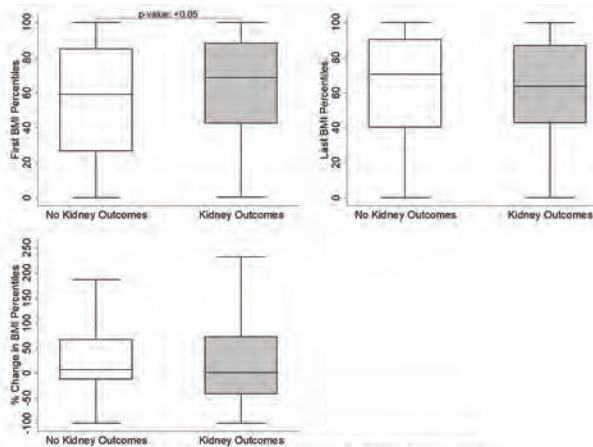

Figure 1: First, Last and %Change in BMI Percentile stratified by Kidney Outcome status

Table 1: Odds Ratios of Risk Factors for Developing Kidney Outcomes by First, Last and % Change in BMI Percentile

Risk factors	Adjusted OR	p-value
<b>Main exposure: First BMI percentile</b>		
First BMI percentile	1.01 [1.00-1.02]	0.018*
<b>Compared to Central</b>		
East	0.28 [0.16-0.50]	0.000***
West	0.51 [0.31-0.84]	0.008**
<b>Compared to leukemia or lymphoma</b>		
CNS and miscellaneous intracranial and intraspinal neoplasms	0.50 [0.25-0.97]	0.040*
Neuroblastoma and other peripheral nervous cell tumors	0.78 [0.30-2.01]	0.600
Renal or hepatic tumors	1.62 [0.76-3.44]	0.213
Malignant bone tumors, soft tissue and other extrasosseous sarcomas	0.90 [0.42-1.91]	0.785
Other <sup>†</sup>	0.41 [0.10-1.68]	0.214
Graft vs Host	2.75 [0.76-9.58]	0.133
Number of hematopoietic transplants	1.40 [1.23-1.59]	0.000***
<b>Main exposure: Last BMI Percentile</b>		
Last BMI Percentile	1.01 [0.99-1.02]	0.328
<b>Compared to Central</b>		
East	3.38 [0.44-24.69]	0.249
West	4.75 [0.64-35.92]	0.128
<b>Compared to leukemia or lymphoma</b>		
CNS and miscellaneous intracranial and intraspinal neoplasms	1.30 [0.49-3.49]	0.598
Neuroblastoma and other peripheral nervous cell tumors	2.26 [0.81-6.30]	0.119
Renal or hepatic tumors	7.01 [2.91-16.89]	0.000***
Malignant bone tumors, soft tissue and other extrasosseous sarcomas	2.88 [0.99-8.42]	0.053
Other <sup>†</sup>	0.77 [0.10-6.04]	0.806
Graft vs Host	6.19 [1.98-19.36]	0.002**
Number of hematopoietic transplants	1.43 [1.24-1.64]	0.000***
<b>Main exposure: BMI Percentile Change</b>		
BMI Percentile Change	1 [1-1]	0.990
<b>Compared to Central</b>		
East	2.11 [0.27-16.24]	0.475
West	3.88 [0.52-29.16]	0.187
<b>Compared to leukemia or lymphoma</b>		
CNS and miscellaneous intracranial and intraspinal neoplasms	0.86 [0.26-2.86]	0.807
Neuroblastoma and other peripheral nervous cell tumors	2.13 [0.63-7.12]	0.221
Renal or hepatic tumors	5.93 [2.25-15.64]	0.000***
Malignant bone tumors, soft tissue and other extrasosseous sarcomas	2.23 [0.70-7.09]	0.178
Other <sup>†</sup>	1.14 [0.15-8.91]	0.902
Graft vs Host	5.54 [1.63-18.79]	0.006**
Number of hematopoietic transplants	1.42 [1.20-1.66]	0.000***

\*p<0.05, \*\*p<0.01, \*\*\*p<0.001

<sup>†</sup>Other cancer diagnosis include: retinoblastoma, germ cell tumors, trophoblastic tumors, and neoplasms of gonads, other malignant epithelial neoplasms and malignant melanomas, other and unspecified malignant neoplasms

FR-PO417

**Feasibility of the NIH Toolbox Cognitive Battery for Children With Mild to Moderate CKD**

Stephen R. Hooper,<sup>1</sup> Rebecca J. Johnson,<sup>3</sup> Marc Lande,<sup>2</sup> Joann M. Carlson,<sup>4</sup> Lyndsay Harshman,<sup>5</sup> Camille Wilson,<sup>6</sup> Anne E. Dawson,<sup>6</sup> Matthew Matheson,<sup>7</sup> Bradley A. Warady,<sup>3</sup> Susan L. Furth.<sup>8</sup> <sup>1</sup>University of North Carolina at Chapel Hill School of Medicine, Chapel Hill, NC; <sup>2</sup>University of Rochester Medical Center, Rochester, NY; <sup>3</sup>Children's Mercy Hospitals and Clinics, Kansas City, MO; <sup>4</sup>Robert Wood Johnson University Hospital, New Brunswick, NJ; <sup>5</sup>The University of Iowa Stead Family Children's Hospital, Iowa City, IA; <sup>6</sup>Nationwide Children's Hospital, Columbus, OH; <sup>7</sup>Johns Hopkins University Center for Teaching and Learning, Baltimore, MD; <sup>8</sup>The Children's Hospital of Philadelphia, Philadelphia, PA.

**Background:** Children with CKD show cognitive difficulties in attention, working memory, and executive functions (EF). There is a need for neurocognitive surveillance in clinical research to detect these challenges, but availability of traditional neurocognitive assessments remains elusive. Computerized assessment batteries have promise to assist in this process. The NIH Toolbox Cognitive Battery (NIH-TCB) provides the opportunity to: collect assessment data in a standardized, replicable fashion; use common data elements; employ electronic scoring to reduce examiner error; and allow for increased cross-site collaborations. Its feasibility has not been tested in pediatric CKD.

**Methods:** The NIH-TCB has been administered over the past 3 years by trained Research Coordinators. Analyses examined level of functioning and explored the associations between cognitive outcomes, sociodemographic (age, sex, maternal education), and CKD variables (glomerular diagnosis, U25eGFR, Urine Pr/Cr, blood pressure stage).

**Results:** The CKiD study is a multi-site, prospective cohort of children with eGFR 30-90ml/min/1.73m<sup>2</sup> at entry. The sample included 110 cases, median age=16.8 yrs., 58% males, and 28% Glomerular diagnoses. Primary outcomes from the NIH-TCB included: Working Memory (active recall), Executive Functions (regulatory abilities), and Crystallized Reasoning (academic knowledge). Scores placed in the average range with mild problems present in EF. Linear regressions for EF showed better scores were associated with higher maternal education (p<.03) and less proteinuria (p<.10). For working memory, better scores were associated with less proteinuria (p<.06) and older chronological age (p<.10). For Crystallized Reasoning, better scores were associated with higher maternal education (p<.03). None of the other sociodemographic or CKD factors were associated with the cognitive outcomes.

**Conclusions:** This study is the first to utilize the NIH-TCB for children with mild to moderate CKD. Findings from NIH-TCB had good applicability in the clinical research setting to detect and describe emerging cognitive concerns. Associations between selected cognitive abilities, maternal education, and proteinuria were noted. These findings show the promise of using the NIH-TCB for clinical research in pediatric CKD.

**Funding:** NIDDK Support

FR-PO418

**Pediatric to Adult Nephrology Transition Program: The Northwestern Experience**

Jay H. Kang,<sup>1</sup> Laura Nishi,<sup>2</sup> Cybele Ghossein.<sup>1</sup> Northwestern Nephrology <sup>1</sup>Northwestern University Feinberg School of Medicine, Chicago, IL; <sup>2</sup>Northwestern Medicine, Chicago, IL.

**Background:** Young adults (YA) with chronic kidney disease (CKD) transitioning care from pediatric to adult medical facilities face many obstacles. Six years ago, the Nephrology division at Northwestern Medicine (NM) implemented a transition program for YA with CKD. The initial transfer visit was led by an adult nephrology team in the pediatric nephrology space at Lurie Children's Hospital. Follow up care then occurred in the adult nephrology clinic at NM. Here we report on our outcomes.

**Methods:** All patients that were seen in transition clinic between 2016-2021 were included. Successful transfer of care was defined as a completed transition clinic appointment. Successful transition was defined as one or more completed appointments in the NM adult nephrology clinic. An enhanced communication protocol of phone calls, texts, and emails from the adult nephrology team would be triggered for any patients who failed to show up for their follow up appointment.

**Results:** There were 141 patients who completed their transfer visits. 67 (47%) were female and 74 (53%) were male, with the most common diagnoses being congenital kidney disease (30%) and glomerular disease (24%). 82 patients (58%) were insured with private insurance, 54 (38%) with government insurance, and 5 (4%) had no insurance. Five patients were discharged from nephrology care at the initial transition clinic appointment. Six patients transitioned to external nephrology providers. Successful transition initially occurred in 93 patients (74%) with 32 (26%) patients missing their follow up appointment. Sixteen patients (13%) subsequently successfully transitioned after the enhanced communication protocol was activated, increasing our successful transition rate to 87%. Sixteen patients (13%) were lost to follow up.

**Conclusions:** Based on our experience, successful pediatric to adult transition can be achieved with a dedicated transition program. Enhanced communication protocols for those missing their first adult nephrology clinic appointment can improve successful transition.

## FR-PO419

**Impact of Psychology Integration on Pre-ESKD Care of Children With Congenital Anomalies of the Kidney and Urinary Tract (CAKUT)**

Anne E. Dawson,<sup>1,2</sup> Camille Wilson,<sup>1</sup> Jennifer Cass,<sup>1</sup> Daryl J. Mcleod,<sup>3,2</sup> Brian Becknell,<sup>4,2</sup> Kidney and Urinary Tract Center <sup>1</sup>Department of Pediatric Psychology and Neuropsychology, Nationwide Children's Hospital, Columbus, OH; <sup>2</sup>Kidney and Urinary Tract Center, Abigail Wexner Research Institute at Nationwide Children's Hospital, Columbus, OH; <sup>3</sup>Department of Pediatric Urology, Nationwide Children's Hospital, Columbus, OH; <sup>4</sup>Division of Pediatric Nephrology and Hypertension, Nationwide Children's Hospital, Columbus, OH.

**Background:** Children with congenital disorders of the kidney and urinary tract (CAKUT) require laboratory monitoring, invasive tests, surgical interventions, and multiple medications. These stressors are associated with anxiety, nonadherence and quality of life concerns. Moreover, CAKUT and associated kidney disease can impact neurodevelopmental outcomes. The role of psychology in caring for these children has been historically reserved for later stages of kidney disease. This study examines rates and outcomes of psychology referrals before and after integration of a psychology provider in the multidisciplinary urology/nephrology clinic, which follows children with all pre-ESKD stages of kidney disease with CAKUT.

**Methods:** A retrospective chart review identified psychology referrals placed from the Urology/Nephrology Clinic at Nationwide Children's Hospital (pre- and post-psychology integration). Number of referrals placed, adherence to follow-up recommendations, common diagnoses and results of evaluations were recorded.

**Results:** From 2014-2018 (pre-integration), no patients were referred to pediatric psychology/neuropsychology (PPNP). In 2020, once psychology was integrated fully, referrals increased 10 fold, which was sustained in 2021 with 12% of patients referred and the majority successfully scheduling an appointment. Most common medical diagnoses of referred patients included prune belly syndrome, posterior urethral valves, and solitary kidney. PPNP evaluations identified low cognitive functioning, risk for attention disorders, and areas of specific learning deficits in the majority of patients and provided recommendations for intervention, including behavioral health supports and school accommodations.

**Conclusions:** Integration of psychology into a multidisciplinary urology/nephrology clinic allows for a holistic assessment of patient and family. Without psychology support, patients may go undiagnosed and/or miss the opportunity for early intervention. By intervening early, patients may benefit from interventions to promote disease self-management and engagement, ease learning burdens in school, address mental health concerns and enhance quality of life. Future studies are necessary to evaluate the potential impact of early psychology involvement on disease progression by enhancing patient compliance and adherence to interventions related to disease mitigation.

## FR-PO420

**Uremic Toxins and Extracellular Vesicles as Drivers of Cardiovascular Disease in CKD**

Felix Behrens,<sup>1,2</sup> Johannes Holle,<sup>2,3</sup> Chia-Yu Chen,<sup>3,4</sup> Benjamin C. Krause,<sup>5</sup> Fabian L. Kriegel,<sup>5,10</sup> Lisa Peters,<sup>1,9</sup> Laura F. Ginsbach,<sup>1</sup> Toralf Kaiser,<sup>7</sup> Pawel Durek,<sup>7</sup> Katrin Lehmann,<sup>7</sup> Laura Michalick,<sup>1,8</sup> Jennifer A. Kirwan,<sup>6,4</sup> Sofia K. Forslund,<sup>3,4</sup> Nicola Wilck,<sup>3,12</sup> Mir-Farzin Mashreghi,<sup>7,6</sup> Dominik Müller,<sup>2</sup> Ulrike Löber,<sup>3,4</sup> Wolfgang M. Kuebler,<sup>1,11</sup> Szandor Simmons,<sup>1,8</sup> <sup>1</sup>Institute of Physiology, Charité – Universitätsmedizin Berlin, Berlin, Germany; <sup>2</sup>Department of Pediatric Gastroenterology, Nephrology and Metabolic Diseases, Charité – Universitätsmedizin Berlin, Berlin, Germany; <sup>3</sup>Experimental and Clinical Research Center (ECRC), a cooperation of Charité – Universitätsmedizin Berlin and Max Delbrück Center for Molecular Medicine (MDC), Berlin, Germany; <sup>4</sup>Max Delbrück Center for Molecular Medicine (MDC), Berlin, Germany; <sup>5</sup>Department of Chemical and Product Safety, German Federal Institute for Risk Assessment (BfR), Berlin, Germany; <sup>6</sup>Berlin Institute of Health (BIH) at Charité – Universitätsmedizin Berlin, Berlin, Germany; <sup>7</sup>German Rheumatism Research Centre (DRFZ), Berlin, Germany; <sup>8</sup>German Centre for Cardiovascular Research (DZHK), Berlin, Germany; <sup>9</sup>Institute of Biology, Department of Biology, Chemistry and Pharmacy, Freie Universität Berlin, Berlin, Germany; <sup>10</sup>Nuvisan, Innovation Campus Berlin, Berlin, Germany; <sup>11</sup>Departments of Physiology and Surgery, University of Toronto, Toronto, ON, Canada; <sup>12</sup>Department of Nephrology and Intensive Medical Care, Charité – Universitätsmedizin, Berlin, Germany.

**Background:** Cardiovascular disease (CVD) is the main cause of death in chronic kidney disease (CKD). However, the pathogenesis of CVD in CKD remains incompletely understood. We hypothesized that microbiome-derived uremic toxins (UTs) trigger the release of endothelial (EC-) and immune cell (IC)-derived extracellular vesicles (EVs), promoting endothelial damage and CVD.

**Methods:** We recruited a cohort of 94 children (mean age 10.9 years) at different stages of CKD, including patients on dialysis and after kidney transplantation (KTx), and age-matched healthy donors, offering the unique opportunity to analyze cardiovascular effects of CKD and metabolite-EV interaction in the absence of age-related confounders like diabetes and metabolic syndrome. Plasma metabolomics for 31 tryptophan-derived UTs were performed. Plasma EVs were analyzed by nanoparticle tracking analysis, flow cytometry and small RNA sequencing. EV release from PBMCs was assessed upon UT exposure.

**Results:** UTs of indole and kynurenine pathways were stage-dependently increased in children with CKD. Indoxyl sulfate (IS) increased 21-fold in peritoneal dialysis (PD) patients compared to healthy donors. Similar trends were seen in hemodialysis (HD), while more subtle increments were seen in CKD without dialysis and UT levels after KTx were almost normal. PD patients had elevated levels of total plasma EVs compared to healthy donors and KTx patients. Macrophage- (3-fold) and T-cell-derived EVs (6-fold) were increased in CKD without dialysis compared to healthy donors, while EC-EVs were reduced after KTx in longitudinal follow-ups and cross-sectionally comparing HD and KTx (3-fold). Sequencing revealed several differentially regulated microRNAs in EVs from CKD patients, including miR-16-5p, miR-19b-3p, miR-106a-5p, miR-451a and miR-4485. *In vitro*, IS dose-dependently increased EV release from PBMCs.

**Conclusions:** Increased levels of microbiome-derived UTs and subsequent EV release from ICs and ECs may present both a biomarker and a pathomechanism in CKD that may drive or contribute to long-term CVD.

**Funding:** Government Support - Non-U.S.

## FR-PO421

**Idiopathic Infantile Hypercalcemia in Children With CKD due to Kidney Hypodysplasia**

Evgenia Gurevich,<sup>1,2</sup> Yael Borovitz,<sup>1</sup> Shelly S. Levi,<sup>1</sup> Sharon Perlman,<sup>3,4</sup> Daniel Landau,<sup>1,4</sup> <sup>1</sup>Schneider Children's Medical Center of Israel, Petach Tikva, Israel; <sup>2</sup>Bzarilal Medical Centre Ashkelon, Ashkelon, Israel; <sup>3</sup>Rabin Medical Center, Petach Tikva, Israel; <sup>4</sup>Tel Aviv University Sackler Faculty of Medicine, Tel Aviv, Israel.

**Background:** Idiopathic infantile hypercalcemia (IIH) etiologies include mutations in CYP24A1, leading to increased 1,25(OH)<sub>2</sub>D, hypercalciuria and suppressed PTH, and in NaPi2, leading to the same metabolic profile via phosphaturia. IIH has not been previously described in CKD due to kidney hypodysplasia (KHD).

**Methods:** Retrospective study of children with bilateral KHD and simultaneously tested PTH and 1,25(OH)<sub>2</sub>D, followed in a tertiary care center between 2015-2021.

**Results:** Of 295 screened patients, 139 had KHD, 16 (11.5%) of them had IIH (study group), another 26 with normal PTH and any 1,25(OH)<sub>2</sub>D served as controls. There were no differences between groups' gender, obstructive uropathy rate and baseline eGFR. Study patients were younger [median (IQR) age: 5.2 (3.2-11.3) vs 61 (13.9 -158.3) months, p<0.001], had higher 1,25(OH)<sub>2</sub>D (259.1±91.7 vs 156.5±46.4 pmol/l, p<0.001), total Ca (11.1±0.4 vs 10.7±0.3 mg/dl, p<0.001), and lower phosphate standard deviation score (P-SDS) [median (IQR): -1.4 (-1.9,-0.4) vs -0.3 (-0.8,-0.1) in controls, p=0.03]. During 12 months of follow up, PTH increased among study group (8.8±2.8 to 22.7±12.4 pg/ml, p<0.001), serum calcium decreased (11±0.5 to 10.3±0.6 mg/dl, p=0.004), and 1,25(OH)<sub>2</sub>D decreased (259.5±91.7 to 188.2±42.6 pmol/l, p=0.1). P-SDS remained lower in study group vs controls at 12 months [-0.3 (-0.9, 0.4) vs 0.7 (0.6, 0.7), p<0.001]. eGFR did not deteriorate. Five of 9 study group patients with available urine calcium had hypercalciuria. Nephrocalcinosis/lithiasis was found in 5 patients.

**Conclusions:** Transient IIH was observed in infants with mild CKD due to KHD, in association with relative hypophosphatemia, resembling NaPi2 mutations metabolic profile.

## FR-PO422

**Selumetinib-Induced Hyperphosphatemia in a Pediatric Patient: A Rare Adverse Event**

Vimal Master sankar raj, Megan Narula. *UICOMP, University of Illinois Chicago College of Medicine at Peoria, Peoria, IL.*

**Introduction:** MEK, small molecule downstream inhibitors of Ras and Raf oncogenes are targets for oncological therapeutics in resistant malignancies. Selumetinib is one such MEK inhibitor used in Neurofibromatosis, type 1. We report the incidence of hyperphosphatemia, a rare adverse effect in a pediatric patient on treatment with the same.

**Case Description:** A 7-year-old girl was started on selumetinib for treatment of NF type 1-related recurrent plexiform neurofibroma of the ankle. Prior to initiation, her serum phosphorus (P) was in the normal range for age at 5.4. Three weeks on therapy a rise in serum P was noted, reaching a peak of 6.7 approximately two months into treatment. Workup showed normal renal function with an estimated glomerular filtration rate (eGFR) >90 ml/min, parathyroid hormone normal at 37 pg/ml and alkaline phosphatase at 256 U/L. 25 hydroxy Vitamin D level was measured at 68 pg/ml and 1,25 dihydroxy Vitamin D at higher end of normal range at 80 pg/ml. Serum calcium level was 9.4 mg/dl with calcium phosphorus product ratio elevated at 63. Urine showed tubular reabsorption of phosphorus (TRP) of 90%, inappropriately elevated in the setting of hyperphosphatemia. Fibroblast growth factor 23 (FGF23) was measured and elevated at 55 pg/ml indicating resistance at the renal tubular level.

**Discussion:** The mitogen activated protein kinase (MAPK) cascade consisting of RAF/MEK/ERK molecular pathway regulates various aspects of cell survival, proliferation and differentiation via transducing signals from cell surface to nucleus. MEK is an attractive therapeutic target as it is the only known substrate in extracellular signal related kinase (ERK). MEK inhibition by altering cellular homeostasis has shown in toxicology studies of various adverse effects mimicking FGF23 or klotho knockout mice. The main phenotype is that of hyperphosphatemia, elevated 1,25 - dihydroxy vitamin D3 levels, and tissue mineralization indicative of renal resistance to FGF23. Pediatric literature on the adverse metabolic effect of selumetinib has not shown many issues with calcium or phosphorus homeostasis. The most common reported adverse effect is an increase in creatine phosphokinase. Here we report a case of isolated hyperphosphatemia noted after selumetinib initiation in a pediatric patient. This is likely due to FGF23 resistance as shown by elevated FGF23 levels and increased TRP with a normal GFR.

**Key: TH - Thursday; FR - Friday; SA - Saturday; OR - Oral; PO - Poster; PUB - Publication Only**

**Underline represents presenting author.**



## FR-PO423

## Sclerostin and Wnt Signaling in Pediatric Renal Osteodystrophy

Lauren V. Albrecht,<sup>1</sup> Marciana Laster,<sup>2</sup> <sup>1</sup>University of California Irvine School of Biological Sciences, Irvine, CA; <sup>2</sup>University of California Los Angeles David Geffen School of Medicine, Los Angeles, CA.

**Background:** Renal osteodystrophy (ROD) is a complex disorder of bone and mineral metabolism that impacts pediatric CKD patients. Adverse clinical consequences of ROD include bone loss, increased fractures, and cardiovascular events, which often persist into adulthood. Current therapies and biomarkers of disease are limited by a lack of molecular insight into the mechanisms of disease at the cellular level. An emerging player in CKD progression is the osteocyte and its secreted factors. Sclerostin is secreted from osteocytes and leads to decreased bone formation through the inhibition of the Wnt signaling pathway. Whether sclerostin is misregulated in pediatric ROD and contributes to bone loss through the inhibition of the Wnt signaling pathway remains to be defined. Understanding the molecular underpinnings of ROD and the impact of relative signaling pathways could help to develop new targeted therapies or biomarkers.

**Methods:** Cross-sectional analysis of ROD pediatric CKD patients were used to evaluate bone sclerostin expression by immunofluorescence analyses. Bone biopsies were evaluated from patients before and after dialysis treatments. Sclerostin expression was evaluated with antibodies towards phosphorylated  $\beta$ -catenin and an unphosphorylated (active)  $\beta$ -catenin, marking Wnt inhibition or activity, respectively.

**Results:** We report that pediatric ROD patients demonstrated elevated levels of serum sclerostin was elevated in both early and late CKD. The increased levels of sclerostin in circulation were associated with histomorphometric parameters of bone turnover and mineralization. High resolution microscopy immunofluorescence revealed that the levels of sclerostin expression in bone corresponded to relative levels of circulating sclerostin. Further, sclerostin expression in bone was colocalized with a classic marker of Wnt inhibition with a phosphorylated  $\beta$ -catenin antibody. Patients with lower circulating sclerostin levels osteocytes had increased levels of an unphosphorylated  $\beta$ -catenin antibody, which indicates Wnt signaling activity.

**Conclusions:** We report that sclerostin expression in bone regulates the canonical Wnt pathway, which results in elevated serum sclerostin and regulation of Wnt signaling by sclerostin. These new insights into the pathogenesis of CKD-MBD raise the possibility that sclerostin should be investigated as a potential biomarker and/or therapeutic target in pediatric ROD.

**Funding:** NIDDK Support, Other NIH Support - USPHS grants (DK-35423, DK-67563, U01DK122013, NCATS UL1 TR000122)

## FR-PO424

## Metabolic Changes and Growth Impairment in a Rat Model of Juvenile CKD

Alison J. Kriegel, Chetan N. Patil, Emma T. Schwasinger. *Medical College of Wisconsin, Milwaukee, WI.*

**Background:** Many pediatric patients living with chronic kidney disease (CKD) experience growth impairment. Metabolic changes accompanying this are incompletely understood. Our laboratory has applied the surgical 5/6 nephrectomy (5/6Nx) model to study CKD in adult rats. The goal of this study was to determine if application of 5/6Nx in juvenile rats could be used to study CKD-related growth impairment. We hypothesized that 5/6Nx surgery in juvenile rats would lead to impaired somatic growth and metabolic dysregulation.

**Methods:** Young male Sprague Dawley rats (4-5 weeks of age; food and water ad libitum) underwent nuclear magnetic resonance imaging (NMR) in the to assess body composition and were randomized to naïve (N; n=6), Sham (S; n=9) or 5/6 nephrectomy (5/6Nx; n=11) groups. Two weeks later rats underwent a second NMR followed by 4 days of housing in a Promethion (Sable Systems International), a non-invasive metabolic phenotyping system.

**Results:** Rats from N and S groups more than doubled their body mass the initial two weeks of the study (2.27±0.22 and 2.43±0.19-fold, respectively), while 5/6Nx rats gained less mass (1.47±0.19-fold, p<0.05). NMR analysis revealed that the mean % fat mass at baseline averaged 4 to 4.5%. The % fat mass tend to increase in N and S rats (5.65±0.20% and 6.07±0.20%, respectively) while dropping precipitously in 5/6Nx rats (2.08±0.52%; p <0.05 vs. control groups). The % lean mass showed an inverse relationship to that of % fat mass. Hydration (body water as % of body weight) increased in 5/6Nx rats (71.68±0.38%) when compared to N or S groups (69.06±0.15% and 68.75±0.30%, respectively). Promethion system data revealed that, when compared to N or S groups, 5/6Nx animals had significantly lower daily food intake and energy expenditure and were less active during their active phase. The respiratory exchange ratio was higher in 5/6Nx rats suggesting increased carbohydrate metabolism. The 5/6Nx animals exhibited greater water consumption during their inactive period than control groups.

**Conclusions:** Application of the 5/6Nx surgical model of CKD to juvenile rats impaired somatic growth, changed body composition, and altered metabolism, activity and drinking behavior. This indicates that this model recapitulates characteristics of CKD-related growth impairment in pediatric patients and may be a useful tool for developing new therapies to counteract these changes.

**Funding:** Private Foundation Support

## FR-PO425

## Impact of Lowering Dialysate Sodium Concentration on Interdialytic Weight Gain in a Pediatric Hemodialysis Center: A Quality Improvement Study

Malek Al Barbandi,<sup>1,2</sup> Vaka K. Sigurjonsdottir,<sup>1,2</sup> Carolyn L. Abitbol,<sup>1,2</sup> Chryso P. Katsoufis,<sup>1,2</sup> Wacharee Seeherunvong,<sup>1,2</sup> Jayanthi Chandar,<sup>1,2</sup> Marissa J. Defreitas,<sup>1,2</sup> <sup>1</sup>Jackson Memorial Hospital, Miami, FL; <sup>2</sup>University of Miami School of Medicine, Miami, FL.

**Background:** Chronic fluid overload in hemodialysis (HD) patients is associated with increased morbidity and mortality due to cardiovascular disease (CVD). We evaluated the safety and impact of decreasing dialysate sodium concentration on interdialytic weight gain (IDWG) in HD patients in a pediatric center.

**Methods:** This was a quality improvement study in which the aim was to decrease the average monthly IDWG in 50% of patients. We included 11 participants in a single HD pediatric center. The participants underwent two 8-week treatment phases. During phase 1 the dialysate sodium concentration was 140 mEq/L, during phase 2, the concentration was lowered to 137 mEq/L. The primary outcome was the average monthly IDWG, 2-months before and after the intervention.

**Results:** We included 11 patients, median age 19.7 years, 54.5% were male. Two did not tolerate the change due to hypotension during sessions and were excluded from the analysis and switched back to a sodium concentration of 140 mEq/L. The mean IDWG was 4.94 ± 1.04% compared to 4.27 ± 1.57% during phase 1 and phase 2, respectively. The IDWG decreased significantly by 0.67% in phase 2 compared with phase 1 (p = 0.04) (Figure, left). In addition, 89% of the patients had a decline in their average IDWG after the decrease in dialysate sodium, which was above our target of 50% (Figure, right).

**Conclusions:** While low sodium dialysate concentration in pediatric patients undergoing HD resulted in a clinical and statistically significant decrease in IDWG, it was not tolerated in some participants. Lower sodium gradient should be considered in children and young adults who are not prone to hypotension to decrease the thirst drive, limit excessive IDWG, and subsequent risk of CVD.

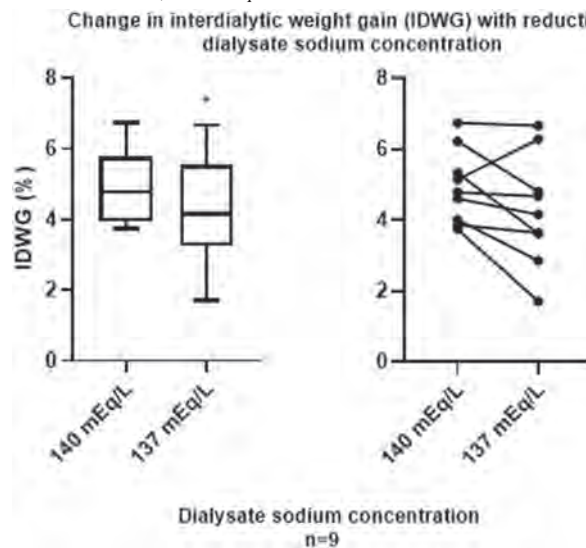

## FR-PO426

## Machine Learning Approach to Predict Post-Hemodialysis Blood Pressure in Children With ESKD

Raed Bou Matar, Amy Bobrowski. *Cleveland Clinic, Cleveland, OH.*

**Background:** Hypertension in end-stage kidney disease (ESKD) is associated with increased cardiovascular morbidity. Blood pressure (BP) control on chronic hemodialysis (HD) is directly related to fluid removal targets and interdialytic fluid gains (IDWG). Clinicians rely on clinical judgement to set a prescribed dry weight (DW), taking into consideration complex trends in BP, IDWG and other clinical parameters.

**Methods:** A system to predict post-HD BP values was developed using machine learning (ML) models to assist clinicians in determining optimal DW. Our dataset included patient-specific trends in BP, IDWG, heart rate and weights collected from 2011 to 2021. To help improve the model's performance and scalability, input features were selected based on initial descriptive analysis. Input features included age, height, DW, post-HD weight, pre-HD weight, pre-HD heart rate, pre-HD BP and IDWG. Six models were fed the input features, trained and hyperparameters tuned using Sci-kit Learn and XGBoost python libraries. Model performance was assessed utilizing time series cross validation on a rolling basis (30-90 day training, 1 day testing). Tukey's HSD test was applied to compare mean absolute error (MAE) values between models after Box-Cox normalization.

**Results:** Children who underwent chronic HD for at least 3 months were included (49 patients, 14604 dialysis sessions). Support vector machines regression (SVR) with a linear kernel achieved better accuracy than K-nearest neighbor (p=0.013), extreme

gradient boosting (p<0.0001) and SVR with RBF kernel (p<0.0001). However, the differences in MAE between SVR (linear kernel), random forest and linear regression were not statistically significant (Table).

**Conclusions:** Utilizing vital signs trends and other readily available parameters, ML models may be useful in predicting post-HD BP in children with ESKD. Predictions are intended to guide DW adjustment, supplementing clinical judgment.

	R	MAE	RMSE
Support Vector Machines (Linear kernel)	0.75	8.21	10.5
Linear Regression	0.73	8.41	10.8
Random Forest	0.73	8.46	10.8
K-Nearest Neighbors	0.73	8.53	10.9
Support Vector Machines (RBF kernel)	0.71	8.71	11.1
Extreme Gradient Boosting (XGBoost)	0.68	9.42	12.1

R: Pearson's Correlation Coefficient; MAE: Mean Absolute Error; RMSE: Root Mean Square Error

**FR-PO427**

**High Prevalence of Sleep Pathology in Pediatric Hemodialysis Patients as Assessed by the ActiGraph® Accelerometer**

Jonathan S. Chawla,<sup>1,2</sup> Molly R. Vega,<sup>2</sup> Shweta S. Shah,<sup>1,2</sup> Kevin Kaplan,<sup>1</sup> Jessica Geer,<sup>2</sup> Cortney T. Zimmerman,<sup>1,2</sup> Ayse Akcan Arikian,<sup>1,2</sup> Sarah J. Swartz,<sup>1,2</sup> Poyyappakkam Srivaths,<sup>1,2</sup> <sup>1</sup>Baylor College of Medicine, Houston, TX; <sup>2</sup>Texas Children's Hospital, Houston, TX.

**Background:** Adults with end-stage kidney disease (ESKD) have a higher prevalence of sleep disturbances, which is associated with higher rates of depression and worse quality of life. Poor sleep quality is underdiagnosed in pediatric (ped) ESKD. ActiGraph accelerometers (ACG) are validated assessors of ped sleep quality. We hypothesized ACG is more sensitive than sleep questionnaire in detecting poor sleep quality in ped HD pts.

**Methods:** In this prospective cohort study, pts 8-18 years on HD for >3 months wore an ACG on their non-dominant wrist for one week. They were asked to log sleep/wake times daily. Pts/parents completed the Sleep Disturbance Scale for Children (SDSC) and a restless leg syndrome (RLS) screening. Sleep time <7hrs, ACG sleep efficiency <85% and SDSC Total T-scores >55 considered significant sleep impairment as per previous published standards.

**Results:** 14 pts completed ACG: 64% male, mean age 15.6 ±2.5yr, mean HD vintage 1 ±0.9yr, mean BMI Z-score -0.42 ±1.5. All pts had three 240min treatments per week. ACG showed 50% pts had sleep duration <7hrs, and 85.7% had impaired sleep efficiency, while SDSC showed only 71.4% pts had poor sleep. There was a poor correlation between SDSC total score, RLS score, and ACG sleep efficiency (Pearson's R). ACG-detected total sleep time had positive correlation with sleep efficiency (R=0.64, p=0.01) and number of awakenings (R=-0.59, p=0.03), though those awakenings were shorter (R=-0.64, p=0.01). Age, vintage or CKD labs were not associated with sleep efficiencies. Pts with <7hrs of sleep tended to have lower sleep efficiency (mean 65.9% ±14.4%) compared with >7hrs (mean 77.4% ±5.6%; p=0.07).

**Conclusions:** In this study using ACG in ped HD pts, there was high prevalence of sleep disturbances with half getting <7hrs sleep and high prevalence of poor efficiency in all. ACG provided objective measures of sleep disturbance, superior to sleep questionnaire. Further studies are needed to assess the impact of poor sleep on quality of life and CV morbidity in ped HD pts.

Sleep Disturbance Scale for Children Scores							
Subsection	DIMS	SBD	DA	SWTD	DOES	SH	Total
T-score, mean (range)	64.6 (47-99)	54.3 (45-72)	48.6 (47-58)	57.7 (41-84)	53.8 (42-77)	35.6 (45-99)	61.1 (42-81)
# > cutoff for significance (%)	10/14 (71.4)	6/14 (42.9)	2/14 (14.3)	7/14 (50.0)	5/14 (35.7)	7/14 (50.0)	10/14 (71.4)

ActiGraph Sleep Analysis		
Latency, min, mean (range)		21 (0-75)
Sleep efficiency, % (range)		71.85 (47.13-90.79)
Total time in bed, min, mean (range)		535 (291-660)
Total sleep time, hr, mean (range)		6.45 (2.47-8.50)
Wakefulness after sleep onset, min, mean (range)		126 (24-257)
Number of awakenings, mean (range)		26.4 (8-47)
Average length of awakenings, min, mean (range)		5.4 (1.89-15.88)
Movement index, mean (range)		23.57 (7.30-52.58)
Fragmentation index, mean (range)		12.87 (0.00-28.40)
Sleep fragmentation index, mean (range)		36.22 (7.30-65.08)

Table 1: Sleep Disturbance Scale for Children subsection scores and ACG sleep data. DIMS: disorder initiating/maintaining sleep; SBD: sleep disorder breathing; DA: disorder of arousal; SWTD: sleep-wake transition disorder; DOES: disorder of excessive somnolence; SH: sleep hyperhidrosis.

**FR-PO428**

**Characteristics and Outcomes of Arteriovenous Fistula in Hemodialysis Pediatric Patients: Impact of the Monocyte-to-Lymphocyte Ratio in Access Dysfunction**

Ana C. Brás,<sup>1</sup> Maria Faria,<sup>2</sup> Patrícia Sousa,<sup>3</sup> Ana Teixeira,<sup>2</sup> Teresa V. Costa,<sup>2</sup> Gabriela Teixeira,<sup>4</sup> Paulo J. Almeida,<sup>2</sup> Conceição Mota,<sup>2</sup> <sup>1</sup>Hospital Professor Doutor Fernando Fonseca EPE, Amadora, Portugal; <sup>2</sup>Centro Hospitalar Universitario do Porto EPE, Porto, Portugal; <sup>3</sup>Hospital Senhora da Oliveira, Guimarães, Portugal; <sup>4</sup>Centro Hospitalar Tamega e Sousa EPE, Penafiel, Portugal.

**Background:** Arteriovenous fistula (AVF) is considered the gold-standard access in adult and pediatric patients on hemodialysis (HD). Age and size combined with vessel immaturity can pose a challenge in creating AVF in children. We aimed to compare distal (dAVF) and proximal AVF (pAVF) regarding patency rates, complications and outcomes in a population of pediatric HD patients and evaluate the impact of monocyte-to-lymphocyte ratio (MLR) in access dysfunction.

**Methods:** All patients aged 0 to 18 years who underwent AVF creation for HD between January 2004 and May 2022 were included.

**Results:** We evaluated 33 patients with a median age of 13 years (IQR 5); 58% male. Median weight at time of AVF construction was 41kg (IQR 21.5); 30% weighted less than 30kg. The most frequent etiology of kidney disease was congenital anomalies of kidney and urinary tract (64%). Most patients (75%) underwent kidney replacement therapy previous to AVF construction. Of the AVF constructed, 46% were dAVF (radiocephalic) and 54% pAVF (brachiocephalic and brachioabasilic). Primary failure rate was 27%. Primary and secondary patency rate at one year were 62.5% and 93.8% respectively. AVF related complications were stenosis/thrombosis (54%), ischemic steal syndrome (6%) and high flow/aneurismatic AVF (6%). Regarding outcomes, 64% received a kidney transplant (KT) (median time of 11 months (mo) (IQR 21)); 6% died. Patients with pAVF were younger (p=0.03) and smaller (p=0.001). Median secondary patency was 29 mo (IQR 36.5) and 6.5 mo (IQR 10.8) in pAVF and dAVF respectively (p=0.01). There was no statistical significance regarding primary patency, AVF related complications or outcomes between the two groups. There was no association between MLR and access dysfunction.

**Conclusions:** Achieving a functional vascular access while sparing vascular territory for the future is of most importance in pediatrics. We showed that pediatric patients with pAVF as first access, although younger and smaller, had longer access patency and no more complications than those with dAVF. Although larger studies are needed, these results demonstrate the safety and efficacy of building such accesses in these patients. We found no association between MLR and access dysfunction.

**FR-PO429**

**Safety and Practical Use of 4% Tetrasodium EDTA for Pediatric Hemodialysis (HD) Line Locking**

Cal Robinson,<sup>1,2</sup> Rosaleen M. Nemece,<sup>1</sup> Lor Tecson,<sup>1</sup> Elizabeth A. Harvey,<sup>1</sup> <sup>1</sup>The Hospital for Sick Children, Toronto, ON, Canada; <sup>2</sup>University of Toronto Institute of Health Policy Management and Evaluation, Toronto, ON, Canada.

**Background:** Central venous line (CVL)-associated bloodstream infections (CLABSI) are common in pediatric HD patients, and are associated with significant morbidity and healthcare costs. Unlike standard locking solutions (e.g., heparin and alteplase), 4% tetrasodium EDTA (KiteLock™) has antimicrobial and antibiofilm properties. We aim to study the safety and efficacy of 4% tetrasodium EDTA in pediatric HD patients.

**Methods:** Single-center, before-and-after quality improvement study. We included all chronic HD patients (6mo-18yr old), and excluded those with an active CLABSI, EDTA allergy, or <5kg. Our standard locking solution was heparin (1000 units/mL) pre-intervention and 4% tetrasodium EDTA post-intervention. For both, alteplase (1mg/mL) was used as required. We compared unit-level pre- and post-intervention data for laboratory results, alteplase use, HD treatment parameters, and CVL dysfunction.

**Results:** We present preliminary data for ten patients (median age 14yr, 50% female, median 14mo since CVL insertion). After introducing 4% tetrasodium EDTA, the prescribed blood flow rate was achieved in more HD sessions (115/117 (98.3%) post- vs. 100/108 (92.6%) pre-intervention, p=0.04). There was a trend towards decreased alteplase use (6.7% of sessions post- vs. 12% pre-intervention, p=0.11). There was no difference in CVL dysfunction (12% of sessions post- vs. 12% pre-intervention, p=0.99), after adjudicating for events unrelated to 4% tetrasodium EDTA use. Significant calcium, magnesium, and iron chelation were seen on labs drawn from the CVL after small discard volumes (<5mL), but not after a larger discard (≥6mL), or a small discard plus flushing protocol. We noted increased viscosity of the CVL discard using 4% tetrasodium EDTA. There were no differences in other HD treatment parameters (e.g., ultrafiltration, arterial/venous pressures). The mean locking solution cost decreased from \$20.71 to \$18.55 CAD per patient-session, which was due to lower alteplase use.

**Conclusions:** In pediatric HD patients, 4% tetrasodium EDTA locking increased the proportion of HD sessions achieving the prescribed blood flow, and slightly reduced alteplase use. However, significant chelation was seen on labs drawn from the CVL after small-volume discards, necessitating a change in sampling protocol. Further data is needed to evaluate if 4% tetrasodium EDTA can reduce CLABSI risk.

**FR-PO430**

**Use of Alteplase in Long-Term Catheters Causes Hyperphosphataemia in Children on Hemodialysis**

Simone Vieira, Maria fernanda C. Carvalho, Cristina Henriques, Samanta L. Bergamo, Mariana G. Rockenbach, Belise K. de Sá, Camila P. Genzani, Ilka P. Gonçalves, Deborah Hirata, Vanessa Scaranti, Eliane Takabatake, Paulo C. Koch Nogueira. Hospital Samaritano de Sao Paulo, Sao Paulo, Brazil.

**Background:** Alteplase has phosphoric acid in its composition, and catheter use may distort patients' phosphatemia depending on where the sample is collected. To investigate whether the use of Alteplase in the permeabilization of connectorized catheters influences the levels of serum P in children on hemodialysis (HD). To analyze the influence of the site and time of collection.

**Methods:** We studied 40 children in HD at Hospital Américas Samaritano, using Alteplase to avoid obstruction of the long-stay catheter. We analyzed 6 blood samples obtained following: 1. peripheral vein before the HD session; 2 after aspiration of the catheter lumen volume preserving the connector; 3 after the connector is removed; 4. Pre-filter collection when starting HD; 5: after 3 minutes of HD start; 6. After 5 minutes of initiation of hemodialysis.

**Results:** The age of the children ranged from 7 m to 17 years, 82.5% of males. The mean difference of the peripheral P (Sample 1) was with the others by the Bland Altman Plot method and 95% confidence interval outside: Sample 2: -12.32 (-15.75 to -8.89); Sample 3: -2.93 (-4.12 to -1.73); Sample 4: 0.16 (cl -0.12 to 0.44); Sample 5: 1.04 (cl 0.61 to 1.48); Sample 6: 1.33 (cl 0.89 to 1.77). The results showed agreement between the P in the peripheral blood and the collected prefilter.

**Conclusions:** Altelase has phosphoric acid in its composition, and use in catheters may distort the phosphataemia of patients depending on the site of sample collection. Patients with a long-stay catheter in the use of altelase should analyze the serum P after the withdrawal of the connector, aspiration of the lumen volume and prefilter collection after the onset of hemodialysis, under risk of false diagnosis of hyperphosphatemia and introduction of unnecessary treatments.

**FR-PO431**

**Beneficial Addition of Donor-Derived Cell-Free DNA Testing in Pediatric Kidney Transplantation**

Jayanthi Chandar,<sup>1,2</sup> Marissa J. Defreitas,<sup>1,2</sup> Renata Ponsirenas,<sup>3</sup> George W. Burke,<sup>1,2</sup> University of Miami <sup>1</sup>University of Miami School of Medicine, Miami, FL; <sup>2</sup>Miami Transplant Institute, Miami, FL; <sup>3</sup>CareDx Inc, San Francisco, CA.

**Background:** Donor-derived cell-free DNA (dd-cfDNA) is a plasma biomarker to assess allograft injury in kidney transplant recipients (KTRs). Herein, we describe a single-center experience regarding indications for performing dd-cfDNA in pediatric KTRs and compare dd-cfDNA fractions in various clinical states.

**Methods:** Pediatric KTRs tested for dd-cfDNA for a clinical indication were reviewed in a cross-sectional, observational study. Median values were compared between each indicated category. Sensitivity and specificity of dd-cfDNA to predict biopsy-proven graft injury was determined by ROC curve analysis.

**Results:** dd-cfDNA was done in 77 children with a mean age of 11.6 ± 5.9 years. Mean time from transplant to testing was 3.5 ± 3.2 years. Indications for testing included presence of alloantibodies (N=12), clinical suspicion of rejection (N=7), BK nephropathy (N=1), reduced immunosuppression because of leukopenia, viral replication or recurrent bacterial infections (N=30), fluctuating serum creatinine (N=7), or increased serum creatinine with normal growth (N=6), increased post-transplant baseline creatinine for age (N=10) and suspected non-adherence with low tacrolimus levels (N=4). There was a significant difference in dd-cfDNA between children who had biopsy-proven acute rejection (BPAR), BK virus nephropathy (BKVN) and those who had alloantibodies (median 1.35 (95% CI 0.6,2.4) versus those who did not [median 0.3 (95%CI 0.25, 0.43); p=0.0012]. Children who were on lower doses of immunosuppression because of leukopenia, viral or bacterial infections had low dd-cfDNA [median score: 0.32 (95%CI 0.25, 0.45); Figure 1]. ROC curve analysis revealed AUC of 98%, specificity 92.5% and sensitivity of 70% for dd-cfDNA to predict graft injury in the presence of alloantibodies.

**Conclusions:** dd-cfDNA is a clinically useful adjuvant tool to determine allograft injury in pediatric KTRs which helps distinguish immune activation from immune quiescence. It has the potential to guide and serially monitor immunosuppression dosing.

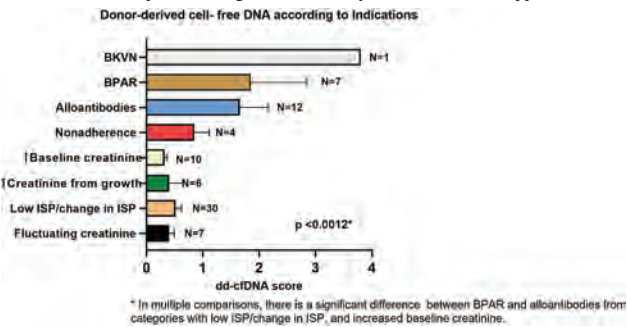

Figure 1

**FR-PO432**

**Incidence and Outcomes of Vesicoureteral Reflux After Pediatric Renal Transplant**

Kelsi Alexander, Sharon M. Bartosh, Rachel M. Engen. University of Wisconsin-Madison, Madison, WI.

**Background:** Vesicoureteral reflux (VUR) is a common complication following pediatric renal transplant. There is little data on the incidence of VUR or its effect on histologic graft changes or graft survival.

**Methods:** All pediatric renal transplant recipients from 2007-2020 underwent voiding cystourethrogram at 6 months post-transplant and protocol biopsy at 3 months and 12 months post-transplant. Lich-Gregoir anastomosis was used for 95% of patients. Patients were categorized based on VUR grade: no/low-grade VUR (grades 0-2) and high-grade VUR (grades 3-5). Outcomes included time to graft failure, change in eGFR, and Banff score on protocol biopsy.

**Results:** Of 67 renal transplant recipients, 35% had no VUR, 2% had grade 1 VUR, 21% had grade 2 VUR, 30% had grade 3 VUR, 11% had grade 4 VUR, and 2% had grade 5 VUR. When controlling for age, patients with high-grade VUR had increased risk

of graft failure compared to patients with low-grade VUR (aHR 4.6 (95%CI 1.3-16.5) p=0.019)). Median decline in eGFR from 3 months to 5 years post-transplant was greater among those with high-grade VUR (-15.5 (IQR -19 to 16.7) ml/min/1.73m<sup>2</sup>) compared to those with no/low-grade VUR (0.55 (IQR -31.2 to -8.2) ml/min/1.73m<sup>2</sup>) (p=0.007). There was a trend toward more acute inflammation on protocol biopsy among those with high-grade VUR, as demonstrated by change in Banff t and i score, but this did not reach statistical significance.

**Conclusions:** Pediatric patients with high-grade VUR at 6-months post-renal transplant appear to have worse long-term graft function and increased risk of graft failure compared to patients with no or low-grade VUR. Larger studies are needed further characterize the relationship between VUR and graft outcomes.

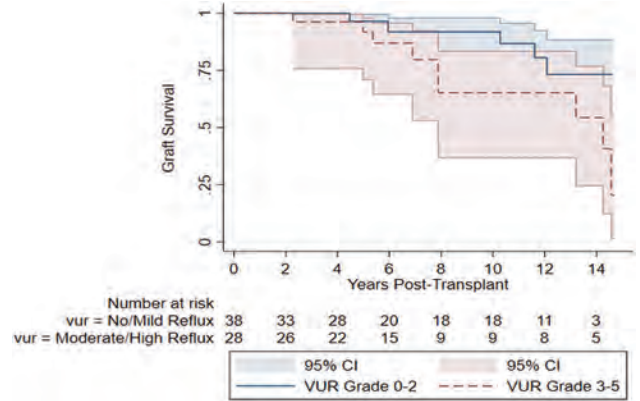

	VUR 0-2, N=38		VUR 3-5, N=28		P Value
	n	%	n	%	
<b>3 month biopsy results</b>					
i>0	3	9.4%	6	25.0%	0.115
o>0	2	6.25%	4	16.7%	0.212
ct>0	13	40.6%	12	50%	0.485
ci>0	11	34.4%	9	37.56%	0.809
<b>12 month biopsy results</b>					
i>0	6	19.4%	8	36.4%	0.166
o>0	5	16.1%	8	36.4%	0.092
ct>0	24	77.4%	16	72.7%	0.696
ci>0	22	71.0%	13	59.1%	0.368
<b>Change in Banff score 3mo-12mo</b>					
t increase >=1	5	17.9%	6	30%	0.324
i increase >=1	4	14.3%	6	30%	0.186
ct increase >=1	14	50%	6	30%	0.166
ci increase >=1	13	46.4%	8	40%	0.658

Protocol biopsy Banff Scores

**FR-PO433**

**Association of Early Life Growth and Kidney Function With Blood Pressure in Ethiopian Children: Birth Cohort Study (IABC)**

Daniel Yilma Bogale,<sup>1</sup> Beakal Z. Tefera,<sup>1</sup> Rahma A. Abagero,<sup>1</sup> Bikila Soboka Megersa,<sup>2</sup> Mubarek Abera,<sup>1</sup> Rasmus Wibæk,<sup>3</sup> Gregers S. Andersen,<sup>3</sup> Tsinuel Girma Nigatu,<sup>1</sup> Henrik Friis,<sup>2</sup> Jonathan C. Wells,<sup>4</sup> Dorothea Nitsch,<sup>5</sup> IABC-Kidney study Team <sup>1</sup>Jimma University, Jimma, Ethiopia; <sup>2</sup>Kobenhavns Universitet, Kobenhavn, Denmark; <sup>3</sup>Steno Diabetes Center Copenhagen, Herlev, Denmark; <sup>4</sup>University College London, London, United Kingdom; <sup>5</sup>London School of Hygiene & Tropical Medicine, London, United Kingdom.

**Background:** The prevalence of hypertension is increasing in low and middle-income countries (LMIC). Studies in high-income countries have indicated the association of early life growth with hypertension later in life; but limited studies have examined this in LMIC. We examined the associations of low birth weight (LBW), linear growth in first five years of life, and kidney function with blood pressure (BP) at 7-11 years in Ethiopian children.

**Methods:** Children from birth cohort were followed up at age 7-11years. Sociodemographic, anthropometric, and body composition data, and blood samples were collected. BP was measured three times five minutes apart and average was taken. Kidney function was assessed using estimated glomerular filtration rate (eGFR) using cystatin C. Term neonates with a birth weight <2.5 Kg were considered as LBW. Linear growth was assessed using height/length-for-age (HAZ) using WHO reference data and stunting was defined as HAZ <-2. Associations of LBW, HAZ and stunting (yes/no) at 2, 4, and 5 years and kidney function with BP were evaluated in separate linear regression models with adjustment for age, sex, fat mass and fat-free mass, height at current age.

**Results:** A total of 355 children participated in the current follow-up (mean age ± SD: 9 ± 1 year, boys: 51.3%). The median (IQR) systolic and diastolic BP was 93 (90, 100) mmHg and 60 (50, 60) mmHg respectively. Kidney function was assessed for 347 children and median (IQR) eGFR was 76 (70, 84) ml/min/1.73 m<sup>2</sup>. For every unit increase in HAZ at 2 year, there was 1% (95%CI: 0.4, 2) decrease in systolic BP at 7-11 years of age. Children who were stunted at 2 year had 3% (95%CI: 0.4, 5) higher in systolic BP compared to non-stunted children. We found no association between LBW, HAZ at 4 and 5 years and BP. We found 0.04% (95%CI: 0.01, 0.07) decrease in systolic BP per 1 ml/min/1.73 increase in eGFR.

**Conclusions:** Our findings from healthy Ethiopian children revealed that linear growth at two years of life and eGFR inversely associated with systolic BP at 7-11 years of age. Further follow up of this cohort during the adolescent and adulthood period will help to understand the association of early-life linear growth with hypertension in LMIC.

**Funding:** Commercial Support - GlaxoSmithKline African NCD

**FR-PO434**

**Schoolchildren From Disadvantaged Backgrounds Present a Significant Increase of Body Fat Mass and Blood Pressure During the COVID-19 Lockdown in Germany: Results From the MEDdirect Study**  
 Rainer Büscher, *Universitätsmedizin Essen, Essen, Germany.*

**Background:** The coronavirus (COVID-19) outbreak has become an unprecedented threat to global health which aggravated already existing health and emotional problems for children from underprivileged areas. MEDdirect is a medical students'-based project which encourages young medical students to teach schoolchildren in health care, sanitation, nutrition and physical activity. The study was designed to evaluate the regular commitment of first-year medical students as health advocates for underprivileged pupils and monitor changes in health, blood pressure and body composition during COVID-19 pandemic lockdown.

**Methods:** Twenty-five healthy schoolchildren from disadvantaged neighborhoods participated in this prospective prevention study and received regular courses about health care, sanitation, nutrition and exercise carried out by the medical students. Anthropometric and body composition monitoring (BCM) data were collected in parallel.

**Results:** Trainers and scholars finished four complete school days in 3-4-month intervals over a period of two years with different training courses. All participants gave an overwhelming positive response to the project. During the COVID-19 month-long school lockdown, body composition monitoring revealed a significant increase of body weight ( $28.7 \pm 9.2$  kg vs.  $38.0 \pm 11.8$  kg,  $p=0.023$ ) and BMI ( $18.8 \pm 2.0$  vs.  $23.3 \pm 0.4$ ). Particularly, body fat mass was increased ( $6.6 \pm 4.8$  vs.  $11.9 \pm 7.5$ ,  $p=0.031$ ) and muscle mass decreased. In addition, we observed a significant increase of the diastolic blood pressure (Figure 1).

**Conclusions:** The COVID-19 pandemic-related school lockdown lead to a significant weight gain and increase of body fat mass and blood pressure with unpredictable health consequences in the youngest. Therefore, stronger efforts to support this high-risk group are urgently needed and MEDdirect might be a feasible micro-intervention.

**Funding:** Private Foundation Support

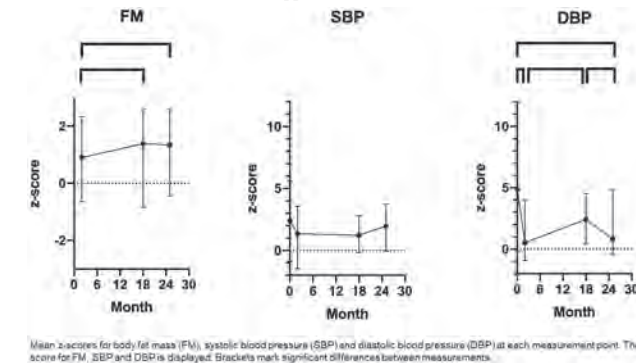

**FR-PO435**

**Improving Blood Pressure Control in Young Patients at Elevated Cardiovascular Risk: A Pilot Study**

Divya Seth,<sup>1,2</sup> Alexandra Bicki,<sup>2</sup> Sanobar Sadiq,<sup>2</sup> Elaine Ku.<sup>1,2</sup> <sup>1</sup>UCSF, University of California San Francisco, Division of Nephrology, San Francisco, CA; <sup>2</sup>UCSF, University of California San Francisco, Division of Pediatric Nephrology, San Francisco, CA.

**Background:** Promoting physical activity can reduce the risk of cardiovascular disease, potentially lower systolic blood pressure (SBP), and help patients maintain an appropriate weight. We sought to determine if children and young adults with hypertension, diabetes, and/or chronic kidney disease can improve BP control through randomized assignment to a pedometer vs. usual care in a parallel arm crossover design trial.

**Methods:** Subjects from a single-center were randomized in a 2:1 ratio using a Fitbit Flex2 coupled with bimonthly study team feedback on step count. After 6 months, control subjects were crossed over to intervention (Figure 1). Change in SBP (primary outcome), weight and average weekly step count (secondary outcomes) were tracked every 3 months for 1 year and compared using mixed models.

**Results:** 63 subjects enrolled (57% male, 48% Hispanic, 13% Black). Mean age was  $18 \pm 4$  years and mean BMI z-score was  $1.5 \pm 0.95$ . Coupling provider feedback with self-monitored pedometer use did not result in a significant change in step count when comparing intervention to control. There was no change in unadjusted SBP or weight over time. When adjusted for age, sex, baseline SBP, and weight, the intervention arm showed a decline in SBP at Week 39, as compared to the control arm, but this change was not sustained at Week 52 (Table 1).

**Conclusions:** Pilot results suggest that self-monitored pedometer use, even with provider feedback, may not result in sustained improvement in BP, daily step count, or weight. Augmented interventions or alternative strategies to mitigate risk are needed.

**Funding:** Other NIH Support - NHLBI

Follow-up	SBP in Intervention Median (IQR)	SBP in Control Median (IQR)	P-value for difference
Baseline			
Week 13	121.8 (118.7, 125.0)	120.1 (101.4, 138.7)	0.96
Week 26	122.9 (119.5, 126.4)	124.2 (119.4, 129.0)	0.66
Week 39	120.6 (116.4, 124.8)	128.5 (123.4, 133.6)	0.02
Week 52	120.2 (116.1, 124.2)	123.7 (118.3, 129.2)	0.30

**Figure 1. Study Design**

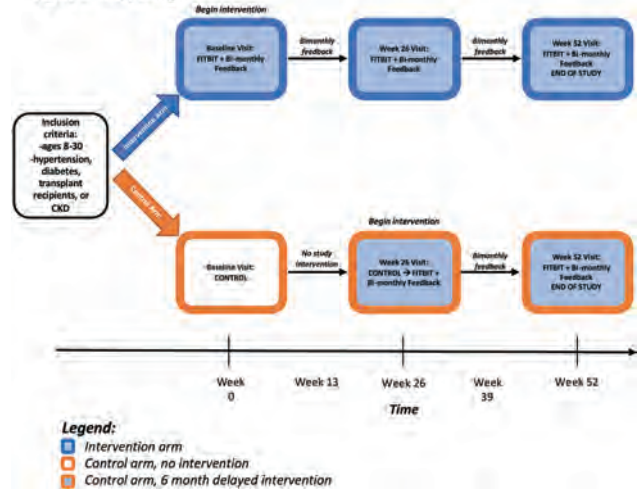

**FR-PO436**

**Association Between Anxiety and Hypertension in Adolescent Patients: A Single-Center Cross-Sectional Study**

Yaritzy M. Astudillo,<sup>1,2</sup> Sankaran Krishnan,<sup>1,2</sup> Tanya E. Pereira,<sup>1,2</sup> Sonia Solomon,<sup>1,2</sup> Dmitry V. Samsonov.<sup>1,2</sup> <sup>1</sup>New York Medical College, Valhalla, NY; <sup>2</sup>Maria Fareri Children's Hospital, Valhalla, NY.

**Background:** Given its rising prevalence, identifying modifiable risk factors of primary pediatric hypertension remains an area of active research. Anxiety is a common childhood problem that may be associated with activation of the sympathetic system, plasma renin, and hypothalamic-pituitary-adrenal axis; thus, resulting in increased peripheral vascular resistance and hypertension (HTN). While anxiety is known to be associated with elevated blood pressure (BP) in adults, this has not been studied in children. The objective of this study was to assess the association between anxiety and HTN in adolescents.

**Methods:** Adolescents, aged 12 to 18 years old, referred to our Pediatric Nephrology clinic were eligible to participate. HTN was defined as either systolic (SBP) or diastolic (DBP) BP above the 95<sup>th</sup> percentile for age, height, and gender. Participants were evaluated for anxiety using the validated Screen for Child Anxiety Related Disorders questionnaire filled independently by child (SCARED-C) and a parent (SCARED-P) evaluating the child. A score of  $\geq 9$  was defined as a positive screen for anxiety. Proportions were compared using chi-square tests and difference in blood pressure between groups compared with the Mann-Whitney U test.

**Results:** 200 adolescents participated in this study with a subgroup of 130, not on any blood pressure medication. In this subgroup, the mean age was  $15.18 \pm 1.7$  years, 50% were male. 45% (58) had positive SCARED-C and 29% (37) positive SCARED-P scores. 43% (16) of SCARED-P positive had diastolic HTN compared to 19% (18) of SCARED-P negative,  $p = 0.005$ . DBP was significantly higher in SCARED-P positive ( $79.0 \pm 10.1$ ) and SCARED-C positive ( $77.1 \pm 10.4$ ) compared to SCARED-P negative ( $73.6 \pm 9.3$ ) and SCARED-C negative ( $73 \pm 8.9$ ) groups respectively (Table 1).

**Conclusions:** In this cohort of adolescents, those who were anxious by parental reporting were more likely to have diastolic HTN. For adolescents not treated with antihypertensive medications, DBP but not SBP was significantly higher in the anxious cohort both by self and parental reporting. The impact of anxiety on the pathogenesis of HTN in children warrants further study.

**Table 1. Association between anxiety and diastolic hypertension in subgroup of adolescents not treated with antihypertensive medications.**

	Self-Reporting		p	Parental Reporting		p
	Anxious SCARED-C $\geq 9$	Non-anxious SCARED-C < 9		Anxious SCARED-P $\geq 9$	Non-anxious SCARED-P < 9	
N=130	58 (45%)	72 (55%)		37 (29%)	93 (71%)	
Systolic HTN, N (%)	19 (33%)	18 (25%)	0.33	14 (38%)	23 (25%)	0.135
Diastolic HTN, N (%)	18 (31%)	16 (22%)	0.52	16 (43%)	18 (19%)	0.005**
Mean SBP $\pm$ SD	123.1 $\pm$ 15.8	120.9 $\pm$ 12.8	0.47	125.6 $\pm$ 14.8	120.4 $\pm$ 14.4	0.052
Mean DBP $\pm$ SD	77.1 $\pm$ 10.4	73 $\pm$ 8.9	0.029*	79.0 $\pm$ 10.1	73.6 $\pm$ 9.3	0.013*

FR-PO437

**Bordetella holmesii: A Rare Pathogen Causing Infective Endocarditis-Associated Glomerulonephritis**

Tara B. Gavcovich,<sup>1,2</sup> Malek Al Barbandi,<sup>1,2</sup> Wendy R. Glaberson,<sup>1,2</sup> Marissa J. Defreitas,<sup>1,2</sup> Chryso P. Katsofuis,<sup>1,2</sup> Yiqin Zuo,<sup>1,2</sup> Carolyn L. Abitbol,<sup>1,2</sup> Wacharee Seeherunvong,<sup>1,2</sup> <sup>1</sup>Jackson Memorial Hospital, Miami, FL; <sup>2</sup>University of Miami School of Medicine, Miami, FL.

**Introduction:** Infective endocarditis (IE) can cause multiorgan failure and chronic kidney disease, in addition to cardiac sequelae. Presentation may be vague and can manifest as acute glomerulonephritis (GN). While the most common pathogens of IE are *Staphylococcus* and *Streptococcus species*, we report the rare pathogen *Bordetella holmesii* causing IE associated GN.

**Case Description:** A 20-year-old male born with pulmonary atresia and ventricular septal defect underwent corrective surgeries, and prosthetic pulmonary valve replacements at 3 and 9 years old. He was admitted to an outside hospital with fever and hematemesis, diagnosed with streptococcal pharyngitis. A month later, he presented to our institution with lower extremity edema and gross hematuria. On exam, he was afebrile, normotensive, had a 7-kg weight gain with anasarca, a loud systolic murmur, but no rash. Investigations revealed elevated serum creatinine, nephrotic proteinuria, hematuria, and hypocomplementemia, consistent with immune-mediated acute GN. Given his cardiac history, blood cultures were collected from 3 sites. Broad-spectrum antibiotics were initiated when he subsequently developed fever. Renal pathology showed IgM and C3-codominant diffuse proliferative GN (Figure). Transesophageal echocardiogram visualized a vegetation on the pulmonary valve. *Bordetella holmesii* was ultimately cultured from the prior and current hospitalization. A serum sample detecting microbial cell-free DNA sequencing confirmed *Bordetella holmesii* at very high levels. After completing 6 weeks of IV antibiotics with concurrent angiotensin receptor blockade, his kidney function recovered with improvement in hypocomplementemia and proteinuria (Table).

**Discussion:** This case report highlights the early recognition and comprehensive evaluation of a rare organism causing IE associated GN, which allowed for renal recovery and preserved cardiac function.

Biochemistry Progression

	Normal	Presentation	Day 4	Week 1	Week 3	Week 6
Serum Creatinine (mg/dL)	0.6-1.2	3.4	3.3	2.3	1.7	1.0
Complement C3 (mg/dL)	90-180	52	49			87
Complement C4 (mg/dL)	10-40	5	3			15
Urine protein to creatinine ratio (mg/mg)	< 0.2	1.9	1.7	2.6	6.5	2.2

FR-PO438

**Renal Involvement and Novel Kidney Biopsy Findings in a Young Girl With Aicardi-Goutières Syndrome**

James B. Johnston, Geneviève Bernard, Sarah Campillo, Catherine Millar, Chantal Bernard, Audrey Lovett, Marie-Michele Gaudreault-Tremblay. *Montreal Children's Hospital, Montreal, QC, Canada.*

**Introduction:** Aicardi-Goutières Syndrome (AGS) is an inherited type I interferonopathy (IFN) characterized by a spectrum of disease manifestations, including neurologic (e.g. microcephaly, global developmental delay, spastic paresis, dystonia, cerebral calcifications) and systemic manifestations (e.g. hypothyroidism, skin lesions, recurrent fevers). Mutations in *TREX1*, *RNASEH2A*, *RNASEH2B*, *RNASEH2C*, *SAMHD1*, *ADAR1* or *IFIH1* have been associated with AGS. Clinical presentation is heterogeneous, with variable onset of disease. Renal involvement has only been rarely reported.

**Case Description:** A 3-year-old girl with a severe phenotype of AGS due to two pathogenic variants in *TREX1* had recurrent vomiting, irritability, and generalized panniculitis only partially responsive to prednisolone 1mg/kg/day. While undergoing screening assessment for JAK1/2 inhibitor therapy, she was found to have severe hypertension (136/94mmHg), hypoalbuminemia (20g/L) and nephrotic range proteinuria (urine protein:creatinine 12.5g/g). Renal function was normal. She was initially treated with enalapril, amlodipine, and prazosin. The renal biopsy revealed podocyte hypertrophy, abundant tubuloreticular inclusions and mild immune complex deposition. Despite initial concerns about EBV viremia and transaminitis, the patient was treated with baricitinib (initially 2mg BID, maximal dose reached 2mg TID). Improvement of vomiting, panniculitis, and irritability was observed over 3 months. Proteinuria also significantly improved (urine protein:creatinine 0.24g/g). Prednisolone was successfully weaned, and antihypertensive treatment reduced to enalapril alone. The patient has remained stable for 18 months, without any EBV disease.

**Discussion:** Renal involvement has not previously been described in association with *TREX1* mutations. Biopsy findings were novel, showing mixed features of podocytopathy, scattered immune deposition, and features of vascular lesions rather than one dominant histopathologic pattern. The effectiveness of JAK1/2 inhibitors in IFN with renal involvement has not been definitively established, but case reports have been encouraging. The correlation between JAK1/2 inhibition and clinical improvement in this case supports the use of baricitinib in other interferon-related disorders.

FR-PO439

**Identification of Mutations in an Atypical Focal Segmental Glomerulosclerosis-Causing Gene**

Gaurav Rajashekar, Ying M. Chen. *Washington University in St Louis, St Louis, MO.*

**Introduction:** Focal segmental glomerulosclerosis (FSGS) is a histopathological diagnosis. More than 50 monogenic forms of FSGS have been identified. With broader utilization of genetic sequencing, mutations in genes, not commonly associated with glomerular disease, have been identified in FSGS.

**Case Description:** Here we present a 29-year old female with an extensive family history of proteinuria on her paternal side (Fig. 1) presenting with proteinuria (urine protein/creatinine ratio 1.7g/g) at the age of 18. Biopsy at that time showed FSGS. She underwent whole exome sequencing which showed variants in *RPGRIP1L*, p.V682I (heterozygous) and p.I1005V (heterozygous), as well as a variant in *CC2D2A*, p.A1050V (heterozygous). Although variants in *RPGRIP1L* or *CC2D2A* have not been associated with FSGS, due to her family history of proteinuria, we performed Sanger sequencing on her family members. Her father, who has proteinuria (without biopsy) carries the same two variants in *RPGRIP1L*, but not in *CC2D2A*. Her mother and sister (no proteinuria) harbor the same variant in *CC2D2A*, but not in *RPGRIP1L*. These sequencing results strongly suggest that the variants in *RPGRIP1L* could be pathogenic.

**Discussion:** *RPGRIP1L* encodes retinitis pigmentosa GTPase regulator-interacting protein-1 like, a ciliary and retinal protein important in ciliogenesis and tubular function. The mutation of *RPGRIP1L* is associated with Meckel and Joubert's syndrome but is not a known FSGS gene. The identified two variants in *RPGRIP1L* occur in relatively poorly conserved regions. The p.I1005V has been identified in the Genome Aggregation Database (gnomAD) with a minor allele frequency (MAF) 0.00004415 (very rare), while the other variant is not found in gnomAD. The in silico prediction about the effect of the missense mutations from the different algorithms is conflicting. Thus, we plan to use CRISPR/Cas9 to introduce these mutations to establish cell models first to determine their pathogenicity. Our case highlights those mutations in genes not typically thought of as glomerular disease genes may lead to FSGS, most likely as a secondary response.

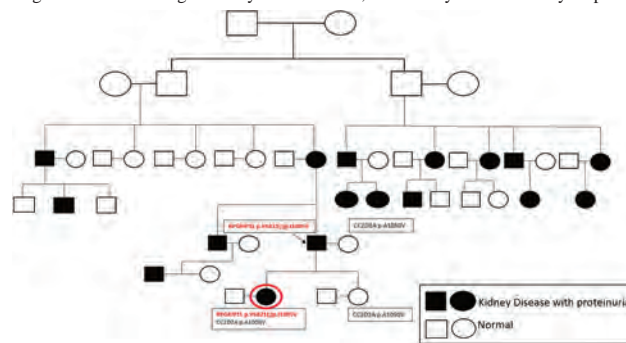

FR-PO440

**Trigenic COL4A3/COL4A4/COL4A5 Pathogenic Variants in Alport Syndrome: A Case Report**

Dipti Rao,<sup>1</sup> Rutger J. Maas,<sup>1</sup> Elisabeth A. Cornelissen,<sup>1</sup> Jack F. Wetzels,<sup>1</sup> Michel van Geel,<sup>2</sup> <sup>1</sup>Radboudumc, Nijmegen, Netherlands; <sup>2</sup>Maastricht Universitair Medisch Centrum+, Maastricht, Netherlands.

**Introduction:** Alport syndrome (AS) is a hereditary autosomal recessive (semi-dominant) or X-linked disorder of type IV collagen caused by mutations in *COL4A3*, *COL4A4* and/or X-linked *COL4A5*. In recent years several cases of digenic AS, caused by two pathogenic variants in two *COL4A* genes, were reported. Patients with digenic AS may present with an atypical phenotype, depending on the percentage affected type IV trimeric collagen chain and inheritance advice may differ. We report a newly discovered case of trigenic AS.

**Case Description:** The female index patient, aged 51 years, was diagnosed with hematuria at age 24 yr, developed hypertension by the age of 30, and had pre-eclampsia and nephrotic syndrome during pregnancy at the age of 36. Post pregnancy proteinuria decreased to levels between 0.5 – 1.5 g/day with an ACE inhibitor. eGFR decreased initially, but has been stable in the past 5 years with eGFR 44ml/min/1.73m2. The patient wears hearing aids due to symmetric high tone sensorineural hearing loss. Her son was diagnosed with hypertension at 10 years old, attributed to the use of methylphenidate. He has minimal proteinuria and hematuria with normal eGFR. The 74-year-old mother is known with hypertension, hematuria and microalbuminuria. eGFR has been stable at 84ml/min/1.73m2. The father died at the age of 48 years, he was not known with a renal disorder or hearing loss. Because AS was suspected, genetic analysis in the index patient was performed. Two heterozygous pathogenic variants were detected: c.2691del in *COL4A3* and c.1663dup in *COL4A4*. Furthermore, a complete heterozygous deletion of *COL4A5* was detected, expanding beyond exon 1-4 of flanking *COL4A6*. Her son carried only the *COL4A3* mutation, and the mother the *COL4A4* mutation, confirming the familial autosomal mutations are present *in trans*. We presume the *COL4A5* deletion has occurred de novo since the father had no clinical symptoms.

**Discussion:** We describe the first patient with Alport syndrome caused by three pathogenic mutations in all three *COL4A* genes, thus trigenic AS. The moderate phenotype in the female patient could be the result of residual functional type IV trimeric collagen. This case report emphasizes the importance of examining all three *COL4A* genes for optimal follow-up and treatment of the patient and adequate genetic counseling of family members.

#### FR-PO441

### Alport Syndrome Caused by a Novel Intronic Mutation Leading to Partial Aberrant mRNA Splicing: A Case Report

Dipti Rao,<sup>1</sup> Michel van Geel,<sup>2</sup> Bartholomeus T. van den Berge,<sup>1</sup> Jitske Jansen,<sup>1</sup> Bart Smeets,<sup>1</sup> Jack F. Wetzels,<sup>1</sup> Rutger J. Maas.<sup>1</sup> <sup>1</sup>*Radboudumc, Nijmegen, Netherlands*; <sup>2</sup>*Maastricht Universitair Medisch Centrum+, Maastricht, Netherlands*.

**Introduction:** Alport syndrome (AS) is a hereditary disorder of type IV collagen. X-linked Alport syndrome (XLAS), caused by a mutation in the *COL4A5* gene, accounts for over 80% of all cases. Hematuria is the main initial symptom of AS. Most male patients develop end-stage-kidney-disease (ESKD) at young age, though there is variability in rate of progression. Genetic testing covering the coding regions of all three *COL4A3*, *COL4A4* and *COL4A5* genes is recommended in patients with suspected AS. However, in 10-20% of patients a mutation cannot be detected.

**Case Description:** We report a 63-year-old male who developed hematuria by one year of age. Over the years he developed proteinuria. The estimated glomerular filtration rate (eGFR) declined gradually; he reached ESKD at the age of 60. Kidney biopsy during childhood showed tubulointerstitial abnormalities and a thin GBM with segmental splitting. A skin biopsy showed absence of  $\alpha 5(IV)$  chains in the epidermal basement membrane, thus providing histological proof for diagnosis of XLAS. Glomerular hematuria was also detected in the patients' mother and both daughters; none of them developed proteinuria nor reduced eGFR. Initial genetic analysis by next-generation sequencing of the Alport gene panel (*COL4A3-COL4A4-COL4A5*) failed to detect the genetic cause. Reverse-transcriptase-PCR analysis on RNA extracted from urine-derived podocyte-lineage cells detected partial cryptic splicing, retaining an extra sequence between exon 21 and 22 derived from intron 21 (c.1423\_1424ins1423+1187\_1423+1230), putatively resulting in a frameshift and premature stop upon translation (p.(Asp476Profs\*96)). Subsequent Sanger sequencing revealed a hemizygous deep intronic variant c.1423+1175G>T in the *COL4A5* gene.

**Discussion:** We report a case of XLAS caused by a novel deep intronic mutation in *COL4A5*. Pathogenicity was experimentally confirmed by analysis of RNA isolated from urine-derived podocyte-lineage cells, which offers a non-invasive diagnostic method. The specific mutation strikingly results in partial aberrant mRNA splicing, putatively resulting in co-existence of a shorter, non-functional *COL4A5* protein and a normal functional protein. This finding could explain the relatively mild phenotype with development of ESKD at an older age as is common for XLAS.

#### FR-PO442

### Late Diagnosis of Fabry Disease in a Kidney Transplant Patient

Tariku T. Guduru, Brian R. Stephany, Richard A. Fatica, Xiangling Wang. *Cleveland Clinic, Cleveland, OH*.

**Introduction:** Fabry disease (FD) is an X-linked lysosomal storage disorder due to deficiency of the lysosomal enzyme  $\alpha$ -galactosidase A ( $\alpha$ -Gal A). It causes deposition of glycolipids such as globotriaosylceramide (Gb3). Diagnosis can be challenging due to non-specific presentation varying from minor symptoms such as heat intolerance, limb pain and skin lesions to end organ damage such as kidney failure, cardiomyopathy and stroke. Here we present a case of delayed diagnosis of FD for a patient with kidney transplant.

**Case Description:** A 47-year-old man with hypertension, cardiomegaly, erythrocytosis, ESRD post kidney transplant in 2006 and recurrent stroke sent for evaluation. When he was 28, he presented to hospital with hypertensive crisis, pulmonary edema and proteinuric acute kidney injury (AKI) with creatinine of 21mg/dl necessitating dialysis. Echocardiogram at that time showed severe concentric left ventricular hypertrophy (LVH) and grade 3 diastolic failure. His kidney failure was presumed to be from thrombotic microangiopathy without kidney biopsy. Prior to recent admission for third stroke, his daughter was found to have FD at age of 14. Further evaluation of his family showed FD associated mutation for his mother, two aunts and his non donor brother. Recent work up during evaluation showed normal kidney allograft function. Erythropoietin and JAK2 mutation done for erythrocytosis was non-revealing. Suspected FD was confirmed by low Alpha Galactosidase S 0.001 U/L (0.0074 – 0.457), elevated total Globotriaosylceramide (GL-3) 7.74 ug/mL (1.37 – 4.04) and Lyso – GL-3 88 ng/ml (< 0.30), and genetic testing that showed pathogenic hemizygous variant in GLA, c.640.1G>A which is associated with X linked FD. He was started on recombinant human Alfa galactosidase.

**Discussion:** Delayed diagnosis of FD is not uncommon due its wide clinical presentation. Our patient presented with severe LVH and proteinuric AKI pre-transplant and recurrent strokes for over 5 years post-transplant. He was diagnosed only after his daughter was found to have disease. Kidney transplant from donor with FD is associated with premature graft loss for which his donor brother was offered testing but declined. While recurrence of disease is not common after kidney transplant, early diagnosis and enzyme replacement therapy will minimize systemic deposition of GL-3/Gb3 and improve patient and donor outcome.

#### FR-PO443

### Recurrent Hemolysis in a Child With Shiga Toxin-Producing *Escherichia coli* and Two Heterozygous Variants Associated With Atypical Hemolytic Uremic Syndrome

Priyanka Chaij, Davoud Mohtat, Patricia Seo-Mayer. *Inova Fairfax Hospital, Falls Church, VA*.

**Introduction:** The most common cause of hemolytic uremic syndrome in children is shiga toxin-producing *E. coli* (STEC-HUS). We report a patient with STEC-HUS who had an unusually persistent course, leading to discovery of two heterozygous gene variants associated with atypical HUS (aHUS).

**Case Description:** A 4 year old girl presented with vomiting and bloody stools. Stool PCR was positive for shiga toxin and labs showed hemolytic anemia, thrombocytopenia, hematuria, proteinuria, hypertension and AKI. The diagnosis was STEC-HUS. She received supportive care and required one red blood cell transfusion. Diarrhea and thrombocytopenia resolved and creatinine nadred at 0.6mg/L. One month post-discharge, she acquired a viral illness and developed worsened anemia, increased LDH and recurrence of thrombocytopenia, resulting in readmission. Due to persistence of HUS, additional workup was pursued, including C3 (81mg/dL, ref 82-163mg/dL) and genetic testing for aHUS. Due to suspicion for aHUS, eculizumab treatment was initiated. Ultimately two heterozygous mutations were identified: a known pathogenic variant in Complement Factor I (CFI): (c.123 A>T), and a mutation in Complement Factor H (CFH) (c.2918 G>A), a variant of unknown significance. One parent carries the CFI mutation; the other has the CFH mutation. Both are well without any history of HUS. After 9 months, eculizumab treatment was paused and the patient has not had recurrence of HUS (Figure 1).

**Discussion:** This case illustrates the role of genetic testing in selected cases of STEC-HUS and the efficacy of eculizumab in an unusual combination of CFI/CFH variants causing aHUS. This combination has never been previously reported. Eculizumab was effective in halting hemolysis in our patient, but she has done well without chronic treatment.

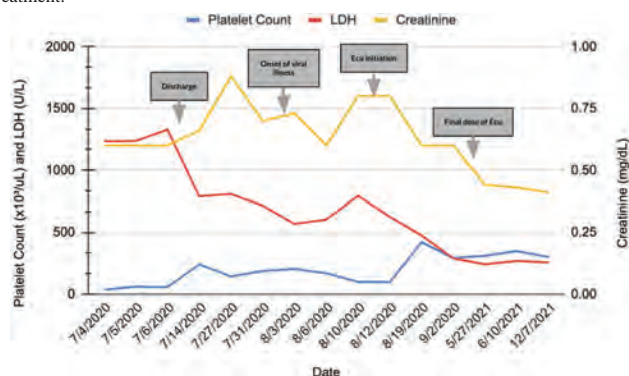

Figure 1: Laboratory trends in relation to discharge from 1st hospitalization, onset of viral illness prior to 2nd hospitalization, Eculizumab (Ecu) initiation and final dose of Ecu.

#### FR-PO444

### Glycogen Storage Disease Type 1a Leading to Recurrent Nephrolithiasis

Nisarg Gandhi,<sup>1</sup> Noor Bazerbashi,<sup>1</sup> Hassan N. Ibrahim.<sup>2</sup> <sup>1</sup>*Houston Methodist, Houston, TX*; <sup>2</sup>*Memorial Hermann Health System, Houston, TX*.

**Introduction:** Nephrolithiasis is a common presenting problem, but recurrence especially at a young age should prompt further laboratory and genetic testing to determine the cause. Herein, we present a case of autosomal recessive glycogen storage disease type 1a with recurrent symptomatic kidney stones.

**Case Description:** A 19-year-old Caucasian man presents to clinic for evaluation of recurrent kidney stones at the ages of 10, 11, and 17. A previous CT scan from 2 years prior revealed multiple bilateral kidney stones and a previous stone analysis revealed its composition to be 50% calcium oxalate monohydrate and 50% calcium oxalate dihydrate. His laboratory testing revealed a parathyroid hormone level of 21 pg/mL, calcium of 10.0 mg/dL, creatinine of 0.92 mg/dL, and uric acid level of 5.1 mg/dL, all within normal limits. A Litholink 24-hour urine collection was conducted to evaluate for cause of kidney stones (Table 1). Given the hypocitratric and hypercalciuric state at a young age with family history of kidney stones, a Natera genetic test was ordered. The results revealed autosomal recessive gene for glycogen storage disease type 1a. Subsequently, he was started on chlorthalidone and potassium citrate to lower urinary calcium and increase urinary citrate, respectively, to decrease his risk of developing additional kidney stones. At his most recent visit, the 24-hour urinary calcium had improved significantly, but the urinary citrate remained low (Table 1).

**Discussion:** Glycogen storage disease is a rare autosomal recessive disorder of fat and glycogen processing in the liver and kidneys, leading to a wide range of metabolic disturbances including hyperuricemia, hyperlipidemia, and fasting hypoglycemia. Kidney stones have been previously reported in approximately 6% of cases with hypercalciuria and hypocitratricuria. Typically, uric acid levels are high in the serum and urine, but not necessary for diagnosis. Treatment involves decreasing urinary calcium, increasing

urinary citrate, and decreasing urinary uric acid. Long-term symptom management is necessary to prevent progression to CKD. This case illustrates the utility of genetic testing in patients with recurrent nephrolithiasis, especially at a young age.

Table 1: Litholink Results

24-Hour Urine Collection (Reference Range)	Volume (0.5-4.0 L)	Calcium (male < 250 mg)	Citrate (male >450 mg)	Uric Acid (male < 0.800 g)
Initial	4.17	326	222	0.535
6 Months Later	2.03	134	182	0.421

FR-PO445

**Renal Vein Thrombosis Leading to the Diagnosis of Nephrotic Syndrome**  
 Kathryn Leonard, Ishmam Y. Alam, Bair Cadet, Jaswinder P. Singh. *Nassau University Medical Center, East Meadow, NY.*

**Introduction:** Primary MN is the most common cause of idiopathic nephrotic syndrome. We present the case of a 31-year-old Hispanic male with no prior past medical or family history, presenting with renal vein thrombosis and lab dysfunction, concerning for nephrotic syndrome. Further workup of kidney biopsy and serum antibody levels revealed the cause to be anti-PLA2R-mediated.

**Case Description:** 31-year-old Hispanic male with no past medical or family history presented with chest pain, dyspnea and swelling in his face and legs for one day. He reported recent pulmonary embolism and was discharged on anticoagulation therapy. He reported the chest pain and dyspnea felt similar to his prior hospitalization but the swelling was new. Physical exam revealed pitting edema to bilateral lower extremities and periorbital edema. Pan CT revealed subsegmental pulmonary emboli, renal vein thrombus and ascites. Laboratory workup revealed hypoalbuminemia less than 1.3 gm with total protein 3.4 g/dL. Lipid panel revealed elevated total cholesterol of 424 mg/dL and LDL of 339 mg/dL. Initial urinalysis showed proteinuria of >300 mg/dL, with spot urine protein creatinine ratio of 6.5, confirmed by 24-hour urine protein and creatinine ratio of 23.5. Serum PLA2R antibody panel was positive with a level of 47 RU/mL. Thrombophilic workup was unremarkable. Kidney biopsy with immunofluorescence staining for IgG, C3, kappa and lambda chains and PLA2R were positive, confirming primary MN

**Discussion:** While renal vein thrombosis is common, thromboembolic events preceding classic symptoms is unusual. MN is associated with lower extremity edema, periorbital edema, proteinuria and ascites. Uniquely, our patient presented with shortness of breath and chest pain. This case emphasizes the importance of imaging and highlights the role of anti-PLA2R antibody levels as a clinical predictor. Antibodies to PLA2R have been reported in 70% of patients with primary MN. Lower titer is associated with better remission rates. One study among patients with biopsy-proven MN revealed that high PLA2R antibody levels were linked with active disease and higher likelihood of declining renal function. These levels can dictate immunosuppressive therapies among patients. Additionally changes in circulating PLA2R antibodies occur more rapidly than changes in proteinuria, making it useful to monitor disease activity and treatment response.

FR-PO446

**Hypophosphatemia and Avascular Necrosis Requiring Hip Replacement in a 24-Year-Old due to SLC9A3R1 Mutation**  
 Ayesha A. Khan, Nabeel Aslam, Michael A. Mao. *Mayo Clinic, Jacksonville, FL.*

**Introduction:** Phosphorus is involved in a variety of biological activities, and hypophosphatemia can result in a range of clinical multiorgan symptoms that can vary in severity. Hypophosphatemia can be due to decreased intestinal absorption, increased urinary excretion, or transcellular movement into cells.

**Case Description:** We report case of a 31-year-old female with history of bilateral distal femoral head avascular necrosis requiring right hip replacement at age 24, vitamin D deficiency, and nephrolithiasis who presented for evaluation of hypophosphatemia of 2.4. Laboratory studies showed creatinine 0.76, calcium 9.2, phosphorus 2.8, 25-hydroxy vitamin-D level 13, PTH 60, magnesium 2.2, and albumin 4.1. Urinalysis showed a bland sediment without proteinuria. Imaging included DEXA scan that was appropriate for age, x-ray of left knee demonstrated sclerotic areas in the distal femur and proximal tibia, and CT showing no nephrolithiasis in setting of patient reported passed stones. She was referred to clinical genomics. Genetic testing showed she was heterozygous for a variant in the SLC9A3R1 gene (mode of inheritance autosomal dominant).

**Discussion:** SLC9A3R1 (SLC9A3 Regulator 1) encodes a sodium/hydrogen exchange regulatory cofactor and is part of a group of rare hereditary renal phosphate wasting disorders. Heterozygous missense and splice site variants of the SLC9A3R1 gene have been reported in individuals with autosomal dominant hypophosphatemic nephrolithiasis/osteoporosis type 2, which is characterized by impaired renal phosphate reabsorption in the renal proximal tubules. This gene mutation can be associated with hypophosphatemia, nephrolithiasis, bone demineralization, and osteoporosis. This report illustrates a case of avascular necrosis of long bones associated with SLC9A3R1 gene mutation and highlights that early genetic testing may improve long-term outcomes and complications. Increased genetic testing will also allow further studies to investigate the penetrance and clinical relevance of SLC9A3R1 variants on clinical management and outcomes.

RESULT(S): UNCERTAIN CLINICAL SIGNIFICANCE						
Gene	Disease(s)	Mode of Inheritance	Variant	Zygoty	Inherited From	Classification
RUNX2	RUNX2-Related Disorder	Autosomal Dominant	c.1361 A>T p.Y451F	Heterozygous	Unknown	Variant of Uncertain Significance
SLC9A3R1	Hypophosphatemic Nephrolithiasis/Osteoporosis Type 2	Autosomal Dominant	c.458 G>A p.R153Q	Heterozygous	Unknown	Variant of Uncertain Significance

INTERPRETATION
This individual is heterozygous for a variant of uncertain significance in the RUNX2 gene. This result does not establish a molecular diagnosis in this individual.
This individual is heterozygous for a variant of uncertain significance in the SLC9A3R1 gene. This result does not establish a molecular diagnosis in this individual.

FR-PO447

**Investigation of the Pathogenicity of Novel Missense Variants in the ARHGAP24 Gene by Quantitative Analysis of the Active Rac1: Two Cases of Proteinuria With Renal Dysfunction**

Atsushi Kondo,<sup>1</sup> China Nagano,<sup>1</sup> Hideaki Kitakado,<sup>1</sup> Chika Masuda,<sup>1</sup> Shinya Ishiko,<sup>1</sup> Yuya Aoto,<sup>1</sup> Nana Sakakibara,<sup>1</sup> Tomoko Horinouchi,<sup>1</sup> Tomohiko Yamamura,<sup>1</sup> Kazumoto Iijima,<sup>2</sup> Kandai Nozu.<sup>1</sup> <sup>1</sup>Kobe University Graduate School of Medicine, Kobe, Japan; <sup>2</sup>Hyogo Prefectural Kobe Children's Hospital, Kobe, Japan.

**Introduction:** Proteinuric kidney diseases including steroid-resistant nephrotic syndrome (SRNS) can lead to renal dysfunction, and one of its causative genes is *ARHGAP24* (NM\_001025616.2). It encodes a Rho-GTPase activating protein and acts as a negative regulator for Rac1. Excessive activation of Rac1 in podocytes has been reported to cause foot process effacement, and lead to persistent proteinuria and SRNS.

**Case Description: Case 1:** The patient is a 15-year-old female. She developed SRNS at the age of five. Although some immunosuppressive therapy had been administered, it was ineffective. At the age of ten, a renal biopsy was performed and the pathological diagnosis was focal segmental glomerulosclerosis. Subsequently, her renal function gradually declined to CKD Stage2. We performed a comprehensive genetic analysis of podocyte-related genes by targeted next-generation sequencing (NGS) using peripheral blood samples. A novel missense variant (c.1217G>T, p.(Ser406Ile)) in the *ARHGAP24* gene was detected, and it was a *de novo* variant. **Case 2:** The patient is a 26-year-old female. She has shown mild proteinuria from the age of ten. In adulthood, the proteinuria became more severe with renal dysfunction as CKD Stage2, so a detailed examination was performed. The pathological findings of the renal biopsy were minor glomerular abnormality. As in case 1, comprehensive genetic testing by targeted NGS was performed, and that revealed a novel missense variant (c.2234T>C, p.(Ile745Thr)) in the *ARHGAP24*. For these two variants, the quantitative analysis of active Rac1 in HEK293T cells transfected with the *ARHGAP24* plasmid vector carrying the variants was performed. As a result, both variants significantly increased active Rac1 compared to the wild type. Therefore, we concluded these novel missense variants are Pathogenic.

**Discussion:** It is definitely important to determine whether novel variants are pathogenic or not because almost immunosuppressive therapy for SRNS associated with genetic variants is often ineffective. In patients with *ARHGAP24* variants, quantitative analysis of active Rac1 protein is a simple and universal test for its pathogenicity, and is useful in determining pathogenicity.

FR-PO448

**An Unexpected Cause of Hypokalemia**

Claire F. Schretlen,<sup>1</sup> Kanza Haq,<sup>1</sup> Carmen E. Cervantes,<sup>1</sup> Mohamad A. Hanounch.<sup>1,2</sup> <sup>1</sup>Johns Hopkins University School of Medicine, Baltimore, MD; <sup>2</sup>Nephrology Center of Maryland, Baltimore, MD.

**Introduction:** Gitelman syndrome is an autosomal recessive hypokalemic and salt wasting tubulopathy caused by loss-of-function mutations in the sodium chloride cotransporter encoded by *SLC12A3*, leading to disrupted entry of sodium and chloride at the apical membrane of distal convoluted tubule cells (fig 1).

**Case Description:** A 20-year-old man with bulimia nervosa and CKD stage IIIA was referred to clinic for refractory hypokalemia attributed to vomiting. Home medications included potassium chloride 60 mEq four times daily. His blood pressure was 100/60 mmHg. Basic laboratory values are shown in fig 2A. Further workup revealed elevated serum renin (62.6 ng/L) and normal serum aldosterone (10 ng/dL). Urine studies showed random urine chloride of 60 mEq/L with renal losses of sodium, potassium, and magnesium along with hypocalciuria (fig 2B). Genetic testing confirmed the diagnosis of Gitelman syndrome with 2 pathogenic variants in the *SLC12A3* gene [c.2221G>A (p.G741R) and c.247C>T (p.R83W)]. Aldosterone secretion is independently regulated by angiotensin II and plasma potassium concentrations. As such, aldosterone may not increase despite of high renin/angiotensin II levels in the context of severe hypokalemia. This can explain the normal level in our case. Further, the patient's CKD is likely due to longstanding severe hypokalemia causing tubulointerstitial disease. He was started on amloride 10 mg daily with a normalization of potassium and magnesium levels without supplementation.

**Discussion:** Gitelman syndrome is associated with reduction of extracellular fluid volume, hyperreninemia and secondary hyperaldosteronism, metabolic alkalosis, renal wasting of potassium, sodium, and magnesium, and decreased urinary excretion of calcium. Its diagnosis is confirmed with genetic testing.

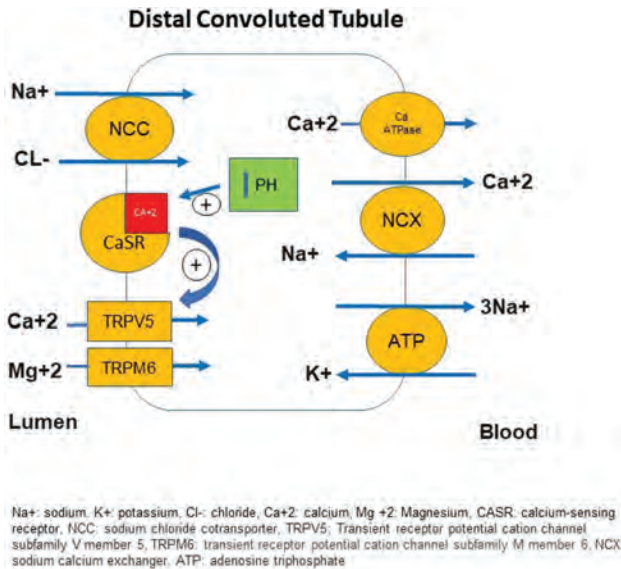

Figure 1

Figure 2-A

Tests	Results	Normal range
Sodium	130 mmol/L	132-148 mmol/L
Potassium	2.2 mmol/L	3.5-5 mmol/L
Chloride	97 mmol/L	98-111 mmol/L
Bicarbonate	30 mmol/L	23-32 mmol/L
Blood Urea Nitrogen	16 mg/dl	10-25 mg/dl
Creatinine	1.59 mg/dL	0.7-1.4 mg/dL
Calcium	9.6 mg/dl	8.4-10.5 mg/dl
Albumin	4.1 g/dl	3.5-5.0 g/dl
Glucose	90 mg/dl	65-100 mg/dl

Figure 2-B

Tests	Results
24-hour urine sodium	210 mmol
24-hour urine potassium	67.2 mmol
24-hour urine magnesium	156 mg
24-hour urine calcium	138 mg
Random urine potassium/creatinine	44.2 mmol/g

FR-PO449

Headache and Diplopia in Identical Twins With Nephropathic Cystinosis  
 Arsalan A. Alvi, Sarah L. Elfering. University of Minnesota Division of Renal Diseases and Hypertension, Minneapolis, MN.

**Introduction:** Cystinosis is an autosomal recessive lysosomal storage disease characterized by the accumulation of cystine in various organs due to a variant in the CTNS gene. Infantile nephropathic cystinosis presents in infancy with failure to thrive and results in kidney failure. There are many non-renal manifestations. We report identical twins with nephropathic cystinosis who both developed idiopathic intracranial hypertension (IIH).

**Case Description:** Case 1 is a female kidney transplant recipient with infantile nephropathic cystinosis who developed symptoms of headache, nausea and diplopia at age 33. Evaluation revealed bilateral optic disc swelling. Brain MRI/MRV was normal and opening pressure was elevated on lumbar puncture. IIH was diagnosed and managed with acetazolamide. Ultimately, a ventriculoperitoneal shunt was required. Case 2 is a female identical twin of case 1, also a kidney transplant recipient, with nephropathic cystinosis who developed headache and vomiting at age 35. Evaluation revealed papilledema, an elevated opening pressure (50 cm) on lumbar puncture and normal brain MRI. She was treated with acetazolamide. Her papilledema and symptoms resolved. After 2 years, acetazolamide was discontinued and symptoms have not recurred.

**Discussion:** We present a case of identical twins who developed IIH. It has been speculated that IIH is a late complication of cystinosis. Both IIH and cystinosis are rare but IIH has been reported to occur in patients with cystinosis at a higher rate compared to the general population. This case of identical twins with cystinosis and IIH contributes to the literature regarding the connection between these two diseases. Though genetic associations with IIH have been identified, none are on chromosome 17 (location of CTNS gene) so we suspect these twins did not have genetic variant causing IIH. It is theorized that cystine crystals deposit in meninges and arachnoid villi, leading to decreased absorption of CSF. Patients with cystinosis presenting with headaches and diplopia should be evaluated for IIH.

FR-PO450

Late Presentation of Bartter Syndrome Type 2

Amit Kaushal,<sup>1</sup> John C. Lieske,<sup>2</sup> Peter C. Harris,<sup>2</sup> Sarah L. Elfering,<sup>1</sup>  
<sup>1</sup>University of Minnesota Division of Renal Diseases and Hypertension, Minneapolis, MN; <sup>2</sup>Mayo Clinic Minnesota, Rochester, MN.

**Introduction:** Bartter syndrome (BS) is an autosomal recessive disorder characterized by salt wasting that results from variants in at least 5 genes that encode proteins important for ion transport in the thick ascending loop of Henle (TALH). Features include polyuria, metabolic alkalosis, hypokalemia, and secondary hyperaldosteronism (often with low blood pressure, BP). Variants in the ROMK1 potassium channel gene (KCNJ1) cause BS2 which often results in severe clinical manifestations in infancy. Cases of BS2 diagnosed in adulthood have only infrequently been reported. Here we report a BS2 patient that presented in adulthood with hypokalemia, metabolic alkalosis and nephrocalcinosis.

**Case Description:** A 33-year-old male with no prior medical history presented with flank pain. Imaging showed no stone but instead bilateral nephrocalcinosis and hydronephrosis. He reported polydipsia (5-6 L daily) since childhood. Family history was pertinent for a brother with kidney stones, polydipsia and polyuria. On evaluation, BP was 131/91, potassium 2.7 mmol/L, bicarbonate 30 mmol/L, and calcium 8.5 mg/dl, creatinine 0.94 mg/dl and eGFR > 90ml/min. A 24-hour urine revealed high calcium (410 mg), low citrate (74 mg), high pH (6.9), and high volume (5 L). Urine potassium was inappropriately high given the hypokalemia (55 mmol). Genetic testing on a 102 candidate gene panel revealed 2 missense variants in KCNJ1, with one variant (c.949A>G; p.Lys317Glu) that has been associated with low BP but not described in BS2 to date and a second novel variant predicted to be pathogenic (c.949A>G; p.Lys336Glu). Oral potassium chloride was initiated and on follow-up serum potassium was 3.1 mmol/L. His brother with a similar phenotype had the same biallelic KCNJ1 changes.

**Discussion:** BS2 is caused by variants KCNJ1 gene that cause loss of ROMK function. Reduced ROMK activity impairs effective TALH function resulting in hypokalemia, salt wasting and volume depletion with subsequent activation of renin-aldosterone axis, and metabolic alkalosis. Generation of an effective TALH transepithelial electrochemical gradient is also essential for paracellular reabsorption of Ca<sup>2+</sup> and Mg<sup>2+</sup>. Thus hypercalciuria, hypomagnesemia, and nephrocalcinosis are also frequently observed. Our case highlights that the diagnosis of BS should be considered beyond the neonatal period in patients who present with hypokalemia, hypercalciuria and nephrocalcinosis.

FR-PO451

Mesothelial and Endothelial Cell Barrier Characterization in Health, CKD, and Peritoneal Dialysis

Iva Marinovic,<sup>1</sup> Maria Bartosova,<sup>1</sup> Rebecca Herzog,<sup>2,3</sup> Juan M. Sacnun,<sup>2,3</sup> Conghui Zhang,<sup>1</sup> Robin Hoogenboom,<sup>2,3</sup> David Ridinger,<sup>4</sup> Eszter Levai,<sup>1,5</sup> Damir Krunic,<sup>6</sup> Felix Bestvater,<sup>6</sup> Michael Hausmann,<sup>4</sup> Sotirios G. Zarogiannis,<sup>1</sup> Klaus Kratochwill,<sup>2,3</sup> Claus Peter Schmitt.<sup>1</sup> <sup>1</sup>UniversitätsKlinikum Heidelberg, Heidelberg, Germany; <sup>2</sup>Medizinische Universität Wien, Wien, Austria; <sup>3</sup>zytoprotec GmbH, Wien, Austria; <sup>4</sup>Ruprecht Karls Universität Heidelberg Kirchoff-Institut für Physik, Heidelberg, Germany; <sup>5</sup>Semmelweis Egyetem, Budapest, Hungary; <sup>6</sup>Deutsches Krebsforschungszentrum, Heidelberg, Germany.

**Background:** Solute transport across cellular barriers is defined by tight-junctions (TJ) and transmembrane transporters. Cell-specific expression and regulation by peritoneal dialysis (PD) is unknown.

**Methods:** Quantitative and functional cellular *in vitro* and peritoneal *ex vivo* barrier studies included RNAseq of polarized cell monolayers, Transwell experiments and tissue multi-omics followed by digital analysis.

**Results:** RNA sequencing of polarized human peritoneal mesothelial, immortalized pleural, umbilical vein and cardiac microvascular endothelial cells demonstrated distinct junction, transmembrane and transcytosis related transcripts across cell lines. Next to the tissue origin and transformation status, major differences in cell adhesion and migration, vasculature development and growth factor response were identified. Sealing TJ, claudin (CLDN)1 was expressed only in mesothelial cells, CLDN5 in endothelial cells. Findings were reconfirmed by western blot and immunofluorescence *in vitro* and in human parietal peritoneum *ex vivo*. Super resolution microscopy revealed less CLDN5 clustering in microvascular endothelial cells and transepithelial resistance was 50% lower compared to the three other cell lines; 4- and 10-kDa dextran permeability was higher. Multi-omics analyses from microdissected omental arterioles of children on high-GDP PD demonstrated downregulation of junctions and transcytosis as compared to non-CKD, ESRD and low-GDP PD treated children, transcellular transporter expression was comparable. The parietal peritoneal endothelial to mesothelial surface area available for exchange was age dependently 1.5 to 2-fold higher and increased with low-GDP PD. PD induced arteriolar TJ regulation was reconfirmed in the parietal peritoneum. Arteriolar and mesothelial pore-forming junctions CLDN2/4/15 correlated with transport function in peritoneal equilibration tests.

**Conclusions:** We provide the first comprehensive analysis of peritoneal solute transporters and their regulation by ESRD and PD. Mesothelial and endothelial sealing and transporter abundance differs substantially, associates with PD membrane function and indicates a functional role of both cellular barriers.

**Funding:** Government Support - Non-U.S.



## FR-PO452

**The Differential Roles of Leptin, Adiponectin, and Omentin on Phenotype Transition of Human Peritoneal Mesothelial Cells**

Hyun-Jung Kang, Dal-Ah Kim, Ye rim Her, Duk-Hee Kang, *Ewha Womans University, Seoul, Republic of Korea.*

**Background:** Functional and structural integrity of peritoneal membrane is essential for successful peritoneal dialysis (PD). Residential cells in peritoneal cavity are mesothelial cells (MCs), endothelial cells, fibroblasts, and adipocytes (ACs) located in submesothelial tissue. Previous studies focused on the role of peritoneal MCs in the development of peritoneal fibrosis, however the role of neighboring adipose tissue and adipokines released from ACs has not been investigated. Since there are now compelling evidences suggesting that ACs exert important metabolic and proinflammatory effects on peripheral tissue, we examined the effect of representative adipokines, leptin, adiponectin, and omentin on phenotype transition of MCs.

**Methods:** The effect of co- and pre-treatment of leptin (10–100 ng/mL) or adiponectin (1–2 µg/mL) or omentin (0.5–1 µg/mL) on epithelial-to-mesenchymal transition (EMT) of cultured human peritoneal MCs was investigated. The effect of leptin, adiponectin, and omentin gene silencing using siRNA technique on TGF-β-induced EMT was examined. EMT was assessed by the changes in morphology and markers of epithelial and mesenchymal cells both in mRNA and protein levels. Activation of Smad2/3, Erk1/2 MAPK, p38 MAPK phosphorylation was also assessed.

**Results:** Leptin, adiponectin or omentin per se did not alter the expression of the markers of EMT of MCs up to 72 hours. Leptin (100 ng/mL) aggravated TGF-β (1 ng/mL)-induced EMT whereas adiponectin (2 µg/mL) and omentin (1 µg/mL) ameliorated TGF-β-induced EMT of MCs at 48 hours of stimulation. Leptin gene silencing alleviated TGF-β-induced EMT and adiponectin or omentin siRNA treatment enhanced TGF-β-induced EMT. EMT induced by 24-hour exposure to TGF-β was reversible upon the removal of TGF-β, and this reversal of EMT was further accentuated with co-treatment of adiponectin for additional 48 hours. Reversibility of EMT after removal of TGF-β stimulation was blocked by leptin treatment. Leptin gene silencing ameliorated TGF-β-induced activation of Smad2/3 in MCs.

**Conclusions:** Our results suggest the differential role of leptin, adiponectin and omentin in phenotype transition of MCs and peritoneal fibrosis. Modulation of the expression/activity of adipokines can be a novel target for prevention and treatment of peritoneal fibrosis.

## FR-PO453

**Role of Cross-Talk Between Mesothelial Cells (MCs) and Adipocytes (ACs) in Phenotype Transition of MCs in Peritoneal Dialysis (PD)**

Hyun-Jung Kang, Ye rim Her, Dal-Ah Kim, Duk-Hee Kang, *Ewha Womans University, Seoul, Republic of Korea.*

**Background:** In peritoneal cavity, adipose tissue is buried under mesothelial monolayer and possibly interacts with neighboring MCs. Although a majority of previous work has focused on peritoneal MCs as a key player of peritoneal fibrosis, the role of neighboring ACs and their secreted adipokines in epithelial-to-mesenchymal transition (EMT) of MCs needs to be investigated.

**Methods:** Transwell co-culture system was used in which MCs were cultured with mature ACs differentiated from 3T3-L1 preadipocytes. EMT of MCs was evaluated by the changes in morphology and markers of epithelial and mesenchymal cells. Adipokines in supernatant and cell lysate were analyzed by adipokine array, real-time PCR, and Western blotting. Effect of stimulation or gene silencing of adipokines on EMT was examined.

**Results:** Co-culture of MCs and ACs induced EMT of MCs from 48 hours. Co-culture of MCs and ACs resulted in a decrease of adiponectin (0.4-fold) and plasminogen activator inhibitor-1 (PAI-1) (0.6-fold) and an increase in IL-6 (3.9-fold) and leptin (1.5-fold) in cell culture supernatant. Co-culture also led to an increased expression of monocyte chemoattractant protein-1 (MCP-1) (1.6-fold), vascular endothelial growth factor (VEGF) (2.4-fold), and PAI-1 (1.4-fold) whereas resulted in a decreased expression of adiponectin (0.9-fold) and resistin (0.8-fold) in cell lysates of ACs. Increased expression of adiponectin (83.5-fold) and PAI-1 (1.5-fold) was also observed in cell lysates of MCs. siLeptin or siPAI-1 treatment alleviated EMT of MCs whereas the treatment of IL-6 (50 ng/ml), MCP-1 (10 ng/ml), or VEGF (2 ng/ml) induced EMT of MCs.

**Conclusions:** ACs could induce phenotype transition of peritoneal MCs and trigger pro-fibrotic signal in peritoneal cavity. Precise mechanism for the pro-fibrotic cross-talk between MCs and ACs and the role of various adipokines which shows the different pattern of up- or down-regulation on co-culture system needs to be further investigated.

## FR-PO454

**Disentangling Peritoneal Protein Loss From Its Sources: A Novel Analytic Peritoneal Effluent Proteomics Approach**

Fabian Eibensteiner,<sup>1,2</sup> Rebecca Herzog,<sup>2,1</sup> Andreas Vychytil,<sup>3</sup> Christoph Aufricht,<sup>1</sup> Klaus Kratochwill,<sup>2,1</sup> <sup>1</sup>*Division of Pediatric Nephrology and Gastroenterology, Comprehensive Center for Pediatrics, Medical University of Vienna, Vienna, Austria;* <sup>2</sup>*Christian Doppler Laboratory for Molecular Stress Research in Peritoneal Dialysis, Medical University of Vienna, Vienna, Austria;* <sup>3</sup>*Division of Nephrology and Dialysis, Department of Medicine III, Medical University of Vienna, Vienna, Austria.*

**Background:** Worldwide, ca. 11% of patients requiring dialysis are being treated with peritoneal dialysis (PD). During each PD exchange high peritoneal protein losses (PPL) occur, reflecting toxin removal, serum loss and inflammation, and predicting

mortality and cardiovascular morbidity. Measured PPL is the result of transmembrane serum loss, lymphatic drainage, trans mesothelial reabsorption, local production, and cellular components. However, this concept is still poorly understood.

**Methods:** Peritoneal dialysis effluent (PDE) samples were obtained from peritoneal equilibrium tests during a prospective, multicenter, double-blinded, controlled, randomized, dual-period, 2-treatment, crossover, phase II, proof-of-concept study in Austria, before administration of the study treatment. PDE samples were submitted to proteomic analysis by Tandem Mass Tag Derivatization 2D-RP/RP Liquid Chromatography Mass Spectrometry. To disentangle transmembrane serum protein loss from local protein production we developed a novel and unique analytical approach. Briefly, partitioning around medoids and proximity in the Euclidean space for between visit single-protein kinetics was utilized to achieve this separation.

**Results:** We were able to identify 2,624 different proteins within the PDE of 12 patients across two time-points. At first a large cluster of proteins with stable abundances in collinearity with well-established clinical characteristics of PPL (e.g., total protein loss, dialysate-to-plasma-protein) was identified. After clustering and separation steps three groups of proteins were identified: transmembrane serum proteins, locally produced proteins, other (reflecting neither of these mechanisms). Locally produced proteins mainly reflect inflammatory activity whereas transmembrane serum proteins mainly describe transport functions.

**Conclusions:** PPL is an important but poorly understood undesired effect of PD associated with morbidity and mortality. Our novel and unique analytical approach enables us to disentangle the complexity of transmembrane serum protein loss and local protein production on single-protein level across the peritoneal proteome. This will aid conceptual pathophysiological understanding and identification of novel drug targets to improve PD patients' outcomes.

## FR-PO455

**L-Cysteine Attenuates Peritoneal Fibrosis by Inhibiting Pyruvate Kinase M2 in Mesothelial Cells**

Ma Xiaokun, Yin Li, Hui Peng. Department of Nephrology, The Third Affiliated Hospital of Sun Yat-sen University *Department of Nephrology, The Third Affiliated Hospital of Sun Yat-sen University, Guangzhou, China.*

**Background:** Peritoneal fibrosis is one of the main causes of peritoneal dialysis (PD) failure, our previous study has demonstrated that peritoneal dialysate-induced hyperglycolysis stimulates mesothelial-to-mesenchymal transition (MMT) in peritoneal mesothelium cells leading to peritoneal fibrosis but there is still a lack of effective and low-toxic drugs for preventing peritoneal hyperglycolysis and fibrosis in clinical practice.

**Methods:** The peritoneal dialysis effluents from patients with long-term or short-term peritoneal dialysis were collected for single cell transcriptome sequencing (scRNA-seq), and differential activation of glycolytic enzymes in the two groups was identified specifically in mesothelial cells. Human primary peritoneal mesothelial cell cultures and MET-5A cells were used to assess the relationship between specific glycolytic enzyme and MMT. Gene silencing, COIP, CHIP and other techniques were used to explore the mechanisms behind of this relationship. Finally, the therapeutic effect of glycolytic enzyme inhibitor was evaluated in mouse model of peritoneal fibrosis.

**Results:** scRNA-seq showed that long-term peritoneal dialysis reduced the number of peritoneal mesothelial cells, stimulated the expression of glycolysis enzymes, especially the pyruvate kinase isozymes M2 (PKM2), a key rate-limiting enzyme of glycolysis. In mesothelial cell cultures, TGF-β1 promoted MMT that was associated with the activation of PKM2, and addition of L-cysteine, a PKM2 inhibitor, significantly suppressed this response. Mechanically, PKM2 promoted the expression of transcription factor SNAIL2 through acetylation of H3K9, thus promoting the occurrence of MMT in mesothelial cells. In C57BL/6 mice, high glucose peritoneal dialysate induced peritoneal fibrosis with increased PKM2 expression in mesothelial cells. Administration of L-cysteine to these mice significantly reduced peritoneal fibrosis that was associated down-regulation of PKM2 activity and improved peritoneal ultrafiltration.

**Conclusions:** PKM2 activation is a critical step to induce mesothelial hyperglycolysis during peritoneal dialysis. Inhibition of PKM2 by L-cysteine suppresses mesothelial hyperglycolysis and hence peritoneal fibrosis, thus, providing a new therapeutic strategy for preventing peritoneal fibrosis in patients with peritoneal dialysis.

## FR-PO456

**Inhibition of H3K4 Trimethylation Ameliorates Peritoneal Fibrosis and Senescence**

Daisuke Hara, Kensuke Sasaki, Ayumu Nakashima, Takao Masaki. *Hiroshima University Hospital, Hiroshima, Japan.*

**Background:** Senescence is induced by aging as well as various stimuli, resulting in the development of organ inflammation and fibrosis. Recently, the accumulation of p16<sup>INK4a</sup>-positive cells is considered as a feature of organ senescence, and p16<sup>INK4a</sup> gene expression is regulated by Mixed-lineage leukemia 1 (MLL1)/WD-40 repeat protein 5 (WDR5)-mediated histone 3 lysine 4 trimethylation (H3K4me3). In this study, we investigated whether MLL1/WDR5 complex inhibition ameliorates peritoneal senescence together with peritoneal inflammation and fibrosis in methylglyoxal (MGO) induced peritoneal injury mice and cultured human peritoneal mesothelial cells (HPMCs).

**Methods:** Peritoneal fibrosis was induced by intraperitoneal injection of MGO in male C57/B6 mice for 3 weeks. MM-102, a MLL1/WDR5 complex inhibitor, was administered subcutaneously at the same time. After 3 weeks of treatment, peritoneal tissues were examined. In an *in vitro* study, TGF-β1 stimulated HPMCs were examined

with or without MM-102 preincubation. Chromatin immunoprecipitation (ChIP) assays were performed to clarify the status of p16<sup>INK4a</sup> gene promoter as an H3K4me3-enrichment region. Human nonadherent cells were isolated from the effluent of PD patients.

**Results:** MLL1 was upregulated in the peritoneum of MGO-injected mice, TGF- $\beta$ 1-stimulated HPMCs and human nonadherent cells. MM-102 significantly suppressed p16<sup>INK4a</sup> expression, as well as submesothelial zone thickness and cell density in MGO-injected mice. Immunohistochemical staining revealed that MM-102 decreased not only H3K4me3 and p16<sup>INK4a</sup> expression, but also peritoneal inflammation and collagen deposition. Moreover, p16<sup>INK4a</sup> expression was positively correlated with dialysate-to-plasma (D/P) ratio of creatinine in PD patients. In the *in vitro* study, MM-102 suppressed TGF- $\beta$ 1-induced upregulation of p16<sup>INK4a</sup>, H3K4me3 and fibrotic markers in HPMCs. Finally, ChIP assay revealed that MM-102 decreased the H3K4me3 levels at the promoter of p16<sup>INK4a</sup>.

**Conclusions:** The MLL1/WDR5 inhibitor MM-102 ameliorates peritoneal inflammation and fibrosis through suppression of senescence.

#### FR-PO457

### Plasminogen Activator Inhibitor 1 (PAI-1) and Nuclear Factor of Activated T-Cells 5 (NFAT5) Mediates TGF $\beta$ -Induced Phenotype Transition of Human Peritoneal Mesothelial Cells (MCs)

Dal-Ah Kim, Hyun-Jung Kang, Ye rim Her, Duk-Hee Kang, *Ewha Womans University, Seoul, Republic of Korea.*

**Background:** The epithelial-to-mesenchymal transition (EMT) of MCs is an early mechanism of peritoneal dysfunction in peritoneal dialysis (PD). Plasminogen activator inhibitor-1 (PAI-1) is an inhibitor of fibrinolysis by hindering the proteolytic activity of tissue type plasminogen activator, and recently reported to regulate EMT of cancer cells. NFAT5 is known to regulate PAI-1 transcription, and also to promote EMT of cancer cells. The aim of this study is to investigate the role of PAI-1 and NFAT5 in TGF $\beta$ -induced EMT of MCs and its mechanism.

**Methods:** EMT was evaluated by the changes in morphology and markers of epithelial and mesenchymal cells. Effect of gene silencing of PAI-1 or PAI-1 inhibitor (Tiplaxtinin, 20  $\mu$ M) on TGF $\beta$ -induced EMT was examined. Activation of Smad2/3, Erk1/2 MAPK phosphorylation, snail expression, nuclear translocation of snail was assessed. MMP2 expression was evaluated by real time PCR and WB. The interaction between NFAT5 and  $\beta$ -catenin was analyzed by immunoprecipitation. RNA-seq was performed to analyze gene profiling in MCs isolated from omentum (HPMC, N=4) or MCs isolated from overnight dwell dialysates from PD patients (PDMC, N=9), respectively.

**Results:** Either PAI-1 gene silencing or Tiplaxtinin ameliorated TGF $\beta$ -induced changes in cell morphology and the expression of E-cadherin,  $\alpha$ -SMA, and fibronectin. TGF $\beta$ -induced decrease in E-cadherin promoter activity and nuclear translocation of snail were also alleviated by siPAI-1. PAI-1 gene silencing ameliorated TGF $\beta$ -induced activation of smad2/3 and Erk1/2 MAPK in HPMC. In addition, TGF $\beta$ -induced increase MMP2 expression was alleviated by siPAI-1. TGF $\beta$ -induced increase in PAI-1 was blocked by siNFAT5. siPAI-1 also ameliorated TGF $\beta$ -induced NFAT5/ $\beta$ -catenin interaction. RNA-seq analysis revealed an increased in PAI-1 expression in PDMC compared to HPMC, which was associated with altered expression of EMT-related genes.

**Conclusions:** PAI-1 plays a role in TGF $\beta$ -induced EMT of peritoneal MCs via an interaction with NFAT5, and modulation of PAI-1 expression/activity in MCs could be a novel strategy to prevent peritoneal fibrosis in PD patients.

#### FR-PO458

### BMSC-Derived miR-34b-3p Inhibits Peritoneal Fibroblast-to-Myofibroblast Transdifferentiation by Downregulating Spi-C

Fang Yu, Kehong Chen, Yani He. *Army Medical Center of PLA, Chongqing, China.*

**Background:** Peritoneal fibrosis is the main reason for the failure of peritoneal dialysis (PD). However, there is no effective intervention. Here, we examined the role and mechanism of bone marrow mesenchymal stem cell-derived exosomes (BMSC-Exos) in regulating the differentiation of fibroblasts (FB) to myofibroblasts (MFB) in peritoneal fibrosis.

**Methods:** C57BL/6 mice were randomly divided into 3 groups: a control group (Saline), a peritoneal injury group (2.5% glucose peritoneal dialysate + LPS), and a peritoneal injury + BMSC-Exos group. The mice were sacrificed and the peritoneal peritoneum was collected after 6 weeks of modeling. The peritoneum of mice was examined by transcriptomics. The composition and function of BMSC-Exos were analyzed by miRNA sequencing.

**Results:** Our previous studies have confirmed that exosomes can inhibit peritoneal fibrosis. The expression level of MFB markers increased gradually with the prolongation of the peritoneal fibrosis model. BMSC-Exos treatment significantly decreased the expression of mouse peritoneal MFB markers, suggesting that exosomes can inhibit the differentiation of FB into MFB. Similarly, we further confirmed the effect of BMSC-Exos *in vitro*. Transcriptomic analysis results revealed that SPIC gene ranked first in the differential expression genes. The mRNA and protein levels of Spi-C were significantly increased in peritoneal injury group, while were significantly down-regulated in BMSC-Exos group. After overexpression of Spi-C *in vitro*, the differentiation of FB to MFB was significantly increased, and the fibrotic factor (TGF- $\beta$ 1) and TGF- $\beta$ /WNT pathway (Smad3,  $\beta$ -Catenin) related to FB differentiation was significantly increased, whereas BMSC-Exos intervention could inhibit FB differentiation. miRNA sequencing and bioinformatics analysis showed that miR-34b-3p is one of the main components of BMSC-Exos, and it is the only miRNA that can specifically bind to SPIC gene sequence.

*In vitro*, miR-34b-3p mimics could down-regulate the expression of Spi-C, and the expression of Spi-C was not affected after miR-34b-3p inhibitor intervention. The results suggested that BMSC-Exos-derived miR-34b-3p inhibited the differentiation of FB into MFB by targeting Spi-C.

**Conclusions:** BMSC-derived miR-34b-3p targeting Spi-C can alleviate peritoneal fibrosis by inhibiting the differentiation of subperitoneal mesothelial FB into MFB.

#### FR-PO459

### Decorin Deficiency Accelerates Peritoneal Fibrosis in a Murine Model of Peritoneal Dialysis

Wing Long Cody Mok,<sup>1</sup> Rafter Y. Wu,<sup>1</sup> In Young Oh,<sup>1</sup> Renato V. Iozzo,<sup>2</sup> Tak Mao D. Chan,<sup>1</sup> Susan Yung,<sup>1</sup> <sup>1</sup>Department of Medicine, School of Clinical Medicine, the University of Hong Kong, Hong Kong SAR, Hong Kong; <sup>2</sup>Department of Pathology, Anatomy, and Cell Biology, Thomas Jefferson University, Philadelphia, PA.

**Background:** Preservation of structural and functional integrity of the peritoneal membrane is a major challenge limiting the feasibility of long-term peritoneal dialysis (PD). Decorin is a soluble dermatan sulphate proteoglycan, synthesized by peritoneal mesothelial cells, with anti-fibrotic properties. We investigated the role of decorin in a murine PD model.

**Methods:** Wild-type (WT) and decorin-knockout (DKO) mice were randomized to receive saline (Control) or glucose-based PD fluid containing 40 mM methylglyoxal (PDF Group) by intra-peritoneal injection, twice daily for up to 12 weeks, after which time the parietal peritoneum was excised to investigate the expression of  $\alpha$ -smooth muscle actin ( $\alpha$ -SMA), collagen and fibronectin (FN). Human peritoneal mesothelial cells (HPMC) were isolated from omentum and incubated with spent dialysate from stable PD patients, in the presence or absence of decorin (1  $\mu$ g/ml) for 24 h, and mediators of fibrosis assessed.

**Results:** After 12 weeks of treatment, PDF Group WT mice showed submesothelial thickening accompanied by decreased decorin expression and increased  $\alpha$ -SMA, FN and collagen expression, with infiltration by F4/80<sup>+</sup>CD206<sup>+</sup> macrophages and CD86<sup>+</sup>CD4<sup>+</sup> T cells. The submesothelium was inhabited with elongated fibroblast-like cells which were positive for  $\alpha$ -SMA and collagen I suggestive of myofibroblasts. These abnormalities were exacerbated in DKO mice ( $P < 0.05$  compared with WT), and was observed earlier, after 8 weeks of treatment. In cultured HPMC, PDF induced the expression of FN and its extra domain A/B isoforms (EDA-FN and EDB-FN) through increased ERK, p38 MAPK and PI3K phosphorylation, while addition of decorin decreased FN, EDA-FN and EDB-FN expression by 56.5%, 46.7% and 50.0% respectively.

**Conclusions:** Our data suggest that decorin ameliorates PDF-induced peritoneal fibrosis through its effects on FN and inflammatory cell infiltration.

**Funding:** Government Support - Non-U.S.

#### FR-PO460

### Entangled: An Unusual Case of Encapsulating Peritoneal Sclerosis

Ricardo Uribe, John M. Duch, Chandan Takkar. *Audie L Murphy VA, San Antonio, TX.*

**Introduction:** Encapsulating Peritoneal Sclerosis (EPS) is one of the most serious complications of peritoneal dialysis (PD), characterized by progressive peritoneal membrane fibrosis and adhesions, and associated with high morbidity and mortality. Patients present with episodes of bowel obstruction, abdominal pain and distention, and weight loss. Risk factors include longer duration on PD, recurrent episodes of peritonitis and a high transporter status. We report a case of EPS on a patient presenting with new onset ascites and small bowel obstruction after transition from PD to Hemodialysis (HD).

**Case Description:** A 71 male with ESRD secondary to Diabetic Nephropathy, treated with HD for the past 6 months, presented with new onset ascites, abdominal pain and symptoms of small bowel obstruction (SBO). He had received PD for approximately 2.5 years, and was transitioned to HD due to 3 episodes of peritonitis. His transporter status prior to transition was high average. Ascitic fluid work up revealed serosanguinous fluid with a WBC count of 273/mm<sup>3</sup> with 67% lymphocytes, Protein concentration of 4g/dL, Albumin concentration 2g/dL and SAAG of >1.1, negative cultures and cytology. Evaluation for cardiac and hepatic causes of ascites was unremarkable. CT showed bowel loop dilatation affecting duodenum and proximal jejunum. Patient was discharged after paracentesis and bowel rest. This was followed by six additional hospitalizations with similar presentation, over the course of one year, managed with bowel rest regimen for partial SBO. Abdominal imaging one year after index hospitalization revealed loculated ascites, small bowel clustering with surrounding peritoneal thickening and scattered calcifications. A diagnosis of EPS was made, and he was started on Tamoxifen and Prednisone.

**Discussion:** This is an unusual case of EPS, presenting after a PD vintage of less than 3 years, albeit with the risk factors of recurrent peritonitis and high average transporter status. While the incidence of EPS in patients on PD < 3 years has been reported close to 0, there may be significant detection bias, related to the non-specific presenting symptoms and lack of characteristic imaging findings earlier on. Nephrologists should maintain a high index of suspicion in patients who have been on PD and present with non-specific GI symptoms, since intervention in the early, inflammatory phase, could perhaps lead to improved outcomes.

## FR-PO461

**Stimulator of Interferon Genes: A New Player in Peritoneal Damage**

Vanessa Marchant,<sup>1,2</sup> Jorge García-Giménez,<sup>2,3</sup> Guadalupe T. Gonzalez-Mateo,<sup>4</sup> Irene Rubio,<sup>1,2</sup> Valeria Kopytina,<sup>4</sup> Lucia Tejedor,<sup>1,2</sup> Laura Marquez-Exposito,<sup>1,2</sup> Pilar Sandoval,<sup>4</sup> José A. Jimenez,<sup>5</sup> Manuel Lopez-Cabrera,<sup>4</sup> Adrian M. Ramos,<sup>2,3</sup> Marta Ruiz-Ortega.<sup>1,2</sup> <sup>1</sup>Cellular and Molecular Biology in Renal and Vascular Pathology Laboratory, Fundación Instituto de Investigación Sanitaria-Fundación Jiménez Díaz-Universidad Autónoma Madrid, Madrid, Spain; <sup>2</sup>Red de Investigación Renal (REDINREN), Madrid, Spain; <sup>3</sup>Laboratory of Nephrology, IIS-Fundación Jiménez Díaz, School of Medicine, UAM, Madrid, Spain; <sup>4</sup>Molecular Biology Centre Severo Ochoa (CBM-SO), Spanish Council for Scientific Research (CSIC), Universidad Autónoma de Madrid, Madrid, Spain; <sup>5</sup>Servicio de Anatomía Patológica, Hospital de la Princesa, Madrid, Spain.

**Background:** Peritoneal dialysis (PD) is a current replacement therapy for ESRD patients. However, long-term exposure to PD fluids (PDF) may lead to a peritoneal membrane (PM) damage and solute transport failure through mechanisms that include activation of the inflammatory/immune response, mesothelial to mesenchymal transition (MMT), and fibrosis. Stimulator of Interferon Genes (STING) is a cytosolic DNA sensor involved in the innate immune response that induces the transcription of type I interferons, cytokines, chemokines, and interferon-stimulated genes (ISGs). This work aimed to study the role of STING in peritoneal damage development.

**Methods:** STING<sup>+</sup> cells were first studied in peritoneal biopsies from PD patients and mice exposed to PDF. Then, we performed 2 models of peritoneal damage in WT and STING-KO mice: a fibrosis model induced by daily ip. injections of 0.1% chlorhexidine gluconate (CHX) for 4 weeks and a 5-day model of post-surgical adhesions (ischaemic buttons). Animals were euthanized and peritoneal tissue and lavage fluids were collected. Peritoneal mRNA and protein levels of STING pathway, MMT, fibrosis, and inflammatory markers were measured by qPCR, western blot, or immunohistochemistry. Cell populations present in the peritoneal cavity were assayed by flow cytometry.

**Results:** STING<sup>+</sup> cells were found in the peritoneum of both PD patients and mice exposed to PDF. In CHX-treated WT mice, peritoneal levels of STING and their downstream effectors (TBK1, IRF3, and ISGs) were increased and STING<sup>+</sup> cells were found in PM thickness and cell infiltration areas. In STING-KO mice, the absence of STING improved CHX-induced peritoneal damage including decreased PM thickness and fibrosis, inflammatory cell tissue infiltration, and cell recruitment into the peritoneal cavity. At the molecular level, the absence of STING prevented NFκB pathway activation and reduced the peritoneal expression of MMT/fibrosis markers, cytokines, chemokines, and ISGs. Additionally, STING-KO showed less peritoneal adhesion formation and decreased expression of inflammatory markers and ISGs.

**Conclusions:** The absence of STING prevented peritoneal damage suggesting that it may become a new potential therapeutic target in PD-associated peritoneal damage.

**Funding:** Government Support - Non-U.S.

## FR-PO462

**Comparison of Single-Cell Transcriptomic Profiles of Early and Late Peritoneal Dialysis**

Yi-Wen Chiu,<sup>1,2</sup> Siao Muk Cheng,<sup>3</sup> Daw-yang Hwang.<sup>3</sup> <sup>1</sup>Kaohsiung Medical University, Kaohsiung, Taiwan; <sup>2</sup>Kaohsiung Medical University Chung Ho Memorial Hospital, Kaohsiung, Taiwan; <sup>3</sup>National Institute of Cancer Research, Tainan, Taiwan.

**Background:** The bio-incompatibility of peritoneal dialysate leads to peritoneal inflammation and fibrosis. However, the type of immune cells involving chronic inflammation and the interaction and coordination of each immune cell population during peritoneal dialysis (PD) treatment remains unclear.

**Methods:** PD samples from two early and two late PD patients were subjected to single-cell RNA sequencing analysis (scRNA-seq) and immune cell type identification. We further compared the hallmark pathways, cell trajectory, and cell-cell communications between early and late PD patients.

**Results:** A total of 16,986 qualified cells were analyzed, and eight subtypes of immune cells were identified. Monocytes (~55%) dominated both early and late PD, followed by T cells (~25%) and mesothelial cells (~12%) in similar portions. Compared with those in early PD, there were more hematopoietic-like proliferating cells and conventional type 1 dendritic cells and fewer B cells, neutrophils, and plasmacytoid dendritic cells in late PD. Among the four subsets of monocytes, inflammatory responses were enriched in early PD. All five T cell subtypes were at effector status and like monocytes, had more enriched inflammatory pathways in early PD, with epithelial and fibroblastic characteristics found in all four subtypes of mesothelial cells. Again, inflammation was enriched in early PD, while mesothelial-to-mesenchymal transition (EMT), angiogenesis, and fibrosis in late PD. Further trajectory analysis of mesothelial cells revealed two different cell fates, that is, more inflammatory responses and enriched in early PD, with more cell stress and apoptosis and enriched in late PD. Cell-cell interaction analysis showed a close and complicated linkage between monocytes and mesothelial cells.

**Conclusions:** The dynamic changes in cellular composition during early and late PD identified by scRNA-seq might open new avenues for developing cell-based and anti-inflammatory therapies.

**Funding:** Government Support - Non-U.S.

## FR-PO463

**Inhibition of IL-18 Ameliorates Lipopolysaccharide-Induced Peritoneal Fibrosis in Mice**

Satoru Shichijo, Masayoshi Kukida, Itsuki Miyake, Ayu Makita, Jun Aono, Osamu Yamaguchi. *Ehime Daigaku Daigakuin Igakukei Kenkyuka Igakubu, Toon, Japan.*

**Background:** Peritoneal dialysis (PD)-related bacterial peritonitis causes peritoneal fibrosis, leading to peritoneal deterioration and discontinuation of PD. Preventing peritoneal fibrosis is essential for the long-term PD, while there is no established treatment for peritoneal fibrosis. Interleukin (IL)-18 is a member of the IL-1 family of cytokines. We have previously demonstrated that IL-18 is involved in the pathophysiology of renal interstitial fibrosis. This study examined the role of IL-18 on the progression of peritonitis-induced peritoneal fibrosis.

**Methods:** We examined the effects of IL-18 deletion on peritoneal fibrosis using 8-week-old male C57BL/6J (WT) and IL-18-knockout (IL-18<sup>-/-</sup>) mice. Either vehicle or LPS (10mg/kg lipopolysaccharide, dissolved in 2ml saline) was injected to these mice once a week and sacrificed at days 15 after the first injection. Subsequently, mouse embryonic fibroblasts (MEF) from the E13.5 embryos of WT and IL-18<sup>-/-</sup> mice were extracted and incubated with 10ng/ml recombinant IL-18 to investigate the direct impacts of IL-18 on fibroblast *in vitro*. IL-18 binding protein (BP), a constitutively secreted protein, prevents IL-18 binding to its receptor. Since our results supported that IL-18 promoted fibroblast-mediated peritoneal fibrosis, we tested whether IL-18 BP is a therapeutic tool in LPS-induced peritoneal fibrosis. LPS-infused WT mice were also intraperitoneally administrated with either vehicle or 200µg/kg IL-18 BP.

**Results:** LPS induced significant peritoneal thickening with fibroblast proliferation compared with the vehicle injection in WT mice. The peritoneal fibrosis was attenuated in IL-18<sup>-/-</sup> mice. To examine these mechanisms, mice peritoneum were evaluated at days 2. LPS mainly induced macrophage infiltration in the peritoneum, which was attenuated by IL-18 deletion. Recombinant IL-18 increased the mRNA expression of TGF-β and CTGF in MEF from WT and IL-18<sup>-/-</sup> mice, equivalently. Both LPS- and IL-18 BP-injected mice showed less peritoneum thickening and fibroblast proliferation compared with only LPS-injected mice.

**Conclusions:** These data indicate IL-18 plays a pivotal role on LPS-induced peritoneal fibrosis. IL-18BP has a previously unrecognized therapeutic potential for peritonitis-induced fibrosis in PD patients.

## FR-PO464

**Fasting Blood Glucose Level and All-Cause Mortality in Peritoneal Dialysis Patients**

Sojin Lim, Hyeon Seok Hwang, Kyung hwan Jeong, Jin sug Kim, Soo-Young Yoon, Jongho Kim, Geon Woo Kim. Division of Nephrology, Department of Internal Medicine, Kyung Hee University Kyung Hee University, Seoul, Republic of Korea.

**Background:** Dialysis solutions that are used in Peritoneal dialysis (PD) patients contain high concentration of glucose, so the issue of glycemic control is especially important for PD patients. Fasting Blood Glucose (FBG) is the most widely used blood glucose index in the clinical field because it is a principal indicator of daily status of glycemic status and it can help determine the anti-diabetes management. While these strength of FBG monitoring is considered as critical component for ideal glycemic control, there is no consistent evidence to support the optimal level of FBG in PD patients.

**Methods:** We used data from the National Health Insurance database of Korea, screening 29,266 patients who received maintenance PD treatment between 2002 and 2018. A total of 943 patients were included, who diagnosed diabetes and received national health screening examination. The primary endpoint in this study was the association between time-updated FBG and all-cause mortality.

**Results:** During a median follow-up of 6.55 years, we analyzed 943 patients divided into 6 groups according to the FBG level. The mean age was 52.6 years and 63.6% was male. In addition, the mean FBG was 128.8 mg/dL. In the time-varying Cox models, 125 mg/dL ≤ FBG < 150 mg/dL group showed a significant increase in all-cause mortality (HR, 1.27; 95% confidence interval [CI], 1.02-1.58; p = 0.032) compared with 80 mg/dL ≤ FBG < 100 mg/dL group as the reference. Similar results were observed with 150 mg/dL ≤ FBG < 180 mg/dL and FBG ≥ 180 mg/dL groups (HR, 1.35; 95% CI, 1.02-1.58; p = 0.021/HR, 1.61; 95% CI, 1.32-1.96; p < 0.001, respectively). Subgroup analysis revealed that patients who had age of <65 years, female gender, higher body mass index or less comorbidity score were significantly associated with higher mortality risk at FBG > 100 mg/dL, compared to those with 80 mg/dL ≤ FBG < 100 mg/dL.

**Conclusions:** Peritoneal dialysis Patients with 80 ≤ FBG < 100 mg/dL were significantly associated with lower risk of all-cause mortality than those with FBG < 80 mg/dL or ≥ 100 mg/dL. In addition, patient-specific conditions allowed even tighter FBG target for lower risk of mortality.

**Funding:** Government Support - Non-U.S.

## FR-PO465

**Association Between Calcium, Phosphate, Intact Parathyroid Hormone Levels, and Mortality Among Patients on Peritoneal Dialysis**

Miho Murashima,<sup>1</sup> Takayuki Hamano,<sup>1</sup> Shunsuke Goto,<sup>2</sup> Takeshi Hasegawa,<sup>3</sup> Masafumi Fukagawa,<sup>4</sup> Masanori Abe,<sup>5</sup> Norio Hanafusa,<sup>6</sup> <sup>1</sup>Nagoya Shiritsu Daigaku, Nagoya, Japan; <sup>2</sup>Kobe Daigaku, Kobe, Japan; <sup>3</sup>Showa Daigaku, Shinagawa-ku, Japan; <sup>4</sup>Tokai Daigaku, Hiratsuka, Japan; <sup>5</sup>Nihon Daigaku, Chiyoda-ku, Japan; <sup>6</sup>Tokyo Joshi Ika Daigaku, Shinjuku-ku, Japan.

**Background:** Association between calcium, phosphate, intact parathyroid hormone (PTH) levels and mortality has been extensively studied among patients on hemodialysis. However, studies limited to patients on peritoneal dialysis (PD) are lacking.

**Methods:** This is a prospective cohort study on Japan Renal Data Registry. Adults on PD at the end of 2009 were included. The observation period was up to 9 years and data were censored at the time of transplantation or transition to hemodialysis. Exposures were time-averaged albumin-corrected calcium (cCa), phosphate, and intact PTH levels. Outcomes were all-cause and cardiovascular (CV) mortality. Data were analyzed using Cox regression models and the results were shown as cubic spline curves.

**Results:** Among 2,017 patients with data for analyses, the mean age was 62 (14) years, 67 % were male, and the median PD vintage was 2.3 (1.0-4.3) years. During a median follow-up of 3.0 years, 590 death and 211 CV death (62 atherosclerotic and 149 non-atherosclerotic) were observed. Higher time-averaged cCa levels tended to be associated with higher mortality. Lower time-averaged phosphate levels were associated with lower all-cause mortality. No significant association between intact PTH levels and all-cause mortality was observed. The association between time-averaged cCa and CV mortality was U-shaped. Higher phosphate levels were associated with death due to atherosclerotic CV diseases but not with death due to non-atherosclerotic CV diseases. Sensitivity analyses by time-dependent model yielded similar results.

**Conclusions:** Among PD patients, higher cCa levels tended to be associated with higher all-cause mortality, and the relation between cCa levels and CV mortality was U-shaped. Lower phosphate levels were associated with lower all-cause mortality. Targeting cCa toward normal levels and phosphate levels toward the lower limit of normal range seems to be reasonable. Control of intact PTH might be of less importance among PD patients.

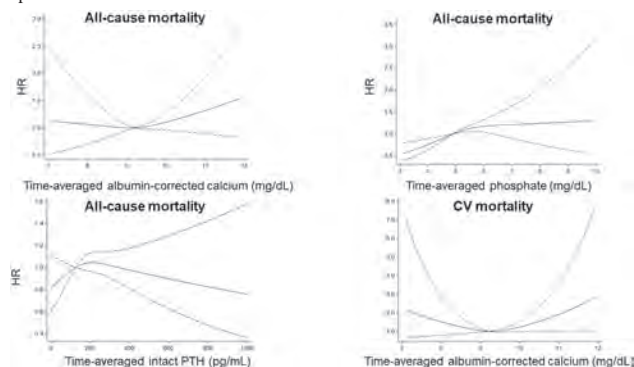

## FR-PO466

**Plasma Fibrinogen: A Driver of Left Ventricular Remodeling in Peritoneal Dialysis Patients and Its Related Risk Factors**

Yun Chen, Chuanming Hao, Tongying Zhu. *Huashan Hospital Fudan University, Shanghai, China.*

**Background:** Plasma fibrinogen (FIB) has been recently proven to be significantly associated with an increased risk of cardiovascular events and all-cause mortality in patients undergoing peritoneal dialysis (PD). Left ventricular hypertrophy (LVH) is common among PD patients. However, the relationship between the plasma FIB and the LV remodeling in PD patients was rarely discussed. The study aimed to investigate the role of plasma FIB in LV remodeling and LV functions in patients on PD, and explore risk factors related to plasma FIB level.

**Methods:** Patients with echocardiography for three consecutive years were recruited between Dec. 2010 and May 2020. Echocardiographic measurements of LV geometry and LV function were collected and LVH-progression was evaluated. Correlation analysis was performed to explore the plasma FIB level and LV geometry and LV function. Pathogenic factors correlated to the LVH-progression were explored by logistic regression models and the role of FIB in it was verified by receiver operating characteristic (ROC) curve analysis. Linear regression models were conducted to identify factors associated with plasma FIB level.

**Results:** A total of 268 PD patients (96 males, 57.8%) were recruited with an average age of 55.9 ± 16.5 years. Patients were trisected according to plasma FIB level. Patients in the third tertile (with higher FIB level) had higher mean wall thickness (MWT), relative wall thickness (RWT) and left ventricular mass index (LVMI) and lower E/A ratio than those in the other tertiles. 112 patients were detected to have LVH progression. Multivariable logistic regression showed that plasma FIB level was an independent risk factor for LVH-progression (OR, 1.591; 95% CI, 1.243–2.037; p < 0.001). And the ROC analysis indicated that the area under the curve (AUC) of fibrinogen level for predicting

LVH-progression was 0.637 (p < 0.001). Multiple linear regression analysis identified history of diabetes, age, PD duration, CRP and ApoB were risk factors for a higher plasma FIB level in PD patients.

**Conclusions:** An elevated plasma FIB level was independently associated with LVH-progression and significantly related to declined LV function in patients undergoing PD. History of diabetes, age, PD duration, CRP and ApoB were risk factors for a high level of plasma FIB. Plasma FIB might be a valuable marker for LV-remodeling monitoring.

## FR-PO467

**Origin of Proteins and Metabolites in Peritoneal Dialysis Explained by a Multi-Omic Approach**

Klaus Kratochwill, Rebecca Herzog, Andreas Vychytil, Christoph Aufricht. *Medical University of Vienna, Vienna, Austria.*

**Background:** Peritoneal dialysis effluent (PDE) is a rich but underexplored source for therapy monitoring and investigation of deregulated processes during PD. Modern high performance mass spectrometry (MS) and sequencing methods allow monitoring of hundreds of analytes in parallel. For understanding PD related processes on a systems biology level, a multi-level omics approach is particularly attractive. Here, we investigate the cellular transcriptome and cell-free proteome of PDE samples to investigate the origin of proteins found in PDE.

**Methods:** The effluent material from stable patients was separated into a cellular and cell-free component. Proteins in the cell-free compartment were processed using our equalizing and TMT-labelling workflow followed by LC-MS. The cellular material was subjected to RNA sequencing. A bioinformatic workflow conjoined information from the datasets to reveal novel insights into the "PD effluentome", especially clarifying the source of proteins found in PDE.

**Results:** Metabolomics methods enabled detecting 207 unique metabolites in cell-free PDE. A mixed-effect ANOVA of all metabolites demonstrated dwell time-dependent concentration changes of 173. Post-hoc testing revealed most metabolites to be changed between 1h and 16h of fluid dwell, followed by 114 and 46 differently concentrated metabolites between 4h and 16h and 1h and 4 h of dwell respectively. We quantified 9,797 transcripts in PD-effluent cells and 2,729 proteins in PDE. 342 proteins were filtered from plasma, while 800 proteins were attributable to local production. A quantitative analysis of the interaction proteome and cellular transcripts of roughly 1700 protein-transcript pairs showed clusters of proteins explained by over-expression in peritoneal cells compared to plasma concentrations.

**Conclusions:** The exploitation of PD effluent information on multiple omics levels as identified by our bioinformatic approach will improve our understanding of the molecular processes in the peritoneal cavity and their role in development of complications for ultimately improving PD therapy. Our work suggests feasibility of multi-omics approaches to investigate cell derived biomarkers for their involvement in pathomechanisms relevant in PD.

## FR-PO468

**Can We Use the Modified Creatinine Index for Assessment of Muscle Mass in Peritoneal Dialysis Patients?**

Cheuk-Chun Szeto, Gordon C. Chan, Winston W. Fung, Jack K. Ng. *The Chinese University of Hong Kong, Hong Kong, Hong Kong.*

**Background:** Sarcopenia is common in chronic dialysis patients and is associated with increased morbidity and mortality. The modified creatinine index (MCRi) is a simple that represents dietary protein intake and skeletal muscle mass, and has been found to be a reliable prognostic marker for chronic hemodialysis (HD) patients. Since single-pooled Kt/V (sp-Kt/V) for urea and pre-HD serum creatinine level for the calculation of MCRi, it remains unknown whether the index could be extrapolated to peritoneal dialysis (PD) patients.

**Methods:** We studied 138 patients (88 males) who were converted from PD to HD. We compared their MCRi measured within 6 months while on HD as computed by the standard formula and that computed by using the total weekly Kt/V and serum creatinine while the patient was on PD. The two parameters were compared by the Bland and Altman method.

**Results:** The mean age was 50.9 ± 12.7 years; 82 patients (59.4%) were converted to HD because of severe or recurrent peritonitis, and 56 (40.6%) due to mechanical problems. The average MCRi during HD and PD were 22.21 ± 2.90 and 22.97 ± 3.24 mg/kg/day, respectively. The bias of using total weekly Kt/V and serum creatinine in PD for the calculation of MCRi was 0.758 mg/kg/day (95% confidence interval [CI] -4.356 to +5.873 mg/kg/day), or 4% (95%CI -20% to +28%). The difference in MCRi calculated during HD and PD significantly correlated with serum albumin (r=0.342, p<0.0001), and inversely with residual glomerular filtration rate (GFR) (r=-0.359, p<0.0001). MCRi during PD significantly correlated with the Charlson's comorbidity index (r=-0.356, p<0.0001), serum albumin (r=0.315, p<0.0001), residual GFR (r=-0.362, p<0.0001), percentage of fat-free edema-free body mass by creatinine kinetics (r=0.684, p<0.0001), lean tissue mass by multi-frequency bioimpedance spectroscopy (r=0.641, p<0.0001), but not normalized protein nitrogen appearance (r=0.034, p=0.7) or adipose tissue mass (r=-0.146, p=0.17).

**Conclusions:** MCRi, when calculated by total weekly Kt/V and serum creatinine in PD, results in a small bias, but it remains significantly correlated with other measures of skeletal muscle mass. Further studies are needed to determine the prognostic value MCRi in PD patients.

**Funding:** Clinical Revenue Support

Key: TH - Thursday; FR - Friday; SA - Saturday; OR - Oral; PO - Poster; PUB - Publication Only

Underline represents presenting author.

FR-PO469

**Pleuroperitoneal Leak in Peritoneal Dialysis: A Case Series**

Gonçalo Ávila, Patrícia Matias, Rita Calça, Patrícia Q. Branco. *Centro Hospitalar de Lisboa Ocidental EPE Hospital de Santa Cruz, Carnaxide, Portugal.*

**Background:** Pleuroperitoneal leak (PPL) is a rare cause of pleural effusion in peritoneal dialysis (PD) patients due to congenital or acquired defects in the diaphragm muscle fibers or connective tissue. In the first case, it manifests on the first days after beginning PD. The latter situation may present months or years after and is associated with excessive intra-abdominal pressure. Peritoneal scintigraphy with Tc-99m macroaggregated albumin (MAA) injected into the abdominal dialysate port is a useful diagnostic test with good sensitivity. The aim of this study was to describe the characteristics and outcomes of a group of PD patients with diagnosed PPL.

**Methods:** We conducted a single center, retrospective study, that included patients on PD with confirmed PPL from 2011 to 2022. Demographic and clinical parameters were obtained. Patients were followed since the beginning of PD until technique dropout.

**Results:** Ten patients with PPL were included, with mean age of 56.5 ± 11.3, and 70% females. Mean body mass index was 26.9 ± 4.4 kg/m<sup>2</sup>. Median DP vintage at the time of diagnosis was 92 days (IQR 29.5 - 412.5). All cases were right-sided leaks. In three patients it developed in the first month, in four patients within 3 months and in three patients after one year. Only one patient had one episode of peritonitis before diagnosis. The most common symptoms at the time of diagnosis were cough (50%) and pleuritic pain (40%). Diagnosis was made using peritoneal scintigraphy with MAA in 90% of patients. Seven patients underwent talc pleurodesis after a median time of 8 days after the diagnosis. In four patients, the pleural effusion recurred in the period of approximately one month after restarting PD. The median technique survival of patients in whom the procedure was effective was 12 months.

**Conclusions:** PPL are a rare cause of pleural effusion in PD patients that carry important morbidity, requiring immediate switching to another renal replacement therapy and requiring an invasive procedure for its treatment, which has a limited efficacy (42% in our cohort). There is currently no standardized method for its diagnosis. In this study, peritoneal scintigraphy with MAA demonstrated to be a safe, noninvasive, and cost-effective exam. Patients presenting with new onset right sided pleural effusion, particularly in the first weeks or months after beginning PD, should be investigated for PPL.

FR-PO470

**Fast and Precise Pathogen Detection and Identification in Peritoneal Dialysis-Associated Peritonitis: Insight From Metagenomics Next-Generation Sequencing**

Xiaoxiao Ma, Xiaowen Ha, Reziwanguli Abudula, Jiayinaxi Azati, Yaqin Wu, Yixiang Tan, Hong Jiang. *People's Hospital of Xinjiang Uygur Autonomous Region, Urumqi, China.*

**Background:** PD-associated peritonitis (PDAP) is one of the most common and detrimental complications for patients receiving PD. Metagenomics next-generation sequencing technique (mNGS) potentially provides a fast and precise option for the detection and identification of pathogens in the PDAP by sequencing the nucleic acid of microorganisms in the samples.

**Methods:** We investigated 12 PDAP patients by identifying the potential pathogens of the peritoneal dialysate samples using the traditional microorganism culture (TMC) and mNGS respectively. The pathogens detection rate, species coverage of pathogens, sensitivity, and specificity between these two assays were analyzed.

**Results:** Total concordance between TMC and mNGS was noted. The pathogenic bacteria detection rate using mNGS was significantly higher than that of TMC (75% vs 58.3%, P<0.05). The rates for greater than 2 pathogens using mNGS dramatically increased than that of TMC (91.7% vs 58.3, 41.4% vs 0%, P<0.05). The sensitivity and specificity of mNGS for the detection of pathogens in the PDAP are higher than that of TMC. Of note, the TMC results from three PDAP patients showed negative due to previous antibiotics treatment before enrolling in this study, whereas positive pathogens were still detected by using mNGS. The adjustment of treatment according to the result of mNGS controlled the infection, 2 patients and peritoneal dialysis was achieved independently after 1 week. The time of results was 5-7 days for TMC and 1-1.5 days for mNGS. The sensitivity of mNGS is 70% and the specificity of it is 100%.

**Conclusions:** These findings suggest that mNGS in diagnosis and guidance of treatment for PDAP is possibly superior to TMC its higher sensitivity and specificity.

**Funding:** Government Support - Non-U.S.

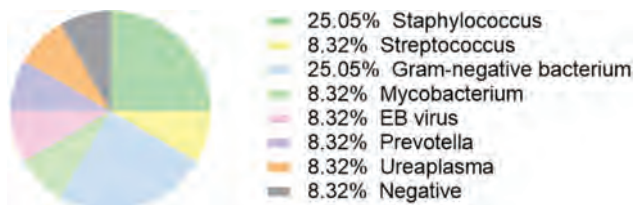
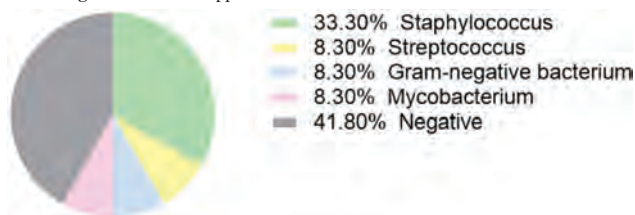

FR-PO471

**QuickCheck: A Point-of-Care Leukocyte Counter for PD Management**

Curtis B. Dobson<sup>1,2</sup>, Rachel Cant<sup>1</sup>, Michael G. Barker<sup>2</sup>, Darren Kell<sup>2</sup>, Stephnie M. Kennedy<sup>2</sup>, Adam S. Milner<sup>2</sup>, Ida M. Jackson<sup>2</sup>, Thomas C. Willett<sup>2</sup>, Ryan Griffiths<sup>2</sup>, John P. Foster<sup>2</sup>, Chris Knight<sup>3</sup>, David M. Lewis<sup>4</sup>, Anand Vardhan<sup>5</sup>, Martin E. Wilkie<sup>6</sup>, Nishal Govindji-Bhatt<sup>2</sup>. <sup>1</sup>The University of Manchester Faculty of Biology Medicine and Health, Manchester, United Kingdom; <sup>2</sup>Microbiosensor Ltd., Manchester, United Kingdom; <sup>3</sup>School of Natural Sciences, The University of Manchester, Manchester, United Kingdom; <sup>4</sup>Salford Royal NHS Foundation Trust, Salford, United Kingdom; <sup>5</sup>Manchester University NHS Foundation Trust, Manchester, United Kingdom; <sup>6</sup>Sheffield Teaching Hospitals NHS Foundation Trust, Sheffield, United Kingdom.

**Background:** Peritonitis is a major cause of peritoneal dialysis (PD) technique failure, and causes significant morbidity, mortality and anxiety. Cloudy effluent caused by increased leukocytes (typically neutrophils) is an early indicator, but visual assessment is unreliable. We have developed QuickCheck, a simple point-of-care device to provide an instant leukocyte count. Here we confirm which leukocytes are present in PD patients without peritonitis, and which should be detectable by the instrument. We also compare the relative performance of QuickCheck and a UK 'gold standard' hospital laboratory flow cytometer (Sysmex UF5000).

**Methods:** Leukocytes present in PD effluent were determined for 9 PD patients without peritonitis. Isolated leukocytes were stained (with CD45, CD3, CD4, CD8, CD19, CD33, CD14, CD16, CD56, CD66b, HLA-DR, CD11b, CD303 and EpCam) followed by mass cytometry to identify the leukocyte type. QuickCheck performance was compared with Sysmex using leukocytes from effluent from 6 PD patients (IRAS 294250) resuspended in filtered (cell-free) effluent to yield test concentrations (10-1000 cells/µl). The percentage error, linearity of response and bias were compared. Accuracy and precision were also calculated.

**Results:** Leukocytes from PD patients without peritonitis comprised many sub-types, including macrophages (47%), monocytes (11%), T-Cells (CD4+) (7%), T-Cells (CD8+) (12%), B-Cells (6%), neutrophils (12%), NK cells (0.4%). Percentage error between the QuickCheck and Sysmex was 10% across the range 10-1000 cells/µl, linearity (R<sup>2</sup>) was 0.99 and Bland-Altman analysis showed no bias (0.000). Accuracy of the Sysmex was 95.9% and QuickCheck was 90.5%. Precision for Sysmex was 5.6% and QuickCheck was 3.0%.

**Conclusions:** Leukocytes present in PD patients without peritonitis are diverse, and so detecting all types is important for use with initially 'well' patients, as infection begins to develop. QuickCheck and Sysmex both showed good correlation with each other by linearity, and neither showed appreciable bias. Independent analysis showed QuickCheck was more precise though slightly less accurate than Sysmex, but has the advantage of speed, simplicity, portability and suitability for use at point-of-care.

**Funding:** Commercial Support - Microbiosensor Ltd., Government Support - Non-U.S.

FR-PO472

**Regular Monitoring for Nasal Carriage of Staphylococcus aureus May Reduce Risk of Peritoneal Dialysis Associated Infections**

Hari Dukka, Ugonna Onwuchekwa. *University of Derby and Burton, Derby, United Kingdom.*

**Background:** Staphylococcus Aureus (SA) causes a significant proportion of Peritoneal dialysis (PD) associated infections. Patients with nasal carriage of SA are four times more likely to develop PD catheter exit site infections, which can lead to peritonitis. Mupirocin has been used to treat SA nasal carriage.

**Methods:** We did a retrospective study to see if patients receiving PD in our department were being monitored for SA carriage with nasal swabs, every 3 months as per department policy and the impact it had on PD associated infections (PDAI). The study period was 2.5 years and electronic data base was used to capture information. Timing of nasal swabs and any PDAI were captured.

**Results:** 60 patients were analysed during the study period. The mean age 72±/4 years. 23 patients received 3 monthly nasal swabs to identify SA carriage (group 1). The rest had swabs done at median time of 4 months (4-17 months) (group 2). 29 patients during this study period developed PDAI. There were 26 peritonitis episodes and 23 exit site infections. The relative risk of developing PDAI with a positive nasal swab was 1.5 (odds ratio of 2.34). Patients in group 1 who had 3 monthly monitoring and appropriate treatment with mupirocin (n= 8) developed PDAI and in group 2 the incidence was (n= 21). Three monthly monitoring for nasal carriage of SA reduced risk of PDAI by 22%.

**Conclusions:** Patients on PD should have regular and timely monitoring for nasal SA carriage. This may reduce the incidence of PDAI.

FR-PO473

**Icodextrin Is Associated With Lower Risks of Peritonitis, Technique Failure, and Mortality: A Cohort Study From Taiwan**

I-kuan Wang,<sup>1,2</sup> Chan Ip Chan,<sup>3,4</sup> Hsing-Fen A. Lin,<sup>5</sup> Ping chin Lai.<sup>1,4</sup> <sup>1</sup>*Divisions of Nephrology, China Medical University Hospital, Taichung, Taiwan;* <sup>2</sup>*Department of Medicine, College of Medicine, China Medical University, Taichung, Taiwan;* <sup>3</sup>*Baxter Healthcare Ltd., Taipei, Taiwan;* <sup>4</sup>*Graduate Institute of Management, National Taiwan University of Science and Technology, Taipei, Taiwan;* <sup>5</sup>*Raising Statistics Consultant Inc, Taipei, Taiwan.*

**Background:** It studied the effects of icodextrin (ICO) on the risks of peritonitis, switching to HD, death and technique failure in a large group of PD patients using extended data from a medical center in Taiwan.

**Methods:** The study included incident PD patients receiving PD for at least 90 days from Jan. 1, 2007 to Dec. 31, 2018 at China Medical University Hospital, Taiwan. ICO users were defined as use of ICO for >50% of their PD duration. ICO was considered a time-varying exposure in Cox proportional hazard model. The outcomes of interest were the first episode of peritonitis, switching to HD (defined as transfer to HD for at least 30 days), death, and technique failure (defined as transfer to HD for at least 30 days or death on PD). If patients died within 90 days after switching to HD, the death was attributed to PD and counted as a death event.

**Results:** A total of 725 PD patients including 190 ICO users and 535 ICO non-users were recruited. Compared to ICO non-users, ICO users had significant lower risks of the first peritonitis episode (adjusted HR=0.22, 95% CI=0.14-0.34), switching to HD (adjusted HR=0.55, 95% CI=0.37-0.80), mortality (adjusted HR=0.58, 95% CI=0.39-0.88) and technique failure (adjusted HR=0.60, 95% CI=0.45-0.80). Age, diabetes (DM), nPNA and 24-hour net ultrafiltration were the risk factors for peritonitis. The subgroup analyses showed ICO delivered additional benefits for lowering the risk of peritonitis in PD patients with DM (adjusted HR=0.07 in DM vs. 0.56 in non-DM; *P* for interaction<0.001) and with cardiovascular diseases (CVD) (adjusted HR=0.04 in CVD vs. 0.31 in non-CVD; *P* for interaction=0.02). The protective effect of ICO on mortality was more prominent in high transporter PD patients (adjusted HR=0.16 in high transporter vs. 0.70 in non-high transporters; *P* for interaction=0.063).

**Conclusions:** ICO can lower the risks of peritonitis, switching to HD, mortality and technique failure in a large group of Asian PD population. Its protective effects on mortality were more prominent in high transporter and patients with DM or CVD.

Table 1. The association between the use of ICO and the risk of outcomes without and with covariates adjustment

Outcome	Number of patients	Incidence* (95% CI)	Reference	HR (95% CI)	P value	Adjusted HR (95% CI)	P value
Death on PD	None	335	7.2 (6.0-8.4)	Reference		Reference	
	ICO	190	4.0 (3.3-4.8)	0.55 (0.40-0.72)	0.000	0.50 (0.39-0.64)	0.000
Technique failure	None	695	35.2 (33.4-37.0)	Reference		Reference	
	ICO	190	22.1 (19.0-25.3)	0.60 (0.45-0.80)	0.000	0.60 (0.45-0.80)	0.000
Switch to HD	None	535	5.4 (4.6-6.3)	Reference		Reference	
	ICO	190	2.9 (2.3-3.6)	0.55 (0.40-0.72)	0.000	0.55 (0.37-0.80)	0.000
Peritonitis	None	535	17.0 (14.6-19.2)	Reference		Reference	
	ICO	190	7.0 (5.6-8.5)	0.41 (0.25-0.69)	<0.001	0.41 (0.24-0.58)	<0.001

CI, confidence interval; HD, hemodialysis; ICO, icodextrin; PD, peritoneal dialysis.  
 \*Adjusted for age, sex, education level, diabetes, hypertension, cardiovascular disease, mortality (ART vs. CAPD), PET (HD vs. LA), total K<sub>V</sub>, pre-metformin K<sub>V</sub>, nPNA, 24-hour net UF, 24-hour urea output, albumin, hemoglobin and year of dialysis initiation.  
 †Number of events per 100 person-years.  
 ‡These were 14 patients suffered from peritonitis before the initiation of ICO.

**Results:** From June 2021 to February 2022, 74 participants were randomized to the intervention group (N=37) and control group (N=37). Both groups had comparable demographics and baseline serum albumin. Dietary protein intake on the 30<sup>th</sup> day was 1.4±0.4 g/kg/day in the intervention group and 1.0±0.2 g/kg/day in the control group (*p*=0.07). Primary outcome events were reported in 15 (41%) and 19 (51%) participants in the intervention and control groups, respectively (hazard ratio 0.84; 95% confidence interval [CI] 0.43-1.67). Serum albumin concentrations were significantly higher in the intervention group across study period (linear mixed-effects model, *p*<0.001), with a mean difference on the 120<sup>th</sup> day of 0.35 g/dL (95% CI 0.06-0.64) (*p*=0.02).

**Conclusions:** Serum albumin concentrations in patients with PD-associated peritonitis were higher with protein supplementation compared with nutritional counseling alone, although death or relapsing/repeat peritonitis were not affected. Further studies with a longer follow-up period and a larger number of participants are warranted.

**Funding:** Private Foundation Support

FR-PO475

**Influence of Peritoneal Dialysis Solution Type and Strength on Bacterial Growth**

Annie V. Hong,<sup>1,2</sup> Arunima Mishra,<sup>3</sup> Soo min Jang,<sup>4,2</sup> Sergio Infante,<sup>2</sup> Enrica Fung,<sup>1,2</sup> Jeffrey Perl,<sup>5</sup> Roy O. Mathew,<sup>2,1</sup> Hansel M. Fletcher.<sup>3</sup> <sup>1</sup>*Loma Linda VA Medical Center, Loma Linda, CA;* <sup>2</sup>*Loma Linda University School of Medicine, Loma Linda, CA;* <sup>3</sup>*Loma Linda University Health, Loma Linda, CA;* <sup>4</sup>*Loma Linda School of Pharmacy, Loma Linda, CA;* <sup>5</sup>*St. Michael's Hospital, Toronto, ON, Canada.*

**Background:** The role of solution type and strength on peritonitis risk is unclear in patients receiving peritoneal dialysis (PD). We evaluated the *in vitro* growth characteristics (inhibition or promotion) of common peritonitis bacterial species in various PD solution types.

**Methods:** Common bacterial pathogens including: *Staphylococcus aureus* (SA), *Staphylococcus epidermidis* (SE), *Pseudomonas aeruginosa* (PA), and *Enterococcus faecalis* (EF) were cultured in a compatible growth medium overnight (Brain heart infusion, Luria-Bertani broth, or Todd Hewitt broth). An aliquot from the cultures was grown in a 1:1 combination of growth media (control- CON) + PD solution (Baxter: 1.5%, 2.5%, 4.25% dextrose (DEX), and 7.5% icodextrin (ICO)). All cultures were incubated in glass tubes aerobically for 16 h and 20 h at 37 °C; growth at 16h is reported due to minimal increase after that. Bacterial concentrations were measured by optical density of each sample at 600 nm (OD600) and a mean of three independent experiments were taken. The error bars represent the standard deviations.

**Results:** Compared to control, PA growth was most robust in combined growth media and PD fluid (Figure: growth in PD fluid to growth medium 1:1 mixture at 16h). In particular, PA underwent stronger growth in DEX (*p*<0.001 DEX vs CON) and grew less in ICO versus all DEX (*p* = 0.002). In contrast, SA had greater growth in ICO versus all DEX (*p* < 0.001). EF demonstrated the weakest growth in growth medium + PD fluid.

**Conclusions:** Common PD-associated bacteria appear to grow similarly in routine PD fluids with the most favorable growth environment for SE. When PD fluids are combined with growth media to better simulate physiologic conditions, ICO limits PA and DEX limits SA growth. Further research is warranted in clinical settings.

FR-PO474

**Effect of Protein Supplement in Patients With Peritoneal Dialysis-Associated Peritonitis on Clinical Outcomes: A Multicenter, Randomized-Controlled Trial**

Surasak Faisatjatham,<sup>1,2</sup> Piyatida Chuengsaman,<sup>3</sup> Chaiwat Pisutpaisan,<sup>4</sup> Rhonchai Lawsuwanakul,<sup>5</sup> Chanchana Boonyakrai,<sup>6</sup> Sarassawan Kananuraks,<sup>2</sup> Rutchanee Chiochanthanakij,<sup>7</sup> Kamol Khositransikun,<sup>8</sup> Jeerath Phannajit,<sup>1</sup> Somkanya Tungsanga,<sup>1</sup> Somchai Eiam-Ong,<sup>1</sup> Talerngsak Kanjanabuch.<sup>1</sup> <sup>1</sup>*Chulalongkorn University Faculty of Medicine, Bangkok, Thailand;* <sup>2</sup>*Khon Kaen Hospital, Khon Kaen, Thailand;* <sup>3</sup>*Banphaeo-Charoenkrung Peritoneal Dialysis Center, Bangkok, Thailand;* <sup>4</sup>*Samut Prakan Hospital, Samut Prakan, Thailand;* <sup>5</sup>*Chonburi Hospital, Chonburi, Thailand;* <sup>6</sup>*Taksin Hospital, Bangkok, Thailand;* <sup>7</sup>*Sawanpracharak Hospital, Pak Nam Pho, Thailand;* <sup>8</sup>*Maharaj Nakhon Si Thammarat Hospital, Nakhon Si Thammarat, Thailand.*

**Background:** Malnutrition is associated with increased mortality in peritoneal dialysis (PD) patients with peritonitis. Data on protein supplementation during peritonitis episodes are limited.

**Methods:** A multicenter, open-label, randomized trial across 9 PD centers in Thailand was conducted. Adult PD patients above 18 years, diagnosed with peritonitis with serum albumin below 3.5 g/dL were randomly assigned to receive protein supplementation (intervention group) or none (control group). Participants with tuberculous/fungal/secondary peritonitis or septic shock were excluded. Whey protein of 30 g/day was given to the intervention group for 30 days. Participants in both groups received nutritional counseling according to SPENT guideline (dietary energy intake of 30 kcal/kg/day and dietary protein intake of 1.5 g/kg/day). The primary outcome was a composite outcome of peritonitis-related death or relapsing/repeat peritonitis. The secondary outcome was serum albumin levels across study period between groups. Outcomes were monitored for 120 days.

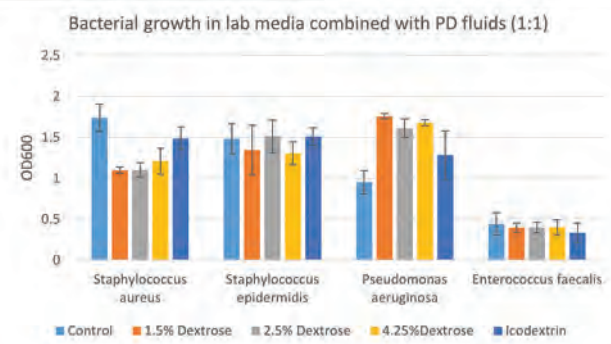

## FR-PO476

**Nationwide Standardized Peritonitis Reporting: Updated Results From the Optimizing the Prevention of Peritoneal Dialysis Associated Peritonitis in the United States (OPPUS) Study**

Muthana Al sahlawi,<sup>1</sup> Brian Bieber,<sup>2</sup> Shweta Bansal,<sup>3</sup> Geoffrey A. Block,<sup>4</sup> Tahsin Masud,<sup>5</sup> Beth M. Piraino,<sup>6</sup> Martin J. Schreiber,<sup>7</sup> Vesh Srivastana,<sup>8,9</sup> Isaac Teitelbaum,<sup>10</sup> Suzanne Watnick,<sup>11,12</sup> Leslie Garcia,<sup>2</sup> Ronald L. Pisoni,<sup>2</sup> Jeffrey Perl.<sup>13</sup> <sup>1</sup>King Faisal University, Al-Hasa, Saudi Arabia; <sup>2</sup>Arbor Research Collaborative for Health, Ann Arbor, MI; <sup>3</sup>The University of Texas Health Science Center at San Antonio, San Antonio, TX; <sup>4</sup>US Renal Care, Inc, Plano, TX; <sup>5</sup>Emory University, Atlanta, GA; <sup>6</sup>University of Pittsburgh School of Medicine, Pittsburgh, PA; <sup>7</sup>DaVita Inc, Denver, CO; <sup>8</sup>Rogovin Institute, New York, NY; <sup>9</sup>Weill Cornell Medicine, New York, NY; <sup>10</sup>University of Colorado Denver School of Medicine, Aurora, CO; <sup>11</sup>Northwest Kidney Centers, Seattle, WA; <sup>12</sup>University of Washington, Seattle, WA; <sup>13</sup>Saint Michael's Hospital, Toronto, ON, Canada.

**Background:** Peritoneal Dialysis (PD) associated peritonitis is a common complication of PD and is the leading cause of transfer to hemodialysis in the US. No formal mechanism or surveillance system exists for nationwide peritonitis reporting. Our primary aim was to develop a uniform widescale peritonitis reporting mechanism and evaluate its implementation in the Optimizing Prevention of PD-associated Peritonitis in US (OPPUS) study.

**Methods:** Following literature review, stakeholder consultation, and ISPD guidelines review, a web-based peritonitis tracker tool (OPPUS-Link) was developed. Pilot sites for one-year data collection were selected based on geography and reported peritonitis rates, including 3 medium-large dialysis organizations. We provided formal training, central data review, and adjudication of all peritonitis episodes and outcomes. Data collection began in October 2020 and is ongoing.

**Results:** Initial data for 53 participating facilities with a median follow-up time of 31 patient-years includes 350 peritonitis episodes (rate of 0.24 episodes/year). Permanent transfer to HD, PD catheter removal, and hospitalization occurred in 14%, 15%, and 41% of episodes respectively, with 6% of episodes resulting in death. Only 1.5% of peritonitis episodes occurred following PD catheter insertion but prior to PD at home. Ongoing challenges include high prevalence of culture-negative peritonitis (22% of episodes) and high percentage of peritonitis acquired in hospital (15%).

**Conclusions:** Standardized, uniform peritonitis reporting is feasible, a first step in national PD-peritonitis surveillance, allowing for benchmarking, outbreak identification, and quality improvement initiative implementation. Further data validation is necessary and integrating routine peritonitis reporting in electronic health records with an overall goal of peritonitis reduction and improved outcomes for PD patients.

**Funding:** Other NIH Support - AHRQ

## FR-PO477

**Variation in the Approach to Antibiotic Administration for the Treatment of Peritoneal Dialysis-Associated Peritonitis: Results From a Survey of US Medical Directors Participating in the OPPUS Study**

Muthana Al sahlawi,<sup>1</sup> Brian Bieber,<sup>2</sup> Sana F. Khan,<sup>7</sup> Osama El Shamy,<sup>8</sup> Beth M. Piraino,<sup>3</sup> Martin J. Schreiber,<sup>4</sup> Isaac Teitelbaum,<sup>5</sup> Leslie Garcia,<sup>2</sup> Ronald L. Pisoni,<sup>2</sup> Jeffrey Perl.<sup>6</sup> <sup>1</sup>King Faisal University, Al-Hasa, Saudi Arabia; <sup>2</sup>Arbor Research Collaborative for Health, Ann Arbor, MI; <sup>3</sup>University of Pittsburgh School of Medicine, Pittsburgh, PA; <sup>4</sup>DaVita Inc, Denver, CO; <sup>5</sup>University of Colorado Denver School of Medicine, Aurora, CO; <sup>6</sup>St. Michael's Hospital, Toronto, ON, Canada; <sup>7</sup>University of Virginia, Charlottesville, VA; <sup>8</sup>Vanderbilt University Medical Center, Nashville, TN.

**Background:** Peritoneal dialysis (PD)-associated peritonitis carries significant morbidity and is the leading cause of technique failure and transition to hemodialysis. This study aimed to explore the variation in antibiotic dosing and administration for the treatment of PD-associated peritonitis among a diverse group of PD facilities participating in the Optimizing Prevention of PD-associated Peritonitis in US (OPPUS) study.

**Methods:** As part of the OPPUS study, an online peritonitis-focused survey was administered in quarter 1 of 2022 to medical directors at 40 PD study sites, representing independent, small, medium, and large sized dialysis organizations. Surveys to date were completed by 38 of these study sites.

**Results:** Most centers (78%) provide patients with antibiotics for self-administration at home whenever peritonitis is suspected but to be taken during clinic off-hours. Clinics differ considerably regarding the types and numbers of intraperitoneal vs oral antibiotics prescribed for such self-administration. Antibiotics are routinely administered in one exchange/day in 95% of facilities; only 47% of facilities adjust dose for residual kidney function. Moreover, most centers (82%) indicated having no access to effluent cell count before initiation of antibiotics, with typically >12-hour turnaround time before effluent cell count results are available at 74% of PD units. Large inter-facility variability was seen as to when repeat PD effluent cell count(s) and culture(s) should be taken. In addition, only 62% of facilities routinely check vancomycin trough levels when intra-peritoneal vancomycin is prescribed.

**Conclusions:** Prompt administration of antibiotics has been consistently shown to be associated with better outcomes of peritonitis treatment. Significant variations exist in antibiotic dosing and administration for PD-associated peritonitis across PD facilities in the US. It is notable that less than 20% of PD units routinely have access to PD effluent

cell count results before treatment is initiated. Identifying optimal antibiotic dosing and administration practices that maximize the likelihood of cure is an important step to improve peritonitis outcomes and decrease related adverse events.

**Funding:** Other NIH Support - AHRQ

## FR-PO478

**Home Pets and Peritonitis: Friend or Foe?**

Zahir Ali Shaikh, Imara Dissanayake, Akilandanayaki Angamuthu, Astha Gupta. *Albert Einstein Medical Center, Philadelphia, PA.*

**Introduction:** Peritonitis is a major complication in peritoneal dialysis and remains the main cause of patients switching to hemodialysis. The usual organisms in peritonitis are pathogenic skin bacteria including staphylococcus epidermidis and staphylococcus aureus. There are rare causes which include gram negative and fungal peritonitis. Here we are presenting a case of pastorella multocida which is transferred by pets, especially cats.

**Case Description:** A 41 year old male with medical history of type 1 diabetes mellitus, hypertension, hyperlipidemia, coronary artery disease status post coronary artery bypass graft, end stage renal disease on continuous cycler peritoneal dialysis came with nausea, vomiting and watery diarrhea of one week. On admission, the exit site was clean with some redness at the peritoneal dialysis catheter insertion site. The initial PD cell count was 8 with 36% neutrophils, however, the PD fluid culture was reported as gram negative rods the following day. The repeat cell count was 2287 with 69% polymorphs. The patient was started on intraperitoneal Cefepime for gram negative peritonitis while awaiting culture and sensitivity. Subsequently the PD fluid culture was positive for pastorella multocida and patient was switched to intraperitoneal ceftriaxone. On further questioning regarding pets at home, the patient attested that his cat plays around the machine tubings while he connects himself for peritoneal dialysis. The patient recovered, however he developed relapsing peritonitis, which was treated successfully, and patient remains on peritoneal dialysis with no complications eight months later.

**Discussion:** Pastorella multocida is an aerobic, small gram negative coccobacillus found in pets (cats & dogs) as part of their normal oral flora. It can cause a variety of infections in humans through scratching, licking or biting, leading to infections ranging from mild cellulitis to severe pneumonia, sepsis or meningitis. Treatment includes penicillin, third generation cephalosporins and carbapenems. The pastorella multocida peritonitis in a peritoneal dialysis is rare, however needs to be considered in patients having pets. The patient's home environment & understanding of sanitization measures should be discussed in detail with patients before starting on peritoneal dialysis and nurse should visit patient's home to ensure the safety and sanitization measures.

## FR-PO479

**Antibiomania With Intraperitoneal Ceftazidime: The First Case Report**

Abdul Hannan A. Rasheed,<sup>1,2</sup> Sujith K. Palleti,<sup>1,2</sup> Anuradha Wadhwa,<sup>1,2</sup> <sup>1</sup>Edward Hines Junior VA Hospital, Hines, IL; <sup>2</sup>Loyola University Health System, Maywood, IL.

**Introduction:** Antibiomania or antibiotic induced mania, is rare (47 published cases with 12 different antimicrobials). Macrolides and quinolones are most implicated followed by beta lactams. We present the first case of mania precipitated by ceftazidime, administered intraperitoneally (IP) for treatment of peritonitis in peritoneal dialysis (PD) patient.

**Case Description:** 55-year-old male with end stage kidney disease (ESKD) due to diabetes and hypertension on PD, history of depression (stable off-medications for a year) presented with abdominal pain. PD effluent was cloudy, WBC's 2694 with 78% neutrophils. He was started on IP ceftazidime for gram negative rods (culture showed capnocytophaga) with gradual improvement in cell counts. On day 12 of treatment, changes in his behavior were noted (agitation, anxiety and tearful). Psychiatry recommended starting sertraline for depression. Patient was discharged home to complete 3 weeks of ceftazidime. He was readmitted 4 weeks later due to disruptive behavior (delusions, irritability, agitation). Psychiatry diagnosed him with mania due to ceftazidime and started him on divalproex sodium. PD fluid showed recurrence of peritonitis with 7251 WBCs, 95% neutrophils and Enterobacter cloacae on culture. He was treated with cefepime but due to abdominal pain and increasing WBC, PD catheter was removed. He was transitioned to hemodialysis and completed 2 weeks of cefepime. His mental status was monitored on divalproex sodium. After a year of therapy with antipsychotics, his mood remained stable, and he has switched back to PD.

**Discussion:** This first reported case of antibiomania with IP ceftazidime highlights the importance of recognizing psychiatric side effects of antibiotics which, if left untreated can have devastating effects on patient care and quality of life. There is strong temporal relationship between start of antibiotic and onset of mania symptoms in this case. Underlying psychiatric history may or may not be present. The pathophysiology of antibiomania remains elusive with several postulated hypothesis including disruption of gut microbes and increased excitability of postsynaptic neurons. Remission of mania symptoms with discontinuation of causative agent has only been reported in 1/3<sup>rd</sup> cases hence treatment with antipsychotics may be required.

## FR-PO480

**The Green Menace: Biliary Peritonitis due to Acute Cholecystitis in Peritoneal Dialysis**

Anuroop Yekula,<sup>1</sup> Aakriti Soni,<sup>1</sup> Suzanne G. Martin.<sup>1,2</sup> Pees in a pod. <sup>1</sup>*Saint Vincent Hospital, Worcester, MA;* <sup>2</sup>*Reliant Medical Group Inc, Worcester, MA.*

**Introduction:** The incidence of acute cholecystitis is significantly higher in dialysis patients compared with the general population (5.8 vs 0.92 per 1000 patient-years). Gallbladder (GB) perforation is a life-threatening complication of acute cholecystitis with an incidence of 2-11%. The dialysate effluent in peritoneal dialysis (PD) is a window into the peritoneal cavity and can help identify this intra-abdominal pathology.

**Case Description:** 57M with ESRD on PD for over 10 years presented with diffuse abdominal pain. Peritoneal fluid analysis revealed straw-colored, hazy fluid with a WBC count of >6000 cells/mL with 70% PMNs. CT abdomen showed a mildly distended gallbladder containing gallstones but no evidence of cholecystitis. There was a mild dilation of the common bile duct (8mm). PD fluid cultures grew *Staphylococcus epidermidis*, and the patient was treated with intraperitoneal (IP) vancomycin for 2 weeks with symptom improvement. Five days after discharge, he developed worsening right upper quadrant pain and green dialysate. Peritoneal fluid analysis showed greenish-amber fluid with a WBC count of 1500 cells/mL with 86% PMNs. PD fluid culture was negative. Repeat CT abdomen showed a markedly distended and thickened GB with cholelithiasis. Ultrasound was concerning for acute cholecystitis, which was confirmed by a HIDA scan, and he was started on IV piperacillin-tazobactam and IP vancomycin. As the patient was at high risk for surgery, a cholecystostomy tube was placed to decompress the gallbladder. PD was held initially and successfully resumed as his symptoms improved. The dialysate fluid cleared within 24 hours.

**Discussion:** Green dialysate is a sign of biliary leak into the peritoneal cavity and reflects an abdominal catastrophe. Appropriate and timely surgical intervention should be employed to ensure definitive therapy and prevent morbidity and mortality. Most reported cases were treated with cholecystectomy with PD catheter removal and transition to hemodialysis. This transition is usually temporary, and patients can resume PD after healing from surgery. In our case, the patient was able to continue PD successfully, as he did not undergo cholecystectomy.

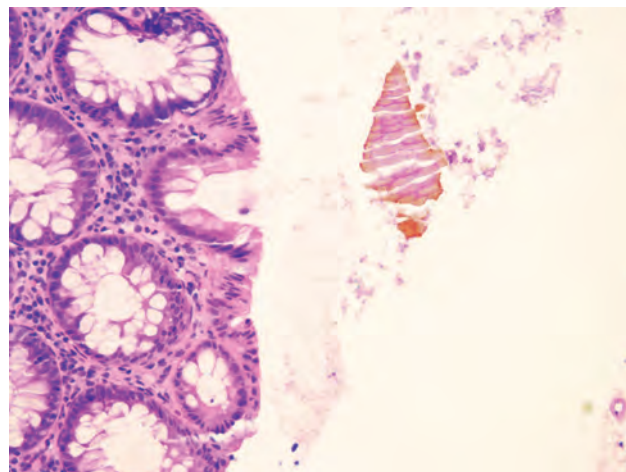

## FR-PO481

**A Rare Case of Peritonitis Associated With Sevelamer-Induced Colitis in a Peritoneal Dialysis Patient**

Takayuki Yamada, Arjun L. Kalaria, Shula Schechter, Filitsa H. Bender. *UPMC, Pittsburgh, PA.*

**Introduction:** Sevelamer is a phosphate binder frequently used for end-stage renal disease (ESRD) patients. Several cases have reported sevelamer crystal-induced colitis. Here, we present a rare case of peritonitis associated with sevelamer-induced colitis in a peritoneal dialysis patient.

**Case Description:** A 24-year-old woman with a history of ESRD on peritoneal dialysis (PD), hypertension, and coronary artery disease presented for abdominal pain and dark stool for two days. Symptoms were associated with a decrease in drain and cloudiness of PD fluid. Laboratory tests were notable for severe anemia. She was admitted for further management. PD catheter was not functioning. We initiated empiric vancomycin and cefepime intravenously. On day 3, she had a colonoscopy which showed ulcerations in the cecum. Biopsy revealed crystalline material consistent with sevelamer. PD culture was positive for *Enterococcus faecalis* and was treated with intraperitoneal vancomycin. Peritonitis is likely due to bacterial translocation in the setting of sevelamer colitis. Sevelamer was discontinued and switched to ferric citrate. She was discharged on day 8 with intraperitoneal vancomycin.

**Discussion:** Hyperphosphatemia is a common complication in ESRD and is associated with vascular calcification. Sevelamer is an anion exchanger free of calcium. Sevelamer can crystallize, leading to gastrointestinal mucosal injury. The adverse events are mild in most cases. However, sevelamer rarely causes gastrointestinal (GI) bleeding or severe colitis. As far as we know, this is the first case of sevelamer-induced colitis, which is complicated by PD peritonitis, likely secondary to bacterial translocation. Sevelamer-induced colitis may be underdiagnosed; it can be confirmed by colonoscopy with biopsy. Thus, it is unclear the risk factors of sevelamer-induced colitis. Clinicians need to be aware of these severe adverse events with sevelamer.

## FR-PO482

**Streptococcus canis: A Rare Cause of Peritonitis in a Peritoneal Dialysis Patient**

Christina E. Thoonkuzhy, Nidhi Sukul. *University of Michigan, Ann Arbor, MI.*

**Introduction:** Peritoneal dialysis (PD) is an effective form of renal replacement therapy, but peritonitis can be a serious complication. The most common peritonitis-causing organisms are gram-positive bacteria, specifically *Staphylococcus aureus* and coagulase-negative *Staphylococcus* species. Bacteria of zoonotic origin are a rare, but well-described cause of peritonitis. While the typical zoonotic culprit pathogen is *Pasteurella multocida*, we present a case of peritonitis secondary to isolated *Streptococcus canis*, a group G streptococcus that colonizes the skin and genital and gastrointestinal tracts of dogs and cats.

**Case Description:** A 66-year-old female with end-stage renal disease on PD presented with a one-day history of abdominal pain, nausea, and purulent drainage from her PD catheter site. She was hemodynamically stable, but her exam demonstrated diffuse abdominal tenderness and erythema surrounding her PD catheter site. Her serum white blood cell count (WBC) was 12,800/uL and peritoneal fluid WBC was 9,300/uL with 84% neutrophils. She was empirically started on intraperitoneal (IP) vancomycin and ceftazidime and admitted for further management. Her final cultures speciated to *S. canis*, and she was initiated on IP ceftriaxone. Repeat peritoneal fluid studies obtained on day 3 of treatment showed a WBC of 91/uL with no bacterial growth. She was discharged with a 2-week course of IP ceftriaxone.

**Discussion:** To the best of our knowledge, this is the first case of isolated *S. canis* peritonitis in a PD patient. *S. canis* is transferred primarily from companion animals such as dogs and cats, though has been isolated from a myriad of other animals as well, and has been implicated in a wide variety of human infections, typically susceptible to penicillin or 3<sup>rd</sup> generation cephalosporins. Our patient later endorsed having 11 dogs at home, which were not kept out of her bedroom when performing her PD treatments, with conflicting reports of the presence of a bedroom door. This case reinforces the importance of thorough screening of the home environment of PD patients and education that pets need to be kept away during PD treatments and away from dialysis supplies. Fortunately, she experienced rapid clinical improvement with ceftriaxone, and catheter removal was deemed unnecessary. The patient continues to tolerate PD well with no further episodes of peritonitis.

## FR-PO483

**An Uncommon Cause of Peritonitis in a Peritoneal Dialysis Patient**

Karla G. Carias Martinez, Dipal Patel. *Johns Hopkins Medicine, Baltimore, MD.*

**Introduction:** Peritonitis is a common complication of peritoneal dialysis (PD), associated with significant morbidity and mortality, catheter loss and transfer to hemodialysis. It is caused mostly by gram-positive organisms. *Neisseria* species have been rarely reported as a causative agent.

**Case Description:** 28-year-old female with ESKD secondary to FSGS on automated PD presented with abdominal pain and cloudy dialysis effluent after sustaining a motor vehicle accident 2 days prior. She was hemodynamically stable with marked midline abdominal pain. Her PD catheter exit site and tunnel were clean and without evidence of inflammation or trauma, but she was noted to have milky white fluid in her catheter tubing. Labs were significant for leukocytosis of 27.5K/mm<sup>3</sup>, hemoglobin 10.4 g/dL, and lipase 15 U/L. Abdominal imaging was negative for pancreatitis, drainable fluid collections, or free air and her PD catheter was appropriately positioned. PD effluent analysis (**Table 1**) revealed leukocytosis with neutrophil predominance and a negative gram stain, with effluent amylase 8 U/L. Given ongoing suspicion for peritonitis, she was started on empiric antibiotics with IV cefepime, vancomycin, and metronidazole. After 3 days of therapy, effluent studies were repeated with improvement in cell counts (**Table 1**). Her effluent culture later grew *Neisseria gonorrhoea*, after which antibiotics were narrowed to ceftriaxone to complete 14 days of treatment. Several months post-treatment, she has not had a recurrence of peritonitis and continues to perform PD successfully without significant change in her transport characteristics. Though she denied breaks in sterile technique, she did mention a preceding episode of unprotected intercourse.

Key: TH - Thursday; FR - Friday; SA - Saturday; OR - Oral; PO - Poster; PUB - Publication Only

Underline represents presenting author.



**Discussion:** Neisseria gonorrhoea is a gram-negative pathogenic microorganism that has rarely been isolated as a cause of peritonitis in patients in PD. Prior to our report, there has been only one other case report in which the patient also effectively responded to IP antibiotic therapy. Neisseria gonorrhoea should be considered as a possible causative agent of peritonitis in young sexually active patients performing PD.

**Table 1. Peritoneal Fluid Diagnostic Studies**

PD Fluid Cell Count	Pre-Treatment	Post-Treatment
Appearance /Color	Cloudy, Yellow	Hazy, No Color
WBC Count	39,415	782
RBC Count	1,000	8
PD Fluid Differential		
Cells Counted	100	100
Neutrophils %	89	79
Lymphocytes %	3	6
Eosinophils %	0	0

**FR-PO484**

**A Rare Case of Bacterial Peritonitis Caused by Ralstonia mannitolilytica in an Adult Peritoneal Dialysis Patient**

Litty Thomas, Ramesh Saxena. *The University of Texas Southwestern Medical Center Department of Internal Medicine, Dallas, TX.*

**Introduction:** Peritonitis is associated with a high risk of morbidity and technique failure, mostly caused by gram-positive or gram-negative commensals. Rarely, PD patients can develop peritonitis from an unusual bacteria. We describe a case of peritonitis caused by *Ralstonia mannitolilytica*. To our knowledge, this is the first reported case of *Ralstonia mannitolilytica* in an adult PD patient.

**Case Description:** A 67-year-old woman with a history of end-stage kidney disease due to obstructive uropathy from renal tuberculosis, status post-Left nephrectomy, and right PCN has been on PD for 12 years, chronic Hepatitis B, atrial fibrillation, type II diabetes, and hypertension, presented to the ED a day after her routine colonoscopy with severe abdominal pain, and cloudy urinary output from the PCN. She was started on empiric antibiotic therapy. Peritoneal fluid studies were done and were consistent with peritonitis. Peritoneal fluid culture grew *E.coli*. Urine culture from the right PCN also grew *E.coli*. She was treated with a 3-week course of intraperitoneal (IP) ceftazidime and ceftazidime with the resolution of peritonitis. The patient presented to the PD clinic with recurrent symptoms 2 weeks after the resolution of 1st peritonitis. PD fluid analysis was consistent with gram-negative rods. Final culture and sensitivity results showed *Ralstonia* species, which is pan-sensitive. She was treated for 3 weeks with cefepime and gentamycin IP with complete resolution of peritonitis. She presented to the ED again due to persistent abdominal pain, N/V. The PD fluid analysis confirmed the third episode of peritonitis. During the 3rd episode of peritonitis, the *Ralstonia* species was resistant to most antibiotics which were sensitive during the prior episodes. Based on the sensitivities she was treated with oral Bactrim. Recurrent infection with the same organism even after treating with appropriate antibiotics and duration raised the concern of PD catheter seeding of the organism. Hence, the PD catheter was removed, and the patient was started on hemodialysis.

**Discussion:** *Ralstonia* is Gram-negative bacteria that have the ability to pass through the filters used to sterilize the solutions, resistant to hospital disinfectants, and moreover, a tendency to form a biofilm that enhances the organism's survival and likely plays a role in their frequent antibiotic resistance.

**FR-PO485**

**A Rare Case of Bilateral Pleuroperitoneal Leaks in a Patient on Peritoneal Dialysis**

Bhamini Gutty, Amar M. Mahdi. *University Hospitals Birmingham NHS Foundation Trust, Birmingham, United Kingdom.*

**Introduction:** We present a case of bilateral pleuroperitoneal leaks in a young patient on peritoneal dialysis (PD). Pleuroperitoneal leak is a rare but important complication of PD, occurring in 1%-2% of patients. It is thought to develop due to increased intra-abdominal pressure on a background of congenital or acquired diaphragmatic defects. Patients typically present with dyspnoea but may have a reduction in ultrafiltration. Pleural effusion due to pleuroperitoneal leak is usually unilateral, most commonly on the right. Left sided pleuroperitoneal leaks are uncommon. It is thought that diaphragmatic defects are protected on the left side by the heart.

**Case Description:** This 28-year-old female, on automated PD for 9 months, presented with dyspnoea and a reduction in ultrafiltration. Chest radiograph revealed moderate bilateral pleural effusions, in a euvoalaemic patient with no prior history of heart disease. She underwent diagnostic bilateral thoracentesis which revealed transudative pleural effusions. Left and right pleural aspirates showed a glucose concentration of 16.3 mmol/L and 18.1 mmol/L respectively. Both showed negligible lactate dehydrogenase (<30 U/L) and protein levels (<8 g/L). A paired serum glucose was 3.6 mmol/L (normal range 3.9 - 5.8 mmol/L) and protein was 60 g/L (normal range 60 - 80 g/L). The presence of high pleural fluid glucose relative to serum glucose confirmed the diagnosis of bilateral pleuroperitoneal leaks. She was managed conservatively with peritoneal rest and transitioned to intermittent haemodialysis. PD was discontinued permanently with subsequent removal of her peritoneal catheter. A chest radiograph two weeks later showed complete resolution of the bilateral pleural effusions.

**Discussion:** By having a high index of suspicion in this patient with bilateral pleural effusions, an early diagnosis of bilateral pleuroperitoneal leaks was made. Although pleuroperitoneal leaks are typically right sided, it is important to recognise that clinical presentation may vary and patients can present with bilateral pleuroperitoneal leaks.

**FR-PO486**

**Peritoneal Dialysis Peritonitis With Acinetobacter pittii**

Tushar Bajaj,<sup>1</sup> Nader Ismail,<sup>1</sup> Anuja Trivedi,<sup>2</sup> Menaka Sarav.<sup>1</sup> <sup>1</sup>*University of Chicago Pritzker School of Medicine, Chicago, IL;* <sup>2</sup>*Jackson Park Hospital Foundation, Chicago, IL.*

**Introduction:** *Acinetobacter baumannii* has been reported as an uncommon cause of PD-peritonitis; however, we report the first case of PD-peritonitis caused by *A. pittii*.

**Case Description:** A 49 YO AA Male with ESRD on PD, HTN, and morbid obesity presented with a 4 day history of nausea, emesis, and diffuse abdominal pain. PD fluid was collected as outpatient and patient was started on intraperitoneal (IP) ceftazidime and IP ceftazidime. Patient was PD dependent for two years, never had a prior similar episode, and was oliguric. The patient was not using the sterile aseptic technique as per usual, rather using dish towels to wipe his hand before and after accessing the transfer set. Physical exam pertinent for a distended abdomen, tenderness to light palpation, positive fluid wave, and dullness to percussion. Labs significant for leukocytosis, hypokalemia, and elevated anion gap. Records from initial sample identified organism as *Acinetobacter pittii*. Table 1 demonstrates the fluid characteristics by day. Empirically IP ceftazidime and IP gentamicin was started; however, sensitivity to ceftazidime returned at 4mcg/mL. Patient was started on IP Ceftazidime as last fill for 3 weeks initially; however, increased to 4 weeks due to persistent cloudy effluent. Unfortunately, readmitted to the hospital with abdominal pain, tachycardia, and tachypnea. Due to concerns for sepsis, increased peritoneal fluid count with the same organism, the PD catheter was subsequently removed, patient was placed on IV antibiotics and discharged with intermittent hemodialysis.

**Discussion:** *Acinetobacter pittii* is a strictly aerobic, gram-negative, non-motile, non-lactose fermenting, oxidase negative, catalase positive coccobacilli. Infections outside hospital settings are rare with such organisms, hand hygiene and infection control practices are crucial to reduce incidence. Common presentations of *acinetobacter* peritonitis include abdominal pain, cloudy dialysate fluid, and fever. Our case is important to demonstrate a rare cause of PD peritonitis, the importance of hand hygiene with sterile technique, and elucidate treatment failure.

**Fluid Characteristics by Day**

	Day 1	Day 4	Day 8	Day 28
Fluid Color	Yellow	Colorless	Colorless	Yellow
Appearance	Cloudy	Clear	Clear	Cloudy
Fluid TNC	93557	998	213	41345
Neutrophil %	80	54	57	80

**FR-PO487**

**Flaccid Paralysis in Peritoneal Dialysis Patient After Using Acetazolamide**

Ahmed S. Sbaïh, Adrian J. Baudy, Farah Harasis. *Tulane University School of Medicine, New Orleans, LA.*

**Introduction:** Neurotoxicity is a serious life threatening and rare side effect of Acetazolamide (ACTZ). There are only several studies found in literature about ACTZ toxicity and pharmacokinetics in dialysis patients. Here, we describe an unusual case of a patient with end stage renal disease (ESRD) on peritoneal dialysis (PD) with normal cognitive function that presented with progressive confusion, lethargy and paralysis. We diagnosed him with ACTZ toxicity and he had a complete recovery after treatment.

**Case Description:** A 58-year-old male with ESRD due to diabetes (DM) on PD was admitted for 3 days of confusion and progressive weakness that presented with flaccid paralysis. Complete workup for cognitive impairment including blood test and images were done without identify a cause. Detailed history was taken and we determined that his symptoms started after treated with high dose of ACTZ 250 mg thrice a day as prescribed by his ophthalmologist after cataract surgery. Symptoms started after 500mg taken over 16 hours and he became paralyzed and confused after 2250 mg over 3 days. ACTZ was stopped on the day of admission, and we did daily PD. He started to improve after 3 days and completely recovered after 8 days of last dose and daily PD with total 93 hours.

**Discussion:** ACTZ is a carbonic anhydrase inhibitor commonly used to reduce intraocular pressure. Since it is entirely excreted in the urine, accumulation and severe side effects may occur with renal impairment. Toxicity is more common in advance age, diabetes, concurrent salicylates use and in renal impairment or ESRD as it depends on renal clearance. Symptoms included lethargy, drowsiness, confusion, and coma which are potentially reversible with early diagnosis and treatment. Early diagnosis is important to avoid life threatening conditions and should be considered in any patient with CKD or ESRD receiving high dose of ACTZ came with neurological symptoms or metabolic acidosis, as it blocks absorption of bicarbonate. Levels should be measured to help in the diagnosis. The drug should be stopped as soon as the diagnosis is made and started on dialysis immediately. The time of recovery vary according to patient condition and risk factors and half-life of ACTZ in PD patient according to one study is prolong to 28.5 hours with continuous PD compared to patient with normal renal function, in which the half-life is 5-10 hours.

FR-PO488

**Developing a Predictive Model for Adverse Outcomes for Patients on Peritoneal Dialysis (PD)**

Alex Blair, Yang Dai, Hwei Hsun Wen, Eric Wu, Girish N. Nadkarni, Shuchita Sharma, Jaime Uribarri, Lili Chan. *Icahn School of Medicine at Mount Sinai, New York, NY.*

**Background:** Peritonitis, cardiac events, and inadequate dialysis are leading causes of morbidity, mortality, and technique failure in PD. New automated cyclers provide remote data that may improve prediction of events

**Methods:** This is a retrospective single-center study of PD patients at the Mount Sinai Kidney Center between 2019 and 2021. We included patients >18 years of age using cyclers with data available on Shoresource. The outcome of interest was a composite of time to first peritonitis, death, or technique failure. Models were developed using Cox regression with covariates selected via univariate testing (p-value ≤0.1) or clinical input. Correlated covariates were removed. Model 1 included demographic variables (age, gender, race/ethnicity) and Elixhauser Comorbidity Index (ECI). Model 2 included model 1 + mean and standard deviation (SD) of 30-day Shoresource Data (blood pressure (BP), pulse, total ultrafiltration (UF), and night fill volume). Model 3 was similar to model 2 but included Shoresource data as time-varying covariates. To evaluate each model, the cohort was split into 70/30 testing and training sets and iterated 100 times. Model performance was assessed using area under the receiver operator characteristic curves (AUC) over time

**Results:** We identified 95 patients with complete remote data, 59 with composite endpoint and 36 controls. Patients with the composite outcome were older (59 vs. 53), more often male (59% vs. 39), and had higher ECI (7.9 vs 5.8). With univariate testing, ECI, BP SD, and total UF SD were significantly associated with events. Model 3 which included the Shoresource data as time-varying covariates had the best performance with an average AUC of 0.724 (Figure 1). In all models, performance was best during the first 6 months of follow-up

**Conclusions:** Addition of Shoresource data as a time-varying covariate improved model performance for prediction of a composite clinical outcome. This model could be used to identify new start PD patients who are at high risk of adverse outcomes

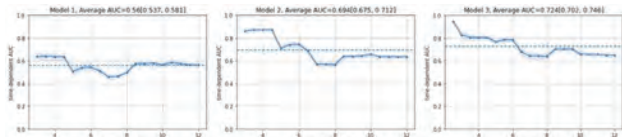

Figure 1: 12-month time-varying ROC curves of models 1 (AUC 0.56), 2 (AUC 0.69), and 3 (AUC 0.72)

FR-PO489

**A Dominican Republic National Health System Retrospective Multi-center Peritonitis Study in Peritoneal Dialysis Patients According to the 2022 ISPD Guidelines**

Erwin I. Campos,<sup>1,2</sup> Elianny S. Polanco,<sup>1</sup> Sergio O. Hernandez-Ordóñez,<sup>1</sup> Mercedes Aquey,<sup>1</sup> Janny Guzman Chavez,<sup>1</sup> Miguel A. Cuevas Budhart,<sup>3</sup> Jose C. Divino-Filho,<sup>4</sup> Alfonso Ramos,<sup>1</sup> Macrotech <sup>Macrotech, Santo Domingo, Dominican Republic;</sup> <sup>Hospital Salvador Bienvenido Gautier, Santo Domingo, Dominican Republic;</sup> <sup>Instituto Mexicano del Seguro Social, Ciudad de Mexico, Mexico;</sup> <sup>Division of Renal Medicine, CLINTEC, Stockholm, Sweden.</sup>

**Background:** Among the peritoneal dialysis (PD) complications, those microbial related or infectious peritonitis figures as the most frequent. Peritonitis (P) is recognized as one of the main causes of technique failure and HD transfer. It is associated with faster loss of residual renal function, greater peritoneal membrane damage (sclerosis) and consequently PD adequacy issues. Also, those with P have a lower quality of life and impose a higher healthcare expenditure<sup>(1)</sup>. Early on this year, the ISPD recommended a new target for the overall peritonitis rate and the percentage of patients free of P per unit time<sup>(2)</sup>. Our aim is to apply these new ISPD targets to our 7-year PD cohort.

**Methods:** A retrospective, multicentric, and descriptive cohort study in patients with PD, belonging to the National Health System of the Dominican Republic. Conducted between January 1, 2016, and December 31, 2021. Sociodemographic data and disease characteristics were included. Quantitative variables are expressed as mean ± standard deviation, while qualitative variables were presented with absolute and relative frequencies. In addition, the incidence of peritonitis rate, HD transfer, deaths, and cure was analyzed. The Peritonitis was diagnosed according to the ISPD guidelines.

**Results:** A total of 4,575 PD patients were included, 57% men; the mean age was 49 ± 19 years, 53% had Diabetes Mellitus (DM) diagnosis, and 65% had a basic educational level. Patients censored were 151 (11%). 575 peritonitis episodes were recorded, the median time to the 1st peritonitis event was 476 days, 81% episodes cured, 10% were transfer to HD 7.3% death, and 63 patients present more than 1 peritonitis episode. The overall peritonitis rate was 0.13/year, having 53% of positive cultures.

**Conclusions:** Our PD program showed a superior peritonitis rate than that recommended by the new ISPD 2022 guidelines. We found no difference between our HD transfer rate and that reported by other programs. We still need to improve our culture-negative peritonitis rates which are high (47%). As a result of our continuous quality improvement (CQI) program, home visit, and follow-up protocol explains the median time to the 1st peritonitis event, far beyond the year.

**Funding:** Commercial Support - Macrotech

FR-PO490

**The Prevalence of Frailty in Patients on Peritoneal Dialysis**

Yi-Ting Chen, Shuei-Liong Lin, Yung-Ming Chen. *National Taiwan University Hospital, Taipei, Taiwan.*

**Background:** Frailty is an age-related disorder and it is associated with fall, hospitalization and mortality. Recent studies displayed high prevalence of frailty in chronic kidney disease and hemodialysis population but the study of patients under peritoneal dialysis (PD) was rare. The aim of this study was to evaluate the prevalence of frailty in patients on PD.

**Methods:** We prospectively enrolled patients under PD. The Asian Working Group for Sarcopenia criteria, the Fried Frailty phenotype and the Frailty Index 80 (FI<sub>80</sub>) were used to diagnose sarcopenia and frailty and second times survey were measured after 6 months.

**Results:** Totally 337 patients under PD had been enrolled since Jan. 01 to Dec. 31, 2020. 258 of whom were prevalent PD patients and others were incident PD patients. The prevalence of frailty in all patients were 73 (21.7%). Incident PD patients had initially higher frailty rate and improved after starting dialysis. Although elderly patients (age>75 years) had initially improved frailty but aggravated when dialysis more than 5 years.

**Conclusions:** Dialysis improved frailty in incident PD patients and frailty transitions were common in prevalent PD patients. However, frailty in elderly patients with PD more than 5 years was worse.

**Funding:** Clinical Revenue Support

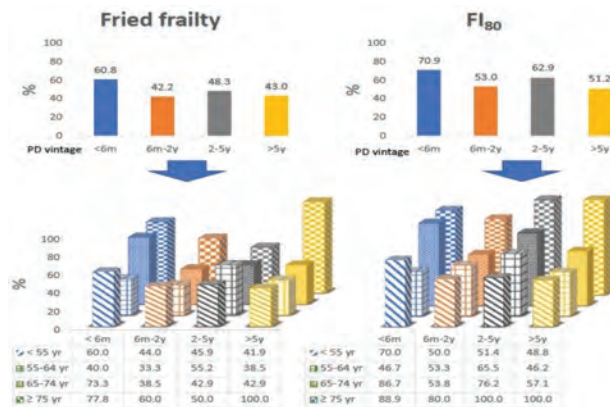

FR-PO491

**Increased Access, Widened Inequities: Trends in Disparities in Peritoneal Dialysis Access, 2010-2020**

Christopher D. Knapp,<sup>1</sup> Jiannong Liu,<sup>2</sup> Haifeng Guo,<sup>2</sup> Eric D. Weinhandl,<sup>3,2</sup> James B. Wetmore,<sup>2,4</sup> Kirsten L. Johansen.<sup>2,4</sup> <sup>Hennepin Healthcare, Minneapolis, MN;</sup> <sup>Hennepin Healthcare Research Institute, Minneapolis, MN;</sup> <sup>Satellite Healthcare, San Jose, CA;</sup> <sup>University of Minnesota Twin Cities, Minneapolis, MN.</sup>

**Background:** The percentage of incident dialysis patients electing PD as their initial dialysis modality increased over the last decade. Prior to 2010, PD rates were lower among patients of lower socioeconomic status, older age, urban residence, and Black and Hispanic race/ethnicity. We examined how the increased uptake of PD has changed these disparities.

**Methods:** We used USRDS data to generate PD usage rate among demographic groups of interest (race/ethnicity, neighborhood characteristics using the Social Deprivation Index (SDI), sex, age, rural/urban residence) for incident ESKD patients on dialysis in the US each year between 2010-2020. We analyzed the change and difference of change of PD rate among these groups using generalized linear regression.

**Results:** The proportion of incident dialysis patients selecting PD approximately doubled over the period. Rates of PD usage among incident patients increased more among Asian patients relative to White patients (0.88% annual increase vs 0.58%) and more among White than among Black patients (0.43% per year). The proportion initiating dialysis using PD also increased faster in more advantaged neighborhoods relative to less advantaged ones (0.74% for SDI ≤33 vs. 0.43% for SDI ≥67). Younger patients experienced higher annual increases in PD usage (0.68% for 18-44 vs. 0.50% for age 75+), but older patients had the highest growth in PD use compared to their 2010 baseline (255% increase from 2010 to 2020 for 75+ vs. 178% for 18-44).

**Conclusions:** The increase in PD use resulted in worsened disparities among race groups and SDI groups, in an absolute sense. However, PD access for older patients grew substantially, perhaps as a result of improved payment incentives or increased provider comfort with PD in this population. Further studies of racial and economic disparities in PD access are indicated.

**Funding:** NIDDK Support

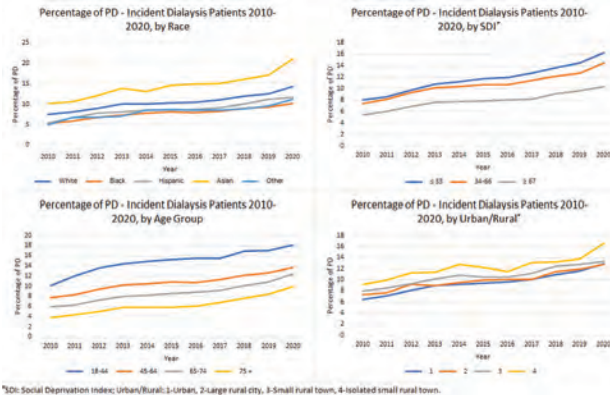

Trend of PD access (% of all incident dialysis patients among age, race, SDI, and rural/urban groups)

FR-PO492

Peritoneal Transport of Small and Large Solutes During Long Dwells With Icodextrin

Bengt Lindholm,<sup>1</sup> Joanna Stachowska-Pietka,<sup>2</sup> Jacek Waniewski,<sup>2</sup> Anna Olszowska,<sup>3</sup> Elvia Garcia-lopez,<sup>1</sup> Zofia Wankowicz,<sup>2</sup> <sup>1</sup>Karolinska Institutet, Stockholm, Sweden; <sup>2</sup>Institut Biocybernetyki i Inżynierii Biomedycznej im Macieja Nalecz Akademii Nauk, Warszawa, Poland; <sup>3</sup>Wojskowy Instytut Medyczny, Warszawa, Poland.

**Background:** Whereas icodextrin maintains effective ultrafiltration during long exchanges, data on solute removal and kinetics in long dwells with icodextrin are more scarce. We investigated impact of dwell duration up to 16h on the removal of small and large solutes.

**Methods:** Twenty patients underwent 16-h dwell with icodextrin. I-albumin was used as volume marker and frequent dialysate plasma samples were taken during the dwell. Clearances were evaluated at 4, 8, and 16-h of dwell for glucose, urea, creatinine, sodium, potassium, b2-microglobuline, total proteins, albumin, and IgG as the mass removed divided by the solute average plasma concentration and dwell duration.

**Results:** Ultrafiltration was increasing during the whole dwell to 0.7±0.3L after 16h. Lower small solutes clearances were found after 4h for glucose (on average from 5.7±1.2 at 4h to 3.0±0.7 at 16h), urea (5.2±0.9 to 3.0±0.5), creatinine (4.8±1.0 to 2.9±0.5), and potassium (4.6±0.9 to 2.5±0.5) mL/min and decreased only between 4 and 8h for sodium (1.2±0.8 to 0.8±0.4) mL/min with p<0.001. Moreover, although small solute concentrations in dialysate increases, they were not fully equilibrated with plasma (D/P being lower than 1 after 16h in case of urea, creatinine, potassium and sodium, p<0.001). Increase of urea and creatinine plasma concentration (by 6 and 4%, respectively) at 16 vs. 4h was found (p<0.001). In case of larger molecules, a decrease from 4 to 8h was found for b2-microglobuline (1.5±0.5 to 1.2±0.4) mL/min, total proteins (85.9±29.9 to 70.1±25.0), albumin (90.4±34.6 to 75.8±29.1), and IgG (74.1±28.0 to 60.5±23.5) μL/min with p<0.001, whereas after 8h it was significant only in case of IgG and total proteins with p<0.05, reaching at 16h 56.0±19.6 and 61.4±18.4 μL/min, respectively.

**Conclusions:** The rate coefficient (clearance) of small and large solute removal slows down with dwell time but is still maintained at 16-h dwell with icodextrin, especially for small solutes that are not fully equilibrated at the end of the dwell.

**Funding:** Government Support - Non-U.S.

FR-PO493

Peritoneal Small Solute Transfer Rate (PSTR) vs. Clinical Outcome in Peritoneal Dialysis Patients: Assessment by Restricted Mean Survival Times (RMST)

Rafael A. Gomez,<sup>1</sup> Bengt Lindholm,<sup>2</sup> Abdul Rashid T. Qureshi,<sup>1</sup> <sup>1</sup>Servicio de Terapia Renal Cali SAS, Cali, Colombia; <sup>2</sup>Karolinska Institutet, Stockholm, Sweden.

**Background:** Fast PSTR is in most studies linked to worse outcomes. To explore the impact of PSTR on clinical outcomes in patients undergoing chronic peritoneal dialysis (PD) in Colombia, we analyzed RMST, a robust and clinically interpretable measure that quantifies the entire observed survival curve.

**Methods:** In a cross-sectional study using peritoneal equilibration test (PET), 8170 prevalent PD patients, 2705 on APD and 5465 on CAPD, were classified by PSTR according to Twardowski method into slow (16.0%), slow average (35.4%), fast average (32.9%) and fast (15.7%) PSTR categories. Demographic and clinical variables were recorded. During follow-up for a median of 1.99 years, 2633 patients died, and 661 patients underwent renal transplantation. All-cause mortality, cardiovascular disease (CVD) mortality, and technique survival were analyzed with RMST and restricted mean time lost (RMTL), adjusting for age, sex, body mass index, albumin, Hb, phosphate, residual renal function, presence of diabetes and hypertension.

**Results:** RMST analysis showed that fast PSTR as compared to slow PSTR associated with shorter patient survival due to all-cause mortality (by -0.28 years; p=0.003) or due

to CVD related mortality (by -0.18 years; p=0.05 as well as shorter technique survival (by -0.22 years; p=0.03) whereas associations of fast-average PSTR with clinical outcomes were not statistically significant.

**Conclusions:** Analysis using RMST confirms that fast PSTR as compared to slow PSTR is associated with impaired patient and technique survival. However, the magnitude of the survival disadvantage (about 0.2 years) may not be clinically significant.

**Funding:** Commercial Support - Baxter Healthcare Corporation, Government Support - Non-U.S.

FR-PO494

Consistency in Membrane Transport in Early and Later Peritoneal Equilibration Testing

Paul E. Smith,<sup>1</sup> Michelle Carver,<sup>2</sup> Christopher R. Rutzen,<sup>1</sup> Sarah Ledoux,<sup>1</sup> Samantha Draughon,<sup>1</sup> Angela L. Davis,<sup>1</sup> Bridget R. Robideaux,<sup>1</sup> Selma Johnson,<sup>1</sup> Joanna Willetts,<sup>2</sup> Sheetal Chaudhuri,<sup>2</sup> John W. Larkin,<sup>2</sup> Dinesh K. Chatoth,<sup>1</sup> The Early PET Group <sup>1</sup>Fresenius Kidney Care, Waltham, MA; <sup>2</sup>Fresenius Medical Care, Global Medical Office, Waltham, MA.

**Background:** The peritoneal equilibration test (PET) has been recommended to be done 6-12 weeks after starting peritoneal dialysis (PD) (Morelle, Perit Dial Int 2021). The PET requires a special overnight pre-exchange process and 4-hour dwell in the clinic, which can be challenging for patients to complete. This can be seen by estimates suggesting >30% PD patients do not have a PET (Mehrotra, CJASN 2015). There is a lack of evidence defining optimal timing for the PET and it might be easier for patients to complete during PD training. We conducted a quality improvement pilot to evaluate if repeated PET results differ during training versus 6-12 weeks after PD start.

**Methods:** From Jan 2020 to Aug 2021, incident PD patients treated at a network of clinics could have a PET ordered during in-center training (typically the first 14 days of PD) and 6-12 weeks after PD start. The D/D0 glucose (ratio of dialysate glucose at 4 vs 0 hours) and D/P creatinine (ratio of dialysate vs plasma creatinine at 4 hours) was assessed between each patient's two PET tests using correlation statistics and ANOVA.

**Results:** Forty-four PD patients from 32 clinics (mean age 55±13 years, 43% female, 50% Black race, 11% Hispanic ethnicity, and 61% with diabetes) had a PET during training and another repeated later (mean=52 days & median=47 days between PETs). There were strong correlations in D/D0 glucose (correlation coefficient=0.45, p<0.001, **Figure 1A**) and D/P creatinine (correlation coefficient=0.43, p<0.001, **Figure 1B**) between the PET during training versus 6-12 weeks after PD start.

**Conclusions:** We found the profiles of peritoneal membrane solute transport identified in the PET during training were significantly correlated to and representative of the membrane transport kinetics performed 6-12 weeks after initiation of PD. It appears the membrane transport characteristics are reasonably consistent throughout the first months of PD.

**Funding:** Commercial Support - Fresenius Medical Care

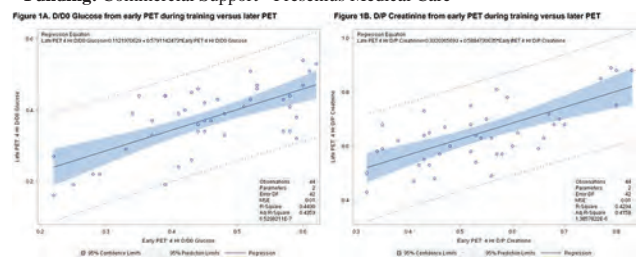

FR-PO495

Successful Measurement of Intraperitoneal Pressure (IPP) in Peritoneal Dialysis Patients With a Pressure Transducer Demonstrates Significant Interindividual Variation and a Complex Relationship With IP Volume

Jaime Uribarri,<sup>1</sup> Nabeel Aslam,<sup>2</sup> Shuchita Sharma,<sup>1</sup> Marzuq M. Billah,<sup>1</sup> Alyssa Wilmington,<sup>3</sup> Brad Keller,<sup>3</sup> Matthew R. Muller,<sup>3</sup> Peter Rutherford,<sup>3</sup> <sup>1</sup>Icahn School of Medicine at Mount Sinai, New York, NY; <sup>2</sup>Mayo Clinic Florida, Jacksonville, FL; <sup>3</sup>Baxter International Inc, Deerfield, IL.

**Background:** High IPP has been linked to abdominal fullness, mechanical complications and reduced ultrafiltration. Studying IPP is limited by the cumbersome manual fluid manometry method. A device making IPP measurement easier to conduct regularly may assist clinicians to adjust prescribed fill volumes (V). This study determined whether pressure-transducer IPP measurement is related to manual IPP measurement and fill volume

**Methods:** IPP measured by a commercially-available transducer was compared to IPP measured simultaneously by fluid manometry in a PD disposable set in 10 APD patients over 3 replicate fill cycles. IPP was measured after the drain, after 750ml fill volume and after 5 additional equidistant increments [(prescribed fill volume - 750ml)/5] up to the individual's prescribed fill volume

**Results:** There was moderate overall agreement between transducer and manual IPP measurements (±3 cm H<sub>2</sub>O, Figure 1), with no systematic biases observed across the range of measured IPP. Large inter-patient variability in IPP was observed; at 750 ml of fill volume, IPP varied from 4-20 cm H<sub>2</sub>O. There was a lack of correlation between the transducer derived IPP and fill volume among the patients (Spearman correlation coefficient 0.2). All 10 patients showed a significant relationship between IPP and IPV

at an individual level, but with significant inter-patient variation in slope and intercept of the best fit line. A potential joint relationship between IPP, IPV and patient weight was observed

**Conclusions:** IPP can be measured with a pressure transducer, results are similar to the manual method but is easier to perform. IPP is highly variable across individuals and has complex relationships with fill volume in individual patients meriting further study to determine the clinical utility of IPP measurement

**Funding:** Commercial Support - Baxter

Figure 1 Scatterplot of Transducer-derived IPP vs Manual IPP

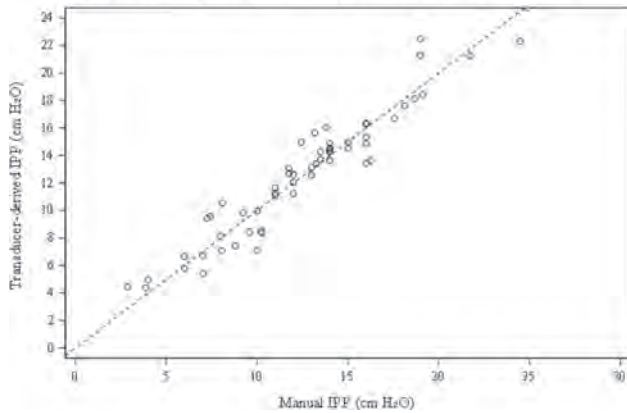

FR-PO496

Assessment of Fluid Transport Between Extra- and Intraperitoneal Spaces During Peritoneal Dialysis Using Segmental Bioimpedance

Fansan Zhu,<sup>1</sup> Laura Rosales,<sup>1</sup> Lela Tisdale,<sup>1</sup> Maricar Villarama,<sup>3</sup> Peter Kotanko.<sup>1,2</sup> <sup>1</sup>Renal Research Institute, New York, NY; <sup>2</sup>Icahn School of Medicine at Mount Sinai, New York, NY; <sup>3</sup>Mount Sinai Hospital Mount Sinai Heart, New York, NY.

**Background:** In peritoneal dialysis (PD), ultrafiltration (UF) failure is generally attributed to excessive absorption of dialysate from the peritoneal cavity. Currently, we are lacking methods to measure the peritoneal fluid absorption rate. Our goal was to evaluate whether fluid absorption and UF can be assessed by monitoring intraperitoneal fluid volume using segmental bioimpedance analysis (SBIA).

**Methods:** Twenty PD patients were studied during either a peritoneal equilibration test (PET; n=7) or automated PD (APD; n=13). Eight electrodes were placed on the lower abdomen (Fig.1) and connected to a bioimpedance device (Hydra 4200). The abdominal extracellular volume ( $V_{ABD}$ ) was measured comprising the tissues surrounding the peritoneal cavity ( $V_{EPF}$ ) plus the intraperitoneal ( $V_{IPF}$ ) fluid (Fig.2). Baseline was defined as the  $V_{ABD}$  at the state prior to dialysate fill ( $V_{IPF} = 0$ ).  $\Delta V_{EPF}$  was calculated after dialysate drainage ( $V_{IPF} = 0$ ) minus the baseline.  $\Delta V_{Dwell}$  was defined as  $V_{ABD}$  at the end, minus  $V_{ABD}$  at the start of the dialysate dwell. The change in  $\Delta V_{Dwell}$  was due to UF or fluid absorption. The clinically measured UF volume ( $UFV_{Clin}$ ) was calculated as the weight of the drained dialysate fluid minus the dialysate fill (2 L; approximated as 2 kg).

**Results:**  $UFV_{Clin}$  and  $UFV_{SBIA}$  were highly correlated (PET:  $R^2=0.98$ ,  $p<0.0001$ ; APD:  $R^2=0.94$ ,  $p<0.0001$ ) (Fig.3).  $\Delta V_{Dwell}$  decreased in eight patients (2 PET; 6 APD) (Fig.4) which indicated absorption of  $V_{ABD}$ ; it was stable in nine patients (4 PET; 5 APD) (Fig.5) and increased in three (1 PET; 2 APD). Stable  $\Delta V_{EPF}$  ( $\Delta V_{EPF}=0$ ) was observed in three PET patients, allowing us to explore its association with membrane transport status; notably, stable  $\Delta V_{EPF}$  was associated with high glucose transport.

**Conclusions:** This pilot study demonstrated a new bioimpedance approach to monitor fluid changes between extra- and intraperitoneal compartments. If confirmed in a larger population, the method may provide a direct measurement of fluid transport across the peritoneal membrane.

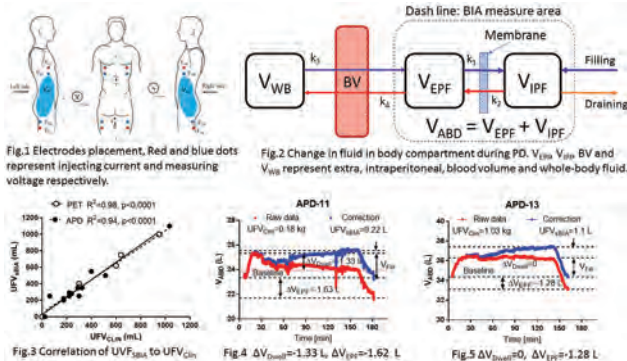

Fig1

FR-PO497

Genetic Determinants of Ultrafiltration With Peritoneal Dialysis

Ian B. Stanaway,<sup>1,12</sup> Olivier Devuyst,<sup>2,5</sup> Jeffrey Perl,<sup>3</sup> Mark Lambie,<sup>4</sup> Johann Morelle,<sup>5</sup> Gail P. Jarvik,<sup>1</sup> Arsh Jain,<sup>9</sup> Jonathan Himmelfarb,<sup>1,12</sup> Olof Heimbürger,<sup>8</sup> David W. Johnson,<sup>10,11</sup> James L. Pirkle,<sup>6</sup> Bruce M. Robinson,<sup>7</sup> Peter Stenvinkel,<sup>8</sup> Simon J. Davies,<sup>4</sup> Rajnish Mehrotra.<sup>1,12</sup> Bio-PD Consortium <sup>1</sup>University of Washington School of Medicine, Seattle, WA; <sup>2</sup>University of Zurich, Zurich, Switzerland; <sup>3</sup>University of Toronto, Toronto, ON, Canada; <sup>4</sup>Keele University, Keele, United Kingdom; <sup>5</sup>Cliniques Universitaires Saint-Luc, Brussels, Belgium; <sup>6</sup>Wake Forest University, Winston-Salem, NC; <sup>7</sup>Arbor Research Collaborative for Health, Ann Arbor, MI; <sup>8</sup>Karolinska Universitetssjukhuset, Stockholm, Sweden; <sup>9</sup>London Health Sciences Center, London, ON, Canada; <sup>10</sup>Princess Alexandra Hospital, Woolloongabba, QLD, Australia; <sup>11</sup>The University of Queensland, Saint Lucia, QLD, Australia; <sup>12</sup>Kidney Research Institute, Seattle, WA.

**Background:** The inter-individual variability in the peritoneal dialysis (PD) ultrafiltration (UF) capacity is largely unexplained by demographic and clinical variables. We tested the hypothesis that common genetic variants are associated with variability in UF.

**Methods:** The Bio-PD study enrolled participants from 69 centers in 6 countries. The phenotype of UF volume at 4 hours was obtained from the 1<sup>st</sup> peritoneal equilibration test (PET) when starting PD. Genotyping was done with the Illumina InfiniumOmni2-5 array and imputed using the Michigan Imputation Server. Heritability was estimated using genomic-restricted maximum likelihood analysis, genome-wide association was performed for single nucleotide variants (SNVs) with minor allele frequency >2%, and gene-wise analyses were done with the Generalized Berk-Jones test. Analyses were adjusted for sex, age, body mass index, country, diabetes, dialysate dextrose concentration, interval between PD start and PET, and principal components of ancestry. Additional analyses included 4-h Dialysate/Plasma (D/P) creatinine ratio as covariate.

**Results:** Analysis included 2413 participants (64% men, 32% diabetes, 82% White). The PETs were done at a median of 63 days (IQR 36-121) from PD start, 78% were completed with 2.5% dextrose, with a mean 4-h D/P creatinine of 0.70 and a median UF of 250mL (IQR 0-494). The heritability of UF was estimated at 58% and 42% in models without and with 4-h D/P creatinine, respectively ( $p=6 \times 10^{-4}$  and 0.01). No SNV reached genome-wide significance using 7,052,235 SNVs. Analyses testing association with 18,330 genes showed significant association of 3 genes at a false discovery rate (FDR) <10% (*PTGES* FDR=0.02, *GPHN* FDR=0.04, *SLC24A3* FDR=0.05). Further adjustment for 4-h D/P creatinine showed association with 2 genes remained significant (*PTGES* and *SLC24A3*).

**Conclusions:** Common genetic variants account for a substantial proportion of the variability in UF and these analyses suggest a potential association with variation in *PTGES* and *SLC24A3* genes.

**Funding:** NIDDK Support, Government Support - Non-U.S.

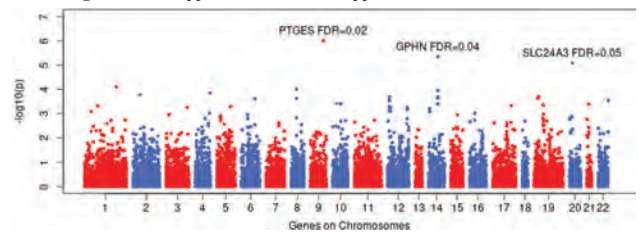

FR-PO498

Phloretin Improves Ultrafiltration and Reduces Glucose Absorption During Peritoneal Dialysis in Rats

Karin Bergling, Giedre Martus, Carl M. Öberg. Lunds Universitet, Lund, Sweden.

**Background:** Harmful glucose exposure and absorption remain major limitations of peritoneal dialysis. We previously showed that inhibition of sodium glucose co-transporter 2 did not affect glucose transport during peritoneal dialysis in rats. However, more recently we found that phlorizin, a dual blocker of sodium glucose co-transporter 1 and 2, was effective in reducing glucose diffusion in peritoneal dialysis, implicating either that sodium glucose co-transporter 1 inhibition or blockade of facilitative glucose channels by phlorizin metabolite phloretin would be effective in reducing glucose transport in peritoneal dialysis.

**Methods:** Here we tested a selective blocker of sodium glucose co-transporter 1, mizagliflozin, as well as phloretin, a non-selective blocker of facilitative glucose channels in an experimental model of peritoneal dialysis in anesthetized Sprague-Dawley rats.

**Results:** Intra-peritoneal phloretin treatment reduced glucose absorption by more than 30% and resulted in a more than 50% higher ultrafiltration rate compared to control animals. Sodium removal and sodium clearances were similarly improved, whereas there was no difference in the amount of ultrafiltration per mmol sodium removed. Mizagliflozin did not influence glucose transport or osmotic water transport.

**Conclusions:** Taken together, our present and previous results indicate that blockers of facilitative glucose channels may be a promising target for reducing glucose absorption and improving ultrafiltration efficiency.

**Funding:** Government Support - Non-U.S.

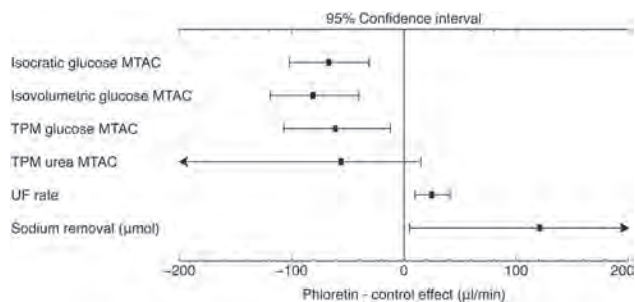

**Forest plot of phloretin effect sizes.** 95% confidence intervals of phloretin effect on Isocratic, Isovolumetric and Three-pore model glucose diffusion capacity (MTAC), Three-pore model urea MTAC, ultrafiltration-rate (UF-rate) and sodium removal compared to sham group. Interval marker represent the median of the difference.

**FR-PO499**

**Association of Bioimpedance Guided Fluid Management in Patients Receiving Peritoneal Dialysis and Cardiovascular Outcomes: A Systematic Review and Meta-Analysis**

Sara S. Almutair, Conor S. Judge, Abdulmajeed A. Alsadhan, K. S. Brimble, Peter Margetts. *McMaster University, Hamilton, ON, Canada.*

**Background:** Fluid management in patients receiving peritoneal dialysis is a major challenge for nephrologists. This systematic review and meta-analysis evaluates the association with bioimpedance guided fluid management in patients receiving peritoneal dialysis and cardiovascular outcomes.

**Methods:** PubMed, Embase and CENTRAL were searched from database inception to 09-Jan-2022 for randomized clinical trials comparing bioimpedance and clinical examination guided fluid management in patients receiving peritoneal dialysis. A random-effects meta-analysis was used to estimate the pooled treatment-effect. The primary outcome measure was a composite cardiovascular outcome. Secondary outcome measures included all-cause mortality, cardiovascular mortality, hospitalizations, technique failure, change in systolic blood pressure (mmHg), weight (kg) and urine output (ml/day).

**Results:** Seven trials were eligible for inclusion (n=1238) (mean follow-up: 19 months). The association of bioimpedance guided fluid management compared to clinical examination guided fluid management and cardiovascular outcomes was not-significant (Odds Ratio (OR) 0.81, 95% Confidence Interval (CI), 0.49-1.33; Absolute Risk Reduction (ARR) 2.2%, -3to7.1). Bioimpedance guided fluid management compared to clinical examination guided fluid management was associated with a significant reduction in cardiovascular mortality (OR 0.50, 95%CI, 0.26-0.98, ARR 4.5%, 0.3-8.7), systolic blood pressure (mean reduction -0.2 mmHg [-0.36 to -0.04]) but not all-cause mortality, weight (kg) or residual urine output (ml/day).

**Conclusions:** Bioimpedance guided fluid management in patients receiving peritoneal dialysis compared to control was not associated with a lower incidence of cardiovascular outcomes. However, bioimpedance guided fluid management, compared to control, was associated with statistically significant lower cardiovascular mortality and lower systolic blood pressure without a reduction in residual urine output.

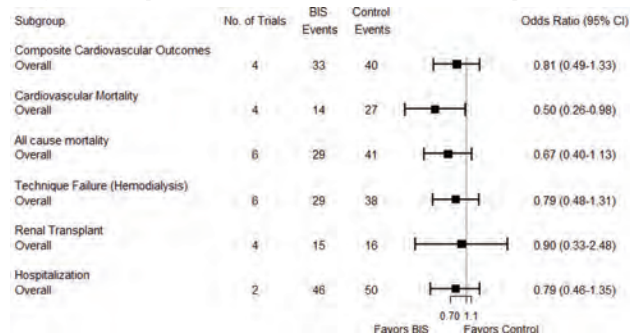

**FR-PO500**

**Peritoneal Dialysis Modality Survival**

Antonia Harford,<sup>1</sup> S. Paine,<sup>1</sup> Nien Chen Li,<sup>1</sup> Karen M. Majchrzak,<sup>1</sup> Christos Argyropoulos,<sup>2</sup> Maria-Eleni Roumelioti,<sup>2</sup> V. Shane Pankratz,<sup>2</sup> Dana Miskulin,<sup>3</sup> Daniel E. Weiner,<sup>3</sup> Caroline M. Hsu,<sup>3</sup> Harold J. Manley,<sup>1</sup> Page Salenger,<sup>1</sup> Doug Johnson,<sup>1</sup> Eduardo K. Lacson.<sup>1,3</sup> <sup>1</sup>Dialysis Clinic Inc, Nashville, TN; <sup>2</sup>University of New Mexico Health Sciences Center, Albuquerque, NM; <sup>3</sup>Tufts Medical Center, Boston, MA.

**Background:** Given limited modality longevity, we evaluated incident peritoneal dialysis (PD) patients at different time points after ESRD start date to identify modifiable factors to improve modality survival.

**Methods:** Incident dialysis patients treated by a national not-for-profit dialysis provider from Jan 2010-Dec 2019 were included in multivariable time-dependent survival analyses. A priori, patients were stratified into 3 groups: PD as initial modality; early conversion from HD to PD (<90 days); or late conversion to PD (≥90 days). Other model variables included patient and facility characteristics. The outcome of interest was sustained transfer to HD for >90 days. Transplant, death or dialysis withdrawal while remaining on PD were considered as competing events. Patients were censored at 5 years follow-up, loss to follow-up or study end.

**Results:** Among 5173 PD patients, 3132 patients initiated dialysis with PD, 937 transitioned early and 1104 transitioned late; 1459/5173 (28%) of the entire cohort subsequently switched from PD to HD. Patients who initiated dialysis with PD were at lowest risk of modality switch, while those with ≥2 peritonitis episodes had the highest risk of modality switch. Prior HD exposure was associated with lower PD modality survival, while higher renal (K<sub>rt</sub>/V) and peritoneal (K<sub>pt</sub>/V) clearances and higher serum albumin were associated with lower modality switch risk (Table). Patient age, sex, race, ESRD cause, number of training days, PD program size and year of training were not significant.

**Conclusions:** Initiating dialysis with PD is associated with increased modality survival while other potentially modifiable factors including peritonitis are associated with decreased PD longevity, highlighting potential strategies including preserving residual renal function and peritoneal membrane function which may increase PD modality survival.

**Table: Significant factors associated with patient modality switch from PD to HD**

Variable	Hazard Ratio	95% Confidence Interval
Peritonitis episodes, ≥2 vs none	5.41	4.61, 6.36
Peritonitis episode, 1 vs none	3.22	2.82, 3.69
Late vs Immediate PD start	1.43	1.26, 1.63
Early vs Immediate PD start	1.21	1.05, 1.39
BMI, per 5 kg/m <sup>2</sup> increase	1.07	1.04, 1.11
K <sub>rt</sub> /V, per 0.1 unit increase	0.93	0.92, 0.95
K <sub>pt</sub> /V, per 0.1 unit increase	0.98	0.96, 0.99
Albumin, per 0.1 g/dL increase	0.93	0.92, 0.94

**FR-PO501**

**Rheologic and Fill/Drain Pressure Differences Between a Novel Gravity-Based Automated Peritoneal Dialysis Cyclers (APD) and Conventional Pump-Based Cyclers**

Steve J. Lindo,<sup>1</sup> Rick Pendergraft,<sup>1</sup> Jacob D. Henderson,<sup>1</sup> James A. Sloand.<sup>1,2</sup> <sup>1</sup>Simergent, LLC, Oklahoma City, OK; <sup>2</sup>Division of Kidney Diseases and Hypertension, Washington, DC.

**Background:** APD offers patients selecting Peritoneal Dialysis (PD) greater convenience, autonomy, & lifestyle flexibility than Continuous Ambulatory PD. APD is the predominant mode of PD in the US and other countries. PD fluid inflow and outflow in most contemporary APD cyclers is pump, rather than gravity-based, technology integrated into cyclers for travel portability. However, a previous study showed PD patients and RNs prefer the features of a quiet, gravity-based cyclers with reduced setup time and portability within the home over current pump-driven cyclers. Data have also shown increased delivery/suction pressures generated by pump-driven PD flow can be associated with patient complaints of drain pain and tidal PD used to help address it. Tidal PD is the leading contributor to development of increased intraperitoneal volume (IIPV), a complication potentially leading to patient morbidity and mortality. This evaluation assessed pressures & fill/drain flow rates generated by a novel gravity-based APD cyclers and current commercially-available pump-based APD cyclers.

**Methods:** Manufacturer-specified\* rheologic and fill/drain pressure differences for pump-based cyclers were compared to gravity-based Archimedes cyclers test results†. These fill/drain flow rate tests were conducted *in vitro* using 71 cm bed height, 305 cm patient line, 15 cm transfer set, and a 60 cm curled catheter placed inside a container. A 140 cm heater bag height and 30 cm drain container height were used.

**Results:** Comparative filling and draining pressures & flow characteristics of three cyclers are shown below.

**Conclusions:** The novel Archimedes gravity-based APD cyclers with features previously demonstrated to be preferred by patients and PD RNs achieves comparable rheologic benchmarks using inflow (fill) and outflow (drain) pressures that are much lower than current pump-based cyclers by leveraging continuous flow vs. pulsatile flow. The former has the potential to significantly improve patient experience and reduce drain pain complaints.

**Funding:** Commercial Support - Simergent, LLC, Government Support - Non-U.S.

APD Cycler	Maximum Fill Pressure (cm H <sub>2</sub> O)	Maximum Drain Pressure (cm H <sub>2</sub> O)	Fill Rate (mL/min)	Drain Rate (mL/min)
Simergent Archimedes†	49	-41	218	125
Baxter HomeChoice Pro‡	155	-155	220	125
Fresenius Liberty Select*	663	-255	n/a	100

FR-PO502

The Impact of Urgent Start Peritoneal Dialysis on Patient Outcomes

Rachel A. Lasky,<sup>1</sup> Sheetal Chaudhuri,<sup>1</sup> Derek M. Blankenship,<sup>1</sup> Michael A. Kraus,<sup>1</sup> Murat Sor,<sup>2</sup> Dinesh K. Chatoth,<sup>1</sup> <sup>1</sup>Fresenius Medical Care, Waltham, MA; <sup>2</sup>Azura Vascular Care, Malvern, PA.

**Background:** In the last decade, there has been significant interest in urgent start PD (USPD), defined as use of PD catheter within 14 days of insertion, as a viable option for patients initiating dialysis. This strategy helps increase PD use in a population that typically would have started on HD. Studies have reported higher rate of pericatheter leaks, exit site infections and peritonitis in patients who started USPD compared to conventional starts at FKC clinics.

**Methods:** All FKC PD patients that had a peritoneal catheter placed at an outpatient surgical center or hospital between August 1, 2019 and August 31, 2021 were included. Unadjusted logistic regression was used to compare patients based on the number of days between catheter placement and the first PD treatment: urgent start ( $\leq 14$  days) or conventional start ( $>14$  days). Catheter leaks, peritonitis events, and exit site infections within the first 90 days following catheter placement were identified using electronic medical records. Patient dialysis treatment data were used to identify breaks in training treatments (three days or more between treatments) and back-up treatments.

**Results:** 5,429 urgent start and 17,435 conventional start patients were included. Urgent start patients had 1.3 times the odds of peritonitis when compared to conventional start patients (2.5% vs 1.9%;  $p=0.01$ ). Urgent start patients also had 2.5 times the odds to experience leaks (1.1% vs 0.4%;  $p<0.0001$ ) and 1.5 times the odds to have a break in training treatment ( $p<0.0001$ ). However, urgent start patients had 0.5 times the odds to have a back-up in-center treatment during training ( $p<0.0001$ ). There was no significant difference between groups in exit site infections.

**Conclusions:** In this large incident PD cohort, while USPD patients were more likely to have peritonitis, pericatheter leaks and break in training treatments, rates of both complications in both groups are quite low. Interestingly, the leaks or mechanical complications associated with PD catheters in USPD patients did not result in significant HD backup treatments but were successfully managed with break in PD training treatments.

**Funding:** Commercial Support - Fresenius Medical Care

CATEGORY		N PATIENTS			
Urgent Start ( $\leq 14$ days)		5,429			
Conventional Start ( $>14$ days)		17,435			
N PATIENTS		EVENT	OR	95% CI	P VALUE
URGENT	CONVENTIONAL				
537	541	Peritonitis	1.30	1.052 - 1.596	0.0110
59	77	Leaks	2.48	1.763 - 3.482	<0.0001
262	659	Exit Site Infections	0.98	0.838 - 1.155	0.8426
1,892	4,557	Breaks in treatment	1.51	1.416 - 1.614	<0.0001
595	3,381	Back-up treatment	0.51	0.466 - 0.562	<0.0001

FR-PO503

Analysis of an On-Call Peritoneal Dialysis Support in an Outpatient Reference Care Center

Christian Albert,<sup>1,2</sup> Philipp Kalk,<sup>1</sup> Rainer P. Woitas,<sup>1</sup> Annemarie Albert.<sup>1</sup> <sup>1</sup>Diaverum Deutschland GmbH, Potsdam, Germany; <sup>2</sup>University Clinic for Cardiology, Magdeburg, Germany.

**Background:** To analyze the nature of medical or technical emergency issues of ambulatory peritoneal dialysis (PD) patients calling an after-hours emergency support of a PD reference center that is provided all year.

**Methods:** We retrospectively analyzed patient issues directed to an on-call PD support service comprising complete years from 2015-2021. Calls were systematically categorized being technical/procedural-, medical-, material-related or type of correspondence and analyzed for necessity and urgency. Patients' chief complaint, resolution and association to current PD treatment and modality were documented in protocols. Call outcomes were classified according to whether patients were able to initiate/resume/finalize their treatments or whether additional interventions were required.

**Results:** In total 753 calls were categorized and evaluated. Of those, 51% (N=384) were related to technical issues, 12.35% (N=93) to medical, 10.62% (N=80) to material related issues and 19.21% (N=144) were other correspondences. 6.24% (N=47) were associated with (intermittent)-PD performed in a teaching hospital. Calls peaked at 6:49 a.m. and 6:28 p.m. (each  $\pm 2:36$  hours). We identified 504 calls (66.9% of total calls) with an "immediate consequence". Of those 69.4% (N=350 calls) were technical/procedural issues, 11.3% (N=57) medical, and 5.6% (N=28) material related and 4.6% (N=23) were categorized as other correspondence. Calls regarding I-PD performed in a teaching hospital (N=47) were labeled as urgent, usually performed perioperatively, or being associated with treating peritonitis on the ICU and normal ward. Issues disrupting the course of PD were identified in 481 cases. In 79.83% (N=384) patients were able to initiate, resume or finalize their treatment after phone consultation. Last-bag exchange was used in 5.2% enabling continued therapy in 85.03% of such cases. In 35 cases, the patient was supposed to visit the center at the earliest possible time while acute hospitalization was required in eight cases (4.65%/1.06% of total calls, respectively).

**Conclusions:** In the majority of calls, the on-call PD service provides patients sufficient and adequate support for acute and imminent issues enabling patients to successfully continue, resume or finalize their prescribed treatment. Medical support amends risk of or averting adverse events considerably.

FR-PO504

Adverse Events and Hospitalizations With Remote Monitoring of Patients on Automated Peritoneal Dialysis (APD)

Ramón Paniagua,<sup>1</sup> Abdul Rashid T. Qureshi,<sup>2</sup> Marcela Avila,<sup>1</sup> Alfonso Ramos,<sup>3</sup> Bengt Lindholm,<sup>2</sup> <sup>1</sup>Instituto Mexicano del Seguro Social, Ciudad de Mexico, Mexico; <sup>2</sup>Karolinska Institutet, Stockholm, Sweden; <sup>3</sup>Macrotech Pharmaceutical, Ciudad de Mexico, Mexico.

**Background:** Remote monitoring (RM) of patients (pts) on APD provides new opportunities to prevent cardiovascular (CV) and metabolic complications derived from low ultrafiltration or insufficient dialysis. We analyzed the impact of RM-APD on adverse events (AdEv) and hospitalizations.

**Methods:** In a cluster-randomized, open-label, controlled trial, 21 hospitals were randomly assigned to treat their APD patients with RM-APD (10 hospitals; 403 pts) or conventional APD (11 hospitals; 398 pts). Rates of AdEv and hospitalizations during follow up of one year were analyzed using Poisson regression, adjusting for pts' identity and centers. Incidence-rate ratio (IRR) was calculated with zero-inflated Poisson model.

**Results:** Rates of AdVe including mechanical, hydro balance, CV-related, and metabolic AdEv, as well as all-cause mortality and CV mortality were significantly lower in RM-APD compared to conventional APD, see table chart. Hospitalizations due to mechanical AdEv (IRR 0.41 (95%CI)(0.22-0.66)  $p=0.001$ ) and AdEv linked to fluid overload or insufficient dialysis efficiency (IRR 3.24 (95%CI)(1.24-7.53)  $p=0.03$ ) were less frequent in RM-APD compared to conventional APD. Rates of AdVe and hospitalizations due to PD infection events were similar.

**Conclusions:** This randomized controlled trial shows that remote monitoring adds important advantages to APD by reducing the rate of adverse events and hospitalizations, which may have economic benefits.

**Funding:** Commercial Support - Baxter, Private Foundation Support

Poisson regression for Group APD versus reference RM APD adjusting for patients' identification and centers

	Crude APD /RM-APD	IRR (95% CI)	P> z
PD infection events	100/86 (p=0.12)	1.28(0.69-2.37)	0.42
Mechanical events	62/33(p=0.001)	0.42(0.18-0.98)	0.04
Intra-abdominal pressure events	6/13(p=0.07)	0.48(0.16-1.40)	0.18
Hydric balance events	123/35(p=0.001)	3.44(1.95-6.07)	0.001
Cardiovascular events	79/44(0.02)	1.81(1.03-3.09)	0.03
Metabolic events	108/44(p=0.001)	2.78(1.51-5.38)	0.005
Other events	53/77(p=0.005)	1.01(0.45-2.29)	0.97
All-cause mortality	55/33(p=0.01)	1.82(1.18-2.81)	0.006
Cardio-vascular mortality	24/13(p=0.05)	2.03(1.03-3.97)	0.04

Results of crude analysis is calculated with Chi-square test. IRR incidence rate ratio is calculated with Poisson regression. IRR incidence rate ratio adjusting for patients' identification and centers. PD infection events sum of exit site infections + peritonitis. Mechanical events sum of leaking + disconnection + catheter removal + reverse exchange (during peritonitis). Intra-abdominal pressure events sum of abdominal discomfort + peritoneal/abdominal fluid + intra-abdominal pressure + leakage + transmembrane + hernia. Hydric balance events sum of glomerular filtration + dehydration + overhydration. Cardiovascular events sum of unstable angina + hypertensive crisis + stroke + heart failure + hypertension + acute myocardial infarct + congestive heart failure + chronic heart failure + coronary + stroke + sudden death. Metabolic events sum of malnutrition + hyperglycemia + hyperkalemia + hyperphosphatemia + hypermagnesemia + hypernatremia + acid base disorder + uremia. Other events sum of gastrointestinal disorder + urinary tract infection + respiratory tract infection.

FR-PO505

Cluster Randomized Controlled Trial (CRCT) of Remote Monitoring (RM) of Patients on Automated Peritoneal Dialysis (APD): Impact on Restricted Mean Survival Time (RMST)

Ramón Paniagua,<sup>1</sup> Abdul Rashid T. Qureshi,<sup>2</sup> Marcela Avila,<sup>1</sup> Alfonso Ramos,<sup>3</sup> Bengt Lindholm,<sup>2</sup> <sup>1</sup>Instituto Mexicano del Seguro Social, Ciudad de Mexico, Mexico; <sup>2</sup>Karolinska Institutet, Stockholm, Sweden; <sup>3</sup>Macrotech Pharmaceutical, Ciudad de Mexico, Mexico.

**Background:** RM of patients (pts) on APD provides new opportunities to prevent complications and improve treatment quality. We analyzed the effects of RM-APD with RMST, a robust and clinically interpretable measure which quantifies the survival curve without assumptions of distribution of events.

**Methods:** In a CRCT, 21 hospitals were randomly assigned to use either RM-APD (n=10) or conventional APD (n=11) for the treatment of pts with recent onset of peritoneal dialysis. 403 pts in RM-APD and 398 in APD were followed up for at least one year. Primary outcomes were time to first event of Composite Index 1 (all-cause mortality or adverse event (AdEv) or hospitalization), and Composite Index 2 (cardiovascular mortality, or first AdEv or hospitalization related to cardiovascular disease, fluid overload and insufficient dialysis efficiency). We used and compared RMST and Cox proportional regression analysis for statistical analysis.

**Results:** Overall RM-APD associated with longer RMST resulting in shorter restricted mean time lost. Over 16 months, RM-APD as compared to APD can delay the first occurrence of outcomes by on average: for Composite Index 1 by 0.78 months ( $p=0.09$ ), and its components mortality index 1 by 1.13 months ( $p=0.001$ ), AdVe index 1 by 0.82 months ( $p=0.08$ ) and hospitalization index 1 by 0.68 months ( $p=0.09$ ), and for Composite Index 2 by 1.12 months ( $p=0.01$ ), and its components mortality index 2 by 1.09 months ( $p=0.001$ ), AdVe index 2 by 1.16 months ( $p=0.007$ ) and hospitalization index 2 by 0.94 months ( $p=0.005$ ). Cox regression analysis showed broadly similar results. All-cause and cardiovascular deaths, shifts to hemodialysis and unscheduled visits were more frequent among APD group.

**Conclusions:** Whereas both RMST and Cox analysis show that RM-APD may delay first occurrence of deaths, AdVe and hospitalizations, RMST is more robust as it is free from assumptions of proportional hazards demanded by Cox models.

**Funding:** Commercial Support - Baxter

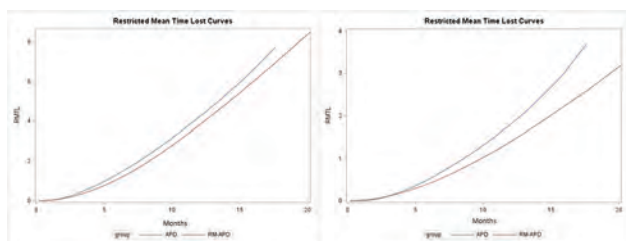

## FR-PO506

### Efficacy of Empirical Voriconazole vs. Amphotericin B Plus Flucytosine in Peritoneal Dialysis Patients With Fungal Peritonitis (VAF Study): Early Results From a Randomized Controlled Trial

Pongpratch Puapatanakul, Somkanya Tungsanga, Talerngsak Kanjanabuch. VAF study steering committee Chulalongkorn University, Bangkok, Thailand.

**Background:** Fungal peritonitis is a rare but life-threatening complication in patients undergoing peritoneal dialysis (PD). We studied the efficacy of two different empirical antifungal regimens for the treatment of PD-related fungal peritonitis.

**Methods:** In a multicenter open-label randomized controlled trial (TCTR20210316001), PD patients aged  $\geq 18$  presenting with fungal peritonitis from 18 centers in Thailand were randomized to receive an empirical antifungal regimen of either oral voriconazole (Vz) 6 mg/kg twice daily on day 1 followed by 4 mg/kg twice daily or intravenous amphotericin B (AmB) 1 mg/kg/day plus oral flucytosine (Fluc) 500 mg twice daily, stratified by fungal types (yeast or mold). The PD catheter was removed as soon as possible, and antifungal drugs were continued for at least 14 days after catheter removal and stopped if clinical response was evident. Change in the antifungal drug was allowed upon knowledge of pathogen species but not earlier than 7 days. The primary outcome was mortality at 90 days.

**Results:** 82 PD patients with fungal peritonitis were enrolled (32 [40%] yeast and 48 [60%] mold) of which 39 and 41 patients received empirical treatment with Vz or AmB plus Fluc, respectively. Empirical drugs resulted in clinical response at 14 days after PD catheter removal, and treatments could be stopped in 87% in Vz group and 83% in AmB plus Fluc group ( $p=0.59$ ). There was a trend toward a higher mortality rate at 90 days in AmB plus Fluc group compared with Vz group but did not reach statistical significance (Vz 5% vs. AmB plus Fluc 20%,  $p=0.052$ ). The proportion of patients in whom physicians attempted to resume PD (Vz 28% vs. AmB plus Fluc 29%,  $p=0.92$ ) and success rate of resuming PD (Vz 82% vs. AmB plus Fluc 83%,  $p=0.92$ ) were not significantly different between treatment groups. Reversible elevation of serum alkaline phosphatase was documented in 5% of patients in Vz group.

**Conclusions:** Both empirical antifungal treatment regimens are feasible and well tolerated by PD patients. A trend of superior 90-day survival for treatment with Vz could be attributable to a high incidence of mold peritonitis in this study.

**Funding:** Commercial Support - Siam Pharmaceutical Co., Ltd. provided study drugs (voriconazole, flucytosine), Government Support - Non-U.S.

## FR-PO507

### Home Dialysis Caregivers in the Veterans Health Administration: Qualitative Study of Motivation, Roles, Experiences, and Needs

Lindsey A. Jones,<sup>1</sup> Elisa J. Gordon,<sup>2</sup> Timothy P. Hogan,<sup>3,4</sup> Cindi Fiandaca,<sup>5</sup> Bridget M. Smith,<sup>5</sup> Kevin Stroupe,<sup>5</sup> Michael J. Fischer.<sup>6,7</sup> <sup>1</sup>VA Information Resource Center, Hines, IL; <sup>2</sup>Northwestern University Feinberg School of Medicine, Chicago, IL; <sup>3</sup>VA Center for Healthcare Organization and Implementation Research, Bedford, MA; <sup>4</sup>Department of Population and Data Sciences, Dallas, TX; <sup>5</sup>Center of Innovation for Complex Chronic Healthcare, Hines, IL; <sup>6</sup>Jesse Brown VA Chicago Healthcare System, Chicago, IL; <sup>7</sup>University of Illinois Chicago Chicago UI Health, Chicago, IL.

**Background:** Although home dialysis often confers greater survival and quality of life than in-center dialysis for end-stage kidney disease patients, it is substantially underutilized. Informal caregivers play a key role in patients' eligibility, availability, and use of home dialysis. Nonetheless, little is known about the burdens confronting caregivers or their unmet needs, which must be addressed to inform support strategies. We assessed motivation, roles, experiences, and needs of caregivers assisting Veterans receiving home dialysis in the Veteran's Health Administration (VHA).

**Methods:** Semi-structured phone interviews were conducted with informal (unpaid) caregivers of Veterans receiving home dialysis at five geographically dispersed VHA facility-based programs during 2017-2018. Transcribed interviews were analyzed using content analysis to identify themes emergent in the data.

**Results:** Participants included 20 caregivers - 16 cared for home peritoneal dialysis patients and 4 for home hemodialysis patients. Caregivers had a mean age of 63 years. Most were female (95%), non-Hispanic (96%), White (79%), married or partnered (95%), had some college education (63%), and were retired (58%). Twenty-five percent of caregivers spent more than 5 hours per day on caregiving tasks, and 50% assisted with at least one-half of dialysis treatments. Themes for motivation included: concern for patient well-being, altruism, conversations with others, prior experience, and convenience. Themes for roles described: treatment supporting tasks, treatment related tasks, and treatment unrelated tasks. Themes for experiences included: impacts on caregiver

wellbeing, freedom, and finances. Themes describing needs included: additional staff and peer support, improved education and resources, incorporation of mental health support, resources to mitigate geographical barriers, assistance with caregiving tasks, respites, and financial support.

**Conclusions:** Our findings underscored the substantial burdens and wide-ranging needs confronting home dialysis caregivers, as well as their motivations for continuing to serve in this role. These insights can inform the development of targeted strategies intended to support caregivers and by extension, enhance use of home dialysis by Veterans.

**Funding:** Veterans Affairs Support

## FR-PO508

### Excess Incidence of Home Dialysis Attrition During the COVID-19 Pandemic

Eric D. Weinhandl,<sup>1,2</sup> Graham E. Abra,<sup>1</sup> Brigitte Schiller.<sup>1</sup> <sup>1</sup>Satellite Healthcare, San Jose, CA; <sup>2</sup>University of Minnesota Twin Cities, Minneapolis, MN.

**Background:** Home dialysis utilization in the United States was rapidly increasing before the COVID-19 pandemic. Although patients dialyzing at home during the pandemic had lower risks of COVID-19 hospitalization, relative to patients undergoing in-center hemodialysis (IHD), it is unknown whether attrition—that is, transfer from home dialysis to IHD—was more likely during the pandemic, possibly due to the stress of isolation, as well as the uncertain impact of telehealth in place of in-person visits. We estimated the excess incidence of home dialysis attrition in a small dialysis organization during the pandemic.

**Methods:** We analyzed home dialysis attrition between March 13, 2020, and March 12, 2022, among patients at Satellite Healthcare. During each month of this interval, we calculated observed and expected numbers of patients who transferred from home dialysis to IHD. The expected number of transfers was derived from a logistic regression model of transfers among all home dialysis patient-days between March 13, 2018, and March 12, 2020, a pre-pandemic interval ending at the declaration of a national emergency. The regression model included time since home dialysis initiation, modality, and age.

**Results:** The excess incidence of transfer from home hemodialysis (HHD) to IHD was  $>1.00$  between June 2020 and August 2021, but  $<1.00$  thereafter, whereas the excess incidence of transfer from peritoneal dialysis (PD) to IHD was typically between 0.9 and 1.1. Overall, there were 94 transfers from HHD to IHD, compared to 91.5 expected transfers, resulting in excess incidence of 1.03 (95% confidence interval, 0.83-1.24). Meanwhile, there were 518 transfers from PD to IHD, compared to 499.2 expected transfers, resulting in excess incidence of 1.04 (0.95-1.13).

**Conclusions:** Despite some variability in the excess incidence of home dialysis attrition during first 2 years of the pandemic, attrition from both HHD and PD was in line with pre-pandemic levels.

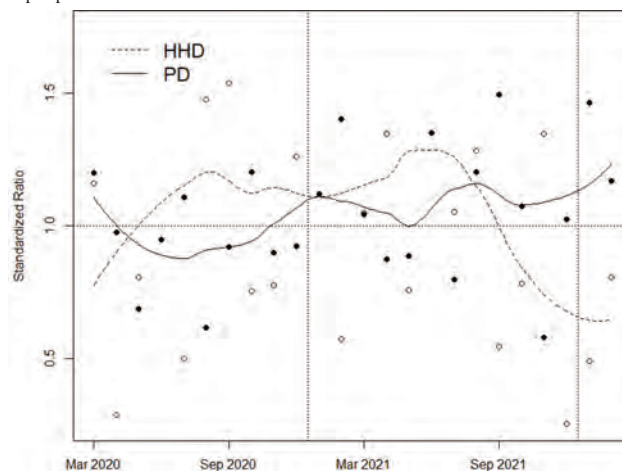

## FR-PO509

### Simulating Strategies to Launch a Home Therapies Program in a Conventional Hemodialysis Facility

Eric D. Weinhandl,<sup>1,2</sup> Stephan C. Dunning,<sup>3</sup> Tonya Saffer,<sup>3</sup> Michael A. Aragon.<sup>3</sup> <sup>1</sup>Satellite Healthcare, San Jose, CA; <sup>2</sup>University of Minnesota Twin Cities, Minneapolis, MN; <sup>3</sup>Outset Medical, San Jose, CA.

**Background:** Over half of dialysis facilities in the United States either do not offer home dialysis or have no active patients (pts) on home dialysis. Launching a home therapies program from this base leads to questions about patient selection, modality mix, device utilization, and financial impact. We designed a Markov chain Monte Carlo simulation to explore 5-year clinical and economic outcomes in a conventional hemodialysis (CHD) facility that pursues various strategies for growing home dialysis.

**Methods:** We simulated modality mix and total revenue in a 100-patient CHD facility in December 2022 and an average of two new patients per month during 2023-2027. We modulated three parameters: (1) prevalent patient conversion from CHD to home

Key: TH - Thursday; FR - Friday; SA - Saturday; OR - Oral; PO - Poster; PUB - Publication Only

Underline represents presenting author.

hemodialysis (HHD); (2) incident patient adoption of peritoneal dialysis (PD) and HHD; and (3) HHD device utilization, using an innovative HHD device that reduces HHD training attrition and the rate of conversion from HHD to CHD by 40%.

**Results:** Under current conditions, the launch of a home therapies program results in home penetration of 12.1% by 2027. Focusing only on increasing home dialysis adoption among incident patients increases penetration to 23.1%, while maintaining that focus and increasing conversion from CHD to HHD increases penetration to 36.8%. Reducing HHD attrition with an innovative device increases HHD utilization by 1.5 to 3.5 percentage points in most scenarios, and increases cumulative revenue per HHD start by 10% to 16%.

**Conclusions:** In a CHD facility, growth of home dialysis requires sustained focus on both incident and prevalent dialysis patients. Utilization of innovative devices, like the Tablo® Hemodialysis System, that improve HHD retention can accelerate home dialysis growth and positively impact facility revenue.

CHD-to-HHD conversion	Incident modality mix	PD (%) in 2027	HHD (%) in 2027	Mean annual revenue (\$ millions) during 2023-2027
Current State	14.5% PD, 0.5% HHD	7.5 (7.5)	5.3 (4.6)	4.97 (4.95)
	20% PD, 5% HHD	10.2 (10.2)	7.5 (6.7)	4.98 (4.99)
	20% PD, 20% HHD	10.5 (10.2)	15.1 (12.9)	5.10 (5.10)
3x Higher Rate	14.5% PD, 0.5% HHD	7.3 (7.4)	14.5 (12.8)	5.07 (5.05)
	20% PD, 5% HHD	10.3 (10.2)	16.4 (14.2)	5.12 (5.07)
	20% PD, 20% HHD	10.1 (10.0)	23.3 (20.5)	5.22 (5.18)
5x Higher Rate	14.5% PD, 0.5% HHD	7.5 (7.3)	22.5 (20.0)	5.20 (5.17)
	20% PD, 5% HHD	10.1 (10.2)	23.9 (20.9)	5.22 (5.22)
	20% PD, 20% HHD	10.3 (10.1)	30.2 (26.7)	5.34 (5.27)

Each cell displays the statistic with (without) use of an innovative HHD device.

**FR-PO510**

**Initial Experience With Home Hemodialysis Using the Tablo Hemodialysis System**

Eric D. Weinhandl,<sup>1,2</sup> Josh Schumacher,<sup>3</sup> Michael A. Aragon,<sup>3</sup> Graham E. Abra.<sup>1</sup> <sup>1</sup>Satellite Healthcare, San Jose, CA; <sup>2</sup>University of Minnesota Twin Cities, Minneapolis, MN; <sup>3</sup>Outset Medical, San Jose, CA.

**Background:** Home hemodialysis (HHD) utilization in the United States is approximately 2%. The modality offers customizability of therapy, but places stress on patients and their care partners. Devices that greatly improve the user experience are needed. One such device, the Tablo Hemodialysis System, was cleared for use in the home setting in early 2020. We analyzed the evolving clinical experience of HHD with Tablo at Satellite Healthcare (SHC), a dialysis provider with >3% utilization of HHD.

**Methods:** We identified patients who initiated use of Tablo for HHD in SHC facilities between 1 January 2021 and 30 April 2022. We summarized patient characteristics, including modality prior to initiation of HHD with Tablo and vascular access. We tallied the number of training sessions and estimated distributions of prescribed treatment frequency and hours per week. Using digital flowsheets, we assessed treatment adherence between 1 October 2021 and 15 May 2022. We estimated the cumulative incidence of attrition due to death, conversion to in-center hemodialysis (IHD), or conversion to HHD with an alternative device.

**Results:** The cohort included 34 patients. Patient proportions were 27% aged 18-44 years, 32% aged 45-64 years, 41% aged ≥65 years, 71% male, and 47% with diabetes. Regarding modality history, 29% were incident end stage kidney disease (ESKD) patients, 41% on IHD, 21% on HHD with an alternative machine, and 9% on peritoneal dialysis (PD). Regarding vascular access, 26% had a catheter. Mean numbers of training sessions were 11, 11, and 9 for incident ESKD, IHD, and existing HHD patients, respectively. Prescribed treatment frequency was 4 sessions/week in 82% of patients; prescribed hours/week were 12.0-14.9 in 70% of patients, with equal shares below and above this range. Adherence to prescribed hours was 90% with ≤3.5 sessions/week and 86% with ≥4.0 sessions/week. At 12 months, the cumulative incidence of death, conversion to IHD, and conversion to HHD with alternative device was 11%, 13%, and 3%, respectively.

**Conclusions:** Patients performing HHD with Tablo have been diverse in age, modality history, and vascular access. On average, HHD training has been completed in 11 or fewer sessions, regardless of prior modality, and treatment adherence at home has exceeded 85%. HHD attrition has been low, thus portending continued growth of the modality with the use of Tablo.

**FR-PO511**

**Low Dialysis Patient Volume in Many Skilled Nursing Facilities: An Obstacle to Improved Outcomes**

Eric D. Weinhandl,<sup>1,2</sup> Alice Hellebrand,<sup>4</sup> Eran Y. Bellin,<sup>3</sup> Allen Kaufman.<sup>4</sup> <sup>1</sup>Chronic Disease Research Group, Minneapolis, MN; <sup>2</sup>University of Minnesota Twin Cities, Minneapolis, MN; <sup>3</sup>Albert Einstein College of Medicine, Bronx, NY; <sup>4</sup>Dialyze Direct, Neptune City, NJ.

**Background:** Approximately 15% of dialysis patients are admitted to a skilled nursing facility (SNF) each year. These high-acuity patients represent a challenge to SNFs, as most facilities lack on-site clinical expertise in this domain. In other medical and surgical domains, maintenance of quality requires adequate volume, thus offering ongoing experience to providers. Nothing is known about the volume of dialysis patients in individual SNFs. We analyzed Medicare fee-for-service claims to quantify the experience of SNFs who have admitted at least one dialysis patient during one recent quarter of the pandemic era.

**Methods:** We analyzed 100% of Medicare Parts A and B claims during the first quarter of 2021. We identified patients who received outpatient dialysis during the quarter, and subsequently ascertained all Part A claims for SNF care during the quarter. We estimated the distribution of dialysis patient placements per SNF with ≥1 placement. We also grouped SNFs into core-based statistical areas (CBSAs), according to ZIP code, and calculated distributions of SNFs per CBSA.

**Results:** We identified 289,858 dialysis patients in the first quarter of 2021, among whom 21,053 (7.3%) received Medicare-covered care in a SNF. These patients were placed in 7858 SNFs. The median number of dialysis patient placements per SNF was 2, with a 25th percentile of 1 patient, a 75th percentile of 3 patients, a 90th percentile of 6 patients, and a 95th percentile of 8 patients. The 7858 SNFs were distributed among 821 CBSAs: 177 (21.6%) CBSAs had only 1 SNF in which dialysis patients were placed, 186 (22.7%) had 2; 170 (20.7%) had 3-4; and 288 (35.1%) had ≥5. CBSAs with ≥5 SNFs represented 89.9% of all dialysis patient placements. The 5 largest CBSAs—New York, Los Angeles, Chicago, Dallas, and Houston—had ≥100 SNFs with dialysis patient placements.

**Conclusions:** Over 75% of SNFs in which Medicare-covered dialysis patients are placed after hospitalization receive ≤3 patients per quarter. This volume is not sufficiently high to sustain expertise, although the large number of SNFs in urban markets offers an opportunity for centralization. On-site dialysis providers with specialized staff and innovative care models, financed by the dialysis process itself and informed by a central organization with amortized resources for quality improvement, can provide local expertise to SNFs.

**Funding:** Commercial Support - Dialyze Direct

**FR-PO512**

**Patient Characteristics Associated With Attrition to In-Center From Home Hemodialysis Treatment**

Derek M. Blankenship, Dinesh K. Chatoth, Michael A. Kraus, Len A. Usvyat, Franklin W. Maddux. *Fresenius Medical Care, Global Medical Office, Waltham, MA.*

**Background:** Numerous clinical and practical benefits exist for patients receiving hemodialysis at home (HHD) compared to incenter (ICHD). As important as patients initiating HHD is patients remaining on HHD as benefits persist. The purpose of this study was to assess factors associated with HHD patients who attrition to ICHD.

**Methods:** This retrospective cohort study identified Fresenius Kidney Care (FKC) patients initiating HHD between Jan. 1<sup>st</sup>, 2016 and Dec. 31<sup>st</sup>, 2020. Patients were followed 2 years for time to ICHD transition. A multivariate Cox regression model with baseline characteristics and time updating clinical factors at 3-month intervals assessed ICHD attrition.

**Results:** 3,434 HHD patients were studied of which 361 transitioned to ICHD. Males (Hazard Ratio=1.6, reference=female), single/unknown relationship status (HR=1.5, ref=partnered), uncollected Patient Health Questionnaire-2 (HR=1.3, ref=PHQ-2<3), and Phosphorous >5.5 mg/dL (HR=1.3, ref=5.5 mg/dL or less) were associated with greater likelihood of attrition. Conversely, albumin >4 g/dL (HR=0.7, ref=<3.5 mg/dL) and residual renal urea clearance (KRU) >2 (HR=0.58, ref=0) had a protective association. Race, ethnicity, BMI, dual Medicare/Medicaid, training year, vascular access, diabetes, heart failure, employment, education, dialysis frequency or change, dialysate volume, stan. Kt/V, training sessions, hospitalizations, and blood stream infections were not statically significant. When adjusting for number of home treatments, an increase in the number of support calls had a protective association as well (HRs=0.67, 0.53, and 0.38 for 1, 2-5, and >5 with ref=0 calls per quarter).

**Conclusions:** Study identified several clinical and demographic factors associated with HHD patients' attrition to ICHD. These factors can be used by social workers and clinical staff to identify patients at risk for HHD attrition. Further research should include the creation of a predictive model to optimize the identification of at risk HHD patients. The unsuspected protective association observed for support calls may be an indirect indication of patients' treatment engagement and should be further investigated as well.

**Funding:** Commercial Support - Fresenius Medical Care

**FR-PO513**

**Changes in Health-Related Quality of Life and Home Dialysis Modality Selection in Predialysis**

Maude Pichette,<sup>1</sup> Catherine Morin,<sup>1</sup> Naoual Elftouh,<sup>1</sup> Benoit Imbeault,<sup>1</sup> Louis-Philippe Laurin,<sup>2</sup> Remi Goupil,<sup>3</sup> Annie-Claire Nadeau-Fredette.<sup>2</sup> <sup>1</sup>Hopital Maisonneuve-Rosemont, Montreal, QC, Canada; <sup>2</sup>Hopital Maisonneuve-Rosemont Centre de Recherche, Montreal, QC, Canada; <sup>3</sup>Hopital du Sacre-Coeur de Montreal Centre de Recherche, Montreal, QC, Canada.

**Background:** Patients with advanced chronic kidney disease (CKD) have lower health-related quality of life (HRQOL) than the general population. There are still few data on patterns and predictors of HRQOL changes before dialysis initiation. We aimed to characterize HRQOL trajectory and assess its association with selected dialysis modality in advanced CKD.

**Methods:** In this prospective study, adult with an eGFR ≤15ml/min/1.73m<sup>2</sup> completed Kidney Disease Quality of Life-Short Form at baseline and every 6-month until dialysis initiation. Planned dialysis modality, our main exposure, was based on patient's choice, with home dialysis defined as selection of peritoneal dialysis or home hemodialysis. Predictors of changes in KDQOL components, including Physical Component scores



(PCS), Mental Component scores (MCS) and Symptoms/Problems of kidney disease (SPKD) were modelled using mixed effect multivariable linear regressions to account for within-patient changes over time.

**Results:** One hundred nine patients were included. Patients selecting home dialysis (n=41) were younger (61±15 vs. 76±11 yrs) and had less cardiovascular disease (34% vs 60%). At baseline, crude PCS (45±10 vs. 39±8) was significantly higher in patients choosing home dialysis, while MCS and SPKD were similar in both groups. (Figure) After adjustment for demographics, comorbidities and psychosocial characteristics, patients choosing home dialysis had an 8-point higher MSC for each year of follow-up (B 8.1 per year, p=0.002) compared to those selecting in-center HD or undecided. Similarly, the decrease in SPKD score through time was attenuate (i.e. lower burden) for patients selecting home dialysis compared to others (B 12.4 per year, p<0.001). These differences were clinically significant considering the minimal important difference of 3-point for this instrument.

**Conclusions:** Patients choosing home dialysis had improved HRQOL scores in predialysis compared to those not selecting home dialysis. More work is needed to determine if differences in process of care (e.g. enhanced multidisciplinary team support) or unmeasured patient characteristics modulate this association.

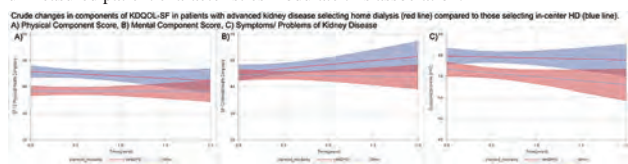

FR-PO514

Sex and Racial/Ethnic Differences in Home Hemodialysis Mortality

Silvi Shah,<sup>1</sup> Nupur Gupta,<sup>2</sup> Annette L. Christianson,<sup>1</sup> Karthikeyan Meganathan,<sup>1</sup> Anthony C. Leonard,<sup>1</sup> Charuhas V. Thakar.<sup>1</sup> <sup>1</sup>University of Cincinnati, Cincinnati, OH; <sup>2</sup>Indiana University, Bloomington, IN.

**Background:** Women and minorities constitute substantial portions of the prevalent population of kidney failure patients. Little is known about sex and racial/ethnic differences in mortality among patients with kidney failure on home hemodialysis in the United States.

**Methods:** Using the United States Renal Data System, we retrospectively evaluated a cohort of 42,849 patients who started home hemodialysis between January 1, 2005, and December 31, 2015. We examined the association of sex and race/ethnicity with the outcome of all-cause mortality using adjusted Cox proportional hazard models and logistic regression models.

**Results:** In the study cohort, 40.4% were women, and 57.4% were White. Women on home hemodialysis had higher unadjusted death rates (26.9 vs. 22.4 per 100 person-years) as compared to men. There was no difference in adjusted all-cause mortality between men and women, but women had an 8% higher adjusted risk of all-cause mortality at one-year after initiating home hemodialysis (OR 1.08, 1.01-1.15). With regards to race/ethnicity, Hispanic, White, and Blacks had higher unadjusted death rates as compared to Asians and Native Americans (25.1 vs. 24.8 vs. 23.2 vs. 17.4 vs.16.6 per 100 person-years). There was no difference in adjusted all-cause mortality in Black, Hispanic, and Native Americans as compared to Whites, while Asians had a lower risk of all-cause mortality than did Whites (HR, 0.81; CI, 0.72-0.92). There was no difference in adjusted one-year mortality for Asian, Black, Hispanic, and Native American patients, as compared to White patients.

**Conclusions:** Among patients undergoing home hemodialysis, women have higher one-year mortality than men, and women and men have comparable survival on long-term follow-up after adjusting for other covariates. Compared to Whites, there was no difference in adjusted survival on long-term follow-up for Blacks, Hispanics, or Native Americans, while Asians had better survival. Our results suggest the need for population-wide strategies to overcome differences in home hemodialysis care.

**Funding:** Other NIH Support - NHLBI K23 career development award, under Award Number 1K23HL151816-01A1

FR-PO515

HOME-R: A Home Dialysis Conceptual Model for Implementation Research

Yuvaram N. Reddy,<sup>1,2</sup> Ann M. O'Hare,<sup>3</sup> Peter P. Reese,<sup>2</sup> Shimrit Keddem,<sup>1,2</sup> Meghan B. Lane-Fall,<sup>2</sup> Robert Burke.<sup>1,2</sup> <sup>1</sup>VA Center for Health Equity Research and Promotion, Philadelphia, PA; <sup>2</sup>University of Pennsylvania Perelman School of Medicine, Philadelphia, PA; <sup>3</sup>VA Puget Sound Health Care System Seattle Division, Seattle, WA.

**Background:** The Advancing American Kidney Health initiative aims to grow home dialysis towards 80% by 2025. With <14% of patients currently receiving home dialysis, there is an urgent need to develop strategies to expand home dialysis. To maximize success, a conceptual model of barriers and facilitators is needed to help identify and evaluate strategies to expand home dialysis.

**Methods:** We reviewed published implementation science models to identify constructs that: 1) aligned with clinical knowledge of home dialysis barriers and facilitators; 2) could be consistently defined, measured, and evaluated in the context of home dialysis; and/or 3) incorporated health equity. We refined the model through an iterative process involving 4 rounds of stakeholder feedback from 4 nephrologists, 3 patients, 3 implementation scientists, 2 nephrology nurses, and 1 care partner.

**Results:** We developed the HOME dialysis conceptual model for implementation Research (HOME-R, Figure 1) using constructs from two frameworks: 1) the Systems Engineering Initiative for Patient Safety (SEIPS) and 2) the Equity-based framework for Implementation Research (EquiR). HOME-R uses SEIPS to define 5 phases of the home dialysis patient journey and 4 system elements. The 5 phases include referral, patient education, patient training, initiation, and maintenance of home dialysis. At each phase, patients interact with 4 system elements: providers, care partners, the dialysis machine and supplies, and the environment (e.g., home, home dialysis clinic, primary care) – all of which can serve as barriers or facilitators to home dialysis use. HOME-R also uses EquiR to identify and evaluate how social determinants of health modify the influence of system elements on home dialysis.

**Conclusions:** HOME-R—a conceptual model that incorporates SEIPS, EquiR, and stakeholder input—can be used to identify and evaluate strategies that are designed to improve home dialysis use, quality, and equity.

**Funding:** Veterans Affairs Support

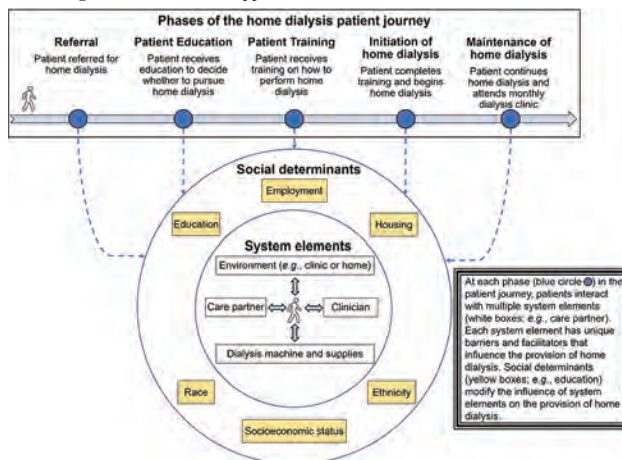

FR-PO516

Identifying Major Barriers to Home Dialysis (The IM-HOME Study): Findings From a National Survey of Patients and Providers

Yuvaram N. Reddy,<sup>1,2</sup> Matthew D. Kearney,<sup>1</sup> Michaela Ward,<sup>1</sup> Robert Burke,<sup>1,2</sup> Peter P. Reese,<sup>1</sup> Meghan B. Lane-Fall.<sup>1</sup> <sup>1</sup>University of Pennsylvania Perelman School of Medicine, Philadelphia, PA; <sup>2</sup>VA Center for Health Equity Research and Promotion, Philadelphia, PA.

**Background:** Increasing home dialysis use from 13% towards 80% of patients with kidney failure by 2025—a goal of the Advancing American Kidney Health initiative—requires a comprehensive understanding of home dialysis barriers. In this national survey, we sought to identify major home dialysis barriers from the perspective of patients and providers to inform strategies to improve home dialysis use.

**Methods:** We identified major home dialysis barriers using the modified Delphi method—a technique that iteratively leverages stakeholder feedback in multiple stages to reach consensus. First, each of the 7 members of our advisory board of patients and providers listed major barriers to home dialysis. The advisory board then met as a group to discuss these barriers and compile a final list of 12 patient-perceived and 9 provider-perceived barriers. This final list of barriers was distributed as a survey to patients and providers across the US. The survey was informed by the Systems Engineering Initiative for Patient Safety 3.0 conceptual model. Participants ranked their top 3 home dialysis barriers from the list included in the survey. We aggregated participants' scores to identify the top 3 patient-perceived and top 3 provider-perceived barriers to home dialysis.

**Results:** There were 522 complete responses: 223 providers and 289 patients (response rates, 11.2% and 1.9%). Patients perceived their top 3 barriers as fear of dialysis, lack of space, and the need for home-based support – all of which occur at home. Providers perceived their top 3 barriers as poor patient education, lack of reimbursable mechanisms to provide additional support, and the need for experienced staff – all of which occur in the clinic.

**Conclusions:** While patients perceived major barriers at home, providers perceived major barriers in the clinic. These findings highlight the need for novel strategies, such as assisted dialysis, that can simultaneously overcome barriers at home and in the clinic.

**Funding:** Other NIH Support - Agency for Healthcare Research and Quality, Veterans Affairs Support

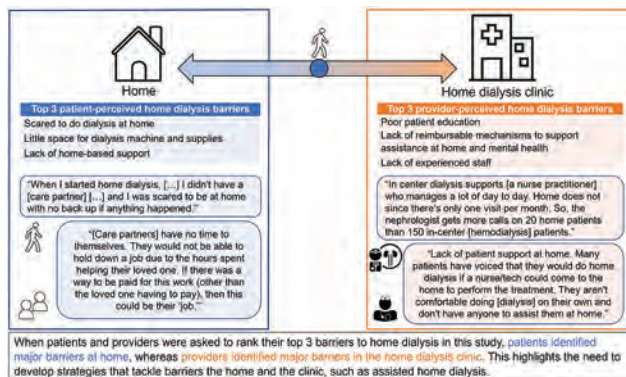

FR-PO517

**Evaluating Home Dialysis Training Requirements: A Survey of Nephrology Program Directors and Division Chiefs**

**Yuvaram N. Reddy,<sup>1,2</sup> Jeffrey S. Berns,<sup>1</sup> Shweta Bansal,<sup>6</sup> James F. Simon,<sup>5</sup> Ryan Murray,<sup>7</sup> Molly Jacob,<sup>7</sup> Jeffrey Perl,<sup>3</sup> Edward Gould,<sup>4</sup> ASN Home Dialysis Task Force <sup>1</sup>University of Pennsylvania Perelman School of Medicine, Philadelphia, PA; <sup>2</sup>VA Center for Health Equity Research and Promotion, Philadelphia, PA; <sup>3</sup>St. Michael's Hospital, Toronto, ON, Canada; <sup>4</sup>Vanderbilt University Medical Center, Nashville, TN; <sup>5</sup>Cleveland Clinic, Cleveland, OH; <sup>6</sup>The University of Texas Health Science Center at San Antonio, San Antonio, TX; <sup>7</sup>American Society of Nephrology, Washington, DC.**

**Background:** The American Society of Nephrology (ASN) convened a Home Dialysis Task Force in 2021 to improve awareness and outcomes of home dialysis. An identified need was to ensure universal and adequate training, education, and exposure to home dialysis during nephrology fellowship. As a first step, The Task Force surveyed program directors and division chiefs to explore perspectives on 1) what constitutes adequate home dialysis training, and 2) what home dialysis training resources are needed.

**Methods:** Using REDCap, we anonymously surveyed program directors and division chiefs of US adult nephrology fellowship programs from 03/04/22-04/05/22. **Program directors were asked to** 1) select the minimum training fellows should receive before they could provide home dialysis without supervision (defined by number of clinics attended or patients seen) and 2) select home dialysis training resources that ASN could support. **Division chiefs were asked to** select the minimum training fellows should receive before they could be hired as faculty to manage home dialysis patients.

**Results:** Among 158 program directors and 170 division chiefs in ASN's database, 43 and 31 responded (response rate, 27% and 18%, respectively). When asked about the minimum training fellows should receive before they could provide peritoneal dialysis without supervision, the most common answers were 10-12 clinics (53% of program directors and 35% of division chiefs), and 11-15 patients (33% of program directors and 29% of division chiefs). For home hemodialysis training, please see Table 1. When program directors were asked which resources they would like ASN to facilitate, 74% requested a virtual case-based home dialysis mentorship program.

**Conclusions:** Most program directors and division chiefs felt that fellows could provide home dialysis independently if they attended a minimum of 10-12 home dialysis clinics. Most program directors wanted ASN to help create a virtual case-based home dialysis mentorship program.

**Funding:** Other NIH Support - Agency for Healthcare Research and Quality

Survey question	Program Directors (n=43)	Division Chiefs (n=31)
In your opinion, upon graduation, how many of your fellows can provide home dialysis without supervision?	—	—
Peritoneal dialysis	—	—
All fellows	3 (7%)	22 (71%)
Most fellows	8 (19%)	6 (19%)
Some fellows	4 (9%)	3 (10%)
Home hemodialysis	—	—
All fellows	13 (30%)	14 (45%)
Most fellows	14 (33%)	6 (19%)
Some fellows	12 (28%)	5 (16%)
None of our fellows	3 (7%)	6 (19%)
No response	1 (2%)	—
In your opinion, how many home dialysis clinics should a fellow attend before they can provide home dialysis without supervision?	—	—
Peritoneal dialysis	—	—
< 4 clinics	2 (5%)	1 (3%)
4-6 clinics	3 (7%)	6 (19%)
7-9 clinics	4 (9%)	3 (10%)
10-12 clinics	23 (53%)	11 (35%)
13-18 clinics	3 (7%)	5 (16%)
19-24 clinics	6 (14%)	2 (6%)
> 24 clinics	2 (5%)	3 (10%)
Home hemodialysis	—	—
< 4 clinics	3 (7%)	8 (26%)
4-6 clinics	5 (12%)	5 (16%)
7-9 clinics	3 (7%)	4 (13%)
10-12 clinics	24 (56%)	7 (23%)
13-18 clinics	3 (7%)	3 (10%)
19-24 clinics	4 (9%)	1 (3%)
> 24 clinics	1 (2%)	3 (10%)
In your opinion, what is the minimum number of patients on home dialysis that a fellow should see before they can provide home dialysis without supervision?	—	—
Peritoneal dialysis	—	—
3-5 patients	—	—
6-10 patients	4 (9%)	2 (6%)
11-15 patients	10 (23%)	5 (16%)
16-20 patients	14 (33%)	9 (29%)
21-30 patients	8 (19%)	5 (16%)
> 30 patients	1 (2%)	7 (23%)
Home hemodialysis	—	—
1-2 patients	1 (2%)	6 (19%)
3-5 patients	13 (30%)	8 (26%)
6-10 patients	12 (28%)	6 (19%)
11-15 patients	10 (23%)	6 (19%)
16-20 patients	3 (7%)	1 (3%)
21-30 patients	2 (5%)	1 (3%)
> 30 patients	2 (5%)	3 (10%)
Does your program use any of the following resources?	—	—
Home dialysis rotation within the program	23 (53%)	—
National home dialysis conference (e.g., Home Dialysis University, Home Dialysis Academy of Excellence)	36 (84%)	—
Home dialysis rotation at an outside academic or private practice setting	5 (12%)	—

FR-PO518

**Predicting Transfer From Peritoneal Dialysis to Hemodialysis Using the Peritoneal Dialysis Surprise Question**

**Ayesha Anwaar,<sup>1,2</sup> Sai Liu,<sup>1</sup> Hatsumi Nielsen,<sup>2</sup> Maria E. Montez-Rath,<sup>1</sup> Graham E. Abra,<sup>2,1</sup> Sumi J. Sun,<sup>2</sup> Brigitte Schiller,<sup>2,1</sup> Wael F. Hussein,<sup>2,1</sup> <sup>1</sup>Stanford University, Stanford, CA; <sup>2</sup>Satellite Healthcare, San Jose, CA.**

**Background:** People on peritoneal dialysis (PD) at risk of transfer to hemodialysis (HD) need support to remain on PD or ensure a safe transition to HD. In this study, we evaluated the clinicians' ability to identify high-risk patients.

**Methods:** In this prospective observational study, we included 1275 patients undergoing PD in 35 home programs of a non-profit dialysis organization. We modified the palliative care 'Surprise Question' to evaluate the risk of transfer to HD by asking the registered nurse (RN) and nephrologist (MD): "Would you be surprised if this patient transferred to HD in the next 6 months?" We called this the PD Surprise Question. A "yes"/"no" answer indicated low/high risk respectively. We followed patients for 6 months. Using Cox proportional hazards regression we estimated the hazard ratio (HR) of transfer to HD.

**Results:** Patients' mean age was 59 ± 16 years and 41% were female. The median PD vintage was 20 months (IQR: 9-40), and 92% were on automated PD. Responses were received from RNs for 1123 patients, indicating 169 (15%) as high risk and 954 (85%) as low risk. Over the next 6 months, transfer to HD occurred in 18 (11%) versus 29 (3%) of the high and low-risk groups respectively (HR: 3.92, 95% confidence interval (CI): 2.17 - 7.05). MD responses were obtained for 692 patients, indicating 118 (17%) and 574 (83%) as high and low risk respectively. Transfer to HD was observed in 14 (12%) of the high-risk group and 14 (2%) of the low-risk group (HR: 5.56, 95% CI: 2.65 - 11.67).

**Conclusions:** The PD Surprise Question can help identify patients at high risk of transfer to HD. This tool can be used to modify care to support patients to remain on PD or to prepare for safe and timely transfer to HD.

## FR-PO519

**A Report on Home Hemodialysis Training Time in Patients With Kidney Failure Using the Quanta SC+ Hemodialysis Device**

Ryan J. Bamforth,<sup>1</sup> Reid Whitlock,<sup>1</sup> Paul Komenda,<sup>1,7</sup> Kelley L. Gorbe,<sup>7</sup> Angela Pietrafesa,<sup>2</sup> Charlotte Bebb,<sup>3</sup> Suzanne Forbes,<sup>4</sup> Saeed Ahmed,<sup>5</sup> David T. Collister,<sup>6</sup> <sup>1</sup>Seven Oaks General Hospital, Winnipeg, MB, Canada; <sup>2</sup>Churchill Hospital, Oxford, United Kingdom; <sup>3</sup>Nottingham University Hospitals NHS Trust, Nottingham, United Kingdom; <sup>4</sup>Barts Health NHS Trust, London, United Kingdom; <sup>5</sup>South Tyneside and Sunderland NHS Foundation Trust, South Shields, United Kingdom; <sup>6</sup>University of Alberta Faculty of Medicine & Dentistry, Edmonton, AB, Canada; <sup>7</sup>Quanta Dialysis Technologies Ltd, Alcester, United Kingdom.

**Background:** Frequent self-care hemodialysis (HD) in the home setting has several advantages to patients and providers including improved health outcomes, health-related quality of life, patient satisfaction, and lower health care costs. The Quanta SC+ is a contemporary, portable HD device intended to be operated by a broad range of lay users. It was developed in collaboration with experienced home HD patients and human factors engineers with intuitive linear workflows, on-screen step-by-step instructions, and troubleshooting help screens that are easy to navigate. This study is a descriptive report on the home HD training time of first-time users of the Quanta SC+ HD device in the United Kingdom.

**Methods:** From August 2020 until March 2022, patients on dialysis across 5 sites in the United Kingdom were trained on the Quanta SC+ HD device as part of standard of care for self-care home HD as treatment for their kidney failure. We collected data on the number of total training weeks and sessions to be signed off as safe by a nephrologist and the frequency of training loss. Training time included organizational delays plus needing training time.

**Results:** As of March 2022, a total of 34 patients completed training on the Quanta SC+ HD device. The mean age of the patients was 52.3 ± 15.1 years, 14 (41.2%) were female. Patients had an average dialysis vintage of 2.6 ± 2.2 years. A total of 9 (26.5%) patients were already on home HD and converted to Quanta SC+ from another device. Training time for these individuals before being signed off as safe by a nephrologist ranged from 2 to 3 weeks (6 to 9 sessions). A total of 25 (73.5%) patients converted to Quanta SC+ from another dialysis modality. The average training time for these individuals before being signed off as safe by a nephrologist was 6 weeks (18 sessions).

**Conclusions:** A descriptive report of 34 patients with kidney failure who trained for frequent self-care home HD with the Quanta SC+ HD device reported an average training time within expectations set from national kidney organizations with minimal training. These results indicate that the device is user-friendly and intuitive to learn.

**Funding:** Commercial Support - Quanta Dialysis Technologies

## FR-PO520

**Patient Perspectives on the Training and Early Initiation Phase of Peritoneal Dialysis**

Christopher D. Knapp,<sup>1,2</sup> Scott Reule,<sup>2,3</sup> Kirsten L. Johansen,<sup>1,3</sup> Allyson Hart,<sup>1,3</sup> <sup>1</sup>Hennepin Healthcare, Minneapolis, MN; <sup>2</sup>VISN 23 VA Midwest Health Care Network, Minneapolis, MN; <sup>3</sup>University of Minnesota Twin Cities, Minneapolis, MN.

**Background:** Patients initiating peritoneal dialysis are at higher risk for PD catheter dysfunction, peritonitis, and transfer to hemodialysis during the first 90 days of treatment, making it an important window to target interventions to reduce PD failure rates. However, qualitative data on patient perspectives and barriers during this time is lacking.

**Methods:** 25 semi-structured interviews of incident PD patients were conducted from six dialysis centers in the Minneapolis area. Participants were interviewed during the last week of their PD training and re-interviewed approximately 90 days after initiation. A grounded theory approach was used to develop an interview codebook and identify themes.

**Results:** The first theme that emerged is “mismatched concerns between patients and family”. Patients’ concerns were oriented towards maximizing independence whereas family members were concerned about medical safety. The second theme is “Comfort with process of PD training.” Patients reported comfort with the technical aspects of PD during their training period or confidence asking for help. The third theme is “Surprising negative experiences”. Unexpected negative experiences that were not discussed prior to starting PD caused patients stress. The fourth theme is “Coping strategies to overcome barriers”. Patients reported that focusing on expected long term benefits of PD and talking to peer mentors helped them. The fifth theme is “Expected benefits of starting peritoneal dialysis”. Patients reported that PD would allow them to maintain their roles within their family and community and improve their sense of ownership about their health.

**Conclusions:** Better preparing patients for potential negative medical experiences with starting PD and improving communication between patients and their families could be targets to improve the patient experience during PD training. A focus on coping strategies and expected benefits of PD could be useful strategies for peer mentorship and provider to patient communication in this period.

**Funding:** Private Foundation Support, Clinical Revenue Support

Theme	Representative Quote
Surprising Negative Experiences after starting PD	"The leaking fluid was a big deal for me but it wasn't nothing that was harming me... But I didn't know that...I think it would have been better if they talk to you"
Coping strategies to overcome barriers to starting or continuing PD	"You know, one thing about the dialysis, this dialysis...is that they don't have no groups...they found this lady that's here and she talked to me. Talking to her is what kept me going through all the other stuff"
Mismatched concerns between patient and family	"My mom would lay her head on me and pray. I need somebody who can talk to me and tell me it's going to be okay and tell me what to do"
Comfort with Process of PD training	"And they're really good about giving me instructions you know, so she gave me a written instruction so if I follow that every time I feel like, that will lessen the chance of getting an infection"
Expected Benefits of PD	"Schedule-wise it's easier too because during the day, it kind of frees me up to do other things, chores around the house, frees me up to help my fiancé with his business"

## FR-PO521

**Human Factors Validation of the Tablo Hemodialysis System in Home Patients**

Brittany Lim, Josh Schumacher, Elise Edson, Cynthia J. D' Alessandri-Silva, Michael A. Aragon. *Outset Medical, San Jose, CA.*

**Background:** Home hemodialysis (HHD) is a complex, lifesaving therapy for patients with end-stage kidney disease (ESKD). As such, the high level patient interaction needed to use devices safely and effectively while educating patients and care partners to administer dialysis at home requires significant training and can be facilitated by using more intuitive, patient-centered technology. The Tablo® Hemodialysis System (“Tablo”) is an all-in-one, easy-to-learn system indicated for clinic, hospital, and home settings. Features include a simplified user interface touchscreen GUI, coupled with images to assist with system operation. Prior validation testing of Tablo, showed a user error rate of 1.2%. Here we report simulated use human factors validation testing of a recent software version of Tablo in the home setting.

**Methods:** Patients and their care partners (one pair considered a “participant”) were recruited to test the Tablo user interface in a simulated use home environment. Participants underwent two days of hands-on training to learn device setup, takedown, monitoring of treatments, maintenance, and alarm resolution. After a decay of at least 24 hours, participants performed all tasks without assistance from the trainer. Task performance (including use errors, close calls, and difficulties) were recorded, along with subjective interview and knowledge task assessments.

**Results:** Fifteen (15) participants were recruited and consisted of 6 who held prior HHD experience and 9 with no prior HHD or self-care experience. A total of 5400 tasks were assessed across all participants, with 98.4% completed without difficulty and 0.7% completed with minor difficulty noted. The remaining 0.9% were classified as use errors, with none of these posing an unacceptable level of residual risk. Following completion of testing, 100% of participants reported confidence they could use Tablo safely and effectively.

**Conclusions:** This human factors study demonstrates that Tablo is safe and easy to use in a simulated home environment regardless of prior experience with self-care. More recent software further reduces Tablo’s already lower user error rate. This data endorses prior reports of Tablo being easy to learn and use for patients and care partners and may contribute to the high adoption and retention rates observed with the Tablo Hemodialysis System for home use.

## FR-PO522

**Exploring Preconceptions in Peritoneal Dialysis Eligibility: The PD Myths Survey**

Nikhil A. Shah,<sup>1</sup> Paul N. Bennett,<sup>2</sup> Graham E. Abra,<sup>3</sup> Talerngsak Kanjanabuch,<sup>5</sup> Yeoung Jee Cho,<sup>6</sup> Saskia Leibowitz,<sup>6</sup> Jyoti B. Baharani,<sup>4</sup> <sup>1</sup>PDMyths <sup>1</sup>University of Alberta, Edmonton, AB, Canada; <sup>2</sup>University of South Australia, Adelaide, SA, Australia; <sup>3</sup>Stanford University, Stanford, CA; <sup>4</sup>University Hospitals Birmingham NHS Foundation Trust, Birmingham, United Kingdom; <sup>5</sup>Chulalongkorn University, Bangkok, Thailand; <sup>6</sup>Princess Alexandra Hospital, Woolloongabba, QLD, Australia.

**Background:** Peritoneal dialysis (PD) is underutilized globally. A contributory factor may be myths around its use, some of which are mistaken as evidence after being shared routinely, gaining credence with repetition.

**Methods:** An online global survey (in English and Thai) was administered for completion by nephrologists and trainees, to ascertain decisions on choosing PD as a treatment modality in various clinical settings. Ethical approval was granted by the University of Alberta, Canada. Informed consent was obtained prior to survey completion from each participant. The obtained outcomes were further evaluated according to status (nephrologist vs. trainee), experience, region and income group of the country.

**Results:** In total, 645 participants (522 nephrologists; 123 trainees; 56% male) from 54 countries completed the survey. Participants were mostly 36-45 years old (36%) with 0-5 years experience in nephrology (39%) and from high-income countries (HIC; 66%). In general, PD was recommended for most scenarios, including repeated exposures to heavy lifting, swimming (especially in a private pool and ocean), among patients with

cirrhosis or cognitive impairment with available support, and those living with a pet if a physical separation can be achieved during PD. Divergent responses were observed in other scenarios, including patients with BMI>40 whereby PD was discouraged by clinicians from low-income countries (75%) but not from HIC (21%). Certain abdominal surgeries were more acceptable to proceed with PD (hysterectomy 90%) compared to others (hemicolecotomy 45%). Similar variation was noted for different types of stomas (nephrostomies 74%; suprapubic catheters 53%; ileostomies 27%). The probability of recommending PD in various scenarios was greater among clinicians from HIC, larger units and consultants with longer years of clinical experience.

**Conclusions:** There is a huge disparity in approach to recommending PD across various clinical scenarios driven by experience, unit-level characteristics and region of practice. Globally, evidence-informed education is warranted to rectify misconceptions to enable greater PD uptake.

**FR-PO523**

**The Tablo Hemodialysis System at Home: Comparing Real World to the IDE Trial**

Josh Schumacher, Michael A. Aragon, Cynthia J. D'Alessandri-Silva. *Outset Medical, Inc., San Jose, CA.*

**Background:** The Tablo® Hemodialysis System (“Tablo”) obtained FDA clearance for home hemodialysis (HHD) in March 2020. Approval was based on a prospective, crossover trial, where 30 patients were followed for 8 weeks during each study phase (in-center and home). Tablo met all safety and effectiveness endpoints, reported high rates of treatment adherence, patient retention, and included a diverse patient population (NCT02460263). The HOME Registry (NCT04526301) is an ongoing study of real-world patients utilizing Tablo for HHD.

**Methods:** Using the same eligibility criteria as the Tablo IDE, incident and prevalent patients were initiated on Tablo at participating study sites. Treatment data were obtained wirelessly via the Tablo data platform. All other data were reported by site staff into the study database. Data collected from the first 30 patients on the HOME Registry over the first 8 weeks was compared to the 30 patients who participated in the IDE.

**Results:** Mean patient age was 55.2 years, with the majority being male (66.7%), white (73.3%) and with an AV fistula (60.0%). Mean prescribed treatment time was 3.3 hours, with a mean prescribed frequency of 3.8 treatments per week. Treatment adherence was 95%, with 92% of treatments completing at least 90% of prescribed time. The mean number of clinically significant alarms per treatment was 1.3 (±2.9), with an average time to resolution of 10.8 (±23.1) seconds. The mean weekly standard Kt/V at the 4-week visit was 2.3±0.5. Patient retention was 100%, with no patients opting out of HHD with Tablo. One serious adverse event (SAE) was reported, a seizure and subsequent hospitalization. The event was deemed not related to Tablo or to the HD treatment by the site investigator.

**Conclusions:** Initial real-world experience from the Home Registry mirrors the IDE with reports of high treatment adherence and patient retention, with low rates of treatment alarms and SAEs. This data supports that Tablo achieves standard adequacy goals in more flexible dialysis schedules than current HHD options for a diverse patient population.

**Funding:** Commercial Support - Outset Medical, Inc.

Table 1. Patient Baseline Characteristics

Characteristic	IDE	Registry
	N = 30 (%)	N = 30 (%)
Age, y	52.3± 11.6	55.2 ± 16.3
Weight, kg	93.8± 17.0	90.4 ± 34.3
Men	19 (63)	20 (67)
Race		
White	17(57)	22 (73)
Black or African American	13(43)	5 (17)
Asian	0(0)	2 (7)
Not reported	0(0)	1 (3)
Ethnicity		
Hispanic or Latino	8 (27)	4 (13)
Not Hispanic or Latino	22 (73)	26 (87)
Vascular access type:		
Fistula	23 (77)	18 (60)
Catheter	4 (13)	9 (30)
Graft	3 (10)	3 (10)

Table 2. Treatment Parameters

Parameter	IDE	Registry
Prescribed treatment time (min)	207 ± 24	195.9 ± 35.3
Actual treatment time (min)	203 ± 31	190.0 ± 45.2
Prescribed UF volume (ml / tx)	2292 ± 1118	1250.8 ± 987.7
Actual UF volume (ml / tx)	2223 ± 1119	1088.8 ± 1064.9
Prescribed UF rate (ml/min)	10.6 ± 4.8	6.5 ± 5.1
Actual UF rate (ml/min)	10.7 ± 4.9	6.7 ± 9.7
Avg Standard Weekly Kt/V	2.8 ± 0.3	2.3 ± 0.5
Avg # Clinically Significant Alarms / tx	1.3 ± 3.0	1.3 ± 2.9
Avg time to Alarm Resolution (s)	11.7 ± 28.5	10.8 ± 23.1

**FR-PO524**

**Abstract Withdrawn**

**FR-PO525**

**Hemodialysis Program in a Subacute Care Facility for ESRD Patients With Tracheostomy**

Guoping Xu,<sup>1</sup> Gary V. Halick,<sup>2</sup> Leonid Pravoverov,<sup>1</sup> Ritchie M. Nabong-Salem,<sup>1</sup> Sijie Zheng.<sup>1</sup> *<sup>1</sup>The Permanente Medical Groups, Oakland, CA; <sup>2</sup>Kaiser Permanente, Oakland, CA.*

**Background:** ESRD patients with tracheostomy require long-term mechanical ventilation in addition to need for maintenance dialysis. Due to regulations in California, majority of such patients have prolonged acute hospital stays due to lack of availability of a lower level of care facility, capable of providing ventilation care and hemodialysis. Need for these services increased during the COVID 19 pandemic. Kaiser Permanente Northern California (KPNC) is an integrated health care system providing health care for 4.6 million members. Partnering with a large dialysis organization (LDO) and a

local Subacute Care facility (SAC), a program has been developed to provide home hemodialysis for patients requiring long-term mechanical ventilation using Low Dialysate Volume Approach (LDVA) machines.

**Methods:** The program was initiated in Q4 2017. A set of clinical criteria for admission was developed between the LDO, SAC and KPNC. Weekly meetings with physicians, dialysis nurses, and SAC staffs were conducted to review the potential candidates currently hospitalized in one of twenty-one KPNC hospitals. Dialysis has been performed by a HD nurse four times a week (M-T-Th-F) for 3-3.5 hours for each dialysis treatment. Each treatment was conducted using a LDVA machine with standard LDVA prescriptions using a Watson calculator to achieve a weekly Kt/V above 2.1.

**Results:** Since the inception of the program, 45 patients have been admitted to the program, 24 female and 21 male patients. The mean age is 65 (±13) on the date of admission. The average length of stay per patient at an acute hospital prior to admission was 125 days, and after the admission, the total days in the SAC is 7,498 days, an average of 167 days per person. Total acute hospital re-admission days after admission to the program is 1,071 days, an average of 25 days per patient (range: 0 to 115 days). Nine patients are currently residing in the SAC.

**Conclusions:** It is feasible to provide hemodialysis care for patients requiring long term mechanical ventilation at the appropriate level of care. This approach reduces the patient length of stay (LOS) in acute hospitals and burden to critically stretched healthcare system. Further discussion with local regulatory agencies is needed to develop additional models of care to effectively deliver dialysis to patients requiring facility-based long-term care.

**FR-PO526**

**A Case of Successful Palliative Care With Peritoneal Dialysis for Severe Cyanotic Congenital Heart Disease**

Nozomi Kadota, Yugo Ito, Kotaro Shimoyama, Kasumi Konishi, Takuya Fujimaru, Fumika Taki, Masahiko Nagahama, Masaaki Nakayama. *St. Luke’s International Hospital, Tokyo, Japan.*

**Introduction:** Peritoneal dialysis (PD) is an optimal renal replacement therapy (RRT) for kidney dysfunction by cardio-renal syndrome and unstable hemodynamics. However, there is little evidence that PD is also effective for terminal care in heart failure patients to improve quality of life (QOL). To our knowledge, this is the first case report that PD enabled a cyanotic congenital heart disease patient to pursue his palliative care at home, maintaining better QOL without aggravation of heart failure.

**Case Description:** A 50-year-old man who was diagnosed with tricuspid atresia and underwent Blalock-Taussig shunt in his infancy was consulted to our clinic with his eGFR of 20 ml/min/1.73 m<sup>2</sup>. His chronic kidney disease was exacerbated gradually. Two years later, as his volume overload was uncontrollable without continuous intravenous inotropic agent and diuretics, he was hospitalized as often as twice a month. As a result of patient-centered team discussion, PD was selected for his RRT, considering for reduction his cardiac burden. On admission, he was classified as New York Heart Association (NYHA) class IV. His blood pressure was 88/52 mmHg, and oxygen saturation was 78% on room air. After the initiation of PD, fluid overload and dyspnea improved to NYHA class II. It allowed him to spend rest of his life at home with better QOL without hospitalization for heart failure for three years. At last, atrial fibrillation, untreatable with anti-arrhythmia drugs nor defibrillation, caused low output syndrome. Although he had no symptoms of uremia nor difficulty breathing, he died of heart failure at the age of 56.

**Discussion:** In general, patients with congenital heart disease with Eisenmenger syndrome and NYHA classification IV are expected to have shorter life spans than those of healthy population for more than 40 years. Among those patients, the main cause of death is heart failure. Declined kidney function is a risk of hospitalization. For this case, hemodialysis might have worsened his hemodynamics or susceptibility to blood stream infection. For the patients of cardio-renal syndrome due to cyanotic heart disease, PD could be the best choice to pursue better palliative care, maintaining QOL.

**FR-PO527**

**Point of Care Peritoneal Dialysis: Initial Usability Assessments**

Ben Talbot,<sup>1,2</sup> Sue R. Lynch,<sup>3</sup> Jenny A. Burman,<sup>2</sup> Vincent J. Garvey,<sup>1,2</sup> Navneet Kaur,<sup>2</sup> John Knight.<sup>1,2</sup> *<sup>1</sup>The George Institute for Global Health, University of New South Wales, Sydney, NSW, Australia; <sup>2</sup>Ellen Medical Devices, Sydney, NSW, Australia; <sup>3</sup>MedTech Pathways, Sydney, NSW, Australia.*

**Background:** The Ellen Medical Devices Point-Of-Care (EM-POC) system can be used by patients and care-givers to produce PD fluid from potable water at the point-of-care. Early identification of potential use errors is important within the medical device design process. IEC 62366-1 is a medical device human factors engineering process standard used to establish the safety of medical devices with respect to usability. Formative evaluations are completed iteratively, early and often throughout an optimal design process, with feedback used to improve device design. We present results from early formative evaluations which have informed the ongoing design and development of the EM-POC system.

**Methods:** Formative human factors evaluations compliant to IEC 62366-1 were completed with an experienced PD patient, PD nurses and internal company personnel: 1. Participants assessed usability of a prototype device when used to complete PD bag fills with sterile water produced by the EM-POC system at home. (n=4) 2. Participants completed tasks and provided opinions regarding aspects of design and usability through online evaluations using images of the prototype and software simulation of the user interface. (n=3)

**Results:** The most common potential harm identified was concern over contamination risk leading to peritonitis. Resulting design adjustments have included: 1. Tactile and auditory feedback during connection of the PD bag 2. Improved geometry and visibility of the connection port 3. A single step connection process 4. Prohibited distilling if the connection is incomplete or incorrect

**Conclusions:** Early formative evaluations have successfully identified potential use errors enabling design refinement and improvement prior to further clinical evaluation.

**Funding:** Commercial Support - Ellen Medical Devices

**FR-PO528**

**Long-Term Survival Rates in Peritoneal Dialysis Initiated Immediately After Catheter Insertion: Comparative Study With Hemodialysis**

**Yoonsun Joo, Young-Il Jo, Jung Hwan Park. Konkuk University Medical Center, Gwangjin-gu, Seoul, Republic of Korea.**

**Background:** The aim of this study was to compare long-term survival rates of patients on peritoneal dialysis (PD) who started immediately after catheter insertion without a break-in procedure and those on hemodialysis (HD).

**Methods:** We conducted a retrospective study including all ESRD patients who started HD or PD between Jan 2005 and Dec 2021. PD catheters were inserted using percutaneous catheter insertion and initiated immediately. All patients were followed up until death, renal transplantation, or the end of the study. Patient survival rates were calculated using Kaplan-Meier analyses.

**Results:** A total of 379 HD patients and 150 PD patients were included. During followup, death occurred in 34.0% (n=129) of HD and 21.3% (n=32) of PD cases. The survival rates of HD patients were 92.5%, 81.1% and 44.8% at 1, 3 and 10 years. In PD patients, the survival rates were 95.5%, 86.4% and 55.7% at 1, 3 and 8 years. There was no difference in long-term survival between two groups (Fig1A). However, in the first year of dialysis, PD was associated with a greater survival than HD (p=0.007) (Fig1B). Advanced age (defined as ≥60 years) and diabetes were associated with an increase in mortality regardless of dialysis modality (Fig1C). Particularly, the survival rate of non-diabetic PD was higher than that of non-diabetic HD as well as HD and PD patients with diabetes (Fig1D).

**Conclusions:** There is no difference in long-term survival rate between HD and immediate-start PD, but in the first year of dialysis, PD patients have better survival rate than HD. In particular, in non-diabetic patients, PD seems to have a superior survival rate than HD.

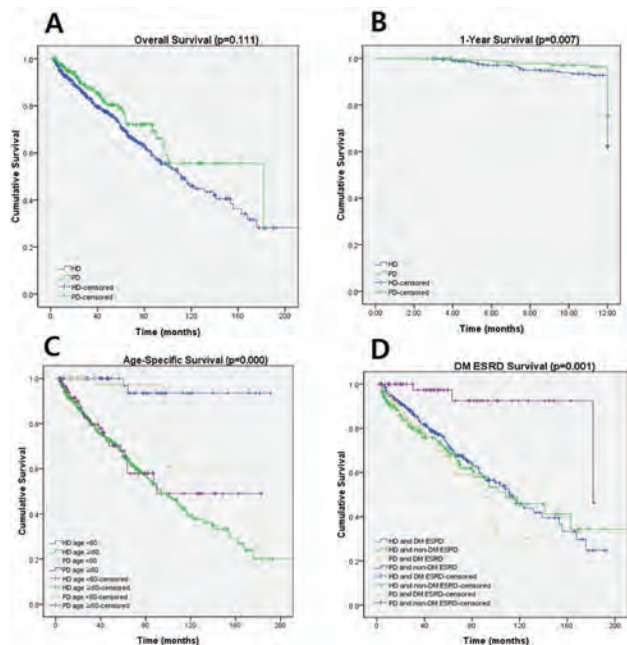

Long-term survival rates in HD and PD patients who started immediately after catheter insertion (A) Overall survival (B) 1-Year survival (C) Age-specific survival (D) DM-related survival

**FR-PO529**

**A Retrograde Implantation Approach for Peritoneal Dialysis Catheter Placement in Mice**

**Isaac E. Sellinger,<sup>1,2</sup> Saran Lotfollahzadeh,<sup>1,2</sup> Lauren D. Stern,<sup>1,2</sup> Jean M. Francis,<sup>2,1</sup> Vipul C. Chitalia,<sup>2,4</sup> Mostafa Belghasem,<sup>3</sup> <sup>1</sup>Boston University School of Medicine, Boston, MA; <sup>2</sup>Boston University Renal Section, Boston, MA; <sup>3</sup>Kaiser Permanente Bernard J Tyson School of Medicine, Pasadena, CA; <sup>4</sup>Veterans Affairs Boston Healthcare System, Boston, MA.**

**Background:** Chronic kidney disease (CKD) has reached pandemic proportions. Almost one in seven and two in 1,000 Americans have CKD, and End-Stage Kidney Disease (ESKD), respectively. While hemodialysis is the mainstay of renal replacement therapy, peritoneal dialysis (PD) provides distinct advantages. Murine models are employed to investigate details of peritoneal membrane failure. Current murine models suffer from technical challenges like catheter migration and kinking that often warrant early catheter removal and compromise the models' performance. We set out to improve a PD murine model and overcome these key limitations.

**Methods:** Ten C57BL/6J mice, 8–12 weeks in age, were used. Peritoneal catheters were placed with a novel retrograde technique. This method was validated using an LPS-induced inflammation assay. LPS was injected with 2 mg/kg bodyweight for 7 days. The peritoneal membrane was probed for fibrosis, neovascularization, and sub-peritoneal space using integrated density measurements normalized to the area.

**Results:** A retrograde method of PD catheter was adopted. Accordingly, the catheter was customized with a side hole and retrograde tube passing through a prefabricated tract. All the implanted catheters were functional till the end of the study. No incidences of catheter dislodgement, leaking of PD fluid, skin damage, or catheter kinking were noted. Compared to PBS, LPS exposure resulted in a significant increase in the extracellular matrix in the sub-peritoneal space (P=0.008), a 3-fold increase in sub-peritoneal fibrosis (P=0.015), and an 8–9-fold increase in the vascularity (P=0.0168).

**Conclusions:** Out of 3 conventional murine models of PD, we now describe a modified method that significantly improved the PD catheter functions and avoided all the complications noted with the previous method. The current modifications will now pave the way to generate a durable murine model to investigate the long-term consequences of peritoneal membrane failure in human ESKD patients.

**Funding:** NIDDK Support, Other NIH Support - NIH 1R01HL132325, R21 DK119740-01, AHA Cardio-oncology SFRN CAT-HD Center grant 857078

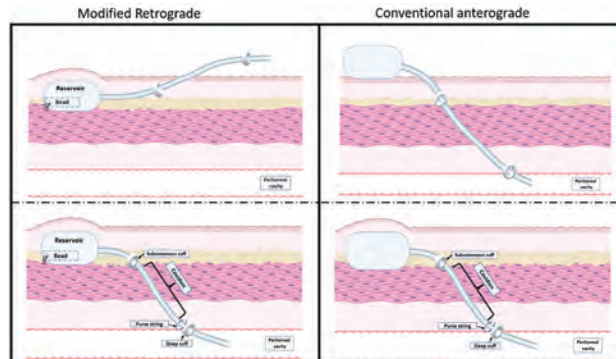

**FR-PO530**

**Medical, Radiological, and Surgical Peritoneal Dialysis Catheter Insertion Outcomes at a Single UK Centre**

**Gemma D. Banham, Matthew Tabinor, Amar M. Mahdi, Jyoti B. Baharani. University Hospitals Birmingham NHS Foundation Trust, Birmingham, United Kingdom.**

**Background:** We sought to determine success rates of peritoneal dialysis (PD) catheters inserted at our centre.

**Methods:** Audit of PD catheter outcomes from 2019 to 2021 at Birmingham Heartlands Hospital (BHH), University Hospitals Birmingham NHS Foundation Trust (UHB). Surgery was performed at BHH and Queen Elizabeth Hospital Birmingham, UHB.

**Results:** In 182 patients referred for PD catheter placement, 220 procedures were performed (83 (37.7%) medical, 80 (36.4%) radiological, 57 (25.9%) surgical). The initial insertion attempt was successful in 128/182 (70.3%) cases - 56/83 (67.5 %) medical, 44/60 (73.3%) radiological and 28/39 (71.8%) surgical. Catheters were successfully sited in 28/35 (80.0%) patients on further attempts. After failed medical placement, catheters were sited medically in 1/23 (4.3%), radiologically in 10/23 (43.5%) and surgically in 7/23 (30.4%), with 5/23 (21.7%) commencing haemodialysis (HD) after another failed attempt. After failed radiological placement, catheters were successfully sited in 1/8 (12.5%) radiologically and 6/8 (75.0%) surgically, with 1/8 (12.5%) commencing HD following unsuccessful placement. Surgical placement was successful with a second procedure in 2/4 (50%) of those failing surgical placement. 19 patients opted against a second attempt. There were no differences in one year catheter survival between catheters inserted medically, radiologically and surgically (log rank test p=0.68). Catheter insertion modality, age, sex, ethnicity, cause of renal disease and index of multiple deprivation were not predictors of catheter failure in cox regression analysis.

**Conclusions:** Catheters placed medically were comparable to those placed radiologically and surgically and offer an option for PD catheter insertion in day case and acute settings in suitable patients. Without predictors of poor outcome, clinical judgement remains critical in determining patient suitability.

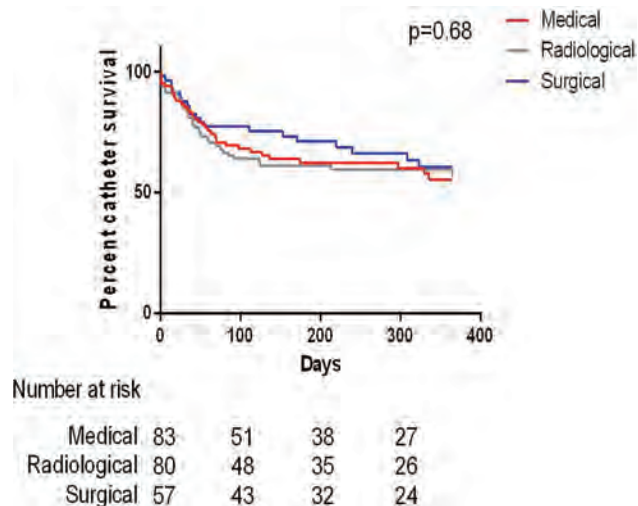

**Table 1. Baseline characteristics at time of PD catheter placement**

	Surgical placement N=39	Percutaneous placement N=34	p-value
Age (years; mean ± SD)	58.4 ± 14.2	57.1 ± 12.0	0.663
Male sex	20 (51%)	23 (68%)	0.156
BMI (kg/m <sup>2</sup> )			0.917
<18.5	1 (3%)	2 (6%)	
18.5-24.9	13 (33%)	11 (32%)	
25-29.9	13 (33%)	11 (32%)	
30+	12 (31%)	10 (29%)	
Primary kidney disease			0.899
Diabetic nephropathy	10 (26%)	8 (24%)	
Glomerulonephritis	11 (28%)	9 (26%)	
Polycystic disease	5 (13%)	4 (12%)	
Hypertension/nephrosclerosis	3 (8%)	2 (6%)	
Others	6 (15%)	4 (12%)	
Uncertain	4 (10%)	7 (21%)	
Previous kidney transplant	4 (10%)	5 (15%)	0.564
Comorbidities			0.259
Diabetes			
Type 1	2 (5%)	2 (6%)	
Type 2	20 (51%)	11 (32%)	
CAD	7 (18%)	6 (18%)	0.973
Cerebrovascular disease	3 (8%)	1 (3%)	0.374
PVD	4 (10%)	3 (9%)	0.836
History of cancer	5 (13%)	0 (0%)	0.031
Chronic lung disease	7 (18%)	3 (9%)	0.258
Smoking			0.075
Never	16 (41%)	21 (62%)	
Current	9 (23%)	2 (6%)	
Former	14 (36%)	11 (32%)	
Era			<0.001
Before 1 June 2017	30 (77%)	0 (0%)	
From 1 June 2017	9 (23%)	34 (100%)	
Catheter exit-site localization (peri-umbilical)			0.012
Right	19 (49%)	7 (21%)	
Left	20 (51%)	27 (79%)	
Time from placement to first PD treatment (days; median (IQR))	34 (19-52)	28 (22-35)	0.183

**FR-PO531**

**Surgical and Image-Guided Percutaneous Peritoneal Dialysis Catheter Placement Associated With Similar Outcomes: A Single-Center Retrospective Study in Canada**

Kahina Ait Zaid,<sup>1</sup> Yaniss Heniche,<sup>2</sup> Isabelle Ethier.<sup>3,4</sup> <sup>1</sup>Universite de Montreal, Montreal, QC, Canada; <sup>2</sup>Universite de Sherbrooke, Sherbrooke, QC, Canada; <sup>3</sup>Centre Hospitalier de l'Universite de Montreal, Montreal, QC, Canada; <sup>4</sup>Centre Hospitalier de l'Universite de Montreal Centre de Recherche, Montreal, QC, Canada.

**Background:** The current ISPD guidelines do not recommend any specific peritoneal dialysis (PD) catheter placement technique due to lack of demonstrated superiority of one technique over the others. We aimed to evaluate outcomes following catheter placement in our center, comparing surgical placement and image-guided percutaneous insertion.

**Methods:** In this retrospective cohort study, all patients (prevalent and incident) enrolled in our PD program from June 2017 until December 2021 were included. Incidence of immediate complications and early (<30 days) exit-site infections and peritonitis were evaluated. Time-to-first peritonitis and first exit-site infection were also analyzed using the Kaplan-Meier product-limit method and log-rank test.

**Results:** Of the 73 patients enrolled in our PD program during the study period, 39 and 34 underwent surgical and percutaneous catheter placement, respectively. Baseline characteristics were similar in both groups, except for history of cancer, year of PD start and left/right localization of the peri-umbilical catheter exit-site. There were 1 and 3 immediate complications; 2 and 1 early exit-site infections; 0 and 1 (associated to an immediate complication) early peritonitis in the surgical and percutaneous groups, respectively. Two patients in each group required repositioning or new catheter placement within 90 days of the first intervention. Percutaneous catheter placement showed similar time-to-first peritonitis (p=0.35) and time-to-first exit-site infection (p=0.30) compared to surgical placement.

**Conclusions:** Surgical and percutaneous PD catheter placement showed similar outcomes in our center. Future studies could also evaluate other aspects of catheter placement techniques, such as cost and patient experience.

**FR-PO532**

**Complications in Peritoneal Dialysis Catheters Placed Percutaneously vs. Surgically in a Second Level Hospital in Merida, Mexico**

Naomi A. Alvarez Zapata, Leticia M. Tapia Silva. Hospital General Agustin O'Horan, Merida, Mexico.

**Background:** The state of Yucatan has the highest prevalence of obesity, diabetes and nephrolithiasis in Mexico. The Hospital Dr. Agustin O'Horan is located in Merida and receives uninsured patients of indigenous Mayan descent. Due to the limited access to healthcare in these regions and the high prevalence of comorbidities, most patients progress to renal failure and end up in the emergency department with uremic syndrome. The objective of our study is to describe the frequency of mechanical and infectious complications within 30 days of peritoneal dialysis (PD) catheter insertion between the percutaneous and surgical technique.

**Methods:** This is a descriptive study conducted at our hospital from January 1st to April 24th, 2022. Data was collected from patients who were candidates to start renal replacement therapy with PD. Percutaneous catheter insertion was performed with a bedside blind technique or with an open mini-laparotomy. Patient preparation in the percutaneous approach included fasting, insertion of a urinary catheter and colonic enema. Informed consent and preoperative blood tests were obtained. Analgesia and antibiotic prophylaxis were administered and double cuff Tenckhoff catheters were used.

**Results:** 48 dialysis catheter insertions took place in 44 patients while 4 of them underwent catheter removal and replacement. The mean age of the participants was 49.9 years, 61.3% were women and 70.4% were diabetic. Of the total of PD catheter insertions, 18 were percutaneous and 30 surgical. There was no difference between groups in terms of mechanical and infectious complications, while transfer to hemodialysis was more common in the surgical group.

**Conclusions:** One of the greatest challenges that Mexico faces is the accelerated growth of chronic kidney disease in a vulnerable population with limited access to healthcare. Achieving safer, and more convenient PD catheter placement with the use of minimal human and material resources is key to our institution in order to reduce the cost and the impact of kidney failure.

Variable	Percutaneous (n=18)	Surgical (n=30)	p
Mechanical dysfunction (%)	2(11)	8(26)	0.16
Exit-site infection (%)	1(5.5)	1(3.3)	0.76
Peritonitis (%)	2(11)	2(6.6)	0.68
Uncomplicated catheter within 30 days (%)	13(72)	15(50)	0.13
Transfer to hemodialysis (%)	0(0)	9(30)	0.007

FR-PO533

Percutaneous vs. Surgical Catheter Placement in Subjects With ESKD Referred Late to Start of Peritoneal Dialysis

Hugo E. Chavez. Instituto Mexicano del Seguro Social, Jalisco, Mexico.

Background: In developing countries, end-stage kidney disease (ESKD) patients are often referred late for renal replacement treatment. In this context requiring immediate treatment, it is unknown whether percutaneous peritoneal dialysis (PD) catheter placement is feasible and safe compared to surgical insertion. Aims: To compare clinical outcomes of percutaneous vs surgical catheter placement in a cohort of ESKD patients with need to initiate as soon as possible dialysis and referred for PD initiation.

Methods: Prospective cohort study performed at the General Regional Hospital IMSS 180, a tertiary reference center for PD care in Jalisco, Mexico (2018-2020). Subjects were selected for percutaneous catheter placement unless there was a contraindication in which case surgical insertion was performed. The goal was a short break-in period to achieve PD initiation as soon as possible.

Results: A total of 261 subjects underwent percutaneous (n=102, 39%) or surgical (n=159, 61%) catheter placement. Patients who underwent percutaneous insertion were younger (39 [IQR 28-58] vs 54 [IQR 35-64] years), had more males (75% vs 50%), had a higher burden of uremic symptoms (54% vs 27%), lower eGFR (4.5 [IQR 3-6] vs 6 [IQR 4-7.5] mL/min/1.73m²), and higher frequency of serum K>6 mmol/L (22% vs 6%), all with a P<0.001. Subjects in percutaneous group had less waiting time between admission and catheter placement (6 [IQR 3-9] vs 11 [IQR 9-15] days), less time of break-in waiting period (1 [1-1] vs 2 [2-3] days) and shorter length of stay (13 [10-19] vs 18 [14-23], days, Fig 1). Nevertheless, percutaneous procedure was associated with a higher number of complications (48% vs 20%, P<0.001), including catheter dysfunction requiring surgery repair and/or exchange (29% vs 11%, P<0.001). Mortality during 3 year of follow-up was similar between percutaneous (23%) and surgical (24%) groups (log-rank=0.76, 95% CI: 0.46-1.26).

Conclusions: Compared to SX catheter insertion, percutaneous catheter placement in patients with need to initiate as soon as possible dialysis, significantly decreases waiting time between admission and catheter placement, break-in period, and the length of stay. Although the need for catheter exchange was more frequent with percutaneous technique, percutaneous placement allowed PD start in the majority of late-referred patients with advanced uremia.

Funding: Clinical Revenue Support

FR-PO534

Antibiotic Prophylaxis for Tenckhoff Catheter Insertion: A Prospective Randomized Controlled Trial

Tatiana Tanasychuk, Daniel Kushnir, Oleg Sura, Ilona Mendelovich, Victor Frajzewicki. Carmel Medical Center, Haifa, Israel.

Background: The incidence of early (postoperative) peritonitis after catheter insertion was described as high as 17%. Current guidelines recommend intravenous (IV) preoperative antibiotic prophylaxis. For the last 20 years, our protocol includes a single dose of Cefazoline administered intraperitoneally (IP) through the Tenckhoff catheter immediately after its insertion. Our previous retrospective study (2016) showed the effectiveness of this protocol. Over the past years, we conducted a prospective randomized trial using the same protocol of Cefazoline prophylaxis. The aim of the trial is to compare the effectiveness of both methods of prophylaxis

Methods: The trial includes all adult patients at our Institution who were candidates for peritoneal catheter insertion, able to give informed consent, without history of antibiotic use in the two weeks prior to the procedure and without history of allergy to cephalosporins. The study has two arms: intravenous preoperative or intraperitoneal postoperative, while in both arms we used the same dose (1 gr) of Cefazoline. Follow-up period was 2 weeks after the catheter insertion procedure

Results: From March 8, 2017 - December 15, 2021 sixty two patients were included in the trial, the IP group included 30 individuals and the IV arm 32 persons. Mean age was 64.7 years (31-87), 64.5% were male and 56.5% were diabetics. A percutaneous insertion was done in 95% of the procedures, only 5% surgical. Patient's characteristics were similar in both groups. Twenty four percent of patients were Staphylococcus aureus nose carriers (37% in IP arm and 13% in IV arm) and received antibiomatic topical prophylaxis. Two cases of peritonitis (3%) were recorded, without difference between the groups (one in each group).

Conclusions: Taking in count the relatively small size sample of one single center, early results of our study support the hypothesis of non-inferiority effectiveness of IP postoperative Cefazolin administration in comparison to IV preoperative for early peritonitis prophylaxis after percutaneous peritoneal catheter insertion.

FR-PO535

Change in Payment Method and the Use of Etelcalcetide and PTH Values Among Dialysis Patients in Two Dialysis Organizations

Carol Moore,<sup>1</sup> Najma Saleem,<sup>1</sup> Junjie Ma,<sup>1</sup> Gina C. Mak,<sup>5</sup> Kevin J. Martin,<sup>4</sup> Stuart M. Sprague.<sup>2,3</sup> <sup>1</sup>Amgen, Thousand Oaks, CA; <sup>2</sup>NorthShore University HealthSystem, Evanston, IL; <sup>3</sup>University of Chicago Pritzker School of Medicine, Chicago, IL; <sup>4</sup>Saint Louis University, Saint Louis, MO; <sup>5</sup>IQVIA Inc, Durham, NC.

Background: The CMS has provided reimbursement for the treatment of end-stage renal disease (ESRD) under a Medicare bundled prospective payment system (PPS) since 2011. A new payment adjustment system, Transitional Drug Add-On Payment Adjustment

(TDAPA), was established in 2016 to account for new therapies. Calcimimetics became eligible for TDAPA in 2018. On January 1<sup>st</sup> 2021 calcimimetics were no longer reimbursed using TDAPA. Instead, the bundle base rate was increased for all patients to support utilization of etelcalcetide based on a national average usage of 6.3% of dialysis treatments. This study described the use of etelcalcetide and the parathyroid hormone (PTH) values before and after January 1<sup>st</sup> 2021.

Methods: This was a repeated cross-sectional study. Data were collected from electronic medical records of two dialysis organizations between January 2019 and December 2021. All etelcalcetide users who visited dialysis facilities operated by the dialysis organizations were included. The number and percent of etelcalcetide continuers and the average PTH values of all patients by month were reported. Additionally, we identified those whose last dose of etelcalcetide was between December 1<sup>st</sup> 2020 and January 31<sup>st</sup> 2021 and reported PTH values among those in the 9 months prior and after the month of last dose.

Results: The mean of monthly average number of patients was 34,924 during the study period. The mean of monthly average number of etelcalcetide continuers was 5,105 (14.2%) between January 2019 and December 2020 and dropped to 217 (0.7%) in 2021 after the ESRD PPS policy change. The mean of monthly average PTH values between January 2019 and December 2020 was 483 pg/ml (range, 436 pg/ml to 533 pg/ml), while it increased to 544 pg/ml (range, 485 pg/ml to 601 pg/ml) in 2021. We identified 3,560 etelcalcetide discontinuers whose last dose was between December 1<sup>st</sup> 2020 and January 31<sup>st</sup> 2021. The mean of monthly average PTH values in the 9 months prior to the last dose was 579 pg/ml, while it was 745 pg/ml in the 9 months after the last dose.

Conclusions: A major decrease in etelcalcetide use and an increase in average PTH values were observed after the implementation of changes in the ESRD PPS. Future studies are warranted to investigate the impact of the policy change on patient outcomes.

Funding: Commercial Support - Amgen

FR-PO536

The Bioimpedance Spectroscopy to Preserve Renal Output (BISTRO) Multicentre Randomised Controlled Trial: Quality of Life and Blood Pressure Outcomes

Simon J. Davies,<sup>1</sup> Mandana Zanganeh,<sup>2</sup> Ivonne Solis-Trapala,<sup>1</sup> David F. Keane,<sup>3</sup> Andrew Davenport,<sup>4</sup> Martin E. Wilkie,<sup>10</sup> Paula Ormandy,<sup>7</sup> Jamie H. Macdonald,<sup>6</sup> Indranil Dasgupta,<sup>9</sup> Ken Farrington,<sup>8</sup> Fergus Caskey.<sup>5</sup> on behalf of the BISTRO Investigators <sup>1</sup>Keele University, Keele, United Kingdom; <sup>2</sup>University of Warwick University House, Coventry, United Kingdom; <sup>3</sup>Leeds Teaching Hospitals NHS Trust, Leeds, United Kingdom; <sup>4</sup>Royal Free London NHS Foundation Trust, London, United Kingdom; <sup>5</sup>University of Bristol, Bristol, United Kingdom; <sup>6</sup>Bangor University, Bangor, United Kingdom; <sup>7</sup>University of Salford, Salford, United Kingdom; <sup>8</sup>Hertfordshire Partnership University NHS Foundation Trust, Hatfield, United Kingdom; <sup>9</sup>NHS Birmingham and Solihull Clinical Commissioning Group, Birmingham, United Kingdom; <sup>10</sup>Sheffield Teaching Hospitals NHS Foundation Trust, Sheffield, United Kingdom.

Background: BISTRO examined if using bioimpedance (BIS) to avoid setting the post-dialysis target weight (PD-TW) below the normally hydrated weight (NHW) could preserve residual kidney function (RKF) when compared to a standardized fluid management protocol. This pre-specified secondary analysis reports the effect of BIS on health-related quality of life, symptoms, and blood pressure.

Methods: BISTRO is an open-label, clinician-blinded, randomized controlled trial in incident HD patients with >500ml urine volume/day or residual GFR >3 ml/min/m². Randomization was by centralized concealed allocation, 1:1, stratified by centre. BIS measurements were taken by independent observers and concealed in the control arm. Secondary outcomes included BP, self-rated health (EQ visual analogue scale), dialysis symptoms, health-related quality of life (EuroQol and Short Form 12), collected at baseline and 3-monthly until month 24. ISCTN Number: 11342007; Funding: UK NIHR Health Technology Assessment Programme

Results: Questionnaire completeness was 52%–89%, similar by group. Median EQ-VAS rose from 60 to 65 in both groups at 3 months, then back to baseline, remaining stable. Despite a progressive fall in RKF, dialysis symptoms were remarkably stable over 24 months (see Table) with only modest worsening of recovery time, no between-group differences. There was no longitudinal change or between-group difference in BP, just a tendency for a lower post-dialytic BP and more hypotensive symptoms in the control group between 18 and 24 months. Mean difference in PD-TW and NHW was not different between study arm assessments: BIS, n=1335 observations, -0.038Kg (SD 2.7); Control, n=1166 -0.25Kg (2.6)

Conclusions: Using a standardised fluid assessment protocol secondary outcomes were stable in those remaining in the trial and not benefited by the addition of BIS, possibly because clinician fluid assessments were close to the NHW.

Funding: Government Support - Non-U.S.

Table with columns for Measure, BL, M0, M1, M2, M3, M4, M5, M6, M7, M8, M9, M10, M11, M12. Rows include EQ-VAS Median (IQR), Recovery Time (h) within 2h, By bedtime or earlier, Cramps, Distress, Polythetism, Low BP Symptoms, and Short of Breath.

\*Data shown are median (IQR), where 0 = never; 1-2=occasionally; 3-5= sometimes; BL=Baseline; M0-M11; B=Biopmpedance; C=Control

FR-PO537

**Discordance Between Cause of Death Reported to USRDS and National Death Index for Hemodialysis Patients**

Yoshitsugu Obi,<sup>1</sup> Anna Xu,<sup>2</sup> Jonathan A. Wilson,<sup>2</sup> Patti Ephraim,<sup>6</sup> Daniel E. Weiner,<sup>3</sup> Julia J. Scialla,<sup>4</sup> Bernard G. Jaar,<sup>5</sup> Benjamin A. Goldstein,<sup>2</sup> Tariq Shafi.<sup>1</sup> <sup>1</sup>The University of Mississippi Medical Center, Jackson, MS; <sup>2</sup>Duke University Medical Center, Durham, NC; <sup>3</sup>Tufts Medical Center, Boston, MA; <sup>4</sup>University of Virginia School of Medicine, Charlottesville, VA; <sup>5</sup>Johns Hopkins University, Baltimore, MD; <sup>6</sup>Northwell Health Feinstein Institutes for Medical Research, Manhasset, NY.

**Background:** The USRDS reports that over 40% of deaths in patients with kidney failure on hemodialysis (HD) are due to cardiovascular disease (CVD), most of which are attributed to sudden cardiac death (CVD-SCD). These data are based on the Death Notification Form completed by dialysis clinics. The validity of USRDS reported cause of death has not been rigorously evaluated against the National Death Index (NDI) death certificate data, which provide epidemiological assessment of cause-specific mortality in the US.

**Methods:** Among 32,640 US adult incident HD patients, we identified 8,029 patients who died between 2003 and 2009 with cause of death not classified as hospice or dialysis withdrawal. We linked the NDI data to the dialysis cohort and compared USRDS vs. NDI cause of death using concordance and kappa ( $\kappa$ ) statistics.

**Results:** At the time of death, the patients' median age was 71 years and 44% were female. CVD accounted for 50% of deaths in the USRDS but only 37% in the NDI (Table). 32% of all deaths were classified as CVD-SCD by the USRDS compared to 17% by the NDI. Overall concordance of the USRDS with the NDI was low at 29%. The agreement between the USRDS and the NDI was poor (overall  $\kappa$ , 0.13), irrespective of the location of death (i.e., in-hospital vs. out-of-hospital) or the time since the last outpatient HD (i.e., <72 hours vs. >72 hours post HD). The poorest agreement ( $\kappa$ , 0.09) was observed among out-of-hospital deaths that occurred >72 hours after the last HD.

**Conclusions:** Significant discordance exists between cause of death reported by USRDS versus NDI. These findings may have major implications for the presumed CVD burden and risk factors associations with cause-specific mortality in the US HD population.

**Funding:** NIDDK Support

	National Death Index						Total [NDI %]
	CVD-SCD	CVD-non-SCD	Cancer	Infection	Other	Unknown/Missing	
CVD-SCD	613 (24%)	621 (24%)	35 (1%)	149 (6%)	754 (29%)	398 (16%)	2570 [32%]
CVD-non-SCD	252 (17%)	464 (31%)	5 (0.3%)	69 (5%)	447 (30%)	243 (16%)	1480 [18%]
Cancer	30 (15%)	14 (7%)	68 (34%)	6 (3%)	46 (23%)	34 (17%)	198 [2%]
Infection	107 (12%)	80 (9%)	7 (1%)	270 (29%)	287 (31%)	170 (18%)	921 [11%]
Other	118 (11%)	104 (10%)	21 (2%)	84 (8%)	568 (53%)	170 (16%)	1065 [13%]
Unknown/Missing	240 (13%)	301 (17%)	63 (4%)	133 (7%)	720 (40%)	338 (19%)	1795 [22%]
<b>Total</b>	1360 (17%)	1584 (20%)	199 (2%)	711 (9%)	2822 (35%)	1353 (17%)	<b>8029</b>

FR-PO538

**Cost-Effectiveness Analysis of Paricalcitol and Calcitriol in Beijing Patients With Secondary Hyperparathyroidism**

Jiannan Zhou. Beijing Aerospace General Hospital, Beijing, China.

**Background:** To compare the cost efficacy analysis and the effect on calcium and phosphorus variability of paricalcitol and calcitriol in the treatment of hemodialysis CKD-MBD patients in Beijing from the payer's perspective.

**Methods:** Patients were divided into the paricalcitol group and the calcitriol group, and both groups could be treated with a combination of cinacalcet. The treatment duration was 6 months, and the attainment endpoint was mean iPTH  $\leq$  300 pg/ml in the 4th-6th month of treatment. Efficacy was the attainment rate of patients in both groups. The cost is the sum of medications and laboratory tests over a 6-month period. We evaluated incremental cost-efficacy analysis (ICER) and plotted to scatter plots of incremental cost-effects using nonparametric Bootstrap repeated sampling 1000 times. A one-way sensitivity analysis of factors affecting ICER was also performed, and probabilistic sensitivity analysis of parametric random sampling was performed using Monte Carlo simulation.

**Results:** The effective rates in the two groups were 88.7% (paricalcitol group) and 56.5% (calcitriol group), respectively. The cost-effect basis analysis showed that the ICER of paricalcitol and calcitriol was CNY 41554.702. Single-factor sensitivity analysis showed that the price of paricalcitol is the most sensitive factor, and the probabilistic sensitivity analysis showed that paricalcitol was a more economical solution when the willingness to pay (WTP) was above CNY 32500. There is no differences of the calcium and phosphorus smoothing index between two groups.

**Conclusions:** Paricalcitol has an economic advantage when the six-month willingness to pay is CNY 32,500 or more per effective patient treated.

Calcitriol vs Paricalcitol

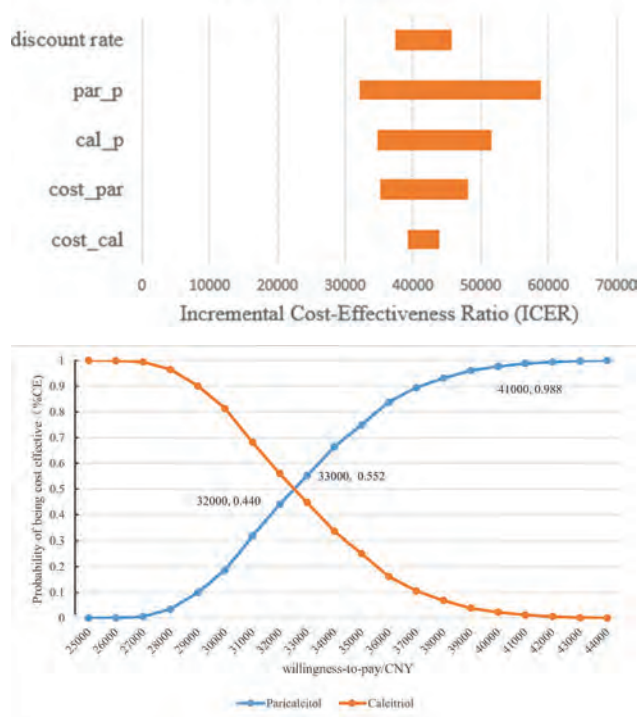

FR-PO539

**Nurse Caseload and Patient Survival in Hemodialysis Units: A Korean Nationwide Cohort Study**

Do Hyung Kim, Seyeon Park, Yoseop Cha, Hayne C. Park. Kangnam Sacred Heart Hospital, Yeongdeungpo-gu, Seoul, Republic of Korea.

**Background:** The patient-to-nurse ratio is highly variable among dialysis facilities. However, there is little known about the association between nurse caseload and hemodialysis (HD) patient outcomes. We evaluated the association between patient-to-nurse ratio and mortality in the Korean patients undergoing HD.

**Methods:** We used HD quality assessment data and National Health Insurance Service claim data from the year of 2013 for collecting demographic and clinical data. Altogether, 21,817 patients who participated in the HD quality assessment in 2013 were included in the study. Nurse caseload was defined as the number of HD sessions performed by a nurse per working day. The patients were divided into two groups according to the nurse caseload as follows: low nurse caseload group ( $\leq$ 6.0) and high nurse caseload group ( $>$ 6.0). We analyzed mortality risk based on nurse caseload using the Cox proportional hazard model.

**Results:** The mean age was 59.1 years, and males accounted for 58.5%. The mean hemoglobin was 10.6 g/dL and albumin was 3.99 g/dL. At the mean follow-up duration of 51.7 (20.6) months, the ratio between low and high groups was 69.6% (15,184 patients) versus 30.4% (6,633 patients). The patients in the high nurse caseload group were older and showed lower levels of hemoglobin, albumin, calcium, and iron saturation and higher levels of phosphorus than those in the low nurse caseload group. A high nurse caseload was associated with a lower survival rate. In the adjusted Cox analysis, a high nurse caseload was an independent risk factor for all-cause mortality (hazard ratio 1.08; 95% confidence interval, 1.02–1.14;  $p = 0.01$ ).

**Conclusions:** High nurse caseload was associated with an increased mortality risk among the patients undergoing HD. Further prospective studies are needed to determine whether a caseload of nursing staff can improve the prognosis of HD patients.

FR-PO540

**Professional Fulfillment and Burnout Among US Dialysis Technicians: A National Association of Nephrology Technicians/Technologists (NANT) Survey**

Megan A. Urbanski,<sup>1</sup> Fran W. Rickenbach,<sup>2</sup> Alexis A. Bender,<sup>1</sup> Courtney E. Hoge,<sup>1</sup> Clarica Douglas-Ajayi,<sup>2</sup> Jennifer C. Morgan,<sup>3</sup> Bernard G. Jaar,<sup>4</sup> Laura Plantinga.<sup>1</sup> <sup>1</sup>Emory University, Atlanta, GA; <sup>2</sup>National Institute of Nephrology Technicians/Technologists, Dayton, OH; <sup>3</sup>Georgia State University, Atlanta, GA; <sup>4</sup>Johns Hopkins University, Baltimore, MD.

**Background:** High levels of professional fulfillment and low levels of burnout are necessary for a stable, satisfied dialysis workforce. We examined professional fulfillment and burnout among critical frontline hemodialysis staff — dialysis technicians.



**Methods:** A one-time, anonymous, online survey was administered to NANT members, recruited via postcards distributed at professional conferences, newsletter and social media announcements, and direct emails. Surveys included Likert-scale items (range, 0-4; see Figure) related to professional fulfillment and two domains of burnout (work exhaustion and interpersonal disengagement).

**Results:** A total of 222 working U.S. dialysis technicians [42.6% aged 35-49; 83.9% female; 20.8% Black; 15.7% Hispanic] completed the survey. Overall domain scores for professional fulfillment, work exhaustion, and interpersonal disengagement [median (interquartile range)] were 2.6 (2.0-3.2), 2.3 (1.3-3.0), and 1.0 (0.3-1.8), respectively; scores for individual items are shown in the Figure. More than half of respondents stated that salary (66.5%), supervisor support (64.0%), respect from other dialysis staff (57.8%), sense of purpose about work (54.5%), hours worked per week (52.9%), respect from patients (52.0%), and autonomy (50.4%) "contributed a lot" to fulfillment and burnout.

**Conclusions:** NANT members report moderate professional fulfillment and low interpersonal disengagement scores, but high work exhaustion scores, which may lead to burnout and compromise patient safety. We identified several modifiable factors, including competitive salaries, reduced workloads and/or work hours, and improved collegial relationships, that could be addressed to improve professional fulfillment and reduce burnout among dialysis technicians.

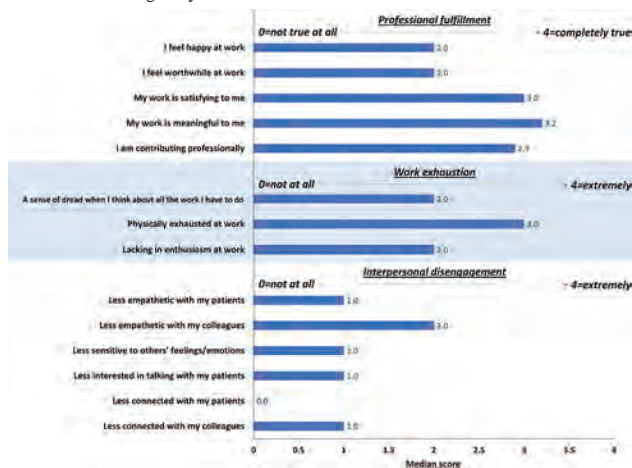

**FR-PO541**

**Work Experiences and Turnover Intention Among US Dialysis Technicians: A National Association of Nephrology Technicians/Technologists (NANT) Survey**

Laura Plantinga,<sup>1</sup> Fran W. Rickenbach,<sup>2</sup> Megan A. Urbanski,<sup>1</sup> Jennifer C. Morgan,<sup>3</sup> Clarica Douglas-Ajayi,<sup>2</sup> Courtney E. Hoge,<sup>1</sup> Alexis A. Bender,<sup>1</sup> Bernard G. Jaar.<sup>4</sup> *Emory University, Atlanta, GA; <sup>2</sup>National Association of Nephrology Technicians/Technologists, Dayton, OH; <sup>3</sup>Georgia State University, Atlanta, GA; <sup>4</sup>Johns Hopkins University, Baltimore, MD.*

**Background:** Turnover among dialysis staff is high, leading to understaffing, increased training costs, and decreased quality of care, but little is known about dialysis technicians specifically. We examined dialysis technicians' work experiences and turnover intention.

**Methods:** We administered a one-time, anonymous, online survey to NANT members, who were recruited via postcards distributed at professional conferences, newsletter and social media announcements, and direct emails. Surveys included items related to participant and work characteristics and turnover intention.

**Results:** A total of 222 actively working dialysis technicians completed the survey (3/22/22-5/5/22). Representing 39 U.S. states/territories, respondents were primarily middle-aged (42.6% aged 35-49), female (83.9%), white (67.8%), and non-Hispanic (85.3%). Most (80.4%) had at least some college. The majority (75.0%) worked in a freestanding outpatient hemodialysis facility. Half (50.0%) treated >9 patients per day, and 72.8% worked ≥40 hours per week; 23.7% worked at multiple facilities. While most respondents reported being certified (most commonly, Certified Clinical Hemodialysis Technician (73.7%) or Certified Hemodialysis Technician (22.4%)), fewer than half (45.5%) reported receiving formal (*i.e.*, not including on-the-job) training. Free responses reinforced perceived excessive work burden and lack of training. Only 52.6% reported that they plan to be working as a dialysis technician in 3 years (Figure).

**Conclusions:** Our results suggest that NANT members experience heavy workloads and have limited access to high-quality training. Even among this relatively engaged group of technicians, turnover intention is high, and with nearly half intending to soon seek new careers. Because of the critical, frontline role of dialysis technicians in hemodialysis care, strategies to improve training and working conditions and reduce turnover are imperative.

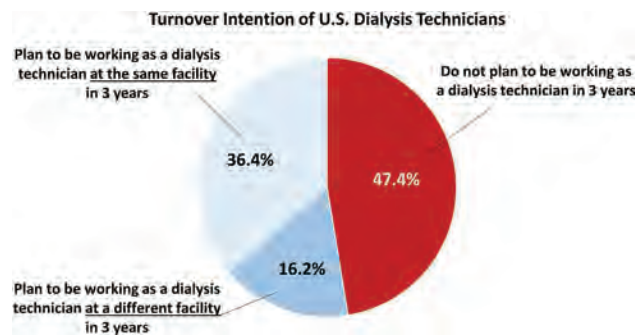

**FR-PO542**

**Cost-Utility of Real-Time Potassium Monitoring in Hemodialysis Patients**

Ryan J. Bamforth, Thomas W. Ferguson, Paul Komenda. *Chronic Disease Innovation Centre, Winnipeg, MB, Canada.*

**Background:** Patients with kidney failure requiring dialysis are at high risk for hyperkalemia, a result of elevated levels of potassium, which is associated with increased morbidity and mortality. Interventions aimed at early detection of hyperkalemic events may be useful to prevent these outcomes and their associated costs. As such, we performed a cost-utility analysis comparing an intervention where a real-time potassium monitoring device is administered in hemodialysis patients in comparison to usual care.

**Methods:** We performed a cost-utility analysis by developing a decision analytic microsimulation model from the perspective of the United States health care payer. Outcomes included the monthly break-even cost per patient of the proposed intervention and the incremental cost-effectiveness ratio (ICER) comparing use of the real-time potassium monitoring device to usual care. Costs associated with hyperkalemic events (emergency department and hospitalization specific) and dialysis were included. Utility estimates from a systematic review and meta-analysis were used to derive utilities for patients on hemodialysis. A reduction in hyperkalemic events of 25% was applied in the intervention scenario as a baseline effectiveness estimate, with a range between 10-50% considered in sensitivity analyses.

**Results:** Threshold analysis yielded a monthly break-even cost of \$689.56 US dollars per patient in the base case scenario. In addition, the microsimulation model found the intervention provided 0.04 additional quality-adjusted life-years (QALYs), and as such at any price point below or equal to the break-even cost the intervention was dominant in comparison to usual care. When altering effectiveness estimates between a reduction of hyperkalemic events between 10% to 50%, the monthly break-even cost ranged from \$265.36 to \$1387.90 USD respectively.

**Conclusions:** Implementing a real-time potassium monitoring device in hemodialysis patients to prevent hyperkalemic events has the potential for cost savings and increased quality of life from the perspective of the United States health care payer.

**Funding:** Commercial Support - Proton Intelligence INC

**FR-PO543**

**Development and Validation of Deep Learning Algorithm for Detecting Hyperkalemia Based on Electrocardiogram**

Dong Hee Lee, Jung Nam An, Sungmin Kim, Jwa-kyung Kim, Sung Gyun Kim. *Hallym University Sacred Heart Hospital, Anyang, Gyeonggi-do, Republic of Korea.*

**Background:** Hyperkalemia is a common electrolyte abnormality, which in severe cases can cause fatal arrhythmia and cardiac arrest. However, it is often asymptomatic, and diagnosis is difficult without blood tests. The purpose of this study is to detect hyperkalemia quickly and easily through a deep learning-based model that has learned an electrocardiogram (ECG) that is non-invasive and can be quickly measured.

**Methods:** Among patients who underwent an ECG at least once from 2006 to 2020, patients with blood test results within 24 hours were included, and dialysis patients were excluded. All ECGs were acquired using a GE ECG machine and the raw data (XML datatype) were stored using the MUSE data management system. For model training and evaluation, the ECG-serum K pair was separated into train, validation, and test set. Hyperkalemia and severe hyperkalemia were defined as 5.5 mEq/L ≤ K<sup>+</sup> and as 6.5 mEq/L ≤ K<sup>+</sup>. We trained a 4-class classification model using a Convolutional Neural Network. The model input was a standard 10-second, 12-lead ECG and the output being the likelihood of the ECG being from a patient with classes of serum potassium concentration.

**Results:** A total of 362,896 cases of ECG-serum K were analyzed in a total of 299431 patients, of which 330,137 cases were in the train set, 15,250 cases in the validation set, and 28,783 cases in the test set. In the validation set, AUROC for hyperkalemia was 0.97 and AUPRC was 0.79, and AUROC for severe hyperkalemia was 0.99 and AUPRC was 0.86. In the test set, for hyperkalemia, the sensitivity and specificity of deep learning model were 81.1% and 80.9%.

**Conclusions:** The deep learning model using the 12-lead ECG waveform detected hyperkalemia with high accuracy, and in severe hyperkalemia, the diagnostic predictive power was further increased. These results suggest the clinical applicability of AI software for diagnosing hyperkalemia using ECG.

FR-PO544

**Impact of Hyperkalemia on Mortality in Patients With Advanced Kidney Disease With and Without Hemodialysis: Implications for Deferring Hemodialysis Initiation Under Value-Based Models**

Elani Streja,<sup>1,2</sup> Jui-Ting Hsiung,<sup>1,2</sup> Abiy Agiro,<sup>3</sup> Souhiela Fawaz,<sup>3</sup> Laura Westfall,<sup>3</sup> Yemisi Oluwatosin,<sup>3</sup> Kamyar Kalantar-Zadeh.<sup>1,2</sup> <sup>1</sup>University of California Irvine, Irvine, CA; <sup>2</sup>U.S. Department of Veterans Affairs, Long Beach, CA; <sup>3</sup>AstraZeneca Pharmaceuticals LP, Wilmington, DE.

**Background:** The relationship between hyperkalemia (HK) and mortality in patients with stage 5 chronic kidney disease (CKD) or end-stage kidney disease (ESKD) with or without hemodialysis (HD) is not well established. This study examines the relationship between HK and all-cause mortality and whether it is dependent on HD initiation.

**Methods:** This retrospective cohort study of the United States (US) Veterans Affairs database identified 14,681 individuals initiating HD (HD cohort, N=5063) or with estimated glomerular filtration rate (eGFR) <10 mL/min/1.73m<sup>2</sup> but not on HD (non-HD cohort, N=9618) who had at least one potassium (K+) measurement within 30 days of HD or eGFR index date and complete data for covariates. The association between HK (K+ >5.0 mEq/L) and all-cause mortality was analyzed by Cox regression analysis.

**Results:** In the total cohort, 8548 (58.2%) individuals had HK within 1 year prior to index (baseline HK). A greater proportion of the HD cohort than the non-HD cohort had baseline HK (69.6% and 52.3%, respectively). All-cause mortality rates within 1 year post-index in the HD and non-HD cohorts were 11.3% and 20.5%, respectively. After adjustment for baseline HK, demographic characteristics, comorbidities, medication use, and baseline eGFR, HD was associated with a 60% decrease in 1-year all-cause mortality compared with no HD (adjusted hazard ratio [aHR] 0.40; 95% CI 0.37–0.44; P<0.0001). In the total cohort, 1-year all-cause mortality rates for those with and without baseline HK were 21.9% and 11.0%, respectively. Baseline HK was associated with a 50% increase in 1-year all-cause mortality compared with no baseline HK (aHR 1.50; 95% CI 1.37–1.64; P<0.0001).

**Conclusions:** HK was a strong independent risk factor for all-cause mortality among patients with stage 5 CKD/ESKD with and without HD. Patients with stage 5 CKD/ESKD managed conservatively without HD likely have less control of HK than those receiving HD. These data may have important implications for the goal of deferring HD initiation under value-based models.

**Funding:** Veterans Affairs Support, Commercial Support - AstraZeneca

FR-PO545

**Hyperkalaemia in Patients Receiving Renin-Angiotensin-Aldosterone System Blockade: Clinical Epidemiology and Outcomes**

Desmond Yap, Yu Fai Benjamin So, Chi Ho Paul Lee, Siu Han Jojo Hai, Tak Mao D. Chan. *The University of Hong Kong Li Ka Shing Faculty of Medicine, Hong Kong, Hong Kong.*

**Background:** Hyperkalaemia is a common side effect of patients receiving renin-angiotensin-aldosterone system (RAAS) blockade, but its prevalence and clinical impact can vary between different localities due to differences in diets and patient characteristics. Data regarding the epidemiology and outcomes of hyperkalaemia in Asian patients is relatively limited.

**Methods:** We analyzed all patients receiving RAAS blockade at Queen Mary Hospital, Hong Kong during 2018-2021 and identified patients with hyperkalaemia. The prevalence and clinical outcomes of patients with or without hyperkalaemia were compared.

**Results:** A total of 14,206 patients were analysed, including 6085 (42.8%), 5849 (41.2%) and 379 (2.7%) patients on angiotensin converting enzyme inhibitors (ACEI), angiotensin receptor blockers (ARB) and mineralocorticoid receptor antagonists (MRA) respectively. 1893 patients (13.3%) received dual or triple RAAS blockade. Hyperkalaemia occurred in 3959 (27.9%) patients. 1647 patients (11.6%) died during follow up, and 3-year mortality rate was significantly higher in patients with hyperkalaemia compared with those without (25.5% vs. 6.2%, p<0.001). 616 patients (4.3%) had major cardiovascular events (MACE), and patients with hyperkalaemia showed increased rates of MACE compared to those without hyperkalaemia (7.8% vs. 3.0%, p<0.001). Patients with hyperkalaemia also showed more rapid deterioration of eGFR compared with those without hyperkalaemia (2.8±6.0 ml/min/year vs. 1.3±4.3 ml/min/year, p<0.001). 314 patients (2.2%) developed end-stage kidney disease (ESKD) during a follow up of 3 years, and the incidence of ESKD was significantly higher in patients with hyperkalaemia (6.2% vs. 0.7%, p<0.001).

**Conclusions:** Hyperkalaemia is highly prevalent among Asian patients receiving RAAS blockade and is associated with unfavourable clinical outcomes.

FR-PO546

**Persistent Reduction in RAASI Therapy Following an Episode of Hyperkalemia**

Anjay Rastogi,<sup>1</sup> Eiichiro Kanda,<sup>2</sup> Toyoaki Murohara,<sup>3</sup> Eva Lesén,<sup>4</sup> Abiy Agiro,<sup>5</sup> Mina Khezrian,<sup>6</sup> Gengshi Chen,<sup>6</sup> Naru Morita,<sup>7</sup> Krister Järbrink,<sup>4</sup> Charles V. Pollack.<sup>8</sup> <sup>1</sup>David Geffen School of Medicine at the University of California Los Angeles, Los Angeles, CA; <sup>2</sup>Kawasaki Medical School, Okayama, Japan; <sup>3</sup>Nagoya University Graduate School of Medicine, Nagoya, Japan; <sup>4</sup>AstraZeneca, Gothenburg, Sweden; <sup>5</sup>AstraZeneca, Wilmington, DE; <sup>6</sup>AstraZeneca, Cambridge, United Kingdom; <sup>7</sup>AstraZeneca, Osaka, Japan; <sup>8</sup>University of Mississippi School of Medicine, Jackson, MS.

**Background:** RAASI therapy reduces the risk of cardiorenal events in patients with CKD or HF, but fear of hyperkalemia (HK) is a barrier towards achieving guideline-directed target dosing. The objective of this analysis was to describe longitudinal RAASI treatment patterns in patients after a HK episode.

**Methods:** This observational study used hospital records and claims data from the US (Optum MarketClarity) and Japan (Medical Data Vision). Patients with a HK episode (ICD-10 E87.5) from Jul 2019-Sep 2021 (US) or May 2020-Sep 2021 (Japan) and CKD or HF were included. RAASI classes encompassed ACE inhibitors, ARB, MRA and ARNi. Average dose across RAASI classes was described as a percentage of local guideline-directed target dose prior to the HK episode and at 3, 6 and 12 months after.

**Results:** Of 46,820 patients from the US, 89% had CKD and 52% had HF. In Japan (N=26,979), 52% had CKD and 74% had HF. 18,652 US patients and 8,467 patients in Japan filled ≥1 RAASI prescription in the 3 months prior to the HK episode. The most common RAASI classes were ACE (used by 56.4%), ARB (31.9%) and MRA (21.8%) in the US, and ARB (74.1%), MRA (26.5%) and ACE (17.2%) in Japan. In the US, 60% attained >50% of target dose across RAASI classes prior to the HK episode (Figure), dropping to 41-45% in the subsequent 3-12 months. At 3 months, 28% had discontinued, and 23% had no RAASI treatment at 12 months. While attainment of guideline-target dose prior to the HK episode was lower in Japan, the patterns over time were similar to those in the US.

**Conclusions:** Despite guideline recommendations to maintain RAASI therapy with antihyperkalemia treatment, RAASI therapy is commonly discontinued following a HK episode and the RAASI reduction persists over time.

**Funding:** Commercial Support - AstraZeneca

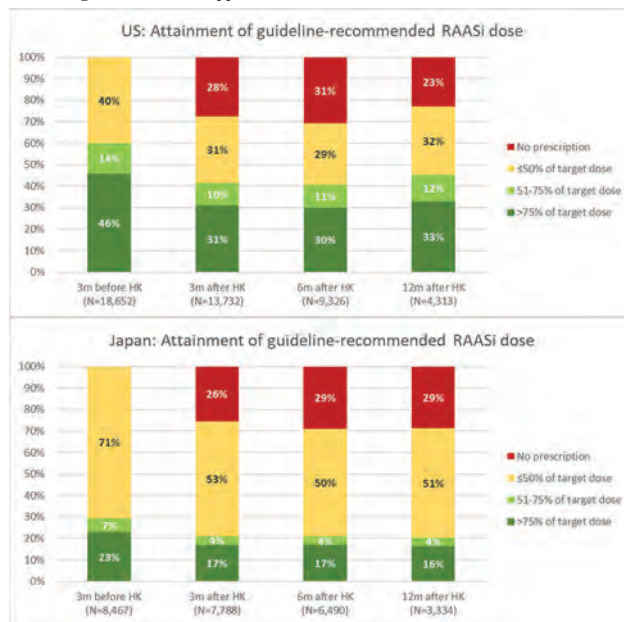

Target RAASI dose attainment

FR-PO547

**Recurrent Hyperkalemia and Renin-Angiotensin-Aldosterone System Inhibitor (RAASI) Down-Titration in a US Integrated Healthcare System**

Hui Zhou,<sup>1,2</sup> Liang Ni,<sup>1</sup> John J. Sim,<sup>3,2</sup> Teresa N. Harrison,<sup>1</sup> Oluwaseye Ogun,<sup>1</sup> Rong Wei,<sup>1</sup> Abiy Agiro,<sup>4</sup> Yasmin G. Brahmabhatt,<sup>4</sup> Yemisi Oluwatosin,<sup>4</sup> Craig G. Schilling,<sup>4</sup> Jaejin An.<sup>1,2</sup> <sup>1</sup>Kaiser Permanente Southern California, Pasadena, CA; <sup>2</sup>Kaiser Permanente Bernard J Tyson School of Medicine, Pasadena, CA; <sup>3</sup>Kaiser Permanente Los Angeles Medical Center, Los Angeles, CA; <sup>4</sup>AstraZeneca Pharmaceuticals LP, Wilmington, DE.

**Background:** While RAASI down-titration (discontinuation and dose reduction) is common after new-onset hyperkalemia, how RAASI down-titration is related to recurrent hyperkalemia is not well understood. We evaluated recurrent hyperkalemia and factors associated with RAASI down-titration among patients with chronic kidney disease (CKD) and/or heart failure (HF).

**Methods:** A retrospective cohort study was conducted among adults with CKD and/or HF who experienced new-onset hyperkalemia (potassium  $\geq 5.0$  mEq/L, index) at Kaiser Permanente Southern California. We required patients to have  $\geq 2$  fills of RAASi within 1 year prior to the index and followed them for up to 1 year. We evaluated recurrent hyperkalemia every 3 months from Month 1 to 9 and RAASi down-titration [discontinuation ( $\geq 90$ -day gap in refills of  $\geq 1$  RAASi) or  $\geq 25\%$  dose reduction compared with the dose prior to the index] in the following 3 months from Month 4 to 12. Secondary analysis was conducted using discontinuation as an outcome. Generalized estimating equation models were performed to identify factors associated with RAASi down-titration.

**Results:** Of 7,875 patients, the percentages of RAASi dose reduction were stable at 17% in all 3-month periods and discontinuation decreased from 12% to 7% in the last 3 months. The percentages of recurrent hyperkalemia were 10% and 8% in the first and the last 3 months, respectively. Recurrent hyperkalemia was associated with a higher likelihood of RAASi down-titration [rate ratio (RR) 1.36, 95%CI 1.16-1.60] and discontinuation [RR 1.75, 95%CI 1.48-2.08] (Figure). Inpatient recurrent hyperkalemia and worse kidney function were associated with a higher likelihood of RAASi down-titration.

**Conclusions:** After new-onset hyperkalemia, those who developed recurrent hyperkalemia were more likely to discontinue or reduce the dose of RAASi.

**Funding:** Commercial Support - AstraZeneca

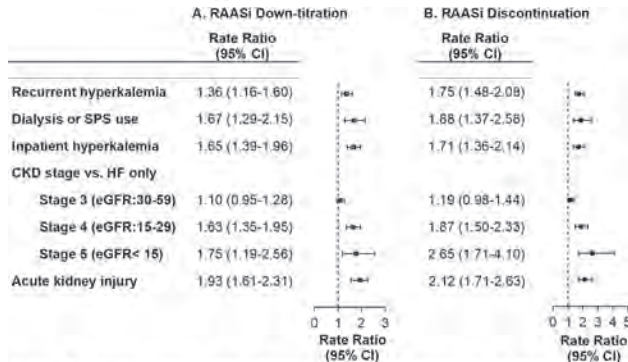

Figure. Rate Ratios of RAASi down-titration (A) or RAASi discontinuation (B) with recurrent hyperkalemia and other selected factors

FR-PO548

**Cardiorenal and Mortality Outcomes Associated With Renin-Angiotensin-Aldosterone System Inhibitor (RAASi) Discontinuation After New-Onset Hyperkalemia**

Jaejin An,<sup>1,2</sup> Hui Zhou,<sup>1,2</sup> Liang Ni,<sup>1</sup> John J. Sim,<sup>3,2</sup> Teresa N. Harrison,<sup>1</sup> Oluwaseye Ogun,<sup>1</sup> Rong Wei,<sup>1</sup> Abiy Agiro,<sup>4</sup> Yasmin G. Brahmhatt,<sup>4</sup> Yemisi Oluwatosin,<sup>4</sup> Craig G. Schilling,<sup>4</sup> <sup>1</sup>Kaiser Permanente Southern California, Pasadena, CA; <sup>2</sup>Kaiser Permanente Bernard J Tyson School of Medicine, Pasadena, CA; <sup>3</sup>Kaiser Permanente Los Angeles Medical Center, Los Angeles, CA; <sup>4</sup>AstraZeneca Pharmaceuticals LP, Wilmington, DE.

**Background:** Discontinuation of RAASi is common after hyperkalemia. We evaluated the risk of cardiorenal outcomes and recurrence of hyperkalemia associated with RAASi discontinuation among patients with chronic kidney disease (CKD) and/or heart failure (HF).

**Methods:** We identified adults with hyperkalemia (potassium  $\geq 5.0$  mEq/L, index) and CKD and/or HF between 2016-2017 from Kaiser Permanente Southern California and followed them through 2019. We required patients to have no history of hyperkalemia and  $\geq 2$  fills of RAASi within 1 year prior to the index. We defined RAASi discontinuation as having  $\geq 90$ -day gap in refills of  $\geq 1$  RAASi within 3 months after index. We used multivariable Cox proportional hazards models to evaluate the association between RAASi discontinuation and cardiovascular (CV) events (myocardial infarction, stroke, HF hospitalization) or all-cause mortality, and recurrence of hyperkalemia. Renal events (40% reduction in eGFR, dialysis, kidney transplant) or all-cause mortality were evaluated among patients with CKD.

**Results:** Of 7,875 patients (mean age 75 years, 91% CKD), 15% discontinued RAASi within 3 months after index. During the median 2 years of follow-up, 32% had a composite of CV/mortality (16% CV, 16% death) and 36% experienced hyperkalemia recurrence. Among those with CKD, 33% had a composite of renal/mortality. Patients who discontinued RAASi had a higher incidence of cardiorenal outcomes compared with those who continued RAASi (Table). RAASi discontinuation was associated with a higher risk of cardiorenal outcomes [adjusted hazard ratio (aHR) 1.20, 95%CI 1.09-1.33 for CV/mortality, aHR 1.20, 95%CI 1.07-1.34 for renal/mortality] and a lower risk of hyperkalemia recurrence [aHR 0.86, 95%CI 0.76-0.97].

**Conclusions:** RAASi discontinuation after hyperkalemia was associated with worsened cardiorenal and/or mortality outcomes, which underscores the benefits of continuing RAASi in CKD and/or HF.

**Funding:** Commercial Support - AstraZeneca

Table. Incidence and Hazard Ratios of Outcomes for Patients who Continued vs. Discontinued RAASi

Outcome	RAASi Continuation (N=7,875)	RAASi Discontinuation (N=6,863)	Crude Hazard Ratio (95% CI)	Adjusted Hazard Ratio* (95% CI)
<b>Cardiovascular events or all-cause mortality (N=7,875)</b>				
Number of event/total person-years	2041/13170	486/2119		
Event per 1000 person-years (95% CI)	155.0 (148.4, 161.8)	229.4 (209.9, 250.7)	1.46 (1.32, 1.61)	1.20 (1.09, 1.33)
<b>Renal events or all-cause mortality<sup>†</sup> (N=6,863)</b>				
Number of event/total person-years	1829/11596	372/1673		
Event per 1000 person-years (95% CI)	157.7 (150.7, 165.1)	222.3 (200.8, 245.1)	1.41 (1.26, 1.58)	1.20 (1.07, 1.34)
<b>Hyperkalemia recurrence<sup>‡</sup> (N=6,863)</b>				
Number of event/total person-years	2103/9311	316/1470		
Event per 1000 person-years (95% CI)	225.9 (216.4, 235.7)	215.0 (192.5, 240.0)	0.94 (0.83, 1.06)	0.86 (0.76, 0.97)

Abbreviations: RAASi = Renin-Angiotensin-Aldosterone System inhibitor. Covariates included age, sex, race/ethnicity, serum potassium levels, body mass index, a history of myocardial infarction, stroke, heart failure, diabetes, unstable angina, atrial fibrillation/flutter, estimated glomerular filtration rate categories, Elixhauser comorbidity index. <sup>†</sup>The analysis excluded patients with missing eGFR or eGFR  $\leq 50$  (no chronic kidney disease) or  $< 15$  mL/min/1.73m<sup>2</sup> or having renal events within 3 month after index. <sup>‡</sup>The analysis excluded patients with recurrent hyperkalemia within 3 month after index and censored at the first hyperkalemia recurrence, or cardiovascular/all-cause mortality.

FR-PO549

**Impact of Chronic Potassium Binder Treatment on Clinical Outcome in Patients With Hyperkalemia: A Nationwide Hospital-Based Cohort Study**

Eiichiro Kanda,<sup>1</sup> Takashi Kikuchi,<sup>2</sup> Naru Morita,<sup>2</sup> Toshitaka Yajima,<sup>2</sup> <sup>1</sup>Kawasaki Medical School, Kurashiki, Japan; <sup>2</sup>AstraZeneca K.K., Osaka, Japan.

**Background:** While hyperkalemia (HK) is often a chronic condition, short-term and intermittent treatment of potassium binders (PB) has been largely applied to control the serum potassium (S-K) level. In this study we investigated the impact of the long-term and chronic PB treatment on the clinical outcomes.

**Methods:** A retrospective observational study using a Japanese hospital-based claim database (April 2008–September 2018) was conducted. HK was defined as at least two S-K  $\geq 5.1$  mmol/L within a 12-months (M) interval. The index date was defined as initial PB prescription date and S-K values were examined at 3M, 6M and 12M after the index. Medication possession ratio (MPR), which is usually used for adherence measures, was used to evaluate the proportion of a time period where PB were prescribed since no prescription refill is allowed in Japan. Clinical outcomes were analyzed by comparing HK patients with MPR  $\geq 80\%$  to those  $< 80\%$  using Cox proportional hazards regression analysis.

**Results:** Out of 1,353,826 patients, 4,321 patients who were on initial PB treatments with HK (mean age 74.6  $\pm$  12.83 years, mean eGFR 28.5  $\pm$  20.8, mean S-K value 5.71  $\pm$  0.64 mmol/L). In MPR  $< 80\%$  (n=993) and MPR  $\geq 80\%$  (n=3,328) groups, mean prescription days were 114.7  $\pm$  9.1 and 1151.2  $\pm$  22.5, and S-K value at 12M were 4.67 mmol/L and 4.64 mmol/L (p < 0.307), respectively. Compared to MPR  $\geq 80\%$  group, the patients with MPR  $< 80\%$  group had significantly higher risks for introduction of hospitalization (HR 1.41, p < 0.001), recurrence of HK (HR 1.67, p < 0.001), eGFR decline (HR 1.41, p < 0.001) and renal replacement therapy (HR 1.25, p = 0.003) (Figure 1).

**Conclusions:** Although S-K levels were similarly controlled in the two groups, PBs treatment with MPR  $< 80\%$  increased the risk of adverse clinical outcomes compared to that with MPR  $\geq 80\%$ . The results suggest that chronic and continuous treatment with PBs might be beneficial for better clinical outcomes, including renoprotective effects in patients with HK.

**Funding:** Commercial Support - AstraZeneca K.K.

Figure 1. Association between MPR and clinical outcomes stratified by MPR 80%

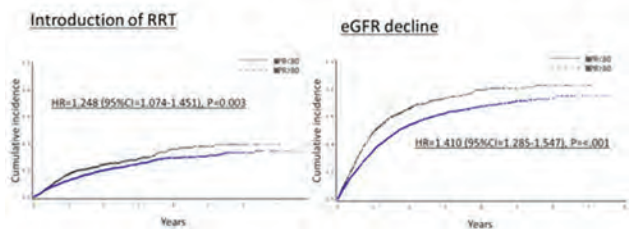

FR-PO550

**Effects of Sodium Zirconium Cyclosilicate (SZC) on CKD Progression: Rationale and Design of the Phase 3 STABILIZE-CKD Trial**

George L. Bakris,<sup>1</sup> Kai-Uwe Eckardt,<sup>2</sup> Tom Greene,<sup>3</sup> Carol A. Pollock,<sup>4</sup> Robert D. Toto,<sup>5</sup> Matthew R. Weir,<sup>6</sup> Ayman Al-shurbaji,<sup>7</sup> Nicolas J. Guzman,<sup>8</sup> Vera Lisovskaja,<sup>7</sup> Peter Wessman,<sup>7</sup> Yanli Zhao,<sup>8</sup> Glenn Chertow.<sup>9</sup> <sup>1</sup>University of Chicago, Chicago, IL; <sup>2</sup>University of Erlangen-Nürnberg, Erlangen-Nuremberg, Germany; <sup>3</sup>University of Utah Health Sciences, Salt Lake City, UT; <sup>4</sup>University of Sydney, Sydney, NSW, Australia; <sup>5</sup>University of Texas Southwestern Medical Center, Dallas, TX; <sup>6</sup>University of Maryland, Baltimore, MD; <sup>7</sup>AstraZeneca, Gothenburg, Sweden; <sup>8</sup>AstraZeneca, Gaithersburg, MD; <sup>9</sup>Stanford University, Stanford, CA.

**Background:** Patients with CKD who may benefit from angiotensin-converting enzyme inhibitor (ACEi) or angiotensin receptor blocker (ARB) therapy frequently discontinue or do not receive ACEi/ARB therapy at recommended doses due to hyperkalemia (HK) or HK risk, and thus do not experience maximal renoprotection. We hypothesize that SZC, an oral anti-hyperkalemic, will enable ACEi/ARB optimization and slow CKD progression in patients with HK or high HK risk.

**Methods:** This Phase 3, international, randomized withdrawal, parallel-group trial is enrolling adult patients with CKD and HK on ACEi/ARB therapy, or CKD and normokalemia on limited/no ACEi/ARB therapy due to HK or high HK risk (NCT05056727; Figure). After establishing normokalemia with SZC (without ACEi/ARB dose change; initiation phase), lisinopril or valsartan therapy will be up-titrated to guideline-recommended doses while continuing SZC (run-in phase), then patients will be administered SZC or placebo (in a double-blind randomized fashion) and lisinopril or valsartan for up to 24 months (maintenance phase), with repeated estimated glomerular filtration rate (eGFR) measurements.

**Results:** The primary endpoints are eGFR measures from randomization to end of study (EOS) and from 12 weeks after randomization to EOS. Secondary endpoints include time to a kidney composite endpoint and time to first lisinopril or valsartan dose decrease. Safety and tolerability will be assessed by an independent data monitoring committee.

**Conclusions:** The STABILIZE-CKD study will assess if SZC attenuates CKD progression in patients treated with ACEi or ARB with HK or high HK risk.

**Funding:** Commercial Support - AstraZeneca

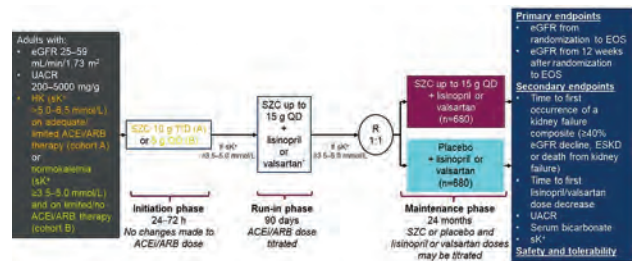

Study Design

FR-PO551

**Evaluation of Patiromer Monotherapy for Acute Hyperkalemia in an Institutional Setting Based on Presence of Renal Impairment**

Pavel Goriacko,<sup>1,2</sup> Katherine E. Di Palo,<sup>1,2</sup> Mark Sinnott,<sup>1</sup> Ladan Golestaneh,<sup>1,2</sup> <sup>1</sup>Montefiore Health System, Bronx, NY; <sup>2</sup>Albert Einstein College of Medicine, Bronx, NY.

**Background:** Patiromer has been widely studied in patients with renal impairment and chronic hyperkalemia. However, its effectiveness for acute, non-life-threatening hyperkalemia is not well described. We aimed to evaluate patiromer monotherapy in a representative cohort of patients with and without renal impairment at an urban medical center.

**Methods:** Using EHR data, we identified adults treated with a one-time dose of patiromer. Patients with pending HD orders or concomitant hyperkalemia therapy within 3 hours of patiromer administration were excluded. The primary endpoint was mean reduction in serum potassium (sK+) from baseline at 3 distinct time intervals (0 to 6 hours, >6 to 12 hours, >12 to 24 hours) and secondary endpoint was incidence of hypokalemia at 24 hours. Outcomes were compared by presence of renal impairment (defined as eGFR <60 mL/min).

**Results:** There were 2048 one-time patiromer doses. Demographics are presented in Table 1. The mean reduction in potassium was 0.4 mEq/L at interval 1, 0.4 mEq/L at interval 2, and 0.4 mEq/L at interval 3 (P <.001 for all compared to baseline). The incidence of hypokalemia was 0.2%. Significant reduction in sK from baseline were noted in both groups at all time intervals. Reduction in sK+ was greater in patients without renal impairment at time intervals 1 and 2 (Figure 1).

**Conclusions:** A single dose of patiromer was associated with a significant decrease in sK+ and low incidence of hypokalemia. These findings suggest clinical utility of patiromer for episodic hyperkalemia in hospitalized patients with and without renal impairment.

**Funding:** Commercial Support - Vifor

Table 1

	< 60 mL/min	≥ 60 mL/min
N	1140	908
Age, years, mean (SD)	69.2 (14.2)	64.0 (14.6)
Black or African-American Race, n (%)	489 (42.9)	323 (35.6)
Latinx Ethnicity, n (%)	393 (34.5)	336 (37.0)
Sex, female, n (%)	536 (47.0)	374 (41.2)
Patiromer dose, 8.4g, n (%)	879 (77.1)	725 (79.8)
Baseline potassium level, n (%)		
5-5.5 mEq/L	614 (53.9)	559 (61.6)
5.6-6.5 mEq/L	519 (45.5)	545 (60.1)
> 6.5 mEq/L	7 (0.6)	4 (0.4)

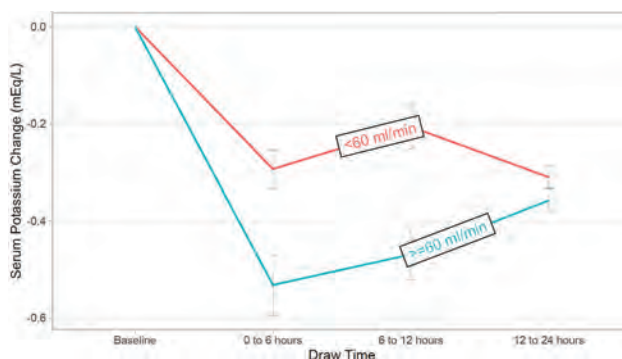

FR-PO552

**APPETIZE: Palatability of and Preference for Potassium Binders in Patients With CKD and Hyperkalemia**

David C. Wheeler,<sup>1</sup> Cathy W. Gwynn,<sup>2</sup> Jonatan Hedberg,<sup>3</sup> Alaster Allum,<sup>4</sup> Eric T. Wittbrodt,<sup>5</sup> Jennifer Kim,<sup>5</sup> Jon D. Morris.<sup>2,6</sup> <sup>1</sup>University College London, London, United Kingdom; <sup>2</sup>AdSAM, Gainesville, FL; <sup>3</sup>AstraZeneca PLC, Mölndal, Sweden; <sup>4</sup>AstraZeneca, Cambridge, United Kingdom; <sup>5</sup>AstraZeneca, Gaithersburg, MD; <sup>6</sup>University of Florida, Gainesville, FL.

**Background:** Traditional K+ binders (PB) such as sodium and calcium polystyrene sulphonate (C/SPS), while not indicated for the chronic management of hyperkalemia (HK) are often believed to be unpalatable, poorly tolerated by patients, and associated with gastrointestinal side effects. Novel PB such as sodium zirconium cyclosilicate (SZC) and patiromer sorbitex calcium (CPaS) may be better tolerated; no published data exist for palatability, an important patient-centric endpoint. The primary study aim was to compare the patient-reported overall palatability of 3 currently available PB.

**Methods:** APPETIZE (NCT04566653) was a cross-sectional, randomized crossover study evaluating the palatability of and patient preference for C/SPS, SZC, and CPaS. Participants with chronic kidney disease (CKD), documented HK, and no recent use of PB were randomized to one of six taste sequences, with a 'sip and spit' taste test approach. Each PB was scored with respect to patient-centric attributes (taste, texture, smell, and mouthfeel) on a 0-10 scale, combined into an overall palatability composite score (0-40), and analyzed using linear mixed models. Patients were also asked to rank by palatability their first choice among the 3 PB. Further analyses of relevant factors are planned for the palatability of and emotional response to HK treatment options.

**Results:** A total of 144 patients participated from the US (N=58), EU (France, Italy, and Spain, N=62), and Canada (N=24) including 77 (53%) dialysis-dependent and 67 (47%) non dialysis-dependent CKD patients; 12% had history of heart failure. Mean age was 66 y, 70% were male.

**Conclusions:** In all regions palatability of SZC was superior to C/SPS and similar to CPaS, and patients ranked preference for SZC numerically higher than for the other products. These findings suggest that patients prefer newer PB, and this may improve compliance to long-term HK treatment.

**Funding:** Commercial Support - AstraZeneca

Product	Palatability Composite Score (mean +/- SD)				Overall Preference Ranking (% who ranked first choice) <sup>†</sup>
	US	EU	CAN	All countries/regions	
SZC	24.9 (8.1) <sup>‡</sup>	23.2 (9.4) <sup>‡</sup>	27.3 (9.3) <sup>‡</sup>	24.6 (9.0)	36.8%
CPaS	24.8 (9.2)	22.6 (9.2)	24.2 (11.9)	23.8 (9.7)	24.3%
C/SPS	18.9 (9.0)	18.6 (12.1)	16.0 (9.6)	18.3 (10.5)	11.8%

<sup>†</sup>p <.001 for SZC vs C/SPS, <sup>‡</sup>p <.025 for SZC vs CPaS, <sup>§</sup>missing values in 27.1%

Table. Palatability composite and preference ranking results

FR-PO553

**Real-World Evaluation of Empagliflozin on Serum Potassium Levels at a Veterans Affairs Medical Center**

Mackenzie Lloyd,<sup>1</sup> Danielle N. Cooney,<sup>1</sup> Alessandra Lyman,<sup>1</sup> Shivali D. Singh,<sup>1</sup> Christopher J. Burant,<sup>1</sup> Niraj Desai.<sup>1,2</sup> <sup>1</sup>VA Northeast Ohio Healthcare System, Cleveland, OH; <sup>2</sup>Case Western Reserve University, Cleveland, OH.

**Background:** Recent major clinical trial results show conflicting data regarding the impact of sodium glucose co-transporter 2 (SGLT2i) inhibitors on serum potassium (K+) levels. This study aimed to identify the effect of SGLT2i use on serum K+ levels in a real-world setting.

**Methods:** We performed a retrospective cohort study of patients prescribed empagliflozin at a Veterans Affairs hospital between 12/1/16 and 11/30/21. The primary outcome was change in serum K<sup>+</sup> value from the date of first empagliflozin prescription to the following timepoints: 2-4 weeks, 3 months, and 6 months. Secondary outcomes included changes in serum K<sup>+</sup> when stratified by eGFR, effect of SGLT2i dose on serum K<sup>+</sup> level, and changes to concomitant medications because of dyskalemia (K<sup>+</sup> < 3.4 meq/L or K<sup>+</sup> > 5.1 meq/L).

**Results:** 100 patients with baseline potassium levels and 47, 61, and 72 patients were included in the analysis at 2-4 weeks, 3 months, and 6 months, respectively. All patients had type 2 diabetes mellitus, 86% were white, 26% had baseline eGFR of 60 ml/min or lower, and 64% of patients prescribed a renin-angiotensin-aldosterone system inhibitor at baseline. Mean change in serum K<sup>+</sup> level from baseline was insignificant at all timepoints: -0.51 mmol/L (95% CI -0.48 to 0.15) at 2-4 weeks, -0.03 mmol/L (95% CI -0.13 to 0.07) at 3 months, and 0.03 mmol/L (95% CI -0.06 to 0.12) at 6 months. Twelve participants had either hypo- or hyperkalemia at any pre-specified timepoint. Hyperkalemia was more common in patients with eGFR < 60 ml/min (70%). There was no dose dependent relationship between SGLT2i and change in serum K<sup>+</sup> value. Hypokalemia more often prompted changes to concomitant medications that may impact serum K<sup>+</sup> values.

**Conclusions:** There was no statistically significant change in serum K<sup>+</sup> values after empagliflozin initiation in subjects with DM2. Monitoring of serum K after initiation of empagliflozin may be considered in patients with CKD or in patients at risk of hypokalemia.

**Funding:** Veterans Affairs Support

**FR-PO554**

**Familial Hyperkalaemic Hypertension Is Associated With Immunodeficiency**

**Keith Siew, Rhys D. Evans, Stephen B. Walsh. University College London, London, United Kingdom.**

**Background:** Familial hyperkalaemic hypertension (FHHT) is also known as Gordon syndrome or pseudohypoaldosteronism type II. It is an autosomal dominant condition that leads to salt retention through over activation of the sodium chloride co-transporter (NCC) in the distal convoluted tubule causing salt-sensitive hypertension. Pathogenic mutations in WNK1, WNK4, CUL3 and KLHL3 cause FHHT. Our recent study on patients with salt-losing tubulopathies (SLTs e.g. Gitelman syndrome) found significantly altered immunity, predisposing patients to a variety of infections. We studied whether FHHT (a salt retaining tubulopathy) also led to an altered immune phenotype.

**Methods:** 12 patients with FHHT were studied. Information such as past medical history, medications, autoimmunity, atopy, allergy status, childhood infections, recurrent adult infections were collected amongst other data. This was compared to 24 healthy controls and 47 patients with salt losing tubulopathy.

**Results:** Patients with FHHT were found to have significantly more viral (p=0.0094) and fungal infections (p=0.04) compared to healthy controls. They also experienced more recurrent upper respiratory tract infections (p=0.04) and urinary tract infections (p=0.04). Compared to patients with salt losing nephropathy, FHHT patients suffered significantly more recurrent viral infections (p=0.0021) but less allergic disease (p=0.03).

**Conclusions:** Our data suggests altered immunity in patients with FHHT. Their phenotype and range of infections were different to both healthy controls and patients with salt losing nephropathy. Further work is required to replicate these differences in larger cohorts and to investigate underlying mechanisms that may explain changes in immunity and whether this can be corrected with treatment. **References:** 1. Evans RDR et al. *Nat Commun* 2020; **11**: 4368

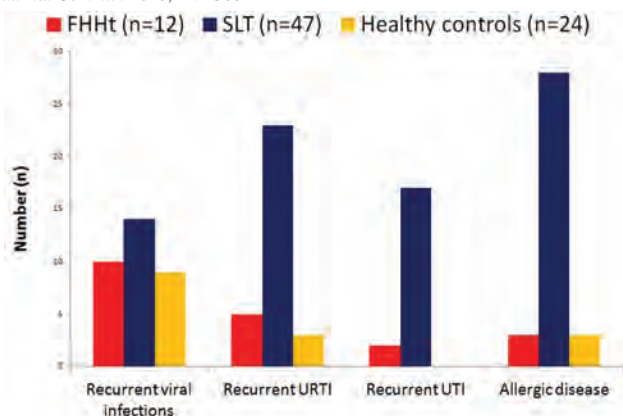

**FR-PO555**

**Abnormal Electrocardiogram Incidence and Risk Factors in Hypokalemic Salt-Losing Tubulopathy**

**Seong Ryeong Kang,<sup>1</sup> Naye Choi,<sup>1,2</sup> Jeesu Min,<sup>1,2</sup> Yo Han Ahn,<sup>1,2</sup> Hee Gyung Kang,<sup>1,2</sup> Seon Hee Lim.<sup>3</sup> <sup>1</sup>Seoul National University Children's Hospital, Seoul, Republic of Korea; <sup>2</sup>Seoul National University College of Medicine, Seoul, Republic of Korea; <sup>3</sup>Korean Society of Nephrology, Seocho-gu, Seoul, Republic of Korea.**

**Background:** Hypokalemic salt-losing tubulopathy including Batter's/Gitelman's syndrome (BS/GS) is characterized by hypokalemia, hyponatremia, and hypomagnesemia, which may prolong the corrected QT (QTc) interval and lead to cardiac arrhythmias. So far, 6 cases of arrhythmia or cardiac death in BS/GS have been reported. Despite its fatality, limited information is known about the frequency or risk factors of arrhythmia in patients with hypokalemic salt-losing tubulopathy.

**Methods:** A total of 83 patients under the age of 18 at diagnosis with hypokalemic salt-losing tubulopathy at our center were reviewed. Thirty-four of 83 patients had a 12-lead electrocardiogram during follow-up. Among them, the abnormalities of the rhythms and the QTc were investigated. Sex, age, body mass index (BMI), serum electrolytes level, and genetic background were compared between those with abnormal ECG and cases with normal ECG.

**Results:** Eight of 34 (23.5%) patients showed abnormal heart rhythms, 21 (61.8%) prolonged QTc beyond borderline, and 7 showed both abnormal heart rhythms and prolonged QTc. These 22 (64.7%) patients were classified as abnormal ECG group. There was no difference in sex, age, BMI, and serum levels of sodium, potassium, magnesium, and calcium at the time of ECG when compared with the normal ECG group (p>0.05). Two of 22 (9.09%) patients had the procedure for arrhythmia. One was performed catheter ablation and the other was inserted a pacemaker. There was no cardiac arrest during follow-up. Only 1 of 9 patients with follow-up ECG was normalized. Among the normal ECG group, 2 cases (16.7%) showed QTc prolongation in adults. Of 13 patients who performed echocardiography, 3 had dilated cardiomyopathy findings, and the rest are normal findings. Currently, 18 of 34 patients (52.9%) are under follow-up at our center, of which 6 have progressed to chronic kidney disease, and one is on hemodialysis.

**Conclusions:** Among hypokalemic salt-losing tubulopathy patients at our center, ECG abnormality was relatively high(64.7%). There were no significant differences in sex, age, BMI, and serum electrolyte levels. As arrhythmia can be fatal when it occurs, prevention is important. Therefore frequent follow-up is required to monitor laboratory findings, ECG, and patient compliance. Cardiologic evaluation should also be performed regularly.

**FR-PO556**

**Familial Autosomal Dominant Hyponatremia With Reset Osmostat**

**Emanuel Zitt,<sup>1</sup> Kate E. Lines,<sup>2</sup> Fadi Hannan,<sup>3</sup> Alistair T. Pagnamenta,<sup>4</sup> Edoardo Giacomuzzi,<sup>4,5</sup> Jenny C. Taylor,<sup>4</sup> Karl Lhotta,<sup>1</sup> Rajesh V. Thakker.<sup>2</sup> <sup>1</sup>Academic Teaching Hospital Feldkirch, Department of Internal Medicine 3 (Nephrology and Dialysis), Feldkirch, Austria; <sup>2</sup>University of Oxford Radcliffe Department of Medicine, Oxford, United Kingdom; <sup>3</sup>University of Oxford Nuffield Department of Women's & Reproductive Health, Oxford, United Kingdom; <sup>4</sup>University of Oxford Wellcome Centre for Human Genetics, Oxford, United Kingdom; <sup>5</sup>Fondazione Human Technopole, Milan, Italy.**

**Background:** Hyponatremia is frequent and we report a four-generation family with autosomal dominant hyponatremia due to reset osmostat, characterised by: reduced Na<sup>+</sup> set-point for arginine vasopressin (AVP) secretion; linear relationship between serum Na<sup>+</sup> and urine osmolality; and normal water load excretion.

**Methods:** Sixteen of 19 living family members (9 males and 7 females, mean±SD age 46±18 years) consented for clinical and genetic studies.

**Results:** The index patient (male aged 59 years) presented with severe resistant hypertension and longstanding hyponatremia (<135 mmol/l). His hypertension eventually responded to amiloride (-20 to -30 mmHg). Similar findings in his 56-year-old brother suggested a hereditary condition. Investigation of family members revealed 10 (62.5%) to have hyponatremia, consistent with autosomal dominant inheritance. Overall, mean±SD serum Na<sup>+</sup> differed significantly between affected (133±5.1 mmol/l) and unaffected individuals (141±1.5 mmol/l; p<0.001), with affected individuals having inappropriately normal plasma copeptin concentrations, when compared to unaffected relatives (4.9±3.1 vs 2.5±2.0 pmol/l, p=0.08). All individuals had normal kidney function, and serum Na<sup>+</sup> and urine osmolality showed a significant positive correlation, but with a set-point shift towards lower Na<sup>+</sup> values in affected individuals. Water loading led to brisk excretion of diluted urine in the index patient and his affected brother, consistent with reset osmostat. Renal response to tolvaptan was normal, which excluded nephrogenic syndrome of inappropriate antidiuresis. Plasma renin concentrations were lower in affected individuals compared to unaffected relatives (3.3±2.2 ng/l vs 12.8±6.7 ng/l, p<0.05). DNA sequence analysis did not reveal abnormalities of candidate genes such as AVP, AVPR2, ENAC subunits (SCNN1A, SCNN1B, SCNN1G, and SCNN1D), and TRPV4.

**Conclusions:** We describe a family with autosomal dominant hyponatremia due to reset osmostat, which is likely caused by a novel gene mutation.

## FR-PO557

**Beer Potomania Is Associated With Normal Uric Acid Homeostasis and Alcohol Tubulopathy**

Gregory L. Braden, Marat Abdullin, Daniel L. Landry, Spencer Hodgins, Jeffrey Mulhern. Kidney Care and Transplant Service of N.E. UMass Chan Medical School-Baystate, Springfield, MA.

**Background:** Uric acid homeostasis has never been studied in beer potomania (BP) & whether alcohol related tubulopathies occur in BP is unknown.

**Methods:** We reviewed all patients (pts) over 6 years referred to our service for severe hyponatremia caused by BP. 8 pts were found, 5 male / 3 female drinking 12-16 cans of beer daily. We looked for signs of volume depletion & compared blood pressure and pulse at admission to 24 hrs later after normal or 3% saline infusion. We also measured uric acid dynamics on admission & 24 & 48 hours during Na correction. All the data shown are mean $\pm$  SEM along with the range of levels found.

**Results:** The mean blood pressure initially was 113 $\pm$ 64 vs 131 /75 24 hours after saline, p<.01. Heart rate decreased from 107 $\pm$ 3 b/min to 81 $\pm$ 5 b/min after 24 hrs, p<.02, suggesting ECF volume depletion. 6 pts developed tremulousness, 1 delirium tremens & 1 hallucinations. Serum Na was initially 108 $\pm$ 3 (95-117) mEq/L, POSM 239 $\pm$ 14 (216-270) mOsm/kg, urine NA 13 $\pm$ 2 (8-19) mEq/L, Fractional Excretion (FE) of Na was 0.6 $\pm$ .04 (4-.9)% & UOSM 231 $\pm$ 14 (127-270) mOsm/kg. All pts had hypokalemia, 3.2 $\pm$ .2 (2.9- 3.6) mEq/L & low serum albumin 3.4 $\pm$ .2 (3-3.6) gm/dl. Serum uric acid (UA) was normal in all 8 pts 4.0 $\pm$  0.4 (3.4-5) mg/dl & the FE UA was normal in all 8 pts, 8.4 $\pm$ 1 (2-11)%. The serum UA and FE UA remained normal during 24 & 48 hrs of Na correction. Serum Mg was low in 4/8 pts (1.3-1.5) mg/dl with the FE Mg increased at >2% in all 4. Serum PO4 was low in 4/8 pts (2.6-3.0) mg/dl with a FE PO4 of 19-24%. IV Mg and PO4 were used in the 4 pts. 3 pts were treated with hypertonic saline clamp and q 6 hr DDVP. 5 pts needed IV D5 & W to prevent overcorrection. No CPM occurred.

**Conclusions:** BP often presents with signs of ECF volume depletion which can be subtle & is associated with normal serum UA levels and normal ranges of FE of UA despite serum Na levels <100 mEq/L. The urine OSM in these pts is >100 mOsm/kg suggesting serum ADH stimulation possibly from ECF volume depletion. All of our pts developed clinical alcohol withdrawal and half had renal Mg and PO4 wasting associated with alcohol tubulopathy. Normal UA and FE UA differentiates BP from SIADH in alcoholics.

**Funding:** Clinical Revenue Support

## FR-PO558

**Hyponatremia in the Outpatient: Does Low GFR Contribute to Hyponatremia?**

Masahiko Nagahama, Takehiko Kawaguchi, Takuya Fujimaru, Yugo Ito, Fumika Taki, Masaaki Nakayama. St. Luke's International Hospital, Tokyo, Japan.

**Background:** The essential mechanism of developing hyponatremia is decreased urinary dilution in response to vasopressin (AVP). Because urinary dilution is affected as kidney function deteriorates, it is plausible that the risk of developing hyponatremia is related to decreased GFR. However, the results of previous studies on the prevalence of hyponatremia in CKD populations are contradictory. On the other hand, AVP secretion by various comorbid conditions, such as CHF and malignancy was identified. We hypothesized that comorbidity induced AVP secretion rather than decreased GFR contribute to hyponatremia.

**Methods:** We performed an observational cross-sectional investigation in a single hospital (35 specialties in outpatient clinic) in Tokyo, Japan. Among 351,662 patients who visited the outpatient clinic from January 2010 to December 2020, we analyzed clinical and biochemical parameters of 131,184 patients. Using the Diagnosis Procedure Combination database, we collected 10 most common comorbidities in clinic: diabetes, malignancy, hypertension, COPD, CVA, dementia, depression, arthritis, anxiety and CHF. Comorbidity in our study is defined by presence of either 1 of those 10 diseases. Dialysis and transplant patients were excluded. Risk factors for hyponatremia were sought using multivariate logistic regression.

**Results:** Prevalence of hyponatremia (serum Na<135mEq/L) was 2.9% in all patients. Multivariate logistic regression analysis identified higher eGFR (OR:1.01 95% CI 1.01-1.01) and positive dipstick proteinuria (OR:2.09 95% CI 1.87-2.33), but not comorbidity (OR:1.0 95% CI 0.79-1.27) as independent risk factors for hyponatremia. However, stratifying the analyses by eGFR of 60ml/min, the association of eGFR, comorbidity and proteinuria with hyponatremia was pronounced in eGFR>60 patients (OR:1.01 95% CI 1.00-1.01 for eGFR, OR:1.42 95% CI 1.02-1.9 for comorbidity, OR:2.46 95% CI 2.09-2.89 for proteinuria), but diminished in eGFR $\leq$ 60 patients (OR:1.00 95% CI 0.98-1.02 for eGFR, OR:0.49 95% CI 0.09-2.54 for comorbidity, OR:0.67 95% CI 0.36-1.25 for proteinuria).

**Conclusions:** The present study shows that development of hyponatremia is correlated with not a lower but a higher GFR. Comorbidity becomes more prominent risk factor as GFR increases. These results suggest that the concomitant comorbidities combined with a higher GFR affect hyponatremia.

## FR-PO559

**The Association of Hyponatremia With Cognitive Function and All-Cause Mortality: A Post Hoc Analysis of the Systolic Blood Pressure Intervention Trial**

Amara Sarwal, Robert E. Boucher, Nikita Abraham, Ravinder Singh, Xiangyang Ye, Farahnaz A. Moghaddam, Sydney E. Hartsell, Guo Wei, Srinivasa Beddhu. University of Utah Health, Salt Lake City, UT.

**Background:** Severe hyponatremia (hypona) needing treatment with hypertonic saline was associated with probable dementia (PD) in a retrospective study. It is unknown whether mild hyponatremia is a risk factor for mild cognitive impairment (MCI) / PD.

**Methods:** The Systolic Blood Pressure Intervention Trial (SPRINT) MIND study (N= 8561) evaluated the effects of intensive systolic BP control (goal <120mmHg) vs. standard SBP control (goal <140 mmHg) on risk of adjudicated MCI/PD. In this post-hoc secondary analysis, we included 8541 SPRINT-MIND participants with baseline serum Na > 130 meq/L and non-missing baseline and 6-months (6m) serum Na. We defined incident hypona as a serum Na < 130 mmol/L at m6 and related incident hypona with time to MCI alone, PD alone, a composite of MCI/PD and all-cause mortality (ACM) in separate Cox regression models adjusted for the SBP intervention, age, gender, race, CVD, CHF, smoking, BMI and eGFR.

**Results:** The mean baseline serum Na was 140  $\pm$  2 meq/L. 129 (1.5%) participants developed incident hyponatremia at 6m with a mean serum sodium of 127 $\pm$ 3 meq/L. Compared to those without incident hyponatremia, those with incident hyponatremia were in general, older, had lower BMI and more likely to be women, African-American, treated with thiazide diuretics and assigned to intensive SBP arm. The mean follow-up duration was 4.8  $\pm$  1.4 yrs. There were 1254 MCI, 324 PD, 1485 MCI/PD and 324 ACM events. As shown in table incident hypona was not associated with MCI or MCI/PD composite but with higher risk of PD and ACM.

**Conclusions:** In this post hoc analysis of SPRINT, while hypona was not associated with subsequent MCI or MCI/PD, it was associated with PD and ACM.

	MCI	PD	MCI/PD	ACM
Unadjusted	0.84 (0.50, 1.43)	2.46 (1.31, 4.61)	1.17 (0.78, 1.77)	1.64 (0.77, 3.46)
+ SBP intervention, age, gender, race	0.83 (0.49, 1.40)	2.00 (1.06, 3.77)	1.10 (0.73, 1.66)	1.59 (0.75, 3.27)
+ CVD, CHF, smoking, BMI, eGFR	0.83 (0.49, 1.42)	2.12 (1.12, 4.01)	1.12 (0.74, 1.69)	1.82 (0.85, 3.87)

## FR-PO560

**Thiazide-Related Hyponatremia: A Nationwide Population-Based Cohort Study**

Heejin Cho, Hyo jin Boo, Jin Ho Hwang. CAUH-NEP Chung Ang University Hospital, Seoul, Republic of Korea.

**Background:** After thiazides were recommended as the first-line drug for adult hypertension in the JNC 7 guideline, hospitalization for thiazide-related hyponatremia (TRH) has often been experienced in clinical settings, but the exact incidence and risk of TRH have not been documented in Korea.

**Methods:** For risk evaluation of thiazide and other drug-associated hyponatremia, we used the big data provided by the National Health Insurance Sharing Service. A total of 1,943,345 adult patients who were confirmed to have been treated for hypertension from January 2014 to December 2016 were included for analysis set. The patients were divided into two groups depending on the use of thiazides.

**Results:** Hospitalization for hyponatremia was significantly higher in the thiazide group than control group (2.19 vs. 1.45%), and the risks further increased when two or more thiazides were concurrently prescribed (2.8 times), or combination therapy with other diuretics or desmopressin (4 times), and thiazide+spironolactone+desmopressin were used at the same time (6.9 times). When thiazide and desmopressin were used together, the risk of multiple hospitalization was 11 times higher. In multivariate analysis, the occurrence of hyponatremia increased with age (HR 1.069, CI 1.068-1.070, per 1-year increase), DM (HR 1.453, CI 1.415-1.492), depression (HR 1.53, CI 1.496-1.565), and the use of thiazides (HR 1.436, CI 1.404-1.469, all P<0.001). The thiazide group showed a better 6-year overall survival than the control group (P<0.001), but had more fractures, and hyponatremia (all P<0.001). Among all patients, patients with hyponatremia showed significantly higher mortality rates, hospitalizations for fractures, and pneumonia compared to those without hyponatremia (all P<0.001).

**Conclusions:** There is an increased risk of hyponatremia and related complications in those who were prescribed thiazides. However, the survival rate decreased in those who received thiazides, suggesting that thiazide itself is not harmful, but that it will be more helpful in reducing complications and improving the prognosis if properly used with caution in high-risk groups.

## FR-PO561

**Comparison of i-STAT Point of Care vs. Indirect Ion Selective Electrode Measurements of Sodium in Severe Hyponatremia**

Daniel G. Gomez, Spencer Hodgins, Vijayakumar Paramasivam, Daniel L. Landry, Jeffrey Mulhern, Brian H. Nathanson, Gregory L. Braden. University of Massachusetts Chan Medical School - Baystate Regional Campus, Springfield, MA.

**Background:** We sought to determine whether point-of-care (POC) sodium (Na) levels by I-STAT were accurate enough compared to Main Lab sodium measured by ion-specific electrode technique (the "Gold Standard") to allow for its use in monitoring the administration of 3% hypertonic saline to correct severe hyponatremia.

**Methods:** We extracted all consecutive data from Baystate Medical Center inpatients with  $Na \leq 135$  mmol/L from January 2015 to December 2019 who had a POC and Main Lab Na level within 30 minutes of each other. This was a venous-to-venous comparison using direct ion-selective electrode by I-STAT vs indirect ion-selective electrode by Main Lab. We compared values with a Bland-Altman plot and repeated the analysis with Main Lab sodium  $\leq 125$  mmol/L.

**Results:** We obtained 406 Na paired samples from 355 patients. The bias (i.e., mean difference) of POC - Main Lab was significantly greater than 0; 1.2 mmol/L; 95% CI (0.8-1.5);  $p < 0.001$ . Severe hyponatremia samples  $\leq 125$  mmol/L ( $n = 44$ ) demonstrated a larger bias with a disagreement by as much as 10 mmol/L: bias = 1.7 mmol/L, 95% CI (0.3-3.1);  $p = 0.003$ .

**Conclusions:** I-STAT POC significantly overestimates Na levels when compared to Main Lab indirect ion-selective electrode analysis when Na is either  $\leq 135$  mmol/L or  $\leq 125$  mmol/L. The use of POC for monitoring Na levels during 3% hypertonic saline administration in severe hyponatremia is not recommended.

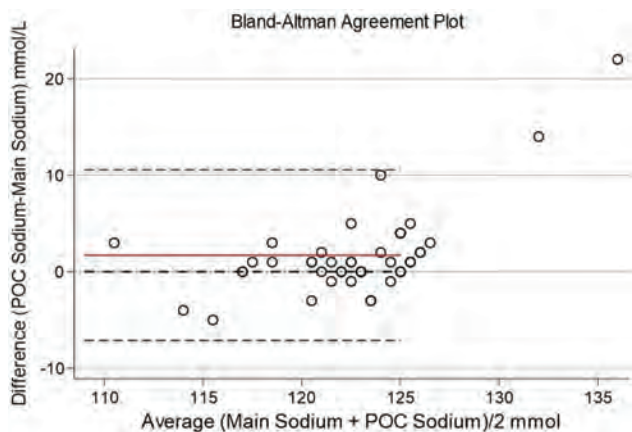
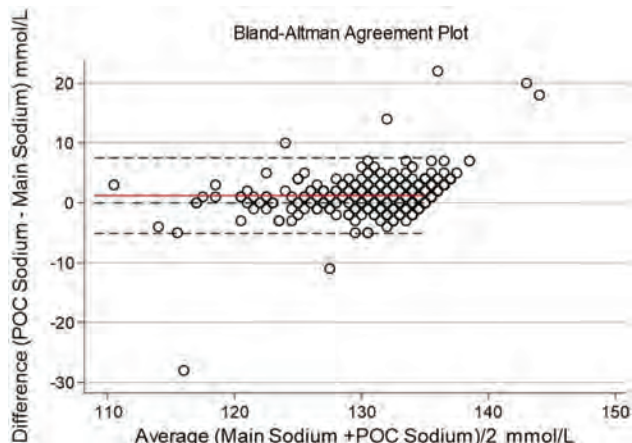

**FR-PO562**

**Treatment of Severe Hyponatremia in the Usual Clinical Scenarios: Time to Include Urinary Output in Algorithms?**

**Grecia J. Gonzalez Rivera, Karina C. Felix Bauer, Alfonso Gindl-Bracho, Ricardo Correa-Rotter, Juan Carlos Ramirez-Sandoval. Instituto Nacional de Ciencias Medicas y Nutricion Salvador Zubiran, Ciudad de Mexico, Mexico.**

**Background:** Rapid correction of severe hyponatremia ( $Na < 125$  mEq/L) can lead to adverse outcomes, including osmotic demyelination syndrome. Although non-modifiable risk factors for rapid correction are widely described, most clinical algorithms do not include bedside biomarker during treatment.

**Methods:** Retrospective cohort of 249 hospitalized patients with severe hyponatremia. We assessed the association between rapid correction (sNa increase of  $> 8$  mEq/L/24 h) and clinical variables during first hours of treatment, including renal free water loss ( $(U_{Na} + U_{K})/S_{Na}$ ),  $U_{Na}$ ,  $U_{osm}$ , and water balance.

**Results:** Median age was 62 (IQR 22-91) years, 54% were women, 47% had AKI, 71% cirrhosis, 45% CKD 3-4, 7% heart failure, and 14% received 3% IV hypertonic saline due symptomatic hyponatremia. In 36% previous use of diuretics was documented. Etiology of hyponatremia was not possible in the first 24h of assessment in 181(73%) subjects; in these cases, the main cause of hyponatremia was evident only retrospectively. Rapid correction during the first 24 h occurred in 17%. Diuresis during the first 12 h was higher in the rapid correction group (1.3 [IQR 0.5-2.6] mL/Kg/h Vs. 0.8 [IQR 0.4-1.2] mL/kg/h,  $P < 0.001$ ). In multivariate analysis, each mL/kg/h was associated with an OR of 1.57 (95% CI 1.12-2.20,  $P < 0.009$ ) for rapid correction. Assessment of  $U_{Na}$ ,  $U_{osm}$ , and free water loss were not associated with the risk of rapid correction.

**Conclusions:** The only bedside prognostic marker to predict overcorrection was diuresis in the first 6-12 hours after treatment initiation, urinary indices had no association with rapid correction. The high prevalence of comorbidities in real clinical scenarios greatly limits the diagnostic value of current algorithms, as cases of hyponatremia are rarely "pure". Preventive measures for rapid correction should include hourly diuresis evaluation.

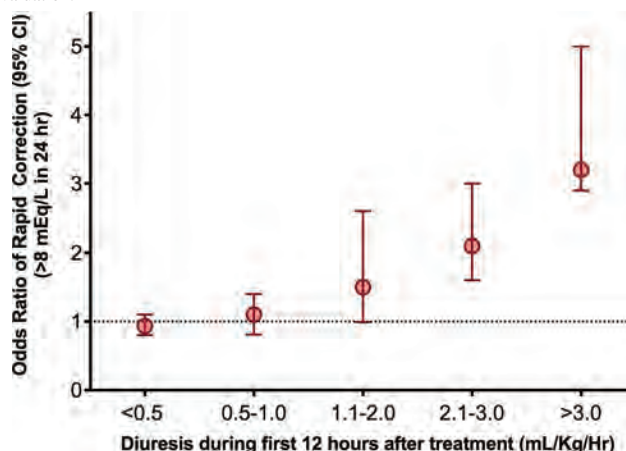

**FR-PO563**

**The Use of DDAVP During Overcorrection of Severe Hyponatremia**

**Florence Lamarche, Helene Ammann, Gabriel Dallaire, Louis Deslauriers, Stephan Troyanov. Hopital du Sacre-Coeur de Montreal, Montreal, QC, Canada.**

**Background:** The correction of severe hyponatremia can be challenging. A too slow or rapid pace increases the risk of neurological complications. Current guidelines recommend a serum sodium (sNa) correction rate of  $\sim 6$  mmol/L per day. Overcorrection can justify lowering the sNa. Desmopressin (DDAVP) is used to decrease free water excretion and thus stabilize or decrease the sNa but to date, the evidence supporting its use is scarce. We studied sNa trends after subcutaneous (SC) DDAVP administration in cases of severe hyponatremia.

**Methods:** We performed a single-center retrospective cohort study looking at all episodes of hyposmolar hyponatremia. Every sNa value  $< 120$  mmol/L from 2012 to 2022 was identified and all subsequent serum and urinary sodium and osmolalities were extracted. Spurious cases were excluded. Correction rates between all measurements separated by  $\geq 8$  hours were calculated and categorized from most to least clinically significant (Table). We also reviewed SC DDAVP administration and sNa trends following it.

**Results:** There were 388 episodes of severe hyponatremia in 356 patients. The correction rates and DDAVP received are listed in the table: 45% of patients had an overcorrection  $> 9$  over  $> 24$ h. Ninety episodes received DDAVP, 70 of which were followed by a drop in sNa. The average drop in sNa 12 h after receiving doses of 1 mcg (35 doses) and 2 mcg (31 doses) were  $-0.6 \pm 3.5$  mmol/L and  $-2.2 \pm 3.1$  mmol/L, respectively ( $p = 0.035$ ). Thirteen episodes treated with DDAVP experienced a  $> 6$  mmol/L maximal drop in sNa.

**Conclusions:** This cohort highlights frequent sNa overcorrections and the usefulness of SC DDAVP to slow or decrease sNa correction rates. One mcg SC DDAVP stabilized sNa for 12 hours whereas 2 mcg SC resulted in a mean 2 mmol/L decrease. The amount of water ingested must be carefully assessed when using DDAVP, as some experience worrisome drops in sNa.

**Funding:** Private Foundation Support

Category (mmol/L)	Cohort (%)	DDAVP doses given (%)
$> 9/day$ over $> 48h$	18 (5%)	5 (28%)
$> 9/day$ over 24-48h	155 (40%)	68 (44%)
7-9/day over $> 48h$	44 (11%)	7 (16%)
7-9/day over 24-48h	95 (24%)	8 (8%)
$> 9/day$ over $< 24h$	24 (6%)	2 (8%)
7-9/day over $< 24h$	33 (9%)	0
Always $\leq 6/day$	19 (5%)	0

**FR-PO564**

**Mathematical Model of Intradialytic Acid-Base Dynamics in Patients Subjected to Extracorporeal CO<sub>2</sub> Removal**

**Paulo Paneque Galuzio,<sup>1</sup> Alhaji Cherif,<sup>1</sup> Lisa-Marie Kunz,<sup>2</sup> Juergen Klewinghaus,<sup>2</sup> Hans Peter Leinenbach,<sup>2</sup> David Thompson,<sup>4</sup> Peter Kotanko.<sup>1,3</sup> <sup>1</sup>Renal Research Institute, New York, NY; <sup>2</sup>Fresenius Medical Care AG & Co KGaA, Bad Homburg, Germany; <sup>3</sup>Icahn School of Medicine at Mount Sinai, New York, NY; <sup>4</sup>Fresenius Medical Care North America, Waltham, MA.**

**Background:** The use of low flow extracorporeal CO<sub>2</sub> removal (ECCO<sub>2</sub>R) devices in ICU has been introduced to assist in decarboxylation and augmenting protective ventilation strategies for patients with acute respiratory distress syndrome (ARDS). AKI

may develop in 25-60% of patients with ARDS. These patients often develop mixed acid-base disorders and need renal replacement therapy (RRT). To manage complex metabolic derangements, it is possible to attach an oxygenator, post-filter, in the continuous kidney replacement therapy (CKRT) circuit as a combined low flow extracorporeal strategy.

**Methods:** Using a previous acid-base model (Cherif, 2020, *Math Biosci Eng*), we incorporated models of dialyzer and ECCO<sub>2</sub>R oxygenator. The model describes the regulation of H<sup>+</sup>, CO<sub>2</sub> and HCO<sub>3</sub><sup>-</sup>. Each component of the system has been separately validated with literature data. The model was structured to capture CVVHD with a gas exchanger integrated into the continuous kidney replacement system post-filter.

**Results:** The model was parameterized to average data from 10 ventilated critically ill patients with ARDS and AKI undergoing renal and respiratory replacement therapy (Forster *et al. Critical Care* 2013). We fixed blood flow 355±79 ml/min, dialysate flow 2.3±0.7 L/h, ultrafiltration rate 58ml/h (ranging from 0 to 200 ml/h), gas flow 5.2±1.0 L/min, and treatment duration 95±68 h. The model accurately predicts serum pH and pCO<sub>2</sub> for the first 24 h of treatment, with R<sup>2</sup> values of 0.98 for pH and 0.94 for pCO<sub>2</sub> (Fig. 1). We observe that pH and pCO<sub>2</sub> equilibrate within the first 4 hrs.

**Conclusions:** Our model captured the appropriate dynamical behavior of serum pH, pCO<sub>2</sub> and HCO<sub>3</sub><sup>-</sup>. The model could be used as a tool to prescribe CKRT parameters to control acid-base status and to help understand the effectiveness of different arrangements.

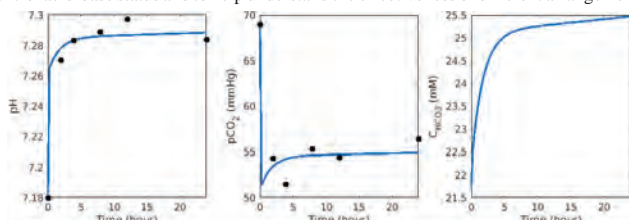

**Figure 1:** Model prediction for a patient with renal failure and low ventilation. The solid line is the model prediction, the dots are patient data. R<sup>2</sup> values of 0.98 for pH and 0.94 for pCO<sub>2</sub>.

**FR-PO565**

**Variability Between Measured Organic Acids and Net Acid Excretion and Estimated Organic Acids and Net Acid Production**  
 Tanushree Banerjee, Lynda Frassetto. *University of California San Francisco, San Francisco, CA.*

**Background:** Formulas for diet acid load use estimates of organic acids (OA) production. Lemann *et al.* and Remer *et al.* have developed differing but widely used methods to estimate OA and hence net acid excretion (NAE) from diet composition. How well estimated dietary OA (DOA) correlates with measured urinary OA excretion (UOAE) is unclear, as is how much this variability contributes to variability in estimates of net endogenous acid production (NEAP) compared to measures of NAE.

**Methods:** 24-hour urine from metabolic balance studies in 13 healthy males on a fixed diet/kg body weight were collected for 6 days sequentially at baseline and intervention phase. Measures for each time period were pooled. We compared repeated measures of UOAE to dietary OA estimates, and NAE to NEAP. DOA was estimated from diet unmeasured anions by Lemann; Remer used individual body surface area (BSA). Lemann used urinary measurements of SO<sub>4</sub> and OA to calculate NEAP, while Remer used BSA (using DuBois and Mosteller formulas) and dietary calculations of SO<sub>4</sub>. UOAE was measured by titration. We determined the concordance correlation coefficient (CCC) for the repeated measures data with the King *et al.* U-statistics approach (Stats Med 2007).

**Results:** 13 males with a median age of 27 years were studied. The estimates of CCC and the confidence intervals are displayed below (Figure). CCC estimates indicate a very poor degree of agreement between UOAE and DOA using either Lemann's or Remer's methodology. We find a modest degree of agreement between NAE and NEAP with Lemann, and better concordance with Remer.

**Conclusions:** Dietary equations estimating OA production do not correlate well with the measured OA. This contributes to the variability for the dietary equations estimating NEAP. Using urinary citrate or targeted metabolomics in a clinical setting may be more accurate to quantify OA.

Table: Concordance Correlation Coefficient (95% CI)	
<b>Between UOAE and DOA</b>	
UOAE and DOA <sub>Lemann</sub>	0.24 (0.08-0.41)
UOAE and DOA <sub>Remer-DuBois</sub>	0.07 (-0.19, 0.27)
UOAE and DOA <sub>Remer-Mosteller</sub>	0.06 (-0.19, 0.28)
<b>Between NAE and NEAP</b>	
NAE and NEAP <sub>Lemann</sub>	0.66 (0.35-0.98)
NAE and NEAP <sub>Remer-DuBois</sub>	0.83 (0.71-0.96)
NAE and NEAP <sub>Remer-Mosteller</sub>	0.82 (0.71-0.97)

**FR-PO566**

**Unmeasured Organic Anions as Predictors of Clinical Outcomes in Lactic Acidosis due to Sepsis**

Richard M. Treger, Kirolos E. Zaki, Mark Asef. *Kaiser Foundation Hospitals, Pasadena, CA.*

**Background:** In lactic acidosis, lactate can only explain 25% of the variance in the anion gap (AG). Our recent work has shown that the elevated AG not explained by lactate is due to unmeasured organic anions (UOA). Small studies suggested that UOA may better predict clinical outcomes than lactate. The aim of this study was to determine whether UOA predict clinical outcomes better than lactate levels.

**Methods:** This was a retrospective cohort study of adult ICU patients with sepsis. A baseline period beginning 1 year prior was used to obtain baseline AG and albumin measurements. An albumin-corrected delta AG was calculated. UOA were estimated using the formula: Delta AG – serum lactate. A logistic regression model was constructed to explore the relationship between in-hospital mortality, UOA and lactate.

**Results:** 526 patients were included (Table). In the adjusted model examining lactate and UOA, the OR [95% CI] for predicting in-hospital mortality was 1.18 [1.03-1.34] and 0.97 [0.89-1.04], respectively.

**Conclusions:** Lactate was associated with higher in-hospital mortality. However, UOA were not associated with increased risk of in-hospital mortality. This disproved our hypothesis that UOA would predict in-hospital mortality better than lactate suggested by previous small studies. However, these studies used strong ion gap to estimate UOA while our study used a more precise quantitative estimate of UOA, including use of baseline albumin-corrected AG. Prior studies attempting to identify UOA have identified Krebs cycle intermediates including citrate and isocitrate, suggesting that in our study UOA were not associated with increased in-hospital mortality because they are a marker of disrupted aerobic metabolism rather than a complete switch to anaerobic metabolism

**Funding:** Commercial Support - The research is supported by a grant from the Regional Research Committee of Kaiser Permanente. Grant No. KP-RRC-20210504.

Patient characteristics

	N	526
Age (years; mean + SD)		71.1 ± 13.14
Male (n/N [%])		268/526 (51.0)
Developed AKI (n/N [%])		242/526 (46.0)
Required dialysis (n/N [%])		124/526 (23.6)
Elixhauser index (mean + SD)		8.9 + 3.41
SOFA score (mean + SD)		5.9 + 4.06
Systolic BP (mean + SD)		112.3 + 27.97
Lactate (mean + SD)		3.1 + 2.68
ICU AG (mean + SD)		15.7 + 4.67
Delta AG (mean + SD)		4.3 + 5.11
Unmeasured organic anions (mean + SD)		1.2 + 4.15

**FR-PO567**

**Immobilization-Associated Hypercalcemia in the Hospital Setting: A Cohort Study**

Jacob Park,<sup>1</sup> Walter Lam,<sup>2</sup> Dustin Chalmers,<sup>2,1</sup> Juan Carlos Q. Velez,<sup>3</sup> Ochsner Nephrology <sup>1</sup>The University of Queensland Ochsner Clinical School, Herston, QLD, Australia; <sup>2</sup>Department of Nephrology, Ochsner Health, New Orleans, LA.

**Background:** Immobility is an established cause of hypercalcemia. Supporting evidence is primarily derived from experimental studies and clinical case reports. Cohort studies are lacking. We examined the relative contribution of immobilization-associated hypercalcemia (Immob-HCa) to all causes of in-hospital hypercalcemia.

**Methods:** A retrospective review of medical records was conducted searching for cases of hypercalcemia at Ochsner Medical Center over a 1-year period. Hypercalcemia was defined as serum calcium > 11.0 mg/dL. *Definite* Immob-HCa was defined as presence of immobility by history combined with absence of disqualifying laboratory data (PTH > 60 ng/dL, 1,25 vitamin D > 70 pg/mL, 25 vitamin D > 80 ng/mL, PTH-related peptide > 2.5 pmol/L or monoclonal gammopathy), lytic lesion by imaging, or alternative etiology (malignancy, sarcoidosis, exposure to thiazide, end-stage kidney disease (ESKD) or calcium or vitamin D supplementation). *Probable* Immob-HCa was defined as documented immobility and absence of alternative etiology, but incomplete laboratory data.

**Results:** From a total of 364 patients with in-hospital hypercalcemia, 114 had elevated PTH, 83 had malignancy, 63 were on calcium or vitamin D supplements, 25 had ESKD, 22 were on a thiazide and 14 had sarcoidosis or elevated 1,25 vitamin D, adding to 321 cases excluded. The remaining 43 charts were manually reviewed. Among them, 5 cases were categorized as *Definite* Immob-HCa and 26 were categorized as *Probable* Immob-HCa. Twelve cases were undetermined. Thus, Immob-HCa accounted for up to 8.5% (31/364) of in-hospital hypercalcemia. Among the 31 Immob-HCa cases, median age was 72 (22-92), 35% women, 48% white, 29% self-identified black; median peak serum calcium was 12.2 (11.2-17.8) mg/dL. Corrected serum calcium was available in 20/31 (65%) of the cases, with a median of 12.8 (11.7-15.4) mg/dL. High ionized calcium was verified in 9 (29%) cases. Concomitant acute kidney injury (AKI) was present in 11 (35%) of the cases of Immob-HCa.

**Conclusions:** Immob-HCa accounts for approximately 1 in 12 of cases of in-hospital hypercalcemia and it is accompanied by AKI in one third of the cases. Incomplete diagnostic work up for hypercalcemia may underestimate its incidence. Raising awareness of this entity could lead to prevention and more prompt diagnosis and treatment.



**FR-PO568**

**BMI and Calcium Kidney Stone Formation**

Tammy Yu,<sup>1,2</sup> Himesh Sheth,<sup>1,2</sup> Jie Tang,<sup>1,2</sup> <sup>1</sup>Lifespan Health System, Providence, RI; <sup>2</sup>Brown University, Providence, RI.

**Background:** Population studies show a clear association between obesity and kidney stone incidence. Here, we examined the relationship between body mass index (BMI) and laboratory markers of stone risk in calcium stone formers (CSF).

**Methods:** Patients were recruited from a kidney stone clinic for this retrospective study. All had either confirmed prior calcium (Ca) stones or a 24-hour urine stone risk index predictive of Ca stones. Participants had a 24-hour urine stone risk profile and a renal ultrasound to evaluate stone burden. Medical history and BMI were obtained within 3 months of laboratory testing.

**Results:** A total of 187 CSF were included in this study. Mean age was 53, 44% were male, 80% were Caucasian, 19% had diabetes, 42% had hypertension, and 32% had dyslipidemia. BMI was positively correlated with calculated 24-hour urine creatinine clearance (CrCl), both before (p=0.00003) and after (p=0.00002) adjustment for demographics (age, race, and gender). However, in subgroup analysis this association became nonsignificant in women (p=0.09), perhaps due to lower muscle mass. Higher BMI was correlated with increased stone burden both before and after demographic adjustment (p=0.02, 0.02, respectively). BMI was inversely associated with serum Ca (p=0.04) and 25-hydroxy vitamin D (p=0.01) levels. No significant association was observed with other serum markers of bone-mineral metabolism, including phosphorus (P), 1,25-dihydroxy-vitamin D, and PTH. Table 1 shows the association between BMI and several urinary markers of increased Ca stone risk. No association was observed with other urinary risk factors (not shown).

**Conclusions:** Higher BMI was associated with higher CrCl, lower serum Ca and vitamin D, and higher stone burden in our cohort of CSF. As in prior studies of uric acid (UA) stone formers, obesity likely contributes to an increased Ca stone risk by lowering urine pH and increasing urine UA and P. Hyperuricosuria promotes the crystallization of Ca oxalate, while hyperphosphaturia may play a role in the formation of Randall plaque.

Table 1

Urine Marker	Without Adjustment for Demographics	Adjusted for Demographics
pH	-0.02 (p=0.004)	-0.02 (p=0.002)
Ammonia	0.5 (p=0.0003)	0.5 (p=0.0008)
Uric Acid	10.6 (p=0.00002)	10.2 (p=0.0003)
Uric Acid Supersaturation	0.04 (p=0.002)	0.03 (p=0.004)
Phosphorus	14.9 (p=0.00003)	13.6 (p=0.00007)

**FR-PO569**

**Artificial Intelligence-Enabled Electrocardiography Helps Identify Severe Dyscalcemia and Provide Additional Prognostic Value**

Shih-Hua P. Lin, Chih-Chien Sung. *Tri-Service General Hospital Department of Internal Medicine, Taipei, Taiwan.*

**Background:** The detection of hypocalcemia and hypercalcemia (collectively dyscalcemia) relies on blood laboratory tests requiring turnaround time while abnormal serum calcium concentrations may affect the heart and alter the electrocardiogram (ECG). The study aimed to develop a bloodless artificial intelligence (AI)-assisted (ECG) to rapidly detect dyscalcemia and analyze its contribution to prognostic predictions.

**Methods:** This study collected 86,731 development, 15,611 tuning, 11,105 internal validation, and 8,401 external validation ECGs from electronic medical records with at least 1 ECG labeled by an albumin-adjusted calcium (aCa) value within 4 hours. The main outcomes were to assess the accuracy of AI-ECG to predict aCa and follow up these patients for all-cause mortality, new-onset acute myocardial infarction (AMI), and new-onset heart failure (HF) to validate the ability of AI-ECG-aCa for previvor identification.

**Results:** ECG-aCa had mean absolute errors (MAE) of 0.78/0.98 mg/dL and achieved an area under receiver operating characteristic curves (AUCs) 0.9219/0.8447 and 0.8948/0.7723 to detect severe hypercalcemia and hypocalcemia in the internal/external validation sets, respectively. Although <20% variance of ECG-aCa could be explained by traditional ECG features, the ECG-aCa was found to be associated with medical complexity. Patients with ECG-hypercalcemia but initially normal aCa were found to have a higher risk of subsequent all-cause mortality [hazard ratio (HR): 2.05, 95% confidence interval (CI): 1.55-2.70], new-onset AMI (HR: 2.88, 95% CI: 1.72-4.83), and new-onset HF (HR: 2.02, 95% CI: 1.38-2.97) in the internal validation set, which were also seen in external validation.

**Conclusions:** The AI-ECG-aCa may help detect severe dyscalcemia for decision support and ECG-hypercalcemia also provides prognostic value for future cardiovascular outcomes.

**FR-PO570**

**Skimmed Milk as an Alternative Treatment for Hypophosphatemia**

Kiara Marie H. Padua, Ivan Kenneth S. Zapanta, Christine D. Pascual, Maricar Esculto. *Makati Medical Center, Makati City, Philippines.*

**Background:** Mild and Moderate Hypophosphatemia (1-2.5 mg/dL) are generally treated with oral supplements. However, oral phosphate is not accessible in the Philippines. Skimmed milk which is known to have high phosphorus content is readily available but no studies yet were done to evaluate its efficacy in correcting phosphorus.

**Methods:** A non-inferiority, open-label, randomized controlled pilot trial was done to assess the efficacy of skimmed milk (150ml divided into three doses, 0.03 mmol

phosphorus: mL) compared to phosphate solution (60mL in three divided doses, 1mmol phosphorus: mL) in correcting mild and moderate hypophosphatemia. Mean percent change was used for the treatment difference, with the non-inferiority limit at 15%. Adverse events were noted and intention to treat was done.

**Results:** Skimmed milk was able to increase phosphorus but was not different from phosphate solution (p = 0.86). There were seven participants who showed no increase in phosphorus post treatment, five of which were admitted in critical units (p = 0.68). The mean percent change was (50.32% vs 30.93%, p = 0.12) hence the mean percent change difference was -19.39% and is not statistically significant, however was outside the non-inferiority margin thus skimmed milk failed to show non-inferiority. There was abdominal pain and vomiting with phosphate solution.

**Conclusions:** Although, skimmed milk failed to show non-inferiority to phosphate solution, this pilot study showed that skimmed milk is an effective, safe, and readily available alternative for non-critically ill hypophosphatemic patients in resource-limited areas.

Table 2. Pre-treatment and Post-treatment Serum Phosphorus (n= 40)

	Phosphate Solution (n = 20)	Skimmed Milk (n = 20)	P-value
Pre-treatment Phosphorus (mg/dL)	2.01 ± 0.23	1.99 ± 0.41	0.88 <sup>1</sup>
Post-treatment Phosphorus (mg/dL)	3.02 ± 0.94	2.62 ± 0.76	0.14 <sup>1</sup>
Mean Change (Mean, SD)	1.02 ± 0.85	0.60 ± 0.62	0.86 <sup>2</sup>
Mean Percent Change	50.32 ± 44.4	30.93 ± 32.3	0.12 <sup>2</sup>
Change in Serum Phosphorus level			
Decrease	3 (15.0)	3 (15.0)	1.00 <sup>3</sup>
Increase	17 (85.0)	16 (80.0)	
No Change	0 (0.0)	1 (5.0)	

Presented as Mean ± SD; Frequency (%)

<sup>1</sup>Student's T-test <sup>2</sup>Wilcoxon-Mann-Whitney test <sup>3</sup>Fisher's Exact Test

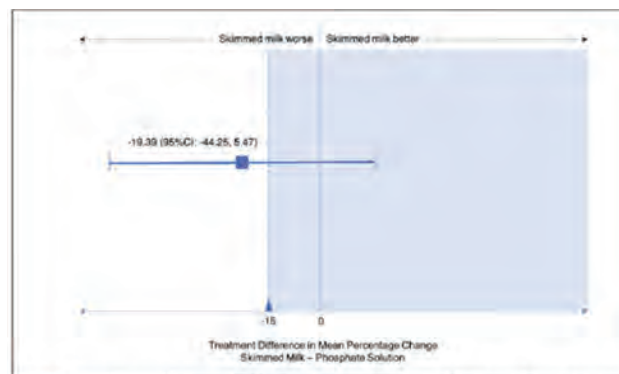

Figure 2. Mean Percent Difference (Phosphate solution - Skimmed Milk), confidence interval, and noninferiority margin

**FR-PO571**

**Ionized Magnesium Correlates With Total Magnesium in High-Risk Kidney Cohorts**

Denise C. Hasson, James Rose, Kyle Merrill, Charles D. Varnell, Stuart Goldstein, Stefanie W. Benoit. *Cincinnati Children's Hospital Medical Center, Cincinnati, OH.*

**Background:** Serum magnesium (Mg) abnormalities are common in critically ill children and kidney transplant (KTx) recipients; abnormal values are associated with poor outcomes including mortality. Mg homeostasis is affected by kidney function, acid-base status, calcium-vitamin D alterations, and medications (eg, immunosuppressants, citrate). The active form, ionized Mg (iMg), is not measured, and studies conflict regarding total (tMg) and iMg correlation. We hypothesized iMg and tMg concentrations will be categorized differently (i.e., low, normal, high) in patients (pts) after KTx and on continuous kidney replacement therapy (CKRT) with citrate, but ionized calcium (iCa) will correlate with iMg.

**Methods:** We collected whole blood from pts in a single center for iMg and iCa measurement. Each CKRT pt could contribute multiple samples as our timepoints would reset with each circuit change. Total Mg and Ca were collected as standard of care. Demographic, lab, and outcome data were recorded from the medical record. iMg and iCa were categorized using normal ranges of 0.44-0.65 mmol/L and 1.0-1.3 mmol/L, respectively, based on prior studies and clinical significance. Fisher's Exact test and Pearson correlation studies were used for statistical analysis.

**Results:** In 9 KTx pts (n= 28 samples), iMg and tMg had similar categorization (p<0.001) and correlated well (R=0.811, p<0.001, Table 1A, Figure 1A), but iCa did not differentiate normal from abnormal iMg concentrations (p=0.118). In 11 CKRT pts (n=70 samples), more time on CKRT resulted in more ionized hypomagnesemia despite 65/70



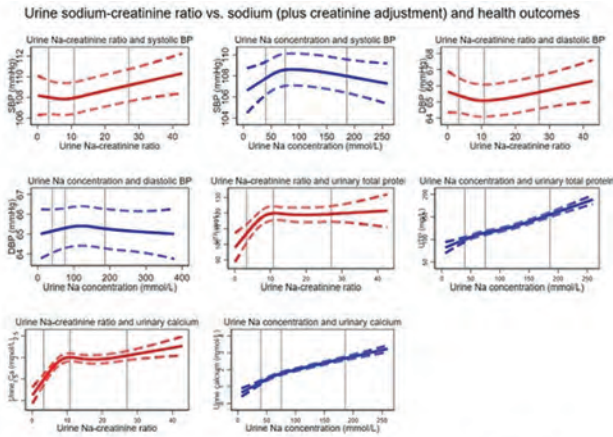

Figure: Restricted cubic spline plots visualizing the relationships of urine sodium-creatinine ratio vs. urine sodium with creatinine adjustment with blood pressure, urine total protein, and calcium concentrations. Red plots are for sodium-creatinine ratio and blue plots are for urine creatinine with regression adjustment. Dotted lines represent the lower and upper limit of the 95% confidence interval of the relationships. Vertical lines represent the 5<sup>th</sup>, 50<sup>th</sup>, and 95<sup>th</sup> percentiles of the exposures (urine sodium creatinine ratio or sodium concentration).

**FR-PO575**

**Endothelial Cell Ferroptosis Promotes Renal Damage in ANCA-Induced Glomerulonephritis**

Anthony Rousselle,<sup>1</sup> Dörte Lodka,<sup>1</sup> Lovis Kling,<sup>2,1</sup> Ralph Kettritz,<sup>2,1</sup> Adrian Schreiber.<sup>2,1</sup> <sup>1</sup>Experimental and Clinical Research Center, Max Delbrück Center for Molecular Medicine (MDC) and Charité, Berlin, Germany; <sup>2</sup>Charite Universitätsmedizin Berlin, Berlin, Germany.

**Background:** Antineutrophil cytoplasmic antibody (ANCA)-associated vasculitides (AAV) are systemic autoimmune diseases characterized by inflammation of small blood vessels and organ damage, including necrotizing and crescentic glomerulonephritis (NCGN). ANCA are circulating immunoglobulin G (IgG) autoantibodies binding to and activating neutrophil granulocytes and monocytes. The persistent inflammation leads to renal cell necrosis. Ferroptosis is a form of programmed cell death characterized by the production of ROS- and iron-dependent lipid peroxidation leading to membrane rupture. The Acyl-CoA Synthetase Long Chain Family Member 4 (ACSL4) enzyme regulates the generation of lipid peroxides. We tested the hypothesis that endothelial cell ferroptosis contributes to ANCA-associated NCGN.

**Methods:** To analyse the biological significance of ferroptosis in endothelial cells in vivo, we generated MPO<sup>-/-</sup> ACSL4<sup>EC</sup> mice, which lack ACSL4 specifically in endothelial cells. MPO<sup>-/-</sup> ACSL4<sup>EC</sup> mice were immunized with murine MPO, irradiated and subsequently transplanted with hematopoietic cells from C/57BL6J (WT) mice. Mice were sacrificed and analyzed 6-8 weeks following transplantation. Ferroptosis was investigated in vitro using human umbilical vein endothelial cells and ANCA-stimulated neutrophils. Cell death and lipid peroxidation were detected by flow cytometry. Ferrostatin-1 (Fer-1) and siRNA against ACSL4 were used to inhibit ferroptosis.

**Results:** We found increased lipid peroxidation (4-HNE staining) in kidney section of mice with AAV. MPO<sup>-/-</sup> ACSL4<sup>EC</sup> chimeric mice showed reduced renal damage as indicated by less necrotic and crescentic glomeruli supporting the notion that endothelial cell ferroptosis is important for the development of MPO-ANCA-induced NCGN. In vitro experiments revealed that ANCA-activated neutrophils induced endothelial cell death and this effect was prevented by ferroptosis inhibition with Fer-1 and siRNA against ACSL4. In contrast, inhibition of either necroptosis or apoptosis did not prevent endothelial cell death. Finally, ferroptosis inhibition alleviated the accumulation of lipid peroxides and endothelial dysfunction induced by ANCA-activated neutrophils.

**Conclusions:** ANCA-activated neutrophils induce ferroptosis in endothelial cells in vitro and endothelial cell ferroptosis contributes to ANCA-associated NCGN in a murine AAV model.

**Funding:** Government Support - Non-U.S.

**FR-PO576**

**β2 Integrin-Dependent Adhesion Is Indispensable for Inflammatory HIF1α Activation in Human Neutrophils**

Lovis Kling,<sup>1,2</sup> Claudia Eulenber-Gustavus,<sup>1</sup> Uwe Jerke,<sup>1</sup> Anthony Rousselle,<sup>1</sup> Kai-Uwe Eckardt,<sup>2</sup> Adrian Schreiber,<sup>1,2</sup> Ralph Kettritz.<sup>1,2</sup> <sup>1</sup>Experimental and Clinical Research Center, Charité – Universitätsmedizin Berlin and Max Delbrück Center for Molecular Medicine in the Helmholtz Association, Berlin, Germany; <sup>2</sup>Department of Nephrology and Medical Intensive Care, Charité – Universitätsmedizin Berlin, Berlin, Germany.

**Background:** Myeloid cells migrate from blood to inflammatory sites with high cytokine but low oxygen concentrations. Hypoxic but also pharmacologic prolyl hydroxylase inhibition induces hypoxia-inducible factor 1α (HIF1α), and thereby enhances myeloid cell performance. We tested the hypothesis that cytokines and β<sub>2</sub>-integrins co-operate in the HIF1α activation process.

**Methods:** We characterized HIF1α in human blood neutrophils and monocytes using immunoblotting and qPCR. Neutrophil suspension was achieved on polyhema, adhesion on fibronectin, and migration through transwells. Prolyl hydroxylases were inhibited with Roxadustat (ROX), and HIF1α translation with YC1. Signaling pathways were analyzed with β<sub>2</sub>-integrin antibodies and the JAK2 inhibitor AZD1480.

**Results:** We observed HIF1α activation in ROX-, but not cytokine-treated neutrophils and monocytes after 4h incubation in tubes. A 3-fold synergistic effect occurred in neutrophils but not in monocytes with combined GM-CSF and ROX treatment. Neutrophils that interacted with fibronectin showed high HIF1α protein abundance, whereas HIF1α protein was completely absent under stringent suspension conditions on polyhema that excluded cell-cell and matrix contacts. Consequently, pre-incubation with blocking β<sub>2</sub>-integrin antibodies prevented neutrophil HIF1α protein in both tubes and on fibronectin. GM-CSF induced strong HIF1α mRNA via JAK2/STAT but independent of adhesion. However, an additional β<sub>2</sub>-integrin signal was required for HIF1α protein upregulation. Adhesion did not accelerate transcription but rather involved post-transcriptional mechanisms stabilizing HIF1α protein as shown by YC1-mediated inhibitory effects. These novel synergistic mechanisms led to strong HIF1α protein in neutrophils that migrated towards GM-CSF and ROX in transwell experiments.

**Conclusions:** Human neutrophils are unable of activating HIF1α in suspension. In contrast, cytokine, β<sub>2</sub>-integrin, and prolyl hydroxylase co-operation at inflammatory sites enables strong HIF1α activation.

**Funding:** Government Support - Non-U.S.

**FR-PO577**

**Enhanced Serum Levels of NF-κB-Regulated Immune Modulators in Lupus Nephritis Patients With TNIP1 Variant rs4958881**

David W. Powell, Makayla Brady, Shweta Tandon, Dawn J. Caster. *University of Louisville School of Medicine, Louisville, KY.*

**Background:** Lupus nephritis (LN) is a prevalent and severe complication of systemic lupus erythematosus (SLE). Non-invasive diagnostics are limited and current therapies have inadequate response rates. This raises a great need for understanding the cellular and molecular mechanisms for LN development to identify novel diagnostics and therapeutic targets. We previously reported the TNIP1 variant rs4958881 as risks for LN. TNIP1 encodes the protein ABIN1, which is a polyubiquitin binding protein that negatively regulates the immune regulatory transcription factor NF-κB. NF-κB activation leads to the expression of inflammatory cytokines and chemokines. We hypothesize that patients with the risk variant for TNIP1 have increased serum levels of NF-κB-regulated cytokines and chemokines.

**Methods:** To test our hypothesis, we acquire serum from 30 LN patients in an active flare (UPCR > 500 mg/g) and 7 healthy control individuals. Of the 30 LN patients, 17 patients had the TNIP1 rs4958881 variant. These serum samples were analyzed with a bio-plex array containing antibodies for 48 human cytokine/chemokine regulated by NF-κB.

**Results:** We found 12 proteins (IL-18, SCF, IL-2Ra, HGF, M-CSF, TRAIL, IFN-γ, MIP-1α, IL-16, IL-8, MIG, and G-CSF) were significantly increased in serum from LN patients compared to control serum and 6 of these were significantly increased specifically in LN patients with the TNIP1 variant compared with controls (IFN-γ, MIP-1α, IL-16, IL-8, MIG, and G-CSF).

**Conclusions:** Our findings indicate that LN patients have an increased serum levels of a panel of specific inflammatory cytokines and chemokines and the presence of TNIP1 risk allele leads to a differential response. These data provide a list of candidate diagnostic markers and potential therapeutic targets and important insight into novel mediators of immune-phenotypes in LN.

**Funding:** NIDDK Support

**FR-PO578**

**Enhanced Neutrophil Activity in Lupus Nephritis Patients With TNIP1 Variant rs4958881**

David W. Powell, Makayla Brady, Shweta Tandon, Madhavi J. Rane, Michelle T. Barati, Dawn J. Caster. *University of Louisville School of Medicine, Louisville, KY.*

**Background:** There is need for understanding cellular and molecular mechanisms of lupus nephritis (LN) to define novel diagnostics and therapeutic. We previously reported the TNIP1 variant rs4958881 as risks for LN. TNIP1 encodes ABIN1, which negatively regulates the immune regulatory NF-κB. Glomerular neutrophil accumulation has been shown in LN patients and we have shown that transgenic mice with loss of ABIN1 function also develop glomerular influx of neutrophils. Release of neutrophil extracellular traps (NETs) is implicated in loss of immune tolerance in SLE and enhanced serum levels of NETs and antibodies against NET components have been reported in LN patients. Thus, we hypothesize that LN patients with the TNIP1 rs4958881 risk variant have increased NET production/release and recruitment of neutrophils due to NF-κB over activation.

**Methods:** We tested our hypothesis by performing in vitro transwell migration (chemotaxis) and supernatant DNA measurements (NET release) assays with neutrophils isolated from 6 LN patients with and 6 LN patients without the TNIP1 variant rs4958881 and 6 healthy control subjects. Neutrophil functions were measured in response to known positive activators (FMLF for chemotaxis and PMA for NET production). Interferon (IFN)-γ is prominent activator of neutrophils that was recently implicated in LN and we found that serum levels of IFN-γ are enhanced in LN patients with the rs4958881 variant. Thus, stimulation with IFN-γ was also assessed.

**Results:** IFN- $\gamma$  did not activate chemotaxis of neutrophils from healthy controls or LN patients without the TNIP1 variant rs4958881, but cells from LN patients with the TNIP1 variant had a robust response to IFN- $\gamma$ . NET production was enhanced in response to PMA and IFN- $\gamma$  in neutrophils from LN patients with the TNIP1 variant as compared to the response in cells from LN patients without the and healthy controls.

**Conclusions:** Our findings indicate that LN patients' neutrophils have an altered response to an LN relevant stimulus compared to healthy control individuals. These data also suggests that the presence of TNIP1 variant rs4958881 further exacerbates this altered response. This suggests this increased neutrophil activation is a contributing factor to inflammatory development in these patients and that targeting and suppressing neutrophil activity could potentially alleviate their LN.

**Funding:** NIDDK Support

**FR-PO579**

**CC Chemokine Receptor 2 (CCR2) in ANCA Disease: Different Roles in Glomerulonephritis vs. Lung Granulomatosis in MPO-ANCA Induced Mouse Model**

Peiqi Hu, Hong Xiao, Marco A. Alba, Shen-Ju Gou, Yanglin Hu, Ronald Falk, J. Charles Jennette. *University of North Carolina, Chapel Hill, NC.*

**Background:** Antineutrophil cytoplasmic autoantibody disease has a spectrum of necrotizing small vessel vasculitis, including necrotizing crescentic glomerulonephritis (NCGN) and lung granulomatosis (LG). Neutrophils and monocytes/macrophages are key players in the pathogenesis of ANCA disease. CC chemokine receptor 2 (CCR2) serves as the main receptor for CCL2, and modulates recruitment of monocytes/macrophages and neutrophils to sites of inflammation. CCR2 has dual pro-inflammatory and anti-inflammatory roles in inflammation. The aim of the present study was to elucidate the role of CCR2 in the pathogenesis of NCGN and LG in an animal model of MPO-ANCA disease

**Methods:** A murine MPO-ANCA induced model was used to evaluate the in vivo role of CCR2 in ANCA GN and LG. CCR2<sup>-/-</sup> and B6 WT mice were treated with a single dose of anti-MPO IgG iv at day 0; or a dose of intratracheal LPS administration at day 0 plus two consecutive doses of anti-MPO IgG on day 0 and day1. Mice were sacrificed at day7 and kidneys and lungs collected for pathologic assessment.

**Results:** On day 7 after receiving a single dose of MPO-ANCA IgG, WT mice (n=8) had 13.9% mean crescents (crescent between arrows in Figure 1), whereas CCR2<sup>-/-</sup> mice (n=3) had less GN with 0.5% crescents. However, WT mice had no LG, whereas CCR2<sup>-/-</sup> mice had well defined LG often with a central core of neutrophils surrounded by macrophages (between arrows in Figure 2).

**Conclusions:** Our preliminary data indicate that CCR2 deficiency reduces the severity of necrotizing inflammation in glomeruli, whereas CCR2 deficiency facilitates granulomatous disease in lungs. Insights into the role of CCR2 in the pathogenesis of ANCA disease will help guide development of safe and effective therapies involving CCR2 and CCR2 ligand modulation for ANCA disease.

**Funding:** NIDDK Support

**Figure 1**

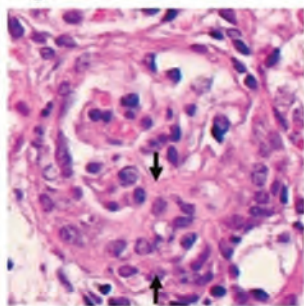

**Figure 2**

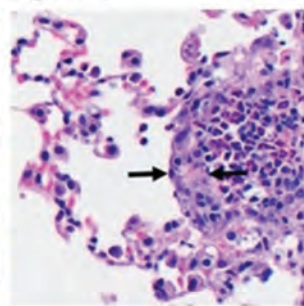

**FR-PO580**

**Kidney Injury Molecule 1 (KIM-1): A Potential Biomarker of AKI and Tubulointerstitial Injury in Patients With ANCA-Glomerulonephritis**

Benoit Brilland,<sup>1</sup> Charlotte Boud'hors,<sup>1</sup> Samuel Wacrenier,<sup>1</sup> Simon Blanchard,<sup>1</sup> Odile Blanchet,<sup>1</sup> Giorgina B. Piccoli,<sup>2</sup> Nicolas Henry,<sup>3</sup> Assia Ilham Djema,<sup>4</sup> Pascale Jeannin,<sup>1</sup> Yves Delneste,<sup>5</sup> Marie-Christine Copin,<sup>1</sup> Jean Francois Augusto.<sup>1</sup> <sup>1</sup>Centre Hospitalier Universitaire d'Angers, Angers, France; <sup>2</sup>Centre Hospitalier du Mans, Le Mans, France; <sup>3</sup>CH Laval, Laval, France; <sup>4</sup>Centre Hospitalier de Cholet, Cholet, France; <sup>5</sup>Universite Angers Faculte des sciences, Angers, France.

**Background:** Kidney injury molecule 1 (KIM-1) is a transmembrane glycoprotein expressed by proximal tubular cells, recognized as an early, sensitive, and specific urinary biomarker for kidney injury. Blood KIM-1 was recently associated with the severity of acute and chronic kidney damage but its value in ANCA-associated vasculitis with glomerulonephritis (ANCA-GN) has not been studied. Thus, we analyzed its expression at ANCA-GN diagnosis and its relationship with clinical presentation, kidney histopathology, and early outcomes.

**Methods:** We assessed KIM-1 levels and other pro-inflammatory molecules (CRP, IL-6, TNF- $\alpha$ , MCP-1 and PTX3) at ANCA-GN diagnosis and after 6 months in patients included in the Maine-Anjou registry, which gathers data patients from four French Nephrology Centers diagnosed since January 2000.

**Results:** Blood KIM-1 levels were assessed in 58 patients. Levels were elevated at diagnosis and decreased after induction remission therapy. KIM-1 was associated with the severity of renal injury at diagnosis and the need for KRT. In opposition to other pro-inflammatory molecules, KIM-1 correlated with the amount of interstitial fibrosis and tubular atrophy (IF/TA) on kidney biopsy, but not with glomerular involvement. In multivariable analysis, elevated KIM-1 predicted initial eGFR ( $\beta = -19 [-31, -7.6]$ ,  $p = 0.002$ ).

**Conclusions:** KIM-1 appears as a potential biomarker for acute kidney injury and for tubulointerstitial injury in ANCA-GN. Whether KIM-1 is only a surrogate marker for IF/TA or a key immune player in ANCA-GN pathogenesis remain to be determined.

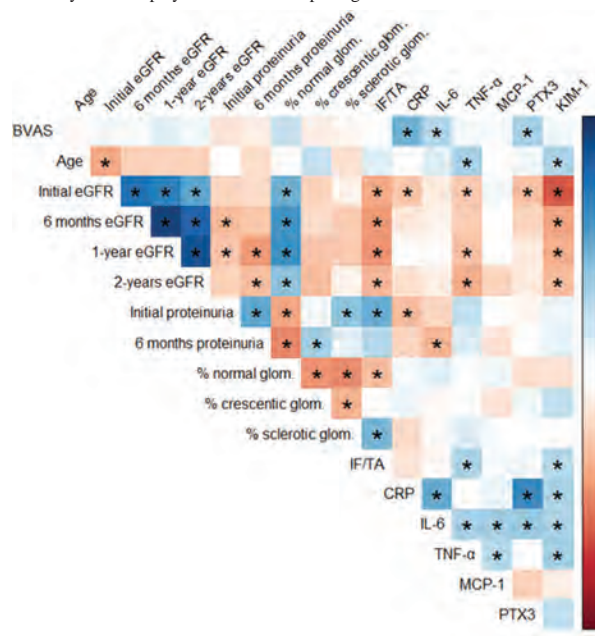

**FR-PO581**

**Intrarenal Synthesis of Complement C3 Localized to Distinct Vascular Compartments in ANCA-Associated Renal Vasculitis**

Desiree Tampe, Samy Hakroush, Bjoern Tampe. *University Medical Center Göttingen, Göttingen, Germany.*

**Background:** The activation of the complement system contributes essentially to its pathogenesis by autoantibody-antigen recognition directed against host cells in anti-neutrophil cytoplasmic antibody (ANCA)-associated renal vasculitis. The measurement of serum complement C3 with immunoassays is routinely used in clinical practice to determine and monitor complement activation. Importantly, C3 hypocomplementemia is only present in a minor subset of ANCA-associated renal vasculitis. These observations suggest that intrarenal synthesis of distinct complement components might contribute to kidney injury in renal vasculitis.

**Methods:** Intrarenal complement C3c localized to distinct vascular compartments (including small-sized arteries, capillaries, and venules) was evaluated in a total number of 43 kidney biopsies with ANCA-associated renal vasculitis. Publicly available transcriptome array datasets for C3 expression (encoded by *C3*) from Nephroseq (www.nephroseq.org, May 2022, University of Michigan, Ann Arbor, MI).

**Results:** Immunostaining confirmed presence of C3c deposits localized to either the glomerular tuft, interlobular arteries, peritubular capillaries, or venules in ANCA-associated renal vasculitis. Glomerular C3c deposits correlated positively with serum levels of complement C3c ( $p=0.011$ ), further supporting intrarenal synthesis of complement C3. As compared to healthy controls, we observed a significant induction of *C3* mRNA transcripts in the tubulointerstitial ( $p<0.0001$ ) and glomerular compartments of renal vasculitis ( $p<0.0001$ ). Interestingly, intrarenal synthesis of C3 was significantly higher in renal vasculitis as compared to lupus nephritis for both compartments ( $p<0.0001$  and  $p<0.001$ , respectively). Intrarenal *C3* mRNA expression correlated with impaired kidney function in the tubulointerstitial and glomerular compartments of renal vasculitis. Gene set enrichment analysis linking intrarenal C3 synthesis to distinct inflammatory signaling pathways.

**Conclusions:** To our knowledge, this is the first report of a systematic analysis of intrarenal synthesis and vascular distribution of intrarenal complement C3 deposits in ANCA-associated renal vasculitis. This is especially relevant because clinical trials currently investigate inhibition of the complement system in ANCA-associated renal vasculitis.

**Funding:** Commercial Support - Vifor Pharma

## FR-PO582

**Reduced ANCA-Sialylation Increases Anti-Myeloperoxidase-Induced Necrotizing Crescentic Glomerulonephritis in a Mouse Model**

Dörte Lodka, Anthony Rousselle, Sylvia Lucke, Maximilian Ebert, Udo Schneider, Ralph Kettritz, Adrian Schreiber. *Charite Universitätsmedizin Berlin, Berlin, Germany.*

**Background:** The glycosylation of IgG and especially of autoantibodies is an important regulator of antibody functionality. It has already been described that IgG glycosylation affects the binding ability to Fc receptors. It is also known that the glycosylation pattern of ANCA is altered during active AAV. However, only a few studies showed a direct relationship between glycosylation patterns and cellular functionality in AAV-relevant processes. We tested the hypothesis that B cells from active AAV patients are hypoglycosylated and that hypoglycosylated ANCA trigger stronger neutrophil activation in vitro and more severe MPO-ANCA induced NCGN.

**Methods:** The glycosylation status of B cells from patients compared to healthy controls was analyzed by flow cytometry. IgG from patients with active AAV were sialylated and desialylated in vitro. These modified antibodies were used in neutrophil stimulation assays to investigate the influence of sialylation status on ROS production, NETs induction and IL-1b secretion. Anti-MPO NCGN was induced in WT mice by passive IgG-transfer from MPO-immunized mice. The administered IgG originated from either MPO<sup>+</sup> (normal IgG) or MPO<sup>-</sup>/St6gal1<sup>-/-</sup>-mice (hyposialylated IgG). Histological evaluation of renal sections as well as flow cytometric analyses of blood and kidney cells were performed.

**Results:** B cells from active patients showed about a third reduced levels of sialic acid, terminal galactose and fucose compared to healthy controls. In vitro sialylation of IgG from active patients resulted in about 64%, 70% and 55% decreased ROS production, NETs formation and IL-1b secretion, respectively. Finally, mice receiving hyposialylated IgG from MPO<sup>-</sup>/St6gal1<sup>-/-</sup>-mice showed worsened NCGN compared to mice receiving IgG from MPO<sup>+</sup>-mice, as evidenced by an increased proportion of crescentic (20.9% vs. 8.4%) and necrotic (10.7% vs. 4.27%) glomeruli.

**Conclusions:** Glycosylation, especially sialylation of IgG, affects the severity of AAV disease. Increased IgG-sialylation had a protective effect as shown by reduced ROS production, NETs formation and IL-1b secretion in vitro. Conversely, sialic acid deficiency aggravated MPO-ANCA induced vasculitis in a murine disease model.

**Funding:** Government Support - Non-U.S.

## FR-PO583

**CD19 CAR-T Cells Protect Against the Development of ANCA-Induced Necrotizing Crescentic Glomerulonephritis in a Mouse Model**

Dörte Lodka,<sup>1</sup> Anthony Rousselle,<sup>1</sup> Ralph Kettritz,<sup>1</sup> Maria Zschummel,<sup>2</sup> Mario Bunse,<sup>2</sup> Adrian Schreiber.<sup>1</sup> <sup>1</sup>*Charite Universitätsmedizin Berlin, Berlin, Germany;* <sup>2</sup>*Max-Delbrück-Centrum für Molekulare Medizin in der Helmholtz-Gemeinschaft, Buch, Germany.*

**Background:** ANCA-induced vasculitis and NCGN are potentially life-threatening and current therapeutic approaches are largely based on cytotoxic drugs or B-cell-depleting antibodies. Chimeric antigen receptor T cells (CAR T cells) are genetically modified T cells that express a protein consisting of intracellular T cell receptor domains that are coupled to an extracellularly located antibody domain. The antibody specificity determines which target cells are recognized and destroyed by the CAR T cells. The use of CAR-T cells in autoimmune diseases is a promising new therapeutic approach. Since ANCA are implicated in ANCA-associated vasculitides (AAVs), depletion of ANCA-producing B cells may be an effective AAV therapy. We tested the hypothesis that CD19 CAR T cells deplete B cells, including MPO-ANCA-producing B cells, thereby protecting from MPO-ANCA induced necrotizing crescentic glomerulonephritis (NCGN).

**Methods:** Anti-MPO NCGN was induced by immunization of MPO<sup>-</sup>-mice with murine MPO, followed by irradiation and transplantation of hematopoietic cells from WT mice. In addition, CD19 CAR-T cells and SP6 CAR-T cells (control CAR) were administered. Effects on disease severity were analyzed by histological examination of kidney sections and by spleen, blood and bone marrow flow cytometry.

**Results:** CD19 CAR T cells showed efficient immigration and stable persistence in the transplanted animals, as they were detectable in bone marrow, spleen and peripheral blood after two and five weeks. In addition, mice receiving CD19 CAR T cells had significantly reduced amounts of CD19-expressing endogenous B cells compared to SP6 CAR T mice at 5 weeks in bone marrow (0.03% vs. 6.68%), spleen (0.05% vs. 60.7%) and peripheral blood (0.004% vs. 38.3%) accompanied by decreased anti-MPO titer. Finally, histology revealed a reduction in both crescentic (0.49% vs. 10.83%) and necrotic (0% vs. 6.04%) glomeruli in mice receiving CD19 CAR T cells compared to SP6 CAR T mice at 5 weeks, thus showing a protection from NCGN induction.

**Conclusions:** Our data suggest that depletion of CD19-expressing B cells by administration of CD19 CAR-T cells is an effective therapeutic option in murine anti-MPO-induced NCGN.

**Funding:** Government Support - Non-U.S.

## FR-PO584

**Assessing Clinical Outcomes of ANCA Vasculitis in the Post PEXIVAS Era: A Single Centre Retrospective Analysis**

Ravindra Rajakarier,<sup>1</sup> Charles Hall,<sup>1</sup> Jack E. Carruthers,<sup>1,2</sup> James Wells.<sup>1</sup> <sup>1</sup>*Barts Health NHS Trust, London, United Kingdom;* <sup>2</sup>*The Francis Crick Institute, London, United Kingdom.*

**Background:** The PEXIVAS trial (2018) showed no outcome benefit with the routine use of plasma-exchange (PLEX) in patients with ANCA vasculitis and eGFR < 50mL/min. As a result, our clinical practice changed in favour of no PLEX and replacing a standard steroid wean with a fast steroid taper, thus altering the burden of immunosuppression in patients with ANCA vasculitis. We performed a retrospective analysis of a cohort of patients with ANCA vasculitis and renal involvement to determine whether this change in management impacted on patient outcomes and infections requiring hospitalisation.

**Methods:** We audited a cohort of ANCA vasculitis patients with renal involvement under follow-up at a tertiary centre diagnosed in the last 20 years. We collected demographic and clinical data including induction agent, PLEX regimen, and details of infections due to immunosuppression. The outcomes measured were patients who were in remission at one year and infections that required hospitalisation or CMV viraemia within 1 year of diagnosis

**Results:** A total of 134 patients were identified, 91 diagnosed pre-PEXIVAS and 43 post-PEXIVAS. 6 patients died from COVID-19 by 1 year in the post-PEXIVAS group, these patients were excluded from analysis. Pre- and post-PEXIVAS mean age (60.6 yrs and 59 yrs respectively) and sex ratio (54/91 (59%) and 24/43 (55%)) were similar. The preferred induction agent pre-PEXIVAS was cyclophosphamide (65/91 (75%)) whilst there was a move to Rituximab in the post-PEXIVAS cohort (13/43 (48%)). Pre-PEXIVAS, 27/91 (29%) patients underwent PLEX versus 2/43 (4%) post-PEXIVAS. Remission rates at 1 year after diagnosis were similar between the two cohorts (pre: 65/91 (71.4%); post: 23/37 (53%); p=0.18 by Fisher's exact test). Infections that required hospitalisation were not significantly different but there was a trend to lower rate of admissions (pre: 16/91 (17.6%); post: 5/37 (12.2%); p=0.61 by Fisher's exact test).

**Conclusions:** Our results suggest that change in clinical management after PEXIVAS was not associated with poorer outcomes in relation to treatment response and there was no significant difference in infections requiring hospitalisation at 1 year in patients with ANCA vasculitis. Our work complements recent findings that PLEX was not associated with improved rates of renal replacement therapy or mortality (Nezam et al. 2022).

## FR-PO585

**Proteomic Analysis of Glomeruli in Myeloperoxidase-ANCA Glomerulonephritis**

Amit Sethi,<sup>1,2</sup> Joseph P. Grande,<sup>1</sup> Ulrich Specks,<sup>1</sup> Fernando C. Fervenza.<sup>1</sup> <sup>1</sup>*Mayo Foundation for Medical Education and Research, Rochester, MN;* <sup>2</sup>*University of Minnesota Twin Cities, Minneapolis, MN.*

**Background:** Myeloperoxidase (MPO)-ANCA-associated vasculitis often involves the kidney resulting a severe necrotizing and crescentic glomerulonephritis (GN). Kidney biopsy shows varying percentages of glomeruli involved by necrotizing and crescentic lesions. Yet, a proportion of the glomeruli appear normal and uninvolved by the necrotizing and crescentic lesions. In this study, we compared the proteomic profile of involved and uninvolved glomeruli in MPO-ANCA-GN.

**Methods:** We performed laser microdissection of glomeruli involved by crescents/fibrinoid necrosis (CF), and glomeruli that appeared normal (N) on light microscopy in 6 cases of MPO-ANCA-GN. Equal number of glomeruli were dissected in each group/case. This was followed by mass spectrometry (MS/MS) to analyze the proteomic profile in the 2 groups. Sclerosed glomeruli were not dissected.

**Results:** Proteomic profile shows higher activation of complement pathways in CF glomeruli compared to N glomeruli with higher total spectral counts (TSC) of C3 (2-fold), C5 (7-fold), C7 (10 fold), C9 (6-fold). In addition, there is 3-7 fold increase in TSC of actinin 4, laminin subunit 2, fibrinogen a, fibrillin 1, agrin, nidogen-2, heat shock protein 90 in CF glomeruli compared to N glomeruli. On the other hand, there is 3-6 fold increase in TSC of desmoplakin, protein S100, and serpin B3 and B12 in N glomeruli compared to CF glomeruli.

**Conclusions:** Complement activation is greater in glomeruli involved by crescents and necrosis. There are also differences in proteins expressed in glomeruli with crescents/necrosis compared to uninvolved glomeruli. Overexpression of certain proteins in normal glomeruli may protect glomeruli from developing crescents/necrosis.

**Funding:** Private Foundation Support

## FR-PO586

**PRTN3 Polymorphism in Antineutrophil Cytoplasmic Antibody (ANCA) Vasculitis**

Dhruti P. Chen, Yichun Hu, Susan L. Hogan, Ronald Falk, Dominic J. Ciavatta. *University of North Carolina System, Chapel Hill, NC.*

**Background:** Patients with vasculitis associated with antibodies to proteinase-3 (PR3-ANCA) experience relapse frequently. We investigated whether a polymorphism (rs62132293) upstream of the *PRTN3* gene is associated with increased relapse among patients with PR3-ANCA.

**Methods:** Patients (n=401) and healthy controls (n=130) from the Glomerular Disease Collaborative Network were genotyped for the variant (G-allele). *PRTN3* mRNA was quantified by RT-qPCR from total leukocyte RNA of 298 (MPO and PR3) patients.

Plasma PR3 was quantified using enzyme-linked immunoassay and means compared using Wilcoxon test. Kaplan-Meier estimates and log rank test were used for time to relapse and multivariable Cox proportional hazards models with hazards ratios for relapse.

**Results:** Patients and healthy controls were genotyped, respectively: 179 (44%) and 62 (48%) who were non-carriers (C/C), 181 (45%) and 54 (41%) heterozygous carriers (C/G), 41 (10%) and 14 (11%) homozygous carriers (G/G). Among patients, 170 were PR3-ANCA, remainder had MPO-ANCA (n=197), dual positive (n=9) or seronegative (n=25). PR3-ANCA patients relapsed more than MPO-ANCA (HR 1.48, 95% CI 1.09, 2.02). Variant carriers with PR3-ANCA had reduced relapse free survival and increased risk of relapse compared to MPO-ANCA (HR 1.66, 95% CI 1.08, 2.54). The relapse risk for non-carriers was similar in PR3 and MPO-ANCA (Figure 1). Among patients, carriers had higher *PR3N3* gene expression compared to non-carriers (C/G vs. C/C and G/G vs. C/C,  $p=0.012$  and  $p=0.001$ , respectively). Gene expression correlated with plasma protein levels ( $p < 0.005$ ) and patients with the variant had higher mean plasma PR3 levels compared to non-carriers (126.3ng/mL vs. 64.01 ng/mL,  $p=0.082$ , (Figure 2).

**Conclusions:** Our study highlights the clinical significance of the risk allele marked by rs62132293, and suggests increased relapse in PR3-ANCA may, in part, be explained by inheritance of the risk variant. Our results underscore disease phenotype in ANCA vasculitis may be contingent on autoantigen availability.

**Funding:** NIDDK Support

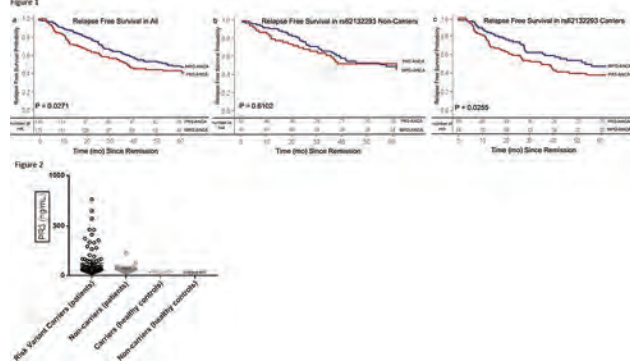

**FR-PO587**

**Serum Sulfatide Level as a Marker for Differentiation and Activity Assessment in Renal Vasculitis Diseases**

**Daiiki Aomura, Makoto Harada, Takayuki Nimura, Yosuke Yamada, Koji Hashimoto, Yuji Kamijo.** Department of Nephrology at Shinshu University school of medicine *Shinshu Daigaku Igakubu Fuzoku Byoin, Matsumoto, Japan.*

**Background:** Sulfatides are glycosphingolipids associated with coagulation and platelet aggregation, suggesting a possible involvement in renal vasculitis (RV). However, research on this notion is extremely limited, with only one study on a small population of healthy individuals and patients with ANCA-associated vasculitis (AAV) revealing serum sulfatide (SS) level as a possible differentiation marker in AAV, especially with active crescentic findings on kidney biopsy. To further assess the association between SS and RV, we performed a retrospective study with a larger sample size including several RV diseases.

**Methods:** This cross-sectional investigation included patients admitted to the Nephrology Department of Shinshu University Hospital (Japan) after April 2008. Patients who were firstly diagnosed as having IgA vasculitis (IgAV), AAV, or anti-GBM disease (GBM) were included. As controls, donor candidates for living kidney transplantation (donors) were analyzed as well. SS levels were analyzed using stored frozen serum samples.

**Results:** The mean±standard deviation SS levels of donors (n=23), IgAV (n=26), AAV (n=64), and GBM (n=10) were  $8.30 \pm 1.68$ ,  $6.14 \pm 1.59$ ,  $5.30 \pm 2.02$ , and  $2.72 \pm 0.94$  nmol/mL, respectively. Regarding associations with kidney biopsy findings, SS levels were significantly higher in patients with a higher crescentic score (Oxford classification) in IgAV. In contrast, SS levels were significantly lower in patients with a crescent-type phenotype (Berdens classification) in AAV and negatively correlated with the percentage of glomeruli with cellular crescents in GBM ( $r=-0.76$ ,  $p=0.02$ ). Those associations of active pathological findings with SS level were stronger than with other possible markers including serum C-reactive protein level in all RV groups.

**Conclusions:** SS level is a possible marker for differentiation and activity assessment in RV diseases.

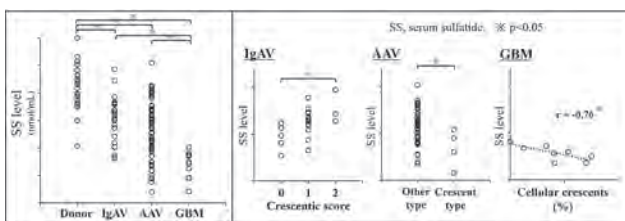

**FR-PO588**

**Association Between ANCA Kinetic, Renal Survival, and Relapse Risk in ANCA-Glomerulonephritis**

**Clément Samoreau,<sup>1</sup> Giorgina B. Piccoli,<sup>3</sup> Cecile Martin,<sup>5</sup> Philippe Gataut,<sup>6</sup> Emeline Vinatier,<sup>1</sup> Frank Bridoux,<sup>5</sup> Jérémie Riou,<sup>1</sup> Alice Desouche,<sup>1</sup> Pierre Jourdain,<sup>1</sup> Samuel Wacrenier,<sup>1</sup> Nicolas Henry,<sup>4</sup> Odile Blanchet,<sup>1</sup> Assia Ilham Djema,<sup>2</sup> Lise-Marie Pouteau,<sup>1</sup> Marie-Christine Copin,<sup>1</sup> Celine Beauvillain,<sup>1</sup> Jean Francois Augusto,<sup>1</sup> Benoit Brilland.<sup>1</sup>** <sup>1</sup>Centre Hospitalier Universitaire d'Angers, Angers, France; <sup>2</sup>CH de Cholet, Cholet, France; <sup>3</sup>Centre Hospitalier du Mans, Le Mans, France; <sup>4</sup>CH de Laval, Laval, France; <sup>5</sup>Centre Hospitalier Universitaire de Poitiers, Poitiers, France; <sup>6</sup>Centre Hospitalier Regional Universitaire de Tours, Tours, France.

**Background:** ANCA kinetic in ANCA-associated vasculitis with glomerulonephritis (AAV-GN) has been suggested to be associated with relapse. Few studies focused on its association with renal prognosis. Thus, we aimed to investigate the relationship between i) ANCA specificity and evolutive profile, and ii) renal outcomes.

**Methods:** This multicentric retrospective study included patients diagnosed with ANCA-GN since 01/01/2000. Patients without ANCA at diagnosis and with fewer than 3 ANCA determinations during follow-up were excluded. We analyzed eGFR variation, renal-free and relapse-free survival according to three ANCA profiles (negative, recurrent, persistent) and to ANCA specificity (MPO or PR3).

**Results:** Over a median follow-up of 56 months, 19 [13-25] ANCA determinations were performed for the 134 included patients. Patients with a recurrent/persistent ANCA profile had a lower renal- ( $p = 0.053$ ) and relapse-free ( $p = 0.019$ ) survival compared to those with negative ANCA profile. Patients with a recurrent/persistent MPO-ANCA profile had the worst renal survival ( $p = 0.015$ ) and those with recurrent/persistent PR3-ANCA profile had the worst relapse-free survival ( $p = 0.013$ ) compared to other profiles. In multivariate regression analysis, a negative ANCA profile was an independent predictor of positive 2-year eGFR percent variation ( $p < 0.001$ ).

**Conclusions:** ANCA kinetic after ANCA-GN diagnosis is associated with outcomes. MPO-ANCA recurrence/persistence identifies patients with a lower potential of renal recovery and a higher risk of ESKD, while PR3-ANCA recurrence/persistence identifies patients with a greater relapse risk. Thus, ANCA kinetic may help identify patients with a smoldering disease.

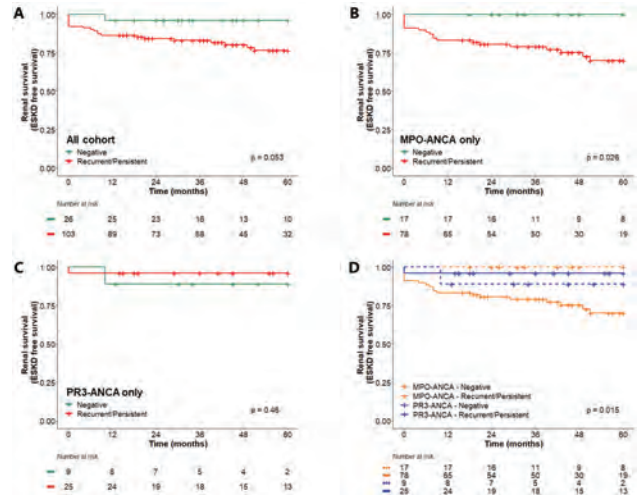

**FR-PO589**

**Histological Subtyping of Interstitial Infiltrates and Long-Term Validation of Renal Risk Score in ANCA-Associated Glomerulonephritis**

**Aglaiia Chalkia,<sup>1</sup> Christos Koutsianas,<sup>3</sup> Panagiota E. Giannou,<sup>1</sup> Georgios Agelis,<sup>1</sup> Harikleia Gakiopoulou,<sup>2</sup> Alexandros G. Panagiotopoulos,<sup>3</sup> Konstantinos Thomas,<sup>3</sup> Dimitrios Vassilopoulos,<sup>3</sup> Dimitrios I. Petras.<sup>1</sup>** <sup>1</sup>Nephrology Department, Hippokraton General Hospital, Athens, Greece; <sup>2</sup>1st Department of Pathology, National and Kapodistrian University of Athens, School of Medicine, Athens, Greece; <sup>3</sup>2nd Department of Medicine and Laboratory, Clinical Immunology - Rheumatology Unit, National and Kapodistrian University of Athens, School of Medicine, Athens, Greece.

**Background:** Data on the prognostic significance of baseline renal histologic findings in ANCA-associated glomerulonephritis (AAGN) are limited.

**Methods:** Retrospective study of 38 patients with AAV and biopsy proven AAGN. Patients were categorized according to their histologic subtype and the composition of their interstitial inflammatory infiltrates as well as their risk for progression to end-stage renal disease (ESRD) according to their renal risk score were estimate.

**Results:** 38 patients (mean age: 68 years, males:50%, MPA: 60%, anti-MPO+: 76%, mean follow-up: 48 months) were categorized into focal (n=9, 24%), mixed (n=12, 32%), crescentic (n=6, 16%) and sclerotic (n=8, 21%) subtypes while 3 patients had isolated tubulointerstitial nephritis (8%). In terms of interstitial infiltrates, mixed type

Key: TH - Thursday; FR - Friday; SA - Saturday; OR - Oral; PO - Poster; PUB - Publication Only

Underline represents presenting author.

biopsies (n=12) had more intense interstitial inflammation (67% vs 25%, p=0.029) with predominant eosinophilic (42% vs 13%, p=0.086) and macrophage (58% vs 16%, p=0.02) compared to the other types. Contrarily, in focal type we noticed absence of macrophage (0% vs 39%, p=0.053) and limited neutrophilic (11% vs 54%, p=0.053) infiltration, compared to the rest. Patients with focal type demonstrated the lowest (HR 0.027 95% CI 0.009-3.238, p=0.09) and those with sclerotic type the highest (HR 5.95 95% CI 1.494-18.059, p=0.010) risk for ESRD progression. According to the renal risk score, the cumulative renal survival at 1, 2 and 5 years was 100% in the low-risk, 94% in the medium-risk and 50%, 38% and 18% respectively in the high-risk (p<0.0001). The high-risk group presented the highest risk for progression to ESRD (HR 25.29, 95% CI 3.145-203.38, p=0.002), compared to low/medium risk groups.

**Conclusions:** Our real-life study confirmed the value of histologic subtyping and the renal risk score for predicting ERSD progression in patients with AAGN. It also demonstrated that the cellular composition of interstitial infiltrates differs significantly according to the histologic subtype. These findings may have important implications for the understanding of the pathogenesis and prognosis of AAGN.

**Funding:** Other NIH Support - Supported in part by grants from the Greek Rheumatology Society and Professional Association of Rheumatologists (ERE-EPERE) and the Special Account for Research Grants (S.A.R.G.), National and Kapodistrian University of Athens, Athens, Greece (DV #12085, 12086), Private Foundation Support

**FR-PO590**

**Histopathologic Prognostication of ANCA-Associated Vasculitis Using Banff Parameters**

Jerome P. Givi, James L. Akers, Adriana Garrison, Khaled Shawwa, Dinesh Kannabhiran, Md. Shahriar Amin. *West Virginia University Health Sciences Center, Morgantown, WV.*

**Background:** ANCA-associated vasculitis (AAV) with renal involvement makes up 80% of rapidly progressive glomerulonephritis cases. Our objective was to determine whether histopathologic parameters adapted from Banff provide prognostic information.

**Methods:** Biopsy slides from patients with AAV from 2008-2021 at West Virginia University Hospitals were reviewed. The biopsies were scored using an expanded Banff scoring system by a renal pathologist blinded to clinical data. Each histopathologic parameter was analyzed both individually and as part of a composite score, to determine association with eGFR and ESKD. Generalized estimating equation model was used to evaluate the association between the parameters and eGFR during follow-up. Proportional hazard model was used to investigate the association between the parameters to end-stage kidney disease (ESKD) (estimated glomerular filtration rate (eGFR) less than 15 ml/min/BSA or need for renal replacement therapy).

**Results:** Slides were available for review in 79 of 155 patients with AAV during the study period. Patients had a mean age of 63 years, 32 (41%) were females and 48 (61%) were MPO-ANCA. Having a crescent score (C) of C1 or C2 was associated with an eGFR decline of 8.19 ml/min/BSA (95% CI: -15.8 to -0.5, p=0.036) during follow up compared to C0. Percent of globally sclerosed glomeruli >25% compared to <10% was also associated with eGFR decline of 17.3 ml/min/BSA during follow up (95% CI: -29.2 to -5.3; p=0.005). Using a single composite score including crescent, vasculitis and total inflammation (CVI) showed that CVI > 3 (median value) was associated with a significant decline of eGFR during follow up compared to CVI < 3 (-15.6 ml/min/BSA, 95% CI: -24.3 to -3.6; p<0.001). Parameters that showed significant association with increased risk of ESKD include - interstitial fibrosis (ci>1 vs ci<1, hazard ratio, HR:2.6, 95% CI:1.1 to 6.4, p=0.03) and total inflammation (ti<1 vs ti>1; HR - 3.4, CI - 1.1 to 10.2, p=0.032).

**Conclusions:** A scoring system that reflects both active inflammation and chronicity provides prognostic information when considering treatment in patients with AAV. Further multicenter studies will be useful to further validate these parameters for clinical use.

**FR-PO591**

**Predicting Death in Anti-Neutrophil Cytoplasmic-Antibody Vasculitis With Glomerulonephritis**

Nicolas Fage,<sup>1</sup> Jérémie Riou,<sup>1</sup> Charlotte Boud'hors,<sup>1</sup> Alice Desouche,<sup>1</sup> Emeline Vinatier,<sup>1</sup> Clément Samoreau,<sup>1</sup> Samuel Wacrenier,<sup>1</sup> Nicolas Henry,<sup>2</sup> Assia Ilham Djema,<sup>4</sup> Lise-Marie Pouteau,<sup>2</sup> Marie-Christine Copin,<sup>1</sup> Giorgina B. Piccoli,<sup>3</sup> Jean francois Augusto,<sup>1</sup> Benoit Brilland.<sup>1</sup> <sup>1</sup>Centre Hospitalier Universitaire d'Angers, Angers, France; <sup>2</sup>CH Laval, Laval, France; <sup>3</sup>Centre Hospitalier du Mans, Le Mans, France; <sup>4</sup>Centre Hospitalier de Cholet, Cholet, France.

**Background:** Several scores have been developed to predict death in Anti-Neutrophil Cytoplasmic-Antibody vasculitis (AAV). However, the performance of these scores in AAV with glomerulonephritis (AAV-GN) remains uncertain. We aimed to evaluate their prognostic value and developed our own death prediction risk model in a large cohort of AAV-GN.

**Methods:** This multicentric retrospective study included patients newly diagnosed with ANCA-GN in 4 French nephrology departments (Maine-Anjou Registry) between 2000 and 2021. Scores (Five Factors Score, FFS; Japanese Vasculitis Activity Score, JVAS; multivariable index for AAV, MVIA; Maldini Score) were assessed at diagnosis before any therapeutic intervention. Clinical, biological and histological characteristics at diagnosis were retrieved. A multivariable cox analysis was performed to determine a death prediction model. Performance (time dependent concordance with C-index and AUC, and prediction accuracy with Brier Score) of these scores and of our model were assessed.

**Results:** Among the 167 patients included, FFS (HR = 2.78 [2.08-3.73]), JVAS (HR = 1.42 [1.25-1.60]), MVIA (HR = 3.06 [1.66-5.64]) and Maldini [HR = 1.23 (1.10-1.37)] scores were significantly associated with death (with performance decreasing in that order) (Figure 1). In multivariable analysis, age, diabetes, need of early kidney replacement therapy or eGFR, and hemoglobin at diagnosis were associated with death. Two new models including these variables were fit (Table 1) and were found with better performance than the existing scores (Figure 1).

**Conclusions:** ANCA-GN-specific models perform better in predicting death than existing scores.

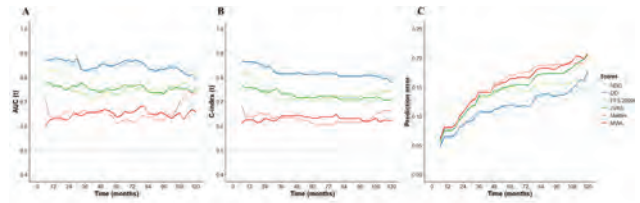

**Figure 1.** Time-dependent AUC (concordance) (A), C-index (concordance) (B) and Brier score (prediction accuracy) (C) of each score and of our models. NDD: non-dialysis-dependent patients, DD: dialysis-dependent patients.

	"DD" model			"NDD" model		
	HR	95% CI	p-value	HR	95% CI	p-value
Age (per 5 years increment)	1.65	1.41 - 1.92	< 0.001	1.62	1.38 - 1.90	< 0.001
Diabetes	1.91	0.98 - 3.75	0.059	1.73	0.90 - 3.36	0.10
Early KRT	2.16	1.24 - 3.75	0.006	-	-	-
eGFR (per 5 ml/min increment)	-	-	-	0.90	0.84 - 0.97	0.007
Hemoglobin (per 1 g/dl increment)	0.86	0.74 - 0.99	0.037	0.85	0.74 - 0.99	0.04

**Table 1.** Multivariable analysis for death prediction in AAV-GN. Estimated glomerular filtration rate (eGFR) was estimated with MDRD formula. Early KRT: Kidney Replacement Therapy within 30 days from diagnosis. CI: Confidence Interval; HR: Hazard Ratio; NDD: non-dialysis-dependent patients; DD: dialysis-dependent patients.

**FR-PO592**

**MC1R Deficiency Enhances Th1 Response and Impairs Regulatory T Cell Homeostasis in Nephrotoxic Serum Nephritis**

Bohan Chen, Xuejing Guan, Yan Ge, Lance D. Dworkin, Rujun Gong. *The University of Toledo Medical Center, Toledo, OH.*

**Background:** The melanocortin neuropeptides, represented by adrenocorticotropic hormone, have recently emerged as a novel therapeutic choice for treating refractory glomerular diseases. As a key cognate receptor of the melanocortin hormone system, melanocortin 1 receptor (MC1R) plays a pivotal role in regulating immune response and inflammation, and has become a novel therapeutic target for a number of diseases. However, its role in the pathogenesis of immune-mediated glomerular disease remains unknown.

**Methods:** Wild-type mice and the recessive yellow mice (e/e) with the naturally occurring loss-of-function null mutation of MC1R received injection of the rabbit anti-mouse nephrotoxic serum (NTS) to develop the NTS nephritis and were examined 2 weeks later.

**Results:** The e/e mice developed more severe crescentic glomerulonephritis than WT mice, marked by aggravated proteinuria, kidney dysfunction, and renal lesions like glomerular hypercellularity, crescent formation, and renal inflammation and fibrosis. The exacerbated NTS nephritis in e/e mice was associated with greater levels of autologous IgG2c and IgG3 either deposited in glomeruli or in sera. In addition, profiling of signature cytokines of Th immunity revealed that e/e mice with NTS nephritis exhibited higher renal expression of IFN-γ, and an increasing trend in renal expression of TNF-α, as compared with WT mice, consistent with a reinforced Th1 immune response. Moreover, shown by immunohistochemistry staining, the number of FoxP3+ regulatory T cells in the NTS nephritic kidneys was diminished in e/e mice, as compared with WT mice. Mechanistically, MC1R was evidently detected in diverse renal leukocytes prepared from the diseased WT mice, including T lymphocytes, suggesting that T cells may be direct effector cells of the melanocortin hormones via MC1R signaling.

**Conclusions:** MC1R-mediated melanocortinergic signaling represses Th1 immune response and is required for regulatory T cell homeostasis in murine models of NTS nephritis, resulting in renal protection in experimental crescentic glomerulonephritis.

**Funding:** NIDDK Support, Commercial Support - Mallinckrodt ARD, LLC

**FR-PO593**

**Inhibition of VEGFR3 by SAR131672 Decreases Renal Inflammation and Lymphangiogenesis in the Murine Lupus Nephritis Model**

Wenjia Li,<sup>1,2</sup> Tian Wang,<sup>1,2</sup> Jihyun Yeom,<sup>1,2</sup> Kyung Pyo Kang.<sup>1,2</sup> <sup>1</sup>Jeonbuk National University Medical School, Jeonju, Jeollabuk-do, Republic of Korea; <sup>2</sup>Jeonbuk National University Hospital Biomedical Research Institute, Jeonju, Jeollabuk-do, Republic of Korea.

**Background:** Lupus nephritis (LN) is an immune complex glomerulonephritis that develops as a frequent and potentially dismal manifestation of SLE. Lymphangiogenesis is the proliferation of pre-existing lymphatic vessels (LVs), which regulate tissue fluid homeostasis and immune cell trafficking, responding to the tissue environment. In this study, we have evaluated the therapeutic effect of the VEGFR3 inhibitor, SAR 131672, on the murine lupus nephritis model by regulation of inflammation and lymphangiogenesis.

**Methods:** Seven to eight-week-old male BALB/c mice were used in this experiment. The back area's skin was shaved and treated topically three times per week, with 100 µg of resiquimod in 100 µl of acetone for eight weeks and concomitantly treatment of VEGFR3 inhibitor, SAR 131672 by oral gavage. We evaluated renal histology and immunofluorescent staining for inflammatory cells and lymphatic vessels. We also assessed inflammatory cytokines and chemokines, lymphangiogenic factors by qRT-PCR.

**Results:** Eight weeks of topical treatment of resiquimod to Balb/c mice induces lupus-like symptoms such as weight loss, splenomegaly, and glomerular immune complexes deposit such as IgG, IgM, and C3 in immunofluorescent staining. Histologically, glomerular mesangial cell proliferation and increased inflammatory cells in tubulointerstitial areas were noted in the H&E stain. Inhibiting VEGFR3 by oral SAR131672 treatment decreases glomerular and tubulointerstitial inflammation and LYVE-1 positive lymphatic vessels. The proinflammatory cytokines and chemokines such as ICAM-1, VCAM-1, MCP-1, CCL19, CCL21, CCR7, CXCL13, and BAFF mRNA levels were increased compared with the vehicle-treated group. Treatment SAR131672 decreases proinflammatory cytokines and chemokine.

**Conclusions:** VEGFR3 inhibition by SAR131672 decreases the resiquimod-induced lupus nephritis model by regulating inflammation and lymphangiogenesis.

**Funding:** Government Support - Non-U.S.

## FR-PO594

### CD11b Activation Suppresses suPAR and Inflammatory Signaling to Ameliorate Lupus Nephritis in Murine Models

Veronica Villanueva,<sup>1</sup> Xiaobo Li,<sup>1</sup> Samia Q. Khan,<sup>4</sup> Viviana Jimenez,<sup>1</sup> Mehmet M. Altintas,<sup>1</sup> Hafeez Faridi,<sup>2</sup> Jochen Reiser,<sup>1</sup> Timothy B. Niewold,<sup>3</sup> Vineet Gupta,<sup>1</sup> <sup>1</sup>Rush University Medical Center, Chicago, IL; <sup>2</sup>Chicago State University College of Pharmacy, Chicago, IL; <sup>3</sup>Hospital for Special Surgery Department of Medicine, New York, NY; <sup>4</sup>Editas Medicine, Cambridge, MA.

**Background:** Lupus nephritis (LN) is a debilitating comorbidity of systemic lupus erythematosus (SLE). CD11b, the alpha-chain of integrin dimer CD11b/CD18, is highly expressed on myeloid cells and plays a critical role in their adhesion, migration, and signaling. Single nucleotide polymorphisms (SNPs) in the *ITGAM* gene, encoding CD11b, are significantly associated with LN and reduce integrin function. Additionally, levels of pro-inflammatory mediators, such as suPAR, are increased in the LN sera. We previously described CD11b activation using novel agonist LA1 as a novel modulator of integrin function. Here we investigated how CD11b-dependent signaling modulates such pro-inflammatory molecules.

**Methods:** We used a combination of in vitro and in vivo assays. We utilized macrophage cell lines and primary macrophages. Cells were treated with TLR agonists, pathway inhibitors, and CD11b agonist leukadherin-1 (LA1). Changes in protein expression were assessed by western blot and proinflammatory cytokine levels were assessed by ELISA. For complementary in vivo studies, we utilized wild type, CD11b knockout (KO) and a CD11b knockin (KI) expressing a constitutively activating mutation. We induced SLE and LN in these models and studied the efficacy of genetic and pharmacologic CD11b activation as a therapeutic strategy.

**Results:** TLR-stimulation increased inflammation and suPAR levels in vitro. Importantly, CD11b activation significantly reduced proinflammatory cytokines and suPAR, suggesting a novel mechanism for controlling inflammation in glomerular diseases. Mechanistically, CD11b activation reduced TLR-dependent activation of NFκB and NLRP3/Caspase-1 pathways. In vivo, CD11b activation significantly reduced levels of suPAR and proteinuria.

**Conclusions:** We demonstrate that CD11b activation reduced myeloid cell generated suPAR in models of lupus and lupus nephritis. These studies provide further support for CD11b activation as a therapeutic strategy for autoimmune diseases.

**Funding:** NIDDK Support

## FR-PO595

### Klotho Deficiency Induces Regulatory T Cells in Mice With Lupus Nephritis

Tsuneo Takenaka,<sup>1</sup> Tsutomu Inoue,<sup>2</sup> Takashi Miyazaki,<sup>2</sup> Toshiaki Miyazaki,<sup>2</sup> Matsuhiko Hayashi,<sup>3</sup> <sup>1</sup>Kokusai Iryo Fukushi Daigaku Kohokai Group, Minato-ku, Japan; <sup>2</sup>Saitama Ika Daigaku, Iruma-gun, Japan; <sup>3</sup>Keio Gijuku Daigaku Igakubu Daigakuin Igaku Kenkyuka, Shinjuku-ku, Japan.

**Background:** Recent studies demonstrate that klotho deficiency participates in various chronic kidney disease. However, it has not been fully assessed the influence of klotho in autoimmune kidney diseases. Klotho is known to binds transforming growth factor β (TGFB) receptor to antagonize its pathophysiological actions including renal fibrosis. Alternatively, TGFB is required to generate and maintain regulatory T cells with inducing FOXP3, an important cell population for immunological tolerance.

**Methods:** NZBWF1 mice were used as a model of lupus nephritis. NZBWF1 mice were housed separately in metabolic cage, and divided into two groups (n=10 for each): one group was treated with daily subcutaneous injection of klotho protein (20 µg/kg/day), and the other received vehicle alone. Systolic blood pressure (SBP) was measured by tail-cuff method. Glomerular filtration rate (GFR) was assessed using FITC-inulin. Four weeks later, the animals were killed to harvest the spleen and kidneys for analyses.

**Results:** Klotho supplementation suppressed SBP, 8-epi-prostaglandin F2a excretion and renal angiotensin II levels (p<0.05 for all) without changes in albuminuria and GFR in NZBWF1 mice. Exogenous klotho protein supplementation increased serum klotho levels, urine klotho excretion, and endogenous renal expression of klotho in NZBWF1 mice (p<0.05 for all). Surprisingly, anti-double strand DNA antibody was

slightly elevated in klotho-treated NZBWF1 mice (p<0.05). Glomerular pathology and interstitial cell infiltration were similar between 2 groups. The spleen tended to be greater in klotho-treated group, but statistical significance was not attained. In consistent, CD8+FOXP3+ T cells were unaltered between 2 groups. However, klotho supplementation reduced CD4+FOXP3+ T cells in spleen of NZBWF1 mice (p<0.05).

**Conclusions:** The present data indicated that klotho protein supplementation suppressed renal renin-angiotensin system, ameliorating blood pressure and oxidative stress. Our results suggest that klotho supplementation worsened auto-antibody, possibly by inhibiting TGFB with resultant deterioration in regulatory T cells. The present findings implicate that while klotho may not suite for the management of autoimmune kidney diseases, klotho supplementation for dialysis patients could partly reverse the defect in cellular immunity and susceptibility to infections.

**Funding:** Government Support - Non-U.S.

## FR-PO596

### IgE Double-Stranded DNA Antibody-Containing Serum From Systemic Lupus Erythematosus Patients With Nephritis Alters the Inflammatory Profile of Basophils, Neutrophils, and Eosinophils

Senka Sencic,<sup>1,2</sup> Ladan Mansouri,<sup>3</sup> Anna Nopp,<sup>3</sup> Iva Gunnarsson,<sup>4,5</sup> Stefan H. Jacobson,<sup>1,2</sup> Joachim Lundahl,<sup>3,6</sup> <sup>1</sup>Karolinska Institutet, Department of Clinical Sciences, Stockholm, Sweden; <sup>2</sup>Division of Nephrology, Danderyd University Hospital, Stockholm, Sweden; <sup>3</sup>Karolinska Institutet, Department of Clinical Science and Education Södersjukhuset, Stockholm, Sweden; <sup>4</sup>Division of Rheumatology, Department of Medicine Solna, Karolinska Institutet, Stockholm, Sweden; <sup>5</sup>Rheumatology, Karolinska University Hospital, Stockholm, Sweden; <sup>6</sup>Karolinska University Hospital, Stockholm, Sweden.

**Background:** Lupus nephritis (LN) is characterized by primarily IgG autoantibodies against double stranded DNA (dsDNA). Recently, attention has been paid to the role of IgE dsDNA antibodies (auto IgE dsDNA) and the involvement of basophils and neutrophils in the pathogenesis. Therefore, we studied the prevalence of IgE dsDNA antibodies in patients with SLE and in healthy controls and the impact of sera on the phenotypic profile of basophils, neutrophils and eosinophils.

**Methods:** In this cross-sectional study 87 patients with SLE were included from the Dep. of Rheumatology, Karolinska University Hospital, Stockholm, Sweden. Disease activity was assessed using the British Isles Lupus Assessment Group (BILAG) index. Sixty-three patients with active nephritis (BILAG A-C) and twenty-four patients had previously active but currently quiescent renal SLE (BILAG D). Forty-one healthy controls were included. Serum levels of auto IgE dsDNA were measured with fluorescence enzyme immunoassay. In a subgroup including 10 patients (BILAG A) and 10 healthy controls, a whole blood method was applied to evaluate the impact of serum on granulocyte subpopulations. Cells were immune stained for markers related to degranulation, adhesion and immune modulation and analyzed by flow cytometry.

**Results:** Patients with active nephritis (BILAG A-C), but not patients with BILAG D, had a significant higher level of autoreactive IgEdsDNA compared to healthy individuals (p=0.030, p=1.0, respectively). Patient sera, but not healthy control sera, up-regulated CD69 on basophils (p=0.023) and patient sera down-regulated CD164 to a higher extent than sera from healthy controls (p=0.043). Patient sera, but not healthy control sera, down-regulated neutrophil expression of CD44 and CD15 (p=0.009 and p=0.029, respectively). CD88 on eosinophils was down-regulated by patient sera to a higher extent than sera from healthy individuals (p=0.001).

**Conclusions:** Patients with active LN, but not patients with currently quiescent renal SLE, have a significant higher level of circulating autoreactive IgEdsDNA than healthy controls and sera from these patients impact the phenotypic profile of basophils, neutrophils and eosinophils. These data indicate a role of these cells in the pathogenesis of LN and may impact treatment strategies.

## FR-PO597

### The Ion Transporter Na<sup>+</sup>-K<sup>+</sup>-ATPase Enables Pathological B Cell Survival in the Kidney Microenvironment of Lupus Nephritis

Irene Chernova, Joseph Craft. Yale University School of Medicine Department of Internal Medicine, New Haven, CT.

**Background:** The kidney is a unique microenvironment characterized by high sodium concentrations [Na<sup>+</sup>], yet susceptible to infiltration by lymphocytes in autoimmune diseases such as systemic lupus erythematosus. The mechanisms used by infiltrating lymphocytes to survive the high Na<sup>+</sup> environment of the kidney are not known.

**Methods:** We investigated how B cells from lupus-prone MRL<sup>lpr</sup> mice respond to Na<sup>+</sup> stress using cell culture and water deprivation experiments. The role of sodium potassium ATPase (Na<sup>+</sup>-K<sup>+</sup>-ATPase, NKA) in intrarenal B cell survival was investigated using small molecule studies, the generation of lupus-prone mice missing an NKA subunit and bone marrow (BM) chimera studies. Key findings regarding NKA expression were validated in additional murine lupus models and human lupus nephritis biopsies.

**Results:** We show that kidney infiltrating B cells in lupus adapt to elevated [Na<sup>+</sup>] and that NKA expression correlates with the ability of infiltrating cells to persist in the kidney. Compared to MRL<sup>lpr</sup> B cells, B cells from non-autoimmune mice had lower NKA expression, evidenced increased apoptosis when exposed to high [Na<sup>+</sup>] and did not take up residence in the kidney. NKA expression was induced by high [Na<sup>+</sup>] *in vitro* and was increased in kidney, as compared to spleen, B cells in several lupus-prone mouse strains. Pharmacological inhibition of NKA and genetic knockout of the NKA γ subunit, previously not known to be expressed in B cells, resulted in reduced kidney B cell infiltration and amelioration of proteinuria without affecting systemic B cells or

Key: TH - Thursday; FR - Friday; SA - Saturday; OR - Oral; PO - Poster; PUB - Publication Only

Underline represents presenting author.



other intrarenal immune cell populations. The  $\gamma$ NKA deletion effect was B cell-intrinsic as confirmed by BM chimera studies. B cells in biopsies of lupus nephritis patients also evidenced higher expression of NKA and its  $\gamma$  subunit than T cells.

**Conclusions:** We show that kidney-infiltrating B cells in lupus initiate a tissue adaptation program in response to  $\text{Na}^+$  stress and identify  $\text{Na}^+-\text{K}^+-\text{ATPase}$  as a potential organ-specific therapeutic target in lupus nephritis.

**Funding:** Other NIH Support - National Institutes of Health grant R37 AR40072, National Institutes of Health grant R01 AI152443, Private Foundation Support

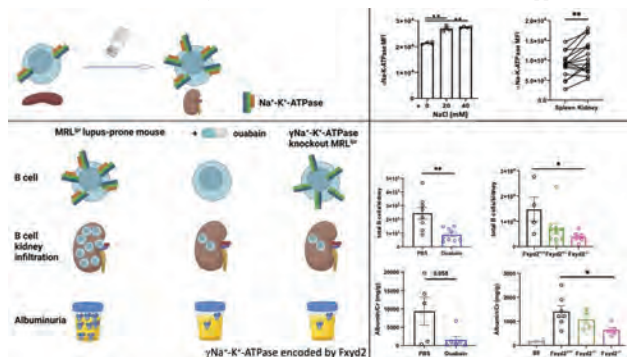

### FR-PO598

#### Inflammatory Dendritic Cell Drive Intra-Renal T Cells to Double-Negative T Cell in Lupus Nephritis

Latha Prabha Ganesan, Shane Bruckner, Noushin Saljoughian, James M. Turman, Murugesan Rajaram, Brad H. Rovin, Wael Jarjour, Samir V. Parikh. *The Ohio State University Wexner Medical Center, Columbus, OH.*

**Background:** The pathogenesis of lupus nephritis (LN) is incompletely understood stalling progress and resulting in suboptimal patient outcomes. We previously identified a novel inflammatory dendritic cells (infDC) accumulating in the peri-glomerular space adjacent to CD3+ T cells forming an immunologic synapse in human kidney biopsies at LN flare. Here, we aim to describe the T cell phenotype(s) in cross-talk with these infDC during LN flare. Characterizing these T cells will further our understanding of the major immune cells driving local inflammatory damage during LN.

**Methods:** Multi-color flow cytometry analysis was performed using antibodies against various immune cell markers, comparing proteinuria NZM 2410 mice and human-chimeric lupus mouse (Hu-lupus) mice with pre-proteinuric NZM (pre-prot-NZM) and humanized healthy (Hu-healthy) mice, respectively.

**Results:** FACS analysis of T cell phenotypes identified upregulation of double negative (CD4-CD8-) (DN) T cells, but not Th1 or Th17, in prot-NZM compared to pre-proteinuric. Also, the DN T cell frequencies paralleled infDC in the intra-renal space and the expression of both cell types correlated with proteinuria. There was no correlation between infDC and DN T cell kidney expression and proteinuria in lymph nodes or spleen. To relate our findings with human LN, we studied Hu-lupus mice and found significantly higher infDC and DN T cell expression compared to Hu-healthy mice. Importantly, the majority of CD3+ cells in the Hu-lupus mice were TCR $\alpha$ +TCR $\beta$ -CD4-CD8-PD1+, suggesting a subtype of DN T that are known to be self-reactive and proinflammatory.

**Conclusions:** In this study, we demonstrate an increase in a novel subtype of pro-inflammatory DN T adjacent to infDC in NZM model of LN and in a humanized mouse model of LN. These infDC, DN T cell subtype and their relationship have not been previously described. These findings enhance our understanding of the mechanisms that drive intra-renal inflammation during LN. Targeting infDC or their associated DN T cell phenotype may attenuate renal inflammation and improve outcomes in LN.

**Funding:** NIDDK Support, Other NIH Support - Multiple PI seed grant OSU

### FR-PO599

#### Atypical Chemokine Receptor 4 Is Expressed in Kidney Glomeruli and Mitigates the Severity of Experimental Glomerulonephritis

Katharina Artinger,<sup>1,2</sup> Elin Hub,<sup>2</sup> Alexander H. Kirsch,<sup>1</sup> Philipp Eller,<sup>3</sup> Alexander R. Rosenkranz,<sup>1</sup> Kathrin Eller,<sup>1</sup> Antal Rot.<sup>2</sup> <sup>1</sup>Clinical Division of Nephrology, Medical University of Graz, Graz, Austria; <sup>2</sup>Centre for Microvascular Research, William Harvey Research Institute, Barts and The London School of Medicine and Dentistry, Queen Mary University of London, London, United Kingdom; <sup>3</sup>Intensive Care Unit, Department of Internal Medicine, Medical University of Graz, Graz, Austria.

**Background:** Besides ligating their cognate GPCRs, chemokines importantly interact with atypical chemokine receptors (ACKRs) that are characterised by mostly non-overlapping microanatomical expression and distinctive ligand specificities. ACKR4 is expressed in primary and secondary lymphoid organs, where it is involved in regulating cell migratory steps required for optimal immune responses and furthermore by a hugely varying types of cells in multiple parenchymal organs with hypothetical scenarios suggesting how ACKR4 scavenging its cognate chemokines might affect the pathophysiology of these organs. Here we investigated the expression of ACKR4 in murine kidney and assessed its contribution to nephrotoxic serum nephritis (NTSN), an experimental murine model of immune complex glomerulonephritis.

**Methods:** Expression of renal ACKR4 was evaluated in healthy ACKR4-eGFP reporter mice as well as after the induction of NTSN. To investigate the contribution of ACKR4 to the NTSN the ACKR4-deficient mice and WT controls were subjected to an anti-basal membrane immunization protocol and the parameters of immunopathogenesis and the ensuing kidney disease were evaluated at 7 and 14 days after the immunization.

**Results:** We found that ACKR4 is expressed in the kidney exclusively in the glomeruli by a discrete subset of parietal cells localising adjacently to the vascular glomerular pole. In mice with NTSN the expression of ACKR4 was diminished and ACKR4+ cells were even missing from some glomeruli, especially in those corresponding with the increased abundance of alpha-SMA, a marker of renal fibrosis. The ACKR4-deficient mice showed a delayed antibody response following immunisation. However, despite this, their NTSN parameters, including albuminuria, PAS-score and crescent formation were significantly increased as compared to the WT controls.

**Conclusions:** ACKR4 is expressed in the kidney by a small subpopulation of glomerular cells and it is decreased during NTSN. Reduced antibody titers following immunisation of ACKR4-deficient mice are in line with its contribution to the effective cell migratory steps within the immune organs. Conversely, the more severe appearance of NTSN in these mice, suggests that ACKR4 in the kidney plays a regulatory role limiting the development of this experimental disease.

### FR-PO600

#### Immune Checkpoint Molecule BTLA Attenuates Experimental Glomerulonephritis by Directly Inhibiting T Effector Cells and Inducing Treg Differentiation

Paul Diefenhardt,<sup>1,2</sup> Marie Braumann,<sup>1,2</sup> Bastian Trinsch,<sup>1,2</sup> Thomas Schömgig,<sup>1,2</sup> Claudio Sierra Gonzalez,<sup>1,2</sup> Bernhard Schermer,<sup>1,2</sup> Thomas Benzing,<sup>1,2</sup> Paul T. Brinkkoetter,<sup>1,2</sup> Sebastian Braehler.<sup>1,2</sup> Braehler Lab <sup>1</sup>Uniklinik Köln, Köln, Germany; <sup>2</sup>Exzellenzcluster CECAD in der Universität zu Köln, Köln, Germany.

**Background:** Excessive, dysregulated inflammation mediated by T-cells in the kidney can lead to acute, crescentic Glomerulonephritis (GN). After T-cell receptor binding to a specific antigen, secondary and tertiary signals are required for successful T cell activation and differentiation. Accordingly, interference with these additional signals might represent a viable treatment option for GN. One of these secondary signal molecules, B and T Lymphocyte Attenuator (BTLA), was shown to mediate anti-inflammatory effects in other T-cell mediated disease models. Its role during glomerular inflammation, however, remains unclear.

**Methods:** Nephrotoxic nephritis (NTN) was induced in wild type (wt) and BTLA knock out (BTLA-KO) mice. For treatment evaluation, an agonistic anti-BTLA antibody was administered i.v. into wt mice after NTN induction. Functional readouts included albuminuria and BUN concentration. Histological damage was assessed 10 days after NTN induction in all groups using PAS stained tissue slides. Extensive immunophenotyping of renal and splenic immune cells was performed using IHC and flow cytometry. Additional *in vitro* assays revealed the impact of BTLA deficiency on the function of dendritic cells and T-cell subsets.

**Results:** Knockout of BTLA results in aggravation of NTN driven by an increase in pro-inflammatory Th1 cells. Systemically, nephritic BTLA-KO mice show a significant reduction of T regulatory cells. Activation of BTLA through administration of an agonistic anti-BTLA-antibody attenuate NTN by reducing the frequencies of Th1 and Th17 cells in the nephritic kidney and increasing systemic Treg numbers. *In vitro* Treg suppression assays reveal an evasion of Treg mediated suppression by BTLA deficient T effector cells. Suppressive capacity of BTLA deficient Tregs, on the other hand, is unchanged. Likewise, no impairment of T-cell activation by BTLA deficient DCs was detected.

**Conclusions:** BTLA attenuates inflammation in experimental GN through two mechanisms: 1) via Treg mediated suppression of BTLA+ T effector cells and 2) through induction of anti-inflammatory T regulatory cells. Activation of BTLA signaling by agonistic antibodies represents an effective treatment strategy in NTN.

### FR-PO601

#### Urine Complement Activation Products in Lupus Nephritis

Nicholas Li,<sup>1</sup> Daniel J. Birmingham,<sup>2</sup> Laura Biederman,<sup>2</sup> Tibor Nadasdy,<sup>2</sup> Brad H. Rovin.<sup>2</sup> <sup>1</sup>University of Calgary, Calgary, AB, Canada; <sup>2</sup>The Ohio State University, Columbus, OH.

**Background:** Complement activation plays a critical role in the development of kidney injury during lupus nephritis (LN). Clinical trials targeting the complement pathway are now underway in LN. It is therefore important to understand the relationship between intra-renal complement activation and kidney histology in LN, and whether complement activation products (CAPs) can serve as biomarkers to guide complement-directed therapies. In this investigation, urine CAPs levels were measured, and associations with kidney injury were determined.

**Methods:** A cohort of 149 patients had urine and blood collected at the time of kidney biopsy for suspected LN. The CAPs C5a, C5b-9, and factor Ba were measured in the urine by ELISA. Biopsies were examined by routine histology, and the NIH activity and chronicity indexes (AICr) were calculated by two nephrologists. CAPs levels were correlated with clinical and histologic data using the spearman correlation r.

**Results:** The results are summarized in the Table. The highest levels of CAPs were found in patients with proliferative or proliferative plus membranous LN, with lower levels in pure class II and V. All three urine CAPs correlated with AI, but the strongest correlation was between C5b-9 and AI. Only Ba and C5a correlated with CI, but this correlation was, at best, modest. All CAPs correlated with proteinuria, while only Ba and C5a correlated with serum creatinine.

Key: TH - Thursday; FR - Friday; SA - Saturday; OR - Oral; PO - Poster; PUB - Publication Only

Underline represents presenting author.

**Conclusions:** Urine C5b-9 was the best measure of histologic activity in LN. Given the size of the C5b-9 complex, it is unlikely to be filtered, even by glomeruli with a damaged glomerular permeability barrier. Urine C5b-9 therefore only reflects intra-renal complement activity. C5a and Ba associated modestly with active lesions, as well as kidney damage, likely accounting for their association with serum creatinine. We suggest levels of urine C5b-9 could be used to follow the success of anti-complement therapies in mitigating intra-renal complement activation in LN.

**Funding:** Private Foundation Support

Parameter	Spearman r			P Value			95% Confidence Interval		
	Ba	C5a	C5b-9	Ba	C5a	C5b-9	Ba	C5a	C5b-9
Activity Index	0.31	0.25	0.37	0.0004	0.005	<0.0001	0.14,0.47	0.07,0.41	0.20,0.52
•Endocapillary Hypercell	0.25	0.23	0.36	0.005	<0.01	<0.0001	0.07,0.41	0.05,0.39	0.19,0.51
•Hyaline Deposits	0.19	0.23	0.23	0.036	0.018	0.0094	0.008,0.36	0.031,0.38	0.05,0.39
•IFMN/Karvorrihexis	0.18	0.18	0.32	0.044	0.044	0.0003	0.0005,0.35	0.0004,0.35	0.15,0.47
•Necrosis	0.19		0.21	0.027	0.42	0.017	0.018,0.37		0.034,0.38
•Crescents	0.21		0.21	0.019	0.06	0.004	0.03,0.38		0.08,0.42
•Interstitial Inflammation	0.35	0.26	0.27	<0.0001	0.003	0.002	0.18,0.50	0.08,0.42	0.097,0.43
Chronicity Index	0.29	0.19		0.0005	0.022	0.22	0.13,0.44	0.02,0.35	
•Glomerulosclerosis				0.23	0.36	0.73			
•Fibrous Crescents				0.98	0.37	0.83			
•Tubular Atrophy	0.31	0.24		0.0002	0.031	0.17	0.15,0.45	0.079,0.39	
•Interstitial Fibrosis	0.31	0.24		0.0002	0.031	0.16	0.15,0.45	0.079,0.39	
Proteinuria	0.41	0.54	0.42	<0.0001	<0.0001	<0.0001	0.25,0.54	0.42,0.66	0.27,0.55
Serum Creatinine	0.51	0.31		<0.0001	0.0001	0.61	0.38,0.63	0.15,0.46	
Complement C3	-0.31			0.0002	0.06	0.16	-0.46,-0.15		
Complement C4				0.09	0.18	0.25			
Urine Ba		0.71	0.46		<0.0001			0.62,0.78	0.31,0.58
Urine C5a			0.68			<0.0001			0.59,0.76

**FR-PO602**

**Integration of Exostosin 1 and 2 Into a Clinical Care Pathway for Membranous Nephropathy**

Jennifer A. Brown, Hyunjae Chung, Graciela Andonegui, Hallgrimur Benediktsson, Daniel A. Muruve, Justin Chun. *University of Calgary Cumming School of Medicine, Calgary, AB, Canada.*

**Background:** Membranous lupus nephritis (MLN), is a renal manifestation of systemic lupus erythematosus. The identification of biomarkers presents an avenue to better explain the pathogenesis, diagnosis, and prognosis of many heterogenous glomerulonephritides. Exostosin 1 and 2 (EXT1 and 2) are proteins that have recently been found in secondary membranous nephropathies including MLN. Existing literature suggests that EXT-associated membranous nephropathy represents a distinct clinical phenotype, with EXT-negative disease leading to higher risk of renal failure, but exactly how these groups differ has not yet been well described.

**Methods:** We evaluated a cohort of 28 patients reported as isolated MLN from the Biobank for the Molecular Classification of Kidney Disease in Calgary, Alberta with kidney biopsies performed between 2010 and 2020. Frozen kidney biopsies preserved in OCT (optimal cutting temperature) compound were subjected to immunohistochemistry to label EXT1 and 2. We then reviewed for correlation to renal function (serum creatinine) and proteinuria (urine protein to creatinine ratio) prior to biopsy, and up until 36 months post-biopsy.

**Results:** We detected both EXT1 and 2 in our cohort. Notably, we identified three distinct staining patterns. Negative/negative, positive/positive, and negative/positive, with respect to EXT1/EXT2 status. The pattern of negative/positive appears to be unique in comparison to previous studies with EXT1 and 2, which have shown uniform results between the two related proteins. Initial analyses show a trend towards resolving proteinuria for the EXT2 positive cohort.

**Conclusions:** Similar to prior reports using formalin fixed, paraffin embedded tissue, we demonstrate that frozen section staining can reliably detect EXT1/EXT2. Distinguishing EXT1/EXT2-positive patients may better predict outcomes with the potential to integrate into patient care. The significance of differential status between EXT 1 and 2 is yet to be determined but represents a distinctive finding that may assist in prognostication for this cohort.

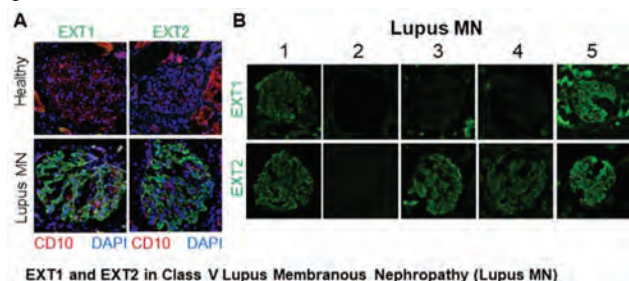

**FR-PO603**

**Pure Membranous Lupus Nephritis (LN) and Renal Outcomes**

Catherine Larned, Sarah M. Gordon, Stephen W. Olson, Robert Nee, Gillian Costa. *Walter Reed National Military Medical Center, Bethesda, MD.*

**Background:** Previous LN studies are mostly comprised of patients with proliferative LN (PLN) with only a small subgroup of membranous LN (MLN). Therefore, MLN is less well characterized. We sought to describe clinical characteristics, treatment, and renal outcomes in the largest and most diverse MLN cohort with the longest follow-up to date.

**Methods:** We used a Military Health System (MHS) ICD9/ICD10 code query to identify and an electronic record review to confirm 105 biopsy-proven adult MLN patients without concomitant PLN. We collected demographic, clinical, treatment and outcome data for each MLN case.

**Results:** Median follow-up was 93 months (7.75 years). The cohort was predominantly black (61%), female (74%), and young (median age 35 years). Median serum creatinine (Scr), estimated glomerular filtration rate (eGFR), urine protein/Cr ratio, and serum albumin at diagnosis were 0.80 mg/dL, 98 ml/min/1.73m<sup>2</sup>, 3.28 gm and 2.8 g/dL, respectively. Proteinuria at diagnosis was not associated with doubling of Scr (3.4 vs. 3.3gm, p=0.81) but reduction of proteinuria to <1gm was associated with lower likelihood of doubling Scr (36.4 vs. 83.0% p=0.001). Complete remission (CR), reduction in proteinuria to <0.5gm and <15% reduction in eGFR within one year, was also associated with a lower likelihood of doubling Scr (8.3 vs. 55%, p=0.003) which remained significant after adjustment for age, race, and baseline eGFR [OR: 0.09 (CI: 0.01-0.80)], p=0.03]. Partial remission (PR,) at least 50% reduction in proteinuria to <3gm at one year, was not significantly associated with a lower likelihood of doubling Scr (54.6 vs. 66.7%, p=0.48). A majority of patients were on a renin-angiotensin system inhibitor (91.4%); 78.1% were treated with immunosuppressive therapy (7.8% treated with steroid only).

**Conclusions:** In this large MLN cohort with long follow up, reduction of proteinuria to <1gm or achievement of CR within one year of diagnosis was significantly associated with preservation of renal function, but partial remission alone was not. Despite overall superior renal prognosis of MLN compared to PLN, our findings suggest that providers should aim to achieve CR to preserve renal function. *Disclaimer: The views expressed in this Abstract are those of the authors and do not reflect the official policy of the Department of the Army/Navy/Air Force, the Department of Defense, or the United States government.*

**FR-PO604**

**Effect of Induction Therapy on Glomerular Morphometry in Lupus Nephritis**

Warangkana Pichaiwong, Rajavithi Hospital, Bangkok, Thailand.

**Background:** Based on a series of randomized controlled trials (RCTs), the data have demonstrated an efficacy treatment response defined by clinical outcomes between intravenous cyclophosphamide (IVCYC) and mycophenolate mofetil (MMF) for induction therapy of lupus nephritis (LN). Only few studies have systematically examined glomerular morphometric responses to induction therapy. This study was aimed to assess the effect of induction therapy in the aspect of glomerular morphometry.

**Methods:** We have analyzed renal biopsies obtained from 20 patients with proliferative and membranous LN patients who underwent protocol renal biopsies after induction therapy. The glomerular morphometry was demonstrated by percentage of mesangial matrix expansion which was quantitated by silver methenamine and podocyte density was counted.

**Results:** Of the 20 patients included, the mean age was 32.20±13.19 years, 85% was female. The mean arterial blood pressure was 160.11±7.15 mm.Hg. The mean baseline estimation for glomerular filtration rate was 83.11±35.03 ml/min/1.73m<sup>2</sup> and the median urine albumin to creatinine ratio was 2.22 (1.60-3.93). The Median range of C3 concentration was 0.65 (0.54-0.85) g/L. The mean of total numbers of glomeruli obtained was 25.07±8.86 glomeruli/biopsy, disease activity and chronicity indices were 5.8/24 and 2.3/12, respectively. After completion of the induction therapy, glomerular tuft area occupied by silver-stained matrix was decreased (pre-induction 8.60±1.77% vs. post-induction 5.91±2.23%, p=0.954). There was an exhibited increase in podocyte number (pre-induction 238.64±117.33 vs. post-induction 268.00±121.52, p=0.388), podocyte density (pre-induction 74.45±25.87/x106 um<sup>3</sup> vs. post-induction 88.25±23.43/x106 um<sup>3</sup>, p=0.590) and decreased glomerular volume/podocyte (pre-induction 15,386.73±6,572.53 um<sup>3</sup> vs. post-induction 12,119.50±4,020.53 um<sup>3</sup>, p=0.575).

**Conclusions:** This study shows that there is a trend to improve glomerular morphometry particularly podocyte density following induction therapy with either IVCYC or MMF in patients with biopsy-proven proliferative LN. However, more sample sizes are needed to adequately assess these outcomes.

**Funding:** Government Support - Non-U.S.

**FR-PO605**

**Clinico-Pathological Associations of Serum CD44 Level in Patients With Lupus Nephritis**

Yawen Gao, Susan Yung, Tak Mao D. Chan. *Department of Medicine, School of Clinical Medicine, the University of Hong Kong, Hong Kong SAR, Hong Kong.*

**Background:** Conventional serological markers do not always correlate with clinical activity in lupus nephritis (LN). CD44 is a transmembrane glycoprotein that is widely expressed in immune and non-immune cells, and has been implicated in tissue inflammation and fibrosis. CD44 also serves as a cell receptor for hyaluronan (HA), a glycosaminoglycan that contributes to inflammatory and fibrotic processes. We previously reported that serum HA level correlated with clinical and serological parameters in LN. This study investigated clinico-pathological associations of circulating CD44 level.

**Methods:** Serial serum samples from patients with biopsy-proven Class III/IV LN were collected at intervals of 3-4 months over 3 years. Sera from sex- and age-matched patients with non-renal SLE or non-lupus chronic kidney disease (CKD) or healthy subjects were included as Controls. Serum CD44 was measured by ELISA.

**Results:** Six hundred and sixty-two sera from 41 LN patients (31 female and 10 male, age 38.78±12.02 years) were included. Serum CD44 level was significantly higher

in active LN compared to remission, non-renal SLE, CKD, or healthy subjects ( $P < 0.0001$ , for all). Serum CD44 level correlated with SLEDAI-2K and renal SLEDAI-2K scores, anti-dsDNA antibody titre, proteinuria, and serum HA level, and inversely correlated with eGFR and C3 level ( $P < 0.0001$ , for all). All episodes of LN flare were accompanied by increased serum CD44 level, which decreased after treatment with immunosuppression. A temporal relationship was observed between CD44 level and SLEDAI-2K and renal SLEDAI-2K scores, anti-dsDNA antibody titre, C3 level, and proteinuria. ROC analysis showed that serum CD44 level distinguished active LN from healthy subjects (sensitivity 98.31%, specificity 100.00%), from LN in remission (sensitivity 86.44%, specificity 98.31%), from non-renal SLE (sensitivity 98.31%, specificity 98.00%), and from non-lupus CKD (sensitivity 98.31%, specificity 100.00%) ( $P < 0.0001$ , for all).

**Conclusions:** Active LN is associated with increased serum CD44 level. Further studies are warranted to investigate whether CD44 may serve as a biomarker in the diagnosis and monitoring of LN activity.

**Funding:** Government Support - Non-U.S.

## FR-PO606

### Comorbidities and Poor Long-Term Outcomes of Lupus Nephritis in Adult Patients in the United States

Isabelle Ayoub,<sup>1</sup> Janice Ma,<sup>2</sup> Konrad Pisarczyk,<sup>2</sup> Richard Leff,<sup>3</sup> Eunmi Park,<sup>3</sup> Li Long.<sup>3</sup> <sup>1</sup>The Ohio State University Wexner Medical Center, Columbus, OH; <sup>2</sup>Maple Health Group, New York, NY; <sup>3</sup>Kezar Life Sciences Inc, South San Francisco, CA.

**Background:** Lupus nephritis (LN) is a serious complication of systemic lupus erythematosus (SLE) associated with considerable morbidities, including but not limited to an increased risk of end-stage kidney disease (ESKD). There is a need to better understand clinical burden specific to LN. This study aimed to summarize evidence on long-term disease outcomes and comorbidities in adults with LN in the United States (US).

**Methods:** A comprehensive targeted literature review was conducted in MEDLINE and Embase to identify studies in patients with adult and juvenile onset of LN, published in English between March 2012 and 2022. The search included conference abstracts indexed in Embase since 2019.

**Results:** Of 4,216 records identified in the medical databases, 20 reported on long-term outcomes of disease and burden of comorbidities in adults with LN. The majority of studies were conducted on longitudinal cohorts and nationwide claims databases. Only 26% of LN adults achieved complete remission (CR) at 1 year and 40-59% achieved CR at 2 years, suggesting limited response to existing therapies. Those achieving CR after 2 years had a significantly lower mortality and ESKD risk compared with those who did not. LN adults suffered from hypertension (35-78%), cachexia (62%), serious infections requiring hospitalization (58%), and mental health disorders (29%). LN adults were more likely to experience cardiovascular (CVD) comorbidities compared to non-SLE, fractures compared to both non-SLE and SLE-only patients, and had 3-times higher odds of hospitalization due to posterior reversible encephalopathy syndrome compared to SLE-only adults. Causes of death were often CVD and serious infections requiring hospitalization. Deaths occurred in 20% of patients with serious infections requiring hospitalization with 49% of those occurring during hospitalization or up to 30 days after discharge. In LN-ESKD adults, 40% of patients died during follow-up, with CVD-related deaths as the most common (>40%) followed by infection-related deaths (14%).

**Conclusions:** LN is associated with poor long-term outcomes including increased risk of comorbidities compared to SLE only. Patients are often hospitalized or die due to comorbid CVDs and infections. There is a high unmet need for a therapy that can improve the long-term disease outcomes in LN.

**Funding:** Commercial Support - Kezar Life Sciences, Inc.

## FR-PO607

### Poor Health-Related Quality of Life in Adult Patients With Lupus Nephritis

Yoe Kie Onno Teng,<sup>1</sup> Janice Ma,<sup>2</sup> Konrad Pisarczyk,<sup>2</sup> Richard Leff,<sup>3</sup> Eunmi Park,<sup>3</sup> Li Long.<sup>3</sup> <sup>1</sup>Leids Universitair Medisch Centrum, Leiden, Netherlands; <sup>2</sup>Maple Health Group, New York, NY; <sup>3</sup>Kezar Life Sciences Inc, South San Francisco, CA.

**Background:** Lupus nephritis (LN) is a serious complication of systemic lupus erythematosus (SLE) associated with considerable morbidity that has a devastating impact on a patient's life. However, little is known about true impact of LN on a patient's health-related quality of life (HRQoL) in an autoimmune disease that can affect several organ systems. The objective of this study was to summarize the evidence on the humanistic burden of LN in adult SLE patients.

**Methods:** A comprehensive targeted literature review was conducted in MEDLINE and Embase to identify studies in patients with adult and juvenile onset of LN, published in English between March 2012 and 2022. The search included conference abstracts indexed in Embase since 2019.

**Results:** Of 4,126 records identified in the medical databases, 9 reported on the HRQoL in adult patients with LN. The studies were conducted in the US (n=5), multiple countries worldwide (n=2), Latin America (n=1) and Europe (n=1). Active LN was significantly associated with poor scores in almost all domains of SF-36 suggesting a deterioration in multiple aspects of life, especially in physical and emotional functioning. The humanistic burden of active LN was more pronounced compared to SLE manifestations in other organ systems. Patients with active LN had significantly worse HRQoL measured by lupus-specific questionnaires such as LupusPRO and LupusQoL,

compared to subjects with inactive LN or those with SLE only, with the most profound impact of active renal disease on procreation, fatigue, physical and emotional health. Three studies examined the perspectives of LN patients on facilitators and satisfaction of disease control and treatment. Physician- and patient-reported dissatisfaction were reported by 33% of nephrologists and 25% of patients and were associated with LN severity and various signs and symptoms of disease. The key patient-relevant aspects of LN treatment were hope for being normal/healthy, improved quality of life, and effective patient-physician communication regarding benefits and harms.

**Conclusions:** LN significantly affects HRQoL across multiple domains of life such as physical and emotional functioning that are particularly affected during periods of active disease. Despite various therapies available, 25% of patients are dissatisfied with their options, indicating a high residual unmet need.

**Funding:** Commercial Support - Kezar Life Sciences, Inc.

## FR-PO608

### Substantial Economic Burden Associated With the Management of Lupus Nephritis in Adult Patients in the United States

Brad H. Rovin,<sup>1</sup> Janice Ma,<sup>2</sup> Konrad Pisarczyk,<sup>2</sup> Richard Leff,<sup>3</sup> Eunmi Park,<sup>3</sup> Li Long.<sup>3</sup> <sup>1</sup>The Ohio State University, Columbus, OH; <sup>2</sup>Maple Health Group, New York, NY; <sup>3</sup>Kezar Life Sciences Inc, South San Francisco, CA.

**Background:** Lupus nephritis (LN) is a serious complication of systemic lupus erythematosus (SLE) associated with considerable morbidity, including an increased risk of end-stage kidney diseases (ESKD) that may impose a substantial economic burden on the healthcare system. Recently, a systematic literature review showed increased costs and healthcare resource utilization (HCU) associated with LN globally but there is a need to better understand the economic impact of the disease in the United States (US). This study aimed to summarize the evidence on costs and HCU related to the management of LN in adult patients in the US.

**Methods:** A comprehensive targeted literature review was conducted in MEDLINE and Embase to identify studies in patients with adult and juvenile onset of LN, published in English between March 2012 and 2022. The search included conference abstracts indexed in Embase since 2019.

**Results:** Of 4,216 records identified in the medical databases, 8 US studies reported on costs and HCU in adults with LN. The majority of studies were conducted based on nationwide claims and inpatient databases. On average, patients with LN had significantly higher utilization of outpatient visits related to spectrum of care (e.g., primary care, neurology, nephrology, dermatology) and hospitalizations per year with approximately 6-day longer lengths of stay, compared to matched subjects without SLE or LN. The mean annual healthcare cost ranged from \$33,500 to \$51,000, being the highest in the first year following LN diagnosis (\$44,205), and 5-7-times higher than in matched non-SLE/LN controls ( $p < 0.05$ ). The main cost drivers were related to inpatient care followed by ambulatory and pharmacy costs. LN-related ESKD and active LN led to excess costs compared to periods of low disease activity, with mean monthly healthcare cost of \$22,000 and \$6,600 vs \$1,100, respectively.

**Conclusions:** LN is associated with significant economic burden on the US healthcare system. The total cost of care is notably high in patients suffering active disease and those developing ESKD, which confirms the urgency of need for effective therapies to treat LN and prevent its complications.

**Funding:** Commercial Support - Kezar Life Sciences, Inc.

## FR-PO609

### Old Friend in Camouflage: Polyarteritis Nodosa With Thrombotic Microangiopathy

Waleed A. ElSheikh Mohammed, Roberto Pisoni, Ruth C. Campbell. *Medical University of South Carolina, Charleston, SC.*

**Introduction:** PAN with TMA and AKI is an uncommon presentation rarely described in the literature. We report two cases below.

**Case Description:** 1) 33 male with HTN presented to ER with abdominal pain, HTN urgency and severe anemia 6 g/dl. Abdominal CT revealed a liver hematoma requiring embolization. He represented in 2 weeks with HTN emergency, AKI and new thrombocytopenia 60 K/uL. U/A no RBC,UPCR 0.5 g/L. Schistocytes present on peripheral smear, LDH elevated and haptoglobin low. PLEX was urgently started with steroids. Shiga toxin, anti-factor H Ab, ADAMTS13, HBsAg and HCV Ab were normal/negative. ANA 1: 1280 + anti SSA but C3, C4, ANCA, cryoglobulins and anti-GBM all negative. Lymph node biopsy unremarkable. Kidney biopsy showed TMA with negative IF and no immune complex deposits. Colonoscopy showed multifocal areas of ischemia concerning for vasculitis. A diagnosis of PAN was made. Cyclophosphamide was added. Hematological markers improved but kidney function did not. He remained HD dependent. 2) 57 female presented with anasarca, Raynaud's, HTN, anemia and AKI peak creatinine 2mg/dl with UPCR 0.3 g/g and albumin 3.7 g/L. Liver biopsy showed nodular regenerative hyperplasia. Viral hepatitis negative. Immunology + ANA 1:160, otherwise negative. Kidney biopsy revealed TMA. Patient was placed on ARB and underwent salpingo-oophorectomy for potential Meigs syndrome with no improvement in ascites, further complicated by spontaneous diverticular rupture. Conventional angiogram assessing for PAN was positive. Induction with steroids and cyclophosphamide followed with good clinical response. Creatinine at last follow up 1.2mg/dl.

**Discussion:** PAN first described in 1866 by Kussmaul and Maier has evolved from encompassing most vasculitides to a subset characterized by necrotizing inflammation of medium arteries. Its incidence and prevalence have declined due to improved hepatitis B prevention and vaccination. PAN may occur in the absence of hepatitis B. Kidneys are involved in 26-43% of cases and new or worsening HTN is a feature of renal involvement.

Key: TH - Thursday; FR - Friday; SA - Saturday; OR - Oral; PO - Poster; PUB - Publication Only

Underline represents presenting author.

Malignant HTN with TMA as presenting feature is reported only in a French case. Recognizing PAN as potential cause of TMA can be lifesaving as untreated, its 5-year survival is only 13%. CT angiography may be diagnostic but findings can be subtle. Renal failure requiring permanent dialysis is not common in PAN and impacts prognosis.

#### FR-PO610

##### A Case of IgA-Dominant Infection-Related Glomerulonephritis Caused by *Streptococcus mutans* Mimicking ANCA-Associated Vasculitis

Ana I. Stark, Swetha Rani Kanduri, Paula A. Medina, Ivo Lukitsch, Juan Carlos Q. Velez. Ochsner Nephrology Ochsner Medical Center, New Orleans, LA.

**Introduction:** Infection-related glomerulonephritis (IRGN) can manifest features similar to anti-neutrophilic cytoplasmic antibody (ANCA) associated vasculitis (AAV) in 10-30% of cases, posing a diagnostic challenge. IgA-dominant IRGN is typically observed in the setting of staphylococcal infections. Herein, we report an unusual case of IgA-dominant IRGN with ANCA positivity mimicking AAV in the setting of *Streptococcus mutans* endocarditis.

**Case Description:** A 73-year-old woman presented to clinic with a 6-month history of fatigue and a skin rash. Medical history was pertinent for chronic heart failure with preserved ejection fraction and mitral regurgitation. Laboratory data revealed elevated serum creatinine of 1.2 mg/dL (baseline 0.8 mg/dL), positive anti-proteinase-3 (PR3) antibodies (4.2 U) and low hemoglobin (8.4 g/dL). Patient was subsequently admitted to the hospital for further work up. Upon arrival, physical examination revealed a purpuric rash in lower extremities. Additional laboratory data showed positive antinuclear antibody (ANA) (1:640), low haptoglobin (<10), low C3 (30 mg/dL), low C4 (< 3 mg/dL), negative rheumatoid factor and cryoglobulins. Urinalysis revealed hematuria and leukocyturia. AAV was suspected and infectious workup was ordered in an attempt to clear her to initiate immunosuppression. Blood cultures were positive for *Streptococcus mutans* and transthoracic echocardiography demonstrated multiple vegetations along the anterior mitral leaflet suggesting infective endocarditis. Kidney biopsy was performed and a suboptimal specimen revealed mesangial and subendothelial IgA-dominant immune complex deposits, confirming a case of IgA-dominant IRGN. Following antibiotic initiation, kidney function recovered to a serum creatinine of 1 mg/dL and patient was discharged home. However, shortly after discharge, the patient was readmitted with bifrontal septic emboli, complicated by subarachnoid hemorrhage, and the patient expired.

**Discussion:** IRGN presenting with features of AAV is diagnostically challenging and warrants careful clinical evaluation and kidney biopsy interpretation. *Streptococcus mutans* should be considered as a causative organism for IgA-dominant IRGN along with the more commonly reported *Staphylococcus sp.*

#### FR-PO611

##### Gross Hematuria: Initial Atypical Manifestation of Anti-Glomerular Basement Membrane Disease

Juan P. Gomez Villarreal, Nayeli N. López Villa, Rita B. Aguilar, Elisa M. Guerrero Gonzalez, Lilia M. Rizo Topete, Giovanna Y. Arteaga Muller. Hospital Universitario Dr Jose Eleuterio Gonzalez, Monterrey, Mexico.

**Introduction:** Anti-glomerular basement membrane disease or Goodpasture syndrome is a rare disease that affects < 2/1,000,000 people annually. Goodpasture syndrome is a small vessel vasculitis that targets the  $\alpha 3$  chain of the type 4 collagen of the glomerular and alveolar membranes. Anti-GMB disease has a high morbidity with almost all patient leading to kidney failure. Our case presents a atypical symptom of Anti-GMB disease.

**Case Description:** A 31-year-old man with history of Hodgkin lymphoma in 2011 was admitted to the ER for hematuria, during his evaluation he mentions that has been with this symptom for one month without pain or tenesmus, he refers that 3 days ago start with hemoptoic coughing, during his assessment his blood pressure was 170/90 mmHg and the only relevant on the physical exploration was decreased breath sounds at lung bases. Admission: Hgb 10.50 g/dL WBC 11.10 K/uL Plt 221 K/uL SCr 11.3mg/dL, BUN 62mg/dL, Urinalysis had 612 mg/dL of proteinuria, hematuria 200 hem/uL, erythrocyturia > 100/ field, serologic anti-GMB 105.37 UR/mL. was positive. Treatment started with methylprednisolone for 3 days then switched to prednisone, cyclophosphamide and plasma exchange with albumin started. Hemodialysis started as support therapy and renal biopsy was performed.

**Discussion:** Anti-GMB disease is known for his aggressive course treatment is very hard to achieve in low income country's due de lack of equipment for plasma exchange, our patient was treated as mention above but the engaging part of the case is that we executed plasma exchange treatment using albumin without the frozen plasma at the end because the unavailability in our center; the literature mentions that patients with alveolar hemorrhage should use frozen plasma during de plasma exchange or if you use albumin give frozen plasma at the end of the exchange, even though we did the plasma exchange with albumin the patient had a good clinical response.

#### FR-PO612

##### Isolated Anti-GBM Disease and COVID-19 Vaccination

Atlee Baker, Maheen Khan, Athip Vatanapradith, Kenneth D. Abreo, Mary A. Buffington, Phani P. Moriseti. LSU Health Shreveport, Shreveport, LA.

**Introduction:** IgA nephropathy is the most reported glomerulonephritis post-COVID vaccination. Other reported cases include atypical anti-GBM nephritis, among others. Treatment consists of immunosuppressants and plasmapheresis with renal replacement therapy. Renal outcomes have varied. A case is presented of isolated anti-GBM nephritis in a patient whose renal injury occurred weeks after receiving a booster dose of COVID vaccine.

**Case Description:** A 59-year-old male with recent history of ureteral stones with stent placement, travel history in the last 6 months and use of doxycycline for suspected Lyme's disease in the last 3 months presented to the emergency department for decreased urine output, fevers, and arthralgias. He also received a Pfizer COVID vaccine booster 6 weeks ago. His symptoms had worsened in the last 2 weeks. On initial evaluation, he was noted to have stage 3 acute kidney injury (AKI) with creatinine 5.3 mg/dL. Although he had findings of nephrolithiasis, no ureteral obstruction or hydronephrosis were noted on imaging. He received extensive infectious work up which was all negative. Hemodialysis was initiated on day 7 for metabolic derangements and volume overload. After infectious work up was negative, renal biopsy was performed revealing linear IgG deposits. Serum anti-GBM antibodies were positive. Despite receiving plasmapheresis, cyclophosphamide and prednisone, the patient continued to require dialysis and was discharged on home hemodialysis.

**Discussion:** The development of AKI with systemic symptoms occurred about 6 weeks following his COVID vaccine, longer than previously reported cases. The patient also has a history of nephrolithiasis. At this time, direct association of this patient's anti-GBM disease with the COVID vaccine is unclear however remains a clinical consideration. The presentation of anti-GBM disease is unique as disease is limited to renal involvement.

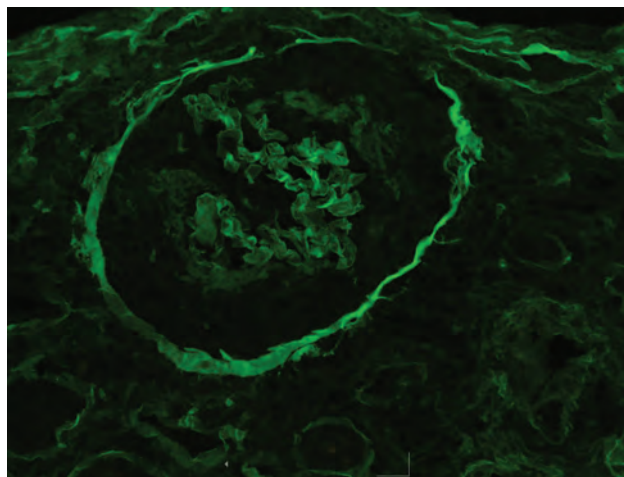

Linear reaction to IgG

#### FR-PO613

##### Glomerular Microangiopathy in a Patient With Takayasu Arteritis

Makiko Fujii, Kensei Taguchi, Kei Fukami, Sakuya Ito. Kurume Daigaku Igakubu Daigakuin Igaku Kenkyuka, Kurume, Japan.

**Introduction:** Takayasu arteritis (TA) is a large vessel inflammation that predominantly involves aorta and its main arteries. TA-caused kidney injury is known to be mainly due to renal artery stenosis. However, glomerulonephritis has been histologically identified in some TA cases.

**Case Description:** A 69-year-old female presented with leg edema and refractory hypertension with nephrotic range proteinuria (17.0 g/gCr). She exhibited >10 mmHg blood pressure discrepancy between left and right upper limbs and severe aortic regurgitation. Lab test showed high level of erythrocyte sedimentation rate. Contrast-enhanced CT identified wall thickening of the left subclavian artery, which led to the diagnosis of TA. Renal biopsy demonstrated that double basement membrane, enlarged subendothelial space, and mesangiolysis with no immunoglobulin deposition. Although azilsartan and nifedipine had been prescribed, systolic blood pressure (sBP) was still >160 mmHg. Thus, while oral prednisolone was started to suppress TA-induced inflammation, azilsartan was replaced with sacubitril valsartan, an angiotensin receptor-neprilysin inhibitor (ARNI), for treating refractory hypertension. After a few weeks, sBP was decreased to 130 mmHg with sacubitril valsartan 200mg QD and proteinuria was dramatically improved to 0.5 g/gCr.

**Discussion:** TA commonly involves the renal artery, leading to stenosis and subsequent ischemic nephropathy. However, no stenosis and occlusion were observed in renal artery of this case. Small vessel inflammation in the kidney such as vessel wall necrosis and immune cells infiltration was not found. Serum levels of pro-inflammatory cytokines including VEGF and IL-6 were within the normal range. The results indicate that TA-caused hypertension, but not vessel inflammation induced by TA, plays a pathological

role for development of glomerular microangiopathy. A previous study showed that 70% of TA patients presenting with glomerular lesion has severe hypertension and intimal thickening in renal arterioles was observed more frequently in TA patients presenting with glomerular lesion when compared to those without glomerulonephritis, which supports our hypothesis. In the present case, ARNI significantly reduced sBP which might directly contribute to the improvement of proteinuria. ARNI can be potent to control hypertension more effectively than conventional hypertensive agents in TA patients.

**FR-PO614**

**Rapidly Progressive Glomerulonephritis Associated With Recurrent Cryoglobulinemia in a Patient With Monoclonal Gammopathy of Undetermined Significance**

Michael B. Neinast, Xueguang (Gary) Chen. *Southern Illinois University School of Medicine, Springfield, IL.*

**Introduction:** Mixed cryoglobulinemia is most often associated with HCV infection, and less commonly, monoclonal gammopathies. Rapidly progressive glomerulonephritis is a common pathway of disease in these patients and early diagnosis is imperative for renal recovery. We present the case of recurrent cryoglobulinemia in a patient with MGUS resulting in RPGN after rituximab suppression therapy.

**Case Description:** A 50-year-old male presented for evaluation of progressive abdominal pain and anorexia. He has a history of cryoglobulinemia and GN three years prior with renal biopsy showing tubular and interstitial inflammation with immune-complex deposition not completely consistent with either monoclonal gammopathy or cryoglobulinemia. It was treated successfully with three courses of rituximab with resultant CKD3b. Further workup revealed MGUS on SPEP and bone marrow biopsy. A repeat bone marrow biopsy two months prior showed normocellular bone marrow with minute population of kappa monocytic plasma cells consistent with his known MGUS. On current admission, his creatinine was 10.2 g/dL with severe proteinuria of 8,216g/24 hours. Other lab values were significant for persistent IgM kappa monoclonal gammopathy on SPEP, low C3 and C4, significantly elevated RF with negative anti-CCP, and cryoglobulin level of 6%, consistent with mixed type II cryoglobulinemia. Renal biopsy showed cryoglobulinemic glomerulonephritis with focal crescentic formation involving 25% of glomeruli, severe tubulointerstitial nephritis, moderate interstitial fibrosis, and tubular atrophy. The patient was started on nine total plasmapheresis sessions over three weeks and dialysis concurrently, with rituximab infusion weekly for four weeks. Repeat RF decreased from 922 to 142 and cryoglobulin level was negative after treatment was completed. Ultimate prognosis is yet to be determined. He is continued on dialysis at this time.

**Discussion:** MGUS is a well-established part of the monoclonal gammopathy spectrum. MGRS was a recently proposed portion of this spectrum in 2012 to underline the need for more aggressive treatment in this population. While this case re-demonstrates promise of rituximab treatment for initial cryoglobulinemia associated with MGUS, it further underlines the need for improved diagnosis of the renal significance in this spectrum to prevent further kidney damage and possible ESRD.

**FR-PO615**

**Eosinophilic Granulomatosis With Polyangiitis (EGPA) Presents With Nephrotic Syndrome (NS) in the Course of the Disease**

Nehemias Guevara,<sup>1,2</sup> Marjorie Mailing Flores Chang,<sup>1,2</sup> Mahmoud Ali,<sup>1,2</sup> Jamil Ibrahim,<sup>1,2</sup> Bessy Suyin Flores Chang.<sup>1,2</sup> *<sup>1</sup>St Barnabas Hospital, Bronx, NY; <sup>2</sup>Albert Einstein College of Medicine, Bronx, NY.*

**Introduction:** EGPA affects small and medium sizes vessels. Asthma, nasal, sinus symptoms, and peripheral neuropathy are hallmarks. Necrotizing pauci immune glomerulonephritis is the most common renal presentation seen in kidney biopsy, rarely associated with nephrotic range proteinuria (NRP). Here we are presenting a case of EGPA associated with NRP.

**Case Description:** A 54 year old male with a PMH HTN, EGPA, Jak 2+ myeloproliferative disorder, presented with 2 months of progressive dyspnea, nasal congestion, productive cough grey sputum with streaks of blood, palpitations, and fatigue. VS: BP: 177/138 mmHg, HR: 129 beats/min, RR:18 breaths/min, T: 98.4 F, SatO2: 97% on room air. PE: ill appearance, eyes anicteric, erythematous and edematous nasal turbinates, erythematous oropharynx with a non-bleeding ulcer on the right side, lungs: decreased breath sounds on bases, lower extremities with no edema, skin intact with no rashes. Works up remarkable for thrombocytosis of 765k, eosinophilia of 179k, elevated creatinine, and D-dimer (Table 1). CXR: unremarkable, EKG: sinus tachycardia, biatrial enlargement, left ventricular hypertrophy, concerning pulmonary embolism (PE). V/Q scan: matched defect in perfusion/ventilation at the left lower lobe superior segment; intermediate probability for PE, the patient was treated with therapeutic enoxaparin. CT Chest (Image 1) scattered bilateral centrilobular ill-defined ground glass nodules throughout the lungs. Course was complicated with worsening renal failure, a 50% drop in baseline renal function with NRP (3.5 gr first time presentation), concern for pulmonary/renal syndrome as an acute flare of EGPA. Renal biopsy showed: focal crescentic and diffuse sclerosing glomerulonephritis, pauci immune type (ANCA-associated), with no activity and mild chronicity. Immunosuppressive therapy with rituximab, mycophenolate mofetil, and steroids were initiated, with the slow recovery of renal function and decrease in proteinuria.

**Discussion:** EGPA and renal involvement are uncommon at 25%; it's associated with autoimmune activity, however, once renal is involved tubulointerstitial nephritis is the classical presentation, NS is rare in EGPA, final outcome and need for renal replacement therapy still unknown, our patient is still receiving immunosuppression with the slow recovery of renal function.

**FR-PO616**

**A Case of Hydralazine-Induced ANCA-Associated Vasculitis**

Waseem Obeid. *Ascension St John Hospital, Detroit, MI.*

**Introduction:** Hydralazine is a direct vasodilator that is widely used for treatment of hypertension and heart failure with reduced ejection fraction. This medication has been associated with autoimmune diseases including ANCA-associated vasculitis (AAV)

**Case Description:** A 73-year-old lady with a past medical history of uncontrolled hypertension and myelodysplastic syndrome presented to the hospital with an asymptomatic increase in serum creatinine on routine blood work that was 2.5 mg/dL. The patient had COVID-19 infection 3 weeks prior to blood work that required no treatment or hospitalization. Patient had been on hydralazine for years at 50 mg three times daily to treat hypertension. Basic metabolic panel showed creatinine of 2.60 mg/dL, BUN of 50 mg/dL. Urinalysis revealed a protein of 100 mg/dL. Microscopy showed RBCs of 90 per hpf and WBC of 11 per hpf. Spot urine protein/creatinine ratio was 1.6 g/g. C-ANCA was negative but P-ANCA was positive with a titers greater than 1:5120, PR-3 antibodies were negative with myeloperoxidase antibodies positive at 1.4 AI. Antihistone antibodies came back positive at 6.8 units. She was started on IV methylprednisolone 500 mg daily for 3 days. The kidney biopsy was performed and showed glomerulosclerosis of 20/70 glomeruli, cellular and fibrocellular crescents in 14 of 50 viable glomeruli. Immunofluorescence was completely negative for IgG, IgA, C3 and C1q with mild mesangial IgM deposition, (+2). Biopsy findings were compatible with ANCA-associated, pauci-immune proliferative glomerulonephritis with crescent formation. Following IV methylprednisolone she was switched to oral prednisone, 60 mg daily. The patient was also given one gram of IV rituximab and discharged with a creatinine level of 1.9 mg/dL.

**Discussion:** This case shows the importance of considering the diagnosis of hydralazine ANCA associated vasculitis when treating patients with nephritic syndrome. It also highlights the importance of reconsidering treatment with hydralazine for hypertension or heart failure and reserve it to certain groups of patients with few alternatives.

**FR-PO617**

**Immune Checkpoint Inhibitors as Potential Triggers for ANCA Vasculitis**

Faten F. Aqeel, Duvuru Geetha, Jose M. Monroy-Trujillo. *Johns Hopkins University, Baltimore, MD.*

**Introduction:** Immune checkpoint inhibitors (ICIs) have made a tremendous impact on the survival of patients with certain cancers. However, Immune-related adverse events (IrAEs) have been implicated in such therapies. Little is known about the relationship between ICIs and ANCA-associated vasculitis (AAV). We report a case of de-novo MPO ANCA positive AAV and a case of relapsing PR3 ANCA positive AAV following treatment with ICI. This observational report highlights two cases of AAV patients occurring after ICI therapy. We looked at the onset of AAV, type of ANCA, kidney biopsy results, and clinical outcomes.

**Case Description:** One patient developed de-novo MPO ANCA positive AAV 11 months after treatment with ICI, pembrolizumab. The second patient with relapsing PR3 ANCA positive AAV developed yet another relapse after 1 month of ICI. Both patients presented with kidney injury, proteinuria, and hematuria. Remission was achieved after rituximab and glucocorticoids treatment. (Table 1)

**Discussion:** ICIs, specifically PD-1 inhibitors could cause de-novo AAV or trigger a relapse of AAV. Close monitoring of disease relapse is critical in AAV patients undergoing ICI therapy.

Patient characteristics, type of cancer, ICI treatment, onset of vasculitis, ANCA type, and treatment

ID	Age (year)	Race	Sex	Type of cancer	ICI	Existing AAV before ICI	ANCA type	Timing of AAV after initiation of ICI (months)	Presenting findings	Treatment	Nadir sCr (mg/dL)	AAV status at last follow up
1	65	C	M	Squamous cell carcinoma of left palatine tonsil	Pembrolizumab	N	MPO	11	AKI (sCr 7.20), hematuria, proteinuria, foot drop	RTX + GC	1.5	Remission
2	67	C	F	Squamous cell cancer of the lung	Pembrolizumab	Y	PR3	1	AKI (sCr 2.2), hematuria, proteinuria	RTX + GC	1.8 (baseline sCr)	Remission

AAV: ANCA associated vasculitis, ANCA: anti-neutrophil cytoplasmic antibody, ICI: Immune checkpoint inhibitor, F: female, M: male, C: Caucasian, PR3: proteinase-3, MPO: myeloperoxidase, GC: glucocorticosteroids, RTX: rituximab, AKI: acute kidney injury, sCr: serum creatinine, N: no, Y: yes

## FR-PO618

## ANCA-Associated Vasculitis With Hypocomplementemia

Juan D. Diaz Garcia, Mario Alamilla Sanchez, Valeria Yanez Salguero, Martin B. Yama Estrella, Jose L. Ortega, Enrique F. Morales Lopez, Julio C. Nieto, Claudia B. López, Irving G. Ramirez, Francisco Velasco Garcia Lascrain. *Centro Medico Nacional 20 de Noviembre, Mexico City, Mexico.*

**Introduction:** It has been suggested that the role of complement activation, mainly of the alternate pathway, in the pathogenesis of ANCA vasculitis is significant. Although ANCA-related necrotizing and crescentic glomerulonephritis is often referred to as a "pauciimmune" process, in certain cases there is deposition of immune complexes and complement in the glomeruli detected by immunofluorescence. Complement deposits in the kidney of patients with ANCA vasculitis correlate with greater kidney damage, more significant proteinuria, and general disease activity.

**Case Description:** 3 patients are reported, 2 men and 1 woman, with histopathological diagnosis of pauciimmune glomerulonephritis and C3 deposits detected by immunofluorescence, positive ANCA PR3, negative ANAS, profoundly decreased C3 with values less than 20 mg/dl in all 3 patients and C4 decreased by less than 10 mg/dl. Active urinary sediment with dysmorphic erythrocytes 70%, proteinuria in 24 hours between 2 g to 2.5 g, progressive deterioration of renal function, requiring 2 of them renal replacement therapy. Management was started with methylprednisolone 1000 mg every 24 hours for 3 days and Rituximab 375 mg/m<sup>2</sup> every week for 4 weeks as induction therapy. 2 patients with a progressive decrease in serum creatinine reaching baseline renal function and one patient who required hemodialysis sessions without recovery of baseline renal function, being diagnosed with chronic kidney disease.

**Discussion:** According to reports, 25% of patients with ANCA vasculitis have low C3 levels at the time of diagnosis, which is associated with more severe kidney disease and worse renal outcomes, with complement deposits being reported in biopsies. In 25-54% of patients with ANCA vasculitis. C3 deposition was associated with proteinuria, higher creatinine, lower C3, and certain parameters of renal histopathology, such as a higher percentage of crescent formation. In our cases, the three patients presented decreased complement in both C3 and C4 with severe kidney disease; however, 2 patients with a favorable outcome thanks to timely management and another patient who ended up with chronic kidney disease on hemodialysis. This should be taken into account in therapeutic and follow-up strategies.

## FR-PO619

## ANCA Negative Pauci-Immune Necrotizing Glomerulonephritis in a Liver Transplant Patient

Arjun Kumar, Audrey McCartney, Nives Zimmermann, Latoya L. Brathwaite, Niralee Patel. *University of Cincinnati, Cincinnati, OH.*

**Introduction:** Pauci-immune necrotizing glomerulonephritis (PING), a common cause of rapidly progressive glomerulonephritis, is associated with antineutrophil cytoplasmic antibodies (ANCA); yet up to 10% of cases may be ANCA-negative. We present a case of ANCA-negative PING in a patient with an orthotopic liver transplant (OLT) on immunosuppressants.

**Case Description:** 40-year-old male with history of OLT 4 years ago from congenital cytomegalovirus cirrhosis and well-controlled post-transplant diabetes had an urgent kidney biopsy due to an acute rise in creatinine (Cr) from 2.5 to 3.5 mg/dL, new nephrotic range proteinuria (urine protein Cr ratio 3.8g/g), and microscopic hematuria. His immunosuppression was tacrolimus (FK) and mycophenolate mofetil (MMF). Kidney ultrasound showed small echogenic kidneys. Biopsy (Figure 1) revealed glomeruli with cellular crescents with focal necrotizing lesions with majority of glomeruli with global sclerosis, and 50% interstitial fibrosis and tubular atrophy. Immunofluorescence staining was negative for immunoglobulins, C3, C1q, and light chains. Electron microscopy did not exhibit any deposits. Serological labs, including ANCA, were negative except for a low (1:80) antinuclear antibody. Given active cellular crescents, despite the signs of chronicity, he was treated with 3 days of high dose methylprednisolone followed by prednisone taper and 2 doses of rituximab in 2 weeks, in addition to chronic FK and MMF. 2 months later, renal dysfunction persists.

**Discussion:** ANCA-negative PING tends to have poorer kidney prognosis, with 25% requiring dialysis at diagnosis and a high mortality compared to ANCA-positive PING. ANCA-negative PING may represent an entirely separate disease and has been associated with malignancy and bacterial infections. Data on the underlying pathophysiology is limited; yet ANCA-negative PING is managed similarly to ANCA-positive cases with corticosteroids, rituximab or cyclophosphamide. The unique *de novo* presentation of a patient on immunosuppressives suggests there may be an atypical underlying pathophysiology and further investigations are warranted.

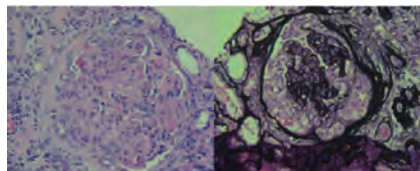

Figure 1 Left: kidney biopsy with H&E stain showing hypercellular glomerulus with occluded glomerular capillary loops, and Right: Silver stain showing extracapillary proliferation (crescent formation).

## FR-PO620

## ANCA Glomerulonephritis With IgA Deposits

Elena Zidan,<sup>1</sup> Aaron M. Domm.<sup>2</sup> <sup>1</sup>Bridgeport Hospital Internal Medicine, Bridgeport, CT; <sup>2</sup>Bridgeport Hospital, Bridgeport, CT.

**Introduction:** We present a patient with antineutrophilic cytoplasmic antibody (ANCA) associated pauci-immune necrotizing crescentic glomerulonephritis (AAV) who was additionally found to have IgA deposits on immunofluorescence. Estimated prevalence of circulating ANCA in biopsy proven IgA nephropathy (IgAN) is approximately 1.4%. There are a limited number of cases in the literature of coexisting AAV and IgAN.

**Case Description:** A 36-year-old female from Peru presented to the hospital with gross hematuria and transient right third finger proximal interphalangeal joint arthritis. Physical exam was unremarkable and stable vital signs. On laboratory evaluation she was found to have kidney failure with serum creatinine of 1.7 mg/dL, no baseline labs available. Urinalysis revealed gross hematuria, and spot protein creatinine ratio revealed nephrotic range proteinuria 3.69 mg/mg Cr (normal <=0.10 mg/mg Cr) with serum albumin 2.7 mg/dL (normal 0.4-1.3 mg/dL). Further serology was remarkable for ANCA titer >1:1280 (normal <1:20) with perinuclear pattern, elevated anti-myeloperoxidase antibody 570.7 (normal <1.0 AU). Anti-glomerular basement membrane and proteinase-3 antibodies were undetectable. Ultrasound guided right renal biopsy was performed after she was started empirically on pulse dose methylprednisolone. Renal biopsy revealed pauci-immune necrotizing crescentic glomerulonephritis and immunofluorescence showed concomitant mesangial IgA deposits. After initial three doses of pulse steroid, she was transitioned to high dose oral prednisone and two one-gram doses of rituximab (14 days apart), with full recovery of renal function. Gross hematuria persisted for 5 weeks after steroid initiation. Renal imaging was unremarkable.

**Discussion:** This is a unique case of AAV with concurrent mesangial IgA staining immune deposits, whereas typically, AAV is a pauci-immune process without significant staining on immunofluorescence. Persistent gross hematuria is unusual for ANCA GN and does raise suspicion that the IgA deposits may be clinically relevant. The clinical significance of the IgA staining in this case of AAV is unclear, as many kidney transplant donors without kidney disease have incidental IgA deposits. Alternatively, this may represent a form of crescentic glomerulonephritis where both ANCA and IgA contribute to pathogenesis. Fortunately, patient had an excellent response to course of steroids and rituximab, with normalization of renal function.

## FR-PO621

## The Great Clinical Masquerade of ANCA Vasculitis

Aditi Singh, Stephen N. Simeone, Duha A. Jweehan, Mamta Shah. *UConn Health, Farmington, CT.*

**Introduction:** Early recognition and treatment of anti-neutrophil cytoplasmic antibody (ANCA)-associated glomerulonephritis (GN) is paramount to halt progression to end stage renal disease. We present a case of new-onset ANCA positive renal-limited vasculitis in an elderly female with failure to thrive.

**Case Description:** A 78-year-old female presented to our institution with altered mental status and poor oral intake. Over the past several months, she had progressive clinical decline with recurrent admissions for suspected interstitial pneumonia, urinary tract infections (UTI) and dysphagia with failure to thrive. Chemistry demonstrated a serum creatinine of 2.5 mg/dL elevated from a baseline of 0.8 mg/dL. The patient received intravenous crystalloid resuscitation and antimicrobial therapy for clinical hypovolemia and suspicion of UTI. Urinalysis revealed large proteinuria with a urine protein-creatinine ratio of 3.35, hematuria, pyuria, and fine granular casts. Further evaluation revealed positive speckled antinuclear antibodies with titers of 1:160, positive perinuclear-ANCA with a titer of 1:1280 and positive myeloperoxidase antibodies. Renal biopsy demonstrated active crescentic necrotizing glomerulonephritis (Figure 1), significant interstitial inflammation with vascular involvement and negative immunofluorescence. High dose corticosteroid and cyclophosphamide therapy was initiated with rapid improvement in her renal function and resolution of hematuria. She clinically improved and was discharged on prednisone and cyclophosphamide with a plan to transition to rituximab.

**Discussion:** We present a case that highlights the diagnostic challenge of ANCA-associated vasculitis with its protean symptoms and multisystem involvement in an aging population where multiple comorbidities co-exist. ANCA positive GN is the most common new onset GN in adults over the age of 50 and yet studies show a significant delay between initial presentation and diagnosis. A high degree of clinical suspicion is required in this challenging population to reduce the morbidity and mortality associated with this disease.

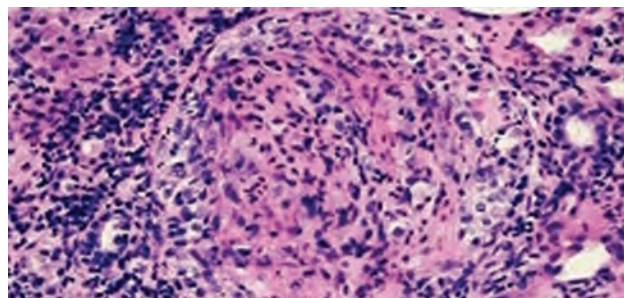

Circumferential cellular crescent

FR-PO622

**Renal Limited ANCA-Associated Vasculitis Associated With Cardiac Tamponade Following Pfizer-BioNTech SARS-CoV-2 Vaccination**

Yasmin N. Mahmoud,<sup>1,2</sup> Omar N. Elhawary,<sup>1,2</sup> Mary C. Mallappallil,<sup>1,2</sup> Sonalika Agarwal,<sup>1,2</sup> Isha Puri,<sup>1,2</sup> <sup>1</sup>SUNY Downstate Health Sciences University, New York City, NY; <sup>2</sup>Kings County Hospital Center, Brooklyn, NY.

**Introduction:** While short-term side effects of COVID-19 vaccine resemble those of other vaccines, long-term side effects remain unknown. We report a case of new-onset renal-limited ANCA-associated vasculitis in an elderly woman who developed acute kidney injury with nephrotic range proteinuria after receiving the Pfizer-BioNTech COVID-19 vaccine.

**Case Description:** 74-year-old woman with history of Hypertension, Diabetes presented with generalized fatigue and occasional cough after getting Pfizer-BioNTech covid vaccine in June 2021. She had nephrotic range proteinuria with UPCR of 4 g/g, serum positive for MPO-ANCA antibody with a titer of 1:160. CT chest showed moderate to large pericardial effusion which was subsequently confirmed on Echocardiogram. Kidney biopsy was done and showed MPO-ANCA mediated crescentic focal necrotizing and focal sclerosing glomerulonephritis. The patient later developed transient episode of SVT which required higher level of care and a pericardiocentesis was done for cardiac tamponade and impending cardiac collapse.

**Discussion:** Six cases of ANCA-associated glomerulonephritis after SARS-CoV-2 vaccination have been reported to date. We report a case of ANCA-associated vasculitis associated with cardiac tamponade following Pfizer-BioNTech SARS-CoV-2 vaccination. Since April 2021, increased cases of myocarditis and pericarditis have been reported in the United States after mRNA COVID-19 vaccination and reported cases have occurred predominantly in male adolescents and young adults 16 years of age and older. To our knowledge this is the first case of renal limited MPO-ANCA-associated vasculitis following Pfizer-BioNTech covid vaccine with association of cardiac tamponade in an elderly female. Diagnosis is often challenging, and post-marketing surveillance systems must continue to assess vaccine safety.

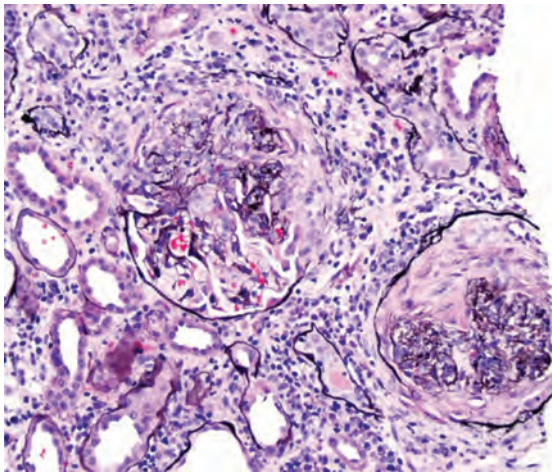

Crescents and Necrosis

FR-PO623

**Belimumab and Multitarget Therapy, Mycophenolate Mofetil, and Tacrolimus as Induction Therapy of Severe Active Lupus Nephritis: Case Series From China**

Min Min,<sup>1</sup> Jiong Zhang,<sup>2</sup> <sup>1</sup>National Clinical Research Center of Kidney Diseases, Jinling Hospital, Nanjing Medical University, Nanjing, China; <sup>2</sup>National Clinical Research Center of Kidney Diseases, Jinling Hospital, Nanjing University School of Medicine, Nanjing, China.

**Introduction:** To assess safety and generate preliminary efficacy data on multitarget therapy (MT) and standard care followed by belimumab (BLM) for severe active Chinese LN patients, a case series were investigated. Four patients with severe active LN were treated with standard care [mycophenolate mofetil (MMF) / tacrolimus (FK506)] or MT, followed by BLM infusions. BLM were given 10mg/kg every 2 weeks for 3 times, then every 4 weeks till Week 24. Primary renal response index, SLEDAI and safety data were analyzed.

**Case Description:** The patients (3 females) affected by LN ISN/RNP Class III/IV±V with high disease activity are 2 de novo LN, 2 refractory LN. At baseline, the SLEDAI score were 20,17,16,15 respectively. Three of them accepted intravenous (IV) methylprednisolone, followed by standard care or MT, one patient started standard care immediately after admission. Within 2 weeks of starting treatment, IV BLM was introduced. The initial oral prednisone doses were 30-45mg/day. At Week 24, the SLEDAI score decreased to 2,8,10,2 respectively. Two patients who accepted MT achieved complete renal remission, the other two achieved partial renal remission (Figure 1). MT and BLM therapy reduced SLEDAI more rapidly than MMF or FK506 regimen (Figure 2). Prednisone reduced to 10-15mg/day. No adverse events occurred.

**Discussion:** The addition of belimumab to MT or standard therapy was safe. This regimen leads to renal remission in severe active LN patients and diminishes SLEDAI. Further studies are needed to evaluate the benefits of belimumab combined with MT in severe active LN.

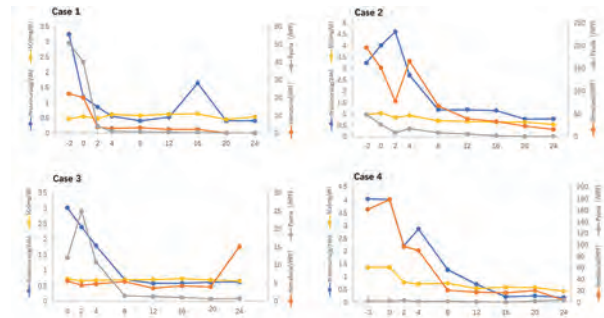

Figure 1. Changes of urinary protein, urinary red blood cells, urinary white blood cells and serum creatinine in 4 patients during the treatment with belimumab and multitarget therapy/standard therapy. 0 week is the time to start the belimumab. Case 1 and Case 4 accepted belimumab and multitarget therapy. Case 2 accepted belimumab and mycophenolate mofetil. Case 3 accepted belimumab and tacrolimus.

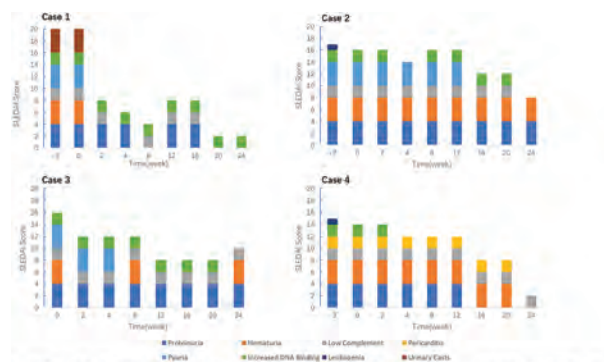

Figure 2. The details of 4 patients' Systemic Lupus Erythematosus Disease Activity Index (SLEDAI). The graph shows the patients' overall scores along with the SLEDAI components with their respective weights during the treatment with belimumab and multitarget therapy/standard therapy. 0 week is the time to start the belimumab. Case 1 and Case 4 accepted belimumab and multitarget therapy. Case 2 accepted belimumab and mycophenolate mofetil. Case 3 accepted belimumab and tacrolimus.

FR-PO624

**Renal Limited PR3-ANCA Vasculitis due to Abiotrophia defectiva Infective Endocarditis**

Leonardo Pozo Garcia, Jeryl P. Varughese, Sehrish Ali, Pascale Khairallah. Baylor College of Medicine, Houston, TX.

**Introduction:** *Abiotrophia defectiva* (*A. defectiva*) is a rare cause of infective endocarditis (IE) and in some cases, it can lead to glomerulonephritis (GN). There is only one report in the literature associating this organism with ANCA-positive vasculitis with renal involvement. This entity is scarcely described.

**Case Description:** A 25-year-old gentleman with a history of type 1 diabetes mellitus and tetralogy of Fallot with multiple repairs including surgical pulmonary valve replacement, tricuspid annuloplasty, and two prosthetic implants on the right ventricle outflow tract was admitted to the ICU for decompensated right heart failure and night sweats with plans for surgical repair. Received further workup, inotropes, IV diuretics, and CVP monitoring. Initial imaging was consistent with diffuse lung and heart nodularity. Blood cultures grew gram-positive cocci, later identified as *A. defectiva*. Antibiotics adjusted. CTA consistent with pulmonary valve and artery vegetations and pulmonary septic emboli. The patient underwent re-replacement of the pulmonary valve, pulmonary artery patch, and tricuspid valve replacement. Valve cultures consistent with *A. defectiva*. Renal function deteriorated from baseline 0.8 mg/dL to 1.4 mg/dL. Urinalysis had 2+ protein, 3+ blood, and 50-100 RBC/HPF. UPC 3 gm/gm. PR3 ANCA elevated 249 with repeat 323 (NL <19 AU/mL). He was started on pulsed-dosed steroids empirically. Renal biopsy revealed pauci-immune GN with mesangial IgM2+ and C3 staining at the vascular pole. The patient was discharged on ceftriaxone and steroid taper.

**Discussion:** The patient developed renal limited PR3-ANCA GN due to *A. defectiva* IE. GN associated with IE is a well-documented entity commonly found in patients with IE caused by staphylococci and streptococci. Only one other case has been previously reported with *A. defectiva* as the pathogenic organism causing both IE and biopsy-proven PR3-ANCA vasculitis. It is unclear if heavy induction immunosuppression followed by maintenance immunosuppression is needed in these rare cases. Individualized treatment is recommended from our experience.

FR-PO625

**Monoclonal Tissue ANA as an Initial Clue to Lupus Podocytopathy**

Gilad S. Guez, Nicole Fernandez, Abdelaziz A. Elsanjak. LewisGale Medical Center, Salem, VA.

**Introduction:** Lupus podocytopathy (LP) is a rare renal manifestation of lupus without immune complex-mediated pathogenesis. By electron microscopy (EM), there is diffuse podocyte foot process effacement (PFPE), without glomerular capillary wall

immune complexes. By light microscopy (LM), glomeruli may be normal or may exhibit mesangial hypercellularity or focal segmental glomerulosclerosis (FSGS); however, proliferative lupus nephritis (LN) is absent. LP is currently not included in the LN classification and may not be recognized without careful clinic-pathologic correlation. This case displays the FSGS variant of LP with monoclonal tissue ANA as the first finding of lupus with good treatment response.

**Case Description:** 19-year-old female was admitted for generalized edema. Labs showed anemia, proteinuria (urine protein/Cr=10.3), microhematuria, hypoalbuminemia, and normal renal function. Renal biopsy LM showed the tip lesion variant of FSGS (Fig. 1A). By IM, there was low level mesangial IgG/IgM staining. Tubular cell nuclei stained for IgG (Fig.1B) with IgG1 heavy chain and kappa light chain restriction. EM showed extensive PFPE (Fig. 1C) and tubuloreticular inclusions (Fig. 1D), but no capillary wall deposits. The findings were suspicious for LP. Serologies were positive for ANA and dsDNA. Skin biopsy showed lupus dermatitis. She was started on prednisone, tacrolimus and hydroxychloroquine. Prednisone was replaced with mycophenolate mofetil for maintenance, and remission was achieved.

**Discussion:** The FSGS variant of LP has low rates of remission with steroids alone. This case shows that robust immune suppression may improve prognosis. LP has histologic similarities with minimal change disease and primary FSGS, so clues from the IF/EM and clinical history help in diagnosis. Monoclonal tissue ANA is a rare finding and was helpful in diagnosing LP in this biopsy.

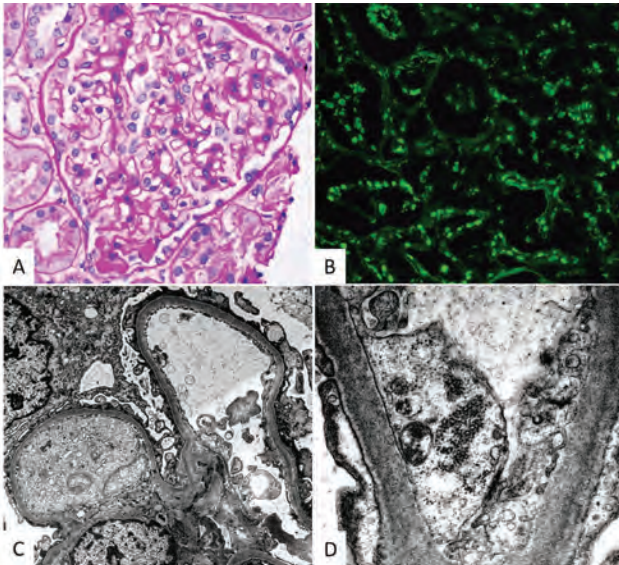

Fig. 1

#### FR-PO626

#### A Case of Histiocytic Glomerulopathy With Features of Thrombotic Microangiopathy With Features of Atypical Sarcoidosis and Lupus Anticoagulant

Mad S. Alom, Catherine A. Moore, Hae Yoon Grace Choung, *Strong Memorial Hospital, Rochester, NY.*

**Introduction:** Hemophagocytic Syndrome (HPS) is a rare, potentially fatal disease, characterized by unrestrained immune activation resulting in hypercytokinemia and multiorgan failure

**Case Description:** We present a case with subacute progressive renal dysfunction, hematuria and proteinuria in a 73-year-old female with a congenital solitary kidney, hypertension, and primary hyperparathyroidism. She was admitted with serum creatinine (s.cr) of 4.1 g/dl up from baseline (0.9 mg/dl). Additional findings included pancytopenia, hypermetabolic lymphadenopathy, mild hypercalcemia, and fatigue. She underwent extensive work up including PET scan and biopsies of the kidney, lymph node and bone marrow. Biopsy of the kidney showed histiocytic glomerulopathy with features of thrombotic microangiopathy (TMA) while LN exhibited non-necrotizing granulomas typical of sarcoidosis. Bone marrow was diagnosed clonal hematopoiesis of indeterminate potential (CHIP). Laboratory values of note included positive IgM for Beta-2-glycoprotein and anti-cardiolipin, random urine total protein/creatinine ratio (UPCR) 2.2 gm/gm, soluble IL2 receptor 1652 U/mL, CRP 156 mg/L, LDH 365 U/L, CPK 294, Ferritin 618 ng/ml, and normal serum protein electrophoresis and serum immunofixation. 1,25 Di-Hydroxy Vitamin D was normal She was placed on prednisone with initial robust improvement in renal parameters: s.cr decrease to 2.1 mg/dL and UPCR to 660 mg/gm. Course was complicated by legionella pneumonia leading to reduction in steroids, and she initiated infliximab infusions. Unfortunately renal function failed to improve with infliximab and s.cr increased to 5 mg/dL

**Discussion:** Histiocytic glomerulopathy (HG) has been associated with Macrophage Activation Syndrome/HPS following viral infections or hematologic malignancies. Glomerular involvement is rare and usually manifests as either a podocytopathy, TMA, or rarely HG. HG has not been reported with sarcoidosis. The pathogenic role of her positive

lupus anticoagulant, given the features of TMA on renal biopsy, and CHIP on LN biopsy is an additional factor under consideration. Findings of CHIP may indicate worse renal prognosis; this association needs further study.

#### FR-PO627

#### Lupus Nephritis Complicated by Multi-Organ Arterial Thrombosis

Noor Bazerbashi, Nisarg Gandhi, Elise Ewing, Angelina Edwards, *Houston Methodist, Houston, TX.*

**Introduction:** Thrombosis is a known complication of Nephrotic Syndrome (NS) and results in significant morbidity and mortality. While thrombotic events (TE) in Lupus Nephritis (LN) are often related to antiphospholipid syndrome, an imbalance between thrombotic and antithrombotic factors in those with nephrotic-range proteinuria (NRP) leads to NS-related hypercoagulability. Here, we report an unexpected case of multi-organ arterial thrombosis in a patient (pt) with LN.

**Case Description:** A 23-year-old woman with active systemic lupus erythematosus underwent kidney biopsy for evaluation of 7.7 g proteinuria on 24-hour urine collection. While serum creatinine was stable at 0.73 mg/dL, her serum albumin was low at 2.7 g/dL, and autoimmune markers including anti-nuclear antibody, anti-dsDNA antibody, ribonucleoprotein, and anti-smith antibody were reactive. Outpatient kidney biopsy showed Class IV and V LN, with global diffuse proliferative and membranous lesions with crescentic formation. Before initiation of therapy, she presented with sudden onset of diffuse abdominal pain, headache, and positional chest discomfort. CT abdomen pelvis with contrast showed multifocal splenic and renal infarcts, and CT head showed lacunar infarcts. Evaluation of chest pain showed no valvular lesions on transthoracic echocardiogram, but further assessment with transesophageal echocardiogram showed a large thrombus in the descending aorta, confirming the embolic source. A comprehensive hypercoagulable workup was collectively unrevealing. The hypercoagulable state was thought to be secondary to underlying inflammatory disease and likely acquired protein C/S deficiency in the setting of NRP. Anticoagulation therapy was initiated, and aggressive management of LN was pursued. Follow-up imaging showed resolution of the thrombus, and the pt continues to show reduction in proteinuria and improvement in serum albumin.

**Discussion:** Venous TE is well-described in NS, but arterial TE is rare and more reported in membranous glomerulonephritis. The cumulative effect of imbalance of antithrombin III, protein C/S, fibrinolytic activity, fibrinogen, and von Willebrand factor increases thrombotic risk. Initiation of thrombotic prophylaxis with appropriate risk stratification guided by pt's serum albumin level is recommended to prevent these detrimental complications.

#### FR-PO628

#### Hydralazine-Induced Antinuclear Antibody (ANA) Negative "Lupus-Like Nephritis" With Normal Complements

Hema Balina, Edva Noel, Rizwan Rabbani, Iris J. Lee, Christine P. Bastl, *Temple University Hospital, Philadelphia, PA.*

**Introduction:** Isolated severe lupus nephritis from hydralazine without systemic manifestations of vasculitis is rare. Hydralazine can trigger autoimmune disease, and most of these cases have positive ANA and anti-histone antibodies. This case describes the presentation of ANA negative isolated lupus-like nephritis with hydralazine with normal complements, but positive anti-histone and anti-phospholipase A2 antibodies (Anti-PLA2R).

**Case Description:** A 65-year-old female with hypertension, and diabetes who was on hydralazine for two years presented with acute kidney injury and edema. Labs include Creatinine 5.38mg/dl, BUN 42 mg/dl, WBC 8.2K/mm<sup>3</sup>, Hemoglobin 7.5g/dl, Platelets 284K/mm<sup>3</sup>. The urine protein creatinine ratio was 16 grams. ANA, Anti-ds DNA, ANCA, Rheumatoid factor, hepatitis panel, kappa lambda ratio, serum electrophoresis, urine electrophoresis, and immunofixation were negative. Anti-histone antibodies and anti-PLA2R were positive. Renal biopsy showed membranoproliferative glomerulonephritis with the crescent formation, membranous glomerulopathy, and "full-house" staining on immunofluorescence. A diagnosis of hydralazine-induced lupus-like nephritis was made based on her medication history, positive anti-histone antibody, lack of criteria fulfilling SLE, and findings of lupus nephritis on biopsy. Treatment with mycophenolate mofetil and prednisone led to improvement in proteinuria and renal function.

**Discussion:** The incidence of hydralazine-induced lupus is approximately around 5-8%. The diagnosis is made based on the temporal relationship between drug exposure and at least one clinical characteristic of SLE: Hydralazine-induced lupus usually presents with arthralgias, myalgias, fever, rash, and/or serositis. In severe cases, vasculitis, glomerulonephritis, or respiratory failure can be seen. The main serological findings in drug-induced lupus include a positive ANA (In 90-95% cases), anti-histone antibodies (90-95%), anemia, leukopenia, and positive Coombs test. Hypocomplementemia can be seen in 50% of the cases. Our patient had a unique presentation of hydralazine-induced lupus-like nephritis with no other systemic manifestations, normal complements, and a negative ANA. In addition, our patient had anti-PLA2R antibodies which are usually associated with primary membranous and rarely seen in membranous disease due to lupus.



## FR-PO629

**Bamboozled: Concomitant Lupus Nephritis and Systemic Thrombotic Microangiopathy**

Margaret Spolnik, Corey J. Cavanaugh, Helen P. Cathro. *University of Virginia, Charlottesville, VA.*

**Introduction:** Lupus nephritis (LN) and thrombotic microangiopathy (TMA) are rare diseases rarely occurring together. Both can have devastating outcomes of kidney failure, neurological demise, and even death.

**Case Description:** A 31-year-old African-American woman with history of lupus and idiopathic thrombotic thrombocytopenic purpura (TTP) presented with malaise, swelling, emesis and diarrhea for 1 week. Initial testing- Cr 8.7 mg/dL (baseline 1.1), plts 30 k/uL, haptoglobin <8, LDH 938 U/L, Hgb 6.7 g/dL, uPr/Cr 2.89 g/g, low C3/C4, ANA >1:640, positive dsDNA, Smith, and SSA antibodies. Shiga toxin neg. Peripheral smear showed schistocytes. Urine microscopy had granular casts, but no RBC casts and no dysmorphic RBCs. Given concern for possible TTP, plasmapheresis (PLEX) occurred for 5 sessions until ADAMTS-13 returned with 57% activity. She was also given eculizumab and solumedrol for concern of complement-mediated TMA. Kidney biopsy showed membranous pattern glomerulopathy with 64% cellular crescents and 63% globally sclerotic glomeruli, acute tubular damage, mild interstitial fibrosis and mild tubular atrophy. IF staining was positive for IgG 1+, IgM trace, kappa 2+, lambda 2+, but negative for C1q and IgA and without evidence of TMA. She was treated as proliferative LN given high clinical suspicion with lupus history and active cellular crescents. She started IV cyclophosphamide at 500 mg every 2 weeks for a total of 6 doses per Euro-lupus protocol with corticosteroids. Repeat labs with Cr 1.3, uPr/Cr decreased to 0.14 g/g, and C3/C4 normalized. Peripheral smear without schistocytes and improved LDH/haptoglobin levels. With a negative atypical HUS genetic panel, eculizumab was terminated after two months. She is currently on low-dose steroids and mycophenolate mofetil 1000mg BID.

**Discussion:** Two rare and severe diseases presented concomitantly in a patient with acute kidney injury. She was treated with multiple agents for immunosuppression including cyclophosphamide, steroids and eculizumab as well as five plasmapheresis sessions with no apparent adverse events. Definitive data for cessation of eculizumab is not available, but cessation has not resulted in a recurrent flare. Despite a biopsy without typical characteristic full-house staining for LN, the patient responded well to the Euro-lupus protocol and remains with stable kidney function and minimal proteinuria.

## FR-PO630

**Bartonella Endocarditis With Crescentic Glomerulonephritis Mimicking Lupus Nephritis**

Mohammad A. Sohail, Kristen Tomaszewski, Juan C. Calle. *Cleveland Clinic, Cleveland, OH.*

**Introduction:** Distinguishing an infectious from an autoimmune cause of glomerulonephritis (GN) is critical in diagnostic challenges such as culture negative infective endocarditis (IE) to avoid exposing patients to inadvertent immunosuppression (IS). Although Bartonella IE appears to be frequently associated with ANCA/PR3 positivity, our case illustrates that Bartonella IE can also cause crescentic GN with positive anti-dsDNA and antiphospholipid (aPL) antibodies, mimicking lupus nephritis.

**Case Description:** A 74-year-old man presented with fevers, night sweats, weight loss, dyspnea and left upper quadrant abdominal pain. Initial evaluation revealed pancytopenia, acute kidney injury with creatinine of 2.1 mg/dl from baseline 0.8 mg/dl, severe aortic stenosis (AS) on echocardiography and a splenic infarct on abdominal imaging. Urine protein/creatinine ratio was 1.0 and sediment showed normomorphic RBCs. Blood cultures were negative. Serologic testing showed positive ANA/anti-dsDNA/MPO-ANCA, low C3/normal C4 and triple positive aPL profile. Bone marrow biopsy was unrevealing. The patient was initiated on steroids and hydroxychloroquine for possible diagnosis of systemic lupus erythematosus (SLE), and underwent a transcatheter aortic valve replacement (TAVR) for severe AS. Subsequent kidney biopsy revealed crescentic GN with IgM and C3 codominant deposits. The patient's history of AS requiring TAVR raised the possibility of a subacute culture-negative IE as a potential cause for GN. Bartonella was detected by blood PCR testing with positive IgG for Bartonella henselae. Subsequent histopathology of the explanted prosthetic aortic valve under Warthin-Starry stain revealed bacillary organisms in fibrinous vegetations. Anti-dsDNA and aPL antibodies turned seronegative after treatment with ceftriaxone and doxycycline.

**Discussion:** Anti-dsDNA and aPL antibodies are not typical of Bartonella IE-associated GN. However, the patient's lack of response to IS, IgM dominant pattern on kidney biopsy, positive Bartonella PCR/serology, and resolution of anti-dsDNA and aPL antibodies following antibiotic therapy, supported Bartonella IE over SLE as the cause of the GN. Although determining the etiology of GN in culture negative IE can be challenging with positive autoimmune serologies, reaching a prompt accurate diagnosis is crucial to prevent inadvertent IS and valve replacement procedures.

## FR-PO631

**A Unique Case of Scleroderma Renal Crisis**

Nickolas Coombs, Mythri Anil Kumar, Jarrod B. Post. *Hartford Hospital, Hartford, CT.*

**Introduction:** Scleroderma renal crisis (SRC) occurs in 5-20% of patients with diffuse cutaneous systemic sclerosis (SSc). Early initiation of angiotensin converting enzyme inhibitors (ACEi) can promote renal stabilization or recovery. We present a case of SRC in amyopathic dermatomyositis (DM) with overlap syndrome.

**Case Description:** A 76-year-old female with hypertension (HTN) presented with months of bilateral lower extremity edema, arthralgias, myalgias, and dyspnea. A transthoracic echocardiogram (TTE) was normal and nuclear stress testing revealed two-vessel coronary artery disease. CT chest showed non-specific interstitial pneumonia. Antinuclear antibody (Ab), PL12 Ab and C-Reactive protein were elevated; mycophenolate mofetil (MMF) and methylprednisone were started for DM. She was admitted to the hospital for pulmonary edema secondary to malignant HTN complicated by acute kidney injury (AKI). Her urinalysis, renal ultrasound and TTE were unremarkable. Respiratory status improved with aggressive diuresis and her AKI was thought to be cardiorenal; serum creatinine (SCr) stabilized at 1.8 mg/dl (baseline 0.6). MMF was thought to precipitate pulmonary edema and she was discharged on hydroxychloroquine. She was readmitted 2 weeks later with similar symptoms and SCr 2.3 mg/dl. Despite diuresis, kidney function declined; right heart catheterization was done and normal. Given a recent diagnosis of DM, accelerated HTN, and worsening AKI this raised suspicion for SRC. Interestingly, sclerodactyly was noted in bilateral fingers as well. Further testing revealed RNA polymerase III Ab positivity; renal biopsy was suggestive of SRC. Hemodialysis (HD) was initiated, and she was discharged on lisinopril, steroid taper, and MMF.

**Discussion:** We describe a case of amyopathic DM with overlap of SSc in which the use of steroids and cessation of ACEi precipitated SRC. In 20% of cases, SRC precedes the clinical findings of SSc making diagnosis challenging. As polymyositis and DM commonly overlap with SSc, clinical suspicion for SRC is required when presented with accelerated HTN and AKI. In the absence of skin changes, RNA polymerase Ab positivity should raise suspicion for SRC. Prolonged ACEi in SRC may reconstitute renal function for up to 18 months after onset of SRC; ACEi should continue even in patients on long-term dialysis. However, while ACEi have decreased mortality by >60%, outcomes in SRC remain poor with 42% requiring HD.

## FR-PO632

**Thrombotic Microangiopathy as a Presentation of Paroxysmal Nocturnal Hemoglobinuria and Lupus Nephritis**

Clementina Elizabeth Calderon Garcia,<sup>1</sup> Guillermo Navarro Blackaller,<sup>1,2</sup> Jonathan Chavez.<sup>1,2</sup> *<sup>1</sup>Hospital Civil de Guadalajara Unidad Hospitalaria Fray Antonio Alcalde, Guadalajara, Mexico; <sup>2</sup>Universidad de Guadalajara Centro Universitario de Ciencias de la Salud, Guadalajara, Mexico.*

**Introduction:** Thrombotic microangiopathy (TMA) characterized by thrombocytopenia, microangiopathic hemolytic anemia, and organ injury. Paroxysmal nocturnal hemoglobinuria (PNH) characterized by intravascular hemolytic anemia, thrombosis, bone marrow dysfunction and hypercoagulability. Systemic lupus erythematosus (SLE) is an autoimmune multisystemic disease. SLE associated with PNH is very rare. We present the case of a man who presented TMA, secondary to lupus nephritis (LN) with PNH both entities coexisting.

**Case Description:** A 48-year-old man with acute kidney injury with creatinine 13mg/dl, urea 148mg/dl, hemoglobin 6g/dl and 56,000 platelets, with peripheral blood smear showing the presence of schistocytes, COOMBS direct negative, low haptoglobins, ANAs 1:640, low C3 and normal C4 levels. ADAMS 13 activity >17%, Shiga toxin and ANCAS negative. Anti-double chain, Anti-SM, lupus anticoagulant, anti cardiolipins, and anti B2 glycoprotein antibodies negatives. HBV, HCV, and HIV serologies negatives. Kidney ultrasound was normal. SLE was diagnosed, requiring hemodialysis. Renal biopsy was performed, reporting class II LN with acute tubulointerstitial nephritis and autoimmune TMA (Image). Given the persistence of anemia and thrombocytopenia, PNH phenotype was addressed, and monocytes were identified as CD59 8.7% TYPE II, CD59 23.3% TYPE III.

**Discussion:** PNH has reduced or absent glycosylphosphatidylinositol (GPI)-anchored proteins on the cell surface. Loss of the GPI-linked complement inhibitors, CD55 and CD59 on erythrocytes leads to chronic or paroxysmal intravascular hemolysis. In our patient, we found a deficient CD59 pattern that can also be observed in SLE or hemolytic anemias. Therapeutics can be directed by targeting complement protein C5, eculizumab is a treatment option that has been shown to significantly reduce hemolysis and thus hemolysis-related side effects in PNH cases.

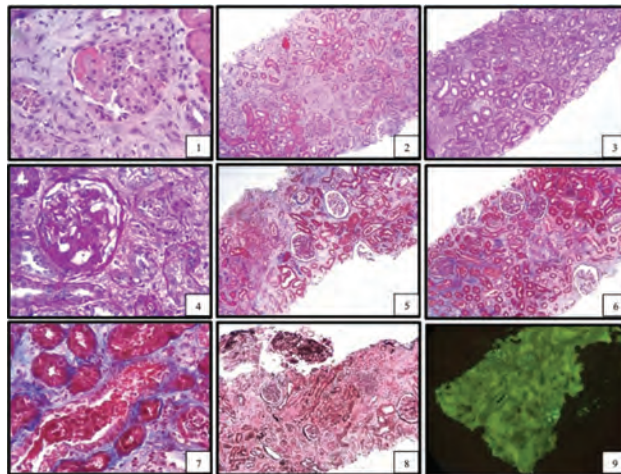

Key: TH - Thursday; FR - Friday; SA - Saturday; OR - Oral; PO - Poster; PUB - Publication Only

Underline represents presenting author.

## FR-PO633

**It's Not Always Lupus Nephritis**

Maris Hardee,<sup>1</sup> Carter V. Schwartz,<sup>2</sup> Neville R. Dossabhoy,<sup>2</sup> Tiffany Caza,<sup>3</sup> Mohammad Atari.<sup>2</sup> <sup>1</sup>University of Mississippi School of Medicine, Jackson, MS; <sup>2</sup>The University of Mississippi Medical Center, Jackson, MS; <sup>3</sup>Arkana Laboratories, Little Rock, AR.

**Introduction:** Systemic lupus erythematosus (SLE) is a complex immunological disease, with a plethora of manifestations. While lupus nephritis commonly affects patients with SLE, other renal diseases may also involve the kidney in SLE patients. Here, we describe a rare case of chronic sclerosing IgA nephropathy in a patient with SLE.

**Case Description:** A 31-year-old African American female with a history of SLE and secondary Sjogren syndrome presented with dyspnea and pleuritic chest pain. On exam, she had severe hypertension and peripheral edema. Labs were significant for pancytopenia, and creatinine elevated to 2.4 mg/dL (up from a baseline of 1 mg/dL). The urine protein-to-creatinine ratio was 6.57 g/g. Antinuclear antibodies, SSA antibodies, and chromatin antibodies were positive, with a low C3 complement but normal anti-double-stranded DNA antibodies. Kidney biopsy revealed chronic sclerosing IgA nephropathy and arterionephrosclerosis. Global (15/31) and segmental glomerulosclerosis with collapsing features were present. Immunofluorescence showed granular mesangial staining for IgA (+3), IgG (+1), IgM (+2), C3 (+3), kappa and lambda (+2), and negative C1q. Electron microscopy showed focal subendothelial and numerous mesangial electron-dense deposits. The patient declined testing for APOL-1.

**Discussion:** The incidence of IgA nephropathy in the setting of SLE is unknown. However, secondary IgA nephropathy has been well described in the setting of Sjogren syndrome. The patient described here presented with nephrotic range proteinuria, elevated creatinine and active systemic lupus, raising concern for lupus nephritis at the time. Kidney biopsy revealed an unexpected glomerular pathology of IgA nephropathy. This case emphasizes the importance of consideration of other etiologies as a cause of renal impairment in SLE patients even with active systemic lupus.

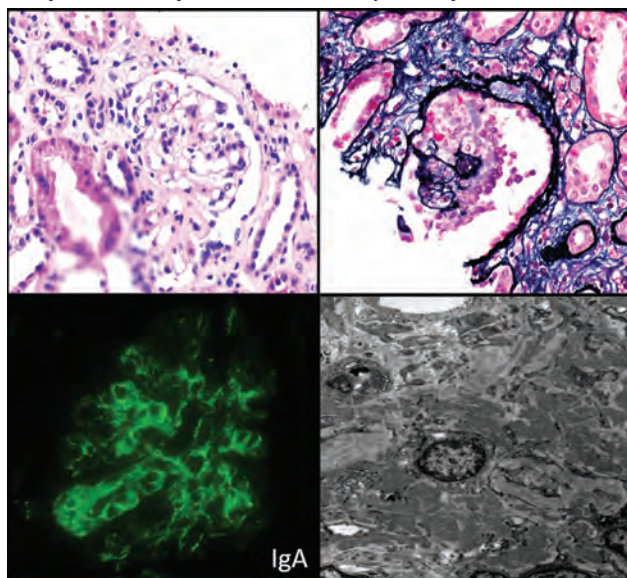

## FR-PO634

**Correlation of Urinary Waxy Casts With Renal Pathology**

Muner Mohamed, Vipin Varghese, Dustin Chalmers, Juan Carlos Q. Velez. Ochsner Nephrology Ochsner Medical Center, New Orleans, LA.

**Background:** Urinary waxy casts (uWxC) are traditionally described in textbooks as indicative of chronic renal parenchymal disease. However, data supporting this contention is lacking. uWxC can be seen in the context of various renal syndromes, including acute kidney injury, chronic kidney disease, rapidly progressive glomerulonephritis (GN) and nephrotic syndrome. Thus, we investigated the correlation between identification of uWxC and renal pathological findings.

**Methods:** We prospectively collected data of patients seen in nephrology consultation with a urine specimen subjected to microscopic examination of the urinary sediment (MicExUrSed) over a 3-year period. Within this cohort, we identified cases in which a kidney biopsy was concomitantly performed. We assessed the association of uWxC with glomerular or tubular pathology and with chronicity [interstitial fibrosis and tubular atrophy (IFTA) and glomerular obsolescence (GO)]

**Results:** Among 683 patients with MicExUrSed, 103 (15%) underwent kidney biopsy and were included. Mean age was 55 years, 51% women, 50% white and 38% self-identified black. Median serum creatinine was 3.2 (0.7-15.6) mg/dL and not significantly different between those with and without uWxC (4.7 vs 3.8 mg/dL, p=0.13). uWxC were identified in 35 (34%) cases. A glomerulopathy was diagnosed in 79 (77%). Among those with uWxC (n=35), a glomerulopathy was more likely to be found with concomitant acute tubular injury (ATI) than without ATI (57% vs 23%, p=0.0006), whereas among

those without uWxC, glomerulopathies were found with or without concomitant ATI with similar frequency (41% vs 34%, p=0.48). Overall (n=103), more patients with uWxC had  $\geq 20\%$  IFTA compared to those without uWxC (74% vs 51%, p=0.03). Among those with glomerulopathy (n=79), more patients with uWxC had  $\geq 20\%$  IFTA compared to those without uWxC (89% vs 56%, p=0.004). uWxC did not correlate with GO.

**Conclusions:** Identification of uWxC denotes greater likelihood of finding evidence of ATI superimposed with a glomerulopathy rather than finding an isolated glomerular lesion. uWxC are associated with greater probability of finding  $\geq 20\%$  IFTA in a kidney biopsy specimen, particularly in those with a glomerular pathology. This observation may help clinicians weigh on suitability of a kidney biopsy when chronicity or coexistence of ATI are in question.

## FR-PO635

**Urinary White Blood Cell Casts Are Commonly Associated With Glomerulonephritis Rather Than Acute Interstitial Nephritis**

Dustin Chalmers,<sup>1</sup> Swetha Rani Kanduri,<sup>1,2</sup> Vipin Varghese,<sup>1</sup> Jay R. Seltzer,<sup>3</sup> Juan Carlos Q. Velez.<sup>1,2</sup> Ochsner Nephrology <sup>1</sup>Department of Nephrology, Ochsner Health, New Orleans, LA; <sup>2</sup>Ochsner Clinical School, The University of Queensland, Brisbane, QLD, Australia; <sup>3</sup>Missouri Baptist Medical Center, St. Louis, MO.

**Background:** Urinary white blood cell casts (uWBCC) are traditionally thought to be indicative of acute interstitial nephritis (AIN). However, clinical data supporting this contention is lacking. uWBCC has also been described in glomerulonephritis (GN) and pyelonephritis (PN). Herein, we investigated the diagnostic performance of uWBCC in differentiating the etiology of kidney disease.

**Methods:** We prospectively collected data of patients seen in nephrology consultation who had a urine specimen subjected to microscopic examination of the urinary sediment (MicExUrSed) as part of the clinical evaluation. Within this cohort, we identified cases in which a kidney biopsy was performed. We assessed the performance of uWBCC in the diagnosis of GN and AIN. To specifically assess for immune-mediated and/or proliferative GN (uWBCC are plausible), podocytopathies (e.g., collapsing glomerulopathy, diabetic nephropathy) were grouped separately. In addition, we pooled cases in which uWBCC were identified, with and without kidney biopsy confirmation, at our site and at an additional contributing site where MicExUrSed is routinely performed.

**Results:** Among 683 patients with MicExUrSed, 103 (15%) underwent kidney biopsy and were included. Mean age was 55 years, 51% women, 50% white and 38% self-identified black. Median serum creatinine was 3.4 (0.7-15.6) mg/dL. Biopsy diagnosis was GN in 42 (41%) and non-GN in 61 cases (59%). The sensitivity, specificity, positive predictive value (PPV) and negative predictive value (NPV) of uWBCC for diagnosis of GN were 26%, 85%, 55% and 62%, respectively, whereas the sensitivity, specificity, PPV and NPV of uWBCC for diagnosis of AIN were 8%, 79%, 5% and 87%. Thus, the PPV of uWBCC to diagnose GN was greater than that for AIN. In addition, out of 37 cases total with uWBCC, 27 (73%) had GN [16 (59%) of them with acanthocytes also present], 3 (8%) had PN, 6 (16%) had others and only 1 (3%) had AIN, further substantiating the observation that uWBCC are more likely to be associated with GN.

**Conclusions:** Identification of uWBCC predominantly reflected a diagnosis of GN rather than AIN. This finding challenges the current paradigm, traditional teaching, and standardized testing on this topic, all of which should be revisited.

## FR-PO636

**Association of Obesity With Cardiorenal Outcomes in the CureGN Cohort**

Evan Zeitler, Yichun Hu, Susan L. Hogan, Dorey A. Glenn, Ronald Falk, Amy K. Mottl. UNC Kidney Center, Chapel Hill, NC.

**Background:** Obesity is a risk factor for cardiorenal outcomes in patients with CKD, but its relevance in glomerulonephropathy (GN) is less known.

**Methods:** Participants  $\geq 16$ yr from CureGN were categorized by age-appropriate BMI status at enrollment: normal (20-24 in adults; 5-85 %ile in children), overweight (25-29 for adults, 85-95th %ile in children), obese (30-34 in adults,  $\geq 95$ th %ile in children) or morbidly obese ( $\geq 35$  in adults and children). Composite kidney (40% decline in eGFR/end-stage kidney disease) and composite cardiovascular (myocardial infarction/heart failure diagnosis/stroke/death) outcomes were evaluated. Baseline characteristics and frequency of outcomes were compared between weight status groups using Chi-square and Kruskal-Wallis tests. A log rank test was used to compare Kaplan-Meier curves of time-to-event for the kidney outcome.

**Results:** Characteristics and outcomes are shown in the **Table**. The cohort was 44% female with a median age of 44 and median (IQR) follow up of 3.74 (2.06, 5.21) years. GN diagnoses were 28% IgAN, 26% FSGS, 31% MN and 14% MCD. Higher baseline BMI was associated with higher blood pressure (p < 0.0001) and urine protein-to-creatinine ratio (uPCR, p = 0.006), and lower eGFR (p = 0.0002) at enrollment compared to those with a lower BMI. More kidney events occurred in the highest weight category, and the time to kidney event was shorter (**Figure**), but this was not true for cardiovascular events.

**Conclusions:** BMI is an important mediator of major kidney outcomes in GN, stressing the importance of this modifiable risk factor in its management.

**Funding:** NIDDK Support

Table with 6 columns: Demographic, Normal (n=488), Overweight (n=156), Obese (n=163), Severe/obese (n=100), Missing, P-value. Rows include Age, BMI, Female Sex, Race and ethnicity, Time since biopsy, Number of cardiovascular events, RAAS blockade, CH type, Systolic BP, Diastolic BP, LDL-C, eGFR, Outcomes (Combined kidney endpoints, AHA/ACC atherosclerotic CVD, Cholesterol Status, Transferrin, eGFR < 30 ml/min/1.73m2, Combined CV endpoints, Myocardial infarction, Heart failure, Stroke, Death).

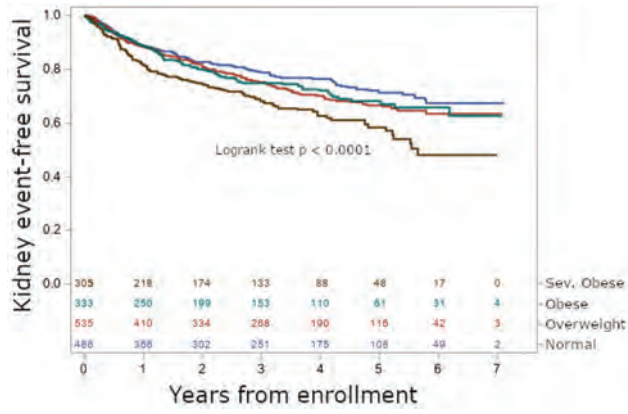

FR-PO637

Epidemiology of Rapidly Progressive Glomerulonephritis in Iceland

Background: Rapidly progressive glomerulonephritis (RPGN) is a serious presentation of glomerulonephritis (GN), defined as deteriorating kidney function over few days to three months. The average yearly incidence of RPGN in Iceland was 0.6/100,000 in the period 1983-2002. The aim of this study was to examine the epidemiology of RPGN in Iceland over the last two decades with regard to incidence and outcome.

Methods: This was a retrospective, population-based study of the period 2002-2021. We identified cases by searching SNOMED diagnosis codes in the database of the Department of Pathology at Landspítali - The National University Hospital of Iceland (LUH). We also searched for ICD-10 diagnosis codes indicative of RPGN in the LUH data warehouse. Nephrology services in Iceland are centralized at LUH, where all kidney biopsies in the country are performed. Demographic and clinical data were obtained from patients medical records. Annual incidence was calculated based on the population of Iceland each year (numbering 376,248 on January 1, 2022)

Results: Eighty-seven cases of RPGN were identified, 80 from biopsy data and additional seven by search for IDC-10 diagnosis codes. The median age was 58 years (range, 8- 89) and 51 (59%) were men. Pauci-immune GN accounted for 41 (47.1%) cases, 36 of which were positive and 5 negative for ANCA. Eighteen patients (20.7%) had anti-GBM disease and 25 (28.7%) immune-complex GN. The mean annual incidence of RPGN was 1.3/100,000 population. Increase in the incidence (per 100,000/year) from the first 5-year period to the last was noted for ANCA-associated vasculitis (from 0.41 to 0.67), ANCA-negative vasculitis (from 0.07 to 0.17) and for anti-GBM disease (from 0.21 to 0.33). The incidence decreased for immune-complex GN (from 0.55 to 0.11). Acute dialysis was needed in 30 cases (34.5%). At 6 months from diagnosis, 23 patients (26%) were dialysis-dependent and 11 (13%) had died.

Conclusions: The study suggests an increase in RPGN incidence in Iceland in the past 20 years. Since most patients with clinical presentation of RPGN are likely to be referred to nephrology and undergo a kidney biopsy, aging of the population or a true increase in incidence are the most likely explanations. Prognosis remains relatively poor and a high proportion of patients requires kidney replacement therapy.

FR-PO638

Are Immunosuppression Treatments for Glomerular Disease Associated With Increased Cardiovascular Risk?

Mohammad Atiquzzaman,<sup>1</sup> Mark Canney,<sup>2</sup> Yuyan Zheng,<sup>1</sup> Lee Er,<sup>1</sup> Yinshan Zhao,<sup>3</sup> Dilshani Induruwege,<sup>1</sup> Sean Barbour,<sup>3</sup> <sup>1</sup>BC Provincial Renal Agency, Vancouver, BC, Canada; <sup>2</sup>University of Ottawa, Ottawa, ON, Canada; <sup>3</sup>The University of British Columbia, Vancouver, BC, Canada.

Background: The risk of cardiovascular disease (CVD) associated with immunosuppression (IS) treatments for glomerular disease is currently unknown. This was investigated in a population-level cohort of patients with glomerular diseases from British Columbia, Canada after adjusting for eGFR and proteinuria over time as measures of disease activity.

Methods: All adults with IgA nephropathy, FSGS, membranous nephropathy or minimal change disease on a kidney biopsy between January 2000 & December 2012 were identified from a provincial registry, excluding those with ESKD prior to the biopsy date or no available follow-up. IS medications were categorized as antimetabolites, calcineurin inhibitors, corticosteroids or cyclophosphamide, and quantified using defined daily doses (DDD) or grams, as appropriate. The primary outcome was acute cardiovascular events and urgent revascularization after biopsy date, evaluated using extended Cox regression models to determine the association with time-varying IS exposure after adjusting for eGFR & proteinuria over time, type of glomerular disease & CV risk factors.

Results: Amongst 1,912 patients with median follow-up 6.8 years, 212 (11.1%) patients developed a CV outcome event. In multivariable models, prednisone and antimetabolite exposures were not associated with CV risk. However, modest (150-300 DDD) & high (>300 DDD) cumulative doses of calcineurin inhibitors were both associated with >2-fold higher risk of CV events, and each 10g of cumulative cyclophosphamide exposure was associated with a 1.5-fold higher risk of CV events (Table).

Conclusions: Calcineurin inhibitors and cyclophosphamide used for the treatment of glomerular diseases are both associated with increased risk of CV events independent of treatment effects on disease activity. These results can inform the selection of therapies in clinical practice with less CVD morbidity.

Table with 5 columns: Exposure to immunosuppression medications, Univariable model (Unadjusted HR (95% CI), P-value), and Multivariable model (Adjusted\* BR (95% CI), P-value). Rows include Prednisone exposure over time, Calcineurin inhibitor exposure over time, Antimetabolite exposure over time, and Cyclophosphamide exposure over time.

FR-PO639

NURTuRE-INS: A Biobank of United Kingdom Idiopathic Nephrotic Syndrome Patients to Enable Research and Disease Stratification

Liz Colby,<sup>1</sup> Melissa Benavente,<sup>2</sup> Maarten W. Taal,<sup>2,3</sup> Elaine M. Davies,<sup>4</sup> Michael L. Nation,<sup>4</sup> Tim S. Johnson,<sup>5</sup> Lorna J. Hale,<sup>6</sup> Uwe Andag,<sup>7</sup> Philipp Skrobilin,<sup>7</sup> Robert J. Unwin,<sup>8</sup> Ania B. Kozielec,<sup>9</sup> Gavin I. Welsh,<sup>1</sup> Moin Saleem.<sup>1</sup> <sup>1</sup>University of Bristol Faculty of Health Sciences, Bristol, United Kingdom; <sup>2</sup>University of Nottingham School of Medicine, Nottingham, United Kingdom; <sup>3</sup>Royal Derby Hospital, Derby, United Kingdom; <sup>4</sup>Kidney Research UK, Peterborough, United Kingdom; <sup>5</sup>The University of Sheffield, Sheffield, United Kingdom; <sup>6</sup>UCB Pharma, Slough, United Kingdom; <sup>7</sup>Evotec AG, Hamburg, Germany; <sup>8</sup>AstraZeneca PLC, Cambridge, United Kingdom; <sup>9</sup>King's College London, London, United Kingdom.

Background: Idiopathic Nephrotic Syndrome (INS) is a heterogeneous disease and current classification is based on observational responses to therapies. The NURTuRE-INS cohort has been established as part of the UK-first standardised renal-biorepository with linked clinical data to develop novel methods to stratify patients for better disease management. Funding and governance was achieved via a unique collaborative partnership between Kidney Research UK, industry and academic investigators.

Methods: Patients are being recruited from 14 adult and 8 paediatric centres throughout Great Britain. Detailed longitudinal clinical data will be collected alongside long-term outcomes with respect to end stage kidney disease and survival. Serum, plasma, urine, RNA and DNA samples are collected and processed according to strict industry standards. Clinically stained histology slides will be digitally scanned, and any surplus biopsy tissue blocks will be cut for additional immunohistochemistry.

**Results:** Recruitment commenced in October 2017 and 664 patients have been recruited with recruitment expected until December 2022. A summary of the cohort is presented in the table. All patients will have SNP array genotyping and exome sequencing and 74% of the cohort have had a kidney biopsy (46.4% FSGS, 50.1% Minimal Change, 3.5% Other). We are currently analysing the data for detailed molecular stratification, and further research studies are invited.

**Conclusions:** NURTuRE-INS is a unique resource of high-quality patient samples alongside clinical data to mechanistically investigate INS patients. This will result in better disease management and help develop new treatments, as stratifying patients prior to clinical trial entry is likely to increase their success. Access to the data and biosamples will be available by application to an independent Strategic Oversight and Access Committee next year.

**Funding:** Commercial Support - UCB Pharma Ltd, Evotec International GmbH, AbbVie, Travere, AstraZeneca, Private Foundation Support

NURTuRE-INS Cohort Characteristics

	Steroid Resistant			Steroid Sensitive	Steroids Not Treated	Unknown	Total
	Primary	Secondary	Presumed				
Number of Patients	83	18	20	412	57	74	664
% Male	43.4%	44.4%	35.0%	53.9%	57.9%	60.8%	52.9%
% White Ethnicity	69.9%	61.1%	55.0%	64.8%	68.4%	85.1%	67.6%
Median Age of Onset (Years) (Inter Quartile Range)	7 Yrs (2.5 - 21)	5.5 Yrs (2 - 14)	0.125 Yrs (0 - 1.5)	16 Yrs (3 - 46)	35 Yrs (25 - 46)	38 Yrs (24 - 60)	20 Yrs (4 - 42.5)
% Undergone Kidney Transplantation	25.3%	16.7%	45.0%	2.7%	24.6%	10.8%	9.9%

FR-PO640

Long-Term Use of Voclosporin in Patients With Class V Lupus Nephritis: Results From the AURORA 2 Continuation Study

Dawn J. Caster,<sup>1</sup> Amit Saxena,<sup>2</sup> Salem Almaani,<sup>3</sup> Amber Rosales,<sup>4</sup> Henry Leher.<sup>4</sup> <sup>1</sup>University of Louisville, Louisville, KY; <sup>2</sup>NYU Langone Health, New York, NY; <sup>3</sup>The Ohio State University Wexner Medical Center, Columbus, OH; <sup>4</sup>Aurinia Pharmaceuticals Inc, Victoria, BC, Canada.

**Background:** Persistent proteinuria increases risk of comorbidities in lupus nephritis (LN) and rapid reductions in protein are predictive of improved long-term renal health. Patients (pts) with Class V LN may take longer to respond to therapy and treatments that efficiently reduce proteinuria in this population are needed. We report on a post-hoc analysis of voclosporin in Class V LN using three years of data from the Phase 3 AURORA 1 and AURORA 2 studies.

**Methods:** AURORA 1 enrolled pts with biopsy-proven active LN, UPCR ≥1.5 mg/mg (≥2.0 mg/mg for pure Class V), and eGFR >45 mL/min/1.73 m<sup>2</sup>. Pts completing AURORA 1 were eligible to enter AURORA 2 on the same blinded therapy (voclosporin or placebo) in combination with MMF and low-dose steroids. Hazard ratios (HR) for the time to UPCR ≤0.5 mg/mg and mean eGFR levels were assessed in pts with mixed and pure Class V LN.

**Results:** A total of 80 Class V pts continued treatment into AURORA 2. Baseline UPCR was 3.7 and 3.4 mg/mg in control and voclosporin arms, respectively. Differences between treatment arms in UPCR reductions were apparent within the first month and sustained at three years; the median time to UPCR ≤0.5 mg/mg was 3.7 and 16.3 months in the voclosporin and control arms, respectively (HR 2.54; p=0.0004). Results were similar in pure and mixed Class V voclosporin arms; control arms took longer to reach the endpoint (Figure 1). Mean corrected eGFR levels were similar in all treatment arms and stable throughout the study (Figure 1).

**Conclusions:** Voclosporin-treated pts with Class V LN saw substantial reductions in UPCR that occurred faster than in pts treated with MMF and low-dose steroids alone. Voclosporin may be beneficial in limiting the negative long-term impact of proteinuria in this population.

**Funding:** Commercial Support - Aurinia Pharmaceuticals Inc.

Figure 1. Time to UPCR ≤0.5 mg/mg in Pure (A) and Mixed (B) Class V LN Patients, and Mean Corrected eGFR Over Time in Pure (C) and Mixed (D) Class V LN Patients

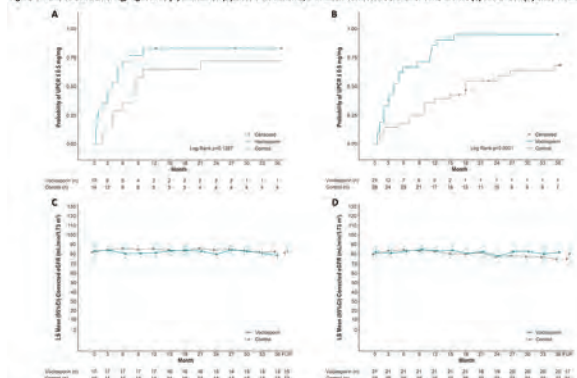

Analysis of AURORA 2 patients with Class V disease includes pooled data from AURORA 1 and AURORA 2. Time to UPCR ≤0.5 mg/mg was assessed with a Kaplan-Meier analysis. Renal function was assessed with corrected eGFR (Cockcroft-Gault). Overall population. Collaborative treatment using a propensity score of 0.77. Analysis of time to UPCR ≤0.5 mg/mg over time includes data from a follow-up visit at four weeks after study drug discontinuation. CI, confidence interval; eGFR, estimated glomerular filtration rate; FUP, follow-up visit; HR, hazard ratio; UPCR, urine protein creatinine ratio.

FR-PO641

The Value of Repeat Kidney Biopsy-Based Directed Management of Lupus Nephritis: A Pilot Study in a Single Centre

Li Jin Ooi, U Zhe Ding, Arvind Ponnusamy, Royal Preston Hospital, Preston, United Kingdom.

**Background:** The duration of maintenance therapy for lupus nephritis (LN) has no fixed guidance at present. It has also been established that there is a discordance between clinical and histological remission. Studies have suggested using histological findings from a repeat renal biopsy as an adjunct to clinical parameters to guide treatment. We undertook a pilot study in a tertiary centre to assess the feasibility of repeat kidney biopsy in directing the management of LN.

**Methods:** Patients with biopsy-proven active lupus nephritis which include class 3,4,5 who had a subsequent planned elective biopsy at our centre (n=7). Disease activity was assessed using the NIH activity (AI) and chronicity indices (CI). Therapeutic management was then modified based on activity and chronicity index from second renal biopsy. AI > 2 was considered for continuation of immunosuppression and maintenance therapy to be reduced or stopped for those with lower AI index.

**Results:** The mean age of the first presentation of lupus nephritis was 51±14.1 years, 6 of whom were female. The median period between the first and subsequent biopsy was 29.9 months. Mean eGFR at first biopsy was 56.2±21.4, 70.5±19.5 at second biopsy and 65±21 at last follow up. uPCR at first biopsy was 666.3±393.2 mg/mmol, 80.6±134.3 mg/mmol at second biopsy and 57.7±88.6 mg/mmol at last follow up. Mean activity index was 7.5±3.3 at first biopsy and 0.67±0.82 (p<0.05) at second biopsy whilst the mean chronicity index was 1.17±0.98 at the first biopsy and 2.17±1.17 (p<0.05) at the second biopsy. Following the results from the second biopsy, Immunosuppression therapy was escalated for 1 patient, reduced for 4 patients, and stopped for 2 patients of whom both had no further relapse at the last follow up.

**Conclusions:** Our pilot study suggests that renal biopsy is a valuable tool alongside clinical parameters. Repeat kidney biopsy may prevent unnecessary continuation of immunosuppression without the risk of relapse. The data also showed that induction immunosuppression and rapid control of clinical disease activity did not necessarily prevent chronic damage in LN suggesting that there may be a role for anti-fibrotic agents. No adverse events were associated with the biopsies done in this cohort suggesting that this is safe. The data above was limited by its single-centre retrospective nature and small sample size.

FR-PO642

Characteristics and Outcomes of a Lupus Nephritis Cohort From Latin America

María F. Zavala Miranda,<sup>1,2</sup> Abril A. Pérez Arias,<sup>1,3</sup> Sofia E. M. Macedo,<sup>1,2</sup> Luis E. Morales-Buenrostro,<sup>1,2</sup> Roque A. Comunidad Bonilla,<sup>1</sup> Juan M. Mejía-Vilet.<sup>1,2</sup> <sup>1</sup>Instituto Nacional de Ciencias Médicas y Nutrición Salvador Zubiran, Ciudad de Mexico, Mexico; <sup>2</sup>Universidad Nacional Autónoma de Mexico, Mexico City, Mexico; <sup>3</sup>Universidad Autónoma de Baja California, Mexicali, Mexico.

**Background:** Differences in Lupus nephritis (LN) presentation, prognosis, and rates of progression to end-stage renal disease (ESRD) have been described among patients from different genetic backgrounds, ethnicities, and geographic regions. Our aim was to characterize the clinical presentation and outcomes of a Hispanic population from Latin America.

**Methods:** We studied 441 subjects with systemic lupus erythematosus and biopsy-proven LN followed for >36 months. We obtained demographic, clinical, laboratory, histopathological, and treatment variables. All outcomes were analyzed by survival analysis and included the response to therapy, renal relapses, progression of kidney disease (decline in eGFR≥30%, doubling of serum creatinine, ESRD), and patient survival.

**Results:** The median age of the study cohort was 29 years (IQR 23-37), and 96% were female. The median eGFR at inclusion was 81mL/min/1.73m<sup>2</sup> (IQR 48-118), and 24h-uPCR was 3.4g/g (IQR 1.9-5.6). Mixed class LN (III/IV+V) was the most frequent. Over a median follow-up of 79 months, complete response rates were 22.3%, 41.7%, and 51.7%, at 6-, 12-, and 24-months, respectively. Renal relapse rates were 32.2% and 50.6% at 3- and 5-years. By 3- and 5-years, 20.9% and 31.5% had decline in eGFR ≥30%, 13.8% and 22.8% doubled their serum creatinine, and 8.6% and 17.7% progressed to ESRD. The factors associated with adverse kidney outcomes were age, eGFR at presentation, the histologic chronicity index, and the response to therapy. Patient survival was 98.2% and 97.1% at 3- and 5-years.

**Conclusions:** The response to treatment and patient survival in our cohort is comparable to that observed in other regions, there is a high rate of renal relapses and progression to ESRD.

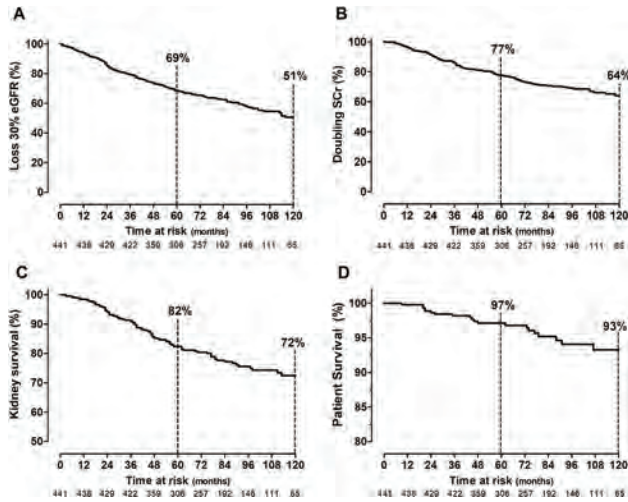

Rates of progression to loss of kidney function by response status at different months of follow up.

FR-PO643

**Trends in Lupus Nephritis: The Co-Management Conundrum**  
 Ryan Rex, Denise Foy. *Spherix Global Insights, Exton, PA.*

**Background:** With new lupus nephritis (LN) treatment options available, patient management is more complex and co-management between nephrologists and rheumatologists presents challenges.

**Methods:** Nephrologists (n=50) and Rheumatologists (n=50) have been surveyed monthly beginning in Feb. 2021 regarding their use of belimumab and voclosporin in LN. Between Aug. 30 and Oct. 30, 2021, we conducted a retrospective, HIPAA-compliant chart audit (n=954 charts for pts with Class III, IV +/-V LN) in collaboration with 92 nephrologists and 110 rheumatologists.

**Results:** Longitudinal tracking of voclosporin and belimumab highlight increased rate of initiation and utilization among rheumatologists and nephrologists for both agents, however notable differences are emerging. Additionally, a potential gap in care is noted as 65% of nephrologists and 72% of rheumatologists agree "Co-management between rheumatologists and nephrologists for patients with LN could be vastly improved." As of May 2022, the percent of physicians prescribing voclosporin is higher among nephrologists than rheumatologists (52% vs. 40%), however, patient initiations by rheumatologists are beginning to outpace those by nephrologists. While both groups used calcineurin inhibitors (CNIs) in about 10% of patients in the chart audit, rheumatologists were more likely to use voclosporin than nephrologists who reported higher use of traditional CNIs (Figure 1 uploaded). Rheumatologists have decades-long experience using belimumab in SLE which translates to greater experience in LN for rheumatologists vs. nephrologists (92% vs. 74%). Rheumatologists report managing over three times as many LN patients on belimumab to date (9.4 vs. 2.6). Further, nephrologists report more than half of their patients on belimumab were initiated by the rheumatologist whereas the converse tends not to occur.

**Conclusions:** Our data suggests rheumatologists are taking increased ownership of treatment initiation and LN patient management. In addition to vast experience with belimumab in SLE, rheumatologists' experience with biologic agents and in-office administration helps them navigate the prior authorization process. It is likely rheumatologists will refer patients to nephrologists later than in the past now that new treatment options are available.

	Nephro	Rheum
% of LN pts on CNIs	10.2%	10.2%
voclosporin	24%	44%
tacrolimus	60%	46%
cyclosporine	16%	10%

FR-PO644

**Lymphangiogenesis in Biopsy-Proven Lupus Nephritis**  
 Jihyun Yeom, Kyung Pyo Kang. *Jeonbuk National University Hospital, Jeonju, Jeollabuk-do, Republic of Korea.*

**Background:** Systemic lupus erythematosus (SLE) is a chronic autoimmune disease characterized by immune complex deposits, inflammatory cell infiltrations in multiple organs, and approximately half of the patients affected kidneys. The histological class and degree of activity/chronicity affected the therapeutic plan and prognosis in lupus nephritis. Thus, we intend to elucidate the correlation between lymphangiogenesis and activity indices in LN patients.

**Methods:** This study was reviewed and approved by the Institutional Review Board of Jeonbuk National University Hospital (CUH- 2020-07-032-001). We reviewed medical records for the biopsy-proven lupus nephritis and immunohistochemistry for D2-40

was performed. D2-40 positive lymphatic vessels were counted in the whole cortex of biopsy specimens, and the density of lymphatics was determined by computer-assisted morphometric analysis (magnification x200).

**Results:** Table 1 shows the clinical characteristics of the patient in our study. All 6 patients were women, demonstrating a female predominance in lupus, and renal manifestation occurred firstly in 2 patients at the time of diagnosis of lupus. In addition, 4 patients were proliferative lupus nephritis and showed high ANA titer, lower C3 levels, and higher activity indices. Figure 1 describes the correlation between the expression of D2-40 positive lymphatic vessels and lupus activity indices, and two factors have a positive correlation. (p value=0.0302)

**Conclusions:** Our study shows the higher the activity indices, the more the expression of lymphatic vessels in lupus nephritis, which may help set treatment target in the future.

	Patient 1	Patient 2	Patient 3	Patient 4	Patient 5	Patient 6
Age at diagnosis	31	45	48	18	16	34
Sex	F	F	F	F	F	F
Time since SLE diagnosis, mo	1	327	264	1	15	6
ISN/RPS class	III(III/IV)	III(III/IV)	V	I	IV	IV
Activity/Chronicity index, score	12/2	5/3	1/0	0/0	19/2	11/2
WBC count (x10 <sup>3</sup> /ul)	3,480	7,760	7,420	3,67	6,82	10,26
Hemoglobin (g/dl)	9.5	9.1	13.9	9.4	12.6	10.3
Lymphocyte count (x10 <sup>3</sup> /ul)	1,200	0,380	2,430	0,99	0,92	1.2
ESR (mm/hr)	11	11	38	94	26	37
Cr (mg/dl)	0.82	0.45	0.59	0.38	0.32	0.71
ANA titer	1:1280	1:1280		1:1280		1:1280
C3 (mg/dl)	32.9	50.7	94.1	79	50.2	57.7
C4 (mg/dl)	1.2	6.2	13.4	8.3	5.3	14.3
Anti-dsDNA positivity	+	+	+	+	+	+
Pyuria (urine WBC > 5/HPF)	1-4	1-4	1-4	3-5	> 50	21-50
Urine protein/creatinine ratio (mg/g)	880.08	4502.23	2806.40	9581.43	6453.54	921.7

Table 1. The clinical characteristics of the patient

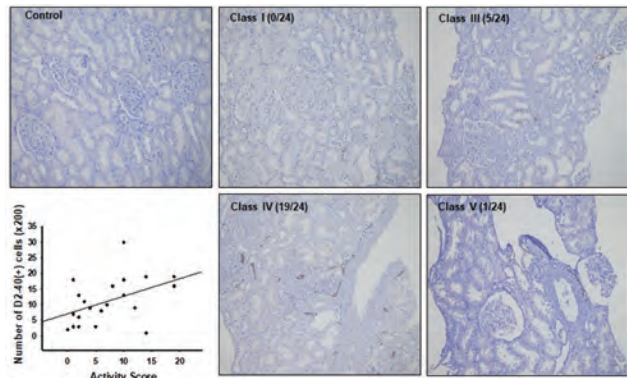

Figure 1. The correlation between the expression of D2-40 lymphatic vessels and lupus activity indices

FR-PO645

**Safety and Tolerability of Avacopan During the Early Access Program for ANCA-Associated Vasculitis**

Jolijn R. van Leeuwen, Yoe Kie Onno Teng. *Leids Universitair Medisch Centrum, Leiden, Netherlands.*

**Background:** ANCA-associated vasculitis (AAV), a rare and severe disease, is associated with a high risk of complications from AAV and the treatment's toxic effects. Avacopan, a selective C5aR inhibitor, was recently approved for the adjunctive treatment of AAV. As part of the Early Access Program (EAP), the safety and tolerability of thirty patients treated with avacopan were analyzed.

**Methods:** Safety data was recorded in a global safety database between February 2019 and November 2021. All participating physicians were ADVOCATE investigators with previous avacopan experience and safety training, including recognizing adverse events (AEs). The safety and tolerability of avacopan during the EAP are described below.

**Results:** Thirty AAV patients had avacopan exposure during three years of EAP. Twenty-four AEs were reported in eight individual case safety reports (ICSRs) from eight patients (27%). Seventy-three percent (22 patients) of patients did not report any AEs. No deaths were reported. Fifteen events in five patients (16.7%) were considered serious AEs (SAEs) and are listed by System Organ Class in Table 1. Four SAEs were categorized as infection-related events occurring in two patients (6.7%), resulting in three hospitalizations. Six SAEs in 2 patients were assessed as related to avacopan by the reporter, leading to the discontinuation of Avacopan.

**Conclusions:** Serious Adverse Events occurred in five patients (16.7%). The most frequently reported SAEs were observed in the Infections and infestations and Renal and Urinary disorders SOCs. Seventy-three percent (22 patients) of patients did not report any AEs.

Serious Adverse Events reported in 30 AAV patients enrolled in the EAP

System Organ Class (Preferred Term)	SAE, n (%); #	SAEs related to Avacopan <sup>®</sup> , n (%); #
Infections and infestations (Klebsiella infection, Staphylococcal bacteraemia, Urrosepsis, COVID 19)	2 (6.7%); 4	1 (3.3%); 3
Renal and urinary disorders (Acute kidney injury, End-stage renal disease, Renal failure, Renal impairment)	3 (10%); 4	1 (3.3%); 1
Eye disorders (Age-related macular degeneration, Visual acuity reduced, Metamorphopsia, Retinal oedema)	1 (3.3%); 4	1 (3.3%); 1
Blood and lymphatic system disorders (Lymphopenia)	1 (3.3%); 1	-
Reproductive system and breast disorders (Prostatitis)	1 (3.3%); 1	1 (3.3%); 1
Vascular disorders (Haemorrhage)	1 (3.3%); 1	-
Total	15	6

N: number of patients. %: percentage of patients. #: number of events.

\*Causality as assessed by reporter.

FR-PO646

**Maintenance of ANCA Vasculitis Remission by Intermittent Rituximab Dosing Based on B Cell Reconstitution vs. Serologic ANCA Flare**  
 Reza Zonozi,<sup>1</sup> Frank B. Cortazar,<sup>2</sup> Pravart Nithagon,<sup>1</sup> Noah Huiuzenga,<sup>1</sup> Anushya Jeyabalan,<sup>1</sup> John Niles.<sup>1</sup> <sup>1</sup>Massachusetts General Hospital, Boston, MA; <sup>2</sup>Vasculitis and Glomerular Disease Center, Albany, NY.

**Background:** Fixed-schedule rituximab dosing over 2 years is effective at maintaining remission for patients with ANCA vasculitis. However, rituximab is associated with adverse events. The ideal dosing strategy for long-term maintenance of remission remains unknown.

**Methods:** This is an open-label, single center, randomized and two-arm controlled trial. Inclusion criteria were AAV, in remission on fixed-rituximab for at least 2 years, and off other immunosuppression including steroids. Exclusion criteria were IgG level < 300 mg/dL and another disease with life expectancy < 36 months. BVAS, B cells and ANCA titers are monitored every 3 months. In the B cell arm, rituximab 1000 mg is reinfused once peripheral B cells are > 10 B cells/mm<sup>3</sup>. In the ANCA arm, rituximab 1000 mg is reinfused x 2 for significant ANCA titer increase. Randomization was stratified by ANCA serotype. The primary outcome measured was clinical relapse, defined by BVAS-WG ≥ 2. Secondary outcomes of interest included SAEs.

**Results:** 57 subjects were randomized to the ANCA arm, and 58 patients to the B cell arm. The median follow-up time was 4.1 years (IQR, 2.5 - 5.0). At 3 years 4.1% (95% CI, 1.0 - 15.6) of patients in the B cell arm experienced a clinical relapse, compared to 20.5% (95% CI, 11.9 - 34.1) of patients in the ANCA arm (log-rank p = 0.045). 22 SAEs occurred in the ANCA arm, compared to 21 in the B cell arm (NS). Discontinuation rate of rituximab due to any SAE/AE(s) was 13.6% (95% CI, 6.7 - 26.4%) in the B cell arm, and 0% in the ANCA arm, at 3 years after entry (log-rank p = 0.02).

**Conclusions:** In patients with AAV in remission after 2 years of continuous rituximab, tailoring rituximab to B cell return is associated with lower rates of clinical relapse, but higher rates of drug discontinuation due to an adverse event, compared to tailoring rituximab to ANCA rise.

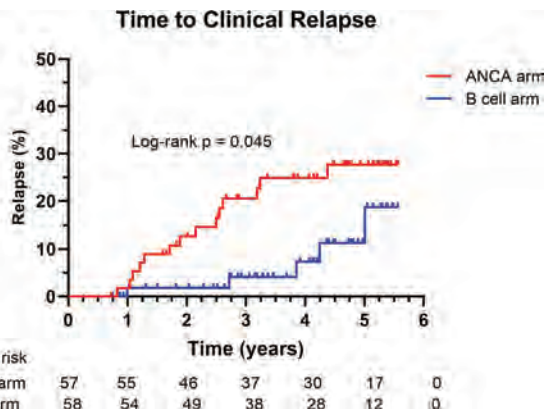

Figure 1. Kaplan-Meier curve to time to clinical relapse.

FR-PO647

**Impact of Immunosuppressive Therapy on Vascular and Vasogenic Alterations of the Central Nervous System in Patients With ANCA-Associated Vasculitis With Renal Involvement**

Arkadiusz Lubas, Artur Maliborski, Anna Grzywacz, Grzegorz Splocharski, Stanislaw Niemczyk. *Wojkowski Instytut Medyczny, Warszawa, Poland.*

**Background:** The data concerning the prevalence of CNS vasculitis in patients with ANCA-associated vasculitis (AAV) with renal involvement is limited. Moreover, the efficacy of systemic immunosuppressive therapy (IS) on CNS alterations in this

population of patients was not clearly evidenced. This study aimed to prospectively estimate the occurrence of CNS vascular alterations and the influence of 1-year IS in patients with AAV with renal involvement.

**Methods:** Patients with acute onset of AAV with renal involvement qualified for the intensive IS were prospectively included in the study. As the treatment, an induction and a maintenance IS were provided. BVAS, creatinine, MPO-ANCA, PR3-ANCA, and non-contrast brain MRI angiography were estimated initially and after 12 months. Vascular alterations in the form of alternating narrowing and dilatation (aND) in secondary and tertiary cerebral artery branches (CAB) were investigated. Moreover, the number of focal ischemic white matter lesions (WML) was estimated. McNamara test was used to compare dependent categorical variables and Wilcoxon's test for continuous dependent variables comparison.

**Results:** In total, 17 patients who completed both brain MRI assessments were included in the study. Initially, aND was found in 12/17 (70.5%) patients, but after treatment, these alterations were investigated in 7/12 (41.2%) participants (p=0.074). In the secondary CAB IS resulted in 50% decrease of aND (10/17 vs. 5/17; p=0.074). Moreover, the reduction of aND in tertiary CAB was significant (9/17 (52.9%) vs. 3/17 (17.6%); p=0.041). In all participants, WML were detected before and after the IS, and the IS did not change the number of these lesions. A significant decrease in BVAS (7.76 ±3.49 vs. 0.65 ±0.86; p<0.001) and MPO-ANCA (60.2 ±46.5 vs. 24.5 ±36.0 p<0.001) after IS was investigated. The decrease of creatinine and PR3-ANCA was not important.

**Conclusions:** The occurrence of brain vasculitis lesions is frequent in patients with a flare of ANCA-associated vasculitis with renal involvement. Immunosuppressive treatment decreases CNS vascular alterations, which corresponds with the decrease of MPO-ANCA and clinical activity of the disease.

**Funding:** Government Support - Non-U.S.

FR-PO648

**Do the Benefits of Subcutaneous Immunoglobulin Therapy for Secondary Hypogammaglobulinemia in ANCA Vasculitis Extend Beyond Infection Prevention?**

Bryce M. Churilla, Faten F. Aqeel, Duvuru Geetha. *Johns Hopkins University School of Medicine, Baltimore, MD.*

**Background:** Rituximab (RTX) is an effective treatment for induction and maintenance of remission in ANCA-associated vasculitides (AAV). However, hypogammaglobulinemia and increased infection risk remain a concern. Subcutaneous immunoglobulin (SCIG) therapy has been shown to improve this RTX induced side effect, but its impact on disease remission is not known.

**Methods:** This observational report highlights a single-center series of 5 AAV patients treated with RTX for remission induction. These individuals received SCIG for moderate to severe IgG deficiency. We examined the effects of SCIG on serum IgG level, disease remission, rituximab use, relapses and infections in this cohort.

**Results:** The median age was 68 yrs, 3 had relapsing disease and 3 were PR3 ANCA positive. At baseline, 4 patients had experienced recurrent infections. Serum IgG levels improved with SCIG administration in all patients and recurrence of infection markedly improved (Table 1). Post SCIG, RTX was either no longer needed or ultimately discontinued. All patients remained in disease remission with SCIG administration with no relapses noted.

**Conclusions:** SCIG therapy has been shown to improve hypogammaglobulinemia in RTX treated AAV. However, our report highlights a potential benefit in minimizing relapses in these patients. This finding which is of significance in management of AAV needs to be confirmed in clinical trials.

ID	Age Year, Sex	Maintenance Treatment		Number of Infections		Number of AAV Relapses		Current Immunosuppression
		Before SCIG	After SCIG	Before SCIG	After SCIG	Before SCIG	After SCIG	
1	68, F	RTX every 6 months and then every 4 months	RTX stopped	5	1	2	None	Prednisone
2	79, F	None	None	4	None	None	None	None
3	69, F	AZA, Prednisone	None	5	None	None	None	Prednisone
4	16, M	AZA, LEF, Prednisone, RTX 1000 mg every 6 months	RTX dose and duration decreased initially and then stopped	None	None	6	None	None
5	50, M	RTX every 6 months	RTX duration decreased initially and then stopped	3	None	1	None	None

ANCA: anti-neutrophil cytoplasmic antibody, AAV: ANCA-associated vasculitis, SCIG: subcutaneous immunoglobulins, F: female, M: male, RTX: Rituximab, AZA: Azathioprine, LEF: Leflunomide

FR-PO649

**Combined Activity and Chronicity Score for Prognostic Assessment in ANCA-Associated Vasculitis With Glomerulonephritis (AAV-GN)**

Marta I. Casal Moura, Fernando C. Fervenza, Ulrich Specks, Sanjeev Sethi. *Mayo Foundation for Medical Education and Research, Rochester, MN.*

**Background:** Previous studies have shown that chronic changes on kidney biopsy are useful for stratifying the risk of kidney failure in patients with AAV-GN. We aimed to evaluate the impact of inflammatory activity for the prediction of renal outcomes.

**Methods:** A retrospective cohort study of MPO- or PR3-ANCA positive patients with AAV and active renal disease. Inflammatory activity was assessed by the Activity Index (AI): a ratio between the number of crescents and/or necrosis and the total number of glomeruli

(in percent). We calculated the AI score (AIS): 0-5 = 0; 6-10 = 1; 11-15 = 2; 16-20 = 3; 21-25 = 4; 26-37.5 = 5; 37.6-50 = 6; 51-65 = 7; 66-80 = 8; 80-90 = 9; 90-100 = 10. Chronicity was evaluated with the Mayo Clinic Chronicity Score (MCCS). For the combined score, we summed the MCCS and the AIS.

**Results:** We analyzed 326 patients with kidney biopsies available to score. The biopsies had in median (IQR), 13 glomeruli (9-20), 4 crescents (2-6) and an AI of 28.6% (15.3-47.6). The population was classified according with the risk of progression to kidney failure (KF) in 3 classes as (i) low (0-6) - 114 (35%), (ii) intermediate (7-11) - 152 (46.6%), and (iii) high ( $\geq 12$ ) - 60 (18.4%). Median eGFR at baseline correlated with the overall risk categories: 42.2 vs. 22.1 vs. 13.4 mL/min/1.73 m<sup>2</sup>, p<0.0001. Renal recovery was more frequent in patients at low risk of progression: 87.7% vs. 64.6% vs. 36.6%, p<0.0001, whereas kidney failure at 12 months and dialysis were more frequent in patients at higher risk (36.7% vs. 12.4% vs. 3.8%, p<0.0001; 35.6% vs. 13.0% vs. 2.9%, p<0.0001, respectively). The combination of AIS with MCCS independently predicted the risk of KF at 12 months (HR 1.916, 95%CI 1.210 - 3.033, p=0.006), particularly increased in patients classified as high risk (HR 3.124, 95%CI 1.224 - 7.970, p=0.017) and in patients with PR3-ANCA (HR 1.896, 95%CI 1.012 - 3.551, p=0.046) independently of eGFR at AAV-GN diagnosis and adjusted for severity of renal involvement and age.

**Conclusions:** The combined assessment of acute inflammatory activity and chronic changes on kidney histology independently predicted renal outcomes in patients with AAV-GN. The impact of the inflammatory activity is cumulative to the chronic changes.

**FR-PO650**

**Development of a Radiomic-Clinical Nomogram to Predict the Treatment Resistance of Myeloperoxidase ANCA-Associated Vasculitis**  
*Zhong Yong, Xiangya Hospital Central South University, Changsha, China.*

**Background:** We aimed to develop a radiomics nomogram to predict the treatment resistance of MPO-AAV patients.

**Methods:** MPO-AAV patients were randomly assigned to a training cohort and a test cohort. Treatment-resistance related features were selected using multivariate logistic regression to obtain the radiomic score (Rad-score). Two models were built. The clinical utility of the good models was assessed by decision curve analysis (DCA). The calibration of combined radiomics nomogram was evaluated.

**Results:** Serum creatinine and 9 radiomics features were selected, which were related to the treatment resistance of MPO-AAV. The accuracy of Model 2 (radiomics nomogram) for the prediction of treatment resistance was 0.948 and 0.913 in the training and test cohorts, which was higher than Model 1 (radiomics) with the AUC of 0.824 (p=0.039), and 0.898 (p=0.043) respectively. The DCA curve demonstrated that Model 2 had a higher net clinical benefit than that of Models 1. The calibration curves of Model 2 closely aligned with the true treatment resistance rate in the training (p=0.28) and validation sets (p=0.70). Furthermore, the validation cohort gained a good AUC of 0.929 in the Model 2.

**Conclusions:** The radiomics nomogram is a useful for predicting the treatment resistance of MPO-AAV.

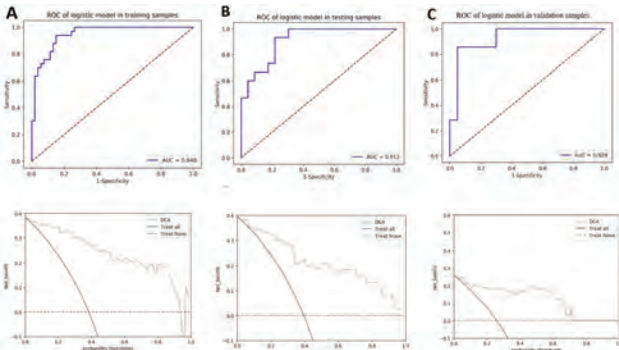

Figure 1. ROC curves of radiomics nomogram and decision curve analysis to detect the presence of treatment resistance in the training(A), test(B) and validation(C) cohort, respectively.

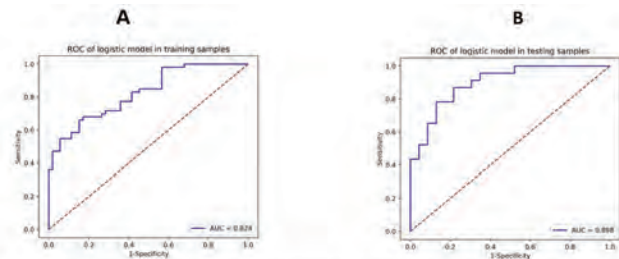

Figure 2: A Diagnostic accuracy of the rad-score in the training set and B diagnostic accuracy of the rad-score in the test set.

**FR-PO651**

**Renal Recovery for Patients With Baseline eGFR  $\leq 20$  in Avacopan ADVOCATE Trial**

*Frank B. Cortazar,<sup>1</sup> David R. Jayne,<sup>2</sup> Annette Bruchfeld,<sup>3</sup> Pirow Bekker,<sup>4</sup> <sup>1</sup>Saint Peter's Hospital, Albany, NY; <sup>2</sup>University of Cambridge, Cambridge, United Kingdom; <sup>3</sup>Karolinska Institutet, Stockholm, Sweden; <sup>4</sup>ChemoCentryx Inc, San Carlos, CA.*

**Background:** In the 330-patient ADVOCATE trial, where 81% of patients with ANCA-associated vasculitis had renal involvement, estimated glomerular filtration rate (eGFR) increased on average 7.3 mL/min/1.73 m<sup>2</sup> with avacopan and 4.1 in the prednisone group (P=0.029) at Week 52 (Jayne et al. 2021).

**Methods:** The aim of this post hoc analysis was to evaluate changes in eGFR in the 50 patients in ADVOCATE who approached the dialysis threshold, i.e., eGFR  $\leq 20$  mL/min/1.73 m<sup>2</sup>.

**Results:** The mean age was similar to the overall study population (66 vs. 61 years), but with a higher proportion of newly diagnosed (88 vs. 69%), MPO+ (84 vs. 57%) and MPA patients (72 vs. 45%), and higher cyclophosphamide use (50 vs. 35%; Table). eGFR increased on average 16.1 and 7.7 mL/min/1.73 m<sup>2</sup> in the avacopan and prednisone groups, respectively (P=0.003). More patients in the avacopan group had an increase in eGFR of  $\geq 2$ -fold (P=0.030) and above 20 mL/min/1.73 m<sup>2</sup> (P=0.024), and a higher number of patients had increases in eGFR above 30 and 45 mL/min/1.73 m<sup>2</sup>. eGFR in one patient in the avacopan group increased to 65 at Week 52 (baseline 17). Serious adverse events occurred in 13/27 patients (48%) in the avacopan group (1 death due to bronchopneumonia) and 16/23 patients (70%) in the prednisone group (1 death due to pleural empyema).

**Conclusions:** In ADVOCATE eGFR improved more in the avacopan vs. control group, with greater proportional GFR recovery in those with the most severe renal involvement. Reference: Jayne et al. NEJM 2021;384:599-609.

**Funding:** Commercial Support - ChemoCentryx

**eGFR Results**

	Avacopan (N=27)	Prednisone (N=23)
Age (years), mean (SD)	67.1 (11.13)	64.8 (17.22)
Newly diagnosed / Relapsed AAV	23 (85%) / 4 (15%)	21 (91%) / 2 (9%)
Myeloperoxidase+ / Proteinase 3+ AAV	22 (81%) / 5 (19%)	20 (87%) / 3 (13%)
Microscopic polyangiitis / Granulomatosis with polyangiitis	20 (74%) / 7 (26%)	16 (70%) / 7 (30%)
Rituximab / cyclophosphamide background treatment	12 (44%) / 15 (56%)	13 (57%) / 10 (43%)
Baseline eGFR (mL/min/1.73 m <sup>2</sup> ), mean (SD)	17.6 (1.86)	17.5 (2.04)
LSM change in eGFR at Week 26, mean (SEM)	11.9 (1.85)*	6.1 (2.00)
LSM change in eGFR at Week 52, mean (SEM)	16.1 (1.85)**	7.7 (2.01)
Last# eGFR $\geq 2$ -fold baseline eGFR, n (%)	11 (40.7%)*	3 (13.0%)
Last eGFR $> 20$ mL/min/1.73 m <sup>2</sup> , n (%)	23 (85.2%)*	13 (56.5%)*
Last eGFR $\geq 30$ mL/min/1.73 m <sup>2</sup> , n (%)	13 (48.1%)*	7 (30.4%)*
Last eGFR $\geq 45$ mL/min/1.73 m <sup>2</sup> , n (%)	6 (22.2%)*	1 (4.3%)*
Last eGFR $\geq 60$ mL/min/1.73 m <sup>2</sup> , n (%)	1 (3.7%)*	0 (0%)*
Last eGFR lower than baseline, n (%)	4 (14.8%)*	4 (17.4%)*
Requiring dialysis during 52-week period##	1 (3.7%)*	2 (8.7%)*
Urinary albumin:creatinine ratio Baseline geometric mean (range) (mg/g)	594 (32-2830)	740 (56-3516)
LSM % change from baseline to Weeks 4 / 13 / 26 / 52	-166%* / -35%* / -55% / -62%	+66%* / +20% / -40% / -42%
Total glucocorticoid dose during 52-week period, mean / median	1094 mg / 384 mg	3661 mg / 2920 mg

AAV=ANCA-associated vasculitis; eGFR=estimated glomerular filtration rate; LSM=least squares mean; SD=standard deviation; SEM=standard error of mean.  
\* P < 0.05, \*\* P < 0.01 for Avacopan vs. Prednisone.  
# Last=last eGFR measurement during the 52-week treatment period.  
## One patient in each group had a single dialysis session; the number of dialysis sessions in the second patient of the prednisone group is unknown.

**FR-PO652**

**Analysis of Clinical Outcomes in ANCA-Associated Glomerulonephritis Treated With Rituximab: A Single Center Experience in Japan**

*Soko Kawashima, Shinya Kaname, Kyorin Daigaku Igakubu Fuzoku Byoin, Mitaka, Japan.*

**Background:** Contrary to many Western countries, MPO-AAV is dominant in Japan. The therapeutic response to rituximab (RTX) might differ. Therefore, we conducted a retrospective analysis of the clinical database of the 80 ANCA associated glomerulonephritis (ANCA-GN)-patients in our hospital.

**Methods:** All patients met the CHCC classification criteria for MPA and GPA at disease onset. Eighty patients [53(66%) females] followed for at least six months since 2014 (up to Mar 2022) were analyzed. Remission was defined as BVAS 0. We divided the ANCA-GN patients into the 4 groups [Group 1 (RTX induction+, maintenance+): 18 cases), Group 2 (RTX induction+, maintenance-): 13), Group 3 (immunosuppressant+): 23) and Group 4 (glucocorticoid only): 26], and their clinical features and renal prognosis were compared.

**Results:** Of the 80 patients (53 MPO-MPA, 21 MPO-GPA, and 6 PR3-GPA), patients [25 newly diagnosed or 6 relapsing diseases] received a remission induction with RTX therapy. The frequencies of RPGN in ANCA-GN were 69%, 72% in group 1, 85% in group 2, 22% in group 3 and 73% in group 4, respectively. The average ages at onset were 64.5  $\pm$  15.6, 79.5  $\pm$  5.1, 74.5  $\pm$  8.1, 81.7  $\pm$  5.5 years. The mean ages at the initiation of RTX were 65.8  $\pm$  14.8 in group 1, 80  $\pm$  5.2 in group 2, of which 33%, 92% were over 75 years. Maintenance therapy was given more often based on changes in CD19+ counts and/or ANCA titer in 81%, as compared to scheduled administration every 6 months. The BVAS were 14.3  $\pm$  6.2, 17.9  $\pm$  2.8, 12.2  $\pm$  4.2, 13.8  $\pm$  5.8. Serum creatinine levels (mg/dl) were 1.9  $\pm$  1.1, 2.7  $\pm$  1.5, 1.7  $\pm$  1.8, 3.1  $\pm$  2.7. Group 1 had high survival and renal survival, which was better than group 3. Most of the deaths in group 2 and 4 were within 1 year,

and renal death had already occurred at the intervention within 3 months during induction therapy. Infection was the most common cause of death in all groups. In group 1 and 2, there was a tendency for recovery of renal function 1 year after the induction of remission, indeed, the dialysis withdrawal rates were 88%. The remission rates at 6/12 months were 85/77, 73/55, 92/67, 58/58%. The achievement rates of daily PSL dose of 10mg at 6 months/5mg at 12 months were 62/54, 64/45, 25/8, 26/11%.

**Conclusions:** These results showed that RTX is effective and has an acceptable safety profile in relatively elder AAV-GN patients in daily practice.

#### FR-PO653

##### Interstitial ANCA-Associated Vasculitis Associates With Severe Kidney Injury Independent of Glomerulonephritis

Desiree Tampe, Samy Hakroush, Bjoern Tampe. *University Medical Center Göttingen, Göttingen, Germany.*

**Background:** Antineutrophil cytoplasmic antibody (ANCA)-associated vasculitis (AAV) is a small vessel vasculitis affecting multiple organ systems, including the kidney. Small vessels in the kidney include small-sized arteries (interlobular artery, afferent and efferent arteriole), capillaries (glomerular and peritubular capillary) and venules. Although crescentic ANCA glomerulonephritis (GN) is a common histological finding reflecting glomerular small vessel vasculitis, it is reasonable that manifestation of AAV could also contribute to interstitial small vessel vasculitis.

**Methods:** A total number of 49 kidney biopsies with confirmed renal involvement of AAV were retrospectively included, a renal pathologist evaluated all biopsies and was blinded to clinical data collection and analysis.

**Results:** Among all active and chronic tubulointerstitial lesions analogous to the Banff scoring system, the only association between severe kidney injury requiring kidney replacement therapy (KRT) was observed for interstitial vasculitis in AAV reflected by peritubular capillaritis (ptc,  $p=0.0002$ ) and arteritis (v,  $p=0.0069$ ), affecting 5/49 (10.2%) and 11/49 (22.4%) of renal biopsies, respectively. Interestingly, no association between interstitial vasculitis (ptc and v correlating with severe kidney injury) and any glomerular lesion in ANCA GN (also correlating with severe kidney injury) was observed, thereby confirming that interstitial vasculitis contributes to severe kidney injury independent of ANCA GN. By contrast, short-term renal recovery from KRT was equal in both groups, suggesting a distinct association with acute decline of kidney function at disease onset.

**Conclusions:** Taken together, by using the Banff scoring system we here expand our current knowledge of renal interstitial lesions in AAV revealing peritubular capillaritis and arteritis as important histological alterations associated with severe kidney injury in a considerable subset of AAV. Furthermore, our findings that interstitial vasculitis did not correlate with crescentic ANCA GN implicate that the characteristics of each vasculitis manifestation are independent and could further improve our understanding of mechanisms contributing to renal injury.

#### FR-PO654

##### Comparison of Outcomes Between Rituximab and Cyclophosphamide for Primary Membranous Nephropathy: A Single Center Experience

Azm U. Hussain, Nadia Sarween. *University Hospitals Birmingham NHS Foundation Trust, Birmingham, United Kingdom.*

**Background:** Rituximab is increasingly being considered first-line treatment for Primary membranous nephropathy. While treatment outcomes have been compared to Calcineurin inhibitors there is no randomized controlled trial to date comparing Rituximab with a Cyclophosphamide-based regime. We aimed to review the outcomes of both treatments at our centre.

**Methods:** All patients with a diagnosis of Primary Membranous Nephropathy made between 2011 and 2020 were included in the study and identified through histology records. The follow-up period was until December 2021. Data were extracted from hospital electronic patient records. Secondary Membranous nephropathy and disease occurring in renal transplant recipients were excluded. Any patient who received Rituximab or cyclophosphamide were included and their clinical outcomes were compared. Complete remission was defined as a reduction in proteinuria to less than 300mg/day while the partial remission was defined as a reduction in proteinuria of  $\geq 50$  per cent from baseline and to  $>300$  mg/day and  $<3.5$  g/day. Statistical analysis was performed using Pearson-Chi square and One way ANOVA tests.

**Results:** 50 patients were identified with a diagnosis of primary membranous nephropathy and received treatment with either or both Cyclophosphamide, and Rituximab. The mean age of participants was 53 years with 30% males, 72% ( $n=32$ ) were PLA2R positive at the point of diagnosis. Response rates between the two treatment groups were not significantly different with 20% achieving full remission in Cyclophosphamide versus 17% in the Rituximab treated group ( $p = 0.40$ ). There were significantly more partial remissions observed in the Cyclophosphamide versus Rituximab group (57% vs 24% respectively,  $p = 0.003$ ). Time to favourable response was shorter in the Cyclophosphamide versus Rituximab group (7 vs 12.6 months respectively,  $p = 0.003$ ).

**Conclusions:** In our study, there is a suggestion that those treated with Cyclophosphamide versus Rituximab were more likely to respond to treatment. Patients treated with Rituximab also appear to take longer to respond. A trial comparing both treatments and reviewing short and long term responses is warranted.

#### FR-PO655

##### Outcomes of Idiopathic Membranous Nephropathy: A Single Centre Experience

Christina Bell, Anna K. Forbes, Benjamin Low, Sumaya Huque, Alexander F. Gardner, David Mankanjuola, Bhriugu Raj Sood. *Epsom and Saint Helier University Hospitals NHS Trust, Carshalton, United Kingdom.*

**Background:** The immunosuppressive approach to treat idiopathic membranous nephropathy is highly variable and outcomes are inconsistent in the published literature.

**Methods:** We conducted a retrospective review of outcomes in patients with high-risk idiopathic membranous nephropathy treated with immunosuppression at a tertiary renal centre in London.

**Results:** We identified 44 patients, comprising 33 males and 11 females. Mean age was 58.6 years (standard deviation 13.4 years) and 82.6% were Caucasian. PLA2R antibody status was assessed in 59.1% (26/44 patients); of these 69.2% were positive. At treatment initiation median urine PCR was 962 mg/mmol (IQR 702 – 1277 mg/mmol), median albumin 21 g/L (IQR 16-28 g/L), median creatinine 136  $\mu$ mol/L (IQR 98 – 180  $\mu$ mol/L) and median eGFR 47 ml/min/1.73 m<sup>2</sup> (IQR 26 -60 ml/min/1.73 m<sup>2</sup>). First line therapy comprised of either IV cyclophosphamide in combination with oral prednisolone (C+P) (70.5%) or Tacrolimus monotherapy (Tac) (29.5%). We found a higher response rate in the Tac group at all time points (6,12 and 24 months) but these findings were not statistically significant. At 6 months, of those who received C+P 11.5% (3/26 patients) achieved complete remission (CR) and 46.2% (12/26 patients) achieved partial remission (PR). With Tac 45.5% (5/11 patients) achieved CR and 36.4% (4/11 patients) achieved PR. Relapse rates within 24 months of treatment initiation were higher in patients who received Tac at 23.1% compared with 12.9% in those treated with C+P. However, this finding was not statistically significant. 7 patients progressed to ESKD and required renal replacement therapy, including 4 on C+P and 3 on Tac.

**Conclusions:** We have been unable to identify a difference in outcomes between C+P and Tac immunosuppression treatment regimens. Published literature suggest Rituximab is superior in patients who are PLA2R antibody positive and we are in the process of analysing this in our population.

#### FR-PO656

##### Associations Between Biomarkers of Complement Activation, Galactose-Deficient IgA1 Antibody, and the Updated Oxford Pathology Classification of IgA Nephropathy

Yunting Juan, Yen-Ling Chiu.<sup>1,2</sup> *Far Eastern Memorial Hospital, New Taipei City, Taiwan; <sup>2</sup>Yuan Ze University, Chung-Li, Taiwan.*

**Background:** Our prior study indicates a close relationship between alternative complement pathway activation, Galactose-Deficient IgA1 (Gd-IgA1) concentration, and clinical severity of IgA nephropathy (IgAN). Nonetheless, the relationship between complement factors and the updated Oxford classification of IgAN remains unclear.

**Methods:** This study enrolled eighty-four previously-untreated, biopsy-diagnosed IgAN patients from two medical centers in Taiwan. The clinical and laboratory findings were collected at the time of biopsy. Plasma levels of complement factor C5a, factor Ba and Gd-IgA1 were measured and analyzed.

**Results:** It was found that levels of proteinuria positively correlated with the updated Oxford classification of mesangial hypercellularity (M), endocapillary hypercellularity (E), tubular atrophy/interstitial fibrosis (T), and crescents (C). In addition, plasma Gd-IgA1 titer was significantly elevated in IgAN patients with tubular atrophy/interstitial fibrosis (T). Factor Ba, a biomarker of the alternative pathway, is also significantly elevated in IgAN patients with tubular atrophy/interstitial fibrosis (T). A similar change was detected for factor C5a but the difference did not reach statistical significance. Levels of factor Ba also negatively correlated with eGFR and positively correlated with proteinuria.

**Conclusions:** The results indicate that both levels of Gd-IgA1 antibody and factor Ba reflect the Oxford classification on IgAN. Whether these biomarkers can be used to guide therapeutic decisions requires further study.

#### FR-PO657

##### Prevalence of Optimal Conservative Therapy Implementation Among CureGN Participants With IgA Nephropathy

Arun Rajasekaran,<sup>1</sup> Maria Larkina,<sup>2</sup> Bruce A. Julian,<sup>1</sup> Laura H. Mariani,<sup>2</sup> Dana Rizk.<sup>1</sup> *<sup>1</sup>The University of Alabama at Birmingham School of Medicine, Birmingham, AL; <sup>2</sup>University of Michigan Michigan Medicine, Ann Arbor, MI.*

**Background:** Immunoglobulin A nephropathy [IgAN] is the most common primary glomerulonephritis in many countries; 20-40% of patients progress to kidney failure by 20 yr after diagnosis. Optimized supportive care is pivotal in addressing modifiable risk factors for progression, including hypertension and proteinuria. Through the Cure Glomerulopathy [CureGN] study, we sought to ascertain prevalence of optimal BP and proteinuria control, and maximal renin angiotensin aldosterone system inhibitor [RAASi] use among IgAN adults at enrollment and longitudinally.

**Methods:** CureGN, an observational longitudinal study, enrolled 458 adults  $\geq 18$  yr with primary IgAN within 5 yr of initial diagnostic kidney biopsy. BP was measured annually and urine protein-to-creatinine ratio [UPCR] values were obtained within 60 d of study visit. RAASi prescription patterns and dosing were ascertained at enrollment and longitudinally. Enrollment visits were classified as incident [ $< 6$  mo of biopsy] or prevalent [ $\geq 6$  mo post biopsy]. Goals for BP and proteinuria control were the 2012 KDIGO guidelines at study inception.



**Results:** At enrollment [median 359 d from initial biopsy], 41% patients had optimal supportive care for BP and proteinuria. Of the 59% patients with suboptimal BP and proteinuria: 7% were not on RAASi, 28% were on sub-maximal RAASi, and 24% were on maximal RAASi not at BP goal. At enrollment, only 36% incident and 45% prevalent patients had achieved optimal supportive care. Longitudinal data after initial biopsy showed > 50% participants had sub-optimal BP [≥ 125/75 mm Hg] and UPCR [≥ 1 g/g] up to 5.5 yr after diagnosis. [Figure 1]

**Conclusions:** Suboptimal control of BP and proteinuria was common in adults with IgAN in the 5 yr after diagnosis. Application of the more stringent 2021 KDIGO guidelines would likely indicate more at-risk patients. These findings highlight the need to continue education about the importance of conservative management. Many participants had proteinuria despite optimal BP, a group that would benefit from enrollment in clinical trials testing therapies that could mitigate disease progression.

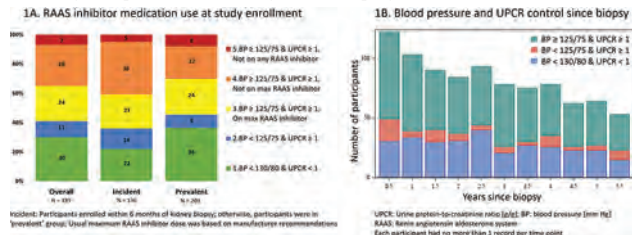

**FR-PO658**

**Practice Patterns in IgA Nephropathy: A Questionnaire-Based Survey**

**Bhavik Bansal,**<sup>1</sup> Amrithesh Grewal,<sup>1</sup> Hernan Trimarchi,<sup>2</sup> Boon Wee Teo,<sup>3</sup> Yuko Shima,<sup>4</sup> Madhivanan Sundaram,<sup>5</sup> Haidong He,<sup>6</sup> Arunkumar Subbiah,<sup>7</sup> Dipankar M. Bhowmik,<sup>7</sup> Sanjay K. Agarwal,<sup>7</sup> Soumita Bagchi.<sup>7</sup> <sup>1</sup>Medical Student, All India Institute of Medical Sciences, New Delhi, New Delhi, India; <sup>2</sup>Nephrology Service, Hospital Británico Buenos Aires Argentina, Buenos Aires, Argentina; <sup>3</sup>Division of Nephrology, Department of Medicine, Yong Loo Lin School of Medicine, National University of Singapore, Queenstown, Singapore; <sup>4</sup>Pediatrics, Wakayama Medical University, Japan, Wakayama, Japan; <sup>5</sup>Department of Nephrology, Royal Darwin Hospital, Darwin, Australia, Darwin, NT, Australia; <sup>6</sup>Division of Nephrology, Fudan University, Minhang Hospital, Shanghai, China, Shanghai, China; <sup>7</sup>Nephrology Department, All India Institute of Medical Sciences, New Delhi, India, New Delhi, India.

**Background:** IgA nephropathy (IgAN) is a common primary glomerular disease with ethnic differences in phenotype. The Kidney Disease Improving Global Outcomes (KDIGO) has provided guidelines for management of IgAN but the actual practice patterns among nephrologists is not known.

**Methods:** An online questionnaire-based survey was conducted focussing on treatment strategies practiced by nephrologists in management of IgAN.

**Results:** Among 402 responders, 76.9% treat adults, 9.2% paediatric patients and 13.9% both. 61.2% respondents were from Asia, 18.4% from South America, 9.7% from North America, 7.2% from Europe and 3.5% from Australia. MEST-C score was not reported in 12.7% centres, mainly in Australia (28.6%) and South America (23.0%). 97% nephrologists use initial supportive therapy by renin angiotensin system (RAS) blockade with ACEi /ARB; ramipril (20.8%) and losartan (23.6%) being most preferred. Also, 26.1% use dual RAS blockade and 56.7% aldosterone blockers. Other treatments used are fish oil (45.0%), SGLT-2 inhibitors (49.5%) and hydroxychloroquine (13.4%). Though 59.5% target blood pressure <130/80 mm Hg, 37.1% target < 120/80 mm Hg. Most nephrologists wait 3-6 months (42.4%) or >6 months (26.6%) before starting immunosuppression. For starting immunosuppression, 92.8% consider degree of proteinuria, 79.1% eGFR and 65.7% MEST-C score. 40.6% start immunosuppression immediately if proteinuria is >3g/day. 31.1% use immunosuppression in non-crescentic IgAN with eGFR < 30 ml/min/1.73m<sup>2</sup>. 89.1% use steroids as first line immunosuppression, while 6.5% use mycophenolate mofetil (MMF). 86.6% use second line immunosuppression in steroid resistant patients, MMF (50%) being most commonly prescribed. 99.2% use immunosuppression for C2 lesions: steroids + cyclophosphamide is the most commonly used regimen (66.7%). 43.5% use immunosuppression in all cases with C1 lesions, 47% individualize therapy based on eGFR and proteinuria while 9.5% do not use immunosuppression.

**Conclusions:** Although most nephrologists agree on the parameters to assess disease status, there is heterogeneity in type of supportive therapy and immunosuppression used especially in difficult to treat cases.

**FR-PO659**

**Updated Interim Results of a Phase 1/2 Study of BION-1301 in Patients With IgA Nephropathy**

**Jonathan Barratt,**<sup>1</sup> Laura Kooienga,<sup>2</sup> Irfan Agha,<sup>3</sup> Hanna Thomas,<sup>3</sup> Biruh Workeneh,<sup>4</sup> Sai Prasad N. Iyer,<sup>5</sup> Rangaraj Narayanan,<sup>5</sup> Taher Sathaliya,<sup>5</sup> Bess Sorensen,<sup>5</sup> Brian S. Schwartz,<sup>5</sup> Andrew J. King.<sup>5</sup> <sup>1</sup>University of Leicester, Leicester, United Kingdom; <sup>2</sup>Colorado Kidney Care, Denver, CO; <sup>3</sup>Dallas Renal Group, Dallas, TX; <sup>4</sup>The University of Texas MD Anderson Cancer Center, Houston, TX; <sup>5</sup>Chinook Therapeutics Inc, Seattle, WA.

**Background:** BION-1301 is a novel humanized monoclonal antibody that blocks a proliferation-inducing ligand (APRIL), a soluble factor that is elevated in patients with IgAN. APRIL promotes the production of pathogenic galactose-deficient IgA1 (Gd-IgA1), leading to immune complex deposition and kidney injury. Blocking APRIL with BION-1301 is a potential disease-modifying approach to directly target the pathogenesis of IgAN. In a Phase 1/2 study (NCT 03945318) in healthy volunteers and patients with IgAN, BION-1301 was well-tolerated with no SAEs and durably reduced free APRIL, IgA, Gd-IgA1, IgM and to a lesser extent, IgG. Here we present updated interim results in BION-1301-treated patients transitioned from IV to subcutaneous (SC) administration (Cohort 1) as well as novel data from IgAN patients with *de novo* SC administration (Cohort 2).

**Methods:** For the ongoing phase 1/2 open-label, multicohort trial, eligibility criteria include adults with biopsy-proven IgAN, eGFR ≥30 mL/min per 1.73 m<sup>2</sup>, baseline urine protein excretion ≥0.5 g/24 hrs or UPCR ≥0.5 g/g, and on stable/optimized RASi (or intolerant). Cohort 1 (n= 10) received 450 mg of BION-1301 administered IV every 2 weeks, transitioning to SC at 600 mg every 2 weeks after at least 24 weeks. Cohort 2 (n= 10) receives 600 mg of BION-1301 SC every 2 weeks.

**Results:** In patients with IgAN who transitioned from IV to SC (Cohort 1), BION-1301 was generally well-tolerated, with no SAEs or terminations due to AEs as of last observation (May 23, 2022). Durable reductions in serum levels of free APRIL and immunoglobulins were observed. As previously reported, clinically meaningful reductions in proteinuria were seen as early as 12 weeks (30.4% geometric mean UPCR reduction, n=7), were sustained through 52 weeks (70.9% geometric mean UPCR reduction, n=6), and were associated with reduced Gd-IgA1 levels. Preliminary response is consistent in patients transitioning from IV to SC. Updated data from Cohort 1 and novel data from Cohort 2 will be reported at the time of presentation.

**Conclusions:** BION-1301 offers disease-modifying potential by directly targeting the initiating pathogenesis of IgAN. Interim biomarker and clinical activity responses support advancement of BION-1301 into later-stage development for patients with IgAN.

**Funding:** Commercial Support - Chinook Therapeutics, Inc

**FR-PO660**

**Long-Term Outcomes of Patients Treated With Tacrolimus as First Line Therapy for Minimal Change Disease**

**Charlotte Seneschall,**<sup>1,2</sup> Rakesh Dattani,<sup>1</sup> Tom Cairns,<sup>1,2</sup> Stephen P. McAdoo,<sup>1,2</sup> Nicholas R. Medjeral-Thomas,<sup>1,2</sup> Megan Griffith.<sup>1,2</sup> <sup>1</sup>Imperial College London, London, United Kingdom; <sup>2</sup>Imperial College Healthcare NHS Trust, London, United Kingdom.

**Background:** Steroids are first line treatment for Minimal Change Disease (MCD) but have significant side effects. Increasingly, alternative immunosuppression such as tacrolimus is used, but there is no data on long term outcomes. This single centre retrospective study reviews long-term outcomes of patients treated with tacrolimus as first line therapy for MCD.

**Methods:** Adult patients with MCD followed up at Imperial College Hospitals NHS Trust were identified from the biopsy database. Clinical data was extracted from records of patients given tacrolimus monotherapy as initial treatment for MCD with >1yr follow up. Statistics were performed using GraphPadPrism.

**Results:** 50 patients had tacrolimus monotherapy as initial MCD treatment from 2004-2021. 21 were female, 29 male; 21 white, 2 Black, 16 Asian & 11 other/not stated. Median age 50.5yrs (17-83). Initial median albumin 13 (5-26), eGFR 90 (10-90). Median follow up 55.5 months (14-162). 44/50 remitted on tacrolimus, median 1 month (0.5-10). 6/50 failed to remit or were intolerant and were then changed to alternative therapy after median time 3.5 months (1-9). In total, 22/44 treated initially with tacrolimus relapsed. 4/44 relapsed on tacrolimus, including 2 noncompliant before relapse. 1 patient was lost to follow up. 39 had tacrolimus weaned or stopped. 17/39 subsequently relapsed: 5 relapsed on weaning & 12 relapsed after stopping. Median time from stopping tacrolimus to relapse was 3 months (1-55). 18/22 patients who relapsed were retreated with tacrolimus monotherapy and all entered remission. 10/18 patients had a 2nd relapse, 6 had a 3rd relapse, 4 had a 4th. There was no significant change in median eGFR for patients only treated with tacrolimus after 1, 3 and 5 years (p=0.73, 0.11, 0.27). No patients reached end stage renal failure.

**Conclusions:** Tacrolimus is an effective treatment for MCD that avoids steroids' side effects. As for steroids, relapse rates in adults are high. Low therapeutic levels increase relapse risk. Patients who initially respond to tacrolimus re-enter remission after 1st relapse. Subsequent relapse rates remain high. eGFR is generally maintained but should be monitored for individual patients.

FR-PO661

**Long-Term Complications in Patients With Childhood-Onset Nephrotic Syndrome: A Report From a Tertiary Care Center in India**

Joyita Bharati,<sup>1,2</sup> Post Graduate Institute of Medical Education and Research, Chandigarh, India; <sup>2</sup>North Shore University Hospital, Manhasset, NY.

**Background:** Childhood-onset nephrotic syndrome (NS), although commonly steroid-sensitive, is associated with long-term complications such as obesity, osteoporosis, growth failure, and hypertension. Reports on long-term complications of childhood-onset NS are mostly from developed countries not representing South-Asian ethnicities. Further, data on cardiovascular health among older children and young adults with childhood-onset NS are limited.

**Methods:** This was an observational study involving patients attending a tertiary care center. Patients aged 15 years or older, identified from the database of childhood-onset NS attending an adult renal clinic, were examined for long-term complications and long-term remission of NS at their visit in December 2021. Childhood-onset NS meant onset of NS before 10 years of age. Long-term complications included obesity, growth failure, low bone mineral density (BMD) Z score, hypertension, and increased carotid intima-media thickness (cIMT). Long-term remission was defined as no relapse for the last 3 consecutive years without immunosuppressive medication to maintain remission.

**Results:** Of 101 patients studied (~80% with frequent relapsing (FR)/steroid-dependent (SD)NS), the mean age was 17.6 (2.4) years at the time of the study. Long-term complications were noted in 89.1% of patients which included one or more of the following- obesity (22.7%), growth failure (31.7%), low BMD Z score (53.5%), hypertension (31.7%), and high cIMT (50.5%). Thirty-nine (38.6%) patients were in long-term remission at the time of the study. Growth failure and low BMD Z scores were less frequent in patients with long-term remission compared to those without long-term remission.

**Conclusions:** In Indian patients with childhood-onset NS (predominantly FR/SDNS) who were studied at 15 years of age, ~90% had long-term complications which included high cIMT in 50%. Only ~40% were in long-term remission.

FR-PO662

**Predictors of Progression to Kidney Failure in Patients With Focal Segmental Glomerulosclerosis**

Katherine R. Tuttle,<sup>1,2</sup> Kenn B. Daratha,<sup>1</sup> Cami R. Jones,<sup>1</sup> Lindsey M. Kornowski,<sup>1</sup> Radica Z. Alicic,<sup>1,2</sup> Martin C. Bunke,<sup>3</sup> Kamlesh M. Thakker,<sup>3</sup> Diana T. Amari,<sup>3</sup> Lionel Pinto,<sup>3</sup> Kaijun Wang,<sup>3</sup> Keith C. Norris,<sup>4</sup> Susanne B. Nicholas,<sup>4</sup> CURE-CKD <sup>1</sup>Providence St Joseph Health, Spokane, WA; <sup>2</sup>University of Washington, Seattle, WA; <sup>3</sup>Traverse Therapeutics Inc, San Diego, CA; <sup>4</sup>University of California Los Angeles David Geffen School of Medicine, Los Angeles, CA; <sup>5</sup>Genesis Research LLC, Hoboken, NJ.

**Background:** Focal segmental glomerulosclerosis (FSGS) is a glomerular disease that often progresses to kidney failure. The study aim was to evaluate clinical predictors associated with progression to kidney failure from real-world data.

**Methods:** Electronic health records from the Center for Kidney Disease Research, Education, and Hope (CURE-CKD) Registry were used to derive the study population from Providence and UCLA Health systems. Demographics, clinical characteristics, and prescription medications were obtained for adults ≥18 years old with FSGS in 2016-2020. Cox proportional hazards modeling was used to evaluate predictors of a primary composite outcome of 40% eGFR decline or eGFR <15 mL/min/1.73 m<sup>2</sup> (≥2 measures ≥90 days apart).

**Results:** Adults with FSGS (N=384) were 45% women and 51±18 (mean±SD) years old. At baseline, median CKD-EPI 2021 eGFR was 49 (interquartile range 30-77) mL/min/1.73 m<sup>2</sup>; UACR/UPCR were 1155 (323-2605) mg/g & 1.9 (0.8-3.4) g/g; systolic blood pressure was 130±15 mm Hg. Prescription medications included: ACE inhibitors/ARBs 72%, glucocorticoids 42%, calcineurin inhibitors 19%. Primary outcome events occurred in 118 (31%) patients. Median (IQR) follow-up time was 2 (1-3) years. Higher baseline eGFR, older age, and longer follow-up time were associated with lower risk of the primary outcome. Predictors of higher risk were hospitalization, treatment at Providence, ACE inhibitor/ARB use, and more outpatient visits (Figure). In a sensitivity analysis adding those with baseline UACR/UPCR measures (n=219), UACR >300 mg/g & UPCR >0.5 g/g yielded a HR=4.41 (1.65-11.80) and overall model stability.

**Conclusions:** Nearly one third of adults with FSGS progressed to 40% eGFR decline or kidney failure over a median of 2 years. Higher risks reflected in intensity of health care utilization and system, as well as by ACE inhibitor/ARB use, may reflect more severe illness.

**Funding:** Commercial Support - Travers Therapeutics

**Predictors of 40% eGFR decline or eGFR <15 mL/min/1.73m<sup>2</sup> in patients with FSGS in 2016-2020**

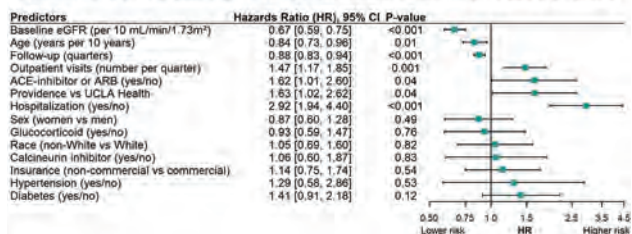

FR-PO663

**Defining Immunosuppression Treatment Futility Indicators in Focal Segmental Glomerulosclerosis: A CureGN Study**

Brooke A. Blazius,<sup>1</sup> Shawn P. Sullivan,<sup>1</sup> Mahmoud Kallash,<sup>2</sup> Jason M. Kidd,<sup>3</sup> Howard Trachtman,<sup>1</sup> Rebecca Scherr,<sup>1</sup> Noelle E. Carozzi,<sup>1</sup> Debbie Gipson,<sup>1</sup> <sup>1</sup>University of Michigan, Ann Arbor, MI; <sup>2</sup>Nationwide Children's Hospital, Columbus, OH; <sup>3</sup>Virginia Commonwealth University School of Medicine, Richmond, VA.

**Background:** Due to the heterogeneity of focal segmental glomerulosclerosis (FSGS) and potential for immunosuppressive therapy (IST) associated risks or non-responsiveness, decisions to initiate and to stop IST is relevant to practice but not evidence based. Physician perspectives on indicators of IST treatment futility in patients with FSGS at diagnosis (Never Start) and after a period of IST (Permanently Stop).

**Methods:** The study used a modified Delphi approach, including an expert panel of nephrologists to elicit Never Start and Permanently Stop concepts and key population subgroups for whom futility indicators may vary. Responses were coded and combined into futility concepts. An electronic survey was developed to elicit additional futility concepts to rate degree of agreement with each Expert Panel concepts using a Likert scale (strongly disagree to strongly agree), enriched by novel concepts reported by the responder. Survey 1 was distributed to practicing nephrologists via email.

**Results:** Four domains were elicited from the expert panel: biopsy findings, lab findings, complications/conditions, patient preference. A total of 109 responded to Survey 1. Pre-specified concepts that reached a threshold of 60% agree included 8/25 Never Start concepts and 14/26 Permanently Stop concepts (Fig). An additional six Never Start and six Permanently Stop concepts reached the 60% threshold for agree plus neutral responses and were included in Survey 1.

**Conclusions:** We found a high degree of conceptual agreement in FSGS IST futility indicators at diagnosis and when discontinuing therapy. Precise indicator thresholds will be confirmed in Survey 2. Future research will compare quantitative assessment of IST practice patterns by physician reported futility concepts at each clinical juncture.

**Funding:** NIDDK Support

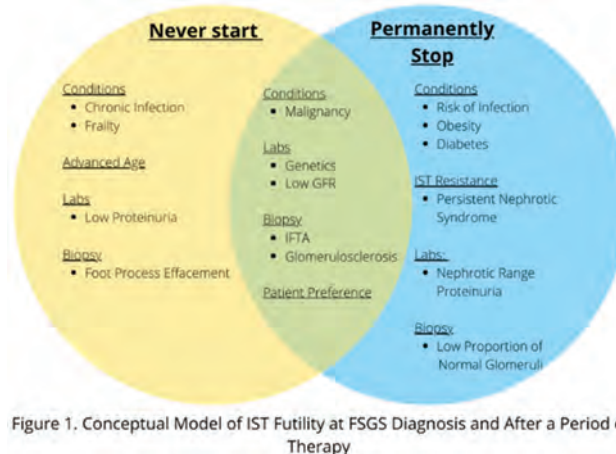

Figure 1. Conceptual Model of IST Futility at FSGS Diagnosis and After a Period of Therapy

FR-PO664

**Direct Oral Anticoagulants for Prophylaxis Against Thromboembolism in Patients With Nephrotic Syndrome**

Omar Osman, Luba Muaddi, Swati Arora. Allegheny Health Network, Pittsburgh, PA.

**Background:** Nephrotic Syndrome (NS) is associated with an increased risk of arterial and venous thromboembolic (VTE) complications when serum albumin is below 2.5 g/dL. Few case reports discussed the use of direct oral anticoagulants (DOACs) as treatment and prophylaxis for thromboembolism in patients with NS. The importance of this case series is to add to the existing literature on the experience of using DOACs in NS.

**Methods:** Charts of 9 patients with NS on DOACs were reviewed. Seven patients had biopsy proven membranous nephropathy, one patient had Class IV Lupus Nephritis and one had primary FSGS. Seven patients were using DOACs purely for VTE prophylaxis, one patient was already on DOAC for atrial fibrillation and one patient was on DOAC for treatment of an acute VTE. Demographic data along with baseline proteinuria, serum albumin and bleeding events were obtained for all patients.

**Results:** Of the 9 patients identified, 1 patient was given rivaroxaban for treatment of IVC thrombus which was extending into the renal veins. The remaining patients used apixaban as a form of prophylaxis for VTE. Follow up for patients on apixaban varied 3 to 24 months during which none of the patients developed VTE. DOACs were discontinued once serum albumin became greater than 2.5g/dL. Only one patient remained on a DOAC for an alternative indication.

**Conclusions:** The importance of our results highlight the use of DOACs for treatment and prophylaxis for VTE. Prior literature identifies successful use of DOACs for prophylaxis in 2 patients illustrated by Sexton et. al. Concern for use of DOACs in patients with nephrotic syndrome is based on data that they are highly protein bound and

so this questions the efficacy of DOACs in NS. However, given that there are real world examples of successful use of DOACs for treatment and prophylaxis of VTE in nephrotic syndrome patients, we recommend further studies to evaluate the efficacy of DOACs in prevention of VTE compared to the current standard of care.

Diagnosis	Proteinuria (g/day)	Serum albumin (g/dL)	Age	Smoking history	Bleeding episodes	Duration of A/C (months)
Membranous	8.5	2	58	No	Yes, epistaxis	5
Membranous	17.7	1.3	65	No	Yes, lower GIB	3
Membranous	11.6	1.9	62	No	No	13
Membranous	9	1	57	No	No	3
Membranous	3.5	1.6	66	No	No	24
Membranous	11	1.7	70	Yes	No	9
Primary FSGS	7	1.6	37	No	No	4
Lupus Nephritis	9	1.5	34	No	Yes, epistaxis	3
Membranous	5.2	2.5	85	No	No	4

**FR-PO665**

**Refractory Membranous Nephropathy With Anti-Rituximab Antibodies Treated Successfully With Obinutuzumab**

Sumit Kumar.<sup>1,2</sup> <sup>1</sup>Texas Kidney Institute, Dallas, TX; <sup>2</sup>Nephrotex Research Group, Dallas, TX.

**Introduction:** Membranous nephropathy results from IgG deposition in glomerular capillaries. A precision-medicine based anti-CD 20 approach has continued to evolve. Rituximab (RTX), has become the cornerstone for treatment after it's demonstration to be noninferior to cyclosporine. Here, we report anti-rituximab antibodies causing rapidly refractory disease, successfully treated with Obinutuzumab (OZB)

**Case Description:** A 65 yr old Caucasian male presented in Nov 2017 with shortness of breath. An acute pulmonary embolism and renal vein thrombosis was diagnosed with 25 g proteinuria and normal renal function. Kidney Biopsy demonstrated Idiopathic membranous nephropathy with No crescents, fibrinoid necrosis, thrombosis or endocapillary hypercellularity. Initial treatment was pulse steroids in Jan 2018 and 1 dose of RTX 1 gram. 2nd dose was never given. He went into a remission and came to our care in Oct 2019. In Mar 2020, he relapsed and underwent RTX infusion 1 g every 2 weeks for 2 doses. His initial response over the next few months was favorable, but he relapsed 4 months later. Other than trace to 1+ edema, he remained asymptomatic. **Anti-RTX Antibody was 158 ng/mL.** He was treated with OZB – Day 1 – 100 mg; Day 2 – 900 mg and Day 8 – 1000 mg, along with hypersensitivity prophylaxis. His Anti PLA 2R Ab became undetectable in 3 months and UPCR dropped steadily. He has remained asymptomatic, without any recurrence of proteinuria in extended follow-up.

**Discussion:** Our patient presented a unique conundrum with steady clinical improvement after being treated with rituximab, and then developing rapid relapse with detection of **anti-rituximab antibodies**. In our review, this has not been described previously. Obinutuzumab, fully humanized type II anti-CD 20 monoclonal antibody produces greater CD20 depletion and is superior to rituximab. While the use of Obinutuzumab has been described in limited case reports for the treatment of refractory membranous nephropathy, anti-rituximab antibodies have not been described in refractory disease.

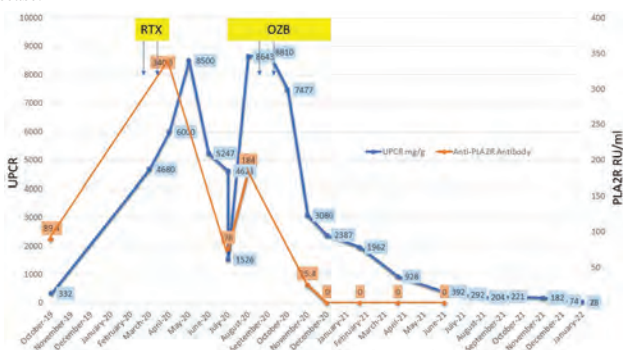

Patient Course

**FR-PO666**

**IgG4 Related Membranous Nephropathy Treated With Anti-CD 20 Therapy**

Arjun L. Kalaria, Bo Chen, Syeda B. Ahmad. *UPMC, Pittsburgh, PA.*

**Introduction:** Primary Membranous nephropathy (MN) is associated with autoantibodies against phospholipase A2 receptor (PLA2R) in the majority of cases. MN is associated with up to 10-15% of Immunoglobulin G4 (IgG4)-related kidney diseases. IgG4-related disease is an immune-mediated condition that can involve multiple organs and appear with lymphoplasmacytic infiltrations of IgG4+ plasma cells, storiform fibrosis, obliterative phlebitis, mild to moderate eosinophilia, and remarkably high serum IgG and IgG4. We report a rare case of IgG4-related MN treated with Rituximab.

**Case Description:** Our patient is a 66-year-old woman with hypertension, allergic rhinitis, and osteopenia who was referred to nephrology for new-onset edema. She denied NSAID use and had been up to date on her cancer screening. A 24hr urine protein was noted to have nephrotic range proteinuria of 5518 mg/24h. Labs showed a creatinine 0.8 mg/dL, BUN 12 mg/dL, serum albumin 2.3 g/dL and an absolute eosinophil count 2.1. Serological work-up notable for anti-neutrophil antibody level 1+ 1:40 in an equivocal pattern, normal C3 and C4, hepatitis B/C and anti-PLA2R antibody negative, free kappa lambda ratio 1.01, and serum immunofixation electrophoresis showing a faint IgG kappa. Further workup showed elevated serum IgG4 level 377 mg/dL (normal 4.0-86.0 mg/dL). Imaging demonstrated mediastinal and retroperitoneal lymphadenopathy with normal-sized kidneys. She underwent a native kidney biopsy which showed membranous glomerulopathy, PLA2R negative, basement membrane IgG4 staining by paraffin immunohistochemistry, small subepithelial electron-dense deposits with minimal to mild interstitial fibrosis, and tubular atrophy. She was treated with rituximab 1000 mg 2 weeks apart and a follow-up dose of 1000 mg in 6 months. Repeat imaging showed decreased size of lymphadenopathy. Follow up labs 3 months from last rituximab dose showed BUN 10 mg/dL, Cr 0.75 mg/dL, Alb 3.2 g/dL and urine protein/creatinine ratio of 0.3g/g.

**Discussion:** IgG4-related MN disease is an extremely rare disease entity. The standard treatment option is high-dose prednisone. We opted for steroid-sparing therapy due to patient preference and history of osteopenia. There is limited data on the use of anti-CD 20 blockade for the treatment of IgG4-related MN. We demonstrate in this case that Rituximab, as dosed per the Mentor trial, is an effective treatment option for IgG4-related MN.

**FR-PO667**

**Remission of Secondary Membranous Nephropathy From Sjogren Syndrome After Treatment With Hydroxychloroquine**

Dina R. Al-Tuhafy, Jean H. Ancion, Saira Sajid, Katerina Hysi, James Drakakis. *NYU Langone Hospital - Long Island, Mineola, NY.*

**Introduction:** Membranous nephropathy (MN) is a common cause of proteinuria. It can be divided into primary and secondary forms. The primary form is characterized by nephrotic syndrome and accounts for 70% of cases of MN. The other 30% may be secondary, attributed to underlying causes, such as infections, drugs, malignancies, or autoimmune diseases. The treatment of secondary MN is targeted to the etiologic cause and when effectively administered, can lead to a remission or cure of MN. While treatment options are well defined for underlying SLE or RA in the setting of MN, those for Sjogren's are much less so.

**Case Description:** 69 year old female with PMHx of Sjogren's syndrome (sicca symptoms, +ANA/SS-B), initially presented with anasarca and proteinuria quantified at 7 g/day. Kidney biopsy was performed showing membranous nephropathy, with negative staining for PLA2R. In addition, serum PLA2R Ab neg, favoring secondary form (likely Sjogren's related). At first immunosuppression was held. Renal function remained stable (serum creatinine 1.3 mg/dL). After several months, due to lack of improvement, she received two doses of 1000 mg of Rituximab. Proteinuria reached nadir of 3.5 g/g, but 6 months after the infusion, rose back up to 8 g/g. At this point, she started Hydroxychloroquine 400 mg per day. Improvement in proteinuria followed after 6 months of this therapy (down to 3.7 g/g). After an additional 8 months, the urine protein quantification was 561 mg/g and by 1 year later down to <200 mg/g.

**Discussion:** Renal involvement in Sjogren's syndrome is typically rare, only affecting <10% of patients. When present, this is usually in the form of tubulointerstitial nephritis and renal tubular acidosis. However, MN (secondary) has also been reported as a cause of renal disease in patients with Sjogren's, as high as in 36% in one cohort. Those patients with glomerular involvement are said to carry a worse prognosis. In fact, little data is available about the effectiveness of steroids or other immunosuppression to slow progression of renal disease and improve proteinuria. Our case is illustrative in that it showed a complete remission of secondary MN from Sjogren's syndrome only after treatment with Hydroxychloroquine. This strategy was enacted only after Rituximab proved ineffective.

**FR-PO668**

**Screening for Anti-Rituximab Antibody in Management of Rituximab Refractory PLA2R-Associated Membranous Nephropathy**

Ayotunde Ositelu, Andrew Vissing, Wadah J. Ayoub, Yonatan A. Peleg, Yashpal S. Kanwar, Vikram Aggarwal. *Northwestern Memorial Hospital, Chicago, IL.*

**Introduction:** Phospholipase A2 receptor associated Membranous Nephropathy (PLA2R-MN) accounts for 80% of primary MN (pMN). High titers of anti-PLA2R-Ab and non-remission of Nephrotic syndrome (NS) are associated with poor renal outcomes.

Rituximab (RTX), a chimeric monoclonal antibody (mAb) targeting CD20 on B-cells, is a first-line agent for moderate to high-risk pMN. However, 20-40% of pMN remain refractory to RTX. We report an approach to manage RTX refractory PLA2R-MN based on the use of the anti-RTX Ab assay.

**Case Description:** A 78 year-old male presented to our Nephrology clinic to manage severe N.S. He was on high dose of diuretics and ACEI for 3 months. Evaluation revealed proteinuria of 15 g/day, serum albumin (S. A) of 2 g/dl, eGFR=47 ml/min and anti-PLA2R Ab level was 751.6 RU/mL (positive test > 20 RU/ml). Renal biopsy findings were consistent with MN. He met high-risk criteria for pMN and received RTX 1g i.v twice within 2 weeks. 3 months later, anti-PLA2R levels decreased to 48.1 RU/mL. At 6 months he had partial remission (P.R) of proteinuria, improvement in edema and S.A remained 3-3.3 g/dl. Overall suggesting RTX-responsive course however due to lack of immunologic remission (I.R) he received RTX(1g) at 6 months. We noticed worsening of proteinuria and edema at 8 months. Anti-PLA2R level had risen serially up to 794.6 RU/mL at 10 months. Lack of I.R (refractory pMN) and worsening N.S prompted us to investigate factors contributing to RTX resistance and reduced bioavailability. We screened him for neutralizing Abs against RTX and his anti-RTX Ab level was elevated: 1,432 ng/mL (normal < 25 ng/mL) and he had undetectable RTX level. We obtained approval and he received Obinutuzumab (OBI, fully humanized mAb) at 12 months. OBI is directed to a different epitope on CD20 and has higher affinity for CD20 than RTX. Within a month of OBI, anti-PLA2R Ab came down to 25 RU/mL. UPCR was 2.19 g/g & S.A 3.5 g/dL at 14 months thus denoting P.R and near complete I.R.

**Discussion:** This case report highlights the clinical utility of anti-RTX Ab screening when managing patients with refractory PLA2R-MN. The presence of anti-RTX should prompt the use of new generation (more humanized) anti-CD20 therapy to achieve immunologic and clinical remission.

#### FR-PO669

#### Novel Treatment Option for PLA2R-Positive Membranous Nephropathy

Aditi A. Sen,<sup>1</sup> Nidhi Aggarwal,<sup>1,2</sup> Sarvari Yellapragada,<sup>1,2</sup> John E. Mbue,<sup>2</sup> Maulin Shah,<sup>1,2</sup> <sup>1</sup>Baylor College of Medicine, Houston, TX; <sup>2</sup>Michael E DeBakey VA Medical Center, Houston, TX.

**Introduction:** B-cell depletion with rituximab has been shown to be effective in treating anti-phospholipase A2 receptor (aPLA2R) antibody-associated membranous nephropathy (MN). While rituximab is generally well tolerated, some patients may develop serious side effects limiting its use. Novel anti-CD20 agents are now available, but evidence of their effectiveness in aPLA2R-MN is limited. We present a case of aPLA2R-MN treated with ofatumumab.

**Case Description:** A 45-year-old man presented with recurrence of MN. He had Hodgkin's lymphoma at age 14 and underwent splenectomy and chemotherapy (MOPP/ABVD regimen) which caused neuropathy. Sixteen years later, he developed polymorphous large cell lymphocytosis, a complication of prior chemotherapy and splenectomy. He first developed membranous nephropathy in 2014 (age 38), which was successfully treated with rituximab. He had recurrent membranous nephropathy (2017) with biopsy revealing aPLA2R (serum level 37 RU/mL) and again achieved remission with rituximab. Subsequently, he developed worsening neuropathy, likely due to rituximab. He had another recurrence (2020), initially treated with cyclosporine but was not effective (aPLA2R level 110.5 RU/mL). Given prior response to anti-CD20 therapy and given high risk of side-effects with cyclophosphamide, we opted to treat with ofatumumab (no known reports of neuropathy) guided by B-cell depletion confirmation. Three months after treatment, he has achieved serological remission and shown significant improvement in proteinuria.

**Discussion:** This case highlights that novel anti-CD20 agents may be considered for aPLA2R-MN when use of rituximab is prohibitive. Rituximab, a chimeric monoclonal antibody, may cause development of human anti-chimeric antibodies, which can affect efficacy and tolerability. Novel agents, such as ofatumumab, being fully human or humanized, decrease immunogenicity. Many of them have boosted efficacy due to increased binding affinity to Fc receptor on B-cells with increased complement-dependent cytotoxicity and/or antibody-dependent cellular cytotoxicity. It remains to be seen if our patient achieves complete and persistent remission. Further studies are needed to investigate the ability of these agents to achieve and maintain serological and clinical remission in aPLA2R-MN and understand their overall tolerability.

#### FR-PO670

#### Can PLA2R Antigen in Kidney Tissue Turn Positive After Recent COVID-19 Infection in Membranous Nephropathy?

Syeda S. Bukhari,<sup>1,2</sup> Omar N. Elhawary,<sup>1,2</sup> Isha Puri,<sup>1,2</sup> Mary C. Mallappalli,<sup>1,2</sup> Sonalika Agarwal,<sup>1,2</sup> <sup>1</sup>Kings County Hospital Center, Brooklyn, NY; <sup>2</sup>SUNY Downstate Health Sciences University, New York City, NY.

**Introduction:** COVID-19 infection has been associated with variety of kidney diseases including glomerulopathies. To our knowledge, only 8 cases of membranous nephropathy post COVID infection have been reported so far out of which 3 were PLA2R antigen positive. We report another case of such a rare association.

**Case Description:** 33 y/o AA obese male admitted with worsening anasarca for 1 month. His labs showed normal kidney function, hypoalbuminemia and nephrotic range proteinuria of 4 g/d. Urinalysis was otherwise bland. Serology including ANA, ANCA, C3, C4, Anti-PLA2R, Hepatitis panel, HIV were all negative. USG showed normal kidneys. Kidney biopsy was done which showed membranous nephropathy. There were no signs of virus in the kidney tissue. He stained positive for PLA2R antigen. Further history revealed that he had mild COVID infection 2 weeks before the swelling started.

He did not require hospital admission. For his kidney disease, he is started on losartan and diuretics. He is being observed for 6 months for possible spontaneous resolution.

**Discussion:** Based on the clinical presentation and serology it would suggest that the patients with COVID-19 infection may be associated with subsequent membranous nephropathy. The clinical presentation of the infection two weeks prior may be the stimuli for the PLA2R antigen and the membranous nephropathy, while the serum anti-PLA2R antibody was negative.

#### FR-PO671

#### Novel Target Antigens in Sarcoidosis-Associated Membranous Nephropathy

Luca Nardelli,<sup>1</sup> Dalia Zubidat,<sup>1</sup> Benjamin J. Madden,<sup>1</sup> Satoru Kudose,<sup>2</sup> Vivian C. Negron,<sup>1</sup> Louann Gross,<sup>1</sup> Samih H. Nasr,<sup>1</sup> Fernando C. Fervenza,<sup>1</sup> Sanjeev Sethi,<sup>1</sup> <sup>1</sup>Mayo Foundation for Medical Education and Research, Rochester, MN; <sup>2</sup>Columbia University, New York, NY.

**Background:** Kidney involvement occurs in 10-20% patients with sarcoidosis. Membranous nephropathy (MN) is the most frequent glomerular disease in patients with sarcoidosis. Previous small case series have shown that greater than 50% of MN diagnosed in patients with sarcoidosis are positive for Phospholipase A2 receptor (PLA2R). However, no target antigens have been identified in the remaining sarcoidosis-associated MN.

**Methods:** We performed a retrospective study of 19 patients diagnosed with sarcoidosis and biopsy-proven MN. We performed laser microdissection of glomeruli followed by mass-spectrometry (MS/MS) to detect MN antigens. This was followed by immunohistochemistry (IHC)/ immunofluorescence microscopy (IF) staining to confirm and localize the antigens.

**Results:** Using MS/MS, we identified PLA2R in 7/19 (37%), neural epidermal growth factor-like 1 protein (NELL1) in 4/19 (21%), and 1/19 (5%) each of thrombospondin type 1 domain-containing 7A (THSD7A) antigen, protocadherin 7 (PCDH7) and Proprotein Convertase Subtilisin/Kexin Type 6 (PCSK6/abstract submitted) (Fig 1). IHC/IF confirmed MS/MS findings and showed PLA2R, NELL1, THSD7A and PCDH7 staining along the GBM (Fig 2). Segmental NELL1 staining was noted in 2 of the 4 NELL1-positive MN. No known antigen was detected in the remaining 5/19 (26%) MN cases.

**Conclusions:** The presence of PLA2R antigen in renal biopsy should not exclude a secondary cause of MN, particularly sarcoidosis. The incidence of PLA2R-negative MN associated with sarcoidosis is probably higher than what has been previously reported. NELL1, PCDH7, THSD7A, and PCSK6 represent new antigens in sarcoidosis-associated MN.

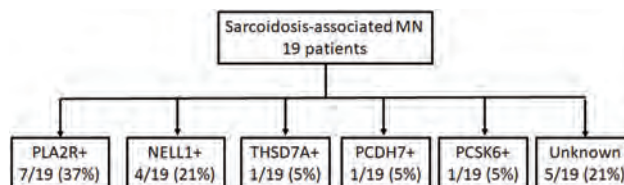

Target antigens in Sarcoidosis-associated MN.

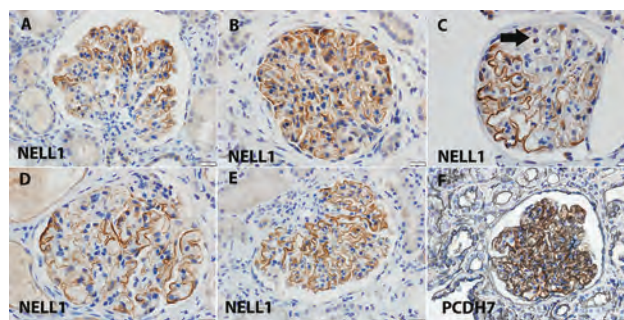

IHC showing granular GBM staining for (A-E) NELL1 in 4 cases, panel C shows segmental GBM staining, arrow points to few loops showing no staining (C and D are same case) and (F) PCDH7.

#### FR-PO672

#### Hydrocarbons to Pulmonary Renal Syndrome: A Risky Road

Martha Catalina Morales-Alvarez,<sup>1</sup> Samuel T. Eley,<sup>2</sup> Isaac E. Stillman,<sup>1</sup> Bhavna Chopra,<sup>1</sup> <sup>1</sup>Beth Israel Deaconess Medical Center, Boston, MA; <sup>2</sup>Harvard Medical School, Boston, MA.

**Introduction:** Anti-GBM syndrome is rare small vessel vasculitis with an incidence of <2 cases/million population and a bimodal age distribution in the third and sixth decades of life. Environmental factors such as URIs, smoking, and inhalation of hydrocarbons in genetically susceptible individuals are associated with increased anti-GBM antibodies production. We present a rare case of a young patient with Toluene exposure manifesting anti-GBM syndrome in a background of PLA2R membranous nephropathy (MN).

Key: TH - Thursday; FR - Friday; SA - Saturday; OR - Oral; PO - Poster; PUB - Publication Only

Underline represents presenting author.

**Case Description:** A 23-year-old man with new onset HTN and headaches presented to the ED with hemoptysis for 2 days. He was hemodynamically stable with normal oxygen saturation. Initial laboratory results revealed a Hb of 5.7 g/dL and SCr of 19.7 mg/dL. CXR revealed bilateral diffuse infiltrates and urine sediment showed several dysmorphic RBCs. Total urine Pr/Cr ratio was 6.2 g/g. Due to concern for pulmonary-renal syndrome with diffuse alveolar hemorrhage and hypoxic respiratory failure he was initiated on pulse dose steroids, plasmapheresis (total x5), and hemodialysis within 1 day of admission. Serologies returned positive only for anti-GBM antibodies. A kidney biopsy showed active crescentic GN with minimal IFTA and granular staining of PLA2R in the capillary loops by IF (Fig 1). Oral cyclophosphamide was initiated on day 5. He reported repeated high exposure to toluene since childhood while repairing bikes. During a 3-month follow up, he was still HD dependent.

**Discussion:** This case exhibits a unique presentation of anti-GBM syndrome following repeated hydrocarbon exposure in a setting of underlying MN. Inhaled toxins promote recurrent localized inflammation and increased capillary permeability unmasking hidden epitopes and allowing antibody formation, potentially manifesting as anti-GBM syndrome. Early diagnosis and appropriate use of immunosuppressive and extracorporeal therapies is necessary to prevent morbidity and to improve survival of this rare condition.

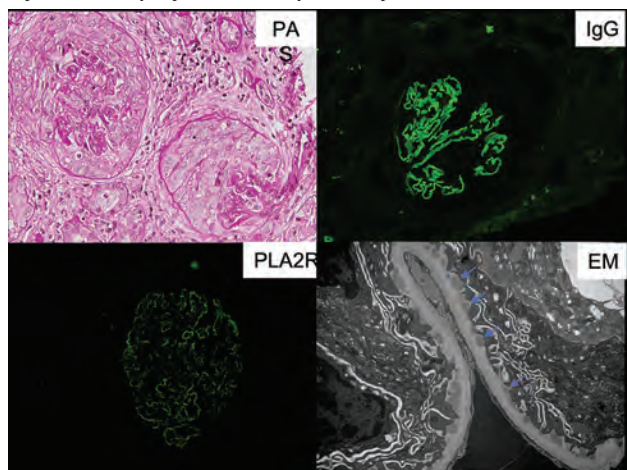

#### FR-PO673

##### A Unique Case of Atypical Anti-Glomerular Basement Membrane Disease

Muhammad Rawala, Hania Kassem, Nidal Alhosainat, Marjan Afrozian. *The University of Texas Medical Branch at Galveston, Galveston, TX.*

**Introduction:** Classic anti-glomerular basement membrane (GBM) nephritis is clinically and pathologically the most aggressive form of glomerulonephritis. The binding of the autoimmune antibodies to GBM leads to crescent formation and rapidly progressive glomerulonephritis (RPGN). We present a case of a 56-year-old female with atypical features of anti-GBM disease who did not require immunosuppression.

**Case Description:** A 56-year-old female with a history of chronic kidney disease (CKD) stage III, diabetes mellitus type II, smoking, hypertension, chronic obstructive pulmonary disease, hepatitis C-related cirrhosis presented to the hospital with a 2-month history of worsening ascites that did not respond to diuretics. Large volume paracentesis was performed, after which the patient developed acute kidney injury, which was initially thought to be secondary to decreased effective circulating volume. However, work-up identified nephrotic range proteinuria and dysmorphic RBCs on urine microscopy. This prompted a renal biopsy for evaluation of glomerulonephritis (GN). The biopsy was reported as atypical Anti-GBM disease with proliferative GN and diabetic glomerulosclerosis. The patient's anti-GBM antibody was negative. She was managed conservatively as creatinine stabilized around 1.2-1.4 mg/dL.

**Discussion:** The incidence of atypical anti-GBM is reported to be 11.8%. Our patient exhibited IgG linear staining along the glomerular and tubular basement membranes, the pathologic hallmark of the anti-GBM disease. But the clinical characteristics of our patient having nephrotic range proteinuria and mild nonprogressive worsening in kidney function, differed from the traditional presentation of pulmonary symptoms and RPGN found in anti-GBM disease. Also, similarly to other cases of atypical anti-GBM, the patient was a smoker, had a negative anti-GBM antibody, and histologically had evidence of endocapillary proliferation. The objective of the case is to delineate that anti-GBM disease can present atypically with a less aggressive phenotype, variable histologic changes, and undetectable anti-GBM antibody. This subset of patients has an overall better prognosis and may be managed conservatively.

#### FR-PO674

##### From ESRD to CKD5: An Unlikely Path for an Anti-Glomerular Basement Membrane (Anti-GBM) Patient

Christopher F. Middleman, Maura A. Watson. *Walter Reed National Military Medical Center, Bethesda, MD.*

**Introduction:** Anti-GBM is a rare small vessel vasculitis with estimated fewer than two cases per one million population. The disease is caused by circulating antibodies directed against the glomerular basement membrane and alveolar basement membrane, leading to glomerulonephritis (GN) and/or alveolar hemorrhage.

**Case Description:** A 60 year old female was admitted for acute renal failure with a rapidly rising serum creatinine. Lab work-up revealed a highly elevated anti-GBM titer. Kidney biopsy revealed 100% crescentic disease with 15% interstitial fibrosis and tubular atrophy due to anti-GBM. Plasmapheresis plus immunosuppressive therapy (cyclophosphamide and steroids) vs. IV steroids followed by oral taper were considered. Given her biopsy findings conveyed low likelihood of renal recovery the patient elected treatment with IV, followed by oral, steroids and initiated chronic dialysis May 2020. Her anti-GBM antibody activity was monitored monthly (peak of 153 units May 2020) and down-trended over time. She reported increased urine output in early summer 2021 and 24 hour urine studies, completed between dialysis sessions, revealed an up-trending creatinine clearance. Her dialysis needs decreased to twice-weekly and she was ultimately liberated from dialysis entirely 16 months after initiation.

**Discussion:** Necrotizing anti-GBM associated GN with 100% crescent formation carries a poor renal prognosis and it is not unreasonable to forgo immunosuppressive therapy and plasmapheresis, as risks of these therapies often outweigh potential benefits. This case illustrates a patient who, not having received PLEX or cyclophosphamide, eventually recovered enough renal function to become a dialysis-free CKD5 patient. Other such case reports exist in literature and beckon us to ask: should we change our perspective of crescentic disease in anti-GBM and more strongly consider available therapies? Further research is needed to determine optimal treatment in anti-GBM patients with 100% crescent formation on biopsy. The views expressed in this Abstract are those of the authors and do not reflect the official policy of the Department of the Army/Navy/Air Force, the Department of Defense, or the United States government

#### FR-PO675

##### Immune Complex-Mediated Membranoproliferative Glomerulonephritis in TAFRO Syndrome: A Case Report

Alaa S. Hrizat, Jaime Eberle-Singh, Li Li. *Thomas Jefferson University, Philadelphia, PA.*

**Introduction:** TAFRO syndrome is a clinical subset of idiopathic multicentric Castleman disease (iMCD) characterized by thrombocytopenia, anasarca, fever, reticulin fibrosis or renal dysfunction, and organomegaly. Renal involvement is a significant complication of TAFRO syndrome; however, only a small number of cases have been reported.

**Case Description:** A 42-year-old woman presented with hypertensive crisis and dyspnea. She was incidentally found to have a large mediastinal mass (11cm), pericardial and bilateral pleural effusions, and extensive multifocal hypermetabolic lymphadenopathy. The anterior mediastinal mass biopsy was diagnosed with iMCD with negative serologies for HIV and HHV-8. The patient was treated with 16 cycles of Siltuximab (anti-IL-6). While her dyspnea and metabolic activity of adenopathy improved, she continued to have anasarca and worsening hypergammaglobulinemia. This inflammatory state was consistent with TAFRO syndrome of iMCD and treatment was changed to Rituximab. Shortly after, the patient developed acute decompensated heart failure and worsening renal function with a Cr of 2.30 mg/dL (baseline Cr 1.5 mg/dL), BUN 65 mg/dL. Renal biopsy revealed that most of the glomeruli had membranoproliferative glomerulonephritis (MPGN) injury patterns without thrombi or fibrinoid necrosis. Immunofluorescence study revealed (all 1-2+) mesangial and capillary loop granular IgG, C3, kappa and lambda light chain deposits. Electron microscopy identified subendothelial electron-dense immune-type immune deposits. Overall the findings are consistent with immune deposit-associated MPGN.

**Discussion:** We present an iMCD patient with TAFRO syndrome with renal insufficiency secondary to immune deposit-mediated MPGN. Amyloidosis MPGN and thrombotic microangiopathy (TMA) have been reported in MCD. Further research is needed to elucidate the roles of VEGF and IL-6 and their impact on renal pathology in TAFRO syndrome.

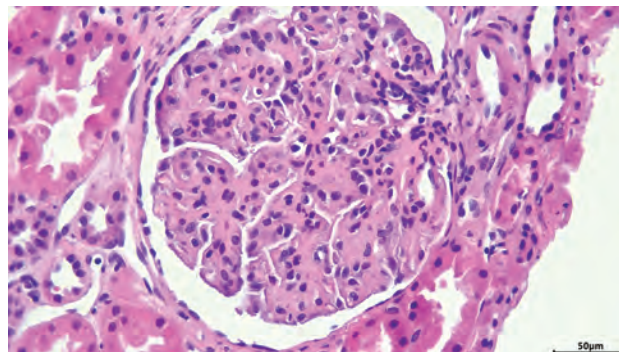

A. Representative glomerulus shows MPGN injury pattern (H&E, 40X).

FR-PO676

**Images of Sea Blue Histiocytosis in Lupus Nephritis**

Jin Wen. Hunan Provincial People's Hospital, Changsha, China.

**Introduction:** Sea blue histiocytosis (SBH) is a rare disease characterized by the deposition of abundant sea-blue histiocytes in various organs, most of which is regarded as a hereditary disorder. The association between SBH and lupus nephritis (LN) has never been reported before. Herein, we present a series of images of the deposition of SBH in the bone marrow of an adult woman with LN.

**Case Description:** A 32-year-old Chinese female was diagnosed with systemic lupus erythematosus (SLE) and LN for twelve years. The significant manifestations were recurrent fever with rash, proteinuria, hematuria, blood cell reduction (leukopenia, thrombocytopenia, and hemolytic anemia), and strong positive ANA and ds-DNA antibodies. She has also suffered from paravertebral infection with mycobacterium xenopi for two years, which was detected by the next-generation sequencing with paravertebral tissue. She has been under anti-mycobacterial therapy for two years. One month ago, the deposition of SBH was obtained in the bone marrow. The whole-exome sequencing (WES) of the patient and her parents has been done by Kindstar Global Company to exclude the primary hematologic hereditary disease.

**Discussion:** To our knowledge, this is the first case of SBH and LN. Secondary SBH could be diagnosed according to the typical images of SBH in the bone marrow and the negative result of the WES examination. However, the association between SBH and LN remains unknown, and there is another possibility that SBH is associated with non-tuberculous mycobacterial infection.

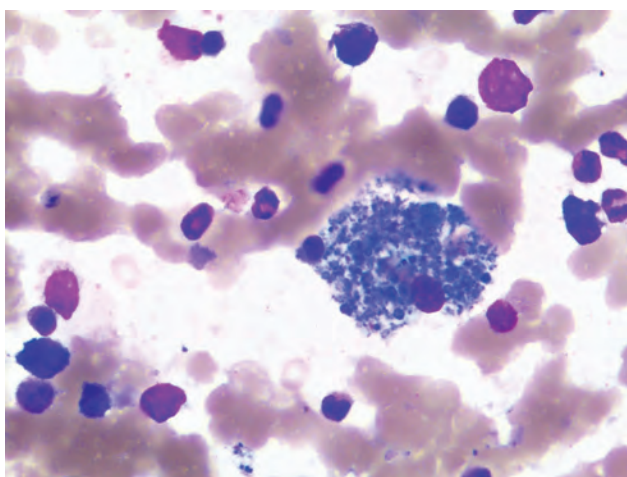
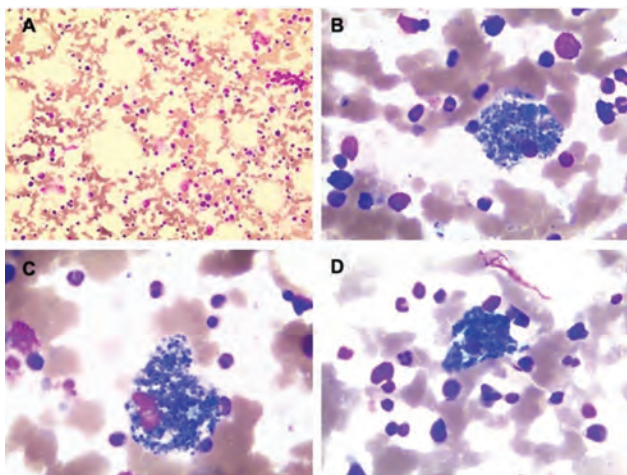

FR-PO677

**ANCA-Systemic Lupus Erythematosus Overlap Syndrome: Case Series**

Nitpriya Paliwal, Gaia M. Coppock. University of Pennsylvania, Philadelphia, PA.

**Introduction:** Systemic lupus erythematosus (SLE) is characterized by development of autoantibodies against nuclear components. ANCA-associated vasculitides (AAV) are characterized by a small-sized vessel vasculitis & ANCA positivity. SLE & AAV are rarely associated as vasculitis may occur during SLE but rarely fits AAV classification criteria. A clinical entity that fulfills criteria for both SLE & AAV was first described in 2008.

**Case Description:** All 3 patients presented with hematuria, proteinuria & AKI. Case 1: 71 y/o F. Renal biopsy revealed glomerulonephritis (GN) with dominant IgA deposits and crescents. P-Anca titers were 44. Treated with steroids with improvement &

maintained on MMF for 6 months with complete remission. She had a recurrence 6 years after stopping all therapy & repeat renal biopsy revealed crescentic GN with immune complex deposits & near full-house pattern on immunofluorescence (IF). P-ANCA remained positive. She was treated with steroids and started on MMF with her creatinine now stable at 1. Case 2: 69 y/o F with high ANA titers (1:10240) & + MPO (57). Renal biopsy showed crescentic GN with full house staining on IF & intramembranous & subepithelial immune-type deposits on electron microscopy (EM). Treated with steroids & Cytoxan, followed by maintenance therapy with azathioprine & prednisone. Currently off maintenance therapy for 6 months with stable renal function. Case 3: 39 y/o F with high ANA titers (1:5120), normal complements, elevated MPO (66) & anti-ds DNA of 344. Prelim biopsy results revealed marked endocapillary cellularity with few crescents. Treated with solumedrol x3 followed by MMF. Final biopsy report showed full house IF & diffuse crescentic GN, so her treatment was switched to Cytoxan & steroid taper with clinical improvement.

**Discussion:** We discuss 3 cases of overlap with different presentations & approaches to treatment. Incidence of SLE & ANCA vasculitis overlap syndrome has increased over the last decade. The largest case series to our knowledge was of 8 patients reviewed between 1995-2014. The low number of cases prompts the question of underdiagnosis & significance of ANCA positivity in lupus nephritis. We recommend that ANCA testing be performed in all patients with lupus nephritis who have crescents on biopsy to test for overlap syndrome. Further studies are needed to identify the standard approach to treatment or if treatment should be tailored to individual patient presentation.

FR-PO678

**Collapsing Glomerulopathy and Systemic Lupus Erythematosus: Case Series**

Fernando L. Strufaldi, Mateus J. Luvizotto, Gabriela C. Segura, Viktoria Woronik, Cristiane B. Dias, Livia B. Cavalcante, Luis Yu, Leticia Jorge. Universidade de Sao Paulo Hospital das Clinicas, Sao Paulo, Brazil.

**Introduction:** Collapsing glomerulopathy is a clinical entity characterized by massive proteinuria, elevated serum creatinine, and rapid progression to end-stage renal disease. It is associated with autoimmune diseases, viral infections, and medications. Here we report 5 cases, which had the association between collapsing glomerulopathy (CG) and systemic lupus erythematosus (SLE).

**Case Description:** Clinical features of the patients are summarized in Table 1. At the beginning of the clinical presentation, 4 patients had nephrotic syndrome, with creatinine values ranging from 0.9 up to 3.37 mg/dL, without complement consumption. Regarding clinical manifestation of SLE, all patients had arthritis as the main symptom. Histological findings showed that the patients had focal to moderate focal fibrosis and tubular atrophy. One also had diabetic nephropathy. Another male patient, whose renal outcome was worse, had class IV lupus nephritis. The mean follow-up time of patients was 138 months, with 2 patients achieving complete remission, 1 patient partial remission, and 1 patient reached the combined endpoint of doubling creatinine and progression to end-stage renal disease. Of the 5 patients, one still does not have sufficient follow-up

**Discussion:** The pathogenesis of cases of CG associated with SLE remains unclear. Humoral and/or cellular immunity factors seem to be involved in the development of the disease. Due to the relative rarity of prevalence, there is currently no treatment based on clinical evidence

Table 1. Clinical and laboratory findings at the time of biopsy

Age(years)	Gender	Ethnicity	Creatinine (mg/dL)	C3d-SPI (ml/min)	Proteinuria (g/d)	Albumin (g/dl)	ANA pattern	Anti-dsDNA (IU/ml)	Complement (mg/dl)	Clinical Symptoms	
1	64	Woman	White	3.37	11	<4.6	3.3	Nuclear homogeneous 1:640	>200	C3=51 C4=11	Arthritis, rash, Raynaud
2	28	Woman	White	0.9	84	9.22	2.4	Nuclear fine speckled 1:640	Negative	C3=111 C4=93	Arthritis and serositis
3	60	Woman	White	1.05	58	1.03	3.3	Nuclear coarse speckled 1:320	Negative	C3=102 C4=16	Arthritis
4	35	Man	White	1.13	80	6.22	4.1	Nuclear fine speckled 1:640	Negative	C3=112 C4=38	Arthritis and neurological symptoms
5	35	Woman	White	2.1	26	8.8	2.5	Nuclear fine speckled 1:320	Negative	C3=188 C4=39	Arthritis

Table 2. Renal histopathological findings

	Glomeruli	Tubular Intercepts	Interstitial Fibrosis	Tubular atrophy	Immunofluorescence	Other Findings
1	-	Yes	Focal	Focal	IgM 1+/2 C3 2+/3	No
2	0	No	Focal	Focal	IgM 1+/2 C3 1+/2	No
3	14	Yes	Focal	Moderate	Negative	Diabetic Nephropathy
4	02	Yes	Focal	Moderate	IgG trace IgM 1+/2 C3 1+/2	Class IV Lupus Nephritis
5	13	No	diffuse	Moderate	IgM 2+/3 C3 2+/3	No

Table 3 - Follow-up data

Patient	Time from SLE diagnosis to collapsing glomerulopathy	Follow-up (months)	Treatment	CRP (mg/dl)	Complete remission (proteinuria < 0.5 g/day and eGFR > 60 ml/min/1.73 m <sup>2</sup> )	Significant of creatinine at HD
1	Simultaneous	108	Steroids and MMF <sup>a</sup>	22	No	No
2	8 years	144	Steroids, MMF <sup>a</sup> , AZA <sup>b</sup> , and tacrolimus	90	Yes	No
3	12 years	108	AZA <sup>b</sup>	56	Yes	No
4	13 years	192	Steroids, CYC <sup>c</sup> , MMF <sup>a</sup> and AZA <sup>b</sup>	5.96	No	Yes
5	18 years	90	Steroids, MMF <sup>a</sup> and CYC <sup>c</sup>	20	No	No

<sup>a</sup>Complete remission was defined by KDIGO criteria as proteinuria < 0.5 g/day and eGFR > 60 ml/min/1.73 m<sup>2</sup>. <sup>b</sup>AZA: azathioprine. <sup>c</sup>CYC: cyclophosphamide.

**FR-PO679**

**Messenger RNA COVID-19 Vaccine-Associated Collapsing Focal and Segmental Glomerulosclerosis**

Duha A. Jweehar. UConn Health, Farmington, CT.

**Introduction:** A novel coronavirus (SARS-CoV-2) mRNA vaccine was invented as a mitigation strategy to control COVID-19 pandemic and as a promising approach to reduce the spread of COVID-19 infection among population worldwide with impressive reduction in new COVID-19 infection cases. We report a first case of collapsing focal and segmental glomerulosclerosis (FSGS) was diagnosed post-second dose of SARS-CoV-2 Moderna vaccine.

**Case Description:** A 75-year-old Caucasian female with unremarkable medical history who was admitted anasarca started 6 weeks after receiving the second dose of SARS-CoV-2 Moderna vaccine. She was found to have anuric acute kidney injury, blood pressure 210/110 mmHg. Laboratory results showed serum creatinine 8.2 mg/dl, serum albumin 2.6 g/dl. Urine microscopic showed numerous granular casts and tubular epithelial cells. 24 hr. urinary collection revealed proteinuria of 6.9 g. Transthoracic echocardiogram was normal. Kidneys were normal in size with increased cortical echogenicity on renal ultrasound. Unremarkable comprehensive workup. Kidney biopsy showed segmental sclerosis with associated hyperplastic visceral epithelial cells with intracytoplasmic protein reabsorption droplets. The associated capillary loops appeared collapsed. Immunofluorescence showed segmental glomerular staining for IgM, C3 and C1q (3+).

**Discussion:** Several case reports have been published suggesting a temporal association between glomerular disease and relapsing glomerular disease after receiving SARS-CoV-2 RNA (mRNA) vaccines of either Pfizer- Bio-Tech or Moderna mRNA-1273, SARS-CoV-2 mRNA vaccines generate humoral and cell-mediated immune response by CD4 and CD8 expansion to T helper-based response with production of interferon-gamma, tumor necrosis factor- alpha, interleukin-2 and antibody production predominantly of immunoglobulin G1 and IgG subclass. That suggests cell-mediated immune reaction that may cause podocyte injury or recurrence of glomerular disease. Potential mechanism of podocyte injury post SARS-CoV-2 mRNA vaccine may be triggered by cytokine-mediated response, direct toxic effect or a rapid T cell-mediated immune response and lead to podocytopathy. Further investigations are needed to establish the causal relationship between SARS-CoV-2 and glomerular injury in susceptible individuals. Increase awareness in that regard might help to expand database of those cases.

**FR-PO680**

**Minimal Change Disease Superimposed on Diabetic Nephropathy: A Very Rare Clinical Occurrence**

Tanzul T. Pariswala, Khawaja A. Bashir, Hitesh H. Shah. Donald and Barbara Zucker School of Medicine at Hofstra/Northwell, Great Neck, NY.

**Introduction:** Diabetic nephropathy (DN) is a leading cause of ESKD in the US. Patients with DN usually develop progressive proteinuria and kidney failure over the years. A subset of patients with DN may develop nephrotic syndrome. However, sudden onset of nephrotic syndrome in patients with history of diabetes mellitus (DM) may suggest the presence of nondiabetic kidney disease. Here, we present an interesting and challenging case of minimal change disease superimposed on DN.

**Case Description:** 78-year-old male with type 2 DM presented to our hospital for worsening bilateral LE swelling and significant weight gain. Of note, pt. was seen in another hospital approximately 3 months ago for similar complaints. During that hospital stay, pt. was found to have nephrotic syndrome. Kidney biopsy performed at the time showed diffuse effacement of epithelial foot processes consistent with minimal change disease (MCD) and mild diffuse diabetic glomerulosclerosis. Pt. was not initiated on oral corticosteroid therapy for MCD at the time as he had lab findings of latent TB. Pt. was initiated on oral rifampin as outpatient. Pt. however took rifampin for only 2 weeks as he felt that it contributed to his worsening LE swelling. On presentation to our hospital, pt. found to have significant bilateral LE edema and nephrotic syndrome. Urine TP/CR ratio was 10 and serum albumin was 1.5. Scr was elevated at 2.9 on admission, peaked to 4.8 during hospital stay. Pt. initiated on IV diuretic therapy with good clinical response. ID was initially consulted for concerns for latent TB. Pt. found to have abnormal lung findings on CT scan hence pulmonary team was also consulted. Pt. underwent bronchoscopy. BAL fluid studies were negative for AFB and active TB was ruled out. Pt. subsequently initiated on oral rifampin (for latent TB) and oral prednisone therapy (for MCD). Scr decreased to 4.2 prior to discharge. Pt. was discharged on oral diuretics, rifampin, and prednisone with advice to follow-up in nephrology clinic.

**Discussion:** While nephrotic syndrome has been described in patients with DN, MCD superimposed on DN has been rarely reported. Sudden onset of nephrotic syndrome

should raise suspicion for nondiabetic kidney disease in patients with DM. Our case also highlights the importance of kidney biopsy in diabetic patients presenting with sudden onset nephrotic syndrome and kidney failure.

**FR-PO681**

**A Case of Proteinuria Associated With Thrombotic Microangiopathy in a Patient With Sickle Cell Disease**

Sachin V. Pasricha,<sup>1,2</sup> Richard Ward,<sup>1,2</sup> Christopher J. Patriquin,<sup>1,2</sup> Rohan John,<sup>1,2</sup> Tushar S. Malavade.<sup>1,2</sup> <sup>1</sup>University Health Network, Toronto, ON, Canada; <sup>2</sup>University of Toronto, Toronto, ON, Canada.

**Introduction:** Thrombotic microangiopathy (TMA) causes renal dysfunction. Classic causes include thrombotic thrombocytopenic purpura, atypical haemolytic uremic syndrome, pregnancy, malignancy, drugs, transplant, autoimmune disease, infection, malignant hypertension, antiphospholipid (APLA) syndrome. We describe the case of patient with SCD with TMA shown on renal biopsy when evaluated for proteinuria.

**Case Description:** A 25 year-old male with SCD (HbSS) had proteinuria (1+ on dipstick, urine PCR of 212 mg/mmol, 24-hour protein of 2.75 g) with normal renal function (creatinine 83µmol/L) on screening. He had no known renal disease, diabetes, or nephrotoxic medications (including no NSAIDs). Routine blood-work was unremarkable, aside from baseline haemolytic indices. Autoimmune, vasculitis and infectious workup was negative. Morphological review was done to confirm schistocytes were not being mistaken for sickled RBC. Renal biopsy showed changes suggestive of SCN/hypertension (Fig 1a), and TMA (Fig 1b). Work-up for TMA causes was negative - normal ADAMTS13 levels (>98%), negative blood cultures, and no APLA antibodies. Genetic studies did not show any TMA pathogenic variants in complement or coagulation genes. The TMA was thus attributed to SCD in the absence of acute pain episodes.

**Discussion:** Case reports describe SCD-associated TMA, but these are in the setting of vaso-occlusive pain episodes, which are hypothesized to trigger TMA. Our case of SCD-associated TMA, without a pain crisis, is thus novel and proposes that SCD itself may be a secondary cause of renal TMA. Our case highlights the importance of renal biopsy for patients with SCD and proteinuria to identify if entities aside from SCN are contributory. Patients with SCD-associated TMA have responded to plasma exchange and/or RBC exchange transfusion in the setting of a pain crisis. Whether patients like ours, presenting outside a pain crisis, also respond to these therapies remains to be studied.

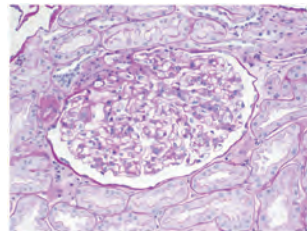

Fig 1a: Glomerulomegaly with arteriolar hyalinosis.

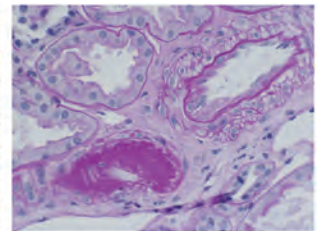

Fig 1b: Arteriole with intimal fibrin

**FR-PO682**

**Detection of Acid-Fast Bacillus, Interstitial Granulomatous Inflammation, and Infection-Associated Glomerulonephritis in a Patient With Tuberculosis**

Supriya Gerardine,<sup>1</sup> Victoria Gutgarts,<sup>1,2</sup> Steven Salvatore,<sup>2</sup> Aisha Shaikh.<sup>1,2</sup> <sup>1</sup>Memorial Sloan Kettering Cancer Center, New York, NY; <sup>2</sup>Weill Cornell Medicine, New York, NY.

**Introduction:** Mycobacterium tuberculosis (TB) can affect the urinary collecting system and the kidney. Direct renal TB infection can cause glomerulonephritis (GN) and interstitial granulomatous nephritis. Extra-renal TB infection can lead to infection-associated GN. We report a case of infection-associated GN, interstitial granulomatous inflammation, and the presence of acid-fast bacillus in the kidney in a patient with disseminated TB.

**Case Description:** A 70-year-old man with laryngeal cancer presented to the hospital with fever, cough, and blood-tinged secretions from the tracheostomy. He had acute kidney injury (creatinine 1.7 mg/dL), hematuria, pyuria, and severe proteinuria (UPCR 8 g/g). Blood and urine cultures showed no growth. CT chest revealed small bilateral nodules consistent with miliary TB, and bronchial secretions grew mycobacterial TB. Kidney biopsy showed IgA-dominant immune complex GN with sub-epithelial hump-shaped deposits suggestive of infection-associated GN. The kidney biopsy also showed an interstitial non-caseating granuloma with an acid-fast bacillus (Image). Anti-tuberculosis therapy was initiated for disseminated TB infection involving the lungs and kidneys.

**Discussion:** This report describes a rare case of infection-associated GN and interstitial granulomatous inflammation due to disseminated TB. The presence of acid-fast bacillus in the kidney suggests renal TB infection. The combination of isoniazid, rifampin, pyrazinamide, and ethambutol is used to treat disseminated TB. A favorable response to anti-tuberculosis therapy in TB-associated infectious GN has been reported, but such findings are limited to a small number of cases. Knowledge of the renal manifestations of TB infection can lead to early diagnosis and timely initiation of anti-tuberculosis therapy.

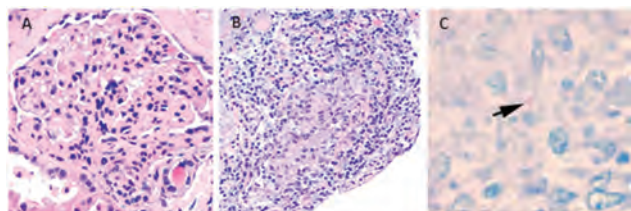

Kidney biopsy findings. A. Proliferative GN, B. Non-casating granuloma, C. Acid-fast bacillus

**FR-PO683**

**Pronase Digestion to the Rescue**

Matthew R. Johnson, Pravir V. Baxi, William L. Whittier, Stephen M. Korbet. *Rush University Medical Center, Chicago, IL.*

**Introduction:** Pronase digestion of paraffin-embedded kidney biopsy tissue is a valuable salvage technique used when glomeruli are not present on tissue reserved for routine immunofluorescence (IF). An additional advantage for this technique is that it can “unmask” immunoglobulin (Ig) deposits not seen on routine IF which has both diagnostic and treatment implications. Here, we present three cases in which pronase digestion was utilized in this way to make unanticipated alternate diagnoses.

**Case Description:** *Case 1:* A 70-year-old woman with HTN and follicular lymphoma in remission presented with AKI, subnephrotic proteinuria, and hypercalcemia with an IgG lambda on serum and urine immunofixation. Standard biopsy techniques revealed normal glomeruli and interstitial nephritis. *Case 2:* A 50-year-old woman with HTN presented with AKI, hematuria, and nephrotic-range proteinuria with an IgG lambda on serum immunofixation. Standard biopsy methods revealed idiopathic MPGN. *Case 3:* A 60-year-old man with HTN presented with nephrotic-range proteinuria and serum and urine immunofixation (-) for monoclonal proteins. Standard biopsy techniques revealed idiopathic immune-complex mediated MPGN. See Table 1 for details of pronase digestion & final diagnosis.

**Discussion:** MGRS encompasses a wide spectrum of kidney lesions, and a diagnosis is essential in guiding treatment which is directed towards a clonal disorder. In these cases, routine IF failed to provide a tissue diagnosis and pronase digestion was vital in unmasking a paraprotein-related lesion which ultimately led to appropriate treatment. Pronase digestion should be considered in all cases where there is a high index of clinical suspicion for MGRS despite negative routine IF findings to facilitate early recognition and treatment for these patients.

	Presentation	Pathology	Diagnosis Pre Pronase Digestion	Pronase Digestion	Diagnosis Post Pronase Digestion	Follow Up
1	AKI, hypercalcemia, IgG lambda in serum and urine Urine P/C 1.5 g/g	AJN, normal glomeruli. IF: casts with equal kappa and lambda	Interstitial nephritis	Casts with lambda light chain restriction	Follicular Lymphoma, crystalline light chain cast nephropathy	Treatment with rituximab, significant reduction in lambda light chain load
2	AKI, hematuria, serum with IgG lambda, normal serum kappa/lambda ratio Urine P/C 18 g/g	MPGN pattern IF: Glomeruli with IgG, equal kappa and lambda	Idiopathic immune-complex MPGN	IgG and lambda restriction	Light and heavy chain deposition disease	Died prior to the start of chemotherapy
3	AKI, no monoclonal in serum or urine Urine P/C 11.3 g/g	MPGN pattern IF: Glomeruli with IgG, equal kappa and lambda	Idiopathic immune-complex MPGN	Monoclonal IgG3 kappa deposits	PGNMD	Treatment with CyBorD resulted in complete remission

Table 1: Use of Pronase Digestion Unmasks the Diagnoses

**FR-PO684**

**Cell Cycle and Senescence Regulation by Podocyte Histone Deacetylases 1 and 2**

Paulina Medina Rangel, Shuta Ishibe. *Yale University, New Haven, CT.*

**Background:** The loss of integrity of the glomerular filtration barrier results in proteinuria which is often attributed to the loss of podocytes. Despite the rising prevalence of proteinuric diseases, it is still unclear how podocytes are lost following damage. Senescence has been implicated to occur in age-related or by genomic stress such as DNA damage. Podocyte histone deacetylases (HDAC) are essential in maintaining a normal glomerular filtration barrier by modulating DNA-damage and preventing senescence.

**Methods:** Germline podocyte specific *Hdac1* and *2* double knockout (DKO) mice were generated.

**Results:** Our research describes that podocyte-specific loss *Hdac1* and *2* in mice results in severe proteinuria, collapsing glomerulopathy and sustained DNA damage, likely caused by deficient DNA damage repair in the absence of these enzymes. DNA damaged-podocytes not only re-entered the cell-cycle as studied with the FUCCI (Fluorescence-Ubiquitination-based Cell Cycle Indicator) system, but also exhibited p21-mediated cell-cycle arrest, which has been associated with cellular senescence. Consistent with these findings, podocyte senescence was demonstrated *in vivo* and *in vitro* by senescence-associated  $\beta$ -galactosidase activity and lipofuscin aggregates in the podocyte cell body. Through the senescence secretory associated phenotype, we evaluated that senescent podocytes secrete matrix metalloproteinases that may contribute to their detachment. Moreover, senescent podocytes were observed in the urine from these mutant mice.

**Conclusions:** Our findings suggest that *Hdac1* and *2* are essential in podocytes development, as the deletion of these genes lead to sustained DNA damage, senescence and loss of podocytes. The role of HDACs in cell cycle regulation and senescence may provide important clues in our understanding of how podocytes are lost following injury.

**Funding:** NIDDK Support

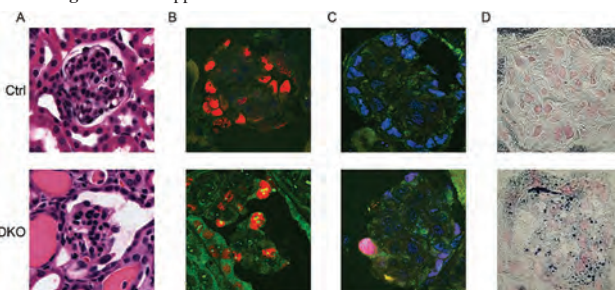

**Figure 1.** Loss of podocyte *Hdac1* and *2* in mice results in (A) collapsing glomerulopathy, (B) DNA damage (green) co-localized with WT-1 (red), (C) cell cycle re-entry, studied by FUCCI (WT-1 in blue, G1 phase in red) and (D) lipofuscin (blue granules), a marker of senescence.

**FR-PO685**

**Glomerular-Tubular Cells Cross-Talk Mediated by Soluble RARRES1, a Podocyte-Secreted Protein**

Ye Feng, John C. He, Kyung Lee. *Icahn School of Medicine at Mount Sinai, New York, NY.*

**Background:** Retinoic acid receptor responder protein 1 (RARRES1) is a transmembrane protein whose expression is found mainly in podocytes and its expression is correlated with human glomerular disease progression. Our previous study also showed that extracellular cleavage of RARRES1 results in soluble form (sRARRES1), which is taken up via endocytosis to cause podocyte injury. Importantly, sRARRES1, but not full-length RARRES1, is pathogenic, as RARRES1 mutant with cleavage defect fails to induce podocyte injury. Therefore, we further determined the mechanism of RARRES1 cleavage to injure podocytes in an autocrine manner and whether podocyte-secreted sRARRES1 may injure tubular cells in a paracrine manner.

**Methods:** Human primary tubular epithelial cells were treated with sRARRES1 obtained from the supernatants of human podocytes with RARRES1 overexpression. Mice with podocyte-specific overexpression of human wildtype RARRES1 or RARRES1 cleavage mutant were generated and used for the study.

**Results:** We previously demonstrated that RARRES1 is cleaved by the MMP protease family. Among MMPs, multiple kidney scRNAseq datasets identified MMP23b to be highly and uniquely expressed in podocytes. In cultured human podocytes, TNF- $\alpha$  leads to enhanced MMP23b mRNA and protein expression, and MMP23b knockdown partially blocked RARRES1 cleavage. Treatment of tubular cells with purified sRARRES1 from podocyte supernatants induced tubular cell injury following its endocytic uptake. Interestingly, KIM-1 knockdown reduced tubular uptake of sRARRES1. Markers of ER stress were enhanced in tubular cells with sRARRES1 uptake *in vitro*. Consistently, kidneys of aged mice with podocyte-specific RARRES1 overexpression showed marked increase in ER stress and tubular injury markers, in the absence of significant proteinuria, suggesting that podocyte-derived sRARRES1 induces tubular cell ER stress and injury via glomerulo-tubular crosstalk.

**Conclusions:** Increased podocyte RARRES1 expression in glomerular disease results increased cleavage and uptake of sRARRES1 that results in autocrine podocyte injury as well as significant paracrine tubular cell injury, suggesting an important role of RARRES1 in podocyte-tubular cell crosstalk in kidney disease.

**Funding:** NIDDK Support, Veterans Affairs Support



## FR-PO686

**Inflammation and Calorie Restriction in *Erc1* PKO Mice**

Amrei M. Mandel,<sup>1,2</sup> Linda Blomberg,<sup>1</sup> Paul Diefenhardt,<sup>1</sup> Fabian Braun,<sup>3</sup> Bernhard Schermer,<sup>1</sup> Sebastian Braehler,<sup>1</sup> Björn Schumacher,<sup>4</sup> Thomas Benzing,<sup>1</sup> Christine E. Kurschat.<sup>1</sup> <sup>1</sup>Department II of Internal Medicine and Center for Molecular Medicine Cologne, University of Cologne, Faculty of Medicine and University Hospital Cologne, Cologne, Germany; <sup>2</sup>Research Center On Rare Kidney Diseases (RECORD), University Hospital Erlangen, Erlangen, Germany; <sup>3</sup>III. Department of Medicine, University Medical Center Hamburg-Eppendorf, Hamburg, Germany; <sup>4</sup>CECAD, University of Cologne, Faculty of Medicine and University Hospital Cologne, Cologne, Germany.

**Background:** Terminally differentiated podocytes are highly susceptible to stress. Nucleotide excision repair (NER) genes are regulated in FSGS patient glomeruli. To study NER in podocytes, we generated a podocyte-specific *Erc1* knockout mouse (pko), which develops FSGS and shows activation of mTORC1 and inflammation, the latter shown here. Rapamycin treatment ameliorates the phenotype of *Erc1* pko mice. We present a calorie restriction study, known to inhibit mTORC1 and suppress inflammation and aging.

**Methods:** At 9 weeks of age, spleens and kidneys of *Erc1* pko and control mice were harvested and single-cell suspensions were prepared. T-cell and mononuclear phagocyte (MNP) populations were analyzed by flow cytometry using the BD LSRFortessa 2 cell analyzer. Immunohistochemistry for CD3 and MAC-2 was performed on kidneys of 12-week-old mice. 4-week-old *Erc1* pko mice were fed with 3.5 g standard diet over 4 weeks (CR). Two control groups were fed once daily with 4 g (SD) or *ad libitum* (AL). Histology as well as serum and urine analysis was performed at the end of the intervention period.

**Results:** 9-week-old *Erc1* pko mice showed an increased leukocyte count, mainly represented by Th1 cells. Systemically, Th17 cells were significantly decreased in *Erc1* pko-spleens with no changes in other immune cell populations. However, at 12 weeks *Erc1* pko mice showed a strong increase in glomerular macrophages, whereas glomerular T-cell-counts were unchanged. Albuminuria and glomerulosclerosis in *Erc1* pko mice were significantly reduced after 4 weeks of calorie restriction in line with a decrease of glomerular pS6RP signal, a downstream target of mTORC1.

**Conclusions:** *Erc1* deficiency causes progeroid syndromes in humans and mice. Podocyte-specific deletion of *Erc1* leads to glomerulosclerosis and early death, accompanied by mTORC1 activation and inflammation. Calorie restriction and rapamycin ameliorated disease progression. Next to inhibition of mTORC1 and deceleration of aging, calorie restriction is known to reduce inflammation. We show that renal inflammation is increased in *Erc1* pko mice. Interestingly, T-helper cell infiltration proceeds MNP infiltration into the kidneys. This influx and activation of immune cells might be regulated by calorie restriction and thus might explain the attenuation in the intervention group.

**Funding:** Private Foundation Support, Government Support - Non-U.S.

## FR-PO687

**The E3 Ubiquitin Ligase HUWE1 Is a Central Regulator of Podocyte Homeostasis**

Linus A. Volker,<sup>1,2</sup> Paul T. Brinkkoetter,<sup>1,2</sup> Bernhard Schermer,<sup>1,2</sup> Thomas Benzing,<sup>1,2</sup> Martin Höhne.<sup>1,2</sup> <sup>1</sup>University Hospital of Cologne, Cologne, Germany; <sup>2</sup>Exzellenzcluster CECAD in der Universität zu Köln, Köln, Germany.

**Background:** Terminal differentiation is a hallmark of renal podocytes. As terminally differentiated cells, podocytes need tight control of homeostasis. This is achieved through various signaling cascades such as mTOR, MAP-kinase signaling, AKT, and Wnt/Notch acting on diverse processes like proteostasis, DNA-damage repair, energy homeostasis and others. We identified the ultra-large E3 HECT-type ubiquitin-ligase HUWE1 as an interactor of the slit diaphragm associated protein complex. HUWE1 features a circular protein-protein interaction domain rendering it highly context-sensitive and versatile as a central modifier of intracellular signaling events via ubiquitination.

**Methods:** A podocyte-specific knockout mouse model of HUWE1 and shRNA- and CRISPR/Cas9-engineered podocyte cell-lines were used to elucidate the effects of HUWE1 on kidney function, podocyte homeostasis, and intracellular signaling. We employed a three-tiered multiomics approach including transcriptomics, proteomics, and ubiquitinomics to unravel the profound changes in podocyte homeostasis induced by HUWE1-deficiency.

**Results:** HUWE1-deficient mice develop albuminuria and progressive kidney failure at week 4. They develop severe glomerular damage and foot process effacement on the ultrastructural level. *Huwe1*-deficient mice die at week 7 to 14. *Huwe1*-deficient podocytes show decreased migratory activity and a general reduction in protein turn-over in the 26S proteasome fluorogenic peptidase assay, indicating defects in proteostasis. All three tiers of the multiomics approach demonstrated profound alterations in response to HUWE1-deficiency. An integrated analysis revealed podocyte-specific defects in mitochondrial energy metabolism, cell cycle and differentiation control, and actin cytoskeleton rearrangement. Moreover, a HUWE1-protein interaction network overlapped significantly with targets of mir193b-3p, a microRNA closely related to mir193a-3p, a known inductor of podocytopathy and FSGS.

**Conclusions:** HUWE1-deficiency causes a disruption of podocyte homeostasis via interaction with microRNA-associated networks and global changes in proteostasis, energy metabolism, cell cycle control, and actin cytoskeleton regulation.

**Funding:** Private Foundation Support

## FR-PO688

**Farnesoid X Receptor Agonist Obeticholic Acid Reduces Kidney Disease in a Mouse Model of Alport Syndrome**

Bryce A. Jones,<sup>1</sup> Priscilla E. Perry,<sup>1</sup> Shania R. Davidson,<sup>1,2</sup> Isabel Lopez Santiago,<sup>1,3</sup> Sharmila Adapa,<sup>1</sup> Katherine C. Allen,<sup>1</sup> Katelyn Dial,<sup>1</sup> Emma Rowland,<sup>1</sup> Komuraiah Myakala,<sup>1</sup> Xiaoxin Wang,<sup>1</sup> Moshe Levi.<sup>1</sup> <sup>1</sup>Georgetown University Medical Center, Washington, DC; <sup>2</sup>Howard University College of Arts and Sciences, Washington, DC; <sup>3</sup>Johns Hopkins University, Baltimore, MD.

**Background:** Alport syndrome is a rare hereditary kidney disease caused by a mutation in the collagen IV  $\alpha3(\alpha4\alpha5)$  heterotrimer. The farnesoid X receptor (FXR) is a nuclear hormone receptor that is activated by bile acids. FXR agonism has been shown to protect the kidney in preclinical models of kidney disease, but no study thus far has investigated FXR agonism in an orphan kidney disease. Obeticholic acid is an FXR agonist approved for clinical use, and this greatly increases the translational value of preclinical studies with OCA. In this study, we test the hypothesis that obeticholic acid protects the kidney in a mouse model of Alport syndrome.

**Methods:** Male Col4a3<sup>tm1Jm</sup> mice on 129S1/SvImJ were fed control diet (PicoLab 5053) alone or admixed with OCA (30 mg/kg BW) between 3 and 10 weeks of age. Col4a3<sup>-/-</sup> mice were the diseased mice, and Col4a3<sup>+/+</sup> and Col4a3<sup>+/+</sup> were the control mice. Plasma, urine, and organs were harvested at time of euthanasia for biochemical analyses.

**Results:** As expected, vehicle-treated Col4a3<sup>-/-</sup> mice had increased blood urea nitrogen (P < .0001), plasma creatinine (P < .0001), and urinary albumin-to-creatinine ratio (P < .0001) compared to control mice. Compared to vehicle-treated Col4a3<sup>-/-</sup> mice, OCA-treated Col4a3<sup>-/-</sup> mice had lower blood urea nitrogen (P < .05), plasma creatinine (trend, P < .06), and urinary albumin-to-creatinine ratio (P < .05) compared to vehicle-treated Col4a3<sup>-/-</sup> mice. Immunostaining for fibronectin and polarized imaging of picrosirius red (PSR) stained kidneys showed that OCA treatment prevented renal fibrosis compared to vehicle-treated mice (P < .05).

**Conclusions:** Obeticholic acid reduces kidney disease in a mouse model of Alport syndrome. Reduced renal fibronectin and PSR-positive staining suggests an OCA-mediated antifibrotic mechanism underlies at least part of the observed benefit.

**Funding:** NIDDK Support

## FR-PO689

**Increased Glomerular Elasticity Corresponds to Podocyte Injury and Loss in Alport Mice**

R. Tyler Miller,<sup>1,2</sup> Zhenan Liu,<sup>1</sup> Joonho Yoon,<sup>1</sup> Leslie A. Bruggeman,<sup>3</sup> Chao Xing,<sup>1</sup> Adwait Sathe,<sup>1</sup> Paul A. Janney,<sup>4</sup> Joel M. Henderson,<sup>3</sup> Audrey N. Chang,<sup>1</sup> UT Southwestern Medical Center <sup>1</sup>The University of Texas Southwestern Medical Center, Dallas, TX; <sup>2</sup>VA North Texas Health Care System, Dallas, TX; <sup>3</sup>Case Western Reserve University, Cleveland, OH; <sup>4</sup>University of Pennsylvania, Philadelphia, PA; <sup>5</sup>Boston University School of Medicine, Boston, MA.

**Background:** In primary glomerular renal disease, podocyte injury leads proteinuria, hematuria, and later fibrosis with loss of tubular function. Podocyte injury causes disruption of cytoskeletal architecture with loss of foot processes and podocyte loss. We used Col4a3 KO Alport model mice to understand early steps in podocyte injury and loss.

**Methods:** Col4a3 knockout (KO) mice (Alport Syndrome model, C57Bl/6j) are born with normal renal function and progress to ESRD by 7 months. Activation of the unfolded protein response (UPR) in podocytes, attributed to accumulation of misfolded collagen heterotrimers, is a potential cause of podocyte injury in Alport nephropathy. We studied the structural and biophysical properties of podocytes in glomeruli from WT, KO, and tauroursodeoxycholic acid (TUDCA)-treated KO mice using microindentation, confocal microscopy, transmission EM, and bulk- and single-cell RNAseq to evaluate gene expression differences. We tested the hypotheses that 1) glomerular biophysical properties reflect podocyte injury and reduced cell number and 2) alleviation of the UPR reduces podocyte injury and preserves podocyte cell number and glomerular function.

**Results:** Increased glomerular deformability precedes proteinuria and increased serum creatinine that corresponds to increased podocyte loss that is associated with reduced podocyte adhesion. This period is followed by glomerular stiffening, reduced renal function, proteinuria, and fibrosis. Treatment with TUDCA reduced podocyte loss, normalized glomerular elasticity, and slowed progression of renal disease by functional and morphologic criteria. Bulk RNAseq and qRT-PCR showed patterns of fibrosis and inflammation that intensified with glomerular stiffening, proteinuria and reduced renal function, and that was reduced by TUDCA. scRNAseq of podocytes early in the course of disease before significant podocyte loss demonstrated injury pathway activation, with compensation by podocytes to resist injury and enhance cytoskeletal structure and adhesion.

**Conclusions:** Significant podocyte injury and loss occur before proteinuria and renal function deteriorates and fibrosis is a late event. Therapeutic efforts might be most effective when directed at early podocyte injury and loss.

**Funding:** NIDDK Support, Veterans Affairs Support, Private Foundation Support

## FR-PO690

**miR-193a and Nanoparticle Technology: A Novel Therapeutic Target in Alport Syndrome**

Laura Perin,<sup>1,2</sup> Astgik Petrosyan,<sup>1</sup> Sinem Kargin,<sup>1</sup> Paola Aguiari,<sup>1</sup> Qi Zhang,<sup>1</sup> Xiaogang Hou,<sup>1</sup> Roger E. De Filippo,<sup>1</sup> Kevin V. Lemley,<sup>1</sup> Eun ji Chung,<sup>2</sup> Stefano Da Sacco,<sup>1</sup> <sup>1</sup>Children's Hospital Los Angeles, Los Angeles, CA; <sup>2</sup>University of Southern California, Los Angeles, CA.

**Background:** Significant molecular and functional changes within the glomerulus, and specifically in podocytes, the cells in charge of the ultrafiltration, are responsible for the initiation and progression of renal damage. Our data indicate that elevation of miR-193a plays a key role in regulating podocyte biology by controlling podocyte cell cycle phases. Using different tools (glomerulus-on-a-chip: GOAC, human COL4-defective podocytes, Fucci mice, nanoparticles, and spatial transcriptomics), we have identified miR-193a as a possible specific disease target in our model of CKD, Alport Syndrome (AS).

**Methods:** GOAC was seeded with human glomerular endothelial cells and podocytes derived from amniotic fluid of AS and healthy patients to recapitulate the function and structure of the glomerular filtration barrier. miR-193a studies were performed using mimics and inhibitors. Nanoparticles (micelle) containing miR-193a inhibitor were designed to specifically target podocytes. AS Fucci mouse model (cell cycle indicator mouse model) was used to track podocyte miR-193a cell cycle modulation. Biopsies of Alport patients were used to confirm miR-193a expression by in situ hybridization and to perform Digital Spatial Profiling (DSP) using Nanostring technology.

**Results:** Spatial transcriptomics identified in human AS glomeruli altered gene expression for podocyte structure (foot process and slit diaphragm), GEC structure (glycocalyx), matrix turnover proteins, miR-193a targets, and cell cycle. Generated AS-GOAC presented impaired permeability, and proteomics revealed a distinctive AS signature. In AS-GOAC, miR-193a inhibition, delivered with innovative nanoparticles designed targeting podocytes, restored to normal the altered podocyte cell cycle, and regulated downstream miR-193a targets (WT1, Itg $\alpha$ V $\beta$ 3/osteopontin, and VEGF) necessary for podocyte homeostasis.

**Conclusions:** We show that upregulating of miR-193a induces changes in gene expression and alteration of the cell cycle phases specifically in AS podocytes. Inhibiting miR-193a using micelle technology may re-establish glomerular function by modulating important molecular pathways responsible for podocyte survival representing a therapeutic target in AS settings.

**Funding:** NIDDK Support

## FR-PO691

**Extracellular Vesicle and Modulation of miR-93 in Kidney Disease**

Laura Perin, Charmi Dedhia, Paolo Neviani, Paola Aguiari, Valentina Villani, Astgik Petrosyan, Xiaogang Hou, Benedetta Bussolati, Sargis Sedrakyan. *Children's Hospital Los Angeles, Los Angeles, CA.*

**Background:** Modulation of miRNA expression in glomerular cells is associated with renal diseases. Our data indicate that miR-93 is down-regulated in glomeruli of mice with Alport syndrome (AS, our model of the renal disease characterized by a mutation in *coll4a5* gene) and in glomeruli of AS patients. Here, we investigated the role of hEVs derived from human amniotic fluid stem cells (hAFSC) in disease-modifying activity in vitro and in vivo by regulation of miR-93.

**Methods:** Isolated hEVs were characterized by cytometry, Exoview, immunomodulatory activity, RNA-seq, and proteomics. KO hEVs for miR-93 were generated by the use of an antagomir. Transfer and modulation of miR-93 (and its targets) in damaged human glomerular cells were evaluated in vitro. hEV disease-modifying activity was evaluated in AS mice by biodistribution, renal function, survival, and spatial transcriptomics (ST, Visium 10X Genomics Platform).

**Results:** By in situ analysis, we determined that miR-93 expression is decreased in mouse and human AS glomeruli. Cell specific damage decreases expression of miR-93 and its target expression (as VEGF) in human glomerular endothelial cells and podocytes. Expression of miR-93 was restored to normal levels only by normal hEVs and not KO hEVs. Proteomics and miR-seq data identified the specific hEV cargo fingerprint and that between the hEV and KO EV, a total of 59 proteins and 75 miRs were DE. GO and KEGG analysis of these cargo differences between hEVs and KO hEVs identified pathways central to disease progression, thus suggesting the central role of miR-93a in glomerular damage. When injected in AS mice, hEVs localized in the kidney, corrected proteinuria and prolong the lifespan. No side effects were noted. We defined spatial transcriptomics maps of kidneys from WT mice, AS mice, AS mice injected with hEVs and sacrificed after 5d and after 2m. Analysis of ST data on glomeruli showed that both early and late injections restored to normal important pathways responsible for AS progression (collagen formation, extracellular matrix alteration, fatty acid alteration) including miR-93 target pathways

**Conclusions:** hEVs regulated pathways that are central to glomerular homeostasis by modulation of miR-93. This suggests the possibility of using hEVs as a new therapeutic option for treating AS.

**Funding:** NIDDK Support

## FR-PO692

**Ramipril Therapy in Integrin  $\alpha$ 1-Null ARAS Mice Triples Lifespan: Mechanistic Clues From RNA-Seq Analysis**

Dominic E. Cosgrove,<sup>1</sup> Jacob D. Madison,<sup>1</sup> Daniel T. Meehan,<sup>1</sup> Kevin O. Wilhelm,<sup>2</sup> MichaelAnne Gratton,<sup>1</sup> Gina C. Samuelson,<sup>1</sup> John A. Fascianella,<sup>1</sup> <sup>1</sup>Boystown National Research Hospital, Omaha, NE; <sup>2</sup>Baylor College of Medicine, Houston, TX.

**Background:** The standard of care for patients with Alport syndrome is ACE inhibitors. In ARAS mice, the ACE inhibitors double lifespan. In humans, ACE inhibitor treatment extends life as well. Any therapy developed must provide significant benefit over ACE inhibition alone. Here we show that integrin  $\alpha$ 1-null Alport (DKO) mice treated with ramipril live 3X longer than untreated ARAS mice. This effect may be the result of laminin 211-mediated suppression of the transcriptional regulator FOXC2, which reduces expression of nephrin and podocin.

**Methods:** DKO mice were treated with vehicle or ramipril starting at 4 weeks of age. Proteinuria and glomerular filtration rates were measured at 5-week intervals. Glomeruli were analyzed for laminin 211 deposition in the GBM and GBM ultrastructure analyzed by TEM. RNA-seq was performed on isolated glomeruli at various timepoints, and cultured podocytes were overlaid with recombinant laminin 211 or not and RNA analyzed by RNA-seq.

**Results:** GFR in DKO mice decline between 10 and 15 weeks of age and in ramipril-treated DKO mice at 30 to 35 weeks. Proteinuria followed these same patterns with normalization of GBM architecture in ramipril-treated DKO mice. RNA-seq analysis showed that alteration of gene expression and pathways were similar comparing DKO with ramipril-treated DKO mice with delayed effects in ramipril-treated DKO mice. Decline in expression of nephrin and podocin mRNA and protein occurred but was delayed in the ramipril-treated DKO mice. GBM accumulation of laminin 211 was delayed in ramipril-treated Alport mice, and laminin 211 treatment of podocytes reduced expression of FOXC2 nephrin, and podocin.

**Conclusions:** Ramipril synergizes with integrin  $\alpha$ 1 blockade slowing the progression of glomerular disease and tripling the lifespan compared to untreated ARAS mice. The slowed progression involves similar genes and pathways, particularly the transcriptional regulator FOXC2, nephrin, and podocin. Reduced accumulation of laminin 211 in the GBM in treated mice. *In vitro*, Cultured podocytes exposed to laminin 211 show changes similar to Alport glomeruli.

**Funding:** Other NIH Support - NIDCD

## FR-PO693

**Altered Podocytes and Glomerular Stiffness in Alport Syndrome Occurs in Association With Increased SMPDL3b Expression**

Margaret Z. Gurumani,<sup>1,2</sup> Shamroop Kumar Mallela,<sup>1,2</sup> Alla Mitrofanova,<sup>1,2</sup> Jeffrey D. Pressly,<sup>1,2</sup> Vincent T. Moy,<sup>1</sup> Sandra M. Merscher,<sup>1,2</sup> Alessia Fornoni.<sup>1,2</sup> <sup>1</sup>University of Miami School of Medicine, Miami, FL; <sup>2</sup>University of Miami Katz Family Division of Nephrology and Hypertension, Miami, FL.

**Background:** Alport Syndrome (AS) is a hereditary disease caused by mutations in different chains of collagen IV, a component of the Glomerular Basement Membrane (GBM). While alterations in the composition of GBM that occur during pathogenesis has been extensively studied, less is known about the immediate cellular consequences occurring in podocytes contacted with an altered GBM. Sphingolipids are essential plasma membrane (PM) constituents, and the PM sphingolipids composition regulates the mobility of integrins, thereby promoting cell adhesion. We, and others have identified sphingomyelin-phosphodiesterase-acidlike-3b (SMPDL3b), an enzyme expressed in lipid raft domains of podocytes, where it regulates receptor assembly in caveolin-rich PM domains and where it regulates the availability of active sphingolipids such as ceramide 1 phosphate (C1P). With this study, we test the hypothesis that increased SMPDL3b expression in podocytes in the context of AS contributes to altered glomerular/podocyte stiffness.

**Methods:** Human podocyte cell lines transfected with a thermosensitive SV40- T construct and AS podocytes established from AS and wild type (WT) control mice were used for analysis. Atomic force microscopy (AFM) was used to assess the stiffness of podocyte in vitro and of micro dissected glomeruli ex vivo. RT-PCR was used to determine SMPDL3b expression in sieved glomeruli. PM fluidity was determined using a membrane fluidity kit from ABCAM.

**Results:** The expression of SMPDL3b was increased in AS podocytes and glomeruli when compared to WT. AS podocytes and glomeruli are associated with a significant decrease in stiffness when compared to WT. However, no changes in PM fluidity were observed in SMPDL3b OE podocytes when compared to control. SMPDL3b OE podocytes are also associated with a decrease in cell stiffness. C1P replenishment restores cell stiffness in SMPDL3b OE podocytes.

**Conclusions:** Our data demonstrate that SMPDL3b expression is increased in AS podocytes and glomeruli. Both SMPDL3b OE and AS podocytes and glomeruli are characterized by decrease in stiffness. Further studies are required to determine if SMPDL3b mediates cells and glomerular stiffness in AS and to determine how changes in stiffness affect the interaction with other components of filtration barrier.

**Funding:** NIDDK Support, Private Foundation Support

## FR-PO694

**SMPDL3b Regulates Proteinuria in Experimental Alport Syndrome via Sphingosin-1-Phosphate**

Alla Mitrofanova,<sup>1</sup> Annapurna Pamreddy,<sup>2</sup> Antonio M. Fontanella,<sup>1</sup> Matthew Tolerico,<sup>1</sup> Shamroop Kumar Mallela,<sup>1</sup> Margaret Z. Gurumani,<sup>1</sup> Judith T. Molina David,<sup>1</sup> Jin Ju Kim,<sup>1</sup> George W. Burke,<sup>1</sup> Sandra M. Merscher,<sup>1</sup> Kumar Sharma,<sup>2</sup> Alessia Fornoni,<sup>1</sup> <sup>1</sup>University of Miami School of Medicine, Miami, FL; <sup>2</sup>The University of Texas Health Science Center at Houston, Houston, TX.

**Background:** Alport Syndrome (AS) is caused by mutations in the gene coding for type IV collagens and is characterized by progressive loss of kidney function, where podocytes play the central role. We previously reported that cholesterol and sphingolipids are major determinants of podocyte function, and that sphingomyelin phosphodiesterase acid-like 3b (SMPDL3b), a lipid raft associated protein, plays an important role in podocyte survival and regulates the availability of bioactive sphingolipids such as sphingosine-1-phosphate (S1P). We tested the hypothesis that altered podocyte SMPDL3b expression affects the generation of S1P thus contributing to the renal failure in AS.

**Methods:** Illumina sequencing RNA data analysis, qRT-PCR and Western blot analysis were used to characterize differentiated immortalized murine podocytes isolated from AS mice. Kidney cortices from 8-week-old AS mice were used for LC-MS analysis. Kidneys from 20-weeks-old podocyte-specific Smpdl3b deficient AS mice (DKO) mice and their controls were processed for in-depth phenotypical analysis, including urinary albumin-to-creatinine ratio (ACR) and matrix-assisted laser desorption/ionization mass spectrometry imaging (MALDI-MSI). 16-weeks-old AS and DKO mice were intraperitoneally injected with 100 nM S1P for 4 weeks. Two-tailed t-test or One-Way ANOVA followed by Tukey's post-test were used to detect statistical changes.

**Results:** SMPDL3b expression is significantly higher in isolated podocytes and in kidney cortices from AS mice. Moreover, decreased expression of S1P phosphatase 1, an enzyme that catalyzes S1P dephosphorylation, in isolated podocytes was observed in association with S1P and ceramide accumulation in kidney cortices from AS mice. Podocyte specific SMPDL3b deletion in DKO mice resulted in decreased ACR levels and increased number of podocytes foot processes. S1P injections in DKO mice caused worsened albuminuria.

**Conclusions:** Our data indicate that SMPDL3b expression may affect availability of S1P, thereby regulating proteinuria levels in experimental AS. Thus, targeting SMPDL3b expression levels in the podocytes may represent a novel approach to improve renal outcomes in patients with AS.

**Funding:** NIDDK Support, Private Foundation Support

## FR-PO695

**Therapeutic Blockade of the SLIT/ROBO Signaling Pathway Alleviates Podocytopathy Defects in Integrin-Linked Kinase Podocyte-Specific Knockout Mice**

Sudhir Kumar,<sup>1</sup> Xueping Fan,<sup>1</sup> Emily Zaltz,<sup>1</sup> Hui Chen,<sup>2</sup> Joel M. Henderson,<sup>1,2</sup> David J. Salant,<sup>1,2</sup> Hongying Yang,<sup>3</sup> Stephen Berasi,<sup>3</sup> Weining Lu.<sup>1,2</sup> <sup>1</sup>Boston University, Boston, MA; <sup>2</sup>Boston Medical Center, Boston, MA; <sup>3</sup>Pfizer Inc, Cambridge, MA.

**Background:** The SLIT/ROBO signaling pathway negatively regulates podocyte adhesion and actin polymerization. Podocyte-specific deletion of integrin-linked kinase (ILK) in mice (ILK cKO) causes a podocytopathy reflecting FSGS with severe proteinuria, podocyte loss, and renal failure. We hypothesized that therapeutically blocking the SLIT/ROBO pathway with a ROBO2-IgG-Fc fusion protein would improve the podocytopathy phenotype in adult ILK cKO mice.

**Methods:** Seven-week-old ILK cKO homozygous mice were generated and treated with the ROBO2-IgG-Fc fusion protein or control IgG at 25 mg/kg every 2-3 days for 16 weeks. The survival probability of ILK cKO mice was calculated using the Kaplan Meier estimator. Urine samples were collected every two days to measure the urine albumin-to-creatinine ratio (UACR). Renal function (BUN measurement), kidney histology (PAS staining), podocyte number (P57 staining), podocyte foot process width (FPW), and slit diaphragm (SD) density of ILK cKO mice were assessed after three weeks of the treatment.

**Results:** Median survival was significantly longer in ROBO2-IgG-Fc treated than control IgG treated ILK cKO mice (105 days versus 52 days). After 3-weeks of treatment, significant mean UACR reductions were observed on day 18 (46%) and day 21 (50%) in ROBO2-IgG-Fc treated ILK cKO mice compared to control IgG treated mice. In addition, BUN was considerably lower in ILK cKO mice treated with the ROBO2-IgG-Fc (88 mg/dL) than the control IgG (124 mg/dL). Finally, podocyte loss, podocyte FPW, SD density, and renal tubular injury in ILK cKO mice were significantly improved by the ROBO2-IgG-Fc treatment compared to control IgG.

**Conclusions:** Therapeutic inhibition of the SLIT/ROBO signaling pathway ameliorates the podocytopathy phenotype and significantly extends the life span of adult ILK podocyte-specific knockout mice via preventing podocyte loss, reducing albuminuria, and improving renal function. Our studies provide additional confidence in rationale for blocking the ROBO/SLIT signaling pathway for treating podocytopathies and proteinuric kidney diseases. A phase 2 (NCT03448692) clinical trial testing the efficacy of a ROBO2-Fc fusion protein (PF-06730512) in FSGS patients is ongoing.

**Funding:** NIDDK Support, Commercial Support - Pfizer Inc.

## FR-PO696

**Therapeutic Blocking of NPRC, a Podocyte-Expressed Target, Is Kidney Protective in ZSF1 Rats**

Mark Lal,<sup>1</sup> Dina Dabaghie,<sup>2</sup> Emmanuelle Charrin,<sup>2</sup> Pernilla Tonelius,<sup>1</sup> Birgitta E. Rosengren,<sup>1</sup> Anna Granqvist,<sup>1</sup> Jaakko Patrakka.<sup>2</sup> <sup>1</sup>AstraZeneca Pharmaceuticals LP, Gothenburg, Sweden; <sup>2</sup>Karolinska Institutet, Stockholm, Sweden.

**Background:** Increasing natriuretic peptide (NP) levels can be achieved by neprilysin inhibition and is a clinically validated therapeutic strategy for heart failure, when combined with an angiotensin receptor blocker. An equally important and fundamental determinant of NP levels is contributed to by the NP clearance receptor, NPRC, a membrane protein abundantly expressed in the kidney. In this study, we aimed to elucidate the role of NPR3 in the pathogenesis of glomerulopathies.

**Methods:** Renal expression of NPR3 was studied using qPCR, scRNAseq and immunohistochemistry. The functional role of NPRC was analyzed using a novel mouse line in which NPRC was genetically inactivated specifically in podocytes (NPRC podKO). NPRC was targeted pharmacologically using an NPRC blocking peptide in a rat model of DN (uninephrectomized obese ZSF-1 rats (UNx ZSF-1 rats)), followed by studies in a mouse glomerulopathy model.

**Results:** NPRC was highly and specifically expressed by podocytes of the glomerulus. NPRC podKO mice showed normal kidney morphology and function and NPRC-deficiency did not readily affect the outcome of an acute mouse glomerulopathy model. In diabetic UNx ZSF-1 rats, pharmaceutical blocking of NPRC activity resulted in increased urinary and plasma cGMP levels, indicative of successful target engagement and elevated NPs. Diabetic rats treated only with NPR3 blocker showed limited impact on readouts of renal injury. However, when NPRC blocking was combined with losartan (angiotensin receptor blocker), it potentiated significantly the ameliorative effects on albuminuria and glomerular sclerosis. In line with this, NPRC blocking showed reno-protective effects in a mouse glomerulopathy model as shown by decreased glomerulosclerosis and reduced podocyte loss.

**Conclusions:** NPRC is highly expressed by podocytes and blocking its clearance activity appears to contribute to reno-protective effects in DN. Additional studies are needed to understand the molecular mechanisms of NP-signaling in the glomerulus and to explore the extent to which local paracrine and systemic NPRC blocking may contribute to functional benefit in kidney disease.

**Funding:** Commercial Support - AstraZeneca

## FR-PO697

**High-Throughput, Prospective Discovery of Splice-Disruptive Variants (SDVs) in the Nephrotic Syndrome (NS) Gene WT1**

Jennifer Lai Yee, Cathy Smith, Ian A. Dunn, Bala Bharathi B. Burugula, Jacob O. Kitzman. *University of Michigan, Ann Arbor, MI.*

**Background:** SDVs contribute to a fraction of nearly every human genetic disorder. Frasier Syndrome, a syndromic NS, is caused by SDVs near *WT1* exon 9 splice donor site (SD), which decrease the ratio between two natural splice forms of *WT1* called +KTS and -KTS. Beyond a few known Frasier Syndrome SDVs, accurately predicting other *WT1* variants' effects on splicing remains a challenge. *In vitro* minigene assays provide one means to test variant effect on splicing in highly multiplexed fashion. Thus, we coupled minigene assays with saturation mutagenesis across *WT1* exon 9 to systematically identify *WT1* SDVs in a high-throughput manner.

**Methods:** *WT1* exon 9 plus 200 bases of the flanking introns were cloned into an established minigene plasmid, in between constant synthetic exons. Saturation mutagenesis was performed to generate a variant library including every single nucleotide variant across the cloned region, each associated with a unique barcode present in the constant downstream exon. This variant library was then transfected into 293T cells, and 24 hours later, RNA was harvested from those cells and spliced transcripts from the minigene library were read by target RNA-seq. The splicing patterns associated with each *WT1* exon 9 variants were quantified from the aligned reads.

**Results:** Every possible single-base mutation was generated in the library, with a high degree of redundancy. Among spliced reads, +KTS and -KTS were the most highly represented isoforms and normally present at roughly 1:1 ratio. We identified 19 single-nucleotide variants near the +KTS SD which disrupt the normal splicing pattern of +KTS and -KTS isoform, favoring the expression of -KTS. Among these we detected all 8 known Frasier Syndrome variants. We also identify 16 single-nucleotide variants clustering near the -KTS SD which increased the expression of +KTS isoform.

**Conclusions:** Our saturation screen identifies all known Frasier syndrome SDVs in *WT1* exon 9. We also nominate an additional 11 variants which similarly decrease the +KTS/-KTS ratio, and these represent possible yet unseen Frasier Syndrome variants. We also discovered a set of variants which increase +KTS expression, which require further study. In summary, high throughput functional analyses can prospectively score genetic variants in NS and guide the functional classification

**Funding:** Other NIH Support - Clinical Scientist Institutional Career Development Program Award (K12)

## FR-PO698

**Combining Multiphoton Microscopy With Super-Resolution Microscopy to Investigate Podocyte Injury in Acute Murine Kidney Slices**

Eva Wiesner, Julia Binz, Agnes Hackl, David Unnersjö-Jess, Thomas Benzing, Matthias Hackl. *Department II of Internal Medicine and Center for Molecular Medicine Cologne, University of Cologne, Faculty of Medicine and University Hospital Cologne, Cologne, Germany.*

**Background:** Maintenance of low intracellular calcium levels is important for podocyte health, as impairments in its homeostasis lead to kidney disease. However, it remains unclear what effects increasing calcium signals have on the actin cytoskeleton and the slit diaphragm. To combine functional measurements with a high-resolution structural readout, we established a novel co-imaging approach using two distinct microscopy techniques: multiphoton and STED microscopy, in an acute murine kidney slices (AKS) model.

**Methods:** For disease induction, nephrotoxic serum was injected into 5-week old C57BL6 mice expressing GCaMP3 under the Pod:Cre promoter exclusively in podocytes. 5 days after injection the animals were sacrificed. The kidneys were removed and cut into slices of 300 µm thickness. The first imaging step was conducted at a multiphoton microscope to measure the fluorescence intensity of the GCaMP3 sensor. During acquisition, the slice was burned at several points in the kidney interstitium, later used as hallmarks. The AKS was fixed and prepared by anti-nephrin staining for follow-up STED microscopy. During STED imaging previously recorded glomeruli were identified by the burning points and high-resolution images of the slit diaphragm were acquired.

**Results:** Imaging of control animals showed low intracellular calcium levels in podocytes and an intact slit diaphragm architecture. In animals after induction of a nephrotoxic serum nephritis, the combination of multiphoton with STED microscopy revealed higher intracellular calcium levels in podocytes and a destruction of the slit diaphragm and demonstrated a correlation between intracellular calcium levels of podocytes and changes in the slit diaphragm morphology of different glomeruli in a single animal.

**Conclusions:** This new co-imaging approach combines the technical advantages of the individual imaging techniques and enables us to image the same glomerulus sequentially to correlate intracellular calcium levels with ultrastructural impairments of the slit diaphragm in a podocyte disease model. Our established co-imaging protocol using AKS can be applied to several research questions, providing both functional and ultrastructural information.

**Funding:** Government Support - Non-U.S.

## FR-PO699

**Synuclein Alpha Accumulation Mediates Podocyte Injury in Fabry Nephropathy**

Fabian Braun,<sup>1</sup> Ahmed Abed,<sup>2</sup> Oystein Eikrem,<sup>3</sup> Nicola Wanner,<sup>1</sup> Soeren W. Gersting,<sup>1</sup> Ania C. Muntau,<sup>1</sup> Oliver Kretz,<sup>1</sup> Behzad Najafian,<sup>4</sup> Camilla Tøndel,<sup>5</sup> Michael Mauer,<sup>6</sup> Tillmann Bork,<sup>2</sup> Florian Grahmmer,<sup>1</sup> Thorsten Eierhoff,<sup>7</sup> Winfried Römer,<sup>2</sup> Hans-Peter Marti,<sup>3</sup> Victor G. Puelles,<sup>1</sup> Christoph Schell,<sup>2</sup> Tobias B. Huber.<sup>1</sup> <sup>1</sup>Universitätsklinikum Hamburg-Eppendorf, Hamburg, Germany; <sup>2</sup>Albert-Ludwigs-Universität Freiburg, Freiburg im Breisgau, Germany; <sup>3</sup>Universitetet i Bergen Det medisinsk-odontologiske fakultet, Bergen, Norway; <sup>4</sup>University of Washington, Seattle, WA; <sup>5</sup>Haukeland Universitetssjukhus, Bergen, Norway; <sup>6</sup>University of Minnesota, Minnesota, MN; <sup>7</sup>University Hospital Münster, Münster, Germany.

**Background:** Anderson-Fabry disease is an X-linked lysosomal disorder characterized by a multisystemic globotriaosylceramides (Gb3) accumulation due to reduced alpha-galactosidase activity (GLA). Current therapies for Fabry disease are based on reversing intra-cellular accumulation Gb3 by enzyme replacement therapy (ERT) or chaperone-mediated stabilization of the defective enzyme, thereby alleviating lysosome dysfunction. However, their effect in the reversal of end-organ damage, like kidney injury and chronic kidney disease remains unclear.

**Methods:** We employed CRISPR/CAS9 to generate GLA knock out lines of immortalized human podocytes *in-vitro*. These cells were investigated by (ultra-) structural, transcriptome and proteome as well as functional analyses in the presence and absence ERT. The acquired data sets were integrated through network analysis and connectivity mapping. These data were complemented by the investigation of human biopsies taken sequentially before and after a period of ERT.

**Results:** Ultrastructural analysis of sequential renal biopsies showed that ERT use reduced Gb3 accumulation in podocytes but did not reverse foot process widening. The α-Galactosidase knockout podocyte cell line confirmed ERT-mediated reversal of Gb3 accumulation without resolution of lysosomal dysfunction. Transcriptome-based connectivity mapping and SILAC-based quantitative proteomics identified alpha-synuclein (SNCA) accumulation as a key event mediating podocyte injury. Genetic and pharmacological inhibition of SNCA improved lysosomal structure and function in Fabry podocytes, exceeding the benefits of ERT.

**Conclusions:** Together, this work reconceptualizes Fabry-associated cell injury beyond Gb3 accumulation, and introduces SNCA modulation as a potential intervention, especially for patients with Fabry nephropathy.

## FR-PO700

**Sarcomere-Like Structures Prevent Podocyte Detachment and Template Synaptopodin-Positive Extensions**

Shumeng Jiang,<sup>1</sup> Jeffrey H. Miner,<sup>2</sup> Guy M. Genin,<sup>1</sup> Hani Suleiman.<sup>2</sup> <sup>1</sup>Washington University in St Louis, St Louis, MO; <sup>2</sup>Washington University in St Louis School of Medicine, St Louis, MO.

**Background:** Podocyte injuries can cause chronic kidney disease, which is widespread and incurable. The biophysical mechanisms underlying podocyte responses to injury are unclear, in part because materials systems for mimicking the microenvironment of relevant kidney cells are limited.

**Methods:** We developed an *ex vivo* micropatterned hydrogel culture system that allows the control of the podocyte microenvironment, including ECM substrate types, stiffness, and cell shapes. This approach allows us to study the primary podocyte cytoskeleton immediately after their migration from isolated glomeruli of both mouse and human origins.

**Results:** In this culture system, primary podocytes upregulated a mat of sarcomere-like structures (SLSs), with striations composed of alternating clusters of α-actinin 4, synaptopodin and myosin IIA in the early stages of spreading. These structures are reminiscent of the SLSs observed in pathological podocytes *in vivo*. The periodic synaptopodin-positive clusters nucleated peripheral, foot process-like extensions, suggesting a role for SLSs in guiding the formation and proper spacing of these processes. SLSs were not found in a podocyte cell line, either before or after differentiation. Functionally, podocytes presenting SLSs were highly contractile. The SLSs were dissembled when we reduced their contractility either by inhibiting myosin, decreasing substrate stiffness, or inhibiting RhoA, ROCK or formins to target the Rho signaling pathway. In addition, our experiments revealed faster detachment of podocytes that lost SLSs, emphasizing the need for SLSs in injured podocytes to prevent podocyte loss as part of an adaptive mechanism after injury.

**Conclusions:** We show that SLSs may have a dual role in podocyte biology: providing sufficient contractility that helps maintain adhesion to the GBM after injury; and templating the formation of foot process in immature podocytes or those recovering from injury. Therefore, the SLSs in injured podocytes may serve as potential therapeutic targets.

**Funding:** NIDDK Support, Other U.S. Government Support, Private Foundation Support

## FR-PO701

**Plasma From Patients With Focal Segmental Glomerulosclerosis Triggers an Abnormal Kidney Organoid Development With Specific Alteration in the Glomerular Structures and Podocytes**

Lorenzo G. Gallon,<sup>1</sup> Ashwani K. Gupta,<sup>3</sup> Jason Wertheim.<sup>2</sup> <sup>1</sup>Northwestern University Feinberg School of Medicine, Chicago, IL; <sup>2</sup>The University of Arizona College of Medicine Phoenix, Phoenix, AZ; <sup>3</sup>The University of Arizona College of Medicine Phoenix, Phoenix, AZ.

**Background:** Focal segmental glomerulosclerosis (FSGS) is a frequently acquired kidney disorder resulting in end-stage renal disease and it is associated with a high rate of recurrence after renal transplantation. Clinical and experimental evidence has shown that a circulating factor is involved in the pathogenesis of FSGS and its recurrence. We hypothesized that FSGS plasma could trigger an FSGS-specific abnormality in the glomerular structures and podocytes of kidney organoids.

**Methods:** The hPSCs were induced to differentiate in kidney organoids. On day 16, kidney organoid media was changed with fresh medium containing 10% healthy plasma, recurrent FSGS plasma, non-recurrent FSGS plasma, or primary FSGS plasma. On day 23, organoids were evaluated under a stereomicroscope, and organoids were stained for podocytes specific proteins, extracellular matrix (ECM) proteins, and injury molecules.

**Results:** Kidney organoids generated with organoid media and healthy plasma showed typical developmental phenotype with intact and tightly packed tubular clusters whereas organoids generated with FSGS plasma showed abnormal or damaged tubular clusters (Fig1. A-E). Podocalyxin staining for podocytes showed the organoids generated in organoid media and healthy plasma had intact presumptive glomerular structures (Fig1. F, G). Recurrent FSGS plasma-treated organoids and primary FSGS plasma-treated organoids showed damaged presumptive glomerular structures and scattered podocalyxin expression patterns (Fig1. I-J). Gene expression analysis by qPCR of kidney organoids cultured with recurrent FSGS plasma or primary FSGS plasma vs media, healthy plasma, or non-recurrent FSGS plasma showed alteration of podocytes specific proteins.

**Conclusions:** FSGS plasma can trigger FSGS specific abnormality in the glomerular structures and podocytes. FSGS plasma induce podocyte and proximal tubule injury. Our kidney organoid model could be a useful tool to study the pathophysiology of primary FSGS.

**Funding:** Other U.S. Government Support

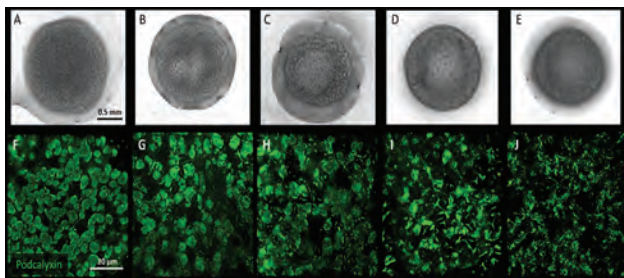

Phenotypic changes to kidney organoids after FSGS plasma treatment.

#### FR-PO702

##### In Vivo High-Content Zebrafish Screening Identifies Podocyte-Protective Drugs

Maximilian Schindler,<sup>1</sup> Florian Siegerist,<sup>1</sup> Jochen Gehrig,<sup>2</sup> Sheraz Gul,<sup>3</sup> Nicole Endlich,<sup>1</sup> Endlich Lab <sup>1</sup>Universitätsmedizin Greifswald, Greifswald, Germany; <sup>2</sup>Acquifer Imaging GmbH, Heidelberg, Germany; <sup>3</sup>Fraunhofer-ITMP, Hamburg, Germany.

**Background:** Podocyte injury is the major cause of FSGS and no curative drugs are currently available. Therefore, identification of small molecules/compounds protecting podocytes is of high relevance. Since zebrafish larvae develop a size-selective filtration barrier within 4 days and we recently established a larval FSGS-like model, this organism is ideally suited for *in vivo* high-content screenings.

**Methods:** A transgenic screening strain expresses the nitroreductase and the fluorescent dye mCherry exclusively in podocytes. Additionally, a 78-kDa circulating eGFP-vitamin D-binding fusion protein is expressed. After incubation of larvae with 80 μM metronidazole (MTZ) for 24 hours, podocyte depletion and glomerular clearance of the eGFP fusion protein is induced. For the screening, larvae were co-treated with MTZ and compounds of a drug library at 4 days post fertilization (dpf) for 24 hours. After washout, the vascular eGFP as well as the podocyte mCherry was imaged at 5 and 6 dpf. The fluorescence ratios depict robust readouts for the degree of podocyte depletion and proteinuria.

**Results:** The screening of a drug library consisting of 138 compounds provided 9 potential hits with a protective effect on podocytes. These compounds significantly reduced the loss of vascular and/or podocyte fluorescence compared to the injury control group. Subsequent validation experiments with n=288 larvae per compound confirmed or rejected a protective effect of the drugs.

**Conclusions:** Our group established an *in vivo* high-content screening that identified potential drugs to treat FSGS.

**Funding:** Private Foundation Support, Government Support - Non-U.S.

#### FR-PO703

##### Flotillin Mediates Raft-Dependent Turnover of Fly Nephrin Within Slit Diaphragms in Drosophila Nephrocytes

Konrad Lang,<sup>1</sup> Julian Milosavljevic,<sup>1</sup> Helena Heinkel,<sup>1</sup> Martin Helmstädter,<sup>1</sup> John S. Poulton,<sup>2</sup> Tobias F. Hermle,<sup>1</sup> <sup>1</sup>Universitätsklinikum Freiburg Abteilung Innere Medizin IV Nephrologie und Allgemeinmedizin, Freiburg, Germany; <sup>2</sup>The University of North Carolina at Chapel Hill, Chapel Hill, NC.

**Background:** Evidence from *in vitro* studies and murine knockout models support a role of endocytosis for the glomerular filtration barrier. Two endosomal regulators, *GAPVD1* and *TBC1D8B*, were discovered as a monogenetic cause of nephrotic syndrome in humans. However, the mechanistic role of endocytosis at the slit diaphragm remains unclear. The nephrocyte model of *Drosophila* provides an accessible, molecularly conserved podocyte model to study slit diaphragm dynamics.

**Methods:** Using acute gain- and loss-of function strategies for endosomal regulators in *Drosophila* nephrocytes, we studied their impact on the trafficking of slit diaphragm proteins in fixed samples and live imaging. Endocytic turnover was investigated by live antibody labeling after genome editing of fly nephrin.

**Results:** Sns, the *Drosophila* ortholog of nephrin, exhibits a half-life of about two days after acute knockdown and the architecture of slit diaphragms appears stable in live imaging short term. However, live antibody labeling of fly nephrin revealed a near complete turnover after two hours, confirmed by FRAP analysis. This suggests that slit diaphragms form a stable yet very dynamic structure. Acute knockdown of Rab5, a small GTPase and key regulator of early endosomes, caused the formation of ectopic slits as well as a severely diminished Sns turnover. Silencing of the early endosomal protein Hrs phenocopied *Rab5*-RNAi. Diminished endocytosis further altered characteristics of the filtration barrier, selectively reducing passage of tracers close to the upper size limit. Silencing of *Rab11*, which promotes recycling, led to a slower turnover of Sns. Rab7, a regulator of degradation, had no overt impact on slit diaphragm formation or turnover, suggesting that degradation is dispensable for maintenance. To study the endocytic routes of entry, we acutely blocked dynamin-dependent endocytosis, which caused ectopic slits but a normal Sns turnover. Conversely, exposure to Cyclodextrin or inhibition raft-mediated flotillin endocytosis reduced the turnover significantly.

**Conclusions:** Dynamin-dependent endocytosis prevents the formation of ectopic slit diaphragms in nephrocytes. Flotillin-dependent endocytosis dominates turnover of nephrin within the slit diaphragm.

**Funding:** Government Support - Non-U.S.

#### FR-PO704

##### Using Drosophila melanogaster to Characterize Potentially Pathogenic Patient Mutations Associated With Nephrotic Syndrome and Focal Segmental Glomerulosclerosis

Johanna Odenthal,<sup>1</sup> Bodo B. Beck, Bernhard Schermer, Thomas Benzing, Paul T. Brinkkoetter, Malte P. Bartram. *Uniklinik Köln, Köln, Germany.*

**Background:** Regulation of actin cytoskeleton organization is at the center of podocyte morphology and homeostasis during health and disease. The actin-binding and -crosslinking protein Alpha-actinin 4 (ACTN4) has been shown to play an essential role in this context, as mutations in the *ACTN4* gene are leading to an autosomal-dominant form of focal segmental glomerulosclerosis (FSGS). Here, performing gene panel sequencing in a pediatric patient presenting with steroid resistant nephrotic syndrome and FSGS, a *de novo*, potentially disease causing variant of *ACTN4* was identified, which was previously undescribed and not found in available genome or exome databases. Our aim is to elucidate the pathogenic potential of this variant for podocytes and FSGS progression.

**Methods:** To investigate the pathogenic potential of the newly identified ACTN4 variant (ACTN4-M240T), we employed the genetic toolbox of *Drosophila*. The fly holds podocyte-equivalent cells called nephrocytes, which are responsible for filtration and detoxification of the hemolymph. Cell-specific genetic manipulation enabled us to analyze RNAi-mediated knockdown of Actinin, the single fly homolog, in nephrocytes and its impact on cell morphology and function. Rescue experiments with the novel human ACTN4 variant will now give indication about possible pathogenic consequences of the mutation when compared to wildtype as well as previously described disease-associated variants of ACTN4.

**Results:** Knockdown of *Drosophila* Actinin in nephrocytes leads to severe functional and morphological defects, as seen by impacted filtration capacity and reduced nephrocyte diaphragm length. Transgenic expression of wildtypic human ACTN4 resulted in partial rescue of the Actinin-knockdown associated phenotypes. In contrast, expression of ACTN4-M240T as well as other FSGS-associated ACTN4-mutant proteins neither ameliorated functional nor morphological defects.

**Conclusions:** Our results underline the importance of Actinin and actin cytoskeleton regulation for nephrocyte/podocyte biology. As ACTN4-M240T was not able to rescue Actinin-knockdown associated phenotypes, but in contrast, showed similar results to other pathogenic variants of ACTN4, we conclude that also ACTN4-M240T is a pathogenic variant of ACTN4.

#### FR-PO705

##### Mitochondrial ROS Sensitize Podocytes to Insulin Resulting in mTOR Activation

Johanna Odenthal,<sup>1</sup> Katrin Reitmeier, Lucas Kuehne, Bernhard Schermer, Thomas Benzing, Paul T. Brinkkoetter. *Uniklinik Köln, Köln, Germany.*

**Background:** Beyond their contribution to maintaining cellular ATP levels, mitochondria have been recognized as signaling hubs regulating podocyte function in states of health and disease. Recently, we established podocyte specific Phb2 deficient mice as *in vivo* model to study dysfunctional mitochondria and their impact on podocyte metabolism. PHB2 acts as scaffold protein at the inner mitochondrial membrane and is required for proper fusion and function of mitochondria. Loss of PHB2 resulted in hyperactive Insulin/IGF1 signaling and increased mTOR activation in podocytes (Ising et al. EMBO Mol Med 2015).

**Methods:** To further elucidate the molecular mechanisms by which mitochondria orchestrate the podocytes' response to insulin, we employed *Drosophila melanogaster* as a model and studied nephrocytes, podocyte-equivalent cells of the fly, responsible for filtration of the hemolymph. Cell-specific RNAi-mediated knockdown and simultaneous overexpression of candidate genes enabled us to investigate genetic interactions to identify the mitochondrial signaling cascade leading to the observed insulin hypersensitivity and subsequent mTOR activation.

**Results:** Knockdown of *Drosophila* Phb2 in nephrocytes leads to severe functional and morphological defects mimicking the published mammalian phenotype and confirming the feasibility of this approach. Simultaneous overexpression of a dominant-negative form of the Insulin-Receptor ameliorated both, functional and morphological defects in Phb2 deficient nephrocytes emphasizing the impact of hyperactive insulin signaling on the disease phenotype. Last, we tested the hypothesis, that increased mitochondrial ROS might lead to an autophosphorylation of the Insulin-Receptor and thereby enhance the intracellular insulin cascade upon binding of exogenous insulin. To this end, we overexpressed *Drosophila* Sod1 in the Phb2-knockdown background and observed a significant rescue effect.

**Conclusions:** Our results underline the importance of mitochondria as signaling hubs for nephrocyte/podocyte biology. The impact of mitochondria on metabolic signaling events can be recapitulated in *Drosophila* and appears to be conserved throughout evolution. Using *Drosophila* nephrocytes, we could identify mitochondrial ROS as important intracellular signal component leading to hyperactivation of the Insulin-Receptor and mTOR activation.

## FR-PO706

**mTOR-Dependent Autophagy Regulates Slit Diaphragm Density in Podocyte-Like *Drosophila* Nephrocytes**

Dominik Spitz,<sup>1</sup> Maria Comas Soberats,<sup>1</sup> Lea Gerstner,<sup>1</sup> Séverine Kayser,<sup>1</sup> Martin Helmstädter,<sup>1</sup> Gerd Walz,<sup>1,2</sup> Tobias F. Hermle.<sup>1</sup> <sup>1</sup>Renal Division, Department of Medicine, Faculty of Medicine and Medical Center - University of Freiburg, Freiburg, Germany; <sup>2</sup>CIBSS - Centre for Integrative Biological Signalling Studies, Freiburg, Germany.

**Background:** Both mTor signaling and autophagy are important modulators of podocyte homeostasis, regeneration and aging, and have been implicated in glomerular diseases. However, the mechanistic role of these pathways for the glomerular filtration barrier remains poorly understood.

**Methods:** *Drosophila* presents a well-established model to study mTor signaling and autophagy with versatile genetic tools like tissue-specific RNAi-mediated knockdown or overexpression of wild type or functionally modified proteins. We used *Drosophila* nephrocytes as a podocyte model to investigate the connection of mTor signaling and autophagy and the homeostasis and maintenance of the nephrocyte ultrastructure and function as a storage kidney.

**Results:** We found that in the podocyte-like nephrocytes, mTor signaling positively controls cell size, survival and the extent of the subcortical actin network. Surprisingly, the inhibition of mTor signaling resulted in increased slit diaphragm spacing, whereas gain-of-function of mTor signaling did not affect slit diaphragm spacing, suggesting that additional cues limit the maximal density. Interestingly, both activation and inhibition of mTor signaling led to decreased nephrocyte function indicating that a fine balance of signaling activity is needed for proper function. We showed that basal autophagy in nephrocytes is required for survival and limits expression of *sns* (nephrin), but does not directly affect slit diaphragm formation or endocytic activity. However, using a genetic rescue approach, we demonstrated that excessive autophagy associated with loss of mTor function is primarily responsible for slit diaphragm misspacing.

**Conclusions:** Utilizing the *Drosophila* nephrocyte model to study the mechanistic role of mTor signaling and autophagy for the glomerular filtration barrier, we discovered a direct regulatory impact on the slit diaphragm architecture.

## FR-PO707

**Podocytes Respond to Mechanical Forces to Spatially Orient Their Processes on Glomerular Capillaries**

David Unnersjö-Jess,<sup>1,2</sup> Amer Ramededovic,<sup>1</sup> Linus Butt,<sup>1</sup> Ingo Plagmann,<sup>1</sup> Martin Höhne,<sup>1</sup> Hans Blom,<sup>2</sup> Agnes Hackl,<sup>1</sup> Bernhard Schermer,<sup>1</sup> Thomas Benzing.<sup>1</sup> <sup>1</sup>Uniklinik Köln, Köln, Germany; <sup>2</sup>Kungliga Tekniska Hogskolan, Stockholm, Sweden.

**Background:** It has recently been proposed by our group that the main role of podocyte foot processes is to counteract forces resulting from filtration pressure in order to compress the basement membrane, thereby optimizing sieving properties. We here expand on these models by studying the role of spatial orientation of foot processes on glomerular capillaries.

**Methods:** We apply novel imaging protocols which allow for confocal in-situ 3D imaging of intact glomerular capillaries at a resolution sufficient to resolve foot processes. This allows for analyzing several thousands of podocyte processes and quantitatively determine their spatial orientation with regards to the capillary orientation.

**Results:** We report the novel finding that podocyte processes display a non-random distribution on glomerular capillaries, which is lost in different types of kidney disease. This finding suggests that the orientation of foot processes is important for the function of the filtration barrier. We further observe a more prominent orientation preference in elongated and more cylindrical capillary segments, where the difference between circumferential and longitudinal wall stress is highest. This strongly indicates that podocytes possess a machinery to regulate and maintain the spatial orientation of their processes based on the forces acting on them.

**Conclusions:** We consider the various forces that foot processes are exposed to and conclude that the observed orientation of foot processes in parallel with the orientation axis of capillaries is likely to ensure that slit diaphragm molecules (e.g. nephrin, NEPH1) are preferably aligned in parallel with the axis of highest wall stress. This adds further evidence to the theory that foot processes and the slit diaphragm act to mechanically counteract lateral wall stress, but also possesses a mechanosensory machinery for maintaining orientation on capillaries.

**Funding:** Private Foundation Support, Government Support - Non-U.S.

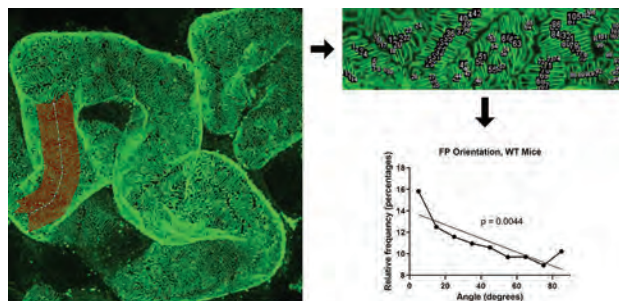

New imaging protocols allow for determining the orientation of foot processes based on nephrin staining (green).

## FR-PO708

**The Redundant and Unique Interactors of YAP and TAZ in Podocyte Homeostasis and Disease**

Lioba Ester,<sup>1</sup> Inês Cabrita,<sup>1</sup> Michel T. Ventzke,<sup>1</sup> Thomas Benzing,<sup>1</sup> Sandra Habbig,<sup>2</sup> Bernhard Schermer.<sup>1</sup> <sup>1</sup>Department II of Internal Medicine and Center for Molecular Medicine Cologne, University of Cologne, Faculty of Medicine and University Hospital Cologne, Cologne, Germany; <sup>2</sup>Paediatric Nephrology, Children's University Hospital Cologne, Faculty of Medicine, University of Cologne, Cologne, Germany.

**Background:** The two effector proteins of the Hippo signaling pathway, YAP and TAZ, play a pivotal role in the cellular homeostasis of podocytes and the pathogenesis of focal segmental glomerulosclerosis (FSGS). The two proteins share 46% amino acid identity and are often regarded as homolog proteins. However, the podocyte-specific knockout of TAZ results in milder proteinuria and FSGS than the podocyte-specific YAP knockout. We aim to unravel the unique and redundant functions of YAP and TAZ in podocytes by identifying podocyte-specific interactors in health and disease.

**Methods:** We used immortalized podocytes (hsMPs) and co-immunoprecipitated YAP or TAZ with specific antibodies. To overcome drawbacks resulting from these two proteins' homology, we generated hsMPs expressing FLAG-tagged YAP or TAZ using TALEN-based genome editing. For in vivo purposes, we generated transgenic mice expressing 3xFLAG.YAP and TAZ.3xFLAG using CRISPR/Cas9. YAP or TAZ were pulled down in vitro from podocytes and in vivo from isolated glomeruli, followed by mass spectrometry analysis. Further, we generated YAP or TAZ podocyte-specific knockout mice as well as double knockouts, to shed light on common, distinct, and possible compensatory roles of YAP and TAZ in podocyte disease.

**Results:** Within the interactome analyses of the hsMPs, we identified shared and non-shared interacting proteins between YAP and TAZ. Of all interactors, 60% overlapped for both, while 40% were unique. These results comprise known and novel interactors, including Fat1, Actn4, or Nephl. Interactome analysis of the nuclear fraction identified specifically nuclear interactors of YAP and TAZ, including known transcription factors (e.g. TEADs) and also ~30% of new nuclear interacting proteins. Currently, we are investigating the mechanistic role of novel candidates in FSGS while we are working on the in vivo models.

**Conclusions:** YAP and TAZ are critical proteins in the podocyte's homeostasis with divergent functions and interactors. Overlapping and distinct candidates identified in interactome analyses conducted both in in vitro and in vivo systems suggest both shared and unique podocyte-specific functions. These novel unique and shared interactors of YAP and TAZ in podocytes will help to understand the specific impact of YAP and TAZ in the development of FSGS and recovery from podocyte injury.

## FR-PO709

**Mutation in Transient Receptor Potential Cation Channel Subfamily C Member 6 (TRPC6) Regulates Yes-Associated Protein 1(YAP1) Phosphorylation**

Chia An Chou,<sup>1,2</sup> Moin Saleem,<sup>1</sup> Gavin I. Welsh.<sup>1</sup> <sup>1</sup>Bristol Renal, Department of Translational Health Sciences, Bristol Medical School, University of Bristol, Bristol, United Kingdom; <sup>2</sup>Kaohsiung Chang Gung Memorial Hospital and Chang Gung University College of Medicine, Kaohsiung, Taiwan.

**Background:** Transient receptor potential cation channel, subfamily C member 6 (TRPC6), is a cation channel associated with hereditary focal segmental glomerulosclerosis. Angiotensin II (Ang II) activates TRPC6 and its downstream signalling. We investigated signalling regulated by TRPC6 in podocytes to understand the disease pathogenesis.

**Methods:** We developed conditionally immortalized wild-type and TRPC6-knockout (T6K) podocytes. Lentiviral transduction was used to express GFP-tagged TRPC6 in T6K cells. Phosphoproteomic analysis was used to identify changes in signalling pathways mediated by knocking out TRPC6. Immunoblotting and quantitative reverse transcription PCR (RT-qPCR) were applied for validation.

**Results:** T6K podocytes showed increased phosphorylation of Yes-associated protein (YAP) compared with the control. Ang II treatment increased YAP phosphorylation in control podocytes but not in T6K. RT-qPCR showed decreased expression of connective tissue growth factor (CTGF) and cellular communication Network Factor 1 (CCN1), YAP

downstream transcriptional targets, which returned to control levels upon expression of TRPC6GFP in T6K.

**Conclusions:** TRPC6 regulates the YAP phosphorylation and its downstream targets' level in podocytes. YAP is a transcriptional factor controlling cell proliferation. Our experiments suggest that knocking-out TRPC6 increases YAP phosphorylation and inhibits YAP-induced transcription.

**Funding:** Private Foundation Support



Immunoblotting of p-YAP in T6K and control podocytes.

Cells were treated by 0.1  $\mu$ M ANG II with various duration.

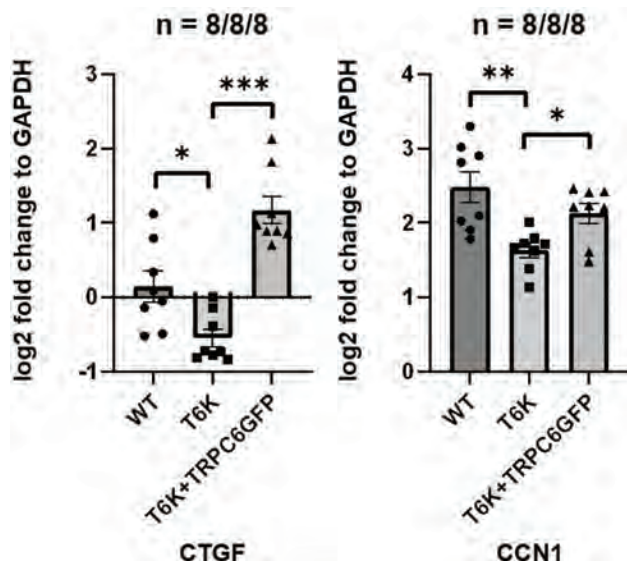

RT-qPCR of CTGF and CCN1 levels in WT, T6K and T6K+TRPC6GFP cell lines. Graphs represent mean $\pm$ SEM. WT: wild-type; T6K: TRPC6 Knockout, T6K+TRPC6GFP: T6K transduced with GFP-tagged TRPC6.

## FR-PO710

### The Mechanosensitive Ion Channel Piezo Activates Rho1 in Drosophila Nephrocytes

Sybille Koehler,<sup>1,2</sup> Maja Lindenmeyer,<sup>1</sup> Tobias B. Huber,<sup>1</sup> Barry Denholm,<sup>2</sup>  
<sup>1</sup>University Medical Center Hamburg-Eppendorf, Hamburg, Germany;  
<sup>2</sup>Biomedical Sciences, University of Edinburgh, Edinburgh, United Kingdom.

**Background:** Podocytes constantly face biomechanical forces such as shear stress and hydrostatic pressure. Increasing forces result in morphological changes, detachment from the glomerular basement membrane and loss into the primary urine. This highlights a requirement for podocytes to sense changes in their physical environment and induce a response to react to increased biomechanical force.

**Methods:** Here, we investigated the functional role of the mechano-sensitive ion channel Piezo in *Drosophila* nephrocytes.

**Results:** First, we confirmed Piezo expression and localisation at the nephrocyte diaphragm. Acute activation of the channel with the chemical compound YODA revealed significantly increased Ca<sup>2+</sup> signalling and Rho1 activation, suggesting a functional role of Piezo in nephrocytes and delineating the putative Piezo mechanosensitive pathway. For further analysis, we used knockout flies and observed a filtration phenotype, while morphology and GTPase activation was not altered. In addition, we also studied the impact of elevated Piezo levels and could show, that in line with the YODA effect, Piezo overexpression revealed severely increased Rho1-GTP levels and FITC uptake, while morphology was not changed. Because of this severe pathological phenotype, we tried to rescue the effects of Piezo overexpression with pharmacological inhibition by using tarantula toxin. Intriguingly, treatment with tarantula toxin reversed the elevated Rho1-GTP levels observed upon Piezo overexpression. Moreover, we were able to confirm Piezo1 and Piezo2 expression in mammalian podocytes and observed an upregulation of Piezo2 in glomerular disease tissue including Lupus, FSGS and hypertension.

**Conclusions:** Taken together, our data confirms the functional expression of Piezo in nephrocytes, its role in regulating GTPases and the beneficial effect of tarantula toxin to reverse the pathological effects caused by increased Piezo levels.

## FR-PO711

### Legumain Attenuates Podocyte Injury by Cleaving Transgelin and Stabilizing Cytoskeleton

Yang Qiu, Chun Zhang, Huazhong University of Science and Technology Tongji Medical College, Wuhan, China.

**Background:** Legumain is a protease which functions diversely in various cell types. It plays significant role in renal tubular cells pathology. However, its participation in podocyte pathology has been rarely explored

**Methods:** We induced podocyte injury with adriamycin injection to mimic human FSGS in mice. In vivo, global legumain knockout mice, podocyte-specific legumain knockout mice and podocyte-specific legumain overexpression mice were applied. In vitro, lentivirus and adenovirus vectors were used to knockdown and overexpress legumain in podocytes. The substrate of legumain, transgelin, was exogenously expressed and then assayed for cleavage. Fragments effects were explored by importing plasmids expressing different transgelin protein domains into podocytes

**Results:** Firstly, legumain was upregulated in podocytes in FSGS model both in vivo and in vitro. Secondly, the knockout of legumain aggravated proteinuria, glomerular sclerosis and podocyte loss. The podocytes showed less nephrin, podocin and F-actin fibers, but higher desmin expression. The overexpression of legumain alleviated these pathologies. Furthermore, we found that transgelin, an actin binding protein, was negatively regulated by legumain. Its cleavage fragments showed less affinity to actin. Compared to full length transgelin, the fragments inactivated RhoA/Rock pathway and upregulated F-actin and paxillin in podocytes

**Conclusions:** Legumain protects podocytes by cleaving transgelin and stabilizing cytoskeleton. This strongly suggests a therapeutic role of legumain in FSGS

## FR-PO712

### Consensus Draft of the Mouse Podocyte-Ome

Arvid D. Hutzfeldt,<sup>1</sup> Yifan Tan,<sup>2</sup> Léna L. Bonin,<sup>2</sup> Moritz Lassé,<sup>1</sup> Fatih Demir,<sup>2</sup> Markus M. Rinschen,<sup>1,2</sup> <sup>1</sup>Universitätsklinikum Hamburg-Eppendorf, Hamburg, Germany; <sup>2</sup>Aarhus Universitet, Aarhus, Denmark.

**Background:** We aim to establish a common, simplified knowledgebase for the mouse "podocyte-ome" by integrating bulk RNA sequencing and bulk proteomics of sorted podocytes and single cell transcriptomics.

**Methods:** Three datasets of each omics type from three different laboratories, respectively, were integrated, visualized and bioinformatically analyzed.

**Results:** The procedure sheds light on conserved processes of podocytes, but also on limitations and specific features of the used technologies. High expression of glycan GPI anchor synthesis and turnover, and retinol metabolism was identified as a relatively understudied features of podocytes, while there are both podocyte-enriched and podocyte-depleted actin binding molecules. We compiled aggregated data in an application that illustrates the features of the dataset and allows for exploratory analyses through individual gene query of podocyte identity in absolute and relative quantification towards other glomerular cell types, keywords, GO-terms and gene set enrichments.

**Conclusions:** This consensus draft is a first step towards common molecular omics knowledge of kidney cells.

**Funding:** Government Support - Non-U.S.

## FR-PO713

### Synaptopodin Enables Podocyte Focal Adhesions to Resist Perpendicular Force

Chengqing Qu, Shumeng Jiang, Guy M. Genin, Hani Suleiman, Jeffrey H. Miner. Washington University in St Louis, St Louis, MO.

**Background:** Focal adhesions resist shear forces in nearly all cell types. Kidney podocytes are unusual in that they must resist stresses perpendicular to their basement membrane. We hypothesized that synaptopodin, a unique actin-associated protein that is highly expressed in podocytes, serves as a linker to enable focal adhesions to resist such perpendicular forces.

**Methods:** We developed an in vitro system to study the effect of perpendicular forces on cells cultured on hydrogels of defined stiffness, coated with defined extracellular matrix (ECM) proteins. By varying these factors, culture conditions, and the centrifugal forces applied, this setup allowed us to simulate the perpendicular forces that podocytes experience in their native glomerular microenvironment. We used primary podocytes taken from control (WT) mice as well as mice lacking synaptopodin (Synpo KO). We compared these cells to 3T3 cells as well as immortalized mouse podocytes cultured in both undifferentiated and differentiated conditions. We assessed the cellular responses to the centrifugal forces using morphological analysis as well immunostaining for integrins, synaptopodin,  $\alpha$ -actinin-4, myosin II and actin.

**Results:** Whereas perpendicular forces caused 3T3 cells to detach or become spindle-like, they caused WT primary podocytes to spread and form a continuous skirt of integrins at their periphery. Synpo KO primary podocytes and podocyte cell lines did not show this continuous integrin b1 pattern at the cell periphery but rather showed a diffuse pattern and were model likely to detach.

**Conclusions:** We uncover a mechanical role for synaptopodin in podocytes. When centrifugal force is applied, WT primary podocytes were able to resist these perpendicular forces through a major rearrangement of the focal adhesions. Lack of synaptopodin weakened podocyte responses to these forces and was associated with more podocyte

detachment. This function of synaptopodin could be important for podocyte adhesion to the basement membrane during their responses to elevated stresses and injury.

**Funding:** NIDDK Support, Other U.S. Government Support, Private Foundation Support

#### FR-PO714

##### Tight Junction Protein Claudin-5 Protects the Podocytes After Injury in Proteinuric Renal Diseases

Sonali Choudhury, Christine V. Behm, Heather A. Riddle, Stephen C. Parnell, Alan S. Yu. *University of Kansas Medical Center Department of Internal Medicine, Kansas City, KS.*

**Background:** Focal and segmental glomerulosclerosis (FSGS) is characterized by podocyte injury and impairment of the glomerular filtration barrier causing proteinuria, nephrotic syndrome and kidney failure. Podocytes respond to injury by foot process effacement and "fusion", with loss of slit diaphragms and replacement by tight junctions (TJ) between neighboring podocytes. Why TJs appear, and their role is unknown. Claudins are membrane proteins which are necessary to form TJs, and claudin-5 (Cldn5) is specifically expressed at the plasma membrane in adult podocytes and migrates to TJs upon injury.

**Methods:** To study the role of Cldn5, we generated Cldn5 homozygous Floxed (fl/fl) mice and crossed them to NPHS2-Cre mice to achieve podocyte-specific deletion of Cldn5 (Cre+). Glomeruli were isolated for Western blotting and immunofluorescence staining. Urine was collected from Cre+ mice and Cre- control littermates (N= 17-18 per group) at 5, 8, 15, 25, 35 and 45-weeks for measurement of albumin, by ELISA, and creatinine. Data was analyzed by linear mixed models with repeated measures over time.

**Results:** Podocyte-specific Cldn5 knockout mice (Cre+) were born at normal Mendelian ratios. Cldn5 was detected in podocytes of control mice by immunofluorescence and Western blotting and was absent from Cre+ mice indicating complete Cre excision. Cre+ mice developed increasing urine albumin/creatinine ratio (UACR) with age, compared to Cre- (P = 0.011), and male mice had increasing UACR with age compared to females (P = 0.015).

**Conclusions:** Cldn5 has a protective role in the glomerular filtration barrier at baseline. Since podocyte foot process effacement and TJ formation is common to all nephrotic disorders, Cldn5 may be critical in the adaptive response to FSGS and other podocytopathies. Ongoing studies are testing the role of Cldn5 in Adriamycin-induced podocyte injury.

**Funding:** NIDDK Support

#### FR-PO715

##### Lack of Complement Factor H Contributes to Endothelial Cell Injury in Shiga Toxin Haemolytic Uraemic Syndrome

Emily E. Bowen,<sup>1,2</sup> Jenny Hurcombe,<sup>1</sup> Fern Barrington,<sup>1</sup> Louise K. Farmer,<sup>1</sup> Carolina G. Ortiz-Sandoval,<sup>2</sup> Valentina Bruno,<sup>2</sup> Niyousha Rostam Shirazi,<sup>2</sup> Gavin I. Welsh,<sup>1</sup> Christoph Licht,<sup>2</sup> Moïn Saleem,<sup>1</sup> Richard Coward.<sup>1</sup> *University of Bristol Faculty of Health Sciences, Bristol, United Kingdom; <sup>2</sup>SickKids Research Institute, Toronto, ON, Canada.*

**Background:** Haemolytic uraemic syndrome (HUS) is a thrombotic microangiopathy that has a predilection for the kidney. In 90% of cases, HUS follows gastroenteritis secondary to infection with Shiga toxin (Stx) producing bacteria such as *Escherichia coli*. STEC HUS is the leading cause of acute kidney injury in children with a mortality of 5%. We have previously shown endothelial cell complement activation in a PodGb3 mouse model of STEC HUS. Here we build upon these findings to show that a reduction in glomerular endothelial CFH occurs both in our animal model and *in-vitro* co-culture models.

**Methods:** To demonstrate that the podocyte Stx receptor (Gb3) is sufficient to trigger the development of HUS, we used conditional gene targeting to engineer human Gb3 expression specifically in the podocytes of mice (PodGb3). Using an *in-vitro* human glomerular cell co-culture model we evaluated the effects of Stx on endothelial cell injury, complement activation (C3b, C5b-9) and regulation (CD46, CD55, CFH).

**Results:** Following intraperitoneal Stx, PodGb3 mice recapitulate all of the histopathological features of HUS. Further interrogation demonstrated glomerular endothelial cell complement activation, loss of CFH protection and rescue of the HUS phenotype following C5 inhibitor treatment. Interestingly, in co-culture studies Stx caused a reduction in glomerular endothelial CFH that was only seen in the presence of co-culture with podocytes.

**Conclusions:** These observations provide compelling evidence for the importance of podocyte-glomerular endothelial cell cross-talk in the development of STEC HUS and suggest a possible therapeutic role for complement inhibition in patients with this devastating disease.

**Funding:** Other NIH Support - Kidney Research UK, Academy of Medical Sciences, BMSA foundation Grant

##### Lack of Complement Factor H contributes to endothelial cell injury in Shiga toxin Haemolytic Uraemic Syndrome (HUS): supporting Figure 1.

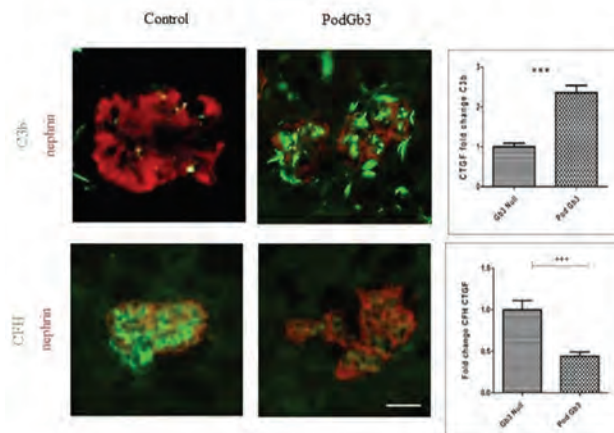

**Figure 1:** PodGb3 mice given intraperitoneal Shiga toxin show evidence of endothelial complement activation (C3b) and loss of CFH protection.

Day 10 post-IP Stx glomerular immunofluorescence analysis for C3b and complement factor H (green) with co-staining for nehrin (red) in PodGb3 mice and controls. Scale bar, 25  $\mu$ m.

Fold change in corrected total glomerular fluorescence intensity (CTGF) was calculated using Image J analysis for C3b and complement factor H deposition in the glomerulus. PodGb3 n=3, controls n=3 with 30 glomeruli per mouse analysed. Unpaired T-test p value \*\*\*<0.0001.

#### FR-PO716

##### Fluorescence Resonance Energy Transfer (FRET) Based Visualization of cGMP Signaling in Glomerular Endothelial Cells and Podocytes

Nelli Rutkowski,<sup>1,2</sup> Frederik Görlitz,<sup>3</sup> Martin Höhne,<sup>1,2</sup> Bernhard Schermer,<sup>1,2</sup> Thomas Benzing,<sup>1,2</sup> Matthias Hackl.<sup>1,2</sup> *Department II of Internal Medicine and Center for Molecular Medicine Cologne, University of Cologne, Faculty of Medicine and University Hospital Cologne, Cologne, Germany; <sup>3</sup>CECAD, University of Cologne, Faculty of Medicine and University Hospital Cologne, Cologne, Germany; <sup>3</sup>Advanced Bioimaging Center, Berkeley, CA.*

**Background:** Cyclic guanosine-3',5'-monophosphate (cGMP) is an ubiquitous intracellular second messenger and is generated by the nitric oxide (NO)/soluble guanylate cyclase (sGC) and natriuretic peptide (NP)/particulate guanylate cyclase (pGC) signaling cascades. Drugs targeting this pathway have been used successfully in the treatment of vascular disease and sparked interest in translation to renal disease. In the kidney field, the literature relies on cell culture and biochemical methods, and lacks both temporal and spatial resolution to reveal the interplay and potential divergence between cell layers of a glomerulus e.g. endothelial cells and podocytes.

**Methods:** Acute kidney slices from mice expressing the genetically encoded fluorescent FRET-based cGMP biosensor cGi-500 exclusively in the cytosol of glomerular endothelial cells or podocytes were prepared. Binding of free cGMP leads to a decrease in FRET efficiency, as evidenced by a simultaneous change in donor and acceptor emission intensity in opposite directions. The donor/acceptor emission ratio (CFP/YFP) reflects the change in cGMP concentration over time. Agents modulating the cGMP pathway were applied with a superfusion system to record intensity measurements of a time series with confocal microscopy.

**Results:** Both endothelial cells and podocytes respond to stimulation with ANP (via pGC) and SNAP (NO donor, via sGC) with an increase in cytosolic cGMP concentrations. While cGMP concentrations decrease rapidly after incubation with an NO donor in the washout phase, cGMP concentrations remain high for a prolonged period after NP incubation. Simultaneous stimulation with ANP and SNAP leads to an additive response in endothelial cells, whereas cGMP concentrations in podocytes evolve in the opposite direction. Preliminary data suggest that enhanced activation of cGMP-degrading phosphodiesterases (PDE) contribute, as demonstrated by the use of the nonspecific inhibitor IBMX.

**Conclusions:** Levels of cGMP in glomerular endothelial cells and podocytes respond to stimulation of the NO-sGC and NP-pGC pathways. Additive stimulation leads to a further increase in cGMP levels in endothelial cells but a decrease in cGMP levels in podocytes. This is most likely due to increased PDE activity in podocytes.

**Funding:** Government Support - Non-U.S.



## FR-PO717

**Angiotensin II Induces Mitochondrial Oxidative Stress in Podocyte**

Tae-Sun Ha,<sup>1,2</sup> *Chungbuk National University Hospital, Cheongju, Chungcheongbuk-do, Republic of Korea;* <sup>2</sup>*Chungbuk National University, Cheongju, Chungcheongbuk-do, Republic of Korea.*

**Background:** Angiotensin II induces glomerular and podocyte injury via systemic and local vasoconstrictive or non-hemodynamic effects including oxidative stress. The release of reactive oxygen species (ROS) from podocytes may participate in the development of glomerular injury and proteinuria. We studied the roles of oxidative stress in angiotensin II-induced podocyte injury.

**Methods:** Mouse podocytes were incubated in media containing various concentrations of angiotensin II and at different incubation times and transfected by Nox4 or negative control scrambled siRNA for 24 h. The changes of the intracellular and mitochondrial ROS production were measured using respective assays and observed by confocal imaging and western blotting according to the presence of angiotensin II.

**Results:** Angiotensin II increased NADH/NADPH oxidase 4 protein and expression in a transcriptional mechanism that was also reversed by probucol. In addition, the suppression of NADH/NADPH oxidase 4 by siRNA reduced the oxidative stress induced by angiotensin II. Angiotensin II also significantly increased the generation of superoxide anions and suppressed the superoxide dismutase (SOD) activity that were significantly recovered with probucol. Furthermore, angiotensin II increased the intracellular ROS levels in dose- and time-dependent manners that were also recovered with probucol. The quantitative data of MitoSOX index demonstrated that mitochondrial superoxide production was significantly higher in angiotensin II -treated condition compared with that in untreated conditions with or without probucol at 24 h. When angiotensin II increased mitochondrial superoxide production by more than 2-fold, it was significantly recovered with probucol. We also found that cytoplasmic 8-oxo-dG immunoreactivity was significantly increased in angiotensin II -treated condition by 2-fold compared with that in untreated conditions with or without probucol at 24 h that was significantly recovered with probucol.

**Conclusions:** Our findings suggest that angiotensin II increased the generation of mitochondrial superoxide anions and ROS levels via the downregulation of the SOD activity and via the upregulation of NADH/NADPH oxidase 4 that were reversed by an antioxidant, probucol.

**Funding:** Government Support - Non-U.S.

## FR-PO718

**Geranylgeranylation of Small GTPase Is Critical to Preserving the Glomerular Filtration Barrier Integrity**

Roberto Boi, Lovisa Bergwall, Kerstin Ebefors, Jenny C. Nystrom, Lisa Buwall. *University of Gothenburg, Institute of Neurosciences and Physiology, Gothenburg, Sweden.*

**Background:** Actin cytoskeleton maintenance in podocytes is carefully and yet dynamically regulated by RhoGTPases Rac1, Cdc42, and RhoA and other small GTPases such as Rap1. These GTPases are commonly post-translational modified by geranylgeranyltransferase type-I (GGTase-I) or farnesyltransferase (FTase), which covalently transfer respectively a geranylgeranyl or a farnesyl to their target GTPases. These modifications are known as prenylation and are known to have a regulatory activity on small GTPases. Our hypothesis is that prenylation plays an important role in the regulation of normal glomerular permselectivity and that dysregulation leads to proteinuria and progression of glomerular disease.

**Methods:** The glomerular expression of GGTase-I was localized using immunofluorescence. Podocyte-specific GGTase-I and FTase knockout mice were generated. Albuminuria and foot process effacement (TEM) were used to investigate filtration barrier function. Depletion of GGTase-I was studied also *in vitro* using an inhibitor or with knockdown of gene expression. Immunofluorescence was used to analyze modifications of the actin cytoskeleton and  $\beta 1$  integrin localization.

**Results:** GGTase-I was found to be expressed mainly by the podocytes in the human glomerulus. *In vivo* experiments in mice showed that GGTase-I knockout caused early-onset progressive albuminuria, accompanied by foot process effacement, while littermate controls and FTase knockout mice did not. *In vitro*, GGTase-I knockdown or inhibition markedly increased RhoA, Rac1, Cdc42, and Rap1 activation. This caused actin cytoskeleton disruption and altered  $\beta 1$  integrin distribution.

**Conclusions:** In podocytes, geranylgeranylation was shown to be important in maintaining the balance of RhoGTPases and Rap1 and to be crucial for maintaining glomerular integrity and function.

**Funding:** Government Support - Non-U.S.

## FR-PO719

**Oxidative Stress Is a Mediator of Slit Diaphragm Defects Initiated by Disruption of Endocytosis**

John S. Poulton, Gang Xi. *University of North Carolina System, Chapel Hill, NC.*

**Background:** Studies in podocytes and fly nephrocytes suggest that disruption of endocytosis leads to loss of slit diaphragms. Previous studies indicate that slit diaphragm integrity also requires redox balance. Therefore, we hypothesized that disrupting endocytosis may lead to oxidative stress, which in turn perturbs slit diaphragm integrity.

**Methods:** Genes were knocked down or overexpressed in *Drosophila* nephrocytes using the Gal4-UAS system. ROS levels were measured using a ROS reporter (GstD>GFP) or DHE dye. To assess slit diaphragm integrity, localization of the slit diaphragm protein

ZO-1 was determined by confocal microscopy. In cultured human podocytes, endocytosis was disrupted by Dynasore, an inhibitor of Dynamin. ROS levels were determined using DHE or Nrf2 levels. Slit diaphragm integrity was indirectly assessed using Western Blot and immunoprecipitation to examine Nephrin's association with ZO-1 or Podocin.

**Results:** In fly nephrocytes, knockdown of regulators of endocytosis (e.g., Rab5, Cubn, Amn, Dlg) all led to significant loss of slit diaphragms, as previously reported. Depletion of these proteins also led to increased oxidative stress and activation of the Nrf2 antioxidant response pathway. Overexpression of the Nrf2 targets and antioxidant enzymes G6PD or Catalase significantly restored slit diaphragm integrity in these cells (as indicated by correct surface localization of ZO-1). Conversely, knockdown of G6PD or Nrf2 significantly enhanced the loss of slit diaphragms in Dlg knockdown cells. Dynasore treatment in human podocytes induced ROS generation within hours, evidenced by DHE staining and Nrf-2 activation. Long-term (e.g., over 6 hr) Dynasore treatment disrupted Nephrin/ZO-1 and Nephrin/Podocin associations, as well as ZO-1 plasma membrane localization. Similar results were obtained when high dose or long-term treatment of hydrogen peroxide was applied. We are currently investigating whether antioxidant reagents, such as Catalase, can rescue the alterations in Nephrin's protein interactions during long-term Dynasore treatment.

**Conclusions:** Our data indicate that disruption of endocytosis leads to increased ROS levels, which disrupt slit diaphragm integrity. Thus, in addition to its direct role in the trafficking of slit diaphragm proteins, endocytosis also affects slit diaphragm integrity by promoting redox balance.

## FR-PO720

**Proteasomal Processivity Influences the Endocytic Activity of Glomerular Cells**

Wiebke Sachs, Lukas Heintz, Stephanie Zielinski, Markus M. Rinschen, Oliver Kretz, Desiree Loreth, Catherine Meyer-Schwesinger. *Universitätsklinikum Hamburg-Eppendorf, Hamburg, Germany.*

**Background:** Glomerular injury is accompanied by intra- and extracellular protein accumulations. Degradation of proteins assures protein quality and prevents the cellular accumulation of unwanted proteins. Whether proteostatic mechanisms of glomerular cells assure the integrity and patency of the glomerular filter by preventing pathological protein accumulations is unknown. The two main intracellular proteolytic systems (ubiquitin-proteasome system (UPS), and autophagosomal-lysosome pathway (ALP)), are both ubiquitin dependent and thereby interconnected. We dissected the physiological cell-type significance of the UPS and ALP for glomerular protein accumulations, and filtration barrier function.

**Methods:** Human and murine glomerular cell-type specific UPS and ALP expression and activity was assessed by proteomic, histologic, and biochemical approaches. The impact of proteasomal or lysosomal inhibition on glomerular cell proteostasis, filtration barrier function, and endocytosis was analyzed clinically, morphologically, and biochemically in BALB/c mice and mechanistically in primary culture podocytes.

**Results:** Podocytes and endothelial cells express distinct active proteasome subtypes, while mesangial cells show a high lysosomal abundance. Treatment with a pan-proteasomal but not with a lysosomal inhibitor result in albuminuria and glomerular tuft enlargement with ultrastructural podocyte and endothelial cell alterations. Tuft enlargement in proteasome-inhibited mice is the result of intra- and extracellular glomerular protein accumulations, especially at the filtration barrier. Mechanistically, a downregulation of endocytic receptors in podocytes and an impaired endocytic uptake of extracellular proteins contributes to the glomerular protein accumulation upon proteasomal inhibition.

**Conclusions:** Proteasomal impairment alters glomerular filtration barrier function and protein clearance in a cell-type specific manner, partly due to a differential regulation of endocytic receptors.

**Funding:** Government Support - Non-U.S.

## FR-PO721

**Nampt Deficiency in Podocyte Causes Severe Glomerular and Tubular Damage Which Is Reversed by NAD+ Supplementation**

Xiaoxin Wang, Komuraiah Myakala, Moshe Levi. *Georgetown University, Washington, DC.*

**Background:** Nicotinamide adenine dinucleotide (NAD+) plays critical roles in the conversion of fuel substrate to energy and as a substrate for important enzymes that regulate cellular homeostasis. The salvage pathway is responsible for most NAD+ production in mammalian cells. As its rate-limiting enzyme, nicotinamide phosphoribosyltransferase (Nampt) deficiency in proximal tubules resulted in renal peritubular fibrotic changes, indicating the importance of NAD+ metabolism in kidney disease. However, the exact role of Nampt in podocyte has not been explored yet.

**Methods:** Nampt podocyte conditional knockout mice, established by crossing the podocyte specific Nphs2-cre and Nampt-flox mice, were followed from birth until 8 months of age. To examine if NAD+ is responsible for the phenotype in the podocyte Nampt deficient mice, nicotinamide was given to 8-month-old mice at 500mg/kg body weight in drinking water for 2 weeks.

**Results:** The podocyte Nampt deficiency caused progressive proteinuria and renal damage. The mild proteinuria noticeable at 3-month-old mice was escalated to more than 100-fold increase in proteinuria compared to wild type mice at 8-month-old in both males and females, with massive glomerulosclerosis, tubular atrophy and fibrosis, and inflammation observed in the podocyte Nampt knockout kidneys (Figure 1). 2-week nicotinamide treatment was able to normalize the proteinuria and significantly decrease the urinary kidney injury molecule (Kim-1) level in 8-month-old podocyte Nampt knockout mice.

Key: TH - Thursday; FR - Friday; SA - Saturday; OR - Oral; PO - Poster; PUB - Publication Only

Underline represents presenting author.

**Conclusions:** Our study shows that Namp1 plays a critical role to maintain podocyte homeostasis, with its deletion in the podocyte causing severe proteinuria and renal damage. This effect is dependent on NAD<sup>+</sup> as its supplementation rapidly corrects the increase in proteinuria, supporting a reversible mechanism through NAD<sup>+</sup> metabolism instead of impairment during development.

**Funding:** NIDDK Support

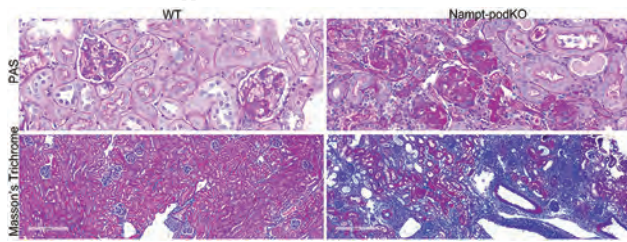

Figure 1. Histology staining shows the severe damage in the kidneys of 8-month-old podocyte-specific Namp1 knockout mice.

## FR-PO722

### Ezetimibe Restores the Communication Between Lipid Droplets and Mitochondria via Modulation of Plin5

Jin Ju Kim,<sup>1</sup> Judith T. Molina David,<sup>2</sup> Flavia Fontanesi,<sup>1</sup> Jeffrey H. Miner,<sup>2</sup> Sandra M. Merscher,<sup>1</sup> Alessia Fornoni,<sup>1</sup> <sup>1</sup>University of Miami School of Medicine, Miami, FL; <sup>2</sup>Washington University in St Louis School of Medicine, St Louis, MO.

**Background:** Alport Syndrome (AS) is a hereditary disease caused by mutations in collagen type IV. Pathogenic renal lipid droplets (LD) and triglyceride (TG) accumulation have been demonstrated in experimental AS (Col4a3KO mice). FFA catabolism resulting from excessive lipolysis of TG is a major contributor to cell lipotoxicity. Perilipin 5 (PLIN5) is an LD-related protein that plays a critical role in regulating TG lipase activity and the interactions between LD and mitochondria, where it protects mitochondria from excessive exposure to FFA. Here we test the hypothesis that PLIN5 expresses in podocytes and that PLIN5 deficiency in AS causes excessive TG breakdown and the loss of LD-mitochondrial contact, thus contributing to kidney failure.

**Methods:** *In vitro*, immortalized AS podocytes and WT podocytes were established and characterized in our laboratory by breeding the Col4a3KO mice (Jackson Laboratory) to H-2kb-tsA58 transgenic mice (Charles River). PLIN5 expression was determined by RT-PCR and western blot analysis in podocytes from Col4a3KO mice when compared to controls. TG lipolysis and FFA quantification were determined and normalized to protein content. LD-Mitochondrial contact was determined by TEM analysis. PLIN5 expression was studied in kidney cortexes, and the effect of Ezetimibe on PLIN5 modulation, on LD-Mitochondrial contact and on podocyte injury was studied *in vitro* and *in vivo*.

**Results:** We demonstrate that PLIN5 is expressed in podocytes, and the expression of PLIN5 is significantly decreased in AS podocytes compared to WT podocytes ( $p < 0.01$ ). AS podocytes also showed significantly increased rates of TG lipolysis ( $p < 0.05$ ), intracellular free fatty acids ( $p < 0.05$ ) and apoptosis ( $p < 0.01$ ) when compared to WT podocytes. AS podocytes had reduced number of LD-mitochondrial contacts ( $p < 0.05$ ), implying that and apoptosis. Moreover, Ezetimibe, which restored LD-Mitochondrial contact *in vitro* ( $p < 0.05$ ) and improved kidney function *in vivo*, was found to restore PLIN5 expression *in vitro* and *in vivo* ( $p < 0.05$ ).

**Conclusions:** PLIN5 deficiency in AS podocytes causes excessive TG lipolysis and inefficient FA transfer from LD to Mitochondria, leading to mitochondrial dysfunction. Ezetimibe improves LD-mitochondria communication via restoring PLIN5 expression.

**Funding:** NIDDK Support

## FR-PO723

### Adriamycin-Induced Nephropathy Is Robust in N and Modest in J Substrain of C57BL/6 Mice

Claire Bryant,<sup>1</sup> Rachel Cianciolo,<sup>2</sup> Rajgopal Govindarajan,<sup>2</sup> Shipra Agrawal,<sup>1,2</sup> <sup>1</sup>Abigail Wexner Research Institute at Nationwide Children's Hospital, Columbus, OH; <sup>2</sup>The Ohio State University, Columbus, OH.

**Background:** Adriamycin (ADR)-induced nephropathy remains the leading model to study human primary focal segmental glomerulosclerosis (FSGS), a common pathway for podocyte damage and glomerular loss of function that leads to chronic kidney disease. However, the use of this model for reverse genetics is limited by historical categorization of C57BL/6 mice as an ADR-resistant strain, which is also the most common genetically modified strain. Additionally, conflicting reports exist utilizing C57BL/6 for ADR-nephrosis due to lack of understanding of substrain differences (J/N) and variability in ADR dosage, timing, and frequency to induce damage. We have undertaken a systematic approach to elucidate the specifics of ADR-nephrosis in C57BL/6 N and J substrains.

**Methods:** We induced nephropathy with 2 doses of ADR, and measured albuminuria for 6 weeks. Additional serum chemistry was performed along with histological evaluations. Podocyte injury markers were evaluated to assess the damage of glomerular filtration barrier.

**Results:** Our findings revealed induction of robust and modest proteinuria in N and J substrains, respectively. The serum creatinine levels were elevated in N, but not J substrain. Both the substrains showed reduction in body weight with N greater than

J, although mortality remained at 0% in both substrains. Histological analysis showed worse renal lesions in the N than the J substrain. Podocyte markers synaptopodin, nephrin, podocin, and WT1 were reduced to a greater extent in the N than the J substrain.

**Conclusions:** In summary, we provide the nephrology community with a reproducible mouse model for FSGS, in a strain otherwise assumed to be ADR-resistant and highlight the differences between J and N substrains. This enables future studies, especially concerning genetically manipulated animal models in C57BL/6.

## FR-PO724

### Development of a Treatment Response Prediction Strategy for Sparsentan in Glomerular Disease

Sean Eddy,<sup>1</sup> Felix H. Eichinger,<sup>1</sup> Brad A. Godfrey,<sup>1</sup> Viji Nair,<sup>1</sup> Wenjun Ju,<sup>1</sup> Celia P. Jenkinson,<sup>2</sup> Patricia W. Bedard,<sup>2</sup> Radko Komers,<sup>2</sup> Laura H. Mariani,<sup>1</sup> Matthias Kretzler,<sup>1</sup> <sup>1</sup>University of Michigan, Ann Arbor, MI; <sup>2</sup>Traverse Therapeutics Inc, San Diego, CA.

**Background:** Sparsentan is a dual endothelin receptor A inhibitor and angiotensin blocker that demonstrated reduced proteinuria in patients with FSGS in Phase II studies (DUET). Gene expression data from Adriamycin (ADR) treated rats treated with sparsentan were used to develop a response profile.

**Methods:** An interventional dose-response study was performed in rats challenged with Adriamycin (ADR) to induce an FSGS phenotype. UPCR randomization was performed at day 7 post-challenge, and daily dosing of sparsentan across a dose range was carried out for 35 days. Kidneys were harvested, stored in FFPE, and kidney cortex RNAseq profiles were generated. Differentially expressed gene (DEG) analysis followed by enrichment analysis was performed. A sparsentan response profile from the model was mapped onto human kidney RNAseq profiles from microdissected kidney biopsies from the NEPTUNE cohort and interrogated against demographic and clinical features of the cohort.

**Results:** DEG profiles were generated in ADR+vehicle vs. Sham animals (4271,  $q < 0.05$ ) and from ADR+sparsentan relative to ADR + vehicle. A high dose group (60mg/kg) generated the largest number of DEGs compared to ADR+vehicle (583,  $q < 0.05$ ); consistent with attenuation of proteinuria ( $p = 0.053$ ) and glomerulosclerosis ( $p < 0.05$ ) in this group at Day 33. Sparsentan reversed directionality 388 DEGs from the model. The 388 genes were enriched for genes in the endothelin pathway ( $p < 0.01$ ) and for genes consistent with active EDN1 ( $p < 0.01$ ). Based on gene expression profiles, activities of IL1B, IFN $\gamma$ , TNF, and TLR4 were predicted to be attenuated by sparsentan. Mapping the signature onto human data revealed elevated signaling in glomerular and tubule profiles of patients with FSGS ( $p < 0.05$ ). The signature was negatively correlated with eGFR ( $p < 0.01$ ) and positively correlated with UPCR ( $p < 0.05$ ). Changes in intrarenal transcriptional profiles were reflected in plasma and urine.

**Conclusions:** Sparsentan treatment attenuated gene expression and activity of disease-related networks in a rat model of FSGS. The sparsentan response signature from rats was elevated in human FSGS kidney tissue, associated with disease severity. Candidate non-invasive biomarkers were identified and are being developed for the NEPTUNE Match clinical trial (NCT04571658).

**Funding:** NIDDK Support, Commercial Support - Traverse Therapeutics

## FR-PO725

### Secreted Frizzled Related Protein 2: A New Therapeutic Target for Glomerular Disease?

Eugenia Papakrivopoulou,<sup>1,2</sup> Maja Lindenmeyer,<sup>3</sup> William J. Mason,<sup>1</sup> David A. Long,<sup>1</sup> <sup>1</sup>Developmental Biology Unit, UCL Institute of Child Health, London, United Kingdom; <sup>2</sup>Clinique Saint Jean Nephrology department, Brussels, Belgium; <sup>3</sup>Nephrological Center, Medical Clinic and Policlinic IV, University of Munich, Munich, Germany.

**Background:** Wnt/b-catenin signalling, critical during development but silenced in adult kidneys, is re-activated in podocytes following injury and plays a detrimental role in glomerular injury. Secreted frizzled-related proteins (sFRPs) modulate Wnt signalling and are involved in conditions such as myocardial infarction and cancer but their role in glomerular pathology is unknown. Here, we examined the role of sFRP2 in podocyte injury using *in vivo* and *in vitro* approaches.

**Methods:** Glomeruli from patients with minimal change disease, focal and segmental glomerulosclerosis, Type 2 Diabetes Mellitus and healthy donor kidneys were isolated from biopsy specimens and gene expression examined on Affymetrix gene chip arrays. Adriamycin (ADR) nephropathy was induced in Balb/c mice with 10mg/kg IV ADR. sFRP2 neutralising antibody or IgG was injected at day 0, and every 3 days, until day 14. Urine and serum samples were collected at 7 and 14 days. In a separate experiment, mRNA changes were examined in isolated glomeruli 2 days after ADR. An immortalised mouse podocyte cell line was used for *in vitro* experiments.

**Results:** sFRP2 mRNA levels were significantly upregulated (6 to 24-fold) versus live donor controls, in all patient cohorts. In mice, ADR injury increased glomerular sFRP2 mRNA expression (2-fold,  $p < 0.05$ ) 48hrs after induction, prior to the appearance of albuminuria and *in vitro*, ADR induced podocyte sFRP2 mRNA expression (10-fold,  $p < 0.01$ ). Increased sFRP2 staining was observed in podocytes following ADR injury. Exposure of podocytes *in vitro* to sFRP2 led to longer processes ( $53 \pm 4.6$  vs  $76 \pm 9.1$ , arbitrary units,  $p < 0.05$ ) and more processes/cell ( $8 \pm 0.96$  vs  $11 \pm 1.01$ ,  $p < 0.05$ ). Next, we examined the effect of sFRP2 blockade on ADR-induced glomerular injury. ADR significantly increased albuminuria compared to baseline (383.23 vs 0.04mg/24hr,  $p < 0.001$ ,  $n = 10$  mice/group) and blood urea nitrogen (BUN) levels (38.14 vs 21.57mg/dL,  $p < 0.05$ ,  $n = 10$ ) at 14 days. sFRP2 inhibition significantly attenuated both albuminuria

(40 vs 383 mg/24hr,  $p < 0.05$ ,  $n = 10$ ) and BUN levels (21.72 vs 38.14 mg/dL,  $n = 10$ ,  $p < 0.05$ ) compared to IgG control, at the same time point. No changes in body to kidney weight ratio were observed.

**Conclusions:** Glomerular *sFRP2* expression is upregulated in response to injury. This appears to be detrimental for podocytes as inhibition by antibody blockade attenuates the response to injury.

**Funding:** Government Support - Non-U.S.

#### FR-PO726

##### Therapeutic Potential of Inducible Co-stimulator Ligand for Treating avb3-Mediated Glomerular Damage

Yan Xu,<sup>1</sup> Ryan Spear,<sup>1</sup> Yanxia Cao,<sup>1</sup> Kwi Hye Koh,<sup>1</sup> Steve Mangos,<sup>1</sup> Nicole Endlich,<sup>2</sup> Jochen Reiser,<sup>1</sup> Eunsil Hahm,<sup>1</sup> <sup>1</sup>Rush University Medical Center, Chicago, IL; <sup>2</sup>University Medicine Greifswald, Greifswald, Germany.

**Background:** Activation of avb3 integrin is an early pathological process in several podocytopathies leading to glomerular disease with no treatment options available. We recently identified inducible co-stimulator ligand (ICOSL) as a renoprotective agent that acts as an antagonist of avb3 integrin. We tested the precise mechanistic action of ICOSL in protecting the kidney from injury and evaluated *in vivo* efficacy of ICOSL and its small peptide in proteinuric animal models.

**Methods:** Expression dynamics of ICOSL during glomerular injury was established by performing quantitative PCR on 3 main glomerular cell types (human podocytes, glomerular endothelial cells, and mesangial cells) after different injury stimuli. We generated double knockout (DKO) mice (ICOS/ICOSL<sup>-/-</sup>) to explore the importance of ICOSL's canonical receptor to renoprotection. ACR and BUN measurements were used to evaluate renal function in DKO and control mice that were subjected to STZ-induced diabetic nephropathy. ICOSL's binding specificity and affinity toward RGD-binding Integrins was tested using surface plasmon resonance (SPR). A 19 amino acid portion of ICOSL was tested for its ability to target podocyte avb3 integrin using an *in vitro* podocyte adhesion assay, and for its ability to mitigate LPS-induced proteinuria in ICOSL KO mice.

**Results:** Glomerular ICOSL expression is regulated by immunological insults, not by conditions that cause oxidative stress. Among the cell types tested, podocytes are the predominant producers of ICOSL and could be stimulated to express ICOSL under immunological stress. Conversely, mechanical stress resulted in reduced ICOSL expression. KO mouse models treated with STZ demonstrate that the renoprotective function of ICOSL is independent of ICOS. Among the 7 different RGD-binding integrins tested, only  $\alpha v\beta 3$  integrin shows strong and preferential binding to ICOSL. Both full-length and a 19-mer portion of ICOSL protein could bind podocytes through avb3 integrin and reverse LPS-induced proteinuria in ICOSL KO mice.

**Conclusions:** Our data suggest that the glomerular expression of ICOSL mainly occurs in podocytes and can be triggered by immunological insults. Given the highly selective binding characteristics to avb3 integrin, ICOSL and ICOSL-based small peptides may offer novel and safe therapeutic options for treating avb3-mediated glomerular diseases.

**Funding:** NIDDK Support

#### FR-PO727

##### Integrin Activation as a Novel Therapeutic Strategy for Podocytopathies

Richard Helmuth,<sup>1</sup> Xiaobo Li,<sup>1</sup> Santiago Balza Pineda,<sup>2</sup> Darlah M. Lopez-Rodriguez,<sup>2</sup> Carl J. Abrahams,<sup>2</sup> Adithya Subramanian Sahasranamam,<sup>2</sup> Antonio Barbosa,<sup>2</sup> Vineet Gupta.<sup>1,2</sup> <sup>1</sup>Drug Discovery Center, Department of Internal Medicine, Rush University Medical School, Chicago, IL; <sup>2</sup>149 Bio, LLC, Miami, FL.

**Background:** Podocyte damage and loss is a key determinant of proteinuria and glomerular injury. Therefore, maintaining podocyte viability and preventing their urinary loss is a validated therapeutic strategy against glomerular diseases. Podocytes selectively utilize integrin  $\alpha 3\beta 1$  to adhere to the glomerular basement membrane (GBM) and such attachment is essential for maintaining their viability. Using a novel high-content imaging-based assay, we previously identified small molecule integrin  $\beta 1$  agonists as podocyte-protective. We have recently discovered integrin  $\alpha 3$  agonists as novel podocyte-protective agents.

**Methods:** K562 cells stably expressing  $\alpha 3\beta 1$  and differentiated podocytes (mouse and human) were used in *in vitro* assays. K562 cells were used in flow-cytometry based assays to characterize  $\alpha 3$  agonists. Podocytes were utilized in cell adhesion based functional assays. Furthermore, podocyte damage was induced using puromycin aminonucleoside (PAN) and treatment in the absence or presence of various agonists, for up to 48 hours, was used to determine efficacy of  $\alpha 3$  agonists. Podocytes were fixed and stained for detection using the confocal imaging based High-Content Screening (HCS) assays. Columbus software was used to quantify morphology properties such as roundness, as well as the overall F-actin and focal adhesion signal. Currently, the agonists are being tested for efficacy in *in vivo* assays.

**Results:** PAN damage resulted in quantitative reduction in F-actin fiber numbers and intensity, and increased roundness in podocytes. It also reduced binding of active  $\beta 1$  integrin probe antibody 9EG7. Newly discovered integrin  $\alpha 3$  agonists increased  $\alpha 3\beta 1$ -dependent cell adhesion and ameliorated PAN-mediated podocyte damage.

**Conclusions:** We have previously shown that integrin agonists are a novel therapeutic strategy for targeting integrins in various diseases. Activation of expressed integrin  $\alpha 3\beta 1$  in podocytes shows that it increases cellular adhesion to matrix proteins and protects cells from damage. Ongoing *in vivo* studies will demonstrate efficacy of this approach and will highlight integrin activation as a novel therapeutic strategy against various glomerulopathies.

**Funding:** Commercial Support - 149 Bio, LLC, Private Foundation Support

#### FR-PO728

##### Plaque-Induced Focal Segmental Glomerulosclerosis

Jack Luo,<sup>1,2</sup> Warda Zaman,<sup>3,1</sup> <sup>1</sup>Alameda Health System, Oakland, CA; <sup>2</sup>Highland Hospital Internal Medicine, Oakland, CA; <sup>3</sup>East Bay Nephrology Medical Group, Oakland, CA.

**Introduction:** Drugs and toxins that are typically associated with focal segmental glomerulosclerosis (FSGS) include interferons, bisphosphates, anthracyclines, lithium, and calcineurin inhibitors, but hydroxychloroquine is not. We present a case of FSGS in a patient on hydroxychloroquine (HCQ) for treatment of scleroderma.

**Case Description:** A 66-year-old female with a history of CREST syndrome with scleroderma was referred to clinic for nephrotic range proteinuria in 2021. She was last seen by rheumatology in the early 2000s. She is originally from Nicaragua, lives in Vallejo, California, and travels back and forth. Since 2020, she has purchased HCQ in Nicaragua which provided relief of joint pain. Physical exam was notable for PIP joint swelling of both hands and bilateral lower extremity edema. Labs showed Cr 0.8-0.9 mg/dL, eGFR 70-75 ml/min/1.73 m<sup>2</sup>, albumin 3.9 g/dL, urinalysis with 2+ protein and no sediment, albumin to creatinine ratio of 1750 mcg/mg in 8/2020. Further work up showed UPCR 4.6, HCV positive but RNA negative, Hep B, RPR, and HIV were negative. SPEP negative, K:L 0.9, dsDNA negative, normal complement, RF negative, Normal CRP. PLA2R antibody was also negative. Kidney biopsy showed myelin figures with widespread foot process effacement in the setting of HCQ use, without any immune complex, paraproteinemic disease, or membranous nephropathy. Patient was diagnosed with secondary FSGS from hydroxychloroquine use. HCQ was stopped, with decrease in proteinuria to 1.2g, almost 4 months since HCQ was held. Irbesartan was continued for medical management of proteinuria.

**Discussion:** Zebra bodies, or myelin figures, are intralysosomal inclusion bodies that suggest kidney phospholipidosis, which is a widely accepted feature of hereditary disorders such as Fabry disease, but it has also been seen in patients on drugs such as HCQ. The majority of cases that have demonstrated this have been in patients on HCQ for management of systemic lupus erythematosus. To our knowledge, there are no previous reports of zebra bodies seen on renal biopsies taken from patients on HCQ for treatment of scleroderma or any previous cases of FSGS occurring in the setting of HCQ use. Our case demonstrates the need to consider HCQ as a cause of FSGS in patients evaluated for proteinuria, with negative work up for the usual causes such as viral infections, drugs, or system conditions, but may be on HCQ for another disorder.

#### FR-PO729

##### Analysis of GR and miRs Expression in Renal Tissues of Patients With Renal Diseases Compared to Controls

Anna Angelousi, Georgios Liapis, Maria Gazouli, Ioannis Kofotolios, Ioannis Boletis, Smaragdī Marinaki. *Ethniko kai Kapodistriako Panepistimio Athenon Iatrike Schole, Athens, Greece.*

**Background:** Glucocorticoid Receptor (GR) is expressed in normal renal podocytes however, its expression differs among renal diseases. In this study, we analysed GR expression in renal tissues of patients with systemic lupus nephritis (LN), minimal changes disease (MCD) and pauci-immune glomeronephritis (PIN) as well as the expression of its epigenetic regulators miR30a, miR24 and miR370.

**Methods:** Fifty-one patients (n=20 with LN, n=14 with MCD and n=17 with PIN) underwent renal biopsy and 22 controls with no history of parenchymal renal disease were recruited from the Clinic of Nephrology and Renal Transplantation of General Laikon hospital through November 2016 to March 2019. All patients were recently diagnosed and were naïve of any treatment. mRNA and protein expression was analysed through real time -polymerase chain reaction (rt-PCR) and immunohistochemistry respectively. Data were collected after obtaining written consents forms from all participants.

**Results:** GR mRNA expression was underexpressed in all pathological specimens of patients compared to "normal" renal tissues of controls ( $p = 0.023$  for LN,  $p = 0.05$  for MCD and  $p = 0.004$  for PIN). Similarly, GR protein expression was lower in all pathological specimens ( $> 6$  GR positive podocytes/glomerulus in 42% of patients with LN, 55% with MCD and 16.68% with PIN) compared with controls ( $> 6$  positive podocytes/glomerulus in all the controls). PIN specimens presented also significantly lower GR mRNA and protein expression comparing with LN and MCD specimens among patients. No significant differences were found in the miR30a expression comparing pathological renal specimens of patients with "normal" renal tissues of controls. miR24 and miR370 expression demonstrated statistically significant difference in all pathological compared to "normal" tissues. miRs expression didn't differ among the 3 studied groups. GR expression was not also associated neither with LN disease activity score nor with eGFR.

**Conclusions:** GR and miR24 expression was significantly underexpressed whereas miR370 significantly overexpressed in all pathological compared with adjacent "normal" renal tissues implying their potential role in nephritis pathogenesis and treatment.

## FR-PO730

**Study on the Pathogenesis of the Leu754Val Mutation of the ARHGAP32 Gene Inducing Focal Segmental Glomerulosclerosis**

Pei S. Chen, Guisen Li. *Sichuan Academy of Medical Sciences and Sichuan People's Hospital, Chengdu, China.*

**Background:** Focal segmental glomerulosclerosis (FSGS) is one of the most common causes of refractory nephrotic syndrome and end-stage renal disease. Previous studies indicated that genetic factors play an important role in the pathogenesis of FSGS. A new candidate pathogenic gene, *ARHGAP32* gene (c.1213C>G, p.Leu405Val), was found in FSGS family, which may be the cause of FSGS. This project is based on the previous studies, through *in vitro* and *in vivo* studies, to preliminarily explore the mechanism of *ARHGAP32* expression changes and mutations leading to podocyte damage, and to provide new ideas for the pathogenesis of FSGS and new treatment measures.

**Methods:** The function of *ARHGAP32* gene mutation was studied by *in vitro* and *in vivo* experiments, and the protein expression level was studied. After the construction of *Arhgap32* gene mutation mice, adriamycin was injected into tail vein to establish the kidney injury model of *Arhgap32* mutant mice. Urine, blood and kidney tissue samples were collected to detect the related biochemical indexes and pathological analysis; the markers of podocyte, nephrin and synaptopodin, were detected to study the effect of *ARHGAP32* gene mutation on podocytes and the mechanism of podocyte injury induced by *ARHGAP32* gene mutation.

**Results:** Immunohistochemical staining showed that there were protein expressions in the kidney of *Arhgap32* mutant mice. After adriamycin induced *Arhgap32* gene mutation mice, weight gain slowed down, proteinuria appeared, serum creatinine and urea nitrogen levels increased, renal tissue showed glomerular mesangial cell proliferation and other renal pathological damage, the podocyte markers Nephrin and Synaptopodin expression decreased, podocyte injury occurred. The expression of Rac1, RhoA and CDC42, which may be affected by Rho GTPase family members, was detected, and the expression of Rac1, RhoA and CDC42 in the mutant mice was increased.

**Conclusions:** This study showed that *ARHGAP32* gene was highly expressed in renal tissue. In addition, the mutations of *ARHGAP32* gene down regulates Rac1, RhoA and CDC42, which cause podocyte damage, affect glomerular filtration barrier, cause proteinuria, and even cause kidney damage, even develop into FSGS. The mechanism of podocyte damage caused by mutations of *ARHGAP32* gene was preliminarily discussed.

## FR-PO731

**Vincristine Treatment Produces a Milieu Which Reverses Podocyte Damage in Focal Segmental Glomerulosclerosis**

William J. Mason,<sup>1</sup> Jennifer C. Chandler,<sup>1</sup> Marilina Antonelou,<sup>2</sup> Scott R. Henderson,<sup>2</sup> David A. Long,<sup>1</sup> Ruth Pepper.<sup>2</sup> <sup>1</sup>University College London Institute of Child Health, London, United Kingdom; <sup>2</sup>Royal Free Hospital, Dept of Nephrology, London, United Kingdom.

**Background:** Focal segmental glomerulosclerosis (FSGS) is a disease that causes damage to podocytes, which form a key component of the glomerular filtration barrier. Mutations in multiple podocyte genes are associated with FSGS, but there is evidence that circulating factors can also induce podocyte damage, manifested as foot process effacement and disorganisation of the F-actin cytoskeleton. Treating FSGS patients with the experimental drug, Vincristine, has been effective in some cases, however, the biological effects in human podocytes are not well understood. The aim of this study is to investigate the effects of Vincristine treatment on podocytes using serum taken from a patient presenting with FSGS who showed full remission of disease with Vincristine treatment.

**Methods:** Human immortalised podocytes were treated with 10% patient serum at different time points of Vincristine treatment (disease presentation, on treatment and remission). Fetal bovine serum (FBS) and serum from a non-renal patient were used as controls. To determine a role for IgG in causing podocyte damage, some experiments were performed with IgG depleted from the presentation serum. Podocytes were stained with Phalloidin after 24 hours of serum treatment to examine the F-actin cytoskeleton.

**Results:** Podocytes treated with the presentation serum showed an increase in cell area, and a reorganisation of cortical F-actin fibres to cytoplasmic stress fibres, compared with podocytes treated with serum from the non-renal patient. This effect was still observed when IgG was depleted from the presentation serum. Podocytes treated with serum from when the patient was responding to Vincristine treatment showed no change in podocyte cell area or F-actin organisation compared with cells treated with serum from the non-renal patient. There was also no change to podocyte cell area or F-actin when podocytes were treated with the remission serum, when compared with the non-renal patient serum, suggesting Vincristine prevented podocyte damage.

**Conclusions:** Serum, but not IgG, from a patient with FSGS directly affects podocyte cell area and F-actin cytoskeleton *in vitro*. Vincristine prevents F-actin related podocyte damage, ultimately leading to a remission of FSGS.

## FR-PO732

**Urinary CD80 and Serum suPAR as Biomarkers of Glomerular Disease Among Adults in Brazil**

Renata D. Zen, Luis Yu, Leccia Jorge, Viktoria Woronik, Cristiane B. Dias. *Universidade de Sao Paulo, Sao Paulo, Brazil.*

**Background:** The objective of this study was to determine whether urinary CD80 and serum suPAR can be used for the diagnosis of MCD and FSGS, respectively, in the adult population of Brazil. We also attempted to determine whether these biomarkers assess the response to immunosuppressive treatment.

**Methods:** This was a prospective study in which urine and blood samples were collected, for analysis of CD80 and suPAR, respectively, only in the moment of renal biopsy, from patients undergoing to diagnostic renal biopsy. At and six months after biopsy, we analyzed serum creatinine, serum albumin, and proteinuria in order to evaluate the use of the CD80 and suPAR collected in diagnosis as markers of response to immunosuppressive treatment. In healthy controls were collected urinary CD80 and proteinuria, serum suPAR and creatinine.

**Results:** The results of 70 renal biopsies were grouped, by diagnosis, as follows: FSGS (n = 18); membranous nephropathy (n = 14); MCD (n = 5); and other glomerulopathies (n = 33). There was no significant difference among the groups in terms of the urinary CD80 levels, and serum suPAR was not significantly higher in the FSGS group, as would have been expected [Table 1]. Urinary CD80 correlated positively with nephrotic syndrome, regardless of the type of glomerular disease (r = -0.5 p < 0.0001). Neither biomarker correlated with proteinuria at six months after biopsy.

**Conclusions:** In adults, urinary CD80 can serve as a marker of nephrotic syndrome but is not specific for MCD, whereas serum suPAR does not appear to be useful as a diagnostic or treatment response marker.

Demographic characteristics and biomarker data at diagnosis in patients with glomerulopathies and in healthy controls

Characteristic	MCD (n = 5)	FSGS (n = 18)	Membranous nephropathy (n = 14)	Control (n = 10)	P value
Age (years), mean ± SD	37.60 ± 15	33.67 ± 13.60	42.15 ± 19.64	33.60 ± 6.63	0.003
Male sex, n (%)	1 (20.0)	10 (55.6)	6 (42.9)	3 (30.0)	0.40
Serum creatinine (mg/dL), median (IQR)	0.90 (0.76–1.95)	2.10 (0.92–2.62)	0.65 (0.50–1.17)	1.11 (0.98–1.18)	0.086
Protein-to-creatinine ratio (g/g), median (IQR)	3.10 (1.04–3.46)	4.05 (1.87–5.44)	4.42 (2.38–7.14)	0.003 (0–0.22)	< 0.0001
Serum albumin (g/dL), mean ± SD	2.08 ± 0.99	2.06 ± 0.87	2.25 ± 0.54	-	0.10
CD80 (ng/g creatinine), median (IQR)	104 (19.70–369.60)	63.15 (30.50–244.60)	76.80 (31.22–402.20)	24.70 (15.10–41.40)	0.15
suPAR (pg/mL), median (IQR)	3266 (2887–4225)	3887 (2359–4620)	3091 (2018–3711)	1336 (1033–1586)	0.0001 <sup>†</sup>

FSGS, focal segmental glomerulosclerosis; IQR, interquartile range; MCD, minimal change disease; SD, standard deviation; suPAR, soluble urokinase plasminogen activator receptor.

\*FSGS vs. control.

## FR-PO733

**B-Cell Lymphoproliferative Disorder With NELL-1 Membranous Nephropathy**

Neha Patel, Timothy P. Mccann, Amit K. Rajput. *TriHealth, Cincinnati, OH.*

**Introduction:** The predominant target antigen for primary membranous nephropathy (MN) has been Phospholipase A2 receptor (PLA2R), present in approximately 70% of cases. Neural epidermal growth factor like 1 protein (NELL-1) was recently identified as a new antigen in a distinct type of primary MN. NELL-1 was found to be the first candidate antigen highly prevalent in malignancy associated MN, seen in 33% of all cases. We will review a case of NELL-1 membranous nephropathy.

**Case Description:** A 54-year-old Caucasian female presented with shortness of breath, left flank/lower back pain, and bilateral lower extremity edema for four days. Physical exam exhibited BP 170/99 mmHg, nontender cervical lymphadenopathy (LAD), left CVA tenderness, and 2+ pitting edema. Initial labs were significant for elevated D-dimer, hypoalbuminemia (Alb 1.7g/dL), and nephrotic range proteinuria (UPCR 13.5g). Imaging revealed bilateral subsegmental pulmonary emboli, left renal vein thrombosis, and extensive bilateral LAD (axillary, supraclavicular, mediastinal, left periaortic retroperitoneal). Given concerns for podocytopathy due to a possible lymphoma, the patient underwent an unremarkable extensive serologic workup. Renal biopsy revealed NELL-1 MN, with diffuse (3+) fine granular staining along glomerular capillary loops for NELL-1 and subepithelial deposits with severe foot process effacement. Bone marrow biopsy, excisional axillary/cervical lymph node biopsies, PET scan, infectious workup, and age-appropriate malignancy screenings were nondiagnostic. Biopsies showed reactive lymphadenopathy concerning for evolving B-cell lymphoproliferative disorder with plasmacytic differentiation. Given the biopsy findings and NELL-1 MN, she was treated with rituximab. However, significant proteinuria persisted despite treatment. The patient refused cyclophosphamide and unfortunately, developed additional complications including a transient ischemic attack.

**Discussion:** NELL-1 is a rare emerging subtype of MN that has been identified in both primary MN and malignancy associated nephropathy. A thorough malignancy workup is warranted in all patients diagnosed with NELL-1 MN. More research is needed in the association between NELL-1 and specific cancers, in hopes of guiding future treatments for this disease.

## FR-PO734

**Nephrotic Syndrome During Pregnancy: Not Everything Is Preeclampsia**

Rita B. Aguilar, Juan P. Gomez Villarreal, Michelle Morcos sandino, Elisa M. Guerrero Gonzalez, Lilia M. Rizo Topete. *Hospital Universitario Dr Jose Eleuterio Gonzalez, Monterrey, Mexico.*

**Introduction:** Nephrotic syndrome (NS) rarely presents during pregnancy, the incidence owing to primary glomerular disease is unknown due to difficulty in differentiating it from preeclampsia. NS increases maternal and fetal adverse outcomes and confers risk for many complications including AKI and thromboembolic events. We present a case of a

Key: TH - Thursday; FR - Friday; SA - Saturday; OR - Oral; PO - Poster; PUB - Publication Only

Underline represents presenting author.

woman who developed progressive edema during second and third trimester of pregnancy, she underwent approach until a diagnosis of polyhydramnios was made.

**Case Description:** 30 year old female who was going through third trimester pregnancy, without history of chronic illness developed anasarca and polyhydramnios. On admission she underwent amniocentesis of 2L, hours later she started with uterine activity and went into labor. Laboratory results at admission revealed SCr 1.3mg/dl, BUN 18mg/dl, serum albumin 1g/dl, urinalysis with proteinuria +++++, RBC 12/field, WBC 10/field, 24hr protein quantification was performed with 11.4gr/1340ml; Nephrology department was consulted. Patient was stable, no hypertension developed during hospitalization and a diagnosis of NS was made. We started IV furosemide, atorvastatin and enoxaparin. At day 12 of puerperium kidney biopsy was performed and included 24 glomeruli (2 glomeruli with global sclerosis and 4 with segmental sclerosis) immunofluorescence staining showed glomerular deposition of albumin; IgG, IgA, C3 and fibrinogen were negative. Based on findings she was diagnosed with Tip Lesion variant Focal and Segmental Glomerulosclerosis, steroid therapy was initiated with oral prednisone at dose of 50mg/day, four weeks after initiation of steroid therapy patient had a 24h protein quantification of 450mg, SCr 0.7mg/dl, serum albumin increased to 4.2g/dl and edema disappeared.

**Discussion:** In this case we faced to a pregnant patient with anasarca, heavy proteinuria and hypoalbuminemia in the absence of hypertension. We started treatment based on steroid as the primary regimen with close monitoring due to increased risk for thrombosis. AKI developed during hospitalization but patient had rapid recovery of renal function and went into complete remission.

**FR-PO735**

**Screening for Primary Hyperaldosteronism in Patients With Resistant Hypertension in an Outpatient Clinic**

Nidharshan S. Anandasivam, Jaya Vasudevan, Douglas Benson, Annika L. Medhus, Paul Sarkaria, Sonal Gagrani, Brandon Herrera-Doerre, Ava Karimi, David J. Ben-Nun, Nisha Soneji, Arjun Aggarwal, Steven Taylor, Holli Sadler, Michelle L. Lubetzky, Christopher Moriates. *The University of Texas at Austin Dell Medical School, Austin, TX.*

**Background:** Clinical practice guidelines recommend screening for primary hyperaldosteronism (PH) in patients with resistant hypertension (HTN). However, screening rates are low in the outpatient setting. We aimed to increase screening rates for PH in patients with resistant HTN in our VA outpatient clinic from 24% to 80%.

**Methods:** Patients with resistant HTN were identified through a VA Primary Care Almanac Metric query with subsequent medical record review for resistant HTN criteria. Medication adherence was reviewed to rule out pseudo-resistant HTN. Three sequential patient-directed interventions were implemented. In the first intervention, patients with resistant HTN had preclinic screening (plasma aldosterone concentration and plasma renin activity) labs added on and were scheduled in clinic for hypertension follow-up. In the second intervention, patients without screening labs were called to confirm adherence to medications and counseled on the need for labs to screen for PH. In the final intervention, patients with positive screening labs (plasma aldosterone concentration >5-15ng/dL and plasma renin activity <1ng/ml/hr) were called to discuss mineralocorticoid receptor antagonist (MRA) initiation and Endocrinology referral.

**Results:** Of 97 patients with resistant HTN, 58 were found to have true resistant HTN, while 39 had pseudo-resistant HTN from medication non-adherence. Of the 58 with resistant HTN, 44 were not previously screened for PH, while 14 (24%) had already been screened or were already taking an MRA. Our screening rate for PH in resistant HTN patients increased from 24% at the start of the study to 84% (37/44 unscreened patients were ultimately screened). A total of 9 patients were found to have a positive screen for PH, and 5 were started on MRAs. None of these 5 patients developed hyperkalemia.

**Conclusions:** This quality improvement project demonstrated that a focused intervention process improved PH screening rates. Over 20% of screened patients had labs positive for PH.

**FR-PO736**

**Primary Aldosteronism in CKD Increases CV Risk and Death Independent of Adrenalectomy vs. Medical Management**

Debbie L. Cohen<sup>1</sup>, Heather Wachtel<sup>1</sup>, Anand Vaidya<sup>3</sup>, Gregory L. Hundemer<sup>2</sup>, Yuta Tezuka<sup>4</sup>, Adina Turcu<sup>4</sup>, Jordana B. Cohen<sup>1</sup>. <sup>1</sup>University of Pennsylvania Perelman School of Medicine, Philadelphia, PA; <sup>2</sup>Ottawa Hospital, Ottawa, ON, Canada; <sup>3</sup>Brigham and Women's Hospital Department of Medicine, Boston, MA; <sup>4</sup>University of Michigan Michigan Medicine, Ann Arbor, MI.

**Background:** Primary aldosteronism (PA) is common and is associated with increased cardiovascular (CV) risk. Diagnosis and treatment of PA in CKD is often deferred for safety and efficacy concerns. Aim was to assess clinical outcomes in patients with confirmed PA and underlying CKD.

**Methods:** We conducted a retrospective cohort study of patients with biochemical PA and eGFR < 60 cc/min/1.73m<sup>2</sup> from 3 academic medical centers, who underwent adrenal vein sampling (AVS) between 2009-2019. Primary outcomes were BP control and number of antihypertensive medications (AHM). Secondary outcomes included CV and renal clinical events and all-cause mortality.

**Results:** Of 239 patients, 159 lateralized on AVS (67%); 158 (66 %) underwent adrenalectomy and 81 (34%) were treated medically. Mean (SD) age was 57 (10) years, 33% were female with mean BMI of 33 (6) kg/m<sup>2</sup>. At baseline 1/3 had DM and CVD with mean serum values: K 3.9 (0.6) mmol/L, creatinine 1.9 (4.5) mg/dL and eGFR (2021 CKD-EPI without race) 54 (21) mL/min; 49% of subjects were on K supplements with 47% receiving K sparing diuretics. Subjects were followed for a median of 4.5 years.

At 5 years mean BP decreased from 149/85 to 131/78 mm Hg and serum K increased from 3.9 to 4.2 mmol/L. Subjects who underwent adrenalectomy vs. medical management (MM) had 3.5 mm Hg lower SBP (p = 0.022) and required 1.8 fewer AHM at 5 years (p < 0.001). Every SD higher baseline eGFR (~20 mL/min/1.73m<sup>2</sup>) was associated with a 2 mm Hg lower SBP and reduced AHM requirement. Clinical event rates were high: MI 12(5%), TIA 11(5%), CHF 14(6%), Afib 21 (9%), dialysis 15(6%), death 23(10%). Using Cox models baseline non race-based eGFR was significantly associated with an increase in RRT and death even after adjustment for age, sex, CKD and DM (Table). No difference in clinical outcomes was detected if patients had adrenalectomy vs MM.

**Conclusions:** PA patient with CKD have a high risk for incident CV events, progression to RRT and death. PA patients with higher baseline eGFR had greater reductions in BP and AHM and are more likely to respond favorably to PA therapy, regardless if treated with adrenalectomy or MM.

**Table. Association of Baseline eGFR and Surgical Adrenalectomy with Longitudinal Clinical Parameters and Risk of Clinical Outcomes**

Longitudinal Change in Parameter (overall effect size with random intercept by patient and site)	Baseline eGFR (SD increase, using 2021 CKD-EPI equation without race)		Surgical Adrenalectomy			
	Unadjusted	Adjusted for age, sex, CVD, DM	Unadjusted	Adjusted for age, sex, CVD, DM		
<b>Beta-coefficient</b>	<b>95% CI (P-value)</b>	<b>Beta-coefficient</b>	<b>95% CI (P-value)</b>	<b>Beta-coefficient</b>	<b>95% CI (P-value)</b>	
Systolic blood pressure, mmHg	-2.18 (-4.4, -0.01) (0.0001)	-1.39 (-4.2, 2.0) (0.47)	1.68 (-4.2, -0.50) (0.002)	1.68 (-4.8, 4.9) (0.61)		
Antihypertensive medications number	0.37 (-0.28, 0.13) (0.0001)	0.46 (-0.35, -0.00) (0.0001)	1.77 (-2.35, 1.19) (0.0001)	1.69 (-2.85, 2.49) (0.0001)		
Serum potassium, mmol/L	0.13 (-0.24, -0.08) (0.015)	0.11 (-0.24, -0.08) (0.0001)	0.30 (-0.85, 0.21) (0.078)	0.37 (-0.94, 0.21) (0.002)		
eGFR, mL/min/1.73m <sup>2</sup>	29.43 (-33.3, 32.4) (<0.0001)	19.87 (-33.2, 21.5) (<0.0001)	7.42 (-1.25, 13.9) (0.0001)	8.86 (-7.34) (0.0001)		
<b>Risk of Clinical Outcomes (Cox model) (adjusted by site)</b>	<b>Hazard Ratio</b>	<b>95% CI (P-value)</b>	<b>Hazard Ratio</b>	<b>95% CI (P-value)</b>	<b>Hazard Ratio</b>	<b>95% CI (P-value)</b>
Composite Heart Failure Hospitalization	1.52 (0.27, 0.28) (0.022)	0.55 (0.27, 1.12) (0.10)	1.09 (0.33, 3.47) (0.36)	1.27 (0.31, 4.42) (0.20)		
Overall Mortality	1.41 (0.16, 0.58) (0.0001)	1.35 (0.26, 2.41) (0.017)	1.74 (0.58, 4.99) (0.0001)	1.89 (0.61, 6.19) (0.0001)		
Renal Replacement Therapy	0.18 (0.06, 0.30) (0.0001)	0.18 (0.07, 0.31) (0.0001)	0.43 (0.22, 1.09) (0.38)	1.04 (0.34, 3.08) (0.038)		
Stroke	0.17 (-0.28, 0.63) (0.0001)	0.19 (-0.26, 0.64) (0.0001)	0.46 (0.19, 1.07) (0.17)	0.46 (0.19, 1.07) (0.17)		

**FR-PO737**

**Influence of Baseline Diastolic Blood Pressure (DBP) on the Effects of BP Lowering on All-Cause Mortality: A Meta-Analysis of NIH BP Trials**

Amara Sarwal<sup>1</sup>, Robert E. Boucher<sup>1</sup>, Sydney E. Hartsell<sup>1</sup>, Guo Wei<sup>1</sup>, Xiangyang Ye<sup>1</sup>, Jincheng Shen<sup>1</sup>, Glenn Chertow<sup>2</sup>, Paul K. Whelton<sup>3</sup>, Alfred K. Cheung<sup>1</sup>, Tom Greene<sup>1</sup>, Srinivasan Beddhu<sup>1</sup>. <sup>1</sup>University of Utah Health, Salt Lake City, UT; <sup>2</sup>Stanford University School of Medicine, Stanford, CA; <sup>3</sup>Tulane University School of Public Health and Tropical Medicine, New Orleans, LA.

**Background:** Lowering systolic BP (SBP) in persons with low DBP might affect tissue perfusion and thereby, increase risk for mortality.

**Methods:** We conducted a meta-analysis of 5 large NIH BP trials that examined the effects of BP goals on ACM outcomes; SPRINT (N = 9264, SBP goal < 120 vs. < 140 mmHg), ACCORD BP standard glycemia arm (N = 2361, SBP goal < 120 vs. < 140 mmHg), SPS3 (N = 3008, SBP goal < 130 vs. < 140 mmHg), MDRD (N=838, SBP goal ≤125 with MAP ≤92 vs SBP = 140 with MAP≤ 107 mmHg) and AASK (N=1094, goal MAP < 92 mmHg vs. 102-107 mmHg). We used DerSimonian-Laird random-effects model in Stata 15.1 version to conduct meta-analyses of the interaction between baseline DBP and the BP intervention on mortality outcomes.

**Results:** Mean baseline DBP in SPRINT, ACCORD BP, SPS-3, MDRD and AASK were 78 ± 12, 76 ± 10, 78 ± 11, 82 ± 11, and 96 ± 14 mmHg, respectively with evidence of heterogeneity. In the 16,565 participants included in the analysis, there were a total of 989 mortality events over 65,656 total years of follow-up. Intensive BP control resulted in overall lower hazard ratio of ACM events, (HR 0.86, CI 0.75, 0.99) (Table). Lower baseline DBP was associated with increased risk of mortality events (HR 1.19, CI 1.09, 1.30) (Table). The interaction term of baseline DBP and the BP intervention on ACM was non-significant in each of the studies and overall (Figure).

**Conclusions:** In this meta-analysis of large, multicenter NIH funded trials, BP intervention was beneficial for improving ACM rates, but there was no evidence that these beneficial effects were modified by baseline DBP.

**Funding:** NIDDK Support, Other NIH Support - NIA, Veterans Affairs Support

**Effects of BP intervention on and the associations of baseline DBP with ACM**

	Intensive vs Standard BP (HR, CI)	HR per 10 mmHg ↓ in baseline DBP (HR, CI)
SPRINT	0.81 (0.68, 0.96)	1.24 (1.14, 1.34)
ACCORD-BP	0.83 (0.60, 1.16)	1.39 (1.18, 1.64)
SPS3	1.02 (0.77, 1.33)	1.11 (0.97, 1.27)
MDRD	1.40(0.70, 2.78)	1.25 (0.92, 1.71)
AASK	0.74 (0.50, 1.10)	1.07 (0.93, 1.23)
Overall	0.86 (0.75, 0.99)	1.19 (1.09, 1.30)

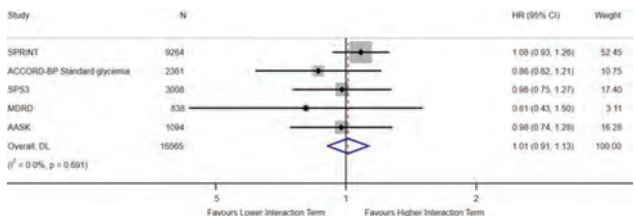

FR-PO738

**Passive Heat Therapy Lowers Blood Pressure and Improves Vascular Function in Older Adults With Reduced Kidney Function**

Vienna E. Brunt,<sup>1,2</sup> Amy Bazzoni,<sup>1</sup> Kathy H. Nguyen,<sup>1</sup> Michel Chonchol,<sup>2</sup> Christopher T. Minson,<sup>3</sup> Douglas R. Seals.<sup>1</sup> <sup>1</sup>University of Colorado Boulder, Boulder, CO; <sup>2</sup>University of Colorado - Anschutz Medical Campus, Aurora, CO; <sup>3</sup>University of Oregon, Eugene, OR.

**Background:** Passive heat therapy—chronic use of hot tubs or saunas—lowers blood pressure (BP) and reduces risk of cardiovascular-related mortality and hypertension in healthy populations but has not been studied in the context of kidney disease. We investigated if heat therapy could lower BP and improve vascular function in middle-aged and older adults (57-79 yrs) with reduced kidney function (MDRD eGFR at baseline <90 mL/min/1.73 m<sup>2</sup>).

**Methods:** As part of a randomized, parallel-design, clinical trial (NCT05300971), subjects underwent 30 x 60-min sessions over 8-10 weeks (~3x/week) of hot water immersion (n=9; 40°C water) or thermoneutral water immersion (n=8; “sham”; 36°C water; no change in body temperature). BP and vascular function were assessed before and after the intervention (24-72 h after the last session).

**Results:** Data are mean±SE. Baseline eGFR was comparable across groups: heat therapy, 74±3 vs. sham, 73±4 mL/min/1.73 m<sup>2</sup> (P=0.75). Remarkably, heat therapy reduced casual seated systolic BP in every subject. On average, systolic BP changed from 124±4 to 114±4 mmHg in the overall group (P<0.001), and from 119±4 to 109±4 mmHg in the subgroup of subjects with baseline eGFR <75 mL/min/1.73 m<sup>2</sup> (n=5; P=0.01). Casual diastolic BP was also reduced (overall group: 80±3 to 75±3 mmHg; lower eGFR subgroup: 76±4 to 70±3 mmHg; both P<0.01). In the overall group, heat therapy improved vascular endothelial function (brachial artery flow-mediated dilation: 4.7±0.6 to 6.3±1.1%Δ units, P<0.01) and reduced aortic stiffness (carotid-femoral pulse wave velocity: 8.8±0.6 to 8.1±0.8 m/sec, P=0.06). The magnitude of improvements in these vascular outcomes were similar in the subgroup of subjects with baseline eGFR <75 mL/min/1.73 m<sup>2</sup> vs. the overall group. Serum C-reactive protein tended to be reduced in the overall group, with the largest reductions observed in subjects with eGFR <75 mL/min/1.73 m<sup>2</sup> (5.5±2.8 to 2.1±0.7 mg/L, P=0.19). There were no changes in any outcomes in sham subjects.

**Conclusions:** Passive heat therapy substantially lowers BP in older adults with mildly reduced kidney function, accompanied by improved vascular function. Heat therapy may be a novel lifestyle intervention for treating hypertension and lowering cardiovascular risk and should be further studied in patients with more advanced kidney disease.

FR-PO739

**The Impact of Repeated SBP Measurements in a Single Visit on Cardiovascular Prediction**

Louis-Charles Desbiens,<sup>1,2</sup> Annie-Claire Nadeau-Fredette,<sup>1,2</sup> Francois Madore,<sup>1,3</sup> Mohsen Agharazi,<sup>4,5</sup> Remi Goupil.<sup>1,3</sup> <sup>1</sup>Universite de Montreal Faculte de Medecine, Montreal, QC, Canada; <sup>2</sup>Hopital Maisonneuve-Rosemont, Montreal, QC, Canada; <sup>3</sup>Hopital du Sacre-Coeur de Montreal, Montreal, QC, Canada; <sup>4</sup>Universite Laval Faculte de medecine, Quebec, QC, Canada; <sup>5</sup>CHU de Quebec-Universite Laval, Quebec, QC, Canada.

**Background:** Blood pressure (BP) is known for its intra-individual variability, even during a single clinic visit. Several guidelines recommend averaging BP measurements during a single office visit to monitor hypertension as it correlates more closely with ambulatory BP. However, whether these averages improve cardiovascular prediction has never been evaluated yet.

**Methods:** We studied individuals aged between 40 and 69 from the CARTaGENE cohort (Canada). Three SBP measurements (SBP<sub>1</sub>, SBP<sub>2</sub>, SBP<sub>3</sub>) at two-minute intervals were taken with an Omron 907L device. These values were averaged to generate SBP<sub>1,2</sub> (mean of SBP<sub>1</sub> and SBP<sub>2</sub>), SBP<sub>1,2,3</sub> (SBP<sub>1</sub> and SBP<sub>2</sub>), and SBP<sub>1,2,3</sub> (SBP<sub>1</sub>, SBP<sub>2</sub> and SBP<sub>3</sub>). Major adverse atherosclerotic events (MACE: cardiovascular death, stroke, myocardial infarction) during a 10-year follow-up were obtained using medico-administrative databases. Associations of each SBP parameter with MACE were obtained using fully adjusted Cox models. Attributable risks were derived for each SBP parameter. Predictive performance was assessed with 10-year atherosclerotic cardiovascular disease scores (ASCVD; using pooled cohort equations) for each SBP parameter and associated C-statistics.

**Results:** From 17,966 included individuals, 2,378 had a MACE during the follow-up. SBP values at baseline were 126.5 mmHg (SBP<sub>1</sub>), 123.2 (SBP<sub>2</sub>) and 122.5 (SBP<sub>3</sub>). After adjustment, SBP<sub>3</sub> had the strongest association with MACE incidence. This association was significantly greater than that observed for SBP<sub>1</sub>, SBP<sub>1,2</sub>, or SBP<sub>1,2,3</sub>. In comparison to SBP<sub>1</sub>, SBP<sub>2</sub> and SBP<sub>3</sub> increased the absolute risk attributable to SBP by up to two times. When included in ASCVD scores, SBP<sub>3</sub> yielded the highest C-statistic, which was significantly higher than all other SBP parameters except SBP<sub>1,2,3</sub>.

**Conclusions:** Averaging repeated SBP measurements during a single office visit improves cardiovascular risk prediction compared to a single measurement. The first SBP value should nevertheless be discarded in order to maximize predictive performance.

**Funding:** Government Support - Non-U.S.

Parameter	Hazard ratio		C-Statistic		Attributable risk ratio (compared to SBP <sub>1</sub> )	
	Fully adjusted value (95% CI)	Comparison with SBP <sub>1</sub> (p-value)	Value	Difference with SBP <sub>1</sub> (95% CI)	Men	Women
<b>Crude values</b>						
SBP <sub>1</sub>	1.06 (1.01, 1.10)	0.042	67.56	-0.35 (-0.19, -0.52)	Ref	Ref
SBP <sub>2</sub>	1.08 (1.03, 1.12)	0.065	67.75	-0.17 (-0.30, -0.03)	1.74	1.29
SBP <sub>3</sub>	1.10 (1.05, 1.15)	Ref	67.92	Ref	2.06	1.82
<b>Mean values</b>						
SBP <sub>1</sub>	1.07 (1.03, 1.12)	0.033	67.69	-0.23 (-0.36, -0.10)	1.43	1.21
SBP <sub>2</sub>	1.09 (1.05, 1.14)	0.064	67.86	-0.05 (-0.12, 0.02)	2.01	1.63
SBP <sub>3</sub>	1.08 (1.04, 1.13)	0.025	67.79	-0.13 (-0.22, -0.04)	1.71	1.46

*Hazard ratios (95% confidence intervals) are displayed for one standard deviation increase. P-values for the comparison with the SBP<sub>1</sub> hazard ratio were computed using non-nested likelihood ratio tests. Fully adjusted models include age, sex, self-reported race, BMI, active smoking, total cholesterol, HDL cholesterol, eGFR, statin use, antihypertensive use, prior cardiovascular disease, and mean heart rate. C-statistics were computed using predicted 10-year MACE risk from the ASCVD score (revised pooled cohort equations). Each C-Statistic was compared to the maximal one (SBP<sub>1</sub>) to generate C-Statistic differences (95% confidence interval). Attributable risk ratios were obtained by dividing the excess risk for a given SBP value (defined as the difference between the predicted risk as the SBP value minus the predicted risk at a reference SBP of 120 mmHg) by the excess risk as the corresponding SBP value for SBP<sub>1</sub> and averaging these ratios over all SBP values. Fully adjusted Cox models were used to generate predicted risks.*

Table

FR-PO740

**Routine Office Blood Pressure and All-Cause Mortality Among US Veterans**

Masaaki Yamada,<sup>1,2</sup> Meenakshi Sambharia,<sup>2</sup> Benjamin R. Griffin,<sup>2,1</sup> Melissa L. Sweeney,<sup>2,1</sup> Heather Reisinger,<sup>1,2</sup> Brian C. Lund,<sup>1</sup> Diana I. Jalal.<sup>1,2</sup> <sup>1</sup>Iowa City VA Medical Center, Iowa City, IA; <sup>2</sup>University of Iowa Carver College of Medicine, Iowa City, IA.

**Background:** Randomized controlled trials have provided accumulating evidence of benefits from intensive blood pressure lowering utilizing standardized blood pressure measurement in individuals at high risk of cardiovascular disease (CVD). However, it remains unclear whether intensive blood pressure control, based on routine office BP, is associated with improved outcomes. Here, we examined the association of routine office blood pressure categories and all-cause mortality in US Veterans.

**Methods:** We identified Veterans with prevalent hypertension defined as International Classification of Disease-10 codes related to hypertension, prescribed antihypertensive drugs, or ≥2 office BP of ≥130/90 mmHg who had ≥2 systolic blood pressure (SBP) readings from 2016-2017 and follow-up through March 2021. We examined the association of mean SBP control (3 groups: <120, 120-129, and ≥130 mmHg) with all-cause mortality by using time-dependent Cox regression models adjusted for demographics, body mass index, and comorbid conditions defined by diagnostic codes after excluding individuals with mean SBP <100 mmHg. In these models, we analyzed effects in the high-risk individuals with CVD as sensitivity analysis.

**Results:** Of the 1,284,131 hypertensive Veterans, 10% (n=128,493) had mean SBP <120 mmHg at baseline; 20% (n=262,887) had 120-129 mmHg; and 70% (n=892,870) had ≥130 mmHg. 28% had previous CVD. Mean SBP <120 and 120-129 mmHg categories were associated with improved mortality compared to ≥130 mmHg (Table 1). Of note, SBP category 120-129 mmHg had the lowest mortality. Sensitivity analysis revealed similar findings among Veterans with prior history of CVD (Table 1).

**Conclusions:** Routine office SBP categories <130 mmHg (vs ≥130 mmHg) were associated significantly with reduced mortality among Veterans with prevalent hypertension independent of pre-existing CVD status.

**Funding:** Veterans Affairs Support

Table 1. Systolic blood pressure group and mortality risk

Patients	Mean SBP (mmHg)	Hazard ratio	95% confidence interval
All patients	<120	0.912	0.908-0.916
	120-129	0.654	0.651-0.658
	≥130	1 (reference)	
History of cardiovascular disease	<120	0.913	0.907-0.919
	120-129	0.644	0.638-0.651
	≥130	1 (reference)	

BP: blood pressure; SBP: systolic blood pressure

FR-PO741

**Routine Office Blood Pressure and All-Cause Mortality Among US Veterans With CKD**

Masaaki Yamada,<sup>1,2</sup> Meenakshi Sambharia,<sup>1</sup> Benjamin R. Griffin,<sup>1,2</sup> Melissa L. Sweeney,<sup>2,1</sup> Heather Reisinger,<sup>2</sup> Brian C. Lund,<sup>2</sup> Diana I. Jalal.<sup>2,1</sup> <sup>1</sup>University of Iowa Carver College of Medicine, Iowa City, IA; <sup>2</sup>Iowa City VA Medical Center, Iowa City, IA.

**Background:** Intensive blood pressure control has been shown to reduce the risk of death in individuals at high risk of cardiovascular disease. Data regarding blood pressure control are limited in chronic kidney disease (CKD). Here, we examined the association of different office blood pressure categories with all-cause mortality in a national sample of US Veterans stratified by kidney function.

**Methods:** Veterans with prevalent hypertension (as defined by i. International Classification of Disease-10 codes related to hypertension, ii. prescription of antihypertensive drugs, or iii. ≥2 office BP of ≥130/90 mmHg) who had ≥2 systolic blood pressure (SBP) readings between 2016-2017 with a follow-up through March 2021 were included. Those with mean SBP <100 mmHg were excluded. CKD categories were defined based on estimated glomerular filtration rate (eGFR): <30, 30-60, and >60 mL/min/1.73m<sup>2</sup>. We examined the association of mean SBP control (3 groups: <120, 120-129,

and  $\geq 130$  mmHg) with all-cause mortality by using time-dependent Cox regression models adjusted for demographics, body mass index, and comorbid conditions. SBP was modeled as a time-dependent variable

**Results:** Total 30,782,873 hypertensive Veterans had eGFR available were included in our analyses. Of those, 1.3% (n=394,132) had eGFR  $< 30$  mL/min/1.73m<sup>2</sup> at baseline; 18.4% (n=5,649,379) had 30-60 mL/min/1.73m<sup>2</sup>; and 80.4% (n=24,739,362) had  $> 60$  mL/min/1.73m<sup>2</sup>. Mean SBP  $< 120$  and 120-129 mmHg categories were associated with reduced mortality compared to  $\geq 130$  mmHg (Table 1), although SBP category 120-129 mmHg was associated with the least risk of all-cause mortality (Table 1). These findings were notable in Veterans across all eGFR categories including those with stage 4 CKD

**Conclusions:** Mean SBP of 120-129 mmHg was indeed associated with lower mortality than  $< 120$  mmHg, and both 120-129 and  $< 120$  were superior to SBP  $\geq 130$  mmHg among all Veterans including advanced CKD

**Funding:** Veterans Affairs Support

Table 1. Mortality risk

Kidney function, eGFR (mL/min/1.73m <sup>2</sup> )	Mean systolic blood pressure (mmHg)	Hazard ratio	95% confidence interval
eGFR $< 30$ , n=394,132 (1.3%)	$< 120$	0.86	0.84-0.89
	120-129	0.63	0.61-0.66
	$\geq 130$	1 (reference)	
eGFR 30-60, n=5,649,379 (18.4%)	$< 120$	0.91	0.90-0.92
	120-129	0.65	0.64-0.66
	$\geq 130$	1 (reference)	
eGFR $> 60$ , n=24,739,362 (80.4%)	$< 120$	0.93	0.92-0.93
	120-129	0.67	0.66-0.67
	$\geq 130$	1 (reference)	

FR-PO742

**Diagnosis of Hypertension in Children Using Ambulatory Blood Pressure Monitoring**

Priyanka Chati, Rasheda Amin. Inova Fairfax Hospital, Falls Church, VA.

**Background:** 24-hour ambulatory blood pressure monitoring (ABPM) is becoming standard practice for diagnosis of hypertension (HTN) in pediatrics. ABPM is used to confirm HTN or white coat hypertension (WCH) in patients with office-based elevated BP readings, masked hypertension (MH) in high-risk populations and to assess treatment efficacy in patients with HTN. We describe the experience of a pediatric subspecialty clinic in improving utilization of ABPM by 2000% in 4 years, using limited resources and staff, and breakdown of diagnoses based on the procedure.

**Methods:** In April 2017, a formal ABPM program was set up by the pediatric nephrology division, comprising 2.0 FTE physicians and 1.5 FTE nurses, at a pediatric specialty practice. Outdated ABPM monitors were replaced by 3 new Spacelabs OnTrak devices. Nephrologists and nurses were trained to use new equipment. ABPM was promoted amongst community pediatricians and cardiologists through grand rounds, fliers and talks. New and established patients underwent ABPM with nurses or physicians performing procedures. Standard parameters of mean BP, BP load and nocturnal dipping were compared with normative pediatric data to determine normal or elevated BP by physicians. Those with no definitive diagnosis were labeled as concerns.

**Results:** The number of ABPM procedures increased from 6 procedures/year in 2017 to 125 procedures/year in 2021 – an increase of 2000%. During the years 2018-2021, a total of 315 ABPM procedures were performed (Figure 1). HTN was diagnosed in 96, WCH in 91 and MH in 7 patients. Poorly controlled HTN was found in 21 of 53 patients with known HTN. 71 patients who had concerning or indeterminate studies were asked to repeat the study.

**Conclusions:** We successfully set up an ABPM program and increased its utilization with limited resources and staff. We increased the number of patients undergoing ABPM and improved diagnosis of patients with HTN, WCH, MH and those with poorly controlled HTN with a goal to better identify and manage HTN.

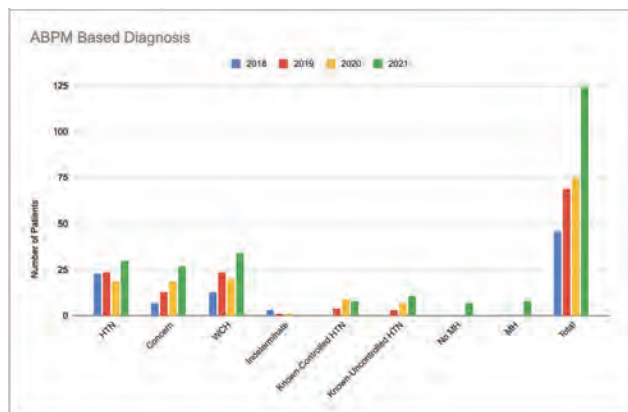

Figure 1: ABPM Based Diagnosis over 4 years

FR-PO743

**Reversal of ESKD After 4 Years of Peritoneal Dialysis (PD) With Improved Cardiorenal Pathophysiology**

Akash Sharma, Rahul Patel, Shweta Bansal. The University of Texas Health Science Center at San Antonio, San Antonio, TX.

**Introduction:** Inadequate treatment of malignant hypertension (MHTN) results in multi-organ failure and sets up a pathophysiologic disequilibrium between heart and kidney where impairment of one causes malfunction of the other. We present a case of MHTN related ESKD who improved his kidney and diastolic dysfunction after 4 years on PD from improved cardiorenal interactions.

**Case Description:** A 39-year male with 10-year history of smoking and HTN on sporadic medications presented with fatigue and vomiting, BP was 230/150 mmHg, and serum creatinine (SCr) was 7.5mg/dl. Exam showed papilledema and 1+ peripheral edema. Pertinent blood work included anemia, normal platelets, high troponin, and potassium 3.2 mEq/L. Urine without blood but 1.7 gm 24H protein. Acute coronary syndrome and secondary hypertension were ruled out. Echo showed severe concentric left ventricular hypertrophy (LVH), moderate diastolic dysfunction (DD) and pulmonary arterial systolic pressure of 48 mmHg. Renal biopsy showed tubular atrophy and interstitial fibrosis in 80% cortex and severe hyperplastic obliterative arterial and arteriolar sclerosis with no acute damage. After initial BP control, he was discharged on oral carvedilol, nifedipine, hydralazine, and furosemide and plan to start PD as outpatient. Training and education let him change his lifestyle mainly by dietary sodium reduction, and he followed best PD practices. BP improved to  $< 115/80$  mmHg with no edema over next few months. He was kept on low dose carvedilol and lisinopril for cardiorenal protection and furosemide. His SCr settled at 10 mg/dl and stayed there for 2 years, when echo showed no LVH and mild DD. He had no PD related infections and maintained 1-1.5L/d urine output. Over the 3<sup>rd</sup> year SCr lowered to 6-7mg/dl and 4<sup>th</sup> year to 4-5mg/dl when PD was stopped. SCr was 3.2mg/dl 6 months later (eGFR 24ml/min) with urine protein-Cr ratio 1.6g/g. BP remained at goal with same medications. Echo had normalization of DD.

**Discussion:** This is a rare case of reversal of ESKD after 4 years due to maintenance of euvolemia and BP control from significant lifestyle changes and daily PD, resulting in resolution of DD and likely improved renal perfusion and healing of remanent nephrons. It highlights the important cardiorenal interactions and need for aggressive BP/volume control to achieve best outcomes.

FR-PO744

**Impact of Blood Pressure on Mortality in Patients Undergoing Peritoneal Dialysis**

Jwa-kyung Kim, Dong Hee Lee, Sungmin Kim, Sung Gyun Kim. Hallym University Sacred Heart Hospital, Anyang, Gyeonggi-do, Republic of Korea.

**Background:** A recent KDIGO guideline recommends intensive blood pressure (BP) control in chronic kidney disease. However, no consensus on the optimal BP has been made in the dialysis population. With a well-characterized peritoneal dialysis (PD) cohort, we evaluated the impact of BP on long-term mortality.

**Methods:** With the incident PD patients who had more than 6 months' follow-up between 2000 to 2019 (n=490), the relationship between BP and mortality rate adjusting for age, sex, BMI, and comorbidities was analyzed. Mean BP levels at 3-6 months after PD initiation were studied for predicting all-cause mortality as well as fatal and non-fatal cardiovascular (CV) events.

**Results:** During the median PD duration of 40 months (IQR, 22 to 66), the mortality rate was 50.3 per 1000 patient-year (102 cases). Overall, the survival rates were much better than previously known; the 3-, 5- and 10-year patient survival rate was 87.6%, 79.1%, and 55.4%. It markedly differed according to the presence of diabetes; the 3, 5, and 10-year mortality were 84%, 71.4%, and 40.7% in diabetes and 92%, 89.0 %, and 74% in non-diabetes, respectively (p<0.001). In multivariate Cox proportional hazard modeling, the risk of death had a U-curved association with systolic BP (SBP) with a nadir between 120 and 140 mmHg. Based on this, the hazard ratios (HR, 95% confidence interval [CI]) for all-cause mortality with SBP  $< 120$  mmHg, 140-160 mmHg, and  $\geq 160$  mmHg were 3.3 (1.7-6.4), 1.68 (0.83-3.4), and 2.3 (1.1-4.9) after adjusting age, sex, diabetes, body mass index, and previous coronary artery diseases. Similarly, fatal and non-fatal CV risks were significantly increased when SBP  $< 120$  mmHg or  $\geq 160$  mmHg.

**Conclusions:** Patients who started PD in the 2000s showed improved survival rates than before. Low SBP  $< 120$  mmHg showed the highest mortality risk. And high SBP  $> 160$  mmHg was also associated with increased mortality even after adjusting for well-known risk factors.

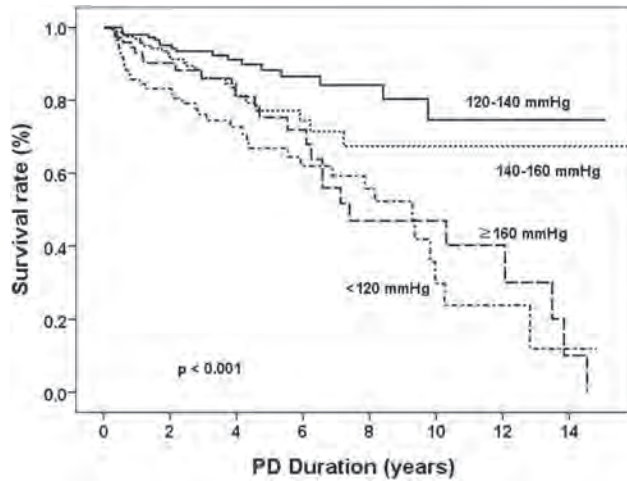

FR-PO745

**Triglyceride-Glucose (TyG) Index Is an Independent Predictor of the Coronary Artery Calcification Progression in CKD Patients**

Ye Eun Ko,<sup>1</sup> Hee Byung Koh,<sup>1</sup> Jong Hyun Jhee,<sup>2</sup> Tae-Hyun Yoo.<sup>1</sup> <sup>1</sup>Department of Internal Medicine, College of Medicine, Institute of Kidney Disease Research, Yonsei University, Seoul, Republic of Korea; <sup>2</sup>Division of Nephrology, Department of Internal Medicine, Gangnam Severance Hospital, Yonsei University College of Medicine, Seoul, Republic of Korea.

**Background:** There have been few studies about the relationship between triglyceride-glucose (TyG) index, which is known to be related to insulin resistance, coronary artery calcification (CAC) progression, and increase in cardiovascular events in general population. The aim of this study is to investigate the association between TyG index and CAC progression in CKD patients.

**Methods:** A total of 1,154 CKD (stage 1 to 5) patients were enrolled from the nationwide multicenter prospective observational cohort of KNOW-CKD (Korean Cohort Study for Outcomes in Patients With Chronic Kidney Disease). TyG index was calculated as follows: ln(fasting triglycerides x fasting glucose/2). The patients were classified into tertile (low, intermediate, high) based on TyG index. The CAC density score was calculated by dividing the Agatston score by the total area score. Primary outcome was annualized percentage change in CAC score: (percent change in CAC score + 1) ≥ (12/follow-up months) - 1, of ≥15%, which was defined as CAC progression.

**Results:** The mean age of study subjects was 52.8±11.9 years and 688(59.6%) were male. During 4 year follow-up, annualized percentage change in CAC score was 16.7±34.7, 20.8±39.4, 24.9±38.5 in low, intermediate, high TyG index respectively. Percentage of patient with CAC progression showed stepwise increasing pattern across TyG index group (28.6%, 37.5%, 46.2% in low, intermediate, high TyG index group in order; P<0.001). In multivariate logistic regression analysis, the high TyG index group was associated with increased risk of CAC progression (OR, 1.48; 95% CI, 1.01-2.16; P=0.04) compared to low TyG index group. Moreover, 1 increase in TyG index was related to increased risk of CAC progression (OR, 1.34; 95% CI, 1.06-1.76; P=0.02) after adjusting confounding factors.

**Conclusions:** High TyG index may be useful predictor of CAC progression in CKD patients.

FR-PO746

**High Hepcidin Is Associated With the Progression of Coronary Artery Calcification in Patients With CKD**

Ye Eun Ko,<sup>1</sup> Hee Byung Koh,<sup>1</sup> Jong Hyun Jhee,<sup>2</sup> Tae-Hyun Yoo.<sup>1</sup> <sup>1</sup>Department of Internal Medicine, College of Medicine, Institute of Kidney Disease Research, Yonsei University, Seoul, Republic of Korea; <sup>2</sup>Division of Nephrology, Department of Internal Medicine, Gangnam Severance Hospital, Yonsei University College of Medicine, Seoul, Republic of Korea.

**Background:** Hepcidin is well known for its role in iron metabolism, but, its relationship with calcium metabolism had also been studied. In addition, a recent report showed a positive correlation between hepcidin level and the incidence of atherosclerotic disease. In hemodialysis population, elevated hepcidin level was related to increased cardiovascular outcome. The aim of this study is to investigate the association between hepcidin and coronary artery calcification progression in non-dialysis chronic kidney disease.

**Methods:** A total of 1,153 CKD (stage 1 to 5) patients were enrolled from the nationwide multicenter prospective observational cohort of KNOW-CKD (Korean Cohort Study for Outcomes in Patients With Chronic Kidney Disease). Primary outcome was CAC progression, which was defined as annualized percentage change in CAC score: (percent change in CAC score + 1) ≥ (12/follow-up months) - 1, of > 15%.

**Results:** The mean age of study subjects was 52.8±12.0 years and 673(59.8%) were male. During 4 year follow up, annualized percentage change in CAC score was

20.0±36.8 in study patients, 15.2±41.7 in group without CAC, 26.9±31.7 in patients with CAC score above 0. There were statistically significant differences in age (50.5±12.3, 56.7±9.9; P<0.001), gender (male 55.6%, 66.4%; P=0.001), DM status (19.6%, 38.4%; P<0.001), and hepcidin level at baseline (14.5±12.9, 16.3±15.4; P=0.04) between CAC non-progression and progression group. In multivariate logistic regression analysis, all patients and patients with baseline CAC score above 0 showed the association between elevation in log (hepcidin+1) and increased risk of CAC progression (OR, 1.74; 95% CI, 1.02-2.96; P=0.04, OR, 2.41; 95% CI, 1.08-5.37; P=0.03).

**Conclusions:** Hepcidin level may be an independent predictor of CAC progression in CKD patients.

FR-PO747

**Does Post-Randomization Diuretics Use Account for the Cardiovascular Benefits of Intensive Systolic Blood Pressure Lowering in the Systolic Blood Pressure Intervention Trial (SPRINT)?**

Shweta Bansal,<sup>1,6</sup> Robert E. Boucher,<sup>4</sup> Guo Wei,<sup>4</sup> Glenn Chertow,<sup>2</sup> Paul K. Whelton,<sup>3</sup> Alfred K. Cheung,<sup>4</sup> Jincheng Shen,<sup>4</sup> Srinivasan Beddhu.<sup>4,5</sup> <sup>1</sup>The University of Texas Health Science Center at San Antonio, San Antonio, TX; <sup>2</sup>Stanford University School of Medicine, Stanford, CA; <sup>3</sup>Tulane University Health Sciences Center, New Orleans, LA; <sup>4</sup>University of Utah Health, Salt Lake City, UT; <sup>5</sup>VA Salt Lake City Health Care System, Salt Lake City, UT; <sup>6</sup>South Texas Veterans Health Care System, San Antonio, TX.

**Background:** We examined whether the beneficial effects of intensive systolic blood pressure (SBP)-lowering on major cardiovascular (CV) events in the Systolic Blood Pressure Intervention Trial (SPRINT) could be explained, in part, by increased use of diuretics in the intensive arm.

**Methods:** The SPRINT evaluated the effects of intensive (<120 mmHg) vs. standard SBP (<140 mmHg) goal on primary outcome (CV composite) and all-cause mortality (ACM) in 9361 participants. In a post-hoc analysis, we examined whether adjustment for post-randomization time-varying diuretic use in Cox regression models attenuated the effects of BP intervention on the primary outcome and ACM. We also performed mediation analyses of post-randomization diuretic use at 6 months to separate the overall effects of the randomized SBP intervention into indirect effects (mediated by diuretic use) and direct effects (mediated through pathways other than diuretic used) on the primary outcome and ACM.

**Results:** The participants age was 67.9±9.4 years, 36% were women. During the trial, diuretics were used in 46% and 74% of participants in the standard and intensive groups, respectively. There were 726 CV events and 502 deaths over 3.8 years of follow-up. As shown in Fig 1A, intensive SBP goal lowered the risk of primary outcome (HR0.76, 95%CI0.65-0.88) and adjustment for post-randomization time-varying diuretics use did not attenuate the effect (HR0.73, 95%CI0.63-0.85). Formal mediation analyses suggested that the beneficial effects of the SBP intervention on primary outcome were mediated through direct effects and were independent of post-randomization diuretic use (Fig 1B). ACM results were similar.

**Conclusions:** In this post-hoc analysis of the SPRINT, post-randomization diuretics use did not appear to mediate the beneficial effects of intensive SBP treatment on the CV events and ACM.

**Funding:** NIDDK Support, Other NIH Support - NIA and NHLBI, Veterans Affairs Support

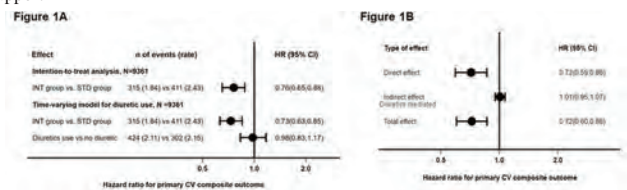

Effect of SBP interventions on primary CV composite outcomes by diuretics use

FR-PO748

**Depression and CKD as Risk Factors of Heart Failure: Post Hoc Analysis of SPRINT**

Nikita Abraham, Sydney E. Hartsell, Ravinder Singh, Guo Wei, Alfred K. Cheung, Tom Greene, Robert E. Boucher, Srinivasan Beddhu. *The University of Utah School of Medicine, Salt Lake City, UT.*

**Background:** Depression and HF are common in CKD. We examined whether the presence of depression augments the risk of HF in CKD.

**Methods:** We used data from SPRINT, a RCT that tested the effects of SBP goal <120 vs. <140 mmHg on CV outcomes. CKD was defined as eGFR <60. Based on the Patient Health Questionnaire (PHQ)-9, we defined 3 groups: no (score 0), minimal/mild (scores 1-9) and moderate/severe (scores 10-27) depressive symptoms. We related baseline PHQ9 groups and CKD status with adjudicated HF events during follow-up in Cox regression models.

**Results:** In 9,111 included participants, the mean age was 68±9 yrs., 36% were female, 31% were Black and 28% had CKD at baseline. Baseline characteristics by depression groups defined by PHQ9 scores are summarized (Table). There were 211 HF events over 34,340 years of follow-up. In a multivariate Cox regression model, higher PHQ9 scores (minimal/mild HR 1.43 (1.05, 1.96), moderate/severe HR 1.84 (1.09, 3.10)) and CKD (HR 3.33 (2.53, 4.37)) were each associated with HF. Highest HF risk was noted when both were present (Fig).



**Conclusions:** Both depression and CKD are risk factors for HF with the highest risk of HF seen when both are present. Interventions targeting depression might reduce the risk of HF in CKD.

**Funding:** NIDDK Support, Other NIH Support - NIA, Veterans Affairs Support

Baseline characteristics by PHQ9 score (N = 9111)

	None (0) 34%	Minimal/Mild (1-9) 69%	Moderate (10-27) 7%
PHQ-9	0 ± 0	3 ± 2	14 ± 4
Age (yr)	69 ± 9	68 ± 10	63 ± 9
Female (%)	28	40	42
Black (%)	31	30	47
Intensive SBP arm (%)	50	50	51
CVD History (%)	18	21	23
SBP (mmHg)	140 ± 15	140 ± 16	139 ± 16
DBP (mmHg)	77 ± 12	78 ± 12	81 ± 12
BMI, kg/m <sup>2</sup>	29 ± 5	30 ± 6	31 ± 7
UAcr (mg/g Cr)	9 (5, 20)	10 (6, 23)	8 (5, 18)
eGFR (ml.min/1.73m <sup>2</sup> )	72 ± 20	71 ± 21	75 ± 23

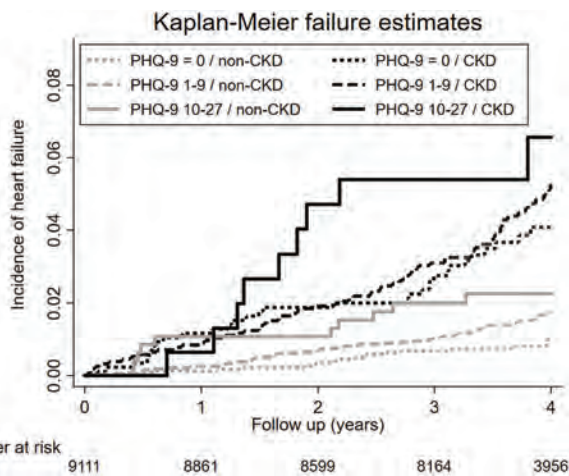

HF Incidence

**FR-PO749**

**Impact of SGLT2 Inhibitors on Cardiovascular and Renal Outcomes According to Baseline Renal Function: A Systematic Review and Meta-Analysis**

Thomas Mavrakanas,<sup>1</sup> Michael A. Tsoukas,<sup>1</sup> Abhinav Sharma,<sup>1</sup> Karim Gariani.<sup>2</sup>  
<sup>1</sup>McGill University Health Centre, Montreal, QC, Canada; <sup>2</sup>Hopitaux Universitaires Geneve, Geneve, Switzerland.

**Background:** The effect of sodium-glucose co-transporter-2 (SGLT-2) inhibitors on cardiovascular and renal outcomes has not been specifically examined across baseline kidney function groups in a meta-analysis including the most recent trials. We conducted a systematic review and meta-analysis of randomized control trials (RCTs) with SGLT-2 inhibitors in patients with and without CKD.

**Methods:** We performed a PubMed/Medline search of randomized, placebo-controlled, event-driven outcome trials of SGLT-2 inhibitors versus active or placebo control in patients with and without diabetes from inception to February 1, 2022. CKD was defined as an estimated glomerular filtration rate <60 ml/min/1.73m<sup>2</sup>. The primary outcome was cardiovascular death. Secondary outcomes included hospitalization for heart failure, major adverse cardiovascular events (MACE), progression to kidney failure, and all-cause mortality. The relative risk (RR) was estimated using a random-effects model.

**Results:** Eleven RCTs were identified and included in this meta-analysis (77541 patients, including 28515 patients with CKD). Use of an SGLT-2 inhibitor was associated with a lower incidence of cardiovascular death in patients with CKD, compared with placebo: RR 0.87 (95% CI 0.79-0.95). Use of an SGLT-2 inhibitor was associated with a lower incidence of heart failure in patients with CKD, compared with placebo: RR 0.65 (95% CI 0.59-0.70). Risk reduction with SGLT-2 inhibitors was more important among patients with CKD compared with patients without CKD (p for interaction 0.03). SGLT-2 inhibitors were associated with a lower incidence of CKD progression among patients with pre-existing CKD, compared with placebo: RR 0.74 (95% CI 0.63-0.88). SGLT-2 inhibitors were also associated with a lower incidence of MACE and death from any cause among patients with CKD, compared with placebo.

**Conclusions:** SGLT-2 inhibitors offer strong protection against cardiovascular and renal outcomes in patients with CKD. These results strongly advocate in favor of using these agents in patients with CKD.

**Funding:** Government Support - Non-U.S.

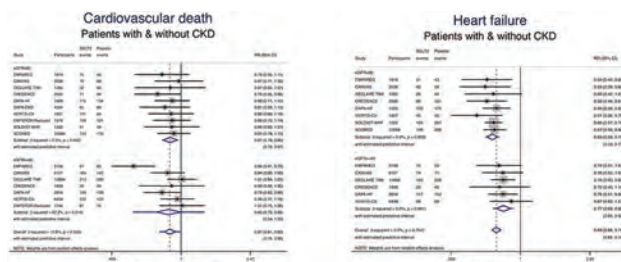

**FR-PO750**

**Efficacy of Sacubitril/Valsartan in Patients With Cardiorenal Syndrome**  
Yue Zhang, Daqing Hong, Guisen Li. Sichuan Academy of Medical Sciences and Sichuan People's Hospital, Chengdu, China.

**Background:** To retrospectively study the efficacy of Sacubitril/Valsartan in patients with cardiorenal syndrome (CRS).

**Methods:** In-hospital patients with CRS who admitted in heart failure(HF) center of our hospital from October 2021 to December 2021, meeting inclusion criteria were involved: age>18y, diagnosed as cardiorenal syndrome and receiving maximum tolerated doses of sacubitril/valsartan therapy(400mg/d) for 3 months. Clinical data were collected at the baseline and 3-month endpoint to assess cardiac and renal function.

**Results:** 69 patients with CRS were observed and participated. After 3-month's therapy, mean sitting systolic pressure(msSBP), mean sitting diastolic pressure(msDBP), heart-rate, type-B natriuretic peptide (BNP) and serum uric acid (sUA) were improved significantly, p-value was 0.000, 0.001,0.011,0.004,0.000 respectively. All the patients were divided into 2 subgroups based on the left ventricular ejection fraction(LVEF) value: group A (EF more than 50%) and group B (EF less than 50%). LVEF and left ventricular (LV) diameter were significantly improved in group B (p=0.008). Kidney function assessed by estimated glomerular filtration rate (eGFR) and serum creatinine (sCr) were improved but not significantly in all patients (p=0.696, 0.514 respectively) and group B (p=0.297, 0.534 respectively).

**Conclusions:** Sacubitril/valsartan might effectively decrease blood pressure and improve cardiac function in patients with CRS. And it seems like be effective to preserving kidney function, especially in CRS patients with lower EF value. It need to be verified in large scale controlled prospective trials.

**FR-PO751**

**Results From a Phase 1 Study Demonstrating the Safety and Pharmacokinetics of the Aldosterone Synthase Inhibitor CIN-107 in Subjects With Varying Degrees of Renal Function**

Mason W. Freeman,<sup>1</sup> Yuan-Di Halvorsen,<sup>1</sup> Mary Bond,<sup>2</sup> Brian Murphy,<sup>2</sup> Jonathan Isaacsohn.<sup>2</sup> <sup>1</sup>CinCor Pharma, Inc., Waltham, MA; <sup>2</sup>CinRx Pharma, LLC, Cincinnati, OH.

**Background:** Hypertension and chronic kidney disease are common comorbidities exacerbated by elevated aldosterone. CIN-107 is a selective inhibitor of aldosterone synthase with the potential to lower blood pressure and slow the progression of kidney disease. This phase 1 open-label study assessed the safety and pharmacokinetics (PK) of a single oral dose of CIN-107 in subjects with varying degrees of renal function.

**Methods:** Subjects enrolled into renal function groups based on estimated glomerular filtration rate (eGFR). The groups were control (eGFR ≥60mL/min), moderate to severe renal impairment (eGFR 15 to 59 mL/min), and kidney failure (eGFR <15mL/min, including subjects on dialysis). A single 10 mg CIN-107 dose was given, followed by 7 days of PK sampling (blood and urine). Safety was assessed based on adverse events, clinical laboratory evaluations, vital signs, ECGs, physical examinations, and weight measurements.

**Results:** 32 subjects completed the study. There were no deaths, and only one mild drug-related adverse event (diarrhea) occurred. There were no clinically meaningful changes in laboratory values, vital signs, physical examinations, or ECGs. The plasma concentration-time curves of CIN-107 in all groups were qualitatively similar (Figure 1). The urine PK parameters in the moderate to severe renal impairment group were similar to control (12% excreted); however, inadequate urine production in the kidney failure group resulted in negligible excretion of CIN-107.

**Conclusions:** A single dose of CIN-107 was well tolerated in all subjects, including those with kidney failure. Renal impairment did not significantly impact systemic exposure or clearance of CIN-107, suggesting that dose adjustment due to PK differences in these patients is unnecessary, even in cases of advanced kidney disease.

**Funding:** Commercial Support - CinCor Pharma, Inc.

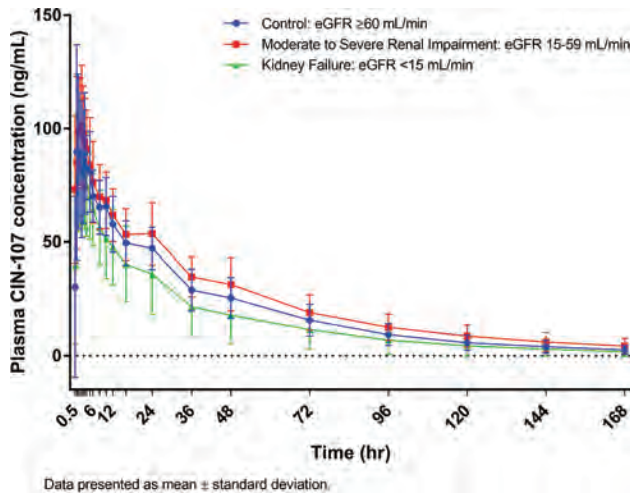

Plasma 107 Concentr vs Time

FR-PO752

**Antihypertensive Treatment and Clinical Outcomes Among Patients Who Develop Severe Hypertension During Hospitalization**

Lama Ghazi, James Nugent, Jason H. Greenberg, Christine Y. Bakhom, Francis P. Wilson. *Yale University, New Haven, CT.*

**Background:** Treatment of severe hypertension (HTN) that develops during hospitalization is not guideline dependent. Compared to oral antihypertensives, treatment with IV antihypertensives could lead to more acute blood pressure (BP) reductions and worse outcomes. Our goal was to assess the effect of treatment, overall and by treatment route, on clinical outcomes in patients who develop severe HTN.

**Methods:** This is a multi-hospital, retrospective study of adults admitted for reasons other than HTN who develop severe HTN. We defined severe HTN as blood pressure (BP) elevation of systolic>180 or diastolic>110 mmHg. Treatment was defined as receiving antihypertensives (intravenous (IV) or oral) within 6 hours of BP elevation. We used overlap propensity score weighted Cox models to study the association between treatment and clinical outcomes.

**Results:** We identified 224,265 patient hospitalizations, 9% developed severe HTN and 40% were treated. Of those treated, 21% and 72% received IV and oral antihypertensives respectively. Patients who received IV compared to oral only antihypertensives were more likely female (60 vs. 54%), less likely to be Hispanic or Latino (9 vs. 12%), less likely to have comorbidities such as hypertension (79 vs. 88%) and diabetes (42% vs. 52%), less likely to be admitted to medical ward (71% vs. 87%), have higher eGFR (63 [40, 86] vs. 55 [30,82]) on admission, have higher BP on admission (168/68 vs. 153/79) and higher BP at time of severe HTN development (188/92 vs. 185/88). Patients who received IV treatment compared to no treatment had higher risk of myocardial injury, acute kidney injury, and death. However, patients who received oral antihypertensives compared to no treatment had lower risk of death (Table 1).

**Conclusions:** IV antihypertensive treatment was associated with worse clinical outcomes and therefore oral antihypertensives should be considered as the more preferable alternative for treatment of severe HTN without acute end organ damage.

**Funding:** Other U.S. Government Support

Table 1. Inpatient Outcomes for Treated vs. Untreated Patients by Treatment Route

	Treated	Untreated	HR (95% CI)
<b>Treatment vs. no treatment</b>			
Myocardial Injury	3.1%	2.1%	1.07 [0.91, 1.26]
Stroke	0.7%	0.5%	1.26 [0.86, 1.84]
Acute Kidney Injury	19%	17%	1.12 [1.05, 1.20]
Death	1.4%	1.3%	0.94 [0.73, 1.21]
<b>IV treatment vs. no treatment</b>			
Myocardial Injury	4.7%	2.8%	1.68 [1.25, 2.19]
Stroke	0.5%	0.5%	0.98 [0.45, 2.15]
Acute Kidney Injury	23%	16%	1.45 [1.29, 1.63]
Death	2.6%	1.3%	1.96 [1.36, 2.81]
<b>Oral treatment vs. no treatment</b>			
Myocardial Injury	2.3%	2.8%	0.83 [0.67, 1.03]
Stroke	0.7%	0.5%	1.41 [0.91, 2.18]
Acute Kidney Injury	17%	17%	0.99 [0.92, 1.08]
Death	0.8%	1.4%	0.58 [0.41, 0.85]

HR: Hazard Rate from overlap propensity Cox model accounting for demographics, comorbidities, admission vital, admission labs, vital at time of severe hypertension.

FR-PO753

**Comparison of Beta Blocker Outcomes Among CKD Patients With Cardiorenal Syndrome**

Albert Yu, Hui Zhou, Katherine J. Pak, Sally F. Shaw, Jiaxiao Shi, Benjamin Broder, Cheng-Wei Huang, John J. Sim. *Kaiser Permanente Southern California, Los Angeles, CA.*

**Background:** Beta blockers reduce mortality and hospitalization in patients with heart failure with reduced ejection fraction (HFrEF). The three guideline directed medical therapy (GDMT) beta blockers are bisoprolol, carvedilol, and metoprolol succinate,

however, their effects in chronic kidney disease (CKD) patients are not well studied. We compared one year outcomes among these three GDMT beta blockers in the patients with both HFrEF and CKD.

**Methods:** A retrospective study was performed within Kaiser Permanente Southern California (KPSC) during 2007-2017 among patients with incident advanced CKD (eGFR<45) who had prevalent HFrEF. We limited the study population to the patients who were taking GDMT beta blockers at baseline and followed them for one year to assess outcomes including major adverse cardiac events (MACE), renal events, all-cause death, and all-cause hospitalization. Multiple models were performed to estimate hazard ratio (HR) or rate ratio (RR) of these outcomes after adjustment for potential confounders or potential competing risk, respectively.

**Results:** A total of 2,355 (16.9%) among incident CKD patients had HFrEF and were treated with GDMT beta blockers. Within one year, 30.3% patients had encountered MACE, 52.2% had ≥ 1 hospitalization and 22.8% died with cardiovascular death accounting for 19.7% (Figure). Compared to carvedilol, bisoprolol had a lower one year MACE with adjusted HR 0.73 (0.58-0.93). There was no statistical difference in renal events and all-cause mortality or all-cause hospitalization.

**Conclusions:** The three GDMT beta blockers were associated with similar one year mortality and hospitalizations in patients with CKD and HFrEF. However, bisoprolol was associated with lower MACE outcomes.

FR-PO754

**Dihydropyridine Calcium Channel Blockers and Incident Albuminuria**

Matthew F. Blum,<sup>1,5</sup> Aditya L. Surapaneni,<sup>2</sup> Alex R. Chang,<sup>3</sup> Lesley A. Inker,<sup>4</sup> Jung-Im Shin,<sup>5</sup> Morgan Grams.<sup>2,5</sup> <sup>1</sup>*Johns Hopkins University School of Medicine, Baltimore, MD;* <sup>2</sup>*New York University Grossman School of Medicine, New York, NY;* <sup>3</sup>*Geisinger Health, Danville, PA;* <sup>4</sup>*Tufts Medical Center, Boston, MA;* <sup>5</sup>*Johns Hopkins University Bloomberg School of Public Health, Baltimore, MD.*

**Background:** Dihydropyridine calcium channel blockers (DHP-CCB) are first-line blood pressure agents that promote systemic vasodilation. In the kidney, they disproportionately vasodilate the afferent arteriole relative to the efferent arteriole, which poses a risk of glomerular hypertension and consequent albuminuria. For this reason, the amlodipine arm was halted early in the African American Study of Kidney Disease and Hypertension. However, DHP-CCBs remain commonly used, and few real-world studies have examined the development albuminuria with DHP-CCB use. Therefore, we sought to measure the association of DHP-CCBs with incident albuminuria compared to beta blockers, an active comparator not known to affect albuminuria.

**Methods:** We included 61,380 patients without known albuminuria who initiated either a DHP-CCB or beta blocker in a cohort from the Geisinger Health System from 2004-2019. We performed 1:1 propensity matching on age, sex, race, systolic and diastolic blood pressure, eGFR, smoking, body mass index, heart failure, diabetes, stroke, and coronary heart disease. We estimated risk of incident albuminuria (albumin to creatinine ratio [ACR] > 300 mg/g, protein to creatinine ratio converted to ACR, or urinalysis with > 2+ protein) using Cox proportional hazards regression.

**Results:** After matching, there were 28,716 patients (14,358 per group). Mean age was 60.5 years, mean systolic blood pressure was 142 mmHg, mean eGFR was 84 ml/min/1.73 m<sup>2</sup>, and 1.8% had heart failure. 2244 (7.8%) patients developed albuminuria over an average 4.8 years of follow up. DHP-CCB initiation was associated with a significantly higher risk of albuminuria compared to beta blocker initiation (hazard ratio 1.37 [95% confidence interval, 1.26-1.50]; Figure).

**Conclusions:** Compared to beta blockers, DHP-CCB use was associated with increased risk of incident albuminuria in a community cohort.

**Funding:** Other NIH Support - NHLBI

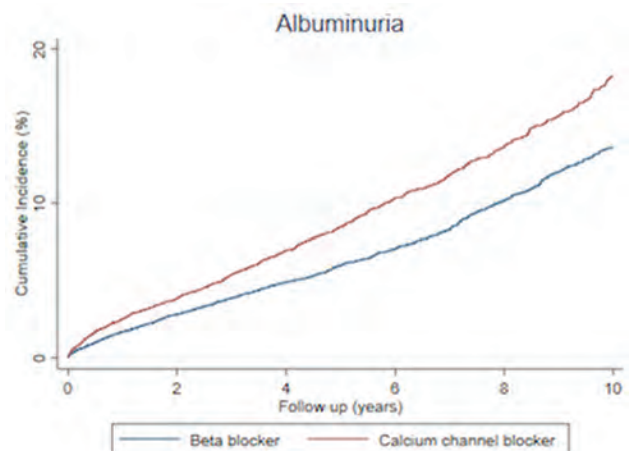

Cumulative incidence of albuminuria in DHP-CCB vs beta blocker use

FR-PO755

**Kidney Tubule Injury and Dysfunction Biomarkers and Risk of Incident Hypertension in Community-Living Individuals: Results From the Multi-Ethnic Study of Atherosclerosis**

Rakesh Malhotra,<sup>1</sup> Ronit Katz,<sup>2</sup> Paul L. Kimmel,<sup>3</sup> Vasani S. Ramachandran,<sup>4</sup> Tala Al-Rousan,<sup>1</sup> Jason H. Greenberg,<sup>5</sup> Chirag R. Parikh,<sup>6</sup> Joseph V. Bonventre,<sup>7</sup> Jeffrey R. Schelling,<sup>11</sup> Mark J. Sarnak,<sup>8</sup> Orlando M. Gutierrez,<sup>9</sup> Michael Shlipak,<sup>10</sup> Joachim H. Ix.<sup>1</sup> <sup>1</sup>University of California San Diego, La Jolla, CA; <sup>2</sup>University of Washington, Seattle, WA; <sup>3</sup>National Institute of Diabetes and Digestive and Kidney Diseases, Bethesda, MD; <sup>4</sup>Boston University School of Medicine, Boston, MA; <sup>5</sup>Yale University, New Haven, CT; <sup>6</sup>Johns Hopkins University, Baltimore, MD; <sup>7</sup>Brigham and Women's Hospital, Boston, MA; <sup>8</sup>Tufts Medical Center, Boston, MA; <sup>9</sup>UAB Health System, Birmingham, AL; <sup>10</sup>UCSF Medical Center, San Francisco, CA; <sup>11</sup>University Hospitals, Cleveland, OH.

**Background:** Hypertension (HTN) is a major risk factor for the onset and progression of chronic kidney disease (CKD) and cardiovascular disease (CVD). However, the mechanisms leading to essential HTN remain elusive. Here, we evaluated the association between tubule biomarkers and risk of developing HTN.

**Methods:** We randomly sampled 463 MESA participants who did not have prevalent CKD or diabetes, but excluded 166 participants who had prevalent HTN. We measured six plasma tubule biomarkers (KIM-1, MCP-1, suPAR, TNFR1, TNFR2 and YKL-40) and five urinary tubule biomarkers (EGF, KIM-1, MCP-1, YKL-40 and urine albumin) at baseline. The primary outcome was the development of incident HTN, defined as either a systolic BP ≥ 140 mmHg, a diastolic BP ≥ 90 mmHg, or the use of any antihypertensive medication during a follow-up period. Multivariable Poisson regression was used to examine associations between baseline kidney tubule markers and urine albumin with incident HTN.

**Results:** Among the 297 participants, the mean age was 58±10 years, 53% were women, 47% were White, and 20% were Black. The median number of BP measurements per participant was 6 (IQR 2 to 10). Nearly half (N=142) developed incident HTN event over 15 years of follow-up. In unadjusted models, higher urinary KIM-1, MCP-1 and urine albumin, as well as higher plasma MCP-1 and YKL-40 were individually associated with risk of incident HTN (Figure 1). However, in the fully adjusted model, only urine albumin remained associated with incident HTN (IRR 1.25 (1.1 to 1.5); P < .005).

**Conclusions:** In this study of community-living individuals without CKD, diabetes, or CVD, in an adjusted model there was no association of selected kidney tubule injury or dysfunction biomarkers with incident HTN. In comparison, urine albumin was independently associated with incident HTN.

**Funding:** NIDDK Support

Association of biomarkers of kidney tubule injury and dysfunction with incident HTN in community-living individuals without diabetes or chronic kidney disease		
	Unadjusted IRR (95% CI)	Model 1 IRR (95% CI)
P KIM-1	1.16 (0.97 to 1.38)	1.07 (0.86 to 1.33)
P MCP-1	1.46 (1.15 to 1.86) <sup>#</sup>	1.31 (0.93, 1.86)
P suPAR	1.25 (0.92 to 1.69)	1.36 (0.94 to 1.97)
P YKL-40	1.28 (1.10 to 1.50) <sup>#</sup>	1.03 (0.87 to 1.21)
P TNFR1	1.11 (0.83 to 1.49)	1.04 (0.76 to 1.43)
P TNFR2	1.16 (0.79 to 1.70)	1.03 (0.71 to 1.49)
U KIM-1	1.29 (1.12 to 1.48) <sup>#</sup>	1.04 (0.83 to 1.28)
U MCP-1	1.38 (1.20 to 1.58) <sup>#</sup>	0.92 (0.70 to 1.20)
U EGF	1.19 (0.99 to 1.41)	0.92 (0.71 to 1.20)
U YKL-40	1.10 (0.95 to 1.27)	1.01 (0.90 to 1.13)
U albumin	1.40 (1.26 to 1.56) <sup>#</sup>	1.25 (1.08 to 1.45) <sup>#</sup>

<sup>#</sup>P value <.05, \* P value <.005, \*\*P value <.001; Sub-cohort: total n=297 and incident HTN= 142; Model 1 = age, sex, race/ethnicity, education, BMI, SBP, smoking, LDL, HDL, triglyceride, urine creatinine, urine albumin and eGFR.  
Abbreviations: IRR, incident rate ratio; Kidney injury molecule-1, KIM-1; monocyte chemoattractant protein-1, MCP-1; soluble urokinase-type plasminogen activator receptor, suPAR; tumor necrosis factor receptor-1 and receptor-2, TNFR1, TNFR2; anti-chitinase-3-like protein 1, YKL-40; epidermal growth factor, EGF.

FR-PO756

**In SPRINT Participants With Creatinine Elevations During Follow-Up, Trajectories of Tubule Injury Markers Associate With eGFR Decline**

Joachim H. Ix,<sup>1,2</sup> Ronit Katz,<sup>3</sup> Judy Shigenaga,<sup>4,5</sup> Alfred K. Cheung,<sup>6</sup> Kalani L. Raphael,<sup>7,8</sup> Stein I. Hallan,<sup>9</sup> Jesse C. Seegmiller,<sup>10</sup> Rakesh Malhotra,<sup>1</sup> Vasantha Jotwani,<sup>4,5</sup> Pranav S. Garimella,<sup>1</sup> Michael Shlipak.<sup>4,5</sup> <sup>1</sup>University of California San Diego, La Jolla, CA; <sup>2</sup>Veterans Medical Research Foundation, San Diego, CA; <sup>3</sup>University of Washington, Seattle, WA; <sup>4</sup>University of California San Francisco, San Francisco, CA; <sup>5</sup>San Francisco VA Health Care System, San Francisco, CA; <sup>6</sup>University of Utah Health, Salt Lake City, UT; <sup>7</sup>Oregon Health & Science University, Portland, OR; <sup>8</sup>Portland VA Medical Center, Portland, OR; <sup>9</sup>St. Olav University Medical Center, Trondheim, Norway; <sup>10</sup>University of Minnesota Twin Cities, Minneapolis, MN.

**Background:** Elevations in serum creatinine (SCr) often prompt clinicians to halt therapies. We hypothesized that biomarkers of tubule cell damage could prognosticate eGFR trajectories in this setting.

**Methods:** The SPRINT trial randomized 9361 hypertensive patients to an intensive (<140mmHg) vs. standard (<140mmHg) systolic blood pressure target. Of these, 652 (7.0%) had SCr elevations (ΔSCr ≥ 0.3 mg/dL from baseline) during follow-up. We measured four urine biomarkers indexed to urine Cr (IL-18, KIM-1, MCP-1 & YKL-40) & 1 plasma (UMOD) biomarker at baseline and annual visits concurrent with SCr elevations. Intra-individual changes were calculated; those in the highest quartile were considered “abnormal”. The outcome was ΔeGFR from SCr elevation through the end of follow-up. Models adjusted for clinical risk factors and stratified by randomization.

**Results:** The median ΔSCr was 0.42 (IQR 0.34, 0.56) mg/dL. At baseline, mean age was 70 years, 33% were female, mean eGFR was 62±25 ml/min/1.73m<sup>2</sup>, & 72% were randomized to the intensive arm. Over 23.5 months mean follow-up after SCr elevation, mean (SD) ΔeGFR was 1.46 ± 2.60% annually. In the standard arm, longitudinal increases of urine IL-18 and KIM-1 or decreases in plasma UMOD associated with faster declines in eGFR, independent of clinical risk factors and albuminuria. In the intensive arm, only increasing uMCP-1 associated with subsequent eGFR trajectory, and the direction was toward eGFR improvement.

**Conclusions:** Among hypertensive patients with SCr elevations, worsening kidney tubule damage associates with faster subsequent eGFR decline. These relationships were not observed in the intensive arm, where SCr elevations more likely result from hemodynamic causes.

**Funding:** NIDDK Support

Biomarker	% Annual Change in eGFR (95% CI)	
	Standard Arm (N=180)	Intensive Arm (N=472)
u-IL-18/Cr	-3.55 (-6.74, -0.35)	-1.65 (-3.58, 0.28)
u-KIM-1/Cr	-3.95 (-7.06, -0.85)	0.24 (-1.68, 2.16)
u-MCP-1/Cr	1.13 (-1.84, 4.11)	2.60 (0.58, 4.62)
u-YKL-40/Cr	-2.09 (-5.24, 1.05)	-0.13 (-2.17, 1.90)
p-UMOD*	-3.58 (-6.71, -0.44)	-0.43 (-2.22, 1.37)
u-ACR	0.40 (-2.25, 3.05)	2.39 (0.10, 4.68)

Adjusted for baseline age, sex, race, CVD, smoking, BMI, SBP, BP, ACE/ARB use, uACR, and eGFR.  
\* pUMOD compares Q1 vs. Q2-4, whereas all others are Q4 vs. Q1-3.

FR-PO757

**Protective Effect of AT1R Antibodies in Patients With ESKD on Hemodialysis**

Maria Lourdes Gonzalez Suarez,<sup>1,2</sup> Neal S. Fedarko,<sup>3</sup> Seungyoung Hwang,<sup>4</sup> Adrienne Tin,<sup>2</sup> Tariq Shafi.<sup>2,3</sup> <sup>1</sup>Mayo Clinic Minnesota, Rochester, MN; <sup>2</sup>The University of Mississippi Medical Center, Jackson, MS; <sup>3</sup>Johns Hopkins University, Baltimore, MD; <sup>4</sup>Boston Strategic Partners Inc, Boston, MA.

**Background:** The renin-angiotensin system (RAS) is one of the major contributors to accelerated CVD. Angiotensin II binds to its type 1 receptor (AT1R) contributing to the clinical phenotype characterized by hypertension, and CVD outcomes. Autoantibodies to AT1R (AT1Rab) mimic angiotensin II effects by binding to its receptor active site. AT1Rab have been described in severe preeclampsia, malignant hypertension, and kidney allograft failure. We assessed the association of AT1Rab with mortality in patients with ESKD on hemodialysis (HD).

**Methods:** Using serum samples from a national prospective cohort study of ESKD patients on HD, we measured AT1Rab by quantitative ELISA using two methods: a) a novel purified antigen sequence AFHYESQ (active site) assay; b) a commercial full length AT1R assay. We assessed the association of AT1Rab with mortality using Cox models adjusting for demographic and clinical factors.

**Results:** A total of 443 samples were measured by both ELISAs. Mean age was 61 (SD±13.9), 45% were women and 39% were Black. Charlson score was 5.7±1.9. Mean number of years on dialysis was 6 (SD±4.3). 211 patients died during follow-up. Compared to the lowest tertile of AT1Rab, the highest tertile was associated with a 42% lower risk of death using the novel assay (HR 0.58; 95% CI, 0.41-0.82; p=0.002). Comparison of both assays is presented in the Table 1.

**Conclusions:** Our findings of a protective effect by AT1Rab that activate AT1 receptor are intriguing. The use of angiotensin receptor blockers, which can elevate circulating levels of AT1Rab may be a possible explanation. Larger population studies are needed to determine ARBs association with AT1Rab.

**Funding:** Other NIH Support - NIGMS

Association of AT1R Levels with All-Cause Mortality

Events/N (HR per 1000 PY)	Model 1 Unadjusted HR (95% CI)	P	Model 2 Adjusted* HR (95% CI)	P
Novel Assay (AFHYESQ <sub>0</sub> , ug/ml)				
Tertile 1, lowest	Reference	---	Reference	---
Tertile 2	0.93 (0.68-1.28)	0.665	0.98 (0.71-1.35)	0.905
Tertile 3, highest	0.64 (0.45-0.90)	0.01	0.58 (0.41-0.82)	0.002
Commercial assay, ug/ml				
Tertile 1, lowest	Reference	---	Reference	---
Tertile 2	0.99 (0.71-1.37)	0.951	1.00 (0.72-1.39)	0.986
Tertile 3, highest	0.64 (0.45-0.89)	0.009	0.69 (0.49-0.97)	0.03

\*Adjusted for age, sex, race, Charlson score, diabetes, albumin, hemoglobin, phosphorus, PTH and spKtv

FR-PO758

Fasting Plasma Glucose and Glycated Hemoglobin Are Associated With Posterior Wall Thickness and Left Atrial Diameter in Patients With CKD

Marta Borges Canha,<sup>1</sup> Mariana F. Marques,<sup>1</sup> João Sérgio Neves,<sup>1</sup> Katherine S. Ravi,<sup>2</sup> Fynnian R. McCausland,<sup>2</sup> <sup>1</sup>Centro Hospitalar Universitario de Sao Joao, Porto, Portugal; <sup>2</sup>Brigham and Women's Hospital, Boston, MA.

**Background:** Cardiovascular (CV) disease is the major cause of death in patients with chronic kidney disease (CKD), particularly among patients with diabetes. Several echocardiographic parameters are known to predict CV events and death in patients with CKD, but data on the association of glycemic metabolism with echocardiographic parameters in CKD is scarce.

**Methods:** Using the Chronic Renal Insufficiency Cohort (CRIC) Study, we excluded patients with baseline heart failure, missing fasting plasma glucose (FPG) or glycated hemoglobin (A1c) measurements, or echocardiography data at year 1 (2557 included patients). We used restricted cubic splines to assess the association of FPG and A1c with: left ventricular mass (LVM); posterior wall thickness (PWT); interventricular septal thickness in diastole (IVSTD); LV internal diameter in diastole and systole (LVIDD and LVIDS); left atrial diameter (LAD); LV ejection fraction (LVEF); A wave duration; E wave velocity and E/A wave ratio. Models were adjusted for age, sex, race, body mass index, systolic blood pressure, heart rate, history of peripheral vascular disease, stroke, myocardial infarction or prior revascularization, antiplatelet, lipid lowering or inhibition of renin-angiotensin-aldosterone axis therapy, hematocrit, serum albumin, baseline estimated glomerular filtration rate (CKD-EPI formula) and 24-hour urine protein excretion (log-transformed).

**Results:** Patients within higher FPG or A1c quartiles are more likely to be males, older, black, and to have medical history of coronary artery disease, stroke, and peripheral vascular disease. These patients have higher PWT, IVSTD, LV mass and LAD, and lower E/A ratio. The spline analyses show that higher FPG and A1c are associated with higher PWT, and that higher FPG is associated to higher LAD (Figure 1).

**Conclusions:** Among patients with CKD, higher FPG and A1c are independently associated with higher PWT, and higher FPG is positively associated to LAD. Whether interventions that improve glycaemic control can result in regression of these parameters is not clear.

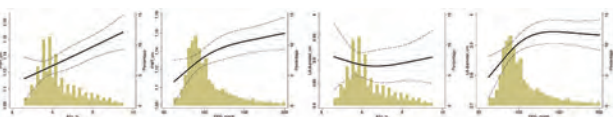

FR-PO759

Exercise Induced Hypertension (EIH) in Healthy Young Individual

Parker Lehmann,<sup>1</sup> Ernest L. Mazzaferri,<sup>2</sup> Salem Almaani,<sup>2</sup> Udayan Y. Bhatt,<sup>2</sup> Asish Thakkar,<sup>3</sup> <sup>1</sup>Idaho College of Osteopathic Medicine, Meridian, ID; <sup>2</sup>The Ohio State University Wexner Medical Center, Columbus, OH; <sup>3</sup>VA Central Ohio Healthcare System, Columbus, OH.

**Introduction:** Exercise induced hypertension (EIH) is a phenomenon that is diagnosed with SBPs of >210mmHg in males and 190mmHg in females while exercising. Untreated, it can lead to increased risk of developing hypertension (HTN) along with an increase in cardiovascular morbidity and mortality. The proposed mechanisms associated with EIH include RAAS changes, arterial stiffness, and endothelial dysfunction. Generally, individuals with pre-exercise stage 1 HTN (SBP 130-139; DBP 80-89) or stage 2 HTN (SBP at least 140 or DBP 90) are evaluated for this condition.

**Case Description:** A 19yo male college lacrosse player was noted to have a pre-participation blood pressure of 125/79 and a mild chest discomfort with training. He has no past medical history and denies any medications or drugs. A cardiology consult was obtained. Baseline EKG, echocardiogram and metabolic panel all were unremarkable. He was found to have a BP of 230/110 at stage IV of the Bruce Protocol during stress testing but EKG was negative for ischemia. He was referred to Nephrology for further evaluation. He had relatively normal ambulatory BPs while not exercising and hormonal evaluation unremarkable. The patient was felt to have EIH and was started on an ACE with improvement in his BP with exercise.

**Discussion:** Demographically, EIH is more often reported in middle-age, distance runners than in young healthy athletes with a normal pre-participation exam. This patient is a healthy young individual who had accelerated HTN during exercise. In addition, given his pre-participation exam, he did not meet criteria for any further testing based on current recommendations. Also, his level of general fitness may not have prompted an evaluation of blood pressure during exercise. This case does support the contention that screening for EIH could be expanded to encompass those individuals with elevated blood pressure but not meeting the criteria for Stage 1 HTN or beyond.

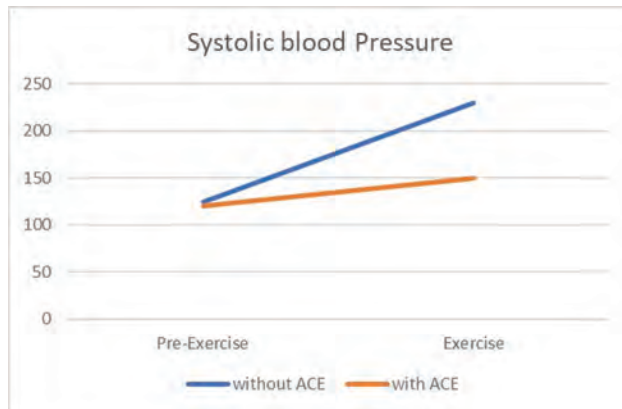

FR-PO760

Impact of Kidney Function on the Association Between Selected Proteomic Biomarkers and Cardiovascular Events and Mortality

Barbara Salzinger,<sup>1</sup> Kristina Lundwall,<sup>1</sup> Marie Evans,<sup>1</sup> Josefin L. Mortberg,<sup>2</sup> Hakan Wallen,<sup>1</sup> Tomas Jernberg,<sup>1</sup> Thomas Kahan,<sup>1</sup> Pia Lundman,<sup>1</sup> Bertil Lindahl,<sup>2</sup> Jonas Spaak,<sup>1</sup> Stefan H. Jacobson,<sup>1</sup> <sup>1</sup>Karolinska Institutet, Stockholm, Sweden; <sup>2</sup>Uppsala Universitet, Uppsala, Sweden.

**Background:** The link between chronic kidney disease (CKD) and the high burden of cardiovascular disease remains unclear. We aimed to explore whether CKD G3+ (eGFR<60 ml/min/1.73m<sup>2</sup>) modified the association between selected biomarkers reflecting systemic inflammation, endothelial activation, angiogenesis, and vascular calcification, and major adverse cardiovascular events (MACE) and mortality in patients admitted to hospital with an acute coronary syndrome.

**Methods:** In all, 1293 patients 2008-2015 hospitalized with an acute coronary syndrome registered in the SWEDEHEART registry were followed until Dec 31, 2017. Thirteen biomarkers were *a priori* identified and analyzed with two proteomic methods, the proximity extension assay technology and multiple reaction monitoring mass spectrometry. The primary outcome (MACE+) was a composite of the first event of readmission for myocardial infarction, heart failure, ischemic stroke or death from any cause. Adjusted Cox proportional hazard models with an interaction term for CKD G3+ was used.

**Results:** Six of the biomarkers (ESM-1 (endocan), IL-1Ra, FGF-23, PIGF, TIM1 and VEGF-A) showed a significant association with MACE+ in the Cox regression models adjusted for age, gender, diabetes, smoking and CKD. Of these biomarkers, only FGF-23 remained independently associated after additional adjustment for the other biomarkers (Figure). None of the 13 selected biomarkers showed significant interaction with CKD G3+.

**Conclusions:** In patients with acute coronary syndrome, FGF-23, ESM-1, IL-1ra, PIGF, TIM1 and VEGF-A were associated with cardiovascular events and mortality. FGF-23 was independently associated with MACE and death regardless of presence of CKD or not.

**Funding:** Commercial Support - fund from astra zeneca, Clinical Revenue Support, Government Support - Non-U.S.

Figure: Cox proportional hazard model, standardized association with outcome (HR, 95% CI)

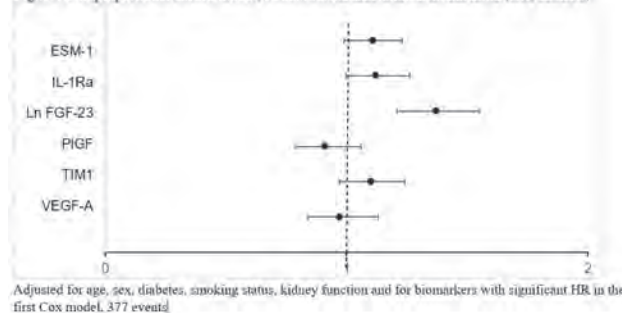

FR-PO761

**Genome-Wide Association Study of Apparent Treatment Resistant Hypertension in the Million Veteran Program**

Adriana Hung,<sup>1,2</sup> Jacklyn N. Hellwege,<sup>2,1</sup> Hua-Chang Chen,<sup>2,1</sup> Peter W. Wilson,<sup>8,7</sup> Yan Sun,<sup>7,8</sup> Elvis A. Akwo,<sup>2</sup> Philip S. Tsao,<sup>5,6</sup> Ran Tao,<sup>2,1</sup> Csaba P. Kovacs,<sup>3,4</sup> Todd L. Edwards,<sup>2,1</sup> Million Veteran Program <sup>1</sup>VA Tennessee Valley Healthcare System, Nashville, TN; <sup>2</sup>Vanderbilt University Medical Center, Nashville, TN; <sup>3</sup>Memphis VA Medical Center, Memphis, TN; <sup>4</sup>The University of Tennessee Health Science Center College of Medicine, Memphis, TN; <sup>5</sup>VA Palo Alto Health Care System, Palo Alto, CA; <sup>6</sup>Stanford University, Stanford, CA; <sup>7</sup>Emory University, Atlanta, GA; <sup>8</sup>Atlanta VA Medical Center, Atlanta, GA.

**Background:** Apparent treatment resistant hypertension (ATRH) is common. 9-16% of individuals in different populations are affected, and it is associated with poor outcomes compared with controlled hypertension, including increased risk of ESRD, cardiovascular morbidity and mortality.

**Methods:** We performed a large GWAS of ATRH in US veterans enrolled in the Million Veteran Program. ATRH was defined as treated with 3 different antihypertensive drugs including a thiazide with BP above goal (SBP ≥ 140 mm Hg and/or diastolic BP ≥ 90 mm Hg) or the use of 4 or more antihypertensive drugs regardless of BP control. Controls were patients with controlled hypertension. All participants had eGFR ≥60 ml/min/1.73m<sup>2</sup>. The analysis included 26,902 cases (27% AA, 73% EA) and 81,187 controls (18% AA, 82% EA). Association analyses were performed with logistic regression with an additive model adjusting for age, sex, body mass index, and 10 principal components of ancestry in GWAS data imputed using 1000 genomes project haplotypes. Analyses were stratified by ancestry (EA and AA) and inverse variance-weighted fixed-effects meta-analyses were carried out using METAL.

**Results:** Twenty one loci reached genome wide significance in the transethnic meta-analysis: CASZ1 (2.46E-11), WNT2B(2.84E-09), KCNK3 (2.78E-15) CACNA1D (2.14E-11), ENPEP (6.38E-10), FBN2(1.05E-11), HTR4(3.88E-09), TRIM36 (1.89E-09), RSP03(3.17E-10), SLC22A7 (1.25E-09), HOTTIP (8.50E-17), HOXA10-HOXA9 (8.40E-11), CYP11B2-GML (4.84E-09), GATA4 (1.03E-11), MAPKAP1(2.10E-08) LSP1 (3.09E-10), TBX3(1.39E-09), RXFP2 (4.27E-24) and KLF5 (1.33E-11). CASZ1 was previously reported associated with ATRH in REGARDS and CACNA1D has also been reported in candidate gene studies. The remaining associated loci are novel for ATRH. All these loci have been previously associated with BP or hypertension. We also performed a phenome-wide association analysis for each sentinel variant and three loci were associated with hyperaldosteronism and hypopotassemia.

**Conclusions:** These results indicate that RH genetic susceptibility likely arises at known BP loci. Also our study results suggests an underlying physiology related to mineralocorticoid physiology.

**Funding:** Veterans Affairs Support

FR-PO763

**Impact of ABO-Incompatibility and Early Antibody-Mediated Rejection on Kidney Allograft Outcomes**

Ga Young Heo, Hyo Jeong Kim, Kyung Won Kim, Hee Byung Koh, Jaeseok Yang. Yonsei University College of Medicine, Seodaemun-gu, Seoul, Republic of Korea.

**Background:** Early active antibody-mediated rejection (ABMR) has been reported to increase the risk of chronic ABMR and decrease long-term graft survival. Although desensitization has improved the long-term outcome of ABO blood type-incompatible (ABOi) kidney transplantation (KT), ABMR is still an important problem after ABOi KT. However, the impact of early ABMR on long-term outcomes in ABOi KT is not well-known.

**Methods:** We analyzed patients undergoing living-donor KT from Severance Hospital and Seoul National University Hospital between 2010 and 2019. Patients were categorized into 4 groups based on ABO incompatibility and early ABMR during the first year post-transplant. The primary outcome was a composite kidney outcome, defined as a ≥30% decline in the eGFR from baseline or graft loss. Secondary outcomes were the diagnosis of chronic ABMR and *de novo* donor specific antigen (DSA) production after 1 year.

**Results:** There were 1,335 ABOc and 367 ABOi KT patients, with a median follow-up of 6.37 years. In multivariate Cox model, both ABOc with ABMR (HR 1.71, 95% CI 1.14-2.56) and ABOi with ABMR (HR 1.61, 95% CI 1.01-2.55) showed increased risk of composite kidney outcome compared to ABOc without ABMR group. However, ABOi without ABMR group did not show significant difference on risk of composite kidney outcome. In parallel, ABOi without ABMR group had a lower risk for the *de novo* DSA (HR 0.52, 95% CI 0.34-0.79) and chronic ABMR (HR 0.35, 95% CI 0.12-0.98) than ABOc without ABMR.

**Conclusions:** Our findings suggest that desensitization in ABOi KT might reduce *de novo* DSA production and chronic ABMR, as well as mitigate the adverse impact of anti-ABO antibody on long-term graft outcome. However, early ABMR in ABOi abrogates these beneficial effects and contributes to poor graft outcome.

Multivariate analyses for composite kidney outcome, *de novo* DSA, and late chronic ABMR according to categories based on ABO incompatibility and the early ABMR.

	Composite kidney outcome		<i>de novo</i> DSA		Late chronic ABMR	
	HRs (95% CI)	P	HRs (95% CI)	P	HRs (95% CI)	P
ABOc without ABMR	Ref		Ref		Ref	
ABOc with ABMR	1.71 (1.14-2.56)	<0.001	2.66 (1.74-4.07)	<0.001	6.70 (3.71-12.0)	<0.001
ABOi without ABMR	1.12 (0.89-1.41)	0.30	0.52 (0.34-0.79)	0.002	0.35 (0.12-0.98)	0.04
ABOi with ABMR	1.61 (1.01-2.55)	0.04	1.38 (0.68-2.82)	0.36	2.58 (0.92-7.20)	0.07

Adjusted for age, sex, donor age, HLA mismatches, induction drugs, calcineurin inhibitors and hospital.

FR-PO765

**Donor-Derived Cell-Free DNA (dd-cfDNA) for Assessment of Response After Treatment of Allograft Rejection**

Reginald Y. Gohh,<sup>1</sup> Enver Akalin,<sup>3</sup> Jeffrey A. Klein,<sup>2</sup> Nikhil Agrawal,<sup>4</sup> Grigoriy Shekhtman,<sup>4</sup> Yi Fu,<sup>4</sup> Matthew R. Weir,<sup>5</sup> <sup>1</sup>Rhode Island Hospital, Providence, RI; <sup>2</sup>University of Kansas Medical Center Department of Internal Medicine, Kansas City, KS; <sup>3</sup>Montefiore Medical Center, Bronx, NY; <sup>4</sup>CareDx Inc, Brisbane, CA; <sup>5</sup>University of Maryland Baltimore, Baltimore, MD.

**Background:** Surveillance of dd-cfDNA after therapy for rejection represents a promising strategy for monitoring post-treatment response. We assessed post-rejection kinetics of dd-cfDNA among kidney transplant recipients in the Kidney allograft Outcomes AlloSure Registry (KOAR, NCT03326076).

**Methods:** We identified patients with biopsy-proven allograft rejection (BPAR), defined as ABMR, TCMR, or Mixed (Banff 2019), biopsy-paired dd-cfDNA measurements (within ≤30d of biopsy), and follow-up results 60-150 days after BPAR. When available, treatment and follow-up histology data was also analyzed.

**Results:** 48 episodes of BPAR (24 TCMR, 19 ABMR, 5 Mixed) and paired dd-cfDNA results were identified in 42 patients. Overall, a significant reduction was seen between the median index (1.36%, IQR: 0.29-2.25) and follow-up dd-cfDNA results (0.35%, IQR: 0.13-0.95; p < 0.01) [Figure 1a]. For patients with concurrent eGFR measurements, no statistically significant improvement was seen. These patterns held when analysis was limited to TCMR and ABMR/Mixed rejections [Figure 1b, 1c]. 7 patients (2 ABMR, 4 TCMR, and 1 Mixed; median index dd-cfDNA 1.15%, IQR: 0.31-2.46) had repeat biopsies within 30days of their follow-up testing; 1 patient with acute ABMR had chronic active ABMR on repeat biopsy, with a dd-cfDNA of 1.86%, while the remainder had either no rejection or borderline findings (median dd-cfDNA 0.74%, IQR: 0.30-2.59).

**Conclusions:** Our findings highlight that reduction in dd-cfDNA is commonly seen following BPAR, suggesting that most patients experience a “molecular response” to therapy. Studies are needed to better understand the prognostic significance of a molecular response and how persistent elevations in dd-cfDNA after treatment should guide subsequent management.

**Funding:** Commercial Support - CareDx

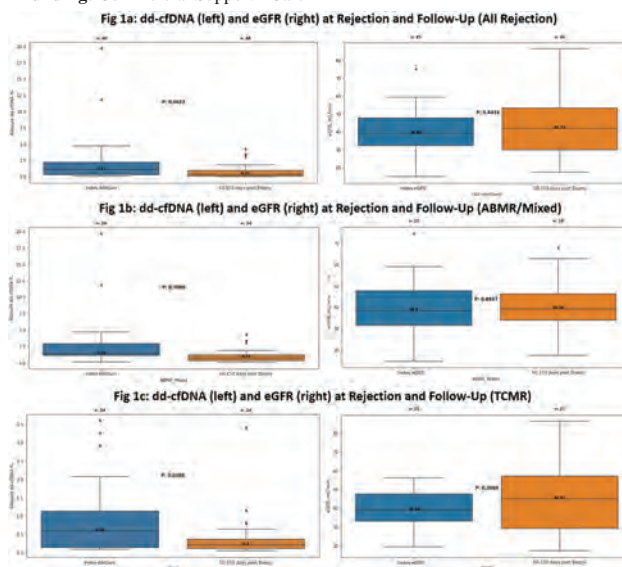

FR-PO766

**Kidney Endothelial Injury and Mononuclear Interstitial Inflammation in Hematopoietic Cell Transplant (HCT) Recipients: An Analysis of 81 Consecutive Kidney Biopsies**

Shab E Gul Rahim,<sup>1</sup> Supriya Gerardine,<sup>2</sup> Steven Salvatore,<sup>1</sup> Victoria Gutgarts,<sup>2</sup> Sangeeta R. Hingorani,<sup>3</sup> Edgar A. Jaimes,<sup>2</sup> Surya V. Seshan,<sup>1</sup> Thangamani Muthukumar.<sup>1</sup> *Weill Cornell Medicine, New York, NY; <sup>2</sup>Memorial Sloan Kettering Cancer Center, New York, NY; <sup>3</sup>University of Washington, Seattle, WA.*

**Background:** Graft versus host disease (GvHD) of the kidney in HCT recipients has not been well described. Kidney endothelial injury and interstitial inflammation frequently observed in kidney biopsies could be a manifestation of GvHD. We sought to characterize the spectrum of kidney endothelial injury and interstitial inflammation in HCT recipients.

**Methods:** We reviewed 81 consecutive kidney biopsies done between July 2009 and February 2022 at our institution. Biopsies were evaluated by light, immunofluorescence, and electron microscopy.

**Results:** The 81 biopsies were obtained from 76 HCT recipients (age 58 years, median); 67 (88%) were allogeneic transplants; 28 (37%) were women; 48% received total body irradiation (TBI) as part of conditioning regimen. Time from transplant to biopsy was 18.8 (9.8-40.9) months. Thrombotic microangiopathy (19 [23%] biopsies, 15 chronic and 4 acute) was the most common primary diagnosis (Fig. 1 left). Membranous nephropathy was present in only 7 (9%) biopsies. Endothelial injury was found in 70% of biopsies; 35 (43%) had glomerular endothelial basement double contouring. By logistic regression, TBI was not associated with biopsy findings of endothelial injury (P=0.18). Moderate to severe mononuclear interstitial inflammation (inflammation in >25% of unscarred cortical parenchyma) was observed in 57% of biopsies (Fig.1 right). Moderate to severe interstitial fibrosis and tubular atrophy (involving >25% of the cortical area) was present in 70% of the biopsies.

**Conclusions:** In this large kidney biopsy study of HCT recipients, thrombotic microangiopathy was the most common primary diagnosis and the majority of biopsies had an endothelial injury and mononuclear cell interstitial inflammation, raising the possibility of GVHD involving the kidneys. Further studies are ongoing in our laboratory to characterize kidney injury at a molecular level and to develop noninvasive biomarkers.

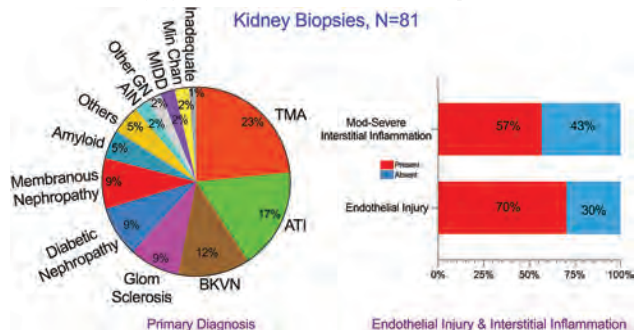

FR-PO767

**Natural Killer Cell Activity Is Increased in Chronic Active Antibody-Mediated Rejection (caABMR) of Human Kidney Allografts**

Shab E Gul Rahim, Elly Varma, Thalia Salinas, Carol Y. Li, Catherine Snopkowski, Steven Salvatore, Surya V. Seshan, Darshana M. Dadhania, Manikkam Suthanthiran, Thangamani Muthukumar. *Weill Cornell Medicine, New York, NY.*

**Background:** caABMR of the kidney allograft has several unique clinicopathological features that are distinct from acute ABMR. Using RNA sequencing of kidney allograft biopsies, we tested the hypothesis that caABMR is characterized by heightened natural killer (NK) cell activity.

**Methods:** We studied 57 biopsies from 57 adult kidney transplant recipients; 18 surveillance biopsies reported as No Rejection (normal) and 39 for-cause biopsies reported as caABMR (N=15), acute ABMR (N=7), and TCMR (N=17). Biopsies were independently assessed by two transplant pathologists using immunofluorescence, light, and electron microscopy. Individual cDNA libraries were prepared from each RNA sample, pooled, and sequenced on an Illumina sequencer. All quality measures were met. Standard tools were used for bioinformatic analysis.

**Results:** There were 1425 upregulated and 29 downregulated genes that were different (two-fold difference and P-FDR<0.05) between caABMR and No Rejection biopsies. Among the 391 highly overexpressed genes (four-fold difference and P-FDR<0.05) between caABMR and No rejection, 60 were specific for caABMR (Fig 1A). Cell-type annotation of these 60 genes revealed an increase in NK cells (Fig 1B). Several genes involved in the NK cell-mediated cytotoxicity pathway were upregulated in caABMR. Deconvolution analysis revealed an increased proportion of NK cells in caABMR (Fig 1C). Gene set variation analysis score for the NK cell cytotoxicity pathway set of 133 genes was highest for caABMR (Figure 1D). In addition, tissue expression of the terminal complement protein C9 was increased in acute ABMR but not in caABMR compared to No Rejection.

**Conclusions:** Our findings of heightened NK cell activity in caABMR suggest that the antibody-dependent cellular cytotoxicity pathway mediated by NK cells likely plays a major role in mediating tissue injury in caABMR.

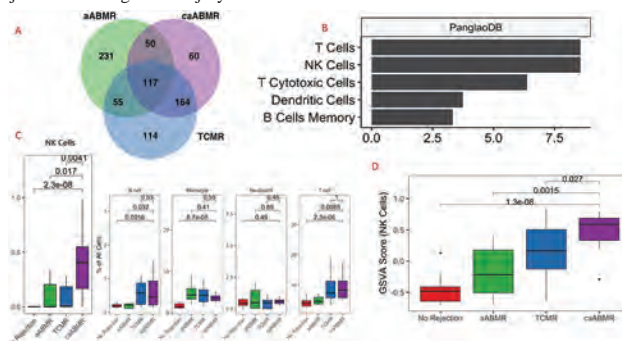

A. Venn diagram depicts the number of genes that were highly overexpressed in each of the three diagnostic categories (versus No Rejection biopsies). B. Cell type annotations from PanglaoDB database of the 60 highly overexpressed genes specific for caABMR. C. Proportion of NK cells, B cells, monocytes/macrophages, neutrophils, and T cells by deconvolution analysis of the RNA-sequencing data. D. Gene set variation analysis (GSVA) score of the genes implicated in NK cell-mediated cytotoxicity pathway. GSVA is a technique for characterizing pathways or signature summaries from a gene expression dataset.

FR-PO768

**Genetic Polymorphism and Serum Levels of Toll-Like Receptors (TLR-2 and TLR-4) in Renal Transplant Recipients With and Without Cytomegalovirus (CMV) Infection**

Sandeep Mahajan, Arshi Rizwan. *All India Institute of Medical Sciences, New Delhi, India.*

**Background:** Viral infections like CMV are important cause of morbidity, mortality & limited graft survival in RTRs. TLR-2 & TLR-4 play important role in innate immune response & regulating production of antiviral peptides & inflammatory cytokines. Reduced TLR expression & polymorphisms (TLR2: Arg677Trp & Arg753Gln, TLR4: Asp299Gly & Thr399Ile) are associated with blunted immunological response & higher infectious complications. No study has looked at TLR expression & polymorphisms in RTRs & their association with infectious complications like CMV. Identifying this population at higher risk of infections can help in individualizing immunosuppressive therapy

**Methods:** 85 consenting RTRs (35 with CMV & 50 without CMV infection) & 50 healthy controls were studied. All RTRs were on standard triple drug immunosuppression of Tacrolimus, MMF & steroids. Patients given ganciclovir prophylaxis, rATG induction and with recent infection & anti-rejection therapy were excluded. Diagnosis of CMV infection was based on blood quantitative CMV DNA PCR testing (>500 copies/ml), done as per protocol at 45 days, 3, 6, 9 & 12 months post-RT and/or as per clinical need. Allele-specific polymorphisms were studied on extracted DNA samples by using PCR-based genotyping assay and serum levels of TLR-2 & TLR-4 were determined by using commercially available ELISA kits

**Results:** Mean age and gender distribution were similar in three groups. CMV infection was symptomatic in 23 (60 %) patients & all presented with history of fever & diarrhea. As shown in table: RTRs having CMV infection had lower serum TLR2 and TLR4 values as compared to other groups. While, RTRs without CMV infection only had lower TLR4 levels as compared to controls. None of studied subject showed polymorphism in either TLR-2 or TLR-4 genes

**Conclusions:** We found that RTRs with CMV disease had lower serum TLR-2 & TLR-4 levels as compared to RTRs without CMV infection & healthy controls. However, we did not document any polymorphism in studied genes. These results require further validation in larger studies

**Funding:** Government Support - Non-U.S.

Serum Concentration (pg/mL) (mean ± SD)	RTRs with CMV infection	RTRs without CMV infection	Healthy Control	P-value Group 1 vs Group 2	P-value Group 1 vs Group 3	P-value Group 2 vs Group 3
TLR-2	11.5±3.1	22.7±8.1	28.1±9.6	<0.001	<0.001	>.05
TLR-4	6.1±1.3	8.2± 2.2	12.4±4.1	<0.001	<0.001	<0.02

FR-PO769

**Clinical and Native Histological Predictors of Recurrent IgA Nephropathy After Kidney Transplantation**

Chukwuma A. Chukwu,<sup>1,2</sup> Christopher Holmberg,<sup>3</sup> Rachel Middleton,<sup>1</sup> Philip A. Kalra,<sup>1,2</sup> Howida Shawki,<sup>3</sup> Anirudh Rao.<sup>3</sup> *<sup>1</sup>Salford Royal Hospital, Salford, United Kingdom; <sup>2</sup>The University of Manchester Faculty of Biology Medicine and Health, Manchester, United Kingdom; <sup>3</sup>Royal Liverpool University Hospital, Liverpool, United Kingdom.*

**Background:** Although recurrent IgA Nephropathy (rIgAN) in kidney transplant recipients (KTR) has been regarded as benign, there is increasing evidence that rIgAN may lead to late allograft loss in a significant proportion of KTR. Data on the risk predictors and outcomes of rIgAN is limited. We investigated the incidence, clinical and histologic predictors, and outcomes of rIgAN in KTR.

**Methods:** KTR with biopsy-proven IgA nephropathy between 2005 and 2020 at 2 tertiary nephrology centers in North-west England were evaluated. Demographic,

clinical, and native kidney histological data were analysed. Risk factors and allograft outcomes were assessed using Cox proportional hazard method.

**Results:** rIgAN was diagnosed in 35 of 203KTR(17%). mean age was 45±13yr, and median follow-up was 7yr. Time to recurrence and from recurrence to graft loss was 4.8yr(IQR 2.7-6.7) and 2.9yr(IQR 1.3-4.3) respectively. Factors associated with rIgAN include younger age(Hazard ratio[HR] 0.68, 95%CI 0.51-0.9; p=0.009); higher pre-transplant proteinuria(HR 1.21, 95% CI 1.09-1.35; p<0.001); living donor graft(HR 2.32, 95%CI 1.1 - 4.6;p=0.016), Cyclosporin use(HR 2.82, 95%CI 1.07-7.41;p=0.035); history of acute rejection(HR 2.33, 95%CI 1.14-4.77;p=0.020); higher proportion of native glomeruli with segmental sclerosis (HR 1.05, 95%CI 1.01-1.09; p=0.014). Death censored graft loss was 11 times higher in recipients with rIgAN (HR 11.0, 95%CI 4.35-27.7; p<0.001).

**Conclusions:** KTR with rIgAN were 11 times more likely to lose their graft than those without recurrence. Younger age, higher pre-transplant proteinuria, living donor allograft, history of acute rejection, cyclosporin use and a higher degree of segmental sclerosis in the original disease are associated with rIgAN.

**Table 1: Factors associated with recurrent IgA Nephropathy**

Variables	Hazard ratio	95% CI	P-value
Age (every 10-yr increase)	0.68	(0.51-0.91)	<b>0.009</b>
Gender	1.50	(0.62-3.61)	0.369
Ethnicity	1.48	(0.93-2.34)	0.099
BMI (Every 5kg/m <sup>2</sup> increase)	0.77	(0.53-1.11)	0.163
Pre transplant uPCR (every 100mg/mmol increase)	1.21	(1.09-1.35)	<b>&lt;0.001</b>
Donor type (LD vs DD)	0.43	(0.22-0.85)	<b>0.016</b>
Pre-emptive transplant	0.69	(0.28-1.66)	0.402
Total mismatch	0.91	(0.70-1.18)	0.481
Total ischaemia time	0.97	(0.91-1.02)	0.219
Induction type	1.95	(0.59-6.50)	0.275
CNI (Tac vs Cyc)	2.82	(1.07-7.41)	<b>0.035</b>
Antimetabolite	1.36	(0.58-3.20)	0.478
Steroid use	1.41	(0.71-2.81)	0.330
Post-transplant proteinuria	1.00	(1.00-1.01)	0.406
History of acute rejection	2.33	(1.14-4.77)	<b>0.020</b>
Baseline eGFR	1.01	(0.99-1.03)	0.281
<b>Histological variables</b>			
Proportion of sclerosed gloms	0.99	(0.97-1.01)	0.223
Proportion of Gloms with segmental sclerosis (Every 10% increase)	1.77	(1.18-2.66)	<b>0.006</b>
mesangial proliferation	1.14	(0.41-3.15)	0.807
Crescents	1.14	(0.44-2.94)	0.793
Proportion of gloms with crescents	0.99	(0.96-1.03)	0.681
IFTA	0.90	(0.54-1.50)	0.678
Chronic vac changes	0.73	(0.30-1.77)	0.482
IgG deposits	2.75	(0.79-9.54)	0.111
IgM Deposit	0.96	(0.40-2.28)	0.919
C3 deposit	1.37	(0.18-10.23)	0.761

BMI body mass index; CNI, calcineurin inhibitor; Cyc, cyclosporin; DD, diseased donor; DCGS, Death censored graft survival; DFS, Dialysis free Survival; DSA, Donor specific antibody; eGFR, estimated glomerular filtration rate; ESKD, end stage kidney disease; IFTA, interstitial fibrosis and tubular atrophy; IgA, immunoglobulin A; IgG, immunoglobulin G; IgM, immunoglobulin M; IMF, immunofluorescence; LD, living donor; Tac, Tacrolimus; uPCR, urine protein creatinine ratio

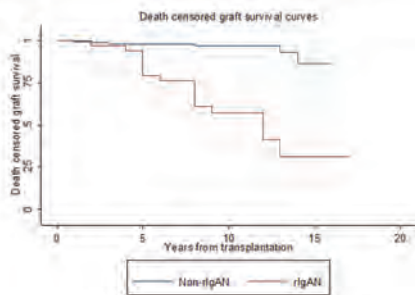

**FR-PO770**

**Clinical and Histologic Predictors of Recurrent Focal Segmental Glomerulosclerosis After Kidney Transplantation**

Chukwuma A. Chukwu,<sup>1,2</sup> Christopher Holmberg,<sup>3</sup> Rachel Middleton,<sup>1</sup> Philip A. Kalra,<sup>1,2</sup> Anirudh Rao,<sup>3</sup> Howida Shawki.<sup>3</sup> <sup>1</sup>Salford Royal Hospital, Salford, United Kingdom; <sup>2</sup>The University of Manchester Faculty of Biology Medicine and Health, Manchester, United Kingdom; <sup>3</sup>Royal Liverpool University Hospital, Liverpool, United Kingdom.

**Background:** Recurrent FSGS (rFSGS) after transplantation is a major cause of allograft loss. Data on the clinical and native kidney histological predictors of rFSGS is limited. We investigated the clinical and histological predictors of rFSGS and its impact on allograft outcome

**Methods:** 71 KTR with biopsy-proven FSGS transplanted between 2005 and 2020 at two tertiary nephrology centres in North-west England were evaluated. Demographic, clinical, and native kidney histological data were analysed. Risk factors of rFSGS and their impact on allograft outcomes were evaluated using Cox proportional hazard methods

**Results:** FSGS recurrence was diagnosed in 14 of 71 KTR(20%). Mean age at transplantation was 43.8±17yr, and median follow-up was 7yr. The median duration to rFSGS was 0.6yr(IQR 0.2-2.9) and the time from rFSGS to graft loss was 4.9yr(IQR

3-10). rFSGS was associated with higher pre-transplant proteinuria (HR 1.115, p=0.002); alemtuzumab induction(HR 3.38, p=0.035); younger donor age(HR 0.95, p=0.020); proteinuria at 12months post-transplant(HR 1.16, p<0.001); history of acute rejection(HR 3.17, p<0.039), lower baseline eGFR(HR 0.30, p<0.037), mesangial proliferation(HR 5.38, p=0.043); glomerular IgG(HR 20.5, p<0.033) and IgA(HR 12.1, p<0.001) deposits in the native disease. Death-censored graft loss adjusted for donor type, history of acute rejection and baseline eGFR was 6 times higher in KTR with rFSGS(HR 6.1, 95% CI 1.5-24.7;p=0.012)

**Conclusions:** rFSGS occurred early post-transplantation and was associated with a 6 fold increase in graft loss. Higher pre-and post-transplant proteinuria, alemtuzumab induction, acute rejection, low baseline eGFR, as well as mesangial proliferation, IgG and IgA deposits in native disease are factors associated with rFSGS

Factors associated with rFSGS			
Variables	Hazard ratio	95% CI	P-value
Age	0.97	(0.94-1.01)	0.100
Gender	1.05	(0.33-3.37)	0.931
Ethnicity	0.66	(0.23-1.93)	0.446
BMI	0.80	(0.44-1.46)	0.472
Duration from diagnosis to ESKD	0.96	(0.88-1.04)	0.288
Pre transplant uPCR (per 100mg/mmol increase)	1.15	(1.05-1.25)	<b>0.002</b>
Pre-emptive transplant	0.46	(0.10-2.08)	0.314
Total mismatch	0.79	(0.55-1.13)	0.204
Total Ischaemia time	1.05	(0.96-1.16)	0.306
induction type (Bas vs C1H)	3.38	(1.08-10.5)	<b>0.035</b>
delayed graft function	2.75	(0.86-8.81)	0.088
Donor type (LD vs DD)	1.07	(0.34-3.42)	0.905
Donor age	0.95	(0.92-0.99)	<b>0.020</b>
Donor gender	0.32	(0.07-1.51)	0.152
CNI (Tac vs Cyc)	1.33	(0.17-10.23)	0.784
Antimetabolite	0.44	(0.10-1.85)	0.263
Steroid use	1.47	(0.51-4.20)	0.472
Post-transplant proteinuria (per 100mg/mmol increase)	1.16	(1.09-1.22)	<b>&lt;0.001</b>
History of acute rejection	3.17	(1.06-9.49)	<b>0.039</b>
Baseline eGFR	0.30	(0.10-0.93)	<b>0.037</b>
Proportion of sclerosed gloms	0.97	(0.93-1.01)	0.098
Proportion of gloms with segmental sclerosis	1.01	(0.99-1.02)	0.392
Presence of mesangial proliferation	5.38	(1.06-27.32)	<b>0.043</b>
IFTA	0.64	(0.29-1.41)	0.266
Chronic vascular changes	0.30	(0.06-1.46)	0.136
IgG deposits	20.49	(1.28-327.71)	<b>0.033</b>
IgA Deposit	12.11	(2.38-61.67)	<b>0.003</b>
IgM Deposit	0.63	(0.13-3.13)	0.572
C3 deposit	0.95	(0.24-3.81)	0.939

BMI body mass index; CNI, calcineurin inhibitor; Cyc, cyclosporin; DD, diseased donor; DCGS, Death censored graft survival; DFS, Dialysis free Survival; DSA, Donor specific antibody; eGFR, estimated glomerular filtration rate (MDRD equation); ESKD, end stage kidney disease; IFTA, interstitial fibrosis and tubular atrophy; IgA, immunoglobulin A; IgG, immunoglobulin G; IgM, immunoglobulin M; IMF, immunofluorescence; LD, living donor; Tac, Tacrolimus; uPCR, urine protein creatinine ratio

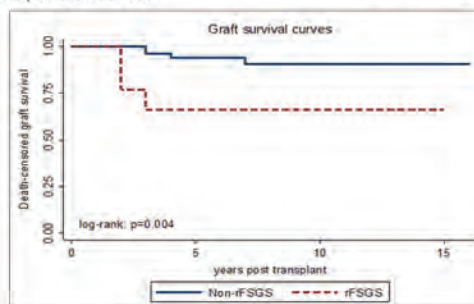

**FR-PO771**

**The Role of Gut Microbiome in Dose Selection of Envarsus Among High Tacrolimus Metabolizers**

Joseph K. Melancon,<sup>1</sup> Mehdi Nayeypour,<sup>2</sup> Obi D. Ekwenna,<sup>3</sup> Hanaa Ibrahim,<sup>1</sup> Naoru Koizumi.<sup>1</sup> <sup>1</sup>The George Washington University, Washington, DC; <sup>2</sup>Virginia BioAnalytics, Washington, DC; <sup>3</sup>The University of Toledo, Toledo, OH.

**Background:** The role of gut microbiome in kidney transplant outcomes has been of great interest among researchers and physicians. Yet the number of studies to investigate the effect of microbiome on kidney transplant has been limited, particularly in regard to personalized medicine. Preliminary studies show significant associations between the relative abundance of certain bacterial species such as *Faecalibacterium prausnitzii* and tacrolimus (Tac) dosing. No study has translated the findings into application. This study develops a dose selection algorithm based on gut microbiome and gene marker profile of kidney transplant patients.

**Methods:** 30 kidney transplant patients from the George Washington University Hospital and the University of Toledo Medical Center were recruited. From each subject 3 ml of blood was collected for gene marker sequencing of CYP3A5. 2 stool samples were collected per subject for gut microbiome sequencing using shotgun metagenomics. The first stool sample was collected 1 week pre-transplant and the second sample was collected 1-2 months post-transplant. Administered dose of Envarsus and Tac trough concentrations were recorded from day of transplant till 90 days post-surgery. Relative abundance of all bacterial genera was analyzed for detection of association with Envarsus dosage and potential inclusion in a dose selection model.

Key: TH - Thursday; FR - Friday; SA - Saturday; OR - Oral; PO - Poster; PUB - Publication Only

Underline represents presenting author.

**Results:** All patients were high metabolizers of Tac by expressing either the homozygote or heterozygote CYP3A5\*1 allele. Building upon the gene-guided dose selection model of Jacobson et al., we added the relative abundance of two bacterial genera as predictors of optimum Envarsus dose. Using a linear OLS regression model, the pre-transplant relative abundance of *Phocaeicola* in days<10 and the change in relative abundance of *Bacteroides* in 10<days<90 were predictors of optimum Envarsus dose with p<0.01. Our gene/microbiome-guided dose selection model is a better predictor for optimum dose of Envarsus compared to the gene-only dose selection model.

**Conclusions:** Personalized dose selection for high Tac metabolizers has been proven to improve transplant outcomes. For this purpose we recommend using gut microbiome profile matched with gene marker information. In the next phase we will conduct a clinical trial to investigate the effectiveness of our dose selection model on transplant outcomes.

**Funding:** Commercial Support - CareDX, Virginia BioAnalytics LLC

**FR-PO772**

**Outcomes of ABO-Incompatible Living Donor Kidney Transplantation Compared to Waiting or Deceased Donor Kidney Transplantation**

Tai yeon Koo,<sup>1</sup> Ga Young Heo,<sup>2</sup> Hyo Jeong Kim,<sup>2</sup> Beom Seok Kim,<sup>2</sup> Jaeseok Yang,<sup>2</sup> <sup>1</sup>Korea University Anam Hospital, Seoul, Republic of Korea; <sup>2</sup>Yonsei University College of Medicine Department of Internal Medicine, Seoul, Republic of Korea.

**Background:** ABO-incompatible (ABOi) living donor kidney transplantation (LDKT) is one of efforts to overcome organ shortage for end stage kidney disease (ESRD) patients. However, it is unclear whether ABOi LDKT has better outcomes compared to remaining on dialysis while waiting for ABO-compatible (ABOc) deceased donor kidney transplantation (DDKT).

**Methods:** We performed a retrospective study with propensity matching. Four hundred twenty-six patients underwent ABOi LDKT between 2010 and 2020 in Seoul National University Hospital and Severance Hospital in Korea. We compared outcomes between ABOi LDKT group and the matched control groups (ABOc LDKT group, n = 426; waiting-list-only group, n = 1278; waiting-list-or-ABOc-DDKT group, n = 1278). The matched controls were derived from 3,053 adult waiting lists for first-time KT, 426 ABOc DDKT and 1366 ABOc LDKT patients.

**Results:** Patient survival rates of the ABOi LDKT group were significantly lower than those of the ABOc LDKT group at 1 year (97.9% vs. 99.8%, respectively) and 8 years (95.2% vs. 97.2%), respectively (P = 0.032). Furthermore, ABOi LDKT group showed significantly lower death-censored graft survival rate compared to ABOc LDKT group (P=0.032). Interestingly, ABOi LDKT with a low baseline anti-ABO titer ( $\leq 1:32$ ) also showed lower patient and death-censored graft survival rate compared to ABOc LDKT group (P<0.011, P=0.005, respectively). Next, we compared outcomes of ABOi LDKT compared to those of waiting-list-only group and waiting-list-or-ABOc-DDKT group. Patient survival rates at 1- and 8-years in the waiting-list-only group were 97.8%, and 89.1%, respectively, and those in the waiting-list-or-ABOc-DDKT group were 97.7% and 89.3%, respectively. ABOi LDKT group showed significantly better patient survival rate compared to waiting-list-only group (P=0.015) and waiting-list-or-ABOc-DDKT group (P=0.018).

**Conclusions:** ABOi LDKT is a better choice for end stage kidney disease patients without potential ABOc living donors, especially in Asian countries with a long waiting time for DDKT.

**FR-PO773**

**PRO-C6-Rec: Investigating Circulating Endotrophin as a Biomarker in Kidney Transplantation**

Federica Genovese,<sup>1</sup> Daan Kremer,<sup>2</sup> Firas F. Alkaff,<sup>2</sup> Stephan J. Bakker,<sup>2</sup> Martin Tepel,<sup>3</sup> Olivier Thauan,<sup>4</sup> Jacob van den Born,<sup>2</sup> Morten A. Karsdal,<sup>1</sup> Daniel Guldager Kring Rasmussen,<sup>1</sup> <sup>1</sup>Nordic Bioscience, Herlev, Denmark; <sup>2</sup>Universitair Medisch Centrum Groningen, Groningen, Netherlands; <sup>3</sup>Syddansk Universitet, Odense, Denmark; <sup>4</sup>Hospices Civils de Lyon, Lyon, France.

**Background:** Novel biomarkers are needed to improve management of kidney transplant recipients. During kidney injury, collagen type VI formation increases. The C-terminal fragment from the alpha3 chain (endotrophin) is released during formation and promotes inflammation and fibrosis. In the Eurostars (Eureka) funded consortium, PRO-C6-Rec, we investigated endotrophin in nine transplant cohorts from three European countries to obtain a comprehensive insight on the ability of this fragment to predict disease progression.

**Methods:** We analyzed plasma endotrophin with the PRO-C6 ELISA in nine transplant cohorts from three European countries. In incident kidney transplant recipients (KTR), levels were investigated both before and after transplantation, and the association with both acute (delayed graft function and rejection) and long-term outcomes (graft failure and mortality) was investigated. Relevant clinical variables were used to adjust the associations of endotrophin with the investigated outcomes.

**Results:** Levels of endotrophin in donors of kidney grafts were the same as observed in healthy individuals (7.1 [6.2-8.2] vs 7.8 [7.1-8.3]). Pretransplant endotrophin levels were independently associated with delayed graft function in three independent cohorts (OR [95% CI] per increase in one SD of 1.56 [1.13-2.17], 2.09 [1.30-3.36], and 2.06 [1.43-2.97]). Levels of endotrophin were markedly reduced after transplantation (Figure, p<0.001). KTRs who experienced rejection had significantly higher endotrophin (p<0.001). In prevalent KTRs  $\geq 1$  year after transplantation, levels of endotrophin independently predicted both graft failure and all-cause mortality (HR [95% CI] per doubling; 1.87 [1.07-3.28] and 2.59 [1.73-3.87], respectively).

**Conclusions:** We show that the pro-fibrotic and pro-inflammatory molecule endotrophin is markedly increased in plasma of patients known to have increased risk of outcome, and that endotrophin is an independent predictor of clinically relevant outcomes, likely related to kidney fibrosis and inflammation.

**Funding:** Government Support - Non-U.S.

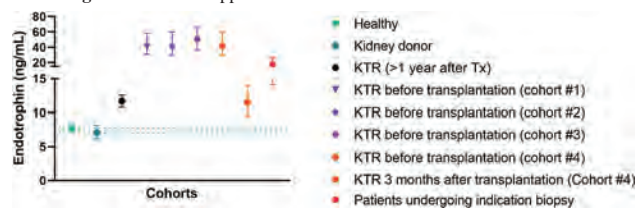

**FR-PO774**

**Donor-Derived Cell-Free DNA (dd-cfDNA) in Kidney Transplant Recipients With Indication Biopsy: Results of a Prospective Single-Center Trial**

Louise Benning,<sup>1</sup> Annette Fink,<sup>2</sup> Florian Kälble,<sup>1</sup> Claudius Speer,<sup>1</sup> Christian Nussbag,<sup>1</sup> Martin G. Zeier,<sup>1</sup> Caner Süsal,<sup>3</sup> Christian Morath,<sup>1</sup> Thuong H. Tran,<sup>2</sup> <sup>1</sup>Department of Nephrology, University Hospital Heidelberg, Heidelberg, Germany, Heidelberg, Germany; <sup>2</sup>Transplantation Immunology, Heidelberg Institute of Immunology, University Hospital Heidelberg, Heidelberg, Germany, Heidelberg, Germany; <sup>3</sup>Transplant Immunology Research Center of Excellence, Koç University Hospital, Istanbul, Turkey, Istanbul, Turkey.

**Background:** Donor-derived cell-free DNA (dd-cfDNA) is a marker of allograft injury in kidney transplant recipients (KTR). Little is known about the possible use of dd-cfDNA in evaluating response to anti-rejection treatment.

**Methods:** This far, we enrolled 84 KTR with indication biopsy between November 2020 and May 2022. Besides routine transplant laboratory, AlloSeq dd-cfDNA was quantified at time of biopsy and on days 7, 30, and 90 following biopsy.

**Results:** 27/84 (32%) biopsies were graded as different types of rejection, whereof 19/27 (70%) showed borderline changes, 5/27 (19%) antibody-mediated rejections (ABMR) and 3/27 (11%) T-cellular mediated rejections (TCMR). Patients with signs of active rejection, including borderline changes, had significantly higher levels of dd-cfDNA at time of biopsy than patients without any signs for rejection, whereas estimated glomerular filtration rate did not differ significantly between the two groups (P<0.001 and P>0.99, respectively, Figure 1A). Patients with ABMR or TCMR showed highest dd-cfDNA levels with a median (IQR) of 2.6% (0.57–9.13) compared to 0.44% (0.20–1.10) in patients with borderline changes and 0.18% (0.11–0.50) in patients with no signs of rejection. dd-cfDNA levels decreased in most of these patients with ABMR or TCMR following initiation of anti-rejection therapy (pooled slope -0.02, Figure 1B). In patients with borderline changes and low levels of dd-cfDNA (<1%) at time of biopsy we see an increase in eGFR after initiation of corticosteroid pulse therapy, whereas patients with high levels of dd-cfDNA ( $\geq 1\%$ ) show subsequent eGFR decline (Figure 1C).

**Conclusions:** dd-cfDNA significantly discriminates active rejection at time of biopsy in KTR. Decreasing levels of dd-cfDNA may indicate treatment response in patients with ABMR and TCMR. dd-cfDNA may further help to identify borderline changes with favorable outcome from changes where additional therapy and closer monitoring is needed.

**Funding:** Commercial Support - CareDX

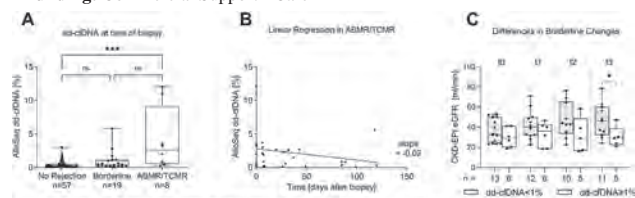

Figure 1: dd-cfDNA in monitoring response to anti-rejection treatment in kidney transplant recipients. (A) dd-cfDNA (%) measurements at time of biopsy (B) Linear regression in ABMR/TCMR patients after initiation of treatment (C) Differences in Borderline changes according to dd-cfDNA level (%) at time of biopsy. dd-cfDNA, donor-derived cell-free DNA; eGFR, estimated glomerular filtration rate; n, number; L, time point; \*\*\* P<0.001; \* P<0.05; ns, non-significant

**FR-PO775**

**The Gut Microbiome Links to Metabolic Syndrome Following Kidney Transplantation**

Peter J. Mannon, Roslyn B. Mannon. University of Nebraska Medical Center, Omaha, NE.

**Background:** The metabolic syndrome (MBS) contributes to cardiovascular morbidity and mortality following kidney transplantation. Gut microbiome dysbiosis impacts lipid metabolism, insulin resistance, atherosclerotic factors, and in kidney transplant recipients (KTRs), may be linked to alloimmunity. We hypothesized that changes in gut microbiome pre- and post-transplant are linked to the outcome of MBS in KTRs.

**Methods:** Stool specimens (pre and 6-12 months post) from 14 serial KTRs from living donors and 8 healthy controls had 16S rRNA gene sequencing, microbial metagenome analysis, and targeted (69 gut metabolites) in serum and 104 fecal



metabolites) and untargeted metabolomics. Clinical data were extracted from the EMR. The primary outcomes were differences in microbiome and metabolome pre-Tx vs control and vs post-Tx. Secondary outcomes were differences in microbiome and metabolome between pre-Tx vs post-Tx stratified by MBS status and if a microbiome or metabolome "signature" predicted MBS outcome in KTRs.

**Results:** 11 KTRs met criteria for MBS pre-Tx, of which 8 were stable or worsened and 3 improved MBS post-Tx; 1 developed MBS *de novo*. Versus controls, pre-Tx gut microbiome were less diverse, with significantly ↑ *E coli* and *Fusobacterium*, ↑ CKD metabolites, and ↑ glutathione (oxidative stress) & proteolytic metabolic pathways with ↓ *Coprococcus* and *Roseburia* and ↓ short chain fatty acids. Post-Tx microbiome showed significantly ↑ *Roseburia* with ↓ *Akkermansia*, ↓ uremic toxins, and ↓ proteolytic pathways. Untargeted metabolomics aligned with improvement in MBS post-Tx (Fig 1) and independently discriminated between MBS outcomes (Fig 2). Improved MBS post-Tx was associated with ↑ *Ruminococcus*, ↓ *Akkermansia*, and dominant saccharolytic, butyrogenic, and methanogenic pathways.

**Conclusions:** We found that the gut microbiome discriminates pre- and post-KTR MBS states and provides a signature of MBS post-Tx. These data support using targeted prebiotics and probiotics to confer a beneficial metabolic state pre-Tx and post-Tx to improve long term patient and graft survival.

**Funding:** Private Foundation Support

Figure 1. Heat map of untargeted stool metabolites (vertical axis) with pre-Tx (green) or post-Tx (red) transplant samples. Post-Tx samples separated in two distinct groups, which correlate with clinical MBS status.

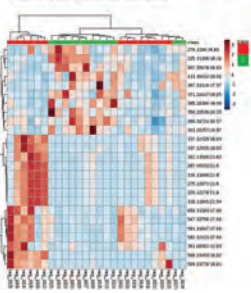
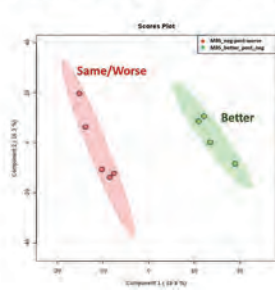

Figure 2. Principle component analysis showing separation of post-transplant stool metabolites based on patients with same/worse (red) or better (green) MBS after transplantation.



## FR-PO776

### FGF23 Is Associated With Cardiovascular Functional Capacity Before and After Kidney Transplantation

Arvin Halim,<sup>1</sup> Heather Burney,<sup>1</sup> Xiaochun Li,<sup>1</sup> Yang Li,<sup>1</sup> Tzongshi Lu,<sup>5,4</sup> Thomas Hiemstra,<sup>2</sup> Daniel Zehnder,<sup>3</sup> Kenneth Lim.<sup>1</sup> <sup>1</sup>Indiana University School of Medicine, Indianapolis, IN; <sup>2</sup>University of Cambridge, Cambridge, United Kingdom; <sup>3</sup>North Cumbria Integrated Care NHS Foundation Trust, Whitehaven, United Kingdom; <sup>4</sup>Harvard Medical School, Boston, MA; <sup>5</sup>Brigham and Women's Hospital, Boston, MA.

**Background:** Impaired cardiovascular functional capacity is a major complication in CKD and associated with mortality. Fibroblast Growth Factor 23 (FGF23) is a bone-derived phosphaturic hormone that is involved in cardiac remodelling in CKD. To-date, it is unknown whether FGF23 has a role in regulating cardiovascular functional capacity in CKD. Herein, we sought to examine the relationship between FGF23 and exercise ventilatory response variables of cardiovascular functional capacity.

**Methods:** We analyzed a total of 235 patients from the Cardiopulmonary Exercise Testing in Renal Failure and After Kidney Transplantation (CAPER) cohort: 87 advanced chronic kidney disease (CKD) stage 5 patients who underwent kidney transplantation, 65 non-transplanted waitlisted CKD patients, and 83 hypertensive controls. 186 patients were followed longitudinally for 1-year. All patients underwent cardiopulmonary exercise testing (CPET).

**Results:** Patients in higher FGF23 quartiles had significantly lower mean arterial pressure ( $p < 0.001$ ) and lower BMI ( $p = 0.004$ ) compared to patients with lower levels of FGF23. There was no significant difference in sex ( $p = 0.5$ ) or age ( $p = 0.08$ ) across quartiles. Patients with high FGF23 levels exhibited impaired  $\dot{V}O_{2\text{Max}}$  ( $p < 0.001$ ) as well as  $\dot{V}O_{2\text{AT}}$  ( $p < 0.001$ ), peak exercise heart rate ( $p < 0.001$ ), max workload ( $p < 0.001$ ), and endurance time ( $p < 0.001$ ) compared to patients with low FGF23 levels. There was no significant difference in oxygen pulse ( $p = 0.2$ ). Patients in all quartiles achieved a mean respiratory exchange ratio  $\geq 1.0$ . Among patients who underwent kidney transplantation, FGF23 significantly decreased at 2 months post-transplant ( $p < 0.001$ ), followed by significant improvement in  $\dot{V}O_{2\text{Max}}$  ( $p < 0.001$ ) and max workload ( $p < 0.001$ ) at 1-year. Multivariable regression modelling revealed significant association between FGF23 and  $\dot{V}O_{2\text{Max}}$  before and after kidney transplantation after adjusting for age, sex, systolic blood pressure, smoking status, dyslipidemia, and albumin and hemoglobin levels.

**Conclusions:** FGF23 levels are inversely associated with cardiovascular functional capacity before and after kidney transplantation. Our study suggests that FGF23 may be a regulator of alterations in cardiovascular functional capacity in CKD.

**Funding:** Other NIH Support - K23 DK115683, Private Foundation Support

## FR-PO777

### 25(OH)D- but Not 1,25(OH)2D- Is an Independent Risk Factor Predicting Graft Loss in Stable Renal Transplant Recipients

Shufei Zeng,<sup>1</sup> Yide Yang,<sup>4</sup> Shuping Li,<sup>2</sup> Chang Chu,<sup>3</sup> Zhihua Zheng,<sup>2</sup> Bernhard K. Krämer,<sup>3</sup> Berthold Hoher.<sup>3</sup> <sup>1</sup>Southern Medical University Nanfang Hospital, Guangzhou, China; <sup>2</sup>The Seventh Affiliated Hospital Sun Yat-sen University, Shenzhen, China; <sup>3</sup>Universitätsklinikum Mannheim, Mannheim, Germany; <sup>4</sup>Hunan Normal University, Changsha, China.

**Background:** Vitamin D deficiency (VDD) or vitamin D insufficiency is common in kidney transplant recipients (KTRs). The impact of VDD on clinical outcomes in KTRs remain poorly defined and the most suitable marker for assessing vitamin D nutritional status in KTRs is unknown so far.

**Methods:** We conducted a prospective study including 600 stable KTRs (367 men, 233 women) and a meta-analysis to pool existing evidence to determine whether 25(OH)D or 1,25(OH)<sub>2</sub>D predicted graft failure and all-cause mortality in stable KTRs.

**Results:** Compared with a higher 25(OH)D concentration, a low concentration of 25(OH)D was a risk factor for graft failure (HR 0.946, 95%CI 0.912-0.981,  $p = 0.003$ ), whereas 1,25(OH)<sub>2</sub>D was not associated with the study end-point graft loss (HR 0.993, 95%CI 0.977-1.009,  $p = 0.402$ ). No correlation was found between either 25(OH)D or 1,25(OH)<sub>2</sub>D and all-cause mortality. We furthermore conducted a meta-analysis including 8 studies regarding the association between 25(OH)D or 1,25(OH)<sub>2</sub>D and graft failure or mortality, including our study. The meta-analysis results were consistent with our study in finding that lower 25(OH)D levels were significantly associated with the risk of graft failure (OR=1.04, 95%CI: 1.01-1.07), but not associated with mortality (OR=1.00, 95%CI: 0.98-1.03). Lower 1,25(OH)<sub>2</sub>D levels were not associated with the risk of graft failure (OR=1.01, 95%CI: 0.99-1.02) and mortality (OR=1.01, 95%CI: 0.99-1.02).

**Conclusions:** Baseline 25(OH)D concentrations but not 1,25(OH)<sub>2</sub>D concentrations were independently and inversely associated with graft loss in adult KTRs.

## FR-PO778

### Association Between the Distribution of Regulatory T Cell Populations and Immunosuppressant

Yangyeon Kim,<sup>1,2</sup> Sujung Heo,<sup>1,2</sup> Nagyem Lee,<sup>1,2</sup> Ye na Kim,<sup>1,2</sup> Ho Sik Shin,<sup>1,2</sup> Yeonsoon Jung,<sup>1,2</sup> Hark Rim.<sup>1,2</sup> <sup>1</sup>Renal Division, Department of Internal Medicine, Gospel Hospital, Kosin University College of Medicine, Busan, Republic of Korea; <sup>2</sup>Transplantation Research Institute, Kosin University College of Medicine, Busan, Republic of Korea.

**Background:** Current immunosuppressants cannot achieve induction of immune tolerance and their nonspecific immunosuppressive effects result in many adverse effects. Regulatory T cells (Tregs) play crucial roles in controlling allosteric immune responses. This study evaluated the distribution of Tregs and their effects on kidney allograft function in Korean KT recipients.

**Methods:** We enrolled 113 KT recipients with stable graft function between 1995 and 2018. Differentiation and expansion of Tregs were studied by flowcytometry to compare the Tregs subpopulations. Tregs were defined as CD4+CD25 high CD 127 low/- Fox P3+ cells.

**Results:** Among the 113 patients, 73 patients (64.6%) were males and mean follow-up period was  $147.5 \pm 111.3$  months. All patients received calcineurin inhibitors as maintenance immunosuppressants. Patients with follow-up period more than 144.3 months tended to have more gating Tregs numbers than that in shorter follow-up period ( $92.3 \pm 142.4$  vs.  $50.1 \pm 76.4$ ,  $p = 0.061$ , respectively). There were no significant differences in Tregs subpopulations between patients with serum creatinine more than 1.5 mg/dL and patients with serum creatinine less than 1.5 mg/dL. In terms of the number of Tregs, when the trough level of tacrolimus was at an appropriate level, the number of Tregs tended to be higher than that of Tregs when the trough level of tacrolimus was low or high, and the organ function of the transplant was also stable.

**Conclusions:** In the present study, there was significant association between the distribution of Tregs and immunosuppressant's type and dose. However, there was no significant relationship between Tregs and kidney allograft function.

Table 1-1. Demographics of patients

Variables	All patients (n = 113)
Age (years)	54.5 ± 9.7
Sex (Male)	73 (64.6)
Height (cm)	163.7 ± 13.5
Body weight (kg)	63.9 ± 11.7
Follow-up duration (months)	147.5 ± 111.3
DDKT	23 (21.3)
Induction therapy	
Basiliximab	113 (100)
Maintenance therapy	
CNI	109 (96.5)
Tacrolimus	70 (61.9)
Cyclosporine	39 (34.5)
MMF	73 (64.6)
PDN	79 (69.9)
CNI + MMF + PDN	58 (51.3)
Tacrolimus + MMF + PDN	49 (43.4)
Cyclosporine + MMF + PDN	9 (8.0)
Drug level	
Tacrolimus trough level (ng/ml)	5.8 ± 2.2
Cyclosporine trough level (ng/ml)	98.1 ± 45.4
Drug dose	
Tacrolimus (mg)	2.6 ± 1.2
Cyclosporine (mg)	106.7 ± 45.0
HBV	7 (6.2)
HCV	2 (1.8)
Laboratory findings	
Creatinine (mg/dl)	1.2 ± 0.7
Creatinine > 1.2 mg/dl	34 (30.1)
Creatinine > 1.5 mg/dl	17 (15.0)
Total Cholesterol (mg/dl)	177.2 ± 42.1
Low-density lipoprotein (mg/dl)	100.9 ± 30.4
Triglyceride (mg/dl)	127.7 ± 84.3
High-density lipoprotein (mg/dl)	53.0 ± 13.4
Triglyceride/High-density lipoprotein	1.3 ± 0.9

Table 1. Baseline characteristics of the patients

FR-PO779

Wide Spectrum of Molecular Injury Highlights Heterogeneity of Banff Tubulitis and Interstitial Inflammation Lesions

Sridhar Reddy Allam,<sup>1</sup> Daniel C. Brennan,<sup>2</sup> Thin Thin Maw,<sup>3</sup> Erik Stites,<sup>4</sup> Nikhil Agrawal,<sup>5</sup> Grigoriy Shekhtman,<sup>5</sup> Fuad S. Shihab,<sup>6</sup> <sup>1</sup>Medical City Fort Worth, Fort Worth, TX; <sup>2</sup>Johns Hopkins University, Baltimore, MD; <sup>3</sup>University of Southern California, Los Angeles, CA; <sup>4</sup>University of Colorado, Denver, CO; <sup>5</sup>CareDx Inc, Brisbane, CA; <sup>6</sup>University of Utah Health, Salt Lake City, UT.

**Background:** The pathological definition and clinical significance of borderline T cell-mediated rejection (BL-TCMR) remains active debate, leading to inconsistencies in therapeutic strategy. Previously published data suggests that donor-derived cell-free DNA (dd-cfDNA) levels at the time of BL-TCMR diagnosis may identify patients at risk of adverse long-term outcomes. We characterized dd-cfDNA levels associated with BL-TCMR among patients in the Kidney allograft Outcomes AlloSure Registry (KOAR, NCT03326076).

**Methods:** Patients with BL-TCMR findings (Banff 2019) on either for-cause or surveillance biopsy and a dd-cfDNA result within 30 days were included in the analysis. Patients with biopsies showing isolated tubulitis or interstitial inflammation without tubulitis were also analyzed.

**Results:** We identified 56 cases of BL-TCMR with paired dd-cfDNA results; median dd-cfDNA among these patients was 0.34% (IQR:0.17 - 1.00) [Figure 1a]. The differences in dd-cfDNA among individual BL-TCMR combinations (t1/i1, t2/i1, t3/i1, t1/i2, t1/i3) were not significant, though the number of t3/i1 (n = 3, dd-cfDNA = 0.04%, 4.85%, 9.06%) and t1/i3 (n = 1, dd-cfDNA = 3.03%) cases was small. No differences were observed between biopsies with BL-TCMR and those with isolated tubulitis (t1/i0, t2/i0) or isolated inflammation without tubulitis (t0/i1) [Figure 1b]. 31 of 56 BL-TCMR cases had prior dd-cfDNA measurement, with median result of 0.24% (IQR: 0.20 - 0.37) obtained 63 (IQR: 53.5 - 100) days before the index biopsy. The median percent increase between these sequential results was 55% (IQR: -9 - 235%).

**Conclusions:** Substantial heterogeneity is observed with regards to dd-cfDNA levels at the time of BL-TCMR and the trajectory of dd-cfDNA preceding index biopsy. No differences in dd-cfDNA are observed between BL-TCMR and t/i lesions not presently included in Banff criteria for BL-TCMR. BL-TCMR, isolated tubulitis, and isolated inflammation without tubulitis represent a spectrum of molecular injury that may be further characterized via assessment of dd-cfDNA.

**Funding:** Commercial Support - CareDx

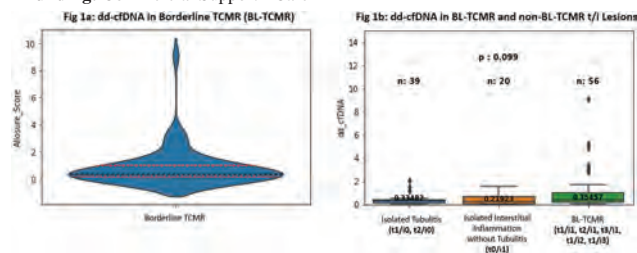

FR-PO780

Non-Invasive Monitoring With Torque Teno Virus for the Prediction of Antibody-Mediated Rejection in Kidney Transplant Patients

Paul Van Hummelen,<sup>1</sup> Jessica Tang,<sup>1</sup> Dhiren Kumar,<sup>2</sup> Felecia Mcdougan,<sup>2</sup> Kannagi Yashroy,<sup>1</sup> Ebad Ahmed,<sup>1</sup> Adam Prewett,<sup>1</sup> Gabrielle Heilek,<sup>1</sup> Hossein Tabriziani,<sup>1</sup> Phil Gauthier,<sup>1</sup> Gaurav Gupta,<sup>2</sup> <sup>1</sup>Natera, Inc., Austin, TX; <sup>2</sup>Virginia Commonwealth University, Richmond, VA.

**Background:** Kidney transplant (KT) patients require immunosuppressive (IS) treatment to prevent allograft rejection. The final net state of IS is a result of preexisting comorbidities, induction therapy and maintenance regimens. Torque Teno Virus (TTV) has been reported to be a marker of immune function and transplant-related complications in immunocompromised patients. TTV is a prevalent, non-pathogenic single-strand DNA virus that is easily detected in blood. Evidence for the clinical benefit of quantitative TTV monitoring in KT recipients is still emerging.

**Methods:** We selected 245 longitudinal serum samples from 66 KT patients with: a) stable without rejection in 1st year of transplant [N=26]; b) BK Polyoma viremia/nephropathy [N=10]; c) T-cell mediated Rejection (TCMR) [N=7]; and d) Antibody-mediated Rejection (AMR) [N=23]. Samples were obtained within days of transplantation surgery (Tx), pre-diagnosis, at biopsy diagnosis and several weeks after diagnosis. TTV levels were quantified by real-time quantitative PCR.

**Results:** At Tx, TTV levels were between 103-105 cps/ml and increased to 1010 in the first three months, followed by a gradual decrease to around 106 cps/ml. TTV levels varied by 2 logs between patients within each diagnosis group, confirming earlier published results, while the kinetics within each patient was more consistent. A delayed TTV increase in the first 3 months was observed in AMR patients, with overall lower TTV levels, while TCMR patients had higher and steady TTV levels. Patients with BK viremia/nephropathy generally had the highest titers, suggesting more robust IS.

**Conclusions:** Lower TTV titers in patients who were diagnosed with AMR may indicate an active immune state, possibly due to poor IS response. In contrast, BK viremia may be associated with high immune suppression and high TTV titers. More studies and patients are needed to confirm these results.

**Funding:** Commercial Support - Natera, Inc.

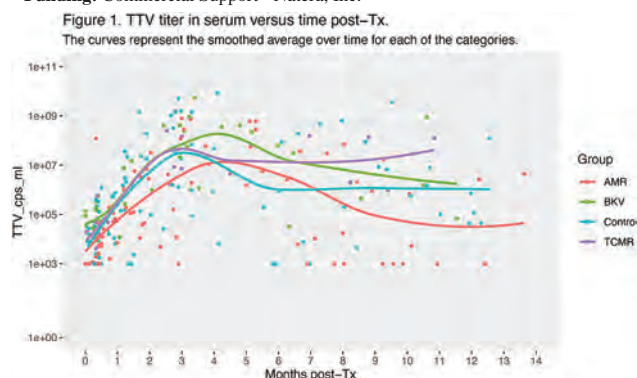

FR-PO781

**Delta Changes in Donor-Derived Cell-Free DNA (dd-cfDNA) Complement the Donor Fraction in Kidney Transplant Surveillance**

Alexander C. Wiseman,<sup>1</sup> Mohanram Narayanan,<sup>2</sup> Nikhil Agrawal,<sup>3</sup> Grigoriy Shekhtman,<sup>3</sup> Yi Fu,<sup>3</sup> Kevin Pinney,<sup>3</sup> Gaurav Gupta.<sup>3</sup> <sup>1</sup>Centura Health, Englewood, CO; <sup>2</sup>Baylor Scott & White Health, Dallas, TX; <sup>3</sup>CareDx Inc, Brisbane, CA; <sup>4</sup>Virginia Commonwealth University, Richmond, VA.

**Background:** We explored dd-cfDNA trajectories preceding biopsy-proven rejection (BPAR) events among kidney transplant recipients in the Kidney allograft Outcomes AlloSure Registry (KOAR, NCT03326076) and undergoing surveillance with dd-cfDNA.

**Methods:** We compared the change in dd-cfDNA from baseline to the time of BPAR (for-cause or surveillance biopsies). We identified patients with first-time rejection events and at least 3 prior dd-cfDNA results; selected the lowest of two preceding results as the baseline and compared this with the index result. We then analyzed patients with rejection (first or subsequent, at least 90 days apart) and  $\geq 2$  dd-cfDNA results. The reference change value (RCV) was calculated using a reference population of patients with stable allograft function, at least 3 dd-cfDNA measurements, and no significant clinical events.

**Results:** A total of 28 patients with BPAR met criteria for the primary analysis; among these, median baseline dd-cfDNA was 0.22% (IQR: 0.19 - 0.35) and median dd-cfDNA at the time of rejection was 1.35% (IQR: 0.75 - 2.75), representing a 491% (IQR: 177 - 1133) increase between these results, obtained 71.5 (IQR: 46 - 113) days apart [Table 1a]. 51 events met criteria for the second analysis where a median increase of 253% (IQR: 72 - 821%) between sequential dd-cfDNA values obtained 69 days (IQR: 45 - 108) apart preceded biopsy-proven rejection events [Table 1b]. The calculated RCV for the stable reference population within KOAR was 56.3%. 39 of these 51 events (76%) demonstrated increases greater than this RCV.

**Conclusions:** Longitudinal surveillance with dd-cfDNA allows the integration of delta changes and trajectories over time, allowing earlier identification of evolving allograft injury.

**Funding:** Commercial Support - CareDx

Table 1a: Dd-cfDNA Levels at Rejection compared to Baseline Values

	All Rejection (excl. borderline)	ABMR	TCMR (excl. borderline)
Rejection Events (n)	28	15	13
Median Baseline dd-cfDNA (IQR)	0.22% (0.19 - 0.35)	0.19% (0.19 - 0.28)	0.23% (0.21 - 0.50)
Median dd-cfDNA at Rejection (IQR)	1.35% (0.75 - 2.75)	1.50% (0.88 - 2.95)	0.99% (0.73 - 2.10)
Median % Change from Baseline to Index dd-cfDNA (IQR)	491% (177 - 1133)	532% (245 - 1867)	450% (66 - 900)
Percent of patients with % Change Exceeding 56.3% (stable RCV)	82%	87%	77%
Median # of Days between previous dd-cfDNA measurement and Rejection	71.5 (46 - 113)	91 (51 - 113)	69 (31 - 84)

Table 1b: Dd-cfDNA Levels at Rejection compared to Most Recent Prior Values

	All Rejection (excl. borderline)	ABMR	TCMR (excl. borderline)
Rejection Events (n)	51	29	22
Median Prior dd-cfDNA (IQR)	0.24% (0.19 - 0.59)	0.32 (0.19 - 0.73)	0.23 (0.18 - 0.40)
Median dd-cfDNA at Rejection (IQR)	1.40% (0.73 - 2.95)	2.40% (1.10 - 3.20)	0.83% (0.48 - 1.5)
Median % Change from Baseline to Index dd-cfDNA (IQR)	253% (72 - 821)	295% (95 - 1082)	211% (17 - 664)
Percent of patients with % Change Exceeding 56.3% (stable RCV)	76%	79%	55%
Median # of Days between previous dd-cfDNA measurement and Rejection	69 (45 - 108)	84 (48 - 113)	55.5 (32 - 89.3)

FR-PO782

**Interactive Impact of Tacrolimus Inter-Patient Variability and Intra-Patient Variability in Allograft Outcomes in Kidney Transplantation**

Yohan Park,<sup>1</sup> Hanbi Lee,<sup>2</sup> Sang Hun Eum,<sup>2</sup> Se-Hee Yoon,<sup>1</sup> Won Min Hwang,<sup>1</sup> Sung-Ro Yun,<sup>1</sup> Chul Woo Yang,<sup>2</sup> Byung ha Chung.<sup>2</sup> <sup>1</sup>Konyang University Hospital, Daejeon, Republic of Korea; <sup>2</sup>Seoul Saint Mary's Hospital, Seocho-gu, Seoul, Republic of Korea.

**Background:** Concentration to dose ratio (CDR) of tacrolimus (TAC) is an index of inter-patient variability that reflects tacrolimus metabolism, and whether it influences allograft outcomes is controversial in kidney transplantation (KT). This study analyzed the effect of TAC inter-patient variability combined with TAC intra-patient variability (IPV) on allograft outcomes.

**Methods:** In total, 1,080 patients with immunologic low risk were enrolled. Inter-patient variability was calculated as the mean value of CDRs up to 3 months after KT, and was defined as rapid metabolizer (RM) if it was lower than 1.05. IPV was calculated as the time-weighted coefficient variability (TWCV) of the TAC-trough level (C0) up to 1 year after KT, and was defined as high IPV group if it was higher than 30%. According to CDR and TWCV, patients were divided into 4 groups: Low IPV/Non-rapid metabolizer (NRM), High IPV/NRM, Low IPV/RM, and High IPV/RM.

**Results:** Death-censored graft loss (DCGL) rates were 5.5% (25/452) in the Low IPV/NRM group, 10.5% (38/375) in the High IPV/NRM group, 5.7% (6/106) in the Low IPV/RM group, and 19.1% (28/147) in the High IPV/RM group, which was the significantly highest in the High IPV/RM group (P < 0.001). In Cox regression analysis, the odds ratio (OR) of High IPV/RM was 3.06 (1.78-5.25), which was observed as a significant risk factor. In the analysis in which the TAC time weighted average value was adjusted, High IPV/RM was remained as a significant risk factor with OR 2.60 (1.41-4.79).

**Conclusions:** High TAC-IPV in patients with low CDRs in the early post-transplantation period is thought to have a significant adverse effect on the allograft outcomes. Stratification is required for patients with RM characteristics (low CDRs) in the clinical field, and more careful tacrolimus dose adjustment efforts are needed in these patients.

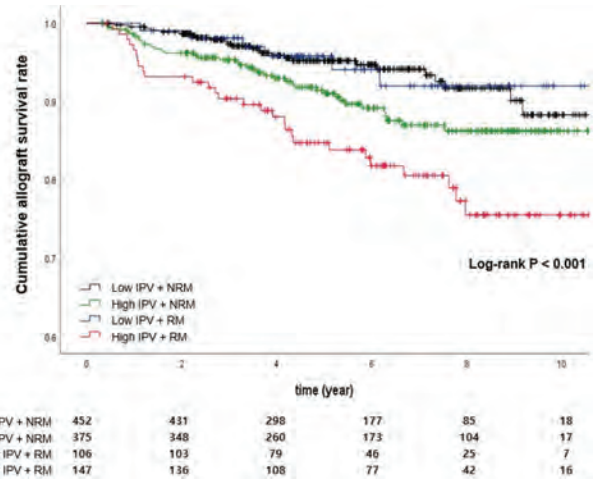

FR-PO783

**Plasma Cell Rich Rejection (PCRR) of Kidney Allografts: A Review of 94 Patients**

Hameeda T. Khan, Jonathan T. Lin, Thalia Salinas, Steven Salvatore, Darshana M. Dadhania, Choli Hartono, Surya V. Seshan, Thangamani Muthukumar. Weill Cornell Medicine, New York, NY.

**Background:** PCRR, defined as an acute rejection in which plasma cells constitute >20% of the cells infiltrating the kidney interstitium, occurs in the context of mixed AMR/TCMR or TCMR. Allograft outcome after PCRR is poor and risk factors have not been well defined.

**Methods:** We did a chart review of 94 consecutive transplant kidney biopsies (7/2007-12/2021) at our center reported as PCRR. Patients with functioning grafts were censored at 60 months after biopsy diagnosis. Allograft outcome and risk factors were assessed by Kaplan-Meier and Cox regression analysis.

**Results:** Mean (SD) age of patients was 40 (17) years; 43% were women; 36% were Black. Mean (SD) age of donors was 35 (17) years; 45% were deceased donors; 63% were women; 29% were Black. 83% received Thymoglobulin induction and all were on calcineurin-based immunosuppression. Time (median, IQR) from transplantation to biopsy was 48 (16-75) months. Medication nonadherence was observed in 37%. 75 (80%) patients had mixed acute rejection. Besides methylprednisolone pulse, treatment included combinations of thymoglobulin, intravenous immunoglobulin, plasmapheresis, and bortezomib. During a median follow of 49.8 months, 58 patients lost their grafts. The median allograft survival was 27.5 months (Fig 1). Variables associated with the outcome are shown in Fig 2. Bortezomib-based antirejection therapy did not improve outcome (HR 0.75 [0.39-1.44], P=0.38).

**Conclusions:** PCRR, irrespective of whether it occurs in the context of mixed AMR/TCMR or TCMR, is associated with poor allograft outcomes. Molecular characterization of PCRR biopsies may provide clues to better understand the pathogenesis and develop targeted therapeutics.

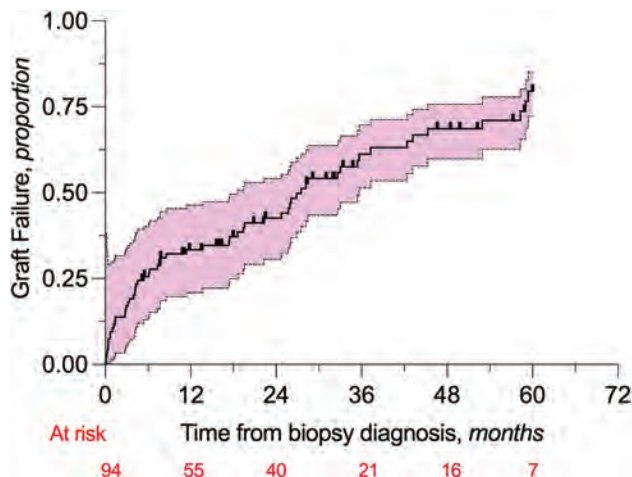

Fig 1

Variables (at the time of allograft biopsy)	N (%)	Reference	Hazard Ratio (95%CI)	P value for graft failure
Age of the transplant recipient	94 (100)	per year	0.98 (0.96-1.00)	0.199
Time from transplantation	94 (100)	per month	1.00 (1.00-1.01)	0.034
Serum creatinine	94 (100)	per mg/dl	1.12 (1.05-1.17)	0.000
Proteinuria >1 g/day	26 (28%)	<1 g/day	2.27 (1.19-4.33)	0.013
Microvascular inflammation (g+ptc ≥2)	78 (83%)	score <2	0.24 (0.11-0.52)	0.000
Intimal arteritis (v ≥1)	20 (21%)	score <1	2.59 (1.22-5.40)	0.012
IFTA (c+rct ≥2)	61 (65%)	score <2	0.58 (0.28-1.2)	0.147
Chronic endothelial injury (cg+eptc ≥2)	60 (64%)	score <2	1.31 (0.72-2.39)	0.370
Vascular fibrous intimal thickening (cv ≥2)	51 (54%)	score <2	0.95 (0.54-1.67)	0.855
C4d positive	23 (24%)	negative	0.61 (0.31-1.18)	0.141
TCMR Phenotype	19 (20%)	AMR/TCMR	0.51 (0.21-1.22)	0.133

Fig 2

FR-PO784

Selectively Increased Urinary Endotrophin Levels in T-Cell Mediated Kidney Transplant Rejection

Firas F. Alkaff,<sup>1,2</sup> Daan Kremer,<sup>1</sup> Daniel Guldager Kring Rasmussen,<sup>3</sup> Martin Tepel,<sup>4</sup> Olivier Thauant,<sup>5</sup> Marius C. van den Heuvel,<sup>1</sup> Stefan P. Berger,<sup>1</sup> Federica Genovese,<sup>3</sup> Morten A. Karsdal,<sup>3</sup> Jacob van den Born,<sup>1</sup> Stephan J. Bakker,<sup>1</sup> <sup>1</sup>Universitair Medisch Centrum Groningen, Groningen, Netherlands; <sup>2</sup>Universitas Airlangga Fakultas Kedokteran, Surabaya, Indonesia; <sup>3</sup>Nordic Bioscience, Herlev, Denmark; <sup>4</sup>Odense Universitetshospital, Odense, Denmark; <sup>5</sup>Hospices Civils de Lyon, Lyon, France.

**Background:** Endotrophin (ETP) is a proteolytic fragment of collagen VI α3 chain and involved in adipose tissue homeostasis. However, upon renal tissue remodeling, collagen VI is increased and ETP is released. In this study we evaluated whether plasma and/or urinary ETP is associated with graft rejection in kidney transplant recipients (KTR).

**Methods:** This is a cross-sectional study among KTR who are enrolled in TransplantLines Biobank and Cohort Study. Blood and urine were collected on the same day as the biopsy procedure. Plasma and urinary ETP were measured using Enzyme-Linked Immunosorbent Assay. Diagnosis of graft rejection was according to the BANFF classification at the time the biopsies were taken.

**Results:** See Table for results. KTR with indication biopsy showed increased plasma ETP and urinary ETP/Creatinine ratio (ECR). Among patients who underwent indication biopsy, both plasma ETP and ECR were significantly correlated with C-reactive protein, serum creatinine, and eGFR but not with urinary protein excretion. Further, those with T-cell mediated rejection (TCMR) had higher ECR but similar plasma ETP level. In the logistic regression analysis, ECR was significantly associated with TCMR, even after adjustment for age, sex, eGFR, and 24-hour protein excretion (OR per doubling 1.39, 95%CI = 1.08-1.78, p = 0.011).

**Conclusions:** Our findings show that in urine, but not in plasma, ETP is selectively increased in TCMR independent of kidney function and proteinuria, suggesting increased renal ETP release upon TCMR. Further studies focusing on T-cell specific cytokines in collagen VI synthesis needs to be done.

**Funding:** Commercial Support - Astellas BV, and Chiesi Pharmaceuticals BV, Government Support - Non-U.S.

	Protocol biopsies (n = 17)	Indication biopsies (n = 100)	TCMR in indication biopsy (n = 26)	non-TCMR in indication biopsy (n = 74)
Plasma ETP* (ng/mL)	[0.8 [9.2-11.7]]	18 [14.3-26.1]**	18.2 [14.6-25.8]**	17.6 [13.6-26.6]**
ECR (ng/minol)	273 [214-573]	2079 [421-7153]**	4333 [1801-13106]** <sup>§</sup>	918 [308-5892]**

66% male, age 54±15 years, eGFR 33.3±17.7 mL/min/1.73 m2, median 13 [5-71] months after transplantation. \*p<0.001 compared to protocol biopsies. #p=0.003 compared to non-TCMR.

FR-PO785

Torque Teno Virus Might Be a Better Predictor of Immunosuppressive Burden in BK Viremia Post Renal Transplant

Ramyangshu Chakraborty, Jon Bible, Michelle E. Allan, Tasnuva S. Kashem, Stanley Fan, Kieran McCafferty, Teresa M. Cutino Moguel, Muhammad Magdi Yaqoob. *The Royal London Hospital, London, United Kingdom.*

**Background:** The ubiquitous Torque Teno DNA virus (TTV) promises increased accuracy in IS burden prediction. We examined the presence and change in TTV titres in patients with BK viremia in preparation for a prospective observational study evaluating TTV as a measure of IS burden.

**Methods:** Stored blood samples and electronic records from 20 renal transplant recipients from 2017-19 at a tertiary care centre were included in the analysis. All received standardised tacrolimus based IS and experienced a clinically significant episode of BK viremia which responded to standard of care cessation of mycophenolate (MMF). BK & TTV titres, 30-day average tacrolimus concentration, antiproliferative & prednisolone doses were collected at four-time points: the last negative BK PCR; the onset of viremia; the peak BK titre & BK titre <500 copies. TTV PCR was performed on DNA extracted from frozen plasma. Multivariable linear regression analysis was performed in R to assess the relationship between TTV and other variables.

**Results:** TTV DNA was detectable at 78 out of 80 time points. The mean TTV titre at the 4 time points were 5.0 (2.07), 5.5 (1.74), 6.2 (2.14) & 4.6 (1.27) log copies respectively. In the linear model, log-transformed BK virus titre was strongly associated with TTV titres once adjusted for tacrolimus concentration: every 1 log rise in TTV titre led to 0.6 (0.17) log copies increase in BKV titre (p <0.001). The tight relationship between BKV and tacrolimus concentration (p <0.001) disappeared when TTV titre was added as a predictor variable, implying the superiority of TTV to tacrolimus concentration as a predictor for BK viral load. Changes in MMF or prednisolone dose did not predict linear changes in BKV titres. Five patients had graft loss within the follow-up period (mean 2.8 years). All had low (p<0.05) TTV titres indicating suboptimal IS burden. There was no relationship between rejection (n=5) or de novo DSA (n=3) with TTV titre in this cohort.

**Conclusions:** This pilot study suggests that TTV is detectable in most instances post-transplant. TTV titres indicate the effect of IS changes on BK titre independently. An ongoing adequately powered prospective study will further assess the relationship between TTV titres & post-transplant immunological events.

FR-PO786

Serial Testing of Blood Gene Expression and Donor-Derived Cell-Free DNA for Predicting Future Kidney Allograft Failure

Kexin Guo,<sup>1</sup> Alexis J. Kushner,<sup>1</sup> Christabel Rebello,<sup>1</sup> Bradley M. Kinsella,<sup>1</sup> Rohita Sinha,<sup>2</sup> Lihui Zhao,<sup>1</sup> John J. Friedewald,<sup>1</sup> Sookhyeon Park.<sup>1</sup> <sup>1</sup>Northwestern University Feinberg School of Medicine, Chicago, IL; <sup>2</sup>Eurofin Viracor, Lee Summit, MO.

**Background:** Both gene expression profiles (GEP) and donor-derived cell-free DNA (dd-cfDNA) have been established as non-invasive biomarkers to detect subclinical and clinical acute rejection in a kidney allograft. However, the clinical impact of combined serial testing of GEP and dd-cfDNA on kidney allograft survival has not been well studied. We hypothesized that we could predict future kidney allograft survival using serial testing of combined GEP and dd-cfDNA.

**Methods:** We analyzed 261 subjects from a previously reported multicenter, prospective observational study. Multiple serial samples of GEP and dd-cfDNA were collected throughout the study period. Graft failure was defined as returning to dialysis or re-transplant. We used a joint model to predict future allograft survival using serial GEP and dd-cfDNA and allograft failure. The study cohort was randomly divided into 70 and 30%, training and testing sets, respectively. We assessed the model performance with the area under the receiver operating characteristic (AUROC).

**Results:** Of 261 subjects, 182 (70%) were used for training the model. A total of 16 cases of allograft failure were observed in the training set. In the training set, the AUROC to predict graft failure at 4-year post kidney transplant (KT) was 0.83 using GEP and dd-cfDNA until 1 year KT (Fig 1A). When we used GEP and dd-cfDNA data from up to 2 years post KT, the AUROC improved to 0.88 (Figure 1B). For the validation set, 7 graft failures were observed from 79 subjects. The performance remains stable in the validation set. The AUROCs were 0.67 and 0.83, using up to 1-year and 2-year serial GEP and dd-cfDNA data, respectively.

**Conclusions:** The combination of GEP and dd-cfDNA tests can be used to predict future graft failure.

**Funding:** Private Foundation Support

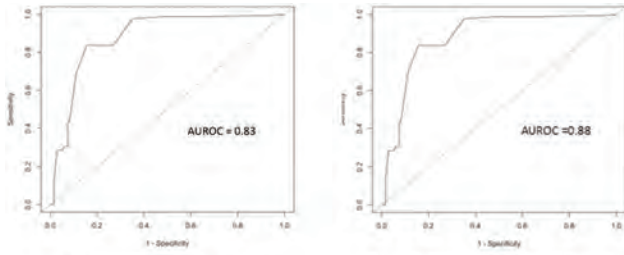

Figure 1A) Graft survival prediction at 4-year Using GEP and dd-cfDNA until 1-year post-KT

Figure 1B) Graft survival prediction at 4-year using GEP and dd-cfDNA until 2-year post-KT

FR-PO787

**Molecular and Cellular Landscape of Peripheral Blood Mononuclear Cells (PBMCs) Associated With Kidney Transplantation Operational Tolerance**

Shafquat Azim,<sup>1</sup> Haseeb Zubair,<sup>1</sup> Amol C. Shetty,<sup>2</sup> Jennifer M. McDaniels,<sup>1</sup> Thomas Rousselle,<sup>1</sup> Cem Kuscus,<sup>3</sup> Canan Kuscus,<sup>3</sup> Manish Talwar,<sup>3</sup> James D. Eason,<sup>3</sup> Daniel G. Maluf,<sup>4</sup> Valeria R. Mas,<sup>1</sup> Mas Lab <sup>1</sup>University of Maryland School of Medicine, Baltimore, MD; <sup>2</sup>University of Maryland Baltimore, Baltimore, MD; <sup>3</sup>The University of Tennessee Health Science Center College of Medicine, Memphis, TN; <sup>4</sup>University of Maryland Medical Center, Baltimore, MD.

**Background:** Under rare event kidney transplant recipient (KTR) establish long-term allograft acceptance without the need of immunosuppressive drugs (ISD), usually due to medical nonadherence. Understanding the immune landscape in patients of spontaneous tolerance can define novel mechanisms of tolerance induction and provide biomarkers for clinical testing to reduce or withdraw ISD.

**Methods:** PBMCs isolated from non-transplant healthy control (Nor, n=2), KTR on ISD (NwIS, n=3), and KTR with operational tolerance (OT, n=1) were processed for single-cell RNA-seq according to the 10X Genomics Chromium platform and analyzed on Cell Ranger and Seurat.

**Results:** Subclusters of T-cell included Treg (FOXP3). Treg was present in higher fraction in NwIS (Fig 1A). Pathway analysis on Treg differentially expressed genes (FDR≤0.05, log<sub>2</sub>FC≥±1.5) was done using Metascape (Fig 1B). *LGALS1* an important effector of Treg-mediated regulation was upregulated specifically in OT. Interestingly, perforin (*PRF1*), also a mediator of Treg-induced tolerance, was >5-fold less in NwIS compared to N and OT. B cell population was also dissimilar between the three. OT had the highest proportion, while NwIS the lowest. Subclustering B cell identified the presence of a single activated B cell subpopulation in NwIS, which were very low in OT and Nor (Fig 2). However, most of the activated B cells in NwIS were in the G1 phase with decreased CD27 and CD24 expression indicating B cell exhaustion.

**Conclusions:** Increased *LGALS1* and *PRF1* in OT indicates a role in achieving tolerance via Tregs. Moreover, abundance in B cell subtypes and associated transcriptome found in OT also indicate tolerance maintenance.

**Funding:** NIDDK Support

FR-PO788

**Development of a Tissue-Based Classifier of Allograft Inflammation Using Imaging Mass Cytometry**

Mariam P. Alexander,<sup>1</sup> Mark Zaidi,<sup>2</sup> Mark D. Stegall,<sup>1</sup> Andrew J. Bentall,<sup>1</sup> Trevor D. Mckee,<sup>3</sup> Timucin Taner.<sup>1</sup> <sup>1</sup>Mayo Clinic Minnesota, Rochester, MN; <sup>2</sup>University of Toronto, Toronto, ON, Canada; <sup>3</sup>Deciphex Ltd, Dublin, Ireland.

**Background:** Molecular phenotyping of allograft inflammation has improved both diagnostic accuracy & our understanding of the heterogeneity of rejection. Current molecular techniques lack histological correlation & spatial dimensionality. Our goal was to use Imaging Mass Cytometry (IMC) to develop a tool to accurately predict the cause of allograft inflammation.

**Methods:** Our cohort included biopsies of rejection, BK nephropathy, pyelonephritis & normal kidneys. Using a panel of 28 markers, IMC images were processed by the Hyperion imaging system. Details of analysis are in Fig 1A. Cell segmentation was performed using Universal StarDist for Qupath. Cell classification was performed based on mean intensity threshold.

**Results:** 139 regions of interest (ROI) were processed. Violin plots ensured there were measurable differences in known markers associated with each allograft inflammation category. Distribution of percent positive scoring of immune cells are seen in the heatmap (1B) [e.g.: cellular & mixed rejection cases enriched in CD45<sup>+</sup>, HLA-DR<sup>+</sup> cells and CD4<sup>+</sup> memory T cells]. The trained regularized gradient boosting classifier model XGBoost was used to predict the allograft inflammation category for all cells, ROIs and each original histological diagnosis. (Fig 1C & D). The trained model accurately predicted the allograft inflammation category for each cell with an accuracy of 64.3%. When using the mean intensity parameter of each cell, the classifier accuracy improved to 87.8% in predicting the type of renal allograft inflammation, independent of ROI. The accuracy improved to 90.9% when dimension of intracellular spatial features (proximity metrics) were added to the algorithm. Granzyme, CD68 and Vista were the three most important markers in achieving this high accuracy.

**Conclusions:** Using highly multiplexed imaging of renal allograft biopsies with subcellular resolution by IMC we have developed a novel classifier of allograft inflammation, which demonstrates high diagnostic accuracy.

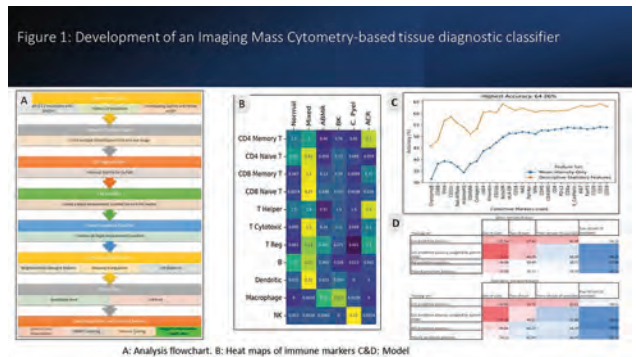

Figure 1

FR-PO789

**Non-human Leukocyte Antigen (Non-HLA) Antibodies Against GSTT1 Are Associated With Homozygote Status for the Null Allele and With Histological Changes of Antibody Mediated Rejection**

Bogdan Obrisca,<sup>1</sup> Nicolae Leca,<sup>2</sup> Elaine Chou-Wu,<sup>3</sup> Gener Ismail,<sup>1</sup> Idoia Gimferrer.<sup>3</sup> <sup>1</sup>Fundeni Clinical Institute, Bucharest, Romania; <sup>2</sup>University of Washington, Seattle, WA; <sup>3</sup>Bloodworks Northwest, Seattle, WA.

**Background:** The presence of anti-GSTT1 Abs have been detected in patients with Antibody Mediated Rejection (AMR) after liver and kidney transplantation (KTx). We aimed to evaluate the relation between anti-GSTT1 Abs and AMR in a cohort of KTx patients.

**Methods:** Pre and Post-transplant samples from 87 KTx recipients were analyzed by Immunocor's non-HLA Luminex assay. We included 29 patients with AMR due to HLA-DSA (AMR/DSA+), 28 patients with non-HLA mediated AMR (AMR/DSA-) and 30 patients without rejection with stable allograft function (control).

**Results:** At an MFI cut-off of 3,000, the overall prevalence of anti-GSTT1 Abs was 14%. The prevalence was higher among AMR/DSA- patients (25%), compared to the control group (13.3%) and AMR/DSA+ group (3.4%)(p=0.06). 81/87 patients underwent GSTT1 genotyping, 16 (19.75%) were negative: 9 AMR/DSA- patients (33.3%), 6 controls (22.2%) and 1 AMR/DSA+ (3.7%)(p=0.02). In the ABMR/DSA- group, the anti-GSTT1 ab MFI was significantly higher in patients negative compared to patients positive for GSTT1 gene (Figure 1). In two multivariate logistic regression models, negativity for GSTT1 gene (OR 43.2; 95%CI, 2.6-716) and anti-GSTT1 Ab positivity (OR 11.9; 95%CI, 1.1-129) were strongly associated with AMR. 14/57 patients with AMR (24.5%) lost their allograft at a median 6.1 years (IQR: 3.7-7.7). Patient with anti-GSTT1 Abs had AMR earlier (17 vs 35 months) than patients without GSTT1 Abs (p=0.02). Despite this, there were no differences in graft loss. When taking into consideration the GSTT1 gene status, among subjects displaying homozygote null status those without allograft failure had an overall higher MFI levels of anti-GSTT1 ab compared to those that lost their allograft (Figure 1).

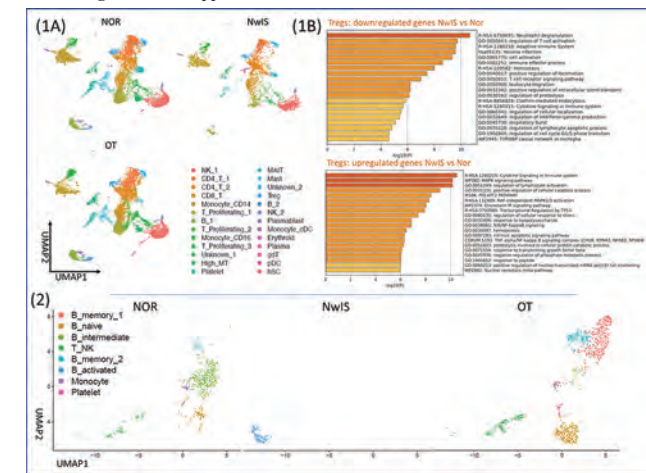

Figure 1: (A) UMAP showing main clusters identified between groups. (B) Pathway analysis using differentially expressed genes between NwIS and Nor.

Figure 2: UMAP of subclustered B-cell population

**Conclusions:** Presence of GSTT1 Abs and GSST1 gene negative status are associated with AMR, but do not appear to lead to increased graft loss, possibly being a marker of favorable response to rejection treatment.

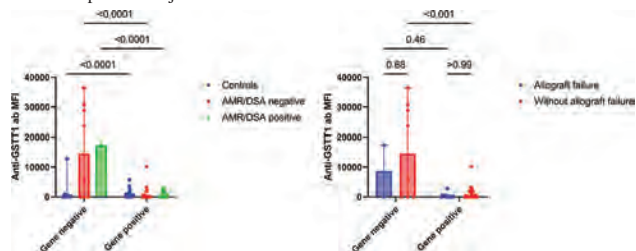

Figure 1

**FR-PO790**

**The Number of Episodes of Subtherapeutic Tacrolimus Levels During the First Year Post Transplant Is Independently Associated With Reduced Graft Survival**

**Benaya Rozen-zvi, Dana Bielopski, Ruth Rahamimov. Rabin Medical Center, Petah Tikva, Israel.**

**Background:** Multiple studies have shown that tacrolimus (TAC) trough level variability is associated with reduced graft survival. However, specific patterns of TAC level that are associated with adverse outcome were not identified. In this study we sought to evaluate the association between the number of episodes of sub therapeutic TAC level during the first year after transplantation and graft outcome.

**Methods:** a single center retrospective cohort study including all kidney transplanted patients between 2001 and 2017 inclusion criteria were immunosuppression with tacrolimus and graft survival of more than one year. An Episode of sub therapeutic TAC level was defined as any value below 6 ng/ml during the first year, following a value above 6 ng/ml. exposure variable was the number of episodes of Tac sub therapeutic levels with cap of six (all patients with six or more episodes were categorized as having six episodes). Univariate and multivariate Cox model were used to evaluate the primary outcome of death censored graft loss. Tac level variability during the first year was included in the multivariate model.

**Results:** the study included 1305 patients, the mean age was 49.5±14.8 years and 884(67.7%) of them were men. The median number of sub therapeutic Tac level episodes was 1 (IQR 0-3) and 327 (25.1%) patients had no sub therapeutic Tac levels during the first year. Increased number of sub therapeutic Tac level episodes was associated with reduced graft survival (Hazard Ratio (HR), 1.41 per episode, 95% Confidence Interval (CI) 1.27-1.55, p<0.001). the results were not significantly changed after multivariate adjustment (HR, 1.23 per episode, 95% CI 1.09-1.37, p=0.001). when the composite outcome of graft loss and mortality was evaluated the results were comparable (HR, 1.23 per episode, 95% CI 1.15-1.32, p<0.001) and (HR, 1.16 per episode, 95% CI 1.07-1.26, p<0.001) for univariate and multivariate analysis respectively.

**Conclusions:** Episodes of sub therapeutic Tac level are associated with reduced graft survival independent of Tac level variability. Studies evaluating the effect of strategies to reduce the number of sub therapeutic Tac levels on graft outcomes might be helpful.

**FR-PO791**

**Association Between Tacrolimus Level and Graft Outcome According to Bisphosphonate Use in Kidney Transplantation Patients**

**Hee Byung Koh,<sup>1</sup> Ga Young Heo,<sup>1</sup> Hyo Jeong Kim,<sup>1</sup> Chan-Young Jung,<sup>1</sup> Hyung Woo Kim,<sup>1</sup> Seung Hwan Song,<sup>3</sup> Hoon Young Choi,<sup>2</sup> Jaeseok Yang,<sup>1</sup> Kyu ha Huh,<sup>1</sup> Beom Seok Kim.<sup>1</sup> <sup>1</sup>Yonsei University College of Medicine, Seodaemun-gu, Seoul, Republic of Korea; <sup>2</sup>Gangnam Severance Hospital, Seoul, Republic of Korea; <sup>3</sup>Ewha Womans University Seoul Hospital, Seoul, Republic of Korea.**

**Background:** Although the introduction of tacrolimus significantly improved the prognosis of kidney transplantation (KT), an immunosuppressive drug that further improves the current prognosis has not yet been developed. Several recent studies have shown that bisphosphonate (BPP) use was associated with a favorable graft outcome in patients with KT. Therefore, we investigated whether the association between tacrolimus and graft outcome was different according to the use of BPP in patients with KT.

**Methods:** This retrospective study was conducted by analyzing 1,657 patients who underwent KT at Severance Hospital in South Korea between January 2006 and December 2020. Patients with preoperative BPP use, cyclosporine use, rapamycin use, re-transplantation, and missing information were excluded. Primary exposure was time-dependent cross-product term of tacrolimus trough level (low TAC vs. normal-high TAC with reference of 4ng/mL) and BPP use. Primary outcome was graft failure defined as patient's death or conversion to kidney replacement therapy. Sensitivity analysis was performed with outcome of eGFR <30 ml/min/1.73 m<sup>2</sup>

**Results:** Among 1,657 patients, 362 (21.8%) patients were BPP user. During the 1121.8 person-year, graft outcomes occurred in 183 (11.0%) patients. In multivariable Cox regression analysis, normal-high TAC without BPP was associated with a lower risk of graft outcome (HR, 0.40 [95% CI, 0.29-0.54]) compared to low TAC without BPP. Normal-high TAC with BPP was associated with a further lower risk of graft outcome

(HR, 0.17 [95% CI, 0.09-0.31]) compared to low TAC without BPP. Low TAC with BPP was also associated with a lower risk of graft outcome (HR, 0.15 [95% CI, 0.06-0.36]) compared to low TAC without BPP. This association was maintained in analyses using tacrolimus trough level of 5 or 6 ng/mL as reference. In addition, similar results were observed with outcome of eGFR <30 ml/min/1.73 m<sup>2</sup>

**Conclusions:** The use of BPP was associated with favorable graft outcomes even in lower tacrolimus trough level. The addition of BPP to the conventional immunosuppressant regimen may reduce tacrolimus requirement.

**FR-PO792**

**High Pretransplant FGF-23 Level Is Associated With Poor Graft Survival and Persistent Vitamin D Insufficiency in Kidney Transplant Patients**

**Jung-hwa Ryu,<sup>1</sup> Tai yeon Koo,<sup>3</sup> Hyo Jeong Kim,<sup>2</sup> Ga Young Heo,<sup>2</sup> Jaeseok Yang,<sup>2</sup> KNOW-KT Study group <sup>1</sup>Ewha Womans University Seoul Hospital, Seoul, Republic of Korea; <sup>2</sup>Yonsei University College of Medicine, Seodaemun-gu, Seoul, Republic of Korea; <sup>3</sup>Korea University, Seongbuk-gu, Seoul, Republic of Korea.**

**Background:** Vitamin D [25(OH)D] insufficiency and FGF-23 elevation in chronic kidney disease (CKD) is usually ameliorated after kidney transplantation (KT). However, post-transplant vitamin D insufficiency are still associated with poor graft outcome. This study aimed to investigate the effect of pretransplant FGF-23 level on post-transplant vitamin D status and clinical outcomes.

**Methods:** The KoreaN cohort study for Outcome in patients With Kidney Transplantation (KNOW-KT) is a multicenter, observational cohort study. Four hundred subjects for whom serum FGF-23 measurement was available, were included in this study. Annual serum 25(OH)D and clinical outcomes; all-cause mortality, cardiovascular event, graft survival, and fracture were assessed according to baseline FGF-23 levels.

**Results:** Median follow-up duration was 6.5 years. Serum 25(OH)D<sub>3</sub> levels were increased after KT (before KT, 12.6±7.4; 1 year after KT, 22.6±6.4; 3 years after KT, 24.3±5.8 ng/mL). However, they were declined to 20.9±9.2 ng/mL at 7 years after KT. Vitamin D deficiency was present in 79.1% just before KT, then it was decreased to 30.8% at 3 years after KT, whereas it was increased 37.8% at 6 years after KT. Serum FGF-23 level was decreased after KT [2140.6 (391-9277) pg/ml before KT vs. 50.0 (23.6-94.6) pg/ml at 3 years after KT, P=0.001]. The FGF-23 showed negative correlation with serum vitamin D levels. When we categorized subjects into tertile according to baseline FGF-23 level (low, middle, high FGF-23 groups), the 25(OH)D<sub>3</sub> in the low baseline FGF-23 group was lowest at any point during follow-up. High baseline FGF-23 level was a risk factor for poor graft survival (HR 5.882, 95% C.I.; 1.443-23.976, P=0.022).

**Conclusions:** Increased FGF-23 could interfere vitamin D activation even after KT and is a risk factor for poor graft survival.

**FR-PO793**

**Postoperative Neutrophil to Lymphocyte and Platelet Ratio as a Predictor of Delayed Graft Function**

**João M. Oliveira, Joana Gameiro, Marta R. Neves, Alice Santana, Jose A. Lopes. Centro Hospitalar Universitario Lisboa Norte EPE, Lisboa, Portugal.**

**Background:** Development of delayed graft function (DGF) has been associated with worse short and long-term outcomes after kidney transplantation (KT). Inflammation plays a key role in the development of DGF. The neutrophil to lymphocyte and platelet (NLP) ratio is an affordable biomarker of systemic inflammation easily determined from a complete blood cell count. We aimed to assess whether postoperative NLP ratio may be used as an early predictor of DGF in KT patients.

**Methods:** We conducted a retrospective cohort of adult patients submitted to KT at our unit, between 1 January 2010 and 31 December 2020. NLP was calculated at 24h post-KT. Primary outcome was development of DGF. Logistic regression was calculated to determine significant factors which may have contributed to DGF.

**Results:** We included 527 patients with a mean age of 49.9 ± 12.8 years and the majority were male (n=308, 58.4%). Patients had been under renal replacement therapy for 5.9±4 years. In 47.8% of patients expanded criteria donors were used, and in 3.6% non-heart-beating donors. DGF occurred in 17.8% of patients. Use of rabbit anti-thymocyte immunoglobulin for induction therapy was similar between groups (DGF vs. early graft function, p=0.078). Mean post-KT NLP was 26.4±3.5 and, as expected, was higher in patients submitted to induction therapy with lymphocyte depleting antibodies (50.2±40.3 vs. 11.9±7.4 in patients treated with basiliximab, p<0.001), but it was found to be higher even before KT (and thereby before induction therapy) (5.2±1.8 in patients treated with rabbit anti-thymocyte immunoglobulin vs. 1.9±1.2 with basiliximab, p=0.001) and not predictive of DGF. Grafts from non-heart-beating donors (OR 13.989, 95% CI 4.741, 41.274, p=0.000), longer warm ischemia time (OR 1.035, 95% CI 1.007, 1.064, p=0.014) and higher NLP ratio 24 hours after transplantation (OR 1.009, 95% CI 1.002, 1.016, p=0.015) were independent predictors of DGF. Creatinine at discharge (3.3±2.2 versus 1.4±0.5, p=0.000) was higher in patients with DGF.

**Conclusions:** In our cohort, a higher NLP ratio at 24 hours after KT was an independent predictor of DGF. This reflects the impact of inflammation on KT outcomes and highlights the role of the NLP ratio as a sensitive marker of systemic inflammatory response after KT.

FR-PO794

**Longitudinal Analysis of Donor-Derived Cell-Free DNA (dd-cfDNA) in En Bloc Kidney Transplantation**

Sanjeev Akkina,<sup>1</sup> Neeraj Singh,<sup>2</sup> Jeffrey A. Klein,<sup>3</sup> Nikhil Agrawal,<sup>4</sup> Mingwei Fei,<sup>4</sup> Amishi S. Desai.<sup>1</sup> <sup>1</sup>Loyola University Chicago, Chicago, IL; <sup>2</sup>Willis-Knighton Health System, Shreveport, LA; <sup>3</sup>University of Kansas School of Medicine, Kansas City, KS; <sup>4</sup>CareDx Inc, Brisbane, CA.

**Background:** The longitudinal dd-cfDNA patterns in en-bloc kidney transplant recipients have not been studied. It is unknown how the initial smaller mass of the two pediatric organs impacts ddcfDNA early post-transplant or if the dd-cfDNA rises over time as the organs enlarge. We analyzed ddcfDNA scores over the first 12 months in recipients of pediatric en-bloc kidneys enrolled in the Kidney allograft Outcomes AlloSure Registry (KOAR, NCT03326076).

**Methods:** 16 recipients of pediatric en-bloc kidneys with donors aged ≤7 years old were identified and compared with 931 single, non en-bloc deceased donor recipients. Patients with rejection were excluded.

**Results:** Of the 16 en-bloc recipients, 56.2% were male with median donor age of 1.4 years and median cold ischemia time (CIT) of 20 hours. None of the en-bloc transplants had delayed graft function. Aside from KDPI, donor age, and recipient age, no other differences were observed between groups. Higher median ddcfDNA values were seen in the en-bloc cohort compared to not en-bloc at month 1 (M1, 1.4% vs 0.4%) and month 2 (0.58% vs 0.23%) after transplant (p<0.001) [Figure 1a]. Median ddcfDNA values were comparable for month 3 (0.21% vs 0.16%, p = 0.07) and all subsequent time points. [Figure 1a,1b]. Among 8 patients with M1 ddcfDNA results, there was no significant association between M1 ddcfDNA and either CIT (r=0.33, p=0.419) or KDPI (r=0.23, p=0.589).

**Conclusions:** Our results demonstrate higher early post-transplant ddcfDNA values among en-bloc kidney compared to single kidney recipients however, no difference or upward trend is observed beyond month 2 and out to 12 months.

**Funding:** Commercial Support - CareDx

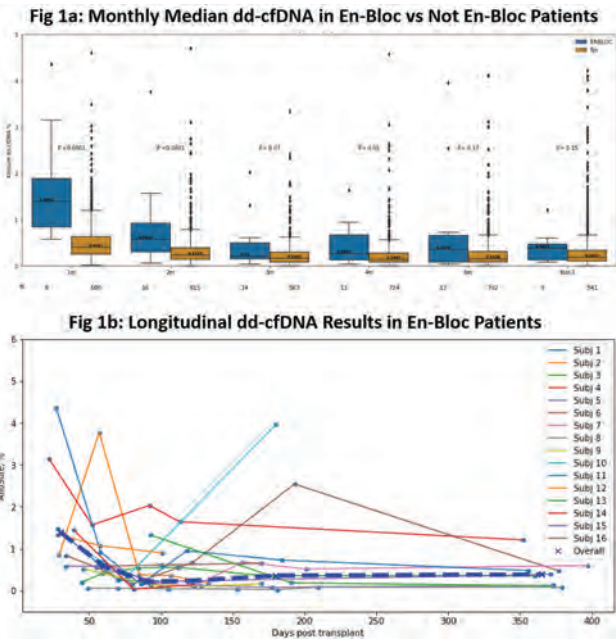

FR-PO795

**Tegoprubart Reduced Inflammation in Patients With Amyotrophic Lateral Sclerosis (ALS): Potential Implications for Its Use in the Prevention of Rejection in Kidney Transplant**

Steven Perrin,<sup>1</sup> Alan Gill,<sup>2</sup> Jeffrey D. Bornstein,<sup>1</sup> Joachim Theilhaber.<sup>1</sup> <sup>1</sup>Eledon Pharmaceuticals, Irvine, CA; <sup>2</sup>ALS Therapeutic Discovery Institute, Boston, MA.

**Background:** Tegoprubart (AT-1501) is a monoclonal antibody that inhibits CD40 ligand (CD40L); it is expected to downregulate both cell mediated and antibody mediated immunity while also creating a more tolerogenic environment, and preventing antibody class switching, reducing high affinity IgG antibodies. Tegoprubart is currently being evaluated in an ongoing trial in kidney transplant (KT).

**Methods:** Tegoprubart was studied in an open-label, dose-escalating trial in patients with ALS. 54 participants received tegoprubart at doses of 1mg/kg (N=9), 2mg/kg (N=9), 4mg/kg (N=18) or 8mg/kg (N=18) IV every 2 weeks for 6 infusions. Safety and the effect of tegoprubart on inflammatory biomarkers were assessed. Target engagement was measured directly via reduction in CD40L and indirectly using CXCL13, a marker of B cell activation. Pro-inflammatory chemokines and cytokines previously shown to be elevated in ALS patients were assessed, and several of these biomarkers may be relevant to the ongoing studies in KT, notably CXCL9 and CXCL10.

**Results:** Tegoprubart appeared safe and well tolerated at the doses administered. Target engagement was achieved in a dose dependent fashion. In this population of ALS patients, tegoprubart reduced inflammatory biomarkers with the same dose dependent pattern as target engagement. Importantly for KT, tegoprubart reduced CXCL9 and CXCL10, chemokines reported to be associated with acute allograft rejection.

**Conclusions:** In a study of patients with ALS, tegoprubart at doses of 4mg/kg and 8mg/kg IV every 2 weeks demonstrated target engagement with an associated reduction in inflammation. Among the inflammatory biomarkers reduced were CXCL9 and CXCL10, positive signals for tegoprubart's ongoing program in KT.

**Funding:** Commercial Support - Eledon Pharmaceuticals

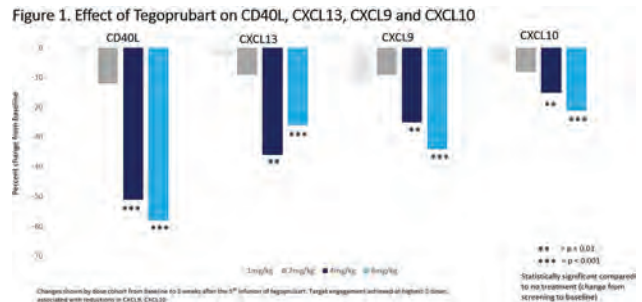

FR-PO797

**Donor Derived Cell-Free DNA in Stable Dual Kidney Transplant Recipients**

Kunal Yadav,<sup>1</sup> Navchetan Kaur,<sup>2</sup> David C. Barnes,<sup>2</sup> Ebad Ahmed,<sup>2</sup> Phil Gauthier.<sup>2</sup> <sup>1</sup>The University of Toledo, Toledo, OH; <sup>2</sup>Natera, Inc., Austin, TX.

**Background:** Dual kidney transplants from deceased donors with limited renal function expand the donor pool to help circumvent the organ shortage. It is unclear whether the donor derived cell-free DNA (dd-cfDNA) fraction, a validated biomarker for the detection of allograft injury, has a different baseline in individuals with dual kidney transplants, compared to those with single kidney transplants. Here we evaluate the baseline dd-cfDNA in a cohort of stable dual kidney transplant recipients (DKTR).

**Methods:** dd-cfDNA testing was performed clinically with the Prospera™ test (Natera, Inc.) on 117 plasma samples from 13 DKTR. dd-cfDNA fractions ≥ 1% were considered at high risk for rejection. Of these patients, 11/13 had functioning grafts, 2/13 patients had interstitial fibrosis and glomerulosclerosis on biopsy and 1/13 patient died during the study. A randomly selected clinical cohort consisting primarily of stable single kidney transplant recipients was chosen for comparison.

**Results:** The median time from transplant to sample collection was 6.4 months (IQR: 2.8-10.6 months). The median dd-cfDNA fraction in DKTR was 0.25% (IQR: 0.14%-0.39%) as compared to 0.23% (IQR: 0.12%-0.45%) from a clinical cohort of 5067 samples. However, in the initial three months post transplant median dd-cfDNA fraction was significantly higher in the DKTR cohort 0.46% (IQR: 0.28%-0.89%) compared to clinical samples 0.30% (IQR: 0.16%-0.54%) (p=0.002). The median dd-cfDNA was similar in organs with kidney donor profile index ≥ 85% vs. < 85%. Locally weighted scatterplot smoothing shows similar DKTR and clinical sample dd-cfDNA fraction trends, plotted against time since transplant, in Figure 1.

**Conclusions:** This preliminary analysis demonstrated that the baseline dd-cfDNA fractions in dual kidney transplants is comparable to that of single kidney transplants from standard criteria donors. Furthermore, the quality of the donor kidneys (KDPI) does not appear to affect baseline dd-cfDNA fractions. This study is limited due to the small cohort size. Future studies will be needed to validate these findings.

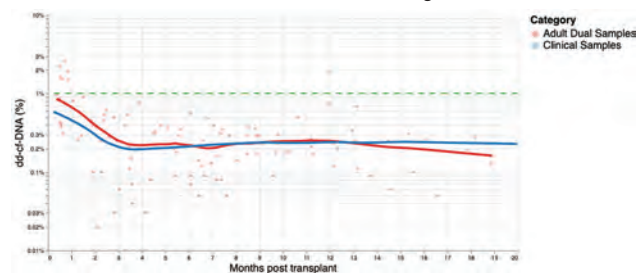

FR-PO798

**Obinutuzumab-Containing Multimodality Induction in Kidney Transplantation**

Evaldo Favi,<sup>1,2</sup> Maria Teresa Gandolfo,<sup>1</sup> Mariarosaria Campise,<sup>1</sup> Samuele Iesari,<sup>1</sup> Carlo Alfieri,<sup>1,2</sup> Marta Perego,<sup>1,2</sup> Giuseppe. Castellano,<sup>1,2</sup> Mariano Ferraresso,<sup>1,2</sup> <sup>1</sup>Fondazione IRCCS Ca' Granda Ospedale Maggiore Policlinico, Milan, Italy; <sup>2</sup>Universita degli Studi di Milano, Milano, Italy.

**Background:** Hard-to-match deceased donor kidney transplant (KT) candidates can rarely benefit from desensitization programs and often arrive at transplant with elevated donor-specific antibodies (DSA) levels. In this particular setting, current

immunosuppressive strategies have been associated with exceedingly high antibody-mediated rejection (AMR) rates and poor graft survivals. We report our experience with a novel induction protocol.

**Methods:** We analysed data from 7 high-risk (PRA 95%, DSA >3000 MFI) deceased donor KT recipients who had been treated with the following scheme. One session of plasma exchange (PEX) was carried out before surgery and 3 sessions between post-op day 5 and 14. Patients received eculizumab 900 mg prior graft reperfusion. Post-op, they were given thymoglobulin 5 mg/kg total dose from day 0 to day 4, IV immunoglobulin 2 gr/kg total dose (after PEX), methylprednisolone, and obinutuzumab 1000 mg within 2 weeks of the last PEX. As maintenance, we used LCP-tacrolimus (C0, 10-15 ng/mL), mycophenolate mofetil (MMF, 2000 mg/day), and prednisone.

**Results:** After a median follow-up of 13 (3-16) months, all patients were alive with a functioning allograft and a median serum creatinine of 1.6 (1.1-2.5) mg/dL. DGF was recorded in 5 recipients. Overall, we observed one episode of cell-mediated rejection and 2 episodes of AMR rejection in 2 patients. Notably, both cases of AMR were recorded before obinutuzumab could be administered (day 7 and day 13). By week 2 after obinutuzumab infusion, all subjects showed full CD19+ cell depletion with no signs of repopulation up to the last visit. Changes in anti-HLA antibodies were extremely variable, but no de novo DSA were identified. Obinutuzumab was not associated with infusion-related adverse events. One of the patients developed severe leukopenia requiring MMF withdrawal. Asymptomatic CMV, EBV, or BKV viraemia were detected in 57%, 14%, and 0% of the recipients, respectively. No features of AMR could be detected in protocol biopsies obtained 6 months after KT.

**Conclusions:** Our experience shows that obinutuzumab induction is safe and effective in high-immunological risk KT recipients. Also, obinutuzumab-induced B-cell depletion appears to be uneffected by concomitant complement inhibition. Such encouraging findings should prompt further investigation.

**FR-PO799**

**Association Between Fecal MicroRNAs and B-Glucuronidase Activity in Kidney Transplant Recipients**

Guillaume C. Onyeaghala,<sup>1,2</sup> Sarah Elmer,<sup>1,2</sup> Mohammad H. Khan,<sup>2</sup> Pa Chia Yang,<sup>1</sup> Matilda Wagner,<sup>2</sup> Levi Teigen,<sup>2</sup> Baolin Wu,<sup>2</sup> Weihua Guan,<sup>2</sup> Christopher Staley,<sup>2</sup> Arthur J. Matas,<sup>2</sup> Samy M. Riad,<sup>2</sup> Casey R. Dorr,<sup>1,2</sup> Rory P. Remmel,<sup>2</sup> William S. Oetting,<sup>2</sup> Pamela A. Jacobson,<sup>2</sup> Ajay K. Israni,<sup>1,2</sup> <sup>1</sup>Hennepin Healthcare Research Institute, Minneapolis, MN; <sup>2</sup>University of Minnesota Twin Cities, Minneapolis, MN.

**Background:** The inactivated metabolite of Mycophenolate mofetil is de-glucuronidated by gut bacterial beta-glucuronidase and the active metabolite MPA is reabsorbed back into the blood. This enterohepatic recirculation likely enhances immunosuppression and toxicity in kidney transplant recipients. Further, host microRNA (miRNA) can influence the microbiome, leading to changes in b-glucuronidase levels. We hypothesized that host miRNA levels would be associated with b-glucuronidase levels in kidney transplant recipients.

**Methods:** In this analysis, 30 stool samples were collected from participants of the Microbiome and Immunosuppression in Kidney Transplantation (MISSION) study within 60 days post-transplant. Fecal miRNA was profiled using the nCounter human v3 miRNA codeset. b-glucuronidase activity levels were measured using the ab234625 Assay Kit. After QC and data normalization, we examined the association of 798 miRNA probes with b-glucuronidase activity. In a secondary analysis, we conducted focused analyses of 17 microbiome associated fecal miRNAs and their association with b-glucuronidase activity.

**Results:** At the Bonferroni corrected 0.05 significance level, we found 20 fecal miRNAs associated with b-glucuronidase activity, with miR-2116-5p, miR-4888 and miR-600 being the most abundant. In our focused analyses, we found that miR-1253, miR-1224-5p, miR-194-5p and miR-200a-3p were associated with b-glucuronidase activity (p-value < 0.05). Interestingly, miR-1224-5p was shown to align with *E. coli* DNA, while miR-1253 was shown to align with *F. nucleatum* DNA (Figure 1), which are known producers of b-glucuronidase enzymes.

**Conclusions:** Our preliminary findings show that fecal miRNAs are associated with b-glucuronidase. Further mechanistic studies are needed to validate these findings. Fecal miRNAs may enter bacteria, such as *E. coli* and *F. nucleatum* and potentially regulate bacterial growth or gene transcripts such as b-glucuronidase.



Figure 1: Alignment of microbiota-associated host miRNA-1253 and miRNA-12245p with *E. coli* and *F. coli* targets.

**FR-PO800**

**A Novel, Sensitive Assay for Rapid Point of Care Monitoring of Tacrolimus Level in Capillary Blood of Kidney Transplant Recipients**

Kamyar Kalantar-Zadeh,<sup>1</sup> Trong Nguyen,<sup>2</sup> Maria Ortega,<sup>2</sup> Yalcin Kulaheci,<sup>3</sup> Fatih Zor,<sup>3</sup> Vijay S. Gorantla,<sup>3</sup> Andrea C. Daza Aguilar,<sup>1</sup> Ekamol Tantisattamo,<sup>1</sup> Uttam G. Reddy,<sup>1</sup> Connie Rhee,<sup>1</sup> Rahul Ganguli,<sup>2</sup> <sup>1</sup>University of California, Irvine, Irvine, CA; <sup>2</sup>Intelligent Optical Systems, Inc., Torrance, CA; <sup>3</sup>Wake Forest for Regenerative Medicine, Winston-Salem, NC.

**Background:** Frequent monitoring of immunosuppression in kidney transplant recipients (KTRs) is needed to prevent allograft rejection and toxicity. This is due to the short therapeutic window and the differences in pharmacokinetics/dynamics across KTRs. Intelligent Optical Systems (IOS) has partnered with the University of California Irvine (UCI) Nephrology and Wake Forest Institute for Regenerative Medicine to develop a novel enhanced lateral flow assay (ELFA) platform, with a point-of-care (POC) assay, to determine tacrolimus (TAC) levels from fingerstick capillary blood.

**Methods:** We performed assay validations for ELFA using spiked whole blood, and then clinical validation using whole blood from 16 KTRs. For technical validation we assessed intra-/inter-assay repeatability based on CV% across measurements of samples spiked at different TAC levels. Each sample was measured with five replicates (n=5) to obtain CV% values. We also built a standard calibration curve (SCC) with n=3 for each level of the relevant ranges to determine the TAC levels from ELFA readouts from KTR samples. ELFA TAC measurements, n=3, of capillary blood from fingerstick were compared to LC-MS measurements of venous blood collected from the same patient immediately before the KTR's next dose of TAC. Pearson correlation was used to estimate ELFA and LC-MS correlations.

**Results:** Inter-/intra-assay assessment with spiked human whole blood demonstrated good repeatability, with CV ≤ 10%. SCCs indicated the assay has good performance in the range from 0-30 ng/ml, with limit of detection of 1 ng/ml. ELFA and LCMS measurements showed strong correlation (r = 0.89) for blood samples from KTRs (figure).

**Conclusions:** The ELFA platform is a minimally invasive, convenient sampling POC device using capillary fingerstick blood, and provides accurate, rapid measurements of TAC, which demonstrate good repeatability and strong correlation against LC-MS standard reference measurements.

**Funding:** Other U.S. Government Support

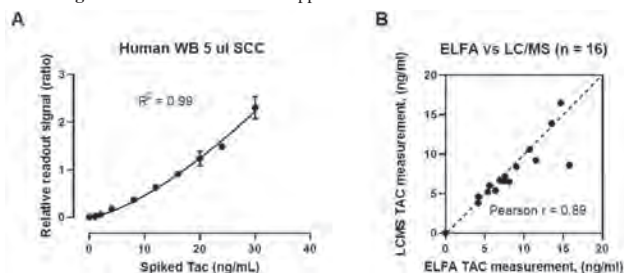

**FR-PO801**

**Metagenomic Detection of Clinical and Potentially Undiagnosed Infections in Kidney Transplant Recipients**

Steven Kleiboeker,<sup>1</sup> Mikaela A. Miller,<sup>1</sup> Rohita Sinha,<sup>1</sup> Sookhyeon Park,<sup>2</sup> Christabel Rebello,<sup>2</sup> Bradley M. Kinsella,<sup>2</sup> John J. Friedewald,<sup>2</sup> <sup>1</sup>Eurofins Viracor Inc, Lee's Summit, MO; <sup>2</sup>Northwestern University Feinberg School of Medicine, Chicago, IL.

**Background:** Kidney transplant recipients are immunosuppressed and predisposed to infections. Current diagnostics detect single pathogens, often by qPCR. Unbiased detection of common viruses with sensitivity and specificity comparable to qPCR allows more comprehensive diagnosis or surveillance. Quantification of donor-derived cell-free DNA (dd cfDNA) is an established method for diagnosis of allograft rejection. Combining dd cfDNA and pathogen detection by sequencing (mNGS) into one test represents an opportunity to screen for both infection and rejection.

**Methods:** A total of 1,980 plasma samples from 256 CTOT-08 study subjects were tested by whole genome sequencing, with dd cfDNA analyzed as described (CJASN 16:1539). Non-human reads underwent reference-assisted assembly and taxonomic annotation using KrakenUseq (K-mers of 16, 21, and 31) trained on ~12,000 viral genomes. Final predictions were made with a majority-wins rule.

**Results:** For transplant viruses, BK virus (BKV) was most often detected (11.5% of samples), followed by cytomegalovirus (CMV, 8.3%), adenovirus (ADV, 2.6%), Epstein Barr virus (EBV, 2.6%) and JC virus (JCV, 2.0%). Concordance with qPCR results was 97.7%. Clinical infections of BKV, CMV and EBV were reported, and a total of 62 samples collected up to 60 days prior to the onset of infection were tested by mNGS (Table 1). The pathogen diagnosed clinically was detected by mNGS for 32 of 33 samples collected at infection onset to 10 days prior to onset. From 11 to 60 days prior to onset, detection ranged from 31% to 50% of samples. Additionally, 19 BKV infections >10,000 copies/mL and 10 CMV infections >1,000 IU/mL, all from different subjects, were detected by mNGS but not reported as clinical infections, suggesting under-diagnosis or lack of reporting for these viruses.



**Conclusions:** Viral detection by sequencing demonstrated sensitive and specific detection of key viral pathogens which correlated with clinical diagnoses, as well as suggested an unrecognized pathogen burden. Prospective studies will assess the clinical utility of combined metagenomic and dd-cfDNA analysis.

**Funding:** Commercial Support - Eurofins Viracor

**Table 1.** Metagenomic NGS detection of viral pathogens prior to reported clinical infection

Clinical Infection	Days prior to onset of clinical infection							
	0	1-10	11-20	21-30	31-40	41-50	51-60	
BKV	15/15*	6/7	4/8	2/4	4/9	5/11	4/8	
CMV	4/4	5/5	1/3	2/4	3/8	0/5	0/1	
EBV	1/1	1/1	N/A	N/A	0/1	N/A	N/A	
<b>TOTAL</b>	<b>20/20</b>	<b>12/13</b>	<b>5/11</b>	<b>4/8</b>	<b>7/18</b>	<b>5/16</b>	<b>4/9</b>	
(%)	(100%)	(92.3%)	(45%)	(50%)	(39%)	(31%)	(44%)	

\*Number detected by mNGS/number diagnosed clinically

**FR-PO802**

**Serum and Urine Uromodulin, Kidney Volume, and Function in Living Kidney Donors**

**Arda Erdut,<sup>1</sup> Jabrayil Jabrayilov,<sup>1</sup> Ceren Önal,<sup>1</sup> Muge Uzerk Kibar,<sup>1</sup> Tuncay Hazirolan,<sup>2</sup> Ali C. Bozaci,<sup>3</sup> Tolga Yildirim,<sup>1</sup> Bulent Altun,<sup>1</sup> Fazil T. Aki,<sup>3</sup> Mustafa Arici.<sup>1</sup>** <sup>1</sup>Hacettepe University Faculty of Medicine, Department of Nephrology, Ankara, Turkey; <sup>2</sup>Hacettepe University Faculty of Medicine, Department of Radiology, Ankara, Turkey; <sup>3</sup>Hacettepe University Faculty of Medicine, Department of Urology, Ankara, Turkey.

**Background:** Uromodulin is an indicator of nephron mass and tubular function. This study has investigated the relationship between serum uromodulin (Sumod), urine uromodulin (Uumod) and remaining kidney volume and function in living kidney donors (LKD).

**Methods:** One hundred LKD (Mean age 52.46 ± 10.38, 65 women, average follow-up 63.23±56.82 months) were included in the study. Kidney volumes were assessed by preoperative abdominal computed tomography and by magnetic resonance imaging at the last clinic visit. Uromodulin levels were measured in blood and urine by uromodulin human ELISA kit.

**Results:** There was a correlation between Sumod and glomerular filtration rate (GFR) (r=-0.29, P=0.006), creatinine (r=-0.25, P=0.02) and age (r=-0.36, P<0.001) (Table 1). 16 donors had chronic kidney disease (CKD) during the follow up. Sumod levels of 16 patients with CKD was lower than those without CKD (78.12±34.19 vs. 94.03±32.55 ng/ml, P=0.047). A strong correlation between Uumod and GFR was found in patients with CKD (r=0.64, P=0.007). Uumod level changed in parallel with the follow-up period (r=0.28, P=0.006). A negative correlation between Uumod and proteinuria difference was demonstrated (r=-0.32, P=0.002). The remaining kidney was found to be enlarged by 22% (Table 2). The increase in volume correlated with GFR (r=0.34, P=0.001) and follow-up time (r=0.37, P<0.001). There was no relationship among Sumod, Uumod and remaining kidney volume.

**Conclusions:** Kidney function in LKD were associated with Sumod, Uumod and remaining kidney volume. Uumod was a better indicator of kidney function in donors who developed CKD.

**Funding:** Government Support - Non-U.S.

	Correlation coefficient (r)	P
<b>Sumod</b>		
GFR	0.29	0.006
Creatinine	-0.25	0.02
Age	-0.36	<0.001
<b>Uumod</b>		
Proteinuria difference	-0.32	0.002
Follow-up period	0.28	0.006
<b>MRI Volume</b>		
GFR	0.29	0.004
Ad-GFR	0.53	<0.001
Follow-up period	0.37	<0.001
<b>Kidney Volume Difference</b>		
Ad-GFR	0.34	0.001
Follow-up period	0.37	<0.001

**Table 1.** Correlations between Sumod and Uumod levels, residual kidney volume, renal function, age and follow-up period after donor nephrectomy. Sumod: Serum uromodulin, Uumod: Urine uromodulin, GFR: Glomerular filtration rate, Proteinuria difference: Change in proteinuria before and after donor nephrectomy, MRI Volume: Residual kidney volume measured by MRI, Kidney Volume Difference: Change in volume of the residual kidney before and after donor nephrectomy

	Preoperative Abdomen CT n=92		Postoperative Abdomen MRI n=98	Change in Volume (ml) (%Δ)	P
	Right	Left	Remaining		
Kidney Volume (ml)	130.66±29.32	140.5±29.57	164±40.88	28.66± 26.67 (%22)	<0.001
BSA Adjusted Kidney Volume (ml/m <sup>2</sup> )	72.17±13.8	77.53±12.81	89.58±17.48	14.11± 17 (%22.28)	<0.001

**Table 2.** Patients' kidney volumes before and after donor nephrectomy and change in volume of the remaining kidney. BSA: Body surface area.

**FR-PO803**

**Enhanced Histological Yield and Actionable Findings When Biopsy Is Guided by Donor-Derived Cell-Free DNA (dd-cfDNA)**

**Matthew R. Weir,<sup>1</sup> Didier A. Mandelbrot,<sup>2</sup> Emilio D. Poggio,<sup>3</sup> Jonathan Bromberg,<sup>1</sup> Shikha Mehta,<sup>4</sup> Wenlan Tian,<sup>5</sup> Nikhil Agrawal,<sup>5</sup> Matthew Cooper.<sup>6</sup>** <sup>1</sup>University of Maryland Baltimore, Baltimore, MD; <sup>2</sup>University of Wisconsin System, Madison, WI; <sup>3</sup>Cleveland Clinic, Cleveland, OH; <sup>4</sup>University of Alabama, Birmingham, AL; <sup>5</sup>CareDx Inc, Brisbane, CA; <sup>6</sup>MedStar Georgetown University Hospital, Washington, DC.

**Background:** Implementation of molecular biomarkers in kidney transplantation has expanded the amount of information available to clinicians before deciding to pursue biopsy. We evaluated how use of donor-derived cell-free DNA testing (dd-cfDNA) impacts histologic biopsy yield.

**Methods:** 1663 kidney transplant (KTx) recipients enrolled in the Kidney allograft Outcomes AlloSure Registry (KOAR, NCT03326076) were followed with dd-cfDNA post-transplant; testing was obtained either as part of a surveillance strategy or for-cause; indications for biopsy and histologic diagnoses were captured. This analysis included only for-cause biopsies.

**Results:** 65 biopsies (from 59 pts) driven by elevated dd-cfDNA levels were compared to 540 biopsies (392 pts) obtained for causes other than elevated dd-cfDNA. Patient age (55 vs 56 years), percent deceased donor (84.75% vs 78.83%), and biopsy timing post-transplant (123 vs 105.5 days) did not differ between groups. Among dd-cfDNA-guided biopsies, yield was enriched for rejection (48% vs 29%) and included fewer cases of ATII/ATN (12% vs 22%) compared to biopsies obtained for other causes (p<0.05) [Figure 1]. Among dd-cfDNA-guided biopsies with rejection (ABMR, TCMR, or Mixed), median dd-cfDNA was 1.46% (IQR: 1.15 - 2.87). Among biopsies not performed due to elevated dd-cfDNA but with paired results available (n = 267), median dd-cfDNA was 0.24%. Within this group, patients with rejection had median dd-cfDNA of 0.82% and demonstrated an increase of 133% from the preceding result.

**Conclusions:** Dd-cfDNA surveillance enhances the histologic yield for actionable results in for-cause allograft biopsies. A low dd-cfDNA result can obviate the need for biopsy even in the presence of other clinical factors that are routinely used to guide the biopsy decision.

**Funding:** Commercial Support - CareDx

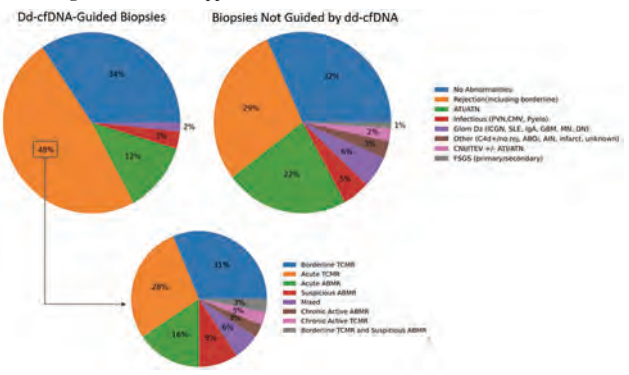

**FR-PO804**

**Elevated Donor-Derived Cell-Free DNA (dd-cfDNA) in the Early Post-Transplant Period Is Associated With an Increased Incidence of Adverse Clinical Outcomes in Kidney Transplant Recipients**

**David Wojciechowski,<sup>1</sup> Daniel C. Brennan,<sup>2</sup> Anil S. Paramesh,<sup>3</sup> Jeffrey A. Klein,<sup>4</sup> Nikhil Agrawal,<sup>5</sup> Mingwei Fei,<sup>5</sup> Kunbin Qu,<sup>5</sup> Puneet Sood.<sup>6</sup>** <sup>1</sup>The University of Texas Southwestern Medical Center, Dallas, TX; <sup>2</sup>Johns Hopkins University School of Medicine, Baltimore, MD; <sup>3</sup>Tulane University School of Medicine, New Orleans, LA; <sup>4</sup>University of Missouri Kansas City, Kansas City, MO; <sup>5</sup>CareDx Inc, Brisbane, CA; <sup>6</sup>UPMC, Pittsburgh, PA.

**Background:** Early post-transplant elevations in dd-cfDNA, even in the absence of histologic rejection or other overt pathology, have been suggested to carry a risk of adverse outcomes among solid organ transplant recipients. We investigated this association among kidney transplant recipients enrolled in the Kidney allograft Outcomes AlloSure Registry (KOAR, NCT03326076).

**Methods:** To assess the impact of early post-transplant dd-cfDNA elevations, we evaluated the incidence of a clinical composite that included biopsy-proven rejection (BPAR), detection of de novo donor specific antibodies (dnDSA) and return to dialysis in patients with and without median dd-cfDNA >1% over the first 100 days post-transplant. Patients with events before day 100 were excluded. Univariate and multivariate analyses were performed.

**Results:** 51 of 1296 patients (3.9%) had a median dd-cfDNA ≥1.0% during the first 100 days post-transplant. In a univariate model, these patients had a significantly higher risk of experiencing both the composite outcome and each individual component during the first post-transplant year [Figure 1]. In a multivariate Cox proportional hazards model that included recipient age, delayed graft function, donor type (living vs deceased), and recipient sensitization, only 100-day median dd-cfDNA elevation ≥1.0% was a statistically significant predictor of the composite outcome, with a hazard ratio of 2.99 (95% CI: 1.59 -5.61, p < 0.005).

**Conclusions:** Our findings suggest that early post-transplant elevations in dd-cfDNA among kidney transplant recipients, even in the absence of clear immunologic or histologic correlates, identify a population of patients at risk for adverse clinical outcomes during the first post-transplant year. Molecular risk-stratification using dd-cfDNA may have implications for clinical surveillance and therapeutic management of these patients.

**Funding:** Commercial Support - CareDx

**Figure 1: Rejection, dnDSA, and Death-Censored Graft Loss after Day 100**

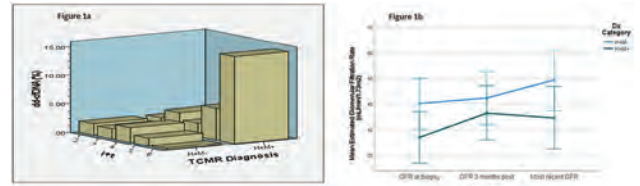
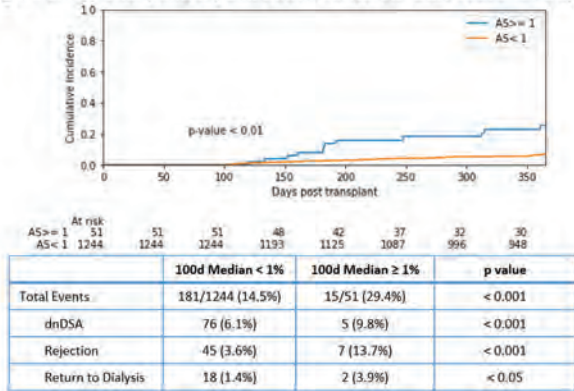

**FR-PO806**

**Predictors of Kidney Delayed Graft Function and Its Prognostic Impact Following Combined Liver-Kidney Transplantation**

Paolo Vincenzi,<sup>1,2</sup> Jeffrey J. Gaynor,<sup>1</sup> Gaetano Ciancio,<sup>1</sup> Miami Transplant Institute <sup>1</sup>Miami Transplant Institute, Miami, FL; <sup>2</sup>ASUR Area Vasta 1 Pesaro Fano Urbino, Pesaro, Italy.

**Background:** Combined liver-kidney transplantation (CLKT) improves patient survival among liver transplant recipients with renal dysfunction. However, kidney delayed graft function (KDGF) still represents a common and challenging complication that can negatively impact clinical outcomes. This retrospective study analyzed the incidence, potential risk factors, and prognostic impact of KDGF development following CLKT in a recently transplanted cohort.

**Methods:** 115 consecutive CLKT recipients who were transplanted at our center between January 2015 and February 2021 were studied. All transplanted kidneys received hypothermic pulsatile machine perfusion (HPMP) prior to transplant. The primary outcome was KDGF development. Secondary outcomes included the combined incidence and severity of developing postoperative complications, development of postoperative infections, biopsy-proven acute rejection (BPAR), renal function at 1, 3, 6, and 12 months post-transplant, and death-censored graft and patient survival.

**Results:** KDGF was observed in 37.4% (43/115) of patients. Multivariable analysis of KDGF revealed the following independent predictors: preoperative dialysis (P=0.0003), lower recipient BMI (P=0.006), older donor age (P=.003), utilization of DCD donors (P=0.007), and longer delay of kidney transplantation after liver transplantation (P=0.0003). With a median follow-up of 36.7 months post-transplant, KDGF was associated with a significantly increased risk of developing more severe postoperative complication(s) (P<0.000001), poorer renal function (P<0.000001), and worse death-censored graft (P=.00004) and patient survival (P=.0002).

**Conclusions:** KDGF may be responsible for remarkable negative effects on immediate and potentially longer-term clinical outcomes after CLKT. Understanding the important risk factors for KDGF development in CLKT may better guide recipient and donor selection(s) and improve clinical decisions in this increasing group of transplant recipients.

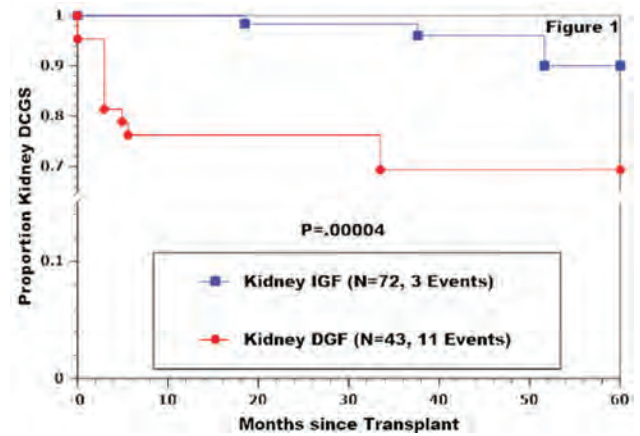

**FR-PO807**

**Safety of Sodium-Glucose Cotransporter 2 Inhibitors and Glucagon-Like Peptide-1 Receptor Agonists in Diabetic Kidney Transplant Recipients**

Tarek S. Mahmoud,<sup>1,2</sup> Jude A. Yagan,<sup>1,2</sup> Amal Hasan,<sup>3</sup> Osama Gheith,<sup>1</sup> Mohamed M. Mostafa,<sup>1</sup> Suzann Rida,<sup>1</sup> Mohamed Shaker,<sup>1</sup> Mahmoud M. Abdrabou.<sup>1</sup> <sup>1</sup>Hamed Al-Essa Transplant Center, Kuwait City, Kuwait; <sup>2</sup>Jaber Al Ahmed Armed Forces Hospital, Kuwait, Kuwait; <sup>3</sup>Dasman Diabetes Institute, Kuwait City, Kuwait.

**Background:** Kidney transplant recipients (KTRs) with type 2 diabetes (T2D) have poorer cardiovascular and renal outcomes. The favorable impact of the new glucose lowering therapies like sodium-glucose cotransporter 2 inhibitors (SGLT2i) and Glucagon-like peptide-1 receptor agonists (GLP-1RA) on patients with T2D is clearly evident now based on the recent outcome trials. However, there is inertia in using these drugs for KTRs due to the fear of their side effects and the absence of clear guidelines. We retrospectively assessed the efficacy, safety and short-term outcomes of these drugs.

**FR-PO805**

**Correlation of Donor-Derived Cell-Free DNA With Histology and Molecular Diagnoses of T-Cell Mediated Rejection in Kidney Transplant Biopsies**

Dhiren Kumar,<sup>1</sup> Irfan A. Moinuddin,<sup>1</sup> Layla Kamal,<sup>1</sup> Johanna L. Christensen,<sup>1</sup> Meagan Shinbashi,<sup>1</sup> Nihar G. Raju,<sup>1</sup> Robert J. Minniti,<sup>1</sup> Philip F. Halloran,<sup>2</sup> Gaurav Gupta.<sup>1</sup> <sup>1</sup>Virginia Commonwealth University Health System, Richmond, VA; <sup>2</sup>University of Alberta, Edmonton, AB, Canada.

**Background:** We reported correlation of donor-derived cell-free DNA (dd-cfDNA) with histologic and molecular diagnosis (MMDx) of kidney transplant biopsies (Gupta et al, Transplantation 2021). Here we build on that initial cohort with a larger TCMR sample size and provide data on therapy and outcomes.

**Methods:** We identified biopsies classified as TCMR by histology and/or MMDx. Those with viral/bacterial nephritis/mixed rejection were excluded. 37 such biopsies were divided into two groups, H+M+ (concomitant TCMR; N=18) and H+M- (discordant TCMR; N=19).

**Results:** Median dd-cfDNA was lower (p=0.02) in H+M- (0.32%; IQR: 0.15-0.43) compared to H+M+ group (1.03%; IQR: 0.38-1.8). In histologic findings interstitial and tubular inflammation (i+t) (4.8±1.5 vs 3.3±1.2, p=0.002) was worse for H+M+ vs H+M-. A graded dose-response was seen between i+t and dd-cfDNA for H+M+ and not seen in H+M- (Figure 1a). Borderline/1A TCMR was seen frequently in the H+M- (16/19, 84%) while TCMR ≥1B was seen in the H+M+ group (12/18, 67%). MMDx scores for TCMR (0.50±0.29 vs 0.02±0.02, p<0.0001) and inflammation (4.6±2.1 vs -0.55±1.5, p<0.0001) were higher in the H+M+ vs H+M- group. eGFR at biopsy was worse in the H+M+ group (27±19ml/min) compared to the H+M- (40±23ml/min; p=0.06). A majority of H+M+ were treated (16/18; 89%; 14 rATG and 2 steroids only) and a minority of H+M- received steroids only (7/19; 37%). Despite this discrepancy, there was improvement in eGFR in both groups. At median follow-up of 14.7 months eGFR improved to 34±24ml/min in the H+M+ and 49.2±26ml/min in the H+M- group (Figure 1b). All 4 graft losses and one patient death was in the H+M+ group (p=0.02).

**Conclusions:** We confirm our findings in patients with histologic TCMR absent on molecular gene expression is associated with low dd-cfDNA. Majority of patients had improvement in kidney function without targeted therapy. This may indicate low-grade TCMR is a ‘response to wounding’, rather than cognate allo-recognition.

**Key: TH - Thursday; FR - Friday; SA - Saturday; OR - Oral; PO - Poster; PUB - Publication Only**

**Underline represents presenting author.**

**Methods:** We collected one year follow up data from records of 98 diabetic KTRs who received SGLT2i and 41 who received GLP-1RA in addition to standard of care therapy (SOC) for at least 3 months. We compared them to 70 diabetic KTRs who were on only SOC. Patients were over 3 months post-transplant with minimum estimated glomerular filtration rate (eGFR) of 25 ml/min/1.73m<sup>2</sup>. No significant difference in the demographics between the groups except for a lowish HbA1c in the control group (8.0% versus 7.2%)

**Results:** HbA1c dropped by 0.4% in SGLT2i (p=0.0001) and GLP-1RA (p=0.0003) compared to only 0.05% in the control group. BMI decreased by 0.32 (p=0.0450) in SGLT2i and 0.34 (p=0.0105) in GLP-1RA compared to an increase by 0.015 in control group. There was a tendency for better eGFR by the end of the year in both study groups (figure 1) though it was not statistically significant except for KTRs on SGLT2i with eGFR more than 90 ml/min (p=0.0135). A dip in eGFR was observed in SGLT2i group at 1 and 3 months. Albuminuria was significantly reduced at 12 months in SGLT2i by a median of 28 mg/mmol (p=0.0095) and by 20 mg/mmol in GLP-1RA (p=0.0072) compared to increase by 3.4 mg/mmol in control group (figure 2). Adverse events were minimal.

**Conclusions:** Use of SGLT2i and GLP-1RA appears to be safe in diabetic KTRs with good outcome. Randomized control trials are required to confirm these findings and establish guidelines.

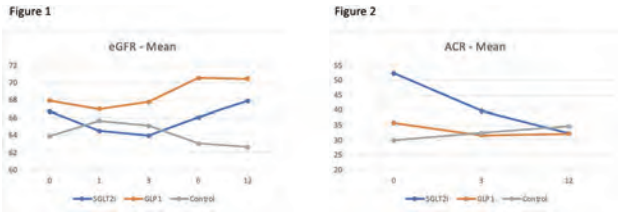

**FR-PO808**

**Measured Glomerular Filtration Rate Compared to Creatinine and Cystatin C Estimating Equations in Predicting Graft Failure, Cardiovascular Events, and Death in Kidney Transplant (KTx) Recipients**

Mira T. Keddis, Matthew Howard, Nan Zhang, Richard J. Butterfield, Andrew D. Rule. Mayo Foundation for Medical Education and Research, Scottsdale, AZ.

**Background:** We compared CysC eGFR, Cr eGFR, Cr-CysC eGFR and measured GFR in predicting graft failure, cardiovascular (CV) events, and death in a cohort of KTx recipients.

**Methods:** Consecutive adults that received a KTx between 2011-2013 at a single center were evaluated. CysC eGFR, Cr eGFR, Cr-CysC eGFR, and mGFR by urinary iohalamate clearance were obtained at the same time at least 1 year after KTx. The risk of graft failure or of CV events or death with eGFR was assessed after adjusting for mGFR, and for risk factors (recipient age, diabetes, serum albumin, hemoglobin, deceased donor transplant, 24-hour urine protein, and history of CV events).

**Results:** There were 1148 recipients: mean age 56.0 years, 56% male, 35% with diabetes, 94% with hypertension, 11% with prior history of CV events, 53% required dialysis, and 76% received living donor KTx. After a median follow-up of 74 months, there were 203 (18%) graft failures, 229 (20%) deaths, and 290 (25%) CV events. Graft failure and CV events or death were predicted by lower GFR by any method (Figure 1). After adjusting for mGFR, CysC eGFR and Cr-CysC eGFR but not Cr eGFR were predictive of graft failure. After adjusting for risk factors, CysC eGFR and Cr-CysC eGFR remained predictive of graft failure. After adjusting for mGFR, CysC eGFR and Cr-CysC eGFR but not Cr eGFR were predictive of CV events or death. After further adjusting for risk factors, CysC and Cr-CysC eGFR no longer predicted CV events or death.

**Conclusions:** In KTx recipients, Cr eGFR predicts clinical outcomes via the same pathway as mGFR, whereas CysC eGFR and Cr-CysC eGFR predict these same outcomes via both GFR and non-GFR pathways. The risk of CV events or death via the non-GFR biology of CysC appears to be via the same pathway as risk factors for CV disease. These findings do not support the routine use of CysC based eGFR in KTx recipients due to its non-GFR biology that distorts the prediction outcomes.

GFR method and prediction of graft failure (per-10ml/min/1.73m <sup>2</sup> )	Unadjusted HR(95% CI), p-value	Adjusted for mGFR alone	Adjusted for mGFR and risk factors *
mGFR	1.53 (1.46, 1.55), p<0.001	-	-
Cr eGFR	1.49 (1.37, 1.52), p<0.001	1.37 (0.984, 1.46), p=0.025	1.11 (0.905, 1.33), p<0.001
CysC eGFR	1.76 (1.63, 1.90), p<0.001	1.50 (1.32, 1.42), p<0.001	1.83 (1.33, 1.72), p<0.001
Cr-CysC eGFR	1.48 (1.54, 1.73), p<0.001	1.50 (1.21, 1.86), p<0.001	1.33 (1.07, 1.67), p<0.002

GFR method and prediction of CV events or death (per-10ml/min/1.73m <sup>2</sup> )	Unadjusted HR(95% CI), p-value	Adjusted for mGFR alone	Adjusted for mGFR and risk factors *
mGFR	1.28 (1.17, 1.39), p<0.001	-	-
Cr eGFR	1.18 (1.07, 1.30), p<0.001	0.993 (0.895, 1.08), p=0.712	0.957 (0.865, 1.06), p=0.893
CysC eGFR	1.40 (1.25, 1.57), p<0.001	1.43 (1.25, 1.64), p<0.001	1.08 (0.940, 1.24), p=0.272
Cr-CysC eGFR	1.31 (1.18, 1.45), p<0.001	1.15 (1.00, 1.31), p=0.043	1.00 (0.873, 1.13), p=0.388

Figure 1

\*Risk factors include recipient age, diabetes, serum albumin, hemoglobin, deceased donor transplant, 24-hour urine protein, and history of CV events.

**FR-PO809**

**Malignancy Risk in Kidney Transplant Recipients Exposed to Immunosuppression Pre-Transplant for the Treatment of Glomerulonephritis**

David Massicotte-Azarniouch,<sup>1,2</sup> Randal K. Detwiler,<sup>2</sup> Yichun Hu,<sup>2</sup> Ronald Falk,<sup>2</sup> Manish K. Saha,<sup>2</sup> Susan L. Hogan,<sup>2</sup> Vimal K. Derebaal.<sup>2</sup>  
<sup>1</sup>University of Ottawa, Ottawa, ON, Canada; <sup>2</sup>University of North Carolina System, Chapel Hill, NC.

**Background:** Kidney transplant patients with glomerulonephritis (GN) as their native disease may be exposed to significant amounts of pre-transplant immunosuppression (PTI), which could increase the risk for the development of malignancy post-transplant.

**Methods:** We conducted a single-center, retrospective study of adult and pediatric kidney transplant recipients at University of North Carolina Hospitals from January 2005 until May 2020. Patients with GN as their native kidney disease who received PTI for the treatment of GN (n=184) were compared to a control cohort (n=579) of non-diabetic, non-PTI receiving kidney transplant patients. We calculated hazard ratios (HR) with 95% confidence intervals (95%CI) for the outcomes of the first occurrence of solid or hematologic malignancy, non-melanoma skin cancer (NMSC) and post-transplant lymphoproliferative disorder (PTLD).

**Results:** Over a median follow-up of 5.7 years, PTI for GN was associated with significantly increased risk for malignancy compared to controls (13.0% vs 9.7% respectively, adjusted HR 1.82 [95%CI 1.10-3.00]), but not for NMSC (10.3% vs 11.4% respectively, adjusted HR 1.09 [95%CI 0.64-1.83]) nor PTLD (3.3% vs 3.1% respectively, adjusted HR 1.02 [95%CI 0.40-2.61]). The risk for malignancy was significantly increased in those who received cyclophosphamide (HR 2.59 [95%CI 1.48-4.55]) or rituximab (HR 3.82 [95%CI 1.69-8.65]) pre-transplant, and particularly in those who received both cyclophosphamide and rituximab, but not for calcineurin inhibitors nor mycophenolate.

**Conclusions:** The use of PTI for treatment of GN, in particular cyclophosphamide or rituximab, is associated with increased risk for development of solid or hematologic malignancy post-transplant.

**FR-PO810**

**Urinary Copper Excretion Is Associated With Graft Failure in Kidney Transplant Recipients**

Manuela Yepes Calderon,<sup>1</sup> Daan Kremer,<sup>1</sup> Tim J. Knobbe,<sup>1</sup> Kai Luersen,<sup>2</sup> Michele F. Eisenga,<sup>1</sup> Martin H. De Borst,<sup>1</sup> Gerjan Navis,<sup>1</sup> Gerald Rimbach,<sup>2</sup> Stephan J. Bakker.<sup>1</sup> TransplantLines Investigators <sup>1</sup>Universitair Medisch Centrum Groningen, Groningen, Netherlands; <sup>2</sup>Christian-Albrechts-Universität zu Kiel Institut für Humanernährung und Lebensmittelkunde, Kiel, Germany.

**Background:** Urinary copper (Cu) excretion increases with the development of proteinuria due to an increase in excretion of Cu carries. This Cu overload is proposed to enhance nephropathy through tubular damage. We aimed to assess whether in kidney transplant recipients (KTR) proteinuria is associated with urinary Cu excretion. Furthermore, if urinary Cu excretion is associated with the biomarker of tubular damage urinary liver-type fatty acid-binding protein (u-LFABP) and with graft failure development.

**Methods:** In this prospective cohort study, KTR with a functioning allograft ≥ 1 year were recruited. Urinary Cu was measured in 24-hours urine samples by coupled plasma mass spectrometry. Multivariable linear regression and Cox regression analyses were performed.

**Results:** In 693 KTR (57% men, 53 ± 13 years old), baseline Cu excretion was 23.57 [Interquartile range (IQR) 11.32–15.87] µg. Cu was directly associated with proteinuria (Std β 0.45, P<0.001) independent of graft function and with u-LFABP (Std β 0.34, P<0.001) independent of proteinuria. During a median follow-up of 5.3 years, 83 (12%) KTR developed GF. Being on the third tertile of urinary Cu excretion was associated with an increased risk of GF (HR 2.94 [95% CI 1.34–6.45]; P < 0.001) independent of adjustment by multiple potential confounders. u-LFABP significantly mediated this association accounting for 46% of the total effect.

**Conclusions:** We concluded that in KTR proteinuria is associated with increased Cu excretion and this is further associated with the risk of graft failure apparently by enhancing tubular damage. Further studies seem warranted to elucidate whether Cu-targeted interventions may decrease the burden of GF in KTR.

**Funding:** Government Support - Non-U.S.

Number of events	Tertile 1			Tertile 2			Tertile 3		
	10	26	47	Reference	Hazard ratio (95%CI)	P	Reference	Hazard ratio (95%CI)	P
<b>Cox Regression</b>									
<b>Crude</b>	Reference	2.62 (1.26-5.43)	0.01	Reference	5.07 (2.56-10.04)	<0.001			
<b>Model 1</b>	Reference	1.89 (0.86-4.14)	0.11	Reference	2.94 (1.34-6.45)	0.007			
<b>Model 2</b>	Reference	1.85 (0.83-4.11)	0.13	Reference	3.19 (1.44-7.06)	0.004			
<b>Model 3</b>	Reference	2.18 (0.99-4.80)	0.05	Reference	3.45 (1.57-7.58)	0.002			

**Urinary Copper excretion and graft failure.** Model 1: adjustment for age, sex, eGFR, proteinuria, 24-hours urinary volume, and u-LFABP. Model 2: Model 1 + pre-emptive transplantation, transplant vintage, donor type, donor age, donor sex, and HLA mismatch. Model 3: Model 1 + prednisolone cumulative dose, use of calcineurin inhibitors and proliferation inhibitors, and acute rejection treatment.

## FR-PO811

**One Year Outcome of SGLT2 Inhibitors Amongst Diabetic Kidney Transplant Recipients**

Chelsey Song, Andrew Brown, Ryan Winstead, Sara Sterling, Johanna L. Christensen, Idris Yakubu, Gaurav Gupta. *Virginia Commonwealth University, Richmond, VA.*

**Background:** The use of Sodium Glucose Linked Transporter Inhibitors (SGLT-2i) among non-transplant diabetic patients with chronic kidney disease (CKD) have demonstrated reduced cardiovascular mortality and delayed CKD progression. As more published data has validated the early safety outcomes of SGLT-2i, there is currently a lack of evidence on the long term renal benefits amongst kidney transplant (KT) recipients and its impact on kidney function, and metabolic outcomes. We aimed to bridge this knowledge gap and report our 12 months experience with SGLT-2i at our center.

**Methods:** This was a single center, retrospective study conducted in adult KT recipients who met SGLT-2i initiation criteria at our center. Patients were eligible if they had type II diabetes (pre-existing or new onset post-transplant); no AKI  $\leq$ 30 days prior to drug initiation; and an estimated glomerular filtration rate (eGFR)  $>$  25 mL/min. Primary outcomes were changes in weight, hemoglobin A1C (HbA1C), and eGFR. Secondary outcomes included rates of treated urinary tract infections (UTIs), diabetic ketoacidosis (DKA), amputations, and sever. Choice of the specific SGLT-2i agent was based upon insurance preference.

**Results:** 123 patients met enrollment criteria. The median time to initiation from transplant was 250 days (IQR 88-887). The mean change in eGFR from the time of initiation to 6 and 12 months of therapy was 2.95 mL/min [(SD:14.8, p=0.04(CI:0.19,5.72)] and 4.09 mL/min [(SD:17.7, p=0.02 (CI: 0.60,7.57))]. There were also significant improvement in weight by -1.35 kg [(SD 3.27, p=0.001 (CI:-0.75, -1.96))] over the course of 12 months. Mean change in HbA1c was 0.05 [(SD 1.72, p=0.759 (CI: -0.28, 0.39))]. Of those, 112 (91%) received empagliflozin, 2 (2%) canagliflozin, and 9 (7%) dapagliflozin. Overall 1 patient had euglycemic DKA, and 18 (15%) experienced UTI, none of the patients experienced amputations or hospitalizations due drug induced AKI.

**Conclusions:** Amongst diabetic KT patients, we found that patients who were treated SGLT-2i had statistically significant improvement in eGFR at 6 and 12 months. The risk of adverse events with SGLT-2i initiation post-kidney transplant were comparable with previously published data and confer a trend towards both improvement in renal function and metabolic profile.

## FR-PO812

**Clinical Significance of Incident Osteoporotic Fractures After Kidney Transplantation: A Nationwide Matched Comparative Cohort Study**

Yunyoung Jang,<sup>1</sup> Ji Eun Kim,<sup>2</sup> Jina Park,<sup>3</sup> Sehoon Park,<sup>4</sup> Yong Chul Kim,<sup>1</sup> Kwon Wook Joo,<sup>1</sup> Hajeong Lee.<sup>1</sup> <sup>1</sup>*Seoul National University Hospital, Jongno-gu, Seoul, Republic of Korea;* <sup>2</sup>*Korea University Guro Hospital, Seoul, Republic of Korea;* <sup>3</sup>*Biomedical Research Institute of Seoul National University Hospital, Seoul, Republic of Korea;* <sup>4</sup>*Seoul National University College of Medicine, Seoul, Republic of Korea.*

**Background:** Osteoporotic fracture is one of the main concerns of kidney transplantation recipients (KTR) due to mineral bone disorders and the use of immunosuppressive agents including glucocorticoid, although its incidence and clinical significance remains unclear.

**Methods:** We constructed a nationwide cohort consisting of 141,674 end-stage kidney disease patients from 2008 to 2020 using the National Health Insurance System database of Korea. We excluded patients experiencing parathyroidectomy and previous osteoporotic fracture or taking osteoporosis-treating medication. Then, we compared osteoporotic fracture incidence between KTRs and 1:1-matched dialysis patients. Osteoporotic fractures are defined as fractures associated with low bone mineral density including hip, spine, forearm, and humerus. After the comparison, we explored the effect of incident osteoporotic fracture after kidney transplantation on death and death-censored graft failure using fracture status as a time-varying covariate in an extended Cox model.

**Results:** After exclusion, 53964 dialysis patients and 12297 KTRs were included and their new-onset osteoporotic fracture was 8.0% of dialysis patients and 5.0% of KTRs, respectively. After matching, both groups showed similar incidence of osteoporotic fracture with 5.2% of dialysis patients and 5.6% of KTRs, respectively. During overall 5.7  $\pm$  3.0 years of follow up, KTRs showed a lower risk for the incident osteoporotic fracture than matched dialysis controls (adjusted hazard ratio [aHR] 0.83, 95% CI 0.73-0.94, p = 0.04). Among osteoporotic fracture sites, the hip was significantly lower (aHR 0.43, 95% CI 0.33-0.57, p <0.001) in KTRs, although the other sites were not. Among KTRs, the incident osteoporotic fracture was associated with an elevated risk of mortality (aHR 2.07, 95% CI: 1.54-2.78, p<0.001), but not with death censored graft failure (aHR 1.29, 95% CI: 0.96-1.72, p=0.087)

**Conclusions:** Incident osteoporotic fracture risk was significantly lower in KTRs than in patients remaining in dialysis. However, once it occurred in KTRs, it was associated with a higher mortality risk than in KTRs without experience of it.

## FR-PO813

**The Application of Artificial Intelligence in IgA Nephropathy After Kidney Transplantation**

Xumeng Liu,<sup>1,2</sup> Qunjuan Lei,<sup>3,2</sup> Xiaoshuai Hou,<sup>4</sup> Dongmei Liang,<sup>1,2</sup> Feng Xu,<sup>2</sup> Shaoshan Liang,<sup>2</sup> Dandan Liang,<sup>2</sup> Fan Yang,<sup>2</sup> Yuan Ni,<sup>4</sup> Guotong Xie,<sup>4</sup> Cai-hong Zeng.<sup>2</sup> <sup>1</sup>*Nanjing University, Nanjing, China;* <sup>2</sup>*Nanjing General Hospital of Nanjing Military Command Research Institute of Nephrology, Nanjing, China;* <sup>3</sup>*Southern Medical University, Guangzhou, China;* <sup>4</sup>*Ping An Healthcare Technology, Shanghai, China.*

**Background:** A convolutional neural network named Analytic Renal Pathology System (ARPS) was trained to identify glomerular lesions in immunoglobulin A nephropathy (IgAN). However, whether ARPS can be applied to renal graft biopsy is still unknown. This study aimed to analyze the application of ARPS in transplant patients with IgAN.

**Methods:** From January 2016 to April 2020, patients diagnosed as IgAN by renal graft biopsy in our center were collected. The performance of ARPS in transplant patients with IgAN was evaluated. The correlation of clinicopathologic data were further analyzed.

**Results:** A total of 57 patients were enrolled. The median (interquartile range: IQR) age at renal biopsy was 32 (28, 40) years. ARPS could identify the types of glomerular lesions and intrinsic cells in transplant patients with IgAN, achieving F1-scores for different lesions ranged between 72.40% and 96.05%. The ratio of mesangial cells (M), endothelial cells (E), and podocytes (P) was 0.37:0.39:0.25. Compared with autologous IgAN patients (0.41:0.36:0.23), the percentage of E was higher in transplant patients with IgAN. Urine protein level was negatively correlated with the number of P (p<0.05), but positively correlated with mesangial area (p<0.05). Serum creatinine level was negatively correlated with the number of E (p<0.05). The course of disease after transplantation was positively correlated with the glomerular and mesangial area (p<0.05). According to the results of receiver operating characteristic curve, the lower number of E or P, and higher percent segmental sclerosis (SS) or glomerular sclerosis (GS) could indicate poorer prognosis, with all the area under curve of them greater than 0.7 (p<0.05).

**Conclusions:** ARPS can automatically identify and quantify the types of glomerular lesions and intrinsic cells in transplant patients with IgAN. The ARPS quantified glomerular lesions and intrinsic cells correlated well with key clinical indicators and the prognosis of transplant patients with IgAN.

**Funding:** Government Support - Non-U.S.

## FR-PO814

**Associations of Social Determinants of Health With SGLT2 Inhibitor Use in Kidney Transplant Recipients: A National Study**

Krista L. Lentine,<sup>1</sup> Kana N. Miyata,<sup>1</sup> Yasar Caliskan,<sup>1</sup> Nagaraju Sarabu,<sup>2</sup> Sandeep Singh Dhindsa Dhindsa,<sup>1</sup> David Axelrod,<sup>3</sup> Huiling Xiao,<sup>1</sup> Mara McAdams-DeMarco,<sup>4</sup> Sunjae Bae,<sup>4</sup> Gregory Hess,<sup>5</sup> Corey Joseph,<sup>6</sup> Daniel C. Brennan,<sup>6</sup> Mark Schnitzler.<sup>1</sup> <sup>1</sup>*Saint Louis University School of Medicine, Saint Louis, MO;* <sup>2</sup>*University Hospitals, Cleveland, OH;* <sup>3</sup>*University of Iowa, Iowa City, IA;* <sup>4</sup>*New York University, New York, NY;* <sup>5</sup>*Thomas Jefferson University, Philadelphia, PA;* <sup>6</sup>*Johns Hopkins University, Baltimore, MD.*

**Background:** Recent clinical trials demonstrate benefits of SGLT2 inhibitors (SGLT2i) in patients with chronic kidney disease, but data on SGLT2i use in kidney transplant (KTx) recipients are limited.

**Methods:** We examined a novel database linking SRTR registry data for KTx recipients (2000-2021) with outpatient fill records from a large pharmaceutical claims warehouse (2015-2021). Adult (age  $\geq$ 18) KTx recipients treated with SGLT2i were compared to those who received other non-insulin diabetes medications without SGLT2i. Characteristics associated with SGLT2i use were quantified by multivariable logistic regression (adjusted odds ratio, aOR).

**Results:** Among 18,988 KTx recipient treated with non-insulin diabetes agents in the study period, 2,224 filled an SGLT2i. Mean time from KTx to SGLT2i prescription was 6.7 yrs. vs.4.7 yrs. to first captured non-SGLT2i fill. SGLT2i use was more common in adults who were age  $>$ 30 (compared to age 18-30 yrs.), Asian (aOR, 1.3), or had BMI $\geq$ 30 (aOR, 1.24), and trended higher with self-pay status (aOR, 1.52). SGLT2i use was lower in patients who were women (aOR, 0.88), Black (aOR, 0.88), other race (aOR, 0.75), publicly insured (aOR, 0.92), or had less than college education (aOR, 0.87). SGLT2i use in KTx patients increased dramatically in 2019-2021 (aOR, 5.64 vs prior yrs). [Figure]

**Conclusions:** SGLT2i use is increasing in KTx recipients, but varies with factors including race, education and insurance. While ongoing study is needed to define risks and benefits of SGLT2i use in KTx patients, attention should also focus on reducing treatment disparities related to social determinants of health rather than clinical indications.

**Funding:** NIDDK Support

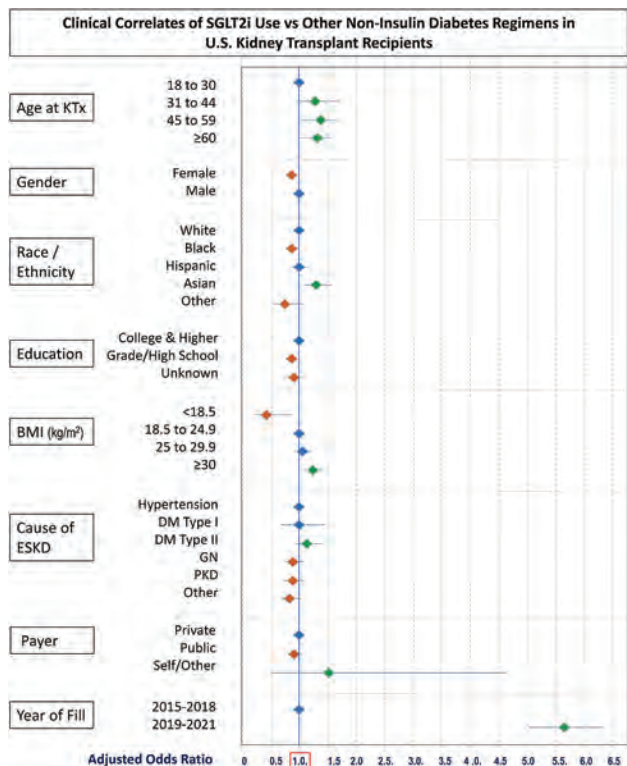

FR-PO815

Deep Learning-Based Instance Medullary Pyramid Segmentation in Routine CT Examinations

Adriana Gregory, Amr Moustafa, Bhavya Poudyal, Aleksandar Denic, Andrew D. Rule, Timothy L. Kline. Mayo Foundation for Medical Education and Research, Rochester, MN.

**Background:** The kidney accounted for ~60% of the total transplanted organs in the U.S. in 2021. We recently demonstrated that smaller medullary volume predicted allograft loss independent of donor's and recipient's characteristics. In addition, the number of medullary pyramids has been suggested as a surrogate for nephron endowment, but manual quantification of pyramids is time consuming. Therefore, we developed the first fully automated approach for segmenting and differentiating individual medullary pyramids from angiogram-phase CTs.

**Methods:** Contrast-enhanced axial abdominal CTs were collected from 178 predonation living kidney donors. CTs from 158 subjects were used to train and validate a deep learning model that could automatically segment medullary pyramid edges and cores. 20 CT images were held out for testing. The nnU-Net framework was used to train a 5-fold cross validation ensemble model. Manual segmentations from two independent readers were used to establish interobserver variability. We used the Dice score to evaluate the segmentation similarity and Bland-Altman analysis to estimate the bias in pyramid count and volume with the reference.

**Results:** The test set interobserver Dice score was 0.93. The automated method had a Dice score of 0.82 compared to the first reader and 0.81 compared to the second reader. The predicted medullary pyramid count and average pyramid volume bias±sd with the reference standard was 2±5 pyramids and -0.02±0.3 ml, respectively.

**Conclusions:** A fully automated instance medullary pyramid segmentation method was developed and tested for healthy kidney CT scans. This approach unlocks the potential of medullary size and count as a kidney biomarker. Further work needs to determine whether size and number of medullary pyramids relates to nephron size and number and associates with kidney disease risk factors and outcomes.

**Funding:** NIDDK Support

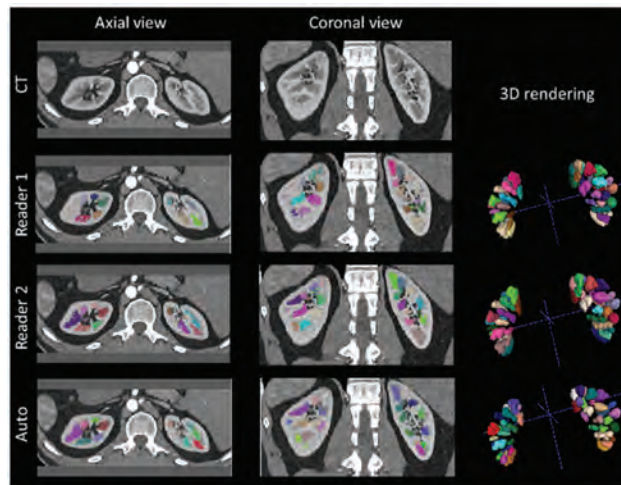

Figure. Example case. The colors show the difference between adjacent pyramids and are assigned arbitrarily.

FR-PO817

Effectiveness of Metformin in Kidney Transplant Recipients With Post-Transplantation Diabetes Mellitus

Dongyeon Lee,<sup>1</sup> Jiyun Jung,<sup>2,3</sup> Jangwook Lee,<sup>3,4</sup> Sung Joon Shin,<sup>3,4</sup> Sichan Kim,<sup>1</sup> Chung Hee Baek,<sup>1</sup> Su-Kil Park,<sup>1</sup> Jae Yoon Park,<sup>3,4</sup> Hyosang Kim.<sup>1</sup>  
<sup>1</sup>Asan Medical Center, Songpa-gu, Seoul, Republic of Korea; <sup>2</sup>Data management and Statistics Institute, Dongguk University Ilsan Hospital, Goyang, Gyeonggi, Republic of Korea; <sup>3</sup>Research Center for Chronic Disease and Environmental Medicine, Dongguk University College of Medicine, Goyang, Gyeonggi, Republic of Korea; <sup>4</sup>Dongguk University Medical Center, Goyang, Gyeonggi, Republic of Korea.

**Background:** Post-transplantation diabetes mellitus (PTDM) is an important risk factor for cardiovascular disease and mortality. We aimed to determine the influence of metformin on cardiovascular and graft outcome in PTDM.

**Methods:** We included 618 kidney transplant recipients with new-onset PTDM in Asan Medical Center and Dongguk University Ilsan Hospital between 2000 and 2018. PTDM was defined as maintained hypoglycemic treatment, three months or more after transplantation. We conducted the propensity score matching (PSM) in metformin and non-metformin group by estimated Glomerular Filtration Rate (eGFR), sex, age, body mass index, and immunosuppressive agents. Cox proportional hazard models were also conducted to estimate the effects of the metformin usage compared to non-metformin on percutaneous coronary intervention (PCI), major adverse cardiovascular events (MACE), acute rejection (AR), and graft failure (GF).

**Results:** Before matching, 406 patients (66%) prescribed metformin, and the average eGFR (59.8 mL/min/1.73m<sup>2</sup>) and HbA1c (7.5%) in metformin group was higher than non-metformin group (53.3 mL/min/1.73m<sup>2</sup> for eGFR; 7.2 % for HbA1c). After 1:1 matching in PSM, no group differences in eGFR and HbA1c were observed. In Kaplan-Meier plot, metformin usage was associated with higher survival probability on PCI (p=0.01) and GF (p=0.03). In Cox proportional hazard model, metformin usage was associated with lower risk of PCI (hazard ratio [HR]: 0.31; 95% confidence interval [CI]: 0.11–0.86; p=0.02). In addition, compared with the non-metformin group, the HR of the long-term use of metformin (≥1664 days, median value) was 0.21 (95% CI 0.06–0.70; p=0.01).

**Conclusions:** This study demonstrates that the use of metformin was associated with a decreased risk of coronary artery disease in kidney transplant recipients with PTDM. Metformin would be considered as one of feasible treatment options for PTDM.

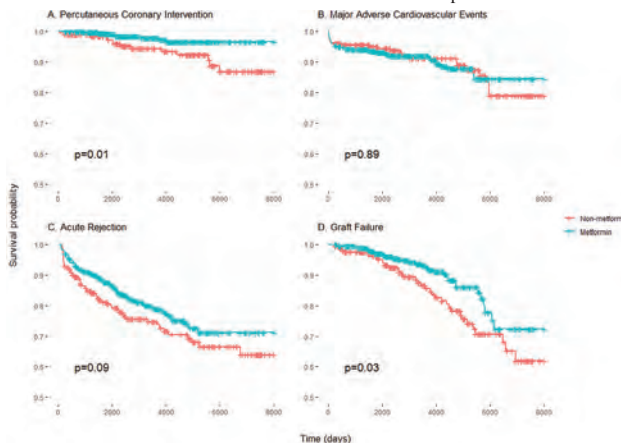

FR-PO818

**Transition of Metabolic Dysfunction After Kidney Transplantation and Its Association With Transplant Outcomes: A Nationwide Prospective Cohort Study**

Yu ho Lee,<sup>1</sup> So-young Lee,<sup>1</sup> Jin sug Kim,<sup>2</sup> Kyung hwan Jeong,<sup>2</sup> Hyeon Seok Hwang,<sup>2</sup> <sup>1</sup>CHA Bundang Medical Center, Seongnam, Gyeonggi-do, Republic of Korea; <sup>2</sup>Kyung Hee University Medical Center, Dongdaemun-gu, Seoul, Republic of Korea.

**Background:** Metabolic dysfunction (MD) is prevalent disorder in patients with end-stage kidney disease and kidney transplantation is expected to modify the metabolic status. However, it remains unclear whether the transition of metabolic status before and after transplantation affects the transplant outcomes.

**Methods:** We analyzed 4187 kidney transplant recipients registered in a nationwide prospective cohort from 2014 to 2020. MD was considered, if  $\geq 3$  conditions are met (body mass index, blood pressure, fasting blood glucose, triglyceride, and high-density lipoprotein cholesterol level). Patients were categorized into four groups based on the presence of MD at pre-transplant and one-year post-transplant. The primary outcome was the occurrence of death-censored graft failure and patient death.

**Results:** Prevalence of pre- and post-transplant MD was 49.0% and 40.1%, respectively. Among recipients without pre-transplant MD, 19.6% (419/2135) developed MD at one-year post-transplantation. By contrast, MD disappeared in 38.7% (794/2052) of the recipients with pre-transplant MD. The cumulative event rate of composite of graft failure and patient death was significantly higher in both recipients with newly developed post-transplant MD and recipients with persistent MD ( $p < 0.001$ ). Compared to recipients without pre- and post-transplant MD, those with newly developed post-transplant MD showed an increased risk of graft failure (adjusted hazard ratio [HR] 2.41, 95% confidence interval [CI] 1.17-4.98) and those with persistent MD had higher risk of patient death (adjusted HR = 2.51, 95% CI 1.12-5.63). The risk of composite event was increased as more metabolic components was converted to be dysfunctional after transplantation. An analysis of each component of MD showed that a normalization of blood pressure after transplantation led to a decrease in the risk of composite event.

**Conclusions:** Kidney transplantation significantly affects the metabolic status in patients with end-stage kidney disease. Newly developed post-transplant MD increases the risk of graft loss and persistent post-transplant MD adversely affects patient survival, suggesting that transition of metabolic status was significantly associated with kidney transplant outcomes.

**Funding:** Government Support - Non-U.S.

FR-PO819

**Effect of Delayed Graft Function on Early Pancreatic Graft Failure in Simultaneous Pancreas-Kidney Transplant Recipients**

Ahmed Daoud,<sup>1,2</sup> Zemin Su,<sup>1</sup> Genta Uehara,<sup>1</sup> Karim M. Soliman,<sup>1</sup> Maria Aurora C. Posadas,<sup>1</sup> David J. Taber,<sup>1</sup> Derek Dubay,<sup>1</sup> Michael Casey,<sup>1</sup> <sup>1</sup>Medical University of South Carolina, Charleston, SC; <sup>2</sup>Cairo University Medical School, Cairo, Egypt.

**Background:** A recent single center study suggests kidney DGF may be a risk factor for early pancreas graft failure in simultaneous pancreas-kidney transplants (SPK). We explore whether kidney DGF continues to be a risk factor for early pancreas graft failure in a national database study.

**Methods:** We analyzed the SRTR database for all adult SPK recipients from 2000-2018. Our primary outcome was pancreas graft failure  $\leq 90$  days. We determined the association between kidney DGF and pancreatic graft failure. We adjusted for recipient age, gender, race, PRA, HLA mismatch, transplant era, and pretransplant dialysis, as well as donor age, gender, race & donation after cardiac death.

**Results:** 15512 adult SPK recipients were identified with 1258 (8.1%) with kidney DGF. 90-day pancreas transplant survival with and without kidney DGF was 81.8% and 92.4% (Figure 1). After adjusting for covariates, kidney DGF was associated with a higher risk of early pancreas loss versus non-DGF (HR 2.457, 95% CI 2.121-2.846,  $p < 0.0001$ ). Other risk factors for early pancreas loss include female recipient, obesity, peak PRA 80-100%, & donor age. Pretransplant dialysis and transplants after 2009 were associated with a lower risk of early pancreas failure (Table 1).

**Conclusions:** Our study suggests that kidney DGF may be a major risk factor for early pancreas graft failure in SPK recipients. Future studies are still needed.

Cox regression for time to Pancreas Graft Loss within 90 days after transplant

Variable	HR	95%CI	P-value
Kidney DGF	2.457	2.121-2.846	<0.0001
Female recipient	1.151	1.028-1.287	0.0145
Recipient BMI (Ref=30+)			
<18	0.62	0.372-1.033	0.0667
18-30	0.708	0.608-0.823	<0.0001
Peak PRA (ref= $\leq 1\%$ )			
80-100%	1.406	1.003-1.975	0.0498
Transplant Era (ref =2000-2009)			
2010-2018	0.836	0.726-0.962	0.0052
Pretransplant Dialysis	0.822	0.716-0.943	0.0052
Donor Age (ref= $\leq 18$ )			
18-34	1.208	1.035-1.412	0.0168
35-49	1.399	1.335-1.915	<0.0001
50+	2.681	1.948-3.692	<0.0001

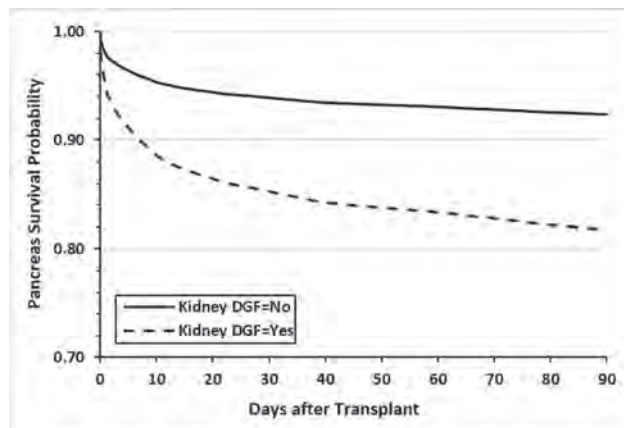

FR-PO820

**Differences in Outcomes Between High Dose and Low Dose Belatacept Conversion on Allograft Function in Kidney Transplant Patients**

Hay Me Me, Pooja Budhiraja, Lavanya Kodali, Sumi Sukumaran Nair. Mayo Clinic Arizona, Scottsdale, AZ.

**Background:** Belatacept, a selective costimulation T cell blocker is used to avoid unwanted side effects from calcineurin inhibitors. Improved allograft function despite increased risk of early rejection and viral infection have been reported.

**Methods:** This is a single center retrospective study conducted at Mayo Clinic Arizona. We converted patients to the high dose belatacept (10mg/kg) if transplanted within 1 month and to the low dose (5mg/kg) after 1 month if they had significant side effects with calcineurin inhibitors or suboptimal allograft function with chronicity changes on biopsy findings. Tacrolimus dose was discontinued immediately in high dose conversion group but was overlapped and tapered down within 4 weeks in low dose conversion group. We included both deceased donor and living donor transplant recipients from 2013 to 2021. We compared the effect of high dose and low dose on the occurrence of rejection and infection at 1 year.

**Results:** Total of 75 patients were switched to belatacept and 56 (74%) was converted to low dose and 17 (26%) were converted to high dose. No statistical difference found in recipient and donor characteristics between 2 groups (Fig 1). There was no statistical significance in allograft function, rejection rate and infection rate at 1 year (Fig 2). However, the occurrence of COVID 19 infection was statistically significant in high dose conversion group.

**Conclusions:** Allograft function was comparable at 12 months between 2 groups for those transplanted within 1 year. It is important to recognize the potential for over-immunosuppression when transitioning to belatacept.

**Comparison of Recipient and Donor Characteristics**

	High dose Conversion (N=17)	Low dose Conversion (N=56)	P value
<b>Recipient Characteristics</b>			
Gender (Female)	9 (53%)	19 (34%)	0.4
Diabetes	6 (35%)	19 (34%)	0.2
Hypertension	16 (94%)	49 (88%)	0.7
Pretransplant dialysis	1 (5.9%)	12(21%)	0.3
DDRT	12 (71%)	42 (75%)	0.7
<b>Donor Characteristics</b>			
Age	41 (SD 12.1)	45.8 (SD 13.6)	0.2
KDPI	48.4 (SD 18)	60 (SD 24.9)	0.13
DDRT	83 (28.1%)	95 (26.5%)	0.63
Induction (Campath)	10 (59%)	34 (61%)	0.9
Induction (Simulect)	6 (35%)	20 (36%)	0.9
Induction (Thymoglobulin)	1 (6%)	2 (3.5%)	0.9

### Comparison of Allograft function and infection rate based on Belatacept conversion cohort

	High dose Conversion (N=17)	Low dose Conversion (N=56)	P value
<b>Allograft Function</b>			
Creatinine before switch	3.7 (SD 1.7)	3.4 (SD 2.7)	0.7
Creatinine after 6 <sup>th</sup> month	1.7 (SD 0.7)	2.1 (SD 1)	0.2
GFR at the time of switch	16.5 (13.2)	27 (21)	0.03
GFR at 6 <sup>th</sup> month	51 (18.7)	39.7 (19.5)	0.04
GFR at 1 year	48 (16.5)	47.4 (20.3)	0.93
Rejection at 1 year	1 (6%)	10 (18%)	0.4
DSA	0	4 (7%)	0.57
<b>Infection rate</b>			
Infection at 1 year	10 (58.8%)	21 (37.5%)	0.16
CMV	7 (41%)	11 (20%)	1
BK	6 (35%)	9 (16%)	0.09
COVID	8 (47%)	11 (20%)	0.05
EBV	1	0	0.93

FR-PO821

### The Impact of Mycophenolate Dosing on BK Viremia in Low-Risk Kidney Transplant (KT) Recipients

Dylan Thomas,<sup>1</sup> Shuangcheng Hua,<sup>2</sup> Jon R. Von Visger,<sup>3</sup> Vaqar H. Shah,<sup>3</sup> Samer Kareem,<sup>3</sup> Michael C. Ott,<sup>1</sup> Kabir Jalal,<sup>2</sup> Shirley S. Chang.<sup>3</sup> <sup>1</sup>Erie County Medical Center, Buffalo, NY; <sup>2</sup>University at Buffalo, Buffalo, NY; <sup>3</sup>University at Buffalo Jacobs School of Medicine and Biomedical Sciences, Buffalo, NY.

**Background:** BK polyomavirus infection affects 10-60% of KT recipients. Risk factors include degree of immunosuppression, and allograft rejection. Management of BK viremia includes reduction of immunosuppression with close monitoring for rejection. The data is limited in MMF dosing at time of KT & effect on BK.

**Methods:** This is a single-center, retrospective study examining effect of MMF dosing in low-risk (CPRA <20%, non-Black) KT recipients on BK viremia at Erie County Medical Center between 8/2019-8/2021. Per protocol, MMF dosing was reduced from 750 mg BID (Higher MMF group) to 500 mg BID (Lower MMF group) for low-risk KT recipients on 8/2020. We performed chart review one-year prior & one-year post 8/2020. Exclusion criteria: multiorgan transplants, CPRA ≥20%, Black race, not on MMF. All had serum BK PCR at 2 weeks, monthly x 1-year, then 6 months x 2-years post-transplant. For those with BK viremia, MMF reduction was per clinician discretion, dosing was recorded with time. Primary outcome: BK viremia rate; Secondary outcome: biopsy-confirmed acute rejection rate.

**Results:** There were 75 in the Higher MMF group, and 62 in the Lower MMF group. Clinical characteristics were similar (age, gender, race, BMI, cPRA, KDPI, EPTS, type of KT). All received thymoglobulin induction (3 mg/kg) and steroid. MMF dosing in the Higher MMF group was 1527 mg/day after transplant, 1510 at month 1, 1389 at month 3 post-transplant; MMF dose in the Lower MMF group was 1082 mg/day after transplant, 1103 at month 1, 1123 at month 3 post-transplant (p<0.01, p<0.01, p=0.005 respectively). Other immunosuppressions, eGFR, allograft loss, and death were not different. BK viremia rate was 32% in the Higher MMF group vs. 16% in the Lower MMF group (p=0.052). Of those with BK viremia, BK duration was not different, however, time from transplant to BK onset was shorter in the Lower MMF group (91 days vs. 190 days, p=0.019). Biopsy confirmed acute rejection rate was not different. There were 16 patients (21%) who develop ACR in the Higher MMF group; 10 patients (14.5%) developed ACR and 1 patient (1.6%) with AMR in the Lower MMF group (p=NS).

**Conclusions:** Lower MMF at time of KT in low-risk KT recipients tend to have lower BK viremia rate and has no effect in acute rejection rate. More and larger studies are needed to confirm above findings.

**Funding:** Other NIH Support - NHLBI K12 Implementation Science Scholar

FR-PO822

### Outcomes of Kidney Transplantation in Cystic Fibrosis

Mirjana Stevanovic,<sup>1</sup> Asha Zimmerman,<sup>2</sup> Martha L. Graber.<sup>2</sup> <sup>1</sup>Dartmouth Guarini School of Graduate and Advanced Studies, Hanover, NH; <sup>2</sup>Dartmouth College Geisel School of Medicine, Hanover, NH.

**Background:** There is a paucity of published data on the outcomes following kidney transplantation in patients with cystic fibrosis (CF).

**Methods:** The USRDS database was used to locate all patients with CF who were diagnosed with ESRD prior to 12/31/2018 undergoing a first kidney transplant. CF patients were compared to non-CF patients undergoing first kidney transplant for the same period. Demographic data was compared using linear and logistic regression. Survival curves for death-censored graft survival and death were compared between groups using cox regression.

**Results:** A total of 192 patients with CF and 248,820 patients without CF underwent kidney transplantation. Compared to the non-CF population, CF patients were more likely to be female (52.1% vs 40.2%, p < 0.001), have a lower BMI (21.8 vs 27.7, p < 0.001), be white (91.7% vs 67.2%, p < 0.001), have a transplant as first ESRD treatment (22.9% vs 14.1%, p < 0.001), be on dialysis for less time (1.95 yr vs 3.29 yr, p < 0.001), have a living donor transplant (60.4% vs 32.9%, p < 0.001) and less likely to have transplant failure (22.9% vs 30.6%, p = 0.021). Death censored graft survival was no different between the groups (p = 0.28). Five-year death-censored graft survival was 90% vs 85% for patients

with CF and non-CF patients, respectively. Patients with CF had worse survival when compared to patients without CF (p < 0.001). Five year and median survival was 92% vs 95% and 17.7 yrs vs 26.8 yrs for CF and non-CF patients, respectively.

**Conclusions:** There is no difference in death-censored graft survival for patients with CF. Patients with CF have shorter survival after transplantation when compared to a non-CF cohort.

**Funding:** Private Foundation Support

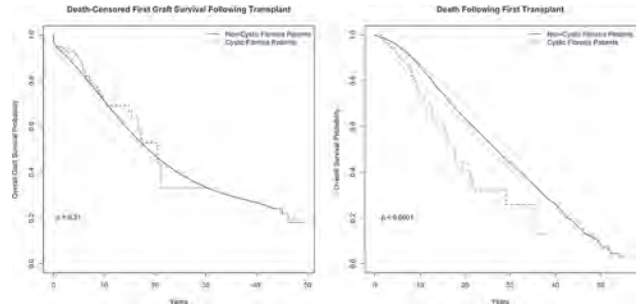

FR-PO823

### Thrombotic Microangiopathy (TMA) After Kidney Transplant: A 10-Year Experience

Gaurav Rajashekar, Nyein Chann Wai Lynn, Karen Flores, Massini Merzkani, Rowena B. Delos Santos, Anuja Java. Washington University in St Louis, St Louis, MO.

**Background:** TMA is primary when a genetic or acquired defect is identified [e.g. complement genetic variants in atypical hemolytic uremic syndrome (aHUS)] or secondary when occurring in the setting of infection, malignancy, or drugs. Kidney transplant is associated with multiple triggers such as drugs, rejection, or infections, making it challenging to distinguish aHUS from secondary TMAs. This distinction is critical since aHUS is non-responsive to conservative measures. We report our approach to TMA evaluation and demonstrate how comprehensive analyses can facilitate clinical decision-making regarding treatment and recurrence risk.

**Methods:** Between 2011 and 2020, pre-transplant patients with TMA in the native kidney and post-transplant patients with recurrent or *de novo* TMA were evaluated. Genetic testing was conducted using the clinically validated aHUS panel. Variants were classified based on the American College of Medical Genetics (ACMG) guidelines.

**Results:** 69 patients (41 post-transplant and 28 pre-transplant) underwent genetic testing (Table 1). 11 of 69 had a known aHUS diagnosis; 19 patients (27.5%) were (mis)diagnosed as hypertensive nephrosclerosis and nine (13%) developed ESKD after preeclampsia. 42 patients (60.8%) carried a complement genetic variant and 10 patients (14.4%) harbored a Factor H autoantibody (Table 2). 26 of 42 (61.9%) were classified as variants of unclear significance (VUS). A systematic antigenic and structure-function analysis of the VUS determined their clinical significance, re-categorized them as pathogenic or benign and guided treatment decisions (Fig 1).

**Conclusions:** 1) Patients with ESKD due to HTN/preeclampsia or another TMA whose evolution is aggressive should be evaluated for complement defects. 2) Functional assessment of VUS determines their clinical significance, aids in diagnosis, informs disease etiology, facilitates assessment of recurrence risk and helps to determine treatment.

**Funding:** Private Foundation Support

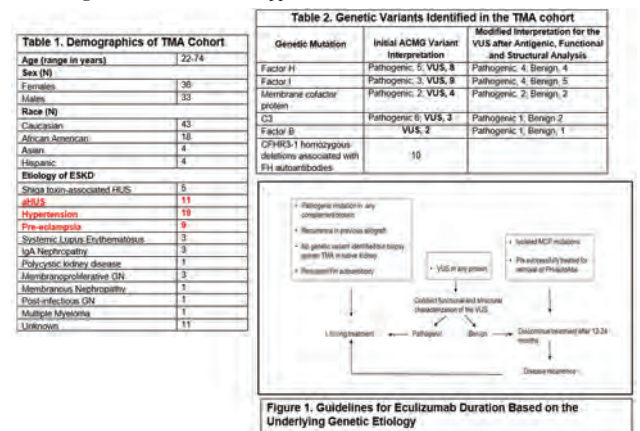

Figure 1. Guidelines for Eculizumab Duration Based on the Underlying Genetic Etiology

FR-PO824

**A Propensity-Score Matched Analysis of Long-Term Outcomes for Living Kidney Donation in Alternative Complement Pathway Diseases**  
 Yasar Caliskan,<sup>1</sup> Seda Safak,<sup>2</sup> Ozgur A. Oto,<sup>2</sup> Arzu Velioglu,<sup>3</sup> Berna Yelken,<sup>4</sup> Ahmet B. Dirim,<sup>2</sup> Abdulmecit Yildiz,<sup>5</sup> Safak Mirioglu,<sup>2</sup> Nurana Guller,<sup>2</sup> Halil Yazici,<sup>2</sup> Alparslan Ersoy,<sup>5</sup> Aydin Turkmen,<sup>2</sup> Krista L. Lentine.<sup>1</sup> <sup>1</sup>Saint Louis University School of Medicine, Saint Louis, MO; <sup>2</sup>Istanbul University Istanbul Tıp Fakultesi, Istanbul, Turkey; <sup>3</sup>Marmara Universitesi, Istanbul, Turkey; <sup>4</sup>Koc Universitesi, Istanbul, Turkey; <sup>5</sup>Bursa Uludag Universitesi, Bursa, Turkey.

**Background:** We examined the clinical course of living donors (LDs) to recipients with atypical hemolytic-uremic syndrome (aHUS) and C3 glomerulopathy (C3G) and compared their outcomes with a control group to improve understanding of the clinical course and outcomes of living donation in this context.

**Methods:** The cohort of LDs of aHUS/C3G recipients (Complement-LD group) and propensity score-matched control LDs without any family history of aHUS/C3G (Control-LD group) were retrospectively identified from data at 4 transplant centers (2003-2021). LD were followed for major cardiac events (MACE), *de novo* hypertension, cancer, death, post-donation eGFR and proteinuria.

**Results:** The cohort comprised 24 LD to recipients with aHUS (46%) and C3G (54%) including 18 related LDs. Long-term outcomes were compared with propensity score-matched control group over 5 years (IQR,3-11.8) follow-up. During follow-up, none of the LDs in complement-LD group developed MACE whereas two LDs in control-LD group developed MACE (18.5%) after 8 (IQR,2.6-12.8) years (p=0.15). New-onset hypertension was similar between groups (20.8% vs 25%, p=0.73) (Table 1). There were no differences between study groups regarding last eGFR and proteinuria levels (p=0.11 and p=0.40, respectively). None of the donors developed kidney failure (eGFR<15ml/min/1.73m<sup>2</sup> or dialysis). In complement-LD group a related donor developed gastric cancer and another related donor developed a brain tumor and died at 4<sup>th</sup> year after donation (Table 1).

**Conclusions:** The risks of kidney failure, cardiovascular disease, *de novo* aHUS and C3G in carefully selected LD to recipients with aHUS and C3G appear to be low. Cancer development in related LDs of recipients with complement mediated disease may need further investigation.

Table 1. Demographic and follow up characteristics of living donors of recipients with complement related kidney diseases and propensity score matched control donor group.

Characteristics	Complement-LD Group (n=24)	Control-LD Group (n=24)	P value
Age at donation (years), mean±SD	45.5±11	49.1±8.4	0.21
Sex, male/female, n (%)	15 (62.5) / 9 (37.5)	12 (50.0) / 12 (50.0)	0.38
HLA mismatch, mean±SD	3.5±1.3	3.2±1.4	0.52
Donor's relationship to recipients, n (%)			
Mother	5 (20.8)	6 (25.0)	
Father	7 (29.2)	7 (29.2)	
Sibling	3 (12.5)	3 (12.5)	
Cousin	1 (4.2)	1 (4.2)	
Aunt/Uncle	1 (4.2)	1 (4.2)	0.98
Son	1 (4.2)	0 (0)	
LURD (spouse)	6 (25.0)	6 (25.0)	
Recipients' causal genes and inheritance pattern in the family, n (%)			
CFH (AD)	5 (20.8)	-	
CFH (AR)	3 (12.5)	-	
CFHR3 (AD)	2 (8.3)	-	
CFI (AD)	1 (4.2)	-	
C3 (AR)	1 (4.2)	-	
No causal variant detected	4 (16.7)	-	
Genetic test not known/not performed	8 (33.3)	-	
Follow-up Data			
Duration of follow-up (years), median (IQR)	5.0 (3.0-11.8)	8 (2.6-11.8)	0.89
Serum creatinine at last follow-up (mg/dL), mean±SD	1.05±0.12	0.99±0.23	0.26
eGFR at last follow-up (ml/min/1.73 m <sup>2</sup> ), median (IQR)	72.0 (66.8-87.5)	67.0 (60.0-84.8)	0.11
Proteinuria at last follow-up (g/g), median (IQR)	0.08 (0.04-0.1)	0.1 (0.04-0.1)	0.40
Hypertension after donation, n (%)	5 (20.8)	6 (25.0)	0.73
Diabetes mellitus after donation, n (%)	0 (0)	3 (12.5)	0.07
Major cardiac event, n (%)	0 (0)	2 (8.3)	0.15
Acute coronary ischemia	0 (0)	2 (8.3)	0.15
De novo cancer after donation	2 (8.3)	0 (0)	0.15
Death, n (%)	1 (4.2)	2 (8.3)	0.55

Abbreviations: AD, autosomal dominant; AR, autosomal recessive; eGFR, estimated glomerular filtration rate; LD, living donor; HLA, human leukocyte antigen; LURD, living unrelated donor; NS, not significant; SD, standard deviation

FR-PO825

**Sodium Glucose Cotransporter2 Inhibitors in Kidney Transplant Recipients**

Kristin Progar, Massini Merzkani, Haris F. Murad, Andrew F. Malone, Rowena B. Delos Santos, Anuja Java. Washington University in St Louis, St Louis, MO.

**Background:** Sodium glucose cotransporter2 inhibitors (SGLT2i) demonstrate a cardioprotective effect and are associated with slowing or preventing CKD progression in the native kidney. However, there is limited data in the literature about their use after a kidney transplantation.

**Methods:** This is an observational retrospective study in a cohort of kidney transplant recipients at Washington University in St. Louis, treated with SGLT2i for diabetes mellitus type 2. Data collection was conducted by chart review. Our primary endpoint was to assess the safety and adverse reactions in this cohort. Our secondary endpoints included assessments of change in weight/BMI, blood pressure, serum creatinine and eGFR, LDL,

HDL and hemoglobin A1C every 6 months with a follow up to 2 years. Analysis for change of these parameters from baseline (at the time of start of the medication) was conducted using matched paired t test.

**Results:** A total of 36 of kidney transplant recipients were included. The average age of patients was 55.5 ± 10.4 years. 23 of 36 patients (63.9%) were males. The adverse events reported were congestive heart failure 2/36 (5.6%), AKI 2/36 (5.6%), candidiasis 1/36 (2.8%), and urinary tract infection 1/36 (2.8%). Our results also revealed that two patients died unrelated to medication use (1 patient died after COVID infection and 1 patient died due to septic shock from a foot infection). As shown in table 1 there was no significant change from baseline in weight/BMI, blood pressure, serum creatinine and eGFR, LDL, HDL or hemoglobin A1C at 6, 12, 18 and 24 months.

**Conclusions:** Our preliminary data shows that SGLT2i are relatively safe in the kidney transplant population. Larger multicenter studies are needed to determine the efficacy of these drugs in improving renal function, decreasing cardiovascular events and survival post-transplant, as seen in non-transplant recipients.

Laboratory	Mean difference	3 months		6 months		12 months		18 months		24 months	
		Mean difference	P value	Mean difference	P value	Mean difference	P value	Mean difference	P value	Mean difference	P value
Weight	-0.36	1.4 (1.6, 1.2)	0.19	-0.02	1.1 (0.9, 1.3)	0.79	-0.02	1.1 (1.0, 1.2)	0.93	1.1 (1.0, 1.2)	0.88
BMI	-0.04	1.1 (1.1, 1.1)	0.37	-0.02	1.1 (1.0, 1.1)	0.91	-0.02	1.1 (1.0, 1.1)	0.93	1.1 (1.0, 1.1)	0.93
BP	-0.79	1.1 (1.1, 1.1)	0.39	-0.02	1.1 (1.0, 1.1)	0.91	-0.02	1.1 (1.0, 1.1)	0.93	1.1 (1.0, 1.1)	0.93
SCr	0.01	1.1 (1.1, 1.1)	0.39	-0.02	1.1 (1.0, 1.1)	0.91	-0.02	1.1 (1.0, 1.1)	0.93	1.1 (1.0, 1.1)	0.93
eGFR	1.7	1.1 (1.1, 1.1)	0.39	-0.02	1.1 (1.0, 1.1)	0.91	-0.02	1.1 (1.0, 1.1)	0.93	1.1 (1.0, 1.1)	0.93
LDL	0.06	1.1 (1.1, 1.1)	0.39	-0.02	1.1 (1.0, 1.1)	0.91	-0.02	1.1 (1.0, 1.1)	0.93	1.1 (1.0, 1.1)	0.93
HDL	-0.01	1.1 (1.1, 1.1)	0.39	-0.02	1.1 (1.0, 1.1)	0.91	-0.02	1.1 (1.0, 1.1)	0.93	1.1 (1.0, 1.1)	0.93
HbA1c	0.00	1.1 (1.1, 1.1)	0.39	-0.02	1.1 (1.0, 1.1)	0.91	-0.02	1.1 (1.0, 1.1)	0.93	1.1 (1.0, 1.1)	0.93

FR-PO826

**Domain Specific Changes in Cognitive Function After Kidney Transplantation**

Aditi Gupta,<sup>1</sup> Rebecca J. Lepping,<sup>2</sup> Neal Montgomery,<sup>2</sup> Mark J. Sarnak,<sup>3</sup> Jeffrey M. Burns,<sup>3</sup> William M. Brooks.<sup>2</sup> <sup>1</sup>University of Kansas Medical Center Department of Internal Medicine, Kansas City, KS; <sup>2</sup>University of Kansas Medical Center, Kansas City, KS; <sup>3</sup>Tufts University, Medford, MA.

**Background:** In this largest study assessing cognitive function pre-to post-kidney transplantation (KT) with multiple cognitive tests, we assessed changes in distinct cognitive domains to determine reversibility in cognitive impairment in ESKD.

**Methods:** We measured cognitive function pre-KT (n=97), 3-months post-KT (n=68), and 1-year post-KT (n=50) and compared changes using linear mixed model analysis.

**Results:** Logical Memory IA (fig) and IIA (episodic memory) and Digit symbol substitution (psychomotor speed, visuospatial function) scores were low pre-KT (pre-KT vs. norm: p<0.001 for all) and improved post-KT (pre- vs. post-KT: p<0.001 for Logical Memory IA and IIA, p=0.01 for Digit symbol substitution). Category Fluency (animals) (p<0.001) and Category Fluency (vegetables) (p=0.05) (semantic memory) also improved post-KT. Other cognitive domains did not change with KT (Table).

**Conclusions:** ESKD is associated with impairments in episodic memory, semantic memory, psychomotor speed, working memory, attention, and visuospatial function. Episodic and semantic memory improve post-KT while cognitive deficits persist in other domains. The differential improvement in cognitive function may reflect differences in underlying mechanisms affecting distinct cognitive domains in ESKD.

**Funding:** Other NIH Support - NIA

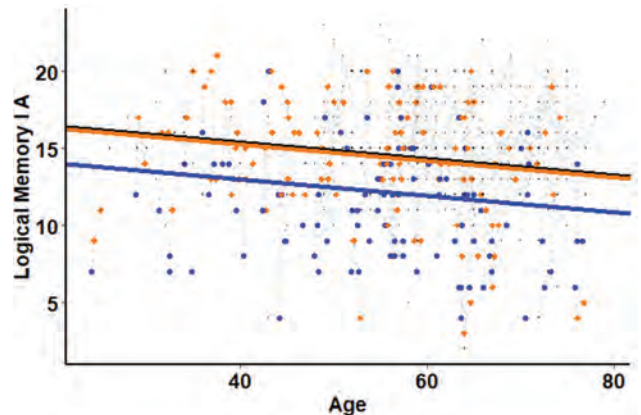

Comparisons of Logical Memory IA test scores in pre-KT (Blue circles) and post-KT (Orange diamonds) patients with age matched normative sample from NACC (Black squares).



p-value for any group difference <sup>a</sup>	Pairwise comparisons		
	Pre-KT vs normative data	Post-KT vs Pre-KT	Post-KT vs normative data
<b>Primary outcomes</b>			
Logical Memory IA	<0.001	2.33 (+0.003)	-2.28 (+0.003)
Logical Memory IIA	<0.001	-2.62 (-0.001)	3.00 (+0.002)
Digit Symbol Substitution Test	<0.001	-7.67 (-0.001)	1.77 (0.01)
<b>Secondary outcomes</b>			
MMSE	<0.001	-0.79 (-0.001)	0.06 (0.67)
Digit Span (Forward)	0.33	-0.29 (0.144)	0.14 (0.43)
Digit Span (Backward)	<0.001	-0.95 (-0.001)	0.23 (0.24)
Category Fluency (Animals)	<0.001	-1.19 (0.03)	2.29 (+0.001)
Category Fluency (Vegetables)	0.05	-0.56 (0.02)	0.77 (0.05)
Trailmaking A	0.43	1.43 (0.27)	-1.19 (0.29)
Trailmaking B	0.31	6.47 (0.14)	-3.59 (0.35)

<sup>a</sup> p value for adjusted linear mixed model F-test for any group differences between pre-KT, post-KT, and controls adjusted for age, cumulative number of neuropsychological testing sessions (practice effects), race, sex and education level. <sup>b</sup> p value for adjusted linear contrast of pairwise estimated between group differences t-test.  
 KT, kidney transplant; MMSE, mini mental scale exam

Comparison of cognitive function in pre-KT, post-KT and normative data using linear mixed effect model, adjusted (for age, cumulative number of neuropsychological testing sessions (practice effects), race, sex and education level).

**FR-PO827**

**Post-Simultaneous Kidney and Pancreas Transplant Outcomes in Type 2 Diabetics Compared to Type 1 Diabetics**

Luz E. Liriano-Ward, Yorg Al Azzi, Sanjana Kapoor, Maria Ajaimy, Cindy T. Pynadath, Enver Akalin. *Montefiore Medical Center, Bronx, NY.*

**Background:** The aim is to evaluate and compare short term and long-term outcomes in simultaneous kidney and pancreas transplant (SPK) recipients with a history of type 2 diabetes compared to those with type 1 diabetes

**Methods:** This is a retrospective review of all kidney and pancreas transplant recipients over 18 years of age transplanted at our center from June 2014 to December 2021

**Results:** 107 SPK were performed at our center during the study period. 46.7% were type 2 diabetics and 53.3% were type 1. 80% were black or Hispanics (80%), but there was no racial difference between the two groups. The type 2 diabetics were older (median 49.5 (IQR 43-53.8) vs 35 (IQR 33-44), p<0.001), had lower pre-transplant HbA1c (7.6 ± 1.6 vs 8.4 ± 1.6 p= 0.04), and had higher c-peptide (5.1±2.6 vs 1.1± 2.4, p<0.001). There was no difference in BMI (25.6 ±3.9 in type 1 vs 27 ± 3.7 in type 2, p=0.096), pre-transplant insulin requirements, history of HTN, HLD, ESRD, and dialysis vintage. Type 1 diabetics developed more acute rejection (22.8% vs 2%, p 0.002) and CMV viremia (31.4% vs 10%, p 0.01). There was no difference in length of hospital stay, 30 days re-admissions, incidence of DGF in both kidney and pancreas allografts, hypoglycemia (BS<55), and need for oral antidiabetic drugs post-transplant. Mean serum creatinine levels were similar at 3 months (1.2 ± 0.45mg/dl vs 1.0 +/- 0.31mg/dl), p=1.6), and 6 months (1.3± 0.4mg dl vs 1.1 ± 0.33mg/dl, p=0.1). Type 2 diabetics had better kidney function at 1 year with mean eGFR 71 ± 27.3 vs 61 ± 22.7, p=0.06, but there was no difference in renal function at last follow up. There was no difference HbA1c levels at 6 months (median 5.2 (IQR 5-5.6) in type 1 vs 5.2 (IQR 5-5.6) in type 2, p=0.97) and 1 year (5.4 (IQR 5.3-5.7) vs 5.7 (IQR 5.2-5.7), p=0.3). During a median follow-up of 22 months (IQR 16-34.5), patient's survival was 98% and kidney and pancreas graft survival was, 100% and 92%, respectively in type 2 diabetics. Meanwhile, patients' survival was 88% and kidney and pancreas graft survival was 90% for both at a median follow up of 42months (17.5-60.5)

**Conclusions:** Type 1 diabetics were more likely to develop acute rejection and CMV viremia as compared to type 2 diabetics. Both patient's and allografts' survival are comparable between the two groups

**FR-PO828**

**Treatment Outcome of Patients With Chronic Active Antibody-Mediated Rejection After Kidney Transplantation: Follow-Up Report of a Single Center Retrospective Study**

Hsien-Fu Chiu, Cheng-Hsu Chen. *Taichung Veterans General Hospital, Taichung, Taiwan.*

**Background:** Chronic active antibody-mediated rejection is a major etiology of graft loss in renal transplant recipients. Previously, we had reported that aggressive treatment was associated with better graft outcome at a median follow up duration of 32.5 months after the diagnosis of CAMR. Since chronic antibody mediated rejection is a chronic disease, this study aimed to prolong the follow up duration for 3 more years.

**Methods:** Adult kidney transplant recipients in Taichung Veterans General Hospital with CAMR were divided into two groups : Group 1 received aggressive treatment (double filtration plasmapheresis and one of the followings: rituximab, intravenous immunoglobulin, antithymocyte globulin, bortezomib, or methylprednisolone pulse therapy); and group 2 received supportive treatment.

**Results:** After 3 more years of follow up, 1 more patient in supportive treatment group and 15 more patients in aggressive treatment group lost their allograft. Median graft survival was 8.4 and 4.3 years for aggressive treatment group and supportive

treatment group, respectively. 27/59 (45.76%) patients in aggressive treatment group and 12/23 (52.17%) patients in supportive treatment group lost their allograft. Kaplan-Meier analysis of death-censored graft survival showed no significant difference between these two groups (p=0.263 by log-rank test).

**Conclusions:** Aggressive treatment is associated with better graft outcome in short term. However, there is still high risk of graft failure despite aggressive treatment in the long run. Risk and benefit of aggressive treatment should be evaluated before clinical decision.

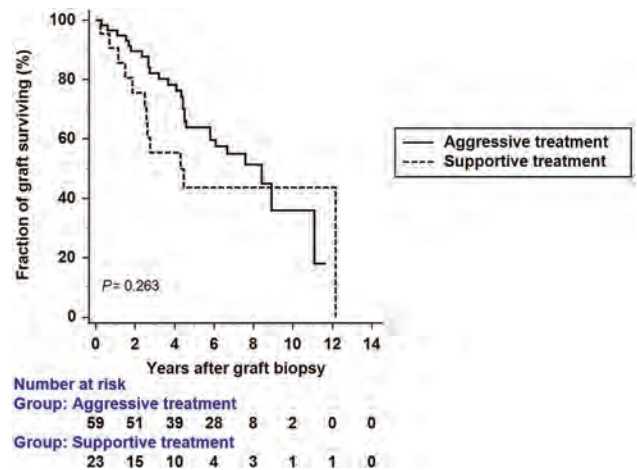

Kaplan-Meier analysis of death-censored graft survival showed no significant difference between aggressive treatment and supportive treatment group (p=0.263 by log-rank test)

**FR-PO829**

**Healthcare Utilization and Costs Associated With Neutropenia in Kidney Transplant Recipients Receiving Valganciclovir Prophylaxis: An Administrative Claims Database Study**

Vladimir Turzhitsky, Amit Raval, Pamela Moise, Sanjay Merchant. *Merck & Co., Inc., Rahway, NJ.*

**Background:** Kidney transplant recipients (KTRs) who have a D+/R- or R+ cytomegalovirus (CMV) IgG status receive valganciclovir (VGCV) as CMV prophylaxis. However, VGCV is myelosuppressive and may cause medically significant neutropenia. In this study, we evaluate healthcare resource use (HCRU) and cost in KTRs who develop neutropenia on VGCV.

**Methods:** KTRs between 1/1/2012 - 12/31/2018 from IBM MarketScan Commercial and Medicare Supplemental claims databases were included if they had 1 year of continuous enrollment before (baseline) and after (follow-up) their kidney transplant (KT). KTRs with VGCV prescription fills of 450mg or 900 mg/day within 30 days of KT were included in the cohort. Neutropenia was identified as either one inpatient or two outpatient claims separated by 14 or fewer days based on ICD-9/10 codes (288.0x/D70.x). HCRU and cost was evaluated for emergency department (ED), inpatient (IP), outpatient (OP), and pharmacy use.

**Results:** 3,258 (66%) of KTRs with requisite enrollment requirements met the VGCV inclusion criteria. Baseline demographics, HCRU, and cost between the neutropenic and non-neutropenic KTRs were similar. KTRs with neutropenia had significantly higher number of ED visits, other outpatient visits, and hospitalizations compared to those without neutropenia (Table 1). Healthcare costs were significantly higher among KTRs with neutropenia compared to those without neutropenia. Similar trends were observed for leukopenia.

**Conclusions:** Neutropenia in KTRs is associated with significantly higher HCRU and cost. We hypothesize that strategies aimed at mitigating the development of neutropenia in this immunosuppressed population may also decrease economic burden. These may include investigating less myelotoxic alternatives for CMV prophylaxis. Future studies are needed to further evaluate clinical outcome impacts of such practices.

**Funding:** Commercial Support - Merck & Co., Inc.

Resource type	With Neuroprotection (N = 313)				Without Neuroprotection (N = 2947)				P value <sup>†</sup>
	Patients (n)	Mean (SD)	Mean	SD	Patients (n)	Mean (SD)	Mean	SD	
<b>Emergency department</b>									
All cause ED visits	209(67.2%)	2,153(37)	\$3,995	\$2,245	1649(55.8%)	1,432(41)	\$4,884	\$1,770	<.001
CHF-related ED visits	28 (9%)	6,709(389)	\$3,855	\$3,397	421 (47%)	6,075(314)	\$3,896	\$1,962	<.001
Hypertensive ED visits	54(17.8%)	2,929(81)	\$1,991	\$1,365	2969(49.8%)	6,130(401)	\$2,252	\$1,995	<.001
Traumatic-related ED visits	10(3.2%)	1,465(78)	\$1,432	\$1,208	171(5.8%)	3,801(193)	\$2,219	\$1,902	<.001
<b>Diabetic outpatient visits</b>									
All cause diabetic visits	79(25.1%)	2,661(84)	\$8,617	\$8,081	750(24.9%)	146(10)	\$6,790	\$391	0.005
<b>Other outpatient visits (all ED or diabetic)</b>									
All cause other outpatient visits	3711(107%)	61,910(8)	\$48,173	\$39,835	2947(100%)	51,232(7)	\$42,618	\$26,037	<.001
DM-related other outpatient visits	107(31.4%)	3,648(51)	\$16,061	\$3,182	383(13.3%)	6,662(91)	\$3,455	\$1,164	<.001
DM-related other ED visits	17(5.1%)	2,568(37)	\$8,812	\$3,110	84(2.9%)	1784(23)	\$3,475	\$958	<.001
DM-related other ED visits	16(4.8%)	2,542(37)	\$8,791	\$3,099	83(2.9%)	1,766(23)	\$3,475	\$958	<.001
<b>Hospitalizations<sup>‡</sup></b>									
All cause hospitalizations	205(65.3%)	1,361(74)	\$67,321	\$32,246	1192(40.3%)	654(46)	\$57,051	\$23,032	<.001
DM-related hospitalizations	38(11.7%)	2,240(77)	\$52,404	\$27,149	163(5.5%)	6,641(235)	\$34,222	\$19,641	<.001
DM-related ED hospitalizations	7(2.2%)	3,375(86)	\$6,292	\$5,081	36(1.2%)	6,162(84)	\$4,591	\$2,332	<.001
DM-related non-ED hospitalizations	13(4.0%)	3,529(121)	\$39,688	\$21,648	111(3.7%)	6,046(219)	\$3,887	\$1,719	<.001
Total number of hospitalizations (days)	352 (48)				438(11.2)				<.001
Length of stay per visit (days)	16 (14.9)				16(8.8)				0.037
<b>Medication use (inpatient or outpatient)</b>									
DM-related medication	279(87.5%)	8,860(51)	\$6,847	\$2,342	43(2.1%)	6,740(14)	\$6,425	\$1,047	<.001
Type II diabetes medications	14(4.2%)	2,119(3)	\$2,110	\$1,373	5(0.2%)	17,022(95)	\$42,263	\$1,373	<.001
Type I diabetes medications	9(2.8%)	1,72(13)	\$1,815	\$1,602	1(1.7%)	6,079(51.4)	\$1,788	\$380	<.001
Type II diabetes medication other than insulin	7(2.2%)	6,779(23)	\$4,104	\$3,712	5(0.1%)	6,662(71)	\$30,307	\$1,441	0.012
<b>Outpatient pharmacy</b>									
All cause pharmacy prescriptions	3111(100%)	66,615(4)	\$36,000	\$24,232	2947(100%)	84,133(3)	\$48,558	\$23,225	0.002
DM-related pharmacy prescriptions	311(10%)	3,362(71)	\$14,184	\$10,300	2947(100%)	44,52(4)	\$10,889	\$6,048	<.001
Type II DM-related pharmacy prescriptions	481(15%)	3,941(99)	\$4,379	\$2,627	1214(11%)	6,091(67)	\$13,574	\$1,792	<.001
Type I DM-related pharmacy prescriptions	311(10%)	\$12,848	\$19,732	2947(100%)	358(3%)	\$66,182	<.001		

<sup>†</sup>Standardized to 2007 medical consumer prices.  
<sup>‡</sup>Median length of stay per patient episode; utilization for those with or without neuroprotection.  
 §Includes only hospitalization events.  
 SD = Standard Deviation; ED = Emergency Department; DM = Diabetes Mellitus; CHF = Chronic Heart Failure (including Ischemic, Cardiomyopathy, or other); DM = Diabetes Mellitus (including type 1 and type 2); DM = Diabetes Mellitus (including type 1 and type 2); DM = Diabetes Mellitus (including type 1 and type 2).

Table 1. HCRU and costs in the follow-up year.

FR-PO830

**Impact of Iron Status on Kidney Outcomes in Kidney Transplantation Patients**  
 Hyeo Jeong Kim, Ga Young Heo, Kyung Won Kim, Hee Byung Koh, Jaeseok Yang, Yonsei University Health System, Seodaemun-gu, Seoul, Republic of Korea.

**Background:** Dynamic changes occur in iron storage after kidney transplantation (KT). Recently, iron has been reported to play a crucial role in hemodynamics of the heart, infections, and the immune system, independently of anemia. However, there are insufficient studies on the impact of iron status on kidney functions in KT patients. In this study, we investigated the association of iron status and kidney outcomes in KT patients.

**Methods:** We analyzed data from the KoreaN cohort study for Outcome in patients With KT(KNOW-KT). Patients were excluded who met the following criteria: 1) subjects who did not follow-up for at least 1 year after KT, 2) subjects without ferritin or transferrin saturation (TSAT) level at 1 year after KT. Iron status was classified based on ferritin and TSAT level. Ferritin and TSAT were categorized to 3 groups, where 20%, 35% as reference points for the TSAT, and 100ng/mL, 300ng/mL for the ferritin, respectively. Based on the quartiles of ferritin and transferrin saturation at 1 year after KT, iron status was classified as “Iron replete”, “Iron deficiency”, “Functional iron deficiency”, “High iron”, and “non-classified”. Primary outcome was the composite outcome of graft failure and eGFR decline ≥50%. Cox regression analysis was used to analyze the association of iron status with the primary outcome.

**Results:** A total of 895 patients were included in the final analysis. During median follow-up of 5.8 years, primary outcome occurred in 94 patients, with an incidence rate of 19.8 per 1,000 person-years. The risk of composite outcome was higher in the high TSAT groups (> 35%) compared to the TSAT in range of 20-35% group (adjusted HR 1.68, 95% CI 1.01-2.79). The high ferritin groups also showed a trend of increased risk of the composite outcome despite statistical insignificance. Moreover, high iron groups showed a trend of increased risk of the composite outcomes compared to iron replete group (adjusted HR 2.05, 95% CI 0.97-4.34).

**Conclusions:** High iron status with high TSAT levels increased the risk of graft failure and renal progression in KT patients.

**Figure 1. Hazard ratios (HR) and 95% confidence intervals (CI) for graft loss and renal functional decline ≥ 50%**

	HR	95% CI	P
<b>TSAT (%)</b>			
TSAT ≤ 20	1.40	0.84 – 2.33	0.192
20 < TSAT ≤ 35		Reference	
TSAT > 35	1.68	1.01 – 2.79	0.046
<b>Ferritin (ng/mL)</b>			
Ferritin ≤ 100	0.84	0.52 – 1.35	0.476
100 < Ferritin ≤ 300		Reference	
Ferritin > 300	1.22	0.61 – 2.43	0.580
<b>Category of Iron status</b>			
Iron deficiency	1.03	0.53 – 2.04	0.923
Functional iron deficiency	1.67	0.78 – 3.60	0.189
Iron-replete		Reference	
High iron	2.05	0.97 – 4.34	0.060

FR-PO831

**Proton Pump Inhibitor Use in Kidney Transplant Recipients: A Population-Based Study**  
 James A. Kiberd, Robert R. Quinn, Pietro Ravani, Rachel Jeong, Ngan Lam, Alex Clarke. University of Calgary Cumming School of Medicine, Calgary, AB, Canada.

**Background:** Kidney transplant recipients are commonly prescribed proton pump inhibitors (PPIs), but due to concerns of long-term adverse events, chronic use should be limited to those with specific indications.

Key: TH - Thursday; FR - Friday; SA - Saturday; OR - Oral; PO - Poster; PUB - Publication Only  
 Underline represents presenting author.

**Methods:** We conducted a retrospective, population-based cohort study using linked healthcare databases in Alberta, Canada to study PPI use in prevalent adult kidney-only transplant recipients (2008-2017) who were at least 1-year post-transplant. We compared recipients with evidence of a PPI prescription in the 3 months prior to study entry to those with a histamine-2-receptor antagonist (H2Ra) fill and those with neither. The primary outcome was ongoing or new PPI use and patterns of use, including frequency and duration of therapy, and assessment of indication for PPI use.

**Results:** We identified 1,823 kidney transplant recipients, of whom 868 (48%) were on a PPI, 215 (12%) were on a H2Ra, and 740 (41%) were on neither at baseline. Over a median follow-up of 5.4 years (interquartile range [IQR] 2.6-9.3), there were almost 45,000 unique PPI prescriptions dispensed, the majority (80%) of which were filled by initial PPI users. Recipients who were on a PPI at baseline would spend 91% (IQR 70-98) of their graft survival time on a PPI in follow-up, of which Nephrologists were the main prescribers. We identified an indication for ongoing PPI use in 54% of the PPI group with the most common indication being concurrent antiplatelet use (26%).

**Conclusions:** Most kidney transplant recipients are on a PPI at or beyond the 1-year post-transplant date and are likely to stay on a PPI in follow-up. Almost half of the recipients in our study did not have an identifiable indication for ongoing PPI use. Nephrologists frequently prescribe PPIs to kidney transplant recipients and should be involved in deprescribing initiatives to reduce polypharmacy and its associated risks.

FR-PO832

**Hypoxia-Inducible Factor Prolyl Hydroxylase Inhibitors for Treatment of Post Kidney Transplant Anemia**  
 Masatomo Ogata, Takamasa Miyauchi, Marie Murata, Maho Terashita, Kiyomi Osako, Kazunobu Shinoda, Yugo Shibagaki, Masahiko Yazawa. St. Marianna University School of Medicine, Kawasaki, Japan.

**Background:** We previously reported the short-term efficacy of hypoxia-inducible factor prolyl hydroxylase inhibitors (HIF-PHI) for the treatment of post kidney transplant anemia (PTA). The present report re-analyzes our experience with HIF-PHI for PTA in the context of longer follow-ups and using a different class of HIF-PHI.

**Methods:** Nine kidney transplant recipients (KTRs) in our institute who were administered HIF-PHI for PTA were evaluated. The indication of HIF-PHI to erythropoiesis-stimulating agent (ESA) naive patients was an hemoglobin (Hb) level below 11.0 g/dL, and to ESA treated patients was an Hb level below 13.0 g/dL. Either roxadustat (Rox) or enarodustat (Ena) was employed as per the recommended dose adjustments to achieve target Hb levels between 11.0-13.0 g/dL. Anemia-related parameters, including Hb, total iron - binding capacity, and ferritin levels were evaluated along with LDL cholesterol up to 14 months. Adverse events of HIF-PHI were defined as thromboembolic events and malignancy.

**Results:** Rox and Ena were prescribed to 6 and 3 KTRs, respectively. The mean eGFR was 25.6 mL/min/1.73 m<sup>2</sup>. Hb levels and iron metabolism are shown in **Figure** (Solid line: Ena and dashed line: Rox). While most of the KTRs demonstrated an increase or maintain in their Hb levels from baseline, 2 of them kept their Hb level below the target ranges. Further, a few of the Rox-treated KTRs showed rapidly increase and decrease in their Hb and ferritin levels, respectively, despite being prescribed the recommended initial dose. Additionally, a drop in LDL cholesterol levels was only observed in the Rox-treated group. Adverse events were not recorded during the observation period.

**Conclusions:** Based on the recommended dose of HIF-PHI, treatment with Rox resulted in a more rapid increase in Hb levels along with a stronger improvement in iron utilization as compared to that seen in treatment with Ena. For PTA, HIF-PHI would be safe and useful in clinical use.

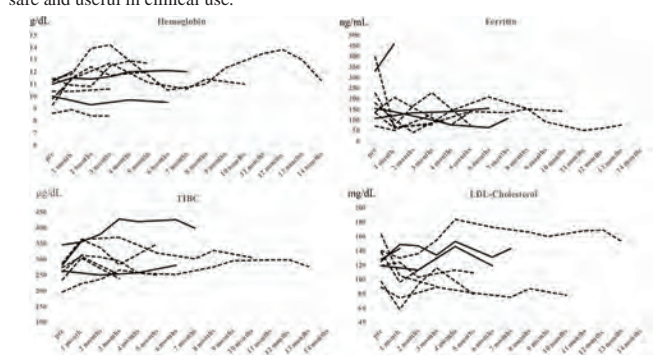

FR-PO833

**Kidney Transplantation Is Significantly Associated With Severe Herpes Zoster Infection: A Nationwide Population-Based Cohort Study With Propensity Score Matching Analysis**  
 Tung-Min Yu, Taichung Veterans General Hospital, Taichung, Taiwan.

**Background:** Kidney organ recipient has been considered to be on immunosuppression lifelong and that is suggested to be likely associated with various infection diseases including virus infection. We conducted a nationwide population-based cohort study to investigate the risk of herpes virus infection in this population.

**Methods:** From the Taiwan National Health Insurance Research Database (NHIRD) records, individuals hospitalized as solid organ recipients including kidney recipients

were defined as a case group of solid organ transplantation (SOT) patients and matched with a non-SOT cohort.

**Results:** A total of 18748 individuals, namely 9374 (50%) with (case) and 9374 (50%) without a medical SOT record (comparison) were enrolled. Because the patients were propensity score matched according to gender, age, index year, and comorbidities, no significant difference was observed between the case and comparison groups for these factors. We classified SOT as kidney, heart, lung, liver, bone, or pancreas transplantation. Compared with patients without SOT, patients with kidney (aHR = 9.07, 95% CI = 6.84–12.03), heart (aHR = 13.95, 95% CI = 8.63–22.57), lung (aHR = 48.47, 95% CI = 21.03–111.73), liver (aHR = 6.03, 95% CI = 4.15–8.75) transplantation had a significantly higher risk of HZ after adjustment for demographic factors and comorbidities.

**Conclusions:** In the present study, our findings disclose that renal transplant recipient was significantly associated with remarkably high risk of herpes alpha virus infection including herpes simplex virus which was neglected previously. For clinical practice, professionals should maintain high index of suspicion in patients with kidney transplantation.

**FR-PO834**

**Risk Factors for Heart Failure Hospitalization in Kidney Transplant Recipients: Results From FAVORIT**

*Martina M. McGrath,<sup>1,2</sup> Finnian R. McCausland,<sup>1,2</sup> Brian Claggett,<sup>1,2</sup> Andrew Bostom,<sup>5</sup> Andrew S. Levey,<sup>3</sup> Daniel E. Weiner,<sup>3</sup> Matthew R. Weir,<sup>4</sup> Marc A. Pfeffer.<sup>1,2</sup> <sup>1</sup>Brigham and Women's Hospital, Boston, MA; <sup>2</sup>Harvard Medical School, Boston, MA; <sup>3</sup>Tufts Medical Center, Boston, MA; <sup>4</sup>University of Maryland School of Medicine, Baltimore, MD; <sup>5</sup>Rhode Island Hospital, Providence, RI.*

**Background:** The development of heart failure (HF) post kidney transplantation is associated with a higher risk of allograft failure and death. Using data from stable kidney transplant recipients (KTRs) enrolled in FAVORIT, we evaluated risk factors for HF hospitalization.

**Methods:** FAVORIT randomized 4,110 stable KTRs to either a high-dose or low-dose multivitamin (folate, B6, B12). HF hospitalizations were determined by review of discharge diagnoses. Stepwise Cox regression models with forwards selection (P<0.05 for entry) were fit to assess for independent risk factors of HF hospitalization events (candidate variables included age, sex, race, country, BMI, cardiovascular disease, diabetes, donor type, graft vintage, albuminuria, smoking, aspirin, statin, ACEi or ARB use; treatment assignment and eGFR were forced in the model).

**Results:** Of the 3,633 patients with complete data available, 115 patients (3.2%) experienced a HF hospitalization over a mean follow-up of four years (0.8 events per 100 patient years (95%CI 0.7-1.0)). The variables associated with a higher adjusted risk of HF events were albuminuria, older age, higher BMI, Black race (vs. non-Black), country (United States+Canada vs. Brazil), prior history of CV disease, and diabetes (Table 1).

**Conclusions:** In a post-hoc analysis of FAVORIT, we identified multiple independent risk factors for HF hospitalization. Some of these, such as BMI and albuminuria, may be modifiable by lifestyle modifications and newer drug therapies, which should be adequately tested in this high-risk population.

Risk factors for heart failure hospitalization among stable kidney transplant recipients

Baseline characteristics	Baseline measurement	Hazard Ratio per unit change	Hazard Ratio	95% Confidence Interval	P
Urine albumin/creatinine ratio, mg/g	53 (9, 101)	per 10-fold log-unit	1.76	1.40 to 2.22	<0.001
eGFR ml/min/1.73m <sup>2</sup>	49 ±16	per 10 ml/min/1.73m <sup>2</sup>	1.09	0.96 to 1.24	0.20
Age, years	52 ±9	per 10 years	1.40	1.14 to 1.72	0.01
Black, n(%)	630 (17%)	Black (vs non-Black)	1.67	1.09 to 2.55	0.02
USA+Canada participants, n(%)	3,021 (83%)	USA + Canada (vs Brazil)	6.01	1.47 to 24.6	0.01
BMI, kg/m <sup>2</sup>	29 ±6	Per 5 kg/m <sup>2</sup>	1.18	1.03 to 1.36	0.02
History of cardiovascular disease, n(%)	729 (20%)	History of cardiovascular disease (vs without)	2.35	1.60 to 3.47	<0.001
Diabetes, n(%)	1,455 (40%)	Diabetes (vs without)	1.54	1.04 to 2.26	0.01
Randomized Treatment (Higher dose), n(%)	1,825 (50%)	Higher vs. lower dose	0.86	0.60 to 1.24	0.35

**FR-PO835**

**Importance of Dedicated Outreach Program to Facilitate COVID-19 Vaccination in Kidney Transplant Patients**

*Aezou Shahmoradi,<sup>1,2</sup> Wilma M. Hopman,<sup>2</sup> Margaret Lacey,<sup>2</sup> Jessy Donelle,<sup>2</sup> Natalie Witton,<sup>2</sup> Lori N. Van Manen,<sup>2</sup> Samuel A. Silver,<sup>1,2</sup> M. Khaled Shamseddin.<sup>1,2</sup> <sup>1</sup>Queen's University, Kingston, ON, Canada; <sup>2</sup>Kingston Health Sciences Centre, Kingston, ON, Canada.*

**Background:** Transplant patients are at high risk of COVID-19 infection and its complications. Timely vaccination in this population is important. To achieve this, we launched an Outreach Program (OP) and a Vaccine Clinic (VC) for transplant patients in early April 2021, as part of Canadian phase II roll out policy.

**Methods:** We started an Outreach Program at our clinic in April 2021 that consisted of a clinical clerk, a nurse and a transplant nephrologist in conjunction with a VC, located separately from the Transplant Clinic, at either hospital site designated for transplant patients. Patients were assessed for vaccination eligibility by the transplant team, consented by phone by the nurse, and then booked in the VC and notified by the clerk prior to their vaccination appointment. Vaccination statuses were assessed on regular intervals up until April 15<sup>th</sup>, 2022. Time between doses in patients who received their vaccinations

at the OP versus those who got vaccinations elsewhere (External Vaccination–EV) were compared using the Mann-Whitney Test.

**Results:** 213 adults kidney transplant patients [Age 57±14 year, female (35.7%), Caucasian (89.7%)] are followed in our clinic. By April 15<sup>th</sup>, 2022, 207 (97.2%) patients received their 1<sup>st</sup> vaccination, 204 (95.8%) received 2<sup>nd</sup> dose, 179 (84%) received 3<sup>rd</sup> dose and 152 (71.4%) received 4<sup>th</sup> dose. Vaccination was facilitated through the OP for 145 (70%), 165 (80.9%), 171 (95.5%), and 152 (100%) of patients for 1<sup>st</sup>, 2<sup>nd</sup>, 3<sup>rd</sup> and 4<sup>th</sup> doses, respectively. The time interval between doses was shorter when vaccination was facilitated by the OP compared with EV [1<sup>st</sup> and 2<sup>nd</sup> doses: 23 (21-24) vs. 35 (26-67) days, P<0.001; 2<sup>nd</sup> and 3<sup>rd</sup> doses: 106 (98-126) vs. 134 (102-173) days, P=0.046]. The 4<sup>th</sup> dose was exclusively provided to our eligible patients through the OP with a median interval of 153 (140-158) days from the 3<sup>rd</sup> dose.

**Conclusions:** An Outreach Program for kidney transplant patients shortened the time between COVID-19 immunizations compared with external vaccination.

**FR-PO836**

**Outcomes of Thymoglobulin vs. Basiliximab Induction in Simultaneous Heart Kidney Transplant: A Single-Center Experience**

*Juhi Bhargava, Rita L. McGill, Sambhavi Krishnamoorthy, Michelle A. Josephson, Yousuf Kyeso. University of Chicago Division of the Biological Sciences, Chicago, IL.*

**Background:** Simultaneous heart kidney transplants (SHK) are less common than kidney-only transplants due to the complex medical and surgical factors involved. Optimal induction immunosuppressive therapy is not known. Arnyamuthu et al. showed no statistically significant difference in mortality or infection rates based on induction agent. Data are sparse on best induction therapy for SHK patients so we studied outcomes associated with different induction therapy approaches.

**Methods:** From 2008-2021, 55 SHK with either Thymoglobulin (r-ATG) or Basiliximab (IL2rAb) induction were performed at our center. We retrospectively reviewed those patient records and compared renal outcomes, infection rates, and mortality over a 12-month period post transplantation. Continuous variables and outcomes were compared using Student's t-test, and categorical variables and outcomes were compared using chi-squared tests.

**Results:** Baseline characteristics are summarized in figure 1. At 12 months, average GFR was 55.4 with r-ATG and 55.1 with IL2rAb (P=0.96). One year mortality was 9.4% with r-ATG and 21.7% with IL2rAb (P=0.20). Delayed graft function (DGF) was 18.8% with r-ATG and 34.8% with IL2rAb (P= 0.2). One-year rejection rate was 25.0% with r-ATG and 17.4% with IL2rAb (P=0.5). BK viremia was 40.6% with r-ATG and 39.1% with IL2rAb (P= 0.9). CMV viremia was 34.3% with r-ATG and 17.4% with IL2rAb (P=0.2). Infection related hospitalization rates in r-ATG and IL2rAb were 43.8% and 39.1% (P= 0.7).

**Conclusions:** In this single-center cohort, we observed roughly 50% lower mortality and DGF in SHK recipients when r-ATG was used, compared to IL2rAb, but the rates of CMV viremia were nearly twice as high and rejection over the first year was 30% greater. These differences were not statistically significant but provide an early signal for differential effects of induction strategy. Further work is needed to clarify optimal approach to this increasingly performed, lifesaving multi-organ transplant

	Baseline Characteristics			
	r-ATG	IL2rAb	ALL	p-value
<b>Age (yrs)</b>	<b>57.8±7.4</b>	<b>55.9±8.7</b>	<b>57.0±8.0</b>	<b>0.38</b>
<b>Female %</b>	<b>28.1</b>	<b>17.4</b>	<b>23.6</b>	<b>0.36</b>
<b>DM %</b>	<b>50</b>	<b>47.8</b>	<b>49.1</b>	<b>0.87</b>
<b>HTN %</b>	<b>71.9</b>	<b>69.6</b>	<b>70.9</b>	<b>0.85</b>
<b>Former smoker %</b>	<b>50</b>	<b>43.5</b>	<b>47.3</b>	<b>0.63</b>
<b>CKD stage</b>				<b>0.49</b>
<b>CKD 3b %</b>	<b>28.13</b>	<b>43.48</b>	<b>34.55</b>	
<b>CKD 4 %</b>	<b>31.25</b>	<b>26.09</b>	<b>29.09</b>	
<b>CKD 5 %</b>	<b>15.63</b>	<b>4.35</b>	<b>10.91</b>	
<b>ESRD %</b>	<b>25</b>	<b>26.09</b>	<b>25.45</b>	
<b>cPRA</b>	<b>2.0±8.6</b>	<b>11.3±23.5</b>	<b>5.9±16.9</b>	<b>0.08</b>
<b>IABP %</b>	<b>50</b>	<b>65.2</b>	<b>56.4</b>	<b>0.26</b>

**FR-PO837**

**Urinary Tract Infections in the First Year After Renal Transplantation in Current of Immunosuppression Setting: A 5-Year Retrospective Single-Centre Study**

*Jorge C. Andrade,<sup>1</sup> Jorge Andrade-Sierra,<sup>2,1</sup> Elsa A. Fuentes Lopez,<sup>1</sup> Enrique Rojas-Campos,<sup>1</sup> Manuel Martinez,<sup>1</sup> Jose Ignacio Cerrillos,<sup>1</sup> Luis Alberto Evangelista-Carrillo.<sup>1</sup> <sup>1</sup>Instituto Mexicano del Seguro Social Delegación Jalisco, Guadalajara, Mexico; <sup>2</sup>Universidad de Guadalajara Centro Universitario de Ciencias de la Salud, Guadalajara, Mexico.*

**Background:** Urinary tract infection (UTI) is associated with development impaired allograft function. Our objective was assessing to UTI risk factors and its impact in the allograft function.

**Methods:** Retrospective Cohort from March-2014 to March-2019 included 1341 patients with kidney transplantation. All patients with development at least one UTI

event during first year after transplantation were registered. Prophylaxis with TMP-SMX (160/800mg) was used for 3-6 months and the main immunosuppression scheme was based on TAC/MMF/PDN.

**Results:** The accumulated incidence of UTI was 41% and ESBL-producing *Escherichia Coli* was the most frequent agent causing. In a Logistic Regression analysis; risks factors were Anti-thymocyte globulin (ATG) (RR 1.5; 1.18-1.91;  $p=0.001$ ), surgical complications (RR 2.4; 1.7-3.4;  $p=0.001$ ), duration of bladder catheterization (RR 1.43; 1.09-1.9;  $p=0.021$ ), transplant number (RR 1.8; 1.09-3.0;  $p=0.001$ ).

**Conclusions:** Despite the high incidence of UTI, there was no impact on graft function at 12 months post transplantation. Use of ATG and prolonged bladder catheterization are some of the risk factors.

	UTI=548	No UTI=793	P
Age (years)	32 ± 12	30 ± 10	0.003
Male-gender n (%)	344 (62.8)	582 (73.4)	0.001
Induction, n (%)			
ATG	322 (59)	507 (64)	0.059
Basiliximab	226 (41)	286 (36)	
Type of Donor (%)			
Living donor	462 (84)	690 (87)	NS
Deceased donor	86 (15.7)	103 (13)	
Transplant n (%)			
First	509 (93)	758 (95.6)	NS
Second	39 (7)	35 (4.4)	
Double J stent n (%)	125 (22.8)	124 (15.6)	0.006
Risk factors catheterization Time: n (%)			
< 5	368 (67.2)	624 (78.7)	
6-7	144 (26.3)	142 (17.9)	0.001
7-14	26 (5.0)	34 (4.0)	
>14	8 (1.5)	3 (0.4)	
CrS at 12-months (mg/dL)	1.14 ± 0.58	1.23 ± 1.25	NS

**FR-PO839**

**Comparison of Trends and Mortality Benefit to Preemptive Kidney Transplantation Over the Last Two Decades**

Abhishek Kumar,<sup>1</sup> Patrick Ten Eyck,<sup>2</sup> Sarat C. Kuppachi,<sup>2</sup> <sup>1</sup>*Yale School of Medicine, New Haven, CT;* <sup>2</sup>*The University of Iowa Hospitals and Clinics, Iowa City, IA.*

**Background:** Pre-emptive kidney transplantation (PKT) is considered the optimal treatment option for advanced chronic kidney disease with improved patient and graft survival. We studied the trends in PKT over the last two decades -to determine whether kidney transplants are being performed at a higher eGFR as a consequence of greater push for preemptive transplant.

**Methods:** We analyzed adult, first time PKT alone recipients using United Network of Organ Sharing data. Baseline characteristics were compared using chi-square analysis for categorical variables and t test for continuous variables. Multivariable Cox regression was used to assess the difference in mortality.

**Results:** 49,675 patients have received preemptive kidney transplant since 2000 in our cohort. PKT rates have been stable at about 15% to 17% of all kidney transplant. Proportion of preemptive kidney transplants from living donors have slightly reduced from 67% to 62% over the last decade. Early PKT (egfr >15ml/min) account for 25% of preemptive transplants and has remained stable over the last decade. Living donors account for 70% of these transplants with some decline in the last five years to 65%. We did not find any mortality benefit in early PKT compared to being on dialysis for < 180 days (HR of 1.12, CI 0.994-1.27,  $p=0.063$ ).

**Conclusions:** Early preemptive kidney transplant in recipients with egfr >15ml/min is not an uncommon occurrence even among living recipients where the procedure timing can be controlled. Starting the proverbial transplant clock earlier does not confer a mortality benefit.

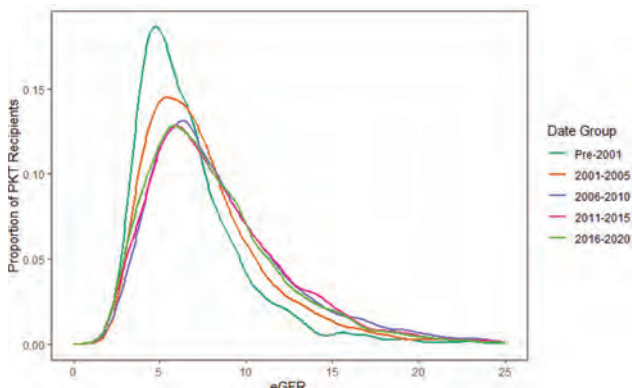

Distributions of eGFR at the time of transplantation in recipient of preemptive kidney transplant as illustrated by kernel density plots.

**FR-PO840**

**Retrospective Evaluation of the Prevalence of Diabetes Mellitus in a Single Center Renal Transplant Cohort**

Carlo Alfieri,<sup>1,2</sup> Elisa Cicero,<sup>1</sup> Paolo Molinari,<sup>1</sup> Donata C. Cresseri,<sup>1</sup> Anna Regalia,<sup>1</sup> Mariarosaria Campise,<sup>1</sup> Maria Teresa Gandolfo,<sup>1</sup> Evaldo Favi,<sup>1,2</sup> Giuseppe. Castellano,<sup>1,2</sup> <sup>1</sup>*Fondazione IRCCS Ca' Granda Ospedale Maggiore Policlinico, Milan, Italy;* <sup>2</sup>*Universita degli Studi di Milano, Milano, Italy.*

**Background:** Novel onset of diabetes after transplantation (NODAT) might impact significantly in renal transplant (RTx) and RTx patients (RTxps) outcome. In this study we evaluated: 1) the prevalence of diabetic patients who access the RTx 2) the incidence of NODAT and 3) the most related factors for the development of diabetes after RTx.

**Methods:** We retrospectively studied 522 RTxps transplanted in our Unit between January 2004 and December 2014. Each patient underwent: 1) to a collection of remote and pathological anamnesis and complete physical examination and to routine and specific clinical and biochemical determinations at 1 (T1), 6 (T6) and 12 (T12) months after RTx. At six months of RTx, the Oral Glucose Tolerance Test (OGTT) was performed.

**Results:** The age of RTxps was 48±12 years. Patients with glucose metabolism abnormalities were significantly older, without differences in gender. In patients with NODAT (12.6%), cyclosporine was used more than tacrolimus, and higher doses of steroids at T1 and T6 were prescribed. They had a worse general metabolic and glucose (HOMA index, glycaemia and HbA1c) status than normoglycemic. Of note, no differences in 25-(OH)-D and in the other mineral metabolism parameters were found. In multivariate analysis, we found that age at transplant (OR 1.28 for 5 years older) ( $p=0.006$ ), BMI at T1 (OR 1.22 for 2 kg / m<sup>2</sup> more) ( $p=0.01$ ) and the dose of steroid prescribed during the first post RTx month (OR 2.7 per 100 mg additional drug) ( $p=0.03$ ) were independently correlated with NODAT.

**Conclusions:** In this study, we demonstrated that the prevalence of NODAT was relatively high in our cohort reflecting data present in the literature. Interestingly, age at RTx, BMI and cumulative dose of steroids resulted the variables that significantly and strongly influence its development. On the other hand, no relationship was observed between blood values of vitamin D, parathormone and the onset of NODAT. Future research, possibly involving a higher number of RTxps could also evaluate the effects of NODAT on graft and patients on long term outcome.

**FR-PO841**

**Safety and Tolerability of Tixagevimab/Cilgavimab for Pre-Exposure Prophylaxis of COVID-19 in Kidney Transplant Recipients**

Thalia Salinas, Gabriel J. Stryjniak, John R. Lee, Deirdre L. Sawinski, Thangamani Muthukumar, Darshana M. Dadhania. *Weill Cornell Medicine, New York, NY.*

**Background:** Kidney transplant recipients (KTR) remain at risk for severe COVID-19 because of emerging SARS-CoV-2 variants and impaired antibody response to COVID-19 vaccines. There is an urgent need for effective vaccination and pre-exposure prophylaxis. In December 2021, the FDA issued an emergency use authorization of tixagevimab/cilgavimab for pre-exposure prophylaxis of COVID-19 in moderately-severely immunocompromised individuals. In PROVENT, tixagevimab/cilgavimab resulted in 83% relative risk reduction in incidence of symptomatic COVID-19, but only 3% of subjects received immunosuppressive medications and <1% had immunosuppressive disease. We report safety and tolerability of tixagevimab/cilgavimab in KTR at our center.

**Methods:** 40 doses initially allocated to KTR. We designed an online questionnaire to assess therapy tolerability. 28/38 KTR who received therapy responded.

**Results:** Patient characteristics of 38 KTR who received tixagevimab/cilgavimab are listed (Table 1a). Negative Anti-S antibody documented in 54.1% patients, with 17(85%) testing negative after three vaccines. 28 KTR completed the survey and authorized use of their deidentified data. Most patients, 81.5%, reported tolerating tixagevimab/cilgavimab "Very Well" (Table 1b). The most common symptom was fatigue, moderate in 25% and mild in 29%. Other symptoms were less frequent, <15%.

**Conclusions:** Tixagevimab/cilgavimab was generally "very well" tolerated. Additional data substantiating safety and tolerability of tixagevimab/cilgavimab over a longer observation period and with more study participants should help increase confidence in a pre-exposure prophylaxis strategy and offer a safety net for kidney transplant recipients and others at risk for severe COVID-19.

**Table 1. Patient characteristics of kidney allograft recipients, responses to questionnaire and symptoms following tixagevimab/cilgavimab administration**

Table 1a. Patient characteristics of KTR treated with tixagevimab/cilgavimab	
No. of participants	38
Age, median (IQR), years	67 (60-75)
Sex, Female, No. (%)	16 (42.1)
Race/Ethnicity, No. (%)	
Asian	4 (10.5)
Black	8 (21.0)
Hispanic	2 (5.3)
Other	3 (7.9)
White	21 (55.3)
Time since kidney transplantation, median (IQR), years	3.7 (1.3-7.2)
Immunosuppression maintenance therapy, No. (%)	
Steroid maintenance regimen	17 (44.7)
Steroid free regimen	21 (55.3)
Anti-S antibody titers (n=37), No. (%)	
Negative, <0.8 U/ml <sup>a,b</sup>	20 (54.1)
Positive, ≥ 0.8 and <100 U/ml <sup>a,b</sup>	6 (16.2)
Positive, ≥ 100 U/ml <sup>a,b</sup>	5 (13.5)
Positive, value not reported <sup>b</sup>	6 (16.2)
COVID-19 vaccination status, No. (%)	
1 dose of Janssen vaccine	1 (2.6)
2 doses of mRNA vaccine	6 (15.8)
≥ 3 doses of mRNA vaccine	31 (81.6)
Serum Creatinine, (n=9), median (IQR), mg/dl	
Pre tixagevimab/cilgavimab therapy	1.70 (1.13-1.97)
Post tixagevimab/cilgavimab therapy	1.70 (1.18-1.73)

Table 1b. Responses to tolerability questionnaire (N=26)				
How well did you tolerate Evusheld therapy?	Very Well No. (%)	Well No. (%)	Somewhat Well No. (%)	Not Well No. (%)
	22 (84.6)	4 (15.4)	1 (3.7)	0 (0)

Did you experience the following symptoms after Evusheld therapy?	Yes		No	
	No. (%)	Mid No. (%)	Moderate No. (%)	Severe No. (%)
Cough	4 (14.3)	3 (10.7)	1 (3.6)	0 (0)
Fatigue	15 (53.6)	8 (28.6)	7 (25)	0 (0)
Headache	4 (14.3)	3 (10.7)	0 (0)	1 (3.6)
Chest discomfort	1 (3.6)	0 (0)	1 (3.6)	0 (0)
Shortness of breath	4 (14.3)	3 (10.7)	1 (3.6)	0 (0)
Dizziness	3 (10.7)	3 (10.7)	0 (0)	0 (0)
Nasal congestion	2 (7.1)	2 (7.1)	0 (0)	0 (0)
Nausea	0 (0)	0 (0)	0 (0)	0 (0)
Vomiting	0 (0)	0 (0)	0 (0)	0 (0)
Diarrhea	3 (10.7)	3 (10.7)	0 (0)	0 (0)
Fever	1 (3.6)	1 (3.6)	0 (0)	0 (0)
Chills	2 (7.1)	1 (3.6)	1 (3.6)	0 (0)
Generalized itching	1 (3.7)	1 (3.7)	0 (0)	0 (0)
Rash	0 (0)	0 (0)	0 (0)	0 (0)
Fainting	0 (0)	0 (0)	0 (0)	0 (0)
Swelling/bleeding at injection site	2 (7.4)	2 (7.4)	0 (0)	0 (0)
Swelling of lips, face, or throat	1 (3.6)	1 (3.6)	0 (0)	0 (0)

<sup>a</sup> Anti-S SARS COV-2 AB (SPIKE) - Immunoassay, QUEST. Value >0.8 U/ml is considered positive. Range is 0.4 to 2500 U/ml |

<sup>b</sup> Anti-S SARS COV-2 AB- Immunoassay, Roche Elecsys. Value >0.8 U/ml is considered positive. Antibody titer value reported at in some patients. Reported as "positive" or "negative", with no antibody titer value at NewYork-Presbyterian/Weill Cornell Hospital Laboratory.

<sup>c</sup> Post tixagevimab/cilgavimab therapy median follow-up (IQR), days: 11 (7-13)

FR-PO843

**Weight Gain in the First Year Post Kidney Transplantation**

Ziad Arabi,<sup>1,2</sup> Jawaher N. Aljabri,<sup>1,2</sup> Mohammed H. Tawhari.<sup>1,2</sup> <sup>1</sup>Division of Nephrology, King Abdulaziz Medical City, Riyadh, Saudi Arabia; <sup>2</sup>King Abdullah International Medical Research Center; College of Medicine, King Saud Bin Abdulaziz University for Health Sciences, Riyadh, Saudi Arabia.

**Background:** Undesirable weight gain following kidney transplantation (KT) is relatively common. In this study we examined the incidence and risk factors for weight gain of >5% in the first post-transplantation year.

**Methods:** A single center retrospective study of the kidney transplant recipients (KTR) who underwent KT between 2017 to 2020 with 12 months follow up. We reviewed the patients' demographics, weight changes and A1C values. We also examined the factors associated with weight gain >5%.

**Results:** A total of 287 KTR were included. 74% were ≥ 30 years, 58% were men and 80% were living-donor KTR. Preemptive KT was 10.1%, PD: 11.5% and HD: 78.4%. At baseline, 20.2% of patients had obesity stage 1 (BMI: 30-34.9), while 4.2% had obesity stage 2 (BMI 35-39.9). Diabetes (DM) was present in 34.5% (n=99) of whom 25.3% had type-1 DM while 74.7% had type-2 DM. The average weight gain by one year of transplant was 6.0±8.3 (kg) and 59.6% patients had weight increase of ≥5%. Both males and females significantly gained weight and in a comparable degree (p: 0.588). Weight gain after living donor KT was much more than after deceased donor KT [6.63 Kg (5.58 to 7.69) versus 3.42 Kg (1.12 to 5.71), p: 0.009]. Multivariate analysis showed that the odd ratio of weight gain ≥ 5% after living donor KT (versus deceased donor) is OR: 2.86 (CI: 1.49 to 5.523, p: 0.002). Baseline BMI was negatively associated with weight gain post KT (OR: 0.9, CI: 0.854 to 0.949, p: <0.00). Age, gender, DM and hypertension were not associated with higher weight gain.

**Conclusions:** About two thirds of the renal transplant recipients gain at least ≥5% of their baseline weight by the first year after kidney transplantation. Recipients of living donor kidney transplant and those with lower BMI are at increased risk factor.

	BMI at baseline (pre-transplant)	BMI at 12 months (post-transplant)
Obese stage 2 (BMI 35-39.9)	12 (4.2%)	23 (11.4%)
Obese stage 1 (BMI: 30-34.9)	58 (20.2%)	59 (29.2%)
Overweight	84 (29.3%)	65 (32.2%)
Normal	103 (35.9%)	52 (25.7%)
Underweight	29 (10.1%)	3 (1.5%)

FR-PO842

**Outcome of COVID-19 Infections After Vaccination in Kidney Transplant Patients**

Mariarosaria Campise,<sup>1</sup> Carlo Alfieri,<sup>1,2</sup> Paolo Molinari,<sup>1</sup> Maria Teresa Gandolfo,<sup>1</sup> Anna Regalia,<sup>1</sup> Donata C. Cresseri,<sup>1</sup> Giuseppe. Castellano.<sup>1,2</sup> <sup>1</sup>Fondazione IRCCS Ca' Granda Ospedale Maggiore Policlinico, Milan, Italy; <sup>2</sup>Universita degli Studi di Milano, Milano, Italy.

**Background:** Kidney transplant recipients (KT) are a vulnerable population with a risk of death after COVID-19 infection (COV-I) four times higher than in the general population. mRNA COVID-19 vaccines changed the prognosis. Although KT have an impaired immunological response to mRNA vaccines, in March 2021 we started a vaccination campaign.

**Methods:** Among 1611 KT, 72 (4.2%) had COV-I (positive molecular nasopharyngeal swab) between 31 October 2021 and 15 January 2022 (3<sup>rd</sup> outbreak). Forty-one (57%) were male and 58 (80.5%) had a deceased donor transplant, median age was 52 (43-60) years, median transplant vintage 57 (27-159) months, median serum creatinine 1.37 (1.0-1.7) mg/dL. KT were on calcineurin inhibitors, prednisone, mycophenolate (MMF) and mTOR inhibitors in 93-87-79% and 5.6% respectively. At COV-I 43 KT had received 3 doses of Comirnaty (BNT162b2)@, 21 two and 4 one, 4 were not vaccinated. Δ variant was present in 36. Treatment included: increase of the daily steroid dosage (69%), MMF withdrawal (70%) or halving (5%) and monoclonal antibodies: Ronapreve® or Xevudy® (32%). Nine δ positive KT were hospitalized for severe respiratory distress: 2 died (6.6%).

**Results:** The variables associated with an increased risk for hospitalization were older age and dyspnea (p=0.023, p<0.0001 respectively). At multivariate analysis, dyspnea (p<0.0001) and MMF (p=0.003) were independently associated with the risk for hospitalization. Combination of the two variables increased the significance (p<0.0001). Comparing this series to the 82/1503 (5.4%) KT infected during the previous waves, hospitalization, mortality and cumulative mortality rates dropped from 45%, 29.3% and 13.4% to 30%, 6.6% and 2.7% respectively, main difference being the absence of vaccination in the first group.

**Conclusions:** Vaccinations did not reduce the incidence of COV-I among KT but provided certain protection associated with a significantly better outcome.

**Weight gain post kidney transplantation**

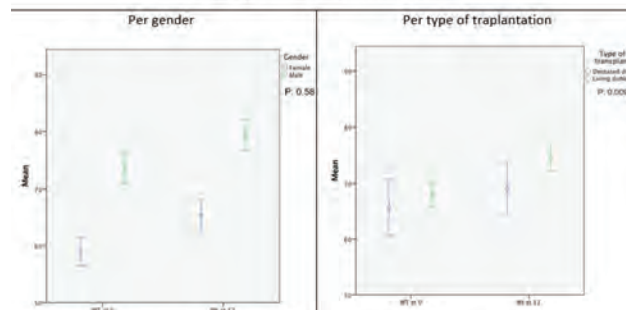

FR-PO844

**The Impact of Kidney Transplantation on Systolic and Diastolic Blood Pressure and the Number of Blood Pressure Medications in the First Year Post Kidney Transplantation**

Ziad Arabi,<sup>1,2</sup> Mohamad Y. Abdulgadir,<sup>1,2</sup> Talha M. Youssouf,<sup>1,2</sup> Abdullah S. Althani,<sup>1,2</sup> Hamzah A. Alhamzah,<sup>1,2</sup> Fayez F. Alhejailli,<sup>1,2</sup> Elwaleed A. Elhassan.<sup>1,2</sup> <sup>1</sup>Division of Nephrology, Department of Medicine, King Abdulaziz Medical City, Riyadh, Saudi Arabia; <sup>2</sup>King Abdullah International Medical Research Center; College of Medicine, King Saud Bin Abdulaziz University for Health Sciences, Riyadh, Saudi Arabia.

**Background:** To examine the impact of kidney transplantation (KT) on systolic (SBP) and diastolic blood pressure (DBP) and the number of blood pressure (BP) medications in the first-year post-kidney transplantation at our center.

**Methods:** This is a single center retrospective study of renal transplant recipients who underwent KT between January 2017 and May 2020 with 12 months follow up. The BP target goal at the time of this retrospective study was <140/90 mm Hg. We reviewed

BP readings before and at one, 6, and 12 months after kidney transplantation. We also reviewed the number of BP medications at the same intervals post transplantation.

**Results:** A total of 278 renal transplant recipients were included. Of those, 74% were ≥ 30 years of age, 58% were men and 80% were living-donor kidney recipients. Preemptive transplantation was 10.1%, PD 11.5% and HD 78.4% respectively. At one year, 70.1% of patients attained the target BP goal. SBP was 138.6±22.3 at baseline and it improved by -6.51 (-9.62 to -3.4) by 12 months (P<0.001). DBP was 77.6±15.1 at baseline and it improved by -5.25 (-7.5 to -3) by 12 months (P<0.001). {Figure.1} These changes were observed in both genders and at a comparable difference (P=0.579 for SBP, P=0.136 for DBP). The number of blood pressure medications also significantly decreased. {Figure.2}

**Conclusions:** Our study demonstrated the positive effect of kidney transplantation on systolic and diastolic blood pressures in the first-year post transplantation in both genders. The number of BP medications also significantly decreased.

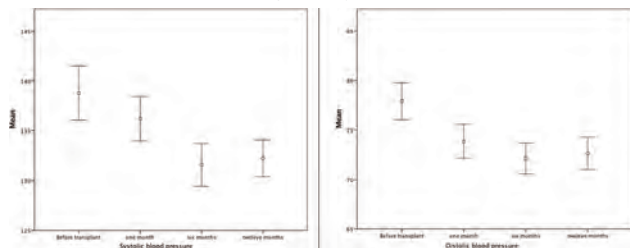

Number of medications	1 month	6 months	12 months	P (For 1 month vs. 12 months)
0	67 (23.3%)	82 (28.6%)	84 (29.3%)	0.001
1	91 (31.7%)	93 (32.4%)	89 (31%)	
2	85 (29.6%)	83 (28.9%)	81 (28.2%)	
3	27 (9.4%)	18 (6.3%)	18 (6.3%)	
4	6 (2.1%)	2 (0.7%)	6 (2.1%)	

**FR-PO845**

**Do the Findings of Arterial Calcifications or Atherosclerosis on Pre-Transplant Cardiovascular Imaging Correlate With Persistent Hyperparathyroidism at 1 Year Post Kidney Transplantation?**

Ziad Arabi,<sup>2,1</sup> Mohamad Y. Abdulgadir,<sup>2,1</sup> Talha M. Youssouf,<sup>2,1</sup> Aya K. Alkhdhairi,<sup>2,1</sup> Osama A. Mahmoud,<sup>2,1</sup> Elwaleed A. Elhassan,<sup>2,1</sup> Ahmad I. Alflaiw,<sup>2,1</sup> Hazim S. Alghamdi,<sup>2,1</sup> Hamzah A. Alhamzah,<sup>2,1</sup> Abdullah S. Althani,<sup>2,1</sup> <sup>1</sup>King Abdullah International Medical Research Center; College of Medicine, King Saud Bin Abdulaziz University for Health Sciences, Riyadh, Saudi Arabia; <sup>2</sup>Division of Nephrology, Department of Medicine, King Abdulaziz Medical City, Riyadh, Saudi Arabia.

**Background:** Hyperparathyroidism is common in chronic kidney disease, and it can persist post kidney transplantation (KT). It is unknown whether the findings of arterial calcifications/ atherosclerosis on cardiovascular imaging pre- transplantation correlate with the persistence of hyperparathyroidism (persHPTH) at one-year post-renal transplantation.

**Methods:** A single center retrospective study of renal transplant candidates from January 2017 to May 2020. We collected patients' demographics, cardiovascular (CV) risk factors, the findings of pre- transplant CV imaging (echo, nuclear cardiac perfusion stress test, calcium scoring, cardiac catheterization results and the degree of calcification/ atherosclerosis of pelvic arteries on screening pelvic CT scan). We also collected iPTH values [at baseline (before transplant), 1- 6 months, 6-12 months, and 12-24 months post transplantation]. We defined persHPTH as iPTH ≥ 25.5 pmol/L after 12 months post kidney transplantation (normal= 12.73 pmol/L).

**Results:** A total of 287 kidney transplant recipients (KTR) were included. 74% were ≥ 30 years, 58% were men and 80% were living-donor KTR. Preemptive transplantation was performed in 10.1%. Dialysis modality used prior to KT was PD in 11.5% and HD in 78.4% (AVF: 42% versus Permcath: 58%). Dialysis vintage was 4.8±3.3 years for deceased donor kidney transplantation (DDKT) versus 2.4±2.6 years for living donor kidney transplantation (LKT). The prevalence of persHPTH was 16.4% (n=47) There were no association between persHPTH and the findings of pre- transplant CV imaging including echo findings (EF, LVH and abnormal wall motion), cardiac nuclear perfusion stress test (cardiac PET), cardiac catheterization, calcification/atherosclerosis of pelvic arteries seen on screening pelvic CT scan. However, the presence of calcium scoring ≥ 400 on pre -transplant cardiac PET scan was associated with higher incidence of persHPTH at 12 months post renal transplantation (37% versus 13.1%; p: 0.013).

**Conclusions:** Higher calcium scoring (> 400) seen on cardiac PET scan during pre-transplant workup is associated with higher incidence of persHPTH at 12 months post KT.

**FR-PO846**

**Do the Findings of Arterial Calcifications or Atherosclerosis on Pre-Transplant Cardiac Workup Correlate With Having Uncontrolled Hypertension Post Kidney Transplantation?**

Ziad Arabi,<sup>1,2</sup> Mohamad Y. Abdulgadir,<sup>1,2</sup> Hamzah A. Alhamzah,<sup>1,2</sup> Nasser M. Alnazari,<sup>1,2</sup> Ahmad I. Alflaiw,<sup>1,2</sup> Mohammed H. Tawhari,<sup>1,2</sup> Elwaleed A. Elhassan,<sup>1,2</sup> Dr Junaid Iqbal,<sup>1,2</sup> Fayeze F. Alhejaili,<sup>1,2</sup> <sup>1</sup>Division of Nephrology, Department of Medicine, King Abdulaziz Medical City, Riyadh, Saudi Arabia; <sup>2</sup>King Abdullah International Medical Research Center; College of Medicine, King Saud Bin Abdulaziz University for Health Sciences, Riyadh, Saudi Arabia.

**Background:** ESKD is often associated with higher calcium scoring, calcification of the arteries or abnormal echocardiography findings. It is unknown if these anatomical changes contribute to uncontrolled hypertension (HTN) post KT.

**Methods:** A single center retrospective study of kidney transplant recipients (KTR) who underwent KT between January 2017 and May 2020 and followed up for 12 months. The BP target was <140/90 mmHg as per published guidelines at the time of this study. We divided patients according to their blood pressure (BP) control at one-year post KT, into two groups: controlled (≤140/90) and uncontrolled (>140/90). We collected data about patients' demographics, baseline cardiovascular risk factors and their pretransplant imaging. Analyzed parameters included echocardiography (ejection fraction and wall motion abnormalities), nuclear stress test (calcium scoring, and cardiac perfusion), cardiac catheterization, and CT of pelvic arteries (assessing severity of calcifications/ atherosclerosis).

**Results:** A total of 254 KTR were included. Of those, 74% were ≥ 30 years, 58% were men and 80% were living-donor kidney recipients. Preemptive transplantation was 10.1%, PD 11.5% and HD 78.4%, respectively. At one year, 76 (29.9%) of the patients did not attain the target BP goal of <140/90. No pre-transplant cardiovascular imaging finding was associated with uncontrolled BP. Age (47 vs. 41 years, P=0.008), and DM (P=0.012) were significantly correlated with higher incidence of uncontrolled HTN. However, gender, dialysis vintage, preemptive transplantation, type of dialysis, and type of transplant (living vs. deceased-donor KT) were not different among the two groups. Multivariate analysis showed that an elevated creatinine (OR=1.016, CI=1.004-0.028, p=0.01) and smoking (OR=3.58, CI=1.001-12.8. p=0.05) were significantly associated with uncontrolled BP.

**Conclusions:** Arterial calcification/ atherosclerosis on pre-KT cardiac work up did not correlate with uncontrolled hypertension at 12 months post KT.

**FR-PO847**

**Persistent Hyperparathyroidism Post Kidney Transplantation**

Ziad Arabi,<sup>1,2</sup> Abdullah S. Althani,<sup>1,2</sup> Jawaher N. Aljabri,<sup>1,2</sup> Mohammed H. Tawhari,<sup>1,2</sup> Ahmad I. Alflaiw,<sup>1,2</sup> <sup>1</sup>Division of Nephrology, Department of Medicine, King Abdulaziz Medical City, Riyadh, Saudi Arabia; <sup>2</sup>King Abdullah International Medical Research Center; College of Medicine, King Saud Bin Abdulaziz University for Health Sciences, Riyadh, Saudi Arabia.

**Background:** Hyperparathyroidism (HPT) is a frequent complication in chronic kidney disease and may persist in 20 to 50% of cases one year after kidney transplantation; and may contribute to long term allograft dysfunction and increased risk of fractures. There is scant data on the prevalence of post-transplant HPT in kidney transplant patients in Saudi Arabia. The aim of this study is to evaluate the prevalence of this complication and to identify its risk factors in single center in Saudi Arabia.

**Methods:** In a retrospective study, data of 287 kidney transplant recipients, who underwent kidney transplant between January 2017 and May 2020 were collected. Data included demographic characteristic, history of hypertension, diabetes mellitus, coronary artery disease, duration of chronic kidney disease and dialysis therapy, dialysis modality, and type of vascular access. Serum iPTH measured prior to transplant then every 6 months post-transplant for 2 years.

**Results:** Of 287 kidney transplant recipients: 119 (41.5%) were diabetic and 38 (13.2%) had coronary artery disease. 231 (80.5%) had received living-donor kidneys and 56 (19.5%) were cadaveric recipients. iPTH was before transplant: 82.2±84.2 pmol/L, 1- 6 months: 27.5±31.4, 6-12 months: 28.8±35.9, and 12-24 months: 30.1±43.3. p value <0.001. Figure.1 Persistent hyperparathyroidism was found in 47 (16%) of patients at one year post renal transplant. The presence of diabetes mellitus as well as the duration of dialysis were predictors of persistent HPT. Type of transplant and allograft function did not seem to have any correlation.

**Conclusions:** In a single center experience, (16%) of kidney transplant patients had persistent HPT and the presence of diabetes mellitus and the duration of dialysis were important risk factors in its development.

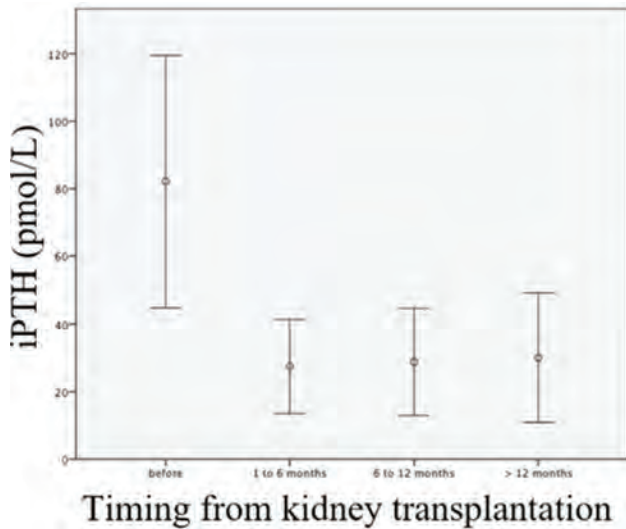

iPTH post kidney transplantation

FR-PO848

**Kidney Transplant Outcomes in Patients With Scleroderma: A Single Center Experience**

Juan P. Portocarrero Caceres, Cybele Ghossein, Ibrahim Tawhari. *Northwestern University Feinberg School of Medicine, Chicago, IL.*

**Background:** Scleroderma Renal Crisis (SRC) is a devastating complication of Scleroderma (SSc) affecting 5-20% of all SSc patients. End stage kidney disease (ESKD) develops in 25-40% of SRC patients. Kidney transplantation (KT) is a viable option for patients that progress to ESKD, but little data exists on outcomes in this population. Here we report on patient and graft outcomes in a case series of SSc patients undergoing KT.

**Methods:** This was a retrospective study of all patients with SSc who underwent KT at Northwestern Hospital between 2000 and 2020. The objective of this study were to determine graft and patient survival at year 1, 5 and 10 post-transplant.

**Results:** Nine patients (eight females and one male) with SSc underwent KT. All the patients had diffuse SSc. Six patients were on HD and three had preemptive transplantation. Five patients had a Living Donor KT (LDKT) while 4 had a deceased donor KT (DDKT). Only one patient had delayed graft function. Standard immunosuppression was used as induction and maintenance. All patients were maintained on ace inhibitors post-transplant. Graft survival at 1, 5 and 10 years was 100%, 100% and 78% respectively (Table 1). The survival rate in our cohort was similar to graft survival. Two patients had recurrence of SRC at 3 and 6 years respectively after transplant[GCI], leading to ESKD.

**Conclusions:** KT is a viable option for patients with ESKD due to SSc with acceptable graft and patient survival. Recurrence of SRC while rare can occur years after initial KT.

Table 1. Clinical characteristics and outcomes of KT in SSc patients

Female Gender	8 (88.9%)
Age in years	61 (+/-4)
Patients on HD	6 (66.6%)
Time on HD in years	2.5 (+/-1)
Living Donor Transplant	5 (55.5%)
Deceased Donor Transplant	4 (44.4%)
ACE-i Post-Transplant	9 (100%)
Graft Survival Rate (%)	
1 year	100%
5 years	100%
10 years	78%

FR-PO849

**Healthcare Resource Utilization Associated With Post-Transplant Neutropenia and Leukopenia Among Kidney Transplant Recipients: A Real-World Evidence Study**

Sanjay Merchant,<sup>1</sup> Amit Raval,<sup>1</sup> Vladimir Turzhitsky,<sup>1</sup> Elnara Fazio-Eynullayeva,<sup>2</sup> Harry Jin.<sup>2</sup> <sup>1</sup>Merck and Co Inc, Rahway, NJ; <sup>2</sup>TriNetX LLC, Cambridge, MA.

**Background:** Kidney transplant recipients (KTRs) are often prescribed medications to reduce the risk of cytomegalovirus (CMV) infection, including valganciclovir/ganciclovir (V/G), however, use of V/G increases the risk of developing post-transplant neutropenia (PTN) and post-transplant leukopenia (PTL). Real-world evidence describing health care resource utilization (HCRU) associated with PTN/PTL are limited.

**Methods:** This retrospective cohort study utilized the TriNetX Dataworks – USA Network, a federated network of de-identified electronic health record data for 82.5 million patients in the US. KTRs who were treated with V/G between January 1, 2012, and September 30, 2020, were included in this analysis. PTN was defined as absolute neutrophil count <1500/ $\mu$ L, and PTL was defined as white blood cell count <3,500/ $\mu$ L. We analyzed HCRU among KTRs and compared HCRU between those with and without PTN/PTL.

**Results:** Overall, 8,791 patients had a mean age of 52.8 years, 40.7% female, 41.6% White, and 32.6% Black. A total of 3,383 patients (38.5%) developed PTN and 6,127 patients (69.7%) developed PTL. The mean (SD) time from transplantation to the development of PTN or PTL were 5.6 (3.1) months and 6.4 (3.7) months, respectively. Among the 3,383 patients who developed PTN, 61.5% had inpatient admission(s), 16.5% had PTN-related hospitalization, 36.7% had emergency room visit(s), and 38.9% were treated with G-CSF. Similarly, among the 6,127 patients who developed PTL, 60.8% had inpatient admission(s), 24.5% had PTL-related hospitalization, 34.9% had emergency room visit(s), and 22.8% were treated with G-CSF.

**Conclusions:** The results of the study suggest that V/G treated KTRs are at elevated risk of developing PTN/PTL, both of which are associated with increased HCRU. Further research is needed to inform the development of interventions designed to decrease the risk of suboptimal health outcomes and HCRU among KTRs.

**Funding:** Commercial Support - Merck & Co., Inc

Health care resource utilization among KTRs

	With PTN (n=3,383)	Without PTN (n=5,408)	P-value	With PTL (n=6,127)	Without PTL (n=2,664)	P-value
Inpatient admission post-transplant	2,080 (61.5%)	2,990 (55.3%)	<0.001	3,724 (60.8%)	1,346 (50.5%)	<0.001
Neutropenia/Leukopenia-related hospitalization	555 (16.5%)	58 (1.1%)	<0.001	1,502 (24.5%)	89 (3.3%)	<0.001
Emergency room visit	1,242 (36.7%)	1,689 (31.2%)	<0.001	2,138 (34.9%)	793 (29.8%)	<0.001
Granulocyte colony-stimulating factor (G-CSF) use	1,316 (38.9%)	195 (3.6%)	<0.001	1,398 (22.8%)	113 (4.2%)	<0.001

FR-PO850

**Kidney Transplantation in Elderly Patients With ESKD: A Systematic Review and Meta-Analysis**

Masahiko Yazawa,<sup>1</sup> Maho Terashita,<sup>1</sup> Takamasa Miyauchi,<sup>1</sup> Hideyo Oguchi,<sup>2</sup> Makoto Tsujita,<sup>3</sup> Tadashi Sofue,<sup>4</sup> Kosuke Masutani.<sup>5</sup> <sup>1</sup>St. Marianna University School of Medicine, Kawasaki, Japan; <sup>2</sup>Toho University Faculty of Medicine, Tokyo, Japan; <sup>3</sup>Masuko Memorial Hospital, Nagoya, Japan; <sup>4</sup>Kagawa University, Kagawa, Japan; <sup>5</sup>Faculty of Medicine, Fukuoka University, Fukuoka, Japan.

**Background:** Kidney transplantation (KT) provides considerably better survival than dialysis, although this reflects outcomes from young or middle-aged adults. With the increasing average age of patients receiving dialysis, it is expected that elderly patients will prefer KT. Although some studies have examined the prognosis of KT in elderly patients, the solid evidence on whether performing a kidney transplant is more effective than continued dialysis needs to be evaluated.

**Methods:** In this systematic review and meta-analysis, a literature search was performed in PubMed/MEDLINE until August 25, 2021, for studies with KT and dialysis therapy in elderly patients as key terms. Primary screenings of 3,116 articles were performed to include observational studies with patients age  $\geq$ 65 years that compared KT and dialysis and with outcomes (mortality). A total of 17 articles were extracted for a full read as secondary screening. Statistical analysis was performed on mortality, which was the only parameter that could be integrated, and the adjusted hazard ratio (aHR) for each study was evaluated using RevMan (Reviewer Manager). This study was conducted according to the Japanese Society of Nephrology for Chronic Kidney Disease guideline 2023.

**Results:** On secondary screening, six observational studies were identified that evaluated mortality. The aHR was calculated for four of these studies. Among end-stage kidney disease (ESKD) patients aged  $\geq$ 65 years, the aHR for mortality of the KT group was 0.52 (95% confidence interval [CI]: 0.47-0.56), which was significantly lower than that of the dialysis group (mainly patients on waiting list). A sub-analysis of three studies for only patients aged  $\geq$ 70 years, showed that the mortality risk was significantly lower in the KT group (aHR: 0.61, 95% CI: 0.55-0.67).

**Conclusions:** This study showed that compared with dialysis therapy, KT was associated with lower mortality in elderly ESKD patients.

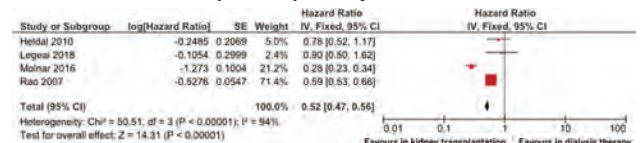

FR-PO851

**Cardiovascular Outcomes in Kidney Transplant Recipients With Autosomal Dominant Polycystic Kidney Disease**

Maroun Chedid,<sup>1</sup> Hasan-Daniel N. Kaidbay,<sup>2</sup> Stijn Wigerinck,<sup>1</sup> Dalia Zubidat,<sup>1</sup> Prajwal Reddy,<sup>1</sup> Parikshit Duriseti,<sup>1</sup> Naim S. Issa,<sup>1</sup> Ziad Zoghby,<sup>1</sup> Christian Hanna,<sup>1</sup> Sarah R. Senum,<sup>1</sup> Peter C. Harris,<sup>1</sup> Vicente E. Torres,<sup>1</sup> Yuyisile T. Nkomo,<sup>1</sup> Fouad T. Chebib.<sup>1</sup> <sup>1</sup>Mayo Clinic Minnesota, Rochester, MN; <sup>2</sup>Lebanese American University, Beirut, Lebanon.

**Background:** Cardiovascular disease leads to high morbidity and mortality in patients with kidney failure who undergo kidney transplantation. Autosomal Dominant Polycystic Kidney Disease (ADPKD) is a systemic disease with various cardiac abnormalities. However, details on the cardiovascular profile in ADPKD patients undergoing kidney transplantation (KT) and its progression following transplantation are limited

**Methods:** Echocardiographic data within 2 years prior to kidney transplantation (1993-2020), and MACE (major adverse cardiovascular events) post transplantation were retrieved. The primary outcome was to assess cardiovascular abnormalities on echocardiography at time of transplant in ADPKD as compared to diabetic (DN) and nondiabetic non-ADPKD (NDNA) (n=217 each group) patients, matched by gender (male, 59.4%) and age at transplantation (57.2 ± 8.8 years) (Table 1)

**Results:** Compared with DN and NDNA patients at time of transplantation, patients with ADPKD had lower rates of left ventricular hypertrophy (39.4% vs 66.4% vs 48.6%), mitral (2.7% vs 6.3% vs 7.45) and tricuspid regurgitations (1.8% vs 6.6%, 7.2%) (Table 1). ADPKD patients had less diastolic (25.3%) and systolic (5.6%) dysfunction at time of transplantation. ADPKD patients had the most favorable post-KT survival (median survival 18.7 years vs 12.0 for DN and 13.8 years for NDNA; P<0.01) and the most favorable MACE-free survival rate (HR=0.51, P<0.001). Finally, ADPKD patients showed an improvement of systolic function post-KT compared to pre-transplantation (7.96 vs 6.20%, P=0.53); however, ADPKD patients had worsening of their valvular function and an increase in the sinus of Valsalva diameter (38.2 vs 39.9 mm, P<0.01).

**Conclusions:** ADPKD transplant recipients had the most favorable cardiac profile pre-transplantation with better patient survival and MACE-free survival rates but worsening valvular function and increasing sinus of Valsalva diameter, as compared to those with other kidney diseases.

Table 1: Baseline characteristics and echocardiographic findings among kidney failure patients at time of transplantation

	ADPKD	Diabetic Hypertrophy	Non-Diabetic, Non-ADPKD	p value
Hypertension at time of transplant, n (%)	257 (84.6)	336 (88.3)	238 (80.0)	p<0.001
Diabetes at time of transplant, n (%)	22 (8.1)	278 (100.0)	54 (19.9)	p<0.001
LV hypertrophy present by LVM/height <sup>2.7</sup> measurement, n (%)	87 (30.4)	342 (66.4)	105 (48.6)	p<0.001
Diastolic dysfunction present, n (%)	38 (25.3)	37 (53.0)	23 (42.6)	p=0.002
≥ Moderate mitral valve regurgitation, n (%)	6 (2.7)	13 (19.3)	37 (17.4)	p=0.06
≥ Moderate tricuspid valve regurgitation, n (%)	4 (1.8)	15 (8.0)	17 (7.2)	p=0.04
LVEF < 45%, n (%)	13 (5.4)	34 (24.6)	29 (12.8)	p<0.002

FR-PO852

**Safety and Efficacy of Long-Term Use of GLP-1RA in Post-Transplant Diabetes Mellitus (PTDM): Analysis of Dulaglutide vs. Liraglutide**

Ritwika Mallik, Dorcas Mukuba, Mahalia Casabar-Licayan, Stanley Fan, Kieran McCafferty, Omer Ali, Muhammad Magdi Yaqoob, Tahseen A. Chowdhury. *The Royal London Hospital, London, United Kingdom.*

**Background:** GLP-1RA are increasingly used in PTDM patients with limited long-term safety and efficacy data. We reviewed the real-world data of the use of Dulaglutide versus Liraglutide in our centre.

**Methods:** Retrospective analysis was performed in kidney transplant recipients with PTDM and T2D treated for a minimum of 6 months on GLP-1RA therapy. Changes in clinical and biochemical parameters, doses of insulin and immunosuppressive medications, rejection episodes and graft function were assessed.

**Results:** 17 patients were on Dulaglutide and 6 on Liraglutide. Mean age was 56 ± 8.5 years, 65% male, 61% South-Asian and 22% White. Between-group differences in change of weight, blood pressure (BP), HbA<sub>1c</sub>, alanine transaminase (ALT), creatinine, eGFR and urine protein: creatinine ratio (uPCR) was not statistically significant at 6, 12 and 24 months. Both treatments resulted in decreased weight (more marked with liraglutide at 24 months), HbA<sub>1c</sub> (more marked in Dulaglutide at 24 months) and insulin doses compared to baseline. There were no changes in immunosuppressive medication due to GLP-1RA despite universal use of mycophenolate. GLP-1RA were discontinued due to adverse effects in 3 patients.

**Conclusions:** Addition of GLP-1RA therapy in transplant patients with diabetes was well tolerated, with improvement in glucose control and weight. There was no between-group difference in the parameters. Further prospective randomized control studies are warranted.

	Dulaglutide	Liraglutide
	Median [IQR], p value	Median [IQR], p value
Change at 6 months		
Weight: kg	-3.9 [-4.95 to 0.25], p = 0.02	-2.9 [-5.83 to -0.11], p = 0.21
HbA1C: mmol/mol	-11 [-22 to -3], p = 0.02	-7 [-29.25 to 3.75], p = 0.26
eGFR: ml/min/1.73m <sup>2</sup>	-0.5 [-6.25 to 7.5], p = 0.7	-1.5 [-1.5 to 6.75], p = 0.33
Change at 12 months		
Weight: kg	-0 [-5.8 to 2], p = 0.48	-6.3 [-6.68 to -3.03], p = 0.02
HbA1C: mmol/mol	-9 [-35 to -1], p = 0.01	-17.5 [-26.75 to 7], p = 0.16
eGFR: ml/min/1.73m <sup>2</sup>	-2 [-8 to 6], p = 0.74	-3 [-1.5 to 7.25], p = 0.31
Change at 24 months		
Weight: kg	-1.75 [-11.38 to 4.2], p = 0.52	-6 [-6.3 to -3.55], p = 0.03
HbA1C: mmol/mol	-19 [-53.5 to -9.5], p = 0.05	-19 [-22 to 6], p = 0.23
eGFR: ml/min/1.73m <sup>2</sup>	-1.5 [-11.75 to 6.75], p = 0.77	-2 [-5 to 10.5], p = 0.67

FR-PO853

**Immunosuppression Practices in Failing Renal Allografts: A South Asian Perspective**

Srikanth Bathini,<sup>1</sup> Vivekanand Jha,<sup>2,3</sup> <sup>1</sup>Asian Institute of Nephrology and Urology, Hyderabad, India; <sup>2</sup>The George Institute for Global Health, New Delhi, India; <sup>3</sup>Manipal Academy of Higher Education, Manipal, India.

**Background:** Immunosuppression practices in failed grafts vary across the world. While the available evidence is not robust, multiple factors complicate the decisions. We conducted a survey to understand these practices in South Asia.

**Methods:** We distributed a web-based survey to identify the patterns and factors influencing immunosuppression use through a mailing list of over 2000 transplant teams. We collected data on factors affecting their practices in failing renal allografts.

**Results:** We received 190 valid responses. 88.9% individualized the decision to wean immunosuppression (IS) while 11.1% used a standard protocol. 63.8% first withdrew antimetabolite whereas CNI was most likely to be withdrawn next at 58.9%. 90% continued steroids. 26.3% made a CNI to mTOR inhibitor switch. Factors considered in changing (IS) included ongoing rejection (77.8%), infections (72.6%), & re-transplant prospects (71.1%). Ongoing rejection/graft intolerance (45.3%) and steroid-resistant rejection (17.4%), were the major indications for nephrectomy.

**Conclusions:** Immunosuppression (IS) practices in failed grafts across South Asia are varied and are guided by individual choices but not a standardized protocol. Ongoing rejection, & re-transplant prospects prompt continuation of IS, and graft intolerance was the most common indication for graft nephrectomy.

Factors Considered in Continuing/Stopping Immunosuppression

Factors Considered in Continuing/Stopping Immunosuppression	Percentage of Respondents
Ongoing Features of Rejection	77.8
History of Infections	72.6
Plans to Re-Transplant	71.1
Urine Output	48.4
History of BK Nephropathy	46.3
History of Rejection	39.5
Panel Reactive Antibody Status	37.4
Refractory Anemia with Raised CRP	33.6
Kidney Disease Recurrence	31.1
Cost of Medication	24.2

Respondents were asked to choose as many factors as they would consider before deciding to stop/continue immunosuppression.

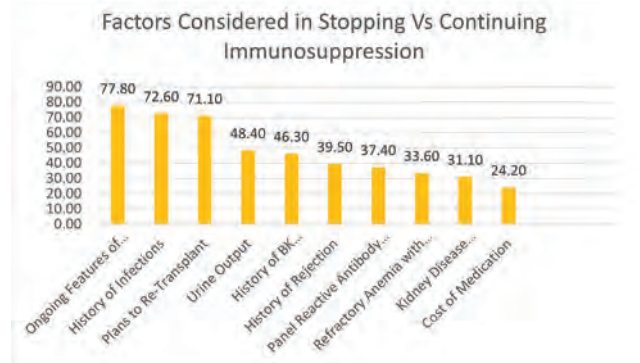

FR-PO854

**Is It Calcineurin Inhibition That Abolishes Cardiovascular Sex Differences in Kidney Transplant Patients?**

Zeynep Ural. *Gazi Universitesi Tip Fakultesi, Ankara, Turkey.*

**Background:** Cardiovascular disease (CVD) is the leading cause of death after renal transplantation. Cardiac hypertrophy is a stronger risk factor for heart failure. Estrogen protects heart by counteracting pro-hypertrophy signaling pathways. Whereas androgen mostly plays an opposite role in cardiac hypertrophy. Cardiac hypertrophy is characterized by abnormality of intracellular calcium homeostasis and calcium related



activation of major hypertrophic signaling pathway (calcineurin-nuclear factor activation transcription pathway). Estrogen inhibits calcineurin expression. In this study we aimed to explore sex difference in cardiac hypertrophy and sex specific cardiac hypertrophy rates in renal transplant patients under CNI (Calcineurin inhibitors) or mTORi (mammalian target of rapamycin inhibitors) based regimes.

**Methods:** This study consist of one hundred and fifty two (152) renal allograft recipients with less than one year of dialysis and who are at least three years of follow-up. The exclusion criterias were, dialysis for more than one year before transplant, pre-transplant cardiac hypertrophy. Echocardiograms of the patients at the third year after transplantation were evaluated. Ejection fraction rate, left atrial diameter, presence of left ventricular hypertrophy were evaluated.

**Results:** Baseline characteristics and helath parameters were similar between CNI and mTORi based regimes. Ejection fraction, left atrial diameter, left ventricular hypertrophy were evaluated. There is important difference between man and women for echocardiography findings. Moreover, cardiac hypertrophy findings were significantly less observed in those using the CNI regimen (%5,7 to %29). In addition, cardiac hypertrophy was more common in males using mTORi regimen (Male/female; %35/%18), while there was no difference males and females using CNI regimen (Male/female; %6/%5,2).

**Conclusions:** The role of the calcineurin pathway in cardiac hypertrophy has been demonstrated in many studies. Cardiac hypertrophy and heart failure, which are one of the most important causes of death in kidney transplant patients, can be prevented by calcineurin inhibition. Further prospective studies with larger numbers of patients examining this effect are needed. This effect of estrogen on the calcineurin pathway may be the solution to one of our most important problems in kidney transplant patients.

**Funding:** Private Foundation Support

**FR-PO855**

**Expanded Experience With Ultra-Short Duration Pangenotypic Direct Acting Anti-Viral (DAA) to Prevent Virus Transmission From Hepatitis C Viremic Donors to Hepatitis C Negative Kidney Transplants**

Idris Yakubu, Dhiren Kumar, Marlon F. Levy, Layla Kamal, Gaurav Gupta. *Virginia Commonwealth University Health System, Richmond, VA.*

**Background:** Studies have shown that HCV D+/R- kidney transplantation (KT) is feasible using 8-12 weeks of DAAs. The use of abbreviated regimens may obviate the need for insurance approval and delay in therapy. We previously showed low transmission with a prophylactic peri-operative 7-day DAA (Sofusbuvir/Velpatasvir; SOF/VEL) regimen for KT. Ezetimibe (EZ), has been shown to restrict HCV entry in hepatocytes in a humanized mouse model. Studies suggest that EZ may be synergistic in reduction of HCV transmission from donors to recipients. We report our experience on 115 D+/R- KT with or without EZ to the prophylactic regimen.

**Methods:** Data were collected via an Ethics Board approved prospective registry (REFORMHEPC). Inclusion criteria included: a) De-novo transplant; b) cPRA ≤50%; c) absence of synthetic liver dysfunction; and c) absence of active viral hepatitis. Primary outcome was donor HCV transmission at 90 days post-transplant. Patients were screened with HCV NAT at Day 7, 14, 28 and 90 post-transplant. All subjects received an initial dose of SOF/VEL +/- EZ on day 0 ≤6 hours prior to transplant and then daily for a total of 7 days. The protocol mandated initiation of full-course DAA therapy in case of 2 consecutive positive NAT tests.

**Results:** 115 D+/R- transplants (mean age=56 yrs) were included from May 2019-August 2021. The distribution of patients across the two groups was Group 1 (7 days prophylaxis with SOF/VEL alone; N=32) and Group 2 (7d prophylaxis with SOF/VEL plus EZ; N=83). Patients enrolled in the two groups were demographically similar. Five patients (5/115; 4.3%; 95%CI:2%-10%) developed HCV viremia [1/32 (3%) in group 1, and 4/83 (4.8%) in group 2]. The donor genotypes (GT) are as follows: 3/5 (60%) GT3; 1/5 (20%) GT1b; 1/5 (20%) GT2b. All 5 patients with HCV transmission achieved SVR with 12 weeks of Glecapravar/Pibrentasvir therapy.

**Conclusions:** Our data suggests that 7-days ultra-short duration pan-genotypic SOF/VEL prophylaxis was safe and largely effective in preventing donor-derived HCV transmission and has the potential of resulting in significant cost-savings by avoiding longer DAA therapy in a large majority of D+/R- KT. The addition of EZ did not appear to provide any additional benefit in preventing HCV viral transmission.

**FR-PO856**

**Three Decades of Dialysis Initiation After Kidney Transplant (KT) Failure: Trends in Waitlisting, Retransplantation, and Survival (1988-2018)**

Pascale Khairallah,<sup>1</sup> Jingbo Niu,<sup>1</sup> Elizabeth C. Lorenz,<sup>2</sup> Wolfgang C Winkelmayr.<sup>1</sup> *<sup>1</sup>Baylor College of Medicine, Houston, TX; <sup>2</sup>Mayo Foundation for Medical Education and Research, Rochester, MN.*

**Background:** The number of persons returning to dialysis after KT failure has been increasing; they now constitute the 4th largest group of dialysis starts. Little is known about the trends in mortality, waitlisting, and retransplantation and after KT failure.

**Methods:** From the USRDS we identified patients age ≥18 yrs who received a first KT and experienced KT failure between 1/1/1988 and 12/31/2017. Recipients of other solid organ allografts were excluded. Patients were followed from the time of KT failure date to the outcomes of 1) death, 2) waitlisting, and 3) retransplantation. Patients were censored at end of dialysis record, end of Medicare coverage, or at 5 yrs from time of KT failure. We used multivariable Cox regression to estimate hazard ratios (HR) and 95% confidence intervals (CI) comparing death, and cause-specific hazard model to compare other outcomes across subsequent eras relative to 1988-92.

**Results:** We studied 100,373 patients with a failed first KT. Of all patients initiating dialysis de novo, the proportion of patients (re)initiating dialysis after allograft failure increased from 2.49% in 1988-92 to 3.94% in 2013-17. The median age at which allografts failed increased from 41 yrs in 1988-92 to 56 yrs in 2013-2017. After adjusting for age, sex, race and ethnicity, and relative to 1988-92: 1) mortality was 10%, 25%, and 34% significantly lower in 2003-07, 2008-12, and 2013-17, respectively; 2) the rates of waitlisting were similar across subsequent eras, but 24% lower in 2013-17 (3.2% of patients were waitlisted preemptively); and 3) the rates of retransplantation were between 13% and 20% lower in later eras (Figure).

**Conclusions:** While mortality rates of patients with failed allografts have improved over time, rates of waitlisting and retransplantation rates have decreased. Understanding the barriers to retransplantation will be crucial to inform potential future interventions designed to improve access to KT in this growing population.

**Funding:** NIDDK Support

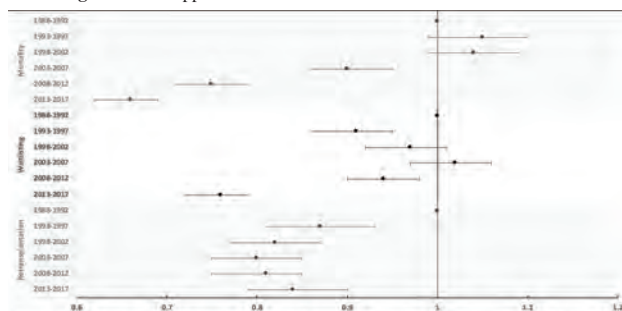

Figure. Hazard ratios and 95% confidence intervals of mortality, waitlisting, and re-transplantation following kidney transplant failure in subsequent eras compared to 1988-1992.

**FR-PO857**

**Nationwide Pregnancy Outcomes After Kidney Transplantation and Prediction of Adverse Pregnancy Outcomes: A Dutch Cohort Study**

Margriet Gosselink,<sup>1</sup> Marleen V. Buren,<sup>2</sup> Judith Kooiman,<sup>1</sup> Henk Groen,<sup>3</sup> Wessel Ganzevoort,<sup>4</sup> Henk W. Van Hamersvelt,<sup>5</sup> Olivier W. van der Heijden,<sup>5</sup> Jacqueline Van De Wetering,<sup>2</sup> Titia Lely,<sup>1</sup> PARTOUT working group <sup>1</sup>Universitair Medisch Centrum Utrecht - Locatie Wilhelmina Kinderziekenhuis, Utrecht, Netherlands; <sup>2</sup>Erasmus MC, Rotterdam, Netherlands; <sup>3</sup>Universitair Medisch Centrum Groningen, Groningen, Netherlands; <sup>4</sup>Amsterdam UMC Locatie AMC, Amsterdam, Netherlands; <sup>5</sup>Radboudumc, Nijmegen, Netherlands.

**Background:** Although numbers of pregnancy after kidney transplantation (KT) are rising, high risks of adverse pregnancy outcomes (APO) remain. Though important for preconceptional counselling and pregnancy monitoring, analyses on APO after KT per pre-pregnancy eGFR-CKD-categories have not been performed on a large scale before.

**Methods:** A Dutch nationwide cohort study investigated consecutive singleton pregnancies >20 weeks of gestation after KT between 1971-2017. Outcomes were analysed per pre-pregnancy eGFR-CKD-category. A composite adverse pregnancy outcome (cAPO) was established including birthweight <2500 gram, preterm birth <37 weeks, 3<sup>rd</sup> trimester severe hypertension (SBP >160 and/or DBP >110 mmHg) and/or >15% increase in serum creatinine (SCR) during pregnancy. Risk factors for cAPO were analysed in a multilevel model after multiple imputation of missing predictor values.

**Results:** 288 pregnancies in 192 women were included. Total live birth was 93%, mean gestational age 35.6 weeks, mean birthweight 2383 gram. Independent risk factors for cAPO were pre-pregnancy eGFR, midterm percentage SCr dip and midterm mean arterial pressure dip; ORs 0.98 (95% CI 0.96-0.99), 0.95 (0.93-0.98) and 0.94 (0.90-0.98). cAPO was a risk indicator for graft loss (HR 2.55, 1.09-5.96) but no significant risk factor on its own when considering pre-pregnancy eGFR (HR 2.18, 0.92-5.13).

**Conclusions:** This was the largest and most comprehensive study of pregnancy outcomes after kidney transplantation. The novel analysis per eGFR-CKD-category, including pregnancies in women with poor kidney function, facilitates pregnancy counselling. Overall obstetric outcomes are good. The risk of adverse outcomes is mainly dependent on pre-pregnancy graft function and hemodynamic adaptation to pregnancy.

**FR-PO859**

**Racial and Ethnic Disparities in the Anatomic Location of Arteriovenous Access (AVA) for Hemodialysis (HD) Initiation**

Melandra L. Worsley, Wolfgang C. Winkelmayr, Kevin F. Erickson, Jingbo Niu, L Parker Gregg. *Baylor College of Medicine, Houston, TX.*

**Background:** Racial/ethnic disparities have been shown in the type of AVA (arteriovenous fistula [AVF] vs graft [AVG]) used at incident HD. We evaluated racial and ethnic disparities in the anatomic location of HD AVA in the U.S.

**Methods:** Using the clinical records of a large dialysis organization we evaluated patients ≥16 years old with incident end-stage kidney disease who initiated outpatient center HD via an AVF or AVG between 2006-2021. Individuals who initiated HD via a catheter, had multiple access types/locations reported at incident HD, were on peritoneal dialysis, or had a kidney transplant were excluded. Race/ethnicity was categorized as White, Black, Hispanic, or other. Access location was defined as forearm vs non-forearm.

Multivariable logistic regression estimated associations of race/ethnicity with AVA forearm location and trends over time in AVA location using race x year interaction terms.

**Results:** Of 42,373 participants, 22,596 were White, 10,729 were Black, 5,054 were Hispanic, and 3,994 were other races; 61% had diabetes and 6% had heart failure. There was a decrease in HD initiation via a forearm AVA over time in all race/ethnicity groups (Figure 1A). In 2006, 48% had a forearm AVA, compared to 28% in 2021. An omnibus test for interaction of race x calendar time was significant (p=.006). In 2021, Black patients were 24% (95% CI, 16%-31%) less likely and Hispanic patients were 19% (95% CI, 8%-28%) less likely than White patients to initiate HD with a forearm AVA; these findings were consistent within the AVF and AVG subgroups (Figure 1B). Other races were 23% (95% CI, 8%-41%) more likely than White patients to initiate HD with a forearm AVA.

**Conclusions:** Racial disparities exist in the anatomic location of AVA used for initiation of outpatient HD with Black and Hispanic patients being less likely than White patients to have a forearm location. Use of forearm AVA, generally the preferred anatomic location, has decreased over time across all racial/ethnic groups. Further investigation is needed into factors influencing these disparities and temporal trends.



FR-PO860

Patient and Physician Perspectives on Treatment Burden in ESKD: a Nominal Group Technique Study

Sarah T. Thomas,<sup>1</sup> Adem Sav,<sup>2</sup> Rae Thomas,<sup>3</sup> Magnolia Cardona,<sup>3</sup> Zoe A. Michaleff,<sup>3,4</sup> Thomas T. Titus,<sup>1</sup> Claudia C. Dobler.<sup>3,5</sup> <sup>1</sup>Gold Coast Hospital and Health Service, Southport, QLD, Australia; <sup>2</sup>Queensland University of Technology Faculty of Health, Kelvin Grove, QLD, Australia; <sup>3</sup>Bond University Faculty of Health Sciences and Medicine, Gold Coast, QLD, Australia; <sup>4</sup>Northern NSW Local Health District, Lismore, NSW, Australia; <sup>5</sup>The George Institute for Global Health, Newtown, NSW, Australia.

**Background:** The treatment workload associated with end stage kidney disease (ESKD) is high. The treatment burdens experienced by ESKD patients are not well understood. We aimed to elucidate the most important areas of treatment burden for discussion in a clinical encounter from ESKD patients and nephrologists' perspectives, as well as possible solutions to these treatment burden challenges.

**Methods:** ESKD participants with diverse characteristics were purposively recruited from one tertiary treatment centre in Queensland, Australia. Nominal group technique (NGT), a mixed-methods consensus approach, was used to collect data. Treatment burden themes generated were ranked in order of importance. Three in-person NGT sessions were conducted with ESKD patients. One online NGT session was conducted with nephrologists from two Australian states.

**Results:** Nineteen dialysis-dependent ESKD patients (mean age 64 years; range 47-82) and six nephrologists participated. All patients were retired or on a disability pension; 74% perceived moderate or severe treatment burden; 90% spent more than 11 hours on treatment-related activities per week (range 11-30). Every patient group ranked health system issues as the most important treatment burden priority encompassing lack of continuity and coordination of care, dissatisfaction with frequent healthcare encounters and challenges around healthcare access. Physicians perceived psychosocial burdens of treatment to be most important to patients and families, which was ranked the second highest priority by patients.

**Conclusions:** Discussing treatment burden in a clinical encounter may lead to a better understanding of patients' capacity to cope with their treatment workload. This could facilitate tailored care, improve health outcomes, treatment sustainability, and patients' overall quality of life.

Figure 1. Comparison of treatment burden priorities in patients and physicians

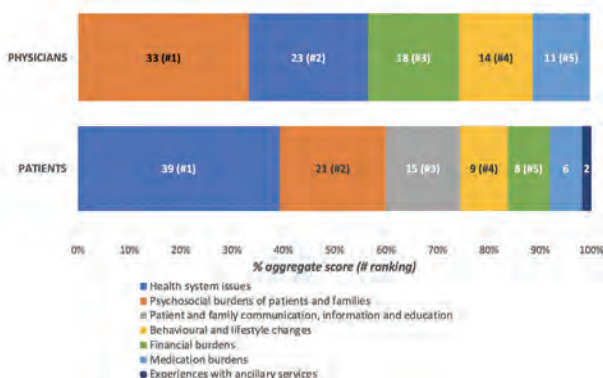

Key: TH - Thursday; FR - Friday; SA - Saturday; OR - Oral; PO - Poster; PUB - Publication Only

Underline represents presenting author.

FR-PO861

Protecting the Vulnerable: The Challenges of Dialysis in the Mentally Ill Julie Steinberg,<sup>1</sup> Lauren Sparber.<sup>2</sup> <sup>1</sup>Cohen Children's Medical Center, Queens, NY; <sup>2</sup>Northwell Health, New Hyde Park, NY.

**Introduction:** We present a case of a patient with mental illness who is refusing life-saving hemodialysis. The interdisciplinary moral distress experienced and the journey of managing chronic illness in the setting of psychiatric illness will be illustrated through the framework of ethical principles. This case brings to light several issues including the role of proportionality and social justice issues related to social determinants of health including potential social and/or moral health disparity.

**Case Description:** We report a case of a 58 year old female with PMH of ESRD on dialysis (often non-compliant with dialysis), hypertension, hyperlipidemia and morbid obesity who presented to the ED with complaint of "vomiting blood". It is noted that when questioned the patient stated "they told me I was vomiting blood" and when asked to elaborate she stated the person she lives with told her this. Patient was admitted for treatment and management of severe electrolyte derangements secondary to non-compliance with hemodialysis and medications. Patient initially evaluated by Psychiatry and diagnosed with major depressive disorder. Throughout this lengthy complex hospital course it was evident that patient was becoming more delusional as she no longer believed she had renal failure despite ten months of dialysis.

**Discussion:** The ethical analysis faces the substantial difficulty of balancing 3 bioethical principles in "managing" the patient's renal disease: Beneficence, which leads her physicians to recommend hemodialysis due to ESRD; Respect for Autonomy, the patient's own right to self-determination in matters related to the integrity of her body and self, and Non-Maleficence, the physician's duty to "do no harm" by an intervention that has distinct risks, but without hemodialysis, the patient would face certain mortality. Individuals with mental illness should be afforded the opportunity to make their own health care decisions if they have the capacity to do so. In this case, the patient continues to lack insight into her medical condition. The patient's genuine interest is served by continuing hemodialysis to prevent life threatening metabolic complications, attempting to restore capacity and intervening in her potentially treatable condition prior to her condition reaching life threatening urgency.

FR-PO862

Reducing Stigma of Chronic Pain by Intervention Patient and Provider Co-Design in Dialysis

Kerri L. Cavanaugh,<sup>1</sup> Jane Liebschutz,<sup>2</sup> Megan E. Hamm,<sup>2</sup> Hailey W. Bulls,<sup>2</sup> Donna Olejniczak,<sup>2</sup> Nwamaka D. Eneanya,<sup>3</sup> Caroline M. Wilkie,<sup>4</sup> Manisha Jhamb.<sup>2</sup> <sup>1</sup>Vanderbilt University Medical Center, Nashville, TN; <sup>2</sup>University of Pittsburgh, Pittsburgh, PA; <sup>3</sup>Fresenius Medical Care, Philadelphia, PA; <sup>4</sup>University of Pennsylvania, Philadelphia, PA.

**Background:** Stigma is frequently experienced by patients with end-stage kidney disease receiving dialysis due to perceptions of health condition etiology or self-care, identity or social context. This is particularly evident for chronic pain, and when considering buprenorphine for therapy.

**Methods:** Semi-structured interviews of patients, multidisciplinary healthcare providers (n=20), dialysis administrators (n=4) and insurers (n=3) informed the conduct and content of three interactive group design sprints with the objective of developing a multilevel intervention to eliminate stigma related to chronic pain care. Group video meeting facilitated sessions occurred twice in one week for two hours and occurred three times with (a) patients only (n=5), (b) providers only (n=5), and (c) both patients, providers and LDO representatives (n=11). Participants prepared by completing assignments and used a whiteboard in meeting to sketch, synthesize and select final strategies.

**Results:** A total of 27 qualitative interviews identified the lack of owning responsibility for pain management, lack of integration with dialysis and perception that pain was not related to ESKD as a key problems. Buprenorphine expertise is rare, perceived to be of low value and inconvenient to use. Design sprint sessions initially mapped and sketched intervention strategies. Patients promoted strategies to educate both patients and providers. Novel training approaches included modeling of how to evaluate, develop and implement a successful treatment plan. Providers identified organizational strategies employing automation/technology to facilitate care coordination and deliver treatment concurrent to dialysis on site. Incentivization was identified as a requirement for adoption and maintenance. Together a detailed step-by-step plan for how this would occur at the dialysis plan was created as a foundational framework for future testing.

**Conclusions:** Chronic pain management suffers from lack of ownership by any one discipline for patients receiving dialysis for ESKD. Patients in partnership with providers designing actions to address current gaps have high potential to be feasible and effective to elevate care and eliminate related stigma.

**Funding:** NIDDK Support

FR-PO863

“The Psychosocial Power Team”: A Multidisciplinary Approach to Mitigating Health Inequities for Pediatric Patients on Hemodialysis

Kristin Whaley,<sup>1</sup> Megan G. Hermetz,<sup>1</sup> Beth A. Vogt,<sup>1,2</sup> Abby Grisham,<sup>1</sup> Tara J. Van Der Eems,<sup>1</sup> Orville Newton-Ray Bignall,<sup>1,2</sup> Anne E. Dawson,<sup>1,2</sup>  
<sup>1</sup>Nationwide Children’s Hospital, Columbus, OH; <sup>2</sup>The Ohio State University College of Medicine, Columbus, OH.

**Background:** Children with kidney failure from minoritized communities face structural inequities that preclude access to home dialysis and portend poor outcomes. In-center hemodialysis (HD) confers disadvantages, including missed school and exposure to traumatizing procedures leading to decreased quality of life (QoL). To improve QoL and mitigate inequities for children on HD, we developed a multidisciplinary collaboration called the “Psychosocial Power Team” (PSPT). This team - comprised of child life, therapeutic recreation, massage therapy, social work, music therapy, nutrition, education, psychology, and nursing - used a modified quality improvement framework to pilot research-based psychosocial interventions to support social development and mental health for children on HD.

**Methods:** The PSPT created patient-specific and unit-wide treatment goals and interventions to support patient coping and adjustment. We sought to measure the impact of our interventions (e.g., collaborative meetings, educational games, cross-unit camaraderie activities, milestone celebrations, and emotional supports) on psychosocial outcomes in 16 children treated with HD.

**Results:** The PSPT created an average of 11 psychosocial goals per patient, with patients meeting 70% of goals. Post-intervention, fewer patients required psychology follow-up for psychosocial concerns (from 80% to 15% of patients). Patients demonstrated improved QoL ratings, often exceeding the average QoL expectations for patients on dialysis (Figure). Physical health metrics (e.g. serum phosphorus) are being tracked at this time.

**Conclusions:** Pediatric patients with kidney failure are at risk for poor psychosocial outcomes, due in part to structural inequities related to HD versus home dialysis. Through intentional, multidisciplinary collaboration, the PSPT demonstrated improved psychosocial health metrics in our pediatric dialysis unit.

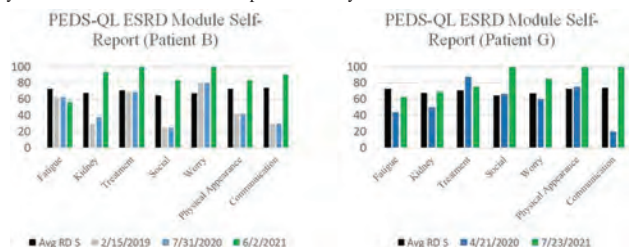

Demonstration of QoL improvement for 2 patients on HD after PSPT intervention.

FR-PO864

ESKD Amongst Irish Travellers

Paul O’Hara,<sup>1</sup> Husam Alzayer,<sup>2,3</sup> David Gorey,<sup>1</sup> Edward P. Mc Monagle,<sup>4</sup> Michelle Madden,<sup>5</sup> Elhoussein A. Elhassan,<sup>2</sup> Donal N. Reddan,<sup>1</sup> Liam F. Casserly,<sup>4</sup> Sean F. Leavey,<sup>5</sup> Peter J. Conlon,<sup>2</sup>  
<sup>1</sup>Galway University Hospitals, Galway, Ireland; <sup>2</sup>Beaumont Hospital, Dublin, Ireland; <sup>3</sup>Saudi Arabia Ministry of Health, Arar, Saudi Arabia; <sup>4</sup>University Hospital Limerick, Dooradoyle, Ireland; <sup>5</sup>University Hospital Waterford, Waterford, Ireland.

**Background:** The occurrence of end stage kidney disease (ESKD) amongst Irish travellers has not been well described. This study will determine the burden of ESKD among the Irish Traveller population and identify determinants of health among this cohort which may differ from the general population.

**Methods:** This was a retrospective cohort study design involving any self-identifying Irish Travellers with ESKD registered in the National Kidney Disease Clinical Patient Management System between (1995-2021). ESKD was defined as a patient; with an eGFR <15ml/min/1.73m<sup>2</sup>, dialysis or transplant. The primary outcome was the prevalence of ESKD in Irish Travellers. Secondary exploratory outcomes were the age of diagnosis, family history or biopsy diagnosis, kidney replacement modality, time to initiation of kidney replacement therapy and the primary vascular access used, and time to receive a kidney transplant.

**Results:** Four hospital groups among six in Ireland participated in the study. A total of 38 patients were identified as Irish Travellers with ESKD with a crude prevalence rate of ESKD of 0.12% or 1.19 per 1,000 Irish travellers. The mean age for diagnosis of kidney disease was 43 (SD, 20.8) and commencement of kidney replacement therapy was 45 (SD, 20.9) years. A biopsy-proven diagnosis was provided in 24% of cases identified. Slightly more than one in five cases (22%) had a diagnosis of PKD or CAKUT. The predominant modality for kidney replacement therapy was hemodialysis (89%) with central venous catheters being the most common initial vascular access (72%). Kidney transplant occurred in 45% of those studied with a mean waiting time of 1.96 (SD, 1.6) years. The main mode of kidney transplant was cadaveric donation at 76%.

**Conclusions:** Allowing for small numbers and ascertainment bias; Irish Travellers are younger, have a higher prevalence of ESKD, and less likely to have a biopsy diagnosis than the prevalent ESKD general population. They tend to have a short time interval from diagnosis until commencement of kidney replacement therapy and are less likely to benefit from home therapies but appear to be in line with the national waiting time to receive a kidney transplant. This data will help build a framework for policy development and practice enhancement in relation to kidney health in Irish Travellers.

FR-PO865

Nephrologist Preferences Exacerbate Disparities in Access to High Quality Dialysis Facilities

Eugene Lin,<sup>1</sup> Khristina I. Lung,<sup>2</sup> Karen Van Nuys,<sup>2</sup>  
<sup>1</sup>University of Southern California Keck School of Medicine, Los Angeles, CA; <sup>2</sup>University of Southern California, Los Angeles, CA.

**Background:** Ideally, patients initiating outpatient dialysis for end-stage kidney disease are referred to higher quality facilities closer to their residence. However, nephrologists might refer patients to “preferred facilities,” even if lower quality or distant. We investigated whether patients were more likely referred to nephrologists’ preferred facilities and racial differences in referrals.

**Methods:** For adults with fee-for-service Medicare initiating dialysis from 2016-2018, we identified the nephrologist’s “preferred facility” or the facility with the plurality of the nephrologist’s patients. For the patient’s first facility and the nephrologist’s preferred facility, we determined the quality (using Medicare’s published Five-Star ratings, a score based on Medicare quality measures) and distance to the patient. Since quality differs by region, we define a high-quality facility as the top quartile of facilities within a referral area (i.e., the highest quality available to the patient).

**Results:** Unadjusted, patients had a 19% probability of dialyzing at their nephrologist’s preferred facility if it was distant but a 65% probability if low-quality/close and a 74% probability if high-quality/close. In multivariable analysis, patients were more likely to dialyze at preferred facilities if close. Relative to when the preferred facility was low-quality/distant, patients were more likely to dialyze at preferred facilities that were low-quality/close (OR: 8.1, 95% CI: 7.7, 8.4) and high-quality/close (OR: 11.6, 95% CI: 11.0, 12.3). When preferred facilities were low-quality/close, patients were more likely to dialyze at low-quality facilities (OR: 3.2, 95% CI: 3.0, 3.4), and when high-quality/close, patients were more likely to dialyze at high-quality facilities (OR: 3.8, 95% CI: 3.5, 4.1). Relative to White patients, Black patients were less likely to have nephrologists with high-quality preferred facilities (OR: 0.93, 95% CI: 0.88, 0.97) and were less likely to dialyze at high-quality facilities (OR: 0.88, 95% CI: 0.84, 0.92).

**Conclusions:** Patients more likely dialyzed at nephrologists’ preferred facilities when close. Patients thus opt for low-quality facilities if their nephrologist prefers a low-quality facility. Because Black patients more likely had nephrologists preferring low-quality facilities, they more likely dialyzed at the lowest-quality facilities available.

**Funding:** NIDDK Support, Private Foundation Support

FR-PO866

Optimising COVID-19 Vaccination and Reducing Health Inequalities in Patients on Renal Replacement Therapy

Dimitrios J. Poulikakos, Rajkumar Chinnadurai, Edmond O’riordan, Rachel Middleton. Northern Care Alliance NHS Foundation Trust, Salford, United Kingdom.

**Background:** COVID-19 vaccine hesitancy has been associated with social deprivation and selected minority ethnic groups who are over-represented in the Renal Replacement Therapy (RRT) population. We designed a COVID-19 vaccination programme for our RRT population with the aim to increase vaccination uptake and decrease health inequalities.

**Methods:** Key interventions included addressing vaccine hesitancy by deploying the respective clinical teams as trusted messengers, prompt eligible patient identification and notification, deployment of resources to optimise vaccine administration in a manner convenient to patients and timely collection and analysis of local safety and efficacy data. First COVID-19 vaccination uptake data in relation to ethnicity and social deprivation, measured by the multiple deprivation index, in our RRT population were analysed and compared with uptake data in the regional total adult clinically extremely vulnerable (CEV) population in Greater Manchester (GM). Univariate logistic regression analysis was used to explore the factors associated with not receiving a vaccine.

**Results:** Out of 1156 RRT patients included in this analysis (Table) 96.7% received the first dose vaccination compared to 93% in the cohort of CEV patients in the GM. Age, sex, ethnicity and index of multiple deprivation were not associated with first dose vaccine uptake. Vaccine uptake in Asian and Black RRT patients was 94.9% and 92.3% respectively compared to 93% and 76.2% for the same ethnic groups in the reference CEV GM. Vaccine uptake was 96.1% of RRT patients in lowest quartile of multiple deprivation index compared to 90.5% in the GM reference population.

**Conclusions:** Bespoke COVID-19 vaccination programme based on local clinical teams as trusted messengers can address vaccine hesitancy and reduce health inequalities.

Variables	Total	Haemodialysis	Peritoneal dialysis	Transplant
	1156	395	94	667
Age	58 (47-68)	62 (50-73)	64 (48-72)	56 (46-64)
Gender (Male)	721 (62.4)	252 (63.8)	58 (61.7)	411 (61.6)
Ethnic Domain				
White	904 (78.2)	276 (69.9)	79 (84)	549 (82.3)
Asian	198 (17.1)	92 (23.3)	13 (13.8)	93 (13.9)
Black	39 (3.4)	21 (5.3)	1 (1.1)	17 (2.5)
Other	15 (1.3)	6 (1.5)	1 (1.1)	8 (1.2)
Diabetes Mellitus	319 (27.6)	195 (49.4)	32 (34)	92 (13.8)
Hypertension	787 (68.1)	285 (72.2)	79 (84)	423 (63.4)
Cardiovascular disease	287 (24.8)	114 (28.9)	37 (39.4)	136 (20.6)
Index of Multiple Deprivation				
Most Deprived Q1	518 (44.8)	231 (58.5)	44 (46.8)	243 (36.4)
Q2	219 (18.9)	70 (17.7)	14 (14.9)	135 (20.2)
Q3	140 (12.1)	38 (9.6)	14 (14.9)	88 (13.2)
Q4	160 (13.8)	33 (8.4)	13 (13.8)	114 (17.1)
Least Deprived Q5	119 (10.3)	23 (5.8)	9 (9.6)	87 (13)
Received first dose vaccination	1118 (96.7)	383 (97)	92 (97.9)	643 (96.4)

FR-PO867

**Sociodemographic Characteristics and Symptom Treatment Status of Hemodialysis Patients With Pain, Depression, and/or Fatigue**

Susan M. Devaraj,<sup>1</sup> Maria-Eleni Roumelioti,<sup>2</sup> Jonathan Yates,<sup>1</sup> Mary M. Schopp,<sup>1</sup> Jennifer L. Steel,<sup>1</sup> Sarah J. Erickson,<sup>3</sup> Bruce L. Rollman,<sup>1</sup> Steven D. Weisbord,<sup>1</sup> Mark L. Unruh,<sup>2</sup> Manisha Jhamb.<sup>1</sup> <sup>1</sup>University of Pittsburgh Department of Medicine, Pittsburgh, PA; <sup>2</sup>University of New Mexico Health Sciences Center, Albuquerque, NM; <sup>3</sup>University of New Mexico Department of Psychology, Albuquerque, NM.

**Background:** End Stage Kidney Disease patients on hemodialysis (HD) often experience clinically significant pain, fatigue and depressive symptoms, and efforts to identify and manage symptom burden are essential to improve patient outcomes. We sought to identify sociodemographic differences by symptom burden and treatment among HD patients consented for a multi-center trial of collaborative care to reduce symptom burden (TACcare).

**Methods:** Protocol-eligible patients screened positive for clinical levels of pain (Likert scale  $\geq 4$ ), fatigue (Likert scale  $\geq 5$ ), and/or depression (Patient Health Questionnaire-9 score  $\geq 10$ ) and provided informed consent to participate in the trial (years 2018-2022). We used ANOVA or Fisher's exact tests to analyze the cross-sectional associations of age, race, ethnicity, gender, employment, education, marital status, home neighborhood walkability, and tobacco, alcohol, and illicit drug use with symptom experience and treatment status (receiving psychosocial/behavioral treatment vs. willing to receive treatment) at baseline.

**Results:** Of n=215 participants, 55% were male, 19% were Hispanic, 29% were Black/African American, 17% were American Indian/Alaskan Native, and 60% had an annual income  $< \$20k$ . Patients with depression were younger than those without [age: 56 (SD:13) vs. 60 (14) years;  $p=0.02$ ]. The percentage of patients experiencing pain was inversely proportional to annual household income ( $< \$20k$ : 75%,  $\$20-40k$ : 80%,  $\$40-60k$ : 69%,  $> \$60k$ : 36%;  $p=0.04$ ). There was a significant association between experiencing pain and history of illicit drug use, with pain most prevalent with use  $> 5$  years ago (never used: 70%, used  $< 5$  years ago: 57%, used  $> 5$  years ago: 92%;  $p=0.03$ ). No significant differences in symptom count were noted across any other sociodemographic subgroup. Women were more likely than men to be receiving treatment for symptoms (52% vs. 34%,  $p=0.01$ ).

**Conclusions:** Sociodemographic correlates with symptoms could help inform targets to improve pain, fatigue, and depression identification and treatment in HD patients. Being male may indicate less frequent symptom treatment, while income and history of illicit drug use may be important to consider in identifying and managing pain.

**Funding:** NIDDK Support

FR-PO868

**Sex, Gender, and Quality of Life in Hemodialysis**

Victoria J. Riehl-Tonn,<sup>1</sup> Sandi M. Dumanski,<sup>1</sup> Meghan J. Elliott,<sup>1</sup> Jennifer M. MacRae,<sup>1</sup> Neesh I. Pannu,<sup>2</sup> Kara Schick-Makaroff,<sup>3</sup> Kelsea Drall,<sup>2</sup> Taryn Gantar,<sup>4</sup> Colleen M. Norris,<sup>3</sup> Sofia B. Ahmed.<sup>1</sup> <sup>1</sup>University of Calgary Cumming School of Medicine, Calgary, AB, Canada; <sup>2</sup>University of Alberta Faculty of Medicine & Dentistry, Edmonton, AB, Canada; <sup>3</sup>University of Alberta Faculty of Nursing, Edmonton, AB, Canada; <sup>4</sup>University of Alberta, Edmonton, AB, Canada.

**Background:** Women on conventional hemodialysis (HD) have a lower reported quality of life (QoL) compared to men. Incremental HD, which gradually increases dialysis dose over time, is a potential strategy to improve QoL. Despite differences in QoL, current HD prescription remain sex (biology) and gender (sociocultural) blind.

**Key: TH - Thursday; FR - Friday; SA - Saturday; OR - Oral; PO - Poster; PUB - Publication Only**  
Underline represents presenting author.

We aimed to determine if sex and gender-related measures (gender roles, relations and identity) were associated with QoL when initiating incremental HD ( $< 3$  sessions/week) compared to conventional HD (3 sessions/week).

**Methods:** Patients initiating HD in Alberta, Canada, were invited to enrol (June-December 2021) in this prospective cohort study. Sex assigned at birth was obtained by self-report. Eligibility for incremental HD at initiation is determined by kidney care providers using standardized assessments. The Kidney Disease Quality of Life 36 (KDQOL-36) and the GENESIS-PRAXY Gender Questionnaires were administered at baseline and at 3-months. The physical component score (PCS) and mental component scores (MCS) of the KDQOL-36 determined QoL. The GENESIS-PRAXY creates a composite gender score that is measured on a spectrum, with lower scores consistent with behaviours ascribed to males and high scores consistent behaviours ascribed to females. Non-parametric tests analysed the association between sex and QoL by HD type. Multiple linear regressions explored the association between gender score and QoL by HD type.

**Results:** All 48 participants identified as cisgender. There were 22 participants on conventional HD (7 female, 15 male) and 26 on incremental (13 female, 13 male) ( $p=0.11$ ). There was no significant change in MCS (female  $p=0.68$ , male  $p=0.41$ ) or PCS (female  $p=0.84$ , male  $p=0.61$ ) after 3-months regardless of HD type. Linear regression analysis showed a significant negative association between gender score and PCS ( $p<0.01$ ,  $R^2=0.54$ ) but not with MCS ( $p=0.09$ ,  $R^2=0.43$ ).

**Conclusions:** Sex was not associated with QoL in this cisgender cohort. Behaviours traditionally ascribed to females as indicated by higher gender scores were associated with decreasing QoL with regards to physical health. Understanding sex and gender differences will allow care providers to better address the needs of patients receiving HD.

FR-PO869

**Informal Advance Care Planning in Black Patients With Kidney Failure**

Marlena Fisher,<sup>1</sup> Deidra C. Crews,<sup>1</sup> Nancy A. Perrin,<sup>1</sup> Justin J. Sanders,<sup>2</sup> Martha Abshire Saylor,<sup>1</sup> Marie T. Nolan.<sup>3</sup> <sup>1</sup>Johns Hopkins University, Baltimore, MD; <sup>2</sup>McGill University, Montreal, QC, Canada; <sup>3</sup>The Catholic University of America, Washington, DC.

**Background:** Research examining advance care planning (ACP) in kidney failure patients is primarily assessed in research by written advance directives. Black patients have limited representation in ACP research, and many prefer informal conversations. We examined the relationship of informal ACP conversations with personal, interpersonal, and structural level factors.

**Methods:** We conducted a concurrent mixed-methods study including a survey and semi-structured interviews to identify personal, interpersonal, and structural factors related to engagement in informal ACP conversation. We conducted a survey of 280 Black patients who are on dialysis or have a history of being on dialysis. We conducted twenty semi-structured interviews using maximum variation sampling among survey respondents focused on the content, context, barriers and facilitators of informal ACP conversations. Multivariable logistic regression, thematic analysis, and triangulation were used to analyze the data.

**Results:** Sixty-six percent engaged in an informal ACP conversation and 38% completed an advance directive. Of the 197 patients who engaged in informal ACP conversations, 51% also completed an advance directive. Mean age was 56 years, 52% were female, and 68% are currently treated with dialysis. In preliminary bivariate analyses of informal ACP, illness acceptance (OR 1.07,  $p=0.016$ ), social support (emotional OR 1.12,  $p=0.002$ ; instrumental OR 1.09,  $p=0.005$ ; informational OR 1.13,  $p=0.00$ ), education (OR 1.32,  $p=0.18$ ), and previous experience as a surrogate decision maker (OR 1.89,  $p=0.017$ ) increased the likelihood of engaging in informal ACP. The interviews revealed that the content often includes financial, healthcare, and funeral planning wishes. These conversations often follow a health status change like a hospitalization or a worsening in their condition. Key facilitators were having a strong trusted social support system and past experience with ACP or a loved one dying. Barriers included distrust of family to carry out their wishes as outlined and a discomfort/avoidance of having informal ACP conversations.

**Conclusions:** Informal ACP conversations with family occur more frequently than written directives in Black dialysis patients. Future efforts should assess the patient's social support system and target interventions to engage patients with limited support networks.

**Funding:** Other NIH Support - National Institute of Nursing Research - F31, Sigma/HPNF End-of-Life Nursing Care Research Grant, Private Foundation Support

FR-PO870

**The Status of Provision of Kidney Replacement Therapy for Undocumented Immigrants in the United States**

Katherine M. Rizzolo, Manisha Dubey, Katherine E. Feldman, Lilia Cervantes. University of Colorado, Denver, CO.

**Background:** There are 6000-8000 undocumented immigrants with kidney failure living in the US. As undocumented immigrants are barred from receiving federal insurance, access to kidney replacement therapies (KRT) is decided at the state, city, or institutional level. In states where maintenance hemodialysis is not available, undocumented immigrants with kidney failure are resigned to emergency hemodialysis, or dialysis when critically ill. In 2019, 12 states were found to cover maintenance hemodialysis for undocumented immigrants at the state level. Since 2019, a wave of advocacy for improved access to kidney care for undocumented immigrants has received greater traction. We investigate the current status of kidney replacement therapies (including maintenance dialysis, home dialysis, and transplantation) available to undocumented immigrants throughout the US.

**Methods:** Identifying state by state policy was conducted via interviews with nephrology providers caring for undocumented immigrants and reviewing state Medicaid policy handbooks.

**Results:** At the time of this submission, 27 states have been reviewed. The results expect to be finished by August 2022. Out of 27 states, 21 offer outpatient dialysis (Figure 1), 14 have state-wide coverage for outpatient dialysis. 5 states changed their laws to cover outpatient dialysis since 2019. 5 states have state-wide access to transplantation.

**Conclusions:** Availability of kidney replacement therapy for undocumented immigrants with kidney failure remains variable by geography in terms of state and institutional policies. Overall, the degree of access by state appears to be expanding, with greater access to maintenance dialysis and transplantation than has been noted previously. This work may be utilized for advocacy efforts to inform state and national policy change.

**Funding:** NIDDK Support

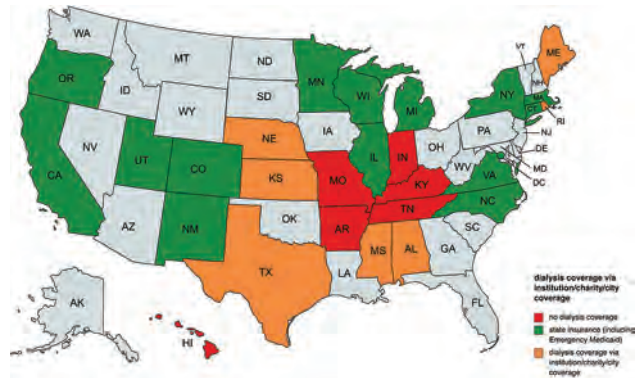

Figure 1. Coverage of outpatient dialysis for undocumented immigrants by state.

**FR-PO871**

**Rural Caregivers' Perspectives on Access to Dialysis and Kidney Transplantation**

Nicole J. Scholes-Robertson,<sup>1</sup> Amanda G. Dominello,<sup>1</sup> Martin Howell,<sup>1</sup> Jonathan C. Craig,<sup>2</sup> Germaine Wong,<sup>1</sup> Allison Tong,<sup>1</sup> <sup>1</sup>The University of Sydney Faculty of Medicine and Health, Sydney, NSW, Australia; <sup>2</sup>Flinders University, Adelaide, SA, Australia.

**Background:** Caregivers of patients with chronic kidney disease (CKD) from rural communities play a crucial role in access to dialysis and transplantation and face many challenges including geographical distance, financial hardship, and limited support. This study aimed to describe the perspectives of caregivers of patients with CKD from rural communities on their experiences of accessing kidney replacement therapy to help inform strategies to address their needs.

**Methods:** Semi-structured interviews were conducted. Transcripts were thematically analysed. We followed the consolidated criteria for reporting qualitative research (COREQ) framework.

**Results:** We included 18 participants aged from 20 to 78 years of age; 13 (72%) were female; 2 identified as Aboriginal or Torres Strait Islander, and 13 (72%) were the spouse/partner of the patient. We identified five themes: devastating social isolation (difficult periods of separation, exclusion from peers, forced relocation); financial dependency and sacrifice (burgeoning out-of-pocket costs, disruption to work life, foregoing autonomy); ongoing psychological trauma (concern for neglect and stress on children, long term emotional distress); overwhelmed by multifaceted roles and expectations (patient advocacy, uncertainty in navigating multiple health systems); and persistent burden of responsibility (loss of self-identity, ongoing travel requirements, scarcity of psychosocial support, unpreparedness for treatment regime).

**Conclusions:** Rural caregivers of people with CKD experience an exhausting physical, financial, and psychological burden. Strategies and improved formal respite services are required to address these profound challenges in the rural setting for caregivers of patients with CKD.

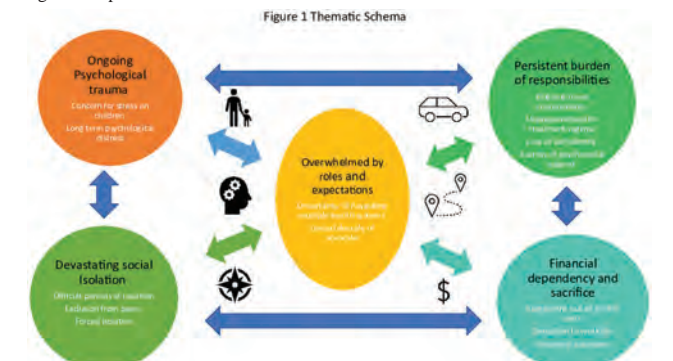

Figure 1 Thematic Schema

**FR-PO872**

**Using Design Ethnography to Identify Barriers to Dialysis Access in Lagos, Nigeria**

Natasha C. Wright, Jacqueline R. Warehime, Benjamin Sztot, Carolyn Bernemann, Ibrahim O. Yekinni, Michelle N. Rheault. University of Minnesota Twin Cities, Minneapolis, MN.

**Background:** There is limited access to renal replacement therapy (RRT) for end stage kidney disease patients in low- and middle-income countries (LMICs). An estimated 9.1 million people globally will not be able to access RRT by 2030. This growth is aided by advancing age, diabetes, and hypertension with a greater burden expected in LMICs which are experiencing an epidemiological transition from communicable to non-communicable disease. While LMICs may be the most affected, they are also the least equipped; less than 10% of those who need RRT in LMICs are able to access it. In this study, interview methods were used to identify barriers to dialysis treatment for patients in Nigeria, where only HD is available, and to elucidate insight on PD as an alternative treatment.

**Methods:** Semi-structured ethnographic design interviews were conducted in Lagos, Nigeria in January 2020. 33 HD patients were interviewed across 3 dialysis centers. Audio recordings were transcribed and analyzed using descriptive and emotion-based coding in NVivo.

**Results:** Matrix analysis of the descriptive and emotion-based codes revealed three primary themes: (i) The high cost of HD leads to lower treatment frequency compared to optimal prescription. Costs include financial (e.g. treatment cost, lab work) and lost time (e.g. transportation, wages). The descriptive code of cost overlapped with the emotion code of sad (n=14), overwhelmed (n=20), and stressed (n=12). (ii) Family involvement is a critical part of the patient's experience. With this high level of moral and financial support, patients often felt a sense of guilt. (iii) PD is associated with feelings of independence and comfort. Patients preferred PD (n=24) compared to HD (n=6).

**Conclusions:** The findings support the hypothesis that patients in Nigeria may be interested in and benefit from PD as a treatment option. Patients performed HD treatment less frequently due to high costs which left them feeling weak between treatments, often resulting in lost wages. Patients were drawn to the perceived independence of PD. The majority of patients indicated strong familial support and comfort with the idea of administering treatment in their home. A service to train patients on treatment administration and local PD fluid production were identified as necessary to increase the feasibility of PD adoption.

**Funding:** Other U.S. Government Support, Private Foundation Support

**FR-PO873**

**Relationship Between Driving Time to Transplant Center and Socioeconomic Factors With Early Waitlisting Among Transplant-Referred ESKD Patients**

Steph Karpinski,<sup>1</sup> Carey Colson,<sup>1</sup> Adam G. Walker,<sup>1</sup> Scott Sibbel,<sup>1</sup> Michael H. O'Shea,<sup>2</sup> Francesca Tentori,<sup>1</sup> Steven M. Brunelli.<sup>1</sup> <sup>1</sup>Davita Clinical Research, Minneapolis, MN; <sup>2</sup>DaVita Inc, Denver, CO.

**Background:** Understanding factors contributing to disparities in kidney transplantation in end-stage kidney disease patients is important. Placement on a transplant waitlist is an important gate-keeping step where disparities have been observed. In this study, we sought to estimate the independent effect of driving time to the transplant center on the probability of waitlisting.

**Methods:** This was a retrospective study of 33,158 adult incident dialysis patients in the United States referred for transplant. Bayesian methods were used to model the relationship between driving time from the patient's home to the nearest transplant center and placement on a waitlist within 90 days of referral. We adjusted for causally relevant socioeconomic factors including educational encounters documented by the dialysis organization and US Census Bureau tract income and education data. We simulated observations based on relative levels of socioeconomic advantage (disadvantage and advantage comprising the 25<sup>th</sup> and 75<sup>th</sup> percentiles for listed variables, respectively).

**Results:** Overall, 2.0% of patients were waitlisted within 90 days of referral. The median [interquartile range] for driving time was 27 [14, 65] minutes. There was a non-linear relationship between driving time and probability of waitlisting (left Figure). This non-linear relationship interacts with the level of socioeconomic advantage to vary the slope (right Figure). A sensitivity analysis adjusting for race did not improve model fit.

**Conclusions:** Among the socioeconomically disadvantaged, there was an inverse relationship between driving time and the likelihood of early waitlisting. For those at higher socioeconomic advantage, early waitlisting was most likely for those living 20-30 minutes from a transplant center and did not vary much otherwise.

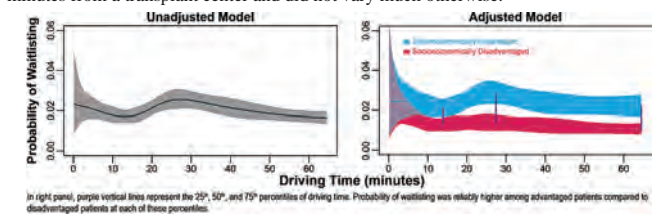

In right panel, purple vertical lines represent the 25<sup>th</sup>, 50<sup>th</sup>, and 75<sup>th</sup> percentiles of driving time. Probability of waitlisting was reliably higher among advantaged patients compared to disadvantaged patients at each of these percentiles.

Key: TH - Thursday; FR - Friday; SA - Saturday; OR - Oral; PO - Poster; PUB - Publication Only

Underline represents presenting author.

FR-PO874

**Employing Certified Clinical Transplant Coordinators (CCTC) in Private Practice to Increase Kidney Transplant Evaluations in Pre-Dialysis Patients**

Jeffrey Mulhern,<sup>1,2</sup> Molly Porter,<sup>2</sup> Gregory L. Braden,<sup>1,3</sup> Lili C. Quiterio,<sup>2</sup> Joy A. Delbuono,<sup>2</sup> Daniel L. Landry.<sup>1,3</sup> <sup>1</sup>Baystate Medical Center, Springfield, MA; <sup>2</sup>Kidney Care and Transplant Services of New England, West Springfield, MA; <sup>3</sup>University of Massachusetts Chan Medical School TH Chan School of Medicine, Worcester, MA.

**Background:** Preemptive kidney transplantation, the preferred renal replacement modality for advanced CKD patients, remains underutilized due to late referral for care, competing needs of renal replacement preparation, and perhaps practice-based issues. Recent monetary incentives for successful renal transplantation allow resource allocation directed at improving rates of transplant evaluation and implantation. We report initial results of our private practice CCTC team effort to initiate and enhance transplantation discussion, referral and evaluation in our pre-dialysis patients participating in the Kidney Care First (KCF) payment model.

**Methods:** Practice-based CCTC were deployed on 1/1/2022 to approach all KCF patients with a GFR <25 ml/m and begin kidney transplant discussions. The CCTC-patient interactions followed a provider visit in over half the interactions. A specific referral was not required to begin the relationship, and the provider was not required to be the first to discuss renal replacement options.

**Results:** We compare usual care during 2021 with CCTC care during the first 4 months of 2022 in table form.

**Conclusions:** The deployment of a private practice CCTC team has potential benefits compared to prior usual care including a near 5-fold rise in monthly transplant center initial evaluations, a reduction in initial transplant center no-show appointments, and an improvement in the initial transplant center evaluations of Black/African American (B/AA) and Hispanic/Latino (H/L) patients. Although preemptive transplantation success will likely require approaching patients at a higher GFR, the substantial increase in initial pre-dialysis transplant center evaluations strongly supports the continuation of this 'Transplant First' approach to advanced CKD care.

Year	2021	2022
Months	12	4
Non-dialysis patients in KCF	NA	478
In-office CCTC contact	NA	120
Transplant Center referrals from office	30	37
Transplant Center initial evaluations (%)	23 (77)	36 (97)
Transplant Center initial evaluations per month	1.9	9
Patient no-show (B/AA and H/L patients)	7 (3)	1 (1)
Transplant Center evaluation of B/AA and H/L patients (%)	7 (39)	19 (53)
GFR > 20 ml/m (%)	18	17

FR-PO875

**Variation in Kidney Failure Risk in Preemptively Listed Patients for Kidney Transplantation**

Jamie S. Hirsch, Mersema Abate, Kenar D. Jhaveri, Vinay Nair. *Northwell Health, New Hyde Park, NY.*

**Background:** ESKD progression depends on several factors, therefore a static eGFR cut-off for listing may lead to disparities. The Kidney Failure Risk Equation (KFRE) is a validated score to calculate 2 & 5 yr ESKD risk. We applied KFRE to pts in our preemptively listed KT candidates and reviewed transplantation rate.

**Methods:** Adult pts listed pre-emptively between 1/1/12 and 12/31/21 with follow-up through 2/18/22. GFR calculated using 2009 CKD-EPI equation (race coefficient; eGFR<sub>2009</sub>), 2021 CKD-EPI equation (race-free; eGFR<sub>2021</sub>), and universal eGFR of 20ml/min for comparisons of risk within and between races. Incidence of KT was examined.

**Results:** Of 279 patients, median age- 57 (IQR 46, 65), 173 (62%) male, 115 (41%) White, 61 (22%) Black, 64 (23%) Asian, and 39 (14%) Hispanic. Median eGFR<sub>2009</sub> was 14.1 (IQR 10.7-16.9) and eGFR<sub>2021</sub> was 14.5 (IQR 10.8-17.5); median Ur alb/crt ratio was 1286 (IQR 426-2480), and the 2- & 5-yr ESKD risk was 64% (IQR 41-83) and 96% (IQR 81-100), respectively. White patients were listed at higher median eGFR<sub>2009</sub> and this discrepancy was exacerbated, and most pronounced for Black patients, with eGFR<sub>2021</sub>. 2 year KFRE risk was higher for all races regardless of eGFR formula used (eGFR<sub>2009</sub>, eGFR<sub>2021</sub>, eGFR 20ml/min) as compared with Whites. Figure 1A shows wide variability within races. At last follow-up, 45 White (39%), 23 Asian (36%), 15 Black (25%) and 12 Hispanic (31%) had pre-emptive KT. Black patients had a longer follow-up time without KT and had a lower cumulative incidence of successful KT within 2 years of listing (Figure 1B).

**Conclusions:** Pre-emptively listed KT candidates had a wide variation in 2-yr ESKD risk by KFRE. Risk was lowest in White patients and Black patients had the lowest incidence of KT.

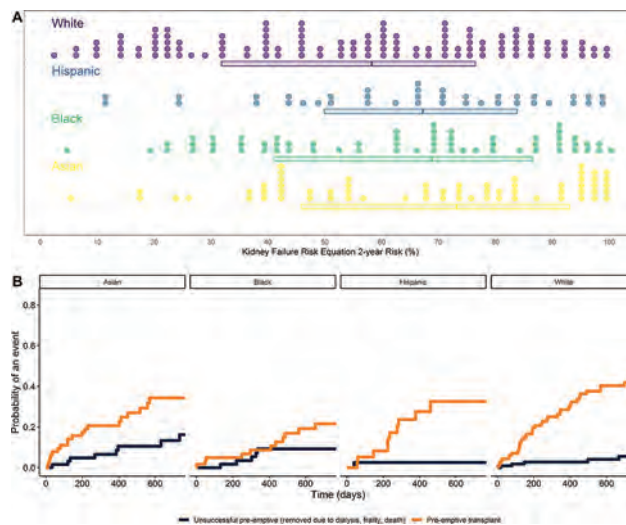

(A) Distribution of 2-year KFRE risk, by race/ethnicity.  
(B) Cumulative incidence of pre-emptive transplant at 2 years of follow up.

FR-PO876

**Impact of the ESRD Treatment Choices (ETC) Model on Kidney Transplant Waitlisting by Race and Ethnicity**

Vishnu S. Potluri,<sup>1,5</sup> Chen Peng,<sup>3</sup> Yuvaram N. Reddy,<sup>1,5</sup> Sri Lekha Tummalapalli,<sup>2</sup> Qian Huang,<sup>3</sup> Joshua Liao,<sup>4,5</sup> Amol Navathe.<sup>1,5</sup> <sup>1</sup>University of Pennsylvania Perelman School of Medicine, Philadelphia, PA; <sup>2</sup>Weill Cornell Medicine, New York, NY; <sup>3</sup>University of Pennsylvania, Philadelphia, PA; <sup>4</sup>University of Washington, Seattle, WA; <sup>5</sup>Leonard Davis Institute of Health Economics, Philadelphia, PA.

**Background:** The ESRD Treatment Choices (ETC) Model - implemented in January 2021 - randomized dialysis providers and nephrologists in 30% of US hospital referral regions to receive financial incentives based on rates of home dialysis and access to transplantation. The model also included a health equity incentive to reduce disparities among dually eligible Medicare and Medicaid patients, who are low socioeconomic status and disproportionately Black and Hispanic. In this study, we used data from the US transplant registry to describe the early impact of the model on transplant waitlisting.

**Methods:** We assembled a cohort of adult Medicare beneficiaries on dialysis who were waitlisted for a kidney transplant between Jan 1, 2017 and Sept 30, 2021. The cohort was divided into the intervention and control arms of the ETC model. Kidney transplant waitlisting between groups was evaluated using an interrupted time series design. We used piecewise linear regression to compare slope changes in waitlist additions between the intervention and control arms for the overall population, Black, and Hispanic transplant candidates.

**Results:** Following implementation of the ETC model, there were 4975 waitlist additions in the intervention arm and 8438 additions in the control arm. Post-ETC model, we found no significant difference in kidney transplant waitlist additions between the intervention and control arm for the overall cohort (Figure 1 slope difference 0.87/month p-value 0.068), Black (slope difference 0.25/month, p-value 0.23), and Hispanic transplant candidates (slope difference 0.04/month, p-value 0.75).

**Conclusions:** In the first 9-months following implementation of the ETC model, we did not detect an increase in new kidney transplant waitlist additions overall or among racial and ethnic minorities. Longer-term follow-up is required to determine if the ETC model incentives are sufficient to overcome barriers to transplant waitlisting.

**Funding:** NIDDK Support, Private Foundation Support

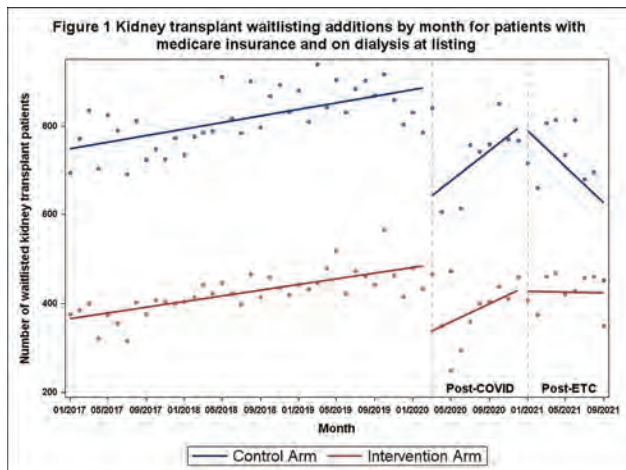

FR-PO877

**Black Americans Experience a Disproportionately Longer Wait Time for Kidney Transplant**

Jack R. Fagan, Emily Belowich, Daniel Labson, Mark J. Gooding, Shalini Parekh. *Avalere Health, Washington, DC.*

**Background:** Almost 786,000 individuals in the United States are living with End-Stage Renal Disease (ESRD), and Black Americans show a three-to-four-fold excess risk in incidence rates. To experience higher survival rates and an optimal quality of life, a kidney transplant is needed to live.

**Methods:** We used 100% Medicare Fee-For-Service (FFS) claims data to identify patients who received a kidney transplant between July 2018 to June 2021. Among these patients, we identified individuals with an initial diagnosis of chronic kidney disease (CKD) or ESRD and were enrolled in Medicare FFS continuously in the year prior to diagnosis to confirm a negative diagnosis period. Beneficiaries entitled to Medicare due to ESRD were excluded to ensure full claims history to capture initial diagnosis, resulting in a total of 3,894 patients. For these patients, we evaluated the time between CKD/ESRD diagnosis and transplantation. Separately, we evaluated the total mortality in the years following either an initial CKD or ESRD diagnosis, excluding patients who received a kidney transplant. Mortality was established utilizing certificate of death data that was identified in Medicare FFS Master Beneficiary Summary File, indexed to diagnosis to establish time to death and subsequent mortality rate by year.

**Results:** The average wait time for Medicare FFS beneficiaries from time of initial diagnosis of CKD/ESRD to receipt of a kidney transplant was 4.46 years. Compared to all patients, Black Medicare FFS beneficiaries had a longer average wait time from diagnosis to transplant of 5.09 years ( $P < .0001$ ). Mortality for all patients 4 years post initial diagnosis of CKD/ESRD was 5.03%, and then increased to 6.03% for 5 years, 27.05% for 6 years or greater, with a total mortality of 47.18% for patients 6+ years after CKD/ESRD diagnosis.

**Conclusions:** Black patients, on average, wait an additional 7.56 months to access a transplantation compared to the average patient. These findings underscore the importance of treatment education and timely access to transplantation as CKD/ESRD mortality increases dramatically with time from 2.54% of patients expiring within one year following diagnosis to a cumulative 47.18% of patients expiring 6 years post diagnosis.

FR-PO878

**Outcome of Kidney Transplantation in Recipients With Intellectual Disability**

Tramahn Phan, Md S. Alom, Stacey Mcgahan, Jeremy G. Taylor, Scott E. Liebman. *University of Rochester, Rochester, NY.*

**Background:** Kidney transplantation offers significant mortality and quality of life benefits compared to dialysis. Every eligible end-stage renal disease patient (ESRD) should be evaluated for a transplant. Historically, ESRD patients with intellectual disability (ID) are at a disadvantage during the transplant evaluation process due to concerns related to their understanding of the process and medical compliance. There is a paucity of data evaluating the outcome of kidney transplantation in this group of people.

**Methods:** Our retrospective study investigated the clinical outcomes of kidney transplantation in recipients with ID at the University of Rochester Medical Center (URMC). Subjects were identified using ICD10 codes utilized by the division of Behavioral Pediatrics in identifying intellectual disability. We identified 23 individuals who received 25 allografts between January 1991 and December 2019. Fifteen individuals receive services from Office for People with Developmental Disabilities.

**Results:** The one-year and three-year graft survival rates of ID recipients were 100%. This compares favorably to our institutional outcomes. URMC's one-year graft survival rate is 95.4%; the rate from living donors is 100%, and from deceased donors is 92%. Our three-year graft survival rate is 92.9%; the rate from living donors is 94.5%, and from deceased donors is 91.5%. The mean follow-up time was 12.6 ± 7.2 years. The mean post-transplant vintage was 11.7 ± 7.5 years. There were 4 allograft failures from 3

recipients. Allograft vintage at the time of failure from two of the subjects was 22.5 years and 17.5 years. In the subject with two episodes of allograft failure, the vintage of the allografts was 5.6 years and 4.7 years. There were 9 rejection episodes; only 2 of these led to graft loss and both occurred in the same subject. Of the subjects with functional grafts, the average creatinine was 1.3 ± 0.47 mg/dl.

**Conclusions:** We believe that ID should not be factored into the kidney transplant evaluation process. If individuals with ID have a good support system, they appear to benefit from transplantation similar to those without ID.

FR-PO879

**Transplantation Outcome Racial Disparities in Autosomal Dominant Polycystic Kidney Disease**

Rita L. McGill, Arlene B. Chapman. *University of Chicago Division of the Biological Sciences, Chicago, IL.*

**Background:** Autosomal dominant polycystic kidney disease (ADPKD) patients access to pre-emptive and living donor transplantation varies by race throughout the United States. In this analysis, we examined transplant outcomes by race among patients with ADPKD.

**Methods:** OPTN/UNOS files were used to identify patients age ≥ 30 with ADPKD who received kidney-only transplants. Race was stratified as White (W), African American (AA), Hispanic (H), and Asian (A). Cox models were used to calculate hazard ratios (HR) for graft failure, using (W) as the reference. The model was then adjusted for age, sex, BMI, cold ischemia time, living donation, pre-emptive transplant, diabetes, use of induction therapy, steroid maintenance, and HLA mismatch.

**Results:** 30898 ADPKD transplant recipients were assessed. Patient characteristics are outlined in Table 1. The unadjusted HR for graft failure among AA was 1.55 (1.45, 1.66)  $P < 0.001$ , and remained 1.30 (1.20, 1.41)  $P < 0.001$  after adjustment. Outcome disparities were not observed among H or A patients with ADPKD. (Table 2)

**Conclusions:** African American ADPKD patients are at higher risk for graft failure after kidney transplant than other patients, above and beyond reduced access to living donor and pre-emptive transplantation. Further work is needed to determine what remediable factors could lead to more equity in transplant outcomes.

	ALL N=30098	White n=23687	African-American n=3215	Hispanic n=2784	Asian n=901
Age, mean(std)	53.9 (9.5)	54.2 (9.5)	53.6 (9.5)	52.0 (9.5)	54.7 (9.9)
Female, %	46.2	45.5	52.0	45.4	45.0
Living Donor, %	43.3	46.4	18.9	31.8	30.0
Pre-emptive Tx, %	33.0	37.4	15.7	19.1	21.5
HLA mismatch%:					
0-2	18.5	20.5	8.2	16.4	10.0
3-4	41.2	41.9	38.0	39.7	37.0
5-6	40.3	37.6	53.8	43.9	53.0
BMI, mean (std)	27.5 (5.1)	27.7 (5.1)	27.6 (5.3)	27.3 (4.8)	24.5 (4.2)
Diabetes, %	4.6	4.0	6.4	5.7	7.8
Cold ischemia time (Hrs)	10	9	15	13	12
Median (IQR)	(1,19)	(1,18)	(8,22)	(3,21)	(4,21)
Induction therapy, %	80.0	79.9	79.7	80.2	81.0
Maintenance steroids, %	67.3	66.5	71.0	69.4	69.8

	Unadjusted		Adjusted	
	HR (95% CI)	P	HR (95% CI)	P
African American	1.55 (1.45, 1.66)	<0.001	1.30 (1.20, 1.41)	<0.001
Hispanic	1.01 (0.93, 1.11)	0.8	0.88 (0.79, 0.97)	0.01
Asian	0.96 (0.82, 1.13)	0.9	0.89 (0.75, 1.06)	0.2
White (ref)	1.00		1.00	
Living donor	0.55 (0.52, 0.57)	<0.001	0.75 (0.69, 0.82)	<0.001
Pre-emptive Tx	0.52 (0.49, 0.55)	<0.001	0.62 (0.57, 0.66)	<0.001
Age, per 10 y	1.42 (1.38, 1.46)	<0.001	1.40 (1.36, 1.44)	<0.001
BMI, per kg/m <sup>2</sup>	1.01 (1.01, 1.02)	<0.001	1.01 (1.01, 1.02)	<0.001
CIT, per 3 hrs	1.06 (1.05, 1.07)	<0.001	1.02 (1.01, 1.03)	<0.001
Female	0.90 (0.86, 0.94)	<0.001	0.86 (0.81, 0.90)	<0.001
Diabetes	1.53 (1.37, 1.71)	<0.001	1.27 (1.12, 1.44)	<0.001
Induction Rx	0.93 (0.88, 0.98)	0.01	0.98 (0.91, 1.04)	<0.001
Steroid maint	1.12 (1.05, 1.19)	<0.001	1.03 (0.97, 1.10)	0.3
HLA mismatch				
1	1.21 (1.03, 1.41)	0.02	1.19 (0.99, 1.42)	0.06
2	1.19 (1.06, 1.35)	0.004	1.26 (1.10, 1.45)	0.001
3	1.21 (1.09, 1.34)	<0.001	1.25 (1.11, 1.41)	<0.001
4	1.41 (1.28, 1.56)	<0.001	1.38 (1.23, 1.54)	<0.001
5	1.47 (1.33, 1.62)	<0.001	1.40 (1.25, 1.56)	<0.001
6	1.48 (1.33, 1.65)	<0.001	1.47 (1.30, 1.66)	<0.001

## FR-PO880

**Sex Disparities in Renal Transplant in Brazil: A Descriptive Analysis**

Renan G. Diniz, Natacha U. Morales, Luciana G. Lutf, Fernando L. Strufaldi, Claudia C. Albuquerque, Maria cristina R. Castro, Elias David-Neto. *Universidade de Sao Paulo, Sao Paulo, Brazil.*

**Background:** Social disparities in Health Care including sex, ethnic and socioeconomic ones are still prevalent and underestimated mainly in developing countries.

**Methods:** It was an epidemiological, retrospective and descriptive analysis comparing clinical data among men(M) and women(W) donor and recipients. Medical records from 2010-20 were collected in a center in Brazil. Variables were clinical and epidemiological data, comorbidities, pregnancies, transfusions, priority for end-stage vascular access failure (ESVaf), waiting list, immunologic profile, graft failure cause, mortality cause and rate and graft survival.

**Results:** A total of 1983 medical records were analyzed. The median age was 46,3y among men and 48,6 for women. A total of 48% were women and 52% men. Diabetes was equal among sexes, but more autoimmune diseases were seen in W. Among 437 relative living donors, W had a tendency to donate more than M (60Wx40%M) with mothers donating more than fathers (73Wx27%M). Among not-related donors, wives donate more than husbands (60Wx40%M). About 75% of women had pregnancies before transplant. W also received more blood transfusions (58,4 x 47%, p=0,00001), data that also justifies the higher number of sensitized women (45% positive PRA in W x 18% in men; p=0,00001). Curiously, 27% of woman recipients were sensitized only due to pregnancies. Women rate in the priority list due to ESVaf were higher (4,9Wx3,7M%; p=0,00001) and they had more time on the waiting list (75Wx62M, P<0,005). There was a tendency for more deaths due to infection in W (54Wx49%M) and cardiovascular reasons in M (9Wx14%M); but patient 10y survival was the same (80Wx78%M). Although not statistically different, graft survival at 10y was higher in women (88Wx71%M).

**Conclusions:** Despite being a retrospective study, we included several variables of the disparities seen in renal transplantation. There was an association between being W renal recipients and sensitization, priority list inclusion due to ESVaf, number of transfusions and pregnancies, and time on the waiting list, variables that could be better approached in the future. Women looks like to donate more than men and although their higher risk at transplant, they present higher long-term graft survival, suggesting better self-care and adherence to treatment.

## FR-PO881

**The Outcomes of Kidney Transplantation in Patients With Different Modalities of Dialysis Under Universal Health Coverage in Thailand**

Pornpen Sangthawan,<sup>1</sup> Thammasin Ingviya,<sup>2</sup> Siribha Changsirikulchai.<sup>3</sup> <sup>1</sup>*Division of Nephrology, Department of Medicine, Faculty of Medicine, Prince of Songkla University, Hat Yai, Thailand;* <sup>2</sup>*Department of Family and Preventive Medicine, Faculty of Medicine, Prince of Songkla University, Hat Yai, Thailand;* <sup>3</sup>*Division of Nephrology, Department of Medicine, Faculty of Medicine, Srinakharinwirot University, Nakhon Naiyok, Thailand.*

**Background:** Thai patients with end-stage kidney disease (ESKD) under the Universal Health Coverage (UC) can access not only dialysis by using peritoneal dialysis (PD) first but also hemodialysis (HD) and kidney transplantation (KT). The previous studies show that KT is the most cost-effective kidney replacement therapy (KRT). There is a controversy about the effect of pre-transplant dialysis modality on graft survival after KT. This study aimed to compare the rates of receiving KT and graft survival between patients with PD and those with HD under UC.

**Methods:** The data of patients who registered with the National Health Security Office (NHSO) Region 4 and received PD, HD, and KT during January 2017-December 2021 were analyzed. The rates of PD or HD patients who received KT were calculated. The characteristics of these patients were identified. The one-year and three-year graft survival were compared between patients with pre-transplantation HD and PD by using Kaplan-Meier analysis.

**Results:** There were 9,169 cases receiving dialysis in the five years of the study period. The number of patients with PD and HD were 5,905 (64.4%) and 3,264 (35.6%), respectively. The number of PD patients receiving KT was 131(2.2%) while the number of HD patients receiving KT was 84 (2.6%). The characteristics and graft survival compared between patients with PD and HD were shown in Table 1.

**Conclusions:** The rates of KT in HD patients were slightly higher than in PD patients. The one-year and three-year graft survival rates were higher than 90% in both PD and HD. The one-year graft survival in PD patients was better than in HD patients but there was no difference in three-year graft survival between these dialysis modalities. The dialysis patients should be encouraged to receive KT.

**Table 1** The characteristics and outcomes of kidney transplantation comparing between patients on PD and HD

Characteristics	PD	HD
Total number of patients	5,905	3,264
Total number to KT, n (%)	131 (2.2)	84 (2.6)
Age at start dialysis (years)		
Median (25 <sup>th</sup> -75 <sup>th</sup> IQR)	38.79 (26.01-48.12)	36.68 (25.05-46.8)
Age at KT (years)		
Median (25 <sup>th</sup> -75 <sup>th</sup> IQR)	40.53 (27.1-49.74)	40.02 (28.18-50.74)
Time interval between start dialysis to KT (years)	1.13	2.52
Gender, n (%)		
Male	83 (63.36)	43 (51.19)
Female	48 (36.64)	41 (48.81)
Diabetes, n (%)	22 (16.79)	18 (21.43)
Graft survival, n (%)		
1 year	96.8 (96.4-97.3)	93.2 (92.3-94.0)
3 year	90.7 (89.9-91.5)	90.5 (89.5-91.6)

## FR-PO882

**Exploring Stigma in the Context of Living Donor Kidney Donor Transplantation (LDKT) Among African, Caribbean, and Black (ACB) Communities in Toronto, Canada**

Princess N. Okoh,<sup>1,2</sup> Ghazaleh Ahmadzadeh,<sup>1</sup> Ranie Ahmed,<sup>1,2</sup> Priscilla Boakye,<sup>3</sup> Beth Edwards,<sup>1</sup> Paula Neves,<sup>1</sup> Emma S. Rogers,<sup>1</sup> Istvan Mucsi.<sup>1,2,3</sup> *University Health Network, Toronto, ON, Canada;* <sup>2</sup>*University of Toronto, Toronto, ON, Canada;* <sup>3</sup>*Ryerson University Daphne Cockwell School of Nursing, Toronto, ON, Canada.*

**Background:** From a medical perspective, LDKT is the best treatment option for kidney failure. Patients from ACB communities are much less likely to receive LDKT than White patients. Stigma surrounding kidney failure and LDKT may contribute to this inequity. This qualitative analysis aims to understand the nature of stigma and how it may influence access to LDKT in ACB communities in Toronto, Canada.

**Methods:** Self-identified ACB participants (individuals with [on dialysis or after kidney transplant] and without lived experience with kidney failure; and health care professionals [HCPs]) were recruited using purposive and snowball sampling via community networks and social media. Semi-structured in-depth individual interviews (IDIs) and focus groups (FGs) were conducted, audio-recorded, and transcribed verbatim. Reflexive Thematic Analysis was utilized, drawing on the tenets of Critical Race Theory (CRT) and Intersectionality to consider the effects of racialization and the interlocking effects of co-occurring social identities such as race, class, and health status and access to LDKT. Themes were developed, refined, and finalized by the research team.

**Results:** The sample is comprised of 6 community FGs (n=81), 7 IDIs with HCPs, 9 patient IDIs, and 2 FGs (n=6) with patients with kidney failure. Participants expressed hesitancy around communicating about kidney disease and the need for LDKT due to anticipated and experienced stigma. Participants with kidney failure feared judgment from family, friends, and community (e.g. due to anticipated assumptions about lifestyle choices), as well as from HCPs (e.g. due to anticipated assumptions about health beliefs and behaviours). Participants also described a strong cultural norm of maintaining privacy around health issues, largely limiting any discussion about LDKT.

**Conclusions:** Stigma is a potential barrier to LDKT as it may prevent discussions about kidney failure and treatment options and reduce the chance of identifying potential living donors. Culturally tailored, competent resources co-developed with ACB communities may help reduce stigma in ACB communities and may improve equitable access to LDKT.

**Funding:** Government Support - Non-U.S.

## FR-PO883

**Rethinking Racial Disparities in Living Donor Kidney Transplantation: A Socioecological Approach**

Bashir El-Khoury, Tse-Chuan Yang. *The University of Texas Medical Branch at Galveston, Galveston, TX.*

**Background:** The incidence of end stage renal disease (ESRD) is higher among Blacks than other racial or ethnic groups and is up to three times higher than the non-Hispanic white population. Despite kidney transplantation having superior outcomes to dialytic therapies, the disparities in living donor kidney transplantation (LDKT) between Black and non-Hispanic white patients have persisted, even after taking into account individual differences in social determinants. Previous studies have shown that Black patients are less likely to receive a kidney transplant and living-donor transplant than white patients in the United States. I argue that using a socioecological approach should better formulate interdisciplinary and comprehensive interventions to help reduce the racial disparities in living donor kidney transplantation.

**Methods:** A comprehensive literature search was performed using PubMed and relevant articles pertaining to individual factors, interpersonal/relationship factors, community/cultural factors, and societal/institutional factors in living donor kidney transplantation were reviewed.



**Results:** At the individual level, public insurance, income and transplant knowledge have been found to be independently associated with living donor kidney transplantation. The interpersonal/relationship factors shaping the disparities include perceived lack of social support and poor communication. Finally, cultural differences and structural inequities in our health care system including the use of race-based glomerular filtration rate calculators and transplant center variability in the screening of Black donors may also play a role.

**Conclusions:** Numerous factors at each socioecological level are likely maintaining the racial disparities witnessed in living donor kidney transplantation. A multidisciplinary and interprofessional approach is necessary to devise strategies and interventions to eliminate racial disparities and reduce inequity noted in LDKT in the United States. By utilizing a socioecological approach, we may be able to rethink how we address this important issue.

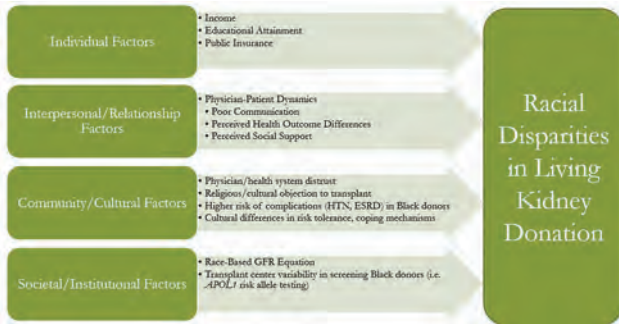

**FR-PO884**

**Incarceration of Black ESKD Patients' Family Members as a Barrier to Living Kidney Donation**

Avrum Gillespie,<sup>1</sup> Jonathan Daw,<sup>2</sup> Andrea Corradi,<sup>3</sup> Briana E. Lee,<sup>1</sup> Hannah Calvelli,<sup>1</sup> Sally B. Quinn,<sup>1</sup> Zoe Pfeffer,<sup>1</sup> Heather M. Gardiner,<sup>4</sup> Edward L. Fink,<sup>5</sup> Crystal A. Gadegbeku,<sup>6</sup> Peter P. Reese,<sup>7</sup> Zoran Obradovic.<sup>8</sup>  
<sup>1</sup>Lewis Katz, School of Medicine at Temple University, Philadelphia, PA; <sup>2</sup>The Pennsylvania State University - University Park Campus, University Park, PA; <sup>3</sup>Georgia Southern University, Statesboro, GA; <sup>4</sup>Temple University College of Public Health, Philadelphia, PA; <sup>5</sup>Temple University College of Liberal Arts, Philadelphia, PA; <sup>6</sup>Cleveland Clinic, Cleveland, OH; <sup>7</sup>University of Pennsylvania, Philadelphia, PA; <sup>8</sup>Temple University, Philadelphia, PA.

**Background:** There are racial disparities in living donor kidney transplantation (LDKT) between Black and White Americans. Few studies have examined how systemic racism has contributed to these disparities. Punitive policies leading to mass incarceration have disproportionately affected Black Americans and are a large contributor to systemic racism in the U.S. In this study, we examine whether the disproportionate impact of mass incarceration may be contributing to racial disparities in LDKT by preventing access to potential living donors because of the incarceration of Black ESKD patients' family members.

**Methods:** This is a cross-sectional interviewer-administered social network survey of prevalent hemodialysis patients as part of a living donor communication intervention conducted in an urban dialysis clinic in the Middle Atlantic region. Participants were asked, "Have any members of your immediate family, NOT including yourself, ever been held in jail or prison for one night or longer?", and the number of family members affected by incarceration. Participants were then asked how many members affected by incarceration could have potentially donated. Chi square and Fisher's exact tests were used to test the statistical significance of the independent variables' association with categorical dependent variables, and a *t* test was used for dependent continuous variables.

**Results:** Between February to March 2022, 23 transplant eligible self-identified Black and Mixed Race ESKD patients participated in the survey. Participant demographics included a mean age of 55 ± 9 years, 65% were female, and 75% had a household income less than \$40,000. 52% of participants reported having a family member incarcerated, with most having 2-3 members. Participants reported that greater than 75% of the family members who were affected by incarceration could have potentially donated. There were no significant differences in family member incarceration and demographic variables.

**Conclusions:** Of the patients surveyed, 39% had at least one incarcerated family member in prison who could have potentially donated if they were not incarcerated. Identifying how systemic racism affects health disparities is the first step to ensuring health equity in kidney transplantation.

**Funding:** NIDDK Support

**FR-PO885**

**The Impact of Gender Affirming Hormone Therapy on Measures of Kidney Function: A Systematic Review and Meta-Analysis**

David T. Collister,<sup>1</sup> Emily Krupka,<sup>2</sup> Thomas W. Ferguson,<sup>2</sup> Reid Whitlock,<sup>2</sup> Adam C. Millar,<sup>3</sup> Mashall Dahl,<sup>4</sup> Raymond Fung,<sup>3</sup> Sofia B. Ahmed,<sup>5</sup> Navdeep Tangri,<sup>2</sup> Michael Walsh.<sup>6</sup> <sup>1</sup>University of Alberta Faculty of Medicine & Dentistry, Edmonton, AB, Canada; <sup>2</sup>University of Manitoba Max Rady College of Medicine, Winnipeg, MB, Canada; <sup>3</sup>University of Toronto Temerty Faculty of Medicine, Toronto, ON, Canada; <sup>4</sup>The University of British Columbia Faculty of Medicine, Vancouver, BC, Canada; <sup>5</sup>University of Calgary Cumming School of Medicine, Calgary, AB, Canada; <sup>6</sup>McMaster University, Hamilton, ON, Canada.

**Background:** Gender affirming hormone therapy (GAHT) modifies body composition and lean muscle mass in transgender persons. We sought to characterize the change in serum creatinine, other kidney function biomarkers, and glomerular filtration rate (GFR) in transgender persons initiating masculinizing and feminizing GAHT.

**Methods:** We searched PubMed, EMBASE, the Cochrane Library, and ClinicalTrials.gov from inception to September 16, 2020 for randomized controlled trials, observational studies, and case series that evaluated the change in serum creatinine, other kidney function biomarkers, and GFR before and after the initiation of GAHT in adult transgender persons. Two reviewers independently screened and abstracted data and disagreements were resolved by a third reviewer. Random effects meta-analysis was performed to determine the change in outcomes over follow-up of 3, 6 and 12 months.

**Results:** Of the 4758 eligible studies, 26 met the inclusion criteria including 9 studies that recruited 488 transgender men and 593 women in which data was meta-analyzed. There was heterogeneity in study design, populations, GAHT routes, and dosing. At 12 months after initiating GAHT, serum creatinine increased by 0.15mg/dL (95% CI 0.00, 0.29) in 370 transgender men and decreased by -0.05mg/dL (95% CI -0.16, 0.05) in 361 transgender women. No study reported the impact of GAHT on albuminuria, proteinuria, cystatin C, or measured GFR.

**Conclusions:** GAHT increases serum creatinine in transgender men and does not impact serum creatinine in transgender women. The impact on GAHT on other kidney function biomarkers and measured GFR is unknown.

**FR-PO886**

**Gender Disparity in CKD: Men From Mars, Women From Venus**

Manisha Sahay,<sup>1</sup> Vivek Kumar,<sup>2</sup> Monica Kundu,<sup>3</sup> Ashok K. Yadav,<sup>2</sup> Vivekanand Jha.<sup>3</sup> ICKD study group <sup>1</sup>Osmania Medical College, Hyderabad, India; <sup>2</sup>Post Graduate Institute of Medical Education and Research, Chandigarh, India; <sup>3</sup>The George Institute for Global Health, Newtown, NSW, Australia.

**Background:** There is no data on sex difference in CKD in developing countries. We examined sex differences in pan-country prospective, observational cohort study

**Methods:** We used data from 1331 women & 2725 men with eGFR 15–60 mL/min/1.73 m<sup>2</sup> or >60 mL/min/1.73 m<sup>2</sup> with proteinuria from different geographical regions & compared demographics, clinical profile, QOL & Outcomes-ESKD (CKD 5/ chronic dialysis/kidney transplantation), 50% decline in eGFR & mortality

**Results:** Cause of CKD was DKD (24.9% in men, 25% in women), CIN (22.8% in men, 24% in women) and unknown 20% in men and 18.3% in women. Urine albumin, BMI, waist-hip ratio, LDL, Phosphours, PTH were higher in females while serum haemoglobin and calcium, use of iron, erythropoietin & statin were lower. SGA scores were similar. Men had better QOL. There was no significant difference in renal outcomes or mortality (Fig1,2) Risk factors for mortality, 50% GFR decline, incident ESRD are shown in Table1

**Conclusions:** This largest CKD cohort study with detailed phenotyping, rigorous follow-up showed that Women have poor literacy, QOL,hemoglobin, lower iron, ESA, statin use. Risk of progression to ESKD & mortality slightly more in women.

**Funding:** Government Support - Non-U.S.

Table 1 Risk factors for renal outcomes and all cause mortality

	Males	Females
risk factor for all cause mortality	Age (HR = 1.03, p = 0.01), sedentary lifestyle (HR = 0.62, p = 0.04), history of renal stone (HR=0.45, p = 0.05), history of CVD (HR=2.04, p<0.01) and BMI (HR = 0.92, p = 0.01)	Age (HR = 1.04, p = 0.02)
Risk of ≥50% GFR decline	Systolic BP (HR= 1.01, p = 0.01), NSAID (HR= 2.14, p <0.01)	Age (HR= 0.97, p = 0.010), ABL systolic bp (HR = 1.04, p < 0.01), diastolic bp (HR = 0.96, p, 0.011) and NSAID (HR = 2.14, p = 0.05).
Risk factors for incident ESRD	age (HR = 0.98, p = 0.01), history of renal stones (HR = 0.54, p = 0.05), systolic BP (HR = 1.02, p <0.01)	ABL, systolic bp (HR = 1.02, p = 0.02) and history of renal stone (HR = 0.34, p = 0.005)

	Males 2725 (67.18)	Females 1331 (32.82)	P value
<b>Clinical characteristics</b>			
Age mean (sd)	50.93 (11.86)	49.02 (11.58)	<0.01
Category of age freq (%)			
• 18 - 60 years	2076 (76.21)	1098 (82.49)	
• >60 years	646 (23.72)	233 (17.51)	<0.01
Employed freq (%)			
• Professional/Nonprofessional	817 (30.08)/1899 (69.92)	78 (5.90)/1244 (94.10)	<0.01
Literacy freq (%)			
• Illiterate	564 (20.77)	524 (39.64)	
• Some schooling	1330 (48.97)	582 (44.02)	
• Graduate or above	822 (30.27)	216 (16.34)	<0.01
Smokers freq (%)	860 (24.46)	87 (6.62)	<0.01
Alcohol freq (%)	300 (11.12)	1 (0.08)	<0.01
Non-Sedentary lifestyle freq (%) (Exercise >= 30 minutes of brisk walk 5 times per week)	1239 (45.92)	479 (36.43)	<0.01
Food consumption freq (%)			
• Veg & egg /Nonveg	903 (33.77)/1771 (66.23)	477 (36.50)/830 (63.50)	0.09
Recurrent UTI freq (%)	298 (11.00)	144 (10.92)	0.94
History of renal stones freq (%)	335 (12.36)	139 (10.54)	0.08
BMI Median (QR)	24.0 (21.5, 26.7)	25.3 (22.1, 29.0)	<0.01
Waist circumference (cm) Median (QR)	89 (82, 97)	90 (82, 99)	0.06
Waist hip ratio Median (QR)	1.05 (1.01-1.08)	1.06 (1.02-1.21)	<0.01
Alb mean (sd) - Right/Left	1.09 (0.19)/1.12 (0.22)	1.09 (0.18)/1.11 (0.19)	0.78/0.48
Hypertension freq (%)	235 (87.5)	1130 (86.1)	0.24
Systolic BP /Diastolic BP Median (QR)	130 (120-145)/ 80 (78-90)	130 (120-141)/ 80 (76-90)	0.01
Diabetes freq (%)	1012 (37.9)	473 (36.6)	0.44
History of CVD freq (%)	621 (22.96)	255 (19.35)	0.01
History of AKI freq (%)	177 (6.6)	91 (6.9)	0.67
History of recurrent UTI freq (%)	298 (11)	144 (10.9)	0.94
Renal stone disease freq (%)	335 (12.4)	139 (10.5)	0.09
NSAID use freq (%)	375 (13.9)	251 (19.1)	<0.01
Alternative medicine use freq (%)	639 (23.5)	284 (21.5)	0.15
Occupational exposure (%)	1406 (51.8)	629 (47.6)	0.01
Heart failure freq (%)	55 (2.03)	34 (2.57)	0.27

Figure 1 Comparison CKD cohort males and females

	Males	Females	P value
<b>Biochemical parameters</b>			
Hemoglobin (mg/dl) Median (QR)	12.4 (11, 13.7)	11 (10, 12)	<0.01
Anemia Mean (sd)	1.607 (60.9)	932 (73.2)	<0.01
Serum creatinine Median (QR)	1.8 (1.5-2.1)	1.6 (1.4-1.9)	<0.01
eGFR (ml/min/1.73m <sup>2</sup> ) Median (QR)	42.9 (33.7-52.3)	36.3 (30.7-45.3)	<0.01
Urine albumin excretion rate (mg/g) Median (QR)	26 (11-206)	45 (12-357)	<0.01
<b>Prescription practices</b>			
Statins freq (%)	1119/2671 (41.89)	483/1295 (37.30)	0.01
Iron supplementation freq (%)	619/2671 (23.17)	420/1295 (32.90)	<0.01
ESA freq (%)	63/2671 (2.36)	49/1295 (3.78)	0.01
<b>Subjective global assessment</b>			
SGA scores Mean (sd)	25.44 (2.69)	25.33 (2.92)	0.08
<b>Quality of life scores</b>			
Symptom problem list (1-2)	91.07 (9.65)	88.93 (10.84)	<0.01
Effects of kidney disease (8)	86.87 (13.23)	84.12 (14.25)	<0.01
Burden of kidney disease (4)	62.76 (31.88)	60.78 (31.33)	0.06
SF-12 Physical Health Composite	46.03 (5.54)	44.76 (5.60)	<0.01
SF-12 Mental Health Composite	43.89 (7.62)	44.09 (7.36)	0.63
<b>Outcomes</b>			
Duration of study (days) Median (QR)	2.65 (1.39, 3.92)	2.63 (1.39, 3.85)	P value
Mean rate of decline in GFR (ml/min/1.73m <sup>2</sup> /year) Mean (95% CI)	2.50 (2.02, 2.98)	2.40 (1.60, 3.19)	0.82 T test
N = 2074		N = 1030	
Mortality %	21 (2225 (7.74%))	106 (1331 (7.96%))	P=NS
All-cause mortality rate	0.058 (0.03, 0.04)	0.065 (0.03, 0.04)	0.95
Event rate (95% CI)			(0.78, 1.27) Poisson test
eGFR <15 ml/min or dialysis or transplantation N = 3335 Freq %	269/2229 (12.07)	159/1106 (14.38)	0.06 (Chi square test)
<b>CV events</b> freq (%)	6/20 (30)	12/44 (27)	0.21

FR-PO887

One Year of Women in Nephrology India: Where Do We Stand and Where Are We Headed?

Priti Meena,<sup>1</sup> Urmila Anandh,<sup>2</sup> Divya P. Bajpai,<sup>3</sup> Krithika Mohan,<sup>4</sup> Namrata Parikh,<sup>5</sup> <sup>1</sup>All India Institute of Medical Sciences - Bhubaneswar, Bhubaneswar, India; <sup>2</sup>Yashoda Hospital, Hyderabad, India; <sup>3</sup>King Edward Memorial Hospital, Mumbai, India; <sup>4</sup>Hosmat Hospital, Bengaluru, India; <sup>5</sup>Ottawa Hospital, Ottawa, ON, Canada.

**Background:** Undoubtedly, women have made outstanding achievements in various areas such as education, clinical practice, interventions, and research and thus, have contributed significantly to the field of nephrology across the globe. Women in Nephrology India (WIN-India) is an organization established in August 2021 to provide mentorship and a support system with its diverse goals in the arena of nephrology. Throughout the year the organization has conducted multiple academic activities in the form of live webinars, quizzes, symposiums, clinical case discussions and newsletters.

**Methods:** We evaluated the status of WIN-India in the country and the quality of content of academic activities that WIN-India conducted from August 2021 to April 2022. Study participants were invited to take part in the study using Survey Monkey, an online survey collection tool. The participants of this study were faculty of nephrology, nephrology residents, dieticians, dialysis technicians, and nurses. The survey included 16 questions of which 4 were related to demographic variables, one was for suggestions and weaknesses. The remaining questions elicited the quality of the content of academic activities and the newsletter (on a scale 1-10).

**Results:** A total of 250 responses were received. 225 respondents (90%) were aware of WIN-India. The most common age group of respondents was 25-35 years, and 60% belonged to male sex. The majority of participants were nephrology faculty (50% private practitioners, 36.6% academic nephrologists, and 10% were trainees), Social media was the most popular source for creating awareness about WIN-India. On a scale of 1-10, academic content of the education of WIN-India and letter was reported as 10 by 35% and 30% and 9 by 38% and 35%, of the respondents respectively. 62% of the respondents reported that WIN-India webinars were beneficial in their clinical practice and research projects and 83% felt that WIN-India is a step forward toward improving nephrology education. 80% of individuals were interested in participating in WIN-India activities.

The main feedback was to increase social media coverage to enhance its outreach while others felt that there should be no gender bias.

**Conclusions:** The findings of the study showed that WIN-India successfully provided a platform for academics, mentoring, networking, advocacy, and the development of leadership.

FR-PO888

Evaluation of Gender Bias in First Authorship in Nephrology Publications From 2011-2021

Rahul R. Abraham, Oluwadamilola Adisa, Fatima Iqbal, Karina Sulaiman, LSU Health Shreveport, Shreveport, LA.

**Background:** Publishing articles is integral to clinical academia and acts as a benchmark for academic prolificacy. Research participation and expertise are essential in the advancement of academic careers. However, the existence of gender bias in publications is a well-established and undeniable reality. No data exists on publication biases in nephrology. This study was carried out to evaluate gender disparities and their trajectory among popular nephrology journals.

**Methods:** A PubMed search was performed using the easyPubMed package in R, version 4.0.3. The code was written to extract all articles indexed in PubMed from 2011 to 2021 from American nephrology journals with high impact factors were selected – Journal of American Society of Nephrology (impact factor), American Journal of Nephrology, American Journal of Kidney Disease, Clinical Journal of the American Society of Nephrology. Gender with predictions >90% were accepted and the remaining were manually searched on the internet. SPSS was used to carry out descriptive statistics, ratios of male to female first authors grouped by years were carried out, followed by Chi-square-tests were used to measure differences in proportions, and Pearson's correlation was carried out. A similar analysis was done for individual journals.

**Results:** 11608 articles were included in the study. Across all journals, the average ratio of male to female first authors improved across the years, from 1.9 to 1.5 (p<0.05). Additionally, in 2011, women accounted for 32% of first authors, a number that rose to 40% in 2021, with the average across the ten years being 37%. Of the four journals analyzed, all except for the American Journal of Nephrology showed an improvement in the ratio of male to female first authors. For the American Journal of the society of Nephrology, the ratio changed from 1.81 to 1.58, p=0.001, for the clinical journal of the American Society of Nephrology, the ratio declined from 1.91 to 1.15, p=0.005 while for the American Journal of Kidney Disease, the ratio declined from 2.19 to 1.19, p=0.002.

**Conclusions:** Gender bias in publications continues to exist in first-author publications in nephrology. However, this review indicates that the gender gap is closing. Multiple factors might be contributory to this. We hope this study lays the groundwork to continue to follow and evaluate gender trends in publication.

FR-PO889

A Framework for Anti-Racist Curriculum Changes in Nephrology Education

Paloma C. Orozco Scott, Jerrel L. Catlett, Carina Seah, Staci A. Leisman, Icahn School of Medicine at Mount Sinai, New York, NY.

**Background:** Despite national commitments to anti-racism, a paucity of guidance exists on how to critically appraise pathophysiological and epidemiological findings with an anti-racist lens. Identifying scientific racism and replacing it with evidence-based rationale is fundamental to anti-racist change. Mention of race within nephrology curricula should not act as a proxy for polygenic contributions, social determinants of health, or systemic healthcare barriers. Anti-racist curricular change necessitates that teachers re-inhabit the role of the learner, entering an interactive and collaborative process of questioning, adjusting, and feedback.

**Methods:** We applied the proposed process to two case-studies: estimated glomerular filtration rate (eGFR) and HIV-associated nephropathy (HIVAN). Citations from widely used nephrology education sources illustrate improper use of race within nephrology.

**Results:** Nephrology educators can apply an inquiry-based process, assessing the problem, themselves, devising solutions, and assessing impact, to identify and intervene upon scientific racism within curricula. Applying this process to the case of HIVAN, we suggest that sources referencing “Black” race as a predominant risk factor should instead center discussion on evidence-based factors such as causal polymorphisms and social determinants that disproportionately impact Black patients.

**Conclusions:** In confronting racial disparities in nephrology, educators must work collaboratively to critically appraise where in their curriculum race is implicitly/explicitly naturalized as a biological variable and the impact their framing of race has on clinical practice.



Text	Quote	Problem	Solution
Robbins and Cotran's Pathologic Basis of Disease, Tenth Edition (2011)	"HIV infection can directly or indirectly cause several renal complications... most commonly, a severe form of the collapsing variant of FSGS, termed HIV-associated nephropathy. The latter has been reported in 5% to 10% of HIV-infected individuals in some older series. more frequently in blacks than in whites... There is some data to suggest that HIV can infect tubular epithelial cells and podocytes, but much remains to be known."	Claims more frequent presentation of HIVAN in black patients without consideration of specific cultural, behavioral, and/or environmental factors that may increase the risk of disease. Also does not consider social determinants of health that influence racial disparities in ESKD presentation.	Avoid attributing race as the causal explanation of discrepant disease incidence. Provide historical context and focus on structural and social determinants of health that explain discrepancies in incidence.
Campbell-Walsh & Wein Urology, Twelfth Edition (2021)	"It has a 12:1 greater incidence in black patients compared with white patients and has become the third leading cause of end-stage renal disease among black patients 20 to 64 years of age. The diagnosis is made by biopsy that demonstrates a collapsing variant of focal segmental glomerulosclerosis, proliferation of renal tubular and vascular cells, tubular microcystic formation, sclerosis, interstitial fibrosis, and infiltration of the interstitium with leukocytes."	Provides epidemiological data for disproportionate incidence of HIVAN in black patients without consideration of specific cultural, behavioral, and/or environmental factors that may increase the risk of disease. Also does not consider social determinants of health that influence racial disparities in ESKD presentation.	
Cecil's Essentials of Medicine, Tenth Edition (2022)	"HIVAN occurs almost exclusively in patients of African descent when CD4 levels are low. It is thought to be caused by infection and subsequent expression of HIV viral genes in podocytes."	Race reference to a broad ancestry group without clear delineation of implicated genes or polymorphisms author believes contribute to disproportionate HIVAN presentation within this population.	Avoid imprecise approximations of ancestry. Instead, reference evidence of known risk variants found more often in patients of African descent, such as ANKRD1 variants G1 and G2. Should also propose alternative or prevailing theory for why there is increased presentation in African descent groups (e.g. evolutionary advantage of protective alleles against hypocoagulants).

FR-PO890

Measuring the Impact of an Interprofessional and Multidisciplinary Graduate Medical Case Conference on Socioeconomic Healthcare Disparities in Nephrology

Morgan Schoer, Gaurav Rajashekar, Frank J. O'Brien, Washington University in St Louis, St Louis, MO.

**Background:** According to the most recent ACGME survey, 70% of fellows reported either no training in cultural competency, or generic training only. Learning to recognize unconscious biases, understand socioeconomic healthcare barriers, and utilize available resources will improve patient care. Specifically in nephrology, in which Black Americans are 4-5x more likely to develop kidney disease than the general population, it is critical that we train fellows how to partner with other health professionals to best navigate cultural differences and advocate for their patients in order to achieve equity and reduce disparities. We developed a specific curriculum at a single large academic institution to address this issue.

**Methods:** We partnered with the rheumatology and infectious diseases divisions to build a four-part curriculum addressing various aspects of health barriers and equity. Each division was tasked to create a one-hour interactive workshop addressing different high-yield topics. Attendings, fellows, social workers, and nurses were invited to participate. Pre- and post-session surveys querying fellows' comfort in identifying and addressing structural and social determinants of health were administered.

**Results:** On a Likert scale from one to five, one being "very uncomfortable" and five being "very comfortable," fellows' (N=16) comfort with understanding and applying St. Louis geopolitical history in the context of medical interactions rose from median value 2.0 to 3.0 (p=0.008). Fellows' comfort in recognizing and strengthening social networks rose from 2.0 to 3.5 (p=0.002). Other metrics showed non-significant improvements.

**Conclusions:** Interprofessional and interdisciplinary case discussions about socioeconomic barriers to healthcare improved fellows' comfort in identifying and addressing structural and social determinants of health.

FR-PO891

Identification of Neglected Kidney Diseases: Results From an International Survey

Chee Kay Cheung,<sup>1,2</sup> Monica Morthy,<sup>3</sup> Olivier Devuyt,<sup>4</sup> Ifeoma I. Ulasi,<sup>5</sup> Jonathan Barratt,<sup>1,2</sup> Vivekanand Jha.<sup>6</sup> <sup>1</sup>University of Leicester, Leicester, United Kingdom; <sup>2</sup>University Hospitals of Leicester NHS Trust, Leicester, United Kingdom; <sup>3</sup>International Society of Nephrology, Brussels, Belgium; <sup>4</sup>Universitat Zurich, Zurich, Switzerland; <sup>5</sup>University of Nigeria, Nsukka, Nigeria; <sup>6</sup>The George Institute for Global Health India, New Delhi, India.

**Background:** Neglected kidney diseases face similar issues to rare kidney diseases: a lack of awareness amongst healthcare professionals, delays in diagnosis, a lack of available or accessible treatments, and low prioritization for research funding. These entities are not well defined, and include both communicable and non-communicable

conditions that affect a broad patient demographic spanning age, gender, ethnicities, and socio-economic groups. Perceptions amongst stakeholder communities of what constitutes a neglected kidney disease are unclear. The aim of this study was to explore views on this topic internationally.

**Methods:** We distributed an online survey to the International Society of Nephrology (ISN) community, that asked respondents to name three neglected kidney diseases, and to specify reasons for their choice. Results from this survey were summarized and grouped according to whether the respondent was from a low- and middle-income country (LMIC) or a high-income country (HIC), according to the Organization for Economic Co-operation and Development (OECD).

**Results:** There were 310 responses from 84 countries. 223 (71.9%) responses were from a LMIC. The top three neglected diseases identified by respondents from a LMIC were diabetic nephropathy, polycystic kidney disease and chronic kidney disease. In contrast, the top three neglected diseases by respondents from a HIC were Fabry's disease, IgA nephropathy and polycystic kidney disease. Conditions found primarily in LMIC such as CKDu (Mesoamerican nephropathy), herbal nephropathy or those due to communicable disease were more likely to be included by respondents from those countries, whereas respondents from HIC were more likely to state ultrarare kidney diseases, such as those due to monogenic causes or disorders of the complement system.

**Conclusions:** Further analysis of the results from this survey will identify what the ISN community consider to be neglected kidney diseases, and the reasons for each choice. Notably, common kidney diseases such as diabetic nephropathy featured frequently in responses from LMIC, which may reflect a lack of access to recently developed therapies. Ongoing work will continue to assess the attitudes of healthcare professionals and the public towards this topic, and help inform the ISN regarding priorities for education, advocacy and research funding.

FR-PO892

Challenges in Diversity and Inclusion in Clinical Trial Enrollment in Autosomal Dominant Polycystic Kidney Disease (ADPKD)

Denise Foy,<sup>1</sup> Barbara C. Khan,<sup>2</sup> Ryan Rex.<sup>1</sup> <sup>1</sup>Spherix Global Insights, Exton, PA; <sup>2</sup>Palladio Biosciences, Horsham, PA.

**Background:** Increasing diversity and inclusion in clinical trials remains challenging in the ADPKD population, but opportunities exist to support expansion of representation among underserved populations.

**Methods:** Real world analysis conducted in Fall 2020 and 2021 evaluating more than 1,500 ADPKD patient charts (collected in collaboration with 243 US nephrologists). Additional data was collected via an online survey of 102 US nephrologists in May 2022.

**Results:** The large-scale chart audits revealed that the ADPKD patient population is 62% White, 18% African American/Black, 12% Hispanic, and 6% Asian. Socioeconomic status was categorized as primarily middle (61%) and upper class (14%), with only 16% identified as lower income. While two-thirds of survey respondents expressed a willingness to enroll patients into a new clinical trial, the data show the patients more likely to be targeted for enrollment are White, in a higher socioeconomic class, with advanced education, and with commercial insurance, revealing potential bias in patient selection for trials. In addition, the majority of respondents ranked "lower income" as the demographic most underrepresented in clinical trials, followed by Black and Hispanic populations (notably, 34% stated there is no unmet need in particular demographic groups). Barriers to patient enrollment included low trial awareness overall, difficulty in identifying appropriate patients, patient resistance and lack of trust, and the burden of managing the enrollment process. Importantly, 65% of the surveyed physicians said that the FDA draft guidance to increase diversity in clinical trials would influence their decisions on which patients to recommend for a clinical trial. Almost all respondents identified several areas to improve participation in clinical trials, including better/more physician education about trials, patient incentives, easier enrollment processes, and more access to live coordinators and resources

**Conclusions:** Physicians need more resources and support to identify opportunities to refer patients to clinical trials and increase enrollment of a more diverse patient population. Compelling educational resources are needed to address barriers, especially those that disproportionately impact underrepresented patient groups.

**Funding:** Commercial Support - Palladio Biosciences, Inc, a Centessa Pharmaceuticals company.

FR-PO893

Directions for Rural Health Research From the COMPASS Project

Darren W. Schmidt, Jesus E. Fuentes, Heidi Rishel Brakey, Larissa Myaskovsky, Christos Argyropoulos. *The University of New Mexico, Albuquerque, NM.*

**Background:** The Community Based Study of the Epidemiology of Chronic Kidney Disease in Cuba New Mexico and Surrounding Areas (COMPASS), a kidney health screening initiative in rural New Mexico (NM), was designed to screen for CKD and discover novel related biomarkers. We explored participants' opinions about CKD research and best practices for delivering kidney lab results to patients with a sub-sample of the study population.

**Methods:** Participants were aged 18-80 years, provided informed consent, and had a mailing address in Cuba, NM; we excluded participants with history of renal replacement therapy. We communicated kidney lab results to participants via a letter using the NKfVisualization tools (Fig. 1). We qualitatively interviewed a subset of participants from the main study to explore their thoughts about general research participation and receive feedback on the results letter. Using descriptive qualitative design and a team-based, iterative, process, we elicited themes from transcribed interviews using NVivo qualitative analysis software.

Key: TH - Thursday; FR - Friday; SA - Saturday; OR - Oral; PO - Poster; PUB - Publication Only

Underline represents presenting author.

**Results:** We interviewed 33 adults: 63% Hispanic; 24% American Indian; and 54.5% female. The most salient themes included positive attitudes toward kidney research; the role of third parties for help interpreting the results letter; and the research participation inspiring lifestyle change (Table 1).

**Conclusions:** Rural community members embraced the opportunity to participate in kidney health research. The NKF visualization tools for displaying lab results were well-received, but patients could use help interpreting results. The letter, however, still inspired positive lifestyle change in rural New Mexican participants.

**Funding:** Private Foundation Support

Themes & Related Subject Responses

Positive Perceptions of Kidney Research	Role of Third Parties for Interpretation of Results Letter	Results Letter Inspiring Lifestyle Changes
"...I believe in research studies. I think it's helpful to a total community..."	"...I took it to my doctor because I have issues [understanding the letter], and it was right on point. He was very happy with the letter that you guys sent..."	"I drink a lot more water now. I try to watch what I eat, not too much fatty foods. I've lost like 25 pounds now..."
"I participate because I'm curious about myself, but it's something that I think is good for the community and try to get people involved in..."	"What happened was that all of this helped me understand what was wrong with me, so you guys are great, honestly. What you gave me, I took to the doctor, and he figured out, so it eliminated a lot of things."	"Just drinking more water daily and going for walks more. Just trying to watch what I eat... Just little things like that I kind of changed a little bit. It's been good, so far."
"[Research is] to help people understand stuff, I guess, and what the research is, I don't know what kind of research studies are doing right now... if it was something that might benefit me or my family or somebody that I know that might have something, I'd probably [participate]."	"...we looked at it, and there were a few numbers that we weren't too sure about. We have a friend who's a nurse, and so we let her look over what the study was. She said it was all good."	"It made me aware that what I put into my body is what I'm getting out of it, in terms of alcohol or junk food, and in terms of diabetes... That really did open my eyes to a lot of that stuff, but I thought it didn't apply to me, but I guess I was just fooling myself."

Dear <Participant Name>,

I am writing to inform you about the results of your screening for Chronic Kidney Disease (CKD) that took place on <Date>. Your GFR reading, which measures how well your kidneys are filtering your blood, is <VALUE>. Values less than 60 usually indicate abnormal kidney filtering. The protein (albumin) reading in your urine is <VALUE>. Values lower than 30 usually mean that there is no damage in your kidneys. This can happen even though your kidneys do not filter your blood efficiently.



These readings were obtained in a research laboratory and thus cannot be validly used to direct your health care. You should discuss these readings with your primary care physician who will prescribe the appropriate course of action. In most cases, this would require repeating the tests in a certified laboratory and/or additional testing. If you want to learn more about Kidney Disease, I strongly encourage you to visit the web page of the National Kidney Education Program, hosted by National Institute of Health:

<http://www.niddk.nih.gov/health-information/health-communication-programs/nkdep/learn/Pages/learn.aspx>

FR-PO894

Stakeholder Perspectives on Engaging Latinx Patients in Kidney-Related Research

Flor Alvarado,<sup>1</sup> Cynthia Delgado,<sup>2,3</sup> Susanne B. Nicholas,<sup>4</sup> Allison Tong,<sup>5</sup> Lilia Cervantes,<sup>6</sup> <sup>1</sup>Tulane University School of Medicine, New Orleans, LA; <sup>2</sup>San Francisco VA Health Care System, San Francisco, CA; <sup>3</sup>University of California San Francisco, San Francisco, CA; <sup>4</sup>University of California Los Angeles David Geffen School of Medicine, Los Angeles, CA; <sup>5</sup>The University of Sydney School of Public Health, Sydney, NSW, Australia; <sup>6</sup>University of Colorado - Anschutz Medical Campus, Aurora, CO.

**Background:** Latinx patients are disproportionately burdened by kidney disease compared to non-Latinx White patients and are underrepresented in kidney-related research. We aimed to describe stakeholders' perspectives on challenges related to engaging Latinx patients in kidney-related research.

**Methods:** We conducted a thematic analysis of qualitative data from two online moderated discussions and an interactive online survey using open text responses among participants (i.e. stakeholders) with personal and/or professional experience with Latinx patients with kidney disease and their families/caregivers.

**Results:** Among eight stakeholders, there were 3 physicians, 1 nurse, 1 patient with kidney disease who received a kidney transplant, 1 policymaker, 1 PhD-trained disparities researcher, and 1 executive director of a non-profit health organization. The majority of themes (and subthemes) reflected barriers to engagement and recruitment: lack of personal relevance (inability to relate to research staff, perceived low importance of clinical trials, limited opportunities to participate; ambiguity of benefit to self and family); fear and vulnerability (immigration concerns, stigma with seeking care, skepticism of Western medicine); financial and logistical barriers (out-of-pocket costs, transportation issues); and distrust and asymmetry of power (related to limited English proficiency or health literacy, and provider bias). The last theme was on stimulating interest and establishing trust in the research process. (Figure)

**Conclusions:** To overcome barriers to engagement in kidney-related research and establish trust among potential Latinx research participants, investigators can employ culturally responsive and community-based strategies. These strategies can help identify

local health priorities, enhance research recruitment and retention strategies, and establish partnerships that continue to elevate research endeavors aiming to enhance the health of Latinx individuals with kidney disease.

**Funding:** NIDDK Support, Other NIH Support - National Heart, Lung, and Blood Institute, Veterans Affairs Support, Commercial Support - Travers Therapeutics Inc, Private Foundation Support

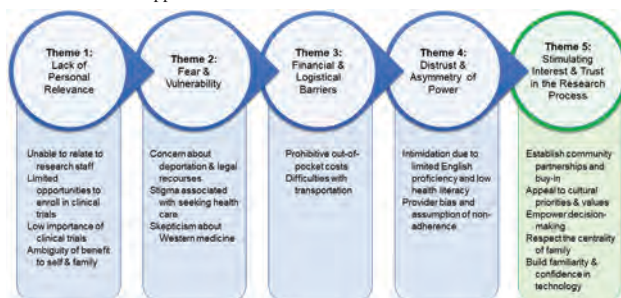

Figure. Thematic schema

FR-PO895

Disparities in ESRD and Mortality Among Older and Younger Black and Hispanic Patients in the United States

Jiannong Liu,<sup>1,2</sup> Haifeng Guo,<sup>1</sup> James B. Wetmore,<sup>1,2</sup> David T. Gilbertson,<sup>1,2</sup> Kirsten L. Johansen,<sup>1,2</sup> <sup>1</sup>Hennepin Healthcare Research Institute, Minneapolis, MN; <sup>2</sup>University of Minnesota Medical School Twin Cities, Minneapolis, MN.

**Background:** ESRD incidence is higher among Black and Hispanic than among White individuals. We assessed disparities in incident ESRD and death among older Medicare and younger Medicaid beneficiaries with CKD stage 4 or 5.

**Methods:** Non-Hispanic White, Black, and Hispanic Medicare beneficiaries aged ≥66 years with Medicare Parts A and B for at least one year and CKD stage 4 or 5 on Jan 1, 2020 were included. In a separate cohort, Medicaid enrollees aged 18-65 years with Medicaid for ≥1 year and CKD stage 4 or 5 on Jan 1, 2020 were included. Patients were followed from January 1, 2020 to the earliest of death, onset of ESRD, loss of insurance, or Dec 31, 2020. Outcomes were death, ESRD, and the combination. We estimated one-year probabilities of ESRD and death and subdistribution hazard ratios (sHRs) from Fine-Gray models with death and ESRD as competing events and adjusted for age, sex, and comorbidities.

**Results:** 298,658 Medicare and 12,067 Medicaid beneficiaries were included. One-year probability of ESRD was 0.04 and 0.14 for Medicare CKD stages 4 and 5, respectively and 0.19 and 0.23 for death. The corresponding numbers were 0.15, 0.27, 0.07, and 0.09 for Medicaid patients. Black and Hispanic beneficiaries were more likely to reach ESRD than White patients (sHR 1.38-1.57 Medicare; 1.26-1.83 Medicaid, Figure) but were less likely to die (sHR 0.74-0.96 in Medicare and 0.68-0.96 in Medicaid). For the combined outcome, disparities were much greater in the Medicaid cohort (HR 1.14-1.47) than in Medicare (HR 0.85-1.13).

**Conclusions:** Older (Medicare) and younger (Medicaid) Black and Hispanic patients with CKD were at higher risk of ESRD and lower risk of death. However, disparities in risk of ESRD or death were greater in younger than older individuals. Disparities in access to care among younger individuals may be an important driver of observed ESRD disparities.

**Funding:** NIDDK Support

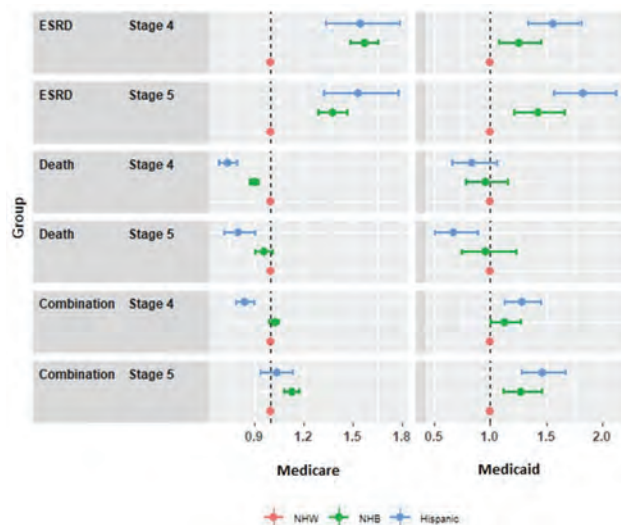

FR-PO896

Understanding Care Gaps in the CKD Clinic

Yuenting D. Kwong, Erik Stewart, Chi D. Chu, Kathleen D. Liu, Lowell J. Lo. University of California San Francisco School of Medicine, San Francisco, CA.

**Background:** Use of renin-angiotensin-aldosterone system inhibitors (RAASi) and sodium-glucose co-transporter 2 inhibitors (SGLT2i) in patients with stage 2-4 chronic kidney disease (CKD) and albuminuria can reduce adverse outcomes. Understanding care gaps is necessary for better implementation of guideline concordant care.

**Methods:** In a single-site academic nephrology practice, we performed a cross-sectional analysis to determine the proportion of current RAASi and SGLT2i use in patients with CKD stage 2-4 with urine albumin-to-creatinine ratio (ACR)  $\geq$  30mg/g (i.e. moderate to severe albuminuria). We assessed for potential gender and racial disparities in the prescription of RAASi and SGLT2i using Pearson's  $\chi^2$  analysis.

**Results:** Of 2458 adults with stage 2-4 CKD, 2046 (83%) had ACR measurements within the last 3 years and 1,281 (62%) of the ACR measurements indicated moderate to severe albuminuria. Among these 1,281 patients, RAASi use was observed in 66% of patients and SGLT2i use was observed in 18.6% of patients. Gender disparities were not observed in RAASi use but SGLT2i use was less common among men. Racial differences were observed with Asian patients having the highest rate of RAASi and SGLT2i prescriptions (76% and 28%, respectively) while White patients had lowest use of RAASi (60%) and Black patients had the lowest use of SGLT2i (12%).

**Conclusions:** Care gaps in RAASi and SGLT2i use can be systemically identified in nephrology clinic and may inform panel management strategies for increasing guideline-concordant care. Factors underlying differences in prescription patterns along gender and racial categories (e.g. patient perception/tolerance/insurance coverage of medications) require further investigation.

Gender and Racial Differences in RAASi and SGLT2i Use Among Patients with Moderate to Severe Albuminuria

	Gender Disparities			Racial/Ethnicity				p-value
	Male	Female	p-value	White	Black	Asian	Other	
N=	524	756		554	137	367	212	
RAASi use (%)	68	65	0.31	60	67	76	62	0.31
SGLT2i use (%)	15	21	<0.01	13	12	28	20	<0.01

FR-PO897

The European Kidney Function Consortium Estimating Glomerular Filtration Rate Equation for Cystatin C: Results for Europe, the United States, and Africa

Pierre Delanaye,<sup>1</sup> Jonas Björk,<sup>7</sup> Natalie Ebert,<sup>2</sup> Bjorn O. Eriksen,<sup>3</sup> Emmanuelle Vidal-Petiot,<sup>9</sup> Anders O. Grubb,<sup>7</sup> Magnus D. Hansson,<sup>8</sup> Karin Littmann,<sup>8</sup> Toralf Melsom,<sup>3</sup> Andrew D. Rule,<sup>4</sup> Elke Schaeffner,<sup>2</sup> Per-Ola Sundin,<sup>1</sup> Anna Åkesson,<sup>7</sup> Anders Larsson,<sup>5</sup> Etienne Cavalier,<sup>1</sup> Justine B. Bukabau,<sup>6</sup> Ernest K. Sumaili,<sup>6</sup> Martin Flamant,<sup>9</sup> Ulf Nyman,<sup>7</sup> Hans Pottel,<sup>10</sup> EKFC (European Kidney Function Consortium) <sup>1</sup>CHU de Liege - Hopital du Sart Tilman, Liege, Belgium; <sup>2</sup>Charite Universitätsmedizin Berlin, Berlin, Germany; <sup>3</sup>UiT Norges arktiske universitet, Tromsø, Norway; <sup>4</sup>Mayo Foundation for Medical Education and Research, Rochester, MN; <sup>5</sup>Uppsala Universitet, Uppsala, Sweden; <sup>6</sup>Universite de Kinshasa, Kinshasa, Congo (the Democratic Republic of the); <sup>7</sup>Skanes universitetssjukhus Lund, Lund, Sweden; <sup>8</sup>Karolinska Institutet, Stockholm, Sweden; <sup>9</sup>Hopital Bichat - Claude-Bernard, Paris, France; <sup>10</sup>Katholieke Universiteit Leuven - Campus Kulak Kortrijk, Kortrijk, Belgium; <sup>11</sup>Orebro universitet, Orebro, Sweden.

**Background:** The creatinine based European Kidney Function Consortium (EKFC<sub>crea</sub>) equation was recently developed as an optimized full age spectrum equation. In the present study, the new EKFC-equation is applied to serum cystatin C (CysC), by replacing rescaled SCr by rescaled CysC.

**Methods:** Individual data from Sweden (n=243,218) were used to estimate the scaling or normalization factor (Q') for CysC in adults. Scaled SCr/Q was replaced by scaled CysC/Q' in the cystatin C based EKFC-equation (EKFC<sub>CysC</sub>) which was then validated in White and Black subjects from Europe (n=11,231), North America (n=1,093) and Africa (n=508), with measured GFR, SCr, CysC, age, and gender available.

**Results:** Rescaling factor Q' for CysC was estimated at 0.79 for adult females and 0.86mg/L for adult males until age 50 years, and (0.79 or 0.86) + 0.005 x (Age - 50) thereafter. A sex-independent scaling factor of 0.83mg/L (and 0.83 + 0.005 x (Age - 50)) was also evaluated. EKFC<sub>CysC</sub> was (nearly) unbiased and showed prediction performances similar to EKFC<sub>crea</sub> in White Europeans, White North Americans, Black Europeans and Black Africans (P10/P30 equal to 40%/85%). EKFC<sub>CysC</sub> was superior to the KDIGO recommended equation CKD-EPI<sub>crea</sub> and CKD-EPI<sub>CysC</sub>. P10/P30 of the arithmetic mean of EKFC<sub>crea</sub> and EKFC<sub>CysC</sub> was greater than 45%/90% in almost all age-subgroups.

**Conclusions:** In our mixed cohorts from Europe, North America and Africa, EKFC<sub>CysC</sub> has the same mathematical form as EKFC<sub>crea</sub>, with different scaling factors for cystatin C and shows similar performance as EKFC<sub>crea</sub>, and better performance than CKD-EPI<sub>CysC</sub>. Moreover, the EKFC<sub>CysC</sub> equation is independent of race and gender. An extra gain in accuracy (reduced bias, plus 5 percentage points in P10/P30 accuracy) is achieved by combining both EKFC-equations.

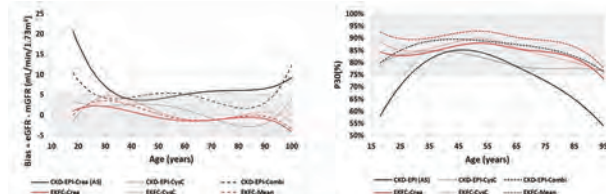

Figure 1. Bias (left panel) and P30-accuracy (right panel) versus age for the SCr-based, CysC-based, and combined SCr+CysC equations, EKFC<sub>crea</sub> and EKFC<sub>cysc</sub> in the pooled dataset (n=12,832) of White Europeans / North Americans and Black Europeans / Africans. The grey area indicates the region where bias is zero ± 5 (left panel) and the region where P30 = 75% (right panel).

FR-PO898

Nephrologists' Perspectives on Kidney and Dialysis Care in Pakistan: A Qualitative Study

Sheza Malik,<sup>1</sup> Ayesha Anwar,<sup>2</sup> Rebecca J. Allen,<sup>3</sup> Fahad Saeed,<sup>4</sup> <sup>1</sup>Rochester General Hospital, Rochester, NY; <sup>2</sup>Allama Iqbal Medical College, Lahore, Pakistan; <sup>3</sup>Mount Saint Joseph University, Cincinnati, OH; <sup>4</sup>University of Rochester Medical Center, Rochester, NY.

**Background:** While most research on kidney care in developing countries has focused on patients, in-depth perspectives of Pakistani nephrologists on kidney and dialysis care are lacking.

**Methods:** Between May 2021 and September 2021, we interviewed 19 nephrologists and nine nephrology fellows working in nine hospitals in Pakistan. Those who hesitated to spare time for the qualitative interviews (n=09) were provided with the opportunity to write their responses to 8 open-ended questions (e.g., 'can you please share some common challenges when a patient needs dialysis?'). For the face-to-face interviews, we recorded and transcribed the conversations. Two reviewers coded the transcripts and used the inductive content analysis approach to formulate themes.

**Results:** We observed the following three main themes: (1) Nephrologists felt privileged when able to relieve patients' suffering. Still, they feared delivering bad news of kidney failure and lifelong dialysis to their patients. (2) Financial issues were the most significant reported barrier to providing maintenance dialysis. (3) Nephrologists were almost evenly divided in their comfort with end-of-life conversation. Some found these discussions challenging, while others found these discussions easy. Other challenges faced by patients with CKD, according to Pakistani nephrologists, included low literacy, limited awareness of kidney disease, fear of dying on dialysis, lack of transportation, poor social support, medical complications of dialysis, and common use of alternative medications.

**Conclusions:** Our study highlights key shortcomings of kidney and dialysis care in Pakistan. Our findings call for raising awareness about kidney disease in the general public. While patients need to be supported financially and psychologically, nephrologists' training in communication skills and end-of-life care is also urgently needed.

FR-PO899

Association of Clopidogrel Use With Renal Outcomes in US Veterans

Ruoxue Wu,<sup>1</sup> Diana Tran,<sup>1</sup> John Sy,<sup>3</sup> Csaba P. Kovessy,<sup>2</sup> Fridtjof Thomas,<sup>2</sup> Keiichi Sumida,<sup>2</sup> Kamyar Kalantar-Zadeh,<sup>1</sup> Elani Streja,<sup>1</sup> <sup>1</sup>University of California Irvine Medical Center, Orange, CA; <sup>2</sup>The University of Tennessee Health Science Center, Memphis, TN; <sup>3</sup>VA Long Beach Healthcare System, Long Beach, CA.

**Background:** Anti-platelet agents like clopidogrel and aspirin have traditionally been used to treat acute coronary syndrome and stroke. However, little is known about the effect on clopidogrel on long-term renal outcomes. We investigated longitudinal data to see if patients using clopidogrel without CKD have an increased risk of developing CKD and ESRD.

**Methods:** 407,343 US veterans without CKD were divided between clopidogrel users and non-users. Cox survival models were utilized to investigate the association between clopidogrel users on with three outcomes of interest: incident CKD, incident ESRD, and death. Hazard ratios for clopidogrel users were calculated with adjustment for demographic, comorbidities, and laboratory data.

**Results:** Clopidogrel users were likely to be older (67.2 ± 9.9 vs 60.2 ± 12.9), male, white, with normal urine albumin levels (<30 mg/dL) and a median Charlson Comorbidity Index of 3. The risk of death was higher among clopidogrel users compared to non-users in unadjusted analysis (HR 1.71, 95% CI 1.69-1.73). Clopidogrel remained associated with CKD in unadjusted and fully adjusted models (HR: 2.24 unadjusted, 95% CI: 2.21-2.27 and HR: 1.42 fully adjusted, 95% CI: 1.40-1.45). With regards to ESRD, clopidogrel use was associated with a higher risk of incident ESRD which became insignificant in our fully adjusted model (HR: 1.79 unadjusted, 95% CI: 1.62-1.97 and HR: 1.00 fully adjusted, 95% CI: 0.88-1.14).

**Conclusions:** Clopidogrel use in non-CKD US veterans is associated with lower risk of mortality, and a higher risk of incident CKD but no association with ESRD.

**Funding:** NIDDK Support, Veterans Affairs Support

**Table.** Models demonstrating the association between clopidogrel exposure and 3 outcomes of interest

Outcome	Model	Clopidogrel HR	95% CI
Death	1	1.71	1.69, 1.73
	2	1.22	1.21, 1.24
	3	0.89	0.88, 0.90
	4	0.87	0.86, 0.87
Incident CKD	1	2.24	2.21, 2.27
	2	1.82	1.80, 1.85
	3	1.38	1.36, 1.41
	4	1.42	1.40, 1.45
Incident ESRD	1	1.79	1.62, 1.97
	2	1.71	1.54, 1.89
	3	1.07	0.94, 1.22
	4	1.00	0.88, 1.14

Model 1 unadjusted; Model 2 adjusted for demographic i.e. age at baseline, female, Black, Other Race, Hispanic, past smoker, current smoker; Model 3 adjusted for demographics and the 15 diseases used to calculate the CCI excluding hemiplegia; Model 4 fully adjusted, adjusted for model 3 in addition to eGFR, UACR, unstable angina, chronic heart disease, atrial fibrillation, cerebral infarction, stenosis of precebral arteries, peripheral arterial disease, coronary angioplasty status, peripheral vascular angioplasty, aortocoronary bypass graft

**FR-PO900**

**Association of Niacin Use With Kidney Outcomes**

Shaun M. Whitecavage,<sup>1</sup> Diana Tran,<sup>1</sup> Keiichi Sumida,<sup>2</sup> Fridtjof Thomas,<sup>2</sup> Csaba P. Kovesdy,<sup>2</sup> Kamyar Kalantar-Zadeh,<sup>1</sup> Elani Streja.<sup>1</sup> <sup>1</sup>University of California Irvine Medical Center, Orange, CA; <sup>2</sup>The University of Tennessee Health Science Center, Memphis, TN.

**Background:** Niacin is a non-statin lipid lowering therapy that has been shown to lower triglycerides and to improve other risk factors for renal outcomes. Despite these favorable data, the effect of niacin on long term kidney outcomes remains unclear.

**Methods:** In a nationwide historic cohort of 1,139,630 US Veterans with normal baseline eGFR, we examined the association of de novo prescription of niacin during 2005-2006 with ESKD, incident CKD (defined as eGFR <60 ml/min/1.73m<sup>2</sup> on two occasions, separated by ≥90 days) and death. Associations were examined in Cox hazard models adjusted for demographics, major comorbidities, and lab measurements. Prescription time-distribution matching was used to control for survival bias.

**Results:** We identified 133,450 new users of niacin. Overall, patients were a mean (SD) 60 (13) years old, with 6% female, 16% Black, and 6% Hispanic. Niacin users were more likely to be male, White, current, or former smokers, with higher frequencies of comorbidities. Niacin was associated with lower risk of death (HR: 0.81, 95% CI: 0.80-0.82) and ESKD (0.85, 0.79-0.92), but with a higher risk of CKD (1.16, 1.15-1.17). The rates at which niacin users experienced death was slower compared to non-users (2.907 versus 3.649). However, the rates at which niacin users experienced ESKD and incident CKD were faster compared to non-users (0.066 versus 0.081 and 3.967 versus 3.018) respectively.

**Conclusions:** Niacin use was associated with a lower risk of ESKD and death, but with higher risk of incident CKD (potentially explained by acute effects on eGFR) in this large national cohort of patients with normal kidney function. Further studies are needed to corroborate the potential benefits of niacin on kidney function and survival.

**Funding:** NIDDK Support, Veterans Affairs Support

	Niacin Users (n=133,450)		Non-Users (n=1,006,180)	
	Event Rate Per 100PY (95% CI)	HR (95% CI)	Event Rate Per 100PY (95% CI)	HR (95% CI)
Death	2.91 (2.85-2.94)	0.814 (0.804-0.823)	3.65 (3.64-3.66)	Ref
ESKD	0.08 (0.08-0.09)	1.280 (1.192-1.374)	0.07 (0.06-0.07)	Ref
Incident CKD	3.97 (3.93-4.01)	1.325 (1.310-1.340)	3.02 (3.01-3.03)	Ref

Event Rates and Hazard Ratios for Death, ESKD, and CKD Among Niacin Users vs. Non-Users

**FR-PO901**

**Atrial Fibrillation in Non-Dialysis Dependent CKD: Prevalence and Time in the Therapeutic Range in Patients Anticoagulated With Vitamin K Antagonists**

Diana Rodriguez-Espinosa,<sup>1</sup> Jose Jesus Broseta Monzo,<sup>1</sup> Aleix Cases.<sup>2,1</sup> <sup>1</sup>Hospital Clinic de Barcelona, Barcelona, Spain; <sup>2</sup>Universitat de Barcelona, Barcelona, Spain.

**Background:** Atrial fibrillation (AF) and chronic kidney disease (CKD) are two closely related entities since not only do they frequently coexist, but one increases the development and progression of the other and vice versa, as well as sharing many risk factors such as age, arterial hypertension, diabetes mellitus or heart failure. In addition, these patients are more prone to poor therapeutic control, although it has been described that the prevalence of AF in CKD is up to 20% and that these patients tend to achieve an INR in the therapeutic range of around 70%. This study aims to determine the true prevalence of this entity in elderly patients with advanced stages of CKD, as well as to determine the time in which acenocoumarol is maintained in the therapeutic range (TTR) in these individuals.

**Methods:** Retrospective observational study of a randomized sample of non-dialysis dependent CKD (NDD-CKD) patients followed at our hospital. Demographic, medical history, and laboratory data were taken from electronic health records. Time in the therapeutic range was calculated with the Rosendaal method

**Results:** A total of 114 cases were analyzed. The mean age was 79 years, 52.2% were men, their body mass index was 29.24 kg/m<sup>2</sup>, their estimated glomerular filtration rate was 22.9 ml/min/1.73m<sup>2</sup> and their mean Charlson comorbidity index was 8. The prevalence of AF was 35%. And this was significantly associated with the presence of heart failure (52.8% vs 9.3%, p<0.001). Half of the patients were anticoagulated with acenocoumarol and the other half with direct-acting anticoagulants (DOACs). Among the former, the mean TTR was 55%. Only 38.5% of patients anticoagulated with acenocoumarol had optimal TTR (>65%).

**Conclusions:** AF is more prevalent in elderly people with NDD-CKD. This population has greater difficulty than the general population in maintaining an optimal TTR level with vitamin K antagonists, increasing both their risk of bleeding and thrombosis. The population with NDD-CKD could benefit from the use of DOACs in the face of this difficulty.

**FR-PO902**

**Nephrologist Use of Sodium-Glucose Cotransporter-2 (SGLT2) Inhibitors Relative to Other Specialties, 2015-2022**

Rishav Adhikari, Kunal Jha, Michael J. Blaha. *Johns Hopkins University School of Medicine, Baltimore, MD.*

**Background:** Multiple clinical trials have demonstrated that sodium-glucose cotransporter-2 inhibitors (SGLT2is) slow progression of kidney disease and reduce cardiorenal mortality in patients with chronic kidney disease (CKD). Clinical guidelines recommend these medications for most patients with CKD, but few receive them. In this study, we characterized trends in SGLT2i use by nephrologists compared to other physicians.

**Methods:** We analyzed near-census level data from IQVIA's National Prescription Audit. This audit collects prescription dispensing activity from 93% of U.S. outpatient pharmacies and then projects that data to estimate 100% of prescriptions. We quantified monthly SGLT2i prescriptions from January 2015-April 2022, stratified by prescriber specialty and molecule. We also used physician census data from the AMA Physician Masterfile to calculate prescriptions per physician.

**Results:** From January 2015 - April 2022, monthly prescriptions of SGLT2is by nephrologists increased 35-fold (from 884 to 31,192) (Fig 1) while monthly prescriptions across all specialties increased 4-fold (from 447,915 to 1,807,389). However, nephrologists accounted for only 1.26% of all prescriptions in the final 12 months of the study. Although nephrologists outnumber them by ~50%, endocrinologists accounted for 11-fold more prescriptions during that period. On a per-physician basis, nephrologists accounted for 21 prescriptions per physician in the final 12 months, while endocrinologists, primary-care physicians, and cardiologists accounted for 316, 33, and 18, respectively. Nephrologists predominantly used dapagliflozin, which was less frequently used by non-nephrologists (52% vs 28% of prescriptions). Notable accelerations in SGLT2i use and shifts in drug choice by nephrologists coincided with the CREDENCE trial, DAPA-CKD trial, and expansion of dapagliflozin's FDA label.

**Conclusions:** Nephrologists have markedly increased use of SGLT2is over the past 7 years, with surges in uptake coinciding with favorable renal outcomes data, but continue to account for a small proportion of overall prescriptions.

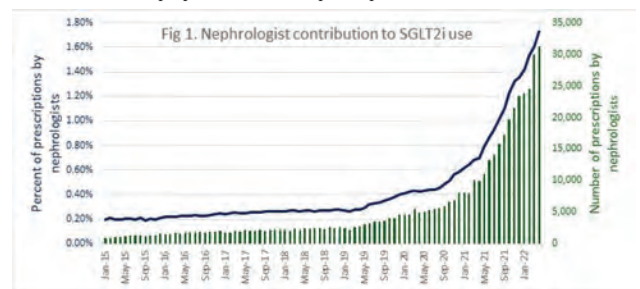

**FR-PO903**

**Renin-Angiotensin Aldosterone System Blockade in Patients With Advanced CKD: A Systematic Review and Meta-Analysis**

Nicolas Vendeville, Marc-Antoine Lepage, Thomas Mavrakanas. *McGill University, Montreal, QC, Canada.*

**Background:** The benefits of renin-angiotensin aldosterone system (RAAS) blockers are not well-established in patients with advanced chronic kidney disease (CKD). These patients may be more sensitive to the functional decrease in glomerular filtration rate (GFR) and increased risk of hyperkalemia that are inherent to RAAS blockade. We conducted a systematic review and meta-analysis to identify potential risks and benefits of RAAS blockade in patients with CKD stage 4-5.

**Methods:** A Medline search was conducted to identify randomized (RCTs) and observational studies with angiotensin converting enzyme inhibitors or angiotensin receptor blockers in patients with advanced CKD, defined as an estimated GFR < 30 mL/min/1.73m<sup>2</sup>. The primary outcome was progression to end-stage renal disease (ESRD).

Secondary outcomes included all cause mortality and major adverse cardiovascular events (MACE). The risk ratio (RR) was estimated using a random-effects model.

**Results:** Eight RCTs (739 patients) and 13 observational studies (59,580 patients) were included. RCTs showed significant reduction in progression to ESRD with the use of RAAS blockade: RR 0.69 (95% confidence interval [CI] 0.56-0.85). Observational studies were suggestive of decreased all-cause mortality with RAAS blockade: RR 0.85 (95% CI 0.78-0.94); but this finding was not reproduced in RCTs. No benefit from RAAS blockade was identified with respect to MACE among patients with advanced CKD.

**Conclusions:** RAAS blockers may be considered in patients with advanced CKD to delay progression to ESRD. However, no clear benefit was identified with RAAS blockade with regards to mortality and MACE in this population.

**Funding:** Government Support - Non-U.S.

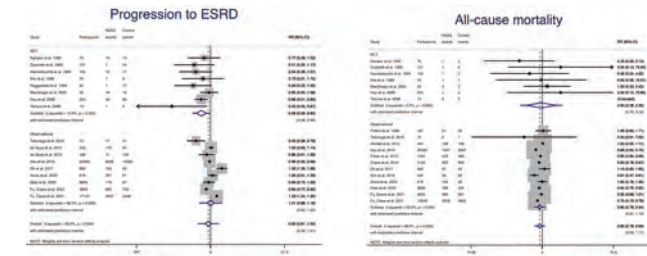

FR-PO904

SGLT2i Prescribers Among CKD Patients: Trends in Real-World Data (RWD)

Joseph Stavas,<sup>1</sup> Emily L. Butler,<sup>1</sup> Jenna Abdelhadi,<sup>2</sup> Tancy C. Zhang,<sup>2</sup> Lexie Rubens,<sup>2</sup> Debra E. Irwin.<sup>2</sup> <sup>1</sup>ProKidney, Raleigh, NC; <sup>2</sup>Aetion, New York, NY.

**Background:** Sodium-Glucose Cotransporter-2 Inhibitors (SGLT2i) reduce CKD risks. RWD may provide insight into early adopters of these agents and treatment trends for CKD due to Type 2 Diabetes (T2DKD).

**Methods:** Adults ≥30 years old with ≥2 eGFR tests, 90-365 days apart, classifying patients as CKD stages 2-4 were identified in the HealthVerity PrivateSource20 closed claims linked with Veradigm Health Insights EHR and Quest laboratory results data between 1/1/2018 and 09/30/2021. The first eGFR test date was the index date, patients were followed for initiation of SGLT2i and the provider type on the prescription claim was identified. Patients with AKI and SGLT2i prescriptions during baseline were excluded.

**Results:** 5.1% of CKD patients (7094/137,874) Stages 2-4 initiated SGLT2i therapy and the number of CKD patients initiating treatment increased over the study period until 2020 (Fig 1). 94% of new SGLT2i use was among T2DKD. SGLT2i initiation was highest in Stage 2 and 3 (5.8%, 4.1%) followed by Stage 4 (1.5%). As disease severity worsened, the proportion of prescriptions initiated by nephrologists increased (0.7% Stage 2 vs. 19.7% Stage 4). Four specialty groups comprised 79% of prescribers overall, with General Medicine (59%) and Endocrinologists (16%) being the early prescribers, while the proportion of Nephrologists and Cardiologists was low but slightly grew by 2021 (Fig 2).

**Conclusions:** RWD indicates sparse initiation of SGLT2i in CKD patients, with increasing trends until 2020 which may, in part, be COVID-19 related. General Medicine and Endocrinologists were consistently the most common prescribing providers, while Nephrologist prescriptions increased over time and as stage advanced.

**Funding:** Commercial Support - ProKidney, LLC

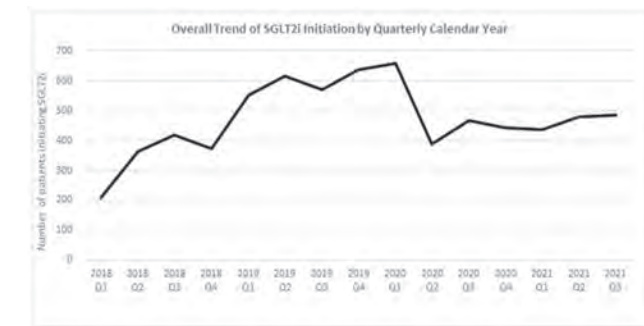

Fig. 1

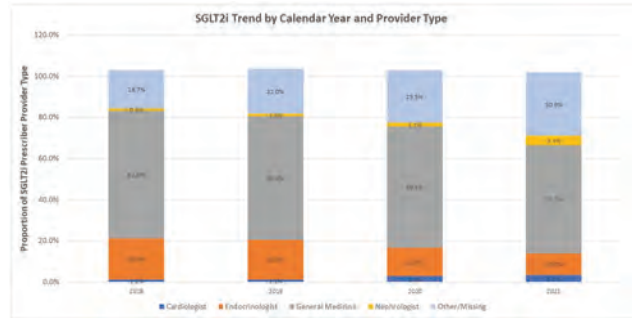

Fig. 2

FR-PO905

Gender Differences in CKD Progression: Real-World Data (RWD) Analysis

Joseph Stavas,<sup>1</sup> Guido Filler,<sup>2</sup> Debra E. Irwin,<sup>3</sup> Kate Lovett,<sup>3</sup> Rohan J. Shah,<sup>3</sup> Emily L. Butler,<sup>1</sup> Maria E. Ferris.<sup>4</sup> <sup>1</sup>ProKidney, Raleigh, NC; <sup>2</sup>London Health Sciences Centre, London, ON, Canada; <sup>3</sup>Aetion, New York, NY; <sup>4</sup>University of North Carolina System, Chapel Hill, NC.

**Background:** Large population-based studies for CKD progression are scant. RWD may better predict population trends for dialysis initiation by gender.

**Methods:** HealthVerity PrivateSource20 closed claims linked with Veradigm Health Insights EHR and Quest laboratory results data of adults with >364 days of continuous enrollment between 1/1/2017 and 11/30/2021 compared progression of CKD stages ≥3b to dialysis, by gender. Patients were required to have ≥2 eGFR measurements 90-365 days apart and followed until they initiated dialysis or end of available data with the first eGFR as the index date. We excluded pregnancy, AKI, ESKD and dialysis during the baseline period. Covariates included gender, country region, age at index date, Deyo-Chronic Comorbidity Index (CCI) Score, eGFRs, payer types, and comorbidities.

**Results:** 14,172 met the study criteria (Table) with a higher proportion of women patients across all stages (p<0.04). Mean (SD) eGFR test results upon cohort entry were clinically similar for men (34.1±8.0) and women (33.8±8.1). The type of insurance differed between men and women (p<0.05) with men more likely to have commercial insurance and women more likely to have Medicaid with no differences in region. Mean Deyo-CCI scores were significantly (p<0.05) higher for men compared to women and a higher proportion of men had osteodystrophy (2.2% vs 1.6%, p = 0.007) while women were more likely to have anemia (21% vs 19.6%, p<0.05). For CKD stages ≥3b, the proportion of men who initiated dialysis was significantly higher (2.5% vs 1.9%, p<0.05), and the mean time to initiation of dialysis was significantly shorter (510±340 vs 530±356 days, p<0.05) compared to women. These results were primarily driven by patients with stage 4 CKD.

**Conclusions:** RWD confirm that CKD prevalence was higher among women while progression to dialysis was only mildly faster among men. Insurance classes, comorbidity scores, anemia and osteodystrophy rates between genders were found to be significantly different.

**Funding:** Commercial Support - ProKidney, LLC

CKD Progression to Dialysis

	Overall		Stage 3b		Stage 4		Stage 5	
	Men n=6,198	Women n=7,974	Men n=4,565	Women n=5,729	Men n=1,521	Women n=2,074	Men n=112	Women n=170
Age on index date; median [IQR]	70 [61, 78]	71 [63, 79]	70 [62, 78]	72 [63, 79]	68 [60, 78]	71 [62, 80]	63 [56, 72]	66 [58, 76]
Dialysis initiation; n (%)	152 (2.5%)	153* (1.9%)	27 (0.6%)	23 (0.4%)	96 (6.3%)	97* (4.7%)	29 (25.9%)	33 (19.4%)
Days to dialysis; mean (SD)	510.0 (340.8)	529.7* (356.4)	567.4 (337.2)	515.4* (417.8)	546.0 (328.1)	588.4* (356.9)	337.3 (342.2)	371.9 (257.4)

\*p < 0.05

FR-PO906

Similar Risk of Kidney Function Decline Between Tenofovir Alafenamide and Besifovir Dipivoxil Maleate in Chronic Hepatitis B

Chan-Young Jung, Hyung Woo Kim, Beom Seok Kim. *Yonsei University College of Medicine, Seoul, Republic of Korea.*

**Background:** Although tenofovir alafenamide (TAF) and besifovir dipivoxil maleate (BSV) are potent antiviral agents in the treatment of chronic hepatitis B (CHB) infection. This study compared the risk of kidney function decline among patients with treatment-naïve CHB treated with TAF or BSV.

**Methods:** This multicenter, retrospective, longitudinal cohort study included 556 patients with treatment-naïve CHB treated with TAF (n = 366) or BSV (n = 190) between November 2017 and August 2021. The primary outcome was chronic kidney disease (CKD) progression, defined as an increase in CKD stage by at least one stage for at least three consecutive months.

**Results:** 1:1 propensity score matching yielded 154 patients in each treatment group. The mean estimated glomerular filtration rate (eGFR) was 100.4 vs. 100.3 mL/min/1.73m<sup>2</sup> in the TAF and BSV groups, respectively. A total of 25 patients developed a progression in

CKD stage  $\geq 1$ , of which 13 and 12 patients were from the TAF and BSV treated groups, respectively (3.1 vs. 3.3 per 1,000 person-years;  $P = 0.751$ ). The unadjusted hazard ratio for risk of progression in CKD stage  $\geq 1$  of the BSV group (vs. the TAF group) was 1.13 (95% confidence interval, 0.50-2.58;  $P = 0.758$ ). This association persisted even after adjusting for potential confounders. Virological, serological, and biochemical responses were also similar between the two treatment groups (all  $P > 0.05$ ).

**Conclusions:** TAF and BSV showed similar risk of kidney function decline in patients with treatment-naïve CHB. Further prospective randomized studies are warranted for validation.

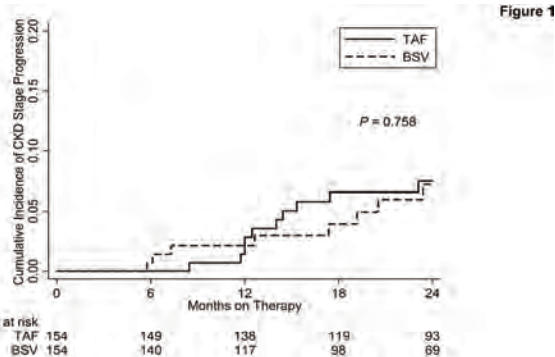

**FR-PO907**

**Associations of Baseline and Longitudinal Uromodulin With ESKD and Mortality: Results From the AASK Trial**

Teresa K. Chen,<sup>1</sup> Michelle M. Estrella,<sup>2</sup> Lawrence J. Appel,<sup>1</sup> Aditya L. Surapaneni,<sup>3</sup> Anna Kottgen,<sup>4</sup> Wassim Obeid,<sup>1</sup> Chirag R. Parikh,<sup>1</sup> Morgan Grams.<sup>3</sup> <sup>1</sup>Johns Hopkins University School of Medicine, Baltimore, MD; <sup>2</sup>University of California San Francisco School of Medicine, San Francisco, CA; <sup>3</sup>NYU Langone Health, New York, NY; <sup>4</sup>Albert-Ludwigs-Universität Freiburg, Freiburg im Breisgau, Germany.

**Background:** Uromodulin (UMOD), the most abundant protein found in the urine of healthy persons, is produced exclusively by the kidney and has emerged as a promising biomarker of tubule health.

**Methods:** We evaluated associations of serum UMOD levels at baseline and change in UMOD over time with subsequent risk of incident ESKD and mortality among African American Study of Kidney Disease and Hypertension (AASK) trial participants. UMOD levels were measured from stored samples from the 0, 12, and 24-month visits. Covariates included baseline age, sex, systolic blood pressure, smoking, GFR, proteinuria, and randomized treatment groups. In secondary analysis, we evaluated whether randomized blood pressure goal or drug were associated with UMOD slopes.

**Results:** Among 500 participants with baseline serum UMOD levels (mean age 54 years; 37% female), 161 ESKD events occurred over a median of 8.5 years. Each 2-fold higher baseline UMOD level was associated with a 26% lower risk of ESKD (HR: 0.74; 95% CI: 0.59, 0.93). For annual UMOD change, each 1 standard deviation (SD) higher change was associated with a 40% lower risk of ESKD (HR: 0.60; 95% CI: 0.50, 0.71). Baseline UMOD and UMOD change were not associated with mortality (Table 1). UMOD levels declined more steeply with intensive vs. standard BP goals (-2.13% per year), whereas ramipril vs. metoprolol was associated with greater increases (3.32% per year).

**Conclusions:** Among African American adults with CKD and hypertension, higher UMOD levels at baseline and greater increases in UMOD over time were associated with lower risk of subsequent ESKD.

**Funding:** NIDDK Support

Table 1: Associations of baseline UMOD and UMOD slope with ESKD in AASK.

Exposure	Model	ESKD	Mortality
		HR (95% CI) Per 2-fold higher	HR (95% CI) Per 2-fold higher
Baseline UMOD n=500	Unadjusted	0.37 (0.30, 0.44)	0.76 (0.61, 0.94)
	+ age, sex, SBP, BMI, smoking	0.39 (0.32, 0.48)	0.71 (0.57, 0.89)
	+ GFR	0.69 (0.55, 0.87)	0.79 (0.61, 1.04)
	+ log <sub>2</sub> (UPCR)	0.72 (0.57, 0.91)	0.79 (0.60, 1.03)
	+ randomized treatment groups	0.74 (0.59, 0.93)	0.81 (0.61, 1.06)
		HR (95% CI) Per 1 SD higher	HR (95% CI) Per 1 SD higher
UMOD slope n=418	Unadjusted	0.49 (0.43, 0.56)	0.90 (0.73, 1.10)
	+ log <sub>2</sub> (biomarker)	0.53 (0.46, 0.61)	0.96 (0.77, 1.20)
	+ age, sex, SBP, BMI, smoking	0.49 (0.42, 0.57)	0.98 (0.79, 1.22)
	+ GFR	0.50 (0.43, 0.58)	0.99 (0.79, 1.24)
	+ log <sub>2</sub> (UPCR)	0.59 (0.50, 0.70)	0.98 (0.78, 1.24)
+ randomized treatment groups	0.60 (0.50, 0.71)	1.00 (0.78, 1.27)	

Abbreviations: SBP=systolic blood pressure, BMI=body mass index, GFR=glomerular filtration rate; UPCR=urine protein-to-creatinine ratio; HR=hazard ratio; CI=confidence interval; SD=standard deviation. All covariates were measured at baseline.

**FR-PO908**

**Computer-Based Renal Sonographic Image Analysis on Renal Progression in Patients With Chronic Glomerulopathies**

Nuntanutch Chanlerdifa, Amnart Chaiprasert, Naowanit Nata, Pamila Tasanavipap, Narittaya Varothai, Paramat Thimachai, Pitchamon Inkong, Wisit Kaewput, Uppatham Supasynhd, Bancha Satirapoj. *Phramongkutklao College of Medicine, Bangkok, Thailand.*

**Background:** Renal sonography is useful diagnostic imaging procedure in chronic glomerulopathies. Quantitative renal echogenicity has not been formerly evaluated regarding its capacity to identify patients at risk for progressive renal disease.

**Methods:** Renal sonography was performed in 79 patients with chronic kidney disease (CKD) including 37 patients with chronic glomerulonephritis (CGN) undergoing renal biopsy and 42 patients with other glomerulopathies. Sonographic images were processed and analysis by computer programs to determine quantitative renal cortical echogenicity. Patients were followed during a three-month period to evaluate renal progression with estimated glomerular filtration rate (GFR).

**Results:** Among 79 patients, 31 (39.24%) patients had renal progression. In patients with CGN undergoing renal biopsy, total renal cortical echogenicity and long axis echogenicity was significantly higher than patients without renal progression. In the multivariable analysis, high renal echogenicity remained significantly associated with increased risk of worsening renal function in CGN patients (HR 1.13, 95%CI 1.01-1.25). Long axis renal echogenicity (AUC 0.71; 95%CI 0.52 to 0.89), combining with other findings (AUC 0.93; 95%CI 0.84 to 1.00) achieved a better score predicting CKD progression in CGN group. Furthermore, renal to liver echogenicity ratio was significantly correlated with interstitial fibrosis and tubular atrophy. Renal/liver echogenicity ratio (AUC 0.83; 95%CI 0.69 to 0.97), combining with other findings (AUC 0.95; 95%CI 0.88 to 1.00) achieved a perfect score predicting IFTA>50% in CGN group.

**Conclusions:** Quantitative renal cortical echogenicity by computer based image analysis might be a useful tool to identify CGN patients with renal progression and related to renal fibrosis.

**FR-PO909**

**Retinal Photograph-Based Deep Learning Predicts CKD Among People With Preserved Kidney Function**

Young Su Joo,<sup>1</sup> Geunyoung Lee,<sup>2</sup> Jung Tak Park.<sup>1</sup> <sup>1</sup>Yonsei University Institute of Kidney Disease, Seodaemun-gu, Seoul, Republic of Korea; <sup>2</sup>Medi Whale, Seoul, Republic of Korea.

**Background:** Predicting kidney disease is challenging, especially in people with preserved kidney function. We developed a novel machine learning based risk scoring system in prediction of future risk of chronic kidney disease (CKD) using retinal photographs and the performance of this risk stratification system was externally validated.

**Methods:** We used 232,779 retinal photographs from three datasets from South Korea, and the UK to train and validate the algorithm. First, using a dataset from a Korean health-screening centre, we trained a deep learning algorithm to predict the probability of the CKD presence (i.e., deep-learning retinal CKD score, RetiCKD). Second, predictability of the RetiCKD was evaluated using Cox hazards models in two separate longitudinal cohorts for future CKD development. Those with eGFR <90 ml/min/1.73m<sup>2</sup> or proteinuria at baseline were excluded. For the UK Biobank cohort, CKD development was defined with ICD-10 and OPCS-4 codes. For the Korean clinical cohort, CKD was defined as  $\geq 2$  occurrence of eGFR <60 ml/min/1.73m<sup>2</sup>.

**Results:** For the 33,814 participants in the UK Biobank cohort, mean age was 54.8 years and 13,670 (44.6%) were males. During a median follow-up of 10.8 years, 879 (1.2%) cases of CKD developed. When the participants were categorized to RetiCKD score tertile, the risk of CKD development increased in the highest tertile than the lowest tertile (Hazard ratio [95% CI], 2.50 [2.03-3.09]). Compared to the eGFR only model, eGFR with RetiCKD model showed superior concordance and reclassification performance ( $\Delta C$ -statistics, 0.052 [95% CI, 0.035-0.069]; net reclassification index [NRI], 0.142 [95% CI, 0.096-0.187]). The Korean clinical cohort consisted of 4,050 diabetes patients. The mean age was 55.9 years and 2,193 (54.1%) were male. CKD occurred in 158 (3.9%) patients during a median follow-up of 6.1 years. CKD development risk was higher in the highest tertile than the lowest tertile (Hazard ratio [95% CI], 4.95 [2.42-10.1]). Predictability improvement was observed in the eGFR with RetiCKD model compared to the eGFR only model ( $\Delta C$ -statistics, 0.039 [95% CI, 0.004-0.075]; NRI, 0.207 [95% CI, 0.049-0.267]).

**Conclusions:** A novel deep-learning and retinal photograph-derived CKD risk score successfully stratified future CKD risk among people with normal kidney function, in both the general population and diabetes patients.

**FR-PO910**

**Correlation Between Fibrosis-4 Index and Renal Dysfunction but Limited Causality**

Makoto Araki. *Sapporo Tokushukai Hospital, Sapporo, Japan.*

**Background:** Metabolic dysfunction-associated fatty liver disease has been increasing, with the high prevalence of renal dysfunction complications suggesting a causal relationship. Therefore, we examined whether the fibrosis-4 index (Fib4 index), a well-known marker of liver fibrosis, had a direct effect on CKD.

**Methods:** This single-institutional observational study screened subjects measured simultaneously for creatinine, aspartate aminotransferase, alanine aminotransferase,



and platelet levels during annual physical examinations between 2012 and 2021. Those younger than 18 years, undergoing dialysis, and having blood test results for only 1 year were excluded. Patients were then divided into high and low Fib4 index groups based on a cutoff of 1.3, as previously reported, and compared in terms of renal function changes. Both groups were evaluated using time-to-event analysis in terms of a 30% and 40% estimated glomerular filtration rate (eGFR) decline.

**Results:** Among the 93,404 individuals initially assessed, 5,906 satisfied the criteria (mean observation period: 1654 days). High Fib4 index levels were correlated with age (4% of patients under 50 years old; 93% of patients over 70 years old). Univariate analysis via the Log-rank test showed that the high Fib4 index group had significantly worse renal function (Figure), although both groups had a mean age difference of 10 years. Therefore, after adjusting for sex, age, and eGFR in the first year, mean observation period, and number of patients with diabetes using propensity score matching, the difference between both groups nearly disappeared although a significant trend remained (Figure). Furthermore, on multivariate Cox regression analysis, significant findings were found for age and presence of diabetes but not the Fib4 index.

**Conclusions:** Although the Fib4 index was correlated with renal dysfunction, no causal relationship surpassed age or the presence of diabetes in our study.

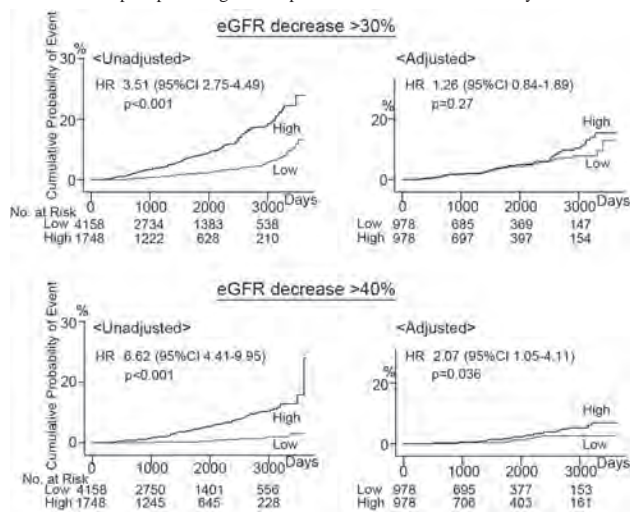

**FR-PO911**

**SGLT2 Inhibitor Reduces eGFR Variability Leading to Improve eGFR Slope in CKD**

Yukihito Nakano, Mika Sakaguchi, Yoshihisa Nakatani, Shuji Arima. *Kinki Daigaku Igakubu Daigakuin Igaku Kenkyuka, Osakasayama, Japan.*

**Background:** SGLT2 inhibitor has been demonstrated to improve cardiovascular, kidney outcomes in participants with diabetic kidney disease (DKD). However, there remains to be elucidated about mechanisms of efficacy of SGLT2 inhibitor. SGLT2 inhibition changes intrarenal hemodynamics by tubuloglomerular feedback(TGF) through glucosuria. We examined the estimated glomerular filtration rate (eGFR) slope and variability before and after SGLT2 inhibitor treatment.

**Methods:** We obtained eGFR values from 77 participants diagnosed DKD who have visited our hospital over two years. To estimate eGFR change after SGLT2 inhibitor treatment reliably, we selected eGFR values at least 3 months after the SGLT2 inhibitor prescription. Using a standard linear regression model for individuals, we stored the slope coefficient, the expected eGFR, and the regression residual, respectively. eGFR variability was calculated as  $(\text{mean sqrt} [\text{residual of eGFR}]^2) / (\text{mean observed eGFR}) \times 100 (\%)$ .

**Results:** Of 77 participants, median age was 68 years (IQR 55 to 73) and 71.4% were male. 25 (32.5%) participants had a history of cardiovascular disease. Median eGFR at SGLT2 inhibitor prescription was 46 ml/min/1.73m<sup>2</sup> (IQR 32 to 67) and median eGFR slope was 0.99 ml/min/1.73m<sup>2</sup> per year (IQR -4.45 to 0.58). eGFR variability was 5.87% (IQR 4.44 to 7.64). The initial dip was observed in about 80% of participants. We divided the participants into responders and non-responders by the difference of eGFR slope before and after SGLT2 inhibitor initiation. Responders significantly had a reduction in eGFR variability than non-responders (-1.16% vs -0.28%, p<0.05). Also, eGFR variability negatively correlated with the degree of changes in eGFR slope (p=0.31, p<0.01).

**Conclusions:** We confirmed that the initial dip is usually observed in CKD. SGLT2 inhibitor is supposed to be optimize the TGF. Our results suggest that SGLT2 inhibitor stabilizes eGFR by reduces eGFR variability through TGF.

**FR-PO912**

**Evaluating Renal Fibrosis Using Diffusion Tensor Imaging (DTI)-MRI**

Shimrit Avraham, Rohan S. Virgincar, Joshua Webster, Hans D. Brightbill, Ben Korin, Andrey S. Shaw, Luke Xie. *Genentech Inc, South San Francisco, CA.*

**Background:** The estimated glomerular filtration rate (eGFR) is the standard method to determine kidney function. However, GFR measurements can differ based on the patient sex, age, ethnicity, background, and measurement variability. MRI can potentially allow renal structure and function to be assessed in real-time and noninvasively.

**Methods:** Here, we used diffusion tensor imaging MRI (DTI-MRI) to reveal details about kidney architecture. We characterized normal mouse kidneys and three chronic kidney disease (CKD) mouse models: TLR-7 enhanced lupus, calcium oxalate, and the nephrotoxic nephritis (NTN) model of glomerular injury, to evaluate disease progression.

**Results:** Using DTI-MRI, we were able to detect changes associated with inflammation and interstitial fibrosis and found that MRI diffusivities can distinguish renal injuries in CKD models. In all of the models, we identified decreased axial diffusivity (AD) and fractional anisotropy (FA) over time correlated with histological increased destruction of glomeruli and fibrosis of the kidney. While the TLR-7 enhanced lupus and the calcium oxalate models develop marked inflammation that can interfere with the DTI-MRI signal, the NTN model, which has separate and time-dependent inflammatory and fibrotic stages, allowed us to follow fibrotic processes from early-stage to severe fibrosis. Interestingly, the most significant changes in DTI-MRI were at the cortical-medullary junction and included decreases in FA, apparent diffusion coefficient (ADC), AD, and radial diffusivity (RD). This finding was supported by Masson's trichrome staining, which revealed that most of the fibrosis was also in this same region. This suggests that fibrosis may be more anatomically focused.

**Conclusions:** Taken together, our results show that DTI-MRI is sensitive to inflammation and fibrosis and has the potential to detect early changes of CKD before significant functional decline, demonstrating the advantages of DTI-MRI over traditional measurements.

**Funding:** Commercial Support - Genentech

**FR-PO913**

**Differentiating Primary and Secondary Focal Segmental Glomerulosclerosis Using Non-Invasive Urine Biomarkers**

Bruce M. Hendry,<sup>1</sup> Justyna Siwy,<sup>2</sup> Harald Mischak,<sup>2</sup> Ralph Wendt,<sup>3</sup> Joachim H. Beige,<sup>3,4</sup> Lorenzo Catanese,<sup>5,6</sup> Michael Wolf,<sup>1</sup> Harald D. Rupprecht.<sup>5,6</sup> <sup>1</sup>Travere Therapeutics Inc, San Diego, CA; <sup>2</sup>Mosaïques-Diagnostics GmbH, Hannover, Germany; <sup>3</sup>St. Georg Hospital Leipzig, Leipzig, Germany; <sup>4</sup>Martin-Luther-University Halle-Wittenberg, Halle an der Saale, Germany; <sup>5</sup>Klinikum Bayreuth GmbH and Kuratorium für Dialysis and Transplantation (KfH) Bayreuth, Bayreuth, Germany; <sup>6</sup>Friedrich-Alexander-University Erlangen-Nürnberg, Medicincampus Oberfranken, Bayreuth, Germany.

**Background:** Focal segmental glomerulosclerosis (FSGS) includes primary (p) and secondary (s) forms. These subclasses differ in management and prognosis, but differentiation is challenging. We aimed to identify specific urine protein/peptides discriminating between pFSGS and sFSGS, and to combine these into a classifier using machine learning.

**Methods:** 56 urine samples were collected at two different centers (17 pFSGS and 39 sFSGS) prior to biopsy. Samples were analyzed using capillary electrophoresis coupled mass spectrometry (CE-MS). Additional CE-MS datasets were extracted from a urinary proteome database to increase specificity. For biomarker definition, data from additional age/sex matched healthy controls (HC, n=98) and patients with other chronic kidney disease (CKD, n=100) were used. Independent specificity assessment was performed in additional data of HC (n=110) and CKD (n=170).

**Results:** Proteomics data from patients with pFSGS were first compared to HC (n=98). This resulted in 1054 biomarker candidates. Then, the pFSGS group was compared to sFSGS. In the third step, to define biomarkers independent of other forms of CKD, data of pFSGS patients were compared to data from different CKD etiologies (n=100). Only biomarker candidates also significant in the second and third statistical comparison were accepted as specific biomarkers for pFSGS. The 95 biomarkers defined were combined in a classifier, FSGS-95. Total cross validation of this classifier resulted in an area under the receiving operating curve (AUC) of 0.94. The specificity investigated in an additional independent set of HC and CKD of other etiologies resulted in 100% for HC and 92.5% for CKD, respectively. The defined biomarkers are mostly fragments of different collagens (54%) decreased in pFSGS. We also observed reduced abundance of polymeric immunoglobulin receptor fragments and increased alpha-1-antitrypsin, transthyretin, and uromodulin peptides.

**Conclusions:** Based on a preliminary review of CE-MS analysis and leveraging machine learning, development of a urine peptide-based classifier that selectively detects pFSGS is feasible; however, analysis of specificity and sensitivity in an independent sample should be completed to support this approach.

**Funding:** Commercial Support - Travere Therapeutics, Inc., San Diego, CA

**FR-PO914**

**Evaluation of the Biomarker Dickkopf 3 in More Than 1100 CKD Patients of a German Single Center Cohort Using Algorithm-Based Data Analysis**

Thomas Weinreich,<sup>1</sup> Eric Seibert,<sup>1</sup> Elias Brohammer,<sup>2</sup> Marcus Rüb,<sup>2</sup> Frank Gehlen,<sup>1</sup> Axel Sikora,<sup>2</sup> Bernd Hohenstein.<sup>1</sup> <sup>1</sup>Nephrological Center Villingen-Schwenningen, Villingen-Schwenningen, Germany; <sup>2</sup>Hahn-Schickard-Gesellschaft für angewandte Forschung eV, Villingen-Schwenningen, Germany.

**Background:** Dickkopf 3 (Dkk3) has been identified as a urinary biomarker and values above 4000 pg/mg creatinine (Cr) were assumed to be linked with the risk of short-term decline of kidney function (J Am Soc Nephrol 29: 2722-2733). However, as of today, there is little experience of DKK3 as a risk marker in everyday clinical practice. We used algorithm-based data analysis to evaluate the potential dependence of DKK3 in a cohort from a large single center in Germany.

**Methods:** DKK3 was measured in all CKD patients (pts) in an outpatient clinic from October 1<sup>st</sup> 2018 till Dec. 31 2019, together with calculated GFR (eGFR) and urinary albumin/creatinine ratio (UACR). Pts with a kidney transplant were excluded. Until the end of follow-up Dec 31<sup>st</sup> 2021 repeated measurements (mm) were performed for all parameters. Data analysis was performed using MD-Explorer (BioArtProducts, Rostock, Germany) and Python with multiple libraries. Linear regression models were applied in Pts for DKK3, eGFR and UACR. Comparison of the models was performed with a two-sided Kolmogorov-Smirnov test.

**Results:** 1206 DKK3 mm were performed in 1103 pts (621 male, age 70yrs, eGFR 29.41 ml/min/1.73qm, UACR 800mg/g). 134 pts died during follow-up. DKK3 mean was 2905 pg/mg Cr (max. 20000, 75% percentile 3800). 121 pts had a DKK3 >4000. At the end of follow-up 7% of pts with DKK3<4000 (initial eGFR 17.6) versus 39.6% of pts with DKK3>4000 (initial eGFR 15.7) underwent dialysis. Compared to eGFR and UACR at baseline, DKK3>4000 performed best to predict eGFR for the next 12 months.

**Conclusions:** DKK3>4000 reflected a higher risk of progression towards ESRD despite similar eGFR levels. IN this cohort of CKD patient, DKK3 >4000 at baseline predicted the eGFR slope better than eGFR or UACR.

## FR-PO915

### Imputation-Powered Whole-Exome Analysis Identifies Rare Coding Variants and Genes Associated With Kidney Function and Disease in the UK Biobank

Maria-Alexandra Katsara,<sup>1</sup> Eva König,<sup>2</sup> Matthias Wuttke.<sup>1</sup> on behalf of all authors <sup>1</sup>Institute of Genetic Epidemiology, Uniklinik Freiburg, Freiburg, Germany; <sup>2</sup>Institute for Biomedicine, Bolzano, Italy.

**Background:** Chronic kidney disease (CKD) is a major public health concern affecting ~10% of the global adult population. Genome-wide association studies on imputed common genotypes have identified variants associated with kidney function and CKD, but cannot comprehensively investigate rare coding variation. We aimed to identify rare pathogenic variants and genes impacting human kidney function and disease.

**Methods:** A genotype imputation approach was applied to whole exome sequencing data of European ancestry participants from the UK Biobank to increase our sample size from 166,891 to 408,511. We used exome-wide association studies (ExWAS) and gene-level Burden tests in order to identify rare variants and genes associated with different kidney phenotypes including eGFR, UACR, urea, urate and clinically diagnosed CKD. We performed a phenotype-wide association study of the resulting genes.

**Results:** We imputed ~7.5 million exonic variants for 241,620 individuals without WES data. In a validation sample, the overall concordance of sequenced and imputed genotypes was >0.98. We identified 158 rare variants and 106 genes significantly associated with kidney function. Among these genes, there were known monogenic kidney disease genes such as *CUBN* and *PKD2*, for which we highlight novel putatively disease-causing mutations. Furthermore, we implicate genes currently not linked to kidney function and disease in humans, such as *FNIP1* and *EPB41L5*. Disruption of *Fnip1* in mice is sufficient for renal cyst formation, and *Epb41l5*-deficient mice are known to develop focal-segmental glomerulosclerosis. Our results not only establish human relevance, but also identify potentially causal variants. Across the phenotype, we identified numerous instances where the assumed loss-of-function of implicated genes resulted in increased disease risk, often reflecting known clinical signs and symptoms. For example, carriers of rare damaging variants in *COL4A3* showed higher odds of hematuria.

**Conclusions:** Our study underscores the value of imputation-powered analysis and reveals both novel and confirms known variants associated with kidney disease. It generates a comprehensive resource to direct future functional and clinical studies. Results will be shared via an interactive website.

## FR-PO916

### Plasma Prolactin and Kidney Outcomes in REGARDS

Alexander L. Bullen,<sup>1,2</sup> Ronit Katz,<sup>3</sup> Mary Cushman,<sup>4</sup> Joachim H. Ix,<sup>1,2</sup> Dena E. Rifkin.<sup>2,1</sup> <sup>1</sup>University of California San Diego, La Jolla, CA; <sup>2</sup>VA San Diego Healthcare System, San Diego, CA; <sup>3</sup>University of Washington, Seattle, WA; <sup>4</sup>University of Vermont, Burlington, VT.

**Background:** Chronic kidney disease is common, costly and it is associated with cardiovascular disease and increased mortality. Early identification of CKD is imperative to prevent progression and potentially reduce cardiovascular morbidity and mortality. Plasma prolactin (ProNT) is a precursor of neurotensin (NT). NT and its related peptides have been linked to risk for disease processes related to kidney disease, including cardiovascular disease, and type 2 diabetes mellitus. It is unknown whether ProNT is directly associated with incident CKD.

**Methods:** Among 3914 participants who were part of BioMedioR, a nested cohort within the Reasons for Geographic and Racial Differences in Stroke (REGARDS) who completed the second visit, we measured ProNT by Sphingotest (double monoclonal sandwich immunoassay). Primary outcomes were significant eGFR decline (defined as 30% decline), incident albuminuria (defined as albumin/creatinine greater or equal to 30 at second visit) and incident CKD (defined as eGFR less than 60 ml/min/1.73m<sup>2</sup> plus 40% decline in eGFR). Logistic regression with inverse probability sampling weights for analysis. Sequential models adjusted for age, sex, and race (Model 1); BMI, SBP, DBP, diabetes, smoking, cholesterol and prevalent CVD (Model 2); and baseline eGFR and albuminuria (Model 3). Using model 3, we tested for interaction ProNT and race and explored analyses by race. We used similar models to evaluate for incident albuminuria, excluding albuminuria in model 3.

**Results:** Higher ProNT levels were associated with greater eGFR decline among all participants independent of baseline eGFR and albuminuria (OR: 1.12, 95% CI [1.00,

1.26]) and incident albuminuria (OR: 1.31, 95% CI 1.14,1.50). Higher ProNT levels were also associated with greater incidence of CKD; however, this association was attenuated after including baseline eGFR and albuminuria (OR: 1.25, 95% CI 0.98, 1.59). We did not find any interactions between ProNT and race or sex in any of the three outcomes.

**Conclusions:** Assessment of ProNT provides information about significant eGFR decline and incident albuminuria but not incident CKD among persons at high risk of hypertension and diabetes, known risk factors of incidence and progression of CKD. These associations were independent of race or sex. Further studies should evaluate if ProNT can help tailor treatments to slow progression of CKD in a high-risk population.

**Funding:** Veterans Affairs Support

## FR-PO917

### Quantification of DNA-Methylation at Loci Associated With Metals, Pesticides, and Temperature Provide No Evidence for a Role of These Exposures in the Aetiology of Mesoamerican Nephropathy

Amin Oomatia,<sup>1</sup> Ali M. Al-Rashed,<sup>1</sup> Marvin A. Gonzalez,<sup>2</sup> Andres Cardenas,<sup>3</sup> Neil Pearce,<sup>4</sup> Simone Ecker,<sup>5</sup> Stephan Beck,<sup>5</sup> Brianna Heggeseth,<sup>6</sup> Olga Chervova,<sup>5</sup> Ben Caplin.<sup>1</sup> The Colt/UK MRC CKDu study group <sup>1</sup>University College London Department of Renal Medicine, London, United Kingdom; <sup>2</sup>Research Centre on Health, Work and Environment at National Autonomous University of Nicaragua, Leon, Nicaragua; <sup>3</sup>School of Public Health, University of Berkeley, Berkley, CA; <sup>4</sup>London School of Hygiene and Tropical Medicine Faculty of Epidemiology and Population Health, London, United Kingdom; <sup>5</sup>University College London Cancer Institute, London, United Kingdom; <sup>6</sup>Macalester College, Saint Paul, MN.

**Background:** Mesoamerican nephropathy (MeN) is a leading cause of death amongst working age men in Central America, yet its aetiology remains unclear. Several potential environmental causes have been proposed including heat-stress, pesticides and heavy metals, but intermittent and cumulative exposures are difficult to capture using biomonitoring. Epigenetic studies have identified DNA-methylation (DNAm) at specific loci associated with these exposures. Therefore, we first conducted an epigenome-wide association study (EWAS) focusing on incident cases. Then, using a hypothesis driven approach, explored the association between DNAm at loci previously associated with implicated exposures and MeN.

**Methods:** MeN cases from a population-based longitudinal study were empirically derived using a hidden Markov model based on departure from a healthy population eGFR distribution. Our data consisted of 2-3 blood samples collected across a 5-year period from each of 57 incident-cases (pre- and post-evidence of disease onset), 57 matched-controls and 16 established cases. DNAm was quantified (Illumina MethylationEPIC BeadChip) in a total of 320 blood-samples. Raw data were processed using established pipelines. Associations between differentially methylated positions (DMPs) and MeN were examined using covariate-adjusted mixed-effect models, allowing for repeat measures. DMPs previously reported to associate with ambient temperature, arsenic, cadmium, chromium and pesticides, were collated from a systematic search, and potential association of MeN with these loci was investigated.

**Results:** The EWAS demonstrated no DMPs associated with MeN at standard epigenome-wide statistical thresholds. Furthermore, hypothesis driven analyses examining the coefficients of DMPs reported to be associated with ambient temperature, pesticides and metals, demonstrated no associations with MeN. Further calculations suggested adequate power to detect biologically important differences.

**Conclusions:** DNAm studies in our dataset do not support the hypotheses that pesticides, temperature or the examined metals have a causal role in early-stage MeN. Therefore, other aetiological factors should be considered.

**Funding:** Private Foundation Support, Government Support - Non-U.S.

## FR-PO918

### Serum Metabolomic Markers of Protein Intake and Incident CKD Risk

Lauren Bernard,<sup>1,2</sup> Jingsha Chen,<sup>1</sup> Hyunju Kim,<sup>1</sup> Kari E. Wong,<sup>9</sup> Lyn M. Steffen,<sup>5</sup> Bing Yu,<sup>3</sup> Eric Boerwinkle,<sup>3,4</sup> Eugene P. Rhee,<sup>8,7</sup> Andrew S. Levey,<sup>6</sup> Morgan Grams,<sup>2,1</sup> Casey Rebholz.<sup>1,2</sup> <sup>1</sup>Johns Hopkins University Bloomberg School of Public Health, Baltimore, MD; <sup>2</sup>Johns Hopkins University School of Medicine, Baltimore, MD; <sup>3</sup>The University of Texas Health Science Center at Houston, Houston, TX; <sup>4</sup>Baylor College of Medicine Human Genome Sequencing Center, Houston, TX; <sup>5</sup>University of Minnesota School of Public Health, Minneapolis, MN; <sup>6</sup>Tufts University School of Medicine, Boston, MA; <sup>7</sup>Harvard Medical School, Boston, MA; <sup>8</sup>Massachusetts General Hospital, Boston, MA; <sup>9</sup>Metabolon Inc, Research Triangle Park, NC.

**Background:** Untargeted metabolomics is a promising approach for capturing dietary intake with less bias than traditional methods of dietary assessment. An important application of this technique is the identification of biomarkers of specific dietary protein sources, which may explain the diet-chronic kidney disease (CKD) relationship.

**Methods:** We analyzed dietary data collected from an interviewer-administered questionnaire and 359 serum metabolites at visit 1 (1987-1989) in the Atherosclerosis Risk in Communities (ARIC) study (n=3,724). Multivariable linear regression models were used to estimate cross-sectional associations between specific sources of protein (red and processed meat, nuts, legumes) previously associated with CKD risk in the ARIC study and serum metabolites. For metabolites that were significantly associated with these dietary protein sources, we assessed their prospective associations with incident CKD

Key: TH - Thursday; FR - Friday; SA - Saturday; OR - Oral; PO - Poster; PUB - Publication Only

Underline represents presenting author.

using Cox regression models. Bonferroni correction was used to account for multiple comparisons in the cross-sectional analysis. *A priori*, we expected metabolites positively associated with red and processed meat to be associated with higher risk of CKD and metabolites positively associated with nuts or legumes to be inversely associated with CKD.

**Results:** There were 31 significant protein-metabolite associations. Six metabolites were representative of red and processed meat consumption. Five metabolites were associated with nut intake, including 4-vinylphenol sulfate and tryptophan betaine, and no metabolites were associated with legume intake. Higher levels of two metabolites (glucose, 10-nonadecenoate) were associated with higher intake of red and processed meat and higher risk of incident CKD (Table). Higher levels of catechol sulfate were positively associated with nut intake and higher risk of incident CKD.

**Conclusions:** We identified candidate biomarkers of specific dietary protein sources. Glucose and 10-nonadecenoate may serve as metabolomic markers of the red and processed meat-CKD association.

**Funding:** NIDDK Support, Other NIH Support - R03 DK128386

Table. Potential Metabolomic Markers of Dietary Protein Intake-CKD Association

Metabolite	Protein Source	Cross-Sectional Analysis with Dietary Protein <sup>a</sup>		Prospective Analysis with CKD (N=3724; incident CKD-1411) <sup>b,c</sup>	
		$\beta$ (SE)	P value	HR (95% CI)	P value
catechol sulfate	Nuts	0.20 (0.04)	$1.41 \times 10^{-3}$	1.10 (1.01-1.20)	0.02
glucose	Red and Processed Meat	0.02 (0.01)	$1.93 \times 10^{-2}$	1.69 (1.31-2.18)	$5.98 \times 10^{-1}$
10-nonadecenoate (19:1n9)	Red and Processed Meat	0.05 (0.01)	$2.10 \times 10^{-3}$	1.17 (1.02-1.34)	0.02

<sup>a</sup>Linear regression models adjusted for age, sex, race, study center, body mass index, total energy intake, estimated glomerular filtration rate (eGFR) based on creatinine, smoking status, physical activity, education, alcohol consumption, total fruit intake, total vegetable intake, dairy intake, whole grains intake, and refined grains intake.

<sup>b</sup>Cox regression models further adjusted for hypertension, coronary heart disease, and diabetes.

<sup>c</sup>Incident CKD was defined as meeting at least one of these criteria: 2021 eGFR <60 with a 25% eGFR decline at any subsequent study visit relative to baseline, ICD-9/10 hospitalization codes related to CKD stage 3+, ICD 9/10 mortality codes related to CKD stage 3+, or end-stage kidney disease in the US Renal Data System (USRDS) registry. Abbreviations: CI, confidence interval; CKD, chronic kidney disease; HR, hazard ratio; SE, standard error.

FR-PO919

**Ultrasongraphic Assessment of Normal Kidney Size in Malawi**  
 Laura Carey,<sup>1,3</sup> Sylvester Kaimba,<sup>3</sup> Karen Chetcuti,<sup>2,4</sup> Elizabeth Joekes,<sup>1,4</sup> Benno Kreuels,<sup>5</sup> Marc Y. Henrion,<sup>1,3</sup> Jamie Rylance.<sup>1,3</sup> <sup>1</sup>Liverpool School of Tropical Medicine, Liverpool, United Kingdom; <sup>2</sup>University of Malawi College of Medicine, Blantyre, Malawi; <sup>3</sup>Malawi Liverpool Wellcome Trust, Blantyre, Malawi; <sup>4</sup>Worldwide Radiology, Liverpool, United Kingdom; <sup>5</sup>Bernhard-Nocht-Institut für Tropenmedizin, Hamburg, Germany.

**Background:** Sonographic assessment of kidney size is needed to make diagnostic and therapeutic decisions. However, there is a paucity of normative data from sub-Saharan Africa (SSA). We determined estimates of kidney size based on age, sex, and HIV status, among apparently healthy outpatient attendees of Queen Elizabeth Central Hospital radiology department, Blantyre, Malawi.

**Methods:** We performed a cross-sectional study of 320 adults attending the radiology department between October 2021 and January 2022. The sample was stratified by age, sex, and HIV status. Bilateral renal ultrasound was performed using a Mindray DP-50 machine and a 5MHz convex probe. Participants with kidney disease, hypertension, diabetes, BMI >35, heavy alcohol intake, smoking and ultrasonographic abnormalities were excluded. Predictive linear modelling was used to construct reference ranges for kidney size.

**Results:** There were 162/320 (51%) male participants. The median age was 47 (IQR 34-59), 138/320 (43%) were living with HIV, 134/138 (97%) were receiving antiretroviral therapy. The mean (± SD) size of the right kidney was 9.61 cm (0.93) in males and 9.38 cm (0.98) in females, and 9.76 cm (0.90) and 9.54 cm (0.97) for the left kidney in males and females respectively.

**Conclusions:** For the first time in Malawi, we provide estimates of normal kidney size using ultrasound, and a population specific reference for assessment of kidney disease.

**Funding:** Government Support - Non-U.S.

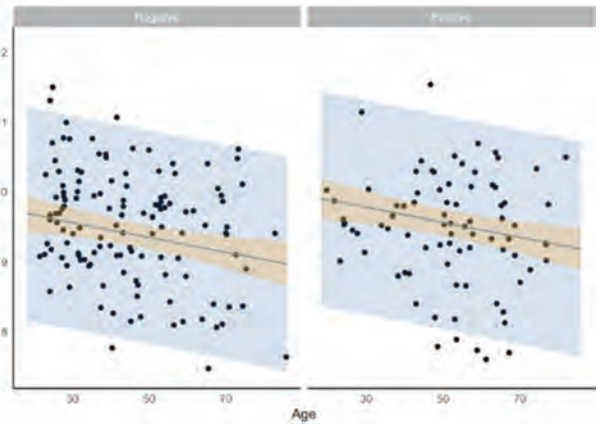
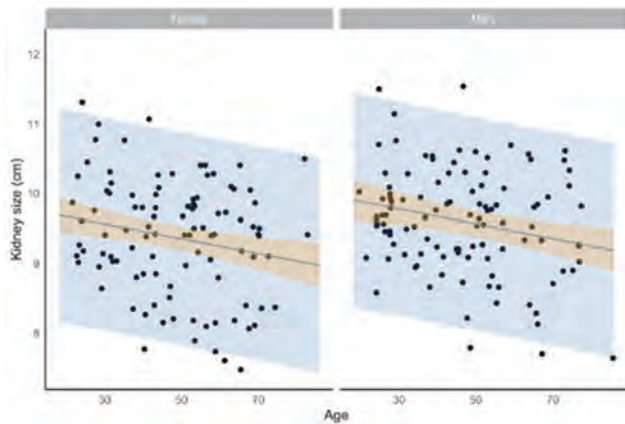

Predicted ranges (blue) and 95% confidence intervals (orange) of kidney size dependent on a.) sex b.) HIV status

FR-PO920

**Urinary Epidermal Growth Factor Is a Distal Tubule Marker for Kidney Health in the General Population**

Frank Geurts,<sup>1</sup> Anna C. van der Burgh,<sup>1</sup> Robert A. Fenton,<sup>2</sup> Layal Chaker,<sup>1</sup> Ewout J. Hoorn.<sup>1</sup> <sup>1</sup>Erasmus MC, Rotterdam, Netherlands; <sup>2</sup>Aarhus Universitet, Aarhus, Denmark.

**Background:** Kidney health is usually assessed by glomerular rather than tubular markers. In the kidney EGF is exclusively expressed in the distal tubule. In patients with chronic kidney disease (CKD) urinary epidermal growth factor (uEGF) correlates with interstitial fibrosis and tubular atrophy and predicts kidney failure. Here, we hypothesize that uEGF is a distal tubule marker of kidney health in the general population.

**Methods:** To assess uEGF as tubular marker, it was initially measured before and three months after kidney donation (n = 19). Tubule segment-specific proteins were also quantified in urinary extracellular vesicles (uEV) using immunoblot. Next, uEGF was measured in the Rotterdam Study (n = 2382), a population-based cohort with long-term follow-up (median 13.0 years). The association between uEGF excretion and estimated glomerular filtration rate (eGFR, median of 7 eGFRs available) was assessed using multivariable linear regression. Furthermore, multivariable Cox regression analysis was used to analyze kidney outcomes (eGFR < 60 or 45 ml/min/1.73m<sup>2</sup>, 40% loss of eGFR). eGFR, albumin creatinine ratio (ACR), age, sex, body mass index, hypertension, diabetes, smoking status, history of cardiovascular disease and total cholesterol were used as covariates. uEGF was measured in 24 h urine (kidney donors) or spot urines (general population, normalized to creatinine, uEGF/cr).

**Results:** Kidney donation decreased eGFR from 91 to 58 ml/min/1.73m<sup>2</sup> (36% reduction, 95%CI 31-42%), while uEGF excretion reduced from 28 to 14 µg/day (51% reduction, 95%CI 46-58%). In uEVs, proximal tubule markers increased while distal tubule proteins remained unchanged. In the population-based cohort, uEGF/cr correlated with baseline eGFR (β 0.02, 95%CI 0.02-0.03) and ACR (β -0.09, 95%CI -0.15- -0.03). uEGF/cr was inversely associated with incident eGFR < 60 ml/min/1.73m<sup>2</sup> (HR 0.85, 95%CI 0.76-0.95). Similar results were obtained using an outcome of two consecutive eGFR measurements < 60 ml/min/1.73m<sup>2</sup> (HR 0.81, 95%CI 0.69-0.94), eGFR < 45 ml/min/1.73m<sup>2</sup> (HR 0.84, 95%CI 0.69-1.02) and 40% loss of eGFR (HR 0.83, 95%CI 0.7-0.98).

**Conclusions:** Urinary EGF is a distal tubule marker that is not affected by glomerular hyperfiltration and proximal tubule hypertrophy. In the general population, uEGF/cr is associated with incident CKD independent of eGFR and ACR.

FR-PO921

**Urine Creatinine Excretion and Mortality in CKD: From the KNOW-CKD Study**

Jihyun Yang,<sup>1</sup> Sang-Eun Kim,<sup>1</sup> Kyu-Beck Lee,<sup>1</sup> Hyang Kim,<sup>1</sup> Kook-Hwan Oh,<sup>2</sup> Young Youl Hyun.<sup>1</sup> KNOW-CKD Investigators <sup>1</sup>Kangbuk Samsung Hospital, Sungkyunkwan University School of Medicine, Seoul, Republic of Korea; <sup>2</sup>Seoul National University College of Medicine, Seoul, Republic of Korea.

**Background:** Previous studies have shown that low muscle strength or function is a risk factor for poor prognosis in chronic kidney disease (CKD). However, the prognosis associated with low muscle mass is uncertain. 24-hour urine creatinine excretion is surrogate marker of muscle mass. The aim of this study is to investigate the relationship between urine creatinine excretion and mortality in predialysis CKD patients.

**Methods:** We analyzed 1,620 patients from the Korean Cohort Study for Outcome in Patients with CKD (KNOW-CKD). Participants were divided into four groups according to their sex-specific quartiles of baseline 24-hr urinary creatinine excretion (UCr). The study end point was all-cause death.

**Results:** During a follow-up of 10,519 person-years (median 7.0 years), 123 patients (7.6%) died, with a corresponding death rate of 11.7 (95% CI 9.8-14.0) per 1,000 patients-years. 65 (16.4%), 28 (6.8%), 21 (5.3%) and 9 (2.2%) patients from each 1st

to 4th quartile group of sex-specific UCR died. In multivariate Cox proportional hazard analysis, there was a graded association of UCR with all-cause mortality. The adjusted hazard ratios (95% CI) of 2nd to 4th quartile were 0.51 (0.32-0.82), 0.48 (0.28-0.82) and 0.25 (0.12-0.53) compared with the 1st quartile.

**Conclusions:** Higher creatinine excretion is associated with lower risk of mortality in predialysis CKD patients. This association was independent of various conventional and CKD-related risk factors.

**Funding:** Government Support - Non-U.S.

The association between urine creatinine excretion and mortality

Creatinine excretion quartile	Model 1		Model 2		Model 3	
	Hazard ratio (95% CI)	P value	Hazard ratio (95% CI)	P value	Hazard ratio (95% CI)	P value
1	reference		reference		reference	
2	0.59 (0.25-0.61)	<0.001	0.49 (0.31-0.78)	0.002	0.51 (0.32-0.82)	0.005
3	0.28 (0.17-0.47)	<0.001	0.43 (0.26-0.72)	0.001	0.48 (0.28-0.82)	0.007
4	0.11 (0.06-0.22)	<0.001	0.23 (0.11-0.47)	<0.001	0.25 (0.12-0.53)	<0.001
P for trend	<0.001		<0.001		<0.001	

Model 1: unadjusted

Model 2: adjusted for age, sex, economic status, education level, body mass index, systolic blood pressure, diabetes, cardiovascular disease, angiotensin-converting enzyme inhibitors or angiotensin receptor blocker and statin

Model 3: model 2 + estimated glomerular filtration rate, low-density lipoprotein cholesterol, random urine protein to creatinine ratio, hemoglobin, albumin, C-reactive protein, phosphorus, calcium, parathyroid hormone, smoking, alcohol intake and physical activity

**FR-PO922**

**Causal Effects of Kidney Function on Various Biochemical Parameters: A Mendelian Randomization Study**

Sehoon Park, Yong Chul Kim, Seung Seok Han, Hajeong Lee, Kwon Wook Joo, Yon Su Kim, Dong Ki Kim. *Seoul National University Hospital, Jongno-gu, Seoul, Republic of Korea.*

**Background:** The causal effects of the estimated glomerular filtration rate (eGFR) on various biochemical parameters should be further investigated. Mendelian randomization (MR) provides opportunity to investigate causal estimates minimally affected from confounding effects or reverse causation.

**Methods:** In this MR study, genetic instruments for eGFR were developed from the CKDGen data from subjects of European ancestry (N=567,460). Two-sample MR analysis was performed on 60 biochemical parameters measured in 337,138 white UK Biobank participants of British ancestry. Both the inverse variance-weighted method and pleiotropy-robust MR sensitivity analyses were performed. Additional nonlinear MR analysis was performed to investigate the shapes of the causal estimates according to eGFR values.

**Results:** A higher genetically predicted eGFR was significantly associated with higher lymphocyte percentage, HDL cholesterol, and alanine aminotransferase. The causal estimates indicated that a higher genetically predicted eGFR was associated with a lower urea, urate, insulin growth factor-1, and triglycerides levels. The parameters with significant but non-linear causal estimates were hemoglobin concentration, calcium, vitamin D, and urine creatinine values, identified by non-linear MR.

**Conclusions:** In conclusion, eGFR levels may causally related to various biochemical parameters with diverse patterns.

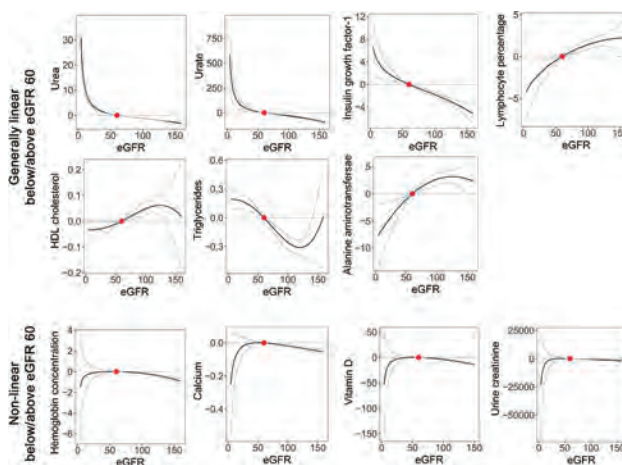
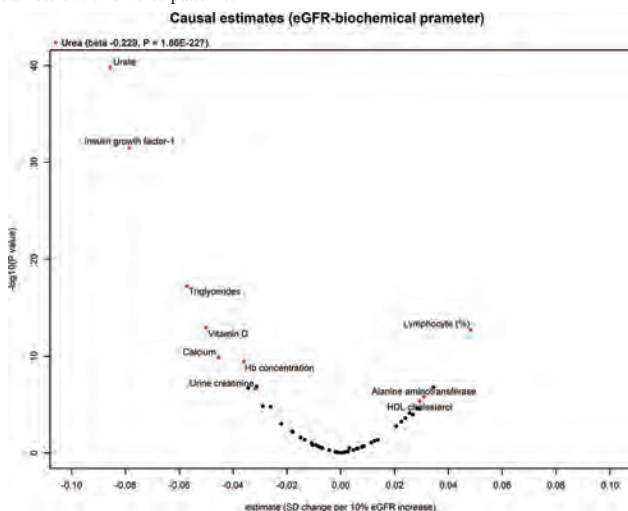

**FR-PO923**

**Clinical Characteristics Associated With Higher Mayo Clinic Chronicity Score**

Dries Deleersnijder,<sup>1,2</sup> Evert J. Cleenders,<sup>1</sup> Wim Laurens,<sup>3,4</sup> Amélie Dendooven,<sup>5,6</sup> Johan M. De Meester,<sup>3</sup> Ben Sprangers,<sup>1,2</sup> FCGG collaborative group <sup>1</sup>Katholieke Universiteit Leuven, Leuven, Belgium; <sup>2</sup>Katholieke Universiteit Leuven Universitaire Ziekenhuizen Leuven, Leuven, Belgium; <sup>3</sup>AZ Nikolaas, Sint-Niklaas, Belgium; <sup>4</sup>Universiteit Gent, Ghent, Belgium; <sup>5</sup>Universitair Ziekenhuis Gent, Ghent, Belgium; <sup>6</sup>Universiteit Antwerpen, Wilrijk, Belgium.

**Background:** The Mayo Clinic Chronicity Score (MCCS) is a standardized scoring system to uniformly grade chronic changes in kidney biopsies. The Flemish Collaborative Glomerulonephritis Group (FCGG) registry is the first multicenter native kidney biopsy registry in Europe to systematically collect MCCS in all included biopsies.

**Methods:** From 2018-2019, MCCS was available for 890 included adult biopsies (each containing ≥10 glomeruli). The association between MCCS and sex, age, kidney injury, proteinuria and nephrological diagnosis was determined using a multiple linear regression model. A linear mixed-effect model showed no significant confounding pathologist-effect.

**Results:** Sex was not associated with significant changes in MCCS (Table 1). Increasing patient age was associated with only mild increase in MCCS. When compared to patients with normal kidney function, chronic kidney disease (CKD) was associated with a large MCCS increase (2.596, 95% CI [2.079, 3.112], P<0.001). Nephrotic-range proteinuria was associated with a smaller MCCS increase (0.982 (95% CI [0.520, 1.444], P<0.001), likely because it may reflect both disease activity and chronicity. When compared to IgA nephropathy, diagnoses of FSGS, nephrosclerosis, diabetic kidney disease and hyperoxaluria/hypercalcemic nephropathy were all associated with significantly higher MCCS.

**Conclusions:** CKD and diagnoses of FSGS, nephrosclerosis, diabetic kidney disease and hyperoxaluria/hypercalcemic nephropathy were associated with highest degrees of chronicity in native kidney biopsies in Flanders, Belgium.

**Table 1: Multiple linear regression analysis of clinical characteristics and MCCS**

Variables	β	95% CI	P-value
Sex category			
Female (reference)			
Male	0.100	[-0.242, 0.442]	0.567
Age (decades)	0.257	[0.147, 0.366]	<0.001
Kidney injury			
No kidney injury (reference)			
Acute kidney injury	1.624	[1.139, 2.109]	<0.001
Chronic kidney disease	2.596	[2.079, 3.112]	<0.001
Proteinuria (g/g or g/24h)			
< 1.0 (reference)			
≥ 1.0 and < 3.5	0.414	[-0.016, 0.844]	0.059
≥ 3.5	0.962	[0.520, 1.444]	<0.001
Final nephrological diagnosis <sup>a</sup>			
IgA nephropathy/IgA vasculitis (reference)			
Congenital/hereditary syndromes <sup>b</sup>	4.034	[0.611, 7.457]	0.021
Crystal/cylinder deposition <sup>c</sup>	2.318	[0.657, 3.979]	0.006
Diabetic kidney disease	1.839	[1.111, 2.568]	<0.001
Focal segmental glomerulosclerosis	0.736	[0.075, 1.397]	0.029
infection-related immune-complex GN	-1.931	[-3.444, -0.417]	0.012
Lupus nephritis	-1.212	[-2.059, -0.365]	0.005
Minimal change disease	-1.872	[-2.771, -0.973]	<0.001
Medication-induced nephropathy <sup>d</sup>	-1.390	[-2.749, -0.031]	0.045
Membranous nephropathy	-1.419	[-2.257, -0.580]	0.001
Nephrosclerosis	1.680	[0.861, 2.499]	<0.001
Nephrotic syndrome, no histology	-2.936	[-5.383, -0.489]	0.019
Tubulointerstitial nephritis	-1.061	[-1.761, -0.360]	0.003

The β indicates the change in estimated MCCS, P-values < 0.05 considered significant (bold).

<sup>a</sup>: only diagnoses with a significant result for β shown; <sup>b</sup>: Fabry disease and tuberous sclerosis; <sup>c</sup>: enteric hyperoxaluria and hypercalcemic nephropathy; <sup>d</sup>: non-specific nephrototoxicity and nephropathy due to analgesic drugs, lithium or tacrolimus.

FR-PO924

**Estimating Underdetection of CKD in Real-World Health Systems**

Chi D. Chu,<sup>1</sup> Fang Xia,<sup>2</sup> Yuxian Du,<sup>2</sup> Delphine S. Tuot,<sup>1</sup> Michael Shlipak,<sup>1</sup> Julio Lamprea,<sup>1</sup> Rakesh Singh,<sup>2</sup> Ralph Gualtieri,<sup>2</sup> Sheldon X. Kong,<sup>2</sup> Todd E. Williamson,<sup>2</sup> Michelle M. Estrella.<sup>1</sup> <sup>1</sup>University of California San Francisco, San Francisco, CA; <sup>2</sup>Bayer Corporation, Whippany, NJ.

**Background:** Albuminuria testing is widely underused in persons at risk for CKD but is crucial to guide implementation of evidence-based treatments to prevent CKD progression and reduce cardiovascular morbidity. We aimed to estimate the extent of albuminuria underdetection due to lack of testing in a large real world US cohort of patients with hypertension or diabetes.

**Methods:** We used National Health and Nutrition Examination Survey (NHANES) 2007-2018 data and the Optum EHR 5PCT Database, which includes EHR data from diverse US healthcare organizations. We included persons aged ≥18 years with hypertension, diabetes, or both. Using NHANES, we developed a logistic regression model to predict albuminuria (urine albumin/creatinine ratio ≥30 mg/g) using age, sex, race-ethnicity, systolic blood pressure, diabetes, heart failure, coronary artery disease, and eGFR. Our Optum EHR study population included patients with ≥2 outpatient visits from January 1, 2017 to December 31, 2018. Among those who did not have albuminuria testing during this period, we applied the prediction model from NHANES to estimate the prevalence of albuminuria.

**Results:** The albuminuria prediction model had c-statistics of 0.73 for NHANES and 0.68 when applied to the subset of Optum patients with albuminuria testing. The Optum study population included 192,108 patients (mean age 60±15 years; 26% with diabetes; mean eGFR 84±21 mL/min/1.73m<sup>2</sup>). 18% had albuminuria testing (n=33,629), of whom 34% had albuminuria (n=11,525), representing 6.0% of the total study population. Among patients who had not been tested (n=158,479), the predicted prevalence of albuminuria was 15% (n=23,369). Thus, the projected proportion of patients with albuminuria who had been detected was only 11,525/34,894 (33%). In the top quintile of predicted risk, only 37% had been tested (14,033/38,421).

**Conclusions:** In a real-world patient population with hypertension or diabetes, we estimated that approximately 2/3 of patients with albuminuria are undetected due to lack of testing. Improving detection of CKD represents a significant missed opportunity to optimize care delivery for reducing CKD progression and its cardiovascular complications.

**Funding:** Commercial Support - Bayer Inc

FR-PO925

**Height Loss Is Associated With Decreased Kidney Function: The Japan Specific Health Checkups (J-SHC) Study**

Takaaki Kosugi,<sup>1</sup> Masahiro Eriguchi,<sup>1</sup> Hisako Yoshida,<sup>2</sup> Hikari Tasaki,<sup>1</sup> Masatoshi Nishimoto,<sup>1</sup> Masaru Matsui,<sup>1</sup> Ken-ichi Samejima,<sup>1</sup> Kunitoshi Iseki,<sup>3</sup> Shouichi Fujimoto,<sup>3</sup> Tsuneo Konta,<sup>3</sup> Toshiki Moriyama,<sup>3</sup> Kunihiro Yamagata,<sup>3</sup> Ichiei Narita,<sup>3</sup> Masato Kasahara,<sup>3</sup> Yugo Shibagaki,<sup>3</sup> Masahide Kondo,<sup>3</sup> Koichi Asahi,<sup>3</sup> Tsuyoshi Watanabe,<sup>3</sup> Kazuhiko Tsuruya.<sup>1,3</sup> <sup>1</sup>Department of Nephrology, Nara Medical University, Kashihara, Japan; <sup>2</sup>Department of Medical Statistics, Osaka Metropolitan University Graduate School of Medicine, Osaka, Japan; <sup>3</sup>Steering Committee of The Japan Specific Health Checkups (J-SHC) Study, Fukushima, Japan.

**Background:** Height loss that occurs with aging is a common phenomenon associated with musculoskeletal abnormalities, such as osteoporosis and sarcopenia. Notably, such height loss is also associated with cardiovascular disease and mortality. However, the relationship between height loss and kidney outcome remains unclear.

**Methods:** This is a longitudinal study based on data from the J-SHC Study from 2008 to 2014. The first three visits (visits 1-3) were used to estimate height loss, and kidney outcomes were evaluated using data from visit 3 to the last visit. Of 933,488 participants, we excluded participants based on the following criteria: 1) ≤4 visits during the study period, 2) less than three measurements of height during visits 1-3, 3) missing serum creatinine at baseline (visit 3), 4) a height below or above 3 standard deviations, 5) a baseline serum creatinine level of ≥8 mg/dL or <0.3 mg/dL. The annual height change (cm/year) for each participant was estimated using mixed-effects model, and participants were divided into five groups according to the quintile of the rate (Q1 to Q5). The association between height change and the incidence of 1.5-fold increase in serum creatinine level from baseline was analyzed using Cox regression analysis. The decline rates of eGFR (mL/min/1.73 m<sup>2</sup>/year) among the groups were compared using a linear mixed-effects model.

**Results:** The median rate of height change was -0.11 cm/year. During the median follow-up period of 26 months, 1,941 of 187,682 participants developed a 1.5-fold increase in serum creatinine levels. The adjusted hazard ratio (95% confidence interval) in participants with the steepest category of height loss (Q1) was 1.45 (1.26-1.67) compared with the reference (Q4). The decline rate of eGFR in Q1 (-1.25 mL/min/1.73 m<sup>2</sup>/year) was significantly higher than that of Q4 (-0.92 mL/min/1.73 m<sup>2</sup>/year) (p for interaction <0.001).

**Conclusions:** Height loss is associated with a rapid decline in kidney function.

**Funding:** Government Support - Non-U.S.

FR-PO926

**Five-Year Risk of ESKD in the US Population: Implications for Kidney Care Referral**

Maria Clarissa Tio,<sup>1</sup> Rajesh Talluri,<sup>1</sup> Aliba Syed,<sup>2</sup> Elani Streja,<sup>2</sup> Sriram Sriperumbuduri,<sup>1</sup> Yoshitsugu Obi,<sup>1</sup> Michael Hall,<sup>1</sup> Kamyar Kalantar-Zadeh,<sup>2</sup> Tariq Shafi.<sup>1</sup> <sup>1</sup>University of Mississippi Medical Center, Jackson, MS; <sup>2</sup>University of California Irvine, Irvine, CA.

**Background:** CKD definition and stratification are based on eGFR and albuminuria as both relate to the risk of ESKD. Unlike eGFR, the Kidney Failure Risk Equation (KFRE) was specifically developed to predict the risk of ESKD. However, the distribution of this risk in the US population is unknown.

**Methods:** We used data from the 2017-2020 National Health and Nutrition Examination Survey (NHANES; N=8,016), to calculate the 5-year ESKD risk using the 8-variable KFRE among adults with CKD (either an ACR >30mg/g or eGFR [CKD-EPI 2021] <60mL/min/1.73m<sup>2</sup>). We categorized the 5-year ESKD risk as <1%, 1-4.9%, 5-9.9%, and ≥10% and compared its distribution across CKD stages. We also calculated the US population eligible for nephrology evaluation using two of the UK National Institute for Health and Care Excellence (NICE) 2021 criteria (ESKD risk ≥5% or ACR ≥600 mg/g).

**Results:** The prevalence of CKD was 14% in the US. The mean age of US CKD population was 60 years and 57% were female. Of the 31.1 million US adults classified as CKD, 25 million (81%) had a <1% risk (Table 1); 2 million (7%) had a ≥5% risk of ESKD in 5 years. In CKD stage G3A with ACR <30 mg/g, the median [interquartile range] 5-year ESKD risk was 0.5% [0.36%-0.75%] and none had a risk of >5%. Using the NICE criteria, 3.2 million (10.4%) of those with CKD warrant referral for nephrology care.

**Conclusions:** Calculation of 5-year ESKD risk can help identify and prioritize patients that need nephrology care. The 5-year ESKD risk should be incorporated in the definition, categorization, and Nephrology referral recommendations for CKD.

**Funding:** Other NIH Support - NIGMS

**Table 1: Distribution of 5-Year ESKD Risks Across Increasing Stages of CKD**

CKD Stage	N (Weighted US Population)	5-Year ESKD Risk in the US Population			
		<1%	1% to <5%	5% to <10%	≥10%
G1	12.8 million	12.8 million (100.0%)			
G2	6.0 million	5.8 million (96.6%)	203,131 (3.4%)		
G3A	8.9 million	6.7 million (75.3%)	2.1 million (23.5%)	79,739 (0.9%)	17,220 (0.2%)
G3B	2.5 million	81,060 (3.3%)	1.6 million (63.7%)	542,856 (22.1%)	270,200 (11.0%)
G4	731,644		2,927 (0.4%)	69,506 (9.5%)	659,211 (90.1%)
G5	294,112				294,112 (100.0%)

FR-PO927

**Seven-Year Follow-Up in a Population at Risk of Mesoamerican Nephropathy: Associations With Early Evidence of Kidney Injury and Incident CKD**

Marvin A. Gonzalez,<sup>1,2</sup> Brianna Heggeseth,<sup>3</sup> Nicholas P. Jewell,<sup>4</sup> Dorothea Nitsch,<sup>4</sup> Neil Pearce,<sup>4</sup> Ben Caplin.<sup>1</sup> Colt/MRC CKDu study group <sup>1</sup>University College London, London, United Kingdom; <sup>2</sup>Universidad Nacional Autonoma de Nicaragua Leon, Leon, Nicaragua; <sup>3</sup>Macalester College, Saint Paul, MN; <sup>4</sup>London School of Hygiene & Tropical Medicine, London, United Kingdom.

**Background:** Mesoamerican Nephropathy (MeN) is a leading contributor to premature mortality in Central America but the primary cause remains unclear. Early disease is challenging to identify given absent urinary abnormalities and variation in eGFR within and between healthy individuals. We explored the incidence of CKD as well as evidence of early kidney injury (EKI) in the at-risk population from NW Nicaragua.

**Methods:** We conducted a community-based study of 2 cohorts (n=351 and 420) of adults aged 18-30, collecting questionnaire data, and bi-annual/annual eGFR measures for 7 and 4 years follow-up respectively. We used Hidden Markov Modelling to estimate EKI, the point of sustained departure from the healthy eGFR distribution, and examined associations between time-updated exposures and both incident CKD and EKI using Cox-proportional hazards and fractional regression respectively.

**Results:** CKD occurred in men only (incidence rates of 0.8%/year and 0.5%/year in the two cohorts). 14% of men and 3% of women experienced EKI. Cumulative time spent in sugarcane work and symptoms of excess occupational sun exposure associated with incident CKD. Other risk factors associated with EKI (Table). Weight loss and cramps remained independently associated with EKI in multivariable models.

**Conclusions:** CKD burden in this population is high. Risk factors for established disease are occupational but a symptom constellation suggesting an alternative exposure is associated with EKI, supporting separate initiating and exacerbating factors in MeN. The initiating factor remains unknown, but identifying episodes of EKI may facilitate efforts to uncover it. Meanwhile interventions to reduce the impact of exacerbating factors should be vigorously pursued.

**Funding:** Private Foundation Support, Government Support - Non-U.S.

Table: Selected associations between exposures and early kidney injury

Exposure	OR	(95% CI)	
<b>Occupation since last visit (yes versus no)*</b>			
Sugarcane	1.59	(0.96 to 2.61)	
Paid agricultural	1.03	(0.66 to 1.61)	
Unpaid agricultural	0.97	(0.61 to 1.55)	
<b>Occupational environment (all yes versus no except where stated)</b>			
Work outdoors (regularly or more frequently versus less frequently)	1.60	(0.94 to 2.58)	
Work in a very hot environment (regularly or more frequently versus less frequently)	1.10	(0.68 to 1.82)	
<b>Symptoms of excess sun exposure at work</b>			
Agrochemical use	1.60	(1.05 to 2.61)	
	1.19	(0.74 to 1.92)	
<b>Social factors, yes versus no unless otherwise stated</b>			
Piped water source	0.61	(0.34 to 1.09)	
Daily water intake	per litre	1.11	(1.00 to 1.22)
Premature birth	1.01	(0.31 to 3.34)	
<b>Medical factors, since last visit, yes versus no unless otherwise stated</b>			
Mean systolic blood pressure (measured, at this visit)	per 10mmHg	1.04	(0.88 to 1.22)
Mean Diastolic blood pressure (measured, at this visit)	per 10mmHg	1.22	(1.00 to 1.49)
Weight loss of more than 2.5kg (measured, since last visit)		1.99	(1.20 to 3.31)
Diagnosis of UTI		1.27	(0.63 to 2.58)
NSAIDs regularly or more frequently		2.10	(1.01 to 4.37)
Paracetamol regularly or more frequently		0.66	(0.19 to 2.26)
<b>Symptoms, since last visit, more frequent than 'never or almost never' versus 'never or almost never', unless otherwise stated</b>			
Any back pain	1.07	(0.71 to 1.62)	
Any unintentional weight loss	1.53	(0.99 to 2.37)	
Dysuria	0.84	(0.54 to 1.30)	
Cramps	2.27	(1.36 to 3.78)	
Fever	1.57	(0.95 to 2.49)	
Nausea	1.88	(1.07 to 3.28)	
Diarrhoea	0.65	(0.26 to 1.68)	
Vomiting	2.26	(1.17 to 4.36)	

OR, odds ratio; 95% CI, 95% confidence interval; UTI, urinary tract infection. Adjusted for age, sex, study visit and follow-up duration. \*Participants could report more than one occupation at each study visit. Coefficients in bold where 95% confidence intervals exclude unity.

FR-PO928

Frailty Is Associated With Hospitalizations in Adults With CKD: Findings From the CRIC Study

Mary Hannan,<sup>1</sup> Jinsong Chen,<sup>1</sup> Ana C. Ricardo,<sup>1</sup> Milda R. Saunders,<sup>2</sup> Julia Brown,<sup>1</sup> Anna C. Porter,<sup>1</sup> James P. Lash.<sup>1</sup> The CRIC Study Investigators <sup>1</sup>University of Illinois Chicago College of Medicine, Chicago, IL; <sup>2</sup>University of Chicago Department of Medicine, Chicago, IL.

**Background:** Adults with chronic kidney disease (CKD) experience high rates of hospitalization. Although the association between frailty and high hospitalization risk is established in the general population, it has not been examined in patients with CKD. The objective of this study is to evaluate frailty status as a predictor of hospitalizations in adults with CKD.

**Methods:** We utilized data on 2539 participants from the Chronic Renal Insufficiency Cohort (CRIC) Study. Frailty status was assessed using five criteria (slow gait speed, muscle weakness, low physical activity, exhaustion, and unintentional weight loss). Hospitalizations were ascertained based on self-report and review of medical records. Cardiovascular disease (CVD) hospitalizations were defined as those from a disease of the circulatory system. Analysis was conducted using multivariable Poisson regression adjusting for relevant covariates.

**Results:** Baseline age was 62.0 years, 46% were female, mean eGFR was 45.2 mL/min/1.73m<sup>2</sup>, and median urine protein was 0.2 mg/day. In the sample, 12% were frail, 51% pre-frail, and 37% non-frail. Over a median follow-up of 8.61 years, there were 19,630 hospitalizations. The rates of all-cause, CVD, and non-CVD related hospitalizations were highest for those who were frail. On multivariable analysis, both pre-frailty and frailty status were associated with having higher risk for all-cause, CVD, and non-CVD related hospitalizations.

**Conclusions:** Frailty status is associated with higher risk for hospitalizations in adults with CKD. Future work is needed to evaluate whether interventions to improve frailty status reduce the risk of hospitalization in this high risk population.

**Funding:** NIDDK Support, Private Foundation Support

	Frailty Status	Rate of Hospitalization (per 100 person years)	Adjusted Rate Ratio (95% CI)*
All Cause Hospitalization	Non-frail	16.4 (15.3,17.5)	Reference
	Pre-frail	25.8 (24.4,27.3)	1.59 (1.43,1.58)
	Frail	35.1 (31.3,39.4)	1.92 (1.82,2.03)
CVD Hospitalization	Non-frail	4.7 (4.2,5.1)	Reference
	Pre-frail	8.0 (7.5,8.6)	1.46 (1.34,1.58)
	Frail	11.2 (9.9,12.8)	1.83 (1.64,2.03)
Non-CVD Hospitalization	Non-frail	14.1 (13.1,15.1)	Reference
	Pre-frail	21.8 (20.6,23.1)	1.52 (1.44,1.61)
	Frail	30.3 (27.0,34.0)	1.94 (1.83,2.07)

\*Adjusted for clinical site, age, sex, race, ethnicity, education, marital status, smoking, BMI, SBP, DM, CVD, ACE/ARB, aspirin, statin, LDL, & baseline eGFR and proteinuria

FR-PO929

Full Age Spectrum eGFR Formula Corrected by Height to Adapt to a Population Endemic for Mesoamerican Nephropathy as a Tool to Diagnose and Follow Up CKD

Antonino Sidoti,<sup>1,2</sup> Maria Jose Sequeira,<sup>2</sup> Paolo Mazzacani,<sup>2</sup> Clinica Nefrologia Fundacion Coen Chinandega <sup>1</sup>Nefrologia Valdelsa, Poggibonsi, Italy; <sup>2</sup>Fundacion Coen, Chinandega, Nicaragua.

**Background:** We have to diagnose monitor for developing CKD and follow up people age 12-20 affected and by Mesoamerican Nephropathy. Recommendation is from NKDEP to notate values from Schwartz formula (Schw) above 75 ml/min' as 75 ml/min' due to inaccuracy. CKD-EPI is not suitable to a pediatric cohort, we have to follow children after their passage to adult age. Our attention is focused on Full Age Spectrum formula (FAS) (Pottel: 2017, 2020) that is recommended to be adapted whenever used to the population at hand.

**Methods:** We completed 1099 records with creatinine, height, weight, age. FAS was winsored at 169.5 ml/min' using Q-Q graph, as a consequence Schw was winsored at 169.5. Adjustment of FAS for height (FASAdj) was accomplished using a people categorization via Schw values for eGFR < 60 n=11, < 75 n=153 and above 75 ml/min' n= 935 and applying FAS Pearson coefficients via a sub-categorization by sex also. Bland-Altman analysis was performed using Schw as standard method.

**Results:** Fig 1 and Fig 2 show Bland-Altman analysis for eGFR < 60 and < 75 ml/min'. On the whole cohort mean difference between Schw and FASAdj was -11.98, 1.96 SD lies between +9.42 and -33.39.

**Conclusions:** FASAdj seems suitable as a tool for diagnosis and follow up of CKD, is adapted to the population to monitor; differences from Schw seem not clinically significant particularly in the eGFR level below 75 ml/min'.

**Funding:** Private Foundation Support

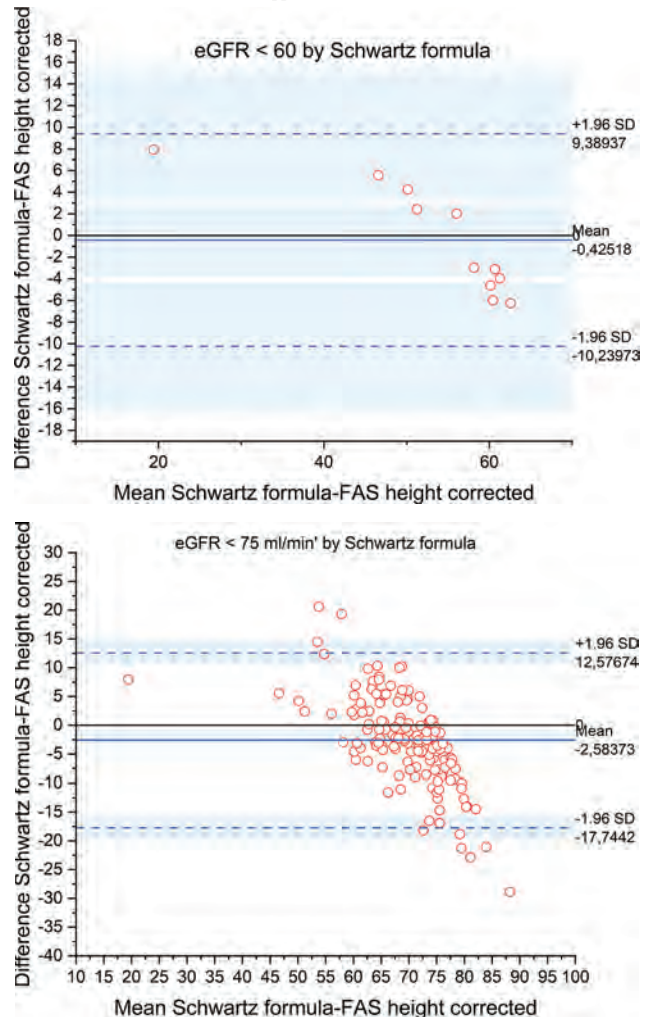

FR-PO930

**Hospitalization Lengths of Stay Among a National Cohort of Advanced CKD Patients Treated With Conservative Management vs. Dialysis**

Amy S. You,<sup>1</sup> Kamyar Kalantar-Zadeh,<sup>1</sup> Yoko Narasaki,<sup>1</sup> Dana B. Mukamel,<sup>1</sup> Susan T. Crowley,<sup>2</sup> Ji Hoon Yoon,<sup>1</sup> Csaba P. Kovacs,<sup>3</sup> Danh V. Nguyen,<sup>1</sup> Connie Rhee.<sup>1</sup> <sup>1</sup>University of California Irvine, Irvine, CA; <sup>2</sup>Yale University, New Haven, CT; <sup>3</sup>The University of Tennessee Health Science Center, Memphis, TN.

**Background:** While dialysis has been the prevailing treatment paradigm in advanced CKD patients progressing to ESKD, this approach may lead to loss of independence/function and greater healthcare utilization in certain groups. We compared the impact of dialysis vs. conservative management (CM) on hospitalization lengths of stay (LOS) in advanced CKD.

**Methods:** We examined a national cohort of advanced CKD patients treated with CM vs. dialysis over 1/07-6/20 from the Optum Labs Data Warehouse, which contains de-identified administrative claims, including medical and pharmacy claims and enrollment records for commercial and Medicare Advantage enrollees as well as EHR data. In primary analyses, patients were categorized according to receipt of CM, defined as not receiving dialysis within 2-yrs of the index eGFR (1<sup>st</sup> eGFR<25), vs. dialysis. We compared LOS among patients treated with CM vs. dialysis hospitalized within 2-yrs of their index eGFR using linear mixed effects models that separately considered fixed age of the cohort (65-years), with varying time of hospitalization from the index eGFR, as well as a fixed time of hospitalization from the index eGFR (12 months) with varying age.

**Results:** Among 169,479 advanced CKD patients who were hospitalized within 2-yrs of the index eGFR, there were a total of 620,168 hospitalizations over this period. In analyses considering fixed age, dialysis patients had longer average LOS vs. CM patients, with differences attenuating over time (Fig A). In analyses considering fixed time of hospitalization from the index eGFR, dialysis patients >20-yrs had longer average LOS vs. CM patients, with differences increasing with older age (Fig B).

**Conclusions:** Compared to dialysis, CM patients had shorter LOS across varying time points and ages. Further studies are needed to examine the comparative effectiveness of CM vs. dialysis transition on CKD outcomes.

**Funding:** NIDDK Support

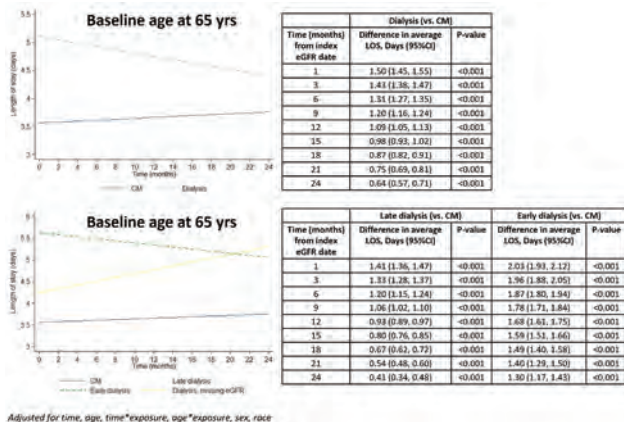

FR-PO931

**Incident Events and Their Combinations After 6.5 Years of Follow-Up in the German Chronic Kidney Disease Study**

Fruzsina K. Kotsis,<sup>1,2</sup> Inga Steinbrenner,<sup>1</sup> Jan Lipovsek,<sup>1</sup> Helena Stockmann,<sup>3</sup> Ulla T. Schultheiss,<sup>1,2</sup> GCKD Investigators <sup>1</sup>Institute of Genetic Epidemiology, Faculty of Medicine and Medical Center - University of Freiburg, Freiburg, Germany; <sup>2</sup>Renal Division, Faculty of Medicine and Medical Center - University of Freiburg, Freiburg, Germany; <sup>3</sup>Charite Universitätsmedizin Berlin, Berlin, Germany.

**Background:** Chronic kidney disease (CKD) patients are at an increased risk for adverse cardiovascular, non-cardiovascular events, and early mortality. Yet, a detailed analysis of the spectrum and patterns of adverse events from large CKD cohorts is lacking. We studied incident events, their combinations and mortality in the prospective German CKD (GCKD) study.

**Methods:** Incident events in the GCKD study are continuously adjudicated from hospital discharge records and death certificates following a standardized event catalogue containing: cardiovascular ("A"), cerebrovascular ("B"), peripheral arterial occlusive disease, ("C"), kidney ("E"), cancer ("G"), infection ("H"), and death ("F") events. Event frequencies and their combinations were compared by sex. Incidence rates per 1000 patient-years (IR +/-recurrent events) were calculated. Combinations of events (intersection plot) were considered per participant regardless of time.

**Results:** Out of 5217 participants 60% were men. Over 6.5 years, 2933 participants (65.5% men) experienced at least one event. Incidence rates were overall (o) 97 (IR -); 338 (IR +). Men (m) experienced more events (108 IR -; 392 IR +) than women (w) (82 IR -; 260 IR +, respectively). Incidence rates were: A (o: 46; 114; m: 54; 135; w: 36; 82), E (o: 46; 75; m: 52; 85; w: 38; 61), H (o: 40; 66; m: 42; 68; w: 37; 63), F (o: 22; m: 28;

w: 14; respectively). For 1314 participants, events in only one category (mainly A, E, H) were observed (Figure 1). In total, 787 participants experienced a combination of two events (66% men) and 467 a combination of 3 events (67% men). The most frequent combinations were (E, H; n=176) and (A, E, H; n=154).

**Conclusions:** This study provides a comprehensive overview of incident adverse events, their combinations, and differential events by sex in CKD patients under regular nephrological care. Cardiovascular, kidney and infection events were most frequent, and men experienced more events than women. Frequent events occurred in patients that also experienced an event of another category.

**Funding:** Government Support - Non-U.S.

Figure 1: Combination of incident events and number of patients by main event category.

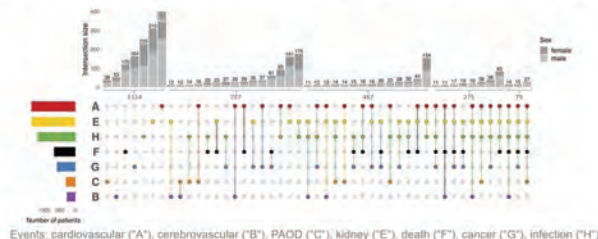

FR-PO932

**Long-Term Exposure to High Perceived Temperature and Risk for Mortality Among Patients With CKD**

Boram Weon,<sup>1</sup> Jeonghwan Lee,<sup>2,1</sup> Jung Pyo Lee,<sup>2,1</sup> Chun Soo Lim.<sup>2,1</sup> <sup>1</sup>Seoul National University Boramae Medical Center, Seoul, Republic of Korea; <sup>2</sup>Seoul National University College of Medicine, Seoul, Republic of Korea.

**Background:** With the global warming, the interest in health risks from the high temperature exposure is growing. The Perceived Temperature (PT) is an equivalent temperature based on a complete heat budget model of the human body. We aimed to analyze the effect of PT on the overall mortality among chronic kidney disease (CKD) patients.

**Methods:** A total of 32,870 patients with CKD living in Seoul metropolitan region were recruited in a retrospective cohort (2001-2018). PT during summer season (from July to September, at each year) was calculated using various climate factors including air temperature nearby automated weather station, dew point temperature, wind velocity, height of anemometer above ground, and total cloud amount. We assessed the association of PT using inverse distance weighting (IDW) on mortality in CKD patients in the Cox proportional hazard model that was adjusted for sex, age, body mass index, eGFR, hypertension, and diabetes mellitus.

**Results:** During the 6.14±3.96 years, 3,863 deaths (13%) were observed. We confirmed the significant effects of PT (average PT: hazard ratio [HR] 1.21, 95% confidence interval [CI] 1.18-1.23; minimum PT: HR 1.02, 95% CI 1.00-1.05; maximum PT: 1.20, 95% CI 1.18-1.22) on mortality in CKD patients in univariable analysis. In multivariable analysis, average PT (HR 1.22, 95% CI 1.19-1.25) and maximum PT (HR 1.20, 95% CI 1.17-1.23) showed increased risk for overall mortality among CKD patients.

**Conclusions:** Long-term exposure to high PT during summer season increased the risk of mortality among CKD patients.

FR-PO933

**Monoclonal Gammopathy of Undetermined Significance (MGUS) and Risk of CKD: Results of the Population-Based Iceland Screens, Treats, or Prevents Multiple Myeloma (iStopMM) Study**

Thorir E. Long,<sup>1,2</sup> Olafur S. Indridason,<sup>3</sup> Sæmundur Rögnvaldsson,<sup>4,3</sup> Elias Eythorsson,<sup>3,2</sup> Sigrún Thorsteinsdóttir,<sup>5</sup> Thorvardur J. Love,<sup>2,3</sup> Runolfur Palsson,<sup>3,2</sup> Sigurdur Y Kristinnsson.<sup>2,3</sup> iStopMM research group <sup>1</sup>Skans universitetssjukhus Lund, Lund, Sweden; <sup>2</sup>Heilbrigdisvisindasvid - Haskoli Island, Reykjavik, Iceland; <sup>3</sup>Landspítali, Reykjavik, Iceland; <sup>4</sup>University of Iceland, Reykjavik, Iceland; <sup>5</sup>Rigshospitalet, Kobenhavn, Denmark.

**Background:** The prevalence of both monoclonal gammopathies of undetermined significance (MGUS) and chronic kidney disease (CKD) increase with age. In recent years, studies have shown association between MGUS and CKD, suggesting an underdiagnosis of monoclonal gammopathies of renal significance (MGRS). The aim of this study was to examine the risk of CKD in participants with MGUS compared with those without MGUS for the first time in a screened cohort, to estimate the prevalence of MGRS.

**Methods:** A total of 75,422 participants of the iStopMM study were screened for MGUS. CKD was defined as proteinuria, hematuria or estimated glomerular filtration rate (eGFR) <60 mL/min/1.73 m<sup>2</sup>, present for >90 days. Participants with lymphoproliferative disorders or without data on kidney function were excluded. Risk of CKD was evaluated with multivariable logistic regression. Power analysis yielded 90% power to detect 1.5% absolute difference between groups.

**Results:** Of the participants, 35,202 had available urine measurements and 69,120 data on eGFR, median (range) age was 61 (52-70) years, 44.8% were men. MGUS was detected in 4547 (6.6%) participants, 2242 (3.2%) of which were non-IgM, 703 (1.0%) IgM, 1295 (1.9%) LC-MGUS, and 307 (0.4%) biclonal. A total of 6680 (9.7%) participants had CKD, 14.8% in the MGUS group and 9.3% in the group without MGUS. In an age- and sex-adjusted analysis, there was no significant association between non-IgM MGUS,

Key: TH - Thursday; FR - Friday; SA - Saturday; OR - Oral; PO - Poster; PUB - Publication Only

Underline represents presenting author.

IgM MGUS, or biconal MGUS and CKD (Table I). Participants with LC-MGUS were less likely to have CKD than those without MGUS. The inverse correlation between age and eGFR was similar in the groups with and without MGUS (r= -0.56).

**Conclusions:** In this large population-based screening study, we observed no increase in the risk of CKD in individuals with MGUS. This finding suggests a low prevalence of MGRS in the general population.

**Funding:** Private Foundation Support, Government Support - Non-U.S.

Table I. Risk of chronic kidney disease in subgroups of MGUS compared with persons without MGUS. Logistic regression adjusted for age and sex (n = 69120).

Variable	Adjusted OR (95% CI)	p-value
No MGUS	1.00	
- Non-IgM MGUS	1.06 (0.93 - 1.20)	0.382
- IgM MGUS	1.01 (0.82 - 1.24)	0.901
- LC-MGUS	0.39 (0.31 - 0.49)	<0.001
- Biconal MGUS	0.93 (0.68 - 1.26)	0.665
Age (per year)	1.12 (1.12 - 1.13)	<0.001
Sex (male)	0.98 (0.93 - 1.04)	0.557

The adjusted model included age and sex

**FR-PO934**

**Performance of Race Neutral CKD-EPI 2021 eGFR Equations in Indian Population**

Prabhjot K. Johal,<sup>1</sup> Ashok K. Yadav,<sup>1</sup> Vivek Kumar,<sup>1</sup> Vivekanand Jha,<sup>2</sup> *Post Graduate Institute of Medical Education and Research, Chandigarh, India; <sup>2</sup>The George Institute for Global Health, New Delhi, India.*

**Background:** Recently, race neutral CKD-EPI 2021 equations have been described. As these equations are being adopted in clinical use, it is important to validate these estimating glomerular filtration rate (eGFR) equations in Indian population. We present the performance of these equations against measured GFR (mGFR) in Indian subjects.

**Methods:** In the ongoing 'Indian GFR study', healthy individuals or stable patients with chronic kidney disease (CKD) are being enrolled with the objective of testing performance of eGFR equations in Indian population. Demographic details, anthropometric measurements, diagnosis, treatment and dietary details are being recorded. GFR was measured using urinary clearance of inulin in the first 130 subjects. Thereafter, it is being measured by plasma clearance of iothexol. Bias, precision, and accuracy of CKD-EPI 2021 equations were calculated. We present data of participants whose measurements were available till October 2021.

**Results:** mGFR was available for 412 participants (187 healthy and 225 with CKD). Average age was 47.2±11.5 years, 50% being males. Mean mGFR in study population was 54.23±30.21 ml/min/1.73m<sup>2</sup>. eGFR using CKD-EPI<sub>Cr-2021</sub> and CKD-EPI<sub>Cr-cys-2021</sub> were 73.45±38.37 ml/min/1.73m<sup>2</sup> and 60.81±33.58 ml/min/1.73m<sup>2</sup>, respectively. Bias for CKD-EPI<sub>Cr-2021</sub> and CKD-EPI<sub>Cr-cys-2021</sub> equations were -19.22±21.55 ml/min/1.73m<sup>2</sup> and -6.58±19.19 ml/min/1.73m<sup>2</sup>, respectively. eGFR by CKD-EPI<sub>Cys</sub> had least bias and highest P<sub>30</sub> (table 1).

**Conclusions:** Race neutral CKD-EPI 2021 equations did not enhance performance of eGFR equations in Indian subjects. There is a need for extensive validation of eGFR equations in Indian population.

**Funding:** Government Support - Non-U.S.

Table 1. Performance of GFR estimating equations as compared to measured GFR

Method	Bias	95% Limits of agreement	Precision (95% CI)	Accuracy	
				RMSE	P <sub>30</sub> (%)
CKD-EPI <sub>Cr-2009</sub>	-17.04±21.36	24.82 to -58.90	-19.11 to -14.97	27.31	43.20
CKD-EPI <sub>Cr-2021</sub>	-19.22±21.55	23.01 to -61.45	-21.31 to -17.13	28.86	41.50
CKD-EPI <sub>Cr-cys-2012</sub>	-0.86±18.40	35.20 to -36.92	-2.64 to 0.91	18.40	59.95
CKD-EPI <sub>Cr-cys-2021</sub>	-6.58±19.19	31.03 to -44.19	-8.44 to -4.72	20.27	55.83
CKD-EPI <sub>Cys</sub>	3.56±19.29	41.36 to -34.24	1.69 to 5.43	19.59	60.92

P30: Percentage of participants with eGFR within ±30% of mGFR, RMSE: root mean square error

Values are in ml/min/1.73m<sup>2</sup> except P30

**FR-PO935**

**Polygenic Burden as a Predictor of Age at Onset of ESRD**

Kane E. Collins,<sup>1</sup> Edmund H. Gilbert,<sup>1</sup> Katherine A. Benson,<sup>1</sup> Elhussein A. Elhassan,<sup>2</sup> Graham M. Lord,<sup>3</sup> Gianpiero Cavalleri,<sup>1</sup> Peter J. Conlon,<sup>2,1</sup> *Royal College of Surgeons in Ireland, Dublin, Ireland; <sup>2</sup>Beaumont Hospital, Dublin, Ireland; <sup>3</sup>King's College London, London, United Kingdom.*

**Background:** There are a large number of well-established clinical risk factors for age of onset of ESRD including diabetes, hypertension, heart disease, and obesity. Patients with CKD have also been shown to have a significant enrichment of rare variation in genes related to kidney disease. However, little research has been done to investigate the role of burden from common genetic risk factors on age of onset of ESRD, as quantified using polygenic risk scores (PRS) which estimates the cumulative effect of common genetic variation on an individual's disease status. Here, we investigate the association between polygenic burden for hypertension, albuminuria, eGFR and kidney volume (KV) and age of onset of ESRD.

**Methods:** We utilised 2,122 genotyped kidney transplant recipients from across the UK and Ireland (UKIRTC) and 5,519 ancestry matched controls. For these transplant recipients, we used age of transplant as a proxy for age of onset of ESRD. We also used 190 genotyped Irish individuals with Polycystic Kidney Disease (PKD). We calculated PRSs for each trait using large published GWASs of European ancestry. We then investigated the relationship between age of onset of ESRD and polygenic burden in each cohort separately and then together.

**Results:** The UKIRTC recipients had a higher polygenic burden than healthy controls for reduced eGFR (p-value 0.006) and albuminuria (p-value 0.056). The PKD patients also had increased burden for albuminuria (p-value: 0.003). Taken together, all the patients from the two cohorts had higher polygenic burden for albuminuria and reduced eGFR than healthy controls (p-values: 0.003, 0.01 respectively). We compared age of onset of ESRD between individuals in the top 20% of polygenic risk for each trait to those in the bottom 80% and found an Odds Ratios (OR) of 3.75 for hypertension (p-value: 0.052) and 0.261 for reduced eGFR (p-value: 0.051).

**Conclusions:** These observations support the hypothesis that individuals with CKD have higher common variant burden for traits related to reduced kidney function and that polygenic burden is a borderline statistically significant predictor of age of onset of ESRD. A larger sample size may verify the magnitude of this effect. If replicated in a larger dataset, these findings could lead to modifications of screening and treatment of ESRD.

**Funding:** Government Support - Non-U.S.

**FR-PO936**

**Prevalence and Awareness of Kidney Disease Among Individuals With Prediabetes**

Yiting Li,<sup>1</sup> Michael Heung,<sup>1</sup> Tiffany C. Veinot,<sup>1</sup> Brenda W. Gillespie,<sup>1</sup> Yun Han,<sup>1</sup> William H. Herman,<sup>1</sup> Alain Koyama,<sup>2</sup> Meda E. Pavkov,<sup>2</sup> Rajiv Saran,<sup>1</sup> Jennifer L. Bragg-Gresham,<sup>1</sup> *<sup>1</sup>University of Michigan, Ann Arbor, MI; <sup>2</sup>Centers for Disease Control and Prevention, Atlanta, GA.*

**Background:** About 96 million US adults have prediabetes; 80% are unaware they have the condition. Prediabetes can progress to type 2 diabetes and complications such as chronic kidney disease (CKD). Here we compare the prevalence of CKD and its awareness among those with prediabetes and diabetes in the US.

**Methods:** Analysis included 47,000 U.S. adults aged 20+ years in the National Health and Nutrition Examination Survey (NHANES, 2001 to Mar 2020). Prediabetes was defined as HbA1c 5.7% to 6.4%; diabetes (DM) by self-report, medication, or HbA1c ≥ 6.5%. CKD was defined by eGFR < 60 ml/min/1.73m<sup>2</sup> or albuminuria. CKD awareness and health behaviors were self-reported and nutritional intake was estimated from daily recall questionnaires. Survey weighted logistic regression was used to model changes in prevalence and awareness over time.

**Results:** Compared to adults with diabetes, those with prediabetes were younger and more likely to be female and Black (p<0.001). Those with prediabetes had a lower, though substantial comorbidity burden: 19% with CKD but only 7% aware of their condition. During the study, CKD prevalence among individuals with prediabetes decreased from 22% to 17% (p=0.03), with no significant change in age and comorbidities, but with improvements in lifestyle behaviors (p<0.001): increase in moderate physical activity (45.7% to 66.3%) and decline in sugar intake (123 g to 108 g). In addition, CKD awareness among individuals with prediabetes rose from 4.8% to 8.1%, although not statistically significant (p=0.18).

**Conclusions:** Nearly 1 in 5 individuals with prediabetes has CKD, yet only 7% were aware of their kidney disease. While improvements have been seen, opportunities remain to intervene at this potentially reversible stage, including improvement in diagnosis and awareness of prediabetes and in response to the high burden of CKD even among those with prediabetes.

Characteristics of Adults by Diabetes Status (NHANES 2001-Mar 2020)

Measure	Mean (SEM) or %			
	Diagnosed DM	Undiagnosed DM	Prediabetes	No Diabetes
CKD (%)	40.4	30.6	18.9	9.3
CKD Awareness (%)	15.8	3.5	6.9	7.3
Age (years)	59.8(0.3)	56.8(0.5)	55.9(0.2)	43.8(0.2)
Male (%)	51.8	53.7	47.5	47.9
Race (%)				
Non-Hispanic White	61.8	50.7	61.7	71.7
Non-Hispanic Black	14.3	17.1	15.8	8.6
Non-Hispanic Other Race	8.6	11.5	8.2	8.7
Hispanic	15.3	20.7	14.2	13.6
BMI ≥ 30 kg/m <sup>2</sup> (%)	60.6	69.2	46.5	29.3
CVD (%)	27.7	34.7	12.6	4.9
Hypertension (%)	72.5	82.5	50.6	27.3

DM: self-reported, taking medication, or hemoglobin (Hb)A1c ≥ 6.5%; BMI: measured body mass index; CVD: self-report cardiovascular disease; No Diabetes includes individuals with HbA1c < 5.7% and no report of diabetes diagnosis.



## FR-PO937

## Predicting Rapid eGFR Decline in the CURE-CKD Registry

Tyler A. Davis,<sup>1</sup> Panayiotis Petousis,<sup>1</sup> Davina J. Zamanzadeh,<sup>1</sup> Keith C. Norris,<sup>1</sup> Obidiugwu Duru,<sup>1</sup> Katherine R. Tuttle,<sup>2</sup> Alex Bui,<sup>1</sup> Susanne B. Nicholas,<sup>1</sup> Majid Sarrafzadeh,<sup>3</sup> CURE-CKD <sup>1</sup>University of California Los Angeles David Geffen School of Medicine, Los Angeles, CA; <sup>2</sup>Providence St Joseph Health, Spokane, WA; <sup>3</sup>University of California Los Angeles Department of Computer Science, Los Angeles, CA.

**Background:** Patients with rapid eGFR decline tend to progress to kidney failure. Automated tools can identify individuals at risk of severe kidney function decline and facilitate disease mitigation. We describe a machine learning model for predicting the risk of rapid eGFR decline (>40% over 2 years) and identify specific populations with elevated risk using the CURE-CKD Registry.

**Methods:** Variables include age, sex, race and ethnicity, ACE inhibitor/ARB, SGLT2 inhibitor, GLP-1 receptor agonist, NSAID, and PPI use, eGFR, systolic blood pressure (SBP), HbA1C, hypertension, type 2 diabetes, and chronic kidney disease (CKD) based on ICD-9/10 coding from patients with CKD (N=234,219) and at-risk for CKD (N=935,329) with CKD-EPI eGFR  $\geq 15$  mL/min/1.73 m<sup>2</sup> and 2 years of follow-up. We trained, tuned, and validated a gradient boosted tree ensemble model (GBTe) using a 60/20/20 train/validation/test split. We computed the risk distribution of all 8,503,055 subpopulations, based on all possible expert defined combinations of the above variables, and compared each risk distribution to the whole population's risk distribution using the Kolmogorov-Smirnov (KS) test. Subgroups with the highest risk of eGFR decline were identified using the KS test (Holm-Bonferroni method with  $\alpha=0.05$ ).

**Results:** The GBTe model achieved an area under the precision-recall curve (PR-AUC) of 0.099 and an area under the receiver operating characteristic curve of 0.75 on the test set. 480,344 subpopulations were significantly above average predicted risk in the test set. We identified the most frequent predictors of rapid eGFR decline across the highest risk subpopulations. Of the top 100 significantly higher risk subpopulations the following variables are the most frequent: CKD (100%), PPI use (100%), SBP >140 mmHg (98%), HbA1C >8% (87%), and age 45-66 years (79%). Patients in these 100 subpopulations were 13.7 times more likely to experience rapid decline than the overall study population.

**Conclusions:** We developed a methodology that uses a risk model for rapid eGFR decline to identify subpopulations with significantly high risk for rapid eGFR decline. These subpopulations are strong candidates for closer study and early intervention.

**Funding:** Other NIH Support - NIMHD

## FR-PO938

## Relationship of Light-Intensity and Moderate-to-Vigorous Intensity Physical Activity Habits for Kidney Dysfunction: A General Population Cohort Study

Goro Sakurai, Tadashi Toyama, Akinori Hara, Yuta Yamamura, Shiori Nakagawa, Megumi Oshima, Taro Miyagawa, Hisayuki Ogura, Shinji Kitajima, Norihiko Sakai, Miho Shimizu, Takashi Wada, Yasunori Iwata. Department of Nephrology and Laboratory Medicine, Kanazawa University Kanazawa Daigaku, Kanazawa, Japan.

**Background:** There are limited studies considering exercise intensities and their frequencies in relation to kidney dysfunction.

**Methods:** A community-based historical cohort study was conducted including Japanese general people aged  $\geq 40$  years. Participants were divided into four categories according to the combination of their exercise habits: regular light-intensity physical activity (R-LPA: 1.5 to 3.0 metabolic equivalents [METs] at least 60 minutes a day) and occasional moderate-to-vigorous physical activity (O-MVPA: > 3.0 METs at least 30 minutes twice a week). The outcome was the incidence of a 40% decrease in estimated glomerular filtration rate (eGFR) from baseline. Cox proportional hazards models were used to examine the association of exercise habits.

**Results:** A total of 72,999 people were included. During the mean follow-up of 5.9 years, 2,989 (4.1%) participants achieved the outcome. Compared to the people with neither R-LPA nor O-MVPA, the adjusted hazard ratios were 0.94 (95% CI: 0.85, 1.03;  $p = 0.182$ ) for R-LPA alone, 0.97 (95% CI: 0.85, 1.10;  $p = 0.618$ ) for O-MVPA alone, and 0.83 (95% CI: 0.76, 0.91;  $p < 0.001$ ) for a combination of R-LPA and O-MVPA. There was a significant interaction between sex and exercise habits.

**Conclusions:** In general people, a combination of R-LPA and O-MVPA was associated with a lower risk of kidney dysfunction compared with no exercise habit. Future studies are warranted to determine the exercise intensity and duration that protects kidney function.

## FR-PO939

## Stratifying Patient Risk for eGFR Decline Over a Year

Zahra Mahmoodzadeh,<sup>1</sup> Keith C. Norris,<sup>1</sup> Katherine R. Tuttle,<sup>2</sup> Alex Bui,<sup>1</sup> Susanne B. Nicholas,<sup>1</sup> CURE-CKD Registry Team <sup>1</sup>University of California Los Angeles David Geffen School of Medicine, Los Angeles, CA; <sup>2</sup>Providence St Joseph Health, Spokane, WA.

**Background:** Electronic health records (EHR) data enables assessment of patient-level risk by advanced data-driven artificial intelligence. This study used curated EHR data to stratify patients' risk of eGFR decline over a 1-year prediction period. We tested a 2-stage model that first predicted the risk of unstable eGFR (decline >5 mL/min/1.73 m<sup>2</sup>) in the next year. For an unstable patient, a second model estimated the patient's expected eGFR in the next year.

**Methods:** We designed a 2-stage modeling technique with a binary classifier sequentially connected to a regressor, using the CURE-CKD data of 857931 patients. The binary classifier predicts the chance of having a stable eGFR (decline <5 mL/min/1.73 m<sup>2</sup>) over the next year, given a set of static (sex; race; rural-urban commuting area codes; hypertension, type 2 diabetes (DM), pre-DM, and CKD based on ICD coding) and temporal observations (past 2 years of eGFR, medications (ACEI/ARB, SGLT2 inhibitor, GLP1 RA, MRA, NSAID, PPI) and age. If the likelihood of remaining stable is <50%, the patient's information is passed to a second model trained to estimate the eGFR in the next year. The first model is a deep neural network consisting of a convolutional neural network (CNN-processes longitudinal patient data; trained on the whole training set) concatenated to a feedforward neural network (FNN-processes static patient data). The second stage model is an extreme gradient boosting regressor, trained on a cohort of the training set with eGFR decline >5 mL/min/1.73 m<sup>2</sup> in a 1-year prediction window. Both models were trained, validated, and tested on a 60/20/20 split.

**Results:** The first model's area under the receiver operating curve was 0.814. When the classification threshold was set to 50%, the classifier accuracy reached 76% and the precision reached 70%. The second model achieved the mean absolute error (MAE) of 3.47 and root mean squared error of 4.59, while the best stand-alone regressor trained on the whole training set had MAE of 5.73. Therefore, the 2-stage modeling technique increased the eGFR prediction accuracy for more critical patients.

**Conclusions:** Our 2-step model stratified patient risk for eGFR decline over a 1-year period. The model can support clinical decision-making on the risk of >5 mL/min/1.73 m<sup>2</sup> eGFR decline in the next year. If the chance is high, the second model can estimate the eGFR value for the next year.

**Funding:** Other NIH Support - NIMHD, CTSI ULI

## FR-PO940

## The Association Between Mean Blood Pressure and the Rate of Progression of CKD Is Dependent on the Underlying Disease

Tatsuo Kondo, Tsutomu Inoue, Daichi Fukaya, Hiroaki Amano, Yusuke Watanabe, Koji Tomori, Hirokazu Okada. Saitama Ika Daigaku, Iruma-gun, Japan.

**Background:** The correction of intraglomerular pressure suppresses glomerulosclerosis thereby retarding CKD progression in animal models whereas the degree of increase in intraglomerular pressure in the human kidney in patients with CKD is assumed to vary with etiology. In this study, we examined the association between mean blood pressure (mBP) and the rate of progression of CKD, with a focus on different etiologies.

**Methods:** We recruited patients with chronic glomerulonephritis (CGN), diabetic kidney disease (DKD), or nephrosclerosis (HNS). The progression rate was defined as the SLOPE:  $\Delta eGFR_{cre}/year$  (mL/min/1.73m<sup>2</sup> per year). Regression coefficients for predicting the SLOPE using each risk factor were examined using Bayesian analysis. A model with linear combination of each explanatory variable was assumed.

**Results:** A total of 167 patients (37.7% female; mean observation period, 3.17 years; eGFR, 43.89 $\pm$ 23.54; urinary protein (UP), 1.54 $\pm$ 2.01 g/gCr; mBP, 96.90 $\pm$ 9.58 mmHg) with CGN (n=64), DKD (n=26), or HNS (n=77) were included. The mean SLOPE values for CGN, DKD, and HNS were -3.15, -5.19, and -1.91, respectively, and ANOVA showed significant differences among groups ( $p < 0.01$ ). Multiple regression analysis using age, gender, and known risk factors revealed that UP and mBP were significant explanatory variables for the SLOPE. In addition, the interaction was also significant for mBP (age\*etiology,  $p=0.08$ ; UP\*etiology,  $p=0.05$ ; mBP\*etiology,  $p=0.01$ ). After adjusting for age and UP, the coefficient of mBP was estimated for each etiology. Model: SLOPE-normal (intercept+age+UP+mBP\*etiology,  $\sigma^2$ ), prior distribution Normal (0, 100),  $\sigma^{-iy}$  (0.01, 0.01), iter=12500, burn-in=2500, chains=4. All MCMC sampling results were well-converged. The mean values [95% Cred. Inter.] for the MCMC samples of CGN, DKD, and HNS were -0.063 [-0.113, -0.013], -0.020 [-0.035, -0.005], and -0.003 [-0.016, 0.010], respectively. The mBP did not affect the SLOPE in HNS.

**Conclusions:** Unlike UP, the association between mBP and SLOPE is dependent on the underlying disease/etiology of CKD. Factors associated with decreased renal function differ depending on the primary disease, and careful consideration is needed to construct a renoprotective strategy with antihypertensive therapy, particularly for patients with HNS.

## FR-PO941

## Impact of Conservative Management vs. Dialysis on Survival Among US Veterans With Advanced CKD

Connie Rhee,<sup>1</sup> Yoko Narasaki,<sup>1</sup> Susan T. Crowley,<sup>2</sup> Csaba P. Kovessy,<sup>3</sup> Dana B. Mukamel,<sup>1</sup> Amy S. You,<sup>1</sup> Ji Hoon Yoon,<sup>1</sup> Danh V. Nguyen,<sup>1</sup> Kamyar Kalantar-Zadeh.<sup>1</sup> <sup>1</sup>University of California Irvine, Irvine, CA; <sup>2</sup>Yale University, New Haven, CT; <sup>3</sup>The University of Tennessee Health Science Center, Memphis, TN.

**Background:** Among >1 million US Veterans with CKD, ~10% of those with advanced kidney disease annually progress to ESKD in whom dialysis is the dominant treatment paradigm. Given high rates of early mortality, healthcare utilization, and withdrawal experienced by dialysis patients, we examined the impact of non-dialytic conservative management (CM) vs. dialysis on survival.

**Methods:** Using linked national VA, USRDS, and Medicare data, we examined Veterans with advanced CKD ( $\geq 2$  eGFRs <25 separated by  $\geq 90$  days) categorized according to receipt of CM, defined as those who did not receive dialysis within 2-yrs of the index eGFR (1<sup>st</sup> eGFR <25), vs. receipt of dialysis within 2-yrs of the index eGFR. We compared survival among CM vs. dialysis patients matched by propensity score (PS) to account for differences in demographics, comorbidities, laboratory tests, medications,

and treatment factors (hospitalization, nephrology care within 1-yr of index eGFR) in a 1:1 ratio with a caliper distance of  $\leq 0.2$  using complete case analysis.

**Results:** In the PS-matched cohort of 34,628 patients, 17,314 vs. 17,314 were in the CM vs. dialysis groups, respectively, among whom baseline characteristics were well-balanced. In the overall cohort, there were 24,677 death events over a median (IQR) follow-up of 3.7 (2.2, 5.7) yrs. In the main PS-matched unadjusted model, compared with CM, dialysis was associated with higher all-cause mortality: HR (95%CI) 1.11 (1.08-1.14). Similar findings were observed in analyses doubly-adjusted for PS covariates: HR (95%CI) 1.08 (1.05-1.10) for dialysis (Fig).

**Conclusions:** In PS-matched analyses, compared with CM, transition to dialysis was associated with higher death risk in US Veterans. Further studies are needed to examine the comparative effectiveness of CM vs. dialysis transition on other hard endpoints and patient-centered outcomes.

**Funding:** NIDDK Support

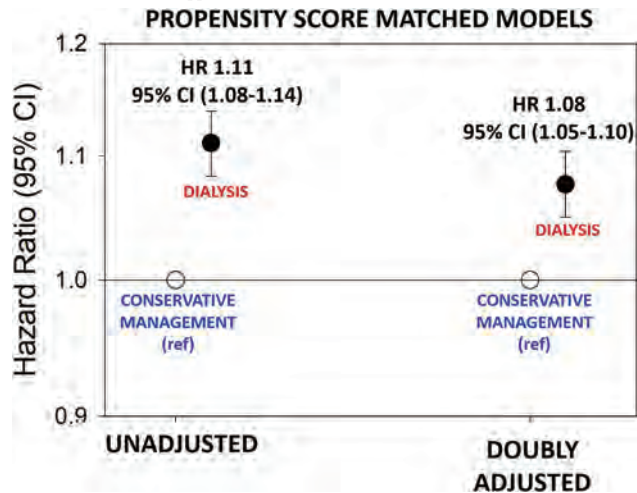

FR-PO942

Lower Central Venous Catheter Rates With Use of Kidney Failure Risk Reporting

Joanna Willetts,<sup>1</sup> Diana Strubler,<sup>4</sup> Yue Jiao,<sup>1</sup> Sheetal Chaudhuri,<sup>1</sup> John W. Larkin,<sup>1</sup> Len A. Usvyat,<sup>1</sup> Sam Gopal,<sup>4</sup> Timothy McNamara,<sup>3</sup> Franklin W. Maddux.<sup>2</sup> <sup>1</sup>Fresenius Medical Care, Global Medical Office, Waltham, MA; <sup>2</sup>Fresenius Medical Care AG & Co KGaA, Bad Homburg, Germany; <sup>3</sup>Fresenius Medical Care North America, Waltham, MA; <sup>4</sup>Acumen Physician Solutions, Nashville, TN.

**Background:** About 80% of kidney failure patients initiate hemodialysis (HD) with a central venous catheter (CVC), a rate that has been unchanged for decades (USRDS 2021). There is an unmet need to reduce CVC use at the transition to HD, which may be secondary to the dynamic nature of chronic kidney disease (CKD) progression and barriers in patient education/literacy. Since 2018, an electronic health record (EHR) system for CKD practices made a glomerular filtration rate (GFR) forecast reporting tool available to nephrologists. This report is based on a machine learning model that predicts the bi-monthly change in GFR over the next year. To understand the potential impacts of this risk reporting, we assessed its use by nephrologists and the CVC rates among patients who progressed to kidney failure and started HD.

**Methods:** We used data from an EHR system for CKD practices in the United States. We included data from nephrologists with  $\geq 15$  patients who progressed from CKD to kidney failure and initiated HD from April 2018-2020. We categorized nephrologists by use of the GFR forecast tool. Frequent users accessed the tool for  $>5\%$  of their CKD patients, occasional users accessed the tool for 0-1% of their CKD patients, and non-users never accessed the tool, then we assessed CVC rates at HD initiation.

**Results:** Among 677 nephrologists, 34 were frequent users, 177 were occasional users, and 466 never used the GFR forecaster. Nephrologists provided care to 459,586 CKD patients, of which 26,164 progressed to kidney failure and started HD. Patients treated by nephrologists who were frequent users of the risk report had a 4.9 and 4.2 percentage point lower CVC rate at the start of HD compared to occasional and non-users of the tool, respectively (Figure 1).

**Conclusions:** We found frequent use of a kidney failure risk report associates with lower CVC rates at HD initiation. CVCs continue to be the primary access type used at the start of HD. Adoption of kidney failure risk reporting may provide some help through decision support and a way to enhance patient education in care planning.

**Funding:** Commercial Support - Fresenius Medical Care

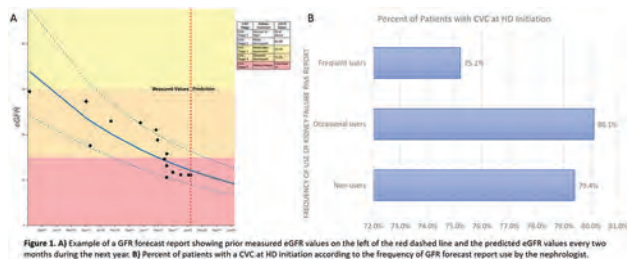

Figure 1. A) Example of a GFR forecast report showing prior measured eGFR values on the left of the red dashed line and the predicted eGFR values every two months during the next year. B) Percent of patients with a CVC at HD initiation according to the frequency of GFR forecast report use by the nephrologist.

FR-PO943

Pilot Feasibility of Coordinated Multidisciplinary Model Can Improve Management and Outcomes of Patients With CKD Under University Healthcare in Thailand

Manoch Rattanasompattikul,<sup>1</sup> Nuttawut Rongkiettechakorn,<sup>1</sup> Malinporn Jampong,<sup>1</sup> Sumana Masoodi,<sup>2</sup> Moltira Promkan,<sup>2</sup> Aungkura Supokawej,<sup>2</sup> <sup>1</sup>Golden Jubilee Medical Center, Faculty of Medicine Siriraj Hospital, Phuthamonthon, Thailand; <sup>2</sup>Mahidol University Faculty of Medical Technology Salaya Campus, Salaya, Thailand.

**Background:** Thailand's renal care system is an evolving educational healthcare system. The limitation of the data system for chronic kidney disease (CKD) patients is the lack of the generation of data that can be analyzed. An appropriate kidney care model for individual hospitals allows for better and safer care at lower cost, enhancement of public health, and patient empowerment is needed. A learning CKD care system should aim to collect, accumulate and analyze data, interpret results, deliver a tailored message, and take action to change practices.

**Methods:** Adult non-pregnant participants 18 years of age or older with diagnosed CKD stages G3 toward G5ND (non-dialysis) were enrolled in the CKD clinic of Golden Jubilee Medical Center between April 2019 and March 2021. A robust and efficacious CKD clinic is always underpinned by applicable workflow (Figure 1).

**Results:** There were 454 patients identified as requiring multidisciplinary care (65% male; 35% female; mean age 72), and the majority of these were in stages 3a, 3b, and 4 CKD (34%, 31%, and 19%). Compliance with established practice guidelines prior to clinic restructuring and post-intervention were 30% vs. 31% for ASA use; 22% vs. 35% for vitamin D supplement; 44% vs. 48% for ACEi/ARB use; 78% vs. 95% for statin use. The age and gender adjustment identified the odds ratio (OR) of eGFR  $< 30$  ml/min/1.73m<sup>2</sup> as an independent risk factor for serum bicarbonate below 22 mEq/L was 5.02; 2.49-10.13;  $P < 0.001$ .

**Conclusions:** Through the established database and data analysis, an integrated care system should improve clinical outcomes and achieve the most cost effective care. Awareness of the process is important for clinicians who are aiming to advocate for effective changes in prevention or improvement of outcomes in CKD clinics.

**Funding:** Government Support - Non-U.S.

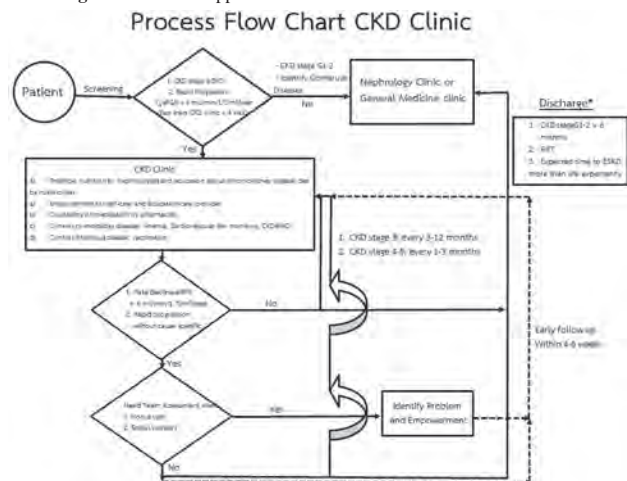

Figure 1.

FR-PO944

**Associations of Urine Albumin to Protein Ratio With Histopathologic Lesions, Clinicopathologic Diagnoses, and Kidney Disease Progression**

Anand Srivastava,<sup>1</sup> Afolarin A. Amodu,<sup>2</sup> Jing Liu,<sup>2</sup> Ashish Verma,<sup>2</sup> Suraj Sarvode Mothi,<sup>3</sup> Ragnar Palsson,<sup>3</sup> Isaac E. Stillman,<sup>5</sup> Bryan R. Kestenbaum,<sup>4</sup> Sushrut S. Waikar.<sup>2</sup> <sup>1</sup>Northwestern University Feinberg School of Medicine, Chicago, IL; <sup>2</sup>Boston University School of Medicine, Boston, MA; <sup>3</sup>Brigham and Women's Hospital, Boston, MA; <sup>4</sup>University of Washington School of Medicine, Seattle, WA; <sup>5</sup>Beth Israel Deaconess Medical Center, Boston, MA.

**Background:** The relative content of urine albumin to other proteins may provide additional information on the site of the kidney lesion. The urine albumin to protein ratio (UAPR) may aid in the differential diagnosis of kidney disease but has not been studied in depth.

**Methods:** We evaluated the UAPR, UACR, UPCR, in 338 individuals who underwent clinically indicated native kidney biopsies from the Boston Kidney Biopsy Cohort (BKBC) Study and 2288 individuals with common forms of CKD from the Chronic Renal Insufficiency Cohort (CRIC) Study. Two kidney pathologists adjudicated biopsy specimens for semiquantitative scores of histopathology in BKBC. Multivariable linear regression models tested the association of UAPR with histopathologic lesions. We constructed receiver operating characteristic curves to compare the ability of UAPR, UACR, and UPCR to distinguish tubulointerstitial disease from other forms of kidney disease. We compared the performance of the kidney failure risk equation to predict 5-year risk of ESKD from proportional hazards models using UAPR, UACR, and UPCR through a likelihood ratio test.

**Results:** In BKBC and CRIC, the mean age was 53±17 and 57±11 years, mean baseline eGFR was 54.7±34.9 and 41.9±14.7 ml/min/1.73m<sup>2</sup>, median UPCR was 1.62 [0.6–3.7] and 0.5 [0.2–1.5] g/g creatinine, and median UAPR was 0.69 [0.55–0.77] and 0.50 [0.33–0.67] respectively. More severe chronic glomerular, tubulointerstitial, and vascular lesions were associated with higher UAPR. Inflammation of intact tubulointerstitial area was associated with lower UAPR (Figure 1A). UAPR outperformed UACR and UPCR to discriminate between tubulointerstitial disease and other forms of kidney diseases (Figure 1B). UAPR did not outperform UACR and UPCR as a predictor of kidney failure (Figure 1C).

**Conclusions:** UAPR may hold promise to identify specific histopathologic lesions and to differentiate tubulointerstitial disease from other forms of kidney disease.

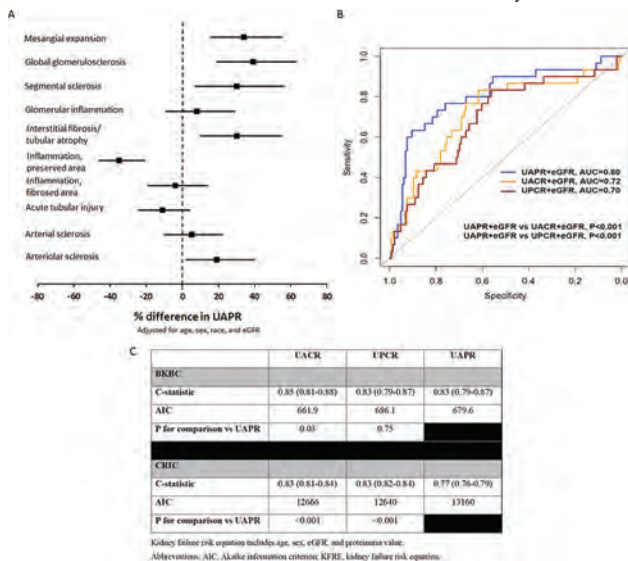

FR-PO945

**Importance of Promoting CKD Health Literacy in the Younger Generation: Data From the Niigata Prefectural Health and Nutrition Survey and Questionnaire Survey of High School Students in Japan**

Yuya Suzuki,<sup>1</sup> Ryohei Kaseda,<sup>1</sup> Yusuke Nakagawa,<sup>1</sup> Mizuki Takeuchi,<sup>2</sup> Junko Nakamura,<sup>2</sup> Minako Wakasugi,<sup>1</sup> Ichiei Narita.<sup>1</sup> <sup>1</sup>Niigata University, Niigata, Japan; <sup>2</sup>Niigata University of Health and Welfare, Niigata, Japan.

**Background:** Promoting health literacy is important for preventing chronic kidney disease (CKD). However, few studies have investigated the level of CKD awareness. This study aimed to clarify the level of CKD awareness for providing helpful information to narrow down the target of CKD educational activities.

**Methods:** We analyzed data regarding CKD awareness from the Niigata Prefectural Health and Nutrition Survey conducted in 2019, Japan (N=1,225). Furthermore, we conducted a questionnaire survey among high school students (N=103).

**Results:** The proportion of people who had heard of CKD was 40.6% (men 32.9%, women 47.5%). When stratified by age, people aged 20–39 had heard less about CKD than those aged 40–59, and those over 60 (20.5%, 31.6%, and 51.5%, respectively). As the level of awareness regarding the term “CKD” was poor in the people aged 20–39, we

thereafter studied the CKD knowledge of high school students. The proportion of students who had heard of CKD was only 3.8%. While 80.5% of students knew that the function of kidney is to excrete waste products, 12.6% knew that kidney regulates blood pressure, and 24.3% knew its function of adjusting water content and electrolytes.

**Conclusions:** The level of awareness regarding the term “CKD” was poor in men aged 20–39. Additionally, high school students lacked knowledge of CKD and detailed kidney function. Educational activities for CKD should be more effective for the younger generations, and more in line with their diverse lifestyles. We have just begun activities for promoting CKD health literacy among teenage students, such as through giving lectures in high school classes.

**Funding:** Government Support - Non-U.S.

FR-PO946

**Mechanistic Evaluation and In Vivo Validation of a Novel HIPK2 Inhibitor as Anti-Fibrosis Therapy for Kidney Disease**

Kyung Lee,<sup>1</sup> Ye Feng,<sup>1</sup> Yibang Chen,<sup>1</sup> Richard T. Beresin,<sup>4</sup> Robert Drakas,<sup>2,3</sup> John C. He.<sup>1</sup> <sup>1</sup>Icahn School of Medicine at Mount Sinai Department of Medicine, New York, NY; <sup>2</sup>Rila Therapeutics Inc., San Francisco, CA; <sup>3</sup>Shang Pharma Innovations Inc., San Francisco, CA; <sup>4</sup>ChemPartner Co., San Francisco, CA.

**Background:** HIPK2 is a multifaceted kinase that potentiates key pathways implicated in CKD pathogenesis (i.e., TGF-β/Smad3, NF-κB, Wnt/β-catenin, and p53 signaling). Substantial experimental evidence indicates the renoprotective effects of HIPK2 loss. Since global HIPK2 KO mice are viable, fertile, and without overt defects, HIPK2 is considered an optimal druggable target for CKD and fibrosis. However, some oncogenic concerns remained with p53 inactivation with HIPK2 loss. We recently developed a small molecule HIPK2 inhibitor (HIPK2i) that allosterically inhibits HIPK2-Smad3 interaction without altering its kinase activity. It effectively and selectively mitigated TGF-β/Smad3 signaling in kidney tubular cells and kidney fibrosis, without affecting p53. Based on this parental HIPK2i molecule, we have developed superior HIPK2i analogs, including HIPK2i-174, with improved physicochemical properties with acceptable safety profiles. We examined the specific pathways inhibited by HIPK2i-174 in tubular cells and its effects in vivo.

**Methods:** We examined HIPK2i-174-affected gene expression by RNA sequencing and its effects on Smad3 phosphorylation and protein-protein interaction by IP/MS analysis in kidney cells. To expand the in vivo efficacy profile of HIPK2i-174, we have narrowed the effective dose range of HIPK2i-174 in Tg26 HIVAN model of CKD. We also examined the effects of concurrent treatment of ACE inhibitor, Ramipril, and HIPK2i-174 in Col4a3-deficient Alport syndrome mice.

**Results:** RNAseq analysis confirmed that HIPK2i-174 treatment effectively and selectively blocked TGF-β signaling in primary kidney tubular cells. HIPK2i-174 affected Smad3 phosphorylation and decreased its activity. It inhibited Smad3's interaction with several proteins including TAK, Ezrin, and EIF3F following TGF-β stimulation. In vivo, 30mg/kg dose of HIPK2i-174 was equally effective in attenuating proteinuria and fibrosis in Tg26 mice in comparison to higher doses (60 and 90mg/kg), and concurrent treatment of Ramipril and HIPK2i-174 in Col4a3-deficient Alport syndrome mice showed synergistic renoprotective effects with improved survival rate.

**Conclusions:** New HIPK2i-174 demonstrates favorable drug-like properties, safety profiles, and in vivo efficacy in CKD models, indicating its potential as a novel anti-fibrosis therapy in CKD.

**Funding:** Commercial Support - Rila Therapeutics, Inc.

FR-PO947

**Renal Dysfunction due to Mitral Valve Repair-Induced Hemosiderosis With Partial Recovery After Corrective Surgery**

Nicole Fernandez,<sup>1</sup> Gilad S. Guez,<sup>1</sup> Abdelaziz A. Elsanjak,<sup>1</sup> Christine A. Vanbeek.<sup>2</sup> <sup>1</sup>LewisGale Medical Center, Salem, VA; <sup>2</sup>AmeriPath Inc, Oklahoma City, OK.

**Introduction:** Renal hemosiderosis (RH) occurs when free hemoglobin is filtered by glomeruli and reabsorbed by proximal tubular cells (PTC). Hemosiderin subsequently accumulates within PTC lysosomes. Various conditions associated with intravascular hemolysis may lead to RH. Mechanical hemolysis is a known complication of severe heart valve disease and heart valve replacement. However, biopsy-proven RH is rarely reported following mitral valve (MV) repair. Here, we describe a case of renal dysfunction due to RH after MV repair with follow-up after corrective surgery.

**Case Description:** 77 year-old male with history of severe MV regurgitation and atrial fibrillation. He underwent a MV repair that included triangular resection, primary leaflet repair, and cosgrove posterior annuloplasty ring. This resulted in significant improvement in cardiac function. Baseline serum Cr was 0.9 mg/dL. 3 months post-procedure, he developed gross hematuria. U/A showed 3+ blood, 1+ protein, and 2-5 RBCs. Macrocytic anemia (Hb 7.6 g/dL, MCV 117 fL) and hemolysis (LDH 2,043 U/L, haptoglobin < 20 mg/dL) were also noted. Peripheral smear was negative for schistocytes. Platelet count was normal. Serum Cr was elevated at 2.1 mg/dL. Renal biopsy showed abundant golden refractile granules within PTC cytoplasm on the H&E stain (Fig. 1A), which were confirmed to be hemosiderin on the Prussian Blue stain (Fig. 1B). Arteriosclerosis and mild interstitial fibrosis (~20%) were present. Glomeruli were normal. Transesophageal echo showed new mild MV regurgitation with a posteriorly directed annuloplasty ring and new small ventricular septal defect. He then underwent a corrective surgery. His hemolytic anemia and hemoglobinuria resolved within 2 months and serum Cr improved to 1.3 mg/dL.

**Discussion:** The few prior case reports of MV repair-induced RH had clinical manifestations ranging from asymptomatic urinary abnormalities to renal dysfunction and did not describe repeat surgery. This case demonstrates that corrective surgery can lead to resolution of hemolysis and at least partial recovery of renal dysfunction.

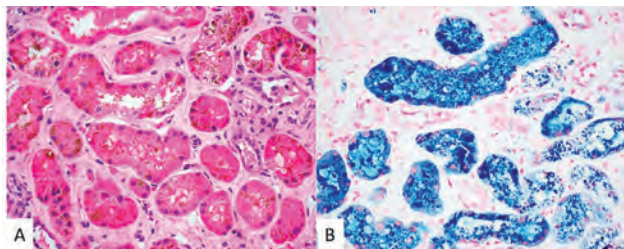

**FR-PO948**

**Coping and Adverse Kidney Outcomes**

Tessa K. Novick,<sup>1</sup> James Custer,<sup>1</sup> Alan B. Zonderman,<sup>2</sup> Michele K. Evans,<sup>2</sup> Melissa D. Hladek,<sup>3</sup> Marie Kuczmarzski,<sup>2</sup> Deidra C. Crews.<sup>3</sup> <sup>1</sup>The University of Texas at Austin Dell Medical School, Austin, TX; <sup>2</sup>National Institute on Aging, Bethesda, MD; <sup>3</sup>Johns Hopkins University, Baltimore, MD.

**Background:** We evaluated whether coping behaviors were associated with incident CKD and rapid kidney function decline, and whether coping behaviors mediated associations between depressive symptoms and outcomes.

**Methods:** We used data from the Healthy Aging in Neighborhoods of Diversity across the Life Span study for this analysis. Adaptive and maladaptive coping behaviors were measured using the Brief COPE Inventory at study visit 1, and analyzed as 2 continuous scales, with higher numbers reflecting higher self-reported use of the coping behaviors. We used multivariable logistic regression to assess the odds of incident CKD (eGFR <60 ml/min/1.73m<sup>2</sup> and ≥25% decline at study visits 3 or 4 in relation to visit 1) and rapid kidney function decline (loss of >3 ml/min/1.73m<sup>2</sup> per year) per point increase in coping scales. We evaluated for mediation of the relationship between depressive symptoms using the Center for Epidemiologic Studies Depression scale at visit 1 and outcomes by coping scales.

**Results:** Among 2336 participants, after a median of 8.2 years of follow-up, incident CKD and rapid kidney function decline occurred in 139 (9%) and 453 (31%) of participants. After multivariable adjustment, higher adaptive coping was associated with reduced odds of incident CKD (adjusted OR 0.97 per 1-point increase in adaptive score, 95% CI 0.95 – 0.99; Table 1). Higher adaptive coping mediated the association between high versus low depressive symptoms and incident CKD (average causal mediation effect [ACME] 0.009, p = 0.03 for adaptive; ACME -0.002, p = 0.90 for maladaptive). Coping behaviors were not associated with rapid decline, nor did they mediate associations between depressive symptoms and rapid decline.

**Conclusions:** Adaptive coping behaviors could represent a target for CKD prevention interventions.

**Funding:** Other NIH Support - National Institute on Aging

Table 1. Primary analysis- associations between coping scales and adverse kidney outcomes.

Exposure	Primary Analysis: OR (95% CI) of the outcome per 1-point increase in coping scale	
	Model 1	Model 2
Incident CKD (N = 1173; Events = 113)		
Adaptive	0.98 (0.95 - 0.998)	0.97 (0.95 - 0.99)
Maladaptive	1.02 (0.98 - 1.05)	1.02 (0.98 - 1.05)
Rapid kidney function decline (N = 1147; Events = 341)		
Adaptive	0.99 (0.98 - 1.00)	0.99 (0.98 - 1.00)
Maladaptive	1.00 (0.98 - 1.02)	1.00 (0.98 - 1.02)

Model 1: coping scales + adjustment for age, sex, race, baseline eGFR, and poverty status.

Model 2: model 1 + adjustment for baseline hypertension and diabetes status.

**FR-PO949**

**Calcific Non-Uremic Arteriolopathy: An Uncommon Disease Presenting Uncommonly**

Stephanie M. Floyd,<sup>1,3</sup> Kristen N. Tillquist,<sup>1,3</sup> Ankur Shah,<sup>2,3</sup> <sup>1</sup>Kent Hospital, Warwick, RI; <sup>2</sup>Rhode Island Hospital, Providence, RI; <sup>3</sup>Brown University Warren Alpert Medical School, Providence, RI.

**Introduction:** Calcific uremic arteriolopathy (CUA) is a rare and devastating disease presenting with painful necrotic ulcers and eschars on extremities and areas of high adiposity, typically in patients with ESKD. It is commonly thought to be a manifestation of dysregulation of parathyroid hormone, calcium and phosphorus metabolism commonly seen in dialysis patients. However, studies have shown a subset of patients without pre-existing kidney disease who develop ‘non-uremic CUA’. We present a rare case of CUA in a patient without CKD in the setting of decompensated alcohol cirrhosis and warfarin use.

**Case Description:** A 39-year-old woman with alcoholic cirrhosis decompensated by encephalopathy, portal vein thrombosis transiently on warfarin, hyponatremia, and paracentesis dependent ascites presented with 2 weeks of bilateral leg pain and rash. Pain predated the lesions which blistered and progressed to a dark purple scabbed area. She had no history of kidney disease or hyperparathyroidism. Presenting exam was notable

for exquisitely tender purpuric plaques on bilateral thighs with right thigh erythema, induration and ulceration. Lab work showed Na 123 mmol/L, sCr 0.99 mg/dL, Ca 9.4 mg/dL, Po4 4.3 mg/dL and iPTH 65 pg/mL. Punch biopsy of the lesions revealed deposition of calcifications around small vessels and adipocyte lobules with fibrin thrombi and ischemic necrosis of the epidermis consistent with calciphylaxis. Sodium thiosulfate (STS) was started, with dose adjustment due to acidemia. Lesions remained stable for much of the hospitalization. Hospital course was complicated by hepatorenal syndrome, hyponatremia, and gastrointestinal bleeding. She developed worsening hemodynamic compromise and expired after transition to hospice.

**Discussion:** This case of CUA in the absence of kidney disease highlights risk factors that should increase clinical suspicion and multidisciplinary approach required to manage this disease. Pain often precedes the development of visible lesions as it did for our patient. Given the severity of the disease there should be a high clinical suspicion prompting early investigation of suspicious lesions. Management includes STS with close monitoring for acidemia. Second line therapies include bisphosphonates and hyperbaric O2. This case highlights underappreciated risk factors, the need for multidisciplinary care, early diagnosis, and difficulty in management.

**FR-PO950**

**IL-33 (Interleukin 33)/ST2 (Interleukin 1 Receptor-Like 1) “Alarmin” Signaling Axis Regulates Innate Immune Response in Kidney Injury**  
Vikram Sabapathy, Gabrielle Costlow, Saleh Mohammad, Sanja Arandjelovic, Rahul Sharma. University of Virginia, Charlottesville, VA.

**Background:** Macrophages (MΦs) following kidney injury play a vital role in inflammation, repair, and fibrosis. MΦs are a highly heterogeneous class of cells that are activated upon tissue injury or inflammation. IL-33 is a nuclear-localized ‘alarmin’ cytokine that is typically released upon tissue damage. IL-33 signals through a receptor complex of IL-1 receptor-like 1 (IL1RL1), also known as ST2. ST2 is expressed in a variety of immune cells, including myeloid-derived cells such as MΦs. The MΦ regulation by IL-33 following its release with respect to kidney injury is unknown.

**Methods:** For myeloid cell-specific deletion of ST2, ST2<sup>fl/fl</sup> mice were crossed with LysM<sup>Cre</sup> mice. To examine the physiological relevance of endogenously expressed ST2+ myeloid cells during renal injury, we performed acute and chronic ischemia perfusion injury studies. The structure and function of the kidney were probed using flow cytometry, histology, immunohistochemistry, quantitative gene expression, and biochemical analysis. The invitro efferocytosis assay, RNA Seq, and Seahorse assay were carried out using peritoneal MΦs and bone-marrow-derived MΦs.

**Results:** We hypothesized that the ST2 receptor could play a vital role in activating and mobilizing immune cells to the injury site. Preliminary results from metanalysis of single-cell RNA seq data analysis indicated high expression of ST2 receptor on macrophages. The *in vivo* data from the acute injury model indicated a loss of ST2 on myeloid cells resulted in attenuation of renal injury. On the contrary, results from the chronic injury model showed absence of IL33/ST2 signaling resulted in exacerbation of injury. Intriguingly, efferocytosis assay on both peritoneal and bone-marrow-derived MΦs demonstrated loss of ST2 on MΦs, resulting in a decrease in functional phagocytosis. Through Seahorse assay, it was also observed that ST2 deficient peritoneal macrophages exhibited altered mitochondrial metabolism. RNA-seq data and gene ontology analysis showed loss of ST2 affects critical genes responsible for macrophage homeostasis.

**Conclusions:** Activation of the IL-33/ST2 signaling axis on MΦs is essential for the regulation of inflammation, apoptosis, and repair in renal tissue during inflammation and injury.

**Funding:** NIDDK Support

**FR-PO951**

**lncRNA Antisense Noncoding RNA in the INK4 Locus (ANRIL) Mediates Endothelial Dysfunction Through Brain-Derived Neurotrophic Factor Downregulation in CKD**

Hong Su, Zhimei Lv, Rong Wang. Department of Nephrology, Shandong Provincial Hospital Affiliated to Shandong First Medical University, Jinan, China.

**Background:** Cardiovascular risk is increased in chronic kidney disease (CKD), endothelial dysfunction is the earliest phenomena of cardiovascular diseases, which could be induced by accumulation of uremic toxins in CKD. long non-coding RNA (lncRNA) antisense non-coding RNA in the INK4 locus (ANRIL) has been reported to be associated with a variety of vascular disease. And evidence also suggested that it may be involved in the occurrence and development of vascular disease in CKD.

**Methods:** The endothelial function in adult patients with CKD were evaluated and plasma ANRIL levels were measured. C57Bl/6J wild type or ANRIL knockout mice subjected to CKD were used to evaluate the role of ANRIL in vascular endothelial injury *in vivo*. Meanwhile, endothelial cells were incubated with serum derived from CKD patients and uremia toxins, then ANRIL expression was detected and the proteins that interact with ANRIL were explored. By making use of the gain- and loss-of-function approaches, ANRIL biological function and underlying mechanism were confirmed.

**Results:** In humans, the circulating ANRIL levels were increased and correlated with vascular endothelial dysfunction in patients with CKD, also negatively correlated with plasma brain-derived neurotrophic factor (BDNF) concentration. Then we found that ANRIL deficiency reversed the endothelial dysfunction and relative BDNF abnormal expression in CKD mice. In addition, serum derived from CKD patients and uremia toxins induced ANRIL upregulation in endothelial cells, and ANRIL mediated endothelial dysfunction through BDNF downregulation. Mechanically, we verified the binding of ANRIL to histone methyltransferase Enhancer of zeste homolog 2 (EZH2). Further

Key: TH - Thursday; FR - Friday; SA - Saturday; OR - Oral; PO - Poster; PUB - Publication Only

Underline represents presenting author.

experiments found increased EZH2 and histone H3 lysine 27 trimethylation levels at the BDNF promoter region. Collectively, we demonstrated that ANRIL mediate BDNF transcriptional suppression through recruitment of EZH2 to the BDNF promoter region, then regulated the proteins expression related to endothelial function.

**Conclusions:** In the present study, we provide the evidence that ANRIL were associated with endothelial dysfunction in CKD, and ANRIL mediated endothelial dysfunction through BDNF downregulation. This may provide a new theoretical basis for the occurrence and development of endothelial dysfunction in CKD.

**Funding:** Government Support - Non-U.S.

#### FR-PO952

### Genetic and Pharmacological Activation of Endothelial Tie2 in Experimental CKD Alleviate Endothelial Injury and Reduces Tubulointerstitial Fibrosis by Decreasing Tubular PDGFB

Riikka S. Pietilä,<sup>1</sup> Susan E. Quaggin,<sup>3</sup> Christer Betsholtz,<sup>1,2</sup> Marie Jeansson.<sup>1,2</sup>  
<sup>1</sup>Uppsala Universitet, Uppsala, Sweden; <sup>2</sup>Karolinska Institutet, Stockholm, Sweden; <sup>3</sup>Northwestern University Feinberg School of Medicine, Chicago, IL.

**Background:** Progressive renal diseases are associated with loss of peritubular capillaries. Both mouse models and patients show a decline of endothelial tyrosine kinase receptor (Tie2) signaling in CKD. We hypothesized that loss of Tie2 signaling in blood vessels leads to endothelial dysfunction, resulting in ischemia and tubular injury with onset of Pdgfb expression. Pdgfb is a mitogen for fibroblasts/pericytes and tubular overexpression leads to activation and ECM production. Furthermore, we investigate if Tie2 activation can alleviate kidney injury in experimental CKD with a Tie2 activating antibody or by genetic deletion of Veptp (a negative Tie2 regulator).

**Methods:** To investigate this, we utilized inducible endothelial specific Tie2 knockout mice with endothelial lineage reporter also crossed to Pdgfra-H2b-GFP as a myofibroblast reporter. Mice were subjected to experimental CKD, the UO model. Capillary density and perfusion, tubulointerstitial fibrosis, and Pdgfb expression were evaluated in renal cortex 1-10 days after UO. To reduce kidney injury by increasing Tie2 signaling, mice with endothelial Veptp deficiency and mice treated with a Tie2 activating antibody were investigated after UO.

**Results:** Endothelial loss of Tie2 in experimental CKD resulted in increased endothelial injury, loss of fenestrations, decreased perfusion, and increased tubulointerstitial fibrosis. We found no colocalization of endothelial lineage reporter and Pdgfra-H2b-GFP, hence, no evidence of endothelial-mesenchymal transition. Treatment with Tie2 activating antibody, or genetic deletion of endothelial Veptp, both reduced endothelial injury and maintained capillary density after UO. UO induced overexpression of Pdgfb was reduced by both Tie2 activating antibody and Veptp knockout as well as tubulointerstitial fibrosis.

**Conclusions:** Our results suggest that endothelial health is upstream of tubulointerstitial fibrosis and therapies to preserve vascular function are essential in CKD. In addition, we demonstrate that Tie2 signaling affects blood vessel function and that Tie2 activating agents should be explored as therapies for patients with CKD.

**Funding:** Private Foundation Support, Government Support - Non-U.S.

#### FR-PO953

### Porcupine in the Kidney Protects Against Nephrotoxic Serum Nephritis by Inhibiting Innate Immune Signals

Xiaohan Lu, Jiafa Ren, Yi Wen, Ting Yang, Steven D. Crowley. Crowley Lab Duke University, Durham, NC.

**Background:** 10% of the world's population suffers from chronic kidney disease (CKD), and glomerulonephritis is a prominent cause of CKD. Wnt/β-catenin signaling can protect the renal tubule by modulating apoptosis and survival pathways. All 19 Wnt ligand isoforms must undergo porcupine (PORCN)-dependent Wnt O-acylation to be secreted. Therefore, we hypothesized that PORCN could mitigate CKD by driving Wnt secretion in the nephron.

**Methods:** To examine the role of tubular PORCN in CKD, we bred 129/SvEv *PORCN<sup>lox/lox</sup>* mice with the Pax8-rtTA and Tet-On lines to generate inducible renal epithelial cell PORCN knockout mice (PORCN iKKO). Mice with all 3 transgenes were used as the PORCN iKKO group, whereas mice lacking Pax8-rtTA or Tet-On transgene acted as wild-type (WT) controls. After 14 days of nephrotoxic serum nephritis (NTS), kidney injury was assessed by BUN, renal pathology, and kidney mRNA levels of injury/fibrosis biomarkers. The expression of cytokines and other innate immune signaling components was determined by real-time PCR. A TNFα antagonist (R7050, 12mg/body weight) was administered by intraperitoneal injection every other day during NTS.

**Results:** At baseline, mRNA levels for PORCN are reduced by 88% in the PORCN iKKO kidneys compared to WT littermates with preserved PORCN expression in other tissues. On day 14 of NTS, PORCN iKKO mice exhibited higher BUNs (202 ± 12 vs. 101 ± 38, mg/dL; p<0.01), and renal mRNA levels for NGAL (6.1±1.14 vs 1.0±0.35 au, p=0.0013), KIM-1(2.5±0.65 vs 1.0±0.26 au, p=0.046), collagen I (2.4±0.31 vs 1.0±0.38 au, p=0.025), and fibronectin (2.5±0.35 vs 1.0±0.27 au, p=0.006) compared to WTs. Renal protein levels for collagen I and fibronectin recapitulated the mRNA patterns. In the diseased kidneys, PORCN iKKO had a higher cytokine mRNA level for TNFα (2.6±0.67 vs. 1.0±0.30 au, p=0.036) than WTs at day 14 NTS. In addition, mRNAs for CD74 (2.7±0.53 vs. 1.0±0.44 au, p=0.038) and OPN (3.6±0.68 vs. 1.0±0.49 au, p=0.012), which are linked in a signaling network that lies downstream of Wnt/β-catenin were significantly increased in PORCN iKKO kidneys during NTS. Blockade of TNFα signaling blunted the exaggerated kidney injury in PORCN iKKO mice.

**Conclusions:** PORCN in the kidney limits autoimmune nephritis severity, suggesting that activation of PORCN-dependent Wnt/β-catenin signaling in the renal tubule may ameliorate CKD.

**Funding:** NIDDK Support

#### FR-PO954

### Cellular Senescence in Repeated Low-Dose Repeated Cisplatin-Induced CKD

Siyao Li,<sup>1,2</sup> Man J. Livingston,<sup>2</sup> Zheng Dong.<sup>2</sup> <sup>1</sup>Central South University, Changsha, China; <sup>2</sup>Augusta University Department of Cellular Biology and Anatomy, Augusta, GA.

**Background:** Recent studies have implicated renal tubular cell senescence in the development of chronic kidney pathologies or CKD after acute kidney injury (AKI). Here we investigate the role of cellular senescence in chronic renal injury following cisplatin exposure, and the therapeutic potential of the senolytic drug ABT-263 in cisplatin-induced AKI to CKD progression.

**Methods:** BUMPT cells and C57/B6 Mice were subjected to repeated low-dose cisplatin (RLDC) treatment for in vitro and in vivo studies, respectively. In BUMPT cells, morphological change and senescence markers were measured after RLDC treatment. The conditioned medium derived from control (CT-CM) or RLDC(RLDC-CM) treated BUMPT cells were added to NRK49F fibroblasts to examine the effects on fibroblasts. Following RLDC treatment, BUMPT cells were treated with ABT-263 to investigate its specificity and validity in killing senescent cells. Clonogenic assay was conducted to test the pro-regenerative effect of ABT-263. In vivo, after 4wks of RLDC treatment, mice were given 4 consecutive cycles of ABT-263 injection. Then, GFR was monitored, and the mice were sacrificed 1 day later to collect blood and kidney tissues for analysis.

**Results:** In Vitro, RLDC induced an enlarged and flattened morphology in BUMPT cells, and decreased cell proliferation. These cells showed notably increased fibrotic markers and typical senescent changes, including positive SA-βgal staining, increases of p21, p53, decreases of LaminB1, and elevated transcription of CDKN1A and CDKN2A. Moreover, RLDC-CM induced higher expression of fibrotic markers in NRK49F cells, indicating the production and secretion of pro-fibrotic factors by RLDC-treated tubular cells. ABT-263 selectively killed senescent cells and promoted cell regeneration as shown by higher clonogenic activities. In Vivo, ABT-263 suppressed the expression of p53, p21 and p16, abolished SA-β gal staining, and decreased the γH2AX/Ki67<sup>+</sup> senescent cells. Mice treated with ABT-263 after RLDC showed improved renal function, better kidney structure, and attenuated fibrosis.

**Conclusions:** Tubular cell senescence is an important factor in the pathogenesis of chronic kidney problems following cisplatin exposure. Clearance of senescent cells by senolytic drugs may be a useful therapeutic strategy for improving kidney repair and functional recovery after cisplatin chemotherapy in cancer patients.

**Funding:** NIDDK Support, Veterans Affairs Support

#### FR-PO955

### Cooperative Action of p53 and Autophagy Delays Kidney Aging by Suppressing DNA Damage and the Senescence-Associated Secretory Phenotype

Satoshi Minami,<sup>1</sup> Takeshi Yamamoto,<sup>1</sup> Yoshitsugu Takabatake,<sup>1</sup> Atsushi Takahashi,<sup>1</sup> Tomoko Namba,<sup>1</sup> Jun Matsuda,<sup>1</sup> Shinsuke Sakai,<sup>1</sup> Jun Nakamura,<sup>1</sup> Shihomi Maeda,<sup>1</sup> Sho Matsui,<sup>1</sup> Motoko Yanagita,<sup>2</sup> Yoshitaka Isaka.<sup>1</sup> <sup>1</sup>Department of Nephrology, Osaka University Graduate School of Medicine, Suita, Japan; <sup>2</sup>Department of Nephrology, Kyoto University Graduate School of Medicine, Kyoto, Japan.

**Background:** p53 is a crucial tumor suppressor and has long been recognized to suppress cancer through the induction of cell-cycle-arrest or apoptosis programs. Recently the diverse and global functions of p53 in the kidney under disease pathogenesis, especially acute kidney injury (AKI), has been studied intensively; however, its pathophysiological role in kidney aging remains uncertain.

**Methods:** Using proximal tubular epithelial cell (PTEC)-specific *p53*-deficient (*p53<sup>fl/fl</sup>*-TSKO) mice and PTEC-specific *atg5*-deficient (*atg5<sup>fl/fl</sup>*-TSKO) mice, we investigated the role of p53 and a possible interplay between p53 and autophagy in the aged kidney. To examine whether and how the interaction between p53 and autophagy impinges on kidney aging, we assessed the phenotypes of PTEC-specific *p53* and *atg5*-deficient (TSDKO) mice at 24 months.

**Results:** *p53<sup>fl/fl</sup>*-TSKO at 24 months exhibited DNA damage, thereby upregulating autophagy. On the other hand, aged *atg5<sup>fl/fl</sup>*-TSKO mice activated p53. Aged TSDKO mice deteriorated renal histology and function, accompanied by accelerated tubular senescence and the senescence-associated secretory phenotype (SASP), thus facilitating tertiary lymphoid tissues (TLTs) development. Mechanistically, autophagy suppressed the SASP by degrading cytoplasmic chromatin fragments (CCFs) in aged kidneys.

**Conclusions:** p53 and autophagy cooperatively delay kidney aging by suppressing DNA damage and the SASP. These findings provide key insights into the pathophysiology of kidney aging and clues to a novel intervention that might prevent age-related kidney disease and maintain kidney health.

**Funding:** Commercial Support - Scientific Research from the Ministry of Education, Culture, Sports, Science and Technology and Osaka Kidney Bank, Government Support - Non-U.S.

## FR-PO956

**Empagliflozin Reduces Kidney Fibrosis and Improves Kidney Function by Alternative Macrophage Activation in Rats With 5/6-Nephrectomy**

Hongwei Wu, Berthold Hoher. *Universitätsklinikum Mannheim, Mannheim, Germany.*

**Background:** Sodium glucose cotransporter 2 (SGLT2) inhibitors originally developed for the treatment of type 2 diabetes are clinically very effective drugs halting chronic kidney disease progression. The underlying mechanisms are, however, not fully understood.

**Methods:** We generated single-cell transcriptomes of kidneys from rats with 5/6 nephrectomy before and after SGLT2 inhibitors treatment by single-cell RNA sequencing.

**Results:** Empagliflozin treatment decreased BUN, creatinine, and urinary albumin excretion compared to placebo by 39.8%, 34.1%, and 55%, respectively ( $p < 0.01$  in all cases). Renal interstitial fibrosis and glomerulosclerosis were likewise decreased by 51% and 66.8%; respectively ( $p < 0.05$  in all cases). 14 distinct kidney cell clusters could be identified by scRNA-seq. The polarization of M2 macrophages from state 1 (CD206<sup>+</sup>CD68<sup>+</sup> M2 macrophages) to state 5 (CD206<sup>+</sup>CD68<sup>+</sup> M2 macrophages) was the main pro-fibrotic process, as CD206<sup>+</sup>CD68<sup>+</sup> M2 macrophages highly expressed fibrosis-promoting genes and can convert into fibrocytes. Empagliflozin remarkably inhibited the expression of fibrosis-promoting (*IFG1* and *TREM2*) and polarization-associated genes (*GPNMB*, *LGALS3*, *PRDX5*, and *CTSB*) in CD206<sup>+</sup>CD68<sup>+</sup> M2 macrophages and attenuated inflammatory signals from CD8<sup>+</sup> effector T cells. The inhibitory effect of empagliflozin on CD206<sup>+</sup>CD68<sup>+</sup> M2 macrophages polarization was mainly achieved by affecting the mTOR-mitophagy pathway.

**Conclusions:** The beneficial effects of empagliflozin on kidney function and morphology in 5/6 nephrectomized rats with established CKD are at least partially due to an inhibition of CD206<sup>+</sup>CD68<sup>+</sup> M2 macrophage polarization by targeting mTOR and mitophagy pathways and attenuating inflammatory signals from CD8<sup>+</sup> effector T cells.

**Funding:** Private Foundation Support

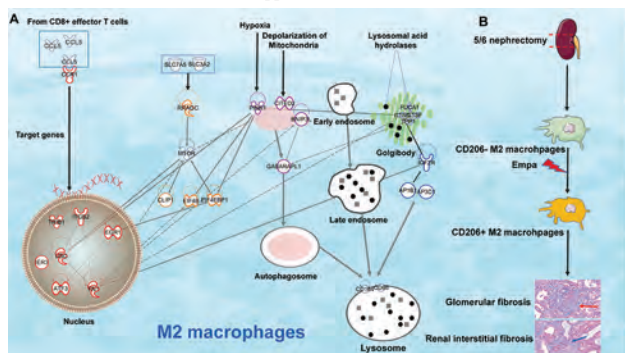

The mechanism map for CD206<sup>+</sup>CD68<sup>+</sup> M2 macrophages polarization and the target effects of empagliflozin on kidney fibrosis

## FR-PO957

**Excessive Mitochondrial Copper Load Driven by Upregulated Copper Transporter 1 Contributes to Mitochondrial Dysfunction and Renal Fibrosis**

Saiya Zhu, Chen Yu. *Shanghai Tongji Hospital, Shanghai, China.*

**Background:** Copper is an essential trace element for eukaryotes. Our previous study indicated that intracellular copper overload plays an important role in renal fibrosis. However, the underlying mechanism remains largely unknown. In this study, we found copper ions in cells were mainly accumulated in mitochondria, which damage the structure and function of mitochondria. Furthermore, copper transporter 1 (CTR1), the major transporter for copper influx, was significantly increased in fibrotic kidneys. The activity of cytochrome c oxidase (COX), a copper coenzyme mediating the final step in the electron transport chain, was decreased. Downregulation of CTR1 decreased mitochondrial copper overload. Therefore, we proposed that CTR1 might be involved in mitochondrial copper overload and renal fibrosis.

**Methods:** Expression of CTR1 was examined in fibrotic kidneys of patients, ischemia-reperfusion injury (IRI 28d) mice model and TGF- $\beta$ 1-treated tubular epithelial cells. We also use stable CTR1 knockdown cell lines in vitro, and in vivo, we use CTR1 transgenic mice subjected to IRI operation. Copper chelator tetrathiomolybdate (TM), ICP-MS, mitoSOX Red, electron microscopy, realtime-PCR and western blot analysis were applied in the current study.

**Results:** We found that stimulated by TGF- $\beta$ 1, COX activity was declined. Mitochondria and cytosol, especially mitochondria, accumulated a large amount of copper in fibrotic kidney tissues. Furthermore, we found CTR1 expression was increased in fibrotic kidneys from chronic kidney disease patients, in vivo and in vitro. More importantly, compared to WT mice, CTR1<sup>-/-</sup> mice subjected to ischemia-reperfusion injury (IRI) had reduced mitochondrial copper level, and ameliorated mitochondrial function and renal fibrosis, as evidenced by improving mitochondrial structure, inhibiting mROS

production and reducing expression of  $\alpha$ -smooth muscle actin ( $\alpha$ -SMA), collagen I and fibronectin. In addition, mitochondrial function and kidney fibrosis were improved in IRI mice kidney after TM treatment.

**Conclusions:** Collectively, our study showed that copper overload in mitochondria could damage mitochondrial function and lead to renal fibrosis. Among which CTR1 plays an incomparable role in the mitochondrial copper overload. Copper overload inhibits the activity of COX and impairs mitochondria, subsequently leading to renal fibrosis.

## FR-PO958

**Kidney Tubule Polyploidization Is a Novel Target to Block CKD Progression After AKI**

Letizia De Chiara, Elena Lazzeri, Paola Romagnani. *Universita degli Studi di Firenze, Firenze, Italy.*

**Background:** Acute Kidney Injury (AKI) is characterized by a rapid deterioration of kidney function and represents a global healthcare issue. In addition, AKI survivors frequently develop chronic kidney disease (CKD). Tubular epithelial cells (TC) respond to AKI by triggering polyploidy, a condition in which a normally diploid cell acquires additional sets of chromosomes. Polyploidy offers several advantages and in the kidney we have demonstrated to be an adaptive response to survive after AKI. However, polyploidization in the absence of damage drives CKD progression. Building on these novel paradigms we hypothesized that: 1) polyploid TC are a heterogeneous population with distinctive features and 2) polyploid TC may represent a novel target to successfully prevent CKD progression.

**Methods:** We employed in vivo models based on the Fluorescence Ubiquitin Cell Cycle Indicator (FUCCI) technology in combination with YAP1 modulation or conditional deletion. In these models, mice were subjected to ischemia reperfusion injury or nephrotoxic AKI. Mice were treated with different combination of compounds at different times and analyzed by single cell-RNA sequencing (scRNA-seq) analysis, cell sorting, FACS analysis, super-resolution microscopy.

**Results:** After AKI, YAP1 is activated triggering TC polyploidization. Conditional TC deletion of YAP1 resulted in a reduced number of polyploid cells, worsened kidney function and a dramatic reduction of mouse survival. However, delayed block of YAP1-driven polyploidy after AKI by pharmacological inhibition prevented AKI-CKD transition by attenuating continuous cycles of polyploidization in TC. Senolytic therapy proved that cycling polyploid TC were responsible for the senescent profibrotic phenotype acquired over the time by polyploid TC and the primary trigger of CKD progression. scRNA-seq and tubular specific YAP1 deletion triggered after AKI excluded any systemic effect of compound administration and demonstrated that the observed protective effect is mediated exclusively by TC and not by other cells.

**Conclusions:** In conclusion, we demonstrated that: 1) continuously cycling polyploid TC and not growth arrested polyploid TC are senescent and the primary driver of CKD; 2) blocking cycling polyploid TC in the right window of opportunity is sufficient to prevent AKI-CKD transition with important translational implications in clinical setting.

## FR-PO959

**Hematopoietic Cell Kinase (HCK) Is a Key Regulator of Macrophage Function in Kidney Fibrosis**

Chengguo Wei, Man Chen, Weijia Zhang, Kyung Lee, John C. He. *Icahn School of Medicine at Mount Sinai Department of Medicine, New York, NY.*

**Background:** Our previous study identified HCK as a regulator of renal fibrosis. We recently find HCK could regulate autophagy in macrophages. Here we tested HCK's role in macrophage function in the context of renal fibrosis.

**Methods:** Bone marrow-derived macrophage (BMDM) and RAW264.7 macrophage in vitro and UUO in vivo for global, macrophage HCK-KO and WT mice were used to determine the effects of HCK on macrophage autophagy and activation.

**Results:** Single cell sequencing data confirmed that HCK is mainly expressed in macrophages (Fig. 1A). IP/MS identified HCK interacts with autophagy proteins ATG2A and CBL(data not shown) and confirmed by IP/WB (Fig. 1B) in macrophage cell line RAW264.7. KO of HCK increased autophagy activity as increased LC3II/LC3I ratio and decreased P62 in BMDM (Fig. 1C). We also found KO of HCK decreased macrophage M1 polarization and increased M2 polarization in BMDM by qPCR, WB(Fig. 1D, 1E), and flow cytometry (Fig. 1F). In the UUO model, we found that global and macrophage-specific HCK-KO mice had significantly attenuated tubulointerstitial fibrosis with decreased mRNA profibrotic markers (Fig. 2C) and Masson's trichrome staining (Fig. 2D, 2E).

**Conclusions:** HCK promotes kidney fibrosis by suppressing macrophage autophagy and inducing macrophage polarization.

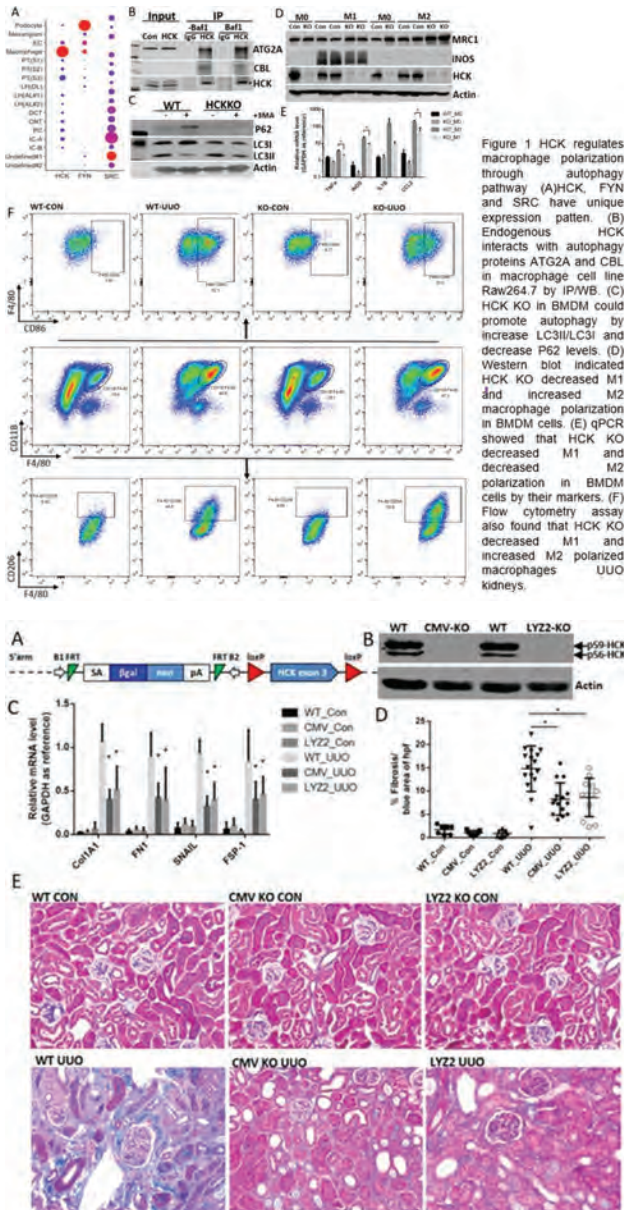

**Figure 1** HCK regulates macrophage polarization through autophagy pathway (A)HCK, FYN and SRC have unique expression pattern. (B) Endogenous HCK interacts with autophagy proteins ATG2A and CBL in macrophage cell line Raw264.7 by IP/WB. (C) HCK KO in BMDM could promote autophagy by increase LC3II/LC3I and decrease P62 levels. (D) Western blot indicated HCK KO decreased M1 and increased M2 macrophage polarization in BMDM cells. (E) qPCR showed that HCK KO decreased M1 and decreased M2 polarization in BMDM cells by their markers. (F) Flow cytometry assay also found that HCK KO increased M1 and increased M2 polarized macrophages UUO kidneys.

colony formation, apoptosis, cell cycle and RNA-seq analysis were performed in tubular epithelium cells to explore the mechanism of SP/NK-1R.

**Results:** SP and NK-1R were overexpressed in renal tubular epithelial cells of mice after UUO. In addition, pharmacological and genetic inhibition of NK-1R resulted in reduction of interstitial inflammation, fibrosis and renal cell apoptosis, whereas SP treatment aggravated UUO-induced progressive damage. *In vitro*, SP administration suppressed growth of NK-1R-overexpressed HK-2 cells with and without SP treatment were mainly enriched in MAPK signaling. Consistently, phosphorylated p38/JNK levels were increased in SP-treated cells and mice obstructed kidneys. Furthermore, inhibition of NK-1R decreased expression of phosphorylated p38/JNK in SP-treated cells and mice subjected to UUO. In support, the p38 or JNK specific inhibitors partly alleviated SP-mediated effect, and intriguingly, combined use of p38/JNK inhibitors further ameliorated it.

**Conclusions:** These results demonstrate that neuropeptide SP/NK-1R axis plays an important role in kidney interstitial fibrosis via activating the MAPK pathway of renal tubular epithelial cells, which may be a promising therapeutic target for chronic kidney disease.

**FR-PO961**

**Arginine Metabolism Regulates the Transcription Factor Nrf2 and Prevents Renal Interstitial Fibrosis Through Tubular Spermidine Production**

Seishi Aihara, Kumiko Torisu, Toshiaki Nakano, Takanari Kitazono. *Kyushu University, Fukuoka, Japan.*

**Background:** Our previous research showed that arginase 2 (ARG2) is a mediator of ischemia-reperfusion injury in the kidney through regulation of nitrosative stress. However, the physiologic role of ARG2 or the metabolite polyamines in renal interstitial fibrosis remains poorly understood.

**Methods:** Metabolic change in kidney fibrosis was examined using unilateral ureteral obstruction (UUO) model mice by mass spectrometry. In human proximal tubule cells (HK-2), changes in expression of ARG2 and its metabolites, polyamines and spermidine (Spd), during oxidative stress were examined. The effects of Spd on Nrf2 activation and autophagy were investigated. UUO models of wild type and Arg2 knockout (KO) mice were employed and kidney fibrosis was evaluated.

**Results:** "Arginine and proline metabolism" and "arginine biosynthesis" were most altered in UUO kidney. In HK-2 cells, the expression of ARG2 and polyamines were increased in hydrogen peroxide-treated cells. Furthermore, the polyamines and Spd were decreased in ARG2 knockdown. Spd strongly induced Nrf2, an antioxidant transcription factor, accompanied with induced expression of target genes and also strongly induced autophagic flux. Fibrotic signals such as TGFβ1 and collagen I in renal tubules were suppressed by Spd. The kidney of mice lacking Arg2 showed significantly exacerbated fibrosis and increased expression of collagen I, αSMA and TGFβ compared to the wild type UUO kidney. An activation of Nrf2 and downstream gene expression were suppressed in Arg2 knockout UUO kidneys.

**Conclusions:** Our data support that arginine metabolism is activated to produce Spd, which activates Nrf2 and autophagy, resulting in a protective effect against kidney fibrosis.

**FR-PO962**

**The Protective Role of GPER1 Against Renal Fibrosis**

Xiangchen Gu,<sup>1,2</sup> Lin Xie,<sup>2</sup> Min Chen,<sup>2</sup> Yi Wang,<sup>2</sup> Jingyuan Xie.<sup>1</sup> *<sup>1</sup>Department of Nephrology, Shanghai Ruijin Hospital, Shanghai Jiao Tong University School of Medicine, Shanghai, China; <sup>2</sup>Department of Nephrology, Yueyang Hospital of Integrated Traditional And Western Medicine, Shanghai University of Traditional Chinese Medicine, Shanghai, China.*

**Background:** Male patients have a higher prevalence of CKD and increased rates of ESRD than those observed in female patients. Many factors are believed to be involved in this phenomenon. Whether GPER1(G protein-coupled estrogen receptor1), a de-novo estrogen receptor, plays a protective role against renal fibrosis remains unclear.

**Methods:** Using CRISPR/Cas9 gene-editing technique, we generated *Gper1* global knockout mice. We subjected the mice to Aristolochic acid(AA) and Folic acid(FA) injection. We further analyzed the differentially expressed genes by bulk RNA-sequencing. We also cultured primary tubular epithelial cells from wild-type and *Gper1*<sup>-/-</sup> mice and treated the cells with TGFβ1. Finally, we treated AA-injected and FA-injected mice with a GPER1 agonist.

**Results:** In both AA and FA injection models, *Gper1* knockout mice exhibited more severe renal fibrosis, increased inflammation infiltration, and decreased fatty acid oxidation, compared to wild-type mice. Bulk RNA sequencing also indicated a down-regulation of fatty acid oxidation and upregulation of inflammation in *Gper1*<sup>-/-</sup> renal tissues. In primary cell culture, TGFβ1-treated *Gper1*<sup>-/-</sup> TECs showed a reduction in the fatty acid oxidation pathway. Further, GPER1 agonist ameliorated renal fibrosis in AA-injected and FA-injected mouse models.

**Conclusions:** These results suggest that GPER1 may play a protective role against renal fibrosis through the fatty acid oxidation pathway. Activation of GPER1 expression may provide a new therapeutic target for CKD treatment.

**Funding:** Government Support - Non-U.S.

**FR-PO960**

**The Neuropeptide SP/NK-1R Axis Promotes Renal Interstitial Fibrosis via MAPK Pathway in Unilateral Ureteral Obstruction Mice**

Enyi Zhu, Ming Zhong, Yang Liu, Yu Liu, Jinhong Li, Zhihua Zheng. *The Seventh Affiliated Hospital Sun Yat-sen University, Shenzhen, China.*

**Background:** Renal interstitial fibrosis is considered to be the major contributor to chronic progressive kidney function loss, and suggested as a significant predictor of renal survival in chronic kidney disease. The potential mechanism which initiates the profibrogenic process during kidney injury is not completely understood. Substance P (SP) is a proinflammatory neuropeptide that binds to its high-affinity receptor neurokinin-1 receptor (NK-1R) and it has been involved in multiple fibrotic diseases. However, the role of SP/NK-1R axis in renal interstitial fibrosis is largely undefined.

**Methods:** To investigate the role of SP/NK-1R in renal interstitial fibrosis, mice were administrated with NK-1R pharmacological inhibitor or SP during unilateral ureteral obstruction (UUO) and NK-1R<sup>-/-</sup> mice were subjected to UUO. Cell counting,

## FR-PO963

**Macrophage-Specific Deletion of Cytosolic Nucleotide Sensors Ameliorates Kidney Fibrosis and Inflammation**

Andrea Sanchez-Navarro, Poonam Dhillon, Katalin Susztak. *University of Pennsylvania, Philadelphia, PA.*

**Background:** The cytosolic DNA sensors, such as cGAS-STING are part of the innate immune system providing the first line of defense against cytosolic viruses and prime and activate the adaptive immune system. Our previous studies suggested that global deletion or pharmacological inhibition of STING ameliorates fibrosis. Here we analyzed the cell-type specific role of cGAS-STING.

**Methods:** We generated a macrophage-specific cGAS and STING knockout mice by crossing the cGAS<sup>flx</sup> and STING<sup>flx</sup> mice with Ly2z-Cre animals. We induced kidney injury by unilateral ureteral obstruction (UUO) or cisplatin injection. The degree of kidney injury was estimated based on blood biomarkers, BUN, creatinine, renal histology and kidney gene and protein expression changes by QRT-PCR and Western blots, respectively. We studied macrophages (RAW264.7) cells in vitro using cGAS and STING siRNA.

**Results:** Mice with macrophage-specific deletion of cGAS or STING was healthy at baseline. Wild type cisplatin injected animals had increased expression of kidney injury markers (Ngal, Kim1), which was lower in cGAS and STING knock-out mice. UUO mice showed higher expression of fibrosis associated markers, which again was ameliorated in macrophage specific cGAS and STING knock-out mice. Markers of inflammation Mcp1, Interleukin-6 (Il-6) and Interleukin-1 $\beta$  (Il-1 $\beta$ ) was markedly lower in both models. Expression of Il-6 and Il-1 $\beta$  was lower peritoneal macrophages isolated from Ly2zCre-STING mice. Moreover, silencing STING in cultured mice macrophages cell line ameliorated M1 pro-inflammatory polarization and enhanced M2 anti-inflammatory polarization.

**Conclusions:** cGAS-STING mediated macrophage polarization play an important role in the inflammatory and profibrotic response in kidney injury and fibrosis.

**Funding:** NIDDK Support

## FR-PO964

**Transcription Factor Foxp2 Promotes TGF- $\beta$ 1-Induced Kidney Fibrosis in Obstructive Nephropathy**

Yixin Zou, Wai Han Yiu, Sarah W.Y. Lok, Jingyuan Ma, Loretta Y.Y. Chan, Sydney C. Tang. *The University of Hong Kong, Hong Kong, Hong Kong.*

**Background:** Forkhead Box P2 protein (Foxp2) is a transcription factor involved in multiple biological activities including organ development, tissue injury and tumor growth. Recent studies showed that Foxp2 regulates epithelial-mesenchymal transition (EMT) during tumorigenesis. Given that EMT is a crucial process in kidney fibrosis, we aim to investigate whether Foxp2 has a functional role in the progression of chronic kidney disease.

**Methods:** Foxp2 expression was evaluated in cultured tubular epithelial cells (C1.1) treated with TGF- $\beta$ 1 (10ng/mL). Foxp2 was knocked down by siRNA prior to TGF- $\beta$ 1 stimulation. Tubule-specific Foxp2 knockout (Ksp-Foxp2 KO) mice and wild type control (WT) were generated by Cre-LoxP strategy and subjected to unilateral ureteral obstruction (UUO). Kidneys were collected at day 7 after UUO for the assessment of kidney fibrosis by real-time qPCR, Western blotting and immunohistochemical staining.

**Results:** In C1.1 cells, FoxP2 expression was significantly induced by TGF- $\beta$ 1, which was partly inhibited by Smad3-specific inhibitor. Knocking down FoxP2 significantly suppressed the expression levels of TGF- $\beta$ 1-induced fibrotic markers collagen 1, PAI-1 and restored the loss of epithelial marker E-cadherin. In the UUO kidneys, TGF- $\beta$ 1 expression level was lower in Ksp-Foxp2 KO group compared to that of WT. Collagen deposition and expression of fibrosis markers fibronectin and PAI-1, and macrophage infiltration were greatly reduced in UUO kidneys from Foxp2 KO compared to WT group.

**Conclusions:** Foxp2 promotes TGF- $\beta$ 1-induced EMT and fibrotic changes in obstructed kidneys and may become a novel therapeutic target for kidney fibrosis.

**Fundings:** Research Grants Council of Hong Kong (General Research Fund, grant no.17108719) and Hong Kong Society of Nephrology/Hong Kong Kidney Foundation Research Grant 2020

## FR-PO965

**STING Facilitates Renal Fibrosis Induced by Ischemia-Reperfusion Injury Through Regulation of Glycolysis**

Anni Jiang. *Department of Nephrology, Union Hospital, Tongji Medical College, Huazhong University of Science and Technology, Wuhan, China.*

**Background:** Renal fibrosis is the main pathological manifestation of chronic kidney disease (CKD). Studies have shown that the hypoxic microenvironment caused by ischemia-reperfusion injury (IRI) plays a key role in the progression of CKD, but the specific mechanism is not clear. A recent research hotspot, stimulator of interferon genes (STING), has been shown to have an important role in immune and inflammatory responses associated with kidney diseases, and its functional significance in the field of CKD remains poorly understood. Our aim was to investigate the role and mechanism of STING in IRI-associated renal fibrosis.

**Methods:** Wild-type C57BL/6J male mice were selected to interfere with the expression of STING by renal injection of STING lentivirus and intraperitoneal injection of STING inhibitor C-176. The model of IRI was established by unilateral renal pedicle clamping, and the mice were euthanized 7 days after reperfusion. In vitro, human kidney 2 (HK2) transfected with STING lentivirus were stimulated by hypoxia for 48 hours. Blood was collected from mice for serum biochemistry, and kidney tissue and HK2 cells

were collected to detect the expression of STING and glycolysis changes (extracellular acidification rate, hexokinase activity and phosphofructokinase activity). The interaction of STING and its downstream interferon regulatory factor 3 (IRF3) with 6-phosphofructo-2-kinase/fructose-2,6-biphosphatase 3 (PFKFB3) was detected by immunoprecipitation.

**Results:** The expression of STING increased significantly in the model of renal fibrosis induced by IRI. In vitro, hypoxic stimulation caused epithelial mesenchymal transformation (EMT) in HK2 cells with concomitant upregulation of STING expression. Seven days after IRI, fibrosis markers and glycolysis levels were less elevated in the kidneys of mice with inhibited STING expression than in those of wild-type mice. Immunoprecipitation showed that STING/IRF3 interacted with PFKFB3 and that inhibition of STING expression in HK2 cells reduced the level of hypoxia-induced glycolysis and blocked EMT.

**Conclusions:** STING activated in hypoxic environment regulates the level of glycolysis through IRF3/PFKFB3 pathway, which leads to EMT in renal tubular epithelial cells and promotes the progression of renal fibrosis. Down-regulation of STING attenuates IRI-induced renal fibrosis by inhibiting the level of glycolysis.

**Funding:** NIDDK Support

## FR-PO966

**RIPK3-MLKL Signaling Drives Mitochondrial Dysfunction and Kidney Fibrosis During CKD**

Anjali Srivastava, Bhawna Tomar, Shrikant R. Muly. *CSIR-Central Drug Research Institute, Lucknow, India.*

**Background:** TGF $\beta$  is believed to be a major driver of kidney fibrosis involved in all forms of chronic kidney diseases (CKD). Despite several reports, anti-TGF $\beta$  therapies have consistently failed to reduce kidney fibrosis in CKD patients indicating the need for novel therapeutic strategies. Here, we aim to investigate the molecular mechanisms of kidney fibrosis during CKD.

**Methods:** We performed a series of in-vitro and in-vivo experiments using murine fibroblasts cell lines and an oxalate-induced CKD mouse model, respectively. We used biochemical analysis, RNA sequencing, histology, immunohistochemistry, immunoblotting, etc. techniques to understand the extent of injury, inflammation, and fibrosis in the kidney.

**Results:** First we analyzed increased expressions of necroptosis signaling molecules (RIPK1, RIPK3, MLKL) and profibrotic markers in both humans and oxalate-induced mice fibrotic kidneys subjected to RNA seq. Next, using CRISPR/Cas9 we generated stable Ripk3 and Mlkl-deficient murine fibroblasts. Further, we suppressed the expression of RIPK3 and MLKL specifically in kidneys by renal intraparenchymal injections of lentivirus containing CRISPR gRNAs for either RIPK3 or MLKL along with Cas9 protein preceding oxalate-induced CKD. Knockdown of either RIPK3 or MLKL exerted overall renoprotective effects and mtTGF $\beta$ -induced fibrotic response. Moreover, CKD mice were administered either TGF $\beta$  signaling inhibitor SIS3 or RIPK1 inhibitor necrostatin-1s, RIPK3 inhibitor dabrafenib with or without SIS3. Similarly, fibroblasts were treated with inhibitors before mtTGF $\beta$  exposure. Inhibition of RIPK3 or MLKL also prevented overall fibrotic response. Interestingly, mtTGF $\beta$  exposed RIPK3-MLKL deficient fibroblasts did not induce mitochondrial ROS. Declined mitochondrial genes expression and impaired oxidative phosphorylation was observed in CKD mice kidneys subjected to RNA seq. Also, we observed RIPK3-MLKL translocation on mitochondria isolated from oxalate-induced CKD mice kidneys and mtTGF $\beta$  exposed fibroblasts, confirming that mitochondrial RIPK3 and MLKL translocation induce mitochondrial dysfunction.

**Conclusions:** We show that TGF $\beta$  induces translocation of RIPK3-MLKL to mitochondria, where it induces ROS production subsequently leading to Smad2/3 phosphorylation and ECM production. Together, RIPK1, RIPK3, MLKL, and Smad2/3 are molecular targets to inhibit kidney fibrosis during CKD.

**Funding:** Government Support - Non-U.S.

## FR-PO967

**Reduction of DUSP4 Enhances Macrophage Infiltration and Contribution to Renal Fibrosis**

Marina Rousseau, Pedro M. Geraldes. *Universite de Sherbrooke, Sherbrooke, QC, Canada.*

**Background:** Chronic kidney disease (CKD) affects 15% of the world population and is the leading cause of end-stage kidney disease in which 45% of patients are patients with diabetes. Patients with advanced CKD will eventually need dialysis or renal transplantation. Renal interstitial fibrosis (RIF) is an essential characteristic of CKD and is associated with renal function decline. Although macrophages are known to play a role in the generation of fibrosis, their contribution to RIF is not well elucidated. Our laboratory has previously shown reduced DUSP4 expression in the kidney of diabetic mice and patients, and the deletion of DUSP4 in diabetic mice lead to RIF. Objective: Evaluate the role of DUSP4 in macrophage related RIF generation.

**Methods:** Mice with (*Dusp4*<sup>WT</sup>) or without DUSP4 (*Dusp4*<sup>KO</sup>) were subjected to toxin- (4 weeks of adenine-rich diet) and obstructive-induced (UUO) RIF. Renal function was evaluated by 24-hour urinary albumin excretion. To evaluate the role of DUSP4 in macrophage infiltration, *Dusp4*<sup>WT</sup> and *Dusp4*<sup>KO</sup> were irradiated and transplanted with the bone marrow of the opposite group (generating WT mice specifically DUSP4 KO in the macrophages (*Dusp4*<sup>WT/m $\Phi$ KO</sup>) and DUSP4 null mice with regular expression of DUSP4 in the macrophages (*Dusp4*<sup>KO/m $\Phi$ WT</sup>)).

**Results:** The adenine diet increased albuminuria in *Dusp4*<sup>WT</sup> mice, phenomenon exacerbated in DUSP4 null mice. Adenine and UUO models were associated with increased RIF (Masson Trichrome), RIF markers (Col1, TGF- $\beta$ , KIM-1 gene expression), macrophage infiltration (F4/80 immunohistochemistry), inflammation

Key: TH - Thursday; FR - Friday; SA - Saturday; OR - Oral; PO - Poster; PUB - Publication Only

Underline represents presenting author.



markers (IL-1 $\beta$ , TNF- $\alpha$  and CD206 gene expressions), and myofibroblast deposition ( $\alpha$ -SMA immunohistochemistry) in *Dusp4*<sup>WT</sup> mice. DUSP4 deletion worsened the above characteristics as well as aggravated tubular atrophy. Furthermore, macrophage and myofibroblast markers colocalized in the interstitial space of *Dusp4*<sup>WT</sup> mice, suggesting macrophage contribution to RIF. Interestingly, the adenine diet administered to *Dusp4*<sup>WT/m $\phi$ KO</sup> mice worsened albuminuria to levels similar to *Dusp4*<sup>KO</sup> mice, while *Dusp4*<sup>KO/m $\phi$ WT</sup> albuminuria levels were lower. Likewise, *Dusp4*<sup>WT/m $\phi$ KO</sup> exhibited similar amounts of RIF compared to whole-body *Dusp4*<sup>KO</sup> mice while *Dusp4*<sup>KO/m $\phi$ WT</sup> exhibited lower levels of RIF compared to whole-body *Dusp4*<sup>KO</sup> mice.

**Conclusions:** The loss of DUSP4 in macrophages contributes to macrophage infiltration and total RIF in the progression of CKD.

**Funding:** Government Support - Non-U.S.

## FR-PO968

### Integrin-Linked Kinase Depletion Exerts Protective Effects in Vascular Fibrosis Associated With CKD

Sofia Campillo de Blas,<sup>1,2</sup> Elena Gutierrez Calabres,<sup>1,2</sup> Mariano de la Serna,<sup>3,2</sup> Natalia Canales Bueno,<sup>2,1</sup> Cristina González Valero,<sup>1,2</sup> Mercedes Griera,<sup>1</sup> Sergio De frutos garcia,<sup>4</sup> Diego Rodriguez puyol,<sup>5,6</sup> Laura Calleros,<sup>1,2</sup>  
<sup>1</sup>Department of Systems Biology, Physiology Unit, University of Alcalá, Alcalá de Henares, Spain; <sup>2</sup>NOVELREN, Instituto Ramon y Cajal de Investigación Sanitaria (IRYCIS), Fundacion Renal Iñigo Alvarez de Toledo (FRIAT) and REDinREN, (ISCIII), Madrid, Spain; <sup>3</sup>Biomedical Research Foundation, Hospital Universitario Principe de Asturias, Alcalá de Henares, Spain; <sup>4</sup>Department of Systems Biology, Physiology Unit, University of Alcalá, Biomedical Research Foundation, Hospital Universitario Principe de Asturias, Alcalá de Henares, Spain; <sup>5</sup>Nephrology Unit, Hospital Universitario Principe de Asturias, Biomedical Research Foundation, Hospital Universitario Principe de Asturias, Department of Systems Biology, Physiology Unit, University of Alcalá, Alcalá de Henares, Spain; <sup>6</sup>Graphenano Medical Care S.L., NOVELREN, Instituto Ramon y Cajal de Investigación Sanitaria (IRYCIS), Fundacion Renal Iñigo Alvarez de Toledo (FRIAT) and REDinREN, (ISCIII), Madrid, Spain.

**Background:** Cardiovascular diseases are one of the most common causes of morbidity and mortality in chronic kidney disease (CKD) patients. Integrin-linked kinase (ILK) is a serine/threonine protein kinase and a scaffold protein between the extracellular matrix and intracellular signaling pathways. The aim of this study was to investigate the role of ILK in CKD-associated vascular damage.

**Methods:** We induce CKD in both wild-type (WT) and adult conditional ILK knock-down (cKD-ILK) by feeding mice with a 0.2% adenine-supplemented diet during 2, 4 or 6 weeks. Animals receiving this diet develop a tubulointerstitial damage resembling CKD observed in humans. Aortic tissue mRNA levels of ILK, fibrosis markers as the extracellular matrix proteins collagen type I, fibronectin and the profibrotic cytokine TGF- $\beta$ 1 were determined by RT-qPCR. By *in vitro* experiments in human aortic-vascular smooth muscle cells (HA-VSMC), we tested the effect of uremic toxins, indoxyl- and p-cresyl sulfate (IS and pCS), on ILK activity and ILK and fibrosis markers expression. We transfected the cells with ILK-specific siRNA to verified the effect of ILK-deletion in vascular fibrosis.

**Results:** We found a progressive and significant increase in the mRNA expression of ILK in adenine-fed WT mice that was not observed in cKD-ILK mice on the same diet. Moreover, a significant increase in mRNA levels of fibrosis markers and TGF- $\beta$ 1 in the adenine-fed WT mice was also observed, which was significantly lower in adenine-fed cKD-ILK mice. Interestingly, we found statistically significant correlations between the vascular mRNA content of ILK and the fibrosis markers and TGF- $\beta$ 1 ( $p < 0.0001$ ,  $r$  between 0.81 and 0.82). *In vitro* experiments show an increase of ILK activity and fibrosis markers expression in the HA-VSMC treated with IS and pCS, while this increase was reversed in ILK-deleted cells.

**Conclusions:** ILK depletion protects against vascular fibrosis associated with CKD and TGF- $\beta$ 1 and consequent fibrosis increase is probably associated with an ILK-dependent mechanism. Therefore, ILK could be a potential therapeutic target for the prevention or treatment of development of vascular fibrosis in renal patients.

**Funding:** Other NIH Support - This work was supported by co-funded grants from the Instituto de Salud Carlos III (ISCIII) and FEDER funds (PI17/01513, PI17/00625, PI20/00634, PI20/00664, RICORS2040, "Kidney disease" RD21/0005/0023), Madrid Community funds (B2017/BMD-3751), and University of Alcalá and FRIAT funds., Government Support - Non-U.S.

## FR-PO969

### Resident Memory T Cells in Aristolochic Acid-Induced CKD

Kyle H. Moore,<sup>1,2</sup> Elise Erman,<sup>2</sup> Matthew D. Cheung,<sup>2</sup> James F. George,<sup>2</sup> Anupam Agarwal,<sup>1</sup> <sup>1</sup>The University of Alabama at Birmingham Division of Nephrology, Birmingham, AL; <sup>2</sup>The University of Alabama at Birmingham Department of Surgery, Birmingham, AL.

**Background:** Chronic Kidney Disease (CKD) is a significant health burden affecting millions of Americans. No current therapeutics can halt or reverse the progression of CKD. The immune system, inflammation, and fibrosis are known to be involved in the progression of CKD, but specific contributions of T cells and how they become involved in the pathophysiological process remain poorly understood.

**Methods:** Mice were injected with 2mg aristolochic acid (AA) per kg body weight i.p. (saline control) for five consecutive days to induce a prolonged decline in kidney function. Glomerular filtration rates (GFRs) were measured using FITC-sinistrin clearance at baseline before injury, and at one day, two weeks, four weeks, and six weeks after their first AA injection. Blood was collected and kidneys were harvested and processed for flow cytometry, imaging, and single cell RNA sequencing. Serum creatinine (SCR) was measured using LC-MSMS.

**Results:** There were no signs of acute injury one day post-injection, but by two weeks, AA mice had reduced GFR and increased SCR. At six weeks GFRs of AA mice remained low compared to controls (114 mL/min vs 220 mL/min, respectively), and SCR remained elevated (0.29 mg/dL AA vs 0.09 mg/dL Vehicle). The numbers of intrarenal CD45+ cells, CD4+ T cells, and CD8+ T cells were significantly elevated at two, four, and six weeks post-injury. Interestingly, CD103+ resident memory T cells (TRMs) expanded to represent 54% of the CD8+ and 36% of the CD4+ populations (7% and 3% in controls). CD8+ TRMs had increased expression of GZMB and PRF1. At six weeks there were also histological signs of interstitial fibrosis and tubular atrophy.

**Conclusions:** There was sustained impairment of kidney function in animals treated with AA, as indicated by reduced GFR and increased SCR at least six weeks after injury. There was also a sustained increase in CD4+ and CD8+ T cells with a large expansion of TRMs expressing apoptotic cytokines. TRMs have been recently characterized as non-circulating immune cells that contribute to chronic inflammation and, based on our findings, may contribute to inflammation in CKD. Future studies will aim to fully describe the cytokine profile of kidney TRMs in order to determine their role in tubular apoptosis and interstitial fibrosis.

**Funding:** NIDDK Support

## FR-PO970

### Pharmacological Inhibition of Lysine-Specific Histone Demethylase 1 With GSK-LSD1 Ameliorates Renal Fibrosis

Baihai Jiao,<sup>1</sup> Hao Du,<sup>1</sup> Melanie Tran,<sup>1</sup> Bo Song,<sup>1</sup> Yanlin Wang,<sup>1,2</sup> <sup>1</sup>University of Connecticut School of Medicine, Farmington, CT; <sup>2</sup>VA Connecticut Health System - Newington Campus, Newington, CT.

**Background:** Renal fibrosis is a pathological hallmark of chronic kidney disease (CKD) which is characterized by tubular epithelial cell dedifferentiation, fibroblast activation, and excessive production and deposition of extracellular matrix resulting in progressive loss of kidney function. However, the molecular mechanisms of renal fibrosis are not fully elucidated. In this study, we investigated the role of lysine-specific histone demethylase 1 (LSD1) in the regulation of tubular epithelial cell dedifferentiation and fibroblast activation during the development of CKD.

**Methods:** To examine the role of LSD1 in renal fibrosis *in vivo*, wild-type (WT) mice were subjected to unilateral ureteral obstruction (UUO) and treated with a selective LSD1 inhibitor GSK-LSD1 or vehicle for 10 days. Cultured tubular epithelial cells and fibroblasts were used to examine the role of LSD1 in the regulation of tubular epithelial cell dedifferentiation and fibroblast activation *in vitro* respectively.

**Results:** The expression of LSD1 was increased in tubular epithelial cells and myofibroblasts of the UUO kidneys and human kidneys with CKD. Compared with vehicle-treated mice, pharmacological inhibition of LSD1 with GSK-LSD1 significantly repressed UUO-induced histone H3K4 demethylation and Smad3 phosphorylation, reduced tubular epithelial cell dedifferentiation, suppressed myofibroblasts accumulation, and attenuated total collagen deposition and extracellular matrix protein production in the kidneys in response to UUO. Furthermore, pharmacological inhibition of LSD1 with GSK-LSD1 or genetic knockdown of LSD1 with sgRNA eliminates tubular epithelial cell dedifferentiation and fibroblast activation, which is associated with decreased histone H3K4 demethylation and Smad3 phosphorylation.

**Conclusions:** Our study identifies LSD1 as a critical factor in tubular epithelial cell dedifferentiation, fibroblast activation, and kidney fibrosis through regulation of histone H3 methylation and Smad3 phosphorylation. Therefore, LSD1 may represent a novel therapeutic target for chronic kidney disease.

**Funding:** NIDDK Support, Veterans Affairs Support

## FR-PO971

### Single-Cell Transcriptomic Profiling of Kidney Fibrosis Identifies a Novel Fibroblast Marker and Putative Disease Target

Valeria Rudman-Melnick, Mike Adam, Prasad Devarajan. Devarajan lab Cincinnati Children's Hospital Medical Center, Cincinnati, OH.

**Background:** Fibrosis is a key underlying process in CKD, resulting in renal parenchymal remodeling and progressive functional decline with prominent mortality. Cellular identity of renal fibrosis along with putative molecular targets regulating it remain elusive.

**Methods:** We used 10x Chromium and Drop-seq platforms to create transcriptomic profiles of two clinically relevant unilateral ischemia/reperfusion (UIR) and ureter obstruction (UUO) murine models of renal fibrosis. Moreover, we used primary human *in vitro* model of epithelial-to-mesenchymal transition (EMT) to identify novel putative CKD targets.

**Results:** Using scRNA-seq, we observed several novel injury induced kidney cell clusters, including three distinctive stromal populations, and identified Gucy1a3 as a novel specific marker of renal fibroblasts. Both CKD models exhibited robust nephrogenic program reactivation and intercellular communications, particularly between activated fibroblasts and tubular epithelial cells (TECs). We revealed elevation of fibrogenic factors in the injured TECs, including Ahnak which we previously reported in AKI. We showed that AHNAK ablation causes elevation of EMT and downregulation of epithelial markers

in primary human renal proximal tubular epithelial cells (RPTECs) with and without TGFβ (Figure 1). We also found that p38, p42/44, pAKT, BMP and MMP signaling underlies AHNAK effects in primary human *in vitro* model of EMT.

**Conclusions:** Our novel findings, including identification of Gucy1a3 as a specific kidney fibroblast marker and AHNak as an injury target, might improve our understanding and approach to halting kidney fibrosis.

**Funding:** NIDDK Support

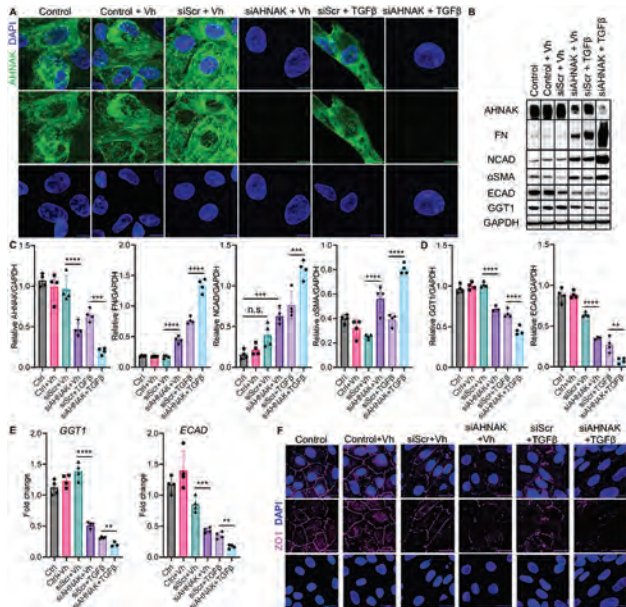

**Figure 1.** AHNAK ablation exacerbates EMT in primary human RPTECs. (A) and (F) AHNAK and ZO1 ICC, RPTECs. (B-D) Western blots for AHNAK, EMT and epithelial markers. (E) qPCR of Ecad and Ggt1. \*\*pValue ≤ 0.01, \*\*\* ≤ 0.001, \*\*\*\* ≤ 0.0001, one-way ANOVA (C, D), *t* test (E).

**FR-PO972**

**Major Vault Protein Contributes to Tubulointerstitial Inflammation and Fibrosis Through PI3K/AKT Signaling in a Murine Model of CKD**

Cheuk Yin Wong, Susan Yung, Caleb C. Chan, Tak Mao D. Chan. *The University of Hong Kong, Hong Kong, Hong Kong.*

**Background:** Chronic kidney disease (CKD) is characterized by progressive tubulointerstitial fibrosis and tubular atrophy, influx of immune cells, and progression to kidney failure. We previously demonstrated that major vault protein (MVP), a key component of the vault complex, was increased in proximal renal tubular epithelial cells (PTEC) in CKD patients. We further investigated the role of MVP in tubulointerstitial inflammation and fibrosis.

**Methods:** CKD was induced in wild-type (WT) and MVP-knockout (KO) mice by feeding with casein-based chow containing 0.2% adenine for 8 weeks; and mice fed casein-based chow served as non-CKD control. Mice were sacrificed and renal cortical tissue harvested for qPCR, immunohistochemistry, and flow cytometry analysis. MVP-deficient HK-2 cells were generated using CRISPR/Cas 9; and non-transfected cells served as control.

**Results:** WT mice with CKD showed increased MVP expression in PTEC compared to control WT mice without CKD. WT mice with CKD showed marked tubular atrophy, macrophage infiltration, and increased expression of pro-inflammatory and pro-fibrotic mediators comprising CCL2, CCR2, CCL5, CCR5, TNF-α, IL-6, VCAM-1, alpha-smooth muscle actin, vimentin, fibronectin, and collagen. Increased CD45<sup>+</sup> immune cells and F4/80<sup>+</sup> CD11b<sup>+</sup> macrophages were shown with flow cytometry. In MVP KO mice with CKD the histopathological abnormalities were less severe, with reduced expression of pro-inflammatory and pro-fibrotic mediators and decreased AKT phosphorylation. Exogenous TNF-α increased MVP expression and CCL2 secretion in non-transfected HK-2 cells, mediated in part through increased PI3K/AKT phosphorylation. In contrast, MVP-deficient HK-2 cells showed significantly less AKT phosphorylation and CCL2 secretion upon exposure to TNF-α.

**Conclusions:** Our data suggest that MVP contributes to the pathogenesis of renal tubulointerstitial inflammation and fibrosis in CKD through increased PI3K/AKT phosphorylation.

**Funding:** Government Support - Non-U.S.

**FR-PO973**

**KLF5 Is Upregulated via NFkB to Promote Renal Injury and Fibrosis After Cisplatin Nephrotoxicity**

Zhengwei Ma, Xiaoru Hu, Zheng Dong. *Augusta University Medical College of Georgia, Augusta, GA.*

**Background:** Acute and chronic nephrotoxicity are the major side effects of cisplatin during chemotherapy in cancer patients. Kruppel Like Factor 5 (KLF5) is a transcriptional factor that has been implicated in renal pathogenesis such as diabetic kidney diseases. The roles and regulation of KLF5 in acute and chronic nephrotoxicity are unclear.

**Methods:** Changes in KLF5 expression were investigated in acute cisplatin and repeated low dose cisplatin treatment (RLDC) treated BUMPT cells *in vitro* and in C57BL/6 mice *in vivo*. Homozygous kidney proximal tubule *Klf5* knockout (*PT-Klf5-KO*) and wild-type (WT) mice were given one injection of 20mg/kg cisplatin to examine acute kidney injury. Heterozygous *Klf5* WT or KO (*PT-Klf5<sup>fllox/+</sup>*, with Cre- or Cre+) mice were subjected to 4 weekly injections of 7mg/kg cisplatin to examine chronic kidney injury 1 week later. The effect of KLF5 inhibition (ML-264 or KLF5 knockdown) was investigated in RLDC-treated HK2 cells. The expression of fibrotic proteins and renal injury were analyzed.

**Results:** Both acute cisplatin and RLDC induced KLF5 protein and mRNA in the kidney *in vivo* and in BUMPT cells *in vitro*. KLF5 was mainly induced in proximal tubules after RLDC treatment by IHC staining. KLF5 inhibition by ML-264 or KLF5 knockdown decreased the induction of fibronectin, vimentin, and profibrotic cytokine CTGF in RLDC treated HK2 cells. There was less cleaved caspase 3 in the kidney in homozygous KLF5 knockout mice after acute cisplatin treatment. Unexpectedly, RLDC induced more KLF5 in the kidney in heterozygous *PT-Klf5* KO mice compared to their WT littermates by immunoblot and IHC staining. Heterozygous KLF5 KO mice showed more renal injury, including higher KIM1, p-p53(Ser15), cleaved caspase 3 levels, and more apoptotic tubular cells. Heterozygous *Klf5* KO mice showed higher BUN and lower eGFR levels than WT mice, indicating declined renal function. RLDC induced more FN, Collagen I, α-SMA, and Vimentin in the kidney in heterozygous *Klf5* KO mice. Upregulation of KLF5 by RLDC is NFkB dependent in RLDC *in vitro*, and JSH23, an NFkB inhibitor, reduced the induction of KLF5 protein and mRNA by RLDC. Chip analysis showed that KLF5 was a direct transcriptional target of NFkB.

**Conclusions:** KLF5 is upregulated by acute cisplatin and RLDC treatment and promotes renal injury and renal fibrosis. The upregulation of KLF5 is NFkB dependent.

**Funding:** NIDDK Support, Veterans Affairs Support

**FR-PO974**

**Disruption of Annexin A2 Protects Against Obstruction-Induced Kidney Fibrosis and Inflammation**

Ling Lin, Kebin Hu. *Penn State College of Medicine, Hershey, PA.*

**Background:** Annexin A2, a member of the Ca<sup>2+</sup>- and phospholipid-binding protein family, forms the heterotetramer through binding with S100A10, and acts as a cell surface receptor for tissue plasminogen activator (tPA) and plasminogen. It regulates fibrinolysis and hemostasis; and has been implicated in the pathogenesis of cardiovascular diseases and cancers. However, little is known regarding the role of annexin A2 in chronic kidney disease (CKD). Our previous *in vitro* work has shown that annexin A2 mediates NF-κB activation and promotes macrophage M2 to M1 phenotypic change, suggesting a critical role of annexin A2 in kidney fibrogenesis and inflammation.

**Methods:** We induced a classic CKD model, unilateral ureteral obstruction (UUO), in wildtype C57BL/6 mice and examined the renal expression of annexin A2 during the course of CKD. We also induced UUO in the novel annexin A2 knockout mice and their wildtype controls and evaluated the renal fibrosis and inflammation in these mice.

**Results:** It was found that expression of annexin A2 was dramatically induced in the obstructed kidneys, as early as 3 days after UUO; and the upregulation continued up to 14 days after UUO. With the progression of kidney fibrosis, as indicated by increased fibronectin deposition in a time-dependent manner, annexin A2 was dramatically induced, and its induction correlated with the content of kidney fibrosis. Intriguingly, double immune staining analysis found that annexin A2 was dramatically induced in the renal interstitium, primarily in F4/80 positive macrophages. We further found that, after obstructive injury, annexin A2 knockout mice displayed significantly reduced tubular epithelial damage and dramatically decreased deposition of matrix components such as collagen and fibronectin than that of their littermates. Additionally, immunostaining showed that obstruction-induced infiltration of F4/80-positive macrophages was alleviated in the fibrotic kidneys from annexin A2 knockout mice.

**Conclusions:** Thus, it is clear that annexin A2 promotes kidney fibrosis and macrophage infiltration after obstructive injury.

**Funding:** NIDDK Support, Other U.S. Government Support

**FR-PO975**

**Scavenging Lipid Oxidation Products Improves Intestinal Inflammation and Integrity After Renal Injury**

Jianyong Zhong, Haichun Yang, Sean S. Davies, Valentina Kon. *Vanderbilt University Medical Center, Nashville, TN.*

**Background:** Kidney disease affects intestinal structure and function. We previously showed that kidney injury amplifies intestinal lymphangiogenesis and increases mesenteric lymph flow that enhances systemic delivery of gut-originating harmful substances, including the highly reactive product of lipid oxidation, isolevuglandin (IsoLG). IsoLG is best known for its harmful effects to modify apolipoprotein A-I (apoA1)/high-density lipoprotein (HDL) which promotes atherosclerosis. 2-Hydroxybenzylamine (2-HOBA)

is a selective scavenger of IsoLG that protects proteins and lipids from being modified. Since oxidation and lipoprotein modification prevails across the entire spectrum of kidney disease, we investigated the potential benefit of 2-HOBA on intestinal disruption following kidney injury.

**Methods:** Puromycin nephrotoxicity (PAN) was induced in Sprague Dawley rats, while saline-injected rats served as control (Cont). Half of the PAN rats were treated with water containing 2-HOBA (1 g/L). Eight days after induction of PAN injury, mesenteric lymph, intestine, blood, and urine were collected for analysis.

**Results:** PAN rats had significant proteinuria and ascites. Mesenteric lymph of PAN injured rats contained 1.8-fold higher level of IsoLG-modified apoA1 vs Cont which was decreased by 63% in mesenteric lymph of 2-HOBA treated rats. PAN increased macrophage infiltration, evidenced by greater number of CD68-positive cells which was lessened by 2-HOBA. PAN injury caused a significant increase in intestinal expression of inflammatory genes, including monocyte-chemoattractant protein-1, interleukin 17A, interleukin 10, and tumor necrosis factor- $\alpha$  vs Cont. Vascular cell adhesion molecule 1 which maintains intestinal integrity was also increased in PAN vs Cont. All these injury-driven changes were attenuated by 2-HOBA.

**Conclusions:** Scavenging the lipid oxidation product lessened kidney injury-induced mesenteric lymph IsoLG modification of apoA1 together with reduction in intestinal inflammation and disruption of integrity. Our data support a novel therapeutic approach to CKD provoked intestinal dysfunction.

**Funding:** NIDDK Support

## FR-PO976

**Impact of IL-11 as a Renal Fibrosis Marker in CKD Using Mouse Model**  
Yaerim Kim,<sup>1</sup> Sunhwa Lee,<sup>5</sup> Hyung Ah Jo,<sup>6</sup> Kyung Don Yoo,<sup>2</sup> Jin hyuk Paek,<sup>1</sup> Woo Yeong Park,<sup>1</sup> Kyubok Jin,<sup>1</sup> Seungyeup Han,<sup>1</sup> Dong Ki Kim,<sup>3,4</sup> Yon Su Kim,<sup>3,4</sup> Seung Hee Yang,<sup>4</sup> <sup>1</sup>Keimyung University School of Medicine, Daegu, Republic of Korea; <sup>2</sup>Ulsan University Hospital, Ulsan, Republic of Korea; <sup>3</sup>Seoul National University Hospital, Jongno-gu, Seoul, Republic of Korea; <sup>4</sup>Seoul National University College of Medicine, Seoul, Republic of Korea; <sup>5</sup>Kangwon National University Hospital, Chuncheon, Kangwon, Republic of Korea; <sup>6</sup>Inje University Ilsan Paik Hospital, Goyang, Republic of Korea.

**Background:** Fibrosis is a common pathophysiology of chronic kidney disease (CKD) progression, but the role of IL-11, which is highly expressed in the fibroblast remains elusive. Herein, we aimed to evaluate the role of IL-11 in the fibrosis pathway and apoptosis.

**Methods:** We examined the impact of IL-11 in the UUO model using B6 mouse aging 7 to 8 weeks. An *in-vitro* experiment was performed using primed human tubular epithelial cells (hTECs) to figure out the role of recombinant IL-11 induced fibrosis. In addition, we examined the change in the expression of phosphorylated STAT3 (pSTAT3) and IL-18 after treated recombinant TGF $\beta$  (rTGF $\beta$ ) and rTGF $\beta$  with an IL-11 blockade antibody (Ab) via fluorescence-activated cell sorting (FACS). Finally, we evaluated an impact on apoptosis using TGF $\beta$  and TGF $\beta$  with an IL-11 blockade Ab.

**Results:** Expression of IL-11 in bulk-tissue RNA-sequencing was significantly higher in the kidney lysates from the UUO model than those from sham. The levels of IL-11 expression in kidney sections from the UUO model were remarkably correlated with the intensity of COL1 in the look-up section. Likewise, two days after treating rIL-11 with doses of 100 or 500 ng/mL in hTEC, the expression of COL1 mRNA was dose-dependently increased. rTGF $\beta$  treatment significantly increased the expression of COL1, STAT3, and CXCL1 mRNA, while IL-11 blockade Ab restored the mRNA expressions of the molecules. Also, rTGF $\beta$  treatment increased the expression of pSTAT3 and IL-18. IL-11 blockade Ab significantly abrogated these expressions by 60% and 33% in pSTAT3 and IL-18, respectively. Finally, the Annexin V assay revealed relevant increases in apoptotic cells treated with rTGF $\beta$ , and IL-11 blockade Ab significantly attenuated the increase.

**Conclusions:** IL-11 has a role in the induction of fibrosis. The inhibition of IL-11 significantly attenuates the fibrotic changes, indicating that IL-11 pathway could be a treatment target for CKD progression.

## FR-PO977

### Deletion of PTP4A1 Ameliorate Renal Fibrosis Induced by Unilateral Ureteral Obstruction (UUO) in Mice

Dae Eun Choi,<sup>1</sup> Hyunsu Choi,<sup>2</sup> Wonjung Choi,<sup>2</sup> Yoon-Kyung Chang,<sup>2</sup> <sup>1</sup>Chungnam National University, Daejeon, Republic of Korea; <sup>2</sup>Catholic University of Korea Daejeon St Mary's Hospital, Daejeon, Republic of Korea.

**Background:** Inhibitors of protein tyrosine kinases (PTP) has been investigated as potential anti-fibrotic agents. PTP4A1 belongs to a sub-class of three prenylated PTP. PTP4A1 has known as promoting growth and migration of tumor cells. The role PTP4A1 has little known in kidney. We evaluated whether the PTP4A1 could be target of renal fibrosis.

**Methods:** 10 week old male background PTP4A1 KO mice and wild type mice were divided into 4 groups; wild, PTP4A1 KO, wild with UUO, and PTP4A1 KO with UUO. Mice were sacrificed at 7 days after surgery and kidney tissue were collected. Molecular study and Histologic examination were performed.

**Results:** PTP4A1 KO with UUO mice showed decrease of renal tubule-interstitial damage and fibrosis compared to wild type UUO mice. PTP4A1 KO with UUO reduced the renal expression of  $\alpha$ -SMA and TGF- $\beta$  in UUO kidney, compared to wild type with UUO mice. Wild type with UUO kidney showed decrease of renal expression of

E-cadherin, compared to sham mice. However, PTP4A1 KO UUO showed increase of renal expression of E-cadherin, compared to Wild type UUO mice. *In vitro*, silencing of PTP4A1 in TGF- $\beta$  treated HK2 cell showed increase of E-cadherin and decrease of phosphorylation of AKT and GSK3 $\beta$ .

**Conclusions:** PTP4A1 KO ameliorate renal fibrosis in UUO kidney.

**Funding:** Government Support - Non-U.S.

## FR-PO978

### Association of Aging-Related Decline in Quinolate Phosphoribosyl Transferase Expression and Expression of Profibrotic Genes

Marie Christelle Saade, Amanda J. Clark, Brenda Mendoza Flores, Samir M. Parikh. Parikh Lab The University of Texas Southwestern Medical Center Department of Internal Medicine, Dallas, TX.

**Background:** De novo nicotinamide adenine dinucleotide (NAD<sup>+</sup>) biosynthetic pathway was shown to be impaired in chronic kidney disease (CKD) and routine aging with a particular role for quinolate phosphoribosyl transferase (QPRT), a bottleneck enzyme of the de novo NAD<sup>+</sup> pathway. Yet, it is still undetermined whether QPRT and generalized NAD<sup>+</sup> biosynthetic suppression is simply correlated with CKD progression or whether loss of these pathways may drive disease progression. Therefore, we investigated aged QPRT deficient mice.

**Methods:** Custom QPRT +/- were bred and aged under routine care on a normal chow diet. Expression of QPRT and fibrotic genes TGF $\beta$  and COL1A1 was measured in QPRT +/- (HT) and wildtype (WT) littermates at an 8-week-old "young" time point and a 72-week-old "aged" time point. Serum blood urea nitrogen (BUN) and creatinine were measured using a commercial kit and capillary electrophoresis respectively.

**Results:** QPRT expression significantly declined with age in HT and WT mice. Old WT mice expressed less QPRT than young HT mice. In the aged group, TGF $\beta$  expression was significantly higher in aged HT mice despite unchanged BUN and creatinine. There was no significant difference between young and old HT vs WT COL1A1 gene expression, though expression trended higher in aged HT. (Figure 1) TGF $\beta$  expression significantly correlated with QPRT expression in both old and young mice populations (Figure 2).

**Conclusions:** Our data demonstrate a suppression of kidney QPRT expression with age. QPRT reduction may exacerbate fibrotic gene expression even in the absence of overt kidney disease.

**Funding:** Other NIH Support - K12-HD000850, R01 DK095072, R01 AG027002, Private Foundation Support

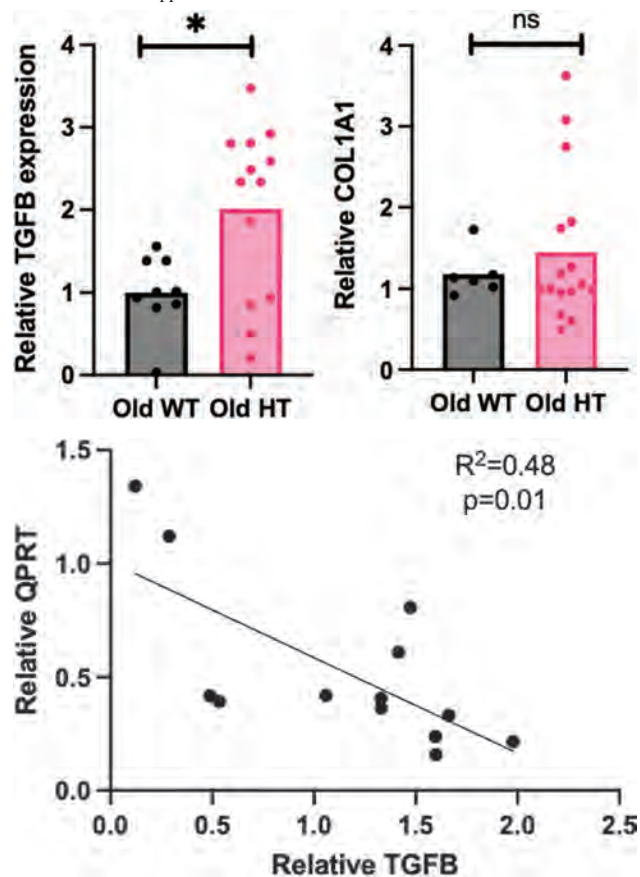

## FR-PO979

**Chemokine Ligand 14 Is a Pro-Fibrotic Stimulus in CKD Progression Through Regulating the GATA2 Transcription Factor**

Sunhwa Lee,<sup>1</sup> Yong Chul Kim,<sup>2</sup> Seung Seok Han,<sup>2,3</sup> Dong Ki Kim,<sup>2,3</sup> Yon Su Kim,<sup>2,3</sup> Seung Hee Yang.<sup>2,3</sup> <sup>1</sup>Kangwon National University Hospital, Chuncheon, Kangwon, Republic of Korea; <sup>2</sup>Seoul National University Hospital, Jongno-gu, Seoul, Republic of Korea; <sup>3</sup>Seoul National University College of Medicine, Seoul, Republic of Korea.

**Background:** Chemokine ligand 14 (CCL14), a ligand for CCR1, has been known as a M2 polarizing marker and chemotactic cytokine. By performing urine proteomic analysis of chronic kidney disease patients, we previously found out CCL14 expression tends to increase in patients with progressive CKD and GATA2 could be possible upstream transcription factor. To validate pathophysiologic role of CCL14 and its molecular pathway, we performed in vitro and in vivo evaluations.

**Methods:** To determine how CCL14 is involved in the fibrosis process, recombinant CCL14(9-74) were treated in primary cultured tubular epithelial cells (hTECs). Moreover, anti-CCL14 blocking antibody were treated in fibrosis induced hTECs using rTGFβ (2ng/ml) or Hypoxia (1% O<sub>2</sub>, 72hrs). Fibronectin, collagen IV, E-Cadherin, CCL14, CCR1 and GATA2 level was evaluated. And cell apoptosis and necrosis was also measured using an Annexin-PI assay. For in vivo validation, we used C57BL/6 unilateral ureteral obstruction (UUO) model to re-inforce the CCL14/CCR1/GATA2 pathway in chronic kidney disease progression. We also further performed GATA2 immunohistochemistry staining in kidney specimens of CKD patients.

**Results:** Recombinant CCL14 itself increased the expression of fibronectin in hTECs. Adding anti-CCL14 with rTGFβ showed decreased expression level of collagen IV and increased cell junction marker, E-cadherin. Annexin-PI assay result showed decreased apoptotic cell count with anti-CCL14 stimulation. In hypoxia-induced hTECs, anti-CCL14 antibody significantly suppressed the mRNA expression levels of fibronectin, αSMA, and periostin. In addition, decrease in the expression of CCR1 receptor and GATA2 transcription factor were also observed. In C57BL/6 UUO mouse model, on the 7<sup>th</sup>, and 14<sup>th</sup> day after operation, GATA2 mRNA expression were significantly increased. Similarly, in human kidney specimens, the expression level of GATA2 transcription factor increases as the chronic kidney disease stage progresses.

**Conclusions:** CCL14 could play a pro-fibrotic role in CKD progression via regulations of CCR1 receptor and GATA2 transcription factor. Since CCL14 acts not only as a biomarker of increased expression in CKD progression, but also as a direct pro-fibrotic stimulus, it can be considered as a target for the treatment of chronic kidney disease.

**Funding:** Government Support - Non-U.S.

## FR-PO980

**Fn14 Knockout Ameliorates Cisplatin-Induced Nephrotoxicity in Mice by Reducing Inflammation, Preventing Tubular Cell Death, and Decreasing Renal Fibrosis**

Ross Villiger,<sup>1</sup> Michael Ortega,<sup>2,1</sup> Malia H. Harrison-Chau,<sup>1</sup> Geetika Y. Patwardhan,<sup>1</sup> Ben Fogelgren.<sup>1</sup> <sup>1</sup>University of Hawai'i at Manoa, Honolulu, HI; <sup>2</sup>Queen's Medical Center, Honolulu, HI.

**Background:** Tumor necrosis factor receptor superfamily 12A (TNFRSF12a), also known as Fn14, is a transmembrane cytokine receptor often upregulated in damaged tissues or in malignancies. Fn14 has a single known ligand, the cytokine TWEAK, although at high concentrations, Fn14 can self-oligomerize. Primarily associated with activating the non-canonical NF-κB pathway, TWEAK-Fn14 signaling can also contribute to multiple downstream cellular pathways, including cell death and fibrosis, depending on contributions from other TNF receptors and the cell microenvironment. We detected strong upregulation of the Fn14 gene in stressed cells of the kidney and urinary tract, and the goal of this study was to determine if Fn14 signaling contributes to the pathogenesis of chronic kidney disease (CKD).

**Methods:** With CRISPR-Cas gene editing, we generated a novel Fn14-knockout mouse (Fn14-KO). We challenged male and female wild-type C57BL/6J and Fn14-KO mice to a repeated low dose regimen of cisplatin to model CKD. After the dosing regimen, we analyzed blood biochemistry, renal histopathology, and renal gene expression using the NanoString nCounter platform.

**Results:** The Fn14-KO mouse demonstrated complete absence of Fn14 protein, was fertile, and lacked gross abnormalities. Compared to wild-type mice, Fn14-KO mice had reduced cisplatin-induced nephrotoxicity assessed by blood biochemistry and renal histopathology. Cisplatin-treated wild type mice showed substantial renal tubular cell death, which was absent in Fn14-KO kidneys. Transcriptomic data revealed significant reductions in genes associated with inflammation and fibrosis in the Fn14-KO kidneys, which correlated with histopathological findings.

**Conclusions:** Fn14 signaling contributed to tubular cell death and renal fibrosis in this mouse model of CKD. Blocking TWEAK-Fn14 signaling may help ameliorate cisplatin-induced nephrotoxicity and other forms of CKD, although targeting the Fn14 receptor may be more effective if it can self-activate with high expression.

**Funding:** NIDDK Support, Other NIH Support - NIGMS

## FR-PO981

**Role of Kidney Derived Extracellular Vesicles Containing Mitochondrial Proteins and Splicing Factors in Renal Fibrosis**

Krishna P. Maremanda,<sup>1,2</sup> Chitran Roy Chowdhury,<sup>1</sup> Amrendra K. Ajay,<sup>1,2</sup> Venkata Sabbiseti.<sup>1,2</sup> <sup>1</sup>Brigham and Women's Hospital, Boston, MA; <sup>2</sup>Harvard Medical School, Boston, MA.

**Background:** Extracellular vesicles (EVs) are lipid bilayer nanoparticles enriched with biomolecules such as DNAs, RNAs, protein and lipids. They help in cellular communication and have potential theranostic applications based on their nature and origin. Organ-specific EVs have been shown to play pathophysiological role including fibrosis.

**Methods:** Here we describe the role of kidney specific EVs in initiating and promoting kidney fibrosis in mouse models. Kidneys were isolated from three mechanically different animal models of chronic kidney injury which includes mice treated with Folic acid (FA), aristolochic acid (AA), and unilateral ureteral obstruction (UUO).

**Results:** Kidney specific EVs were isolated by restricted enzymatic digestion followed by differential centrifugations. Isolated EVs were characterized using TEM and by western blotting for enrichment of different exosomal protein markers, including CD63, flotillin-1, and alix. Enriched EVs from kidneys isolated from untreated and FA-treated mice were used for differential gene expression and proteomic studies. Gene expression analysis showed that these EVs were enriched in various splicing factors, including SRp40 along with its interacting lncRNA partners such as NEAT1, which are shown to be upregulated in fibrotic conditions. We also found that EVs isolated from fibrotic kidneys are enriched with various pro-fibrotic signaling molecules including EDAA+ Fn, Col1A1 and TGF-β1. Proteomic analysis showed several differentially expressed proteins in various EVs isolated from fibrotic kidneys.

**Conclusions:** We found novel targets for kidney fibrosis in EVs.

**Funding:** NIDDK Support, Other NIH Support - American Heart Association, NCI

## FR-PO982

**Cluster of Differentiation-14 Contributes to Tubulo-Interstitial Fibrosis in a Murine Model of CKD**

Tak Mao D. Chan, In Young Oh, Jing Yu, Susan Yung. *Department of Medicine, School of Clinical Medicine, the University of Hong Kong, Hong Kong SAR, Hong Kong.*

**Background:** Chronic kidney disease (CKD) is characterized by progressive tubulo-interstitial fibrosis and tubular atrophy, leading to kidney failure. CD14 is a GPI-anchored membrane protein that functions as a pattern recognition receptor in sepsis. We previously demonstrated that tubulo-interstitial CD14 expression was increased in kidney biopsies showing CKD from patients without sepsis. We further investigated the role of CD14 in the pathogenesis of tubulo-interstitial inflammation and fibrosis in CKD.

**Methods:** CKD was induced in wild-type (WT) and CD14-knockout (KO) mice by feeding with casein-based chow containing 0.2% adenine for 8 weeks. Mice were sacrificed, kidneys were harvested and histopathological changes examined. Mice fed casein-based chow served as non-CKD controls. The role of CD14 in inflammatory and fibrotic processes was investigated in HK-2 cells that overexpressed CD14.

**Results:** Tubulo-interstitial CD14 expression was increased in WT CKD mice compared with non-CKD WT controls. WT CKD mice showed tubular atrophy, influx of F4/80<sup>+</sup>CD260<sup>+</sup> macrophages and increased tubulo-interstitial α-smooth muscle actin, fibronectin and collagen expression. CD14-KO mice with CKD showed less severe histopathological abnormalities and reduced immune cell infiltration, with decreased expression of mediators of fibrosis. HK-2 cells overexpressing CD14 showed increased fibronectin expression and IL-6, IL-8 and MCP-1 secretion compared to non-transfected cells, mediated in part through increased p38 MAPK and PI3K phosphorylation, and TGF-β1 stimulation further augmented fibronectin expression and cytokine secretion.

**Conclusions:** Our data suggest that CD14 contributes to tubulo-interstitial inflammation and fibrosis in murine adenine-induced CKD.

**Funding:** Government Support - Non-U.S.

## FR-PO983

**Possible Role of Calpains 2 and 5 in CKD Progression and Renal Fibrosis**

Elena Gutierrez Calabres,<sup>1,2</sup> Sofia Campillo de Blas,<sup>1,2</sup> Mariano de la Serna,<sup>3,2</sup> Natalia Canales Bueno,<sup>2,1</sup> Cristina González Valero,<sup>1,2</sup> Mercedes Griera,<sup>4,1</sup> Sergio De frutos garcia,<sup>4,5</sup> Laura Calleros,<sup>1,2</sup> Diego Rodriguez puyol.<sup>6,4</sup>  
<sup>1</sup>Department of Systems Biology, Physiology Unit, Universidad of Alcalá, Alcalá de Henares, Spain; <sup>2</sup>NOVELREN, Instituto Ramon y Cajal de Investigación Sanitaria (IRYCIS), Fundación Renal Iñigo Alvarez de Toledo (FRIAT) and REDinREN, (ISCIII), Madrid, Spain; <sup>3</sup>Biomedical Research Foundation, Hospital Universitario Príncipe de Asturias, Alcalá de Henares, Spain; <sup>4</sup>Graphenano Medical Care S.L., NOVELREN, Instituto Ramon y Cajal de Investigación Sanitaria (IRYCIS), Fundación Renal Iñigo Alvarez de Toledo (FRIAT) and REDinREN, (ISCIII), Madrid, Spain; <sup>5</sup>Department of Systems Biology, Physiology Unit, Universidad of Alcalá and Biomedical Research Foundation, Hospital Universitario Príncipe de Asturias, Alcalá de Henares, Spain; <sup>6</sup>Nephrology Unit and Biomedical Research Foundation, Hospital Universitario Príncipe de Asturias and Department of Medicine and Medical Specialties, Universidad de Alcalá, Alcalá de Henares, Spain.

**Background:** Calpains (CAPN) are intracellular cysteine proteases that play an important role in multiple biological processes linked to tissue damage and repair mechanisms, such as epithelial-mesenchymal transition and fibrosis. These two phenomena are critical in the development of chronic kidney disease (CKD), but a relationship between them and CAPN in CKD has not been definitively proved. The aim of this study was to investigate the possible role of CAPN in the development of CKD and renal fibrosis in an experimental model of CKD induced by adenine and in human kidney proximal tubular cells (HK-2).

**Methods:** Tubulointerstitial damage resembling that is observed in human CKD was induced in mice fed an adenine-rich diet (0.2%, for 5 days and 2 weeks). *In vitro* experiments were performed in TGF- $\beta$  HK-2 treated cells (1 ng/ml, different times), and two CAPN inhibitors (calpeptin, calpain inhibitor III, 50  $\mu$ M). Mice renal function was assessed by measuring plasma BUN and creatinine. Fibrosis markers (collagen type I and fibronectin) were determined by RT-qPCR. Protein content of CAPN 2 and 5 were analyzed by western blot. CAPN activity was analyzed by fluorescence assays.

**Results:** Our results show a progressive worsening of renal function and fibrosis in adenine-fed mice, with increased BUN, creatinine, COL I and FN mRNA expression, being significantly higher at 2 weeks of treatment. Protein content of CAPN 2 and 5 was significantly higher in animals that received adenine for 2 weeks when compared to control, together with a statistically significant increased renal CAPN activity. Our results point out that CAPN 2 and 5 content in renal tissue increases as CKD and fibrosis progresses. To verify this potential relationship, we induced fibrosis in HK-2 cells with TGF- $\beta$ , that increased COL I and FN mRNA expression, as well as CAPN 2 and 5 levels. The two CAPN inhibitors prevented the TGF- $\beta$ -induced increase in CAPN activity and COL I expression.

**Conclusions:** We suggest a direct relationship between the fibrosis observed in CKD and the cellular content of CAPN, which could be involved in the genesis or progression of kidney disease. Thus, effective CAPN blockade or downregulation could be useful as a therapeutic strategy to prevent CKD.

**Funding:** Other NIH Support - This work was supported by co-funded grants from the Instituto de Salud Carlos III (ISCIII) and FEDER funds (PI17/01513, PI17/00625, PI20/00634, PI20/00664, RICORS2040, "Kidney disease" RD21/0005/0023), Madrid Community funds (B2017/BMD-3751), and University of Alcalá and FRIAT funds., Government Support - Non-U.S.

## FR-PO984

**4-(2-Aminoethyl) Benzenesulfonyl Fluoride Hydrochloride (AEBSF) Reduced Kidney Fibrosis in Part by Targeting CREB3L1 in Myofibroblasts**

Ayaha Yamamoto, Masanori Obana, Yasushi Fujio. *Osaka Daigaku, Suita, Japan.*

**Background:** Since kidney fibrosis is a critical event for the onset of renal failure, novel therapeutic agents to prevent and/or mitigate kidney fibrosis are urgently needed. Previously, we found that cAMP-responsive element binding protein 3-like 1 (CREB3L1), a transcription factor, exacerbated kidney fibrosis, using conventional knockout mice. However, it is unclear that pharmacological approach to inhibit CREB3L1 is useful for the treatment of kidney fibrosis. CREB3L1 is cleaved by site-1/2 protease, resulting in activation. In this study, we examined whether 4-(2-aminoethyl) benzenesulfonyl fluoride hydrochloride (AEBSF), a site-1 protease inhibitor, suppressed kidney fibrosis.

**Methods:** CREB3L1 expression in human and murine kidneys was examined by immunohistochemistry with anti-CREB3L1 and  $\alpha$ -SMA antibodies. To examine the effects of CREB3L1 in myofibroblasts on kidney fibrosis, myofibroblast-specific CREB3L1 knockout (cKO) mice were subjected to unilateral ureteral obstruction (UO). Day 7 after UO, kidney fibrosis was examined by Sirius Red staining, hydroxyproline assay and immunofluorescence analysis. Cultured TGF- $\beta$ -stimulated NRK49F cells (myofibroblasts) were treated with AEBSF. In addition, C57BL/6 mice were intraperitoneally injected with AEBSF for 9 consecutive days starting 2 days before UO.

**Results:** CREB3L1 was increased in myofibroblasts in human and murine fibrotic kidneys. Kidney fibrosis was attenuated in CREB3L1 cKO mice compared with control mice. In addition, CREB3L1 cKO mice showed reduced number of Ki-67-positive proliferative myofibroblasts in fibrotic kidneys, suggesting that CREB3L1 in myofibroblasts may be therapeutic target for kidney fibrosis. AEBSF suppressed CREB3L1 activation in myofibroblasts. Significantly, AEBSF treatment reduced kidney fibrosis after UO (hydroxyproline content: PBS-contralateral; 0.17 $\pm$ 0.03  $\mu$ g/mg, PBS-UO; 0.32 $\pm$ 0.06  $\mu$ g/mg, AEBSF-contralateral; 0.12 $\pm$ 0.03  $\mu$ g/mg, AEBSF-UO; 0.25 $\pm$ 0.05  $\mu$ g/mg, n = 9 for PBS, n = 6 for AEBSF).

**Conclusions:** AEBSF could be a novel therapeutic tool for kidney fibrosis by targeting CREB3L1 in myofibroblasts.

## FR-PO985

**Testing the Relationship Between NBL1 and CKD in a Cisplatin-Induced Mouse Model**

Rei Bui, Susan M. Sheehan, Ron Korstanje. *The Jackson Laboratory, Bar Harbor, ME.*

**Background:** Increased serum levels of neuroblastoma suppressor of tumorigenicity 1 (NBL1), a bone morphogenetic protein (BMP) inhibitor, have been associated with a faster decline in kidney function in patients with diabetes, and *in vitro* experiments have shown a linkage between increased NBL1 levels and podocyte apoptosis. We aim to discover the causality-effector relationship and the role of NBL1 in kidney disease.

**Methods:** We obtained a transgenic (TG) mouse model that has a cDNA copy of *Nbl1* behind a chicken B-actin promoter in a DBA/2 and B6J mixed background. In addition, a knockout (KO) model was created using CRISPR technology in the B6J background. We induced chronic kidney disease (CKD) by following a low dose cisplatin protocol for 4 weeks. Wild type (WT), TG, and heterozygous KO mice received either cisplatin (treatment) or saline (control) for 4 weeks. Urine, serum, and kidneys were collected 3 days after the last treatment.

**Results:** We observed substantial decrease in weight for all mice that received cisplatin with no significant differences between genotypes. In addition to podocyte number as measured by staining with a podocyte marker-specific, we will present our results including measurements of albuminuria, BUN, and histology to establish whether there is a causal relationship between NBL1 and CKD.

**Conclusions:** Previous literature suggest NBL1 has a damaging effect on podocytes, and we speculate that white blood cells expressing NBL1 drive the mechanism. Results from our measurements of changes in podocytes due to differences in serum NBL1 levels expressed in white blood cells from our WT, TG, and heterozygous KO mouse models could lead to identification of pathways useful for drug targets.

**Funding:** Other NIH Support - DK131019, DK131061

## FR-PO986

**Empagliflozin Attenuates Renal Fibrosis Through the DsbA-L-CAS-STING Pathway in Unilateral Ureteral Obstruction Model**

Junghyun Cho, Eui Suk Chung, Haekyung Lee, Soon hyo Kwon. *Soonchunhyang University Hospital, Seoul, Republic of Korea.*

**Background:** Chronic kidney disease (CKD) is associated with an increase in morbidity and mortality. Renal fibrosis is a common pathway leading to the progression of CKD. Recent studies have reported an improvement of CKD with use of sodium glucose cotransport 2 inhibitors (SGLT2i) in both patients with DM and those without it. However, the mechanism of SGLT2i's effect upon CKD has not been elucidated. In current study, we examined the effect of SGLT2i on renal fibrosis in rats caused by unilateral ureteral obstruction (UO).

**Methods:** Sprague Dawley rats were randomly divided into two groups (each n=8). One group was treated by Empagliflozin after UO induction while the other group was left untreated. Kidneys were harvested two weeks after UO. We evaluated the mitochondrial damage pathway presumed to contribute to the inflammation.

**Results:** UO has resulted in marked renal fibrosis and triggered the activation of the cGAS-STING pathway. Empagliflozin has been shown to attenuate renal fibrosis and decrease the activation of the cGAS-STING pathway. The expression of disulfide-bond A oxidoreductase-like proteins (DsbA-L) was increased in the Empagliflozin group (Figure 1).

**Conclusions:** These findings suggest that SGLT2i attenuates the development of renal fibrosis via inhibition of mitochondrial damage.

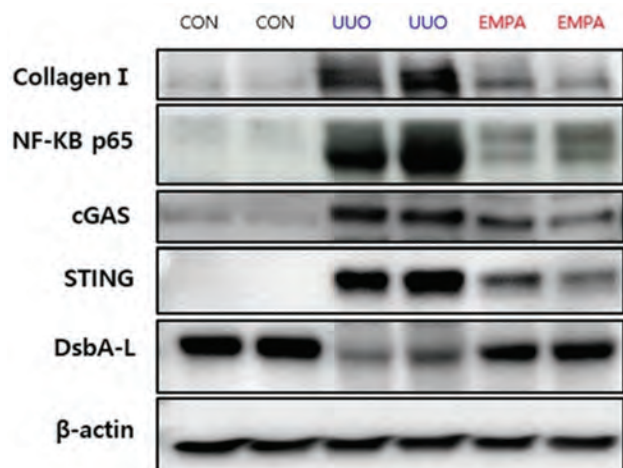

**Conclusions:** Our results suggest that *Lactiplantibacillus* preparations could be used for multiple purposes, such as removal of phosphorus and uremic toxins from CKD patients, and demonstrate the novel concept of a probiotic phosphate binder.

**Funding:** Commercial Support - Funding from MH corporation from South Korea

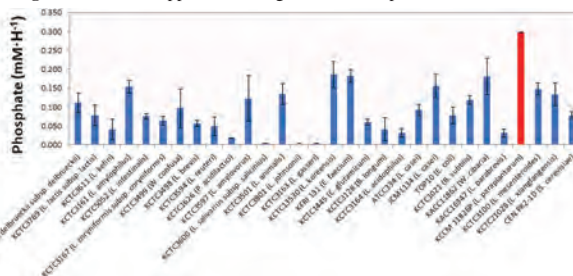

**Fig 1. Experimental procedure to screen a probiotic strain possessing a high phosphate absorbing ability.** Isolation of *L. paraplantarum* KCCM 11826P by comparison of phosphate consumption.

**FR-PO987**

**BCL2 Associated Athanogene 2 (BAG2) Mediates Kidney Fibrosis Through TGF-β1 Signaling Pathway**

Min ji Sung,<sup>1</sup> Hyun-Ju An,<sup>1</sup> Min Heui Ha,<sup>1</sup> Hyeyun Jeong,<sup>2</sup> Yu ho Lee,<sup>2</sup> Taeyoung Yang,<sup>2</sup> Dong Ho Yang,<sup>2</sup> So-young Lee.<sup>2</sup> <sup>1</sup>CHA University - Bundang Campus, Seongnam, Gyeonggi-do, Republic of Korea; <sup>2</sup>CHA Bundang Medical Center, Seongnam, Gyeonggi-do, Republic of Korea.

**Background:** Kidney fibrosis, regardless of its etiology, is the inevitable consequence of almost chronic kidney diseases. Transforming growth factor-β1 (TGF-β1) plays a central role in kidney fibrotic disease. Therefore, it is important to find novel targets that regulate TGF-β1 signaling. An increasing number of studies have revealed that BAG2 is involved in the pathogenesis of various diseases, including cancer. However, the regulatory mechanisms of BAG2 in kidney fibrosis remain unclear.

**Methods:** Expression of BAG2 was validated by western blot, RT-PCR and FACS in unilateral ureteral obstruction (UUO) and adenine-diets WT or BAG2 knockout mouse model. The molecular mechanism study was performed in TGF-β1-induced human kidney proximal tubular cells (HKC-8) cells by gene expression analysis, and BAG2 lentiviral knockdown and overexpression cell lines. Human serums were isolated from patients with renal failure and healthy controls and BAG2 expression level was detected by ELISA.

**Results:** In the Kidney fibrosis mouse model, mRNA and protein showed that compared with the control group, the expressions of BAG2, and fibrotic marker were all increased, FACS analysis also shows that BAG2 increased during fibrotic changes. At the same time, overexpression of BAG2 suppressed enhancements on epithelial to mesenchymal transition and fibrosis via the TGF-β1 / SMAD3 / BAG2 complex. Also, BAG2 was increased in serum from chronic kidney disease patients.

**Conclusions:** This is, to our knowledge, the first report about the function of BAG2 in kidney fibrosis. These results demonstrate that BAG2 regulates kidney fibrosis via the TGF-β1 signaling and suggest that BAG2 is a potential therapeutic target for the treatment of kidney fibrosis.

**Funding:** Government Support - Non-U.S.

**FR-PO988**

**The Probiotic Lactiplantibacillus paraplantarum Modulates Serum and Intestinal Environments of Phosphorus in CKD Rats**

Sung Jin Moon,<sup>1</sup> Jwa-kyung Kim,<sup>3</sup> Hyo Jin Kim.<sup>2</sup> <sup>1</sup>Catholic Kwandong University International Saint Mary's Hospital, Incheon, Republic of Korea; <sup>2</sup>Seoul National University, Gwanak-gu, Seoul, Republic of Korea; <sup>3</sup>Hallym University, Chuncheon, Gangwon-do, Republic of Korea.

**Background:** The human gastrointestinal tract contains more than 100 trillion microorganisms, including >1000 species of bacteria. Despite many studies linking gut microbes to human diseases, most of the mechanisms by which lactic acid bacteria have beneficial effects on the human body are related to immune modulation. Controlled studies of the ability of lactic acid bacteria to absorb phosphorus directly in the intestine and thereby control serum phosphorus level in *in vivo* uremic animal models are limited.

**Methods:** We screened lactic acid bacteria living in Korean fermented foods to identify those that absorb the most phosphorus and noted *Lactiplantibacillus paraplantarum* KCCM 11826P (Fig 1). Genomic sequencing and CKD animal experiments were performed to explain the mechanism.

**Results:** That *L. paraplantarum* strain has a polyP gene cluster, so it absorbs phosphorus better than other bacteria and can suppress strains that produce indole. Supplementing the diets of 5/6 nephrectomized rats with the *L. paraplantarum* strain significantly decreased serum phosphate level (by 22%) and reduced blood indoxyl sulfate concentration by 40%.

**FR-PO989**

**Inhibition of TGF-β Unlocks Multiple Proximal Tubule Functions In Vitro**

William H. Fissell,<sup>1</sup> Rachel C. Evans,<sup>1</sup> Kuniko Hunter,<sup>3</sup> Harold D. Love,<sup>1</sup> Shuvo Roy.<sup>2</sup> The Kidney Project <sup>1</sup>Vanderbilt University Medical Center, Nashville, TN; <sup>2</sup>University of California San Francisco, San Francisco, CA; <sup>3</sup>Vanderbilt University, Nashville, TN.

**Background:** Renal proximal tubule cells are both essential to renal function and vulnerable to toxins and ischemia. In vitro, renal tubule cells quickly lose structural, biochemical, and functional features characteristic of their identity. This dedifferentiation of cell culture stress limits the use of tubule cell culture in drug screening and tissue engineering. We examined the role of TGF-β in the dedifferentiation of cell culture stress.

**Methods:** Renal proximal tubule epithelial cells were grown to confluence in 50:50 DMEM/F12 on permeable supports under constant fluid shear stress. Half the wells (n=12) were treated with an inhibitor of TGF-β receptor 1, SB431542. Another 12 wells served as controls. Cells were cultured over 300 days. Confluence of the monolayer was assessed by dextran leak and all experiments were performed only on confluent monolayers. Apical/basal fluid transport, organic anion excretion, and glucose transport were measured. Inhibitors of NHE3 (tenapanor), OAT3 (probenecid), and SGLT2 (phlorizin) were used to examine the specificity of response.

**Results:** Renal tubule cells in control wells did not transport fluid volume, glucose, or organic anions; concentrations in apical and basolateral compartments were identical. Cells treated with SB431542 showed tenapanor-inhibitable volume transport, probenecid-inhibitable para-amino hippurate excretion, and phlorizin-inhibitable glucose uptake.

**Conclusions:** Startlingly, inhibition of a single cytokine receptor, TGF-βR1, was necessary and sufficient to unlock a wide range of differentiated tubule cell functions over a very prolonged period of time. It may be possible to extend the medical use of cell culture to applications requiring stable quantitative fidelity between the *in vitro* and *in vivo* phenotypes.

**Funding:** Private Foundation Support

**FR-PO990**

**Transcription Factor PKNOX2 in Myofibroblasts and Tubular Epithelial Cell Contributes to Their Function and Survival During Kidney Fibrosis Progression**

Masanori Obana, Ayaha Yamamoto, Yasushi Fujio. *Osaka Daigaku, Suita, Japan.*

**Background:** PBX/Knotted Homeobox 2 (PKNOX2), a nuclear transcription factor, belongs to the Three Amino acid Loop Extension (TALE) class of homeodomain proteins. We found that PKNOX2 was increased in murine fibrotic kidneys using microarrays. However, the pathophysiological roles of PKNOX2 in kidneys remain unclear. The aim of this study is to elucidate the role of PKNOX2 in fibrotic kidneys.

**Methods:** To assess the relevance of PKNOX2 to kidney fibrosis, murine unilateral ureteral obstruction (UUO) model was induced and the spatiotemporal expression of PKNOX2 was examined using quantitative PCR, western blotting and immunofluorescence. To examine the function of PKNOX2, lentiviral shRNA knockdown system was performed in myofibroblast cell line NRK49F cells and tubular cell HK-2 cells. After NRK49F cells were treated with TGF-β1, cell migration was examined using scratch assay. The viability of myofibroblasts and tubular cells was analyzed using CellTiter Blue assay and TUNEL staining.

**Results:** The mRNA and protein expression of PKNOX2 was increased after UUO in a time-dependent manner. Immunofluorescence revealed that the number of PKNOX2-expressing myofibroblasts was increased, whereas the expression of PKNOX2 was decreased in tubular epithelial cells after UUO. PKNOX2 was upregulated by TGF-β1 in NRK49F cells. PKNOX2 knockdown reduced TGF-β1-induced migration of NRK49F cells and differentiation of fibroblasts into myofibroblasts. The viability was suppressed in PKNOX2-knockdown NRK49F cells either in the presence or absence of TGF-β1 (Cell viability vs control (%): shcontrol-TGFβ1+; 139.8±46.9, shPKnox2#1-

TGF $\beta$ 1+; 34.0 $\pm$ 10.5, shPKnox2#2-TGF $\beta$ 1+; 34.0 $\pm$ 12.3, n=6). Interestingly, knockdown of PKNOX2 also decreased the viability and increased apoptosis of HK-2 cells (Cell viability (%): shcontrol; 100.0 $\pm$ 3.6, shPKNOX2#1; 84.8 $\pm$ 6.0, shPKNOX2#2; 63.9 $\pm$ 12.7, n=6).

**Conclusions:** PKNOX2 regulates (myo) fibroblast functions and tubular cell survival during kidney fibrosis progression.

### FR-PO991

#### Repeated Episodes of Ischemia/Reperfusion Induced Hemoxygenase-1 (HO-1) and Anti-Inflammatory Reactivity and Protect Against Chronic Kidney Injury

Juan Antonio Ortega-Trejo, Rosalba Pérez-Villalva, Andrea Sanchez Navarro, Norma Bobadilla. *Molecular Physiology Unit, Instituto de Investigaciones Biomédicas, UNAM, Mexico City, Mexico.*

**Background:** Repeated episodes of ischemia/reperfusion (IR) induce protection against acute kidney injury (AKI), but their long-term effects are unknown. This study was designed to evaluate the transition to chronic kidney disease (CKD) after three moderate and three severe episodes of IR compared to a single episode of IR.

**Methods:** AKI was induced in male Wistar rats that received a single IR (1IR) or three episodes of IR separated by an interval of 10 days (3IR) of moderate (20 min, n=8) or severe (45 min, n=8) bilateral renal ischemia, in both cases, sham operated groups were included (n=6). AKI to CKD transition was evaluated after 9 months. The immediate effects of IR were studied in another set of experiments done 24 h after in the 1IR group (n=5) and after the last IR in the 3IR group (n=8).

**Results:** IR induced AKI that improved before the next episode of IR in the 3IR group. During the subsequent 9-months, the 1IR group (underwent moderate or severe IR) developed CKD, evidenced by progressive proteinuria and renal fibrosis. In contrast, the late adverse effects of IR were markedly ameliorated in the 3IR groups. The immediate response after the 3<sup>rd</sup> IR episode was a robust increment in the expression of hemoxygenase-1 (HO-1), IL-10, TGF- $\beta$  and CD206 positive infiltrating cells, and a decrease of IL-6, TNF- $\alpha$ , and phosphorylation of NF $\kappa$ B-p65. Interestingly, most CD206 positive cells co-localized with HO-1 in the interstitium. These results contrasted with the response to a single IR episode. In addition, repeated episodes of IR downregulated the expression of CHOP and BiP, endoplasmic reticulum (ER) stress markers.

**Conclusions:** AKI induced by IR results in progressive CKD. Repeated episodes of IR induced overexpression of HO-1, anti-inflammatory activity, reduced RE stress and long-term renal protection.

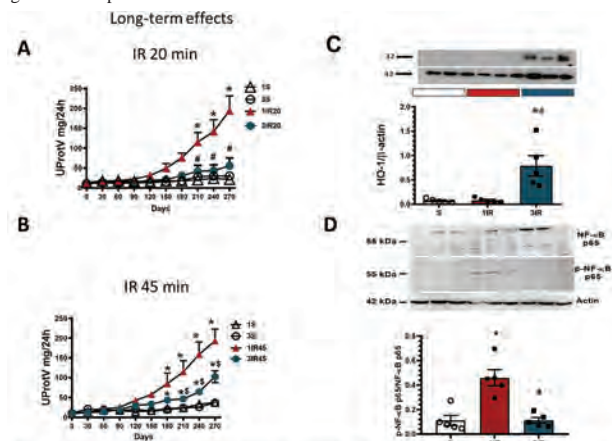

Figure 1. Long-term and acute effects of repeated episodes of ischemia/reperfusion. Proteinuria of animals with A) IR 20 min, B) IR 45 min at long-term of following. Immediate expression of C) HO-1 and p-NF- $\kappa$ B p65 after the last IR episode.

### FR-PO992

#### Hypoxia Induces Metabolic Alterations in Kidney Organoids

Akihiro Minakawa, Matthew Fischer, Jamal El Saghir, Chenchen He, V. Vega-Warner, John R. Hartman, Felix H. Eichinger, Jennifer A. Schaub, Subramaniam Pennathur, Matthias Kretzler, Jennifer L. Harder. *University of Michigan Division of Nephrology, Ann Arbor, MI.*

**Background:** Kidney hypoxia may contribute to development and progression of kidney disease, but the mechanism is difficult to model *in vivo*. The aim of this study was to demonstrate the relevance of a newly developed *in vitro* hypoxic kidney organoid model.

**Methods:** Kidney organoids containing multiple cell types and organ-specific architecture were generated from human pluripotent stem cells (PSCs) and placed in a hypoxia chamber filled with 1% O $_2$  for 3 and 24 hours. Samples were analyzed for alterations in gene expression of HIF1A and its known targets (qRT-PCR, ELISA of cell lysates and supernatant, IF), and in functional metabolites (LC-MS of  $^{13}$ C glucose flux) followed by transcriptional pathway analysis (TPA).

**Results:** Hypoxia induced nuclear accumulation of HIF1A, and increased transcription and/or protein levels of known HIF1A targets (VEGF and SLC2A1), glycolytic genes (HK1, HK2 and ENO1) and lactate synthesis. Genes related to Acetyl CoA synthesis (LDHA and PDK1) were suppressed. A flux analysis of glucose metabolism demonstrated

that glycolysis increased, and oxidative phosphorylation decreased in organoids exposed to a hypoxic environment. TPA revealed Glycolysis, Sirtuin Signaling, Cell Cycle Control of Chromosomal and mitochondrial dysfunction as top canonical pathways, with HIF1A being the most significant upstream regulator.

**Conclusions:** Our hypoxic kidney organoid model successfully recapitulates key transcriptional, protein and metabolic alterations generated by hypoxic conditions. This novel *in vitro* model will facilitate investigations into hypoxia's contribution to kidney cell dysfunction, especially in combination with other kidney cell stressors such as inflammation. In the future, a comparison of the hypoxic response of kidney organoid and human kidney cells at a single cell level may help to identify what cell type specific transcriptional alterations are associated with disease development related to hypoxia.

**Funding:** Other NIH Support - NCATS, Private Foundation Support

### FR-PO993

#### A Novel, Small-Molecule Inhibitor of Ketoheokinase Attenuates Tubular Injury, Immune Cell Infiltration, and Renal Failure in Models of Acute and Chronic Kidney Injury

Natalie Sroda,<sup>1</sup> Shawn S. Badal,<sup>1</sup> Ivan G. Gomez,<sup>1</sup> Maile Velasquez,<sup>1</sup> Frank Y. Ma,<sup>2</sup> Zachary A. Kasun,<sup>1</sup> Petr Jansa,<sup>1</sup> David J. Nikolic-Paterson,<sup>2</sup> John T. Liles.<sup>1</sup> <sup>1</sup>Gilead Sciences Inc, Foster City, CA; <sup>2</sup>Monash Medical Centre Clayton, Clayton, VIC, Australia.

**Background:** Acute or chronic injury to proximal tubule cells (PTECs) causes endogenous production of fructose via the polyol pathway and increases ketoheokinase (KHK) activity. KHK activation causes sustained ATP depletion, cell death and propagation of inflammation cascades, which contributes to loss of kidney function. Here we describe the therapeutic activity of a potent small molecule inhibitor of KHK in models of kidney tubular injury.

**Methods:** The biochemical potency of KHK inhibitor (KHKi), GS-9328, was characterized (IC $_{50}$  <50nM) and then evaluated in an ischemia/reperfusion injury (IRI) mouse model (17min ischemia, 24hr reperfusion, -1hr pre-treatment; 115 mg/kg/PO BID); and in an adenine injury rat model (6 weeks 0.25% adenine in diet, 2 week treatment, 60 mg/kg/PO BID). Tubular injury was assessed by histology (PAS), *Kim1* mRNA levels, infiltrating immune cells via flow cytometry, and function by serum levels of creatinine (sCr) and BUN.

**Results:** In the IRI model KHKi administration reduced the percentage of damaged tubules ( $\downarrow$ 28%, P<0.001) and kidney *Kim1* mRNA levels ( $\downarrow$ 52%, P<0.001), and protected against renal failure based on sCr (0.23 $\pm$ 0.05 vs veh 1.15 $\pm$ 0.09 mg/dL) and BUN (36.8 $\pm$ 7.9 vs veh 126.7 $\pm$ 20.8 mg/dL). In the adenine model, the administration of KHKi began after animals had impaired kidney function (avg sCr = 0.67 $\pm$ 0.02 vs. control diet 0.23 $\pm$ 0.02 mg/dL). Animals treated with KHKi had significantly greater kidney function at the end of the study (sCr = 1.01 $\pm$ 0.06 vs veh 1.26 $\pm$ 0.06 mg/dL & BUN= 46 $\pm$ 1.8 vs veh 59.2 $\pm$ 3.1 mg/dL). KHKi also significantly reduced immune cell infiltration into the kidney cortex [e.g. CD45 ( $\downarrow$ 25%; P<0.05), CD8 ( $\downarrow$ 43%; P<0.05)] as assessed by flow cytometry. Finally, to extend translatability of these findings, we confirmed upregulation of the polyol pathway in human CKD datasets via RNA and protein levels of Aldose Reductase.

**Conclusions:** A novel, potent small molecule inhibitor of KHK is efficacious at preventing kidney function decline in rodent models of acute and chronic tubular injury. These data support KHK as a therapeutic target for kidney disease indications where tubular injury plays a major role.

**Funding:** Commercial Support - Gilead Sciences

### FR-PO994

#### Renoprotective Effect of Phosphodiesterase (PDE) 3A Mutations in a Rat Model of CKD

Thekla U. Bartolomeaus,<sup>1,2</sup> Reika Langanki,<sup>2</sup> Olena Potapenko,<sup>1</sup> Anastasiia Sholokh,<sup>2,1</sup> Kerstin Zuehlke,<sup>2</sup> Sylvia Bähring,<sup>1</sup> Michael Bader,<sup>2</sup> Sofia K. Forslund,<sup>1,2</sup> Lajos Marko,<sup>1,2</sup> Enno Klussmann,<sup>1,2</sup> <sup>1</sup>Charite Universitätsmedizin Berlin, Berlin, Germany; <sup>2</sup>Max-Delbrück-Centrum für Molekulare Medizin in der Helmholtz-Gemeinschaft, Berlin-Buch, Germany.

**Background:** Hypertension is associated with chronic kidney disease (CKD) in more than 80% of cases. Along with diabetes, hypertension is considered as a major risk factor. Here, we are studying a Mendelian form of hypertension (HTNB) that is associated with activating mutations in the *PDE3A* gene. Without treatment, mutation leads to premature death caused by stroke, but remarkably patients are free from impaired kidney function and other forms of target-organ damage. Here, we tested *PDE3A* as a target for renoprotection against CKD.

**Methods:** *PDE3A*-activating (d3aa), *PDE3A*-deleted (functional DEL), and littermate wild-type (WT) rat strains were generated and CKD was induced by bilateral renal ischemia by clamping renal artery for 45 minutes. Blood pressure was continuously measured by telemetry 2 weeks before and 4 weeks after renal ischemia. Renal function was assessed before, 24 hours and 4 weeks after CKD induction. After 4 weeks, kidneys were harvested for further analysis.

**Results:** Serum creatinine was significantly elevated 4 weeks after CKD induction (baseline 0.33, 0.31 and 0.34 mg/dL vs. 0.48, 0.49 and 0.38 mg/dL at 4 weeks, in d3aa, WT and functional DEL, respectively). Rats with *PDE3A*-activating mutation had significantly higher systolic blood pressure than WT or functional DEL animals (142 vs 121 and 115 mmHg, respectively). Despite high blood pressure, d3aa animals had similar serum creatinine, blood urea nitrogen and cystatin-C levels before, 24 hours after and 4 weeks after bilateral renal ischemia. The same was true for gene expression of renal

damage markers lipocalin-2 (Ngal) and kidney injury molecule-1 and fibrosis markers collagen 1 or fibronectin. Western blot and histology confirmed gene expression data.

**Conclusions:** Our data argue that PDE3A modulation can be a useful approach in hypertension associated CKD.

**Funding:** Government Support - Non-U.S.

#### FR-PO995

##### DZnep, a Histone Modification Inhibitor, Inhibits HIF1 $\alpha$ Binding to TIMP2 Gene by Reducing Open Chromatin Area

Tomotaka Yamazaki, Imari Mimura, Masaomi Nangaku. Division of Nephrology and Endocrinology Tokyo Daigaku Daigakuin Igakukei Kenkyaku Igakubu, Bunkyo-ku, Japan.

**Background:** Even after complete resolution of acute kidney injury (AKI), some patients develop chronic kidney disease (CKD) and end-stage renal failure. The mechanism of AKI to CKD is thought to be that transient AKI damage may cause the epigenetic changes, such as histone modification and DNA methylation, that lead to CKD progression. Our previous report showed that 3-Deazaneplanocin A (Dzne), a histone modification inhibitor, suppressed renal fibrosis and the expression of Tissue Inhibitor of Metalloproteinase 2 (TIMP2), which is thought to be a profibrotic factor, in ischemia-reperfusion mice. In this study, we investigated the epigenetic regulation of TIMP2 in tubular cells.

**Methods:** Human kidney-2 (HK-2) cells were treated with Dzne and examined for histone methylation and open chromatin status by Western-blotting, Chip-qPCR and Formaldehyde-Assisted Isolation of Regulatory Elements (FAIRE)-qPCR. The relationship with hypoxia-inducible factor 1 $\alpha$  (HIF1 $\alpha$ ) was also examined by Chip-qPCR and reporter assay.

**Results:** In HK-2 cells, TIMP2 expression was upregulated under hypoxia and suppressed by Dzne. Dzne treatment had a repressive effect on various histone methylation such as H3K4me3, H3K27me3 and H3K9me3. The Chip-qPCR of H3K4me3 for TIMP2 gene region showed that Dzne treatment reduced H3K4me3. The FAIRE-qPCR of TIMP2 gene region showed that Dzne treatment suppressed the percentage of open chromatin area, which was elevated by hypoxia. In addition, the Chip-qPCR of HIF1 $\alpha$  for TIMP2 gene showed that Dzne inhibited the binding region of HIF1 $\alpha$ , which was elevated by hypoxia. The reporter assays for the binding region of HIF1 $\alpha$  showed enhanced transcriptional activity by hypoxia.

**Conclusions:** Dzne suppresses the expression of TIMP2, which is elevated by hypoxia, by altering the histone methylation state of TIMP2 gene, decreasing the percentage of open chromatin, and inhibiting HIF1 $\alpha$  binding.

**Funding:** Government Support - Non-U.S.

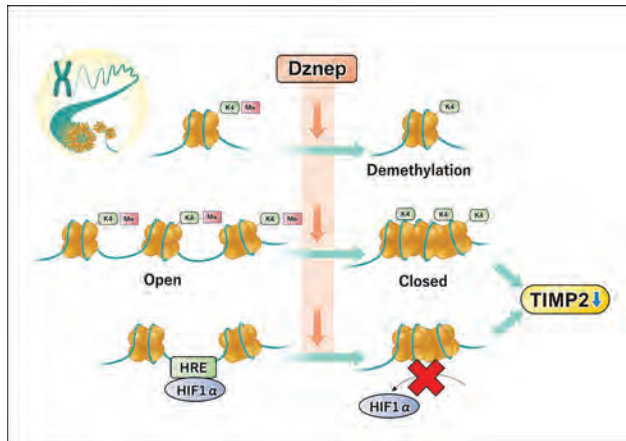

The epigenetic regulation of TIMP2 by TIMP2.

#### FR-PO996

##### Urate Regulates Mitochondrial Function in a URAT1 Dependent Manner in Renal Epithelial Cells

Owen M. Woodward,<sup>1</sup> Victoria L. Halperin Kuhns,<sup>1</sup> Allison C. Lane-Harris,<sup>1</sup> Ava M. Zapf,<sup>1</sup> Krister Bamberg.<sup>2</sup> <sup>1</sup>University of Maryland School of Medicine, Baltimore, MD; <sup>2</sup>AstraZeneca Translational Sciences and Experimental Medicine, Early Cardiovascular, Renal and Metabolism (CVRM), Biopharmaceuticals R&D, Gothenburg, Sweden.

**Background:** Alterations in cell metabolism in the proximal tubule are a recognized component in the initiation and progression of chronic kidney disease (CKD). Previously, we used whole kidney RNAseq to determine genes and pathways that were differentially expressed in a genetic mouse model of hyperuricemia (*Uox-iKO*). The pathways most affected in the *Uox-iKO* males were related to metabolism and oxidative phosphorylation. The *Uox-iKO* male animals also showed significant increases in urinary lactate excretion after induction of *Uox* KO. Here, we focused on the role of renal urate handling in controlling lactate secretion and mitochondrial function in human renal epithelial cells. Lactate is a substrate of URAT1 (*SLC22A12*) moving in *trans* with the apical entry of

urate from the renal tubule lumen. We hypothesized that increased extracellular urate will promote the secretion of lactate via URAT1 and alter cellular respiration and mitochondrial function.

**Methods:** Using cultured primary normal human cortical renal epithelial cells (NHCRE) we measured the effect of chronic extracellular urate on intracellular lactate and oxygen consumption rate using the Seahorse XFe96 analyzer.

**Results:** In NHCRE cells we found that chronic exposure to increased extracellular urate (500 $\mu$ M from 24hrs to 2 weeks) significantly lowered intracellular lactate in the presence of either high (4.5g/l) or reduced glucose (1g/l), and that additional extracellular lactate rescued intracellular levels. Further, the application of probenecid, a general anion transporter blocker with affinity for URAT1, or verinurad, a specific URAT1 inhibitor, abolished the effects of extracellular urate on lactate levels, though URAT1 inhibition alone had no effect. Next, we measured the oxygen consumption rate (OCR, normalized to cell number) in NHCRE cells using the Seahorse analyzer. We found chronic exposure to increased extracellular urate (500 $\mu$ M for 24 hours) significantly increased basal respiration and the maximum respiratory capacity. Both effects were abolished in the presence 0.5 $\mu$ M of verinurad.

**Conclusions:** We conclude that increased tubular urate alters intracellular lactate levels and mitochondrial function in a URAT1 dependent manner, providing mechanistic evidence that urate alters cell metabolism in the proximal tubule and may contribute to kidney disease progression.

**Funding:** NIDDK Support, Commercial Support - AstraZeneca

#### FR-PO997

##### ALDH2 Expression Is Reduced in Human and Mouse Renal Tissue Following CKD

Jjen Chiu,<sup>1</sup> Amrendra K. Ajay,<sup>1,2</sup> Kavya M. Shah,<sup>2</sup> Li-Li Hsiao.<sup>1,2</sup> <sup>1</sup>Brigham and Women's Hospital, Boston, MA; <sup>2</sup>Harvard Medical School, Boston, MA.

**Background:** Chronic kidney disease (CKD) poses a tremendous socioeconomic burden in addition to increasing rates of morbidity and mortality, and several East Asian countries have a much higher prevalence of CKD compared to the global average. The ALDH2 E504K polymorphism is found in 35-45% of East Asian populations and has been linked to a higher risk of various cardiovascular diseases, neurological disorders, and cancers. However, despite the high prevalence of the ALDH2 polymorphism and of CKD among East Asian populations, little is known about the role of ALDH2 in CKD.

**Methods:** ALDH2 expression patterns in kidney tissue were determined via immunohistochemical staining of mouse kidneys and human kidney biopsy samples. To explore the role of ALDH2 in CKD, ALDH2 expression was studied *in vivo* using an aristolochic acid-induced CKD mouse model and *in vitro* via human renal proximal tubular epithelial cells (RPTECs). RPTECs were further utilized and cultured with the profibrotic protein TGF- $\beta$  to investigate the role of ALDH2 in kidney fibrosis.

**Results:** ALDH2 was highly expressed in the renal proximal tubules of healthy human and mouse kidneys. ALDH2 expression was significantly downregulated in CKD patients and inversely correlated with the severity of CKD, in human and mouse studies. Mechanistically, it was demonstrated that a deficiency in ALDH2 expression was associated with kidney fibrosis *in vitro*, due to the role of ALDH2 protein in modulating the epithelial-mesenchymal transition.

**Conclusions:** ALDH2 has a specific and localized expression pattern in the kidneys, and a deficiency in ALDH2 expression is linked to kidney fibrosis. These findings may have significant clinical implications in the development and progression of kidney disease, especially among East Asian populations.

**Funding:** Other NIH Support - American Heart Association

#### FR-PO998

##### A Molecular Mechanism Study to Reveal Hirudin Downregulation to PI3K/AKT Signaling Pathway With PDGFB in Renal Fibrosis Treatment

Ying Li,<sup>1</sup> Haitao Tu,<sup>2</sup> <sup>1</sup>Chongqing Traditional Chinese Medicine Hospital, Chongqing, China; <sup>2</sup>The First Affiliated Hospital of Guangzhou University of Chinese Medicine, Guangzhou, China.

**Background:** Chronic kidney disease, also known as CKD, is a prevalent chronic disease jeopardizing public health; however, there is no an efficient therapy to prevail over this disease. Our study was committed to revealing the hirudin's regulation to chronic kidney disease as well as the molecular mechanism.

**Methods:** We built renal fibrosis model on animal levels, which was subsequently given with hirudin disposal, then we performed the HE and Masson to evaluate for renal fibrosis (RF) and had our detection to relevant marker proteins of RIF with western blot. Finally, we detected on the expressions of PDGFRBB, PDGFR $\beta$  and the PI3K-AKT pathway.

**Results:** Our outcomes of the animal level demonstrated that the conditions of severe tubular dilatation or atrophy, interstitial fibrosis, inflammatory cell infiltration, and massive deposition of interstitial collagen in model group were withdrew after the addition of hirudin. WB results showed that the marker proteins of RF, PDGFRBB, PDGFR $\beta$  and the PI3K-AKT signal molecules were significantly reduced by addition of hirudin.

**Conclusions:** The declining in PDGFR $\beta$  phosphorylation because of the hirudin's interaction with PDGF-BB is capable of suppressing PI3K-AKT signaling pathway as well as the EMT.

**Funding:** Government Support - Non-U.S.



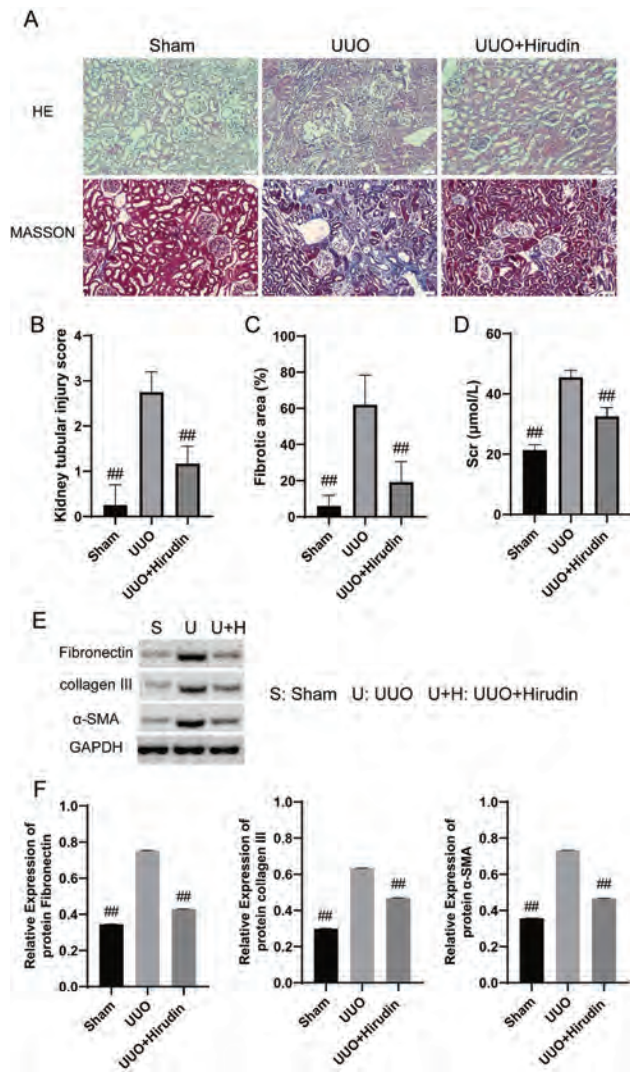

Figure 1 Alleviating ability of hirudin on the renal fibrosis of rat

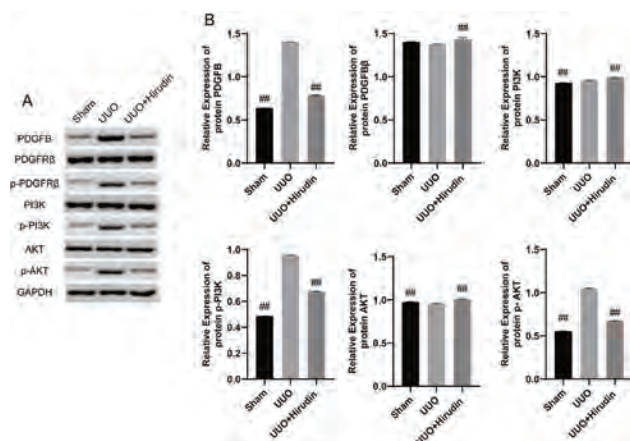

Figure 2 Detection on the expressions of the PI3K-AKT pathway

FR-PO999

Cadherin-11 Inhibitor SD-133 Prevents Renal Fibrosis in a Model of Tubulointerstitial Disease in Male Mice

Shania R. Davidson,<sup>1,2</sup> Sharmila Adapa,<sup>1</sup> Katherine C. Allen,<sup>1</sup> Bryce A. Jones,<sup>1</sup> Katelyn Dial,<sup>1</sup> Komuraiah Myakala,<sup>1</sup> Xiaoxin Wang,<sup>1</sup> Moshe Levi,<sup>1</sup> <sup>1</sup>Georgetown University Medical Center, Washington, DC; <sup>2</sup>Howard University College of Arts and Sciences, Washington, DC.

**Background:** Fibrosis of the kidney is the last and highly morbid stage of various types of chronic kidney diseases. The progressive decline of kidney function is the result of prolonged states of inflammation and maladaptive repair mechanisms of extracellular matrix and transmembrane proteins. Cadherin-11 is transmembrane cell junction protein upregulated in various organs within fibrotic diseases, including the kidney. With this, we hypothesized that Cadherin-11 antagonism is nephroprotective in the adenine model of kidney disease.

**Methods:** 12-week-old male 129S1/SvImJ mice were fed chow or chow supplemented with adenine (0.2% w/w) ad lib for 7 weeks. Mice were injected IP with vehicle (30% PEG-400) or Cadherin-11 antagonist SD-133 (40 mg/kg BW) 3 days per week for the duration of the study. GFR was measured in vivo by transdermal clearance of FITC-Sinistrin. Plasma and organs were later collected following euthanasia and processed for biochemical analysis.

**Results:** Mice fed the adenine diet had decreased body weight compared to control mice, but bodyweight was unchanged between vehicle and SD-133 treatment groups. Plasma creatinine increased with disease and was unchanged with SD-133 treatment. Additionally, there was an increase in BUN (P<0.0001), but there was no change with SD-133 treatment. In vivo measurements showed that GFR was decreased with disease (P<0.0001), but again there was no change with SD-133 treatment. However, on western blot, fibronectin and phosphorylated SMAD3 were increased with disease (p<0.001) and reduced with SD-133 treatment (p<0.05).

**Conclusions:** Cadherin-11 antagonism did not exhibit beneficial kidney effects in the adenine diet model using male mice on the 129S1/SvImJ background at the 7-week timepoint as determined by BUN, plasma creatinine, and in vivo GFR measurements. However, western blots showed that Cadherin-11 antagonism reduced renal fibrosis and inhibited the pro-fibrotic SMAD3 pathway, therefore indicating that Cadherin-11 antagonism was nephroprotective in this model.

**Funding:** NIDDK Support

FR-PO1000

Metabolomics and Mechanistic Approaches to Identify Therapeutic Targets for Progressive Kidney Disease

Afaf Saliba, Hongping Ye, Kumar Sharma. Center for Precision Medicine, The Laboratory of Dr. Kumar Sharma The University of Texas Health Science Center at San Antonio, San Antonio, TX.

**Background:** The role of MDM2 in chronic kidney disease has not yet been clarified. Thus, we aim to (1) establish the link between MDM2 loss and skewed metabolic pathways in the DKD kidney and (2) screen precise therapeutic pathways that improve mitochondrial function.

**Methods:** (1) To elucidate a metabolic mechanism through which MDM2 absence reduces mitochondrial biogenesis and promotes kidney dysfunction, we developed transgenic 3-4 months mice with doxycycline-inducible deletion of MDM2 in renal tubule cells (MDM2cKO). We performed ZipChip CE MS metabolomics analysis on MDM2cKO kidneys and plasma samples. (2) To determine if AMPK activation could benefit tubular epithelial cells, we transfected HK2 cells with siRNA-MDM2 (HK2; MDM2KD) vs. siRNA-scramble, treated the cells with AICAR (AMPK activator) and performed Annexin V apoptosis assay.

**Results:** (1) While the control group (n=19) survived at 100% during the doxycycline treatment, the MDM2cKO mice group (n=8) had a 65% survival percentage at day 6 and 0% survival beyond day 8. In addition to substantial increase in the Blood Urea Nitrogen (BUN) (300-fold increase) in the cKO compared to control mice, we observed a significant decrease in PGC-1α (master regulator of mitochondrial biogenesis) and MCCC2 kidney mRNA levels. MCCC2 is an essential enzyme for Leucine (Leu) metabolism. ZipChip MS analysis revealed a significant decrease in Alanine (Ala) levels in the MDM2cKO plasma. Both Leu and Ala are essential to support mitochondrial biogenesis. (2) Annexin V assay on MDM2KD HK2 cells showed a significant decrease in apoptotic cells with AMPK stimulation (HK2; MDM2KD: 66.67% ± 7.572; HK2; MDM2KD + AICAR 1mmol/L: 30.67% ± 9.452; p=0.0068).

**Conclusions:** MDM2cKO mice are models for metabolic progressive kidney disease associated with decreased mitochondrial biogenesis and altered Leu and Ala metabolism. AMPK stimulation *in vitro* significantly improved cell survival upon loss of MDM2 in HK2 cells. We are currently exploring mechanisms that connect MDM2 to Leu and Ala and testing AMPK activation role in improving kidney function, metabolic outcome, and survival of MDMcKO mice. The outcomes of this study will lead to improved treatment approaches for metabolic-related kidney diseases such as DKD.

**Funding:** Other NIH Support - The project described was supported by the National Center for Advancing Translational Sciences, National Institutes of Health, through Grant TL1 TR002647. The content is solely the authors' responsibility and does not necessarily represent the official views of the NIH.

## FR-PO1001

**Psoralen Ameliorates Renal Fibrosis Induced by Unilateral Ureteral Obstruction in Mice**

Tae won Lee,<sup>1</sup> Eunjin Bae,<sup>1,3</sup> Se-Ho Chang,<sup>2,3</sup> Dong Jun Park.<sup>1,3</sup> <sup>1</sup>Gyeongsang National University Changwon Hospital, Changwon, Gyeongsangnam-do, Republic of Korea; <sup>2</sup>Gyeongsang National University Hospital, Jinju, Gyeongsangnam-do, Republic of Korea; <sup>3</sup>Gyeongsang National University Graduate School of Medicine, Jinju, Gyeongsangnam-do, Republic of Korea.

**Background:** Renal fibrosis arises in most progressive renal diseases, regardless of the disease underlying end-stage kidney disease. Psoralen (PSO), a major active component extracted from *Psoralea corylifolia* L. seed, has several biological effects. However, the role of psoralen in renal fibrosis is still unclear. This study was undergone to evaluate the PSO on the development and progression of renal fibrosis induced by unilateral ureteral obstruction (UO) in mice model.

**Methods:** The mice were divided into four groups: PSO (20 mg/kg, i.g., n = 5), PSO + Sham (n = 5), UO (n = 10), and PSO + UO (n = 10). PSO was intragastrically administered 24 hour before the UO and continued afterward for 7 days and all mice were killed 7 days after UO.

**Results:** Severe tubular atrophy, tubular injury, and tubulointerstitial fibrosis were significantly developed in UO mice. Higher expression of TGF- $\beta$ 1 is accompanied by elevated  $\alpha$ -SMA and p-Smad2/3 after 7 post-UO. However, PSO treatment reduced tubular injury and interstitial fibrosis and the expression of TGF- $\beta$ 1,  $\alpha$ -SMA, and p-Smad2/3. Furthermore, level of macrophages (represented by F4/80 positive cells) and inflammasome reflected by inflammasome markers such as NLRP3 and cCASP-1 were significantly decreased by PSO treatment.

**Conclusions:** This is the first study to show that PSO reduces renal fibrosis in UO mice model. These results suggest that PSO had merits of further exploration as a therapeutic agent in the management of chronic kidney disease.

## FR-PO1002

**Cyclosporine A and Paraquat Induce Lysosomal Deacidification in Proximal Tubular Cells In Vitro**

Sylvina da Silva Fernandes, Gerd Schreurs. Lab of Pathophysiology - CINAC Universiteit Antwerpen, Antwerpen, Belgium.

**Background:** Chronic interstitial nephritis in agricultural communities (CINAC) is a chronic toxin-induced nephropathy of which the underlying molecular mechanism and causal toxins are unknown. Due to the geographical distribution of CINAC cases in and around agricultural communities, we and others suspect that environmental toxins could play a role in disease development. Recently, we discovered a diagnostic lesion in CINAC renal biopsies encompassing large dysmorphic lysosomes in proximal tubular cells (PTCs). The same phenotype was found in PTCs of transplant patients receiving nephrotoxic calcineurin inhibitors (CNIs) as immunosuppressive therapy. Hence, it is hypothesized that CINAC is caused by exposure to an (unknown) environmental toxin, which affects the lysosomal system. In search for the CINAC culprit(s), we therefore aimed to optimize a *in vitro* assay to assess effects on PTC lysosomal function.

**Methods:** Since impaired lysosomal acidification indicates a functional defect, the central approach to the assay consists in exposing PTCs to various toxins and quantifying acidification. HKC-8 cells were exposed to Bafilomycin A1 (Baf), an inhibitor of lysosomal acidification (positive control), Cyclosporine A (CsA, a CNI) or Paraquat (PQ, a herbicide). For each toxin a sub-toxic dose was chosen from a concentration range based on cell death quantification using Sytox Green. Lysosomal acidification was assessed by incubating cells with LysoTracker (LT) (50 nM, 30 minutes) followed by flow cytometric quantification. To correct for the size of the lysosomal compartment in these cells, a Western Blot targeting LAMP-1, a lysosomal protein, was performed.

**Results:** In the optimized assay, HKC-8 cells were incubated with normal medium (Control), 10nM Baf, 25  $\mu$ M CsA and 100  $\mu$ M PQ for 6 hours. The mean LT Red signal, relative to control, was significantly lower ( $p < 0.01$ ) in all three conditions. No significant difference in LAMP-1 abundance was found, indicating no significant contribution of lysosome to the LT signal. CsA exposure caused a significant increase in granularity as measured by flow cytometry and observed visually as clear, irregular vacuoles under brightfield microscopy.

**Conclusions:** Both CsA and PQ induce lysosomal deacidification in PTCs *in vitro*, but only CsA causes an increase of granules. Immunostains are planned to identify the nature of these granules.

**Funding:** Government Support - Non-U.S.

## FR-PO1003

**Mycophenolic Acid Decreases TGF- $\beta$ 1 Induced Fibronectin Expression Through Inhibition of F-actin Polymerization and Downregulation of SMAD3 Phosphorylation in Human Proximal Tubular Epithelial Cells**

Tsz Wai Tam, Susan Yung, Tak Mao D. Chan. *The University of Hong Kong Li Ka Shing Faculty of Medicine, Hong Kong, Hong Kong.*

**Background:** Despite advances in immunosuppressive treatment, many patients with lupus nephritis (LN) develop chronic kidney disease (CKD) characterized by increased TGF- $\beta$ 1 expression and accumulation of matrix proteins in the tubulo-interstitium leading to progressive kidney failure. Fibronectin serves as a scaffold for the deposition of other matrix proteins. We previously reported that mycophenolic acid (MPA) inhibited fibronectin expression in proximal tubular epithelial cells (PTEC) in murine LN. This

study investigated the mechanism through which TGF- $\beta$ 1 induced fibronectin expression in PTEC and how MPA exerted its anti-fibrotic effect.

**Methods:** Confluent growth arrested PTEC were stimulated with TGF- $\beta$ 1 (1 ng/ml) in the presence or absence of MPA (5  $\mu$ g/ml), LY2109761 (specific inhibitor of TGF- $\beta$ RI/II activity, 1  $\mu$ M), SIS3 (specific SMAD3 inhibitor, 7 $\mu$ M), PD98059 (specific ERK inhibitor, 50  $\mu$ M) or cytochalasin B (inhibitor of actin polymerization, 2  $\mu$ M), for up to 48 h, and cells were harvested for qPCR, Western blot and immunohistochemistry.

**Results:** TGF- $\beta$ 1 induced fibronectin expression in a time-dependent manner, accompanied by increased SMAD2, SMAD3, TGF- $\beta$ RI and TGF- $\beta$ RII expression and F-actin polymerization with the formation of thick stress fibres that traversed the cells. Constitutive fibronectin expression was mediated through ERK phosphorylation, whereas fibronectin induced by TGF- $\beta$ 1 was mediated through SMAD2, SMAD3 and ERK phosphorylation. MPA inhibited fibronectin expression through suppression of F-actin polymerization, decreased TGF- $\beta$ RII expression and phosphorylation of SMAD3 and ERK, but had no effect on SMAD2 phosphorylation.

**Conclusions:** MPA inhibits fibronectin synthesis in PTEC by targeting TGF- $\beta$ 1 canonical and non-canonical signaling pathways and F-actin reorganization. The results could have implications on the intervention of CKD due to LN or other causes.

**Funding:** Government Support - Non-U.S.

## FR-PO1004

**Enhancer of Zeste Homolog 2 Promotes Renal Interstitial Fibrosis Through Downregulation of Phosphoenolpyruvate Carboxykinase 1 Mediated Gluconeogenesis**

Yanze Wang, Ming Wu, Chaoyang Ye. *Shuguang Hospital, Shanghai, China.*

**Background:** Renal fibrosis is the common pathological pathway of various chronic kidney diseases progressing to the end stage of renal failure. The methyltransferase enhancer of zeste homolog 2 (EZH2) has been identified as a therapeutic target to inhibit renal interstitial fibrosis. However, the mechanism underlying the role of EZH2 in renal fibrosis is not completely understood.

**Methods:** Unilateral ureteral obstruction (UO), unilateral ischemia-reperfusion injury (UIRI) mouse models were established. PCR, cleavage under targets and tagmentation (CUT&Tag) and Western blotting was performed to evaluate the expression of EZH2 and phosphoenolpyruvate carboxykinase 1 (PCK1).

**Results:** By using EZH2 inhibitor 3-DZNeP and *Ezh2* conditional knockout mice, we confirmed the pro-fibrotic effect of EZH2 in unilateral ureteral obstruction (UO). Through RNA sequence and cleavage under targets and tagmentation (CUT&Tag) sequence analysis, we found that the phosphoenolpyruvate carboxykinase 1 (PCK1), a critical enzyme in gluconeogenesis, is negatively regulated by EZH2 in fibrotic kidneys, which was further confirmed by quantitative PCR, CUT&Tag and Western blotting. We further showed that deletion or inhibition of EZH2 inhibited renal fibrosis and enhanced PCK1 expression and activity in unilateral ischemia-reperfusion injury (UIRI) and folic acid induced mouse nephropathy. Moreover, the dysregulated production of renal glucose and lactate in mouse UO kidneys was restored after EZH2 inhibition by 3-DZNeP. Finally, inhibition of PCK1 by 3-mercaptopropionic acid (3-MPA) abrogated the anti-fibrotic effect of 3-DZNeP in UO kidneys.

**Conclusions:** We conclude that EZH2 promotes renal interstitial fibrosis through inhibition of PCK1 mediated gluconeogenesis.

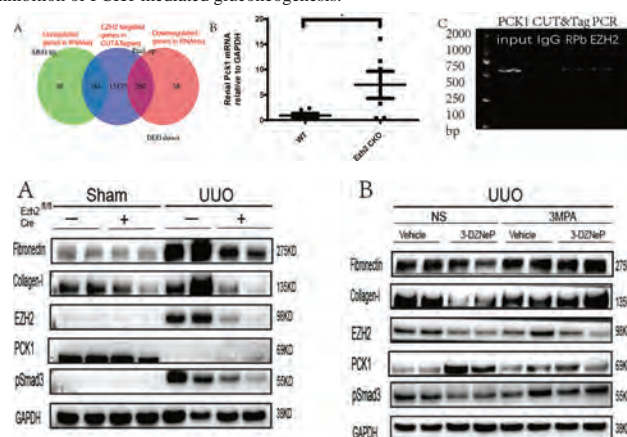

## FR-PO1005

**CDK5 Deletion Prevents Proximal Tubule Cell Maladaptive Dedifferentiation and Kidney Fibrosis**

Sho Sugahara, Kensei Taguchi, Bertha C. Elias, Craig R. Brooks. *Vanderbilt University Medical Center, Nashville, TN.*

**Background:** Acute kidney injury (AKI) occurs in more than 20% of hospitalized patients. AKI not only increases morbidity and mortality risks in patients, but also dramatically increases the incidence of chronic kidney disease (CKD), involving progressive fibrosis and loss of organ function, in a process termed AKI-to-CKD transition. Maladaptive repair and dedifferentiation of proximal tubular cells is a hallmark of AKI-to-CKD transition. Cyclin-dependent kinase 5 (CDK5) is a kinase first identified

in neuronal cells that regulates cell cycle exit in basal conditions, while hyperactivation of CDK5 and promotes dedifferentiation, G2/M arrest, and neuronal pathology. The role of CDK5 in kidney tubular cells is largely unknown.

**Methods:** CDK5fl/fl mice were bred to Six2-Cre to generate tubule specific CDK5 knockout (CDK5<sup>fl/fl</sup>). Wild-type, CDK5fl/fl, and CDK5<sup>fl/fl</sup> mice aged 8-12 weeks were subjected to unilateral ureter obstruction (UO) model. Inhibition of CDK5 was performed in wild-type mice and primary cultured proximal tubular cells with/without aristolochic acid and markers of dedifferentiation and fibrosis were compared.

**Results:** Kidney injury increased total CDK5 and phospho-CDK5 levels in proximal tubule cells, which correlated with increased markers of dedifferentiation and fibrosis. Despite having similar levels of G2/M arrest as CDK5fl/fl controls following UO, CDK5<sup>fl/fl</sup> mice had reduced renal fibrosis following injury. CDK5<sup>fl/fl</sup> mice had markedly reduced numbers of dedifferentiated tubule cells and decreased expression of profibrotic and dedifferentiation markers, compared to injured CDK5fl/fl mice. Administration of a specific inhibitor of hyperactive CDK5, GLX, to wild-type mice subjected to UO suppressed dedifferentiation and fibrosis similar to CDK5<sup>fl/fl</sup> mice. Suppression of CDK5 in cultured proximal tubular cells resulted in a decrease in profibrotic cytokine secretion and a reduction in dedifferentiation markers, while overexpression of CDK5 induced dedifferentiation.

**Conclusions:** CDK5 is a novel regulator of AKI-to-CKD transition. Elevated CDK5 in proximal tubule cells increases cell dedifferentiation and secretion of profibrotic cytokines, resulting in exacerbation of fibrosis. Inhibition of proximal tubular dedifferentiation by targeting CDK5 may be a new therapeutic strategy for AKI-to-CKD transition.

**Funding:** NIDDK Support

## FR-PO1006

### Single-Cell Analysis Identifies the Interaction of Altered Renal Tubules With Basophils Orchestrating Kidney Fibrosis

Tomohito Doke, Amin Abedini, Daniel Aldridge, Jihwan Park, Michael S. Balzer, Rojesh Shrestha, Gaia M. Coppock, Christopher A. Hunter, Katalin Susztak. *University of Pennsylvania, Philadelphia, PA.*

**Background:** Inflammation is an important component of fibrosis; however, immune processes that orchestrate kidney fibrosis are not well understood. Here we apply single-cell sequencing to a mouse model of kidney fibrosis. We identify a subset of kidney tubule cells with a profibrotic-inflammatory phenotype characterized by the expression of cytokines and chemokines associated with immune cell recruitment.

**Methods:** Single-cell libraries were generated from the control and unilateral ureteral obstruction (UO) model of kidney fibrosis and patient samples using the 10x system and sequenced 77,393 high-quality mice and 13,380 human cells after quality control. Clustering and data processing and cell trajectory analysis followed established pipelines. Bulk RNA sequencing and in silico deconvolution was used to define cell fractions. Flow sorting (FACS) with established antibodies and in situ hybridization (ISH) were used for validation. Two complementary methods were used to delete basophils, using the Mcpt8Cre-DTR mice and MAR-1 antibody. Flow sorted basophils were analyzed in vitro.

**Results:** Unbiased clustering identified 28 cell populations in renal fibrosis. Sub-clustering of UO proximal tubule cells (PT) cells identified 8 PT cell types including profibrotic PT cells that expressed a proinflammatory gene signature (Il3a, Tnfrsf12a, Cd74, Pdgb, Cxcl1, Cxcl10, and Cxcl16). Receptor-ligand interaction analysis and experimental validation indicate that CXCL1 secreted by profibrotic tubules recruits CXCR2+ basophils. Basophils were identified based on the expression of Mcpt8, Fcεr1a, and Cd200r3, and their presence were validated by FACS and ISH. In mice, these basophils are an important source of IL-6 and recruitment of Th17 cells. Genetic deletion or antibody-based depletion of basophils as well as IL-6 receptor blockade results in reduced renal fibrosis. Human kidney single-cell, bulk gene expression, and immunostaining validated the functional role of basophils in patients with kidney fibrosis.

**Conclusions:** Collectively, we identify profibrotic proximal tubules activating basophils and Th17 cells as important contributors to the development of renal fibrosis and suggest that targeting these cells might be a useful clinical strategy.

**Funding:** NIDDK Support

## FR-PO1007

### Intrinsic TGF-β Signaling in Proximal Tubule Metabolism and Response to Chronic Injury

Merve Kayhan,<sup>1</sup> Judith Vouillamoz,<sup>1</sup> Milica Bugarski,<sup>1</sup> Andrew Hall,<sup>1</sup> Leslie S. Gewin,<sup>2</sup> Roland H. Wenger,<sup>1</sup> Stellan Nlandu khodo.<sup>1</sup> <sup>1</sup>Universitat Zurich, Zurich, Switzerland; <sup>2</sup>Washington University in St Louis, St Louis, MO.

**Background:** The proximal tubule (PT) is the most metabolic and pivotal renal segment in the pathogenesis of chronic kidney disease (CKD). Excessive TGF-β signaling and mitochondria dysfunction are two features of CKD, however, how intrinsic TGF-β signaling and mitochondria interplay in PT response to chronic injury is unknown. We recently reported the beneficial effect of intact TGF-β signaling in PT response to chronic injury; our RNAseq analysis revealed mitochondria as the most affected cellular component in PT cells lacking the TGF-β receptor (TβRII). We therefore hypothesized that intrinsic TGF-β signaling is crucial for PT mitochondrial integrity and response to chronic injury.

**Methods:** To test this, mice lacking TβRII in the PT (γGT-Cre;Tgfb2<sup>fl/fl</sup>) and their floxed littermates were injured using aristolochic acid (AA) model of CKD, and PT mitochondria and renal outcomes were analyzed.

**Results:** Electron and multiphoton intravital microscopy showed severe mitochondrial injury and dysfunction in AA-injured γGT-Cre;Tgfb2<sup>fl/fl</sup> mice as compared to their floxed littermates. FACS analysis showed increased adaptive immune response, especially the

Cgas/Sting/IFNγ axis in γGT-Cre;Tgfb2<sup>fl/fl</sup> mice. Consistently, 10X spatial transcriptomics confirmed increased cortical injury and fibrosis, and decreased renal function (BUN) in γGT-Cre;Tgfb2<sup>fl/fl</sup> mice. Further analysis revealed impaired expression of electron transport chain (ETC) proteins (Complex I), mitochondrial biogenesis and mitophagy (mito-QC reporter mice) associated with oxidative stress and a metabolic rewiring towards aerobic glycolysis (Seahorse) in the absence of TβRII. Treatment of PT cells with NAD+ increased ATP production and reduced oxidative stress in PT cells lacking TβRII.

**Conclusions:** This study points out the role of TGF-β signaling in maintaining PT metabolism partly by controlling ETC proteins expression, mitochondrial biogenesis and mitophagy, and how this role affects PT response to CKD.

**Funding:** Government Support - Non-U.S.

## FR-PO1008

### Investigating Lysozyme as a Mediator of Tubular Epithelial Inflammation: An Example of CKD Knowledge Graph Target Discovery and Validation

Kevin Woollard,<sup>1</sup> Barbara Musial,<sup>1</sup> Karolina A. Nilsson,<sup>1</sup> Elena Liarte Marin,<sup>1</sup> Lisa Buval,<sup>1</sup> Iain MacPhee,<sup>1</sup> Maria Ryaboshapkina,<sup>1</sup> Ufuk Kirik,<sup>1</sup> Dirk S. Paul,<sup>1</sup> Mohammad Bohlooly,<sup>1</sup> Andrea Taddei,<sup>2</sup> Delphine M. Rolando,<sup>2</sup> Andres Mori,<sup>2</sup> Claus Bendtsen,<sup>1</sup> Pernille B. Laerkegaard Hansen.<sup>1</sup> <sup>1</sup>AstraZeneca, Cambridge, United Kingdom; <sup>2</sup>BenevolentAI, London, United Kingdom.

**Background:** Lysozyme (Lyz) is an antimicrobial enzyme catalysing hydrolysis of bacterial cell walls. Lyz was identified as a potential target for CKD by applying an AI-driven drug discovery approach to a Knowledge Graph. Clinical evidence included nephropathy of chronic myelomonocytic leukaemia associated with increased circulating levels of Lyz with tubular kidney staining. Orthogonal genetic support from Mendelian mutations as cause for renal amyloidosis, and common variants in *LYZ* associated with increased monocyte counts, associated with systemic inflammation and cardiovascular risk in CKD. Published data shows circulating levels of Lyz is associated with decline in renal function and predict worse CKD survival. Therefore, we wanted to investigate if Lyz is a mediator of kidney injury using in-vitro models of tubular inflammation using proximal tubular epithelial cells (PTEC).

**Methods:** Primary PTEC were cultured with human Lyz at physiological concentrations (0-50ug/ml) over 0-30mins-7hrs-2days. We measured markers of PTEC injury, inflammation, ROS, ER stress, MAPK signalling and viability.

**Results:** Overall while we saw a dose dependent increase in KIM-1/clusterin, there was very limited or no change in cytokines (IL8, IL1b, TNFa, IL6), ROS, ER stress, MAPK phosphorylation or cell death after Lyz treatment at all time points. We confirmed PTEC intracellular Lyz uptake using in-direct fluorescence assays. We examined Lyz expression directly from PTEC or primary macrophages in response to CKD inflammatory triggers. We could not detect any expression from PTEC, but potent secretion from macrophages. Therefore, we tested PTEC:macrophage co-culture. Like Lyz incubation alone, activated macrophages secreting lysozyme did not overtly lead to PTEC inflammation.

**Conclusions:** Our data show that Lyz has limited effect on PTEC inflammation in-vitro. These observations may indicate that elevated Lyz seen in CKD patients could be a marker of disease or of systemic inflammation in CKD. However, in-vivo data would be needed to draw firm conclusions on the relationship between long-lasting chronic exposure to elevated Lyz levels and tubular damage in CKD patients.

**Funding:** Commercial Support - AstraZeneca

## FR-PO1009

### The VEGF Inhibitor Soluble FLT1 Does Not Aggravate AKI-to-CKD Transition

Cleo C. Van Aanhoud, Angela Koudijs, Kyra L. Dijkstra, Cees van Kooten, Jan A. Bruijn, Hans J. Baelde. *Leids Universitair Medisch Centrum, Leiden, Netherlands.*

**Background:** Soluble Fms-like tyrosine kinase 1 (sFLT1) is an endogenous VEGF inhibitor. sFLT1 critically maintains the podocyte cytoskeleton and has anti-inflammatory effects in diabetic kidney disease (DKD). However, sFLT1 has also been related to peritubular capillary (PTC) loss which contributes to chronic kidney damage following acute kidney injury (AKI-to-CKD transition). Here, we studied whether overexpression of sFLT1 aggravates experimental AKI-to-CKD transition and whether sFLT1 is increased in human kidney fibrosis.

**Methods:** Mice were transfected with a *sFlt1* DNA construct via electroporation. After confirming transfection efficacy, control and sFLT1-treated mice underwent renal unilateral IRI and were sacrificed after 28 days; untreated mice underwent sham surgery. Serum KIM-1 was measured by ELISA. Sirius red, F4/80 and endomucin stainings were quantified in renal cortex and medulla. Glomerular and cortical *sFLT1-i13* mRNA expression was measured in biopsies obtained from DKD patients (n=23) and unaffected tumour-nephrectomy tissues as a control (n=14).

**Results:** At 48h after IRI, serum KIM-1 was increased compared to sham and baseline; however, sFLT1 did not affect serum KIM-1, indicating similar levels of AKI in sFLT1 and control mice. One month after IRI, cortical and medullary fibrosis and the number of macrophages were increased compared to sham; the PTC number was decreased in IRI mice. Overexpression of sFLT1 did not increase the amount of fibrosis or renal macrophages in IRI mice; further, sFLT1 had no effect on the PTC number in IRI mice. Finally, *sFLT1* mRNA levels were similar in fibrotic and normal kidney biopsies; in fibrotic kidney cortex tissues, high *sFLT1* levels correlated with increased thrombospondin and decreased syndecan-1 mRNA levels, which may reflect renal endothelial protection.

Key: TH - Thursday; FR - Friday; SA - Saturday; OR - Oral; PO - Poster; PUB - Publication Only

Underline represents presenting author.

**Conclusions:** sFLT1 does not aggravate experimental AKI-to-CKD transition: sFLT1 has no effect on chronic renal fibrosis, macrophage infiltration and PTC loss after IRI. Moreover, *sFLT1* expression is not increased in human CKD; in contrast, renal sFLT1 levels are correlated with markers of nephroprotection. Because we previously found that sFLT1 has profound anti-inflammatory potential in DKD, our findings suggest that sFLT1 can be administered at a therapeutically effective dose without aggravating maladaptive kidney damage.

**SA-PO001**

**Computational Segmentation of Glomeruli to Align Histomorphology With Spatial Transcriptomic Signature**

Brandon Ginley,<sup>1</sup> Ricardo Melo ferreira,<sup>2</sup> Ulysses G. Balis,<sup>4</sup> Sanjay Jain,<sup>3</sup> John E. Tomaszewski,<sup>1</sup> Tarek M. El-Achkar,<sup>2</sup> Michael T. Eadon,<sup>2</sup> Pinaki Sarder,<sup>1</sup> Kidney Precision Medicine Project <sup>1</sup>University at Buffalo, Buffalo, NY; <sup>2</sup>Indiana University, Bloomington, IN; <sup>3</sup>Washington University in St Louis, St Louis, MO; <sup>4</sup>University of Michigan Michigan Medicine, Ann Arbor, MI.

**Background:** Glomerular histomorphology establishes kidney disease diagnosis and prognosis. Spatial transcriptomics facilitates spatial resolution of molecular signatures superimposed upon histology. We trained a machine learning (ML) method to automatically segment glomeruli and quantify pixel level image features to align with spatial transcriptomics (ST) performed on the same section.

**Methods:** Brightfield histology images of 17 kidney disease biopsies and 3 reference kidney sections were used for training a deep learning model for glomerular segmentation. We used 3 additional reference images for testing. Unsupervised clustering of ML features was performed across all glomeruli using Seurat. Transcriptomic signatures of 10X Visium ST spots were deconvoluted with Seurat 3.2.3 transfer scores using the kidney precision medicine project (KPMP) snRNA-seq atlas as reference. Association between cell type composition and ML classification was assessed.

**Results:** The ML glomerular segmentation achieved sensitivity/specificity/precision 0.88/1.0/0.97. The glomeruli were classified into 3 clusters; with cluster one statistically associated with increases in degenerative podocyte; and a second cluster with a glomerular capillary signature ( $p < 0.033$ ).

**Conclusions:** Our pipeline will serve as a framework to map molecular to histomorphologic data over large areas captured from large sample libraries, and will aide in the development of kidney precision medicine.

**Funding:** NIDDK Support

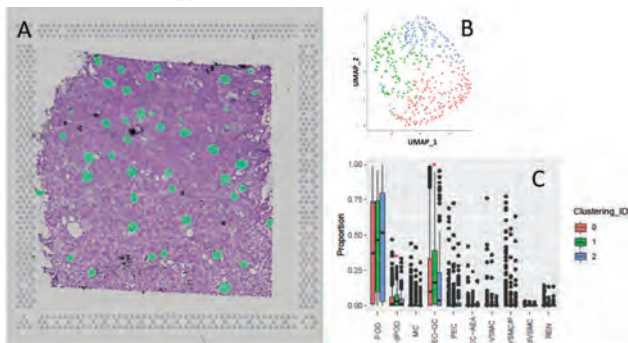

Fig. 1. [A] Computationally segmented glomerular boundaries overlaid on frozen section histology captured via 10X slide. [B] Uniform Manifold Approximation and Projection of glomeruli from all 23 cases using features defining glomerular sub-cellular morphometry. Each dot is a glomerulus. [C] Cell type proportions for spatial transcriptomics spots associated with glomeruli in each glomerular cluster shown in (B). Red asterisk indicates significance ( $p < 0.033$ ).

**SA-PO002**

**Computational Assessment of Glomerular Basement Membrane Width and Podocyte Foot Process Width in an Animal Model of Podocytopathy**

Aksel D. Laudon,<sup>1,2</sup> Connor Kim,<sup>1</sup> Yingzhe Qian,<sup>1</sup> Zhaoze Wang,<sup>1</sup> Qin Ye,<sup>1</sup> Vijaya B. Kolachalama,<sup>2</sup> Joel M. Henderson,<sup>2</sup> Weining Lu.<sup>2</sup> <sup>1</sup>Boston University College of Engineering, Boston, MA; <sup>2</sup>Boston University School of Medicine, Boston, MA.

**Background:** Transmission electron microscopy (TEM) measurements of glomerular basement membrane (GBM) width and podocyte foot process width (FPW) are important diagnostic tools for podocytopathy. Currently, these measurements in TEM images are performed manually, which limits experimental ultrastructural analysis. Here, we describe a computational approach to measure GBM width and podocyte FPW of healthy and pathological kidney specimens using TEM images from Integrin-Linked Kinase podocyte-specific knockout mice (ILK cKO), an animal model of podocytopathy.

**Methods:** We obtained TEM images from five wildtype (WT) littermates and five ILK cKO mice at 4 weeks of age. We developed a computational approach with two stages: a pre-trained U-Net-based machine learning framework for GBM segmentation and an image processing algorithm for GBM width and FPW measurement. We evaluated its performance in a five-fold cross-validation study. Segmentation accuracy was assessed in terms of Jaccard index, the ratio of the size of intersection to the size of union for

an image's predicted GBM and manually annotated reference GBM label. Automated measurements were compared to corresponding manual measurements between WT and ILK cKO mice.

**Results:** The cross-validation study resulting mean TEM image Jaccard index was 0.56 for WT and 0.66 for ILK cKO. Automated mean GBM width and FPW closely matched manual measurements for WT ( $p = 0.63$ ,  $p = 0.31$ ) but differed for ILK cKO specimens ( $p = 0.06$ ,  $p = 0.06$ ). Automated GBM width ( $p = 0.008$ ) and FPW ( $p = 0.03$ ) measurements were significantly wider for ILK cKO than WT mice, which aligns with known morphology.

**Conclusions:** We developed a machine-learning based approach to measure GBM width and FPW in TEM images for an animal model of podocytopathy. Our results suggest that automated measurements could distinguish healthy from pathological kidneys. Our tool provides high-throughput, objective morphological analysis and could potentially facilitate podocytopathy and other glomerular disease research and diagnosis in the future.

**SA-PO003**

**Computational Characterization of Lymphocytic Inflammation on Digital Kidney Biopsies**

Xiang Li,<sup>1</sup> Gina Sotolongo,<sup>5</sup> Jeffrey B. Hodgin,<sup>3</sup> Yvonne M. Mowery,<sup>1</sup> Lawrence B. Holzman,<sup>2</sup> Laura H. Mariani,<sup>3</sup> Yijiang Chen,<sup>4</sup> Anant Madabhushi,<sup>4</sup> Jarcy Zee,<sup>2</sup> Andrew Janowczyk,<sup>4</sup> Laura Barisoni,<sup>1</sup> Kyle Lafata,<sup>1</sup> <sup>1</sup>Duke University, Durham, NC; <sup>2</sup>University of Pennsylvania, Philadelphia, PA; <sup>3</sup>University of Michigan, Ann Arbor, MI; <sup>4</sup>Case Western Reserve University, Cleveland, OH; <sup>5</sup>Duke University Hospital, Durham, NC.

**Background:** Dispersion patterns of inflammatory cells in kidney tissue are hypothesized to be associated with patient outcomes, yet remain challenging to quantify visually in a standardized fashion. This study developed a deep learning (DL) model to automatically identify lymphocytic inflammation on H&E images.

**Methods:** 18 FFPE kidney specimens with moderate to severe inflammation were H&E stained and scanned at 40x, then rescanned after IHC staining for CD3/CD20 (T+B lymphocytes). After co-registering H&E and IHC, lymphocytes were identified as IHC-positive cells, with all other cells being negative. A Hover-Net DL model was trained to segment these IHC-positive cells using 6 whole slide images (WSIs) and tested on 12 WSIs. Model generalization was evaluated on NEPTUNE WSIs (visual inspection). Cell graphs were calculated to characterize the topology of the lymphocytic microenvironment. The predicted topology on H&E was compared to the measured topology on IHC via the structural similarity index measure (SSIM).

**Results:** The training and testing datasets included 22,732 nuclei (12,618 lymphocytes) and 7,984 nuclei (3,712 lymphocytes), respectively. The model precision, recall, f1, and AUC were 0.69, 0.77, 0.73, and 0.74, respectively. The topology-pattern level similarity was high, with mean SSIM of  $0.82 \pm 0.05$  between H&E and IHC WSIs. In the NEPTUNE dataset, the DL model correctly differentiated lymphocytic from non-lymphocytic inflammation.

**Conclusions:** Co-registering retained H&E and IHC WSIs provides an efficient way of generating large quantities of training material for DL. Here, our model accurately recapitulated lymphocyte topology patterns using only H&E. These patterns will subsequently be tested for outcome prediction in glomerular diseases.

**Funding:** NIDDK Support, Other U.S. Government Support

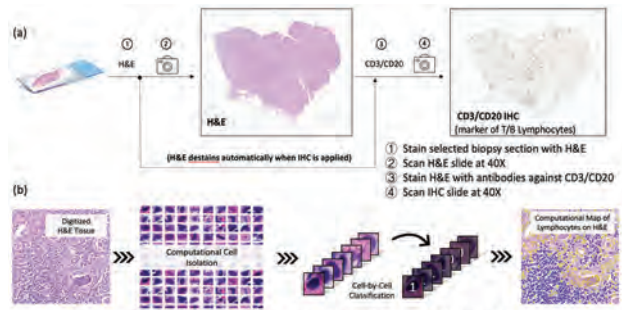

Figure 1. Computational interrogation of the immune microenvironment. (a) Pipeline for tissue staining, image acquisition and registration. (b) DL-derived computational isolation and classification of nuclei on H&E WSIs.

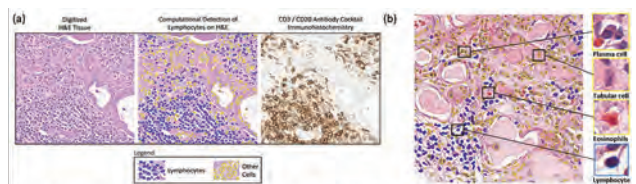

Figure 2. (a) Data testing: model input (left) and output (middle) (H&E) compared to (ground truth (CD3/CD20) (right)). (b) NEPTUNE WSI: DL-detected lymphocytes (blue), and non-lymphocytes (yellow).

## SA-PO004

**AI in the Loop: Using Ensemble Model Agreement as a Surrogate for Segmentation Confidence in Renal Stone CT Evaluations**

Timothy L. Kline, Mayo Foundation for Medical Education and Research, Rochester, MN.

**Background:** Deep learning-based semantic segmentation has been shown to perform at the level of human readers in a wide range of medical image processing tasks. However, the ability to automatically: (i) flag out of domain cases, or (ii) identify cases where a model may be less confident, has received much less attention. Here we develop an approach to provide insights into model confidence that can be built on top of common approaches for model ensembling. We show the utility of the approach in a highly imbalanced problem of segmentation of both kidneys, as well as renal stones.

**Methods:** A total of 400 non-contrast CT images were curated from our institutions image archive. Both kidneys and renal stones were segmented by quality review of previously developed segmentation algorithms. A deep learning framework was used to develop a 5-fold ensemble model in both 2D and 3D (300 cases for training/validation, 100 for testing). The individual folds and ensemble models were evaluated by similarity metrics. The variability of the models between different folds and input image dimensionality was used to establish our framework for creating an 'AI in the Loop' method to automatically flag cases the models were less confident about.

**Results:** The automated models achieved excellent performance for segmentation of kidneys and renal stones on the hold-out test set. The mean±SD of Dice was 0.97±0.03 and 0.89±0.15 for kidney and stones, respectively. Comparing individual models to each other demonstrated how disagreement between models could be used as a surrogate for model confidence.

**Conclusions:** We developed a framework for automatically assessing model confidence by comparison of models trained on different data subsets and different model architectures. This approach will have utility in automated pipelines to draw attention to potential failure cases.

**Funding:** NIDDK Support

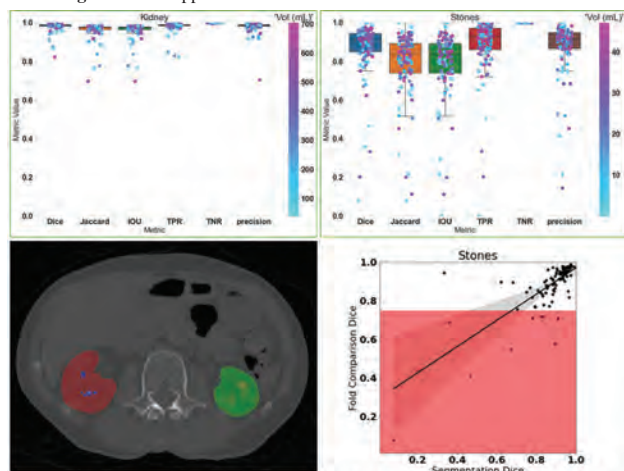

**Figure 1.** Similarity metrics for kidney (top left) and stones (top right) highlight the high degree of accuracy of the automated model. Example visualization of the segmentation for right kidney (red), left kidney (green), right renal stones (blue), and left renal stones (yellow) is shown in the bottom left panel. Comparison of model agreement ('Fold Comparison Dice') with overall segmentation agreement shows a strong correlation. In this example, a threshold of 0.75 (red overlay) would automatically flag ~10% of the cases that need review.

## SA-PO005

**Fully Automated Segmentation of Kidneys and Exophytic Cysts Using Deep Convolutional Neural Networks in Subjects With Autosomal Dominant Polycystic Kidney Disease**

Youngwoo Kim,<sup>1</sup> Seon-ah Bu,<sup>1</sup> Kyongtae T. Bae,<sup>2</sup> KITECH <sup>1</sup>Korea Institute of Industrial Technology, Cheonan, Republic of Korea; <sup>2</sup>The University of Hong Kong Li Ka Shing Faculty of Medicine, Hong Kong, Hong Kong.

**Background:** In diagnosing autosomal dominant polycystic kidney disease (ADPKD), total kidney volume (TKV) is a critical imaging biomarker. Nevertheless, manual computation of TKV, particularly with the exclusion of exophytic cysts, is laborious and time consuming. We developed a fully automated segmentation method for TKV using a deep learning network to selectively segment kidney regions while excluding exophytic cysts.

**Methods:** We used abdominal T<sub>2</sub>-weighted magnetic resonance images from 210 ADPKD subjects who were divided into two groups: 157 to train the network and 53 to test. With a 3D U-Net architecture using dataset fingerprints, the network was trained by K-fold cross-validation in that 80% out of 157 cases were for training and the remaining 20% cases for validation. To assess the performance of the automated segmentation method in reference to the manual method, three metrics were analyzed: Dice similarity coefficient (DSC), intra-class correlation coefficient (ICC), and Bland-Altman analysis.

**Results:** Excellent geometric concordance was achieved between the automated and manual reference methods (DSC: 0.962±0.018, on average) on the test datasets

with widely varying volumes of kidneys (1058.5±706.8 ml, range: 178.9–2776.0 ml) and exophytic cysts (549.0±559.1 ml, range: 113.4–2497.6 ml). The ICC was 0.9994 ( $P < 0.001$ ; CI: 0.9991–0.9996) with a minimum bias of -2.424 ml (95% limits of agreement: -49.80, 44.95).

**Conclusions:** A fully automated segmentation method that we developed measures TKV with exclusion of exophytic cysts as accurately as the level of a human expert. This technique will be useful in clinical studies that require automated computation of TKV to evaluate progression and treatment response of ADPKD.

**Funding:** Government Support - Non-U.S.

## SA-PO006

**Development of a Multimodal "Kidney Age" Prediction Based on Automatic Segmentation CT Image in Patients With Normal Renal Function: A Preliminary Report**

Zuoxian Hou, Peng Xia, Gu-Mu-Yang Zhang, Hao Sun, Limeng Chen. Peking Union Medical College Hospital, Beijing, China.

**Background:** The physiology volumes of the kidney cortex and medulla are presumed to change with age. We established a machine learning model to predict the "Kidney Age" in patients with normal serum creatinine (Scr) levels based on clinical data and an auto-segmentation algorithm separating the kidney cortex and medulla using contrast CT images.

**Methods:** We recruited 238 patients with normal Scr levels and contrast CT images between Oct 2021 and Feb 2022 in Peking Union Medical College Hospital with their demographic and clinical data. An auto-segmentation method was used for both cortex and medullary separation and their volume calculation, respectively. We combined the kidney volume, as well as clinical data for multimodal features of the machine learning model. All data were separated into a training dataset (85%) with ten-fold cross-validation and a test dataset (15%) for accuracy validation. Multiple machine learning models (n=100) with different initial weights are ensemble to reduce the prediction error. The performance of model was measured by the 95% confidential interval generated from the mean value and standard deviation.

**Results:** A total of 149 female patients and 89 male patients were included, with a mean age of 48.9±14.7 years old and Scr of 64.49±13.97 μmol/L. Their mean total kidney volume was 284.23±55.34 mm<sup>3</sup>, using the algorithm separating the kidney volumes of cortex and medulla. The predicted "Kidney Age" is approximately close to the patients' true age, with 92% prediction within the 95% confidential interval. The associated factors of the "Kidney Age" were eGFR ( $r=-0.516$ ,  $p<0.001$ ), hypertension ( $r=0.448$ ,  $p<0.001$ ), diabetic ( $r=0.364$ ,  $p<0.001$ ), kidney cortex volume ( $r=-0.374$ ,  $p<0.001$ ), and cortex ratio ( $r=-0.267$ ,  $p<0.001$ ).

**Conclusions:** We established a machine learning model for predicting the "Kidney Age" of patients with normal kidney function based on contrast CT images and clinical data.

**Funding:** Government Support - Non-U.S.

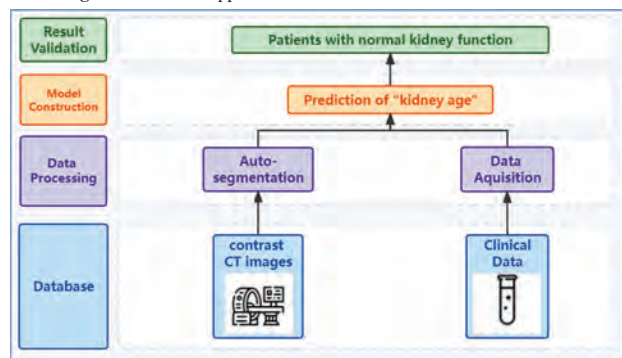

Process of multimodal machine learning algorithm

## SA-PO007

**ADPKD Segmentator: A Cloud-Based Prognostic Tool for Autosomal Dominant Polycystic Kidney Disease**

Vincenzo Carbone,<sup>1</sup> Alessia Baretta,<sup>1</sup> Cristiana Corsi,<sup>2</sup> Roberta Bursi.<sup>1</sup> <sup>1</sup>InSilicoTrials Technologies, Trieste, Italy; <sup>2</sup>Universita degli Studi di Bologna, Bologna, Italy.

**Background:** ADPKD is characterized by the growth of numerous cysts in the kidneys, leading to an increment of Total Kidney Volume (TKV) and progressive decline in renal function. FDA and EMA accept TKV as a prognostic biomarker for disease progression, however TKV calculation from medical images is labor-intensive. ADPKD Segmentator is a user-friendly cloud-based tool for fast and accurate ADPKD classification, based on automated kidney and cysts segmentation from MRI.

**Methods:** An online tool was designed on Microsoft Azure Cloud to automatize the set-up and running of a previously developed software implemented in MATLAB to automatically detect kidney and cysts contours from MRI. Through the web interface, the user is only requested to upload the MRI dataset and select one point inside kidney's parenchyma in the central slice. Then, TKV is automatically calculated and ADPKD

Classification is obtained (Figure 1). The MRI dataset is anonymized before upload to the cloud; data and results are stored in a secure and reliable environment controlled by the user.

**Results:** The proposed solution is very fast and precise compared to manual segmentation of medical images (Figure 1). Moreover, it is faster and more accurate than the commonly used ellipsoid-based method, resulting in a manifold reduction of misclassification error (Table 1). Another advantage is its usability, with no specific computational expertise, numerical software or dedicated hardware required, since all computations are run remotely in the cloud.

**Conclusions:** ADPKD Segmentator provides a reproducible and precise morphologic classification of the renal and cysts volume of ADPKD patients. It represents an extremely useful tool for clinicians, potentially helping in monitoring disease progression, supporting correct therapy administration, and effective stratification of patients. Also, it would represent a great benefit for the patient, since the tool analyzes medical images obtained without the use of contrast medium.

	ADPKD SEGMENTATOR	ELLIPSOID-BASED METHOD
Manual Intervention:	< 1 min	up to 5 min
Absolute mean error	2.4% ± 2.7%	7.4% ± 5.1%
Misclassification error	2.5%	13.7%

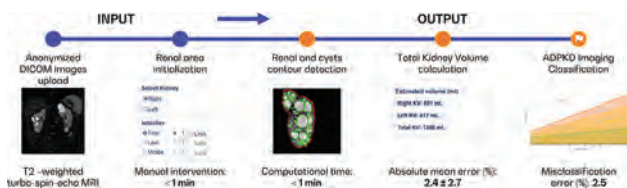

## SA-PO008

### Design of a Polyethersulfone-Based Self-Anticoagulant Endotoxin Hemoperfusion Adsorbent for Sepsis Treatment

Yupei Li, Baihai Su. *West China Hospital of Sichuan University, Chengdu, China.*

**Background:** Sepsis is life-threatening and associated with high mortality. Currently available endotoxin adsorption columns still face significant drawbacks, such as low endotoxin adsorption capacity and unwanted need for systemic heparin anticoagulation or regional citrate anticoagulation. This work aimed to develop a polyethersulfone-based self-anticoagulant endotoxin hemoperfusion adsorbent to evaluate its hemocompatibility and endotoxin adsorption performance *in vitro* and *in vivo*.

**Methods:** First, polyethersulfone-based self-anticoagulant beads (namely, RAHM beads) filled with polyacrylic acid and poly(2-acrylamide-2-methyl propane sulfonic acid) copolymer networks were prepared by phase inversion and *in situ* copolymerization technology, and polyethyleneimine was grafted onto the surface of RAHM beads to obtain RAHM@PEI beads. Second, the surface morphology and specific surface area of RAHM and RAHM@PEI beads were systematically analyzed. Third, the hemocompatibility of RAHM and RAHM@PEI beads was evaluated by measuring complement C3a, platelet count, plasma clotting time and hemolysis ratio *in vitro*. Finally, the feasibility of the RAHM/RAHM@PEI-based endotoxin adsorption column in LPS-induced beagle sepsis models was investigated.

**Results:** Both RAHM and RAHM@PEI beads had high specific surface areas and mesoporous structures and exhibited excellent anticoagulant properties by partially inhibiting the activity of the intrinsic coagulation factors FVIII, FIX, FXI and FXII. With PEI grafting on their surfaces, the endotoxin adsorption capacity of RAHM@PEI beads was significantly higher than that of RAHM beads (164.9 vs. 82.5 EU/g). *In vivo* animal experiments further showed that the RAHM/RAHM@PEI-based endotoxin adsorption cartridge significantly alleviated the decrease in leukocyte and neutrophil counts in LPS-induced beagle sepsis models without obvious adverse effects. Moreover, plasma levels of cytokines (IL-8 and TNF- $\alpha$ ) and neutrophil infiltration and bleeding in the alveolus were also significantly reduced after the use of our endotoxin adsorption cartridge.

**Conclusions:** Our data show that the RAHM and RAHM@PEI beads have high endotoxin adsorption capacities and good anticoagulant properties and are thus promising hemoperfusion sorbents to treat severe septic patients.

**Funding:** Government Support - Non-U.S.

## SA-PO009

### In Vitro Effect of Cartridge Functionalized With Antibiotic on a Bacterial Population in Hemoperfusion Treatment

Massimo de Cal,<sup>1,2</sup> Anna Lorenzin,<sup>1,2</sup> Claudio Ronco,<sup>1,2</sup> Monica Zanella,<sup>1,2</sup> <sup>1</sup>*Ospedale San Bortolo di Vicenza, Vicenza, Italy;* <sup>2</sup>*IRRV, Vicenza, Italy.*

**Background:** HA380 (Jafro, China) is an hemoperfusion (HP) cartridge applied in septic patients that often developed AKI. We have demonstrated that vancomycin (Van) is adsorbed by HA380 during *in vitro* HP. We recreated an *in vitro* HP treatment in presence of bacteria to assess the effect of cartridge pre-treated with Van solution.

**Methods:** We compared the effect of 2 mini-modules of the HA380 cartridge. Saline solution enriched with 1g of Van was circulated in HP in one of the cartridges and 545mg of antibiotic were adsorbed by the sorbent beads. We injected 10<sup>6</sup> S.aureus bacteria sensitive to Van in 800mL of blood and incubated at 37°C. After 24h blood was partitioned into 3 reservoirs: 200mL were maintained as a negative control; 300mL were

circulated in the mini-module previously used with Van solution; 300mL in the other cartridge. The circulations were performed, simultaneously, in a closed-loop at 250mL/min with a dedicate testing platform for 120 minutes (Figure). Blood was maintained at 37°C and stirred. Blood samples were drawn at T0 (before partition), T1 and T2 (after 1 and 2 hours of circulation) from the 3 reservoirs. Samples were cultured in cna agar plates to assess the bioburden and in DB Bactec bottles to estimate the time after which the bacteria replication reaches the predetermined growth threshold.

**Results:** At T0, T1 and T2 in negative control and in the mini-module without antibiotic, growth of bacteria was detected at 1h and 30 minutes and plates showed 2x10<sup>6</sup> bacteria. At T1 and T2 in the mini-module with Van, growth was detected respectively at 7h and 8h and plates showed 10<sup>6</sup> bacteria.

**Conclusions:** The functionalized mini-module has been more effective in the reduction of the bioburden as the bound Van could be still active.



Figure: Experimental set-up of the HP treatments.

## SA-PO010

### Addressing Barriers to Peritoneal Dialysis: Can It Look Pretty?

Fatima Ayub,<sup>1</sup> Larissa N. Whale,<sup>2</sup> Makenzie Kapales,<sup>2</sup> Jose A. Sanchez Gracias,<sup>2</sup> Tayte A. Stephens,<sup>2</sup> Christopher Schaefer,<sup>2</sup> Andrew Tegel,<sup>2</sup> Manisha Singh,<sup>1</sup> <sup>1</sup>*University of Arkansas for Medical Sciences, Little Rock, AR;* <sup>2</sup>*University of Arkansas Fayetteville, Fayetteville, AR.*

**Background:** Peritoneal dialysis (PD) is an effective renal replacement strategy for patients with end-stage renal disease that utilizes the abdominal peritoneum to filter toxins. PD offers a patient survival comparable to in-center hemodialysis while preserving residual kidney function and empowering patient autonomy. The usual PD catheters have a 16 cm tubing set protruding from the patient's abdomen which can have negative implications on their self-image. This set is in part the PD catheter, and in part a transfer set. For the ease of design, we first worked on the transfer set. We present an improved retractable transfer set to address one of the barriers to PD. We believe that this designed set is the first of its kind.

**Methods:** Our project started with a patient-centered survey of PD patients assessing the need for a modified PD tubing set. Most patients wanted to try a smaller catheter set. We studied multiple designs including spiral, retractable and collapsible bulbs. We used Solidworks to design one of the desired tubes and created negative molds for casting and prototyping by 3D printers. Liquid silicone was used to form the 3D shape of a transfer set. We were able to create 3 prototypes. The first prototype utilized Ultimaker as the 3D printer for the mold using PLA filament with PVA supports. For the second, we used the FormLabs resin printer with photopolymer resin. Lastly, for the third prototype, we utilized an elastic photopolymer resin with the formlabs printer to create the model of a transfer set.

**Results:** The final design for our PD transfer set has a bendy straw section that is 7cm when extended and much smaller when collapsed, sandwiched between two connector portions, one fits into the transfer set clamp and the other connects the transfer set to other parts of the catheter. It wasn't until the catheter was printed on the Formlab's Resin

printer without a mold that a successful prototype was created. Flow simulations were also conducted and it was determined that the new design kept the desired flow rate of 0.2 L/min.

**Conclusions:** A PD catheter with a retractable transfer set was modeled and verified as a viable option for a new PD catheter product. Our ultimate goal is to design the catheter portion of the set retractable as well. A shorter set will decrease the negative self-image of our patients.

**Funding:** Private Foundation Support

## SA-PO011

### Bilirubin Removal by Plasmafiltration-Adsorption: Ex Vivo Adsorption Kinetic Model

Matteo Marcello,<sup>1,2</sup> Anna Lorenzin,<sup>3,1</sup> Massimo de Cal,<sup>3,1</sup> Claudio Ronco,<sup>1,3</sup> Monica Zanella,<sup>3,1</sup> <sup>1</sup>International Renal Research Institute of Vicenza, Vicenza, Italy; <sup>2</sup>Università Vita Salute San Raffaele, Milano, Italy; <sup>3</sup>Ospedale San Bortolo di Vicenza, Vicenza, Italy.

**Background:** The removal of bilirubin from blood in patients with severe liver dysfunction is an important blood purification goal. Accordingly, we conducted an ex-vivo study to assess the ability of a novel bilirubin adsorptive cartridge to remove bilirubin from plasma.

**Methods:** We studied the BS330 Plasma Bilirubin Adsorption Column cartridge (Jafron Biomedical, Zhuhai City, China). Our experiment was conducted using a minimodule downscaled 1:3 containing approximately 131 g of BS330 sorbent bead. Using a dedicated machine for extracorporeal treatment simulation named GALILEO, we set up an ex-vivo circulation experiment in which a solution of hyperbilirubinemic plasma was pumped in the circuit and through the cartridge (Figure). Using synthetic bilirubin powder, we obtained a plasma solution with a bilirubin concentration of 92.8 mg/dL. The adsorption trend was evaluated as the bilirubin concentration gap ( $\Delta C$ ) between inlet (C<sub>pin</sub>) and outlet (C<sub>pout</sub>) lines. Removal ratio (RR) at a given time point was calculated as mass adsorbed at a given time point.

**Results:** The change in concentration across the cartridge at 30 minutes was 16.5%. The capacity of the cartridge to adsorb bilirubin and cartridge saturation was reached at 750 minutes, 759 mg of bilirubin has been retained with a Removal Ratio of 78.1%. Therefore, the adsorption capacity of the resin was estimated at 5.76 mg of bilirubin per gram of sorbent. The dynamic adsorption curve (Figure) indicates a fast and efficient removal of bilirubin by BS330 in the beginning of perfusion with a Removal Ratio of 42.6% at 120 minutes.

**Conclusions:** Our findings provide the first assessment of bilirubin adsorption in an ex-vivo model of plasma perfusion and can be used to design interventional studies in humans with appropriately sized cartridges applied for an optimal time period.

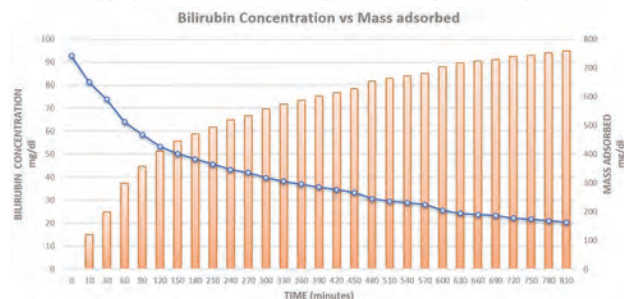

Bilirubin adsorption kinetics. Blue line represents the fall of bilirubin concentration during time. Vertical bars represent total mass adsorbed at each time point.

## SA-PO012

### Effect of Endothelial Nitric Oxide Synthase Expression Levels on the Hemodynamic Parameters in Murine Arteriovenous Fistulas

Shelly R. Baltazar,<sup>1</sup> Brayden Fairbourn,<sup>1</sup> Hannah M. Northrup,<sup>1</sup> Timmy C. Lee,<sup>3</sup> Yan-Ting E. Shiu,<sup>1,2</sup> <sup>1</sup>The University of Utah, Salt Lake City, UT; <sup>2</sup>VA Salt Lake City Health Care System, Salt Lake City, UT; <sup>3</sup>The University of Alabama at Birmingham, Birmingham, AL.

**Background:** The arteriovenous fistula (AVF) is the preferred hemodialysis vascular access but has a high maturation failure rate, which is a significant clinical problem. The creation of AVFs causes aberrant blood flow at and near the AVF anastomosis that may cause maturation failure. Endothelial nitric oxide synthase (NOS3) generates nitric oxide (NO), a vasodilator. Our group previously reported that NOS3 expression levels affect AVF development (i.e., lumen size) in a mouse model. Specifically, the AVF lumen in NOS3 overexpression (OE) was larger (favored AVF remodeling) than in NOS3 knock out (KO) or wild type (WT) mice at Day 7 and Day 21 post AVF creation (Kidney360, 1(9): 925, 2020). In this study, we performed MRI-based computational fluid dynamics (CFD) simulations in a similar model. We hypothesized that blood flow in OE is less aberrant than that in KO and WT.

**Methods:** Carotid-jugular AVFs were created in C57BL/6 mice with three conditions: NOS3 OE, NOS3 KO, and WT control. MR images of AVFs were taken on Day 7 and Day 21 post AVF creation for each strain (n=2-3 per condition, 17 mice total) and used for CFD simulations to quantify the wall shear stress (WSS) and vorticity of the AVF vein.

The WSS and vorticity were averaged over the third cardiac cycle and 5 mm from the anastomosis through the AVF vein.

**Results:** On Day 7, the WSS ( $67.56 \pm 137.9$  dyn/cm<sup>2</sup> for OE,  $120.0 \pm 241.3$  dyn/cm<sup>2</sup> for KO,  $104.1 \pm 181.0$  dyn/cm<sup>2</sup> for WT) and vorticity ( $1146 \pm 1827$  1/s for OE,  $1739 \pm 2766$  1/s for KO,  $1608 \pm 2506$  1/s for WT) were not statistically different among the three groups. On Day 21, OE had lower WSS ( $13.67 \pm 16.17$  dyn/cm<sup>2</sup>) and vorticity ( $190.7 \pm 246.6$  1/s) than KO ( $100.6 \pm 169.3$  dyn/cm<sup>2</sup>;  $1893 \pm 2804$  1/s) and WT ( $165.8 \pm 267.1$  dyn/cm<sup>2</sup>;  $2244 \pm 3045$  1/s) ( $p < 0.0001$ ).

**Conclusions:** At Day 21, lower vorticity in OE suggested that the velocity streamlines in OE were smoother than in KO and WT, and lower WSS in OE suggested that WSS was attempting to return to the pre-surgery baseline. Both are characteristics of favored hemodynamics remodeling. We are continuing to refine CFD protocols and increase animal numbers for future studies.

**Funding:** NIDDK Support, Other NIH Support - NHLBI, Veterans Affairs Support

## SA-PO013

### Comparison of Local Hemodynamics in Rat Arteriovenous Fistula With and Without Accessory Vein

Britney Chen,<sup>1</sup> Brayden Fairbourn,<sup>1</sup> Hannah M. Northrup,<sup>1</sup> Timmy C. Lee,<sup>2</sup> Yan-Ting E. Shiu,<sup>1</sup> <sup>1</sup>The University of Utah, Salt Lake City, UT; <sup>2</sup>The University of Alabama at Birmingham, Birmingham, AL.

**Background:** Arteriovenous fistula (AVF) maturation failure is a major clinical problem. AVF hemodynamics are a significant factor in regulating AVF remodeling and maturation, but our understanding of the precise hemodynamics in the AVF is not yet complete. The presence of accessory veins (i.e., vein branches from the primary venous limb of an AVF) may decrease blood flow through the fistula and consequently contribute to AVF maturation failure. Therefore, in patients, accessory veins may be ligated at the time of AVF creation. Here we investigate the effects of accessory veins on AVF hemodynamics in a rat model.

**Methods:** Femoral AVFs were created in 12 to 16-week-old male Sprague-Dawley mice. MRI scans taken 21 days after AVF creation were used to create reconstructions of the AVF lumen with and without an accessory vein (n = 3). The reconstructions were then used, together with MRI-measured velocities, in computational fluid dynamic (CFD) simulations. Hemodynamic parameters (velocity, wall shear stress (WSS), vorticity, and oscillatory shear index (OSI)) were calculated for the AVF vein segment starting from the anastomosis and ending at the location immediately prior to the vein branch and an equivalent proximal artery segment.

**Results:** The AVF vein WSS result with and without an accessory vein was similar ( $247.1 \pm 291.8$  vs.  $190.0 \pm 195.1$  dynes/cm<sup>2</sup>;  $p > 0.05$ ). The AVF vein OSI result with and without the accessory vein was also similar ( $0.06 \pm 0.06$  vs.  $0.08 \pm 0.06$ ;  $p > 0.05$ ). However, the AVF vein vorticity with and without an accessory vein ( $3569.9 \pm 4381.9$  vs.  $2711.5 \pm 3145.4$  1/s) and AVF vein velocity with and without an accessory vein ( $65.9 \pm 64.1$  vs.  $53.6 \pm 50.6$  cm/s) were significantly different ( $p < 0.05$ ). The proximal artery WSS, OSI, vorticity, and velocity were similar between the AVFs with and without an accessory vein ( $p > 0.05$ ).

**Conclusions:** Except for vorticity and velocity in the AVF vein, the hemodynamics between AVFs with and without accessory veins were largely similar. Including accessory veins when analyzing AVF hemodynamics in CFD simulations may result in some different hemodynamic parameters. Future research will investigate whether these differences are associated with AVF maturation failure.

**Funding:** NIDDK Support, Other NIH Support - NHLBI, Veterans Affairs Support

## SA-PO014

### Renal Autoregulation Assessment in Conscious Rats Using Deep Learning Networks

Geoffrey A. Williamson,<sup>1</sup> Purva R. Chopde,<sup>1</sup> Sebastian Anand A. Alphonse,<sup>4</sup> Aaron J. Polichnowski,<sup>2</sup> Karen A. Griffin,<sup>3,5</sup> <sup>1</sup>Illinois Institute of Technology, Chicago, IL; <sup>2</sup>East Tennessee State University, Johnson City, TN; <sup>3</sup>Loyola University Chicago Stritch School of Medicine, Maywood, IL; <sup>4</sup>Livanova, Houston, TX; <sup>5</sup>Edward Hines Junior VA Hospital, Hines, IL.

**Background:** Renal autoregulation (AR) maintains constant GFR and prevents glomerular transmission of systemic pressure. AR assessment informs about susceptibility to hypertensive renal injury and thus may influence management of patients with chronic kidney disease (CKD). In rats, AR assessment has typically involved measuring the recovery of renal blood flow (RBF) after acute step blood pressure (BP) changes under anesthesia, via AR indices quantifying fractional changes in RBF relative to BP. We developed a Short Segment AR Index (SSARI) methodology for AR assessment in conscious animals (Bidani et al., JASN 31(2):324-336, 2020). This method locates adjacent short segments (0.5 to 20 s) in the BP/RBF record where mean BP changes by  $> 5$  mmHg and averages the AR index for those segment pairs over all pairs. Here, we develop and train a Deep Neural Network (DNN) to effect a similar AR assessment and compare its performance with that of SSARI. Our DNN design leverages our earlier work applying DNNs to differentiate intact and impaired AR (Alphonse et al., 2020 28th EUSIPCO, 1165-1169, 2021).

**Methods:** The DNN input employs a one min. long BP/RBF record sampled at 200 Hz. The DNN architecture includes four convolutional layers followed by two dense layers, each with leaky Relu activation, and max pooling after convolutional layers. The output is a scalar produced with linear activation. Using 2960 30-min. BP/RBF recordings, we trained the DNN to match the average SSARI score (using 2.5 s. segments) for the full 30 min. data set. The DNN was tested using a separate set of 3413 30-min. BP/RBF recordings.

Key: TH - Thursday; FR - Friday; SA - Saturday; OR - Oral; PO - Poster; PUB - Publication Only

Underline represents presenting author.

**Results:** With the test data, we achieved a mean-square error of 0.0555 between the average DNN score using all 30 1-min. segments and the average SSARI value for the full 30 min. Furthermore, averaged DNN scores had 1/10 the variability of the averaged SSARI values.

**Conclusions:** The DNN can distinguish between intact AR and impaired AR (e.g. via calcium channel blockade or renal mass reduction or both), just as does SSARI as we have reported. The DNN, however, provides equivalent accuracy in doing this with only 1/10 the data length. Further refinement of this methodology will allow us to leverage its use in the clinical setting as DNN will inform AR impairment and susceptibility to hypertensive renal injury in patients with CKD.

**Funding:** NIDDK Support, Other NIH Support - NHLBI, Veterans Affairs Support

SA-PO015

**Differences in Early Hemodynamics Between Arteriovenous Fistulas and Grafts in Porcine Models**

Samantha Vranes,<sup>1</sup> Brayden Fairbourn,<sup>1</sup> Hannah M. Northrup,<sup>1</sup> Yong He,<sup>2</sup> Scott A. Berceci,<sup>2,3</sup> Alfred K. Cheung,<sup>1,4</sup> Yan-Ting E. Shiu.<sup>1,4</sup> <sup>1</sup>The University of Utah, Salt Lake City, UT; <sup>2</sup>University of Florida, Gainesville, FL; <sup>3</sup>VA Medical Center Malcom Randall, Gainesville, FL; <sup>4</sup>VA Salt Lake City Health Care System, Salt Lake City, UT.

**Background:** The formation of neointimal hyperplasia (NH) leads to shortened patency rates for long-term hemodialysis vascular accesses – the arteriovenous fistula (AVF) and the arteriovenous graft (AVG). NH is more severe in AVG than AVF in patients, though the reasons are not yet completely understood and may be multifactorial. Blood flow parameters (e.g., wall shear stress (WSS)) are linked to NH formation. Here we investigated and compared hemodynamics and NH in porcine AVF and AVG models. We hypothesized that a higher WSS value leads to less NH formation and better vascular access outcomes. Therefore, we compared early flow hemodynamics to late NH formation.

**Methods:** Carotid-jugular fistulas and grafts were created in young pigs (n=3 each). They were scanned by magnetic resonance imaging (MRI) 1 week after surgery. Black-blood and phase-contrast velocity MRI scans were used to calculate cross-sectional area (CSA) and perform computational fluid dynamics to analyze hemodynamic parameters, including flow rate, velocity, WSS, and oscillatory shear index (OSI). Since NH formation occurs near the venous anastomosis, we focused on the proximal venous segments closer to the anastomosis. Early hemodynamics were obtained at week 1. NH was visualized at weeks 4-6 by histology.

**Results:** The venous CSA in the AVFs (mean±SD, 14.87±7.38 mm<sup>2</sup>) and the AVGs (19.58±5.63 mm<sup>2</sup>) were similar (p=0.06) at week 1. However, the AVF venous flow rate (532.24±87.27 mL/min), velocity (67.70±20.02 cm/s), and WSS (196.68±91.12 dyn/cm<sup>2</sup>) were significantly larger than the AVG (346.49±127.92 mL/min, 31.80±15.65 cm/s, 73.59±51.53 dyn/cm<sup>2</sup>) (p=0.01 – 0.02) at week 1. OSI in the AVF and AVG were similar (0.031±0.029 vs. 0.027±0.03 rotation/s; p=0.07). Histology showed that the AVG had more NH than the AVF at weeks 4-6.

**Conclusions:** Our results reveal differences between the AVF and AVG in early hemodynamics and late NH formation. Specifically, AVFs had less NH than AVGs in our porcine models, similar to human. Our results suggest that higher WSS values in AVF may prevent NH formation and lead to better vascular access outcomes. Future research can consider hemodynamic parameters at later time points, in other regions of the vessel (i.e. the arterial anastomosis), and fluid-structure interactions.

**Funding:** NIDDK Support, Other NIH Support - NHLBI, Veterans Affairs Support

SA-PO016

**Differential Hemodynamics Between Arteriovenous Fistulas With or Without Intervention Before Successful Use**

Hannah M. Northrup,<sup>1</sup> Yong He,<sup>2</sup> Ha D. Le,<sup>1</sup> Scott A. Berceci,<sup>2,3</sup> Alfred K. Cheung,<sup>1,4</sup> Yan-Ting E. Shiu.<sup>1,4</sup> <sup>1</sup>University of Utah, Salt Lake City, UT; <sup>2</sup>University of Florida, Gainesville, FL; <sup>3</sup>Malcolm Randall Veterans Affairs Medical Center, Gainesville, FL; <sup>4</sup>VA Salt Lake City Health Care System, Salt Lake City, UT.

**Background:** A significant number of arteriovenous fistulas (AVFs) fail to mature for dialysis. Although interventions promote maturation, functional primary patency loss is higher for AVFs with interventions (assisted maturation) than AVFs without interventions (unassisted maturation). Blood flow-associated hemodynamics are proposed to affect AVF remodeling. However, the optimal hemodynamic parameters for unassisted maturation are unclear.

**Methods:** Patients (n=6) underwent magnetic resonance imaging (MRI) at 1 day, 6 weeks, and 6 months after AVF creation surgery. Before successful use for hemodialysis, 3 AVFs required intervention and 3 did not. MRI of the AVFs were used to calculate lumen cross-sectional area (CSA) and perform computational fluid dynamics to analyze hemodynamics, i.e. velocity, wall shear stress (WSS), and vorticity.

**Results:** The no-intervention group and intervention group had similar pre-surgery vein diameter and 1-day post-surgery venous CSA. The no-intervention group had significantly larger 1-day venous velocity (0.97±0.67 m/s; mean±SD), WSS (333±336 dyne/cm<sup>2</sup>) and vorticity (1709±1290 1/s) than the intervention group (velocity=0.23±0.10 m/s; WSS=49±40 dyne/cm<sup>2</sup>; vorticity=493.1±227 1/s)(P<0.05). At 6 months, the no-intervention group had significantly larger venous CSA (43.5±27.4 mm<sup>2</sup>) than the intervention group (15.1±6.2 mm<sup>2</sup>)(P<0.05). No-intervention AVF arteries followed the same trend.

**Conclusions:** Lumen area and hemodynamic parameters differ between intervention and non-intervention AVF groups. Larger venous velocity, WSS, and vorticity immediately after AVF creation surgery may be important for later lumen enlargement and AVF maturation.

**Funding:** NIDDK Support, Other NIH Support - NHLBI, Veterans Affairs Support

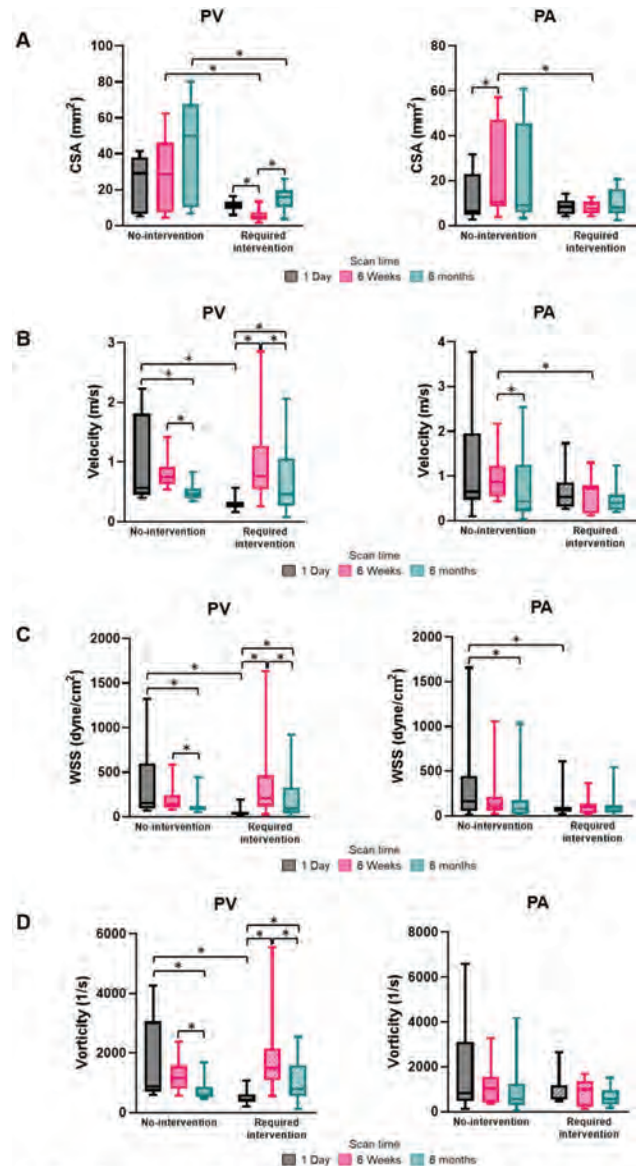

Figure 1: Proximal vein (PV) and proximal artery (PA) results of "no intervention" and "required intervention" groups at 1 day, 6 weeks, and 6 months. (A) cross-sectional area (CSA), (B) velocity, (C) wall shear stress (WSS), and (D) vorticity. Graphs show 25<sup>th</sup> to 75<sup>th</sup> percentiles within the box, with the line in the middle of the box as the median and whiskers extending to the minimum and maximum values. \*P<0.05, n=3.

SA-PO017

**Formulating Customizable Extracellular Matrix Scaffolds From Decellularized Mouse Kidneys**

Nina Cintron Pregosin, Sandeep K. Mallipattu. Stony Brook Medicine, Stony Brook, NY.

**Background:** Current cell culture methods are not adequate for recapitulating the physiology of mature, differentiated kidney cells in vivo. Podocytes plated on plastic tissue culture dishes differ from podocytes within the glomerulus due to their lack of foot processes or slit diaphragms, making human podocytopathies difficult to accurately study in this system. Several researchers have shown that growing podocytes in 2D culture systems that better resemble their native environment, the glomerular basement membrane, can help promote their differentiation. Rather than using expensive commercially available products, here we formulate a cell culture matrix derived from decellularized mouse kidneys. By removing the cellular content from mouse kidneys while leaving the extracellular matrix intact, we create a customizable, non-immunogenic scaffold for cell growth in-house.



**Methods:** Wild-type C57BL/6 mice were initially perfused with D-PBS and kidneys were dissected and sliced into 300µm sections then washed in D-PBS on a shaker overnight. The slices were decellularized by washing in 1% TritonX-100 for 5 hours, then 0.1% SDS for 1 hour. SDS was washed off in D-PBS overnight and kidneys were sterilized by washing in 1% normal saline. The tissue was then lyophilized, crushed, and digested in 3M urea for 36 hours. The decellularized solution was then diluted to a final concentration of 1-3% in Geltrex for coating cell culture plates or mixed with GelMA bioink for 3D bioprinting applications.

**Results:** Decellularized kidney slices had an 89% reduction in DNA content compared to control slices with preserved histological structure. Loss of cellular content was also observed after counting DAPI+ cells in ImageJ. Both glomerular endothelial cells and iPSCs showed adhesion, proliferation, and expression of mature differentiation markers on the decellularized extracellular matrix scaffold as compared to no matrix or commercially available matrix under differentiating conditions.

**Conclusions:** We generated a more accessible, sustainable, and reproducible protocol for generating decellularized extracellular matrix scaffolds in-house. Future work includes measuring the viability of various cells, such as renal epithelial cells and podocytes, and their ability to differentiate on these scaffolds.

**Funding:** NIDDK Support, Other NIH Support - NIH T32, Veterans Affairs Support

## SA-PO018

### Endovascular Nephrectomy in Swine for Evaluation of Implantable Devices for Renal Replacement Therapy

Jarrett Moyer,<sup>1,3</sup> Mark W. Wilson,<sup>1</sup> Ana Santandreu,<sup>1</sup> Caressa Chen,<sup>1</sup> Dean Hu,<sup>4</sup> Amy Kerdok,<sup>4</sup> Edward Porock,<sup>1</sup> Nathan Wright,<sup>1,3</sup> Jimmy Ly,<sup>1,3</sup> Charles Blaha,<sup>1,3</sup> Lynda A. Frassetto,<sup>1</sup> William H. Fissell,<sup>2,3</sup> Shant M. Vartanian,<sup>1</sup> Shuvo Roy,<sup>1,3</sup> <sup>1</sup>University of California San Francisco, San Francisco, CA; <sup>2</sup>Vanderbilt University Medical Center, Nashville, TN; <sup>3</sup>Silicon Kidney, LLC., San Francisco, CA; <sup>4</sup>Outset Medical, San Jose, CA.

**Background:** Silicon nanopore membranes (SNM) are efficient blood-compatible membranes that enable novel approaches to renal replacement therapy (RRT). Previously, arteriovenous SNM hemodialyzers (SNMHD) were patent and effectively cleared solutes after retroperitoneal implant in healthy swine. Renal arterial embolization is a non-invasive approach to near-total nephrectomy that preserves retroperitoneal anatomy for subsequent device implants. An established embolization-to-implantation protocol is key to therapeutic investigation of implantable RRT devices.

**Methods:** A Yucatan minipig underwent staged bilateral renal artery embolization with PVA particles and microcoils to induce renal failure. The right renal artery was embolized until contrast stagnation on fluoroscopy. After a 2-week recovery, 50% of the left renal arterial system was embolized. The animal received intermittent hemodialysis (HD) with the Tablo HD System for 35 days and began daily aspirin (325 mg). A small-scale arteriovenous SNMHD prototype was then implanted in the right retroperitoneum. SNMHD dialysate catheters were tunneled externally for connection to a dialysate recirculation pump. The animal resumed HD in parallel to SNMHD testing for 7 days. SNMHD clearance was determined by intermittent sampling of the recirculating dialysate.

**Results:** Staged embolization successfully induced kidney failure. Embolization, subsequent HD sessions and retroperitoneal SNMHD implantation were well-tolerated. The animal developed anemia (nadir hematocrit 25%), which improved after darbepoetin injection. A chronic venous catheter inserted for HD access was replaced once for tip thrombosis prior to SNMHD implant. Creatinine and urea clearance through the SNMHD were 76-105 mL/min/m<sup>2</sup> and 140-165 mL/min/m<sup>2</sup>, respectively. No albumin was detected in the dialysate.

**Conclusions:** We successfully piloted an embolization-to-implantation protocol enabling the first implant of a SNMHD in a swine renal failure model. Normalized creatinine and urea clearance measured in the SNMHD may translate to a fully-implantable clinical-scale device. This pilot establishes a path toward therapeutic testing of the clinical-scale SNMHD and other implantable RRT devices.

**Funding:** NIDDK Support, Other NIH Support - NIBIB grant, Commercial Support - Outset Medical

## SA-PO019

### Human Mesenchymal Stromal Cells Cultured in a Hollow Fiber Bioreactor Produce Constant Levels of Exosomes in the Perfusion Medium: Relevance to the Simultaneous Production of Two Biotherapeutic Agents

Christof Westenfelder,<sup>1</sup> Mikhail Skliar,<sup>2</sup> Sabiha Sultana Chowdhury,<sup>1</sup> Anna Gooch,<sup>1</sup> <sup>1</sup>SymbioCellTech, LLC, Salt Lake City, UT; <sup>2</sup>University of Utah, Salt Lake City, UT.

**Background:** We have shown that the administration of allogeneic Mesenchymal Stromal Cells (MSCs) to patients at high risk for Acute Kidney Injury (AKI) following on-pump cardiac surgery prevents AKI and progression to Chronic Kidney Disease (CKD). Treatment of rats with severe, progressive IRI AKI with MSC-derived exosomes affords significant survival benefits and rescues their renal function. The current study examined the possibility to simultaneously collect MSC-derived exosomes while culturing human MSCs, both used for various therapies in renal and other diseases. This approach, if successful, would be cost saving, efficient and facilitate up-scaling of the production of both MSCs and their exosomes.

**Methods:** Human MSCs (20x10<sup>6</sup>) were loaded into a hollow fiber Cell Expansion System (Quantum®, TERUMOBCT; pre-conditioned for cell adhesion with Fibronectin) and expanded using αMEM with 5% human Platelet Lysate (hPL). The number and size

of exosomes in aliquots of the perfusion medium were monitored (NanoSight instrument) throughout the course of cell expansion.

**Results:** MSCs reached ~90% confluence within 12 days, yielding 500x10<sup>6</sup> MSCs. The number of exosomes/nanoparticles derived from the 5% hPL per se was 4±1x10<sup>11</sup>/mL. Post seeding of MSCs in the bioreactor, exosome numbers in the perfusate decreased and stabilized at 1-1.5x10<sup>11</sup>/mL. The size of collected exosomes was between 60 and 100 nm.

**Conclusions:** The data from this pilot study demonstrate that hPL-derived exosomes or nanoparticles are taken up by the expanding MSCs, which lowers their total number in the perfusion medium. However, exosome numbers stabilized during the subsequent cell expansion, indicating that growing MSCs release high numbers of exosomes. This conclusion will be confirmed by speciating hPL- and MSC-derived exosomes, using specific markers for each type of nanoparticle. Together, these observations show promise for the efficient generation of MSCs and their exosomes to be used for various clinical applications.

**Funding:** Commercial Support - SymbioCellTech

## SA-PO020

### Mesenchymal Stromal Cells (MSCs) Exposed to Interferon Gamma (INFγ) Secrete Exosomes (Exos) With a More Potent Renoprotective Profile Than Unexposed Cells

Anna Gooch,<sup>1</sup> Mikhail Skliar,<sup>2</sup> Sabiha Sultana Chowdhury,<sup>1</sup> Christof Westenfelder,<sup>1</sup> <sup>1</sup>SymbioCellTech, Salt Lake City, UT; <sup>2</sup>University of Utah, Salt Lake City, UT.

**Background:** Preclinical and clinical studies have shown MSCs to be effective for prevention of AKI [NCT00733876]. Yet studies where MSCs are given 48 hrs. post-insult, a time at which most patients with severe AKI are diagnosed and when no rescue therapy is available, show them to be ineffective or even damaging due to compromised renal blood flow in capillary beds, where introduction of large cells has the potential to cause further deterioration of renal function [NCT01602328]. MSCs' renoprotection is mediated by their paracrine release of anti-inflammatory and trophic cytokines and their Exos. The beneficial paracrine profile of MSCs can be enhanced through exposure to INFγ. Exos signal, post uptake by target cells, through the lateral transfer of mRNAs, miRNAs, DNA, proteins, and lipids. Others have shown that MSC-derived Exos can prevent AKI. We have found that their small size and ability to move through the compromised renal microvasculature allows them to provide effective rescue therapy for late-stage AKI. We hypothesized that priming of MSCs with INFγ would result in the release of Exos enriched in immune modulatory and other beneficial cargo compared to those not so primed, and thus provide a potentially more potent biotherapy for AKI.

**Methods:** 12 sets of human MSCs were cultured to 70% confluence. Serum was removed from the medium, and 6 were exposed overnight to 10ng/ml INFγ (*Expt*), and the other 6 to vehicle (*Control*). Exos were isolated from each of the 12 sets of medium. *Expt* and *Control* Exos were characterized and compared for size and number (Nanosite), mRNA (rtPCR) and miRNA (Rosalind) content.

**Results:** The number of Exos did not vary between *Expt* and *Control* groups. *Expt* Exos were slightly larger than *Controls* (163.2±4.1 vs 134.1±7.6 nm, respectively). *Expt* Exos' cargo showed significantly increased immune modulatory mRNA, specifically IDO-1, CCL8, CXCL9, CXCL10 and PD-L1 vs *Control*. *Expt* Exos showed significant increases in 4 miRNAs associated with anti-inflammatory pathways.

**Conclusions:** Exposure of MSCs to INFγ results in release of Exos that carry significantly greater immune-modulatory and anti-inflammatory cargo, factors that are known to confer renoprotection. We predict such Exos to have enhanced renoprotective ability, which is currently being assessed.

**Funding:** Commercial Support - SymbioCellTech

## SA-PO021

### The CAM Model for Ex Vivo Modeling of Vascularized Kidney Tubuloid Epithelium

Murillo Dorileo Leite Bernardi, Maarten B. Rookmaaker, Marianne C. Verhaar. *Universitair Medisch Centrum Utrecht, Utrecht, Netherlands.*

**Background:** Kidney tubuloids are 3D organoids composed of tubular epithelial cells. Tubuloids can be easily derived from tissue samples as well as urine and have an extensive proliferating capacity. After differentiation, tubuloid epithelium shows active and polarized transport *in vitro*. The next step toward clinical application is connecting epithelialized membranes to a vascular system. We here present a system for modeling the interaction between tubuloid epithelium and a circulating microvasculature, using the Chick Chorioallantoic Assay (CAM).

**Methods:** Fertilized Leghorn chicken eggs were cultured *ex ovo* for 10 days before cell culture inserts were implanted on the CAM. To assess and model the basolateral exposure of tubuloid epithelium in the insert to circulating compounds, the diffusion rate of endogenous urea, and and 70kD dextran-FITC (1mg/ml) from the CAM circulation over bare membranes was quantified with and without angiogenic factors (VEGF and Thrombin). Next, the viability of tubuloid epithelium cultured on the insert membranes on top of the CAM was evaluated. Finally, MRP2/4 dependent transport of CDFDA from the CAM circulation over the membrane as well as through the tubuloid epithelial cells was assessed.

**Results:** The vascularized bare membranes enabled diffusion from circulating compounds as was demonstrated by the time-dependent increase in the concentration of 10 and 70kD dextran-FITC in the insert after injection in the CAM circulation, with more than 10 fold higher diffusion of 10 than 70kD (2.94 ± 1.12, 0.17 ± 0.15 RFU respectively). We can also modulate the vascular permeability of the CAM with an angiogenic cocktail,

Key: TH - Thursday; FR - Friday; SA - Saturday; OR - Oral; PO - Poster; PUB - Publication Only

Underline represents presenting author.

which increases the diffusion of 10kD dextran in 2.5 fold ( $4.02 \pm 0.37$  against  $1.65 \pm 0.96$  RFU in the control). Kidney tubuloids on inserts maintain their viability and monolayer integrity after the incubation in the embryo. Finally, we showed tubuloid function in the model by the selective secretion of CDFDA from the circulation to the apical compartment.

**Conclusions:** The CAM assay is a useful system to model crucial aspects of implantable membranes: epithelial integrity and maintenance, membrane vascularization, supply of circulating compounds over the membrane, and epithelial transport function. The presented CAM model enables rapid optimization of vascularized and epithelialized membranes for clinical application.

**Funding:** Government Support - Non-U.S.

## SA-PO022

### Estimating Changes in Glomerular Filtration Rate During Dialysis With a Fluorescent Tracer

Christopher Pino,<sup>1,2</sup> Goldia Chan,<sup>3</sup> Kimberly Johnston,<sup>1,2</sup> H. David Humes,<sup>1,2</sup>  
<sup>1</sup>Innovative BioTherapies, Ann Arbor, MI; <sup>2</sup>University of Michigan Michigan Medicine, Ann Arbor, MI; <sup>3</sup>University of Michigan, Ann Arbor, MI.

**Background:** Fluorescein-isothiocyanate (FITC)-sinistrin can be used to measure glomerular filtration rate (GFR) as it's removed from the body exclusively by the kidneys and can be detected transdermally. Currently, there's a need to rapidly determine estimated GFR (eGFR) in acute kidney injury (AKI) patients during continuous renal replacement therapy (CRRT) to improve clinical decision-making. The viability of measuring changes in eGFR with FITC-sinistrin was tested in a swine model of progressive AKI during CRRT.

**Methods:** *In vitro* circuits (IVC) (n=2) were first trialed to mimic conditions that would be tested *in vivo*. A FITC-sinistrin solution was circulated through a hemofilter to mimic clearance from the kidneys and then through a dialyzer. Ultrafiltrate (UF) was removed from the hemofilter at three progressively decreasing rates to mimic loss of urine production. Dialysis was delivered at a constant rate. Transdermal devices were placed in the circuit to measure FITC-sinistrin. *In vivo* clearance of FITC-sinistrin was studied by placing anesthetized pigs on CRRT (n=3). Pigs underwent three phases progressing from normal to unilaterally nephrectomized and then bilaterally nephrectomized. FITC-sinistrin was administered prior to each phase and continuously measured transdermally. Dialysis was kept consistent throughout all three phases. Pre- and post-dialyzer blood samples were collected to calculate clearance from measured FITC-sinistrin concentrations in plasma.

**Results:** FITC-sinistrin clearance was reduced in all experiments, either *in vitro*, where UF was decreased or with successive nephrectomies *in vivo*. IVC studies showed agreement between transdermal device-estimated clearance and plasma-measured clearance ( $r^2=0.95$ ). *In vivo* experiments demonstrated no significant differences between transdermal device-estimated and plasma-measured methods of determining proportional changes in clearance from phase to phase. Clearance of FITC-sinistrin, urea, and creatinine by dialysis were demonstrated to be constant.

**Conclusions:** For a subject receiving a constant dialysis prescription, clearance of FITC-sinistrin is constant, allowing for changes in eGFR to be attributed to changes in kidney function. Therefore, measurement of FITC-sinistrin clearance is a viable method for estimating changes in GFR during dialysis.

**Funding:** Other NIH Support - NCATS 5R44TR001324-03

## SA-PO023

### Intraoperative Urine Oxygen During Cardiac Surgery and 12-Month Kidney Injury

Samuel R. Parry,<sup>1</sup> Isaac E. Hall,<sup>2</sup> Natalie Silverton,<sup>3</sup> Gregory J. Stoddard,<sup>2</sup> Lars Lofgren,<sup>3</sup> Kai Kuck,<sup>3</sup> <sup>1</sup>Brigham Young University College of Physical and Mathematical Sciences, Provo, UT; <sup>2</sup>The University of Utah Department of Internal Medicine, Salt Lake City, UT; <sup>3</sup>The University of Utah Department of Anesthesiology, Salt Lake City, UT.

**Background:** Acute renal effects from changes in intraoperative urine oxygen during cardiac surgery are well documented; however, longer-term effects of these fluctuations are unknown. We created a non-invasive oximeter to continuously measure urine oxygen levels during cardiac surgery. We hypothesized that low intraoperative urine oxygen associates with poor 12-month kidney outcomes.

**Methods:** This is a secondary analysis of a prospective cohort of patients undergoing cardiac surgery. 63 patients with at least one serum creatinine measurement within the 12-month follow-up were eligible and included. We measured intraoperative urine oxygen during the post-cardiopulmonary bypass period to determine associations with 12-month kidney outcomes. The post-discharge primary outcome was patient death, chronic dialysis, or estimated glomerular filtration rate (eGFR) decline by more than 30% without recovery by 12 months post-surgery.

**Results:** A total of 9 (14%) patients developed the primary outcome (2 died, 1 started chronic dialysis, 6 had eGFR decline >30%). For every 5 minutes spent below urine oxygen tension cutoffs during the post-cardiopulmonary bypass period of <25, <20, <15, and <10 mmHg, risk for the primary outcome increased via an exposure-response relationship with hazard ratios (95% CI) of 1.15 (1.01-1.31), 1.37 (1.10-1.72), 1.93 (1.34-2.77) and 5.85 (1.42-24.1), respectively.

**Conclusions:** Lower intraoperative urine oxygen values were associated with worse 12-month kidney outcomes in this small cardiac surgery cohort. While these findings support our hypothesis, additional larger prospective studies are warranted for external validation. We believe additional studies are also needed to further explore the potential clinical importance of specific intraoperative urine oxygen tension cutoffs.

**Funding:** Other NIH Support - NCATS award UL1TR002538, Private Foundation Support

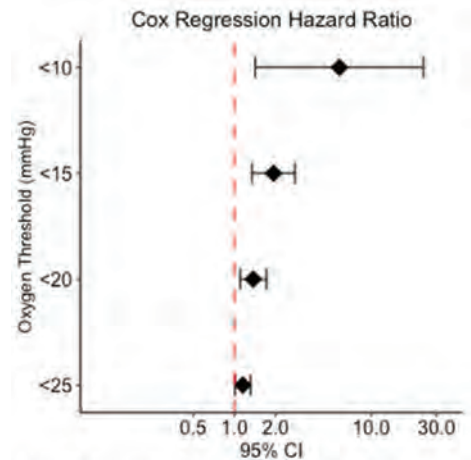

Hazard Ratio confidence intervals per 5 minutes spent below the respective oxygen threshold during the post-cardiopulmonary bypass period. 95% CI = 95% confidence interval. All hazard ratios are significant with  $p < 0.05$

## SA-PO024

### Intracellular Complement Production and Activation in Lupus Nephritis Podocytes

Abhigyan Satyam,<sup>1,2</sup> Masataka Umeda,<sup>1,2</sup> Rhea Bhargava,<sup>1,2</sup> Maria Tsokos,<sup>1,2</sup> George C. Tsokos,<sup>1,2</sup> <sup>1</sup>Beth Israel Deaconess Medical Center, Boston, MA; <sup>2</sup>Harvard Medical School, Boston, MA.

**Background:** Systemic lupus erythematosus (SLE) is a multisystem autoimmune disease that leads to systemic autoimmunity and damage of several tissues and organs. Inflammation of the kidney is one of the most severe exhibitions of SLE that leads to lupus nephritis (LN). Podocytes are critical for the maintenance of the glomerular filtration barrier and are injured in many kidney diseases including LN. Deposition of immune complexes and activation of the complement system are well-established processes involved in the pathogenesis of LN. It has been recognized that besides the well-established pathways of complement (C) activation, C3 can be activated within the cell cytoplasm prior to its secretion. Studies have shown cleavage of C3 and C5 by proteases of the cathepsin family, thus introducing a new pathway of complement activation. Here we explored the intracellular complement production and activation in LN podocytes.

**Methods:** Human immortalized podocytes were cultured on engineered cell-derived decellularized matrix (DCM) coated plates. Podocytes were then exposed to IgG from patients with LN or hypoxia. Podocytes from MRL<sup>lpr</sup> and MpJ control mice were also isolated and cultured on DCM coated plates. Cathepsins and complement molecules were inhibited using nanoparticle-based targeted delivery to impede the generation of intracellular complement split products.

**Results:** We found that MRL<sup>lpr</sup> podocytes and human podocytes exposed to LN IgG or hypoxia displayed changes in the actin cytoskeleton, and increased levels of C3, C4, C5, C5b9, and C3 activation products. Podocytes were also noted to produce cathepsins and inhibition of cathepsins suppressed the C3 activation.

**Conclusions:** Podocytes exposed to IgG from patients with LN or hypoxia produce complement components as do podocytes isolated from lupus-prone mice and this leads to cell injury. Reversal of podocyte injury with inhibitors of hypoxia or complement activation limits intracellular complement activation and may prevent kidney injury in patients with LN.

**Funding:** Other NIH Support - NIH National Institute of Allergy and Infectious Diseases

## SA-PO025

## Coaxial Printing of Convoluted Proximal Tubule for Kidney Disease Modeling

Rosalinde Masereeuw,<sup>1</sup> Anne Metje van Genderen,<sup>1,2</sup> Marta Garcia valverde,<sup>1</sup> Pamela E. Capendale,<sup>1,2</sup> Maj V. Kersten,<sup>1</sup> Elena Sendino Garv, Jitske Jansen,<sup>1</sup> Silvia M. Mihaila,<sup>1</sup> Tina Vermonden,<sup>1</sup> Y. Shrike S. Zhang.<sup>2</sup> <sup>1</sup>Universiteit Utrecht Utrechts Instituut voor Farmaceutische Wetenschappen, Utrecht, Netherlands; <sup>2</sup>Harvard Medical School, Boston, MA.

**Background:** Genetic defects in proximal tubule (PT) transporters can lead to metabolic complications and tubulopathies. To mechanistically study these pathologies, 3D (bio) printing offers new modeling alternatives to *in vivo* by incorporating cell-extracellular matrix (ECM) interactions. Here, we applied co-axial printing to create a convoluted channel within a gelatin-based microfiber to model the convoluted structure of the PT and address the ECM-cells interaction in a disease model. For this, we included a cystinosis-deficient (*CTNS*<sup>-/-</sup>) cell line to model cystinosis, a currently incurable kidney tubulopathy.

**Methods:** A 3D printing system consisting of syringe pumps, heaters, coaxial needles, and a silicon holder was designed. Fine-tuning of the gelatin/alginate-based ink composition, printing temperature and feeding rate allowed an optimal ink viscosity. CaCl<sub>2</sub> and microbial transglutaminase were used to stabilize the ink. Healthily conditionally immortalized PTECs (ciPTEC), and isogenic *CTNS*<sup>-/-</sup> cells were seeded to mimic two genotypes. Immunofluorescent stainings for cytoskeleton organization (F-actin), polarization markers (a-tubulin, Na<sup>+</sup>K<sup>+</sup>-ATPase), ECM-production (collagen IV), and barrier-formation (inulin-FITC leakage) were performed to evaluate the performance of the engineered PT.

**Results:** The printed microfibers (length:>50cm, OD:1.5mm, ID:150µm) exhibited prolonged structural stability (42 days) and cytocompatibility in culture. All cells showed homogenous cytoskeleton organization upon 14 days of culture in the microfibers, as indicated by F-actin directionality measurements, barrier-formation and polarization with the apical marker a-tubulin and the basolateral marker Na<sup>+</sup>K<sup>+</sup>-ATPase. Cell viability was slightly impaired (60%, *p*=0.028) in cystinotic cells upon prolonged culturing for 14 days. Finally, *CTNS*<sup>-/-</sup> cells showed reduced apical transport activity by two efflux pumps, *viz.* breast cancer resistance protein and multidrug resistance-associated protein 4 (*p*<0.0001).

**Conclusions:** Our novel printing device showed potential to mimic a 3D environment compatible with healthy PT and tubulopathy modeling. By further improving this setup, new insights in kidney disease development and progression can be gained. This eventually aids in new treatment options.

**Funding:** Private Foundation Support, Clinical Revenue Support, Government Support - Non-U.S.

## SA-PO026

## Targeting BH3 Domains in iPSC-Derived Tuberos Sclerosis Kidney Organoids for the Development of Novel Therapies for Renal Angiomyolipoma

Dario R. Lemos,<sup>1,2</sup> Marta Lpez-Marfil,<sup>1,2</sup> Ting-Chun Kuo,<sup>1,2</sup> Xichi Wang,<sup>1,2</sup> Lemos Lab HMS <sup>1</sup>Brigham and Women's Hospital, Boston, MA; <sup>2</sup>Harvard Medical School, Boston, MA.

**Background:** Kidney organoids can recapitulate genetic kidney diseases allowing the identification of novel druggable targets. Among those diseases, kidney tumors known as renal angiomyolipomas (AMLs) occur in a majority of patients with Tuberos Sclerosis (TS). Rapamycin analogs with cytostatic and pro-apoptotic activity, are the main therapy for AML. Rapalogs partially shrink AMLs by inhibiting mTORC1 activity, but tumor size stabilizes over time, making life-long treatment necessary. Tumor re-growth is often observed after treatment is interrupted due to adverse effects. A lack of appropriate experimental models, has precluded the development of more effective therapies.

**Methods:** We have developed a kidney organoid model that recapitulates kidney AML *in vitro* and *in vivo*, using patient-derived *TSC2*<sup>-/-</sup> iPSCs. Orthotopic transplantation of AML organoids allowed us to identify previously unknown molecular mechanisms and to test the effect of candidate compounds with prospective anti-tumor activity in immunodeficient rodents.

**Results:** Consistent with the genetic mechanisms observed in TS patients, kidney organoids generated from iPSCs carrying bi-allelic inactivating mutations in the *TSC2* gene (i.e. *TSC2*<sup>-/-</sup>) recapitulated key anatomical and molecular features of renal AML (Hernandez J. et al. Nat. Commun. 2021 Nov 11;12(1):6496). Transcriptional analysis of AML organoids against kidney AML transcriptomes further identified gene sets and major signaling mechanisms shared in common with kidney AML tumors. Among those mechanisms, we identified upregulation of anti-apoptotic members of the BCL-2 family of proteins as a putative mechanism of tumor resistance. Transplantation of *TSC2*<sup>-/-</sup> renal organoids into the kidneys of immunodeficient rats allowed us to investigate AML mechanisms *in vivo* for the first time. Using these novel tools, we have identified the BCL-2 inhibitor drug Venetoclax as a prospective novel therapy, inducing iPSC-derived AML cell death and AML organoid xenograft ablation *in vivo*.

**Conclusions:** Our *TSC2*<sup>-/-</sup> iPSC-derived AML organoid xenograft model allowed us to elucidate previously unknown tumor resistance mechanisms in TS-associated kidney AML, and to identify the BH3 mimetic molecule Venetoclax as an prospectively efficacious new therapy.

**Funding:** Private Foundation Support

## SA-PO027

## Hemodynamic Optimization of an Implantable Artificial Kidney Device Using Computational Analysis

Andre Laffitte Farina,<sup>1</sup> William H. Fissell,<sup>2</sup> Shuvo Roy,<sup>3</sup> Venkat Keshav Chivukula.<sup>1</sup> <sup>1</sup>Florida Institute of Technology, Melbourne, FL; <sup>2</sup>Vanderbilt University, Nashville, TN; <sup>3</sup>University of California San Francisco, San Francisco, CA.

**Background:** Severe loss of kidney function is experienced by end-stage kidney disease patients. An exciting alternative treatment to hemodialysis would be an implantable artificial kidney device (IAKD) that filters blood using the natural pressure drop in the systemic circulation. This study aims to investigate the hemodynamic performance of potential IAKD designs using a computational hemodynamic model (HM).

**Methods:** A custom HM was developed to analyze the implantation of an IAKD (Fig 1a). The time-varying HM encompasses the complete circulation and the IAKD branch. Two IAKD designs were analyzed: serpentine and parallel configurations (Fig 1b and c). For each design, several scenarios for IAKD resistance, pressure drop across and flow through the IAKD and device inlet graft together with vital signs were varied to simulate patient-specific needs. Model optimization was performed by modifying several parameters.

**Results:** In both configurations, an increase in the internal device resistance twofold resulted in a reduction of flow by 25% through the IAKD. Strong interdependencies between the device resistance, the patient's MAP and flow through the IAKD were also observed. During model fine-tuning, the length and diameter of the inlet graft was the most influential parameter to modulate flow through the IAKD (up to 40% in the parallel configuration, see Fig 1d).

**Conclusions:** The HM can investigate clinically relevant scenarios to tailor an IAKD for renal failure patients. Our analysis suggests that there is a complex interplay between the patient's systemic circulation and the IAKD, necessitating detailed hemodynamic analysis. Depending on the patient's needs, it is possible to personalize an IAKD that can best serve to maintain hemodynamic stability and hemodialysis efficiency.

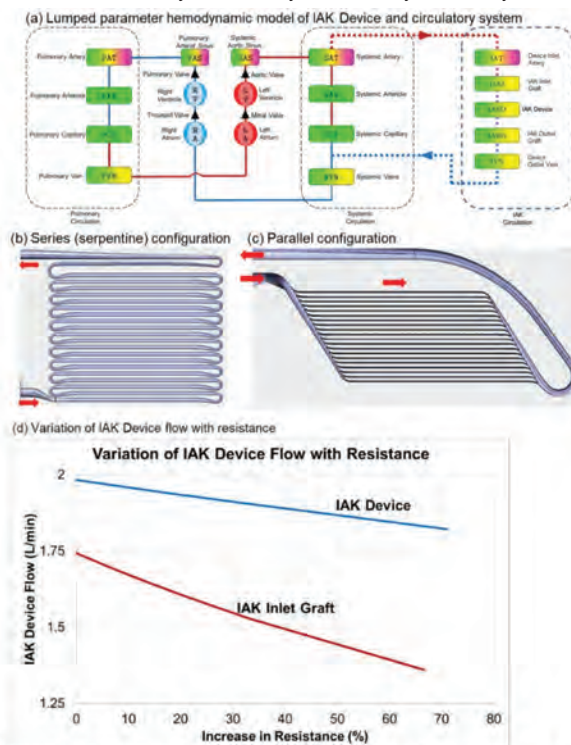

**Figure 1:** (a) Lumped parameter model, (b) and (c) – series and parallel device configurations, respectively, (d) variation of IAK device flow with resistance, indicating higher dependence on IAK inlet graft resistance compared to device resistance

## SA-PO028

## Perfusable Human Tubule Chip System to Model Polycystic Kidney Disease

Sophie Karp, Martin Pollak, Balaji karthick Subramanian. Pollak Lab Beth Israel Deaconess Medical Center, Boston, MA.

**Background:** Ex-vivo systems modeling human kidney tubules may be used for high-throughput drug screening and mechanistic disease studies. Polycystic kidney disease (PKD) is an important tubular disease to model, as it is responsible for 2% of worldwide renal failure. Proximal and distal tubules are affected differently in PKD settings in terms of fluid-activated transport and inflammation, leading to GFR changes and ultimately

renal failure. It is thus important to establish a system in which segment-specific human-derived PKD tubules may be studied in physiologically relevant conditions, such as fluid flow.

**Methods:** Using photolithography, we created a microfluidic chip with a channel insert and ports for media delivery. We then derived kidney organoids from both normal and PKD patient-sourced induced pluripotent stem cells (iPSCs). We extracted proximal and distal tubule cells from these organoids, and delivered them to our chip system. Unidirectional fluid flow for various time frames was introduced through the system and changes in the tubule structure and function were examined. Tubule volume changes, marker protein expression and localization, and transport properties were assessed and compared between normal and PKD disease tubular chips.

**Results:** Kidney organoids formed tubular structures which mimicked human kidney structures and replicated PKD-like cyst formation. Kidney organoid-harvested cells exhibited nephron segment-specific marker protein localization and function, and formed tubular structures when introduced to the chip-system. Normal tubule chip systems exhibited human kidney-relevant structure and function, while PKD systems showed aberration in tubule volume. Diseased systems exhibited altered localization of marker proteins such as E-cadherin, as well as diminished transport capacity of solutes (e.g., 6-Carboxy fluorescein). More importantly, diseased tubules showed aberrations in structure and function in a segment-specific manner, mimicking *in vivo* disease pathology.

**Conclusions:** We have developed and validated a model system to study the effects of PKD *ex vivo*. Our platform will allow both mechanistic studies and drug testing in a nephron-segment specific way. Its conductivity to both distal and proximal human iPSC-derived tubules allows researchers to study disease in a personalized manner.

**Funding:** NIDDK Support, Other U.S. Government Support, Private Foundation Support

### SA-PO029

#### High-Dimensional Imaging of Postnatal Glomerulogenesis in the PodocyteTRAP Model by Simplified Tissue-Clearing Approach

Mathieu Preußner,<sup>1,2</sup> Jonas Einloft,<sup>1</sup> Simon Bedenbender,<sup>1</sup> Andreas Hofmeister,<sup>1,3</sup> Ivica Grgic,<sup>1</sup> <sup>1</sup>Philipps-Universität Marburg Fachbereich Medizin, Marburg, Germany; <sup>2</sup>Goethe-Universität Frankfurt am Main, Frankfurt am Main, Germany; <sup>3</sup>BioNTech SE, Mainz, Germany.

**Background:** The development of glomeruli is complex. Its dynamics and spatio-temporal coordination during the formation of the glomerular architecture are still poorly understood. Classical histopathological methods and microscopy techniques yield a rather limited scope of visualization and reconstruction of evolving glomeruli that can only be fully comprehended in a 3-dimensional context.

**Methods:** To study the successive buildup and maturation of podocytes during glomerulogenesis, we used neonatal kidneys (P0-P7) from transgenic Podocyte<sup>TRAP</sup> mice in combination with an adjusted ethyl cinnamate (ECi)-based clearing approach for immunostaining and subsequent 2-photon and light-sheet microscopy. We used IMARIS for detailed morphometric analysis and 3D-reconstruction of podocytes and glomeruli during advanced stages of kidney development.

**Results:** Tissue clearing is a technique to render biological samples transparent, thereby allowing for high-dimensional 3D-imaging of structures deep within the tissue without the need for tissue-sectioning. We used this technique for 3D-visualization, reconstruction and analysis of different glomerular developmental stages (renal vesicles, S-phase, capillary loop, maturing glomerulus) in transparent kidneys of P0 to P7 and adult Podocyte<sup>TRAP</sup> mice. ECi-clearing followed by 2-photon and light-sheet microscopy allowed for 10-fold larger imaging depth compared to uncleared kidneys (~1500µm vs. ~150µm). EGFP-L10a<sup>+</sup> podocytes in ECi-treated Podocyte<sup>TRAP</sup> kidneys were easily identified by their robust epifluorescence, with eGFP-L10a intensifying as podocyte maturation progressed. We conducted detailed analyses which included comprehensive quantifications of glomerular volume changes during postnatal kidney development.

**Conclusions:** The combination of ECi-tissue clearing with 2-photon and light-sheet microscopy in the Podocyte<sup>TRAP</sup> model is well suited for high-dimensional imaging of renal tissue including detailed morphometry of maturing glomeruli in whole neonatal mouse kidneys. Moreover, this approach could also be useful for holistic histopathological analyses and assessments in various glomerular disease models including experimental GN and FSGS.

**Funding:** Government Support - Non-U.S.

### SA-PO030

#### Differentiation of Human Kidney Organoids Within a Microfluidic Chip Promotes Podocyte-Endothelial Cell Interaction

Sophie M. Blackburn, Giulia Spennati, Benjamin S. Freedman. University of Washington, Seattle, WA.

**Background:** Combining kidney organoids with microfluidic chips has promise as a powerful tool to improve organoid maturation, vascularization, and create a highly tunable environment for drug testing or disease modeling. Organoids can be transferred into microfluidic channels after differentiation, but this risks irreversibly damaging the newly formed structures or inducing their dedifferentiation upon attachment in the channel. Thus, we have developed a protocol to carry out kidney organoid differentiation entirely within a microfluidic device.

**Methods:** A positive-relief mold was generated using a stereolithography 3D printer to make a PDMS device with multiple channels separated by micro-pillars, which could accommodate a physiological flow rate. Then, we optimized our standard kidney organoid protocol for the microfluidic chip by altering the ECM surface coating, undifferentiated human pluripotent stem cell seeding density, and timing of media exchanges to support

the much smaller growth environment. Following these modifications, we identified several organoids in each device with brightfield microscopy by day 18 of differentiation and fixed them for immunostaining.

**Results:** The presence of kidney-specific cells and structures was confirmed by confocal microscopy after fixing and staining for podocyte, proximal tubule, and endothelial cells. The organization of these organoids was comparable to those made in 24-well plates indicating that we have successfully optimized our standard differentiation protocol for a microfluidic platform. Increased endothelial cells were observed in chip-differentiated organoids, compared to 24-well plates. The endothelial cells integrated into organoids in 3D, and demonstrated a tendency to interact with the basal membrane of podocytes which was not observed in 24-wells.

**Conclusions:** This protocol eliminates transfer steps during the differentiation process by creating a stable environment for organoid development within our microfluidic chips. In addition, the confined growth environment of the microfluidic chips or the intermittent shear stress from media changes may be inducing endothelial cell differentiation and podocyte-endothelial cell interactions. The endothelial interactions observed in organoids grown in these devices provides a strong foundation for future vascularization work.

**Funding:** NIDDK Support, Other NIH Support - NCATS, Other U.S. Government Support

### SA-PO031

#### An Open Microfluidic Model to Investigate Podocyte-Parietal Epithelial Cell Cross-Talk *In Vitro*

Yuting Zeng,<sup>1</sup> Jeffrey W. Pippin,<sup>2</sup> Stuart J. Shankland,<sup>2</sup> Ashleigh B. Theberge.<sup>1,3</sup> <sup>1</sup>University of Washington Department of Chemistry, Seattle, WA; <sup>2</sup>University of Washington Division of Nephrology, Seattle, WA; <sup>3</sup>University of Washington Department of Urology, Seattle, WA.

**Background:** Although focal segmental glomerulosclerosis (FSGS) is initially caused by direct injury to podocytes, their neighboring parietal epithelial cells (PECs) also undergo secondary molecular changes that further damage the glomerulus. The crosstalk between injured podocytes and PECs is poorly understood, in part due to a lack of appropriate experimental models for study. The goal of this study is to establish an *in vitro* coculture model to determine what mediators derived from injured podocytes cause PECs damage.

**Methods:** We engineered a novel open microfluidic coculture device where two culture chambers are separated by a half wall that can be connected to study intercellular interactions. Diffusion calculations suggested that moderate sized (10 kDa) signaling molecules take ~ 2 d to reach the other chamber via diffusion. In mouse podocyte-PEC coculture studies, immortalized mouse podocytes were exposed to cytotoxic sheep anti-podocyte antibodies, puromycin, or Adriamycin, and cocultured with mouse PECs for up to 96 h. In human podocyte studies, primary human podocytes were also injured with anti-podocyte antibodies, puromycin, or Adriamycin. Podocyte responses were assessed by phase-contrast imaging, MTT assays, and immunostaining. Immunostaining also measured PEC activation and epithelial-mesenchymal transition (EMT).

**Results:** Immediately following podocyte injury, both mouse and human podocytes displayed foot process effacement and cell body shrinkage. In addition, cell viability was decreased of injured podocytes. The normal contiguous monolayer of mouse podocytes was disrupted, accompanied by a dose-dependent increase in the *de novo* expression of the injury marker desmin, and a decrease in the cytoskeletal marker F-actin along the cell borders. In podocyte-PEC coculture, PECs were activated (expressed CD44) accompanied by increased SM22, an EMT marker. A time course of bulk RNA seq results are pending.

**Conclusions:** This novel *in vitro* microfluidic model for coculturing injured podocytes and neighboring cells has the potential to study many pathways involved in podocyte-related intercellular crosstalk, glomerular disease mechanisms, and drug screening.

**Funding:** NIDDK Support, Other NIH Support - R35GM128648, NIA5R01AG046231, Other U.S. Government Support

### SA-PO032

#### Focal Fungal Granulomatous Interstitial Nephritis on a Background of Class II Lupus Glomerulonephritis

Pedro J. Martinez Pitre,<sup>1</sup> Ana I. Stark,<sup>1</sup> Tomas Fernandez-Correa,<sup>1</sup> Ramya Krishna Velagapudi,<sup>3</sup> Mark Lusco,<sup>3</sup> Juan Carlos Q. Velez,<sup>1,2</sup> Shirisha Bodana.<sup>1</sup> Ochsner Nephrology <sup>1</sup>Ochsner Medical Center, New Orleans, LA; <sup>2</sup>The University of Queensland Ochsner Clinical School, Herston, QLD, Australia; <sup>3</sup>Vanderbilt University Medical Center, Nashville, TN.

**Introduction:** Fungal infections are an exceedingly rare form of granulomatous interstitial nephritis (GIN). Most cases of GIN are associated with sarcoidosis or drug exposure. The most common etiology of infectious GIN is mycobacteria. Herein, we report a case of fungal GIN diagnosed in a patient with systemic lupus erythematosus (SLE) receiving low-dose corticosteroids.

**Case Description:** A 54-year-old woman was hospitalized with acute respiratory failure, acute kidney injury (AKI), anemia and thrombocytopenia following 2 weeks of generalized weakness and altered mental status. The patient had a medical history of SLE and remote history of class III and V SLE glomerulonephritis (GN) for which she had received immunosuppression 27 years prior to presentation. Current medications included low-dose prednisone, hydroxychloroquine, nifedipine, furosemide and insulin glargine. Upon arrival, she was noted to be hypotensive and oliguric. Laboratory data showed a serum creatinine of 3.4 mg/dL (baseline 1.0 mg/dL). Urinalysis revealed hematuria, proteinuria and leukocyturia. Urine microscopy revealed budding yeast and

pseudohyphae. Urine culture was negative and blood culture was positive for *Proteus mirabilis*. CT of the abdomen revealed bilateral perinephric stranding consistent with pyelonephritis. She was started on broad spectrum antibiotics, pulse steroids for possible SLE flare, and dialysis for volume and metabolic derangements. Kidney biopsy was performed for suspected relapse of SLE-GN. Specimen revealed acute tubular necrosis, class II SLE-GN (activity index 0) and focal fungal granuloma with budding yeast and hyphae (by electron microscopy). Repeat cultures grew *Candida albicans* and *Candida glabrata* in blood and *Candida albicans* in the urine. The patient was started on liposomal amphotericin B and her kidney function recovered to a serum creatinine of 1.0 mg/dL.

**Discussion:** Candiduria is a common finding on routine evaluation of hospitalized patients with AKI and often represents colonization or a urinary tract infection. However, in the context of immunosuppression, those findings should raise suspicion for fungal GIN, as shown in this case, so that appropriate intervention can be promptly implemented.

### SA-PO033

#### Creamy Clogged Dialysis Filter Indicating Something Serious: A Case of Propofol Infusion Syndrome With Hyperlipidemia in a Bariatric Surgery Patient

Ahmad S. Al-Alwan,<sup>1</sup> Harshil Fichadiya,<sup>1</sup> Nimit Dalal,<sup>2</sup> Muhammad Tayyeb,<sup>1</sup> Apurva Ketkar,<sup>1</sup> <sup>1</sup>Monmouth Medical Center, Long Branch, NJ; <sup>2</sup>Western Reserve Health Education, Warren, OH.

**Introduction:** Propofol is a short acting intravenous anesthetic and sedative agent. Propofol related infusion syndrome (PRIS) is rare but associated with very high mortality rate. Commonly seen in patients receiving dose >4 mg/kg/hr for prolonged period > 48 hours. The pathogenesis involves impaired beta oxidation of fatty acids, disruption in electron transport chain, blockage of beta adrenergic receptors and calcium channels on myocardial cell. Clinically presents as cardiac dysfunction (bradycardia, ventricular arrhythmia and asystole), high anion gap metabolic acidosis, rhabdomyolysis, hyperkalemia, hyperlipidemia, AKI and hepatocellular injury.

**Case Description:** 69 year old male with ICU course complicated by sepsis from serratia bacteremia post gastric sleeve leak repair, ARDS, oliguric AKI, cardiac arrhythmia, hypotension had recurrent clogging of dialysis filter with a creamy greasy substance. The patient was being sedated with high dose of propofol >25mcg/kg/hr for 1 week. Elevated triglyceride level 799mg, worsening kidney function and acidemia, worsening hepatocellular transaminitis (ALT 283, AST 135) with mild elevation in CPK 293 was noted. Propofol infusion syndrome was suspected and the drug was held following which his transaminitis, acidosis, hyperlipidemia and rhabdomyolysis improved. His renal function continued to decline and required HD.

**Discussion:** A creamy clogged dialysis filter raised suspicion of hyperlipidemia and PRIS in our patient. Severe illness and use of exogenous catecholamines predisposed our patient to this condition. Bariatric surgery patients with possible carbohydrate depletion are at higher risk. Early identification and low threshold for suspicion of PRIS can help in reducing mortality from this condition.

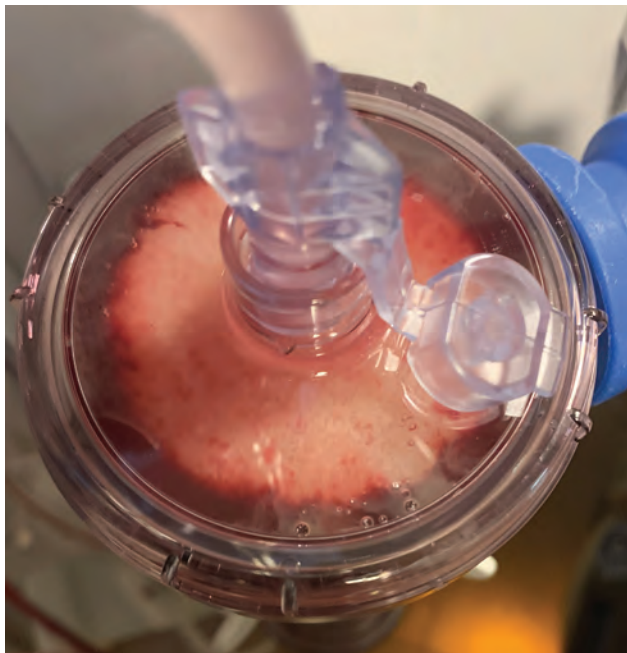

### SA-PO034

#### Falsely Low Serum Creatinine in an AKI Patient on Dopamine Drip

Tram Dao, Brian Y. Young. University of California Davis Department of Internal Medicine, Sacramento, CA.

**Introduction:** Two common methods to measure creatinine concentration in the blood are the Jaffe and enzymatic method. Enzymatic creatinine assays have been reported to be affected by the presence of catecholamines. Specifically, dopamine and dobutamine infusions are known to cause falsely decreased creatinine levels due to interference with the peroxidase reaction.

**Case Description:** We present a 68 year old male with a past medical history of CKD stage 3b (baseline creatinine 1.7 mg/dL), interstitial lung disease status-post double lung transplant, coronary artery disease, heart failure with mildly reduced ejection fraction, and restrictive pericarditis who was admitted for decompensated heart failure. The patient also had acute kidney injury (AKI), presumed from diuretic refractory cardiorenal syndrome, with consistently rising creatinine levels since hospital admission. On hospital day 16, the patient's creatinine decreased from 4.55 mg/dL to 1.28 mg/dL in 24 hours without any renal replacement therapy or medical changes other than dopamine infusion was started the day prior. Serum creatinine over the next few days sporadically fluctuated from 1.81 mg/dL to 5.28 mg/dL. After discussion with nursing staff, we confirmed that labs were drawn using the same intravenous line being used for dopamine infusion. When the nurse obtained labs via a peripheral venous puncture on hospital day 18, the creatinine level was 5.15 mg/dL, most consistent with the patient's AKI. The patient was started on dialysis soon after due to poor clearance and volume control.

**Discussion:** It is important for healthcare providers to be aware of the artifactual effects that dobutamine and dopamine infusions have on serum creatinine levels. A recent survey shows a lack of this awareness among healthcare providers. This issue can be avoided by educating nursing staff to avoid drawing creatinine levels using the same infusion lines for dopamine or dobutamine. It is also noted that the Jaffe method is unaffected by the presence of catecholamines, though the majority of labs now employ the enzymatic method. Consideration could also be made to use cystatin C if readily available.

### SA-PO035

#### When Overdose With Doxylamine Leads to Severe Rhabdomyolysis and Renal Failure That Requires Hemodialysis: A Case Report and Literature Review

Salman Bhutta,<sup>1</sup> Samaan Mahmoudzadeh,<sup>2</sup> Bair Cadet.<sup>1</sup> <sup>1</sup>Nassau University Medical Center, East Meadow, NY; <sup>2</sup>UCI Health, Orange, CA.

**Introduction:** Antihistamines such as doxylamine, represent common components of over-the-counter sleep-inducing agents. The easy availability of these substances increases the potential for both intentional overdose by adults and inadvertent ingestion by children. Doxylamine overdose has increased in recent years due to its availability as an over-the-counter drug commonly used as a nighttime sleep aid. Clinical studies describe symptoms of severe doxylamine intoxication such as rhabdomyolysis, renal failure, impaired consciousness, seizures, and cardiopulmonary arrest

**Case Description:** A 52 year old male with a history of HTN and opioid dependence presented with acute onset right-sided weakness, numbness, right buttock pain, nausea, and vomiting. He reported taking 30 tablets of doxylamine the night prior to presentation due to difficulty sleeping. Upon admission, patient's labs showed elevated creatinine kinase >100,000, blood urea nitrogen/Creatinine 71/5.8, aspartate aminotransferase 2170, alanine aminotransferase 536, and phosphate 7.9. Patient was admitted to the medical intensive care unit (MICU) for severe rhabdomyolysis with acute renal failure, and acute liver failure secondary to doxylamine overdose. He received n-acetylcysteine for acute liver failure and was started on aggressive IV hydration. He remained oliguric and a hemodialysis catheter was placed on hospital day (HD) 1 for emergent dialysis. Throughout the hospital stay, patient received three cycles of dialysis. Urine output gradually improved and the patient was transferred to the medical floors on HD 5. He was subsequently discharged home on HD 13 with an outpatient nephrology appointment.

**Discussion:** Acute kidney injury from rhabdomyolysis due to doxylamine toxicity can result in poor prognosis, necessitating emergent dialysis and critical care management as seen in our patient. The accessibility of this drug alongside its potential for abuse warrants discussion among healthcare providers. Additionally, the adverse outcomes associated with doxylamine overdose demands that clinicians act immediately in treating patients with suspected intoxication. Rapid intervention may prevent progression of renal failure, ultimately reducing the risk of developing chronic kidney disease and requiring long-term dialysis.

### SA-PO036

#### Vanishing Bactrim Stones: A Case for Urinary Alkalinization

Muhammad S. Khan,<sup>1,2</sup> David Geller.<sup>1,3</sup> <sup>1</sup>Yale University, New Haven, CT; <sup>2</sup>Yale New Haven Health System, New Haven, CT; <sup>3</sup>Veterans Health Administration, West Haven, CT.

**Introduction:** Trimethoprim/sulfamethoxazole (TMP-SMX) is a commonly used antibiotic in the clinical setting. It is also a rare cause of renal calculi, the management of which has not been well described. Here we present a case of AKI thought to be secondary to obstructive TMP-SMX stones with rapid resolution of AKI, obstruction and stones with urinary alkalinization.

**Case Description:** A 94 year old man with Waldenstrom's macroglobinemia, bladder areflexia managed with chronic Foley catheter use, and baseline normal renal function

(Cr 1.1 mg/dL, eGFR 62 ml/min) was treated for E. coli bacteremia with 2 double strength TMP-SMX tablets q12h for a total of 9 days. Imaging at the time showed no nephrolithiasis. He presented to the emergency department on the 9th day with decreased urine output, acute kidney injury (Cr 4.5 mg/dL), and hyperkalemia (K 6.8 meq/L). A repeat renal U/S showed the interval development of multiple bilateral renal calculi with moderate hydronephrosis. Urinalysis demonstrated birefringent crystals under polarized light, leading to a presumptive diagnosis of TMP-SMX nephrolithiasis. The patient was treated with IV and oral bicarbonate and discharged on oral bicarbonate for one month. Two weeks later, serum Cr had decreased to 1.3 mg/dL. A renal U/S done 6 weeks after alkalization was initiated showed complete resolution of the hydronephrosis and renal calculi. Cr was 1.1 mg/dL.

**Discussion:** Nephrolithiasis caused by sulfamethoxazole crystals use is rare, and effective medical management strategies have not been well described. Urinary alkalization is based on the premise of increased solubility of sulfonamides at an alkaline pH. We present a case in which rapid improvement in clinical trajectory occurred soon after urinary alkalization. This report is unique in that we demonstrate both the growth and resolution of the stones in a rapid time frame. Further study will be required to determine if this regimen is an effective alternative to ureteral stenting or nephrostomy tubes.

#### SA-PO037

##### Enfortumab-Vedotin as a Cause of Severe Acute Interstitial Nephritis

Muhammad S. Khan,<sup>1,2</sup> David Geller,<sup>1,3</sup> <sup>1</sup>Yale University, New Haven, CT; <sup>2</sup>Yale New Haven Health System, New Haven, CT; <sup>3</sup>Veterans Health Administration, West Haven, CT.

**Introduction:** Enfortumab-vedotin is an antibody-drug molecule recently approved by the FDA for urothelial and other cancers. Data submitted to the FDA lists "increased creatinine in 20% of patients and ARF in a small minority of patients" as an adverse event noted in phase 3 clinical trials of this drug but little information is available beyond that. Here, we present a case of severe acute interstitial nephritis (AIN) thought to be secondary to enfortumab-vedotin use.

**Case Description:** An 86-year-old male with CAD s/p CABG, HTN, CKD3b (baseline Cr 2.1), chronic right hydronephrosis and recurrent transitional cell cancer of bladder s/p TURBT was initially treated with 5 cycles of pembrolizumab but was switched to enfortumab due to an ineffective response. Patient's last dose of pembrolizumab was administered 4 weeks prior to cycle 1 of enfortumab. He received a total of 4 monthly cycles (3 weekly doses each cycle) of enfortumab with CBC and BMP obtained with each infusion. During cycle 3 infusion 2, peripheral eosinophilia (15.8%) was noted, which worsened after the next infusion 8 days later to 23.2%. Eosinophilia normalized (2.7%) prior to initiation of cycle 4. A similar rise in eosinophilia to 9.1% was seen after cycle 4 infusion 1. Labs demonstrated AKI (Cr 6.2 mg/dl) prior to the 2nd infusion so further enfortumab infusions were held, but eosinophils rose to 27.1% and a renal biopsy was performed which showed extensive AIN on H&E staining. Patient was treated with steroids and enfortumab discontinuation with rapid recovery of renal function.

**Discussion:** To our knowledge, this is the first report of AIN caused by enfortumab-vedotin. While delayed AKI caused by AIN has been reported in the setting of pembrolizumab use, the rise and fall of eosinophilia seen during the 3rd and 4th infusion cycles argues strongly that this is the likely culprit, with pembrolizumab perhaps playing a role in immune system priming. Vedotin, a microtubule inhibitor, was first linked to brentuximab and used in hematologic malignancies, but it has been subsequently linked to a wide variety of other cancer targeting antibodies. There have been multiple reports of Karyomegalic interstitial nephritis (KIN) linked to brentuximab-vedotin. Our data coupled with these previous reports suggest that the eosinophil count should be monitored, and AIN should be considered in patients the steadily rising number of antibody drug complexes containing vedotin.

#### SA-PO038

##### Started With the Kidneys, Followed by the Lungs: A Rare Case of Sarcoidosis

Rui Song,<sup>1</sup> Laura Walters,<sup>1</sup> Rahat A. Memon,<sup>1</sup> Ali Arif,<sup>1</sup> Winston Shu,<sup>1,2</sup> <sup>1</sup>Abington Memorial Hospital, Abington, PA; <sup>2</sup>Hypertension Nephrology Associates, Willow Grove, PA.

**Introduction:** Sarcoidosis is a multisystem disorder. Only 8% of patients present with disease at extra-pulmonary sites without lung involvement. Granulomatous interstitial nephritis (GIN) is the classic kidney lesion found in sarcoidosis. However, clinically significant renal sarcoidosis is exceedingly rare. We present a case with acute renal failure (ARF) requiring temporary dialysis due to GIN without lung involvement on presentation.

**Case Description:** A 39-year-old female with a history of hypertension presented to the emergency room with nausea and vomiting. Labs showed a serum creatinine (Cr) 13.29 mg/dL (1.1mg/dL 3 months prior), blood urea nitrogen 106 mg/dL, bicarbonate 13 mg/dL. Arterial blood gas showed a pH of 7.23 with PaCO<sub>2</sub> of 33 mmHg. Urinalysis showed 1+ protein and 2 red blood cells. Dialysis was started for acidosis and uremia. Renal ultrasound showed no obstruction or chronic changes. IV methylprednisolone was started and she underwent kidney biopsy for ARF. Pathology showed GIN. The angiotensin-converting enzyme was 156 nmol/mL/min, and calcium was normal. CT scan of the chest showed no adenopathy or pulmonary disease. She was weaned off dialysis with adequate urine output and a Cr of 2mg/dL. She was discharged on 60 mg prednisone daily for 2 weeks followed by a 3-month taper. After stopping steroids, she developed nausea and vomiting again and presented to the ER with a Cr >10mg/dL. Repeat CT scan of the chest now showed bilateral hilar adenopathy. Bronchoscopy was performed

and lymph node biopsy showed non-caseating granulomas confirming sarcoidosis. She subsequently improved clinically with standard steroid treatment.

**Discussion:** The most common renal feature of sarcoidosis is nephrocalcinosis caused by dysregulated calcium homeostasis, followed by GIN. About 4-10% of renal sarcoidosis may progress to end-stage renal disease. Corticosteroids are the mainstay treatment. In this case, the patient was first found to have GIN with normocalcemia and was treated timely with steroids. Lung involvement was absent until steroids were tapered off 3 months later highlighting the importance of closely monitoring lung features if renal sarcoidosis is detected. Given the lack of treatment guidelines, a longer course of steroids for clinically significant renal sarcoidosis may be needed to prevent full-blown lung sarcoidosis.

#### SA-PO039

##### A Case of Eltrombopag-Associated Renal-Limited Thrombotic Microangiopathy

Nurit S. Katz, Catherine Gutierrez, Yihe Yang, Sujal I. Shah, Geroid M. McMahon. *Brigham and Women's Hospital Department of Medicine, Boston, MA.*

**Introduction:** Medication-induced thrombotic microangiopathy (TMA) is a diagnostic challenge because specific testing is lacking. In addition, renal-limited TMA may lack classic hematological manifestations. We report a case of possible eltrombopag-associated TMA.

**Case Description:** A 46-year-old woman, with history of lupus and antiphospholipid syndrome (APLS) on anticoagulation, was admitted with acute kidney injury (AKI). She had recently been hospitalized with a subdural hematoma and thrombocytopenia that was attributed to immune thrombocytopenic purpura (ITP). This had been managed with cessation of anticoagulation, rituximab, IVIG and eltrombopag (a thrombopoietin receptor agonist). Her dose of eltrombopag had been increased just prior to discharge. Her labs were notable for: creatinine 2.91 mg/dl (baseline 0.6), thrombocytopenia, anemia. Markers of hemolysis including schistocytes were negative. A kidney biopsy revealed extensive microvascular thrombosis consistent with a TMA and widespread cortical necrosis. She was treated with corticosteroids and eculizumab and was initiated on hemodialysis.

**Discussion:** Eltrombopag has been associated with complications including venous thrombosis, stroke, and, rarely, TMA. The mechanism for this risk is unclear and appears to be independent of platelet levels in some cases. In this case, the patient had multiple risk factors for thrombosis including her underlying APLS and the cessation of anticoagulation. However, the AKI developed shortly after the dose of eltrombopag was increased suggesting a temporal relationship. Awareness to the possibility of eltrombopag-associated TMA is important for patient safety in patients with worsening kidney function, especially in the setting of recent dose adjustments. Patients with APLS and ITP may be at higher risk.

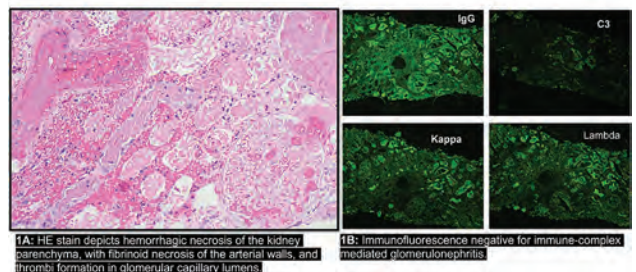

#### SA-PO040

##### Hiding in Plain Sight: Normotensive Scleroderma Renal Crisis

Eric J. Chacko, Anushree C. Shirali. *Yale School of Medicine, New Haven, CT.*

**Introduction:** Scleroderma renal crisis is a rare but recognized complication of systemic sclerosis most notably characterized by the presence of abrupt hypertension and progressive renal failure. Here we present a rare case of normotensive scleroderma renal crisis.

**Case Description:** A 51 year old female with history of systemic sclerosis, pulmonary hypertension, systemic lupus erythematosus presented with worsening lower extremity edema and shortness of breath. She was treated initially with diuretics and antibiotics for volume overload and pneumonia. 13 days later, respiratory status declined and patient became anuric with subsequent rapid creatinine rise from baseline of 1.5mg/dL to 4.98 mg/dL. Urinalysis was significant for 3+ protein and 3+ blood with urine protein-creatinine ratio of 3.2. Serologic workup was negative for the following: ANCA, MPO, PR3, dsDNA, SSA, SSB, C3, C4, and Anti GBM. There was noted positivity for Scl-70 antibody and ANA at 1:1280 in a homogenous pattern. Renal sonogram revealed normal kidney size, patent bilateral renal arteries, normal cortical thickness, and no hydronephrosis. Echocardiogram was obtained which revealed new reduction in ejection fraction to 30%. Blood pressure from admission and until this point remained within systolic range of 120-150mmHg. The patient was transferred to ICU and renal biopsy was obtained which revealed diffuse acute tubular injury and arteriolar vessels with onion skinning and severe luminal narrowing. She was initiated on continuous renal replacement therapy and captopril. Her course was complicated by worsening

respiratory failure and septic/cardiogenic shock requiring vasopressors and inotropes. She was unable to consistently tolerate captopril dosing due to subsequent hypotension and eventually passed.

**Discussion:** This case illustrates the diagnostic dilemma seen in patients with normotensive scleroderma renal crisis. Although only a small minority of patients with scleroderma renal crisis present without associated hypertension, these patients are at greater risk for delayed diagnosis and exposure to therapies that may worsen underlying disease process (i.e. steroids). Clinicians should retain high clinical suspicion for scleroderma renal crises with normotension and be aware of comorbidities that may be masking underlying hypertension. Furthermore, kidney biopsy should be considered in these patients for definitive diagnosis and management.

#### SA-PO041

### AKI in Patients With Lymphoma Submitted to Autologous Hematopoietic Stem Cell Transplant: Incidence, Risk Factors, and Prognostic Impact, A Cohort Analysis

Carolina Branco, Natacha Rodrigues, Claudia Costa, Filipe Marques, Pedro D. Vasconcelos, Carlos M. Martins, Jose A. Lopes. *Centro Hospitalar Universitario Lisboa Norte EPE, Lisboa, Portugal.*

**Background:** Studies on AKI in Hematopoietic Stem Cell Transplant (HSCT) consider heterogeneous definitions for AKI include a miscellaneous of hematologic diagnoses in their cohorts. We aimed to evaluate incidence, risk factors and prognostic impact on relapse and mortality of AKI occurring in the first 100 days post-HSCT in patients with lymphomas submitted to autologous HSCT considering KDIGO classification.

**Methods:** Single-center retrospective cohort study including patients with lymphomas admitted for autologous HSCT between 2005 and 2015. AKI classified by KDIGO classification with daily values of creatinine and 6-hour urinary output (UO) until hospital discharge, and weekly evaluations until 100 days post-HSCT. Survival analysis methods considering death as competing risk were used to evaluate AKI cumulative incidence, risk factors and impact on relapse. Cox regression was used for AKI impact on 3-year mortality.

**Results:** 115 patients were included, 51.3% male, 91.3% Caucasian, age 50.2(33.9-59.5), BMI 25.3(21.8-35.9), HCT-Cl<2 in 84.4% of patients and mean eGFR 107.5ml/min(94.3-124.6). Hematologic diagnosis: 63.5% B-cell lymphomas, 32.2% Hodgkin lymphomas, 4.4% T-cell lymphomas. 19.3% submitted to radiotherapy in the past, number of chemotherapy cycles 9(7-10). Conditioning regimen: 94.8% BEAM and 5.2% TEAM. Cumulative incidence of AKI: 62.8% 30 days post-HSCT and 63.7% 100 days post-HSCT. First diagnosis criteria: creatinine in 54.8%, UO in 41.1% and both in 4.1%. AKI highest stage: 1 in 57.5%, 2 in 17.8% and 3 in 24.7%. In multivariable model for AKI, variables independently associated with higher incidence were: nephrotoxic drugs (HR:2.87,95%CI:1.07-7.65;p=0.035), mucositis (HR:1.95,95%CI:1.16-3.29;p=0.012) and shock (HR:2.63,95%CI:1.19-5.85;p=0.017). In survival analysis, moderate to severe AKI (stage≥2) was independently associated with mortality (HR:2.04,95%CI:1.06-3.94;p=0.033). No independent association was found between AKI and relapse.

**Conclusions:** AKI affects almost 2/3 of patients with lymphomas submitted to autologous HSCT. Nephrotoxic drugs, mucositis and shock are important independent AKI risk factors. More than 1/3 of AKI episodes are moderate to severe and these are associated to higher 3-year mortality.

#### SA-PO042

### Multisystem Inflammatory Syndrome in Adults: A Consequence of COVID-19

Amara Sarwar, Ritika Ohri, Josephine Abraham, Monique E. Cho. *University of Utah Health, Salt Lake City, UT.*

**Introduction:** An association between COVID-19 and a novel pediatric inflammatory condition, coined as multisystem inflammatory syndrome (MIS), has recently prompted an international alert. While multi-organ involvement of COVID-19 is common in all ages, reports of MIS have predominantly involved children. Herein, we present a case of an adult who presented with MIS.

**Case Description:** A 38 year-old Caucasian male, who had contracted COVID-19 two months prior to presentation, was admitted with 1-week history of abdominal pain, frontal headache, fever of 104° F and dark urine. His exam was notable for erythematous, blanching macular rash on his trunk and arms. He quickly progressed to shock, requiring vasopressor and ventilator support. He developed acute kidney injury, with serum creatinine (SCr) increasing to 7.09 mg/dL from 1.9 mg/dL at presentation and required continuous renal replacement therapy (CRRT). Urinalysis revealed > 182 mostly non-dysmorphic RBCs and random urine protein-to-creatinine ratio of 1,273 mg/g. The previous urological evaluation was negative, prompting suspicion for IgA nephropathy. Serum IgG and IgE were elevated, with normal levels of IgA and IgM. Due to development of pulmonary infiltrate with hypoxia, there was concern for pulmonary-renal syndrome. The serologies were negative, including ANCA, anti-GBM, ANA, hepatitis B and C, HIV and complements. Blood cultures were also negative. Elevations were noted in interleukin (IL) 6 at 114.3 pg/mL, soluble IL-2 receptor at 42364.7 pg/mL, and IL-1β at 10.2 pg/mL. The patient had antibodies against COVID-19 IgG spike protein at 1.91 IV. Skin biopsy revealed vacuolar interface dermatitis with eosinophils, consistent with MIS in adults (MIS-A) in the setting of recent COVID infection. The decision was made to treat with solumedrol and IVIG. Within 2 days of IVIG therapy, his renal function improved significantly. CRRT was discontinued and he was transferred out of ICU. Three months following the hospitalization, his SCr improved to 0.9 mg/dL without hematuria.

**Discussion:** Acute renal injury is common in pediatric cases of MIS, with an excellent rate of renal recovery. The course and prognosis of renal injury in adults with MIS (MIS-A), however, have not been well described. Our case provides an important insight that even severe renal injury in MIS-A may carry a favorable prognosis with prompt immunomodulatory therapy.

#### SA-PO043

### Diarrheal Dilemma: A Unique Cause of Atypical Hemolytic Uremic Syndrome

Arsh Bajaj, Jin Huang, Hilmer O. Negrete. *Mercy Health St Elizabeth Youngstown Hospital, Youngstown, OH.*

**Introduction:** Thrombotic microangiopathies (TMA) comprise a variety of diseases ranging from ADAMTS13 deficiency, complement-mediated TMA, shiga-toxin mediated hemolytic uremic syndrome (STEC-HUS) and drug mediated TMA. Atypical HUS (aHUS) accounts for approximately 10% of HUS cases. Organisms implicated in aHUS include *Streptococcus pneumoniae*. Literature review demonstrates only ten adults with C. difficile associated aHUS (CD-aHUS). The case presented below would be the 11<sup>th</sup> known case.

**Case Description:** A 56-year-old female presented with abdominal pain, diarrhea and bright red blood per rectum. She recently had taken antibiotics for a dental procedure. Initial labs revealed a creatinine 0.9 mg/dL, WBC 30k, hemoglobin 15.9 g/dL, platelets 200k. Imaging showed proctocolitis. Further testing revealed negative stool cultures but positive EIA assay for CD. Her creatinine rapidly increased to 3.1. She also had new thrombocytopenia (18k), anemia (62g/dL) and urine sediment showed granular casts. Peripheral smear showed schistocytes. Lactate dehydrogenase (LDH) was 2131 U/L, haptoglobin was <10 mg/dL. Complement and ADAMTS13 levels were normal, anti-factor H antibodies were negative. Methylprednisolone 125mg daily for six days was started with daily PLEX (one volume exchange with fresh frozen plasma). Kidney biopsy showed diffuse global mesangiolytic, RBC fragmentation with scattered presence of luminal fibrin thrombi, all consistent with TMA and acute tubular injury. Her hospital course was complicated by right subcapsular kidney hematoma and COVID19 infection. She underwent eight PLEX sessions during her hospital stay. At the time of discharge, diarrhea had resolved, LDH and creatinine had reduced to 731 U/L and 1.7 mg/dL respectively. One month after discharge, the patient had completed 17 PLEX sessions and her serum creatinine had improved to 1.1 mg/dL. LDH was 297 U/L while haptoglobin continued to be <10 mg/dL, at that point was PLEX was discontinued.

**Discussion:** Atypical HUS is rare but has a high mortality rate, risk of progressing to end stage renal disease and relapse. About 40-60% of aHUS cases occur in individuals >18 years of age and has many triggers including CD. Literature review of CD-aHUS cases showed that out of ten patients, six underwent plasmapheresis with three patients using eculizumab. This case report highlights the efficacy of plasmapheresis as a treatment modality for CD-aHUS.

#### SA-PO044

### Combined Bivalirudin and Citrate Anticoagulation for Recurrent Continuous Kidney Replacement Therapy Clotting in COVID-19-Associated AKI

Chaitanya A. Pal, Victoria Milano, Michelle Shieh, Preeyaporn Sarangam, J. Pedro Teixeira. *University of New Mexico Health Sciences Center, Albuquerque, NM.*

**Introduction:** Extracorporeal circuit (EC) thrombosis commonly complicates continuous kidney replacement therapy (CKRT), especially in prothrombotic COVID-19 patients in which refractory EC clotting is well described. We present a case of recurrent EC clotting in acute kidney injury (AKI) requiring CKRT in COVID-19 managed with regional citrate anticoagulation (RCA) and bivalirudin.

**Case Description:** A 70-year-old man presents with weakness and is diagnosed with COVID-19, pulmonary tuberculosis, left internal jugular (IJ) deep vein thrombosis treated with IV unfractionated heparin (UFH), and cerebellar stroke. He develops respiratory failure requiring mechanical ventilation, septic shock, rectal bleeding causing interruptions in anticoagulation (AC), oliguric AKI, and hyperkalemia for which CKRT is initiated with a PrismaMax device and a 15-cm-long 13-French Power-Trialysis catheter placed in the right IJ. Despite good access function and a mean filtration fraction of 15.3%, recurrent EC thrombosis develops, for which various AC strategies are trialed [Table]. Only the combination of systemic bivalirudin and RCA proves effective. However, he ultimately dies after the family opts to transition to comfort measures.

**Discussion:** The use of direct thrombin inhibitors (DTIs) as AC for CKRT had only been reported pre-pandemic in small studies or case series, with only one case report describing argatroban combined with RCA. Though RCA has repeatedly been shown in non-COVID-19 patients to be superior to UFH as AC for CKRT, both therapies in COVID-19 often fail to prevent EC thrombosis, leading many to try other strategies such as DTIs or RCA combined with UFH. In our patient, UFH with RCA allowed one EC to last >24h, but multiple subsequent ECs clotted in <12h. However, by combining bivalirudin and RCA we prevented premature thrombosis of the subsequent two ECs. This is the first report of using bivalirudin with RCA for CKRT AC and suggests the combination may be useful in COVID-19 patients with recurrent CKRT circuit clotting.

	Hemofilter	Mode	Anticoagulation	Circuit life (h)	Reason for Stopping
1	M-100	CVVHDF	None	4	Filter Clotting
2	M-100	CVVHDF	None	4	Filter Clotting
3	M-100	CVVHDF	UFH* + RCA <sup>1</sup>	39	Filter Clotting
4	M-100	CVVHDF	UFH	10	Filter Clotting
5	HF-1000	CVVHDF	UFH + RCA	8	Filter Clotting
6	HF-1000	CVVHDF	UFH + RCA	3	Filter Clotting
7	HF-1000	CVVHDF	UFH + RCA	2.5	Filter Clotting
8	HF-1000	CVVHDF	Bivalirudin <sup>2</sup> + RCA	72 <sup>3</sup>	Filter Expired
9	HF-1000	CVVHDF	Bivalirudin + RCA	38	Comfort Measures

\*Systemic unfractionated heparin targeting anti-Xa level of 0.3-0.5 units/mL. <sup>1</sup>Regional citrate anticoagulation with Anticoagulant Citrate Dextrose Solution A targeting post-filter ionized calcium of 0.25-0.5 mmol/L. <sup>2</sup>Targeting partial thromboplastin time of 45-75 seconds. <sup>3</sup>Includes two 1.5-hour periods in recirculation mode. CVVHDF, continuous venovenous hemodiafiltration.

## SA-PO045

### AKI Caused by Devastating Hemophagocytic Lymphohistiocytosis Triggered by Multiple Factors

Felipe Pascoal, Jose M. Vieira Jr., Lucia Andrade. *Universidade de Sao Paulo Hospital das Clinicas, Sao Paulo, Brazil.*

**Introduction:** Hemophagocytic Lymphohistiocytosis (HLH) is an aggressive condition defined by cytokine storm and blood cell phagocytosis. Renal involvement is still poorly characterized, but includes hypoperfusion, tubular damage, nephrotic syndrome and thrombotic microangiopathy. We report a case in which a patient with HLH developed acute kidney injury requiring dialysis leading to death.

**Case Description:** A 63-year-old with stable HIV and Type 2 Diabetes was referred to the Emergency Department (ER) due to septic shock and an unsolved oral ulcer. For 3 months he had been seen at the Dermatology Clinic because of a slow-growing hard palate lesion, impairing food intake and leading to malnutrition and weight loss. After clinical stabilization at the ER, he was transferred to the ICU, developed significant pancytopenia (Hb 6.7 g/dL, 450 total leukocytes/ $\mu$ L, 41,000 platelets/ $\mu$ L), hyperferritinemia (41,377 mg/dL), hypertriglyceridemia (318 mg/dL) and was diagnosed with Hemophagocytic Lymphohistiocytosis according to HScore and bone marrow aspirate showing hemophagocytosis. Chest Computed Tomography revealed prominent mediastinal lymphadenomegaly, raising suspicion of lymphoma, and PCR for Epstein-Barr Virus was positive both on bone marrow (927,635 uL/mL) and blood (8,903 uL/mL) analyses. Days after guided antibiotic treatment for *Klebsiella pneumoniae* bloodstream infection, hemodynamic stability, absence of fever, nephrotoxic drug withdrawal and ongoing pancytopenia, serum creatinine levels rose from 1.74 mg/dL to 3.78 mg/dL, BUN levels rose from 67 mg/dL to 105 mg/dL and urinary output decreased from 800 mL/day to 200 mL/day. The patient was placed on Slow Low Efficiency Dialysis due to failure of conservative AKI management. Despite 15 days of treatment with Etoposide and Methylprednisolone, the patient developed painful abdominal distention and deceased from bowel perforation and fecal peritonitis secondary to angioinvasive aspergillosis and candidiasis.

**Discussion:** HIV patients are predisposed to HLH, which can be triggered by multiple factors, including infection (viral, bacterial and fungal) and malignancy, that likely occurred in this case. Although usually neglected in the pathophysiology of this syndrome, kidney involvement should be acknowledged, emphasized and tackled, as it worsens outcomes translating into high morbidity and mortality rates.

## SA-PO046

### Otological Manifestations in ANCA-Negative Pauci-Immune Vasculitis: A Compelling Clue When Serologies Are Negative

Megan L. Baker, Jeffrey M. Turner. *Yale School of Medicine, New Haven, CT.*

**Introduction:** Otological manifestations are often observed in ANCA-associated pauci-immune vasculitis (AAV), and include otalgia, hearing loss, vertigo, and tinnitus. The diagnosis of AAV in a patient presenting with otological manifestations can be challenging when otological symptoms are the predominant presenting feature or when ANCA testing results negative. A delayed diagnosis in these settings may result in more advanced hearing loss or recurrent AAV flares.

**Case Description:** A 66-year-old woman with CKDIIIa and hypertension presented with polyarthralgias, AKI, severe bilateral sensorineural hearing loss, vertigo, oral mucositis, scleritis, and hand joint pain with rash. Laboratory testing revealed leukocytosis, anemia, thrombocytopenia, negative anti-MPO and anti-PR3 titers, positive ANA(1:320), normal complement levels, and otherwise negative serologic workup. MRI brain showed left middle ear cavity scarring. She was given steroids for diagnosis of vestibular neuritis, labyrinthitis, and reactive arthritis with persistent hearing loss but recovery of AKI and other symptoms. Several months later she developed altered mental status, fevers, and AKI, and was found to have a UTI. After initial improvement with antibiotics, steroids, and IV fluids, she developed recurrent polyarthralgias and AKI. Kidney biopsy demonstrated pauci-immune necrotizing glomerulonephritis. Pulse dose steroids and rituximab for ANCA-negative pauci-immune glomerulonephritis resulted in improvement in Cr. With non-recovery of her hearing loss, she ultimately underwent cochlear implant surgery.

**Discussion:** Otological symptoms such as sensorineural hearing loss incurred in this case along with AKI should prompt an evaluation for AAV, as otitis media is a relatively common manifestation of disease. This case demonstrates the specific diagnostic challenge presented by an ANCA-negative pauci-immune vasculitis with otological involvement. In comparison to cases with positive ANCA serologies, cases of MPO- and PR3-negative pauci-immune vasculitis present a significant diagnostic challenge, being less common and less readily recognized. The co-occurrence of otological symptoms and AKI should prompt a higher clinical suspicion for AAV even in the absence of positive ANCA serologies, as these cases are estimated to represent a small fraction (~13%) of cases of otitis media associated with AAV.

## SA-PO047

### Native BK Polyomavirus Nephropathy in an Orthotopic Heart Transplant Recipient

Zachary M. Thompson,<sup>1</sup> George O. Ajene,<sup>1</sup> Mark Kandary,<sup>1</sup> Prathit A. Kulkarni,<sup>1,2</sup> Nidhi Aggarwal,<sup>1,2</sup> Savitri Fedson,<sup>1,2</sup> Maulin Shah,<sup>1,2</sup> <sup>1</sup>Baylor College of Medicine, Houston, TX; <sup>2</sup>Michael E DeBakey VA Medical Center, Houston, TX.

**Introduction:** BK polyomavirus nephropathy (BKVN) is a common cause of kidney allograft dysfunction. It typically occurs within the first year post-transplantation. BKVN in native kidneys after extra-renal solid-organ transplantation (SOT) is unusual. Here, we report a case of native BKVN occurring 13 years after orthotopic heart transplant (OHT).

**Case Description:** A 75-year-old man with Grade 3b chronic kidney disease presented with acute kidney injury. He had undergone OHT 13 years prior with stable allograft function and no recent episodes of rejection. His immunosuppressive regimen consisted of tacrolimus, sirolimus, and mycophenolate mofetil (MMF). Three months prior to presentation, he had developed obstructive ureterolithiasis requiring ureteral stenting. Imaging at the time of his current presentation showed resolution of prior ureteral obstruction. Serum levels of immunosuppressive agents were within therapeutic range. The serum BK viral load was 362,000 copies/mL. Kidney biopsy revealed acute tubular injury with focal viral cytopathic changes and SV40 staining within tubular epithelium, consistent with BKVN. Immunosuppression was reduced by stopping sirolimus and exchanging MMF for leflunomide with subsequent improvement in kidney function.

**Discussion:** While BK virus seropositivity is common worldwide, BKVN is almost exclusively seen in kidney transplant patients. Native-kidney BKVN after extra-renal SOT is uncommon. Intensity of immunosuppression is a well-known risk factor for viral replication; ureteral stenting has also been associated with BKVN. However, since clinical manifestations of BKV infection often include genitourinary (GU) tract pathology, ureteral strictures may be either a symptom or risk factor of infection. Although rare, it is important for clinicians consider BKVN even in patients with non-renal SOT, especially in the clinical context of known GU disease. Treatment of native BKVN is based on experience from treatment of BKVN in kidney transplant patients. While there are no randomized controlled trials, the current mainstay of treatment is reduction of immunosuppression, backed by meta-analyses and observational studies. Additional possible therapies without strong evidence include intravenous immunoglobulin, leflunomide, cidofovir, brincidofovir, and fluoroquinolones.

## SA-PO048

### Utilizing Gadolinium 67 Scintigraphy to Diagnose Acute Interstitial Nephritis

Hiral Patel, Foram Bhagat, Siddhartha Kattamanchi. *Marshfield Clinic Health System, Marshfield, WI.*

**Introduction:** We aim to present a case of acute interstitial nephritis (AIN) secondary to nafcillin, which was diagnosed using gallium scintigraphy, and discuss its role in diagnosing AIN where a biopsy cannot be done.

**Case Description:** An 88-year patient presented to our clinic with altered mental status. The patient was found to have bacteremia with methicillin-susceptible *Staphylococcus aureus* and for which she was treated with nafcillin. After 20 days of nafcillin treatment, the patient's creatinine started to worsen and reached 2.5 mg/dL from a baseline of 0.9-1.0 mg/dL. Urine analysis showed pyuria, and interstitial nephritis from nafcillin was suspected. Nafcillin was stopped, and the patient was started on steroids. The patient was not a candidate for kidney biopsy due to multiple comorbidities and shock; hence we chose to do Gadolinium scintigraphy to diagnose AIN. Gadolinium 67-citrate intravenous 6.75-mCi scan showed diffuse activity in the kidneys bilaterally with at least grade 3 uptake, which was suggestive of AIN. After five days course of IV methylprednisone, creatinine improved to baseline.

**Discussion:** Kidney biopsy is the gold standard for diagnosing acute interstitial nephritis. But in cases where kidney biopsy is not possible, we don't have other alternate tests to confirm interstitial nephritis. Gallium 67 scintigraphy has been shown to be a very useful noninvasive tool to diagnose AIN; an uptake cutoff of 3 had a 75 % specificity, while an uptake cutoff of 1 had a 100% negative predictive value (1). Hence, in cases where kidney biopsy if not possible, gallium 67 scintigraphy can become a good noninvasive modality to diagnose AIN, as shown in our case.



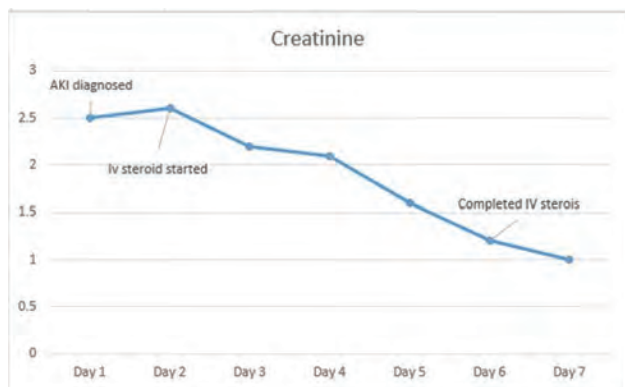

## SA-PO049

### AKI After Taking the Extract of *Cudrania tricuspidata* in a Patient Taking Nonsteroidal Anti-Inflammatory Drugs

Sua Lee, Jaehyun Jun, Jeongwoo Kim. *Eulji University College of Medicine, Daejeon, Republic of Korea.*

**Introduction:** Acute tubulo-interstitial nephritis (ATIN) is an acute kidney disease characterized by infiltration of inflammatory cells localized in the renal tubules and interstitium. ATIN is well known to be developed by hypersensitivity reaction to drugs or infections. We reported an unusual case of ATIN after taking the extract of *Cudrania tricuspidata* (*C. tricuspidata*) with taking long-term nonsteroidal anti-inflammatory drugs (NSAIDs).

**Case Description:** A 69-year-old male patient visited the emergency room with complaints of general edema that occurred 2 weeks ago and oliguria that occurred 2 days ago. He was diagnosed hypertension 3 years ago. He had been taking Naproxen 500 mg intermittently for knee pain for 6 months and *C. tricuspidata* leaf tea every day for 3 months. Initial laboratory findings were as follows: blood urea nitrogen, 53 mg/dL; creatinine (Cr), 9.9 mg/dL; estimated glomerular filtration rate (eGFR), 5.3 ml/1.73m<sup>2</sup>/min; albumin, 3.3g/dL; total immunoglobulin E > 5000 IU/ml; urine protein-creatinine, 14.3 g/mg. He underwent emergent hemodialysis and kidney biopsy to evaluate the cause of acute kidney injury. Light microscopy revealed that numerous lymphoplasmacytic with some eosinophils were infiltrated in the tubulointerstitium, consistent with ATIN. Electron microscopy revealed diffused effacement of foot process and interstitial edema, consistent with minimal change disease (MCD). Steroids were administered intravenously for ATIN and MCD. He was discharged after 4 weeks with Cr 1.5 mg/dL and eGFR 47.1 ml/1.73m<sup>2</sup>/min.

**Discussion:** Each case of acute liver failure and acute generalized exanthematous pustulosis after taking the extract of *C. tricuspidata* was previously reported. Physicians should be concerned that *C. tricuspidata* can cause ATIN as a hypersensitivity reaction.

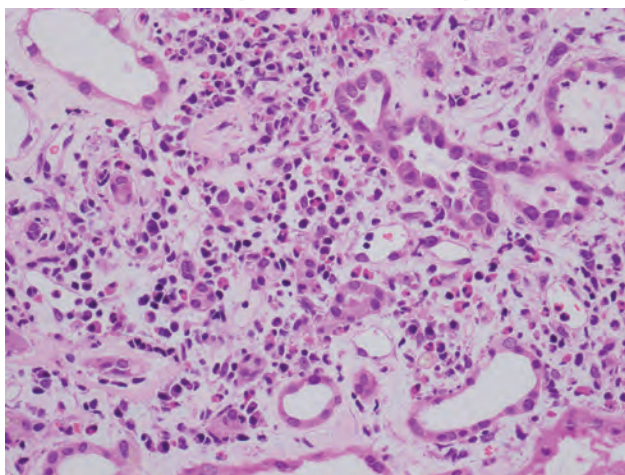

Numerous lymphoplasmacytic with some eosinophils were infiltrated in the tubulointerstitium, consistent with ATIN.

## SA-PO050

### A Rare Case of Light Chain Cast Nephropathy, Light Chain Proximal Tubulopathy, and Crystal-Storing Histiocytosis in a Patient With Multiple Myeloma

Albert Bui, Parikshit Duriseti, Mary E. Fidler, Sarwat Gilani, James R. Gregoire. *Mayo Clinic Minnesota, Rochester, MN.*

**Introduction:** We report a rare case of combined light chain (LC) cast nephropathy, LC proximal tubulopathy (LCPT) and crystal-storing histiocytosis (CSH) in a patient with multiple myeloma (MM).

**Case Description:** A 58-year-old female presented with several days of nausea, anorexia, weakness and on evaluation was found to have serum creatinine of 14.2 mg/dL, hemoglobin of 8.1 g/dL, and serum calcium of 13.2 mg/dL. She was diagnosed with MM/plasma cell leukemia in the context of IgA  $\lambda$ -monoclonal protein with circulating  $\lambda$ -restricted plasma cells, bone lytic lesions on skeletal survey, 80-90% marrow plasma cell infiltration, and  $\lambda$ -free light chain of 2850 mg/dL. A kidney biopsy revealed  $\lambda$ -LC cast nephropathy, crystalline LCPT and CSH. IF noted diffuse granular tubulointerstitial staining with  $\lambda$ -LC without distinct localization to the tubular or glomerular basement membranes. There was no accompanying staining with  $\kappa$ -LC. CD68 stain was positive in interstitial cells confirming large number of histiocytes/macrophages with crystals. EM confirmed numerous intratubular casts and intracytoplasmic needle-shaped and rhomboid crystals with similar crystals within interstitial histiocytes. For acute kidney injury, she required initiation of dialysis. She underwent plasmapheresis for 7 days for cast nephropathy and started chemotherapy with CyBorD. She remained dialysis-dependent at 3-month follow-up.

**Discussion:** Multiple myeloma (MM) is characterized by clonal plasma cell proliferation and is defined by 10% or more bone marrow plasma cells and one or more of myeloma-defining events (hypercalcemia, renal insufficiency, anemia, and bone lesions). About 15-20% of patients with newly diagnosed multiple myeloma present with severe renal insufficiency. The most common MM-related kidney disease is light chain cast nephropathy (LCCN) resulting from co-precipitation of immunoglobulin free light chains with Tamm-Horsfall glycoproteins. Rarely, paraproteins can crystallize within proximal tubular cells (crystalline LCPT) or interstitial histiocytes (CSH). LCCN, LCPT and CSH occurring together in MM as seen in our case is extremely rare. Other unique feature of our case was  $\lambda$ -restricted crystalline LCPT and CSH (majority of cases reported in the literature of crystalline LCPT and CSH are  $\kappa$ -restricted).

## SA-PO051

### Use of Medium Cut-Off Dialyzers in AKI Associated With Multiple Myeloma

Shahzad Zonoozi, Rasha Nakity, Ashte K. Collins, Renu Regunathan-Shenk, Janani Rangaswami. *The George Washington University Hospital, Washington, DC.*

**Introduction:** The pathogenesis of myeloma cast nephropathy (MCN) involves precipitation of serum free light chains (FLC) with uromodulin leading to acute kidney injury (AKI). The benefits of rapidly removing circulating FLC in MCN has not been established. Available literature suggests that along with chemotherapy, intensive hemodialysis using high and medium cut off (MCO) dialyzers is associated with a larger reduction in FLC and a higher rate of renal recovery compared to high flux dialyzers.

**Case Description:** We describe two patients with multiple myeloma (MM) and AKI requiring kidney replacement therapy (KRT) who along with chemotherapy were managed with MCO dialyzers (Theranova 400). Patient 1 is a 72 year old male with history of IgG lambda MM and CKD 4 with dialysis-dependent AKI and work up revealed elevated lambda FLC. Patient 2 is a 58 year old male with history of IgG kappa MM treated with stem cell transplantation and chemotherapy presenting for ongoing care for COVID-19 infection. Course was complicated by respiratory failure, infections and AKI. Rising kappa FLC led to patient receiving chemotherapy. Table 1 shows the trend of albumin, kappa and lambda FLC. MCO dialyzer was initiated on Day 0. After use of MCO dialyzer, Patient 1 had a reduction in lambda FLC of 377.5mg/L and albumin of 0.4g/dL while Patient 2 had an increase in kappa FLC of 3168mg/L and albumin of 0.8g/dL. During follow up neither patient had signs of recovery of kidney function.

**Discussion:** The utility of MCO dialyzers in the management of MCN remains unclear. In our patients, one had a reduction in FLC burden while the other had an increase. Further longitudinal research is required to elucidate the utility of MCO dialyzers in patients with MM.

Day	Albumin (g/dL)	β2M (mg/L)	FLC-k (mg/L)	FLC-λ (mg/L)	Treatments	Albumin (g/dL)	FLC-k (mg/L)	FLC-λ (mg/L)	Treatments
20						3.7			
17						3.5	8322.6	10.4	MCO x 4 VD
7	2.6					2.8			
6	2.7				MCO x3 D + VD	2.6			MCO
4	2.7	26.7	20.8	6189.5		2.7			MCO
3	2.5					2.5	6209.2	11.8	MCO
0	3		24.3	6547	MCO, VD, D	2.9			MCO
-1	2.7		23.8	5394.2	D	2.3			
-3	3.2	30.5	23	4958		2.9			
-4	3					2.6	5154.6	14.9	Dexa
-7	3.2		22.4	4644.6	PLEX x3 CyBorD	2.1			
-10	2.6					2.1	6270	11.6	
-12	2.6		34.9	6754.1		2.2			

Table 1. Trend of albumin, β2M and serum free light chains with use of medium cut off dialyzer and other treatments

FLC-k = kappa free light chain; FLC-λ = lambda free light chain; β2M = beta 2 microglobulin, PLEX = plasmapheresis; D = daratumumab; VD = bortezomib (velcade) and dexamethasone; CyBorD = cyclophosphamide, bortezomib, dexamethasone; dexa = dexamethasone; MCO = medium cut off dialyzer

SA-PO052

**Trabectedin-Associated AKI: A Case Report**

Sarah Hryzak, Abdallah Sassine Geara. University of Pennsylvania, Philadelphia, PA.

**Introduction:** Trabectedin is an alkylating chemotherapeutic agent approved for the treatment of advanced soft tissue sarcoma and ovarian cancer. Pancytopenia is a commonly reported adverse event. Abnormal liver function tests, mainly transaminitis, is reported in more than half of the patients. Rhabdomyolysis is a rarely reported side effect. Most of these events are reversible and rarely require hospitalization as it is generally considered a well-tolerated treatment. Acute kidney injury (AKI) is a not a known side effect. We report a case of fatal trabectedin toxicity with AKI as the predominant feature.

**Case Description:** A 72-year-old woman with stage IA clear cell carcinoma and stage IB leiomyosarcoma status post hysterectomy with lung metastasis had received a single round of trabectedin 1.5 mg/m2 and was admitted the following day with acute liver injury (AST 1595 U/L, ALT 977 U/L) and AKI (baseline serum Creatinine (sCr): 0.9 mg/dL; admission sCr: 1.2 mg/dL). The urine sediment was bland; the creatinine kinase (CK) was not elevated. Since the FeNa was less than 1% the AKI was felt to be prerenal. With crystalloid hydration, the patient progressively became anasarctic and the AKI continued to worsen making acute tubular injury the more likely diagnosis. Eventually, the sCr peaked at 5.39mg/dL and the patient had to be started on kidney replacement therapy (KRT) for progressive encephalopathy and worsening peripheral edema. She continued to decline clinically and became hypotensive requiring vasopressors and hypoxic requiring invasive ventilatory support. The patient eventually died three days after starting RRT. The patient developed rhabdomyolysis twelve days into her admission with the peak of CK of 14,000 and was not a felt to be a major contributor to the AKI that was well established by then.

**Discussion:** We present a case report of severe trabectedin-associated AKI ultimately resulting in patient death. A previous case report described treatment of trabectedin-induced rhabdomyolysis resulting in AKI that resolved with isotonic intravenous fluids. In this present case, the AKI had features compatible of prerenal etiology eventually leading to tubular injury with severe capillary leak physiology. Rhabdomyolysis was not a predominant feature. Although not known to have direct kidney toxicity, trabectedin treatment can lead to AKI through multiple mechanisms and should be further studied.

SA-PO053

**Biopsy Proven Bilateral Pyelonephritis Caused AKI Requiring Hemodialysis: Case Report and Review**

Najjar Yaseen, Laura Hernandez, Mauricio Monrroy. Albany Medical Center, Albany, NY.

**Introduction:** Severe acute kidney injury requiring dialysis caused by only acute pyelonephritis (APN) is rare. A study showed that APN caused AKI in 26.5% and kidney failure in 11.5%. Risk factors were chronic kidney disease, older age, bilateral renal involvement, and hemodynamic shock [1]. Here, we present a case of pyelonephritis leading to acute renal failure requiring hemodialysis with subsequent recovery of kidney function in a patient without prior kidney disease.

**Case Description:** 66-year-old woman presented with fever for 4 days and abdominal pain, no use of nephrotoxics. On exam, she was febrile (102.6F), tachycardic, normotensive, and fluid overload. Labs showed WBC 19.6x10<sup>3</sup>/uL, Na 126mEq/L, creatinine 3.69mg/L, (baseline 0.75 mg/l). CT showed normal kidneys. Blood and urine culture grew E. Coli. Dialysis was started for anuria and hypervolemia. To explain AKI, biopsy was done showing ATN and acute and chronic pyelonephritis with 80% parenchyma destruction with minimum scarring. Day 18, CT showed no renal abscess but new finding of multiple bilateral wedge-shaped hypodensities. Kidney function recovered completely. Dialysis was completely weaned off. Repeated CT showed resolution of kidney hypodense wedges. After 7 weeks of hospitalization, patient was discharge to physical rehabilitation with creatinine and urine output of 2.5mg/L and 1700ml/24hr.

**Discussion:** Only 16 cases were reported of biopsy proven renal failure secondary to APN with normal kidneys [2]. In absence of hemodynamic instability and nephrotoxicity, (APN) was sole cause for AKI-requiring dialysis. Rarity of pyelonephritis to cause AKI to this extent of severity along with complete recovery make this case novel to literature. 1. Jeon, D.H., et al., *Incidence, risk factors, and clinical outcomes of acute*

*kidney injury associated with acute pyelonephritis in patients attending a tertiary care referral center.* Ren Fail. 2019. 41(1): p. 204-210. 2. Jones, S.R., *Acute renal failure in adults with uncomplicated acute pyelonephritis: case reports and review.* Clin Infect Dis. 1992. 14(1): p. 243-6.

SA-PO054

**Baclofen Poisoning in a Patient With AKI**

Saad A. Alshihri, Angela H. Lam, Nicholas Husak, James B. Leonard, Joshua D. King. University of Maryland Medical Center, Baltimore, MD.

**Introduction:** A case of baclofen overdose is presented in a patient who was chronically taking the medication for muscle spasms and suffered acute kidney injury (AKI) while hospitalized, resulting in a prolonged and complicated hospital course. Restoration of the patient’s baseline mental status was achieved with hemodialysis (HD). Baclofen is commonly used in patients with muscle spasms and caution should be applied when using the medication in patients with AKI given extensive kidney clearance.

**Case Description:** A 57-year-old female with a past medical history of tetraplegia, neurogenic bladder with a suprapubic catheter, diverting ileostomy presented to the hospital with fever, nausea, vomiting, and abdominal discomfort. She was found to have cholecystitis and underwent percutaneous cholecystostomy. Following the procedure, her kidney function declined with serum creatinine reaching 3.6 from a baseline of 1.16 mg/dL. On the fifth day of admission, the patient was found to be unresponsive and was transferred to the intensive care unit (ICU). On transfer to the ICU, the patient developed anuria, shock requiring vasopressors, and worsening mental status with subsequent intubation. Baclofen was discontinued on transfer to the ICU, and HD was performed on hospital day #7. Following a single session of HD, mental status notably improved allowing extubation. The patient continued to have a complicated hospital course involving reintubation for respiratory failure, emergent tracheostomy, prolonged mechanical ventilation, and percutaneous gastrostomy tube placement. An attempt was made to reinstitute baclofen, which resulted in lethargy and possible seizures, prompting discontinuation. Her mental status slowly improved and the patient was discharged after a 21-day stay.

**Discussion:** Baclofen is a GABA-B receptor agonist used primarily for spasticity. While it has a half-life of 2-6 hours in normal kidney function, baclofen is 70-85% eliminated unchanged in the urine and may accumulate in patients with reduced kidney function. Baclofen poisoning can result in severe neurotoxicity including confusion, somnolence, coma, seizures, and autonomic dysfunction. Prompt recognition of baclofen toxicity is essential in the management of baclofen overdose, HD may be necessary for patients with impaired kidney function as the estimated half-life in overdose can exceed 30 hours.

SA-PO055

**Pancreatitis-Associated Atypical Hemolytic Uremic Syndrome**

Avilasha Sinha, Jingyin Yan. Baylor College of Medicine Margaret M and Albert B Alkek Department of Medicine, Houston, TX.

**Introduction:** Atypical hemolytic uremic syndrome (aHUS) is a rare form of TMA that can present as AKI and can progress to ESRD and even be fatal making prompt diagnosis and treatment very important.

**Case Description:** A 41-year-old male with a history of recurrent, non-alcoholic pancreatitis presented with epigastric pain. His lipase level was elevated and CT showed acute pancreatitis. Exam was notable only for epigastric tenderness. Labs (Table 1) included an elevated creatinine (Cr) of 14.7 (baseline was 1.0) and were suggestive of hemolysis although ADAMTS13 activity level and platelet count were normal. As the cause of his AKI could not be elucidated and his Cr remained elevated, renal biopsy was performed and showed fibrin thrombi and fragmented red blood cells consistent with TMA. A genetic panel found several polymorphisms strongly associated with aHUS. He was started on eculizumab and is continuing treatment with hopes of renal recovery although he is currently dialysis-dependent.

**Discussion:** The differential for this patient’s AKI included ATN, AIN, and IgG4-related membranous nephropathy. As there were many potential etiologies, biopsy was helpful to definitively determine the cause of his AKI especially because the lack of thrombocytopenia made TMA seem unlikely. The trigger for aHUS in this case was most likely pancreatitis as the inflammation activates complement which compounds the complement overactivation in patients genetically predisposed to produce factor H autoantibodies. Eculizumab, which prevents formation of the membrane attack complex, has shown great efficacy in aHUS and early initiation is associated with better outcomes underscoring the importance of early diagnosis. This case highlights the association of aHUS with pancreatitis and demonstrates how lack of thrombocytopenia does not rule out HUS.

	Measured Value	Normal Range
Lipase	304 U/L	8 – 78 U/L
Creatinine	14.7 mg/dL	0.57 – 1.25 mg/dL
Blood Urea Nitrogen	107 mg/dL	7 – 21 mg/dL
Hemoglobin	5.7 g/dL	13.7 – 17.5 g/dL
Haptoglobin	< 8 mg/dL	14 – 258 mg/dL
Lactate Dehydrogenase	1,008 U/L	125 – 220 U/L
IgG4	125.2 mg/dL	4 – 86 mg/dL
Reticulocyte Count	7.5%	0.5 – 1.8%
Total Bilirubin	0.6 mg/dL	0.2 – 1.2 mg/dL
Platelet Count	200,000/μL	150,000 – 400,000/μL

Table 1: Notable lab values on admission

## SA-PO056

**A Unique Case of Acute Renal Failure With Plasmodium Falciparum Requiring Renal Replacement Therapy**

Aisha Batool,<sup>1,4</sup> Shahzad Chaudhry,<sup>2</sup> Khadija Batool,<sup>5</sup> Muhammad A. Omar.<sup>3</sup>  
<sup>1</sup>Medical College of Wisconsin, Milwaukee, WI; <sup>2</sup>Aurora Health Care, Milwaukee, WI; <sup>3</sup>TidalHealth Nanticoke, Seaford, DE; <sup>4</sup>Ascension Columbia St Mary's Hospital Milwaukee, Milwaukee, WI; <sup>5</sup>Services Institute of Medical Sciences, Lahore, Pakistan.

**Introduction:** Malaria is a serious and endemic parasitic disease in the developing world, causing high morbidity and mortality. Plasmodium falciparum is one of the five protozoa responsible for serious disease manifesting as endorgan damage particularly Acute Renal Failure.

**Case Description:** Our patient is a 54-year-old male of East African origin. Five days after his return from Uganda, he presented to the Emergency room with high grade fever, rigors, black urination and lethargy. In Emergency Room he was found to have Acute Renal Failure with BUN 106 mg/dl, Serum Creatine 5.62 mg/dl and Total Bilirubin 9.5 mg/dl. Rapid Malaria antigen was positive for Plasmodium Falciparum with peripheral blood Parasitemia level of 9.5%. He was admitted to the Intensive Care Unit and started on Intravenous artesunate 2.4 mg/kg. Given the severity of his electrolyte abnormalities and Acute Renal Failure, he was started on intermittent Hemodialysis. Patient was given a total of two sessions of Hemodialysis with enough renal recovery to come off Hemodialysis.

**Discussion:** Plasmodium Falciparum is being accounted for more than 90% of the world's malaria mortality and remains an important threat to public health on a global scale. It causes the most serious illness called Black Water Fever and Cerebral malaria. All suspected cases of malaria should be confirmed using parasite-based diagnostic testing to swiftly distinguish between malarial and non-malarial fevers. Acute Renal Failure complicates up to 40% of Plasmodium Falciparum malaria. Most cases of malaria in the U.S. are imported and could therefore be avoided with appropriate personal protective measures and compliance with prescribed chemoprophylaxis. Healthcare providers must be educated not only on the diagnosis and treatment of malaria but especially on the importance of prevention.

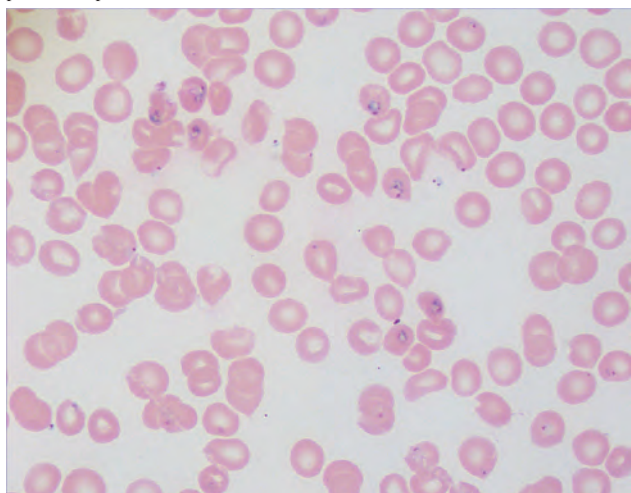

Peripheral Smear showing Intra-erythrocytic Ringlet Forms of Plasmodium Falciparum

## SA-PO057

**Calciphylaxis Associated With AKI**

Patrick J. Jenkinson, Dihan Thilakararatne, Katherine W. Kwon, Wajdi Al-Shweiat.  
 Spectrum Health Lakeland, Saint Joseph, MI.

**Introduction:** Calciphylaxis, also known as calcific uremic arteriopathy, is a disease that carries high mortality and morbidity. It is predominantly found in patients with end-stage kidney disease and is associated with a myriad of risk factors, including hyperphosphatemia, calcitriol therapy, warfarin therapy, diabetes, and female gender. We report a case of biopsy-proven calciphylaxis that developed in a patient with acute kidney injury.

**Case Description:** A 79-year-old woman with a past medical history significant for atrial fibrillation on apixaban, chronic kidney disease stage four with a recent *Clostridium difficile* infection not fully resolved, presented with chest pain, fatigue, shortness of breath, and vomiting. The patient was found to have acute kidney injury, anion gap metabolic acidosis, and hyperkalemia. A urinary catheter was placed with minimal return of urine. A fluid challenge of 500 mL crystalloid did not lead to increased urine output. Computed Tomography of the abdomen and pelvis was unremarkable for obstruction or any structural renal abnormality. Urinalysis revealed bacteria, proteinuria, pyuria and hyaline casts. Hemodialysis was initiated, but had to be terminated due to hypotension and pain in the lower extremities. Subsequent dialysis sessions also had to be cut short due to continued pain exacerbated by dialysis. Patient's renal function did not improve, with persistent hyperkalemia and anuria. During the hospitalization, the patient developed painful purpuric lesions on the legs bilaterally which converted to confluent hemorrhagic

bullae. The lesions were biopsied and revealed calciphylaxis with acute inflammation. Due to the significant ongoing pain, and complicated medical comorbidities, the patient ultimately elected comfort measures.

**Discussion:** This case demonstrates a rare presentation of calciphylaxis from acute kidney injury. It is known that calciphylaxis carries a high mortality and morbidity. Pain control and discontinuing possible exacerbating medications is essential in initial management. Treatment consists of a multidisciplinary approach to treat pain, prevent infection and prevent progression with medical therapies such as sodium thiosulfate. Despite these therapies, the mortality from calciphylaxis remains high and diagnosis portends a grim prognosis.

## SA-PO058

**A Case of Tubulointerstitial Nephritis and Uveitis With Fanconi Features**

Andrew C. Liu, Haiyan Zhang, Rakesh Malhotra. *University of California San Diego, La Jolla, CA.*

**Introduction:** Tubulointerstitial nephritis with uveitis (TINU) syndrome is an uncommon auto-immune disease with ocular-renal manifestations. Here we report a rare case of a patient with TINU and Fanconi features.

**Case Description:** A 20-year-old Chinese male presented with nasal congestion, myalgia and arthralgia for several months. He also complained of bilateral painful red eyes and photophobia. He had no significant medical history and was not taking any prior medications. Patient was seen by ophthalmology and was found to have bilateral posterior uveitis with no granuloma. His physical exam was otherwise normal. He was started on prednisone eye drops. Laboratory results showed increased inflammatory markers (ESR 42mm and CRP 0.57 mg/dL), renal dysfunction (serum creatinine 1.92 mg/dL) and anemia (Hgb 11.0 mg/dL). The chest radiography was normal. Serologies for syphilis, toxoplasmosis, hepatitis B and C, HIV, and tuberculin skin test were negative. No auto-immune marker (HLA-B27, complement C3 and C4, anti-nuclear antibody, and anti-neutrophil cytoplasmic antibody) was positive. Serum potassium, bicarbonate and glucose levels were normal. Whereas urine test showed glucosuria, proteinuria (0.5 g/g) and elevated beta-2 microglobulin (20649 ug/L). Fractional excretions for uric acid and phosphorous were elevated to 16% and 24% respectively. Renal biopsy showed severe diffuse interstitial inflammatory infiltrate with predominantly lymphocytes mixed with other inflammatory cells (Figure 1). No granuloma was identified. Severe tubulitis was present and immunofluorescence staining was negative for immunoglobulin, thus establishing the diagnosis of TINU with Fanconi like features. He was started on oral systemic steroids with improvement in kidney function.

**Discussion:** TINU is an immune-mediated process that involves autoantigens targeting renal interstitium and ocular cells. In cases of more severe tubulitis Fanconi syndrome may present. Future studies should report long-term renal outcomes, duration of steroid therapy and recurrence rates in patients with TINU and Fanconi syndrome.

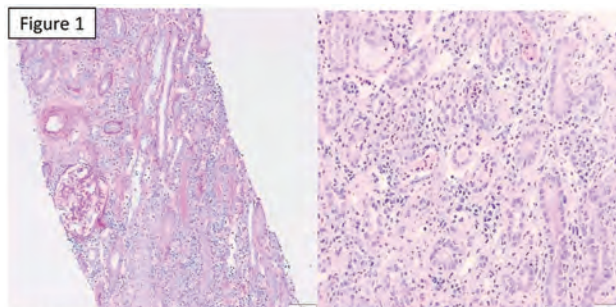

Light microscopy showing diffuse interstitial inflammation composed of mononuclear cells, polynuclear neutrophils and polynuclear eosinophils, with tubular injuries.

## SA-PO059

**NephrotoxicSTINGS: Envenomation Syndrome Caused by Bees**

Maria E. Rivera, Jesus D. Vega-Colon, Alexis Rivera Gonzalez, Ileana E. Ocasio Melendez, Krystahl Z. Andujar-Rivera, Carlos G. Rivera-Bermudez.  
 Universidad de Puerto Rico Escuela de Medicina, San Juan, Puerto Rico.

**Introduction:** Hymenoptera stings may result in a wide range of presentations varying from localized pain to systemic reaction, organ dysfunction and multiple organ failure. Rhabdomyolysis and Acute Kidney Injury are rare manifestations of envenoming syndrome following bee stings.

**Case Description:** An 80-year-old male presented with facial and neck swelling after having been stung by more than 200 bees while working in his backyard during the morning. On scene, patient was treated with epinephrine for suspected anaphylactic reaction. Medical history remarkable for hypothyroidism, ischemic cerebrovascular accident, major depression, and anxiety. Home medications included levothyroxine, lorazepam and paroxetine. No previous history of renal disease. Vital signs with blood pressure 158/92 mmHg, heart rate 104 beats per minute, respiratory rate 20 breaths per minute, oxygen saturation 98% at room air, temperature 36.5°C and weight 58 kg. Physical exam was remarkable for a frail male with multiples stingers present on his face, scalp, bilateral upper and lower extremities, and chest. He had marked periorbital, lips and neck swelling without airway obstruction. Foley catheter with 100 mL of cola colored

Key: TH - Thursday; FR - Friday; SA - Saturday; OR - Oral; PO - Poster; PUB - Publication Only

Underline represents presenting author.

urine. Laboratory results were significant for leukocytosis of 16.88 cells/ $\mu$ L, BUN 23.7 mg/dL, creatinine 1.31 mg/dL, bicarbonate 20.3 mmol/L, CPK 7,570 U/L, urinalysis with proteinuria of 500 mg/dL and blood 3+ but 0-3 RBC cells/hpf, bilirubin 4.12 mg/dL with elevated liver enzymes. Shortly after admission, despite medical management, renal parameters aggravated, concomitant with anuria, hyperkalemia and metabolic acidosis requiring kidney replacement therapy. After 3 weeks of intermittent hemodialysis, renal function recovered.

**Discussion:** Envenoming syndrome is a rare condition that carries significant morbidity and mortality when presents with multiple Hymenoptera stings. Due to small volume of distribution, elderly patients are at a major risk of severe complications as in our case that patient complicated with hepatic dysfunction, rhabdomyolysis, and acute kidney failure.

#### SA-PO060

##### A Rare Case of Severe Calciphylaxis in an Adolescent With AKI

Mingyue He, Sheetal Koul, Jean Lee, Suzanne Boyle. *Lewis Katz School of Medicine at Temple University, Philadelphia, PA.*

**Introduction:** Calciphylaxis is a rare, life-threatening condition characterized by vascular calcification and occlusion of microvessels in the subcutaneous adipose tissue and dermis, resulting in ischemia and painful skin necrosis, mainly diagnosed in end-stage kidney disease. We present a case of a woman without a history of reduced GFR who developed calciphylaxis in the setting of critical illness with acute kidney injury (AKI).

**Case Description:** An 18-year-old woman with morbid obesity (BMI 70) presented with acute hypoxic respiratory failure and shock. Her course was complicated by three weeks of dialysis-dependent AKI. On the first day of dialysis, multiple bullae and erosions overlying retiform violaceous patches were noticed on her bilateral thighs. These progressed to necrotic eschars in 2-3 weeks. Multiple skin biopsies had features of thrombotic vasculopathy without evidence of vasculitis or calciphylaxis. A bone marrow biopsy, viral and autoimmune serologies, hypercoagulability evaluation, and anti-phospholipid antibody syndrome panel were unrevealing. Although her AKI had clinically recovered, a kidney biopsy was performed to find a unifying diagnosis. It showed 10% interstitial fibrosis and tubular atrophy, IgA nephropathy (IgAN), and acute tubular injury without crescents or vasculitis. Her skin wounds continued to worsen despite debridement, empiric steroid therapy, and resolution of her AKI and critical illness. Another skin biopsy captured calcium deposition along deep vessels to finally make a diagnosis of calciphylaxis five months later.

**Discussion:** This case underscores the importance of a high index of suspicion for calciphylaxis with concerning skin findings even in the absence of classic risk factors. Also, a negative Van-Kossa stain for vascular calcium deposits is not necessary to make a diagnosis and initiate empiric treatment. Our patient's risk factors were gender, morbid obesity, transient AKI-related hyperphosphatemia and secondary hyperparathyroidism, ischemia from hypotension, and, potentially, an autoimmune disorder IgAN. However, many patients have these risk factors and never develop calciphylaxis. Therefore, more research is needed to elucidate the epidemiology and pathophysiology of this highly morbid condition.

#### SA-PO061

##### Study of Outcome of AKI in Scrub Typhus

Aswini P. Patnaik. *Kalinga Institute of Medical Sciences, Bhubaneswar, India.*

**Introduction:** Scrub typhus is one of the neglected tropical diseases in the world. Scrub typhus is a mite-borne infectious disease caused by the intracellular Gram-negative bacteria *Orientia tsutsugamushi*. The clinical prognosis of scrub typhus varies from mild-to-severe course. Renal involvement is not uncommon in scrub typhus<sup>1</sup>. Including acute renal failure, nephrotic syndrome and end-stage renal disease leading to long-term hemodialysis<sup>2</sup>. The risk factors and prognosis of AKI associated with scrub typhus have been poorly studied<sup>3</sup>.

**Case Description: Aim:** To study the incidence, outcome of AKI in scrub typhus. To study the requirement of renal replacement therapy. **Material and Methods:** The study was done in Kalinga Institute of Medical Sciences, Bhubaneswar over a period of 30 months (April 2019 to October 2021) after getting approval from the Institute's Research and Ethics committee. It is a Prospective Cohort Study, involving 210 scrub typhus RT PCR positive cases aged more than 18 years. 19 cases were excluded because of co infection with other tropical fevers. Cases with CKD, malignancy, tuberculosis and autoimmune diseases were excluded from our study.

**Discussion: Results:** 191 cases out of 210 cases of scrub typhus (PCR positive) were subjected for study after excluding the co infection. Out of which 95 (45.2%) cases were detected to have AKI. 61 (64.2%) patients were male and 34 (35.8%) were female. Mean duration of hospital stay was 13.6 days. 21 (22.1%) patients underwent hemodialysis. 16 (16.8%) patients had requirement of mechanical ventilation. Average number of sessions of hemodialysis done in patients without requirement of mechanical ventilation was 2.33 times compared to 4.1 times in those requiring mechanical ventilation. All the patients received doxycycline along with other supportive therapy. There was no mortality observed during the study period. 63 cases were followed up for a median of one year, out of which two (3.17%) patients have developed CKD. **Conclusion:** Incidence of AKI in scrub typhus is high and have good outcome if diagnosed and treated early.

#### SA-PO062

##### Granulomatous Tubulointerstitial Nephritis Preceding a Diagnosis of Polyarteritis Nodosa

Clarkson Crane, Bethany E. Karl. *University of California San Diego School of Medicine, La Jolla, CA.*

**Introduction:** The systemic vasculitides are classified based on the size of the vessels involved and ANCA vasculitis is the most common to involve the small vessels of the kidney. Granulomatous tubulointerstitial nephritis (TIN) without glomerular involvement has been described in ANCA vasculitis but is not commonly reported with medium vessel vasculitis. We present a case of necrotizing granulomatous TIN associated with systemic polyarteritis nodosa (PAN).

**Case Description:** A 71-year-old female was admitted with a two-day history of purpuric lower extremity rash, abdominal pain, and AKI (serum creatinine 1.8 mg/dL from baseline 0.6 mg/dL). There was initially concern for IgA vasculitis and prednisone was started. A skin biopsy revealed leukocytoclastic vasculitis but negative IF. A kidney biopsy was notable for necrotizing granulomatous TIN but otherwise unremarkable appearance of the glomeruli. As her AKI and overall clinical status worsened, she was started on HD. Due to worsening liver function, a liver biopsy was done showing neutrophilic inflammation but no granulomas. Rheumatologic workup notable only for ANA 1:360 (normal complements, negative ANCA, MPO, PR3, RF, cryoglobulins). Infectious workup (TB, fungal, and parasitic) was unremarkable. There was neither NSAID nor antibiotic exposure prior to the kidney biopsy. Only home medication was losartan. She received dose 2 of Moderna COVID-19 vaccination 4 weeks prior. Her kidney function improved and dialysis was stopped, however, she developed a new foot drop. A sural nerve biopsy showed necrotizing vasculitis of a medium sized vessel. The clinical picture was felt to be most consistent with PAN. Her steroid dose was increased and she started Cytoxan per CYCLOPS protocol with subsequent clinical improvement.

**Discussion:** There are few prior reports of isolated TIN associated with PAN and there are often confounding exposures that can potentially explain AIN. In the present case, the early histologic diagnosis of TIN in the absence of known exposures suggests the TIN is likely associated with, and potentially secondary to, the concurrent vasculitic process. Clinically, her presentation may represent a small and medium vessel vasculitis overlap syndrome as her pathology was not entirely consistent with an ANCA-negative pauci-immune vasculitis nor PAN. Alternatively, the TIN may simply be a response to the systemic inflammatory condition.

#### SA-PO063

##### Targeted Proteasomal Degradation of IRAK4 Ameliorates Kidney Fibrosis Caused by AKI

Dario R. Lemos,<sup>1,2</sup> Diana O. Lopez Cantu,<sup>1,2</sup> Miriam Segoviano.<sup>1,2</sup> Lemos Lab HMS <sup>1</sup>Brigham and Women's Hospital, Boston, MA; <sup>2</sup>Harvard Medical School, Boston, MA.

**Background:** Proteolysis targeting chimeras (PROTACs) are heterobifunctional molecules that can trigger the selective degradation of intracellular proteins through the ubiquitin-proteasome system (UPS). PROTACs are emerging as a promising therapeutic strategy for variety of diseases, including inflammatory disorders. Here we assessed the anti-fibrotic and anti-inflammatory efficacy of an IRAK4 degrader molecule in acute kidney injury.

**Methods:** We tested the IRAK4 degrader molecule KYM-001/IRW-1080 *in vitro*, on isolated kidney stroma PDGFRb<sup>+</sup> pericyte/fibroblasts cells and on hPSC-derived kidney organoids incubated with interleukin 1b, (IL1b) and *in vivo* in a mouse model of unilateral ischemia/reperfusion injury.

**Results:** Our data *in vitro* results indicate that KYM-001 effectively abrogates myddosome signaling in kidney stromal cells *in vitro*. The results also show inhibition of fibrogenic and pro-inflammatory gene expression. KYM-001 also effectively inhibited fibrosis in kidney organoids induced after incubation of the organoids with IL1b for 96h. In this system, KYM-001 significantly inhibited myofibroblast formation and fibrogenic gene expression, and expression of NF- $\kappa$ B target genes. *In vivo*, IRW-1080 delivered orally via gavage alone was well tolerated and did not cause animal death, nor did it affect normal behavior in healthy wild type C57BL/6 mice. After unilateral IRI, IRW-1080 delivered by gavage at a dose of 50mg/Kg, every 48h starting on the day of IRI surgery and over a period of 14 days, showed superior anti-inflammatory and anti-fibrotic activity compared to the IRAK4 kinase activity inhibitor small molecule CA-4948 delivered at a 75mg/Kg dose. In addition, animals that received IRW-1080 showed reduced levels of tubule injury and expression of the tubule injury marker KIM1.

**Conclusions:** Collectively, our findings validate the role myddosome signaling and particularly of IRAK4 in the process of kidney fibrosis, and indicated that targeted degradation of IRAK4 is an efficacious therapy for acute kidney injury.

**Funding:** NIDDK Support

## SA-PO064

## A Novel ATP Imaging System Using the Kidney Slice Culture Reveals ATP Dynamics in Whole Kidney Under Pathophysiological Conditions

Shigenori Yamamoto,<sup>1,2</sup> Shinya Yamamoto,<sup>1</sup> Masahiro Takahashi,<sup>1</sup> Akihiro Okubo,<sup>1</sup> Masamichi Yamamoto,<sup>1,3</sup> Motoko Yanagita.<sup>1,2</sup> <sup>1</sup>Department of Nephrology, Graduate School of Medicine, Kyoto University, Kyoto, Japan; <sup>2</sup>Institute for the Advanced Study of Human Biology (WPI-ASHBi), Kyoto University, Kyoto, Japan; <sup>3</sup>Department of Research Promotion and Management, National Cerebral and Cardiovascular Center, Suita, Japan.

**Background:** Mitochondrial disorders and ATP depletion play the central role in the pathogenesis of renal diseases. Recently, we generated a mouse line (GO-ATeam2 mouse), which expresses FRET-based ATP biosensor systemically, and reported spatiotemporal ATP dynamics during ischemia-reperfusion (IR) using two-photon microscopy. However, observation from kidney surface did not allow visualization of deeper nephrons or accurate evaluation of ATP production pathways in each segment.

**Methods:** We established the novel *ex vivo* ATP imaging system using slice culture of GO-ATeam2 mouse kidney. We evaluated ATP production pathways in each segment by the administration of oligomycin as an oxidative phosphorylation (OXPHOS) inhibitor and phloretin as a glycolysis inhibitor. We also analyzed ATP dynamics during *ex vivo* IR and cisplatin nephropathy models.

**Results:** We, for the first time, succeeded in visualizing ATP dynamics in whole kidney. After oligomycin administration, ATP in proximal tubules (PTs) decreased most rapidly and severely, followed by the decrease in podocytes. On the other hand, after phloretin administration, ATP decreased in podocytes most severely, but less apparently in other segments, indicating PTs are strongly dependent on OXPHOS for ATP production and podocytes rely on both OXPHOS and glycolysis. We further confirmed that *ex vivo* IR model could recapitulate ATP dynamics in vivo: ATP recovery after reperfusion in PTs varied depending on the length of ischemia, whereas ATP in distal tubules (DTs) recovered well even after long ischemia. After cisplatin administration, ATP in PTs decreased first, followed by the decrease in DTs. The administration of higher concentration of cisplatin resulted in more rapid and severer ATP depletion. Cisplatin accumulation in kidney slices was confirmed using mass spectrometry, which was attenuated by the administration of cimetidine, an OCT2 inhibitor. Cimetidine administration led to ATP recovery in PTs, but not in DTs, suggesting DT injury is not OCT2-mediated. Finally, we confirmed MA-5, a mitochondria protection reagent, delayed cisplatin-induced ATP decrease.

**Conclusions:** This novel system could provide valuable information of energy dynamics and pathogenesis of renal diseases, and might be useful for drug screening.

## SA-PO065

## Tubular Cells Distant From the Site of Injury Enter the Cell Cycle and Undergo Polypliodization After AKI

Elena Lazzeri,<sup>1</sup> Letizia De Chiara,<sup>1</sup> Paola Romagnani.<sup>1,2</sup> <sup>1</sup>Universita degli Studi di Firenze, Firenze, Italy; <sup>2</sup>Meyer Children's University Hospital, Florence, Italy.

**Background:** Acute Kidney Injury (AKI) is defined as a sudden decrease in kidney function affecting specifically the S3 segment of the proximal tubule in the outer medulla, despite a widespread cell cycle marker positivity observed all over the cortex. Importantly, we described the occurrence of polypliodization in tubular cells (TC) in response to AKI instead of proliferation. However, the spatial distribution of tubular cells undergoing polypliodity has never been investigated. Recently, an elegant genetic system has been established to unequivocally identify and trace polypliod cells in vivo, using the multicolored reporter Confetti. In this study, we aimed to 1. characterize the temporal distribution and 2. quantify and localize polypliod TC to different tubular segments after AKI.

**Methods:** To analyze the temporal distribution of polypliod TC, we employed Pax8/FUCCI2aR mice to combine cell cycle phases analysis with the DNA content by flow cytometry. To detect the spatial distribution of polypliod TC in all the tubular segments, we employed heterozygous-Pax8/Confetti mice in which one of the two sets of chromosomes harbors a Confetti allele.

**Results:** Ischemic AKI induced a strong entry into the cell cycle in TC. We found that in the early phase of AKI most cycling TC undergo polypliodization, while the others die during the S or G2/M phase of the cell cycle. To quantify as well as to localize polypliod TC to different tubular segments, we induced AKI in heterozygous-Pax8/Confetti mice. Polypliod TC carrying two or more sets of chromosomes can activate two or more fluorochromes, resulting in multi-colored TC. Multi-colored polypliod TC localized mostly in the cortex and especially in S1 and S2 segments of the proximal tubule, stained positive for cell cycle markers, sparing the injured outer medulla. This study demonstrated that in the early phase of AKI most cycling TC undergo polypliodization and this process occurred mostly distant from the site of injury.

**Conclusions:** We have characterized the temporal and spatial distribution of polypliod TC after AKI. Specifically: 1. most cycling TC undergo polypliodization, while most of the others die; 2. TC polypliodization occurs mostly in the cortex, distant from the injury site, explaining why AKI involves widespread cell cycle marker positivity all over the cortex.

## SA-PO066

## CD8+CD103+ iTregs Attenuate Ischemia-Reperfusion AKI by Suppressing Pyroptosis

Qiuju Chen, Zhenjian Xu, Xiao Zhang, Anping Xu. Sun Yat-Sen Memorial Hospital, Guangzhou, China.

**Background:** Acute kidney injury (AKI) is a disease related to high morbidity, mortality and healthcare costs. It has been reported that there is strong inflammation in AKI. However, specific or effective treatment for AKI hasn't been established at present. Previously, we have reported that CD8+CD103+ Treg induced *ex vivo* with TGF- $\beta$ 1 and IL-2 (CD8+CD103+ iTreg) inhibited response of immune cells to ameliorate excessive autoimmune inflammation. Here, we further explore whether CD8+CD103+ iTreg can ameliorate AKI and determine the potential molecular mechanism.

**Methods:** In vivo, we used mouse model of ischemia-reperfusion injury to investigate whether CD8+CD103+ iTreg can attenuate AKI by protecting tubular epithelial cells. In vitro, we co-cultured tubular cells with CD8+CD103+ iTreg to explore the mechanism of Treg for protecting against renal I/R injury.

**Results:** Adoptive transfer of CD8+CD103+ iTreg but not control cells to the mice of ischemia-reperfusion injury showed decreased levels of serum creatinine and blood urea nitrogen, reduced tissue injury, and lowered tubular apoptosis. Additionally, CD8+CD103+ iTreg treatment decreased infiltration of macrophages and T cells as well as renal levels of IL-6, IL-1 $\beta$ , TNF- $\alpha$ , and IFN- $\gamma$ , but it increased levels of IL-10, arginase-1. Moreover, administering CD8+CD103+ iTreg after ischemia-reperfusion injury limited the number of pyroptotic cells. In vitro, CD8+CD103+ iTreg reversed hypoxia/reoxygenation-induced cell injury partly by suppressing tubular cell pyroptosis via inhibiting the NLRP3/Caspase-1 axis.

**Conclusions:** CD8+CD103+ iTreg suppressed tubular epithelial cell pyroptosis to attenuate AKI after ischemia-reperfusion injury. Our data suggests therapeutic potential of CD8+CD103+ iTreg in renal ischemia-reperfusion injury.

**Funding:** Government Support - Non-U.S.

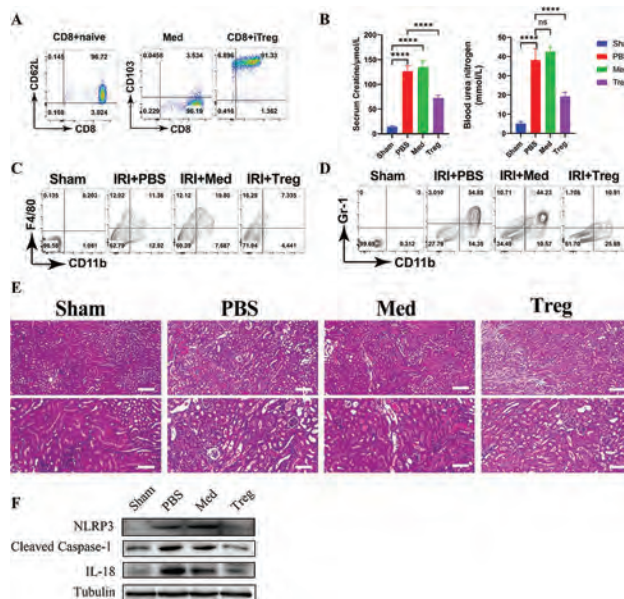

Fig 1. CD8+CD103+ iTregs protect against AKI in mice.

## SA-PO067

## KUS121, an ATP-Retaining VCP Modulator, Exerts Renoprotective Effects in Ischemia-Reperfusion Injury With Enhancing Endoplasmic Reticulum-Associated Degradation

Ryosuke Date, Takashige Kuwabara, Yusuke Hata, Daisuke Fujimoto, Teruhiko Mizumoto, Yuichiro Izumi, Masashi Mukoyama. Department of Nephrology, Kumamoto University Graduate School of Medical Sciences, Kumamoto, Japan.

**Background:** Acute kidney injury (AKI) is a life-threatening condition and often progresses to chronic kidney disease or may develop other organ dysfunction even after recovery, but there has been no established treatment for AKI so far. Valosin-containing protein (VCP) is a major ATPase in the cells and is expressed ubiquitously in various organs including the kidney. VCP is also involved in many cellular functions including endoplasmic reticulum (ER)-associated degradation (ERAD). The aim of this study was to investigate the renoprotective effect of Kyoto University substance 121 (KUS121), a novel VCP modulator, on AKI.

**Methods:** In *in vitro* experiments, we evaluated cell viability and ATP levels of cultured proximal tubular cells with or without KUS121 under ER stress conditions. In *in vivo* experiments, the effects of KUS121 were examined in mice with AKI caused by

ischemia-reperfusion injury. ERAD-processing capacity was evaluated by quantification of the ERAD substrate CD3delta-YFP.

**Results:** KUS121 protected proximal tubular cells from cell death under ER stress. The apoptotic response was mitigated as indicated by the suppression of C/EBP homologous protein expression and caspase-3 cleavage, with maintained intracellular ATP levels by KUS121 administration. KUS121 treatment suppressed the elevation of serum creatinine and neutrophil gelatinase-associated lipocalin levels and attenuated renal tubular damage after ischemia-reperfusion. The expression of inflammatory cytokines in the kidney was also suppressed in the KUS121-treated group. VCP expression levels were not altered by KUS121 both *in vitro* and *in vivo*. KUS121 treatment restored ERAD-processing capacity associated with potentiation of its upstream pathway, phosphorylated inositol-requiring enzyme-1 $\alpha$ , and spliced X box-binding protein-1. Furthermore, KUS121 recovered from stagnation of CD3delta caused by Eeyarestatin I known as an ERAD inhibitor.

**Conclusions:** These findings indicate that KUS121 may contribute to protect renal tubular cells from ER stress-induced injury, suggesting that KUS121 could be a novel and promising therapeutic compound against ischemia-associated AKI.

#### SA-PO068

##### The Oral Hypoxia-Inducible Factor Prolyl Hydroxylase Inhibitor Enarodustat Protects the Kidney From Contrast-Induced Nephropathy

Takashi Tani, Hitomi Tani, Akiko Mii. *Nihon Ika Daigaku, Bunkyo-ku, Japan.*

**Background:** Contrast-induced nephropathy (CIN) is an acute kidney injury (AKI) associated with the use of contrast medium. Vasoconstriction, oxidative stress, and hypoxic environment are considered the main causes of CIN. At under anaerobic conditions, hypoxia-inducible factors (HIFs) serve to restore tissue homeostasis by stimulating erythropoiesis, angiogenesis, and anaerobic glycolysis. HIF prolyl hydroxylase (HIF-PH) inhibitors stabilize HIFs, and then recent studies demonstrate that these drugs show protective effects on kidneys from renal ischemia/reperfusion injury, cisplatin-induced AKI, and diabetic kidney disease. In this study, we sought to show that the use of HIF-PH inhibitors plays a protective role in an animal model of CIN.

**Methods:** Sprague-Dawley rats were randomly allocated into sham-operated group (n=5), vehicle-treated CIN group (vehicle group; n=7), and drug-treated CIN group (enarodustat group; n=6). At 15-week-old, the right nephrectomy was performed. Enarodustat or vehicle was administered daily by oral gavage at a dose of 10 mg/kg from 3 days before the operation day to the induction of CIN. At 17-week-old, the rats were anesthetized and indomethacin (10 mg/kg) and L-NAME (10 mg/kg) were injected. After 30 min, rats were then injected intravenously with iopamidol (OYPALOMIN, 3.7 g iodine/kg). Rats were sacrificed 2 days after surgery.

**Results:** Hemoglobin and hematocrit levels were comparable in all groups. Significant elevation of blood urea nitrogen, serum creatinine, and decreases in 24hr creatinine clearance levels were observed in vehicle group, whereas those parameters were comparable in enarodustat group to sham-operated group. Kidney tissue mRNA expression of *Ngal*, *Kim-1*, and *TNF- $\alpha$*  were all markedly elevated in vehicle group, which were ameliorated by administration of enarodustat. Histopathological examination disclosed severe findings in the kidney of CIN rats, characterized by proteinaceous casts in tubuli, medullary congestion, and hemorrhage in the outer zone inner stripe of medulla, and tubular necrosis in the outer zone outer stripe of medulla. Administration of enarodustat attenuated these histopathological findings.

**Conclusions:** These results showed that HIF-PH inhibitor enarodustat protects the kidney from CIN in a rat model. HIF-PH inhibitors may be potential therapeutic agents for clinical CIN.

**Funding:** Government Support - Non-U.S.

#### SA-PO069

##### Urine-Derived Stem Cell Extracellular Vesicles Ameliorate Injury in a Human Kidney Organoid Model of Cisplatin-Induced Nephrotoxicity

Julie Bejoy,<sup>1</sup> Richard C. Welch,<sup>1</sup> Lauren E. Woodard.<sup>1,2</sup> Woodard Lab <sup>1</sup>Vanderbilt University Medical Center, Nashville, TN; <sup>2</sup>US Department of Veterans Affairs, Nashville, TN.

**Background:** Urine-derived stem cells (USCs) are adult stem cells that originate from the human kidney and can be expanded. Extracellular vesicles (EVs) are mainly comprised of exosomes secreted from the endosomal system and microvesicles formed by direct outward budding. All cells produce EVs which transfer cellular cargo to specific target cells. Stem cell-derived EVs have clinical applications in disease treatment and diagnostics. Therefore, we also investigated USC-secreted EVs (USC-EVs) as a potential therapy to treat nephrotoxic acute kidney injury (AKI).

**Methods:** We tested USCs and USC-EVs in a human kidney organoid model of nephrotoxic AKI. We cultured human kidney organoids from induced pluripotent stem cells. We created a nephrotoxic injury model by adding 5  $\mu$ m of the chemotherapeutic agent cisplatin to the kidney organoid culture for the first 24 h. For the next 48 h, we treated the injured organoids with either 5 x 10<sup>5</sup> USCs or 5  $\mu$ g USC-EVs.

**Results:** First, we performed immunofluorescence for NEPHRIN, LTL, ECAD, and GATA3 to confirm differentiation of the organoids. In injured organoids treated with USCs, viability increased by MTT and LDH assay (p<0.001) and the expression of Kidney Injury Molecule-1 (KIM-1) appeared reduced by immunostaining. Treatment of injured organoids with USC-EVs also increased cell viability by MTT assay (p <0.0001) and decreased KIM1 release into the media by ELISA. USC-EVs lowered oxidative stress as we found increased superoxide dismutase (SOD) activity (p<0.05) and reduced Malondialdehyde (MDA) concentration (p<0.001). USC-EVs altered the levels of EGF (p <0.0001), IL-8 (p=0.0002), and IGF-15 (p<0.01).

**Conclusions:** USC and USC-EVs treatments increased viability of the cisplatin AKI organoids. USC-EVs reduced oxidative stress, KIM-1 and inflammatory cytokines. These results highlight the therapeutic effects of USC through release of USC-EVs in a human organoid model of nephrotoxic AKI, demonstrating the promise of future applications of USCs or USC-EVs for AKI treatment.

**Funding:** Veterans Affairs Support

#### SA-PO070

##### Evaluation of BAM15 on Superoxide Generation in Sepsis AKI by In Vivo Imaging

Naoko Tsuji,<sup>1</sup> Takayuki Tsuji,<sup>1</sup> Yoshitaka Naito,<sup>1</sup> Naoki Hayase,<sup>1</sup> Carolyn C. Woodroffe,<sup>2</sup> Rolf E. Swenson,<sup>2</sup> Peter S. Yuen,<sup>1</sup> Robert A. Star.<sup>1</sup> Renal Diagnostics and Therapeutics Unit, Kidney Diseases Branch <sup>1</sup>National Institute of Diabetes and Digestive and Kidney Diseases, Bethesda, MD; <sup>2</sup>National Heart Lung and Blood Institute, Bethesda, MD.

**Background:** Non-invasive detection of kidney mitochondrial reactive oxygen species *in vivo* has been challenging. Recently, Huang et al (2019) developed a fluorescent superoxide molecular renal probe (MRP1) with high renal clearance and rapid detection. The probe enables real-time optical imaging of *in vivo* renal or *ex vivo* urinary superoxide by near-infrared fluorescence (NIRF). We previously showed that BAM15, a chemical mitochondrial uncoupler, decreased kidney superoxide generated by septic tubule cells exposed to serum of cecum ligation and puncture (CLP) mice *in vitro*, and improved survival and AKI in CLP mice (Tsuji et al., under review). Here, we tested if a MRP could detect sepsis induced superoxide generation in kidney or urine, and if BAM15 decreases it *in vivo*.

**Methods:** We synthesized a MRP that become fluorescent in the presence of superoxide (tested with KO<sub>2</sub> exposure *in vitro*), and then be rapidly cleared into urine. MRP was injected into mice at 1, 3, or 18 h after CLP or sham surgery, followed by NIRF *in vivo* imaging at several time points (0-120 min) after MRP probe injection. The fluorescent signal from urine collected 30 min after MRP injection was measured by NIRF imaging. BAM15 (5mg/kg) was administered immediately after CLP. GFR was measured by a transdermal fluorescent detector following IV injection of FITC-sinistrin.

**Results:** We detected a higher MRP signal *in vivo* kidney at 1, 3, and 18 h after CLP following MRP injection. MRP uptake was detected in tubular cells and glomeruli in kidney sections by confocal microscopy. MRP signal in urine of CLP treated with BAM15 was lower than that of CLP treated with vehicle at 1h after CLP, even though GFR had not changed at 2-3h after CLP. (Figure 1).

**Conclusions:** We detected increased kidney and urinary superoxide in a mouse model of sepsis AKI before GFR decreased. The superoxide was decreased in response to a drug (BAM15) that improves mouse and renal survival. BAM15 and MRP might be a drug-companion biomarker pair. More study is needed to determine if superoxide generation measured by MRP is a robust biomarker to ultimately develop it for clinical use.

**Funding:** Government Support - Non-U.S.

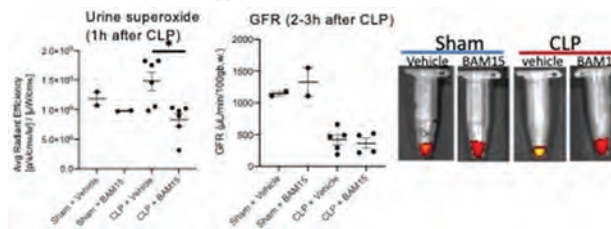

#### SA-PO071

##### Leveraging Metabolomics to Detect Global Alterations in the Renal Cortices of Formoterol Treated Mice

Austin D. Thompson,<sup>1,2</sup> Rick G. Schnellmann.<sup>1,2</sup> <sup>1</sup>The University of Arizona, Tucson, AZ; <sup>2</sup>Veterans Health Administration, Tucson, AZ.

**Background:** Acute kidney injury (AKI) is defined as a sudden and rapid decline in renal function and is often accompanied by a persistent reduction in mitochondrial function and vascular/tubular injury/necrosis. AKI is a public health concern with no FDA-approved treatments. Stimulation of mitochondrial biogenesis (MB) via the  $\beta_2$ -adrenergic receptor agonist formoterol (FORM) has been demonstrated in murine studies to accelerate renal recovery, promote MB, and restore mitochondrial homeostasis post-AKI. Albeit, the renal metabolic alterations induced by FORM, remain unknown. Thus, we used global metabolomics to assess metabolic changes in the mouse renal cortex treated with FORM.

**Methods:** Male 8-week-old C57B/6J mice were administered 0.3mg/kg of FORM or normal saline every 24h over a 60h period (n=6/group). Kidneys were harvested and snap frozen in liquid nitrogen. Renal cortex samples were analyzed by Metabolon via multi-mass spectrometry analysis. After mass normalization, log-transformation, and imputation, Welch's two-sample t-test was used to identify metabolites that differed significantly between treatment groups. A p-value of p<0.05 and a false discovery rate of q<0.10 were used to identify global metabolite changes and correct for multiple comparisons.

**Results:** Total, 914 biochemicals (BC) were detected in the global metabolomic dataset. Of these BCs, we identified 165 BCs statistically different in FORM-treated mice compared to saline controls, 89 BCs increased, and 76 BCs decreased. FORM-treated

mice had elevated 3-hydroxybutyrate and reduced free fatty acids, endocannabinoid, and lysoplasmalogen, which is indicative of increased mitochondrial  $\beta$ -oxidation and reduced inflammation. A decrease in glycolysis was identified by reduced lactate and elevated dihydroxyacetone phosphate (DHAP). This was accompanied by elevated amino acid metabolism, in accord with Mechanistic Target of Rapamycin Kinase Complex 1 (mTORC1) activation by DHAP. Lastly, we observed an increase in antioxidant pathways via elevated gamma-glutamyl amino acids and nicotinate/nicotinamide.

**Conclusions:** These data reveal that global metabolomics can identify 165 metabolic alterations in the renal cortices of FORM-treated mice. This approach will allow us to identify and monitor metabolic changes during AKI and other kidney diseases, and the effects of drugs stimulating repair/recovery.

**Funding:** Veterans Affairs Support

SA-PO072

**Obesity Aggravates Ischemia-Reperfusion Injury (IRI)-Induced AKI in Mice**

Igor O. Da Silva,<sup>1</sup> Nicole K. De Menezes,<sup>1</sup> Heloisa d. Jacobina,<sup>1</sup> Antonio C. Parra,<sup>1</sup> Felipe L. Souza,<sup>1</sup> Leticia U. De Castro,<sup>1</sup> Joris Roelofs,<sup>2</sup> Alessandra Tammara,<sup>2</sup> Talita R. Sanches,<sup>1</sup> Lucia Andrade.<sup>1</sup> <sup>1</sup>University of Sao Paulo School of Medicine, Sao Paulo, Brazil; <sup>2</sup>University of Amsterdam, Amsterdam, Netherlands.

**Background:** Obesity, which is becoming increasingly common worldwide, is known to be associated with cardiovascular disease and progression of chronic kidney disease, due to inappropriate activation of the renin-angiotensin system. Many angiotensin II effects are dependent on AT1 stimulation of reactive oxygen species (ROS). In COVID-19 patients, overweight and obesity are associated with acute respiratory distress syndrome and AKI. Although obesity increases oxidative stress, endothelial dysfunction and inflammation, its effect on IRI-induced AKI is unknown. We hypothesized that obesity would aggravate renal IRI in mice.

**Methods:** We fed mice a high-fat or standard diet (45 and 10 kcal% fat, respectively) for 8 weeks. Some then underwent bilateral 30-min clamping of the kidney hila and subsequent reperfusion (groups: obese, normal, obese+IRI and normal+IRI). All studies were performed 48 h after IRI. Data are mean $\pm$ SEM.

**Results:** Body weight (g) was 33 $\pm$ 1.7, 32 $\pm$ 0.7, 27 $\pm$ 1.4 and 26 $\pm$ 0.9 in the obese, obese+IRI, normal and normal+IRI groups, respectively (P<0.001). Mortality was 42% and 25% in the obese+IRI and normal+IRI groups, respectively (P<0.05); there were no deaths in the non-IRI groups. Serum glucose and cholesterol did not differ among the groups. Creatinine clearance (mL/min/100g BW) was 0.20 $\pm$ 0.05 and 0.20 $\pm$ 0.07 in the obese+IRI and normal+IRI groups, respectively, vs. 0.34 $\pm$ 0.06 and 0.40 $\pm$ 0.08 in the obese and normal groups, respectively. Renal p65 protein expression (%) was 127 $\pm$ 4.8 in the obese+IRI group, vs. 100 $\pm$ 4.1, 92.5 $\pm$ 4.8 and 107 $\pm$ 3.7, respectively, in the normal, obese and normal+IRI groups (P<0.05).

**Conclusions:** In obese individuals with AKI, ROS could be a therapeutic target (FAPESP, NWO).

**Funding:** Government Support - Non-U.S.

Biochemistry, Histology and Protein expression

	Normal	Obese	Normal+IRI	Obese+IRI
Urine osmolality (mOsm/kg)	1669 $\pm$ 625	2648 $\pm$ 173	1557 $\pm$ 144	1084 $\pm$ 156 <sup>α</sup>
Urinary TBARS (nmol/mL)	530 $\pm$ 113	995 $\pm$ 196	723 $\pm$ 92	1145 $\pm$ 158 <sup>β</sup>
Tubular injury score	0.00	0.00	0.35 $\pm$ 0.26	1.50 $\pm$ 0.62 <sup>γ</sup>
Caspase (% of normal)	90 $\pm$ 4.5	116 $\pm$ 5.6	144 $\pm$ 9.4 <sup>α</sup>	183 $\pm$ 14 <sup>αβγ</sup>
ATI (% of the Normal)	90 $\pm$ 5.6	116 $\pm$ 9.1	107 $\pm$ 14	163 $\pm$ 15 <sup>αβγ</sup>

TBARS: thiobarbituric acid reactive substances.

<sup>α</sup> P<0.05 vs. Normal and Obese; <sup>β</sup> P<0.05 vs. Normal; <sup>γ</sup> P<0.05 vs. Normal+IRI.

SA-PO073

**Calponin-2 Dictates Kidney Fate by Regulating Ketogenesis After AKI**

Yuan Gui, Dong Zhou. University of Connecticut School of Medicine, Farmington, CT.

**Background:** Energy generation is critical for tissue recovery from acute kidney injury (AKI). Amid the AKI repair process, the ketone body is a major energy source in the kidney. Our preliminary proteomic analysis indicates that the two topmost biological events after AKI are cell metabolism and actin filament binding. However, whether direct or indirect regulation exists between cell metabolism and mechanics after AKI remains unclear. To address this question, we systemically explored how Calponin 2 (CNN2), an actin filament-associated regulatory protein highlighted from our AKI proteome database, determines AKI prognosis by influencing energy consumption and generation.

**Methods:** AKI patients' kidney biopsy specimens were employed in this study. Two AKI animal models induced by ischemia-reperfusion injury (IRI) and cisplatin were constructed. Global-scale proteomics and *in vitro* / *in vivo* translational experiments were performed.

**Results:** CNN2 is induced in the diseased kidneys obtained from AKI patients and animals. It is predominantly localized in the kidney interstitial compartment. At 1 day after IRI or 3 days after cisplatin injection, knockdown of CNN2 preserved kidney functions, mitigated tubular cell death and inflammation, and promoted tubular cell proliferation. Global proteomic analysis identified that hydroxymethylglutaryl-CoA synthase 2 (HMGCS2), a key rate-limiting enzyme of endogenous ketogenesis that promotes cell self-renewal, was significantly increased in CNN2 knockdown mice kidneys compared with controls. Accordingly, knocking down CNN2 concentrated the levels of  $\beta$ -

hydroxybutyrate ( $\beta$ -OHB), the precursor of ketone bodies, and ATP production by which to release energy for AKI repair. To mimic *in vivo*, we silent CNN2 in cultured fibroblast and collected the conditioned medium. The conditioned medium increased the HMGCS2 level and reduced cell death in cultured tubular cells. However, these protective effects were largely abolished once knocking down HMGCS2 in tubular cells. Conversely, *in vitro*, exogenous CNN2 inhibited HMGCS2 expression and aggravated tubular cell death under hypoxia stress. In addition,  $\beta$ -OHB also exhibited a protective role in CNN2-induced tubular cell death.

**Conclusions:** Our results indicated that in addition to its capacity to regulate cell proliferation and motility, cell mechanics play a direct role in mediating cell metabolism to determine AKI prognosis.

**Funding:** NIDDK Support

SA-PO074

**Lung-Kidney Injury Caused by Innate Derived Mediator suPAR**

Varsha Suresh Kumar, Mehmet M. Altintas, David C. Wei, Babak Mokhlesi, Michael J. Liptay, Jochen Reiser. Division of Nephrology and Rush Lung Center, Rush University Medical Center Rush University Medical Center, Chicago, IL.

**Background:** Soluble urokinase plasminogen activator receptor suPAR is an innate-immune system derived circulating kidney disease risk factor that has its highest physiological expression at baseline in the upper airway. Critical illnesses with high mortality rates often exhibit both acute lung and kidney injury as complications. The objective of our study is to understand whether murine pulmonary airway injury can induce kidney injury, perhaps in a suPAR dependent manner. In the injured human lung, uPAR is documented in several pathological respiratory conditions including COPD, pneumonia and tuberculosis and recently also in COVID-19. Since suPAR levels increase prior to and during kidney injury, we aimed to explore a lung-kidney connection.

**Methods:** Injection of naphthalene, an aromatic hydrocarbon present in tobacco smoke constitutes a well-characterized model for acute airway injury in mice. suPAR over-expressing mice (suPARTg) and uPAR knockout mice (UPARKO) were injected intraperitoneally with naphthalene. To begin to explore mechanisms of lung-kidney axis, lung lavage and serum inflammation was assessed by multi-plex ELISA and flow cytometry.

**Results:** suPAR overexpression accelerated mortality in naphthalene injured mice by 40%. Furthermore, injecting an uPAR antibody in naphthalene injured suPARTg mice increased led to significant reduction in mortality. UPARKO mice exhibited a 100% survival rate post injury. Increased survival observed in UPARKO mice could be attributed to significantly increased IL6 levels in both lung lavage and serum, thereby altering the outcome of naphthalene mediated injury.

**Conclusions:** In conclusion, immune derived factors such as suPAR connect the lung with the kidney. Targeting suPAR may be beneficial in increasing survival in cases where mortality may be attributed to multi-organ failure induced by lung injury.

**Funding:** NIDDK Support

SA-PO075

**AKI due to Cocaine-Induced Thrombotic Microangiopathy**

Ingi A. Elsayed, UHNM, Stoke-on-Trent, United Kingdom.

**Introduction:** Thrombotic microangiopathy (TMA) is a rare potentially life-threatening condition caused by small-vessel platelet microthrombi. TMA Syndromes include thrombotic thrombocytopenia purpura (TTP), Shiga toxin mediated haemolytic uremic syndrome (STEC-HUS), drug induced TMA(DITMA) & complement mediated TMA. Clinical features include microangiopathic haemolytic anaemia & thrombocytopenia, & may have acute kidney injury, neurological abnormalities & cardiac ischemia. Drug induced TMA is either immune mediated or non-immune mediated. cocaine use is associated with non-immune DITMA.

**Case Description:** A case of 29-year-old male known HTN & T2DM, presented with abdominal pains, found to have microangiopathic haemolytic anaemia, thrombocytopenia & acute kidney injury (Table 1). Initially he denied the use of any recreational drugs. His presentation was suggestive of TTP; he was treated by plasma exchange & acute hemodialysis. Following day; he became comatose with a GCS of 7/15; He was transferred to ICU; where he was supported using, mechanical ventilation, inotropic support & he continued on plasma exchange. An emergency CT head showed multiple infarctions. National Complement Centre recommended starting IV Eculizumab; pending further results. Toxin mediated HUS (E.coli O157) was excluded. His ADAMTS13; was normal. Complement mediated TMA was investigated for (immunologic & genetic evaluation) & was also negative; by then he had received two doses of Eculizumab. The decision was to halt further Eculizumab & plasma exchange. Further corroboration from patient & his family; revealed he used cocaine recreationally prior to admission. Serum toxicology samples from admission, confirmed cocaine. We believe that this a case of non-immune DITMA. Performing a native renal biopsy, was deemed inappropriate due to high risk involved & minimal benefit. He remained dialysis-dependent throughout & was discharged after a period of neurorehabilitation, where he continues to dialyse three weekly.

**Discussion:** Cocaine use is associated with TMA although rarely reported & admitting physician need to be alert of this possibility.

Table 1

Serum Creatinine:	1224 micromol/L
Hb	80g/L
Blood film:	Moderate Schistocytes
LDH	2994 IU/L
DCT	Negative
Reticulocytes	170 (misod)

SA-PO076

**Renal Quinolate Accumulation May Reduce Cellular NAD+**  
 Amanda J. Clark,<sup>1,2</sup> Marie Christelle Saade,<sup>1</sup> Brenda Mendoza Flores,<sup>1</sup> Samir M. Parikh.<sup>1</sup> <sup>1</sup>The University of Texas Southwestern Medical Center, Dallas, TX; <sup>2</sup>Children's Health Children's Medical Center Dallas, Dallas, TX.

**Background:** Tubule energy metabolism is required for renal health, and its impairment is a feature of acute kidney injury (AKI). We previously reported that the biosynthesis of NAD+, an essential cofactor for oxidative energy metabolism, becomes suppressed during experimental and clinical AKI. A critical enzyme in this biosynthetic pathway is quinolate phosphoribosyltransferase (QPRT), whose suppression leads to an accumulation of quinolate (Quin) in kidneys during AKI along with a reduction in renal NAD+ despite the existence of non-QPRT dependent pathways to generate NAD+. Therefore, we hypothesized that accumulation of quin may also contribute to NAD+ reduction in AKI.

**Methods:** Intracellular NAD+ was assessed using a recently developed NAD+ biosensor. The effect of Quin on glycolytic flux was measured using a Seahorse XX96 flux analyzer. Intracellular lactate was measured using a commercial assay. Studies were conducted in HK2, human proximal tubule cells.

**Results:** Quin addition (1uM) for 12 hours reduced cytoplasmic NAD+ (Fig 1 B-C, p < 0.0001). Consistent with a reduced cellular NAD+, quin-exposed cells exhibited increased glycolysis (Fig 1 E-F p < 0.0001) and increased intracellular lactate.

**Conclusions:** These data suggest that QPRT suppression during AKI may have distinct contributions to NAD+ reduction, both via NAD+ biosynthesis attenuation and through quin accumulation. Cellular NAD+ reduction led to expected effects on fuel utilization with increased glycolytic acidification. There is no known mechanism where quin may exact these metabolic changes, though many studies have described quin as a non-inert metabolite capable of receptor activation and potential allosteric modulation of enzymes. Understanding NAD+ homeostasis, its role in quin accumulation, and the activity of quin in the kidney may be critical to understanding AKI physiology, and developing novel therapies.

**Funding:** NIDDK Support, Other NIH Support - K12-HD000850, R01 DK095072, R01 AG027002, Private Foundation Support

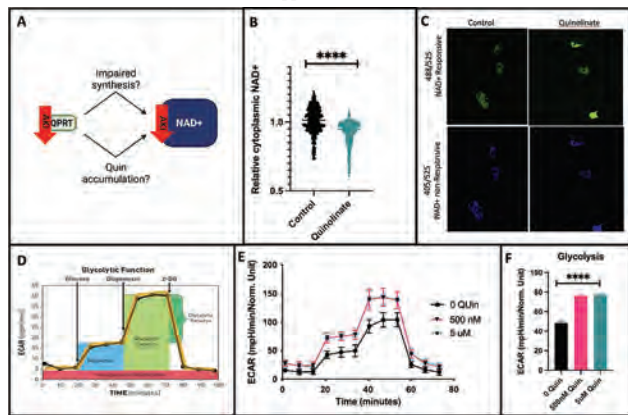

A) Hypothesis. B-C) Quinolinate reduces cytoplasmic NAD+. D) Seahorse illustration. E-F) Quinolinate increases glycolysis.

SA-PO077

**Identifying the Cellular and Molecular Mechanisms That Contribute to Gadolinium-Based Contrast Agent-Induced Nephrotoxicity**  
 Joshua Deaguero,<sup>1,2</sup> Karol Dokladny,<sup>1,2</sup> G. P. Escobar,<sup>1,2</sup> Brent Wagner.<sup>1,2</sup> Kidney Institute of New Mexico <sup>1</sup>University of New Mexico Health Sciences Center, Albuquerque, NM; <sup>2</sup>New Mexico VA Health Care System, Albuquerque, NM.

**Background:** Gadolinium (Gd<sup>3+</sup>) chelates are a dynamic tool used for enhancing magnetic resonance imaging (MRI) examinations. Owing to the vital clinical diagnostic capabilities of Gd<sup>3+</sup>, hundreds of millions gadolinium-based contrast agent doses have been administered worldwide. Long-term tissue retention of gadolinium and nephrogenic systemic fibrosis are well correlated with exposures to these contrast agents. The kidney is the major organ of excretion for most gadolinium-based contrast agents. This study aimed at identifying cellular and molecular perturbations as a result of gadolinium chelate exposure in an *in vitro* model of mouse renal tubular epithelial cells.

**Methods:** Mouse renal tubular epithelial cells (MRTEpiCs) were cultured at density of 25,000 cells/cm<sup>2</sup> and allowed to reach 70-80% confluence prior to exposure. For the

identification of perturbatory effects, cells were exposed to physiological concentrations (0.002 mM-2 mM) of Omniscan or Dotarem for 24h. Intracellular reactive oxygen species was measured using a fluorescent (DCFH-DA) assay. Mitochondrial and lysosomal activity was monitored using fluorescent probes and confocal microscopy.

**Results:** After 24h exposure both Omniscan and Dotarem induced a dose response effect on the increased generation of reactive oxygen species. Mitochondrial membrane potential decreased in response to agent exposure. Omniscan and Dotarem promoted the accumulation of lysosomes, as well as increased lysosomal-associated membrane protein 1 (LAMP1) protein expression.

**Conclusions:** In this study we identify potential cellular and molecular modulators involved in the observed nephrotoxicity of gadolinium-based contrast agents. We demonstrate that gadolinium chelates induces mitochondrial dysfunction and increased lysosomal activity indicating an impact on organelle dynamics. These data can be used to enhance preclinical safety studies by improving assay sensitivities.

**Funding:** NIDDK Support, Other NIH Support - UL1TR001449, Veterans Affairs Support, Other U.S. Government Support, Private Foundation Support

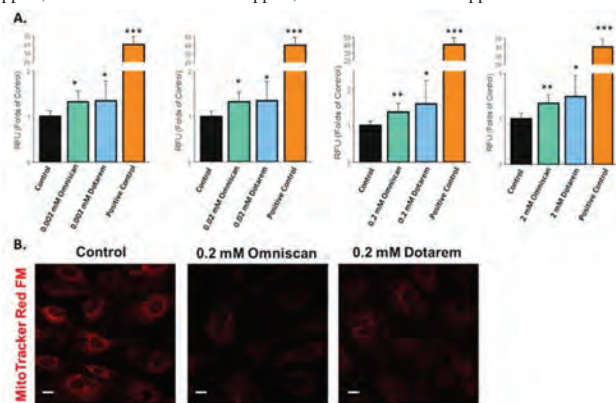

Cellular perturbations induced by GBCAs.

SA-PO078

**Efficacy of Mesenchymal Stromal Cells in Ameliorating Renal Ischemia/Reperfusion Injury In Vitro**  
 Joao Faria,<sup>1</sup> Sandra Calcat-i-Cervera,<sup>2</sup> Renata Skovronova,<sup>3</sup> Benedetta Bussolati,<sup>3</sup> Timothy O'Brien,<sup>2</sup> Silvia M. Mihaila,<sup>1</sup> Rosalinde Masereeuw,<sup>1</sup> <sup>1</sup>Universiteit Utrecht, Utrecht, Netherlands; <sup>2</sup>National University of Ireland Galway, Galway, Ireland; <sup>3</sup>Universita degli Studi di Torino, Torino, Italy.

**Background:** Renal ischaemia/reperfusion injury (IRI) is the leading cause of acute kidney injury. The current standard of care focuses on treatments to support kidney function, reinforcing the need for more efficient therapies. Mesenchymal stromal cell (MSC) therapy has shown promising results in several preclinical studies. However, their full potential is still unknown.

**Methods:** To mimic ischemia, human conditionally immortalized proximal tubule epithelial cells (ciPTECs) were exposed for 24 hours to a combination of antimycin A (AA) and 2-deoxy glucose (2DG) under hypoxia and normoxia conditions. Furthermore, ischemic ciPTECs were treated for 24 hours with either conditioned medium (CM) or extracellular vesicles (microvesicles, MV or exosomes, EX) isolated from various sources of MSCs.

**Results:** When ciPTECs were exposed to ischemic injury (AA and 2DG), actin filaments were lost and nuclei fragmented. In ischemic cells, there was a decrease in metabolic activity (22% in normoxia, 42% in hypoxia; p<0.0001) and ATP production (6% in normoxia, 35% in hypoxia; p<0.001) compared to control cells. In normoxia, the increase in ROS production was more exponential than in hypoxia (p<0.01), and injured cells cultured in hypoxia showed a 75% decrease in mitochondrial mass compared to 20% in normoxia (p<0.0001). The metabolic activity of the injured cells after MSC treatment was similar to that of the injured cells treated with serum (reperfusion group). All cells treated with CM or EVs showed an increase in ATP production of 40-45% (p<0.001) in both normoxia and hypoxia. The Seahorse extracellular flux assay was performed to both injured cells and post-treatment, which revealed a 50% decrease in oxygen consumption rate compared to control cells, that was restored after treatment with either CM from adipose tissue or bone marrow-derived EVs. The extracellular acidification rate, an indicator of a metabolic switch to glycolysis, was reduced by 40% in injured cells and returned to baseline after MSC treatment.

**Conclusions:** Our findings showed that our *in vitro* model was capable of replicating *in vivo*-like morphological and molecular changes observed during IRI. Following MSC treatment, the changes observed in our ischemic cells were moderately reversed, demonstrating MSC's therapeutic potential.

**Funding:** Government Support - Non-U.S.



SA-PO079

**Kidney Prostaglandin Synthesis Alterations in a Case of NSAID-Induced AKI: A Clinical Pathologic Molecular Correlation**

Steven Menez,<sup>1</sup> Richard A. Knight,<sup>3</sup> Avi Z. Rosenberg,<sup>1</sup> Chirag R. Parikh,<sup>1</sup> Brad H. Rovin,<sup>2</sup> Samir V. Parikh,<sup>2</sup> KPMP <sup>1</sup>Johns Hopkins University School of Medicine, Baltimore, MD; <sup>2</sup>The Ohio State University Wexner Medical Center, Columbus, OH; <sup>3</sup>American Association of Kidney Patients, Tampa, FL.

**Introduction:** The Kidney Precision Medicine Project (KPMP) seeks to establish a molecular atlas of the kidney in health and disease, to improve the understanding of molecular drivers of kidney disease. We describe the case of a woman who underwent a kidney biopsy in the setting of acute kidney injury (AKI) as part of the KPMP, with associated tissue proteomics.

**Case Description:** A 38-year-old woman with no significant medical history (baseline serum creatinine (sCr) 0.7-0.8 mg/dL), presented at 36 weeks gestation with premature rupture of membranes. She underwent successful cesarean section delivery. On post-operative day (POD) 0, she received 3 doses of the non-steroidal anti-inflammatory drug (NSAID) ketorolac (15 mg) intravenously, transitioned to oral ibuprofen 800 mg every 6 hours. She was discharged on POD 4, but presented to the emergency room the next day with new onset fatigue. Labs were notable for a sCr of 2.3 mg/dL, peaking at 3.7 on POD 7. Clinical adjudication determined the likely etiology of AKI to be associated with NSAID. She underwent percutaneous kidney biopsy on POD 11, with findings consistent with mild acute tubular injury and no significant interstitial fibrosis nor tubular atrophy. Tissue proteomic analysis demonstrated tissue inflammation and extracellular matrix changes in the glomeruli and tubule-interstitium (Table 1). These cellular changes were present without histologic correlates.

**Discussion:** As NSAIDs were considered to be the primary driver of the participant's AKI, at the molecular level we suspected that prostaglandin expression may have been altered. However, proteomic interrogation revealed a more dynamic molecular landscape, with changes noted in prostaglandin synthesis in response to NSAIDs as well as signs of intra-renal inflammation and fibrosis not evident by histopathology alone. These findings illustrate that routine histology techniques do not necessarily capture the full complexity of cellular injury.

Term	Adjusted P-value	Genes
Extracellular matrix organization Homo sapiens R-HSA-1474244	0.014	FBN2, COL15A1, LAMA2, FN1, TNC, PLOD3, FBLN1, PSEN1, FBLN2, THBS1, FBLN5, VCAN, CAPN5, COL5A1, PAHA2, COL7A1, ITGA1, SERPINH1, SPP1, ITGA8, COL4A3, ITGAV, ITGB6, COLGALT1, CUL7, UBE2H, ERAP2, FBXO2, TAP2, UBE2E2, CYBB, OBE3A, HLA-A, UBE2A, PSMC7, FBXL8, SEC61A1, RNFI14, RNFP213, PSMO5, SEC13G, CDC27, MRCL1, ITGAV, RBCK1, PSME1, SEC24D
Class II MHC mediated antigen processing & presentation Homo sapiens R-HSA-983169	0.038	RYT1, CHTP, TBP, RNMT, CSTF3, SUPT4H1, CDC40, ZC3H11A, ERCC2, POLR2E, POLR2H, TAF5, SNRPB
RNA Polymerase II Transcription Homo sapiens R-HSA-73857	0.038	RYT1, CHTP, TBP, RNMT, CSTF3, SUPT4H1, CDC40, ZC3H11A, ERCC2, POLR2E, POLR2H, TAF5, SNRPB
S Phase Homo sapiens R-HSA-69242	0.038	RBL1, FEN1, RFC3, MCM7, MCM7, RFC2, PSMA7, STAG1, PSMO5, RAD21, PSME1, MCM6, MCM2
Antigen processing-Cross presentation Homo sapiens R-HSA-1236975	0.038	SEC61A1, PSMO5, SEC61G, MRCL1, TAP2, CYBB, ITGAV, HLA-A, PSME1, PSMA7
Elastic fibre formation Homo sapiens R-HSA-1566048	0.038	FBN2, ITGA8, FBLN1, ITGAV, ITGB6, FBLN2, FBLN5
Interferon alpha/beta signaling Homo sapiens R-HSA-909733	0.038	IFITM3, OAS2, STAT1, MX1, PTFN6, HLA-A, SAMHD1, IRF9, IFIT2
Molecules associated with elastic fibres Homo sapiens R-HSA-2129379	0.038	ITGA8, FBLN1, ITGAV, ITGB6, FBLN2, FBLN5
DNA strand elongation Homo sapiens R-HSA-69190	0.049	FEN1, RFC3, MCM7, RFC2, MCM6, MCM2

SA-PO080

**MCM4 Protects Against Cisplatin-Induced AKI Through Regulating the 53BP1/USP28/p53/p21 Signaling Pathway**

Jing Huang, Hua Su, Chun Zhang. Department of Nephrology, Union Hospital, Tongji Medical College, Huazhong University of Science and Technology, Wuhan, China.

**Background:** The minichromosome maintenance (MCM) proteins family exert an essential role in DNA replication and DNA damage repair. Recently, it has reported that MCMs are implicated in various tumors and their expression correlates with the prognosis and recurrence of tumors. However, the role of MCMs in kidney diseases remains unknown. In this study, we aimed to explore the role of MCM4 in the pathogenesis of cisplatin-induced AKI.

**Methods:** Male C57 mice were intraperitoneally injected with cisplatin for 3 days. In vitro, NRK-52E cells were treated with cisplatin for 12h. Expressions of MCM4, NGAL, cleaved-caspase-3, Bax, p53, p21, 53BP1, USP28 and MAD2B were detected by Western blot and immunohistochemistry. MCM4, 53BP1 and USP28 knockdown were achieved by transfected with siRNA, respectively. Lentivirus transfection was utilized to knock down the expression of MAD2B. Flow cytometry was conducted for cell cycle. CCK-8 assay was conducted to evaluate the cell viability. TUNEL assay was used to detect the apoptotic cells and ROS detection kit was utilized for ROS detection.

**Results:** Here, we show that MCM4 is highly expressed in tubules while less in glomeruli, and the expression of MCM4 is upregulated in mice and NRK-52E cells under cisplatin treatment. Silencing of MCM4 inhibits cell proliferation and delays the entry of S phase, and then aggravates cell apoptosis in cisplatin-treated NRK-52E cells. Mechanistically, MCM4 deficiency results in augmented activity of the 53BP1/p53/p21 pathway, which is a key pathway for regulation of cell proliferation and apoptosis. Moreover, based on the previous studies of MAD2B in kidney diseases, we find that MAD2B deficiency inhibits the activity of CDK/Cyclin complex, the phosphorylation of Rb and the transcription level of E2F1, leading to the downregulation of MCM4.

**Conclusions:** Therefore, our data revealed the protective role of MCM4 in cisplatin-induced acute kidney injury. MCM4 was involved in cell proliferation and apoptosis by

53BP1/USP28/p53/p21 signaling pathway under the cisplatin stimulation. On the other hand, MAD2B could influence the phosphorylation of Rb and the transcription level of E2F1, resulting in the changes in MCM4 proteins levels. In conclusion, MCM4 maybe a potential therapeutic target for the treatment of AKI.

SA-PO081

**Gasdermin D Is Required for Control of Necroptotic Cell Death in AKI**

Wulf Tonnus, Francesca Maremonti, Anne M. Brucker, Andreas Linkermann, AG Linkermann Technische Universität Dresden, Dresden, Germany.

**Background:** Within the last decade, it has been established that necrotic rather than apoptotic cell death critically mediates acute tubular necrosis in AKI. While the involvement of necroptosis and ferroptosis has been established, the role of pyroptosis, the third major form of necrosis, remains unclear in AKI. This form of regulated necrosis requires proteolytic activation of members of the gasdermin family and is considered highly immunogenic. Thus, we aimed to investigate the role of pyroptosis and its mechanism of action in AKI.

**Methods:** Immunohistochemistry (IHC) was utilized to detect gasdermin D (GSDMD) in kidney samples of mice after ischemia/reperfusion injury (IRI). Furthermore, gasdermin-deficient mice were investigated in IRI and cisplatin-induced AKI and cisplatin-induced AKI. Mechanistic approaches involved the isolation of renal tubules for studies on cell death propagation and standard biochemistry to detect protein expression kinetics. Finally, MLKL/GSDMD<sup>fl/fl</sup> mice were generated to investigate the interplay of these caspase-dependent forms of regulated necrosis in AKI.

**Results:** In GSDMD-IHC of kidney samples after IRI, we detected as specific signal surrounding necrotic tubules. No such signal was detectable within the tubular compartment at any time. Unexpectedly, GSDMD<sup>fl/fl</sup> mice exhibited higher levels of serum creatinine and serum urea as well as more severe tubular damage compared to wild type controls. Unlike whole kidney lysates, freshly isolated renal tubules do not express the GSDMD protein. In isolated renal tubules, no changes in kinetics of cell death propagation were detectable upon genetic GSDMD deficiency. In addition, we generated combined necroptosis/pyroptosis-deficient MLKL/GSDMD<sup>fl/fl</sup> mice. Here, we demonstrate that co-deletion of MLKL rescued the sensitization of GSDMD<sup>fl/fl</sup> mice. Comparable effects were seen in cisplatin-induced AKI.

**Conclusions:** Our study reveals an unexpected protective role of GSDMD in AKI. Our mechanistic studies indicate the effect of GSDMD to function outside the tubular compartment, specifically surrounding areas of tubular necrosis. This infiltrate appears to limit tubular necroptosis in a non-cell autonomous manner. Alongside with these mechanistic insights, our data urge caution when inhibition of pyroptosis is therapeutically considered.

**Funding:** Private Foundation Support, Government Support - Non-U.S.

SA-PO082

**miR-486-5p Protects Against Ischemic AKI in Rat but Inhibits eNOS and Angiogenesis**

Adrianna Douvris,<sup>1</sup> Jose L. Vinas,<sup>1,2</sup> Alex Gutsol,<sup>1</sup> Dylan Burger,<sup>1</sup> Kevin D. Burns.<sup>1,2</sup> <sup>1</sup>University of Ottawa, Ottawa, ON, Canada; <sup>2</sup>Ottawa Hospital Research Institute, Ottawa, ON, Canada.

**Background:** Acute kidney injury (AKI) is a common complication of hospitalization for which no effective treatments exist. Patients with recovered AKI are at increased risk of progressive chronic kidney disease (CKD). In ischemia-reperfusion (IR) AKI, endothelial injury contributes to capillary rarefaction and development of tubulointerstitial fibrosis. We previously showed that microRNA (miR)-486-5p protects against IR AKI in mice associated with targeting of phosphatase and tensin homolog (PTEN), activation of Akt, and downregulation of genes involved in apoptosis and tumor necrosis factor signaling in proximal tubular cells. However, the effects of miR-486-5p in rat IR AKI and on endothelial cell injury are unknown.

**Methods:** Kidney ischemic injury was induced in male rats by 45-min bilateral renal artery clamping followed by reperfusion, with outcomes after 24hr, 48hr, and 4 weeks. Lipid-encapsulated miR-486-5p (0.5mg/kg) was administered via tail vein injection at the start of reperfusion. Human umbilical vein endothelial cells (HUVECs) were transfected with miR-486-5p (1nM), and angiogenesis was evaluated with matrigel-based tube formation assay.

**Results:** Administration of miR-486-5p to rats with IR injury significantly protected against AKI with normalization of plasma Cr and BUN (p<0.05, n=3), and reduced KIM-1 levels (p<0.01, n=3) at 24 and 48hr. In rats with AKI, miR-486-5p did not affect plasma Cr after 4 weeks, compared to sham rats or rats with AKI alone. However, in rats with AKI, miR-486-5p protected against the development of interstitial fibrosis and tubular atrophy at 4 weeks. In HUVECs, miR-486-5p decreased the expression of PTEN (p<0.05, N=4), and endothelial nitric oxide synthase (eNOS) (p<0.001, N=4). Matrigel-based network formation assay showed that miR-486-5p reduced the angiogenic activity of normoxic HUVECs compared to untreated cells or cells treated with scramble miRNA (p<0.05, N=4).

**Conclusions:** These data suggest that miR-486-5p prevents ischemic AKI in rats, and protects against the development of CKD after AKI. However, miR-486-5p may affect endothelial function with reduced angiogenic activity, possibly related to decreased eNOS expression. Although miR-486-5p shows promise as a therapeutic tool in AKI, long-term effects on kidney microvascular structure and function *in vivo* require further study.

**Funding:** Government Support - Non-U.S.

## SA-PO083

**The Role and Mechanism of Cyclophilin A in Cisplatin-Induced AKI**

Li Tao, Huazhong University of Science and Technology *Tongji Medical College, Huazhong University of Science and Technology, Wuhan, China.*

**Background:** Nephrotoxicity is an important factor that limits the clinical use of cisplatin (CP), with approximately 20%-35% of patients suffering acute kidney injury (AKI) after treated with it. Cyclophilin A (CypA) is an intracellular receptor for the immunosuppressant cyclosporin A (CsA), and is reported to function in protein folding, signal transduction, inflammation, tumorigenesis and viral replication, while the specific role of CypA in CP-induced AKI still lacks in-depth research.

**Methods:** Here, we successfully established an AKI mice model via a single intraperitoneal injection of CP (25mg/kg), and a CsA derivative, NIM811, was used as an inhibitor of CypA to treat the CP mice. In addition, vitro experiment was performed using HK-2 cells.

**Results:** In CP-AKI mouse model, the expression level of iCypA and eCypA were increased; Serum eCypA content positively correlated with Scr. Both the expression level of iCypA and eCypA were increased in HK-2 cells stimulated by CP.Scr was decreased significantly in CP-AKI mice treated with NIM811 and the pathological lesion of renal tubules was reduced. At the same time, NGAL and Cleaved-Caspase3 protein levels were decreased significantly as well as the number of TUNEL positive apoptotic cells was decreased. After CypA knockdown by siRNA transfection, Cleaved PARP1 and CytC protein levels were decreased, the percentage of apoptotic cells was decreased, and cell viability was increased. In vitro, inhibition of CypA by NIM811 increased the cell viability, and decreased the levels of Cleaved PARP1 and CytC protein. Cleaved PARP1 and Cleaved-Caspase3 protein levels were increased after rCypA was administrated in HK-2 cells. In the CP-AKI mouse model, increased CD147 expression was detected by IHC and WB. In vitro of CP-induced HK-2 cell injury, increased CD147 expression was found by WB assay. Knockdown of CypA could down-regulate the expression of CD147 in CP-stimulated HK-2 cells. Using siCD147 in HK-2 cells could down-regulate the increased expression of Cleaved PARP1 and CytC protein levels as well as increase the cell viability. Knocking down CypA expression could alleviate the abnormalities of the AKT/AMPK/mTOR signaling pathway caused by CP stimulation.

**Conclusions:** CypA is increased and plays an injurious role in CP-induced AKI. And the underlying mechanism may attribute to promoting apoptosis by dysregulated CD147 and AKT/AMPK/mTOR signaling pathways.

## SA-PO084

**Identification of Enhancers and Their Impact on the Kidney Injury Regulator Klotho**

Jakub Jankowski,<sup>1,2</sup> Hye kyung Lee,<sup>2</sup> Julia Wilflingseder,<sup>1</sup> Lothar Hennighausen.<sup>2</sup>  
<sup>1</sup>Veterinärmedizinische Universität Wien, Wien, Austria; <sup>2</sup>National Institute of Diabetes and Digestive and Kidney Diseases, Bethesda, MD.

**Background:** Enhancer activity provides new insights into the gene expression machinery and is emerging as a valuable target of research and therapy. Enhancer disruption is involved in development of human disease, but can also be used as a tool to investigate genes key for disease progression and recovery. There is a well-known connection between kidney function and Klotho. While decrease in Klotho is a known sign of kidney disease, deletion of the gene in mice results in severe phenotype and greatly shortened lifespan, making investigating *Klotho* knockouts challenging. Previously, we identified two putative enhancers of *Klotho*, which lost activity in a kidney injury setting. In this study, we used a novel way of gaining insight into the role of *Klotho*. We altered gene regulatory elements, rather than the gene itself, to investigate the impact of the two putative enhancers on *Klotho* expression, and physiological effects of their deletion.

**Methods:** We used Crispr/Cas9 to generate six viable mouse lines with deletions in the distal, proximal or both *Klotho* enhancers, including selective deletion of HNF1b transcription factor binding site. We used qPCR and RNA-seq to investigate gene expression in the kidney, and a blood biochemistry panel and ELISA to investigate phenotype. We also used Chip-seq to analyze changes in histone modifications with focus on the *Klotho* promoter and enhancer regions to assess their activity and verify deletions.

**Results:** Deletion of distal, but not proximal enhancer resulted in 50% lower *Klotho* expression, but only when HNF1b binding site was impacted. Inactivity of the proximal enhancer was confirmed by lack of further expression decrease in double knockout mice. Despite significant *Klotho* depletion, mice did not display *Klotho* knockout phenotype, as lifespan, weight, serum phosphate, calcium and FGF23 levels were not different compared to controls. RNA-seq analysis revealed altered expression of several genes associated with kidney disease.

**Conclusions:** Our study provides new insight into *Klotho* regulation. We identified a new regulatory element of the *Klotho* gene as well as the transcription factor responsible for its activity. Despite significantly lower *Klotho* expression levels, normal phenotype is preserved. Susceptibility of the mice to injury remains to be investigated and will further elucidate *Klotho*'s impact on renal health.

**Funding:** NIDDK Support

## SA-PO085

**Tnik, a Novel Pro-Repair Kinase That Promotes Renal Cell Differentiation After Injury**

Shayna T. Bradford, Yuhei Kirita, Haojia Wu, Yoshiharu Muto, Benjamin D. Humphreys. Humphreys Lab *Washington University in St Louis School of Medicine, St Louis, MO.*

**Background:** Following acute kidney injury (AKI), epithelial cells lining proximal tubules of the nephron repopulate injured tubules to support repair. However, a portion of cells fail to undergo repair and are characterized by increased expression of proinflammatory/profibrotic molecules as well as decreased expression of markers of terminal differentiation. The molecular pathways driving the generation of failed-repair proximal tubule cells are undefined. However, we hypothesize that these cells cause local tissue inflammation and fibrosis, promoting the AKI to chronic kidney disease transition.

**Methods:** Using snRNA-seq, we identified a Traf2 and Nck Interacting Kinase, Tnik, to be exclusively expressed in failed-repair proximal tubule cells post AKI (2 and 6 weeks) in mice. Like failed-repair proximal tubule cells, primary human renal proximal tubule epithelial cells (hrPTECs) adopt an injury phenotype when cultured on plastic and can be used to model failed-repair proximal tubule cells. Therefore, we subjected primary-hrPTECs to 72 hours of Tnik silencing using pooled siRNA against human Tnik. We confirmed Tnik suppression by immunoblotting and proceeded with RNA-seq analysis to assess the transcriptome of Tnik depleted primary-hrPTECs (n = 6).

**Results:** 508 genes were upregulated, and 685 genes were downregulated in response to Tnik depletion (log<sub>2</sub> fold change > 1). Pathway analysis revealed upregulation of Type I Interferon signaling, while organic acid transport pathways were downregulated. By qPCR and immunoblotting, we validated increased levels of inflammatory and injury genes (CCL2, AXIN2), along with decreased levels of organic acid transport and differentiation genes (SLC3A1, HFN4a) found in our RNA-seq dataset.

**Conclusions:** Since Tnik depletion increases inflammatory signals and decreases renal cell differentiation markers, we conclude that Tnik is a novel proximal tubule pro-repair kinase that functions to reduce inflammation and shift cells toward differentiation and repair following injury. Data from these studies may serve as the basis for novel therapeutics that enhance proximal tubule Tnik activity, thereby improving AKI outcomes.

**Funding:** NIDDK Support, Private Foundation Support

## SA-PO086

**Deletion of Spns2 in Proximal Tubules Protects the Mouse Kidney During Ischemia-Reperfusion Injury**

Sylvia Cechova, Junlan Yao, Nabin Poudel, Mark D. Okusa. Division of Nephrology and Center for Immunity, Inflammation and Regenerative Medicine *University of Virginia, Charlottesville, VA.*

**Background:** Spns2 (Spinster homolog 2) is a non-ATP dependent organic ion transporter of S1P (Sphingosine 1-phosphate) that transports S1P from the intracellular to the extracellular cell compartment. Since 2009, several studies demonstrated the important role of SPNS2 in lymphocyte trafficking, immune responses, vascular and embryonic development, many type of cancers, and human liver fibrosis. Previously we demonstrated that Spns2 is expressed in proximal tubules and podocytes. In the present study, we investigated the effect of Spns2 deletion in mice renal proximal tubules (PTs) after bilateral ischemia-reperfusion injury (bi-IRI).

**Methods:** Tamoxifen inducible proximal tubule tissue specific transgenic SL3C34a1-GFPcreER<sup>fl</sup>/Spns2<sup>fl</sup> mice (PT-KO mice) where injected with 1mg of tamoxifen for 5 days and rested for 2 weeks before they underwent bi-IRI (28 min). 24 hours later, we collected plasma and kidney tissues. The relative mRNA expression of *Spns2*, *Ngal*, *Kim1* and chemokines *Cxcl1* and *Cxcl10* in kidneys were estimated by qPCR. To detect protein level of Spns2 we performed gel electrophoresis and Western blot analyses of kidney tissue lysates. To evaluate kidney injuries we measured plasma creatinine, BUN, and calculated ATN score of H&E stained kidney sections.

**Results:** After IRI, we observed significantly decreased mRNA expression of *Spns2*, *Ngal*, *Kim1*, and chemokines *Cxcl1* and *Cxcl10* in the kidney lysates of PT-KO mice compared to WT mice. In both genotypes after IRI, we also observed decreased protein level of Spns2. Results of plasma creatinine and BUN confirmed that deletion of Spns2 from renal proximal tubules exert significant protection from IRI. Plasma creatinine: 1.13±0.19 mg/dl and 0.36±0.06 mg/dl, P<\*\*\*, and BUN: 112.8±10.10 mg/dl and 48.33±5.24 mg/dl, P<\*\*\*\* for WT and PT-KO mice, respectively (n=6). H&E staining and ATN scores (42.63±9.14 and 9.69±2.18 for WT and PT-KO mice, P<\*\*) provided additional evidence of severe damage to proximal tubules of WT mice compared to PT-KO mice after IRI.

**Conclusions:** Our results suggest that SPNS2 can serve as a potential target to prevent acute kidney injury. However, more studies are necessary to elucidate the SPNS2 signaling pathway.

**Funding:** NIDDK Support

## SA-PO087

**A Short Treatment With Resveratrol After Ischemia/Reperfusion Injury Prevents Maladaptive Repair and Long-Term CKD**

Miguel A. Martinez-Rojas,<sup>1,2</sup> Jesus M. Gonzalez Rivera,<sup>2</sup> Maria S. Ponce Nava,<sup>2</sup> Rosalba Pérez-Villalva,<sup>1</sup> Norma Bobadilla.<sup>1,2</sup> <sup>1</sup>Universidad Nacional Autónoma de México, Ciudad de México, México; <sup>2</sup>Instituto Nacional de Ciencias Médicas y Nutrición Salvador Zubirán, Ciudad de México, México.

**Background:** Acute Kidney Injury (AKI) leads to Chronic Kidney Disease (CKD) through maladaptive repair. The reversibility of this process after AKI has occurred remains unclear. Treatment with resveratrol (RSV) before AKI ameliorates renal dysfunction through multiple mechanisms. We aimed to evaluate if a transient administration of RSV after ischemia/reperfusion injury (IRI) is enough to prevent CKD.

**Methods:** Eighteen male Wistar rats weighting 300-350 g were randomized in three groups: Sham surgery, IRI for 30 min (IRI), and IRI + RSV. Daily treatment with RSV was initiated 24 h after IRI and maintained only 10 days. Rats were followed for 5 months. Proteinuria was determined monthly, while kidney function and fibrosis were evaluated at the 5<sup>th</sup> month. To study early reparative process, another 18 rats were included with the same design but euthanized at the 10<sup>th</sup> day. Histologic changes were evaluated with Sirius Red and PAS stains. Gene expression was evaluated with RT-qPCR and Western blot. Differences between groups were analyzed through ANOVA and post-hoc testing with a significance level of p<0.05.

**Results:** Treatment with RSV prevented late CKD as indicated by proteinuria, creatinine clearance and tubule-interstitial fibrosis. Despite having a severe initial AKI, rats receiving RSV for only 10 days after IRI improved drastically kidney histological changes and expression of *Il6*, *Tnfa*, *Ccl2*, *Il10*, *Tgfb1*, *Mrc1* compared to the IRI group, indicating accelerated immune cells clearance. This was accompanied by reduced levels of NfκB-p65. Also, RSV prevented the typical raise in tubular injury-related genes and recovered Sirt3, FoxO3, and catalase expression, leading to a lesser oxidative stress compared to IRI group.

**Conclusions:** A short treatment with RSV after IRI is enough to prevent maladaptive repair and CKD in rats. This renoprotective effect is mediated by a marked reduction in the inflammatory process, tubular injury, and oxidative stress. These findings highlight the relevance of the initial days of reperfusion, indicating that adaptive repair can be induced after severe AKI.

**Funding:** Government Support - Non-U.S.

## SA-PO088

**Contralateral Nephrectomy After AKI Leads to Functional Recovery by Stimulating Epithelial Progenitor Proliferation Whilst Inhibiting Endocycling-Related Hypertrophy**

Lies Moonen,<sup>1</sup> Elena Lazzeri,<sup>2</sup> Anna J. Peired,<sup>2</sup> Carolina Conte,<sup>2</sup> Letizia De Chiara,<sup>2</sup> Paola Romagnani,<sup>2</sup> Benjamin A. Vervaeck.<sup>1</sup> <sup>1</sup>Universiteit Antwerpen, Antwerpen, Belgium; <sup>2</sup>Universita degli Studi di Firenze, Firenze, Italy.

**Background:** Clinical studies of the last decade identified acute kidney injury (AKI) as an important risk factor for the development of chronic kidney disease (CKD). Hence, strategies to improve the reparative efficiency are of great therapeutic interest. We established a murine model in which the functional and histological recovery of a kidney is drastically enhanced by removal of the unharmed contralateral kidney, i.e. nephrectomy-induced recovery. It is unknown whether nephrectomy (Nx) achieves this by stimulating true epithelial regeneration and/or hypertrophy. Insight in the mechanisms underlying efficient nephrectomy-induced recovery may open new therapeutic strategies.

**Methods:** AKI was induced in 2 specific transgenic mouse lines by left unilateral ischemia/reperfusion (UIRI) for 21 min at 34°C, after which either right Nx or no Nx was performed 3 days later. Mice were euthanized 7 and 28 days after UIRI for functional and renal histopathological analyses. Pax2/Confetti mice were applied to track proliferation of individual genetically labeled tubular progenitor cells by histological clone size frequency analysis. Pax8/FUCCI2aR mice were included to assess TEC hypertrophy (i.e. endocycling) by combining DNA content analysis via flow cytometry with expression analysis of genetic fluorescent cellular labels that reveal the cell cycle stage.

**Results:** Nx performed at day 3 after UIRI was confirmed to rescue function and histology. Clonal analysis in PAX2/Confetti mice revealed that Nx significantly stimulated individual progenitor cell proliferation as compared to no Nx and Nx recruited more progenitor cells to start proliferation as compared to no Nx. Analyses of FUCCI mice revealed that Nx prevented accumulation of hypertrophic (endocycling) TECs (i.e. polyploid cells with ≥8C DNA content).

**Conclusions:** Nx-enhanced regeneration is driven by a stimulated clonal expansion of renal progenitor cells that significantly surpasses that of spontaneous repair after UIRI. Moreover, Nx attenuates the build-up of polyploid/hypertrophic epithelial cells. Hence, Nx stimulates recovery by promoting true epithelial regeneration, whilst suppressing endocycle-mediated hypertrophy.

## SA-PO089

**Effect of Ischemia-Reperfusion Injury on Nuclear Malondialdehyde Levels in Kidney Cortex and Medulla of Aged Rats**

Marianna J. Zmlauski-Tucker, Bingwei Ye. Ball State University, Muncie, IN.

**Background:** The present study was undertaken to determine the effect of ischemia-reperfusion injury (IRI) on nuclear malondialdehyde (MDA) levels in kidneys from aged rats. MDA is a product of lipid peroxidation of cell and organelle membranes by free

radicals and is used as an indicator of oxidative stress. Kidney dysfunction is associated with tissue damage caused by free radicals generated in IRI.

**Methods:** Anesthetized old female Lewis rats (22 months of age) were used in the study. The left and right renal pedicles were clamped for 60 min, followed by 60 min of reperfusion in the Experimental Group (n=6). The kidneys were then harvested, separated into cortex and medulla, and homogenized. Kidneys in the Control Group (n=6) were not subjected to IRI before being harvested. The nuclear fractions were isolated using differential centrifugation, and the MDA levels were measured using a spectrophotometric assay. The water contents of the cortex and medulla were determined to allow MDA to be expressed as nmol/g kidney dry wt. A Student's T Test was used to compare the data, and statistical significance was determined at p < 0.05. All data reported as X ± SEM.

**Results:** Nuclear MDA levels were significantly decreased in the kidney cortex of the Experimental Group when compared to the Control group. Nuclear MDA levels in kidney cortex decreased by 49 %, with Nuclear MDA being 36.5 ± 7.9 % nmol/g kidney dry wt in the Control Group and 18.0 ± 1.7 nmol/g kidney dry wt in the Experimental Group. Nuclear MDA levels in the kidney medulla were not different with IRI. Nuclear MDA levels were 45.0 ± 5.9 nmol/g kidney dry wt in the Control Group and 52.5 ± 2.6 nmol/g kidney dry wt in the Experimental Group.

**Conclusions:** The results suggest that in IRI, the nucleus in both the kidney cortex and medulla of aged rats may not be experiencing increased oxidative stress and damage, as indicated by a decrease or no change in MDA levels, respectively, after 60 min of reperfusion.

## SA-PO090

**Loss of Pax2 and Pax8 in Proximal Tubules Protects Against Failed Repair After Ischemic AKI**

Jeffrey A. Beamish,<sup>1,2</sup> Anas Alsuraimi,<sup>1</sup> Madison C. McElliott,<sup>1</sup> Abdul A. Soofi,<sup>1</sup> Greg R. Dressler.<sup>1</sup> <sup>1</sup>University of Michigan, Ann Arbor, MI; <sup>2</sup>VA Ann Arbor Healthcare System, Ann Arbor, MI.

**Background:** Pax2 and Pax8 are two highly homologous transcription factors with critical and overlapping functions in kidney development and physiology. Both proteins are also upregulated following acute kidney injury (AKI), but their function in injury and repair is unknown. Our aim was to determine if selective deletion of Pax2 and Pax8 in proximal tubules affects sensitivity to injury and recovery after AKI.

**Methods:** Pax double mutant mice were generated carrying conditional floxed Pax2 and Pax8 alleles, the proximal-tubule-selective phosphoenolpyruvate carboxykinase (PEPCK) Cre driver, and a Cre-activated green fluorescent protein (GFP) reporter. Control mice included PEPCK-Cre and GFP reporter with wild type Pax2 and Pax8. 12-week-old male mice were subjected to unilateral ischemia-reperfusion injury (uIRI). Animals were sacrificed at various times after uIRI. Kidney tissue was analyzed by immunofluorescence (IF). Areas of failed repair 14 d post uIRI were marked by Kim1 or Vcam1 expression. Stained sections were scanned then quantified using U-net image segmentation.

**Results:** At baseline, mutants showed no difference in histology or kidney function. Gene deletions in proximal tubules were confirmed by IF and PCR. Mutant animals showed significantly fewer Vcam1+ tubules (46.6±33.8 vs 94.1±38.4 per mm<sup>2</sup>, N=14-15, p=0.002) and Kim1+ tubules (31.0±28.0 vs 56.3±27.5 per mm<sup>2</sup>, N=14-15, p=0.017). In mutant animals, we found that areas of failed repair contained significantly fewer GFP+ mutant cells compared with control animals where GFP marks Cre activity without Pax2 and Pax8 deletion (35.9±5.0% vs 46.4±6.7% of Vcam1+ cells, N=14-15, p<0.0001).

**Conclusions:** Surprisingly, mice with proximal-tubule-selective loss of Pax2 and Pax8 were less sensitive to IRI, with fewer Vcam1+ cells indicative of failed repair. As Vcam1+ cells may represent a population of survivors that do not fully recover their proximal tubule phenotype after injury, the data suggest that Pax mutant cells may be less likely to survive the initial injury and are rapidly cleared such that fewer stressed or damaged cells remain. Alternatively, Pax mutant cells may be inherently more resistant to ischemic injury. Mechanisms and experiments that distinguish these possibilities will be discussed.

**Funding:** NIDDK Support

## SA-PO091

**PPARα in Proximal Tubules Attenuates Ischemic AKI**

Takayuki Nimura,<sup>1</sup> Daiki Aomura,<sup>1</sup> Yosuke Yamada,<sup>1</sup> Makoto Harada,<sup>1</sup> Koji Hashimoto,<sup>1</sup> Motoko Yanagita,<sup>2</sup> Yuji Kamijo.<sup>1</sup> <sup>1</sup>Shinshu Daigaku Igakubu Fuzoku Byoin, Matsumoto, Japan; <sup>2</sup>Kyoto Daigaku Daigakuin Igaku Kenkyuka Igakubu, Kyoto, Japan.

**Background:** Peroxisome proliferator-activated receptor alpha (PPARα) is a nuclear receptor. The renal expression of PPARα is mainly localized in the proximal tubules (PTs). PPARα maintains tissue energy metabolism by regulating fatty acid oxidation (FAO), with several studies reporting a possible renoprotective effect of systemic PPARα against ischemic kidney injury. Since the contribution of renal PPARα to this function is unknown, we addressed the above notion using PT-specific PPARα knock-out mice.

**Methods:** Mice harboring *Ndrp1*-CreERT2 transgenes were crossed with *Ppara*<sup>flax/flax</sup> mice to generate *Ndrp1*-CreERT2-*Ppara*<sup>flax/flax</sup> (PTs-PPARα-CKO) mice, which were intraperitoneally injected with tamoxifen for 3 days to knock out PT PPARα. Then, bilateral 40-minute ischemia-reperfusion (I/R) was conducted on tamoxifen-treated 13-week-old *Ppara*<sup>flax/flax</sup> mice (controls) and PTs-PPARα-CKO mice to produce an ischemic acute kidney injury model (n=9 in both groups). A sham operation was also performed (n=3 in each group). All mice were sacrificed 24 hours after I/R or the sham operation.

**Results:** A deficiency in renal PPARα expression was confirmed in the PTs-PPARα-CKO mice for both I/R and sham procedures. PTs-PPARα-CKO animals subjected to

I/R showed significantly higher serum creatinine levels, with pathological findings of more severe renal tubular injury than in controls. Renal cytokine expressions were also significantly higher for PTs-PPAR $\alpha$ -CKO with I/R. Although the renal expressions of FAO-related genes were decreased by I/R in both mice groups, those depletions were significantly more severe in the PTs-PPAR $\alpha$ -CKO mice. The renal expressions of anti-oxidative stress enzymes were also significantly lower in the PTs-PPAR $\alpha$ -CKO mice with I/R versus controls.

**Conclusions:** PPAR $\alpha$  in PTs attenuates ischemic acute kidney injury, presumably through the maintenance of renal FAO and anti-oxidative enzyme expression.

#### SA-PO092

##### Succinylation of Park 7 Activates a Protective Metabolic Response to AKI

Katherine Pfister,<sup>1,2</sup> Anne C. Silva Barbosa,<sup>1,2</sup> Takuto Chiba,<sup>1,2</sup> Eric S. Goetzman,<sup>2</sup> Sunder Sims-Lucas.<sup>1,2</sup> <sup>1</sup>University of Pittsburgh, Pittsburgh, PA; <sup>2</sup>Children's Hospital of Pittsburgh of UPMC, Pittsburgh, PA.

**Background:** Acute Kidney Injury (AKI) is extremely prevalent among hospitalizations and presents a significant risk for the development of chronic kidney disease and increased mortality. Ischemia caused by shock, trauma, and transplant are common causes of AKI. To attenuate AKI occurrence therapeutically we need a better understanding of the physiological and cellular mechanisms underlying damage. The most pronounced effect of AKI is on the Proximal Tubule Epithelial Cells (PTECs) which have the highest metabolic activity and are therefore most reliant on undisturbed blood flow and oxygen content.

**Methods:** We simulate AKI in vitro with hypoxia and glucose deprivation. Hypoxia signaling induces rapid posttranslational modifications (PTMs) on proteins. A growing list of PTMs have been identified and their effects described in AKI but among the understudied are succinylation and glycation.

**Results:** We have previously shown a protective effect on PTECs after depletion of the desuccinylase Sirtuin 5, however Sirtuin 5 is not a druggable target. Mass spectrometry analysis of Sirtuin 5 knockout PTECs revealed changes in mitochondrial and peroxisomal activity and we suggest that this activity is modulated in part by the protective effects of the deglycase Park7. Park7 expression is decreased after Ischemia-Reperfusion Injury but increased in Sirtuin 5 knockout cells.

**Conclusions:** These data in combination with published results of Park7's protective role in cardiovascular damage and chronic kidney disease lead us to hypothesize that Park7 may ameliorate oxidative damage resulting from AKI and prevent disease progression. We hope to harness this mechanism to develop novel therapies for AKI.

**Funding:** NIDDK Support, Private Foundation Support

#### SA-PO093

##### Inhibition of KDM5 Attenuates Renal Fibrosis After Ischemic Kidney Injury

Wonji Jo, Junkyu Park, Eun Sil Koh, Sungjin Chung. *The Catholic University of Korea, Seoul, Republic of Korea.*

**Background:** The histone lysine demethylases 5 (KDM5) are members of the family of Jumonji C domain-containing histone demethylases and catalyze the removal of di- and tri-methyl moieties from the fourth lysine of histone 3 (H3K4me2/3). It has been reported that the KDM5 family mediates a range of physiological and pathological events including cell differentiation, motility, senescence and epithelial-mesenchymal transition (EMT) via activating or repressing transcription in demethylase-dependent or independent manners in both homeostasis and disease. This study investigated the potential role of KDM5 in the development and progression of renal fibrosis in acute kidney injury (AKI) or chronic kidney disease (CKD).

**Methods:** We evaluated therapeutic effects of KDM5 inhibition in AKI model of unilateral nephrectomy plus contralateral ischemia-reperfusion (IR) injury, AKI to CKD model of unilateral IR injury plus removal of contralateral uninjured kidney after 8 days of IR injury, and CKD model of unilateral ureteral obstruction (UUO) in mice.

**Results:** KDM5 C70 inhibitor prevented the increase of blood urea nitrogen and positive areas of trichrome, Sirius red, F4/80 and  $\alpha$ -smooth muscle actin in injured kidneys 7 days after IR injury. Significant reductions in renal mRNA levels of pro-inflammatory cytokine/chemokine, EMT and pro-fibrotic markers (IL-1 $\beta$ , IL-6, TNF- $\alpha$ , CCL2, CCL3, GM-CSF, MMP9, fibronectin, vimentin, TGF- $\beta$ 1, COL4A1) were also observed with attenuated mRNA levels of KDM5a-c. In addition, renal protein levels of antioxidants such as catalase, SOD1 and SOD2 were increased in injured kidneys of KDM5 inhibitor-treated mice. However, parameters of renal fibrosis and inflammation were similar between mice without and with KDM5 inhibitor in both AKI-CKD and CKD models.

**Conclusions:** These data demonstrate that inhibition of KDM5 could prevent renal inflammation and fibrosis after acute and severe IR injury. The activation of KDM5 might be an early step in the development of renal fibrosis after AKI insult.

**Funding:** Government Support - Non-U.S.

#### SA-PO094

##### Microparticles Released From Renal Epithelial Cells Induce Endothelial Cell Activation

Begoña Campos, Robert C. Shondel, Samuel P. Bockhorst, Charuhas V. Thakar. College of Medicine, Division of Nephrology, Kidney C.A.R.E. Program, Kidney Injury Translational Laboratory. *University of Cincinnati, Cincinnati, OH.*

**Background:** Acute kidney injury (AKI) is associated with an interplay between endothelium and epithelium as a part of both injury and repair cycles. We have shown that microparticles (MP) derived from renal epithelial cells are released in the setting of AKI and can carry the biological activity that could induce inflammation.

**Methods:** In this study, we evaluated if the MP derived from renal proximal tubule epithelial cells (RPTEC) after exposure to inflammatory stress-induced human umbilical vein endothelial cells (HUVEC) by using the monocyte adhesion assay. HUVEC and THP1 monocytes were maintained under standard cell culture conditions and exposed to RPTEC derived MP, TNF $\alpha$ , or vehicle (control). For Adhesion of THP1 cells to treated HUVEC, THP1 cells were labeled with Calcein Red Orange at a final concentration of 10  $\mu$ mol/L. Total fluorescence intensity, automated THP1 cell counts, and fluorescence of blank media was measured with a Cytation 5 plate reader. Unbound THP1 cells were removed by washing, and the remaining fluorescence intensity and THP1 cell counts were measured again.

**Results:** Activation of endothelial cells is significantly greater in both RPTEC-derived MP activated (54.13 X 10<sup>3</sup>) and direct activation from TNF $\alpha$  (42.90 X10<sup>3</sup>) when compared with control (14.74X10<sup>3</sup>) (p= 0.0002 and p=0.0047, respectively, Fig 1). Endothelial cell activation between RPTEC-derived MP vs. direct activation from TNF $\alpha$  was similar (p=0.1135).

**Conclusions:** MP derived from renal epithelial cells can induce endothelial cells as demonstrated by their ability to cause monocyte adhesion. These results suggest that microparticles can mediate cellular cross-talk, and in turn can affect injury and repair cycles in AKI.

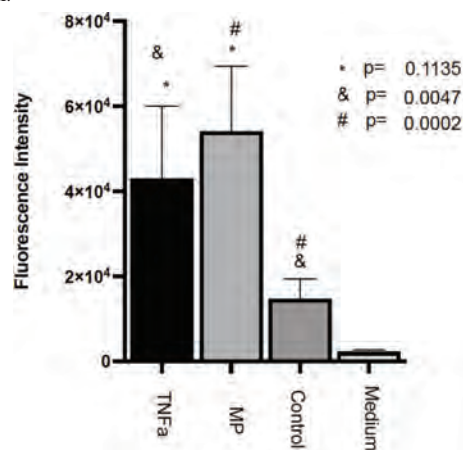

#### SA-PO095

##### Keap1 Inhibition Ameliorates Cisplatin-Induced Mitochondrial Injury and Oxidative Stress in Renal Proximal Tubule Epithelial Cells Through a Glutathione-Dependent Mechanism

Jose A. Chavez. Cardiovascular & Metabolism, Janssen Research & Development *Janssen Global Services LLC, Spring House, PA.*

**Background:** Mitochondrial impairment is strongly associated with renal function decline. The proximal tubule is typically the initial site of injury where mitochondrial dysfunction leads to disrupted tubular integrity and cellular energetics insufficient to perform critical energy-demanding processes essential for kidney function. Therefore, targets addressing mitochondrial dysfunction in kidney disease provide an opportunity to advance novel therapies. The Keap1-Nrf2-ARE pathway regulates the transcription of various genes that encode cytoprotective and detoxifying enzymes and has pivotal roles in the defense against cellular oxidative stress.

**Methods:** To examine the impact of Nrf2 activation on mitochondrial function in the setting of oxidative stress, we exposed human primary renal proximal tubule epithelial cells (RPTECs) to cisplatin and used an inhibitor that interrupt the Keap1-Nrf2 protein-protein interaction (PPI).

**Results:** Cisplatin treatment significantly elevated reactive oxygen species (ROS) production, increased casp3/7 activity, reduced mitochondrial membrane potential, impaired respiration, downregulated genes related to mitochondrial function and decreased nicotinamide adenine dinucleotide (NAD<sup>+</sup>) levels. These effects were notably

suppressed by co-treatment with the small-molecule Keap1–Nrf2 PPI inhibitor. To assess whether the mitochondrial protective effects of Keap1-inhibition in RPTECs are mediated by GSH, an important scavengers of ROS, we treated cells with L-buthionine-(S, R)-sulfoximine (BSO), an inhibitor of GSH synthesis. Notably, BSO treatment negated the protective effects of the Keap1–Nrf2 PPI inhibitor against cisplatin-induced mitochondrial depolarization and apoptosis, while not affecting its ability to induce the transcriptional activation of NRF2 target genes.

**Conclusions:** Together, our results show that inhibition of the Keap1–Nrf2 PPI activates the antioxidant machinery for ROS scavenging in RPTECs, and that increased levels of intracellular GSH plays an important protective role against cisplatin-induced mitochondrial dysfunction and cellular death.

**Funding:** Commercial Support - Janssen Pharmaceuticals

#### SA-PO096

##### Notch Signaling Contributes to the Renoprotective Effects of the Cholinergic Anti-Inflammatory Pathway

Shuhei Kuwabara, Shuqiu Zheng, Junlan Yao, Mark D. Okusa. Division of Nephrology and Center for Immunity, Inflammation, and Regenerative Medicine *University of Virginia, Charlottesville, VA.*

**Background:** A novel strategy for the prevention and treatment of AKI is activating the cholinergic anti-inflammatory pathway (CAP), a neuroimmune circuit. The CAP is initiated by vagus nerve stimulation (VNS) and subsequent activation of splenic macrophages (MΦ) to suppress inflammation. Our previous findings suggest the possibility that Notch signaling pathway (Notch), contributes to the renoprotective effects of CAP. However, a direct relationship between the CAP and Notch has not been reported. In the current study, we focused on Notch in MΦ to unravel the molecular mechanism of CAP and to determine the utility of Notch in ameliorating AKI.

**Methods:** To test if VNS activates Notch in MΦ, we performed electrical VNS before ischemia-reperfusion injury (IRI). After IRI, the expression of cytokines and Notch2 receptor in MΦ were assessed by qPCR and flow cytometry. MΦ-specific *Notch2* knockout mice were also subjected to VNS to evaluate whether Notch2 mediates anti-inflammatory responses in MΦ. The vagus nerve is heterogeneous and composed of efferent and afferent fibers, and neural circuits related to each fiber bundle are independent though both efferent/afferent VNS attenuate AKI. Thus, to determine if specific neural circuits regulate Notch, we used optogenetics, a tool for controlling the functions of particular neurons by expressing light-responsive proteins such as channelrhodopsin 2 (ChR2).

**Results:** The mRNA and protein expression of Notch2 was upregulated in splenic MΦ of VNS-treated mice. This was accompanied by a decrease in *Tnf-α* and an increase in *Il-10*. In splenic MΦ of *Notch2* knockout mice subjected to VNS, *Tnf-α* was higher and *Il-10* was lower than VNS-treated littermates, indicating that anti-inflammatory effects of the CAP were attenuated by *Notch2* deficiency in MΦ. In addition, we performed optogenetic VNS by using transgenic mice expressing ChR2 on vagal efferent fibers. Flow cytometry analysis revealed that efferent VNS did not alter Notch2 protein levels in splenic MΦ.

**Conclusions:** Our findings suggested that: 1) Notch signaling in splenic MΦ contributes to renoprotection by the CAP, 2) optogenetic stimulation of the vagus nerve showed that efferent VNS does not mediate Notch2 upregulation, suggesting that afferent VNS may be responsible for initiating Notch signaling in splenic MΦ.

**Funding:** NIDDK Support, Private Foundation Support

#### SA-PO097

##### Proximal Tubular FHL2 Protects Against Ischemia/Reperfusion-Induced AKI via HIF-1 and β-Catenin Signaling

Yan Wang, Weichun He. *2nd Affiliated hospital of NJMU, Nanjing, China.*

**Background:** Hypoxia inducible factor 1 (HIF-1) and β-catenin signaling pathways activated in proximal tubular epithelial cells (PTECs) play an important role in regulating cell proliferation and apoptosis during acute kidney injury (AKI). Four-and-a-half LIM domains protein 2 (FHL2), an adaptor protein, has been demonstrated involving in HIF-1 and β-catenin signaling, respectively. However, the potential effect of FHL2 on AKI remains to be elucidated.

**Methods:** The expression of FHL2 in PTECs was examined in AKI induced by bilateral ischemia reperfusion (I/R) in mice and in NRK-52E (rat PTECs) cultured in hypoxia/reoxygenation (H/R) conditions, respectively. Mice with PTECs-specific deletion of FHL2 (Tubule-FHL2<sup>-/-</sup>) were generated by mating FHL2-floxed mice with Ggt1-Cre transgenic mice. The function of FHL2 in PTECs during AKI was investigated in Tubule-FHL2<sup>-/-</sup> mice after I/R.

**Results:** The expression of FHL2 was upregulated in PTECs during AKI in vivo. Compared with control littermates, Tubule-FHL2<sup>-/-</sup> mice were phenotypically normal within 2 months after birth but developed more severe kidney dysfunction, tubular cell death, inflammatory cell infiltration and less tubular cell proliferation after I/R. The activation of both HIF-1 and β-catenin signaling pathways was attenuated in Tubule-FHL2<sup>-/-</sup> mice after I/R comparing with control littermates. In vitro, the induction of FHL2 was correlated with upregulation of HIF-1α. Two functional hypoxia responsive elements was identified in the promoter region of FHL2 gene, which interacted with HIF-1α under hypoxia conditions, suggesting that FHL2 is a novel direct target gene of HIF-1. Overexpression of FHL2 induced physical interactions between FHL2 and HIF-1α and between FHL2 and β-catenin, which promoted HIF-1α and β-catenin nuclear translocation, and enhanced the transcriptional activity of their downstream targets, respectively.

**Conclusions:** Our results suggest that FHL2, as a downstream target gene of HIF-1, plays a critical protective role in AKI through regulating the activities of HIF-1 and β-catenin signaling pathways simultaneously, and FHL2 could be a potential future therapeutic target for AKI.

**Funding:** Government Support - Non-U.S.

#### SA-PO098

##### Lysozyme Induced Nephropathy: A Rare Mechanism of Renal Sarcoidosis

Sushmita Prabhu, Suryanarayanan Balakrishnan, Suzanne G. Martin. *Saint Vincent Hospital, Worcester, MA.*

**Introduction:** Classic mechanisms of renal injury in sarcoidosis include hypercalcemia with afferent vasoconstriction, nephrocalcinosis, and acute interstitial nephritis with or without granulomas. Lysozyme is a small cationic enzyme with bactericidal properties produced by monocytes and macrophages, which drive disease activity. Lysozyme is freely filtered by glomeruli and reabsorbed in proximal tubules (PTs), where it causes toxicity in excessive quantities, known as lysozyme-induced nephropathy.

**Case Description:** 75M presented with a creatinine of 5.87 mg/dL (eGFR 9cc/min) after not seeing a physician for years. He reported difficulty sweating and a 22lb weight loss over 18 months, but was otherwise asymptomatic. Blood pressure was 150/73 and exam was unremarkable. Urinalysis: specific gravity 1.020, pH 6, moderate blood, 100 protein, 100 glucose. Sediment: granular casts without RBCs or RBC casts. Urine albumin:Cr ratio (UACR) was 47 mg/g, urine protein:Cr ratio (UPCR) 1321 mg/g Cr, calcium 14 mg/dL, phosphate 6.3 mg/dL, PTH 1.57 pg/mL, PTHrP 30 pg/mL, and 1,25 OH<sub>2</sub> vitamin D 138 pg/mL. Serum and urine immunofixation were negative. Renal biopsy showed moderately severe nephrocalcinosis, with a moderately severe chronic active interstitial nephritis without granulomas. Densely packed eosinophilic protein reabsorption granules were seen in PTs, which stained strongly for lysozyme. Advanced sclerosis was seen. He had high serum lysozyme (28mcg/mL) and ACE (84U/L) levels. Evaluation for Fanconi syndrome showed glycosuria and euglycemia, and a basic urine pH, but normal uric acid handling. He was treated with prednisone 1 mg/kg/day for 6 weeks followed by an 8-week taper, without improvement in GFR. BAL showed multinucleated giant cells, consistent with sarcoidosis.

**Discussion:** Rare case reports describe lysozyme-induced nephropathy in sarcoidosis. It is more commonly seen in chronic monocytic or myelomonocytic leukemia, as these clonal populations produce excessive lysozyme. Measurement of serum lysozyme levels could be considered in patients with sarcoidosis and a rising creatinine, or with UPCR and UACR discordance. This may guide future therapies directed at excessive macrophage activity, thereby improving renal function.

#### SA-PO099

##### Claudin-4, a Core Component of the Tight-Junctional Complex Along the Collecting System, Is Induced in Nephrotic Syndrome

Ali Sassi,<sup>1,2</sup> Valerie Olivier,<sup>1,2</sup> Gregoire Arnoux,<sup>1</sup> Isabelle Roth,<sup>1</sup> Alexandra Chassot,<sup>1</sup> Eric Feraille,<sup>1,2</sup> Suresh Ramakrishnan.<sup>1</sup> *Department of Cell Physiology & Metabolism, Faculty of Medicine, University of Geneva, Geneva, Switzerland; <sup>2</sup>National Centre of Competence in Research "Kidney.ch", Geneva, Switzerland.*

**Background:** Nephrotic syndrome (NS) is characterized by massive proteinuria, hypoalbuminemia and edema secondary to renal sodium chloride retention. Along the kidney tubule, sodium and chloride reabsorption are coupled via a combination of transcellular and paracellular transport pathways. The mechanism of sodium retention in NS has been extensively studied, but the associated chloride transport pathway has not been elucidated.

**Methods:** To investigate the pathway of chloride retention in NS, we assessed the expression levels of both paracellular and transcellular components of chloride transport in the CD of POD-ATTAC mice and PAN rats, two rodent models of NS. We also used cultured mouse cortical collecting duct cells to see how overexpression or silencing of claudin-4 affect paracellular permeability. Finally, human renal biopsies were used to confirm our *in vivo* results.

**Results:** In control animals, claudin-4 was expressed at low levels in collecting duct (CD). In POD-ATTAC mice and PAN rats, claudin-4 expression was strongly increased in CD beta-intercalated cells (B-IC) and to a lesser extent in CD principal cells and was also induced in connecting tubules. Similarly, we found that claudin-4 was expressed at low levels in normal human kidneys and was dramatically increased in CD cells of nephrotic human kidneys (focal and segmental glomerulosclerosis). In parallel, the expression of pendrin, which exchanges chloride for bicarbonates in B-IC, was decreased in nephrotic compared to control animals. However, the increase in claudin-4 expression observed in NS is likely independent of pendrin abundance. Increased claudin-4 abundance is coupled with increased ENaC-dependent sodium transport. Overexpression or silencing of claudin-4 in mCCD<sub>c11</sub> cells confirmed the preferential permeability of claudin-4 to chloride over sodium.

**Conclusions:** These results suggest that during NS, transcellular Cl<sup>-</sup>/HCO<sub>3</sub><sup>-</sup> transport decreases while paracellular chloride transport via claudin-4 may increase along the collecting system. Paracellular chloride permeability may constitute a chloride shunt that favors Na<sup>+</sup> reabsorption and opposes K<sup>+</sup> secretion along the CD in NS.

**Funding:** Government Support - Non-U.S.

## SA-PO100

**Renal Organic Anion and Cation Transporters Are Downregulated in Ischemia/Reperfusion and Cisplatin-Induced AKI Models, but Not in Cecal Slurry-Induced AKI**

Jenson Qi, Henriette Frikke-Schmidt, Kamal Albarazani, Nataliya Skrypnik, Li-Jun Ma, Katharine D'Aquino, Raul Camacho, Lili Guo, Janos Steffen, Tao Chen, Andrea R. Nawrocki, Seunghun P. Lee, Alessandro Poci. Cardiovascular & Metabolic Research Janssen Research and Development LLC, Spring House, PA.

**Background:** Renal proximal tubules excrete metabolites through unidirectional solute transport systems facilitating active secretion of organic ions into urine. We explored 3 classes of transporters: (1) organic anion transporters (OAT), (2) organic cation transporters (OCT), and (3) aquaporins (AQP). We then investigated the effects of acute kidney injury (AKI) induced by ischemia/reperfusion (I/R), cisplatin, or cecal slurry (CS) on the expression of these transporters.

**Methods:** Male SD rats had bilateral renal ischemia or sham-surgery. Kidneys were harvested at 24h. Male C57BL/6N mice were IP dosed with a single injection of cisplatin. Kidneys were harvested at 96h. In the CS model, male C57BL/6N mice were IP dosed with vehicle or cecal slurry and sacrificed at 8 or 24h.

**Results:** SD rats express high levels of renal OAT1/3, OCT2, and AQP1 mRNAs. I/R rats with 33 min of bilateral renal ischemia showed significant decrease of renal OAT1, OAT3, OCT2, and AQP1 mRNAs (76%, 92%, 90%, and 61% reduction, respectively). 40 min I/R led to further decrease of these mRNAs. In C57BL/6N mice, OAT2/3, OCT1/2, and AQP1 are highly expressed in the kidney. We also observed significant decrease of these genes in kidney in I/R mice. In cisplatin-induced mouse nephrotoxic AKI, renal OAT2/3, OCT1/2, mRNAs were significantly reduced (>80%), while AQP1 mRNA was down by 65%. In contrast, no reduction of renal OAT2/3 and OCT1/2 mRNAs, nor any increase of kidney injury marker KIM1 were observed at 8 or 24 in CS mouse AKI. Unlike I/R induced-tubular necrosis in the renal outer medulla, CS induced vacuolation and tubule dilation in the cortex. We detected low expression of OATs/OCTs in human renal proximal epithelial cells which renders it difficult to assess their regulation in vitro.

**Conclusions:** Our data show significant downregulation of renal OATs and OCTs in I/R and cisplatin-induced AKI. These reductions might lead to decreased transport activities in the proximal tubule and further deterioration of renal function after injury. The lack of downregulation of renal OATs and OCTs in the CS mouse AKI suggests that the injury of the renal tubule epithelial cells is less in this model.

**Funding:** Commercial Support - Janssen Research & Development of Johnson & Johnson

## SA-PO101

**Mechanism of Immunogenicity Change of Renal Tubular Epithelial Cells Induced by MDM2 Membrane Translocation in Ischemic AKI**

Jieyu Zeng, Hua Su, Chun Zhang. Huazhong University of Science and Technology, Wuhan, China.

**Background:** Increased immunogenicity of proximal tubular epithelium (PTE) contributes to donor acute kidney injury (AKI) associated TCMR. Formerly, we found MDM2, an E3 ubiquitin ligase, translocated from cytosol to basolateral membrane of tubules during AKI. To explore the underlying relationship between MDM2's translocation and tubular immunogenicity will provide reliable clues to alleviating the shortage of donor as well as preventing the loss of graft.

**Methods:** AKI was induced by ischemia/reperfusion treatment in 8-week C57BL/6 mice. After 45 minutes of bilateral renal pedicle clamping, they were divided into sham, 2 days and 4 days groups according to the time of reperfusion. The expression and distribution of MDM2 and PD-L1 were analyzed by immunostaining and Western blot. In vitro, NRK-52E cells were cultured in a hypoxic environment for different time points (1% O<sub>2</sub>) followed by reoxygenation, and mutated MDM2 plasmid were utilized to interfere the subcellular transportation of MDM2.

**Results:** The distribution of MDM2 gradually shifts to basolateral membrane after renal IRI. Moreover, in IRI groups the abundance of PD-L1, known as a T cell inhibitory co-stimulatory molecule, is weakened significantly. In vitro, by oxygen-glucose deprivation or genetic interfering techniques we demonstrated that MDM2's trafficking attributes to PD-L1 degradation during hypoxia.

**Conclusions:** During ischemic AKI or hypoxia, the translocation of tubular MDM2 leads to basolateral PD-L1 degradation which consequently results in the downregulated inhibitory co-stimulatory signaling with T cell activation.

**Funding:** Government Support - Non-U.S.

## SA-PO102

**Canagliflozin Improves Renal Oxidative Stress and Inflammation in Ischemia-Reperfusion Syndrome in Rats**

Maria de Fatima F. Vattimo,<sup>1,2</sup> Sara Ventura,<sup>1,2</sup> Eloiza O. Silva,<sup>1,2</sup> Victor Debbas,<sup>1,3</sup> Experimental Research Group on Acute Kidney Injury <sup>1</sup>Universidade de Sao Paulo, Sao Paulo, Brazil; <sup>2</sup>School of Nursing, Sao Paulo, Brazil; <sup>3</sup>Universidade de Sao Paulo Instituto do Coracao, Sao Paulo, Brazil.

**Background:** Recent studies have shown that sodium-glucose cotransporter 2 (SGLT-2) inhibitors alleviate acute kidney injury (AKI) in diabetic patients. Ischemia-reperfusion (I/R) syndrome is the most relevant cause of AKI. Several molecular

mechanisms, including oxidative stress as well as the inactivation of anti-inflammatory pathways such as Nrf2, contribute to the I/R syndrome. The aim of this study is to investigate the renoprotective effect of canagliflozin on I/R syndrome in non-diabetic rats.

**Methods:** Wistar rats were divided into: SHAM: surgery control; I/R: ischemic group (30 minute bilateral renal clamping); CANA: canagliflozin (30 mg/kg, once, daily, 5 days); CANA+I/R: as described. Renal hemodynamics such as renal blood flow (RBF) and renal vascular resistance (RVR); renal function (inulin clearance, plasma creatinine); oxidative metabolites (urinary peroxides, TBARS, urinary nitrate and thiols in renal tissue) and Nrf2 were analyzed.

**Results:** [Figure 1] [Figure 2]

**Conclusions:** Canagliflozin did not induce hypoglycemia and has significant potential as a therapeutic intervention to ameliorate renal injury after renal I/R and attenuate oxidative stress and inflammation.

**Funding:** Government Support - Non-U.S.

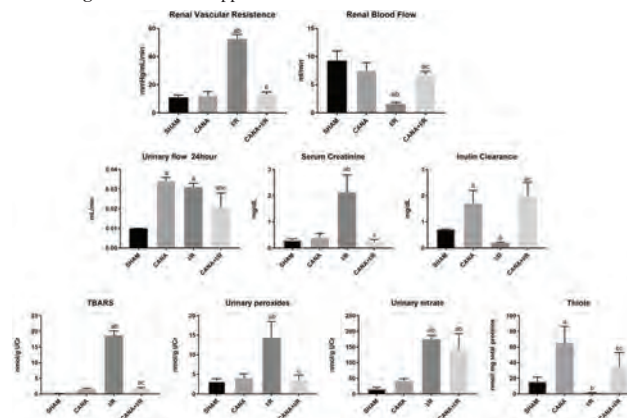

Figure 1. Hemodynamics, renal function and oxidative stress.

Values shown are mean±SE: a p<0,05 versus SHAM; b p<0,05 versus CANA; c p<0,05 versus I/R were significantly different as indicated; one way ANOVA followed by Tukey's post test were performed.

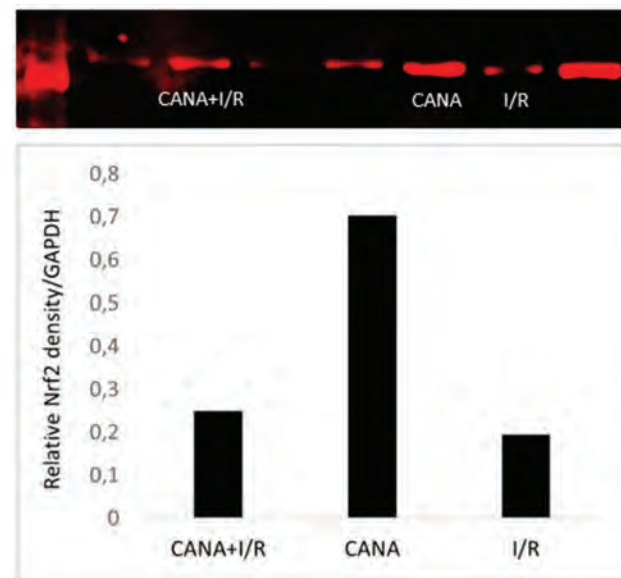

Figure 2. Densitometry of Nrf2. I/R syndrome can inhibit the Nrf2 pathway.

## SA-PO103

**Deficiency of Long-Chain Acyl-CoA Dehydrogenase (LCAD) Protects Against AKI**

Takuto Chiba, Eric S. Goetzman, Sunder Sims-Lucas. University of Pittsburgh School of Medicine, Pittsburgh, PA.

**Background:** Acute kidney injury (AKI) is caused by distinct etiologies including renal ischemia/ reperfusion injury (IRI) and nephrotoxins such as cisplatin. Proximal tubular epithelial cells (PTECs) are particularly vulnerable to such injuries, owing to high energy demands. While fatty acids are the preferred energy source for PTECs via fatty acid oxidation (FAO), FAO-mediated H<sub>2</sub>O<sub>2</sub> production in mitochondria has been shown to be a major source of oxidative stress in multiple diseases, including AKI. We have previously shown that mitochondrial flavoprotein long-chain acyl-CoA dehydrogenase

(LCAD), which catalyzes a key step in mitochondrial FAO, directly produces H<sub>2</sub>O<sub>2</sub> in vitro. However, the role of LCAD during AKI has yet to be determined.

**Methods:** LCAD deficient mice (-/-) and wild-type controls (+/+) were both derived from a common breeding pair of LCAD heterozygous deficient mice (+/-). Western blot analysis confirmed loss of LCAD expression in LCAD-/- kidneys. Male mice age 10-14 weeks were subjected to two distinct AKI models: 1. renal IRI (18 min ischemia) or 2. Single high dose cisplatin (24 mg/kg bw, i.p.). The kidneys were monitored by histologic evaluation (H&E staining) and serum chemistry. Female mice age 10-14 weeks were also subjected to the high-dose cisplatin-AKI model (20 mg/kg bw, i.p.).

**Results:** LCAD deficiency does not cause any overt change in renal histology or function in the absence of injury. However, following renal IRI or cisplatin treatment, age- and sex-matched LCAD-/- kidneys demonstrated protected kidney function (limited BUN/creatinine increase) and less tissue injury when compared with controls. This was coupled with inhibited mitochondrial FAO. Additionally, LCAD-/- mice showed that mitigated reduction of serum albumin or bicarbonate following AKI.

**Conclusions:** LCAD deficiency confers protection against two distinct models of AKI in a sex independent manner. This suggests a therapeutically attractive mechanism whereby decreased mitochondrial FAO mediates protection against AKI.

**Funding:** NIDDK Support, Private Foundation Support

## SA-PO104

### The Fms-Like Tyrosine Kinase Receptor 3 Ligand/Dendritic Cell Axis Contributes to Kidney Recovery in AKI

Li Na,<sup>1</sup> Yao Guo,<sup>1</sup> Chuy Xie,<sup>1</sup> Meihua Lu,<sup>2</sup> Dengyang Zhang,<sup>1</sup> Yuming Zhao,<sup>1</sup> Jiayi Chen,<sup>1</sup> Zhihua Zheng,<sup>1</sup> Yun Chen,<sup>1</sup> Zhizhuang J. Zhao,<sup>3</sup> <sup>1</sup>The Seventh Affiliated Hospital Sun Yat-sen University, Shenzhen, China; <sup>2</sup>Department of General Practice, BaNa Hospital of Chongqing Medical University, Chongqing, China; <sup>3</sup>Department of Pathology, University of Oklahoma Health Sciences Center, Lindsay, OK.

**Background:** Dendritic cells (DC) are involved in the recovery process of acute kidney injury disease (AKD). Lymphoid DC development is critically dependent on Fms-like tyrosine kinase receptor 3 ligand (Flt3L) in vivo. However, the role of Flt3L in the maintenance of kidney DC and the outcome of AKD are not defined. We hypothesized that Flt3L might improve the tubular recovery after AKD by fostering the accumulation of DC.

**Methods:** Blood were collected from patients of prerenal or renal AKD and healthy controls. Wild type mice and IRF8<sup>ko</sup> mice were treated with 15µg rFlt3L or 10mg/kg Flt3 inhibitor gilteritinib. They were subjected to ischemia-reperfusion (IR) to induce post-ischemic AKD or were injected with 15mg/kg cisplatin to induce nephrotoxic AKD. Serum and kidneys were collected. Kidney function, tubular injury, primary/proximal tubular cell numbers were quantified.

**Results:** Initially, we observed an increased level of serum Flt3L in patients with AKD. Further analysis revealed that this increase was specific for trauma- rather than heart failure- or sepsis-induced AKD. A similar increase in serum Flt3L was found in mice with IR-AKD but not cisplatin-induced AKD. This was accompanied by reduced blood DC but increased kidney DC in mice after IR-AKD. The numbers of type I conventional dendritic cell (cDC1) and CD64<sup>+</sup>DC in kidney were significantly decreased in gilteritinib-treated IR-AKD mice, which were associated with more severe tubular injury. With reduced kidney cDC1, IRF8<sup>ko</sup> mice also showed worsen kidney injury and aggravated functional failure upon IR-AKD. Therapeutic administration of rFlt3L significantly increased kidney cDC1 and CD64<sup>+</sup>DC upon IR-AKD in wild type but not IRF8<sup>ko</sup> mice. This was associated with reduced tubular injury, enhanced proliferation activity of tubular cells, and decreased expression of tubular injury markers (*Ngal*, *Timp-2*, *Igf1bp-7* and *Hgf*) in kidney of wild type mice. In addition, pre-treatment of wild type mice with rFlt3L increased kidney cDC1 and protected the mice from severe IR-AKD.

**Conclusions:** Flt3L is upregulated in humans and mice during IR-AKD. It fosters the accumulation of kidney cDC1 and CD64<sup>+</sup>DC, thereby limiting the severity of kidney injury in mice. The current study implies the possibility of DC-based immunotherapy for treatment of AKD.

## SA-PO105

### Discovery of Osteopontin-Dependent and Independent Signaling Networks in AKI-Induced Remote Acute Lung Injury (AKI-ALI)

Yohei Komaru,<sup>1</sup> Liang Ning,<sup>1</sup> Eirini Kefalogianni,<sup>1</sup> Andreas Herrlich,<sup>1,2</sup> Division of Nephrology <sup>1</sup>Washington University in St Louis School of Medicine, St Louis, MO; <sup>2</sup>St. Louis Veterans Administration Health Care System, St. Louis, MO.

**Background:** Using scRNAseq and ligand-receptor pairing analysis across organs, we identified circulating osteopontin (OPN) released from the AKI kidney and deposited into the lung as a causal agent of AKI-ALI [Khamissi et al. *Science Advances* 2022]. Direct ALI complicated by AKI is a frequent clinical problem with high mortality. How AKI modifies ALI outcomes and whether AKI-released OPN deposited into the lung acts as a negative modifier of direct ALI is unknown.

**Methods:** Single-cell RNA sequencing (scRNAseq) of lung or kidney after sham or AKI (ischemia reperfusion injury). Interorgan cell communications were identified using scRNAseq analysis with CellPhone DB or CellChat. Direct ALI was induced with intratracheally instilled lipopolysaccharide (LPS-ALI). In a two-hit model, renal IRI was added 24 hours after LPS-ALI.

**Results:** OPN injection is not sufficient to induce ALI in uninjured mice, thus additional AKI-released mediators are involved. We initially focused on OPN-dependent

kidney-lung networks, which were increased by 3-fold in AKI as compared to the sham. In AKI, the average interaction strength was increased by 90%. Baseline OPN signals towards lung immune cells mainly originated from the proximal and distal tubules. These OPN-dependent signals likely represent early AKI-ALI mediators that don't require transcriptional upregulation. Analysis of OPN-independent kidney to lung networks revealed that total kidney-lung connections were very similar in number and strength between sham and AKI. However, several signaling networks significantly differed in AKI vs sham, likely indicating novel relevant signals for AKI-ALI emanating from the kidney. We hypothesized further that AKI-released osteopontin could modify pre-existing ALI outcomes. We found that OPN protein expression in the directly LPS-injured lung was moderately elevated. However, addition of AKI after direct LPS-induced ALI further significantly increased OPN protein accumulation in the lung. This suggests a mechanistic connection between kidney-released and lung deposited OPN and the clinically observed worsening of direct ALI outcomes in the context of AKI.

**Conclusions:** Studies integrating single-cell transcriptomics and *in vivo* models enable elucidation of novel mechanism(s) of AKI-ALI in clinically relevant contexts at the cell-type and signal-pathway level.

**Funding:** NIDDK Support, Veterans Affairs Support

## SA-PO106

### Kidney HMGCS2 Protects Against Ischemic Kidney Injury

Andrea H. Venable, Lauren Elizabeth Lee, Kyle C. Feola, Sarah C. Huen. *The University of Texas Southwestern Medical Center, Dallas, TX.*

**Background:** Chronic kidney disease (CKD) is a growing global health problem. Evidence for abnormal renal fatty acid oxidation (FAO) in kidney disease suggests that dysregulated metabolism is a key component of kidney disease pathogenesis. Ketogenesis is a central metabolic pathway in which ketone bodies are produced from FAO. While the liver is the main ketogenic organ, the rate-limiting enzyme for ketogenesis, mitochondrial Hydroxymethylglutaryl-CoA synthase 2 (HMGCS2), is induced in the proximal tubule of the kidney during fasting. We previously demonstrated that HMGCS2 induced in the kidney does not contribute to the circulating pool of ketones during fasting and cannot compensate for hepatic ketogenic deficiency. We hypothesized that kidney HMGCS2 may be acting locally within the kidney to maintain normal function during metabolic stress or injury.

**Methods:** Using novel mouse models with proximal tubular hemagglutinin (HA)-tagged mitochondria with (*Ggt1-Cre;Hmgcs2<sup>fl/fl</sup>;MITO-Tag*, Ggt<sup>Hmgcs2KO-MT</sup>) or without (*Ggt1-Cre;MITO-Tag*, Ggt-MT) *Hmgcs2* deletion, proximal tubular-specific mitochondria were isolated using anti-HA magnetic beads and mitochondrial respiration was determined by Seahorse. *Six2-Cre;Hmgcs2<sup>fl/fl</sup>* (*Six2<sup>Hmgcs2KO</sup>*) mice with kidney-specific *Hmgcs2* deletion and *Hmgcs2<sup>fl/fl</sup>* littermate controls were subjected to ischemia/reperfusion injury (IRI). An acute kidney injury (AKI) model with right nephrectomy and left IRI and a chronic kidney disease (CKD) model with unilateral IRI were used. Plasma creatinine and/or kidney mRNA expression was assessed 24 hours (AKI) and 14 days (CKD) after IRI.

**Results:** Proximal tubular-specific mitochondria isolated from 24-hour fasted Ggt-MT and Ggt<sup>Hmgcs2KO-MT</sup> mice demonstrated that mitochondria lacking HMGCS2 had significantly lower basal and ADP-stimulated Complex I and II activity as measured by mitochondrial oxygen consumption rate. Compared to littermate controls, *Six2<sup>Hmgcs2KO</sup>* mice had significantly higher plasma creatinine levels and expression of the kidney injury marker *Kim1* after AKI. In the CKD model, inflammation (*Tnfa*) was significantly elevated and markers of fibrosis (*Colla1*, *Col4a1*, *Tgfb1*) trended higher in *Six2<sup>Hmgcs2KO</sup>* injured kidneys.

**Conclusions:** Our data provide evidence that proximal tubular HMGCS2 may play an important role in maintaining mitochondrial function and protecting against ischemic kidney injury.

**Funding:** NIDDK Support, Other NIH Support - NIGMS

## SA-PO107

### Hypoxia Induces Pro-Regenerative Activity of Renal Fibroblasts via Hif1α

Michael Zeisberg, Gunsmay Nyamsuren. *University of Goettingen Medical Center, Goettingen, Germany.*

**Background:** Fibroblasts are the prototypical cells of connective tissue. In the kidney they are known to be the main mediators of fibrosis. It is often overlooked that renal fibroblasts have important physiological functions, such as control of regeneration from acute damage and the synthesis of erythropoietin. Recent studies demonstrated that acute kidney injury is associated with transient accumulation of activated fibroblasts, which aid regeneration of the injured tubular epithelium. Increased expression of growth factors by activated fibroblasts such as VEGF and FGF4 suggests that fibroblasts aid repair of the injured tubular epithelium through paracrine mechanisms. This study aimed to gain additional insight into the contribution of FGF4 to kidney regeneration and the underlying mechanisms.

**Methods:** Ischemia-reperfusion injury was induced by clamping of the of the left kidney pedicle for 45 min. For reporter assays full length human FGF4 promoter DNA from -650 to +886 bp including three hypoxia response elements were cloned into pGL4.10 luciferase reporter plasmid and subjected to site-directed mutagenesis.

**Results:** We report that acute ischemic kidney injury in mice and in humans was associated with increased expression of FGF4 by interstitial cells and with increased expression of FGF-receptors by tubular epithelial cells. Conditional ablation of FGF4 or administration of FGF4-neutralizing antibodies blunted renal regeneration upon ischemia-reperfusion injury. Cultivation of normal human kidney fibroblasts under

hypoxic conditions induced FGF4 expression. Overexpression of a dominant-negative Hif1 $\alpha$ -mutant blunted FGF4 expression in response to hypoxia, whereas hypoxia-independent intracellular accumulation of Hif1 $\alpha$  under normoxic conditions through its superphysiologic transgenic overexpression induced FGF4 transcription. Use of an FGF4 reporter construct in which hypoxia response elements (HREs) had been mutated further confirmed that hypoxia induces FGF4 expression in renal fibroblasts in Hif1 $\alpha$ -dependent manner.

**Conclusions:** Our studies provide evidence that fibroblast aid in the repair of acute kidney injury through secretion of growth factors such as FGF4. Our studies further demonstrate that FGF4 expression is induced in response to hypoxia via Hif1 $\alpha$ , suggesting that modulation of Hif1 $\alpha$  responses may be an attractive therapeutic target to enhance renal regeneration.

**Funding:** NIDDK Support, Government Support - Non-U.S.

#### SA-PO108

##### **Tubular MPC1 Reduction Is a Protective Adaptive Response to Maintain Redox Balance in Rhabdomyolysis Induced AKI**

Gabriela Vasquez Martinez,<sup>1</sup> Ji Young Kim,<sup>2</sup> Gabriel Mayoral Andrade,<sup>1</sup> Ashley R. Jackson,<sup>1,2</sup> Navjot Singh P. Pabla,<sup>2</sup> Diana Zepeda-Orozco,<sup>1,2</sup> <sup>1</sup>Nationwide Children's Hospital, Columbus, OH; <sup>2</sup>The Ohio State University, Columbus, OH.

**Background:** Pyruvate is the end product of both glucose and lactate metabolism, and it is a key tubular mitochondrial metabolic fuel with important antioxidant properties that is disrupted in AKI. Pyruvate requires mitochondrial pyruvate carrier (MPC) to enter mitochondria. MPC deletion causes redox alteration characterized by disruptions in glutathione metabolism. We hypothesize tubular MPC is disrupted in AKI and has important contribution to redox responses after AKI.

**Methods:** Glycerol-induced rhabdomyolysis (7.5 ml/kg 50% glycerol in the hind-leg muscles) was induced in male ROSA mT/MG/Gt1-Cre that express membrane-localized GFP in renal tubular epithelial cells, whereas all the other cell types express membrane-localized tdTomato. Kidneys were collected at 24 hours, followed by isolation of GFP positive (RTECs) and negative cells for immunoblot and gene expression analysis. Pax8<sup>Cre</sup>-Mpc1<sup>fl/fl</sup> (TMPC1-KO) mice and Pax8<sup>Cre</sup>-Mpc1<sup>fl/fl</sup> (TMPC1-WT) littermates underwent glycerol-induced rhabdomyolysis, blood and kidneys were collected at 30 hours after injury for kidney function, histology and redox response analysis.

**Results:** Rhabdomyolysis induced AKI result a reduction of MPC1 mRNA and protein expression only in tubular cells. TMPC1-KO mice who underwent rhabdomyolysis induced AKI had significant reduction on serum cystatin C, blood urea nitrogen (BUN), and tubular tunnel positive cells compared to WT. TMPC1-KO mice with rhabdomyolysis induced AKI had a significant increase in kidney glutathione and thioredoxin reductase activities, as well as glucose-6-phosphate dehydrogenase activity that was not significant in WT mice

**Conclusions:** Rhabdomyolysis induced AKI results on tubular MPC1 reduction. Tubular MPC1 deletion protects from rhabdomyolysis induced AKI and results on increased hydrogen peroxide antioxidant systems response capacity after injury, suggesting that MPC inhibition could be a novel therapeutic approach to manipulate redox response and protect from AKI

#### SA-PO109

##### **Novel Exosome-Based Therapeutics Targeting NF- $\kappa$ B/p65 for AKI** Chulhee Choi. ILIAS Biologics Inc., Daejeon, Republic of Korea.

**Background:** Either systemic or local inflammation-induced by infection or ischemic reperfusion is the key pathophysiological event driving sepsis associated (SA-) and cardiac surgery-associated (CSA-) AKI development. NF- $\kappa$ B signaling pathway plays a pivotal role in driving inflammation in both SA- and CSA-AKI. Effective/specific inhibition of NF- $\kappa$ B signaling pathway may ameliorate the course of SA- and CSA-AKI. Recent advancements in nano-technology made it feasible to specifically target NF- $\kappa$ B signaling. The intracellular delivery of protein API (NF- $\kappa$ B inhibitor) with exosome as DDS is an attractive approach for tackling NF- $\kappa$ B signaling in the target cells without off-target effect in both SA- and CSA-AKI.

**Results:** Utilizing ILIAS Bio's EXPLOR® (EXosome engineering for Protein Loading via Optically Reversible protein-protein interactions) technology, we have developed Exo-srI $\kappa$ B with srI $\kappa$ B as API which is a constitutively active form of I $\kappa$ B $\alpha$  with a prolonged half-life in the target cells. Exo-srI $\kappa$ B exhibits anti-inflammation function via specific inhibition of stimuli-induced NF- $\kappa$ B/p65 activation. In the septic mice, the treatment of Exo-srI $\kappa$ B inhibits systemic inflammation and improves survival with the amelioration of SA-AKI. In the renal ischemic-reperfusion mice, the treatment of Exo-srI $\kappa$ B alleviates IRI-AKI by down-regulating NF- $\kappa$ B signaling and ameliorating inflammation/apoptosis in the ischemic injured kidney.

**Conclusions:** The direct intracellular delivery of immunosuppressive protein (srI $\kappa$ B) into target cells using exosomes can be used as a promising therapeutic approach for both SA- and CSA-AKI. The therapeutic potential of Exo-srI $\kappa$ B in both SA- and CSA-AKI should be explored further by clinical trials. Via GLP-toxicology and safety pharmacology studies, it has been determined that Exo-srI $\kappa$ B has no toxicity with minimum 20 folds safety margin compared to the efficacy dose, and based on repeated dose study, both NOAEL and HED were determined, which grant Exo-srI $\kappa$ B first-in-human (FIH) study.

#### SA-PO110

##### **Resident Macrophages Occupy Distinct Microenvironments in the Mouse and Human Kidney**

Matthew D. Cheung, Elise Erman, Kyle H. Moore, Gelare Ghajar-Rahimi, Anupam Agarwal, James F. George. *The University of Alabama at Birmingham School of Medicine, Birmingham, AL.*

**Background:** Kidney resident macrophages (KRM) are a unique, self-renewing F4/80<sup>hi</sup>CD11b<sup>int</sup> population important for renal homeostasis and the response to acute kidney injury (AKI). Since they are present throughout the kidney tissue, which contains many distinct microenvironments, we hypothesized that subpopulations of KRM are functionally diverse and location-specific. Here, we combined single-cell and spatial transcriptomics to characterize mouse and human KRM subpopulations during homeostasis and injury.

**Methods:** KRM were isolated from C57BL/6J mice without treatment and after 19 min bilateral ischemia-reperfusion injury (BIRI) as well as from human kidneys from 2 kidney donors with creatinines of 0.9 and 2.5 mg/dL. We combined single-cell RNA sequencing (scRNAseq), spatial transcriptomics, flow cytometry, and immunofluorescence imaging to localize, characterize, and validate KRM populations during quiescence and following kidney injury in both mice and humans. scRNAseq and spatial gene expression data were analyzed using the R package, Seurat 4.0.

**Results:** scRNAseq and spatial transcriptomics revealed seven distinct KRM subpopulations in untreated mice that each reside within distinct zones associated with specific nephron structures. Each subpopulation was identifiable by a unique transcriptomic signature suggesting distinct functions. Specific protein markers were identified for several clusters allowing analysis by flow cytometry or immunofluorescence imaging. After injury, the localization of the KRM subpopulations change indicating either movement or changes in functional phenotypes. The pre-injury KRM topology is not fully restored for at least 28 days post-injury. Several human KRM subpopulations appear analogous to those of the mouse and also localize to specific regions.

**Conclusions:** KRM consist of subpopulations organized into zones associated with nephron structures. The organization of these zones appear to change after function of injury, likely reflecting a differential response to the various damaged kidney structures. Similar subpopulations of KRM were identified in the human kidney. Therefore, further study of the temporal and spatial characteristics and signaling pathways of these subpopulations in the context of homeostasis and injury is warranted.

**Funding:** NIDDK Support

#### SA-PO111

##### **Platelet-Instructed SPP1 Macrophages Drive Myofibroblast Activation in Fibrosis in a CXCL4-Dependent Manner**

Konrad Hoeffl,<sup>1,2</sup> Gideon Schaefer,<sup>1</sup> David Schumacher,<sup>1,3</sup> Hyojin Kim,<sup>1</sup> Barbara M. Klinkhammer,<sup>4</sup> Christoph Kuppe,<sup>1,2</sup> Peter Boor,<sup>4</sup> Sikander Hayat,<sup>1</sup> Rafael Kramann,<sup>1,2</sup> Kramann Laboratory for Translational Cardiovascular and Kidney Research <sup>1</sup>University Hospital Aachen Institute of Experimental Medicine and Systems Biology, Aachen, Germany; <sup>2</sup>Universitätsklinikum Aachen Klinik für Nieren- und Hochdruckkrankheiten rheumatologische und immunologische Erkrankungen, Aachen, Germany; <sup>3</sup>Universitätsklinikum Aachen Klinik für Anästhesiologie, Aachen, Germany; <sup>4</sup>Universitätsklinikum Aachen Institut für Pathologie, Aachen, Germany.

**Background:** Fibrosis represents the common end-stage of chronic organ injury independent of the initial insult, destroying tissue architecture and driving organ failure. Immune cells are key players in fibrosis, which regulate mesenchymal cell activation. However, the signals driving profibrotic immune cell differentiation and subsequent fibroblast crosstalk remain ill-defined.

**Methods:** We analyzed single cell RNA sequencing (scRNA-seq) data of mice after myocardial infarction (MI) to identify profibrotic immune cells. To validate CXCL4 as a mediator of fibrosis we investigated the effect of a CXCL4-KO in monocytes *in vitro*, as well as in mouse models of MI and kidney ischemia reperfusion injury (IRI). To elucidate profibrotic macrophage-fibroblast crosstalk we performed single nuclear RNA sequencing (snRNA-seq) of WT and *Cxcl4*<sup>-/-</sup> mice after IRI. The role of platelet-derived CXCL4 was assessed by co-culturing WT and CXCL4<sup>-/-</sup> platelets with PBMC. Lastly, we analyzed *SPP1* macrophages in open-source scRNA-seq data of human heart failure (HF) and chronic kidney disease (CKD) as well as via immunostaining/in situ-hybridisation in a cohort of 43 human kidneys.

**Results:** We discovered a profibrotic macrophage population marked by *Spp1* (*Spp1* Mac), which expands after MI. Trajectory inference analysis of *Spp1* Mac identified CXCL4 as one of the top upregulated genes during *Spp1* Mac differentiation. *In vitro* and *in vivo* studies demonstrated that loss of *Cxcl4* abrogates *Spp1* Mac differentiation and fibrosis after MI and IRI. SnRNA-seq of WT and *Cxcl4*<sup>-/-</sup> mice after IRI revealed that macrophages orchestrate fibroblast activation via *Spp1*, *Fnl1* and *Sema3* crosstalk. Importantly, we uncovered that platelets drive profibrotic *Spp1* Mac differentiation via CXCL4. Lastly, we show that *SPP1* Mac expand in human HF and CKD and that *SPP1*<sup>+</sup> Mac correlate closely with *COL1A1* expression in 43 human kidneys.

**Conclusions:** We identified a novel profibrotic macrophage population defined by *Spp1* expression and demonstrate that *Spp1* macrophage differentiation is driven by CXCL4. Strikingly, we uncovered an unexpected link between platelets, the main source of CXCL4, macrophages and fibrosis. Targeting platelet-macrophage interaction could serve as a springboard for novel strategies aimed at mitigating fibrosis.



## SA-PO112

## AKI Enhances Aortic Plaque Formation in a Mouse Model of Atherosclerosis in a CCR2-Dependent Manner

Anne M. Brelloh,<sup>1</sup> Vera C. Wulfmeyer,<sup>1</sup> Svenja Gaedcke,<sup>1</sup> Susanne V. Fleig,<sup>1</sup> Song Rong,<sup>1</sup> David S. Deluca,<sup>1</sup> Hermann G. Haller,<sup>1</sup> Roland Schmitt,<sup>1</sup> Sibylle Von Vietinghoff,<sup>2</sup> <sup>1</sup>Medizinische Hochschule Hannover, Hannover, Germany; <sup>2</sup>Universitätsklinikum Bonn, Bonn, Germany.

**Background:** Acute kidney injury enhances the risk of subsequent cardiovascular events. To determine underlying mechanisms, we established a model of atherosclerosis after renal ischemia reperfusion (IR) injury. Leukocytes promote atherosclerotic plaque growth and instability. We here studied underlying recruitment mechanisms.

**Methods:** Atherosclerotic lesions and inflammation were investigated in native and bone marrow-transplanted LDL receptor deficient (*LDLr<sup>-/-</sup>*) mice after unilateral renal IR injury by histology, flow cytometry and gene expression analysis.

**Results:** Aortic root atherosclerotic lesion size was significantly larger after renal IR than in controls. A gene expression screen revealed enrichment of chemokines and their cognate receptors in aortas of IR mice in early atherosclerosis. In advanced disease, this was complemented by T cell-associated genes. Increased aortic macrophage proximity to T cells was observed by confocal microscopy. Differential aortic inflammatory gene regulation in IR mice largely paralleled the pattern in the injured kidney. Renal cell types that produced soluble mediators upregulated in the atherosclerotic aorta were identified by single cell analysis. It revealed a marked early increase in *Ccl2*, which was mainly expressed by CCR2<sup>+</sup> myeloid cells. CCR2 mediated myeloid cell homing to the post-ischemic kidney in a cell-individual manner. Reconstitution with *Ccr2<sup>-/-</sup>* bone marrow dampened renal post-ischemic inflammation, and abrogated excess aortic atherosclerotic plaque formation after renal IR. Ablation of CCR2 significantly altered the inflammatory gene expression profile in the atherosclerotic aortas after renal IR.

**Conclusions:** Our data introduce an experimental model of remote proatherogenic effects of renal IR and delineate myeloid CCR2 signaling as a mechanistic requirement. Further investigations will need to address regulation of aortic gene expression and monocytes as mobile mediators of vascular sequelae after kidney injury.

## SA-PO113

## A Pathological Immunological Approach in Evaluating Immune Checkpoint Inhibitor-Induced Nephritis

Ala Abudayyeh,<sup>1</sup> Liye Suo,<sup>2</sup> Omar Mamlouk,<sup>1</sup> Noha Abdel-Wahab,<sup>1</sup> Yan Heather Lin,<sup>1</sup> Valda D. Page,<sup>1</sup> Jamie S. Lin,<sup>1</sup> Amanda Tchakarov.<sup>2</sup> <sup>1</sup>The University of Texas MD Anderson Cancer Center, Houston, TX; <sup>2</sup>The University of Texas Health Science Center at Houston John P and Katherine G McGovern Medical School, Houston, TX.

**Background:** Immune related adverse events (irAEs) are a management challenge with an associated increased morbidity and mortality. The most common renal toxicity is acute interstitial nephritis (AIN) which may be analogous to kidney transplant rejection. Using both clinical variables and tissue findings focusing on immune cells subtypes we evaluated a cohort of immune checkpoint inhibitor (ICI) cases to determine factors associated with renal response, progression free survival (PFS) and overall survival (OS).

**Methods:** We retrospectively reviewed all patients treated with ICI (2007 to 2020) at MD Anderson. A total of 35 patients with biopsy confirmed AIN were identified and immunofluorescence for CD4, CD8, CD20, and CD68 was performed on 25 cases. All slides were reviewed by two blinded board-certified renal pathologists and the severity of inflammation was graded using BANFF criteria. Patients were categorized as renal responders if creatinine improved or returned to baseline after treatment. Fisher's exact tests for categorical variables and Wilcoxon rank-sum or Kruskal-Wallis for continuous variables were used to compare patient's characteristics between groups. Log-rank test was performed to test the difference in survival between groups.

**Results:** Based on the pathological findings, patients with increased interstitial fibrosis were less likely to have renal response compared to patients with less fibrosis, ( $p = 0.027$ ). Interstitial inflammation, tubulitis, number of eosinophils and neutrophils had no impact on renal response. When evaluating immune subtypes there was no strong association with response ( $p > 0.061$ ). Patients with response within 3 months of AKI had a superior OS (OS rate: 77% vs 27%,  $p = 0.025$ ) compared to late responders. Notably, patients who received concurrent ICI and achieved renal response within 3 months had the best OS in comparison to patients who did not receive concurrent ICI nor achieved renal response (OS rate: 100% vs 27%,  $p = 0.041$ ). Similar trends were observed between response to AKI treatment and PFS.

**Conclusions:** This is the first analysis of ICI induced nephritis where a detailed pathological, immunological and clinical evaluation were performed to predict renal response. Our findings highlight the importance of early diagnosis and treatment of ICI-AIN while continuing concurrent ICI therapy.

## SA-PO114

## A Case of Focal Immune-Complex Membranoproliferative Glomerulonephritis (MPGN) in Low-Risk Chronic Lymphocytic Leukemia

Akira F. Tan, Shin Yeu Ong, Alwin Hwai Liang Loh, Jason Choo Chon Jun, Hui Zhuan Tan. Singapore General Hospital, Singapore, Singapore.

**Introduction:** A broad spectrum of kidney diseases is associated with chronic lymphocytic leukemia (CLL). Optimal treatment of low-risk CLL with renal involvement (CLL-R) is unknown.

**Case Description:** A 48 year-old Chinese man with low-risk CLL presented with new-onset microhematuria and subnephrotic range proteinuria (uPCR 1.88g/g) for evaluation. Peak serum creatinine (sCr) was 115µmol/L (baseline 81µmol/L). Investigations were notable for low C3 (0.88g/L), C4 (<0.06g/L) and IgG-λ monoclonal gammopathy (2g/L). Autoimmune markers, virologies, and serum cryoglobulins were negative. Kidney biopsy showed focal membranoproliferative (MPGN) pattern of injury. No TMA changes were seen. Immunofluorescence showed C3-dominant glomerular and mesangial staining (2+), and segmental IgM mesangial staining (1+). Segmental C4d staining was observed. No deposits were seen on electron microscopy (EM). Pronase digestion was not performed. Findings were most consistent with CLL-related immune-complex MPGN. Venetoclax and Obinutuzumab (Ven-Obi) was commenced. Thrombocytopenia developed 2 days after the first obinutuzumab infusion, leading to gross hematuria and acute kidney injury (AKI) (sCr 161µmol/L). Tumour lysis syndrome was excluded. AKI resolved with conservative management. Interestingly, normalization of complements and proteinuria reduction (uPCR 0.38g/g) were observed within 2 weeks of treatment. Treatment is ongoing but remain uncomplicated.

**Discussion:** We report a case of focal MPGN with C3 dominance in a patient with low-risk CLL. Lack of antigen retrieval techniques precluded the search for masked deposits. Positive C4d staining, together with low C3 and C4, suggested an immune-complex, instead of an alternative pathway mediated process. The absence of deposits on EM was likely due to early focal disease. Studies suggest that clone-directed therapies improve renal outcomes in dysproteinemic-related kidney disease, but the optimal regimen and timing of treatment in early/mild CLL-R is unknown. We demonstrated early renal response to Ven-Obi in our patient. No tumour lysis syndrome was observed during treatment, although thrombocytopenia, a rare adverse effect of Obinutuzumab, did occur together with AKI, the latter possibly due to tubular obstruction by red blood cells casts. Longer follow-up is needed to determine treatment efficacy of Ven-Obi in CLL-R.

## SA-PO115

## On-Treatment Cancer Safety Events With Daprodustat vs. Erythropoiesis-Stimulating Agents: Post Hoc Analyses of ASCEND-ND and ASCEND-D

Ajay K. Singh,<sup>1</sup> Finnian R. McCausland,<sup>1</sup> Brian Claggett,<sup>1</sup> Christoph Wanner,<sup>2</sup> Andrzej Wiecek,<sup>3</sup> Michael B. Atkins,<sup>8</sup> Kevin Carroll,<sup>10</sup> Vlado Perkovic,<sup>4</sup> John McMurray,<sup>6</sup> Janet Wittes,<sup>9</sup> Steven M. Snapinn,<sup>7</sup> Allison Blackorby,<sup>6</sup> Tara Barker,<sup>6</sup> Tara L. Dimino,<sup>6</sup> Stephen Mallett,<sup>6</sup> Amy M. Meadowcroft,<sup>6</sup> Alexander R. Cobitz,<sup>6</sup> Scott D. Solomon.<sup>1</sup> <sup>1</sup>Brigham and Women's Hospital, Boston, MA; <sup>2</sup>University Hospital of Würzburg, Würzburg, Germany; <sup>3</sup>Slaski Uniwersytet Medyczny w Katowicach, Katowice, Poland; <sup>4</sup>The University of Sydney Faculty of Medicine and Health, Sydney, NSW, Australia; <sup>5</sup>University of Glasgow, Glasgow, United Kingdom; <sup>6</sup>GlaxoSmithKline plc, Collegetown, PA; <sup>7</sup>Seattle-Quilcene Biostatistics, Seattle, WA; <sup>8</sup>Georgetown-Lombardi Comprehensive Cancer Center, Washington DC, DC; <sup>9</sup>WCG Statistics Collaborative, Washington, DC; <sup>10</sup>KJC Statistics Limited, Cheshire, United Kingdom.

**Background:** Prespecified on-treatment analyses of ASCEND-ND (NCT02876835) raised concerns for a higher relative risk of cancer-related adverse events (AE) with daprodustat (dapro; a hypoxia inducible factor-prolyl hydroxylase inhibitor) vs darbepoetin (darbe) in patients with anemia of CKD. This was not observed in dialysis patients in ASCEND-D (NCT02879305). As there may be a long latency between onset and diagnosis of cancer AE, we performed post-hoc analyses to estimate risks over time.

**Methods:** ASCEND-ND randomized 3,872 patients to dapro or darbe. ASCEND-D randomized 2,964 patients to dapro or ESAs. Both were open-label; ESA comparators used different dosing intervals (3/week, 1/week, every 2 or every 4 weeks). Cancer-related AE were identified by predefined medical dictionary for regulatory activities terms. The pre-specified approach examined relative risks for cancer AE up to one day after the last dose date (LDD) of randomized therapy. The present analyses used Cox models, adjusted for baseline ESA use and region, to estimate dapro effects by various follow-up periods (censoring at LDD, LDD+dosing intervals, or end of study).

**Results:** In ASCEND-ND, the effect estimate of dapro vs darbe for cancer-related AE depended on the length of follow-up time after LDD (**Fig 1**): hazard ratios 1.04 (95%CI 0.77-1.40) at end of study; 1.12 (95%CI 0.81-1.56) for LDD+dosing interval; 1.50 (95%CI 1.04-2.15) for LDD+1 day. These variations were not seen in ASCEND-D, where shorter ESA dosing intervals were more comparable to dapro.

**Conclusions:** Prespecified on-treatment analyses for cancer-related AE appeared to result in biased estimates of risk in ASCEND-ND, as they preferentially excluded events from patients in the darbe arm. Analyses that account for longer darbe dosing intervals, plus analyses that extend duration of follow-up, may provide a more valid estimate of risk. These resulted in attenuation of effect estimates towards neutrality, similar to ASCEND-D.

**Funding:** Commercial Support - GSK

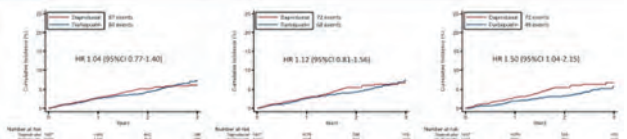

SA-PO116

Urinary Cell BKV-VP1 mRNA Levels in Early Symptomatic Hemorrhagic Cystitis and Kidney Injury in Hematopoietic Stem Cell Transplant Recipients

Victoria Gutgarts,<sup>1,2</sup> Catherine Snopkowski,<sup>2</sup> Yeon Joo Lee,<sup>1,2</sup> Ann A. Jakubowski,<sup>1</sup> Genovefa A. Papanicolaou,<sup>1</sup> Ilya Glezerman,<sup>1,2</sup> Manikkam Suthanthiran,<sup>2</sup> Darshana M. Dadhania,<sup>2</sup> <sup>1</sup>Memorial Sloan Kettering Cancer Center, New York, NY; <sup>2</sup>Weill Cornell Medicine, New York, NY.

**Background:** Asymptomatic BK virus (BKV) viraemia is frequent (up to 60%) peri hematopoietic stem cell transplantation (HCT), however a minority develop BKV hemorrhagic cystitis (HC). We aimed to determine if BKV-VP1 mRNA levels, previously validated urinary biomarker of BKV nephropathy (Dadhania et al, Transplantation 2010) can predict HC and acute kidney injury (AKI) within 3 months of HCT.

**Methods:** Urine samples were collected prospectively from adults undergoing first allogeneic HCT at MSKCC. 4 samples (median) per patient were collected within 3 months of HCT. Urine cell pellets were prepared, total RNA isolated and reverse transcribed to cDNA. Real-time quantitative PCR was used to measure BKV-VP1 mRNA copy number/ug of total RNA. HC was defined as grades 1 to 4; microscopic to macroscopic hematuria with clots, respectively. AKI was defined as Cr ≥ 1.5x baseline at 3 months of HCT.

**Results:** 19 HCT recipients (median age 45, range 24-73, 53% acute leukemia) were profiled and 5 (26%) developed symptomatic HC (4 graded as 1, 1 graded as 3) within 3 months. Eight patients developed AKI at 3 months, majority grade 1. The Figure below shows the average number of BKV VP1 copies per patient. Although the median number of copies were not significantly different between those who developed symptomatic HC and not and those who developed AKI and not in the first three months of HCT, levels in 4 patients exceeded BKV nephropathy (BKVN) diagnostic threshold (>6.5x10<sup>8</sup> BKV VP1 mRNA /microgram RNA).

**Conclusions:** Our novel finding that the BKV VP1 mRNA level exceeded BKVN diagnostic threshold in 21% cases raise the hypothesis that BKVN may be an underappreciated entity in HCT recipients.

Figure: Levels of BKV VP1 in Urinary Cells of HCT Recipients

Patient	Average Urine BKV VP1 mRNA Copies/ug RNA	HC grade	Symptomatic HC Group (N=5)		Asymptomatic and no HC Group (N=14)		Baseline Cr at time of HCT (mg/dl)	Creatinine at 3 months (mg/dl)	AKI (N=8)	No AKI (N=9)
			Median (copies/ug total RNA, [IQR])	Median (copies/ug total RNA, [IQR])	Median (copies/ug total RNA, [IQR])	Median (copies/ug total RNA, [IQR])				
1	4.08E+03	1	2.75E+05 (4.15E+03, 1.14E+08)	3.84E+05 (2.04E+03, 9.23E+09)	1	2.4	5.34E+03 (1.46E+03, 3.33E+07)	2.75E+05 (3.37E+03, 6.16E+09)	AKI	No AKI
2	2.52E+03	1			1.1	0.6				
3	0.00E+00	1			0.5	1.5				
4	7.42E+05	0			1.0	1.6				
5	1.21E+10	1			1.1	0.9				
6	2.27E+08	1		1.2	1.2					
7	1.18E+10	1		1.3	#N/A					
8	8.37E+09	1		0.4	0.9					
9	2.75E+05	1		0.9	0.6					
10	5.84E+03	1		0.4	0.9					
11	2.10E+05	1		0.7	0.9					
12	4.21E+03	1		0.7	0.9					
13	4.43E+07	1		0.8	1.3					
14	1.11E+06	0		0.7	0.8					
15	1.02E+11	0		0.9	1.2					
16	8.58E+05	3		1.3	N/A					
17	5.82E+02	1		0.6	1.1					
18	0.00E+00	0		0.7	1.0					
19	4.84E+03	0		0.7	1.3					

Yellow highlight = symptomatic HC  
Green highlight = AKI  
Red = Copies exceed BKVN diagnostic threshold

SA-PO117

Elevated Creatinine With Selpercatinib Therapy in RET-Dependent Malignancies

Victoria Gutgarts,<sup>1,2</sup> Monica F. Chen,<sup>1</sup> Lauren A. Kaplanis,<sup>1</sup> Guilherme Harada,<sup>1</sup> Alexander Drilon,<sup>1,2</sup> <sup>1</sup>Memorial Sloan Kettering Cancer Center, New York, NY; <sup>2</sup>Weill Cornell Medicine, New York, NY.

**Background:** Selpercatinib (LOXO-292) is a novel selective RET inhibitor for RET-dependent malignancies. The adverse effect profile estimates ~9% elevated creatinine (Cr) after therapy initiation (Drilon et al, NEJM, 2020). Creatinine however may not be the best estimator of kidney function given selpercatinib is a MATE-1 inhibitor that may potentially lower tubular secretion of Cr. To date, there is no literature that describes Cr in these patients or the role of cystatin C (which is not secreted like Cr), as an alternative estimator of kidney function.

**Methods:** We retrospectively reviewed 94 patients at MSKCC initiated on selpercatinib. Baseline Cr was defined as Cr level prior to start of therapy. Creatinine levels that met criteria for acute kidney injury (AKI) (KDIGO stage 1: ≥1.5x but <2x baseline, stage 2: ≥2x but <3x baseline, stage 3 ≥3x baseline) at any point after start of therapy were recorded. Cystatin C data was recorded when available.

**Results:** 11% (10/94) met criteria for AKI after selpercatinib initiation. The Figure below shows five patients had stage 1 (50%), 3 patients stage 2 (30%), and 2 patients stage 3 (20%) AKI. At 12 months Cr remained ≥0.5 in 2 patients (20%). Only 50% of patients had cystatin C levels checked and the Figure below shows that in the majority of cases, cystatin C is lower than Cr when checked at the same encounter. Two patients had kidney biopsies. Kidney biopsy for patient 6 showed acute tubular injury in the setting of diarrhea. Patient 9 had a kidney biopsy at an outside hospital that showed interstitial nephritis but details not known since he was lost to follow up.

**Conclusions:** As the use of selpercatinib grows in patients with RET-fusion malignancies, it is essential to better characterize the significance of elevated Cr findings. At this point, it is unclear if this is true AKI or elevated serum Cr due to inhibition of tubular Cr secretion. Prospective studies that involve Cr and simultaneous cystatin C should be performed to better estimate true kidney function in patients on selpercatinib.

Figure: Creatinine levels for patients on Selpercatinib with AKI

	Baseline Cr (mg/dl)	Cr at time of AKI (mg/dl)	KDIGO Stage 1: yellow 2: green 3: orange	6-month Cr after AKI (mg/dl)	12-month Cr after AKI (mg/dl)	Change in Cr 12 months after AKI	Cr (grey) and Cystatin C (blue) level at same encounter
1	1.2	1.9	1	1.6	-	-	1.5, 1.6
2	1.3	1.9	1	1.3	1.5	-0.2	1.7, 1.1
3	0.9	1.3	1	1	-	-	-
4	0.7	1.2	1	1.1	0.8	0.1	-
5	0.9	1.4	2	1.7	1.8	0.9	1.6, 1.1
6	1	1.5 (peak 2.7)	3	2.3	0.9	-0.1	-
7	0.9	1.8	2	1.4	1.3	0.4	1.1, 0.8
8	0.8	1.4	1	1.4	1.4	0.6	-
9	0.8	1.5	2	-	-	-	-
10	0.7	8.1	3	-	-	-	1.4, 1.1

SA-PO118

GFR in the Era of Precision Medicine: The Relevance of a Measured GFR in the Onco-Nephrology Universe and Solitary Kidney

Francesco Trevisani,<sup>1</sup> Melania Franchini,<sup>2</sup> Giulia Quattrini,<sup>1</sup> Alessandra Cinque,<sup>3</sup> Arianna Bettiga,<sup>1</sup> Umberto Capitanio,<sup>1</sup> Andrea Salonia,<sup>1</sup> Massimo Locatelli,<sup>1</sup> Giorgio Pizzagalli,<sup>1</sup> Francesco Montorsi,<sup>1</sup> <sup>1</sup>IRCCS Ospedale San Raffaele, Milano, Italy; <sup>2</sup>Azienda Ospedaliera Universitaria Federico II, Napoli, Italy; <sup>3</sup>Biorec s.r.l., Milano, Italy.

**Background:** A reliable assessment of renal function in onconeurology (ON) is fundamental. The most used tool to measure GFR is the estimated GFR (eGFR) which harbors a significant error compared to gold standards (mGFR). Aim of this study was to determine the extent of the error of eGFR compared to mGFR in ON and solitary kidney (SK) patients (pts).

**Methods:** A consecutive cohort of 403 ON pts was collected to compare the most used eGFR formulas (MDRD, CKD-EPI SCr 2012, CKD-EPI 2021 SCr, CKD-EPI Cys 2012, CKD-EPI Cys 2021, CKD-EPI Cys/SCr, Cockcroft-Gault) with mGFR (Iohexol Plasma Clearance). Among them, 126 pts were SK for radical nephrectomy. We performed statistical analyses on the overall population and a sub-analysis in SK pts. True positives and False positives were classified in CKD stages. Comparisons between groups were performed using Wilcoxon ranks sum test for numerical variables and Pearson's Chi square test for categorical ones.

**Results:** Clinical data: overall median age was 67 years, median BMI 24.8, Male: 74.9%, F: 25.1%, Diabetes: 10.9%, Hypertension: 53.8%, CKD stage I: 3.7%, II: 25.5%, IIIA: 28%, IIIB: 27.5%, IV: 13.4%, V: 1.74%, mean Creatinine: 1.46 mg/dl, cystatin: 1.23. Both overall population (Figure 1) and SK cohort (Figure 2) harbored a non-negligible errors in each CKD class with a huge discrepancy between eGFR and mGFR, suggesting the great relevance of mGFR in the decision making algorithm.

**Conclusions:** The error in the classification of CKD stages using eGFR by formulas was too common, with a poor agreement with mGFR in all CKD classes. The use of mGFR should be mandatory to obtain a tailored management in ON, especially in SK.

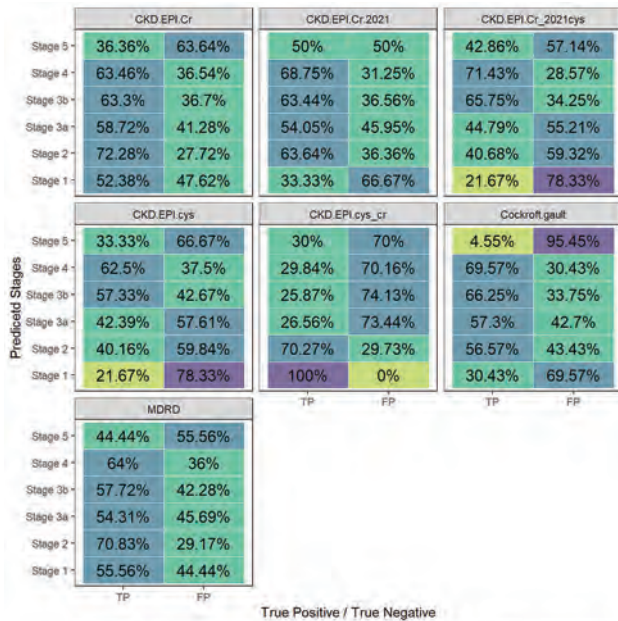

reported for each pt. SCr and eGFR were measured at 24h, 48 h, 72 h and at dismissal in the acute setting for the AKI; at 12,24,36,48,60 months for the chronic setting for CKD. Comparisons between groups were performed using Kruskal-Wallis ranks sum and Pearson's Chi square test Anova was used to identify differences in the evolution of eGFR between groups.

**Results:** Clinical data are present in table. AKI and CKD onset are shown in the figure 1. The results of a four-way ANOVA for each AKI/CKD displayed that surgery is the variable that impacts more on AKI/CKD onset. Regarding the comorbidities, diabetes impact more in CKD stages onset in both the global and the pts population.

**Conclusions:** AKI and CKD are common both in D and in RN, with a similar eGFR decrease over time both in acute than in chronic. Surgery appears to be the predominant factor in the onset of AKI/CKD, while comorbidities, especially diabetes, may have a major impact on the long-term deterioration of kidney function.

Variable	Measurement	Total	D	RN	PN	FN	P value
Age	Median (IQR)	54 (48-64)	51 (44-61)	59 (51-69)	58 (50-65)	58 (50-65)	<0.0001
Sex	Median (IQR)	35.300 (23.0, 57.9)	34.74 (23.3, 54.4)	35.99 (23.5, 58.1)	36.40 (23.5, 58.4)	36.40 (23.5, 58.4)	<0.0001
AKI	Median (IQR)	0.83 (0.72-0.96)	0.7669 (0.65-0.86)	0.84 (0.74-0.95)	0.79 (0.61-0.94)	0.79 (0.61-0.94)	<0.0001
Diabetes	N (%)	34 (8.14%)	1 (0.09%)	19 (18.05%)	14 (16.19%)	14 (16.19%)	<0.0001
Hypertension	N (%)	235 (57.79%)	47 (18.41%)	102 (48.12%)	97 (48.37%)	97 (48.37%)	<0.0001
No AKI	N (%)	466 (57.88%)	119 (46.09%)	204 (96.54%)	199 (93.39%)	199 (93.39%)	<0.0001
AKI stage 1	N (%)	210 (50.79%)	119 (46.09%)	20 (4.74%)	57 (25.29%)	57 (25.29%)	<0.0001
AKI stage 2	N (%)	20 (2.39%)	5 (1.93%)	1 (0.45%)	13 (5.86%)	13 (5.86%)	NS
AKI stage 3	N (%)	7 (0.18%)	1	1 (0.45%)	5 (2.24%)	5 (2.24%)	NS
CKD G1	N (%)	79 (19.86%)	14 (5.47%)	54 (25.88%)	30 (14.42%)	30 (14.42%)	<0.0001
CKD G2	N (%)	185 (45.28%)	81 (31.64%)	110 (51.74%)	104 (48.69%)	104 (48.69%)	<0.0001
CKD G3	N (%)	181 (21.1%)	13 (12.89%)	42 (17.84%)	104 (48.69%)	104 (48.69%)	<0.0001
CKD G4	N (%)	5 (0.12%)	1	1	3 (1.37%)	3 (1.37%)	1
CKD G5	N (%)	1 (0.02%)	1	1	1 (0.45%)	1 (0.45%)	1
No AKI	N (%)	466 (57.88%)	119 (46.09%)	204 (96.54%)	199 (93.39%)	199 (93.39%)	<0.0001
AKI stage 1	N (%)	210 (50.79%)	119 (46.09%)	20 (4.74%)	57 (25.29%)	57 (25.29%)	<0.0001
AKI stage 2	N (%)	20 (2.39%)	5 (1.93%)	1 (0.45%)	13 (5.86%)	13 (5.86%)	NS
AKI stage 3	N (%)	7 (0.18%)	1	1 (0.45%)	5 (2.24%)	5 (2.24%)	NS

Figure 1. eGFR decline over time in each categories

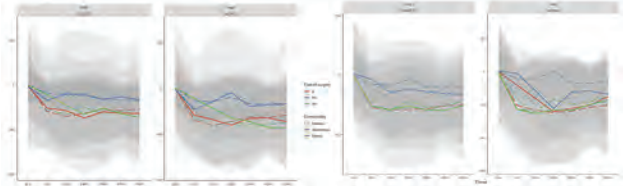

SA-PO120

Renal Safety of FLOT Regimen for Gastroesophageal Cancer: Time for Break Boundaries?

Francesco Trevisani,<sup>1</sup> Matteo Floris,<sup>2</sup> Alessandra Cinque,<sup>3</sup> Roberto Minnei,<sup>2</sup> Antonello Pani,<sup>2</sup> Andrea Angioi,<sup>2</sup> Mario Scartozzi,<sup>4</sup> Marco Puzzone,<sup>4</sup> Jaime Amodeo,<sup>4</sup> Nicole Liscia,<sup>1</sup> Elena A. Mazza,<sup>1</sup> Stefano Cascinu.<sup>1</sup> <sup>1</sup>IRCCS Ospedale San Raffaele, Milano, Italy; <sup>2</sup>Azienda Ospedaliera Brotzu, Cagliari, Italy; <sup>3</sup>BIOREK s.r.l., Milan, Italy; <sup>4</sup>Universita degli Studi di Cagliari, Cagliari, Italy.

**Background:** Currently, peri-operative docetaxel, oxaliplatin, leucovorin, and 5-fluorouracil (FLOT) chemotherapy (CTx) is the gold standard treatment for pts with locally advanced gastric cancer (LAGC), who undergo peri-operative CTx and surgery. The nephrotoxicity of both docetaxel and oxaliplatin may limit the use in CKD pts. Since limited evidence is available, we explored FLOT effects on renal function in our LAGC population.

**Methods:** Retrospective data on patient with LAGC in 3 tertiary hospital between jan/2018 to jan/2022 have been analyzed. Pts have been treated with FLOT, administered every 2 weeks, 4 times before surgery. SCr, Hb, and CKD-EPI eGFR were detected before each cycle. AKI and CKD onset/prevalence were determined according to K-DIGO criteria.

**Results:** A consecutive cohort of 73 pts was enrolled. Baseline CKD was present in 16 pts (21.9%). Median eGFR was 106.2 ml/min. ANOVA showed no significant differences between cycles in eGFR decay and CKD onset; p=0.323 (Table 1 and Figure 1). AKI was very low (1 episode of stage2 (0,7%). New onset anemia was the only significant adverse event observed (p=0.003).

**Conclusions:** Surprisingly, the pre-operative FLOT regimen seems to have a negligible impact on renal function suggesting the possibility to extend its use even in patient with advanced CKD.

**Funding:** Private Foundation Support

SA-PO119

Surgery or Frailty: Who Is the Master in eGFR Decline After Renal Surgery in Living Donor and Renal Cancer Patients?

Francesco Trevisani,<sup>1</sup> Matteo Floris,<sup>2</sup> Lucrezia Furian,<sup>3</sup> Umberto Capitano,<sup>1</sup> Francesco Trepiccione,<sup>4</sup> Alessandra Cinque,<sup>5</sup> Giuseppe Rosiello,<sup>1</sup> Melania Franchini,<sup>6</sup> Arianna Bettiga,<sup>1</sup> Giovambattista Capasso,<sup>4</sup> Paolo Rigotti,<sup>3</sup> Nicola Lepori.<sup>2</sup> <sup>1</sup>IRCCS Ospedale San Raffaele, Milano, Italy; <sup>2</sup>Azienda Ospedaliera Brotzu, Cagliari, Italy; <sup>3</sup>Universita degli Studi di Padova, Padova, Italy; <sup>4</sup>Universita degli Studi della Campania Luigi Vanvitelli Scuola di Medicina e Chirurgia, Napoli, Italy; <sup>5</sup>BIOREK s.r.l., Milano, Italy; <sup>6</sup>Azienda Ospedaliera Universitaria Federico II, Napoli, Italy.

**Background:** AKI and CKD are the 2 main complications after nephrectomy both on living donor(D) and on renal cancer pts(RC). It is still debatable if RN with a normal pre-operative renal function could have worse functional outcomes in term of eGFR decline in comparison to RN due to the comorbidities and frailty. Aim of this study was to evaluate in both D and RN the incidence of AKI andCKD, using a control cohort of oncological partial nephrectomy (PN) to evaluate the impact of surgery and comorbidities.

**Methods:** We collected a multicentric(4 different tertiary hospitals) consecutive cohort of 718 patients:256 D and 462 RC pts of which 236 PN and 226 RN. Inclusion criteria: baseline eGFR higher than 70 ml/min/1.73. Clinical and lab variables were

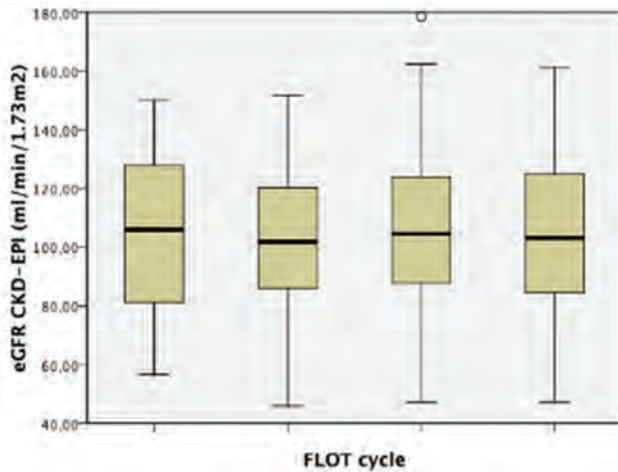

Age - years [Median/ Interquartile range]	65.7 (56.0 - 75.4)
Female sex - no. (%)	29 (39.7)
Diabetes - no. (%)	3 (3.9)
Hypertension - no. (%)	27 (35.5)
Smoker - no. (%)	19 (25)
Alcohol - no. (%)	6 (7.9)
eGFR CKD-EPI [Median/ Interquartile range]	105.9 (80.4 - 128.9)
CKD stage G1-G3a	16 (21.9%)
eGFR <60 ml/min/1.73 m2	1 (1.9)
Cancer site - no. (%)	
Angulus	7 (9.2)
Antrum	15 (19.7)
Cardias	17 (22.4)
Gastric body	11 (14.5)
Distal esophagus	6 (7.9)
Medium esophagus	1 (1.3)
Fundus	2 (2.6)
Gastro-esophagus junction	11 (14.5)
Pylorus	1 (1.3)
Prior Cancer - no. (%)	5 (6.6)
Prior AKI on CT - no. (%)	1 (1.3)
RAAS inhibition - no. (%)	8 (10.5)
Hypothyroidism - no. (%)	4 (5.3)
Beta-blockers - no. (%)	8 (10.5)
Calcium antagonists - no. (%)	8 (10.5)
Diuretics - no. (%)	4 (5.3)
Acetylsalicylic acid - no. (%)	5 (6.6)
Oral antidiabetics - no. (%)	2 (2.6)
Insulin - no. (%)	1 (1.3)
Proton pump inhibitors - no. (%)	35 (46.1)
NSAIDs - no. (%)	9 (11.8)
Nutritional integrations - no. (%)	11 (14.5)

SA-PO121

GFR Estimation Using  $\beta_2$ -Microglobulin and  $\beta$ -Trace Protein in Adults With Solid Tumors: A Prospective Cross-Sectional Study

Veronica T. Costa e Silva,<sup>1</sup> Luiz A. Gil,<sup>2</sup> Lesley A. Inker,<sup>3</sup> Renato A. Caires,<sup>1</sup> Elerson Costalonga,<sup>1</sup> George B. Coura-Filho,<sup>1</sup> Gilberto Castro,<sup>1</sup> Andrew S. Levey,<sup>3</sup> Emmanuel A. Burdmann.<sup>2</sup> <sup>1</sup>Universidade de Sao Paulo Instituto do Cancer do Estado de Sao Paulo, Sao Paulo, Brazil; <sup>2</sup>Universidade de Sao Paulo, Sao Paulo, Brazil; <sup>3</sup>Tufts Medical Center, Boston, MA.

**Background:** We previously showed that estimated glomerular filtration rate (eGFR) based on serum creatinine (Scr) and cystatin C (Scys)(eGFRcr-cys) is more accurate than equations based on Scr (eGFRcr) or Scys (eGFRcys) in solid tumor patients in Brazil (Onco-GFR Study).  $\beta_2$  microglobulin (B2M), and  $\beta$ -trace protein (BTP) are filtration markers (FM) that can further improve the accuracy of GFR estimation when used in multi-marker panels with Scr and Scys, but have not been assessed in patients with cancer. The aim of this study is to evaluate the performance of the CKD-EPI equations without race including B2M and/or BTP with creatinine in the Onco-GFR Study.

**Methods:** Measured GFR (mGFR) was determined using the plasma clearance of <sup>51</sup>Cr-EDTA. Assays for FM were performed at the University of Minnesota.

**Results:** A group of 1,200 patients with active cancer but mostly (85%) not yet treated were recruited between April 2015 and September 2017 and included for analysis. Patients were 58.8±13.2 years, 50.8% male. Mean (SD) mGFR was 78.5±21.7 ml/min/1.73 m<sup>2</sup>. Mean (SD) serum B2M and BTP were 2.32 (1.05) and 0.72 (0.35) mg/L, respectively. eGFRcr-B2M and eGFRcr-BTP had similar accuracy (similar 1-P<sub>30</sub>) compared to eGFRcr-cys, whereas the three-marker panels (eGFRcr-cys-B2M and eGFRcr-cys-BTP) and the four-marker panel (eGFRcr-cys-B2M-BTP) were more accurate (smaller 1-P<sub>30</sub>) than eGFRcr-cys (Table).

**Conclusions:** B2M and BTP can improve the accuracy of GFR estimation and may be useful as a confirmatory test in patients with solid tumors, either by inclusion in multi-marker panel with Scr and Scys, or by substituting for Scys in combination with Scr. This may be of particular importance for use of B2M, which may be more available than Scys in cancer centers. We suggest further evaluation of B2M and BTP in other cancer centers.

Filtration marker (eGFR)	Equation and Year	Median bias (mGFR - eGFR) (ml/min/1.73 m <sup>2</sup> )	Precision (IQI) (ml/min/1.73 m <sup>2</sup> )	Accuracy (1-P <sub>30</sub> ) (%)	Accuracy (RMSE)
eGFRcr-cys	CKD-EPI 2021	-4.1(-4.8 to -3.3)	15.7 (14.6 - 17.1)	9.8 (8.0 - 11.4)	0.171 (0.163 - 0.179)
eGFRcr-B2M	CKD-EPI 2020/2021	-3.5(-4.4 to -2.9)	15.1 (14.1 - 16.5)	9.5 (7.8 - 11.1)*	0.168 (0.161 - 0.177)
eGFRcr-BTP	CKD-EPI 2020/2021	-2.2(-3.3 to -1.2)	15.2 (14.2 - 16.3)	8.4 (6.9 - 10.0)**	0.163 (0.156 - 0.171)
eGFRcr-cys-B2M	CKD-EPI 2020	-1.5(-2.3 to -0.8)	14.3 (13.3 - 15.2)	5.6 (4.3 - 6.8)***	0.155 (0.147-0.163)
eGFRcr-cys-BTP	CKD-EPI 2020	3.4 (2.7 to 4.1)	16.7 (15.3 - 17.9)	6.4 (4.9 - 7.8)***	0.181 (0.173 - 0.190)
eGFRcr-cys-B2M-BTP	CKD-EPI 2020	-1.8(-2.6 to 1.1)	13.5 (12.7 - 14.6)	5.8 (4.5 - 7.1)***	0.152 (0.144 - 0.159)

\*p-value (McNemar test) vs eGFRcr-cys = 0.8  
\*\*p-value (McNemar test) vs eGFRcr-cys = 0.2  
\*\*\*p-value (McNemar test) vs eGFRcr-cys < 0.001

SA-PO122

Outcomes of Kidney Transplantation in Patients With Myeloma and Amyloidosis

Jia Hwei Ng,<sup>1</sup> Naoka Murakami,<sup>2</sup> Amy Sharma,<sup>1</sup> Vinay Nair,<sup>1</sup> Kenar D. Jhaveri.<sup>1</sup> <sup>1</sup>Northwell Health, Great Neck, NY; <sup>2</sup>Brigham and Women's Hospital, Boston, MA.

**Background:** Recent improvement in treatment and patient survival has opened the eligibility of kidney transplantation for patients with ESKD due to plasma cell dyscrasias (PCD), such as multiple myeloma, AL amyloidosis and MGRS.

**Methods:** We conducted a retrospective study of UNOS database (2006-2018) to compare patient and graft outcomes of kidney transplant recipients with ESKD due to PCD vs other causes. The primary outcome was patient survival time, defined as the time from transplantation to death. Secondary outcomes included death-censored graft survival time. First, we described the frequency of transplant in ESRD from various forms of PCD. Also, we determined the absolute and relative outcomes of kidney transplant recipients who had ESKD due to PCD vs other causes.

**Results:** Among 168,369 first kidney transplant adult recipients, 0.22-0.43% per year had PCD as the cause of ESKD. The PCD group had worse survival than the non-PCD group for both living and deceased donor types, (aHR: 2.24 [95% CI: 1.67, 2.99]) and (aHR: 1.40 [1.08, 1.83]), respectively. The PCD group had worse survival than the diabetes group, but only among living donor type (aHR: 1.87 [1.37, 2.53]) vs (aHR: 1.16, [0.89, 1.2]). Graft survival in patients with PCD were worse than non-PCD in both living and deceased donor type (aHR 1.72 [1.91, 2.56], aHR 1.30 [1.03, 1.66]). Patient and graft survival were worse in amyloidosis but not statistically different in multiple myeloma, compared to non-PCD group.

**Conclusions:** The study provides novel data on survival in patients with PCD who received kidney transplant. More study are needed to determine the specific group of patients with PCD who benefit from kidney transplant.

**A Living Donor Recipients**

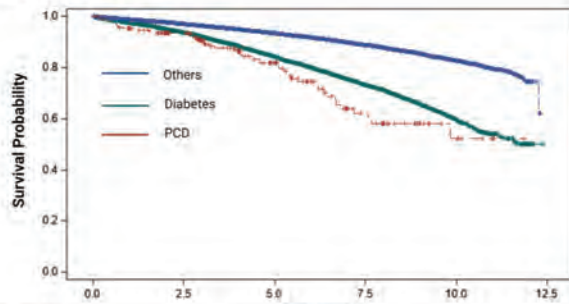

	Time in Years					
No. at Risk	0.0	2.5	5.0	7.5	10.0	12.5
Others	32480	24736	14660	7298	2109	0
Diabetes	10514	7789	4325	2037	525	0
PCD	206	155	85	31	9	0

**B Deceased Donor Recipients**

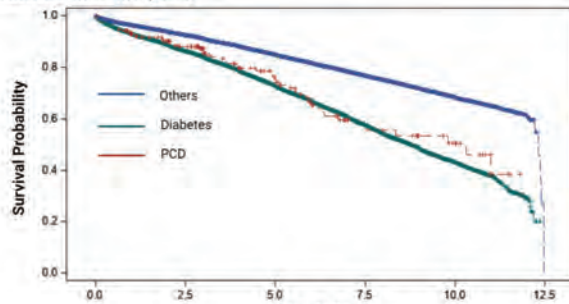

	Time in Years					
No. at Risk	0.0	2.5	5.0	7.5	10.0	12.5
Others	64774	47052	27433	13926	4232	0
Diabetes	28828	19770	10519	4513	1148	0
PCD	204	137	69	29	16	0

Patient survival, stratified by PCD Panel A. Among living donor recipients. Panel B. Among deceased donor recipients.

**SA-PO123**

**Multicenter Study of Renal Outcomes in AL Amyloidosis Patients After Autologous Stem Cell Transplant**

Umut Selamet,<sup>1</sup> Kole Joachim,<sup>1</sup> Yan Heather Lin,<sup>2</sup> Shveta S. Motwani,<sup>1</sup> Valda D. Page,<sup>2</sup> Naoka Murakami,<sup>1</sup> Ala Abudayyeh.<sup>2</sup> <sup>1</sup>Brigham and Women's Hospital, Boston, MA; <sup>2</sup>The University of Texas MD Anderson Cancer Center, Houston, TX.

**Background:** Renal impairment is a common complication with negative impact on survival in AL amyloidosis patients. Autologous stem cell transplant (ASCT) is standard of care for treatment of AL amyloidosis, but data on renal outcomes after ASCT are lacking. We aimed to analyze longitudinal trends in kidney function and its impact on progression-free (PFS) and overall survival (OS) post ASCT in AL amyloidosis patients.

**Methods:** We performed a retrospective review of 314 patients with AL amyloidosis who underwent ASCT at MD Anderson Cancer Center and Dana Farber Cancer Center from 2010 to 2020. We collected data on demographics, comorbidities, ISS stage, disease status at time of ASCT, eGFR (CKD EPI), and laboratory variables at day 0, day 100, 6-months, years 1, 2 and 3 post ASCT. We evaluated the change in eGFR over time using linear mixed effect models. The association between eGFR change and PFS and OS were evaluated using the Cox proportional hazards models.

**Results:** A higher ISS stage at diagnosis was significantly associated with a lower eGFR ( $p = 0.0042$ ). Black and Hispanic races were associated with lower eGFR across all time points ( $p \leq .006$ ). Higher serum light chains were associated with lower eGFR across all time points (decrease by 0.059-fold per 1 fold increase,  $p < 0.0001$ ). There was no significant decline in eGFR over time. A higher eGFR at the time of ASCT ( $>$ median) was significantly associated with a longer PFS at baseline (HR (95% CI) = 1.610 (1.102, 2.354),  $p = 0.0139$ ) and at 2 years post ASCT (HR (95% CI) = 2.351 (1.041, 5.308),  $p = 0.0396$ ). A higher eGFR at baseline (HR (95% CI) = 1.676 (1.054, 2.663),  $p = 0.029$ ) and at 6 months post ASCT (HR (95% CI) = 3.218 (1.709, 6.057),  $p = 0.0003$ ) was associated with better OS. A good disease risk category, lack of kidney amyloid, lower light chains, lower ISS score, were all associated with a higher PFS and OS at different time points. Higher hemoglobin and albumin were also associated with longer PFS.

**Conclusions:** This study provides valuable data on renal outcomes in patients with AL amyloidosis who underwent ASCT. Disease related factors were the main predictors of eGFR, however no significant decline in eGFR observed in AL amyloidosis patients after ASCT. Higher eGFR was associated with better PFS and OS at baseline and at year 2 post ASCT.

**SA-PO124**

**TRPC3, a Key Target in Cisplatin-Induced Renal Fibrosis**

Hinda Najem, Joelle Hajal, Youakim Saliba, Nassim Fares. *Universite Saint-Joseph, Beirut, Lebanon.*

**Background:** Cisplatin (Cisp) is a chemotherapy drug that induces renal cellular lesions with excessive accumulation of extracellular matrix leading to renal fibrosis. Transient receptor potential canonical channels type 3 (TRPC3) are non-selective  $Ca^{2+}$  channels strongly implicated in cardio-renal diseases. We previously demonstrated the role of TRPC3 in renal fibrosis of obstructive origins. Herein, we evaluate TRPC3 implication in renal toxicity mediated by Cisplatin.

**Methods:** 34 adult male C57BL/6 mice were divided into four groups: WT Sham ( $n=8$ ), WT Cisp ( $n=8$ ), KO Sham ( $n=9$ ), and KO Cisp ( $n=9$ ). Cisp was administered by intraperitoneal injections ( $7mg.kg^{-1}$ , one injection per week) for four weeks. Kidney tissues, blood, and urine samples were harvested for histological and biochemical studies.

**Results:** KO Cisp mice showed a decrease in urinary albumin/creatinine ratio, associated with a reduction of fibrotic TGF- $\beta$ /SMADs and NFATc3 pathways compared to WT. Moreover, kidneys of KO Cisp mice showed a significant alleviation in apoptosis and oxidative DNA damage, as well as a reduction of Tcf21/ $\beta$ PDGFR $\alpha$  activated fibroblasts.

**Conclusions:** TRPC3 channels seem to play a substantial role in cisplatin-induced renal fibrosis. TRPC3 might constitute a key therapeutic target for improving renal remodeling in cisplatin chemotherapy.

**Funding:** Private Foundation Support

**SA-PO125**

**Infliximab for Treatment of Immune Adverse Events**

VishnuPriyadevi Parvathareddy,<sup>1</sup> Umut Selamet,<sup>2</sup> Aditi A. Sen,<sup>1</sup> Noha Abdel-Wahab,<sup>3</sup> Juhee Song,<sup>3</sup> Omar Mamlouk,<sup>3</sup> Valda D. Page,<sup>3</sup> Maen Abdelrahim,<sup>4</sup> Ala Abudayyeh.<sup>3</sup> <sup>1</sup>The University of Texas Health Science Center at Houston, Houston, TX; <sup>2</sup>Brigham and Women's Hospital, Boston, MA; <sup>3</sup>The University of Texas MD Anderson Cancer Center, Houston, TX; <sup>4</sup>Houston Methodist, Houston, TX.

**Background:** Immune related adverse events (irAEs) challenge the use of immune checkpoint inhibitors (ICIs). We performed a retrospective study to evaluate the use of infliximab for irAE management, and its role on irAE response, progression free survival (PFS) and overall survival (OS) with a focus on melanoma patients.

**Methods:** This study is a retrospective review of all cancer patients exposed to infliximab after ICI from 2004 to 2021 at MD Anderson. Overall survival was assessed using Kaplan-Meier method. Univariate and multivariate logistic regression models were used to evaluate the predictors of response to infliximab, OS and PFS at months 3, 6 and 12.

**Results:** We identified 185 cancer patients (93 melanoma). Median follow up was 36 months with a median time from ICI initiation to irAE of 2.4 months and from irAE to infliximab of 0.3 months. 71% of the patients responded to infliximab, 27% of the patients had no response and 1.62% had unknown response at 3 months. Among different types of irAEs, colitis was associated with response to infliximab. Patients who had acute kidney injury (AKI) within one month of infliximab were less likely to respond to infliximab at all time points. Subanalysis of melanoma patients showed similar results as the entire cohort. Regarding tumor response in relation to infliximab: 21 were in remission before infliximab 81% continued to be in remission after infliximab. In 135 patients which were not in remission 86% continued to be the same after infliximab. In both entire cohort and melanoma the percent of patients in remission after infliximab is higher than that of patients in remission before infliximab ( $p=0.002$ ). Median OS was 29.4 months in the entire cohort and 42.3 months in melanoma cohort. In melanoma cohort, AKI prior to infliximab initiation was associated with worse survival (HR 2.131,  $P=0.046$ ).

**Conclusions:** Our study is one of the largest retrospective analysis of infliximab use for irAE management. Patients with colitis were the best responders to infliximab. In addition, AKI within one month of infliximab was associated with worse response to infliximab. In melanoma cohort, AKI before initiation of infliximab was also associated with higher risk of death. Interestingly the percent of patients in remission after infliximab is higher than that of patients in remission before infliximab.

**SA-PO126**

**A Case of Immune Checkpoint Inhibitor Related Osmotic Tubular Injury**

VishnuPriyadevi Parvathareddy,<sup>1</sup> Biruh Workeneh.<sup>2</sup> <sup>1</sup>Baylor College of Medicine, Houston, TX; <sup>2</sup>The University of Texas MD Anderson Cancer Center, Houston, TX.

**Introduction:** Checkpoint inhibitor therapy is associated with a variety of kidney complications, like acute interstitial nephritis with or without tubular necrosis, thrombotic microangiopathy and a variety of glomerulonephritis. Here, we describe a case with a rare pattern of injury, osmotic tubulopathy, after exposure to CPI, pembrolizumab.

**Case Description:** 48 y/o Caucasian female with triple negative breast cancer with liver metastasis received a regimen of carboplatin, paclitaxel and pembrolizumab over 16 weeks followed by lumpectomy and sentinel lymph node dissection. Subsequently, she presented with AKI. Her creatinine was 2.19 mg/dl on admission, worsening to 2.53 mg/dl and persisted despite stopping CPI treatment and starting empiric corticosteroids for suspected CPI toxicity, thus prompting kidney biopsy. Biopsy revealed marked vacuolization of proximal tubules, normal appearing glomeruli and no evidence of AIN.

She did not receive medications usually implicated in toxic tubulopathy, nor was she exposed to any other nephrotoxins. Her kidney function started to improve reaching a nadir of 1.15 mg/dl 4 weeks after corticosteroids were initiated.

**Discussion:** This case highlights the possible association of vacuolar tubular injury pattern associated with CPI therapy. Pembrolizumab contains L histidine, polysorbate 80 and sucrose. Of these, sucrose may be a predisposing factor to toxic tubulopathy. This has been described once before in literature by Sekulic et al, where it was male with lung cancer receiving nivolumab which contains small amount of mannitol as an active ingredient which was postulated as being the culprit. **Learning points:** Toxic tubulopathy of proximal tubules is a possible side effect of CPI therapy. Exclude other possible etiologies that can contribute to osmotic tubulopathy e.g., mannitol, CNI toxicity, amphotericin B exposure etc. Treatment remains supportive, possibly steroids and discontinuation of the offending agent until recovery of kidney function.

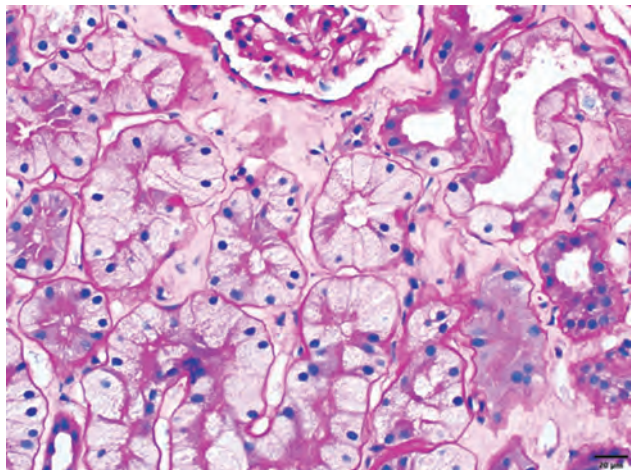

SA-PO127

**Hyperuricemia and Kidney Function in Patients Diagnosed With Multiple Myeloma**

Tadej Petreski,<sup>1,2</sup> Nejc Pulko,<sup>3</sup> Katja Sapek,<sup>2</sup> Sanja Puljek,<sup>2</sup> Nejc Piko,<sup>4</sup> Sebastjan Bevc.<sup>1,2</sup> <sup>1</sup>Department of Nephrology, Clinic for Internal Medicine, University Medical Center Maribor, Maribor, Slovenia; <sup>2</sup>Faculty of Medicine, University of Maribor, Maribor, Slovenia; <sup>3</sup>Department of Hematology, Clinic for Internal Medicine, University Medical Center Maribor, Maribor, Slovenia; <sup>4</sup>Department of Dialysis, Clinic for Internal Medicine, University Medical Center Maribor, Maribor, Slovenia.

**Background:** Multiple myeloma (MM) is a common hematologic malignancy with a high incidence rate in the elderly. Its characteristics include hypercalcemia, anemia, renal impairment, and bone lesions. The presence of CKD makes the diagnosis more difficult, and treatment related morbidity and mortality may complicate management. However, less is known about the effect of serum uric acid in MM. The aim of our study was to assess the impact of hyperuricemia and CKD on survival of patients with MM.

**Methods:** We retrospectively included 42 Caucasian patients from the Hematology outpatient clinic (HOC) who were diagnosed with MM between 2015 and 2020. Average age was 69.5±11.5 years. We recorded past medical history, laboratory tests, and basic demographic data upon first visit to the HOC before treatment was initiated. CKD was defined as eGFR <45 ml/min/1.73m<sup>2</sup> and hyperuricemia as serum uric acid >420 mmol/L.

**Results:** Included patients (54.8% female), who were observed for a median of 760.0 (IQR 746) days, had diabetes mellitus (23.8%), arterial hypertension (64.3%), previous malignant disease (14.3%), dyslipidemia (28.6%), CKD (31.8%), and hyperuricemia (35.7%). Their ECOG performance status (PS) median was 2.0 (IQR 2.0). Most common subtypes of MM were IgG kappa (40.5%), IgG lambda (19.0%), and free light chain lambda (16.7%). Kaplan-Meier survival analysis showed no difference in mortality between the CKD and non-CKD group, however there was a difference between the hyperuricemic and normouricemic group (p=0.007, Log Rank 7.185). Furthermore, the uricemic groups differed in median beta-2-microglobulin, 8.1 (IQR 10.7) and 4.5 (IQR 3.8) mg/L (p=0.021), serum calcium, 2.45 (IQR 0.38) and 2.13 (IQR 0.15) mmol/l (p<0.001), and presence of CKD, 62.5% and 19.2% (p=0.004), respectively. In Cox regression models, hyperuricemia remained a significant marker (p=0.03, Exp(B) 4.4, 95% CI 1.2-16.9), even when adjusted for age, sex, PS, variables that proved different in univariate analysis, and LDH and albumin.

**Conclusions:** Elevated serum uric acid levels showed to be a possible additional prognostic marker for patients diagnosed with MM regardless of baseline kidney function.

SA-PO128

**AKI Post CD19-CAR T-Cell Therapy Among Pediatric Patients at a Tertiary Hospital**

Yonique P. Petgrave,<sup>1,2</sup> Subodh R. Selukar,<sup>2</sup> Noel Delos Santos,<sup>1,2</sup> John J. Bissler,<sup>1,2</sup> Aimee Talleur.<sup>2</sup> <sup>1</sup>The University of Tennessee Health Science Center College of Medicine, Memphis, TN; <sup>2</sup>St Jude Children's Research Hospital, Memphis, TN.

**Background:** Chimeric antigen receptor (CAR) T-cell therapy has shown promising responses in patients with relapsed/refractory B-cell acute lymphoblastic leukemia. In the pediatric population, the incidence of acute kidney injury (AKI) post treatment with CD19-CAR T-cell therapy remains unknown, unlike other well-established immune related complications such as cytokine release syndrome (CRS) and neurotoxicity (NTX).

**Methods:** The objective was to retrospectively identify the incidence of AKI in pediatric patients post treatment with lymphodepleting chemotherapy and CD19-CAR T-cell therapy, potential risk factors for AKI, and kidney function recovery. Serum creatinine values prior to CAR T-cell therapy through day 30 post therapy were used to assess AKI, defined by the Kidney Disease Improving Global Outcomes (KDIGO) criteria

**Results:** In the study period (11/2018 – 4/2021), 34 patients received a total of 35 CD19-CAR T-cell infusions for relapsed and/or refractory B-lineage malignancy. The median age was 9.7 yrs old (range 1.8 –23.6) at time of infusion, with most patients male (55.9%) or white (73.5%), and 28.6% previously treated with a hematopoietic cell transplant (HCT). Median baseline renal function using 24hr creatinine clearance (n=7) was 125 ml/min/1.73m<sup>2</sup> (range 60-207) and by Technicium99 scan (n=19) 155 ml/min/1.72m<sup>2</sup> (range 71-280). The incidence of immune related toxicities included: CRS, 60% (grade 3-4 CRS, 17%), NTX, 25.7%, and HLH-like toxicity, 11.4%. The cumulative incidence of any grade AKI by day 30 was 20% (95% CI 6.5%-33.5%) with severe AKI (Stage 2-3) developing in 5 patients (14.3%). One patient required dialysis. Patients who developed AKI did so within the first 14 days of CAR T, and 50% of patients had kidney function return to baseline within 30 days. There was no association with AKI and pre-treatment risk factors, including level of disease burden in the marrow or prior HCT. In patients experiencing immune mediated side effects, AKI developed after the onset of NTX and HLH in all patients, and all but one patient with CRS.

**Conclusions:** Although the incidence of AKI is low in our pediatric cohort, it developed rapidly after CD19-CAR T-cell therapy. Early recognition and management of CAR T-cell therapy related complications is beneficial, as we see half of patients recovering kidney function within 30 days

SA-PO129

**AKI and CKD in Pediatric Cancer Survivors**

Ahmed S. Zeid, Sara M. Delap, Randal S. Olshefski, Joseph Stanek, Lory Guthrie, Diana Zepeda-Orozco. *Nationwide Children's Hospital, Columbus, OH.*

**Background:** Pediatric cancer survivors are exposed to nephrotoxins and procedures during treatment that put them at risk of kidney disease. Here we evaluated factors associated with acute kidney injury (AKI) and chronic kidney disease (CKD) in a cohort of pediatric cancer survivors.

**Methods:** This was a retrospective chart review that included pediatric cancer survivors who received nephrotoxic chemotherapy, irradiation treatment, and/or had pelvic tumors and were under follow-up at Nationwide Children's Hospital between 01/01/2011 and 06/30/2021. Patients with pre-existing kidney disease were excluded. Variables included demographics, primary malignancy, nephrotoxin and radiotherapy exposures, nephrectomy, and last encounter's laboratory results. AKI was defined as stage 2 or 3 AKI by KDIGO creatinine-based guidelines during therapy. CKD was defined as eGFR < 90 ml/min/1.73 m<sup>2</sup> per Schwartz calculation at the date of last follow-up. Data were summarized and factors associated with AKI and CKD were analyzed with logistic regression models.

**Results:** A total of 128 patients met the inclusion criteria. The median age at cancer diagnosis was 5.4 years and the median duration of follow-up was 6 years. Twenty-six AKI episodes were identified in 25 patients (19.5%). The incidence was more in hematological malignancies (68%) and 41% occurred in the first month after cancer diagnosis. Patients with AKI were more likely to have impaired initial GFR (OR=0.96; p=0.0023). The leading etiology for AKI was dehydration (Table 1). A nephrologist was consulted in 39% of AKI episodes. Eighteen patients developed CKD during follow-up (14%); of whom 2 were followed by a nephrologist. Solid tumors survivors accounted for 83.3% of patients with CKD. Risk factors associated with CKD included nephrectomy (OR=10.5; p=0.005), carboplatin (OR=3.03; p=0.0364), Ifosfamide (OR=8.89; p=0.002), and vincristine (OR=6.7; p=0.0040). There was no significant association between AKI and CKD development in cancer survivors (OR=1.73; p=0.35).

**Conclusions:** Renal complications in pediatric cancer patients are common. In our cohort, renal service involvement in the management of patients with AKI and CKD was limited. Nevertheless, we believe it is crucial for proper diagnosis and management.

Table 1: Causes of AKI in our cohort

Possible etiology of AKI	Tumor lysis syndrome	Dehydration due to fluid losses or poor intake.	Drug related nephrotoxicity	Shock and hypotension	Malignant infiltration of the kidney	Urinary tract obstruction by tumor	Glomerulonephritis
Number of episodes	6	10	4	3	1	1	1

SA-PO130

**Onconephrology, an Essential Subspecialty: Experience of a University Hospital Center**

Sheila Bermejo,<sup>1</sup> Mónica Bolufer,<sup>1</sup> Davide Viggiano,<sup>2</sup> Ana Callejo,<sup>1</sup> Marina López-Martínez,<sup>1</sup> Ander Vergara,<sup>1</sup> Irene Agraz,<sup>1</sup> Oriol Bestard,<sup>1</sup> Maria Jose Soler.<sup>1</sup> <sup>1</sup>Hospital Universitari Vall d'Hebron, Barcelona, Spain; <sup>2</sup>Università degli Studi della Campania "Luigi Vanvitelli", Naples, Italy.

**Background:** Kidney complications of cancer patients and cancer in renal patients have increased in recent years. This study evaluates the characteristics of the patients referred to the Onco-Nephrology Unit from January 2021 to December 2021, studying the cognitive and mood status of these patients.

**Methods:** This is a prospective observational study of the Onco-Nephrology consultation at our hospital during 2021. Clinical and analytical characteristics of the patients and clinical indication for referral were analyzed. In addition, sleep quality, mood and cognitive status were assessed using validated rating scales (Epsworth, Geriatric Depression Scale and Montreal).

**Results:** Seventy-four patients were evaluated, mean age was 69.6(±11) years, 41(55.4%) men, 47(63.5%) had hypertension, 18(24.3%) diabetics, and 11(14.9%) were affected by heart disease. In addition, creatinine 1.93(±1.1)mg/dl, eGFR 39.97(±20.3) mL/min, proteinuria 187[29-515.9]mg/g, and 4(5.4%) had microhematuria. The most frequent cancers were intestinal, gynecological and mammary with 12.16%(n=9) each. 58.3%(n=42) of patients had metastatic disease. 48.7%(n=36) received chemotherapy and 58.1%(n=43) targeted therapies. Platinum was the most frequently used chemotherapy and anti-VEGF in terms of targeted therapies. The most frequent clinical indication for referral was acute renal failure(n=36;48.7%). Rating scales were obtained in 51 patients: 49%(n=25) were snorers, followed by 17.6%(n=9) with insomnia and 11.8%(n=6) with OSAS. 27 patients(36.5%) had cognitive impairment. Mild depression was detected in 13 cases(25.5%) and moderate depression in 11.6%(n=6). 21 renal biopsies were performed, the most frequent diagnosis was acute interstitial nephritis(71.4%, n=15) followed by thrombotic microangiopathy(19% n=4). A total of 15 patients(20.3%) died during the year.

**Conclusions:** Most patients referred to Onco-Nephrology are affected by advanced oncological disease and consequently had a high mortality. The most frequent indication for referral was acute kidney injury(48.7%). Comprehensive patient care is important, given the prevalence of depressive syndrome. Onco-Nephrology is an example of a comprehensive and multidisciplinary approach to improve the survival and quality of life of patients with advanced cancer and renal disease.

SA-PO131

**Differential Epidemiology of Prostate Cancer Specific Mortality for Black Men With ESKD**

Sohilkumar Manvar,<sup>1</sup> Weichuan Dong,<sup>2</sup> Siran M. Koroukian,<sup>2</sup> Nagaraju Sarabu.<sup>1</sup> <sup>1</sup>University Hospitals, Cleveland, OH; <sup>2</sup>Case Western Reserve University, Cleveland, OH.

**Background:** Studies exploring racial disparity in mortality among ESKD patients with prostate cancer (PCa) are limited.

**Methods:** We used Surveillance, Epidemiology and End Results data linked to Medicare to identify men (age >40) diagnosed with PCa years 2004-2015. After excluding patients with missing data, we categorized participants into ESKD (dialysis + kidney transplant) and non-ESKD by using international classification of disease, 9th revision, clinical modification. We compared overall and PCa specific mortality among Blacks, Whites, Hispanics and others using Cox proportional hazards and Fine and Gray competing risk models respectively.

**Results:** We included 18282 Blacks, 107457 Whites, 2397 Hispanics, and 6785 others for analysis. Blacks were five times more likely to having ESKD, more likely to present with metastatic disease, younger, had similar Gleason Score, more likely to be single, and live in higher poverty areas than Whites (Figure 1). Compared to Whites, Blacks had similar all-cause mortality (Hazard Ratio (HR): 0.8, 0.9, 1.1) and PCa mortality (HR: 0.4, 0.6, 1.0) in ESKD group while they had higher all-cause (HR: 1.1, 1.2, 1.2) and PCa mortality (HR: 1.1, 1.2, 1.3) in non-ESKD group (Figure 2).

**Conclusions:** ESKD and prostate cancer are more common among Blacks than Whites. Despite presenting with higher metastatic disease, prostate cancer mortality for Blacks with ESKD is similar but higher for those without ESKD than Whites. Future research should focus on understanding these racial differences.

Patient Characteristics	Baseline Characteristics				P-Value
	Blacks (N = 18282) N (%)	Whites (N = 107457) N (%)	Hispanics (N = 2397) N (%)	Others (N = 6785) N (%)	
ESKD status					<0.01
ESKD	484 (2.7)	576 (0.5)	54 (2.2)	70 (1.0)	
Non-ESKD	17798 (97.3)	106881 (99.5)	2343 (97.8)	6715 (99)	
Stage					<0.01
Local	15885 (86.3)	91370 (85.0)	2017 (84.1)	5638 (83.1)	
Regional	1485 (8.1)	11852 (11.0)	259 (10.8)	879 (13.0)	
Distant	912 (5.0)	4235 (3.9)	121 (5.0)	268 (4.0)	
Age*	69.5 (7.4)	72.4 (6.2)	72.3 (7.8)	72.7 (6.2)	<0.01
Gleason Score					<0.01
<8	14411 (78.8)	84611 (78.7)	1914 (79.8)	5018 (74.0)	
≥8	3871 (21.2)	22846 (21.3)	483 (20.2)	1767 (26.0)	
PSA level					<0.01
<20	14975 (81.9)	95449 (88.8)	2005 (83.7)	5868 (86.5)	
>20	3307 (18.1)	12008 (11.2)	392 (16.4)	917 (13.5)	
Married or Equivalent	10473 (57.3)	84078 (78.2)	1663 (69.4)	5548 (81.8)	<0.01
Census Tract Poverty					<0.01
00-05	1661 (9.1)	31006 (28.8)	206 (8.6)	1932 (28.5)	
05-10	2536 (13.9)	30765 (28.6)	379 (15.8)	1942 (28.6)	
10-20	5077 (27.8)	30058 (28.0)	778 (32.5)	1805 (26.6)	
20-100	9008 (49.3)	15628 (14.5)	1034 (43.1)	1106 (16.3)	

Figure 1: Baseline Characteristics

Figure 2. Association of Race with Prostate Cancer Specific Mortality

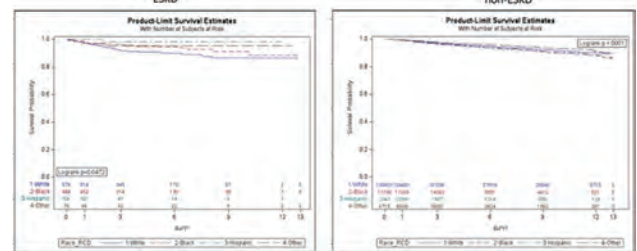

Figure 2: Kaplan Meier Survival Curves for Prostate Cancer Mortality, Stratified by Race and ESKD status.

SA-PO132

**Clinical Characteristics and Outcomes of Membranous Nephropathy Post Stem Cell Transplant**

Nattawat Klomjit,<sup>1,2</sup> Ladan Zand,<sup>2</sup> Mariam P. Alexander,<sup>2</sup> Nelson Leung.<sup>2</sup> <sup>1</sup>University of Minnesota Medical School Twin Cities, Minneapolis, MN; <sup>2</sup>Mayo Clinic Minnesota, Rochester, MN.

**Background:** Glomerulonephritis is rare but one of the important causes of kidney injury in patients with stem cell transplant (SCT). Membranous nephropathy (MN) is the most common etiology but data regarding clinical characteristics and outcomes of these patients are limited.

**Methods:** We included all patients who developed MN post SCT between 2000-2021 from the Mayo Clinic Health System and University of Minnesota. Baseline demographics and pertinent clinical outcomes are collected.

**Results:** Between 2000 to 2021, we identified 16 patients (13 from Mayo Clinic and 3 from University of Minnesota). The median age at the time of SCT and MN diagnosis was 57.1 (21.8-68.4) and 63 (25.7-70.2) years respectively. The most common hematological disease was acute leukemia (62.5%), lymphoma (12.5%), multiple myeloma (6.25%) and other. The median time from SCT to MN diagnosis was 2.6 (1.5-20.8) years. About two-third of patients were female and all were white. Patients typically presented with nephrotic syndrome (13/16, 81.3%). The median serum creatinine was 1.2 (ranged 0.5-4.0) mg/dL with median urine protein 6.6 (ranged 2.0-40.0) g/d. Nearly all patients developed graft-versus-host disease (GVHD) (15/16, 93.8%) with skin manifestation as the most common site (10/15, 66.7%). One patient had PLA2RAb. Of 16 patients, 10 (62.5%) received rituximab (RTX), 5 (31.3%) received other immunosuppression (mycophenolate mofetil, prednisone, cyclosporine and tacrolimus), and 1 (6.2%) did not receive therapy. The median follow-up time was 2.7 (0.2-20.9) years. Twelve patients (75%) achieved complete remission with a median time to remission of 8 (ranged 3-12) months. Eighty percent of RTX and 66.6% of non-RTX group achieved complete remission (p=0.7). Four patients initially did not respond to non-RTX regimen and subsequently RTX was added, resulting in CR in all cases. Three patients relapsed (1 RTX and 2 non-RTX).

**Conclusions:** MN post-SCT typically occur in patients with concomitant GVHD. Patients often respond to immunosuppression and achieve CR relatively quickly compared to MN in non-SCT patients. RTX therapy may portend better outcome compared to other immunosuppression. Future studies are needed to assess the efficacy of RTX.

## SA-PO133

### The Development of "Mayo MGRS" Score to Predict Likelihood of Monoclonal Gammopathy of Renal Significance in Patients With Monoclonal Gammopathy

Nattawat Klomjit,<sup>1,2</sup> Ladan Zand,<sup>2</sup> Fernando C. Fervenza,<sup>2</sup> Sanjeev Sethi,<sup>2</sup> Nelson Leung,<sup>2</sup> <sup>1</sup>University of Minnesota Medical School Twin Cities, Minneapolis, MN; <sup>2</sup>Mayo Clinic Minnesota, Rochester, MN.

**Background:** MGRS is found in only 3-4% of CKD with monoclonal gammopathy (MG). Therefore, there is a need for clinical tool to predict the likelihood of MGRS lesions in patients with MG.

**Methods:** The Mayo MGRS score was developed using all patients from 2013 to 2018 with biopsy proven MGRS and available MG and urine monoclonal protein. A multivariable logistic regression model between the predictors and MGRS status was fit. Using the odds ratios, score weights were derived for each variable and a MGRS risk score was computed for each patient. Internal validation of the risk score model was conducted by 10-fold cross-validation.

**Results:** Between 2013-2018, we included 130 patients in the cohort and 62 patients have MGRS. We found that urine protein (UP)  $\geq 1.5$  g/d (OR 4.01), hematuria (OR 4.88), affected/unaffected free light chain (FLC) ratio  $\geq 4$  (OR 10.87), and diabetes mellitus (DM) (OR 0.30) significantly predicted MGRS. Positive urine MG significantly predicted MGRS in univariate model but did not in multivariate model (OR 1.88). All significant parameters and positive urine MG were included in the scoring system due to clinical relevancy. We assigned the score to each parameter as follows: score 1 for UP  $\geq 1.5$  g/d, hematuria, positive urine MG; score 2 for affected/unaffected free light chain (FLC) ratio  $\geq 4$  (due to magnitude of the OR); score -1 for DM. Therefore, the score could range from -1 to 5. A univariate logistic regression model between the score and MGRS status showed a C-statistic of 0.831 (95% CI 0.758, 0.890) with predicted probability of MGRS increasing linearly from 0.026 (score -1) to 0.957 (score 5), **figure 1**. Ten-fold cross-validation has a median C-score of 0.73 (IQR 0.68, 0.75).

**Conclusions:** Mayo MGRS score is a useful tool to assist clinician in assessing the risk of having MGRS and decide who to biopsy. Future external validation study is needed.

Figure 1

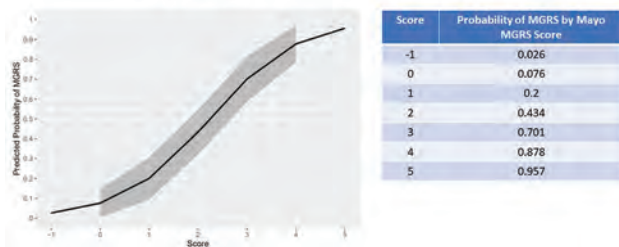

## SA-PO134

### Renal Pathologies and Patient Outcomes Post Allogeneic Stem Cell Transplantation

Praveen Ratanasrimetha,<sup>1</sup> Omar Mamlouk,<sup>1</sup> Amanda Tchakarov,<sup>2</sup> Ala Abudayyeh,<sup>1</sup> <sup>1</sup>The University of Texas MD Anderson Cancer Center, Houston, TX; <sup>2</sup>The University of Texas Health Science Center at Houston, Houston, TX.

**Background:** Renal complications associated with hematopoietic stem cell transplantation (HSCT) have been reported to be as high as 55% with acute kidney injury (AKI) and proteinuria being the most common presentations. With AKI impacting both renal and survival outcomes, a renal biopsy remains the gold standard to diagnose the etiology of AKI. Below we investigated the scope of renal pathologies in allogeneic SCT recipients and their renal outcomes.

**Methods:** A single center retrospective chart review of all patients who underwent a renal biopsy post allogeneic SCT from 2007-2022. We collected baseline characteristics, serum creatinine, proteinuria, treatment for the renal pathology, and the renal outcomes. Renal response was defined as any improvement in creatinine after treatment either complete return to baseline or partial response.

**Results:** We identified 60 cases with the three most common underlying cancers being leukemia, lymphoma and myeloma. Indications for kidney biopsy were mostly due to unexplained AKI (83.3%) and proteinuria/hematuria (17%). TMA was the most common pathology finding at 28.3%, followed by BK nephropathy (15%), FSGS and membranous nephropathy (14.9%), acute tubular injury (13%), acute interstitial nephritis (10%), amyloidosis (6.6%), MGUS (5%), diabetic nephropathy (3%), and IgA nephropathy and MPGN (3.2%). Acute and chronic TMA was the most common pathology. Two out of 5 treated with rituximab had partial response, 1 out of 3 treated with eculizumab had a partial response, all 3 patients switched from tacrolimus to rapamycin had a complete renal response, 3 patients had no treatment with one patient with improved renal function, one patient was treated with cellcept with partial response, and one patient was treated with naprosolamab with no renal response. One third of the patients with renal TMA had died.

**Conclusions:** Based on a single center 15-year experience of kidney biopsies post allogeneic SCT it is evident that transplant related TMA remains the leading cause of SCT related AKI post allogeneic SCT. Renal TMA carries a poor overall prognosis and there is still no established guideline for its treatment in recipient of SCT. Based on our center experience, switching GVHD prophylaxis from tacrolimus to sirolimus might improve renal outcome. Renal response to anticomplement therapy and rituximab was variable.

## SA-PO135

### The Impact of a Low-Normal Protein High Calorie Diet in the Onco-Nephrological Scenario: Do the Opposites Attract?

Arianna Bettiga, Francesco Fiorio, Federico Di marco, Francesca Liguori, Riccardo Vago, Umberto Capitanio, Andrea Salonia, Francesco Montorsi, Francesco Trevisani. *IRCCS Ospedale San Raffaele, Milano, Italy.*

**Background:** Nutritional therapy (NT) based on controlled protein intake represents the cornerstone when managing chronic kidney disease (CKD), however the international guidelines do not clearly define an adequate protein intake for onco-nephrological patients. Aim of our study is to investigate the impact of a low-normal protein high calorie diet (LNPHCD) on the quality of life (QoL) and on the renal and nutritional status in a consecutive cohort of 85 nephrological pts affected or not by urological non-metastatic neoplasia treated with a nephrologist-nutritionist combined approach (NNCA).

**Methods:** Pts were enrolled in the Urological Department at San Raffaele hospital between 2018-2020, screened for absence of malnutrition and administered a conventional CKD protein-controlled diet (0.7-1 g/Kg/die; calories: 30-35 kcal per kg body weight/die) for a period of 6 months. The diet was based on the CKD onco-nephrological clinical conditions and the pts' nutritional state. Anthropometrical outcomes, lab test exams (including Iohexol test for mGFR) and clinical variables were examined at baseline and after 6 months. To evaluate the impact of the combined approach on perceived QoL, multiple 8 scale assessments in a generic QoL-Short Form36 (SF36) questionnaire were administered to each patient.

**Results:** The NNCA was effective in improving mGFR ( $\Delta=+1.8$ ) and uremia ( $\Delta=-16$ ), outlining its effectiveness in managing nephrological complications in the entire population, regardless of the presence of neoplasia. BIA outcomes showed significant improvement, especially when the parameters were malnutrition-related (MR) ( $\Delta\text{PhA}=+0.1^\circ$ ;  $\Delta\text{BCMI}=+0.5$ ;  $\Delta\text{FFMI}=+0.5$ ). The SF36 questionnaire highlighted a good perceived QoL in subjects treated with the NNCA, even if social activities were negatively affected.

**Conclusions:** Our work demonstrated that LNPHCD, as part of a multidisciplinary approach, ameliorates not only the nephrological scenario in this asset of patients but above all the MR parameters, while maintaining a high QoL and a healthy nutritional status. Following NNCA treatment, perceived QoL has improved and does not appear to be influenced by physical health and emotional status. Despite this, we observed that social activities are greatly and negatively affected.

## SA-PO136

### Bortezomib Increases ER Stress in Myeloma-Associated Glomerulopathy

Dao-Fu Dai. *The University of Iowa Hospitals and Clinics Department of Pathology, Iowa City, IA.*

**Background:** Kidney involvement by multiple myeloma (MM) is associated with worse prognosis. The success of Bortezomib, a proteasome inhibitor has been a major breakthrough in the treatment of MM patients and it is believed to have a nephroprotective effect. Bortezomib induces ER stress to kill myeloma cells, but its role in myeloma-associated glomerulopathy is unclear.

**Methods:** Using MM mice carrying IL-6 Tg with concomitant Tg of i-Myc with deregulated expression of the Myc and enhancers in the IgH locus (designated IL6/Myc mice), we compared the glomerulopathy before and after treatment with 50 mg/kg single dose of Cyclophosphamide (C), Cyclophosphamide + Bortezomib at 1 mg/kg at Day 1 and 4 (BC), Cyclophosphamide + TUDCA molecular chaperone 3 doses/week for 4 weeks (CT), or TUDCA (T) only.

**Results:** IL6/Myc mice developed MM at 3-6 months, characterized by significant paraproteinemia, splenomegaly and bone involvement. The presence of splenomegaly is well correlated with glomerulopathy, characterized by glomerular capillary IgM. Kappa monoclonal deposits and segmental membranoproliferative glomerulonephritis (MPGN) pattern of injury. High magnification EM showed that some of the deposits have repetitive structures, suggestive of cryoglobulinemic glomerulonephritis. Compared with pre-treatment biopsy, post-treatment kidney pathological examinations show substantial improvement in glomerulopathy in IL6/Myc mice treated with C or CT. In contrast, mice treated with BC or T show significant progression of glomerulopathy, assessed by endocapillary hypercellularity, the extent of deposits and intracapillary "hyaline / cryo-plugs". The worsening of glomerulopathy in BC-treated kidneys is associated with increased markers of ER stress and Integrated Stress Response ATF4.

**Conclusions:** IL6/Myc multiple myeloma mice showed excellent chemotherapy response to Cyclophosphamide treatment. Surprisingly, the addition of Bortezomib to Cyclophosphamide significantly worsened myeloma-associated glomerulopathy, likely due to increased ER stress induced by Bortezomib. Reduction of ER stress by TUDCA by itself was not effective. However, reduction of ER stress by TUDCA in combination with Cyclophosphamide showed the best kidney protective effect. Our findings suggest that Bortezomib does not have a direct nephroprotective effect. An alternative nephroprotective strategy may need to be developed to ameliorate myeloma-associated kidney diseases.

**Funding:** NIDDK Support

Key: TH - Thursday; FR - Friday; SA - Saturday; OR - Oral; PO - Poster; PUB - Publication Only

Underline represents presenting author.



SA-PO137

**The Urine Protein-Albumin Gap as a Predictor of Multiple Myeloma**

Gregory L. Hundemer,<sup>1</sup> Haris Insirovic,<sup>2</sup> Ayub Akbari,<sup>1</sup> Manish M. Sood,<sup>1</sup>  
<sup>1</sup>Ottawa Hospital, Ottawa, ON, Canada; <sup>2</sup>Institute for Clinical Evaluative Sciences, Ottawa, ON, Canada.

**Background:** Multiple myeloma (MM) frequently presents as an unexplained decline in kidney function. Nephrologists often assess for discordance between the urine protein-creatinine ratio (UPCR) and urine albumin-creatinine ratio (UACR) as a proxy for free light chains in the urine consistent with cast nephropathy. However, thresholds for the urine protein-albumin gap (UPCR-UACR) and its association with MM are not well established.

**Methods:** We conducted a population-level, retrospective cohort study of adults in Ontario, Canada with same day measurements of UPCR/UACR and without a history of MM between 2009-2021 (N=28,231) using provincial health data. Individuals were categorized by quartile of urine protein-albumin gap and stratified by UPCR ( $\leq$  or  $>50$  mg/mmol). Multivariable Cox regression models estimated the association between the urine protein-albumin gap and MM.

**Results:** 116 individuals were diagnosed with MM (0.4%) at a median time of 31 days. In the overall cohort, MM diagnoses increased with each successive quartile of urine protein-albumin gap (Fig. A). However, compared to Quartile 1 ( $\leq 9.3$  mg/mmol), only Quartile 4 ( $>43.4$  mg/mmol) was associated with a significantly higher risk for MM (HR 4.49 [95%CI 2.47-8.15]). Among individuals with a UPCR $\leq 50$  mg/mmol, no association was observed (Fig. B). In contrast, among individuals with a UPCR $>50$  mg/mmol, a higher urine protein-albumin gap was associated with a higher risk of MM (Q1  $\leq 34.2$  mg/mmol: ref, Q2 34.3-57.5 mg/mmol: HR 1.98 [95%CI 0.59-6.62], Q3 57.6-111.8 mg/mmol: HR 3.94 [95%CI 1.29-11.97], and Q4  $>111.8$  mg/mmol: HR 10.97 [95%CI 3.85-31.25]; Fig. C).

**Conclusions:** The urine protein-albumin gap is associated with MM, predominantly when the UPCR is  $>50$  mg/mmol and the urine protein-albumin gap exceeds  $\sim 50$  mg/mmol. These results establish clinically meaningful thresholds for clinicians to utilize when interpreting discordance between UPCR and UACR values as a predictor of MM in cases of unexplained kidney dysfunction.

**A. Overall Study Population (N = 28,231)**

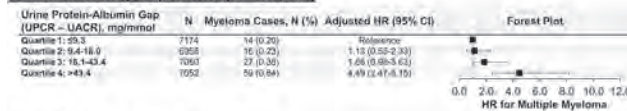

**B. UPCR  $\leq 50$  mg/mmol (N = 20,632)**

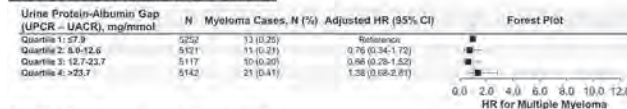

**C. UPCR  $>50$  mg/mmol (N = 7,599)**

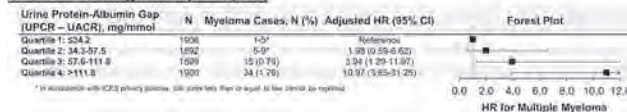

SA-PO138

**Crescents: An Eclipsed Presentation of Multiple Myeloma**

Arsh Bajaj, Kathleen Castillo, Erdal Sarac, Hilmer O. Negrete. *Mercy Health St Elizabeth Youngstown Hospital, Youngstown, OH.*

**Introduction:** Kidney involvement is common in multiple myeloma (MM) and is associated with increased mortality. Light chain cast nephropathy, monoclonal immunoglobulin deposition disease and light chain amyloidosis are the most frequent presentations. Very few cases are reported of MM presenting as crescentic glomerulonephritis (CGN). Here, we present a case of a female with rapidly progressive loss of renal function and proteinuria who was found to have MM and CGN.

**Case Description:** A 45-year old woman with h/o hypertension, diabetes mellitus, GERD, iron deficiency anemia, nephrolithiasis and COVID infection six months presented with worsening renal function. Her baseline creatinine three months prior was 0.88 mg/dL eGFR  $>60$  and had recently increased to 2.81 mg/dL eGFR of 22. Laboratory investigations revealed a hemoglobin 8.3 g/dL, platelet count 404 x 10<sup>9</sup>/L. Serum calcium and uric acid levels were within normal limits. Urinalysis showed proteinuria without hematuria with a urine protein/creatinine ratio 1.9 g/g, urine albumin/creatinine ratio 506 mg/g and urine albumin/protein ratio of 0.27. Complement levels, ANCA, Anti-GBM, ANA, RF and hepatitis serology were all unrevealing. Serum Kappa and Lambda free light chains were elevated with ratio being of 0.09. Bone marrow was done which demonstrated approximately 10% lambda restricted plasma cell clones. In view of progressive renal dysfunction she was admitted with the suspicion of light chain nephropathy for consideration of plasma exchange therapy. Kidney biopsy was obtained which showed findings consistent with crescentic GN, with weak linear IgG staining along glomerular basement membranes without evidence of cast nephropathy, monoclonal immunoglobulin deposition or amyloidosis. The patient was started on Cyclophosphamide-Bortezomib-Dexamethasone regimen and since then her kidney function has remained stable.

**Discussion:** Rare kidney findings in patients with MM include membranoproliferative GN, cryoglobulinemia, immunotactoid and fibrillary glomerulopathy. MM associated Crescentic GN is extremely rare. Its etiology and pathophysiology is unclear but it seems that treatment of MM may temporarily halt its progression as in this case.

SA-PO139

**Spontaneous Remission of Membranous Nephropathy in Hematopoietic Stem Cell Transplantation Patients**

Claudia M. Brauer Ornelas,<sup>1</sup> Ilya Glezerman,<sup>1</sup> Surya V. Seshan,<sup>2</sup> Steven Salvatore.<sup>2</sup>  
<sup>1</sup>Memorial Sloan Kettering Cancer Center, New York, NY; <sup>2</sup>Weill Cornell Medicine, New York, NY.

**Introduction:** Secondary membranous nephropathy (MN) is a known complication of hematopoietic stem cell transplantation (HSCT) and is considered a form of the graft versus host disease (GVHD). It usually presents 2 months after discontinuation of GVHD immunosuppression prophylaxis. Patients with secondary MN are treated with immunosuppression. We present two cases of spontaneous remission of the MN in HSCT patients.

**Case Description:** Case 1. 54-year-old male with history of diffuse large B-Cell lymphoma and HSCT (day +1007) presented with edema. Patient had a history of skin GVHD. He completed the course of tacrolimus for GVHD prophylaxis. Patient developed lower extremity swelling over one month. The vital signs and exam were unremarkable except to lower extremity edema. Serum creatinine was 1.1 (0.6-1.3) mg/dL, urinary protein to creatinine ratio (UPCR) was 9.2. Phospholipase A2 receptor (PLA2R) antibody was negative. Patient was started on an ACE inhibitor and a diuretic and underwent a kidney biopsy. Biopsy revealed diffuse membranous nephropathy with negative PLA2R staining. Proteinuria gradually improved and UPCR was 0.1 approximately 33 months after the kidney biopsy. Case 2. 71-year-old male with history of Crohn's disease, myelodysplastic syndrome and HSCT (day+649) presents to renal clinic with edema. Patient was on tacrolimus taper with currently undetectable trough level for GVHD prophylaxis. The vital signs and physical exam were unremarkable except for lower extremity edema. Serum creatinine level was 1.0 mg/dL, UPC was 5.75. Anti PLA2R antibody was negative. Patient underwent a kidney biopsy which revealed diffuse membranous nephropathy with negative PLA2R staining. Patient was managed conservatively. Patient's proteinuria gradually improved and UPC was 0.8 approximately 21 months after the biopsy.

**Discussion:** In secondary MN associated with HSCT the treatment is geared to address presumed underlying GVHD. Our experience illustrates that conservative management may be an option in selective cases. It is also possible that our patients had PLA2R negative MN. This also highlights the need for wider access to other markers of MN to distinguish between PLA2R negative primary MN such as Thrombospondin type-1 domain-containing 7A and secondary forms of MN for example Protocadherin 7 recently linked to GVHD associated MN.

SA-PO140

**Clinching the Diagnosis: A Case of Marginal Zone Lymphoma Diagnosed on Kidney Biopsy**

Chelsea Gertze, Kavitha Vellanki, Maria M. Picken. *Loyola University Health System, Maywood, IL.*

**Introduction:** Marginal zone lymphomas are low-grade non-Hodgkin B-cell lymphomas that rarely has renal involvement. We describe a case of lymphomatous involvement of the kidneys.

**Case Description:** A 73-year-old female with h/o breast cancer, HTN, HLD, hypothyroidism, monoclonal gammopathy was transferred from an outside hospital for evaluation as extensive work up (as shown in table 1) for diffuse lymphadenopathy, hypercalcemia, acute kidney injury, was inconclusive despite high clinical suspicion for metastasis. Labs were significant for Cr 2.29 (baseline 1.3) calcium 11.3 and ionized calcium 1.8. In the setting of worsening renal function and no unifying diagnosis, the decision was made to pursue kidney biopsy. Biopsy results were consistent with low grade B-Cell Lymphoma with plasmacytic differentiation most consistent with marginal zone lymphoma (Figure 1). The patient underwent guideline directed therapy with normalization in her serum calcium and return of renal function near her baseline.

**Discussion:** This case illustrates the rarity of low grade b cell lymphoma involvement of the kidneys and the role of kidney biopsy in establishing a diagnosis despite multiple an exhaustive work up. At a time where there is a huge debate regarding the necessity of biopsy as a requirement for nephrology training graduation, our case emphasizes that kidney biopsy as diagnostic tool still reigns supreme.

Completed Work Up During 8 Months Prior to Presentation

Endocrine	ACE: 59 nmol/dl/min PTH: 4 pg/ml PTHrP: negative X 2 Vit-D: wnl LDH: wnl
Hematology	Paraprotein studies Serum: IgG: 2206; IgA: 170; IgM: 147 Kappa: 122.1; Lambda: 55.4; Ratio: 2.20 Immunofixation: IgG-K SPEP: 1.3 g/dL Urine: 24H EBV: neg HIV: neg CMV: neg HHV8: eg Quant Gold: neg
Infectious Disease	Mammogram: neg CT C/A/P: diffuse intrathoracic, intra-abdominal, intrapleural lymphadenopathy, pulmonary nodules, enhancing hepatic lesions PET-CT: multiple solid and part solid pulmonary nodules, left greater than right, with hypermetabolic activity Sopradiaaphragmatic, subdiaphragmatic hypermetabolic lymph nodes
Rheumatology	ANA: negative Anti CCP: neg RF: neg D-DNA: 371 VEGF: wnl
Pathology	Parotid Gland FNA: negative for malignancy Left Lower Lobe Lung Wedge Resection: negative for malignancy Mediastinal Lymph Node Biopsy x2: negative for malignancy Bone Marrow Biopsy Normocellular at 30% Plasma cells < 1% Cytology: normal karyotype Negative myeloma FISH panel

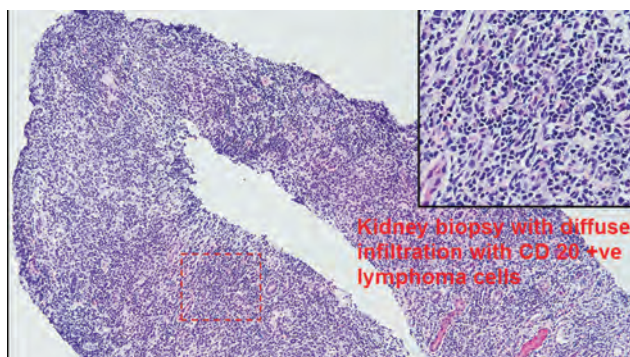

Kidney Biopsy with CD20 positivity

SA-PO141

A Journey From Primary Membranous to Secondary Membranous Nephropathy

Rana Raheel H. Khan,<sup>1</sup> Shoaib B. Fareedy,<sup>1</sup> Amanda Tchakarov,<sup>1</sup> Ala Abudayyeh,<sup>2</sup>  
<sup>1</sup>The University of Texas Health Science Center at Houston, Houston, TX; <sup>2</sup>The University of Texas MD Anderson Cancer Center, Houston, TX.

**Introduction:** Membranous Nephropathy (MN) has been well recognized as a common cause of nephrotic syndrome as primary membranous (autoimmune induction) vs secondary membranous, with up to 20% related to cancers in older patients. We are presenting a case of recurrent proteinuria in a patient who had primary MN in remission that many years later develops secondary MN

**Case Description:** 68 years old male with a history of chronic kidney disease, primary MN, diagnosed in the 1970s and off immunosuppression since 2016. He has a history of prostate cancer, treated melanoma in situ, hypertension, diabetes, with no proteinuria and creatinine at baseline of 1.4mg/dl. On 2022 patient presented with 2.2gms of proteinuria with negative 2<sup>nd</sup> workup. He underwent a renal biopsy, showing MN, negative Phospholipase A2 receptors, 22% global sclerosis and 10% interstitial fibrosis. Imaging studies revealed a lung nodule with a biopsy confirming melanoma with adrenal and brain metastases. The patient was started Ipilimumab and nivolumab with significant tumor response but progression of proteinuria to over 15gms. He has also developed grade II colitis and was started on steroids and rituximab with improved proteinuria to 4g.

**Discussion:** It is well documented that, compared to the general population, patients with MN have a higher cancer incidence. This unique case demonstrates the evolution from primary MN to 2<sup>nd</sup> MN in the same patient which was an indicator of patients underlying malignancy. The patients advanced cancer necessitated emergent treatment in hopes of response of MN in setting of cancer response. Unfortunately, the overwhelming immune activation further impacted the MN and rituximab was successful to attain renal response and continue patient on Immunotherapy. This case demonstrates much more needed research in this field of autoimmune disease in a cancer patient and the use of ICI which is an unmet need.

SA-PO142

AKI due to Light Chain Cast Nephropathy in Non-IgM Lymphoplasmacytic Lymphoma

Natalie Rodziewicz, Meghan Kapp, Arash Rashidi. University Hospitals, Cleveland, OH.

**Introduction:** Plasma cell dyscrasia most notably multiple myeloma known to cause cast nephropathy, we report a case of non- IgM lymphoplasmacytic lymphoma causing an acute kidney injury due to lambda light chain cast nephropathy.

**Case Description:** 74-year-old white male with history of chronic kidney disease stage III, heart failure with reduced ejection fraction of 35%, hypertension, diabetes type II, presented to hospital with chief complaint of 2 days of left lower quadrant abdominal pain. Non-contrast CT scan imaging reported acute diverticulitis, and patient was started on IV antibiotics with Zosyn. Symptoms promptly subsided the following day. Patient was noted to have acute kidney injury on presentation. Laboratory data showed initial serum creatinine (SCr) 2.03 mg/dL, blood urea nitrogen (BUN) 53 m/dL, by day three of hospitalization patient had developed anuria and SCr increase to 4.13 mg/dl and day nine SCr, further increase to 11 mg/dl. Serum protein electrophoreses and free light chains analysis revealed IgG Lambda M-protein 1.7g/dl, Kappa light chain 15.4 mg/dl, Lambda light chain 150.3 mg/dl, with a K/L ratio 0.1. Patient was advised to have bone marrow biopsy due to high concern for plasma cell dyscrasia, which revealed non- IgM lymphoplasmacytic lymphoma. PET scan revealed mild diffuse bone marrow uptake, with no avid lymph node or spleen uptake. Renal biopsy showed atypical granular casts that stain for only lambda, suggestive of early light chain cast nephropathy. Patient was started on hemodialysis due to concerns for uremic encephalopathy and volume overload, with no sign of renal recovery. The following week hematology team initiated patient on chemotherapy with bendamustine and rituximab.

**Discussion:** Lymphoplasmacytic lymphoma is very rare diagnosis that does not commonly produce monoclonal immunoglobulins. It is likely that this malignancy was underlying for some time due to indolent course of the lymphoma, and the acute kidney failure due to light chain cast nephropathy was precipitated by the acute diverticulitis, possible due to volume depletion and NSAID use.

SA-PO143

Treatment Patterns for Low-Risk Prostate Cancer in Dialysis, Kidney Transplant, and Non-Dialysis

Nagaraju Sarabu,<sup>1</sup> Weichuan Dong,<sup>2</sup> Siran M. Koroukian,<sup>2</sup> <sup>1</sup>University Hospitals, Cleveland, OH; <sup>2</sup>Case Western Reserve University, Cleveland, OH.

**Background:** Patients with end stage kidney disease being evaluated for transplant are screened for prostate cancer. When a cancer is found, it is often treated given concerns about transplant eligibility in the presence of a malignancy.

**Methods:** Retrospective population based observational cohort study, using Surveillance, Epidemiology, and End Results-Medicare data (Males > 40 years with localized prostate cancer (2010 – 2015)). Compared low risk localized prostate cancer treatment patterns and mortality rates among dialysis, kidney transplant and non-dialysis patients using logistic regression and cox proportional hazards models.

**Results:** A total of 46 low risk prostate cancer dialysis patients and 20 kidney transplant patients were identified. We age-matched 42 dialysis patients to 210 non-dialysis patients (Table 1). Non-dialysis patients with low-risk prostate cancer were less likely, OR: <sub>0.08</sub> **0.27** <sub>0.8</sub> to get curative treatment, and high mortality, as compared to dialysis patients. None of the kidney transplant patients in low-risk group died of prostate cancer.

**Conclusions:** Dialysis patients, who are more likely to die of other causes, are paradoxically more likely to be treated for low-risk prostate cancer. Active surveillance should be performed in this population, and should not preclude transplant eligibility.

	Dialysis, N = 42 (%)	Non-ESKD, N = 210 (%)
Age (Mean(SD))	63.6 (6.7)	63.6 (6.7)
Race		
White	15 (35.7)	152 (72.4)
Other Race	27 (64.3)	58 (27.6)
Married or Equivalent <sup>†</sup>	25 (59.5)	126 (60.0)
Census Tract Poverty (%)		
Less than 20%	27,64.3 (	167 (79.5)
More than 20%	15,35.7 (	43 (20.5)
Rurality (RUCA 2010)		
Urban	40 (100)	*
Atrial Fibrillation	*	*
Heart Failure	*	15 (7.4)
Hypertension	*	61 (29.1)
Ischemic Heart Disease	11 (26.2)	31 (14.8)
Hyperlipidemia	23 (54.8)	75 (35.7)
Pulmonary disease	*	25 (11.9)
Neuropsychiatric	*	16 (7.6)
Ophthalmologic Disease	*	21 (10.0)
Bone disease	*	17 (8.1)
Diabetes	14 (33.3)	46 (21.9)
Anemia	36 (85.7)	31 (14.8)
Benign Prostatic Hyper	11 (26.2)	40 (19.0)
Treatment		
None	*	134 (63.8)
Radiation	25 (59.5)	*
Surgery	*	*

Baseline Characteristics. Numbers < 11 are masked according to SEER-Medicare policy.

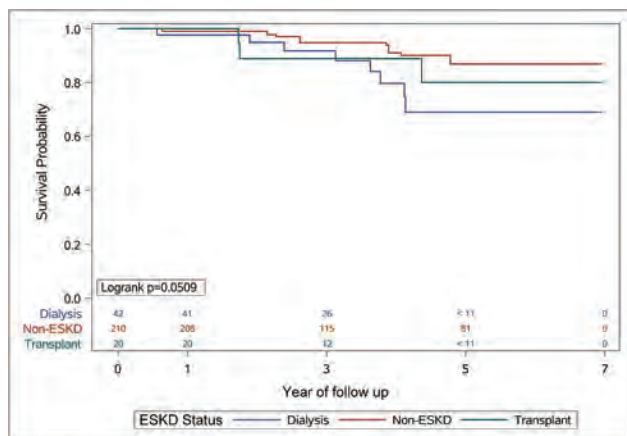

SA-PO144

Capmatinib-Associated AKI: A Case Series

Leticia A. Sandoval, Yeshwanter Radhakrishnan, Ashley Potter, Aaron Mansfield, Sandra Herrmann. *Mayo Clinic Research Rochester, Rochester, MN.*

**Background:** Capmatinib is a MET inhibitor used in non-small cell lung cancers that harbor MET exon 14 skipping mutations. It can cause serum creatinine (SCR) elevation without evidence of a kidney injury (AKI), termed pseudo-AKI, and likely due to

inhibition of renal transporters multidrug and toxic extrusion protein 1 and 2-K (MATE1 and MATE2-K). We present 13 patients who developed AKI with capmatinib therapy.

**Methods:** We performed a retrospective multi-center observational study of all patients who received capmatinib at Mayo Clinic campus between 05/2020 and 10/2021. We analyzed demographics, comorbidities, laboratory values, and outcomes of those who developed AKI.

**Results:** Among 38 patients on capmatinib, 13 (34%) had an elevation of SCR and were diagnosed with AKI based on KDIGO criteria (table 1). Patients had a median age of 78 years ± SD 10.28% were male, with a mean baseline SCR of 1.05 ± SD 0.42 mg/dL. Seven patients presented with dyspnea, fatigue, and lower extremity edema without acid-base or electrolyte disturbances. Patients who had available urinalysis had no active sediment. Cystatin C and Iothalamate Glomerular Filtration Rate (GFR) clearance during AKI did not show variation from baseline, although SCR was elevated, raising the possibility of pseudo-AKI (figure 1). All patients had SCR reduction within three months. None of these patients required kidney replacement therapy.

**Conclusions:** In our experience, one-third of patients at our institution had elevations in SCR while on capmatinib. Pseudo-AKI is possible, as two patients did not have variations in cystatin C or Iothalamate-based GFRs during AKI. Pseudo-AKI may result in inappropriate dose-adjustments. Estimating GFR with cystatin C and iothalamate should be considered in these patients instead of relying on SCR.

Table 1:

	Comorbidities	SCR (mg/dL)		Time to (Days)		Management
		Baseline	Peak	AKI	Mean	
1	n/a	0.88	1.40	114	95 ± 72	Δ
2	n/a	1.22	1.89	37		○
3	DM	0.61	0.96	64		•
4	n/a	0.70	1.20	32		○
5	CKD, HF, HTN	1.60	2.44	21		×
6	CKD, CLD, HTN	2.15	3.77	150		×
7	HTN	1.02	2.02	84		×
8	n/a	0.85	1.28	208		○
9	CKD, HTN	1.41	2.70	48		×
10	HTN	0.79	1.26	61		•
11	n/a	0.95	1.50	12		×
12	HTN	0.84	1.31	160		×
13	HF, HTN	0.64	1.47	246		•

Table 1: Symbols: × capmatinib held; Δ capmatinib dose reduction; • fluid adjustment and/or diuretics; ○ observation only. DM – Diabetes Mellitus, CKD – chronic kidney disease. HF – heart failure, CLD – chronic liver disease, HTN – hypertension, N/a – not applicable to the previous commodities.

Figure 1: Cystatin-C of two patients, before and after AKI.

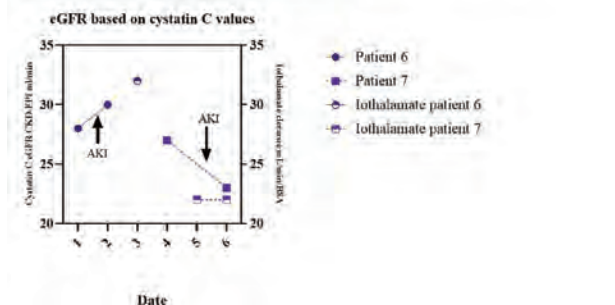

SA-PO145

One Serum Creatinine, Several Dosings of Cytotoxic Drugs: Different Estimations of Filtration Rate Influence Conditioning Intensity (N=959)

Luca-Marie Heinze,<sup>1</sup> Nicole Brueder,<sup>1</sup> Steven Talbot,<sup>2</sup> Elke Dammann,<sup>1</sup> Sophia Koehler,<sup>3</sup> Arnold Ganser,<sup>1</sup> Matthias Eder,<sup>1</sup> Michael Heuser,<sup>1</sup> Jan T. Kielstein,<sup>4</sup> Gernot Beutel.<sup>1</sup> HON Circle of the iCHOP initiative (www.ichop.eu) <sup>1</sup>Hannover Medical School, Department of Hematology, Hemostaseology, Oncology and Stem Cell Transplantation, Hannover, Germany; <sup>2</sup>Hannover Medical School, Institute for Laboratory Animal Science and Central Animal Laboratory, Hannover, Germany; <sup>3</sup>Hannover Medical School, Enterprise Clinical Research Data Warehouse, Hannover, Germany; <sup>4</sup>Academic Teaching Hospital Brunswick, Clinic for Nephrology, Rheumatology and Blood Purification, Brunswick, Germany.

**Background:** Allogeneic stem cell transplantation (alloSCT) is a potentially curative therapy for high-risk patients with hematologic diseases. However, since conditioning is based on classical chemotherapy, dose reduction of cytostatic drugs is required in case of impaired renal function. Our study aimed to evaluate different methods for estimating renal function using creatinine clearance (CrCl) and estimated glomerular filtration rate (eGFR) and to compare the calculated dosage of drugs.

**Methods:** Between 2003 and 2020, 1394 alloSCT were performed at our center. In 959 patients, clinical data were linked to serum creatinine (N=92,229) exported from our data warehouse. CrCl/eGFR was calculated with Cockcroft-Gault, MDRD, and CKD-EPI, classified according to KDIGO criteria, and compared against each other based on the creatinine before the start of conditioning. Within the current recommendations, the required dose reduction for each cytostatic drug was calculated based on the aforementioned methods.

**Results:** CrCl/eGFR show different results depending on the method used. Before conditioning, the proportion of patients with a GFR <60 ml/min was 4.4% (Cockcroft-Gault), 7.1% (MDRD) and 5.0% (CKD-EPI). The need for dose reduction ranged from 0.1% (cyclophosphamide) to 5.8% (fludarabine). In the case of fludarabine, the SmPC recommendation is based on CrCl and requires dose reduction in 8.4% of cases. Using MDRD, reduction would be necessary in 14.2% of cases, 5.8% more than with the SmPC recommendation. Applied to all conditioning regimens, the use of Cockcroft-Gault causes the need for action in only a few cases, while MDRD displays a considerably higher rate of dose adjustments (Fig 1).

**Conclusions:** Dosing of cytotoxic drugs depends on renal function. Although Cockcroft-Gault is rarely used in the clinic nowadays, many dose adjustments still utilize this method. However, our data show that compared with MDRD or CKD-EPI, Cockcroft-Gault usually overestimates renal function. Since a rapid determination of renal function is currently unavailable, therapeutic success and toxicity predictions are hampered by the use of various methods.

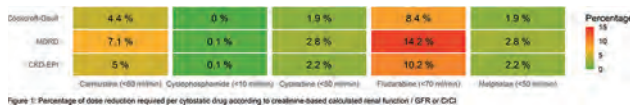

SA-PO146

**A Risk Prediction Model for Contrast-Associated Acute Kidney Injury (CA-AKI)**

Robert H. Seitter Pérez,<sup>1</sup> Yi Mu,<sup>4</sup> Bernard A. Rosner,<sup>4</sup> Donald F. Chute,<sup>2</sup> Shveta S. Motwani,<sup>3</sup> Gary C. Curhan,<sup>4</sup> Shruti Gupta,<sup>1</sup> <sup>1</sup>Brigham and Women's Hospital, Boston, MA; <sup>2</sup>Massachusetts General Hospital, Boston, MA; <sup>3</sup>Lahey Hospital and Medical Center, Burlington, MA; <sup>4</sup>Brigham and Women's Hospital Channing Division of Network Medicine, Boston, MA.

**Background:** Cancer patients undergo frequent CT scans with contrast and may be uniquely predisposed to CA-AKI due to decreased effective circulating volume or concomitant treatment with nephrotoxic chemotherapy. Nevertheless, large-scale data regarding specific risk factors for CA-AKI in this population are lacking.

**Methods:** We collected data on all CT scans with contrast obtained in adult cancer patients without ESKD from 2016 through 2020 at 2 large cancer centers. With each scan serving as an individual unit, we collected data on demographics, comorbidities, labs, and medications related to each scan. CA-AKI was defined either as a ≥0.3 mg/dl rise in serum creatinine (SCr) from baseline within 48 hours of the CT scan or a 1.5-fold rise in SCr to the peak measurement in the 14 days following the scan. Regression models accounting for correlated data were used to identify risk factors for CA-AKI.

**Results:** CA-AKI occurred in 2435 of 46,593 scans (5.2%). Non-white race, contrast volume, diabetes mellitus, congestive heart failure, hypoalbuminemia, thrombocytopenia, baseline proteinuria, lower baseline eGFR, and use of diuretics and ACEI/ARBs were each associated with a higher risk of CA-AKI (Table), and the risk of CA-AKI progressively increased with a higher risk score (Figure).

**Conclusions:** A clinically relevant scoring system is predictive of CA-AKI and can be used to help risk-stratify cancer patients undergoing CT scans with contrast.

**Funding:** Commercial Support - GE Healthcare

Variable	Odds Ratio	Points
Non-white race	1.28	2
Contrast volume 100 to 200 ml	1.13	1
Contrast volume >200 ml	1.86	6
Diabetes mellitus	1.28	2
Congestive heart failure	1.37	3
Serum albumin <3.0 g/dL	2.72	10
Serum albumin 3 to <3.5 g/dL	1.73	5
Platelets <150,000 per µL	1.30	3
Baseline proteinuria on urinalysis	1.31	3
eGFR <30 ml/min/1.73 m <sup>2</sup>	3.82	13
eGFR 30 to <60 ml/min/1.73 m <sup>2</sup>	1.45	4
Diuretic use	1.59	5
ACEI/ARB use	1.24	2

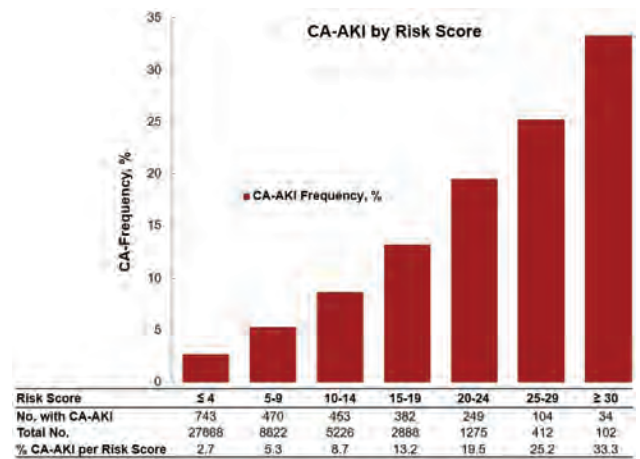

SA-PO147

**Association of Kidney Volume Measurement to 2021 CKD-EPI Estimating Equations Improves the Prediction of Measured Glomerular Filtration Rate in Cancer Patients**

Fernando L. Strufaldi,<sup>1,2</sup> Regis F. Bezerra,<sup>2</sup> Veronica T. Costa e Silva,<sup>2</sup> <sup>1</sup>Universidade de Sao Paulo Hospital das Clinicas, Sao Paulo, Brazil; <sup>2</sup>Universidade de Sao Paulo Instituto do Cancer do Estado de Sao Paulo, Sao Paulo, Brazil.

**Background:** It has been demonstrated that adding total kidney volume (TKV) measurement to glomerular filtration rate (GFR) estimating equations in multivariate linear regression models can improve the prediction of measured GFR in cancer patients. However, the 2021 CKD-EPI equations, now recommended in the United States, have not been assessed in this context.

**Methods:** We enrolled 189 patients with solid tumors at an academic cancer Hospital in Brazil (Instituto do Câncer do Estado de São Paulo) who had undergone abdominal imaging and GFR measurement by plasma clearance <sup>51</sup>Cr-EDTA within 60 days. eGFR was determined based on the 2021 CKD-EPI equations using Scr (eGFR<sub>Scr</sub>) and Scr combined with Scys (eGFR<sub>Scr-cys</sub>). eGFR and mGFR were non-indexed for body surface area. TKV was measured using a semi-automatic segmentation program, excluding non-functional tissues. The correlations between mGFR and TKV, as well as, mGFR and eGFR, were calculated using the Pearson Correlation Coefficient (PCC). Linear regression models were built, having TKV and eGFR equations as predictors and mGFR as the outcome.

**Results:** Patients were 56.3(14.0) years old, 49.2% male. Most common cancer sites were breast (18.0%), colorectal (12.7%), and stomach (10.1%). 96% of patients were ECOG 0/1. Mean (SD) Body mass index was 27.18 (5.6). Mean (SD) mGFR, eGFR<sub>Scr</sub> and eGFR<sub>Scr-cys</sub> were 81.2(22.2), 91.5(20.9), and 87.6(23.2), ml/min, respectively. Mean(SD) TKV for both kidneys was 311.6 (76.2) cm<sup>3</sup>. PCC for mGFR-TKV, mGFR-eGFR<sub>Scr</sub> and mGFR-eGFR<sub>Scr-cys</sub> were 0.79, 0.81, and 0.87, respectively. TKV improved the coefficient of determination of the linear regression models when added to both eGFR<sub>Scr</sub> and eGFR<sub>Scr-cys</sub>, in overall and assessed subgroups (Table 1)

**Conclusions:** In conclusion, our results suggest that TKV measurement improves the prediction of mGFR in association with the 2021 CKD-EPI equations in cancer patients. Thus, TKV could potentially be incorporated to enhance GFR estimation in clinical practice

Table 1: Linear regression models for measured glomerular filtration rate

	Predictors															
	eGFR <sub>Scr</sub>				TKV + eGFR <sub>Scr</sub>				eGFR <sub>Scr-cys</sub>				TKV + eGFR <sub>Scr-cys</sub>			
Population	F	R <sup>2</sup>	ΔR <sup>2</sup>	F	R <sup>2</sup>	ΔR <sup>2</sup>	F	R <sup>2</sup>	ΔR <sup>2</sup>	F	R <sup>2</sup>	ΔR <sup>2</sup>	F	R <sup>2</sup>	ΔR <sup>2</sup>	
Overall (n=189)	2.33	0.85	-	0.65	15.60	0.16	0.52	0.75	5.95	0.86	-	0.75	12.31	0.13	0.60	0.82
Sex																
Male (n=93)	2.33	0.86	-	0.65	15.60	0.16	0.52	0.75	5.95	0.86	-	0.75	12.31	0.13	0.61	0.82
Female (n=96)	2.33	0.85	-	0.65	15.60	0.16	0.52	0.75	5.95	0.86	-	0.75	12.31	0.13	0.61	0.82
Age (y)																
<65 (n=66)	2.33	0.86	-	0.65	15.60	0.16	0.52	0.75	5.95	0.86	-	0.75	12.31	0.13	0.61	0.82
≥65 (n=133)	2.33	0.85	-	0.65	15.60	0.16	0.52	0.75	5.95	0.86	-	0.75	12.31	0.13	0.61	0.82
Diabetes																
Yes (n=24)	2.33	0.86	-	0.65	15.60	0.16	0.52	0.75	5.95	0.86	-	0.75	12.31	0.13	0.61	0.82
No (n=165)	2.33	0.86	-	0.65	15.60	0.16	0.52	0.75	5.95	0.86	-	0.75	12.31	0.13	0.61	0.82
BMI (kg/m <sup>2</sup> )																
<24 (n=66)	2.33	0.86	-	0.65	15.60	0.16	0.52	0.75	5.95	0.86	-	0.75	12.31	0.13	0.61	0.82
24 to <30 (n=89)	2.33	0.85	-	0.65	15.60	0.16	0.52	0.75	5.95	0.86	-	0.75	12.31	0.13	0.61	0.82
≥30 (n=45)	2.33	0.85	-	0.65	15.60	0.16	0.52	0.75	5.95	0.86	-	0.75	12.31	0.13	0.61	0.82

eGFR is the outcome, eGFR<sub>Scr</sub>, eGFR<sub>Scr-cys</sub>, and TKV are the predictors. mGFR: measured glomerular filtration rate; eGFR: estimated glomerular filtration rate as based on CKD-EPI equations; being eGFR<sub>Scr</sub> based on serum creatinine level and eGFR<sub>Scr-cys</sub> being eGFR based on both serum creatinine and serum cystatin C level; CKD-EPI equation: USA; body surface area; BMI: body mass index; CKD: chronic kidney disease; TKV: total kidney volume; F: intercept; R<sup>2</sup>: beta coefficient for eGFR equation; ΔR<sup>2</sup>: beta coefficient for TKV; R<sup>2</sup>: coefficient of determination, represents the proportion of the variance for a dependent variable that is explained by the predictors. eGFR and mGFR were assessed using natural values.

SA-PO148

**Impact of Renal Impairment Criteria on Survival of Patients With Newly Diagnosed Multiple Myeloma**

Fernando L. Strufaldi,<sup>1,2</sup> Gabriela C. Segura,<sup>1,2</sup> Renato A. Caires,<sup>2</sup> Francisco Z. Mattedi,<sup>2</sup> Elerson Costalonga,<sup>2</sup> Gracia Martinez,<sup>2</sup> Veronica T. Costa e Silva,<sup>2</sup> <sup>1</sup>Universidade de Sao Paulo Hospital das Clinicas, Sao Paulo, Brazil; <sup>2</sup>Universidade de Sao Paulo Instituto do Cancer do Estado de Sao Paulo, Sao Paulo, Brazil.

**Background:** The International Myeloma Working Group(IMWG) defines renal impairment(RI) as serum creatinine (SCr)>2.0 mg/dL or estimated glomerular filtration rate(eGFR)<40 ml/min/1.73m<sup>2</sup> at the diagnosis of multiple myeloma(MM)(RI-IMWG). Our aim is to assess if different criteria used to evaluate RI have an impact on the overall survival(OS) in newly diagnosed MM patients(pts)

**Methods:** We screened all pts with newly diagnosed MM admitted for treatment at the Sao Paulo State Cancer Institute, between January 2009 and September 2018. Exclusion criteria were: age<18 y, maintenance dialysis, treatment ineligibility, and follow-up< 3 months. eGFR was determined by the 2009 CKD-EPI equation and expressed as ml/min/1.73m<sup>2</sup>. Chronic Kidney Disease(CKD) criteria was eGFR<60. Acute Kidney Injury(AKI) was classified according to the KDIGO criteria. Baseline SCr was defined as the lowest SCr within 3 months before admission or, if absent, as the lowest SCr during follow-up. Clinical stage was assessed by International Staging System(ISS)(based on serum albumin [Alb] and beta 2 microglobulin [B2M])

**Results:** We enrolled 557 pts. Median age(IQR) was 62.0(54.2-69.9)y, 56.5% were male. ISS stage III(III-III) was observed in 36.1%. Alb<3.5g/dL(Albu), B2M>3.5mg/L(B2Ma), and lactate dehydrogenase above normal limit(LDHa) were observed in 42.4,55.6, and 20.6%, respectively. eGFR at baseline and at diagnosis were 78.7(53.4-97.4), and 68.9(40.8-92.9), respectively. At diagnosis, CKD, RI-IMWG, AKI, and AKI-3 were observed in 28.6, 23.3, 25.5, and 10.6% of patients, respectively. OS was 3.0(1.0 – 4.25)y. In the univariate analysis(long-rank test), variables related to reduced OS(p<0.05) were: age, diabetes, LDHa, ISS-III, B2Ma, CKD, AKI-3, RI-IMWG. Albu and AKI-1 were not associated with reduced OS. Variables retained on Cox Regression Model(CRM) are described in table. RI-IMWG and CKD were not retained in additional CRM(data not shown)

**Conclusions:** Although highly accepted, RI-IMWG definition neither distinguishes CKD from AKI nor performs as well as AKI-3 as an independent predictor of mortality in newly diagnosed MM

Table 1. Cox Regression Model

Variables	p value	Hazard Ratio (95% Confidence interval)
Above limit LDH	<b>0.034</b>	<b>1.37 (1.02-1.85)</b>
ISS = 3	<b>0.001</b>	<b>1.57 (1.20-2.05)</b>
Age at diagnosis	<b>&lt;0.001</b>	<b>1.03 (1.02-1.04)</b>
AKI KDIGO 3	<b>0.059</b>	<b>1.43 (0.98 - 2.09)</b>

SA-PO149

**Cytokines and Immune Cell Profiling in AKI Associated With Immune Checkpoint Inhibitors**

Naba Farooqui, Eram Ahsan, Lisa E. Vaughan, Timucin Taner, Nelson Leung, Mariam P. Alexander, Sandra Herrmann. *Mayo Foundation for Medical Education and Research, Rochester, MN.*

**Background:** Immune checkpoint inhibitors(ICIs) can cause acute kidney injury(AKI-ICI), the most common histopathological finding being acute interstitial nephritis (AIN). Biomarkers can provide mechanistic insight into the pathophysiology of the AKI and may allow for early AKI-ICI detection which would help guide management. In this study, we investigated the associations between cytokines and immune cell profiling and AKI-ICI.

**Methods:** We prospectively included patients with AKI who were on ICI therapy and evaluated T-cell responses in peripheral mononuclear blood cells(PBMCs) and kidney tissue as well as urine and blood cytokines. Patient were adjudicated to either have a histological or clinical diagnosis of AIN [AKI-ICI(N=14)] or AKI due to other causes(e.g., acute tubular injury)[AKI-other (N=10)]. Kidney donors' samples were also used as healthy controls(N=12). Imaging mass cytometry was used for immune cells profiling, and kidney tissue from a subset of patients with archived biopsy samples were also evaluated. Luminex assay was used to obtain urine and blood cytokines.

**Results:** Urine TNF-α levels were higher in the AKI-ICI group compared to AKI-other and healthy controls(Fig 1A), and tissue TNF-α expression was also significantly increased in AKI-ICI patients compared to controls(Fig 1B). However, systemic TNF-α levels were not found to be significantly different between groups(Fig 1C). Results from logistic regression predicting AKI type(AKI-ICI vs AKI-other) from TNF-α yielded strong discriminatory ability(AUC=0.814, 95% CI: 0.623-1.00). We also observed more pronounced increases of specific immune cells including CD4 memory, T helper and dendritic cells in the kidney tissue of patients who developed AKI-ICI compared to healthy controls(Figs 1D, 1E, 1F).

**Conclusions:** These results suggest that increases in TNF-α and specific T-cell responses may contribute to AKI-ICI injury and could potentially serve as targets for therapeutic intervention as well as potential biomarkers.

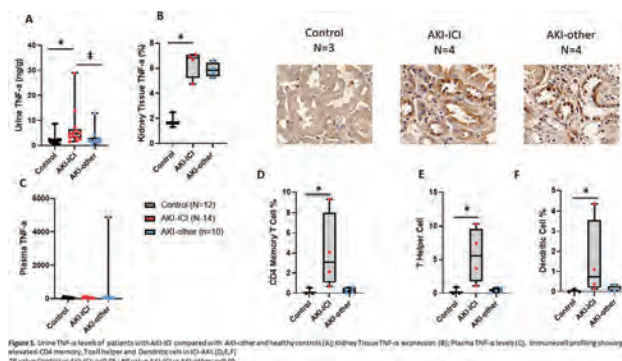

Figure 8. Urine TNF-α levels of patients with AKI-ICI compared with AKI-other and healthy controls. (A) Kidney Tissue TNF-α expression; (B) Kidney Tissue TNF-α level; (C) Immunosuppressant treatment related CD4 memory, T helper and dendritic cells in AKI-ICI, AKI-other, and healthy controls. \*p<0.05, \*\*p<0.01, \*\*\*p<0.001.

SA-PO150

**AKI After Bone Marrow Transplantation**

Andreea Andronesi,<sup>1,2</sup> Bogdan Sorohan,<sup>1,2</sup> Andreea Burcea,<sup>2</sup> Cristina Stanescu,<sup>2</sup> Gabriela Lupusoru,<sup>1,2</sup> Danut Andronesi,<sup>2</sup> Mircea Lupusoru,<sup>1</sup> Gener Ismail,<sup>1,2</sup> <sup>1</sup>“Carol Davila” University of Medicine and Pharmacy, Bucharest, Romania; <sup>2</sup>Fundeni Clinical Institute, Bucharest, Romania.

**Background:** Bone marrow transplantation (BMT) is the best therapeutic approach for an increasing number of blood disorders, as well as for some autoimmune diseases, offering the best disease-free survival in eligible patients. Acute kidney injury (AKI) is a serious complication, with significant impact upon outcomes, including progression to chronic kidney disease (CKD) and overall survival.

**Methods:** The aim was to evaluate the incidence, risk factors and severity of AKI during the first 100 days after BMT. We performed a prospective observational study. AKI definition and staging were done using KDIGO criteria. Renal recovery was defined as a reduction in serum creatinine within 0.3 mg/dl compared to baseline at 3 months after AKI. Cox regression analysis was used to identify independent risk factors for AKI.

**Results:** We included 405 consecutive patients- pts (203 F) with BMT: 240 auto-BMT and 165 allo-BMT. Pts with allo-BMT were significantly younger (mean age 57.8 years in auto-BMT, 39.3 years in allo-BMT, p=0.01). AKI incidence was 40.7%. The incidence (20.4% in auto-BMT, 70.3% in allo-BMT, p<0.001) and severity (in auto-BMT: AKI grade 1- 9.7%, grade 2- 0.5%, no grade 3 cases; in allo-BMT: grade 1- 36.7%, grade 2- 33.9%, grade 3- 47.2%, p=0.02) were significantly higher in allo-BMT. Emergency hemodialysis (HD) was initiated in 15 pts (3.7%), all with allo-BMT. Death was recorded exclusively in the allo-BMT. In allo-BMT, mortality during the first 100 days was 2.05 more frequent in the group of pts who developed AKI, but without statistical significance. The mortality in pts who required HD was very high- 85.5%. Renal recovery was recorded in 70.6% pts. In Cox regression analysis, allo-BMT (HR 9.01, CI 95% 3.1-34.3, p=0.001), preexisting CKD (HR 5.5, 95%CI: 2.4-19.2, p=0.002), and calcineurin inhibitors (CNI) overdosage (HR 2.3, CI 95% 1.1-3.2, p=0.003) were independent risk factors for AKI, while sepsis was the only independent risk factor for AKI stage 3 (HR= 5.1, CI 95% 1.9-17.5, p=0.003).

**Conclusions:** AKI occurs with reduced incidence and severity after auto-BMT and does not have impact upon survival. AKI after allo-BMT is much more severe and has a significant impact upon outcome. A better fluid management, avoidance of the nephrotoxins especially in preexisting CKD, and carefully monitoring of CNI may significant reduce this risk.

SA-PO151

**AKI Treated With Kidney Replacement Therapy in Allogeneic Hematopoietic Stem Cell Transplantation (aHSCT) Patients Admitted to the Intensive Care Unit: Incidence, Risk Factors, and Outcomes**

Helena Kim,<sup>1</sup> Rafia W. Ali,<sup>1</sup> Samuel Short,<sup>3,1</sup> Roman Shapiro,<sup>4</sup> Robert Soiffer,<sup>4</sup> Zachariah Defilipp,<sup>2</sup> Charlotte Thomas,<sup>1</sup> Isabel Park,<sup>1</sup> Shruti Gupta,<sup>1,4</sup> David E. Leaf.<sup>1</sup> <sup>1</sup>Brigham and Women's Hospital, Boston, MA; <sup>2</sup>Massachusetts General Hospital, Boston, MA; <sup>3</sup>University of Vermont College of Medicine, Burlington, VT; <sup>4</sup>Dana-Farber Cancer Institute, Boston, MA.

**Background:** Acute kidney injury (AKI) following allogeneic hematopoietic stem cell transplantation (aHSCT) is a common complication associated with substantial morbidity and mortality. Those who develop AKI treated with kidney replacement therapy (AKI-KRT) have even higher mortality. Few studies have investigated the incidence, risk factors, and outcomes associated with AKI-KRT in critically ill patients following aHSCT.

**Methods:** We performed a retrospective cohort study of 179 patients admitted to an ICU within 1 year following aHSCT (transplanted between 2013 and 2019) at two academic medical centers in Boston, MA. Data on demographics, comorbidities, lab values, medications, and clinical outcomes were obtained through both automated and manual review of medical records. We assessed independent risk factors for development of AKI-KRT using multivariable logistic regression. We assessed mortality during hospital admission and at 3- and 6-months after ICU admission according to maximum KDIGO AKI stage during ICU admission.

**Results:** A total of 42 of 179 patients (23.5%) developed AKI-KRT during ICU admission. Independent risk factors for AKI-KRT included veno-occlusive disease

(VOD) and thrombotic microangiopathy (TMA) prior to ICU admission, receipt of invasive mechanical ventilation on ICU admission, and admission to the ICU within 180 days following aHSTC (Figure 1A). Mortality increased with higher AKI stage, and was highest in those with AKI-KRT, reaching 78.6% during hospitalization and 88.1% at 6 months (Figure 1B).

**Conclusions:** Among aHSTC patients admitted to the ICU, independent risk factors for AKI-KRT included VOD, TMA, receipt of invasive mechanical ventilation, and admission to the ICU within 180 days following aHSTC. Nearly 90% of patients who developed AKI-KRT died with 6 months of ICU admission.

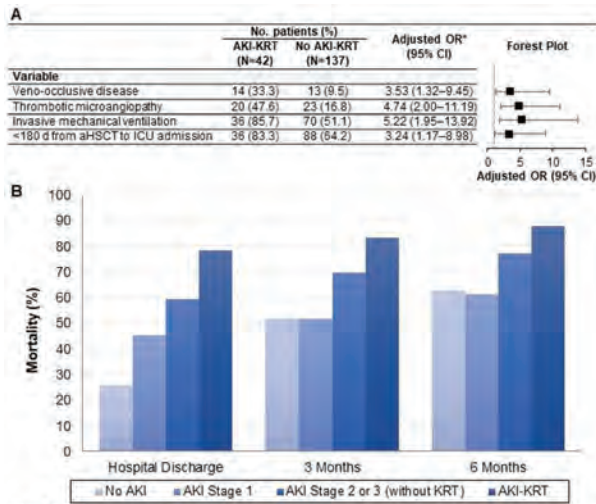

Figure A. Independent risk factors for AKI-KRT. \*Odds ratios are adjusted for each of the four variables shown above. B. Mortality at hospital discharge and 3- and 6- months following ICU admission, stratified by AKI stage.

SA-PO152

**Characterization of Hemoglobin and Renal Function Trends After Reoperative Partial Nephrectomies in Patients With Recurrent Renal Cell Carcinoma (RCC)**

Maria Antony, Nikhil Gopal, Zoe Blake, Sandeep Gurram, Mark Ball. Center for Cancer Research: Urologic Oncology Branch National Cancer Institute, Bethesda, MD.

**Background:** Patients with renal tumor syndromes may undergo multiple reoperative partial nephrectomies (RePN) conferring volume loss and functional sequelae. Though partial nephrectomy is oncologically safe and delays the need for renal replacement therapy compared to radical nephrectomy, few studies quantify outcomes in the reoperative setting. We studied a cohort of RePN to assess renal and hematologic outcomes following second, third-, and fourth-time partial nephrectomy of the same renal unit.

**Methods:** We performed a retrospective query of an institutional registry of nephrectomies for RCC in 2006 to 2021. Demographics, creatinine (SCr), and hemoglobin within one week prior to surgery were reviewed, as well as intraoperative blood loss. SCr was used to calculate eGFR using CKD-EPI 2021. Nephrectomy history was reconstructed based on documented surgical history between 1976 and 2021.

**Results:** Between 2006 and 2021, a total of 424 institutional nephrectomies (415 partial, 9 radical) conducted on 308 patients (60% male, 48 years old (IQR: 38-57)) were analyzed. Time between subsequent ipsilateral nephrectomy was 6.98 years (IQR: 4.4-10.5). We observed a stepwise decline in preoperative GFR with an average GFR decline of 6.3 with each RePN (p<0.001). Estimated blood loss (p=0.002) increased and hemoglobin decreased (p=0.006) with each RePN. On multivariate analysis, patients displayed odds of anemia with subsequent RePN at hemoglobin cut-off of 11 (OR:1.88, p<0.001) and 12 (OR:1.74, p<0.001) when controlling for gender, race, solitary kidney, and preoperative GFR.

**Conclusions:** RePN conveys renal functional decline, as well as increased intraoperative blood loss with each subsequent surgery. Our analysis suggests functional anemia is driven by partial nephrectomy frequency. Together, these impacts must be considered when counseling patients on available treatments to balance oncologic efficacy with prevention of chronic kidney disease and anemia.

**Funding:** Other NIH Support - Supported by the National Institutes of Health (NIH) IRP and the NIH MRSP, a public-private partnership supported jointly by the NIH and contributions to the Foundation for the NIH from the Doris Duke Charitable Foundation, The American Association for Dental Research, the Colgate-Palmolive Company, and other private donors.

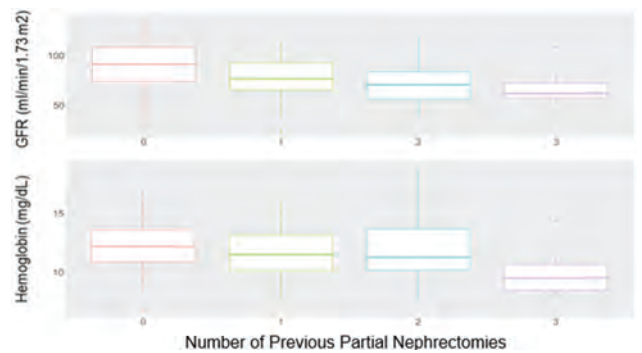

SA-PO153

**Association Between Monoclonal Gammopathy of Undetermined/Renal Significance (MGUS/MGRS) and ESKD and Mortality in Patients With CKD**

Janina Paula T. Sy-Go, Simon Moubarak, Jason K. Viehman, Lisa E. Vaughan, Fernando C. Fervenza, Ladan Zand. Mayo Clinic Minnesota, Rochester, MN.

**Background:** Little is known about the prognostic significance of MGUS/MGRS in patients with CKD. The objective of this study was to determine the association between MGUS/MGRS and ESKD and mortality in patients with CKD.

**Methods:** We identified 109,638 adult patients with CKD at Mayo Clinic from January 1, 2013 to December 31, 2018. We excluded those who did not have monoclonal (M) protein testing (n=98,270). Of 4558 patients, 3142 were diagnosed with MGUS based on positive M protein by either SPEP/UPEP confirmed by immunofixation or abnormal FLC ratio while 64 were considered to have an MGRS lesion based on biopsy.

**Results:** We identified a total of 1535 patients (828 with no MGUS, 648 with MGUS, and 59 with MGRS). Median age was 73.5 years (65.3,80.2), and 57.9% were male. Median eGFR was 45 mL/min/1.73m<sup>2</sup>. Median follow-up was 4.86 years. Patients with MGRS were younger (68.5 years) and had lower eGFR (41 mL/min/1.73m<sup>2</sup>) and higher proteinuria. Patients with MGRS also had the highest mortality compared to those with MGUS and no MGUS with infection being the most common known cause of death (25%). MGRS was associated with an increased risk of ESKD in unadjusted model, but after adjustment for eGFR, it was no longer significant (Table 1). MGUS was also associated with an increased risk of ESKD compared to no MGUS in unadjusted model and after adjusting for age, sex, eGFR, and proteinuria, but after adjusting for comorbidities, it was no longer significant (Table 1).

**Conclusions:** MGUS and MGRS are not independently associated with a higher risk of ESKD in patients with CKD after adjusting for other clinical characteristics. Patients with MGRS had higher rates of death compared to the other groups.

Unadjusted and Adjusted Associations Between Non-MGUS/MGRS, MGUS, and MGRS Status and Risk of ESKD

Adjusting Variables	MGUS		MGRS	
	HR (95% CI)	P	HR (95% CI)	P
Unadjusted	1.250 (0.967, 1.615)	0.088	2.534 (1.517, 4.235)	<0.001
Age	1.243 (0.961, 1.608)	0.098	2.016 (1.183, 3.435)	0.010
Sex	1.256 (0.970, 1.626)	0.084	2.565 (1.526, 4.310)	<0.001
eGFR	1.378 (1.062, 1.786)	0.016	1.759 (0.935, 3.309)	0.080
Age, sex, eGFR	1.369 (1.055, 1.776)	0.018	1.461 (0.760, 2.809)	0.256
Age, sex, eGFR, proteinuria	1.369 (1.041, 1.801)	0.025	0.824 (0.415, 1.636)	0.580
Age, sex, eGFR, Charlson Comorbidity Index	1.206 (0.973, 1.648)	0.079	1.575 (0.798, 3.109)	0.190
Age, sex, eGFR, proteinuria, Charlson Comorbidity Index	1.248 (0.948, 1.644)	0.114	0.906 (0.450, 1.825)	0.783

SA-PO154

**Urinary NGAL (uNGAL) as a Biomarker to Predict Late Nephrotoxicity in Pre-Clinical Models of Peptide-Based Radioligand Therapy (PRRT) for Cancer**

Gabriela Vasquez Martinez,<sup>1</sup> Mengshi Li,<sup>5</sup> Prerna Rastogi,<sup>3</sup> Dijie Liu,<sup>5</sup> Sarah C. Linn,<sup>4,1</sup> Gabriel Mayorcal Andrade,<sup>1</sup> Michael K. Schultz,<sup>5,6</sup> Diana Zepeda-Orozco,<sup>1,2</sup> <sup>1</sup>Nationwide Children's Hospital, Columbus, OH; <sup>2</sup>The Ohio State University College of Medicine, Columbus, OH; <sup>3</sup>The University of Iowa Hospitals and Clinics Department of Pathology, Iowa City, IA; <sup>4</sup>The Ohio State University College of Veterinary Medicine, Columbus, OH; <sup>5</sup>Viewpoint Molecular Targeting, Inc., Coralville, IA; <sup>6</sup>The University of Iowa Hospitals and Clinics, Iowa City, IA.

**Background:** PRRT for cancer has gained traction in oncology due to favorable tumor-targeting performance. A dose limiting organ for most PRRTs is the kidney, and toxicity is thought to be caused by proximal-tubule reabsorption of radiolabeled peptide. The objective of this study was to evaluate the use of uNGAL to predict chronic renal damage after PRRT therapy in a murine pre-clinical model

**Methods:** We conducted a PRRT dose escalation study to anticipated renal injury levels in CD-1 Elite mice (0.9, 3 and 6.7 MBq of a <sup>212</sup>Pb labeled peptide, n = 6 per group). Urine was collected on days 1, 3, 53, and at 7 months. Serum was collected on weeks 1, 5,

8, and at 7 months. Mice were euthanized at 7 months for histology. NGAL was measured by ELISA. BUN and Creatinine were measured by blood chemistry panel. Histological tubular injury (TI), interstitial inflammation (IF), glomerulosclerosis (GS) and interstitial fibrosis (FIB) scores (0 to 5) were performed by pathologist in PAS and trichrome stained sections

**Results:** uNGAL concentration was higher with increasing dosages of the <sup>212</sup>Pb labeled peptide 24 hours after therapy (Table 1). High PRRT dose of the <sup>212</sup>Pb labeled peptide (6.7 MBq) resulted on late TI, IF, GS and FIB (2.6±1.34, 2.2±1.095, 1.4±1.14, 3.2±0.836 respectively, p<0.05). uNGAL positively correlated with alpha dose (r =0.89, p<0.0001), TI (r=0.71, p=0.0001), IF (r=0.65, p=0.0008) and FIB (r=0.75, p<0.0001). BUN and creatinine were significantly increased at 7 months with high PRRT doses (Table1) but not significantly different at 1, 5 or 8 weeks.

**Conclusions:** uNGAL could be a potential early biomarker to predict the progression of AKI to CKD after PRRTs. Comparisons to other radionuclides are needed to develop a more detailed understanding.

**Funding:** Other NIH Support - CA174521 P50, R01 CA243014, Commercial Support - Viewpoint

Kidney Function and Urine Biomarkers

Kidney Function/Urine Biomarker	Control	0.9 MBq	3.0 MBq	6.7 MBq
uNGAL at 24 hrs (ng/ml)	34.72 ± 11.46	301.40 ± 133.49 *	663.01 ± 181.48 ***	1178.62 ± 661.80 **
BUN at 7 months (mg/dl)	16.33 ± 1.86	22.20 ± 6.97	24.33 ± 8.59 **	34.20 ± 9.60 ****
sCreatinine at 7 months (mg/dl)	0.10 ± 0.001	0.10 ± 0.07	0.26 ± 0.15 **	0.38 ± 0.20 ****

BUN: Blood Nitrogen Urea, NGAL: Neutrophil gelatinase-associated lipocalin, MBq: Megabecquerel; Mean ± Standard deviation, \*p<0.05, \*\*p=0.01, \*\*\*p<0.001, \*\*\*\*p<0.0001

SA-PO155

Short- and Long-Term Adverse Kidney Outcomes of CDK 4/6 Inhibitors for Breast Cancer

Paul Hanna,<sup>1</sup> Ian A. Strohhahn,<sup>1</sup> Qiyu Wang,<sup>1</sup> Tianqi Ouyang,<sup>1</sup> Shruti Gupta,<sup>2</sup> Seth Wander,<sup>1</sup> Meghan E. Sise,<sup>1</sup> <sup>1</sup>Massachusetts General Hospital Department of Medicine, Boston, MA; <sup>2</sup>Brigham and Women's Hospital Department of Medicine, Boston, MA.

**Background:** Cyclin-dependent kinase (CDK) 4/6 inhibitors have transformed the treatment landscape for patients with advanced or metastatic breast cancer. Small studies have suggested that CDK 4/6 inhibitors may interfere with creatinine secretion. Yet, there are also case reports of biopsy-proven acute tubular necrosis and acute interstitial nephritis in patients receiving CDK 4/6 inhibitors. We sought to study the short and long-term kidney outcomes in a large cohort of women treated with CDK 4/6 inhibitors.

**Methods:** Retrospective cohort study of women receiving abemaciclib or palbociclib at two cancer centers. We compared the risk of acute 20% estimated glomerular filtration rate (eGFR) decline within 30 days of treatment initiation and the 1-year risk of a composite adverse kidney outcome (>40% eGFR decline sustained >90 days, eGFR <10ml/min/1.73m<sup>2</sup>, or need for dialysis).

**Results:** 253 women received abemaciclib and 238 received palbociclib. Mean age was 61 years (SD=13), baseline eGFR was 87ml/min/1.73m<sup>2</sup> (SD = 21); there were no significant differences between the two cohorts at baseline. The rate of acute 20% eGFR decline within 30 days was significantly higher in patients receiving abemaciclib vs. palbociclib (60% vs. 22%, p<0.001). After adjusting for age, race/ethnicity, baseline eGFR, comorbidities, and medication use, the adjusted odds ratio was 5.38, CI: 3.60 – 8.13, p<0.001). Despite the initial decline in eGFR, kidney function was stable over the next 11 months for both abemaciclib and palbociclib-treated patients (Figure), and no patients experienced the composite adverse kidney outcome at 1 year.

**Conclusions:** CDK 4/6 inhibitors cause an acute decline in eGFR that is significantly more common in patients receiving abemaciclib than palbociclib. Our data suggest benign inhibition of creatinine secretion, as eGFR stabilized, and there was no progressive decline in kidney function or kidney failure events.

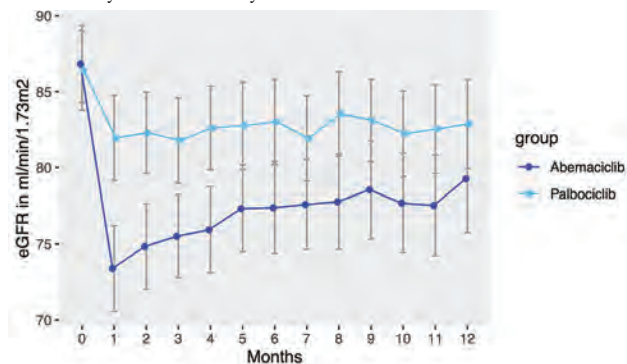

Figure 1. Mean eGFR over 12 months after starting CDK 4/6 inhibitors

SA-PO156

Impact of the 2021 CKD-EPI Equation on Anticancer Drug Eligibility and Dosing in Black and Non-Black Patients

Morgan A. Butrovich,<sup>1</sup> Jiyue Qin,<sup>3</sup> Xiaonan Xue,<sup>3</sup> S. P. Ivy,<sup>4</sup> Thomas D. Nolin,<sup>1,2</sup> Jan H. Beumer,<sup>1,2</sup> <sup>1</sup>University of Pittsburgh School of Pharmacy, Pittsburgh, PA; <sup>2</sup>University of Pittsburgh School of Medicine, Pittsburgh, PA; <sup>3</sup>Albert Einstein College of Medicine, Bronx, NY; <sup>4</sup>National Cancer Institute, Bethesda, MD.

**Background:** Cancer and kidney disease disproportionately impact Black patients, and kidney function is a key consideration in anticancer pharmacotherapy decision-making. In 2021, the new CKD-EPI equation that omits race was recommended to replace the 2009 CKD-EPI equation. The current study evaluated the impact of using the 2021 vs 2009 CKD-EPI equation to determine anticancer drug eligibility and dosing in Black and non-Black patients.

**Methods:** A retrospective analysis of patients enrolled in phase 1 CTEP-sponsored studies from 1995-2010 was performed. eGFR was calculated by the 2021 and 2009 CKD-EPI equations (eGFR<sub>2021</sub> and eGFR<sub>2009</sub>, respectively) and converted to absolute eGFR (i.e., mL/min) by multiplying by BSA/1.73 m<sup>2</sup>. Dosing simulations based on eGFR<sub>2021</sub> and eGFR<sub>2009</sub> were performed for ten anticancer drugs with renal eligibility or dosing cutoffs. Discordance in eligibility and dosing recommendations for eGFR<sub>2021</sub> and eGFR<sub>2009</sub> were compared between races by  $\chi^2$  test. Difference in drug eligibility based on eGFR equation was assessed by GEE logistic regression.

**Results:** 3931 patients were included, 8.6% of whom were Black. The mean change between eGFR<sub>2021</sub> and eGFR<sub>2009</sub> for Black (-10.5 ml/min) and non-Black (4.1 ml/min) patients was significantly different (p<0.001). The proportion of patients with discordant recommendations did not differ between Black and non-Black patients. However, Black patients were 48% (95% CI: 14%–94%) more likely to be ineligible for cisplatin using eGFR<sub>2021</sub> vs eGFR<sub>2009</sub>, controlling for sex, age, and BSA. Non-Black patients were 27% (95% CI: 18%–35%) less likely to be ineligible for cisplatin using eGFR<sub>2021</sub> vs eGFR<sub>2009</sub>.

**Conclusions:** Although discordance rates in eligibility and dosing were similar between Black and non-Black patients, eGFR<sub>2021</sub> was lower than eGFR<sub>2009</sub> for Black patients, translating to Black patients being more likely than non-Black patients to be deemed ineligible for drugs when using eGFR<sub>2021</sub>. eGFR<sub>2021</sub> is negatively biased for Black patients at lower eGFRs, where most drug eligibility and dosing cutoffs lie; this may lead to inappropriate exclusion of therapy for some Black patients. These findings highlight the importance of clinical judgement and use of confirmatory kidney function tests when prescribing anticancer agents, particularly in Black patients with low GFR.

**Funding:** Other NIH Support - Grants UM1CA186690, P30CA47904, and U24CA247643, and contract NO2-CM37106

SA-PO157

A Predictive Model for Kidney Failure After Nephrectomy for Localized Kidney Cancer: The Kidney Cancer Risk Equation

Oksana Harasemiw,<sup>1,2</sup> Jasmir G. Nayak,<sup>1</sup> Nicholas Grubic,<sup>3,4</sup> Thomas W. Ferguson,<sup>1,2</sup> Manish M. Sood,<sup>5,6</sup> Navdeep Tangri,<sup>1,2</sup> <sup>1</sup>University of Manitoba Max Rady College of Medicine, Winnipeg, MB, Canada; <sup>2</sup>Seven Oaks Chronic Disease Innovation Centre, Winnipeg, MB, Canada; <sup>3</sup>Institute for Clinical Evaluative Sciences, Toronto, ON, Canada; <sup>4</sup>Ottawa Hospital Research Institute, Ottawa, ON, Canada; <sup>5</sup>University of Ottawa Faculty of Medicine, Ottawa, ON, Canada; <sup>6</sup>Ottawa Hospital, Ottawa, ON, Canada.

**Background:** Nephrectomy is the mainstay treatment for individuals with localized kidney cancer. However, surgery can potentially result in functional kidney impairment leading to kidney failure requiring dialysis or transplantation. There are currently no clinical tools available for clinicians to pre-operatively identify which patients are at risk of kidney failure, and therefore, the aim of our study was to develop and validate a prediction equation for kidney failure after nephrectomy for kidney cancer.

**Methods:** A population-level cohort study was conducted with adults (≥ 18 years old; n=1,026) from Manitoba, Canada who were diagnosed with non-metastatic kidney cancer between January 1, 2004 and December 31, 2016, were treated with either a partial or radical nephrectomy, and had at least 1 estimated glomerular filtration rate (eGFR) measurement available pre and post nephrectomy. Demographic, clinical, and laboratory data were used to develop the prediction models using Cox proportional hazards regression methods. We subsequently externally validated the models using data from 12,043 individuals from Ontario, Canada. The primary outcome was dialysis, transplantation, or an eGFR < 15 mL/min/1.73m<sup>2</sup> during the follow-up period.

**Results:** Among individuals in the development cohort (mean age 61.2 ± 11.7; mean eGFR 79.5 ± 22.8 mL/min/1.73m<sup>2</sup>; 39.0% partial nephrectomy/61.2% radical), 10.4% reached kidney failure during the follow-up period. The final model included 6 variables: age, sex, baseline eGFR, urine albumin-to-creatinine ratio, nephrectomy type, diabetes mellitus. The 5-year C-statistic was 0.83 (74.8, 91.4) in the development cohort and 0.86 (0.84, 0.88) in the validation cohort.

**Conclusions:** We developed and externally validated a simple equation that incorporates easily accessible data and can accurately predict kidney failure in individuals undergoing nephrectomy for treatment of localized kidney cancer. This tool can help inform pre-operative discussion about kidney failure risk in patients facing surgical options for localized kidney cancer.

**Funding:** Private Foundation Support

SA-PO158

**A Humanized Mouse Model as a Preclinical Tool to Evaluate Nephrotoxicity due to Cancer Immunotherapies**

Lauren E. Thompson,<sup>1</sup> Michael J. Goedken,<sup>2</sup> Kenneth R. Reuhl,<sup>2</sup> Adrian T. Dominguez,<sup>1</sup> Todd Pitts,<sup>1</sup> Katja Kiseljak-Vassiliades,<sup>1</sup> Lauren Aleksunes,<sup>2</sup> Julie Lang,<sup>1</sup> Melanie S. Joy.<sup>1</sup> <sup>1</sup>University of Colorado Health, Aurora, CO; <sup>2</sup>Rutgers The State University of New Jersey, New Brunswick, NJ.

**Background:** Immune checkpoint inhibitors (ICIs) have revolutionized the treatment of cancer by targeting inhibitory receptors on tumor and T cells. However, post-marketing surveillance has demonstrated that these therapies cause immune-mediated adverse events including nephrotoxicity. We evaluated a mouse model with a humanized immune system as a preclinical and translational tool to identify kidney toxicities in response to cancer immunotherapies.

**Methods:** Three feasibility studies were conducted in newborn BALB/c-Rag2<sup>tm1.1</sup>/Il2rγ<sup>tm1.1</sup>/Sirpα<sup>tm1.1</sup> (BRGS; nonhumanized) mice which were irradiated and injected with CD34+ hematopoietic cells isolated from human umbilical cord blood to generate mice with a humanized immune system (HIS-BRGS). After 2 weeks of tumor growth followed by 2-4 weeks of ICI treatment (Table 1), H&E-stained sections of kidneys from the mice were analyzed for histomorphological evidence of injury. Incidence and severity scores (range of 0 to 3) were recorded. Statistical analyses were conducted using rank order one-way ANOVAs with Tukey-Kramer post-hoc tests (R).

**Results:** Humanization of the immune system caused minimal glomerulonephritis (p<0.0001) in all HIS-BRGS mice compared to BRGS mice. Compared to vehicle-treated HIS-BRGS mice, treatment with nivo/ipi trended towards worsening glomerulonephritis (p=0.056). Nivo alone, as well as nivo/ipi, resulted in interstitial nephritis (nivo: p=0.016, ipi/nivo: p=0.004) and periarteritis (nivo: p=0.027, ipi/nivo: p=0.003) in HIS-BRGS mice compared to vehicle-treated HIS-BRGS mice. Pembro/mito- and pembro/cetux/CD-47 antagonist-treatment resulted in increased periarteritis compared to vehicle-treated and single agent-treated HIS-BRGS mice (pembro/mito: p=0.042, pembro/cetux/CD-47 antagonist: p=0.090).

**Conclusions:** Humanized HIS-BRGS mice represent a highly innovative and promising preclinical and translational model to evaluate immune-related kidney toxicities including glomerulonephritis, periarteritis, and interstitial nephritis from ICIs.

**Funding:** Other NIH Support - R01GM123330, T32ES029074, UL1TR003017, P30CA046934, P30CA072720

Table 1. Summary of methods for ICI nephrotoxicity feasibility studies in BRGS and HIS-BRGS mice.

Study	Mouse type (n; M:F)	Cancer type	Treatment regimen	Treatment duration (wks)
1	BRGS (7; 4M:3F) HIS-BRGS (14; 8M:6F)	Triple negative breast cancer MDA-MB-231 cells	Vehicle (PBS)	4
			Nivolumab (20 mg/kg 2x/wk) Nivolumab + Ipilimumab (10 mg/kg each 1x/wk)	
2	HIS-BRGS (14; 8M:6F)	Patient-derived xenografts of adrenocortical carcinoma (ACC)	Vehicle (PBS)	4
			Pembrolizumab (30 mg/kg 1x/wk) Mitotane (440 mg/kg 3x/wk) Pembrolizumab + Mitotane	
3	HIS-BRGS (12; 4M:8F)	Patient-derived xenografts of microsatellite stable-colorectal cancer (MSS-CRC)	Vehicle (PBS)	2-4
			Vehicle + Liposomal doxorubicin (LC) CD-47 antagonist (30 mg/kg 2x/wk) CD-47 antagonist + Pembrolizumab (15 mg/kg 1x/wk) + Cetuximab (15 mg/kg 1x/wk)	

SA-PO159

**Clinicopathologic and Molecular Characteristics of Light Chain Crystalline Podocytopathy**

Samih H. Nasr,<sup>1</sup> Satoru Kudose,<sup>2</sup> Vincent Javague,<sup>3</sup> Samar M. Said,<sup>1</sup> Stéphanie Harel,<sup>6</sup> George A. Osuchukwu,<sup>4</sup> Arjun Das,<sup>5</sup> Elliot J. Suchin,<sup>7</sup> Nelson Leung,<sup>1</sup> Frank Bridoux,<sup>3</sup> Vivette D. D'Agati.<sup>2</sup> <sup>1</sup>Mayo Clinic Minnesota, Rochester, MN; <sup>2</sup>Columbia University, New York, NY; <sup>3</sup>Universite de Poitiers, Poitiers, France; <sup>4</sup>Victoria Kidney and Dialysis Associates, Victoria, TX; <sup>5</sup>Nephrology Consultants of Northwest Ohio, Toledo, OH; <sup>6</sup>Saint-Louis Hospital, Paris, France; <sup>7</sup>Center for Kidney Care, Hainesport, NJ.

**Background:** Monoclonal immunoglobulin (MIg) light chain (LC) crystalline inclusions within podocytes is a rare finding usually seen in association with LC proximal tubulopathy (LCPT).

**Methods:** We describe the first clinicopathologic and molecular series on LC crystalline podocytopathy (LCCP) defined by the presence of extensive podocyte LC crystals.

**Results:** This multicenter cohort included 24 patients (63% male, 75% Caucasian, median age 57 yrs). Presentations included proteinuria (median 3.4 g/day, 56% albuminuria), CKD (median creatinine 2.1 mg/dl), hypertension (54%), nephrotic syndrome (29%), Fanconi syndrome (14%) and visual impairment from crystalline keratopathy (17%). The underlying hematologic condition was MGRS in 81% and symptomatic MM in 19%. The serum MIg was IgGκ in 86%, with urinary MIg detected in 94%, and abnormal serum FLC in all 19 tested (median ratio 12.6). Podocyte crystals were visible by light microscopy in 71%, with FSGS in 63% (including collapsing in 9 cases, NOS in 5 and tip in 1). All 20 cases studied by electron microscopy (EM) exhibited extensive podocyte crystals and 45% had diffuse effacement. Crystals were also present in proximal tubular cells (75%, indicating concurrent LCPT), distal tubular cells (33%), interstitial histiocytes (33%; crystal storing histiocytosis), endothelial cells (17%), mesangial cells (17%) and plasma cells (4%). Concurrent mild LC cast nephropathy was present in 7 cases, AL amyloidosis in 1, and LCDD in 1. While frozen-immunofluorescence (IF) failed to reveal the LC composition of crystals in 22 (91%) cases, this was successfully identified using paraffin-IF (14/20) or immunoEM (3/3) and was κ LC in 87%. The pathogenic LC variable gene segment determined by laser

microdissection of glomeruli followed by mass spectrometry (n=3) or bone marrow plasma cell sequencing (n=2) was IGKV1-33 in 3 cases, IGKV1-39 in 1 and IGKV3-20 in 1. On follow up (median 30 months) in 23 patients, 19 received plasma-cell directed therapy. Outcomes were renal response in 40%, ESKD in 22% and death in 22%.

**Conclusions:** LCCP is a rare entity, mostly associated with IgGκ MGRS. Despite frequently concurrent LCPT and associations with IGKV1-33 & IGKV1-39, Fanconi syndrome is rare. Paraffin-IF and EM are needed to prevent misdiagnosis as FSGS.

SA-PO160

**AKI and Chimeric Antigen Receptor T Cell Therapy in Hematologic Neoplasms**

Juan C. León Román, Gloria Iacoboni, Sheila Bermejo, Cecilia Carpio, Mónica Bolufer, Oriol Bestard, Pere Barba, Maria Jose Soler. *Hospital Universitari Vall d'Hebron, Barcelona, Spain.*

**Background:** CAR-T cell is a treatment for refractory hematologic malignancies(RHM). AKI occurs between 20-30% after infusion. The purpose of this study was to identify risk factors for AKI and long-term outcomes

**Methods:** Medical records of 115 patients treated with CD19-targeted CAR-T cells for RHM at HUVH between July 2018 and May 2021 were reviewed. Clinical data was reviewed within 60 days after CAR-T cells therapy. We performed statistically analysis to identify risk factors for AKI and mortality

**Results:** 24/115 patients presented AKI after therapy. AKI was diagnosed: day+1 in 3 patients, day+7 in 13 patients, day+14 in 1 patient, day+21 in 2 patients, day+28 in 2 patients, day+60 in 1 patient, and 2 patients in conditioning therapy. 19 patients recovered kidney function within the first month. The most frequent hematological neoplasm was diffuse large B-cell lymphoma(90.5%). Investigational product was infused in 27.8%, tisagenlecleucel in 49.6%, axicabtagen ciloleucel in 20%, and brexucabtagene autoleucel in 2.6%. The most frequent complications were CRS(72.2%), febrile neutropenia(67%) and neurotoxicity(16.5%). 3/36 patients died after CAR-T infusion. Male sex, type of CAR-T cell therapy, neurotoxicity, calcium levels at day+21 and +28, phosphorus levels at day+1 and +28, and albumin levels at day+7 and +21 were associated with AKI. Only male sex(p=0.03) and neurotoxicity(p=0.02) were identified as independent risk factors for AKI. Gender, neurotoxicity, and creatinine showed no significant differences for mortality after one-year follow-up

**Conclusions:** AKI is frequent but mild disease with a fast recovery in patients treated with CAR-T

Table 1. Demographic and Clinical Characteristics of the 115 patients

Variable	All	AKI patients (n=24)	Non-AKI patients (n=91)	p value
≥61 years old	61 [20-81]	16	46	0.16
Male	76	20	56	0.04
Hypertension	43	13	30	0.05
Type of CAR-T cell therapy	115	24	91	0.04
Neurotoxicity	19	8	11	0.01
Death by any cause	36	6	30	0.001

Table 2. Adjusted OR for AKI development

Variable	aOR	CI 95%	P value
Male	5.14	1.14-23.0	0.03
Neurotoxicity	9.27	1.31-65.7	0.02

Figure 1. Mortality risk factors for patients treated with CAR-T cell therapy

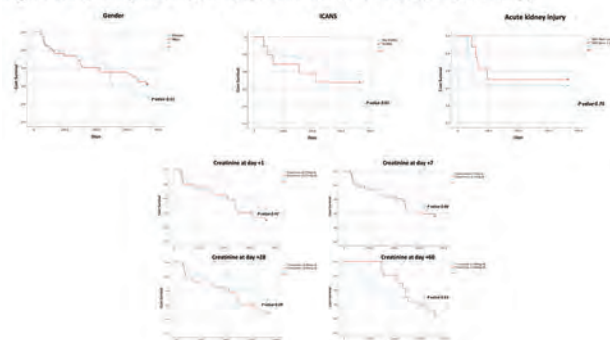



SA-PO161

**Vascular Calcification Is Associated With Fetuin-A and Cortical Bone Porosity in Stone Formers**

Fernanda G. Rodrigues,<sup>1,2</sup> Rodrigo A. Neves,<sup>3</sup> Milene S. Ormanji,<sup>1</sup> Priscila L. Esper,<sup>1</sup> Lucio R. Requião-moura,<sup>1,3</sup> Martin H. De Borst,<sup>2</sup> Ita P. Heilberg.<sup>1</sup>  
<sup>1</sup>Universidade Federal de São Paulo, São Paulo, Brazil; <sup>2</sup>Rijksuniversiteit Groningen, Groningen, Netherlands; <sup>3</sup>Universidade Federal de São Paulo Hospital do Rim e Hipertensão, São Paulo, Brazil.

**Background:** Nephrolithiasis has been associated with bone loss and cardiovascular disease as well as vascular calcification (VC), reflecting abnormal extraosseous calcium deposition. Fetuin-A (Fet-A) acts as a potent inhibitor of ectopic mineralization. The aim of the present study was to evaluate the prevalence of VC in stone formers (SF) compared to non-stone formers (NSF) and to investigate the relationship of Fet-A and bone microarchitecture with VC among SF.

**Methods:** Post-hoc analysis of a cross-sectional trial that evaluated bone microarchitecture parameters by high-resolution peripheral quantitative computed tomography (HR-pQCT) in young SF. Abdominal aortic calcification (AAC) was assessed as a marker of VC, using computed tomography in SF and in age-, sex- and BMI-matched NSF (potential living kidney donors). The association of AAC with serum Fet-A, measured in SF stored blood samples, and with HR-pQCT parameters and other factors was studied using multivariable logistic regression analysis.

**Results:** A total of 62 SF (age 38.0 [28.0-45.3] years) and 80 NSF (40.0 [37.0-45.8] years) were included. There was no statistically significant difference in AAC scores between SF (5.8 ± 0.8 %) and NSF (5.6 ± 0.7 %, p = 0.27). When dividing SF according to their mean value of AAC score, below <5.8% (n=33) or above ≥ 5.8% (n=29), SF with higher AAC had significantly higher BMI and tibial cortical porosity (Ct.Po) and significantly lower serum HDL, klotho, Fet-A and eGFR. Urinary calcium did not differ between groups but fractional excretion of phosphate was higher in SF with higher AAC. Upon multivariate regression analysis, BMI (β 0.31, p<0.01), serum Fet-A (β -0.29, p=0.02) and tibial Ct.Po (β 0.26, p=0.03) were independently associated with AAC (Table 1).

**Conclusions:** This study demonstrates associations of reduced circulating Fet-A levels and higher tibial porosity with AAC, supporting Fet-A as central mediator in the kidney-bone-vasculature axis.

Table 1. Linear regression using AAC Score as dependent variable

Potential determinants	Univariable		Multivariable*	
	B	p	B	p
Age, years	0.17	0.16	-	-
Sex, F	-0.21	0.10	-	-
BMI, kg/m <sup>2</sup>	0.32	0.01	0.31	<0.01
Metabolic Syndrome, yes	0.22	0.08	-	-
Hypertension, yes	0.16	0.22	-	-
Smoking, yes	0.29	0.02	-	-
Serum sclerostin, pmol/L	0.90	0.02	-	-
Tibial Tb.N, 1/mm	0.14	0.27	-	-
Tibial Tb.Sp, mm	-0.15	0.26	-	-
Tibial Ct.Po, %	0.90	0.02	0.26	0.03
Tibial Ct.Th, mm	0.18	0.17	-	-
Radius Tb.N, 1/mm	0.07	0.58	-	-
Radius Tb.Sp, mm	-0.11	0.40	-	-
Radius Ct.Po, %	0.21	0.10	-	-
Radius Ct.Th, mm	-0.02	0.86	-	-
Urinary Calcium, mg/24h	0.09	0.48	-	-
Urinary Phosphate, mg/24h	0.36	<0.01	-	-
FeP, %	0.27	0.04	-	-
eGFR, mL/min/1.73m <sup>2</sup>	-0.31	0.01	-	-
Serum ionized Calcium, mmol/L	0.10	0.40	-	-
Serum Phosphate, mg/24h	0.14	0.27	-	-
Serum 25OH-vitamin D, ng/mL	-0.24	<0.05	-	-
Serum 1-25OH-vitamin D, pg/mL	0.07	0.55	-	-
Serum PTH, ng/mL	-0.04	0.76	-	-
Serum BAP, U/L	0.18	0.15	-	-
Serum klotho, pg/mL	-0.26	0.07	-	-
Serum FGF23, pg/mL	0.16	0.20	-	-
Serum Fetuin-A, ug/mL	-0.35	<0.01	-0.29	0.02
Serum Fetuin-A RR, %	0.15	0.26	-	-

\*Run backwards. Abbreviations: AAC, abdominal aortic calcification; BMI, body mass index; Tb.N, trabecular number; Tb.Sp, trabecular separation; Ct.Po, cortical porosity; FeP, fractional excretion of phosphate; eGFR, estimated glomerular function rate; Ctx, C PTH, parathyroid hormone; BAP, bone alkaline phosphatase; FGF-23, fibroblast growth factor 23.

SA-PO162

**Breast Artery Calcification as a Surrogate Marker for Vascular Calcification in CKD**

Pattraid Mueangpaisarn, Pamila Tasanavipap, Narongrit Siriwattanasit, Pitchamon Inkong, Narittaya Varothai, Paramat Thimachai, Amnart Chairprasert, Naowanit Nata, Theerasak Tangwonglert, Wisit Kaewput, Ouppatham Supasynhd, Bancha Satirapoj. *Phramongkutklao College of Medicine, Bangkok, Thailand.*

**Background:** Arterial calcification is common in patients with chronic kidney disease and contributes to excess cardiovascular mortality. Breast artery calcification could be a potential marker of medial vascular calcification in CKD but is limited for screening vascular calcification in patients with CKD. The study aimed to determine the performance of BAC for detecting vascular calcification in CKD patients and investigate the relationship between BAC and associated factors in CKD patients.

**Methods:** A total of 103 women aged>40 years with estimated glomerular filtration rate (GFR) of less than 90 ml/mL/min/1.73 m<sup>2</sup> with digital mammography, lateral lumbar spine radiographs, and non-contrast computed tomography was included. BAC score (0-12) was calculated by the number of calcified vessels, the longest length and the

density of calcification. Cardiovascular disease risk factors and laboratory profiles were assessed for each patient.

**Results:** BAC was identified 8 (39.1%) in CKD stage II, 26 (56.5%) in CKD stage III, and 26 (76.5%) in CKD stage IV-V (P<0.017). Patients with the presence BAC were significantly older, had lower GFR, higher hemoglobinA1C and increased AAC score than patients without calcification. In a multivariate model including the traditional cardiovascular risk factors, the presence of BAC was significantly associated with lower estimated GFR (adjusted HR=5.67, 95%CI 1.78-17.83) and older age (adjusted HR:1.009, 95%CI 1.02-1.17). BAC increased in sensitivity (85.7%) and accuracy (67.6%) in accordance with coronary artery calcification score (CAC) in patients with GFR less than 30 mL/min/1.73 m<sup>2</sup>. BAC and AAC scores showed significant implications of CAC score in which area under curve (AUC) were 0.67 (95%CI 0.57- 0.78) and 0.84 (95%CI 0.76-0.92), respectively. Remarkably, the combination of AAC and BAC scores showed better CAC score prediction (AUC 0.88, 95%CI 0.81-0.96).

**Conclusions:** The presence and severity of BAC is markedly increased in advanced CKD and it is significantly associated with older age and lower GFR. A combination of BAC and AAC performed good performance in predicting coronary calcification, especially in advanced CKD.

SA-PO163

**Effect of Menaquinone-7 Supplementation on Arterial Stiffness in Chronic Hemodialysis Patients: A Multicenter Randomized Controlled Trial**

Nuanjanthip Naiyaraksaeree,<sup>1</sup> Jeerath Phannajit,<sup>1</sup> Wichai Naiyaraksaeree,<sup>2</sup> Sookkrutai Lekhyananda,<sup>3</sup> Yingyos Avihingsanon,<sup>1</sup> Kearkiat Praditpornsilpa,<sup>1</sup> Somchai Eiam-Ong,<sup>1</sup> Paweena Susantitaphong,<sup>1</sup> <sup>1</sup>Chulalongkorn University Faculty of Medicine, Bangkok, Thailand; <sup>2</sup>The Bangkok Christian Hospital, Bangkok, Thailand; <sup>3</sup>Kidney Foundation of Thailand, Bangkok, Thailand.

**Background:** Vitamin K deficiency is one of the most important risk factors of vascular calcification and arterial stiffness in chronic kidney disease and dialysis patients. However, the benefit of vitamin K supplementation on structural and functional vascular health are still not established. This study was aimed to evaluate the efficacy of menaquinone-7 (MK-7) supplementation on arterial stiffness in chronic hemodialysis (HD) patients.

**Methods:** This open-label multicenter randomized clinical trial was conducted in 96 HD patients who had arterial stiffness, defined by high carotid femoral pulse wave velocity (cfPWV ≥ 10 m/s). The patients were randomly assigned to receive oral MK-7 (375 mcg once daily) for 24 weeks (n = 50) or standard care (control group; n = 46). The change of cfPWV was evaluated as primary outcome.

**Results:** The baseline parameters were comparable between two groups. At 12 weeks, patients who received MK-7 had a trend in decreasing in cfPWV compared with standard care (-13.0 ± 20.7% vs -6.8 ± 21.1%, p=0.18). This effect is more prominent in diabetes patients (-9.9 ± 13.8% vs 1.9 ± 17.2%, p = 0.065). In addition, the MK-7 group had lower rate of arterial stiffness progression compared with control group (21.4% vs 34.1%, p = 0.20), especially in diabetes patients (21.4% vs 58.3%, p = 0.054). There were no serious adverse events observed during 12 weeks.

**Conclusions:** Vitamin K supplementation provided a trend in decreasing arterial stiffness at short term follow up without serious adverse effects, especially patients with diabetes. However, the benefit on vascular health and cardiovascular outcomes are still needed.

**Funding:** Private Foundation Support

SA-PO164

**Clinical Features and Outcomes of Calciphylaxis in Chinese Patients With CKD**

Yongyi Jiao, Xiaoliang Zhang. *Zhong Da Hospital affiliated to Southeast University, Nanjing, China.*

**Background:** Calciphylaxis is a rare disease, predominantly in chronic kidney disease (CKD), characterized by high morbidity and mortality. Data from the Chinese population have been an invaluable resource for a better understanding of natural history, optimal treatments, and outcomes of calciphylaxis.

**Methods:** A retrospective study was conducted in 51 Chinese patients diagnosed with calciphylaxis at Zhong Da Hospital affiliated to Southeast University from December 2015 to September 2020. Descriptive statistical analysis was used in summarizing patients' characteristics, treatments and disease outcomes. Kaplan-Meier method was used to calculate survival. Univariate COX regression models were used to determine survival predictors of patients with calciphylaxis.

**Results:** Between 2015 and 2020, 51 cases of calciphylaxis were registered in The China Calciphylaxis Registry (<http://www.calciphylaxis.com.cn>), which were developed by Zhong Da Hospital. The mean age of the cohort was 52.02 ± 14.09 years, and 37.3% of them were female. 43 patients (84.3%) were on hemodialysis, with a median dialysis vintage of 88 months. 18 patients (35.3%) had a resolution of calciphylaxis and 20 patients (39.2%) died. Patients in later stages had worse survival than those in earlier stages. Time of skin lesions and calciphylaxis-related infection were risk factors in both early mortality and overall mortality. Additionally, dialysis vintage and infections were significant risk factors in calciphylaxis-specific mortality. Among therapeutic strategies, only the use of STS ≥ 3 courses was significantly associated with decreased hazard of death.

**Conclusions:** For Chinese patients with calciphylaxis, time of skin lesions and infection secondary to wounds are risk factors for the prognosis of patients with

calciophylaxis. Additionally, patients in earlier stages have a better survival rate and early continuous use of STS is highly suggested.

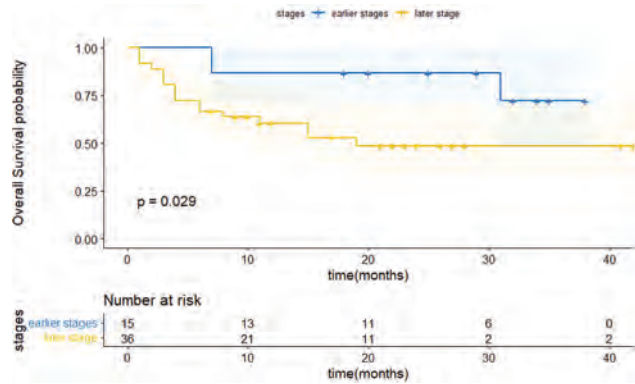

Overall mortality survival for stratified into calciophylaxis patients in earlier and later stages

SA-PO165

**Fracture, Vascular Calcification, and Bone Turnover: The Important Interrelationship in Disorder of Bone and Mineral Metabolism in CKD**  
 Ana Paula Gueiros,<sup>1</sup> Luiz A. Coutinho,<sup>1</sup> Julia B. Vaz,<sup>1</sup> Eduarda C. Russo,<sup>1</sup> Vanda Jorgetti,<sup>2</sup> Jose E. Gueiros.<sup>1</sup> <sup>1</sup>Universidade Federal de Pernambuco, Recife, Brazil; <sup>2</sup>Universidade de Sao Paulo, Sao Paulo, Brazil.

**Background:** Disorders in bone and mineral metabolism are ubiquitous in hemodialysis (HD) patients. The aim of this study was to assess factors associated with the occurrence of fracture in HD patients undergoing bone biopsy (BB).

**Methods:** The medical records of 250 patients were reviewed. Clinical data: age, sex, time on HD and fracture. Laboratory: Calcium, phosphorus (P), intact parathyroid hormone (iPTH), total alkaline phosphatase. Vascular calcification (VC) was assessed by x-rays. A qualitative analysis of BB considered the diagnoses: osteitis fibrosa (OF), mixed disease (MD), adynamic bone disease (ABD), osteomalacia (OM) and osteoporosis (OP). A comparative analysis was performed between patients with and without fracture. Univariate and multivariate analyses verified the predictors of fracture and OP.

**Results:** Median age of patients: 48 years; 57.6% were women and the median time on HD was 9 years. The prevalence of fracture, OP and VC were 8.3%, 43.6% and 45.5%, respectively. In relation to BB, 54.4% of patients presented OF, 30% MD, 12.4% ABD and 3.2% OM. Patients with and without fracture (F x NF) were distinguished by the presence of VC (75% x 41.9%; p=0.01), OP (68.4% x 40.9%; p=0.02), a diagnosis of ABD (31.5% x 10% ; p=0.01), bone turnover (High/Low) (63.1% x 87.6%/36.8% x 12.3%; p=0.01) and by P (mg/dL) (4.6 x 5.9; p=0.003); and a tendency towards iPTH (pg/mL) (415 x 1190; p=0.05). Univariate analysis for risk of fracture: VC (OR 4.15, 95% CI 1.39-15.3; p=0.01), OP (OR 3.12, CI 1.19-9.19; p=0.02), bone turnover (Low OR 4.13, CI 1.43-11.3; p=0.006) and P (OR 0.67, CI 0.49-0.89; p=0.007). In the multivariate model, VC (OR 3.73, CI 1.21-14; p=0.03) and P (OR 0.75, CI 0.53-1.02; p=0.007) remained. Univariate analysis for OP risk: age (OR 1.02, CI 1.00-1.04; p=0.02), fracture (OR 3.12, CI 1.19-9.19; p=0.02), P (OR 0.85, CI 0.73-0.97; p=0.02) and a diagnosis of OF (OR 0.54, CI 0.33-0.90; p=0.01). In the multivariate model, only fracture remained (OR 3.03, CI 1.06-10; p=0.04).

**Conclusions:** 1. There was a high prevalence of OP and VC in HD patients. 2. We have confirmed the important interrelationship of bone metabolism with the vessel. 3. We have demonstrated the association of low bone turnover with fracture.

SA-PO166

**Association Between Probiotic Consumption and Kidney Stone**  
 Api Chewcharat,<sup>1</sup> Sagar U. Nigwekar.<sup>2</sup> <sup>1</sup>Mount Auburn Hospital, Cambridge, MA; <sup>2</sup>Massachusetts General Hospital, Boston, MA.

**Background:** Gut microbiota plays a pivotal role in calcium oxalate kidney stone formation. Probiotic preparations, especially those with Lactobacillus and Bifidobacterium, may help degrade oxalate and reduce the risk of kidney stones. However, data is still controversial.

**Methods:** We conducted a cross-sectional study among 6,354 US adults aged 20-80 years old in the National Health and Nutrition Examination Survey (NHANES) from cycles 2015-2016 and 2017-2018. Probiotic consumption was defined as self-reported yogurt consumption from 24-hour dietary recall or probiotic supplement based upon dietary supplement use 30-day questionnaire. Our outcomes were a history of kidney stones and symptomatic kidney stones in the past year. We examined the association between yogurt consumption and probiotic supplementation and history of kidney stones and symptomatic kidney stones in the past year using weighted multivariable logistic regression.

**Results:** Of 6,354 US adults, 1,274 (20.1%) participants reported probiotic consumption. There were 710 (11.2%) participants who reported a history of kidney stones and 107 (1.7%) participants with symptomatic kidney stones in the past year. The prevalence of kidney stones was 10.2% among those who reported probiotic consumption

vs. 11.4% among those without probiotic consumption (p-value = 0.21). The prevalence of symptomatic kidney stones in the past year was 2.1% among those who reported probiotic consumption vs. 1.6% among those without probiotic consumption (p-value = 0.18). After adjusting for confounders, there were no associations between probiotic consumption and history of kidney stones (OR = 0.98, 95%CI [0.71, 1.34], p-value = 0.88) and symptomatic kidney stones in the past year (OR = 1.34, 95%CI [0.65, 2.78], p-value = 0.42) (Table 1).

**Conclusions:** Probiotic consumption is not associated with either history of kidney stones or a risk of symptomatic kidney stones in the past year.

Table 1. The association between probiotic consumption and the risk of kidney stones

	Odds ratio of history of kidney stones				Odds ratio of symptomatic kidney stones			
	Crude	p-value	Adjusted <sup>1</sup>	p-value	Crude	p-value	Adjusted <sup>1</sup>	p-value
Probiotic consumption (yogurt + other probiotic)	1.01	0.97	0.98	0.88	1.43	0.22	1.34	0.42
	(0.77, 1.31)		(0.71, 1.34)		(0.80, 2.55)		(0.65, 2.78)	
Only yogurt consumption	0.94	0.66	0.99	0.94	1.20	0.54	1.07	0.86
	(0.70, 1.26)		(0.73, 1.34)		(0.64, 2.19)		(0.49, 2.34)	
Other probiotic supplementation	1.04	0.88	1.04	0.59	1.86	0.25	2.01	0.25
	(0.64, 1.68)		(0.45, 1.59)		(0.64, 5.40)		(0.60, 6.74)	

<sup>1</sup>Multivariable logistic regression model was adjusted for age, sex, race, educational attainment, marital status, family income, alcohol drinking, cigarette smoking status, obesity, diabetes and hypertension

SA-PO167

**Association of Serum Klotho and Risks of Fractures and Osteoporosis in Patients With and Without CKD**

Api Chewcharat,<sup>1</sup> Sagar U. Nigwekar.<sup>2</sup> <sup>1</sup>Mount Auburn Hospital, Cambridge, MA; <sup>2</sup>Massachusetts General Hospital, Boston, MA.

**Background:** Serum soluble Klotho (sKlotho) levels are associated with bone abnormalities in animal models. The extension of these findings to clinical bone outcomes in humans, however, remains controversial.

**Methods:** We conducted a cross-sectional study among 8,660 US adults aged 40-79 years old in the National Health and Nutrition Examination Survey (NHANES) 2007-2010 and 2013-2014. Fractures were identified based on self-reported hip, wrist, or spine fractures diagnosed by doctors on standardized questionnaires. Osteoporosis was defined as T-score ≤ -2.5 at either femoral neck or lumbar spine. sKlotho was divided into 4 quartiles. We examined the association between sKlotho and risks of fractures and osteoporosis using weighted multivariable logistic regression among participants with and without chronic kidney disease (CKD)

**Results:** Of 8,660 US adults aged 40-79 years old (847 participants with CKD and 7,813 participants without CKD), 1,042 participants reported history of fractures in either hip, wrist, or spine. Among those who reported a history of fractures, 113 participants were with CKD and 929 participants were without CKD. Median sKlotho among participants with a history of fractures was 788.9 pg/ml vs 804.9 pg/ml among those without a history of fractures. Among non-CKD participants, there was no association between the quartile of sKlotho and the risk of fractures (OR highest vs lowest quartile 0.95, 95%CI [0.75, 1.19], p = 0.64) after adjusting for confounders. Among participants with CKD, after adjusting for confounders, there was no association between the quartile of sKlotho and the risk of fractures (OR highest vs lowest quartile 0.65, 95%CI [0.35, 1.19], p = 0.15) (Table 1). There were no associations between sKlotho and risk of osteoporosis among either CKD or non-CKD (Table 2).

**Conclusions:** sKlotho does not appear to be a predictor of fractures or osteoporosis in either CKD or non-CKD participants.

Table 1. The association between sKlotho and risk of fractures among CKD (n = 847) and non-CKD (n = 7,813)

Quartile of sKlotho	Odds ratio of fractures among CKD				Odds ratio of fractures among non-CKD			
	Crude	p-value	Adjusted <sup>1</sup>	p-value	Crude	p-value	Adjusted <sup>1</sup>	p-value
Q1 < 660 pg/ml			Ref				Ref	
Q2 660-803 pg/ml	0.69	0.36	0.66	0.30	1.05	0.72	1.05	0.70
	(0.31, 1.55)		(0.29, 1.48)		(0.80, 1.38)		(0.51, 1.87)	
Q3 804-988 pg/ml	0.62	0.10	0.68	0.21	1.13	0.35	1.19	0.18
	(0.36, 1.10)		(0.37, 1.26)		(0.87, 1.48)		(0.52, 1.96)	
Q4 > 988 pg/ml	0.63	0.13	0.72	0.30	0.87	0.24	0.95	0.66
	(0.34, 1.16)		(0.38, 1.35)		(0.69, 1.10)		(0.75, 1.20)	

<sup>1</sup>Multivariable logistic regression model was adjusted for age, sex, race, educational attainment, marital status, family income, alcohol drinking, cigarette smoking status, obesity, diabetes, hypertension, and history of cardiovascular disease

Table 2. The association between sKlotho and risk of osteoporosis among CKD (n = 851) and non-CKD (n = 7,817)

Quartile of sKlotho	Odds ratio of osteoporosis among CKD				Odds ratio of osteoporosis among non-CKD			
	Crude	p-value	Adjusted <sup>1</sup>	p-value	Crude	p-value	Adjusted <sup>1</sup>	p-value
Q1 < 660 pg/ml			Ref				Ref	
Q2 660-803 pg/ml	1.42	0.33	1.59	0.26	1.19	0.35	1.11	0.15
	(0.70, 2.88)		(0.70, 3.61)		(0.82, 1.74)		(0.49, 2.10)	
Q3 804-988 pg/ml	0.78	0.53	0.66	0.83	0.98	0.91	0.96	0.84
	(0.32, 1.91)		(0.23, 1.88)		(0.69, 1.39)		(0.64, 1.44)	
Q4 > 988 pg/ml	2.10	0.06	2.23	0.06	0.92	0.70	0.96	0.84
	(0.96, 4.61)		(0.96, 5.71)		(0.61, 1.39)		(0.64, 1.43)	

<sup>1</sup>Multivariable logistic regression model was adjusted for age, sex, race, educational attainment, marital status, family income, alcohol drinking, cigarette smoking status, obesity, diabetes, hypertension, and history of cardiovascular disease

SA-PO168

**Lipid Profile Increased the Risk of Incident Kidney Stones in a Population-Based Cohort Study**

Xiaohong Fan, Jie Ma, Xuemei Li. Peking Union Medical College Hospital, Dongcheng-qu, China.

**Background:** The prevalence and incidence rate of kidney stones has increased in the past ten years in China. The kidney stone was associated with metabolic diseases such as hypertension, diabetes, and obesity and is also considered to be a higher risk factor for cardiovascular diseases. However, the association between lipid profile and kidney stones has not been thoroughly examined in the Chinese population.

**Methods:** We performed a retrospective cohort study in the Department of Health and Medicine in Peking Union Medical College Hospital from January 2014 to December 2021. Thirty-three thousand nine hundred ninety-nine subjects having repeat physical examinations with an interval of 5 years or more were enrolled. Renal ultrasonography was used to define the presence of kidney stones. Lipid profiles such as triglyceride (TG), total cholesterol (TC), high-density lipoprotein cholesterol (HDL\_C), low-density lipoprotein cholesterol (LDL\_C), and TC/HDL ratio were categorized by lipid profiles quartiles.

**Results:** 26,594 subjects were included in the final analysis, and the mean age was 40.9±12.5 years; 50.4% were males. All subjects were followed for 71.5±11.4 months. The prevalence rate of renal ultrasound confirmed kidney stones at baseline was 1.33%, and the incident rate was 289.6 cases per 100,000 person-years. The incident rate increased with the higher quartiles of lipid profiles such as TC, TG, LDL\_C, and TC/HDL\_C (*P* for trend<0.01) but decreased with higher quartiles of HDL\_C (*P* for trend<0.001). After adjusting for age, gender, body mass index, estimated glomerular filtration rate, hypertension, and diabetes, the subjects with quartile 4 of TC/HDL\_C (>4.26) had a 1.415-fold higher risk of incident kidney stone formation compared to those with quartile 1; quartile 4 of HDL\_C (>1.65mmol/L) was significantly associated with decreased risk of incident kidney stones (HR 0.563, 95%CI 0.407-0.778).

**Conclusions:** In the present cohort study, a higher level of TC/HDL\_C showed a significantly increased risk of incident kidney stones, and higher HDL\_C protected against developing kidney stones. The management of dyslipidemia maybe contributes to a lower risk of kidney formation.

### SA-PO169

#### Contribution of Endogenous Oxalate Synthesis to Urinary Oxalate Excretion

**Sonia Fargue, John Knight. The University of Alabama at Birmingham School of Medicine, Birmingham, AL.**

**Background:** Urinary oxalate excretion is a known risk factor for calcium oxalate kidney stones and dietary oxalate absorption can contribute to 50% of urinary oxalate. In the absence of adequate dietary control, the rate of endogenous synthesis of oxalate is unknown. Using isotope tracer methodology, we determined the turnover rate of oxalate in healthy volunteers and compared it with urinary excretions on a controlled diet.

**Methods:** A primed, continuous infusion of <sup>13</sup>C<sub>2</sub>-oxalate was administered for 5 hrs in the fasted state to 16 healthy adults (7M/9F) between 24 and 56 years of age and BMI 23-44 kg/m<sup>2</sup> after 2 days of equilibration on a low oxalate, normal calcium fixed diet. Blood and urine were collected for analysis of oxalate by Ion Chromatography coupled with Mass Spectrometry and the rate of oxalate turnover rate calculated using urine <sup>13</sup>C<sub>2</sub>-oxalate mole percent enrichments at steady-state. Two 24-hr urines and 5 hourly urines in the fasted state were collected after dietary equilibration. Body composition was assessed by impedance.

**Results:** Mean 24-hr urinary oxalate excretion on the fixed diet was 20 ± 4 mg oxalate/day (range 12-28 mg/day), or 13 ± 3 mg oxalate/g creatinine. Projected 24-hr urinary oxalate was 17 ± 4 mg/day using fasted hourly collections. Isotopic equilibration was achieved within 3 hrs for most subjects. Mean urine enrichment with <sup>13</sup>C<sub>2</sub>-oxalate at steady-state was 19 ± 5%. Mean plasma enrichment at steady-state was 19 ± 1% in a subset of subjects analyzed. Average recovery rate of <sup>13</sup>C<sub>2</sub>-oxalate infused was 100 ± 10%. Oxalate turnover rate was 107 ± 26 nmol/hr/kg and endogenous oxalate synthesis 17 ± 4 mg/day (range 11-24 mg/day, 19 ± 4 and 16 ± 4 mg/day for males and females, respectively). There was a positive correlation between lean body mass and oxalate endogenous synthesis.

**Conclusions:** The range of oxalate synthesis rates spanned a two-fold interval even under fasting conditions and the use of fixed diet. The main factor associated with oxalate synthesis was lean body mass. There was good agreement with 24-hr and fasting hourly urinary oxalate excretions under these conditions. Future studies in oxalate kidney stone formers will address whether endogenous synthesis of oxalate is increased in this population and what factors underlie oxalate turnover.

**Funding:** NIDDK Support

### SA-PO170

#### Variability in Uromodulin Production and Its Response to Water Loading in Healthy Subjects and Patients With Stone Disease

**Kaice A. LaFavers,<sup>1</sup> Anna R. Gaddy,<sup>2</sup> Radmila Micanovic,<sup>1</sup> James C. Williams,<sup>1</sup> Fredric L. Coe,<sup>3</sup> Tarek M. El-Achkar,<sup>1</sup> Elaine M. Worcester.<sup>3</sup> <sup>1</sup>Indiana University Purdue University Indianapolis, Indianapolis, IN; <sup>2</sup>Medical College of Wisconsin, Milwaukee, WI; <sup>3</sup>University of Chicago Pritzker School of Medicine, Chicago, IL.**

**Background:** Uromodulin is a protein made only by the kidney and released in the urine and circulation. This protein has multiple functions and its high abundance in the urine inhibits stone formation. The physiological determinants of uromodulin production are incompletely understood.

**Methods:** We investigated the dynamic hourly changes in uromodulin levels and the key factors governing its production and release in urine and serum. We specifically tested the effect of water loading, a common intervention prescribed to prevent stone formation. During a two-day period, 17 stone patients and 14 healthy controls were subjected to water loading (day 1) and compared with normal fluid intake (day 2). Uromodulin levels along with other analytes and creatinine were measured by ELISA on timed hourly measurements in the urine and plasma during the period of the study.

**Results:** Compared to the rate of creatinine excretion, there was a significant variability in the rate of uromodulin secretion within subjects during the hours of the

study in both days. Water loading increased urinary uromodulin secretion (35 vs. 9 ug/min at baseline, *p* <0.0001) in stone formers and healthy controls. Despite high urine volumes, most patients maintained a relatively stable range of urinary uromodulin concentration. Native Western blots for polymerizing and non-polymerizing uromodulin forms suggest that polymerizing uromodulin was the form predominantly produced at higher urinary flow volumes. In addition to urine flow rates, urine sodium excretion and stone disease were significant determinants of increased urinary uromodulin production. Serum uromodulin levels were unaffected by water loading and were not associated with urinary uromodulin.

**Conclusions:** Increased water intake and high urine volumes enhance the secretion of urinary polymerizing uromodulin, which is likely to be beneficial in stone formers. Our study underscores the differential regulation of serum and urine uromodulin. We propose that in a physiological setting, kidney maintains a stable range of polymerizing urinary uromodulin concentration by increasing uromodulin production in the settings of high urine volumes.

**Funding:** NIDDK Support

### SA-PO171

#### Lanthanum Dioxycarbonate Effectively Reduces Urinary Phosphate Excretion in Healthy Volunteers

**Pramod Gupta, Atul Khare. Unicyclic Therapeutics Inc., Los Altos, CA.**

**Background:** ~600K kidney failure patients in the US undergo dialysis. Over 43% of these patients have phosphate(P) >5.5 mg/dL, leading to an increased risk of death. Patients rely on dietary restriction and phosphate(P) binders to avoid hyperphosphatemia. However, current P binders often do not achieve normal P levels and have high pill burdens (many large pills per day). A treatment that reduces pill burden while maintaining efficacy would improve patient adherence, quality of life and may be more likely to achieve P goals. Currently available 3000 mg/day lanthanum carbonate effectively reduces urinary P excretion by 236-468 mg/day. Lanthanum dioxycarbonate, RENAZORB(LDC), is a novel nanotechnology product that combines lanthanum, which has the highest binding capacity vs. other P binders, with a potentially smaller pill size that is swallowed with water rather than chewed. We present results of a phase 1 study evaluating LDC's P binding capacity and tolerability.

**Methods:** A phase 1, double-blind, placebo-controlled study evaluated LDC's P binding capacity and tolerability in 4 cohorts of 8 healthy adults. 3 separate LDC doses of 500 mg tablets were administered after meals for 5 days: 1500, 3000, 4500, 6000 mg/day.

**Results:** All doses reduced the amount of P excreted in urine and increased the amount excreted in feces. Mean overall change in P excretion showed a statistically significant dose-response trend. LDC showed statistically significant mean reduction in urine P excretion with 3000 mg/day (*p*=0.0004), 4500 mg/day (*p*<0.0001), and 6000 mg/day (*p*=0.0001). All treatment-related adverse events (AEs) were mild. There were no severe/life-threatening AEs, serious AEs, deaths, or AEs leading to discontinuation.

**Conclusions:** LDC was effective in binding to dietary P and the efficacy was dose proportional. It was well tolerated. LDC may be a welcome choice for patients as it is effective and is a small swallowable pill.

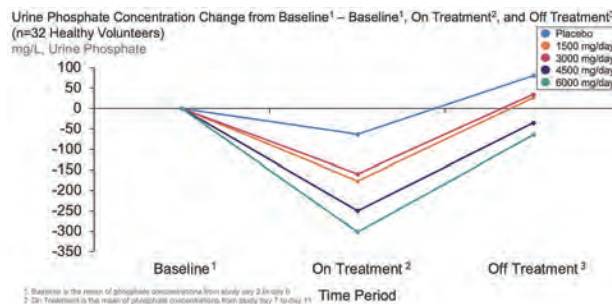

SA-PO172

**A Phase 2 Dose Ranging Study to Evaluate the Efficacy, Tolerability, and Safety of VS-505 in Hemodialysis Patients With Hyperphosphatemia**

Bing Zhuang,<sup>1</sup> Bin Liu,<sup>2</sup> Liangying Gan,<sup>3</sup> Wei jie Yuan,<sup>4</sup> Ming Shi,<sup>5</sup> Ai Peng,<sup>6</sup> Lihua Wang,<sup>7</sup> Xiaolan Chen,<sup>8</sup> Tongqiang Liu,<sup>10</sup> Shiyang Zhang,<sup>11</sup> Hua C. Liu,<sup>12</sup> Qing Gao,<sup>9</sup> Baoxing Wang,<sup>13</sup> Hui X. Zheng,<sup>14</sup> Song Wang,<sup>15</sup> Li H. Lin,<sup>16</sup> Qiang He,<sup>17</sup> Feng Zheng,<sup>18</sup> Ping Luo,<sup>19</sup> Gang Long,<sup>20</sup> Wei Lu,<sup>21</sup> Kanghui Li,<sup>22</sup> Junwei Yang,<sup>1</sup> Yingxue C. Liu,<sup>23</sup> Li Zuo.<sup>3</sup> <sup>1</sup>Nanjing Medical University, Nanjing, China; <sup>2</sup>Wuxi People's Hospital, Wuxi, China; <sup>3</sup>Peking University People's Hospital, Beijing, China; <sup>4</sup>Shanghai General Hospital, Shanghai, China; <sup>5</sup>Wuhan University Renmin Hospital, Wuhan, China; <sup>6</sup>Shanghai Tenth People's Hospital, Shanghai, China; <sup>7</sup>Second Hospital of Shanxi Medical University, Taiyuan, China; <sup>8</sup>Affiliated Hospital of Nantong University, Nantong, China; <sup>9</sup>Zhongshan Hospital Xiamen University, Xiamen, China; <sup>10</sup>The Affiliated Changzhou No 2 People's Hospital of Nanjing Medical University, Changzhou, China; <sup>11</sup>Jilin Province People's Hospital, Changchun, China; <sup>12</sup>Northern Jiangsu People's Hospital, Yangzhou City, China; <sup>13</sup>Hebei Medical University Third Affiliated Hospital, Shijiazhuang, China; <sup>14</sup>The Second Affiliated Hospital of Xingtai Medical College, Xingtai, China; <sup>15</sup>Peking University Third Hospital, Beijing, China; <sup>16</sup>First Affiliated Hospital of Dalian Medical University, Dalian, China; <sup>17</sup>Zhejiang Provincial People's Hospital, Hangzhou, China; <sup>18</sup>The Second Hospital of Dalian Medical University, Dalian, China; <sup>19</sup>Jilin University Second Hospital, Changchun, China; <sup>20</sup>Tianjin People's Hospital, Tianjin, China; <sup>21</sup>Shanghai Jiaotong University School of Medicine Xinhua Hospital, Shanghai, China; <sup>22</sup>Guilin Medical University Affiliated Hospital, Guilin, China; <sup>23</sup>Alembund Biotech Inc., Shanghai, China.

**Background:** VS-505 is a novel non-absorbed phosphate binder with the component of iron and gum Arabic. This was a phase II, 6-week open-label, randomized, active controlled dose-ranging study in hemodialysis (HD) patients with hyperphosphatemia. The primary objective was to investigate the ability of different fixed dose of VS-505 to lower serum phosphorus in this population.

**Methods:** Adult HD patients with serum phosphorus level between 6 - 10 mg/dL were randomized to VS-505 at dosages of 1.50, 2.25, 4.50, 6.75 g/d or sevelamer 4,80 g/d divided into 3 times administered orally with meals for 6 weeks. No dose titration was allowed. Patients were withdrawn if their serum phosphorus > 8.5mg/dL or < 2.5mg/dL during the treatment.

**Results:** There were 133 patients randomized, 131 received the study drugs and 108 patients completed 6-week treatment. A statistically significant decrease in serum phosphorus level from baseline to end of treatment were observed in all VS-505 and sevelamer groups (Table 1). No significant changes of serum calcium, iPTH and iron parameters were observed during the treatment phase. In pooled VS-505 groups, 81.0% patients reported ≥ 1 TEAE; discolored feces (51.4%) and diarrhea (10.5%) were most common TEAEs. No SAE was related to VS-505 as assessed by the investigator. 4.8% of VS-505 and 3.8% of sevelamer treated patients discontinued treatment due to AEs.

**Conclusions:** The dose-dependent serum phosphorus lowering effect of VS-505 has been demonstrated. VS-505 4.50 g/d, 6.75g/d and sevelamer 4.80 g/d groups showed clinically significant serum phosphorus reduction. VS-505 was safe and well tolerated in HD patients with hyperphosphatemia. ClinicalTrials.gov Identifier: NCT04551300.

Study Drugs and Doses	n	Mean [SD] Serum Phosphorus (mg/dL) Full Analysis Set (ITT)		
		Baseline	Change from Baseline to End of Treatment	p-value
VS-505 1.50 g/d	27	7.58 [0.79]	-0.80 [1.29]	0.004
VS-505 2.25 g/d	26	7.44 [0.95]	-0.94 [1.42]	0.003
VS-505 4.50 g/d	26	7.48 [0.80]	-1.62 [1.38]	<0.001
VS-505 6.75 g/d	26	7.41 [1.10]	-1.78 [1.54]	<0.001
Sevelamer 4.80 g/d*	25	7.46 [1.19]	-1.38 [2.03]	0.002

\*: One subject didn't have baseline measurement and was excluded from analysis.

Table 1. Change in serum phosphorus from baseline to end of treatment

SA-PO173

**A Dose Escalation Study to Evaluate the Tolerability, Safety, and Efficacy of VS-505 in Hemodialysis Patients With Hyperphosphatemia**

Liangying Gan,<sup>1</sup> Bing Zhuang,<sup>2</sup> Junwei Yang,<sup>2</sup> Song Wang,<sup>3</sup> Yuan Luo,<sup>2</sup> Hong Ye,<sup>2</sup> Zhizheng Zhang,<sup>4</sup> Jiajun Hong,<sup>4</sup> Weifeng Zhang,<sup>4</sup> Xiaoling Li,<sup>4</sup> Jin Tian,<sup>4</sup> Li Zuo.<sup>1</sup> <sup>1</sup>Peking University People's Hospital, Beijing, China; <sup>2</sup>Nanjing Medical University, Nanjing, China; <sup>3</sup>Peking University Third Hospital, Beijing, China; <sup>4</sup>Alembund Biotech Inc., Shanghai, China.

**Background:** VS-505 is a novel non-absorbed phosphate binder with the component of iron and gum Arabic. This was a dose escalation study to evaluate the safety and efficacy of VS-505 in hemodialysis (HD) patients with hyperphosphatemia.

**Methods:** Adult HD patients with serum phosphorus (P) level between 6 - 10 mg/dL were enrolled. Treatment with VS-505 was 6 weeks with dose escalation every 2 weeks from 2.25 g/d, 4.5 g/d to 9.0 g/d, guided by serum P levels. The dose was divided into 3 times administered orally with meals. Primary efficacy endpoint was the change from

baseline to end of treatment in serum P. Secondary efficacy endpoints were time course of serum P, the change from baseline to end of treatment in serum calcium (Ca), Ca×P product and iPTH. Safety endpoints include adverse events, etc. Analyses were based on intent to treat set.

**Results:** 24 out of 25 patients completed 6-week treatment and 15 out of 25 patients received full dose escalation to 9.0 g/d. The average dose intensity was 4.34 g/d and the average exposure was 40.8 days. At the end of treatment, serum phosphorus level decreased by 2.01 ± 1.55 mg/dL (95% CI -2.65 to -1.37) from baseline (7.73±1.12mg/dL), which was clinically and statistically significant. Serum P was back to baseline in 2 weeks after study drug discontinuation. The time course of serum P is showed in Figure 1. Serum Ca×P product decreased by 18.07 mg<sup>2</sup>/dL<sup>2</sup> (95% CI -23.89 to -12.25) from baseline (69.25± 11.91 mg<sup>2</sup>/dL<sup>2</sup>). No significant change of Ca and iPTH were observed during the treatment. The most frequently reported AEs were gastrointestinal reactions, mainly fecal discoloration (76%) and diarrhea (28%) in mild severity. No increase in the frequency of AEs was recorded with dose escalation. No SAE was related to VS-505 as assessed by the investigator.

**Conclusions:** VS-505, a novel non-absorbed phosphate binder, was safe and well tolerated and showed great effect on lowering serum phosphorus in HD patients with hyperphosphatemia.

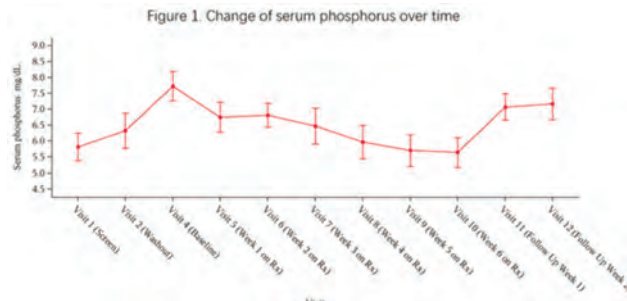

SA-PO174

**Sucroferic Oxyhydroxide Therapy Reduces Endogenous Calciprotein Particle Formation in Dialysis Patients and Attenuates Calcification and Inflammation in Vascular Cells In Vitro**

Ursula Thiem,<sup>1,2</sup> Timothy D. Hewitson,<sup>3,4</sup> Nigel D. Toussaint,<sup>3,4</sup> Stephen G. Holt,<sup>4</sup> Maria C. Haller,<sup>1,5</sup> Andreas Pasch,<sup>6,7</sup> Daniel Cejka,<sup>1</sup> Edward R. Smith,<sup>3,4</sup> <sup>1</sup>Ordensklinikum Linz GmbH Elisabethinen, Linz, Austria; <sup>2</sup>Johannes Kepler Universität Linz, Linz, Austria; <sup>3</sup>The Royal Melbourne Hospital, Parkville, VIC, Australia; <sup>4</sup>The University of Melbourne, Melbourne, VIC, Australia; <sup>5</sup>Medizinische Universität Wien, Wien, Austria; <sup>6</sup>Calcicon AG, Nidau, Switzerland; <sup>7</sup>Lindenhofspital, Bern, Switzerland.

**Background:** Calciprotein particles (CPP), colloidal mineral-protein nanoparticles, have emerged as potential mediators of phosphate toxicity in patients on dialysis, with putative links to vascular calcification, endothelial dysfunction, and inflammation. We hypothesized that treatment with the non-calcium-containing phosphate binder sucroferic oxyhydroxide (SO) would reduce endogenous CPP levels, also manifesting in attenuated pro-calcific and pro-inflammatory effects of patient serum towards human vascular cells *in vitro*.

**Methods:** Secondary analysis of a randomized, controlled cross-over study in 28 hemodialysis patients comparing the effect of two-week binder washout with high-dose (2000 mg/d) and low-dose (250 mg/d) SO therapy on serum CPP, inflammatory cytokine/chemokine arrays and *in vitro* bioassays using aortic smooth muscle cells (HASMC) and human coronary endothelial cells (HCAEC).

**Results:** In our cohort (75% male, 62±12 years) high-dose SO reduced primary (amorphous) and secondary (crystalline) CPP [-62 (-76 to -44)%, p<0.0001 and -38 (-62 to -14)%, p<0.001, respectively] compared to washout. Nine of 14 plasma cytokines/chemokines significantly decreased with high-dose SO, with consistent reductions in Interleukin-6 [IL-6, -31(-51 to -1)%, p<0.001] and Interleukin-8 [IL-8, -46 (-73 to -17)%, p<0.0001]. Compared to treatment with serum collected after washout, exposure of HASMC and HCAEC cultures to serum of SO-treated patients reduced calcification and markers of activation (IL-6, IL-8 and vascular cell adhesion protein 1), respectively. Serum-induced HASMC calcification and HCAEC activation was ameliorated by removal of CPPs from patient sera and enhanced by uremic conditioning of synthetic CPP.

**Conclusions:** High-dose SO reduces endogenous CPP formation in dialysis patients and yielded serum with attenuated pro-calcific and inflammatory effects *in vitro*.

**Funding:** Commercial Support - Vifor Fresenius Medical Care Renal Pharma, Government Support - Non-U.S.

## SA-PO175

**Impact of Targeting Bone Mineral Flow on Achievement of KDIGO Guidelines for CKD-MBD**

Eleanor D. Lederer,<sup>1,2</sup> Michael E. Brier,<sup>3,4</sup> Adam E. Gaweda,<sup>4</sup> <sup>1</sup>VA North Texas Health Care System, Dallas, TX; <sup>2</sup>The University of Texas Southwestern Medical Center, Dallas, TX; <sup>3</sup>VA Robley Rex Medical Center, Louisville, KY; <sup>4</sup>University of Louisville School of Medicine, Louisville, KY.

**Background:** KDIGO guidelines for CKD-MBD management in patients on dialysis focus on achieving calcium (Ca), phosphate (Pi), and parathyroid hormone (PTH) targets. We have developed a Quantitative Systems Pharmacology (QSP) model of CKD-MBD that estimates mineral flow out of bone and into soft tissue. We used an Artificial Intelligence method called Reinforcement Learning (RL) to discover treatment strategies directly aimed at minimization of Ca and Pi flow out of bone and into vascular smooth muscle. We hypothesized that direct optimization of Ca and Pi flux instead of biochemical proxies would result in improved bone mineral metabolism and reduction in soft tissue calcification.

**Methods:** We used a QSP model of CKD-MBD to simulate a virtual cohort of 80 ESRD subjects. The RL Agent representing the treatment strategy was implemented as a Deep Neural Network and trained for 10,000 episodes, each episode representing a 5 year treatment period. The RL Agent observed the Ca, Pi, PTH trajectories and adjusted the doses of Pi binder, Calcitriol, and a Calcimimetic on a monthly basis, to minimize the mineral flow out of bone and into soft tissue estimated by the model (Flux RL). All simulations were performed in Matlab / Simulink (Natick, MA). We compared the results to those achieved by a simulated physician (SP) and a RL Agent trained to achieve KDIGO guidelines for Ca, Pi, and PTH (KDIGO-RL).

**Results:** The Flux-RL Agent achieved 23.9% reduction in Ca flux into the soft tissue, compared to 15.1% (p=0.001) (SP) and 15.6% (p<0.001) (KDIGO-RL). Ca flux out of the bone was reduced by 42.6% (Flux-RL), compared to 28.9% (p<0.001) (SP) and 39.1% (p=0.322) (RL-KDIGO). Mean Pi level was 5.1 (Flux-RL) mg/dL, compared to 5.3 (p<0.001) (SP) and 5.2 (p=0.100) (RL-KDIGO). Mean Ca level was 9.2 mg/dL (Flux-RL), compared to 8.9 (p<0.001) (SP) and 9.0 (p=0.068) (RL-KDIGO). Mean PTH level was 226 pg/mL (Flux-RL), compared to 276 (p=0.012) (SP) and 238 (p=0.779) (RL-KDIGO). Flux-RL Agent utilized greater amounts of Calcitriol than SP or KDIGO-RL.

**Conclusions:** CKD-MBD treatment designed to optimize bone mineral flow significantly reduces the undesired Ca flow into soft tissue compared to targeting conventional biochemical parameters. These findings suggest that Pi control can be achieved even with higher vitamin D use and that the resultant higher Ca levels do not promote soft tissue calcification.

**Funding:** Veterans Affairs Support

## SA-PO176

**Intact PTH Remains a Good Marker of Bone Turnover in Disorder of Bone and Mineral Metabolism in CKD**

Luiz A. Coutinho,<sup>1</sup> Jose E. Gueiros,<sup>1</sup> Julia B. Vaz,<sup>1</sup> Eduarda C. Russo,<sup>1</sup> Vanda Jorgetti,<sup>2</sup> Ana Paula Gueiros,<sup>1</sup> <sup>1</sup>Universidade Federal de Pernambuco, Recife, Brazil; <sup>2</sup>Universidade de Sao Paulo, Sao Paulo, Brazil.

**Background:** Bone biopsy (BB) is the gold standard for diagnosing renal osteodystrophy (RO). Given its invasive nature and low availability in most centers, biomarkers are most commonly used to diagnose and guide the treatment of RO. Among these biomarkers, intact parathyroid hormone (iPTH) and alkaline phosphatase are widely used, but their predictive value is still questioned. There are few available data comparing BB and bone metabolism biomarkers. The aim of this study was to assess the ability of iPTH and total alkaline phosphatase (TAF) to predict bone turnover in hemodialysis (HD) patients.

**Methods:** This was a retrospective cross-sectional study in a single center. The medical records of 250 patients who underwent BB from April 2004 to September 2021 were reviewed. Clinical and laboratory data: age, sex, time on HD, iPTH and TAF (due to methodological differences, it was expressed in the number of times it was above the upper limit of normal; xTAF). According to bone turnover, patients were divided into two groups: High turnover, represented by patients with a histological diagnosis of osteitis fibrosa and mixed disease, and Low turnover, comprising those with adynamic bone disease and osteomalacia. To assess iPTH and TAF as predictors of bone turnover, univariate and multivariate analyzes were performed and an ROC curve was produced.

**Results:** The median age of patients was 48 years, 57.6% were females, and had been on HD for a median time of 9 years. Univariate analysis: iPTH (OR 1.01, 95% CI 1.00-1.01; p<0.001); xTAF (OR 2.83, 95% CI 1.78-5.18; p<0.001); Multivariate analysis: only iPTH was significant (OR 1.01, 95% CI 1.0-1.01; p<0.001). The produced ROC curve demonstrated an area under the curve of 0.9414 for iPTH, with 368 pg/mL as the best cut-off point to discriminate between high and low bone turnover (accuracy 87%, sensitivity 84%, specificity 100%). For xTAF, the area under the curve was 0.782, and the best discriminatory cut-off point for turnover was 1.16 TFA (accuracy 70%, sensitivity 69%, specificity 73%).

**Conclusions:** Our results have demonstrated that iPTH represents a good marker of bone turnover and may be used in clinical practice to discriminate between high and low turnover.

## SA-PO177

**Uremia and Parathyroid Tormone Have Distinct Effects on Protein and Gene Expression on Bone**

Carolina S. Martins,<sup>1</sup> Luciene dos Reis,<sup>1</sup> Marta Martinez-Calle,<sup>2</sup> Ivone B. Oliveira,<sup>1</sup> Ana C. Coelho,<sup>1</sup> Aline Martin,<sup>2</sup> Vanda Jorgetti,<sup>1</sup> Rosilene M. Elias,<sup>1</sup> Valentin David,<sup>2</sup> Rosa M. Moyses,<sup>1</sup> Laboratório de Investigação Médica 16, Hospital das Clínicas da Faculdade de Medicina da Universidade de São Paulo <sup>1</sup>Universidade de Sao Paulo, Sao Paulo, Brazil; <sup>2</sup>Northwestern University Feinberg School of Medicine, Chicago, IL.

**Background:** Bone disease is a well-recognized complication of chronic kidney disease (CKD), characterized by reductions in bone quantity and quality. The uncoupling of bone formation and resorption can be found in high and low bone turnover conditions. Parathyroid hormone (PTH) is a main regulator of bone turnover and increased serum PTH levels is a classical alteration of mineral metabolism in CKD. However, the specific effect of PTH on the bone environment in CKD is still unclear.

**Methods:** To separate these effects, we analyzed bone samples from 76 patients on hemodialysis [grouped according to serum PTH levels: < 130 (n= 28), 130-600 (n= 20) and > 600 pg/ml (n=28)] and 19 healthy controls. Protein and gene expression were quantified through immunohistochemistry and RNA sequencing (RNAseq).

**Results:** Most PTH<130 patients (79%) had low, whereas 93% of those with PTH>600 had a high bone turnover. In comparison with healthy controls, PTH<130 group presented a lower osteocytic number, as well as a higher bone expression of DKK1. In patients with PTH>600, we observed a normal osteocytic number and DKK1 expression, but a decrease in bone sclerostin, phosphorylated beta catenin, and osteoprotegerin. Using RNAseq, we found a significant difference in the expression of almost 2,000 genes between CKD and healthy controls. CKD was associated with an increase in inflammatory signaling, cell death, and impairment of osteoblastic differentiation and bone quantity. In contrast, these changes were attenuated in patients with PTH>600, showing a significant increase in the expression of genes associated with fibrosis, matrix proteins and remodeling. In addition, the increase in PTH did not influence the genes related to bone quantity.

**Conclusions:** Using an unprecedented approach, we showed that CKD bone disease is characterized by an increased expression of markers related to suppression in bone formation. An increase in PTH favors bone resorption more significantly than bone formation further aggravating the formation/resorption uncoupling. These findings help us to better understand the complex physiopathology of renal osteodystrophy, creating a perspective of new therapeutic strategies for these patients.

**Funding:** Government Support - Non-U.S.

## SA-PO178

**Osteosarcopenia Predicts Fractures and Mortality in Hemodialysis Patients**

Shun Yoshikoshi,<sup>1,2</sup> Shohei Yamamoto,<sup>3</sup> Yuta Suzuki,<sup>4</sup> Keigo Imamura,<sup>1</sup> Mana Harada,<sup>2</sup> Juri Uchida,<sup>1</sup> Takuya Nakajima,<sup>1</sup> Narumi Fukuzaki,<sup>1</sup> Atsuhiko Matsunaga,<sup>1</sup> <sup>1</sup>Kitasato University Graduate School of Medical Sciences, Sagami-hara, Japan; <sup>2</sup>Sagami Circulatory Organ Clinic, Sagami-hara, Japan; <sup>3</sup>National Center for Global Health and Medicine, Shinjuku-ku, Japan; <sup>4</sup>National Institute of Public Health, Wako, Japan.

**Background:** With the aging of patients on hemodialysis (HD), the prevalence of osteoporosis (OP) and sarcopenia (SP) is increasing in the HD population. Osteosarcopenia (OS) is a unique syndrome that describes the co-existence of OP and SP. Since the causes of OP and SP share many common risk factors, OS may have a synergistic effect on the clinical outcomes. We investigated the associations of OS with mortality and fractures in HD patients.

**Methods:** This was a retrospective cohort study that targeted outpatients undergoing HD in Japan. OP was defined as T-score < -2.5 according to the WHO criteria. SP was defined according to the Asian Working Group for Sarcopenia criteria 2019. Patients were divided into 3 groups: robust ("non-OP and non-SP"), OP or SP alone ("OP and non-SP" or "non-OP and SP"), and OS ("OP and SP"). The outcomes were all-cause mortality and fractures. We used Cox proportional hazard and negative binomial regression models to estimate these associations.

**Results:** Data from 328 patients (mean age, 66 years; men, 59%) were analyzed. During the follow-up (median, 5 years), 113 fractures and 131 deaths occurred. OP, SP, and OS was identified in 54.6%, 33.5%, and 22.9%, respectively. Compared with the robust group, the incidence of fracture (**Figure A**) and mortality (**Figure B**) was significantly higher in those of OP or SP alone and OS, respectively (all P<0.01). Patients with OP or SP alone (incidence rate ratio [IRR], 1.80; 95% confidence intervals [CIs], 1.08-3.02) and those with OS (IRR: 2.90, 95% CIs: 1.45-5.81) had significantly higher risks for fractures than the robust group. Associations of OS with mortality were similar to those between OS and fractures.

**Conclusions:** The prevalence of OP, SP, and OS was high among patients on HD. Patients with OP or SP had a poor prognosis, and combining OP and SP further worsened their prognosis, suggesting the need for screening and developing the treatment strategy against both OP and SP.

**Funding:** Government Support - Non-U.S.

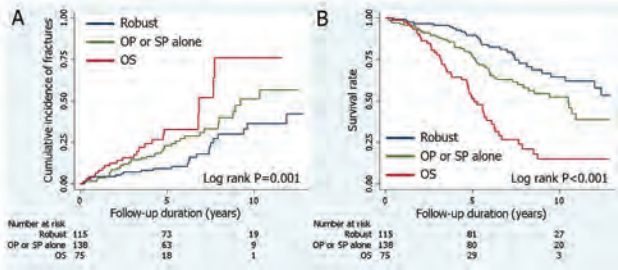

Kaplan-Meier analysis for the incidence of fractures (A) and mortality (B). OP, osteoporosis, OS; osteosarcopenia, SP; sarcopenia.

SA-PO179

**Skeletal Responsiveness to Parathyroid Hormone in Hemodialysis Patients: International Variation and Association With Factors and Risk of Fractures in the DOPPS**

Suguru Yamamoto,<sup>1</sup> Junhui Zhao,<sup>2</sup> Angelo Karaboyas,<sup>2</sup> Hirota Komaba,<sup>3</sup> Hanne S. Joergensen,<sup>7</sup> Marc G. Vervloet,<sup>6</sup> Sandro Mazzaferro,<sup>5</sup> Etienne Cavalier,<sup>8</sup> Brian Bieber,<sup>2</sup> Bruce M. Robinson,<sup>2</sup> Pieter Evenepoel,<sup>4</sup> Masafumi Fukagawa.<sup>3</sup> <sup>1</sup>Niigata University Graduate School of Medical and Dental Sciences, Niigata, Japan; <sup>2</sup>Arbor Research Collaborative for Health, Ann Arbor, MI; <sup>3</sup>Tokai University School of Medicine, Isehara, Japan; <sup>4</sup>University Hospitals Leuven, Leuven, Belgium; <sup>5</sup>Sapienza University, Rome, Italy; <sup>6</sup>Amsterdam University Medical Center, Amsterdam, Netherlands; <sup>7</sup>Aarhus University Hospital, Aarhus, Netherlands; <sup>8</sup>Centre Hospitalier Universitaire de Liege, Liege, Belgium.

**Background:** Bone response to parathyroid hormone (PTH) is impaired in chronic kidney disease (CKD) owing to multiple factors including phosphate loading, calcitriol deficiency, and accumulation of uremic toxins. Other factors may also affect PTH responsiveness including regional and/or ethnic differences, and pharmacological treatment. Using alkaline phosphatase (ALP)/PTH ratio as a proxy for skeletal responsiveness to PTH, we investigated (1) the differences in ALP/PTH by international region and race, (2) patient factors associated with ALP/PTH, and (3) association between ALP/PTH and incidence of fracture in hemodialysis (HD) patients.

**Methods:** The analysis includes 31,701 HD patients with dialysis vintage >120 days in 9 countries in DOPPS phase 3-7 (2005-2021). The primary exposure variable was ALP/PTH. ALP and PTH levels were both divided by the facility upper normal limit to normalize the values. Cox models were used to estimate hazard ratios (HR) of fracture across levels of ALP/PTH and also for normalized ALP alone. Logistic regression was used to model associations between low ALP/PTH (<0.1) and clinical factors. All models were adjusted for potential confounders including country, case-mix, and laboratory values.

**Results:** Median ALP/PTH was 0.21, 0.33, 0.17, and 0.23 in Europe, Japan, US-Black, and US-Nonblack, respectively. ALP/PTH <0.1 was associated with male gender, Black race, higher body mass index, higher serum levels of albumin, phosphorus and calcium, and use of vitamin D analogues and cinacalcet. ALP/PTH was not associated with any fractures (p=0.81). In contrast, normalized ALP had a strong monotonic association with fracture rate; the HR (95% CI) compared to the reference group of 0.75-0.99 ranged from 0.77 (0.60,0.97) for ALP <0.50 to 1.35 (1.06,1.74) for ALP 1.50+.

**Conclusions:** In this large international cohort study, skeletal responsiveness to PTH in HD patients showed regional and ethnical differences and may be affected by pharmacological treatment and clinical factors. We did not observe a direct association between ALP/PTH and fracture, but higher ALP production reflecting bone responsiveness to PTH may increase fracture risk in HD patients.

SA-PO180

**Seasonality in Hip Fracture Among Hemodialysis Patients and Kidney Transplant Recipients in South Korea**

Young Woo Song, Jin Ah Park, Seok Joon Shin, Joo Eun Lee, Sang Hun Eum, Hye Eun Yoon, Yeonhee Lee. Catholic University of Korea Incheon Saint Mary's Hospital, Incheon, Incheon, Republic of Korea.

**Background:** The seasonality of hip fracture in hemodialysis (HD) patients and kidney transplant recipients (KTRs) have not been reported. We assessed seasonal variations in hip fractures among patients with end-stage kidney disease who undergo maintenance HD and KTRs.

**Methods:** Using the Korean National Health Insurance System database from January 2012 to December 2017, monthly counts of hip fracture were calculated among HD patients (n = 77,420) and KTRs (n = 8,921)(Fig 1.). The 6-year normalized monthly fraction and seasonal fractions of hip fractures were calculated. A cosinor analysis was performed to determine the seasonality of the monthly incidence of hip fractures.

**Results:** The 6-year average monthly fraction of hip fractures was lowest in June and highest in October in HD patients, and lowest in February and highest in November in KTRs. The 6-year average seasonal fraction among HD patients was lowest in summer and highest in winter, and lowest in summer and highest in autumn among KTRs, both

without statistical significance. The incidence ratio of hip fractures was lowest in June and highest in January in HD patients, and lowest in August and highest in November in KTRs. On cosinor analysis, HD patients showed significant seasonality in hip fracture incidence, with a trough in summer and a peak in winter (P = 0.002), whereas KTRs did not exhibit a significant trend (P = 0.293)(Fig 2.).

**Conclusions:** Hip fractures occurred more frequently in winter and less frequently in summer in patients undergoing HD, whereas KTRs did not show a seasonal trend.

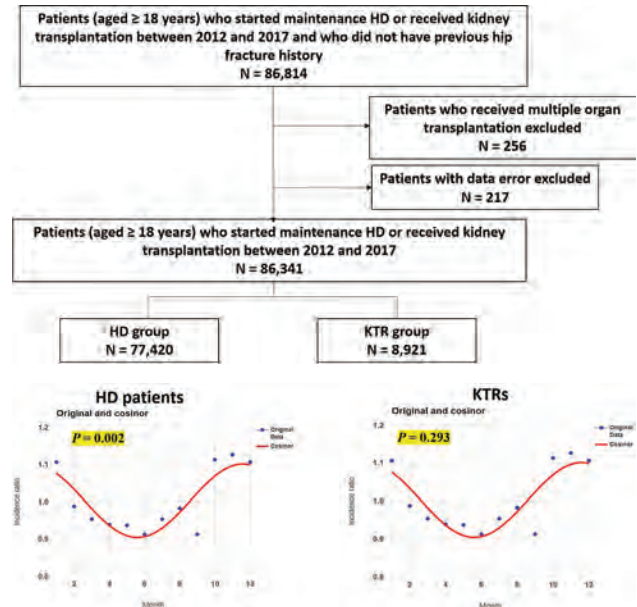

SA-PO181

**Association Between Cause of Kidney Failure and Fracture Incidence in a National US Dialysis Population Cohort Study**

Susan Ziolkowski,<sup>1</sup> Sai Liu,<sup>1</sup> Maria E. Montez-Rath,<sup>1</sup> Michelle Denburg,<sup>2</sup> Wolfgang C. Winkelmayer,<sup>3</sup> Glenn Chertow,<sup>1</sup> Michelle M. O'Shaughnessy.<sup>4</sup> <sup>1</sup>Stanford University, Stanford, CA; <sup>2</sup>The Children's Hospital of Philadelphia, Philadelphia, PA; <sup>3</sup>Baylor Scott & White Health, Dallas, TX; <sup>4</sup>Cork University Hospital, Cork, Ireland.

**Background:** Whether fracture rates, overall and by fracture site, vary by cause of kidney failure in patients receiving dialysis is unknown.

**Methods:** Using the US Renal Data System (USRDS), we compared fracture rates across seven causes of kidney failure in patients who started dialysis between 1997 and 2014. We computed unadjusted and multivariable adjusted proportional sub-distribution hazard models, with fracture events (overall, and by site) as the outcome and IgA nephropathy as the reference group. Kidney transplantation and death were competing events.

**Results:** Among 491,496 individuals, with a median follow-up of 2.0 (0.9-3.9) years, 62,954 (12.8%) experienced at least one fracture. Patients with diabetic nephropathy, vasculitis, or autosomal polycystic kidney disease (ADPKD) had the highest (50, 46, and 40 per 1000 person-years, respectively), and patient with lupus nephritis had the lowest (20 per 1000 person years) fracture rates. After multivariable adjustment, diabetic nephropathy (HR 1.43, 95% CI 1.33-1.53), ADPKD (HR 1.37, 1.26- 1.48), vasculitis (HR 1.22, 1.09-1.34), membranous nephropathy (HR 1.16, 1.02-1.30), or FSGS (HR 1.13, 1.02-1.24) were associated with a significantly higher, and lupus nephritis with a significantly lower (HR 0.85, 0.71-0.98) fracture hazard. The hazards for upper extremity and lower leg fractures were significantly higher in diabetic nephropathy, ADPKD, FSGS, and membranous nephropathy, while the hazard for vertebral fracture was significantly higher in vasculitis.

**Conclusions:** Fracture risk, overall and by fracture site, varies by cause of ESKD. Future work to determine underlying pathogenic mechanisms contributing to differential risks might inform more tailored treatment strategies.

**Funding:** NIDDK Support

SA-PO182

**Therapy With Romosozumab Followed by 1 Year of Denosumab in Hemodialysis Patients With Osteoporosis: An Observational Study**

Tomohiro Saito,<sup>1</sup> Masahide Mizobuchi,<sup>1</sup> Tadashi Kato,<sup>1</sup> Taihei Suzuki,<sup>1</sup> Yasuro Fujiwara,<sup>2</sup> Naoaki Kanamori,<sup>2</sup> Mikio Makuuchi,<sup>2</sup> Hirokazu Honda,<sup>1</sup> <sup>1</sup>Showa Daigaku, Shinagawa-ku, Japan; <sup>2</sup>sannoudai hospital, Ibaraki, Japan.

**Background:** Evidence of the treatment with romosozumab (ROMO) in hemodialysis (HD) patients is limited. Accordingly, here we report clinical characteristics of ROMO in these patients.

**Methods:** We conducted a 24-month prospective, observational, single-center cohort study that analyzed 17 HD patients with osteoporosis. These patients received ROMO (210mg) subcutaneously once monthly for 12 months and were then followed by denosumab (60mg) subcutaneously every six months for an additional 12 months. We examined the incidence of new fractures, safety, changes in bone mineral density (BMD), bone metabolism markers, and coronary artery calcification.

**Results:** There were no cases of new fractures in the study period. The annual percent changes from baseline in the lumbar spine (LS), total hip (TH), and femoral neck (FN) BMD were +9.3%, +3.2%, and +6.9%, respectively. These effects were maintained for 24 months. Relative changes from baseline to 24 months were +14.4%, +5.7%, and +5.6%, respectively. The percent change in TH ( $r = -0.80$ ;  $P < 0.001$ ) and FN ( $r = -0.84$ ;  $P < 0.001$ ) showed negative correlation with the BMD at baseline. Although coronary artery calcification scores slightly increased from 1094.2 at baseline to 1313.1 at 12 months ( $P = 0.013$ ), fatal events including CVD death and all causes of death were not observed during the ROMO treatment period. Asymptomatic hypocalcemia was observed from 1 to 2 months after the start of ROMO. However, no concomitant drug administration was required, and serum calcium levels returned to approximately baseline levels.

**Conclusions:** Our study suggests that ROMO followed by denosumab treatment is safe and has effectiveness in increasing LS, TH, and FN BMD. Studies with larger sample sizes are necessary to confirm the clinical utilities of ROMO in HD patients with osteoporosis.

**SA-PO183**

**Ten Years' Experience Treating Osteoporosis in Hemodialysis Patients**

Kentarō Sakai,<sup>1</sup> Kei Fukami,<sup>2</sup> <sup>1</sup>*Our Lady of the Snow Social Medical Corporation St. Mary's Hospital, Kurume, Japan;* <sup>2</sup>*Kurume Daigaku, Kurume, Japan.*

**Background:** The treatment of osteoporosis in hemodialysis (HD) patients has not been established, as there is insufficient evidence regarding the treatment of osteoporosis. We began treating osteoporosis in HD patients in 2011. Herein, we describe the effects of the treatment based on our 10-year experience.

**Methods:** This was a single-center prospective observational study of 141 HD patients (age 73.9±11.4 yrs; 77 females) treated for osteoporosis from 2011 to 2021. The average observational period was 4.8±2.9 years. We introduced osteoporosis treatment with alendronate in 2011, ibandronate in 2016, and denosumab in 2018. The patients' BMD values including the lumbar spine, femoral neck, and total hip were determined by dual-energy X-ray absorptiometry. We have administered alendronate or ibandronate to patients whose first T-score was ≤-2.5. Beginning in 2018, if a patient's T-score did not improve after the second year, we changed the medication to denosumab. The patients' yearly values of bone metabolism markers such as parathyroid hormone (PTH), bone alkaline phosphatase (BAP), and tartrate-resistant acid phosphatase 5b (TRACP-5b) were assessed.

**Results:** In the alendronate group (n=79), the lumbar spine BMD was significantly improved at 1 year (-3.2±1.0 vs -2.9±0.9, p<0.05), but this BMD did not improve after the second year. In the denosumab group (n=40), the femoral neck BMD has improved significantly since the second year (-2.9±0.8 vs. -2.5±0.6, p<0.05). Serum calcium decreased significantly only in the denosumab group after the start of treatment (8.5±0.6 vs. 7.8±0.9 mg/dL, p<0.01). The PTH level was unchanged during the study period in each group, but the BAP and TRACP-5b levels decreased significantly in the denosumab group (p<0.01). A multivariate analysis demonstrated that a low baseline BMD was significantly associated with BMD improvement in the alendronate group (OR 11.08, 95%CI: 2.67-41.00, p<0.01).

**Conclusions:** The results of this long-term study suggest that the treatment of osteoporosis with the above-mentioned drugs may be effective in patients undergoing HD. Alendronate may be effective the first year, but its effect may not continue after the second year. Although denosumab can decrease serum calcium, it may be more effective than alendronate and ibandronate (especially after the second year).

**SA-PO184**

**Active Vitamin D Use and Fractures in Hemodialysis Patients: Results From the International DOPPS**

HirotaKa Komaba,<sup>1</sup> Junhui Zhao,<sup>2</sup> Angelo Karaboyas,<sup>2</sup> Suguru Yamamoto,<sup>3</sup> Indranil Dasgupta,<sup>8</sup> Mohamed H. Hassan,<sup>4</sup> Li Zuo,<sup>5</sup> Anders Christensson,<sup>7</sup> Christian Combe,<sup>6</sup> Bruce M. Robinson,<sup>2</sup> Masafumi Fukagawa,<sup>1</sup> <sup>1</sup>*Tokai University School of Medicine, Isehara, Japan;* <sup>2</sup>*Arbor Research Collaborative for Health, Ann Arbor, MI;* <sup>3</sup>*Niigata University Graduate School of Medical and Dental Sciences, Niigata, Japan;* <sup>4</sup>*Seha Kidney Care, Abu Dhabi, United Arab Emirates;* <sup>5</sup>*Peking University People's Hospital, Beijing, China;* <sup>6</sup>*Centre Hospitalier Universitaire de Bordeaux, Bordeaux, France;* <sup>7</sup>*Skåne University Hospital, Malmö, Sweden;* <sup>8</sup>*University Hospitals Birmingham NHS Foundation Trust, Birmingham, United Kingdom.*

**Background:** Active vitamin D is used commonly to control secondary hyperparathyroidism and associated high-turnover bone disease in dialysis patients. It is unknown whether active vitamin D improves bone strength and prevents fracture through direct action on bone metabolism, independent of its action to suppress parathyroid hormone (PTH).

**Methods:** We included 41,677 in-center hemodialysis patients from 21 countries in phases 3-6 (2005-2018) of the Dialysis Outcomes and Practice Patterns Study (DOPPS). We analyzed the association between prescription (yes/no) of active vitamin D at study enrollment and incidence of (1) any fracture and (2) hip fracture. We used Cox regression, adjusted for PTH and other potential confounders, and used a per-protocol approach to censor patients at treatment switch during follow-up. As a sensitivity analysis, we also performed a facility preference approach to reduce confounding by indication, assigning exposures at the facility-level based on the proportion of patients prescribed active vitamin D in the facility.

**Results:** The proportion of patients prescribed active vitamin D at study enrollment was 55% overall and ranged from 72% in Sweden to 25% in France. Event rates (per patient-year) were 0.024 for any fracture and 0.010 for hip fracture. The adjusted HR (95% CI) comparing patients prescribed vs. not prescribed active vitamin D was 1.01 (0.89, 1.16) for any fracture and 0.99 (0.80, 1.22) for hip fracture. In the facility preference approach, compared to the reference group of <40% of patients prescribed active vitamin D, the adjusted HR (95% CI) for fracture was 1.07 (0.88, 1.31) for 40-54%, 1.11 (0.90, 1.37) for 55-69%, and 1.21 (0.99, 1.49) for ≥70%. Results were similar when treating hip fracture as the outcome.

**Conclusions:** Active vitamin D use was not associated with the risk of any fracture or hip fracture in hemodialysis patients. Our results do not support the role of active vitamin D in fracture prevention beyond the suppression of PTH. Randomized clinical trials are needed to confirm these findings.

**Funding:** Commercial Support - Kyowa Kirin

**SA-PO185**

**The Vitamin D Metabolite Ratio and Coronary Artery Calcification in the Multi-Ethnic Study of Atherosclerosis**

Charles Ginsberg,<sup>1</sup> Andrew N. Hoofnagle,<sup>2</sup> Ronit Katz,<sup>2</sup> Jonathan Cheng,<sup>1</sup> Simon Hsu,<sup>2</sup> Matthew J. Budoff,<sup>3</sup> Deborah M. Kado,<sup>4</sup> Bryan R. Kestenbaum,<sup>2</sup> Erin D. Michos,<sup>3</sup> David Siscovick,<sup>2</sup> Joachim H. Ix,<sup>1</sup> Ian H. de Boer,<sup>2</sup> <sup>1</sup>*University of California San Diego, La Jolla, CA;* <sup>2</sup>*University of Washington, Seattle, WA;* <sup>3</sup>*Johns Hopkins University, Baltimore, MD;* <sup>4</sup>*Stanford Medicine, Stanford, CA;* <sup>5</sup>*University of California Los Angeles David Geffen School of Medicine, Los Angeles, CA.*

**Background:** Studies examining the relationship between 25(OH)D deficiency and coronary artery calcification (CAC) are conflicted. The vitamin D metabolite ratio (VMR) (ratio of 24,25(OH)<sub>2</sub>D<sub>3</sub> to 25(OH)D<sub>3</sub>) is more strongly associated with fracture and mortality risk and may be a superior marker of vitamin D adequacy compared to 25(OH)D. The relationship of the VMR with CAC remains unknown.

**Methods:** We measured vitamin D metabolites using liquid chromatography mass-spectroscopy in 5,945 participants from the Multi-Ethnic Study of Atherosclerosis (MESA). CAC was measured at baseline and then again annually through year 5. We assessed the relationship of the 25(OH)<sub>2</sub>D<sub>3</sub> and the VMR with CAC prevalence (Agatston scores of >0), severity, and incidence (Agatston scores of >0 in follow-up). We used logistic, linear and Poisson regression to evaluate these associations in models adjusting for demographics, season physical activity, BMI, smoking, diabetes, blood pressure, C-reactive protein, cholesterol levels, eGFR, urine albumin to creatinine ratio (ACR), serum calcium, phosphate, PTH and FGF-23.

**Results:** The mean age was 62 ± 10 years, 54% were women and the median (IQR) 25(OH)D<sub>3</sub> and VMR were 21(15, 30)ng/ml and 15.0(12.3, 18.1)(ng/ml / ng/ml), respectively. The mean eGFR was 79 ± 18 ml/min/1.73m<sup>2</sup> and 10% had an eGFR < 60 ml/min/1.73m<sup>2</sup>. 2,985 participants had prevalent CAC at baseline. In minimally and fully adjusted models, there was no statistical association of 25(OH)D<sub>3</sub> or the VMR with CAC prevalence or severity. Among 2,090 persons without CAC at baseline and follow-up CAC imaging, neither 25(OH)D<sub>3</sub> nor the VMR were associated or the development of incident CAC in follow-up (Table).

**Conclusions:** Among a large sample of community-living individuals without clinically apparent cardiovascular disease, 25(OH)D<sub>3</sub> and the VMR were not associated with prevalence, severity or incidence of CAC. While prior studies associate a low VMR with an increased mortality, it appears unlikely that this risk is mediated through development of CAC.

**Funding:** NIDDK Support

Table 1: Association of 25(OH)D<sub>3</sub> and the VMR with CAC Among MESA Participants

	Prevalence		Severity		Incidence	
	OR Per 100% Higher (95%CI)	P	% Higher CAC Per 100% Higher (95%CI)	P	IRR Per 100% Higher (95%CI)	P
25(OH)D <sub>3</sub>	0.97 (0.87, 1.09)	0.66	6 (-17, 6)	0.35	1.05 (0.93, 1.18)	0.43
VMR	0.94 (0.79, 1.13)	0.53	-4 (-23, 15)	0.66	1.01 (0.84, 1.21)	0.99

SA-PO186

**Free 25(OH)D Concentrations and Clinical Outcomes in Elderly Community-Living Adults: The Health, Aging, and Body Composition Study**

Jonathan Cheng,<sup>1,2</sup> Andrew N. Hoofnagle,<sup>3</sup> Ronit Katz,<sup>3</sup> Stephen B. Kritchevsky,<sup>6</sup> Michael Shlipak,<sup>4</sup> Mark J. Sarnak,<sup>5</sup> Joachim H. Ix,<sup>1,2</sup> Charles Ginsberg,<sup>1</sup> <sup>1</sup>University of California San Diego, La Jolla, CA; <sup>2</sup>Nephrology Section, Veterans Affairs San Diego Healthcare System, San Diego, CA; <sup>3</sup>University of Washington, Seattle, WA; <sup>4</sup>University of California San Francisco, San Francisco, CA; <sup>5</sup>Tufts University School of Medicine, Boston, MA; <sup>6</sup>Wake Forest University, Winston-Salem, NC.

**Background:** 25(OH)D deficiency is believed to contribute to mineral-bone and cardiovascular diseases. 25(OH)D exists as free (~1%) or bound (~99% to vitamin D binding protein) and studies have suggested that serum 25(OH)D may not accurately reflect active, free 25(OH)D concentrations. The associations between measured free 25(OH)D concentrations with clinical outcomes have not been well studied.

**Methods:** We used a case-cohort study design and compared the strength of associations between measured free 25(OH)D with either kidney function decline (≥30% decline in estimated glomerular filtration rate (eGFR) from baseline), fracture, incident cardiovascular disease (CVD), or incident heart failure (HF) in well-functioning community-living adults aged 70 to 79 years in the Health, Aging, and Body Composition Study. Baseline free 25(OH)D concentrations were measured in a random sub-cohort of 459 participants and in participants with kidney function decline (n=381), fractures (n=174), incident CVD (n=151), and incident HF (n=117) during a median 10 years of follow-up. Weighted Cox regression adjusting for age, sex, race, BMI, season of measurements, clinic site, eGFR, calcium, phosphorus, FGF-23, iPTH, and vitamin D supplementation status was used for statistical analysis.

**Results:** In fully adjusted models, a two-fold higher concentration of free 25(OH)D was associated with a 25% higher risk of kidney function decline (95% CI 1.03-1.52) and a 25% lower risk of incident HF (95% CI 0.58-0.96). Free 25(OH)D was not associated with incident CVD (HR=0.87; 95% CI 0.66-1.16) or fractures (HR=1.00; 95% CI 0.66-1.50).

**Conclusions:** Higher concentrations of free 25(OH)D are independently associated with increased risk of kidney function decline and decreased risk of incident HF in community-living older adults. Future studies are needed to determine if these relationships are causal.

**Funding:** NIDDK Support, Other NIH Support - NIH Loan Repayment Grant, National Institute of Health K23DK118197

Association between Measured Serum 25(OH)D Concentration and Clinical Outcomes

	Hazard Ratio (95% CI)*
Incident CVD	0.87 (0.66, 1.16)
Incident HF	0.75 (0.58, 0.96)#
Kidney Function Decline	1.25 (1.03, 1.52)#
Fracture	1.00 (0.66, 1.50)

\*Hazard ratios per Two-Fold Higher vitamin D. #p<0.05. Fully adjusted models.

SA-PO187

**Effects of Vitamin D3 Supplementation on Cardiovascular and Cancer Outcomes by Estimated Glomerular Filtration Rate in the Vitamin D and Omega-3 Trial**

Christine P. Limonte,<sup>1,2</sup> Leila R. Zelnick,<sup>1,2</sup> Andrew N. Hoofnagle,<sup>6,2</sup> Ravi I. Thadhani,<sup>8</sup> Michal L. Melamed,<sup>3</sup> Samia Mora,<sup>7,4</sup> Nancy R. Cook,<sup>4,5</sup> Heike Luttmann-Gibson,<sup>4,9</sup> Howard D. Sesso,<sup>4,5</sup> I-Min Lee,<sup>4,5</sup> Joann E. Manson,<sup>4,5</sup> Ian H. de Boer,<sup>1,2</sup> <sup>1</sup>University of Washington Division of Nephrology, Seattle, WA; <sup>2</sup>Kidney Research Institute, University of Washington, Seattle, WA; <sup>3</sup>Albert Einstein College of Medicine, Bronx, NY; <sup>4</sup>Brigham and Women's Hospital Division of Preventive Medicine, Boston, MA; <sup>5</sup>Department of Epidemiology, Harvard T.H. Chan School of Public Health, Boston, MA; <sup>6</sup>University of Washington Department of Laboratory Medicine & Pathology, Seattle, WA; <sup>7</sup>Brigham and Women's Hospital Division of Cardiovascular Medicine, Boston, MA; <sup>8</sup>Office of the Chief Academic Officer, Mass General Brigham, Boston, MA; <sup>9</sup>Department of Environmental Health, Harvard T.H. Chan School of Public Health, Boston, MA.

**Background:** Metabolism of 25-hydroxyvitamin D (25[OH]D) is reduced and secondary hyperparathyroidism is common with lower eGFR. These abnormalities may contribute to cardiovascular disease and cancer risk, which may be mitigated via vitamin D supplementation.

**Methods:** We assessed for heterogeneity by baseline eGFR of the effects of vitamin D<sub>3</sub> on cardiovascular and cancer outcomes in the Vitamin D and Omega-3 Trial (VITAL). Participants were randomized to 2000IU vitamin D<sub>3</sub> and/or 1g omega-3 fatty acids daily using a placebo-controlled, two-by-two factorial design and followed a median 5 years. The primary study endpoints were incident major cardiovascular events and invasive cancer. Changes in serum 25(OH)D and parathyroid hormone (PTH) were examined as intermediate outcomes.

**Results:** Baseline eGFR was available for 15,917 participants. Vitamin D<sub>3</sub> resulted in higher serum 25(OH)D compared to placebo (difference in change throughout the trial 12.5 [95% CI 12.0, 13.0] ng/mL), without heterogeneity by eGFR. Difference in change in PTH between vitamin D<sub>3</sub> and placebo was larger with lower eGFR: -6.9 (95% CI -10.5,

-3.4), -5.8 (-8.3, -3.4), -4.0 (-5.9, -2.2), and -3.8 (-5.6, -2.0) pg/mL for eGFR <60, 60-74, 75-89, and ≥90 ml/min/1.73m<sup>2</sup>, respectively. The primary cardiovascular and cancer endpoints were observed among 508 (3%) and 1051 (7%) participants. Effects of vitamin D<sub>3</sub> supplementation on cardiovascular events (p-interaction, continuous eGFR=0.61) and cancer (p-interaction=0.89) did not differ by eGFR: HR (95% CI) 1.14 (0.73, 1.79), 1.06 (0.75, 1.50), 0.92 (0.67, 1.25), and 0.92 (0.66, 1.27), across increasing eGFR categories for cardiovascular events and 1.63 (1.03, 2.58), 0.85 (0.64, 1.11), 0.84 (0.68, 1.03), and 1.11 (0.92, 1.35) for cancer, respectively. There was no significant heterogeneity in adverse events (hypercalcemia, kidney stones).

**Conclusions:** We observed no significant heterogeneity by baseline eGFR on the effect of long-term supplementation with vitamin D<sub>3</sub> versus placebo on cardiovascular or cancer outcomes in VITAL. No benefits for these outcomes were observed within any eGFR subgroup despite substantial increases in circulating 25(OH)D and decreases in PTH concentrations.

**Funding:** NIDDK Support, Other NIH Support - National Cancer Institute; National Heart, Lung, and Blood Institute; Office of Dietary Supplements; National Institute of Neurological Disorders and Stroke; and the National Center for Complementary and Integrative Health, Commercial Support - Pharmavite and Pronova BioPharma/BASF (donated study pills), Private Foundation Support

SA-PO188

**Plasma Activin A Rises Through CKD Stages but Is Unrelated to Vascular Calcification and Cardiovascular Events**

Anders Nordholm,<sup>1,2</sup> Ida M. Sørensen,<sup>1</sup> Sasha S. Bjergfelt,<sup>1</sup> Andreas Fuchs,<sup>3</sup> Klaus F. Kofoed,<sup>3</sup> Nino E. Landler,<sup>4</sup> Tor E. Biering-Sørensen,<sup>4</sup> Bo Feldt-Rasmussen,<sup>1</sup> Christina Christoffersen,<sup>5</sup> Susanne Bro,<sup>1</sup> <sup>1</sup>Dept. of Nephrology, Rigshospitalet, Copenhagen, Denmark; <sup>2</sup>Dept. of Nephrology, Herlev & Gentofte Hospital, Copenhagen, Denmark; <sup>3</sup>Dept. of Cardiology, Rigshospitalet, Copenhagen, Denmark; <sup>4</sup>Dept. of Cardiology, Herlev & Gentofte Hospital, Copenhagen, Denmark; <sup>5</sup>Dept. of Clinical Biochemistry, Rigshospitalet, Copenhagen, Denmark.

**Background:** Activin A (ActA) is a hormone related to CKD and mineral and bone disorder (MBD). Animal studies show that ActA is elevated in CKD and that ActA signaling inhibition ameliorates renal fibrosis, vascular calcification (VC) and bone disease in CKD. We examined plasma ActA (p-ActA) levels in a large cohort of CKD and controls and determined if p-ActA was associated with radiographic measures of VC and bone mineral density (BMD) as well as cardiovascular events (MACE).

**Methods:** Prospective cohort study. Patients with CKD stages 1-5 not on dialysis (N=741) and age-/sex-matched healthy controls (ctl) (N=175). Baseline p-ActA was measured by ELISA (DAC00B, R&D). VC in coronary arteries (CA) and thoracic aorta (TA) was determined by non-contrast 320-multidetector CT scans, quantified by Agatston score. Thoracic BMD (Th7-9) in mg/cm<sup>2</sup> was assessed from the CT scans using a Phantom. Comparison between p-ActA and continuous variables were done by linear regression and Spearman's correlation. Comparing p-ActA to CKD stage, Agatston-, and BMD groups was done by ANOVA. MACE (median follow-up 4±1 yrs) was assessed and related to p-ActA quartiles using Kaplan-Meier and Cox regression.

**Results:** P-ActA is inversely correlated to eGFR (r=-0.53, p<0.001), and rises continuously from ctl and through CKD stages (ctl 136±71pg/mL, CKD1 148±90, CKD2 175±106, CKD3 239±120, CKD4 330±218, CKD5ND 397±202), significant from CKD3 to CKD5 (p<0.001). P-ActA was correlated with Agatston score in CA (r=0.23, p<0.01) but not in TA of CKD patients. P-ActA was significantly increased in the Agatston score >400 group from 219±166 to 285±144 (p<0.01) in CA, and from 206±135 to 280±146 (p<0.01) in TA. The associations lost significance when adjusted for either age or eGFR. Thoracic BMD was not correlated to p-ActA and there was no difference in p-ActA levels when stratified into BMD groups of very low (<80), low (80-120), and normal (>120) BMD. The HR of MACE in the highest quartile of p-ActA (>289pg/mL) was 3.98 [2.39-6.61], but 1.67 [0.97-2.88] when adjusting for eGFR.

**Conclusions:** Plasma activin A rises with declining kidney function but was not independently associated with radiographic parameters of BMD, VC or MACE.

SA-PO189

**Bone Marrow Adiposity Is Associated With Aging and Markers of Bone Remodeling in Non-Dialysis CKD Patients**

Joao Victor Salgado, Aluizio B. Carvalho, Maria Eugenia F. Canziani. *Division of Nephrology, Federal University of São Paulo, São Paulo, Brazil.*

**Background:** Patients with moderate to severe CKD are associated with greater bone marrow adiposity than those with normal renal function or mild CKD. However, little is known about the factors related to marrow fat accumulation, particularly in CKD patients. We evaluated the relationship between bone marrow adiposity and, clinical and laboratory parameters in CKD patients.

**Methods:** This was a post hoc analysis of 37 transiliac bone biopsy samples obtained from CKD stage 2-5ND patients (age 50±11 yrs., 68% male, 35% diabetes, GFR 34±17 ml/min/1.73m<sup>2</sup>). Serum concentrations of FGF21, sclerostin (Scl) and undercarboxylated osteocalcin (uOC) were measured by enzyme-linked immunosorbent assay. Quantitative histomorphometry of bone marrow adipocytes was performed including adipose area (Ad.Ar/Ma.Ar, %), adipocyte number (N.Ad/T.Ar, n<sup>2</sup>/mm<sup>2</sup>) and adipocyte width (Ad.Wi, µm).

**Results:** Ad.Ar/Ma.Ar was positively correlated with age (r=0.33, p=0.04), FGF21 (r=0.41, p=0.01) and osteoprotegerin (r=0.41, p=0.01). N.Ad/T.Ar was negatively correlated with TG/HDL-c ratio (r=-0.35, p=0.03) and Scl (r=-0.37, p=0.02). Ad.Wi showed a positive correlation with age (r=0.43, p<0.01), FGF21 (r=0.33, p=0.04), uOC



( $r=0.55, p<0.01$ ), Scl ( $r=0.57, p<0.01$ ), total cholesterol ( $r=0.34, p=0.04$ ), LDL-cholesterol ( $r=0.32, p=0.04$ ), triglycerides ( $r=0.50, p<0.01$ ), TG/HDL-c ratio ( $r=0.43, p<0.01$ ) and a negative correlation with estimated GFR ( $r=-0.34, p=0.04$ ). After adjustment for eGFR, the regression analyses showed that age, osteoprotegerin and sclerostin levels were independently associated with marrow adipocyte parameters.

**Conclusions:** Bone marrow adiposity was independently associated with aging and markers of bone remodeling in non-dialysis CKD patients.

**Funding:** Government Support - Non-U.S.

**SA-PO190**

**Relative Contributions of Excretion (EP) and Reabsorption (TRP) of Phosphate to Fractional Excretion of Phosphate (FEP) in CKD**

Elvira O. Gosmanova,<sup>1,2</sup> Darren E. Gemoets,<sup>1</sup> Kenneth R. Phelps.<sup>1,2</sup> <sup>1</sup>Albany Stratton VA Medical Center Albany, Albany, NY; <sup>2</sup>Albany Medical College, Albany, NY.

**Background:** In a steady state, net flux of phosphate (P) into plasma determines  $E_p$ .  $FE_p$  is commonly used to depict the tubular reabsorption rate of P ( $TR_p$ ).  $E_p/C_{cr}$  and  $TR_p/C_{cr}$ , the amounts of P excreted and reabsorbed per volume of filtrate, determine both  $FE_p$  and the serum P concentration ( $P_s$ ) (Phelps, et al. Clin Nephrol 2015;83:167-76). However, the relative effects of  $E_p/C_{cr}$  and  $TR_p/C_{cr}$  on  $FE_p$  have not been studied. We analyzed relationships among  $FE_p$ ,  $E_p/C_{cr}$  and  $TR_p/C_{cr}$  in CKD stages G1-G5 (dialysis excluded).

**Methods:** This was a retrospective study of 387 veterans seen in the nephrology clinic of the Albany VAMC between 1/2020 and 9/2021. CKD stages were based on eGFR (2012 CKD-EPI). There were 687 concurrent determinations of serum and urine P and creatinine (cr), PTH, and eGFR.  $E_p/C_{cr}$  was calculated as  $P_{u,cr}/C_{cr}$ ,  $TR_p/C_{cr}$  as  $P_s - E_p/C_{cr}$  and  $FE_p$  as  $P_{u,cr}/C_{cr} / P_s$  or  $1 / (1 + (TR_p/C_{cr}) / (E_p/C_{cr}))$  (both formulas yield the same values). Relationships among variables were examined with linear regression.

**Results:** Measured and calculated values are shown in Table 1.  $E_p/C_{cr}$  and  $FE_p$  increased from CKD G1 to G5 by 380% and 226% but  $TR_p/C_{cr}$  fell by only 15%.  $FE_p$  correlated with  $E_p/C_{cr}$  ( $R^2=0.66$ ) and less strongly with eGFR ( $R^2=0.44$ ), PTH ( $R^2=0.28$ ), and  $TR_p/C_{cr}$  ( $R^2=0.20$ ) (all  $p<0.001$ ).  $FE_p$  was robustly determined by  $(TR_p/C_{cr}) / (E_p/C_{cr})$ .  $FE_p$  was  $>20\%$  when  $(TR_p/C_{cr}) / (E_p/C_{cr})$  was  $<4$  regardless of individual  $TR_p/C_{cr}$  or  $E_p/C_{cr}$  values. In 27% of cases with  $FE_p >20\%$ ,  $TR_p/C_{cr}$  exceeded mean values seen in CKD G1-2, and high  $FE_p$  was due solely to increased  $E_p/C_{cr}$ .

**Conclusions:**  $FE_p$  is a function of both  $E_p/C_{cr}$  and  $TR_p/C_{cr}$ . At reduced GFR,  $E_p/C_{cr}$  has a stronger effect on  $FE_p$  than  $TR_p/C_{cr}$  and PTH (a regulator of P reabsorption) have.  $E_p/C_{cr}$  rises as GFR falls if influx of P does not fall proportionately. If  $E_p/C_{cr}$  is sufficiently increased,  $FE_p$  can be  $>20\%$  even when  $TR_p/C_{cr}$  is  $\geq$  normal.  $FE_p$  is an inaccurate and sometimes misleading marker of P reabsorption in CKD.

**Funding:** Veterans Affairs Support

Measured and calculated values	Total N=687	CKD G1-2 N=114	CKD G3a N=140	CKD G3b N=261	CKD G4 N=146	CKD G5 N=26
$cr_s$ , mean (SD), mg/dl	1.9 (0.9)	1.0 (0.2)	1.4 (0.2)	1.8 (0.3)	2.7 (0.2)	4.7 (1.1)
eGFR, mean (SD), ml/min/1.73m <sup>2</sup>	43.2 (19.5)	76.6 (14.1)	51.5 (6.1)	37.5 (5.3)	24.0 (5.0)	11.7 (2.8)
$P_s$ , mean (SD), mg/dl	3.6 (0.7)	3.4 (0.6)	3.5 (0.6)	3.5 (0.6)	3.9 (0.7)	4.9 (1.6)
$E_p/C_{cr}$ , mean (SD), mg/dl	0.9 (0.6)	0.5 (0.2)	0.6 (0.3)	0.8 (0.4)	1.3 (0.6)	2.4 (1.1)
$TR_p/C_{cr}$ , mean (SD), mg/dl	2.7 (0.6)	2.9 (0.5)	2.8 (0.6)	2.6 (0.6)	2.7 (0.6)	2.4 (0.7)
$FE_p$ , mean (SD), %	24 (12)	15 (7)	18 (7)	24 (9)	32 (11)	48 (12)
PTH, mean (SD), pg/ml	96 (95)	55 (30)	64 (39)	88 (50)	143 (106)	314 (286)

**SA-PO191**

**Phosphate Overload Index and Risk of Cardiovascular Disease and Death in CKD: The CRIC Study**

Jing Chen,<sup>1</sup> Myles Wolf,<sup>2</sup> Tamara Isakova,<sup>3</sup> Siyi Geng,<sup>4</sup> Hua He,<sup>4</sup> Sylvia E. Rosas,<sup>8</sup> Claudia M. Lora,<sup>7</sup> Bernard G. Jaar,<sup>5</sup> L. Lee Hamm,<sup>1</sup> Alan S. Go,<sup>6</sup> Jiang He.<sup>4</sup> <sup>1</sup>Tulane University School of Medicine, New Orleans, LA; <sup>2</sup>Duke University, Durham, NC; <sup>3</sup>Northwestern University, Evanston, IL; <sup>4</sup>Tulane University School of Public Health and Tropical Medicine, New Orleans, LA; <sup>5</sup>Johns Hopkins University School of Medicine, Baltimore, MD; <sup>6</sup>Kaiser Permanente Division of Research, Oakland, CA; <sup>7</sup>University of Illinois Chicago, Chicago, IL; <sup>8</sup>Harvard University, Cambridge, MA.

**Background:** Phosphate (Pi) overload may lead to adverse outcomes in CKD, but challenges persist in evaluating Pi overload because serum Pi levels remain in the normal range via tight regulation until later CKD stages, while FGF23 and PTH levels may be affected by factors including eGFR besides Pi. We developed a Pi overload index and studied its relationship with CVD and death in CKD.

**Methods:** The CRIC Study enrolled 3939 adults with CKD and without cirrhosis in the US. 3578 participants without missing data were included in this analysis. Atherosclerotic CVD (ASCVD) was defined as ischemic stroke, myocardial infarction, or peripheral artery disease. Incident ASCVD, heart failure (HF), and death events were adjudicated by the outcome assessment committee. Pi overload index was calculated as [serum Pi x (urinary Pi/Cr ratio) x alkaline phosphatase (ALP - a marker reflecting bone turnover)] to synergistically reflect the effect of high Pi intake on serum Pi, kidneys, and bones. Cox proportional hazards models were used to examine the multivariable association of baseline Pi overload index with the outcomes.

**Results:** During up to 13-year median follow-up, 769 ASCVD, 862 HF, and 1502 death events occurred. ALP was significantly correlated with serum Pi and PTH and

began trending up at CKD stage 2. Pi overload index was significantly and positively correlated with 24-hour urinary Pi, FGF23, PTH, and dietary Pi and also began trending up at CKD stage 2. Higher Pi overload index was associated with higher rates of CVD outcomes and death in multivariable models (Table).

**Conclusions:** Pi overload index was independently associated with CVD outcomes and death and began trending up at CKD stage 2. Its value in diagnosing Pi overload needs to be confirmed in future studies.

**Funding:** NIDDK Support, Other NIH Support - National Institute of General Medical Sciences (NIGMS)

**Multivariable-Adjusted Hazard Ratios of Clinical Outcomes Associated with Phosphate Overload Index**

Quantile	ASCVD HR (95% CI)	HF HR (95% CI)	Death HR (95% CI)
Phosphate Overload Index			
< 121	Reference	Reference	Reference
121 to < 175	1.13 (0.91, 1.40)	1.04 (0.84, 1.29)	1.03 (0.88, 1.20)
175 to < 259	1.26 (1.02, 1.56)	1.10 (0.89, 1.36)	0.98 (0.84, 1.15)
$\geq 259$	1.37 (1.10, 1.71)	1.26 (1.02, 1.56)	1.28 (1.10, 1.50)
P value for linear trend	0.003	0.03	0.006

Adjusted for ASCVD risk factors, education, CVD, BMI, hemoglobin, 24-hour urinary protein, eGFR, and FGF23.

**SA-PO192**

**Associations of Calciprotein Particle Maturation Time With Echocardiographic Measures in the CRIC Study**

Ashwin Sunderraj,<sup>1</sup> Xuan Cai,<sup>1</sup> Andreas Pasch,<sup>2</sup> Matthew Feinstein,<sup>1</sup> Rupal Mehta,<sup>1</sup> Anand Srivastava,<sup>1</sup> Ana C. Ricardo,<sup>3</sup> Debbie L. Cohen,<sup>4</sup> Tamara Isakova.<sup>1</sup> <sup>1</sup>Northwestern University Feinberg School of Medicine, Chicago, IL; <sup>2</sup>Calison AG, Biel, Switzerland; <sup>3</sup>University of Illinois Chicago UI Health, Chicago, IL; <sup>4</sup>University of Pennsylvania Perelman School of Medicine, Philadelphia, PA.

**Background:** Low T50 may indicate a high propensity for calcification. Low T50 is associated with severe coronary artery calcification (CAC) and CAC progression in patients with CKD. Vascular calcification is associated with left ventricular (LV) hypertrophy and ventricular dysfunction, but data on association of T50 with adverse echocardiographic outcomes are sparse. We examined associations of T50 with LV mass, LV concentric remodeling, LV concentric hypertrophy, and LV eccentric hypertrophy in the Chronic Renal Insufficiency Cohort (CRIC) study.

**Methods:** Multivariable linear regression tested the cross-sectional association between year 1 T50 levels and LV mass. Multivariable logistic regression models tested the associations of T50 with concentric remodeling, concentric hypertrophy, and eccentric hypertrophy. Models were adjusted for age, sex, race, smoking status, BMI, systolic blood pressure, history of CVD, diabetes, eGFR and albuminuria.

**Results:** Among 2280 CRIC Study participants, at year 1, mean age was  $59 \pm 11$  years and mean eGFR was  $43.2 \pm 16.1$  ml/min/1.73m<sup>2</sup>. Mean LV mass was  $105.7 \pm 26.2$  g/m<sup>2</sup>, and LV concentric remodeling was present in 28.5%, LV concentric hypertrophy in 15.0%, LV eccentric hypertrophy in 36.3% of participants. One-SD lower T50 was associated with increased odds ratio (OR) of LV eccentric (OR = 1.37, 95% CI = [1.19 - 1.58]) and concentric (1.35 [1.20 - 1.52]) hypertrophy in unadjusted models; these associations were no longer statistically significant in fully adjusted models. In unadjusted models, one-SD lower T50 was associated with higher LV mass index ( $\beta = 3.04$ , 95% CI = [1.97 - 4.10]); this association was no longer statistically significant in fully-adjusted models. When we examined T50 in quartiles, the findings were similar.

**Conclusions:** Among the CRIC cohort, T50 was not associated with echocardiographic outcomes after multivariable adjustment.

**Funding:** Other NIH Support - R01DK110087

**Table. Multi-variable adjusted<sup>1</sup> associations of T50 with LV concentric remodeling, eccentric hypertrophy, concentric hypertrophy, and with LV mass index**

	Concentric Remodeling Odds ratio (95% CI)	Eccentric Hypertrophy Odds ratio (95% CI)	Concentric Hypertrophy Odds ratio (95% CI)	LV Mass Index $\beta$ Coefficient (95% CI)
T50, expressed on continuous scale, per 1-SD (79 min) lower T50				
	0.98 (0.85 - 1.12)	1.11 (0.94 - 1.32)	1.07 (0.93 - 1.24)	0.46 (-0.51 - 1.44)
T50 Quartile				
Quartile 4	Reference	Reference	Reference	Reference
Quartile 3	1.03 (0.73 - 1.44)	1.01 (0.64 - 1.59)	1.14 (0.78 - 1.67)	0.22 (-2.38 - 2.82)
Quartile 2	1.10 (0.77 - 1.58)	1.63 (1.04 - 2.56)	1.38 (0.93 - 2.04)	1.66 (-0.97 - 4.29)
Quartile 1	0.95 (0.65 - 1.39)	1.22 (0.75 - 1.97)	1.16 (0.77 - 1.74)	1.15 (-1.59 - 3.89)

<sup>1</sup> Adjusted for age, sex, race, clinical site, systolic blood pressure, BMI, diabetes, smoking, LDL, history of CVD, eGFR, and albuminuria

## SA-PO193

**Changes in Bone Quality Over 2 Years in Patients With CKD Stages 2-4**

Amr E. Mohamed,<sup>1</sup> Florence Lima,<sup>1</sup> Kelly Meulendyke,<sup>1</sup> Mohamed M. Abdalbary,<sup>2</sup> Eman Nagy,<sup>2</sup> Habib Srour,<sup>1</sup> Marie-Claude M. Faugere,<sup>1</sup> Hartmut H. Malluche.<sup>1</sup> <sup>1</sup>University of Kentucky Medical Center, Lexington, KY; <sup>2</sup>Mansoura University, Mansoura, Egypt.

**Background:** Renal osteodystrophy develops early with loss of kidney function. It encompasses loss of bone quantity and reduced bone quality. This study used Fourier Transformed Infrared Spectroscopy (FTIR) to measure bone quality.

**Methods:** 20 patients (pts) with CKD II-IV underwent iliac crest bone biopsies for FTIR, bone histomorphometry, and dual-photon absorptiometry (DXA) for bone mineral density (BMD) of hip and spine. FTIR parameters included mineral:matrix ratio (M/M), carbonate:phosphate ratio (C/P), collagen crosslinks (Cx) and crystal size (CS). In addition, serum biochemical parameters were measured, including eGFR, Ca, P, iPTH, BSAP, Trap-5B, sclerostin, i and c-term FGF-23,  $\alpha$ -klotho, and Activin A. All tests were done at baseline and after 2-3 years of observation with continuation of the same clinical management following KDIGO guidelines.

**Results:** Age of pts was 60  $\pm$  11 y with 55% female, 65% White, 30% Black, 5% Asian, 55% DM2, 100% HTN, 10% CKD II, 70% CKD III, and 20% CKD IV. Mean eGFR did not significantly change but declined in 9 pts. At beginning of study bone turnover was low in 85% of pts versus 75% at the end; bone volume was low in 25% versus 47% at the end. Mineralization was normal throughout. There was a trend for M/M and CS to go down and histologically, bone turnover increased significantly with increase in the number of pts in the normal range. Change in (D) Cx correlated negatively with DP (p=0.026). There was a negative correlation between DM/M and baseline iPTH (p=0.002), and a positive correlation between DCS and DiPTH. DC/P correlated positively with  $\Delta\alpha$ -Klotho (p=0.002), and negatively with baseline  $\alpha$ -klotho (p=0.011). DCS correlated negatively with D trabecular separation (p=0.017) and positively with D spine T score (p=0.050).

**Conclusions:** The study confirms presence of abnormal bone quality in addition to loss of bone quantity in pts with CKD II-IV. Over 2 years of observation, there was a significant further loss of bone volume by DXA and an increase in turnover towards the normal range by histology. Bone quality parameters trended towards normal and were significantly correlated with changes in parameters indicative of improvement in bone turnover. These results call for management strategies addressing both bone quality and quantity in pts with CKD.

**Funding:** NIDDK Support, Private Foundation Support

## SA-PO194

**Risk of Hypocalcemia With Denosumab Use in CKD Patients**

Sri Mahathi P. Kalipatnapu,<sup>1</sup> Juhi Bhargava,<sup>1</sup> Shirin Hasan,<sup>2</sup> Stuart M. Sprague.<sup>1</sup> <sup>1</sup>University of Chicago Pritzker School of Medicine, Chicago, IL; <sup>2</sup>NorthShore University HealthSystem, Evanston, IL.

**Background:** Several case reports and retrospective studies have demonstrated that denosumab (DNB) can cause hypocalcemia in advanced CKD (4-5) and ESRD patients. However, these are predominantly anecdotal reports and the prevalence of hypocalcemia in patients with CKD 3-4 is unclear. We evaluated the change in serum calcium (Ca) in patients treated with DNB with CKD stage 3B and 4.

**Methods:** A retrospective study on 52 patients with CKD 3B-4 who were treated with DNB between 2017-2021 was performed. Mean ( $\pm$  SE) number of doses of DNB received was 2.4  $\pm$  0.14 with minimum of 1 and maximum of 4 doses. Mean pre and post Ca, PTH, vitamin D and phosphorus (Phos) were evaluated. The patients were stratified based on their eGFR into CKD 3B and CKD 4. The subgroup of patients with hypocalcemia (defined < 8.0 mg/dL) and decrease in calcium greater than 1mg/dl from baseline were also identified.

**Results:** The 52 patients received 122 (2.4  $\pm$  0.14) doses of DNB and had a mean eGFR of 37  $\pm$  0.7. Mean serum Ca (mg/dL) was 9.6  $\pm$  0.05 and 9.3  $\pm$  0.05 before and after DNB, respectively. Mean change in serum Ca was 0.29  $\pm$  0.06. There were 21 patients with CKD stage 4, mean eGFR 24.2  $\pm$  7.7. Mean serum Ca with was 9.5  $\pm$  0.16 before DNB and 9.2  $\pm$  0.13 after DNB. Mean change in Ca was 0.4  $\pm$  0.14. In the 99 patient events with eGFR between 30-45 (39.7  $\pm$  0.58), the mean Ca was 9.7  $\pm$  0.05 before DNB 9.4  $\pm$  0.06 after DNB. Mean change in Ca was 0.3  $\pm$  0.07. In 15 patients (18 patient events) there was a decrease in serum Ca > 1 mg/dl. The mean eGFR was 32.1  $\pm$  1.9 with mean Ca of 10.0  $\pm$  0.14 and 8.6  $\pm$  0.18 pre and post DNB, respectively, and a mean change in Ca of 1.36  $\pm$  0.09. Only one patient had overt hypocalcemia, with a post DNB Ca of 7.7 and an eGFR of 27. Vitamin D was available in 6 patients with mean vitamin D (ng/mL) of 50.7  $\pm$  2.3 and 51.2  $\pm$  3.8 before and after DNB, respectively. PTH was available in 5 patients with mean PTH (pg/mL) 90.6  $\pm$  29.0 and 93.8 34.3 before and after DNB, respectively. Phos was available in 11 patients and mean phos (mg/dL) was 3.4  $\pm$  0.10 and 3.3  $\pm$  0.39 before and after DNB, respectively.

**Conclusions:** DNB did not cause a significant drop in Ca in this random sample of CKD 3B-4 patients. Patients with CKD 4 should be monitored for hypocalcemia, further larger and prospective studies should be performed.

**Funding:** Clinical Revenue Support

## SA-PO195

**Mineral and Bone Disorder in Patients Living With the Human Immunodeficiency Virus on Hemodialysis: A Series of Cases**

Julia B. Vaz, Ana Paula Gueiros, Jose E. Gueiros. Hospital das Clinicas, Recife, Brazil.

**Background:** The survival rate of patients living with the human immunodeficiency virus (HIV) has increased after the intensification of antiretroviral therapy. Decreased bone mineral density and fractures are reported in this population. Chronic kidney disease (CKD) causes mineral and bone disorder (CKD-MBD), which also contributes to low bone mineral density, fractures, and vascular calcification. This study aimed to assess the osteometabolic profile and the occurrence of vascular calcification in HIV patients undergoing hemodialysis.

**Methods:** The clinical and demographic data of 21 patients were assessed. Laboratory parameters were measured: total calcium, phosphorus, albumin, intact parathyroid hormone (iPTH), total alkaline phosphatase, 25OH-vitamin D, CD4 count and HIV viral load. Bone mineral density was assessed by bone densitometry, and x-rays of the pelvis, hands and abdomen were also taken to determine vascular calcification scores.

**Results:** The median age of patients was 48 years; 81% were male and the median times of HIV infection and hemodialysis were 132 and 120 months, respectively. Patients presented with hypertension (95%), heart disease (67%) and a history of smoking (85%). Median serum calcium and phosphorus levels were normal and the median iPTH was 360 pg/mL. Osteopenia was diagnosed in 33% of patients and osteoporosis in 33%. Around 24% of patients had previously suffered fractures. The Kauppila score was higher in patients with fractures (p=0.040). Vascular calcification was identified in 12 (57%) patients. Inverse correlations were demonstrated between the Kauppila score and the T-score of the femoral neck (p<0.001) and the T-score of the lumbar spine (p<0.001); and between the Adragão score and T-score of the femoral neck (p=0.001) and the T-score of the lumbar spine (p=0.001).

**Conclusions:** A high prevalence was observed of low bone mineral density, fractures and vascular calcification in HIV patients on hemodialysis. Our results corroborate the important relationship between bone metabolism and vessel. It is necessary to confirm these results with larger studies and preferably with a control group of non-HIV patients.

## SA-PO196

**Metastatic Calcinosis (MC) in Hemodialysis Patients: May Rheopheresis Play a Role?**

Giuseppe Gemone. ASL BA Nephrology and Dialysis Unit - S. Maria degli angeli and S. Giacomo Hospitals, Putignano- Monopoli, Italy.

**Introduction:** MC cutis primarily occurs in CKD because an underlying defect of Ca/P metabolism that precipitate calcium. Dystrophic Calcinosis, the most common Calcinosis Cutis, frequently in autoimmune connective disease, must be excluded. The management of MC in ESKD is challenging because is based mainly on risk factor control, sometimes with administration of sodium thiosulfate. As data are lack for standardized treatment other approaches are reasonable. LDL-apheresis and rheopheresis successfully treat calciphylaxis but there are no specific indications for MC by ASFA. Aim is to test Double Filtration PlasmaPheresis (DFPP), a rheopheresis technique, to improve the outcome of MC.

**Case Description:** 57-years-old man with Hypertension, Diabetes complicated by neuropathy, fingers amputation and plantar ulcers (left foot) by peripheral vasculopathy. Obese. ESKD in HD for over 6 years. Diagnosis of MC, involving face, trunk and limbs, was made. Despite autoimmunity was negative, AVK never used, intralesional corticosteroids were given, calcium-based phosphate binders and Vitamin D analogues were replaced by Sevelamer and calcimimetics, PTH and Ca/P were in the normal range, there was good dialysis adequacy and no increased plasma viscosity: no clinical improvement was attended. A program of 12 treatment (T) of DFPP was started: 3 times/week (T/W) for the first 2, 2 T/W in week 3 and 1 T/W for the following 4. DFPP was conducted by Rheofilter ER-4000. For the first 8 T a single plasma unit (PU) was treated according to the formula: (0.07x weight) x (1-Hct/100); instead 1.5 PU in the remaining 4 T. Complete blood count, albumin, C-Reactive Protein (CRP), LDL-Chol. and Fibrinogen was evaluated. After 8th T there is a remarkable clinical improvement in all body areas, but unexpectedly between the 9th and 10th T there is a flare-up. Protocol was extending up to 24 T: 2 T/W for further 5 weeks, therefore 1 T/W for the last 4 weeks. So after the 16th T there is a remission of skin manifestations. At T0-T12-T24 complete blood count is unchanged, whereas albumin, CRP and LDL-Chol. show significant reduction. Fibrinogen: p=ns

**Discussion:** DFPP is a promising approach for MC as it leads to clinical remission because specifically improve blood rheology and tissue perfusion with a good safety profile. Larger studies could confirm it as a therapy in patients with MC, but in the meantime, it could help to build a new scientific evidence.

## SA-PO197

**Uremic Leontiasis Ossea Case**

Sara Fakhredine,<sup>1</sup> Jafar Alsaid,<sup>2</sup> Teerath Kumar,<sup>1</sup> Rayees Y. Sheikh.<sup>1</sup> <sup>1</sup>BSH, Manama, Bahrain; <sup>2</sup>Ochsner Medical Center, New Orleans, LA.

**Introduction:** Uremic leontiasis ossea (ULO) is a rare complication of untreated severe hyperparathyroidism in patients with ESRD. It is characterized by abnormal bone mineralization with severe and diffuse enlargement of the maxilla and mandible bones resulting in lion's face features. Given the widespread use of dialysis, calcimimetics, and phosphate binders, ULO is now rare.

**Case Description:** A 37-yr-old woman with ESRD secondary to FSGS. She had developed secondary hyperparathyroidism. She was poorly adherent to her dialysis sessions and prescribed medications. Her condition progressed to tertiary hyperparathyroidism over 10 years with a parathyroid hormone (PTH) level of 1,249 pg/mL and a serum calcium of 12.3 mg/dL. She had refused to undergo parathyroidectomy and was not compliant to her treatment despite multiple discussions. Her PTH increased to 5,814 pg/ml, serum calcium and serum phosphate were 8.8 and 3.9 mg/dl, respectively. Her complaints were headach, diplopia on lateral gaz, gum bleeding and nasal blockage. Over the course of 7 years, she sustained progressive facial changes with deformity of the maxillary and mandibular bones with widening of the interdental spaces (Image). Calciphylaxis, fractures of vertebra and right humerus ensued over the last two years. Maxillofacial computed tomography showed “pepper pot” appearance of skull. Parathyroid scan showed multiple nodules, the largest 3x3 cm. A DEXA scan revealed severe osteoporosis. The patient remains adamant not to have the surgery and the last PTH value of 3,476 pg/mL, serum calcium of 9.0 mg/dL and serum phosphate of 4.2 mg/dL.

**Discussion:** ULO is a rare and disabling complication of tertiary hyperparathyroidism in ESRD. Without treatment, irreversible bony deformities can occur. Adherence to treatment is critical to optimize its prognosis. The term was first used by by Kienböck in 1940. The treatment includes parathyroidectomy, percutaneous fine needle ethanol injection or Calcitriol in non-surgical candidates. Reconstructive surgery might be used to correct the bony deformities.



Figure1: Skin changes in the right leg before (a) and after (b) skin biopsy.

**SA-PO199**

**Two Cases of Brown Tumors in ESRD Patients**

Nihal Bashir, *Seha Kidney Care-Tawam, Al Ain, United Arab Emirates.*

**Introduction:** Two patients among our dialysis cohort were diagnosed with brown tumors, one young male had disfiguring maxillary growth.

**Case Description:** Case 1 A 40-year-old female, known case of lupus nephritis and end stage renal disease on haemodialysis, and history of parathyroidectomy due to tertiary hyperparathyroidism. MRI of the lumbar spine in 2017 showed a well-marginated bone lesion involving the left iliac bone, measuring about 2 x 1.2 cm, second lesion is seen inferior to the former, measuring about 0.8 x 0.7 cm. Bone Scan showed delayed images show increased linear uptake in posterior left 12th rib and focal uptake at left eighth costochondral junction. There are foci of increased uptake in the cranium and mandible. DEXA scan showed T score of -3.1 and confirmed osteoporosis. Due to her Renal status - Bisphosphonate not suitable, other treatment options are Denosumab and Teriparatide but could not start neither of them as the patient had severe hypocalcaemia. Patient was started on teriparatide. Bone biopsy was negative for malignancy. Case 2 A 27 year old male, known to have renal transplant 2006 reinitiated on haemodialysis in 2009. He also suffered secondary hyperparathyroidism of renal origin with Brown tumour of the facial bone with gross distortion with previous debulking surgery, the patient is currently on etelcalcetide 7.5 mg intravenously on dialysis days. He had multiple disfiguring tumours as shown on images.

**Discussion:** Take home messages 1. Brown tumours are devastating and difficult to treat unless detected early in background of CKD-bone mineral disease. 2. Osteoporosis is difficult to diagnose and treat in ESRD patients.

Images of patient 1 showing PTH graph pre and post parathyroidectomy, pelvic x-ray showing red arrow pointing at bony lesion and skull x-ray red arrows showing 2 lesions.

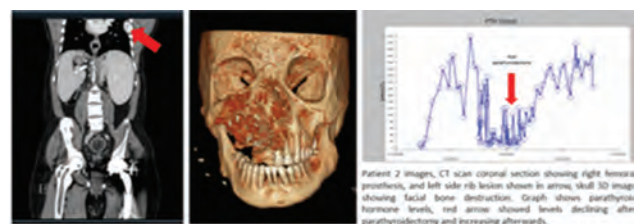
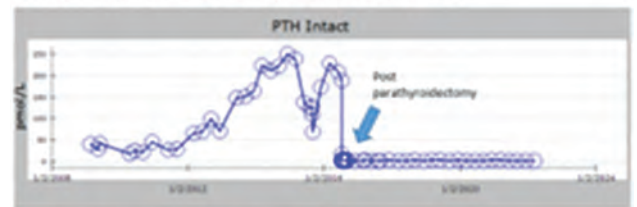

Patient 2 images, CT scan coronal section showing right femoral synostosis, and left side rib lesion shown in arrow, skull 3D image showing facial bone destruction. Graph shows parathyroid hormone levels, red arrow showed levels declining after parathyroidectomy and increasing afterwards.

**SA-PO198**

**Calcific Uremic Arteriolopathy (CUA) Mimicking Infectious Cellulitis**

Mina Awad,<sup>1</sup> Elvira O. Gosmanova.<sup>1,2</sup> <sup>1</sup>Albany Medical Center, Albany, NY; <sup>2</sup>Albany Stratton VA Medical Center Albany, Albany, NY.

**Introduction:** CUA is caused by dermis and subcutaneous fat small vessel calcifications leading to skin ischemia and necrosis. CUA is mainly observed in patients with ESKD. CUA usually presents with intensely painful skin nodules or lesions with characteristic purple net-like patterns in areas with high fat content. In this case, the initial presentation of CUA was a diffuse right lower extremity (RLE) erythema and severe pain that were misdiagnosed as infectious cellulitis.

**Case Description:** A 57-yo male with ESKD on HD developed progressively worsening RLE pain and redness. On exam, RLE was diffusely tender, swollen and erythematous but without skin breaks. There were no associated fever, leukocytosis or DVT. After 10 days of intravenous (IV) vancomycin for the diagnosis of infectious cellulitis, there was no improvement (Fig1a). X-ray of RLE (done to exclude fracture) showed prominent vascular calcifications. Therefore, diagnosis of CUA was suspected. After skin biopsy, empiric treatment with IV sodium thiosulfate 25grams after each HD was started with marked improvement in RLE pain within 1 week. A punch biopsy of RLE skin showed no signs of CUA; however, characteristic stellate lesion for CUA developed at the biopsy site (Fig1b). Patient’s CUA risk factors included ESKD with high fluid gains, diabetes, uncontrolled hyperphosphatemia, treated with lanthanum (previously was on Ca acetate), secondary hyperparathyroidism (PTH>1000pg/ml) on etelcalcetide and paricalcitol.

**Discussion:** It is critical to know unusual presentations of CUA, such as CUA presenting with diffuse skin erythema resembling cellulitis rather than patchy retiform purpura with ulcerative lesions. Misdiagnosis may lead to inappropriate antibiotic use and a delay in CUA treatment. Constellation of severe pain and arterial calcifications in the affected area on x-ray were clues for the diagnosis of CUA. Skin biopsy may lead to skin ulceration and be unrevealing in 50% of cases. We advocate to avoid skin biopsy when clinical suspicion for CUA is high.

## SA-PO200

**The Masked Parathyroid Adenoma in CKD: Is It Overlooked?**

Mohammad Atari. *The University of Mississippi Medical Center, Jackson, MS.*

**Introduction:** Primary hyperparathyroidism (PHPT) is the leading cause of hypercalcemia in the outpatient setting, most commonly resulting from a solitary adenoma. PHPT is associated with hypercalciuria, kidney stones, chronic kidney disease (CKD), and/or nephrocalcinosis. On the other hand, CKD is associated with bone and mineral homeostasis abnormalities. PHPT can be masked or unmasked in certain conditions.

**Case Description:** Case 1: An 80-year-old female patient with multiple myeloma and CKD IV secondary to membranous nephropathy presented for follow-up. Calcitriol was resumed six months before this visit due to high parathyroid hormone (PTH) at 866 pg/mL and adjusted later due to a rise in serum calcium to 11.2-11.6 mg/dL. However, calcium continued to rise reaching 12.1 mg/dL and PTH increased to 1172 pg/mL. Phosphorus was normal. The findings prompted further evaluation; sestamibi scan revealed a large hyperfunctioning parathyroid adenoma in the mid-upper right lobe with concomitant mild hyperplasia on left. Case 2: A 60-year-old female patient with a history of nonischemic cardiomyopathy, atrial fibrillation, obstructive sleep apnea, and progressive CKD of unclear etiology presented for follow up. Labs showed worsening creatinine secondary to loop diuretic-induced hypovolemia with concomitant hypophosphatemia of 1.8 mg/dL, hypokalemia, and hypomagnesemia. Serum calcium was normal at 9.8 mg/dL. Furosemide was held and hydration was recommended, PTH was 360 pg/mL, and repeated labs showed calcium of 10.7 mg/dL and phosphorus of 4.3 mg/dL with improvement in serum creatinine. Sestamibi scan showed a hyperfunctioning adenoma in the inferior left lobe.

**Discussion:** Masked PHPT has been described in the setting of hypothyroidism and hypovitaminosis D secondary to malabsorption or malnutrition. Vitamin D replacement and thiazide therapy have been reported to unmask PHPT. Here we describe unmasking two cases of parathyroid adenoma-induced PHPT in CKD, one case was unmasked by starting calcitriol, and the other was unmasked by stopping furosemide. These cases emphasize the importance of carefully interpreting mineral metabolism parameters in CKD populations where PHPT can be subclinical, normocalcemic, and masked by vitamin D deficiency. Normocalcemic PHPT cannot be easily differentiated from secondary hyperparathyroidism in CKD patients, requiring high clinical suspicion and imaging studies to establish the diagnosis.

## SA-PO201

**When the Mouse Click Becomes a Mouse Bite**

Fatima Ayub,<sup>1</sup> Nithin Karakala,<sup>1</sup> Md R. Hasan.<sup>2</sup> <sup>1</sup>University of Arkansas System, Little Rock, AR; <sup>2</sup>Arkansas College of Osteopathic Medicine, Fort Smith, AR.

**Introduction:** Vitamin D supplements are readily available both over the counter as well as online. Intoxication from vitamin D supplements though rarely reported occurs more frequently, nowadays. We, hereby present a classic case of iatrogenic hypervitaminosis D with recurrent symptomatic hypercalcemia

**Case Description:** 66 years old female with past medical history of bipolar disorder was brought to the hospital for altered mentation. The patient was in her usual state of health until 2 days prior to presentation when she started having generalized weakness followed by confusion. Her only medications at home were over-the-counter vitamin supplements. Upon presentation, she was tachycardic, agitated and only oriented to self. Labs showed a serum calcium level of 17.5 mg/dL, ionized calcium of 2.28 mmol/L, 25-hydroxyvitamin D (25-OH vit D) of 310 ng/mL and a parathyroid hormone (PTH) level of 19.8 pg/mL. She also had acute kidney injury with a serum creatinine of 3.7 mg/dL. The patient was started on aggressive fluid resuscitation. Serum 1,25-dihydroxy vitamin D was reported more than 300 pg/mL. The serum calcium improved over the next 72 hrs with aggressive fluid resuscitation and loop diuretics, with improvement in mental status. Subsequent interview revealed that she was taking 10,000 units of vitamin D supplements for the last 5 years that she was purchasing from an online store as a treatment for her depression. She was recommended to stop taking vitamin D supplements and was subsequently discharged once her symptoms and hypercalcemia had resolved. However, she was readmitted for similar complaints and lab abnormalities within a week. She was again managed supportively with complete resolution of symptoms

**Discussion:** Vitamin D toxicity causing hypercalcemia, is extremely rare. The 25 OH vit D is converted to its active form, 1,25 OH vit D in the kidney, whose half-life is 4-6 hours. However, it is imperative to realize that the half-life of 25 OH vit D which primarily comes from diet is around 2-6 weeks. Hence, despite the normalization of serum calcium levels in a hypercalcemic patient there is usually a rebound increase in serum calcium due to the ongoing conversion of 25 OH vit D to 1,25 OH vit D for weeks. We, therefore, suggest that in patients presenting with concerning symptoms and hypercalcemia, particularly in the presence of normal parathyroid hormone level, a diagnosis of vitamin D toxicity should be suspected

## SA-PO202

**Hypercalcemia Secondary to Granulomatous Disease Caused by Cosmetic Injections**

Shilpi Shah, Jehan Z. Bahrainwala, Amanda K. Leonberg-Yoo. *University of Pennsylvania, Philadelphia, PA.*

**Introduction:** Polymethylmethacrylate (PMMA) is an injectable filler used cosmetically for the augmentation of body parts though only FDA approved for the face and hands. PMMA fillers can cause foreign body granulomas which can rarely

result in calcitriol mediated chronic hypercalcemia. We present a case of a patient with hypercalcemia, recurrent nephrolithiasis, and chronic kidney disease (CKD) due to PMMA injections received fifteen years prior.

**Case Description:** A 54-year-old man was admitted for serum calcium of 14.0 mg/dL (8.9-10.3 mg/dL) and ionized calcium level of 1.83 mmol/L (1.00-1.25 mmol/L). He reported ten years of hypercalcemia and recurrent nephrolithiasis of unknown etiology. He presented with acute kidney injury with a creatinine of 2.94mg/dL (prior baseline 1.8 mg/dL), intact parathyroid hormone (iPTH) level 2.3 pmol/L (1.6-6.9 pmol/L), 25-OH vitamin D level 23 ng/ml (25-80 ng/mL), 1,25-OH vitamin D level 72 pg/ml (19.9-79.3 pg/mL), parathyroid related peptide <2 pmol/L (0-2.3 pmol/L). He had no paraproteinemia. He received PMMA fillers in his face, forearms, calves, and buttocks fifteen years ago and his exam showed raised nontender nodules in these areas. Skin biopsy of a lesion showed foreign body granulomas in the dermis. He was treated acutely with fluids and calcitonin with improvement in serum calcium and creatinine levels to 9.8 mg/dL and 2.13 mg/dL respectively. He was discharged on prednisone 20mg daily. He is off steroids and is now maintained on hydroxychloroquine (HCQ) 200mg twice daily, as reversal or dissolving of PMMA is not possible given the extent of his injections.

**Discussion:** PMMA filler induced hypercalcemia is rare, can be severe, and may present years after injections. Hypercalcemia is due to overactivity of extrarenal 1- $\alpha$ -hydroxylase activity in activated macrophages in granulomas resulting in pathological calcitriol production. Concomitant CKD may result in iPTH and calcitriol levels that are less suppressed and elevated than expected. Treatment options include steroids, bisphosphonates, or ketoconazole. Our patient is maintained on HCQ, which inhibits 1- $\alpha$ -hydroxylase activity and decreases calcitriol production. Early diagnosis of dermal filler-related disease is key to avoid complications such as CKD and recurrent nephrolithiasis as seen in our patient.

## SA-PO203

**Stone Formation in an Ileal Conduit due to a Refluxed Surgical Staple**

Justina Ray,<sup>1</sup> Latoya N. Gayle,<sup>2</sup> Aisha Shaikh.<sup>3,2</sup> <sup>1</sup>Cahn School of Medicine at Mount Sinai, New York, NY; <sup>2</sup>Weill Cornell Medicine, New York, NY; <sup>3</sup>Memorial Sloan Kettering Cancer Center, New York, NY.

**Introduction:** Ileal conduits for urinary diversion are created following cystectomy. Patients with ileal conduits are at high risk for urinary tract calculi. Several factors predispose to stone formation following ileal conduit creation, including metabolic abnormalities, infections due to urea-splitting organisms, and the presence of foreign material in the ileal conduit. We describe a case of ileal conduit stone formation around a refluxed surgical staple.

**Case Description:** A 73-year-old female with a solitary left kidney and a history of bladder cancer underwent radical cystectomy and ileal conduit creation 10-years ago. She did not have a previous history of nephrolithiasis. She presented to the hospital after passing a stone in her urostomy bag. The stone was white in color, 2 cm in diameter, with a surgical staple encased within it (Image). The patient did not complain of abdominal or flank pain, and no hematuria or pyuria was present. CT Urogram showed no filling defect, foreign body, calculus, or dilatation of the renal calyces and pelvis. Metabolic acidosis, hypercalcemia, hyperuricemia, or hyperparathyroidism were not present. The stone was composed of 90% magnesium ammonium phosphate (struvite) and 10% calcium phosphate (apatite). No intervention was performed as no residual stones, or foreign bodies were present in the kidney or the ileal conduit.

**Discussion:** In ileal conduits, a loose surgical staple can serve as a nidus for stone formation. In most cases, the stone is passed spontaneously without any complications. However, in some cases, the loose surgical staple can reflux from the ileal conduit into the kidney leading to nephrolithiasis. Furthermore, the surgical staple can be completely embedded within the stone and not be visible to the naked eye. In such cases, radiographic imaging of the stone can reveal the encased staple. Nephrologists must be aware of this rare complication in patients with ileal conduits where a loose surgical staple can serve as a nidus for stone formation.



Image. A stone encasing a loose surgical staple.

## SA-PO204

**Frustratingly Frail: Following the Phosphorous**

Nolan M. Giehl,<sup>1,2</sup> Minhtri K. Nguyen.<sup>1</sup> *University of California Los Angeles David Geffen School of Medicine, Los Angeles, CA; <sup>2</sup>Kaiser Permanente Southern California, Woodland Hills, CA.*

**Introduction:** Determining the etiology of persistent hypophosphatemia can be humbling and elusive. We present an extraordinary case of tumor-induced osteomalacia (TIO) after steadfast investigation.

**Case Description:** A 71-year-old man presented after 4 years of progressive muscle weakness, bony pain and debilitating osteoporosis with multiple pathologic fractures. He had no history of kidney disease, steroid use, growth deficiencies, hypogonadism, thyroid, or prostatic disease. Past bone marrow biopsy was normal. Initial laboratory data revealed severe hypophosphatemia (1.8 mg/dL), low vitamin-D-1,25 (10 pg/mL), but high-normal parathyroid hormone (57 pg/mL). Subsequent urine testing showed inappropriate phosphate wasting (740 mg/24hr) and high fractional excretion of phosphate (20.4%). Urinalysis was negative for glucosuria or proteinuria. Further serum testing for FGF23 was remarkably high (321 RU/mL). Follow up functional radiographic testing via <sup>68</sup>Ga-DOTATATE-based PET/CT showed a hyperdense lesion in C7-T1 concerning for mesenchymal tumor (Figure 1). This was confirmed on cervical spine MRI. Upon surgical consultation for tumor removal, he was deemed not a candidate based on tumor location. Started on anti-FGF23 therapy with IV burosumab monthly while awaiting reassessment for surgical candidacy, he has had normalization of serum phosphate and near resolution of musculoskeletal symptoms.

**Discussion:** TIO is a rare paraneoplastic syndrome of abnormal phosphorus metabolism caused by small mesenchymal tumors that secrete FGF23 leading to impaired bone metabolism and disability. Delayed diagnosis is common due to nonspecific symptoms, and years may elapse before patients receive a correct diagnosis and proper treatment. Increased awareness of the appropriate recognition and management of TIO is vital among providers who may encounter patients with suspected TIO to reduce morbidity. Furthermore, our case demonstrates that while curative surgical intervention is preferred, the newly FDA-approved anti-FGF23 therapy (burosumab) is an effective second line therapy at achieving phosphorus homeostasis and clinical improvement.

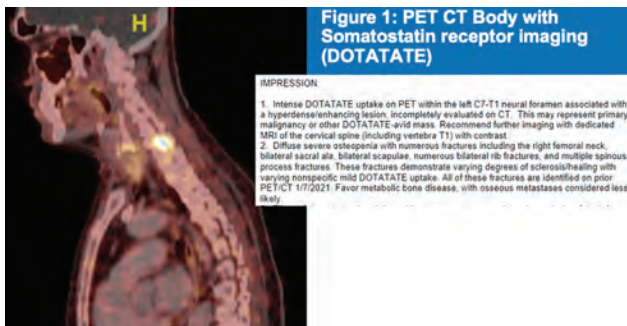

## SA-PO205

**Burosumab: An Option for Adults With Symptomatic X-Linked Hypophosphatemia**

Amer A. Belal, Rupam Ruchi. *University of Florida College of Medicine, Gainesville, FL.*

**Introduction:** X-linked hypophosphatemia (XLH) is a dominant disorder caused by an inactivating mutation in the PHEX gene. This increases fibroblast growth factor 23 (FGF23) that subsequently acts to inhibit phosphate reabsorption in the proximal renal tubules. While traditional treatment with phosphate replacement and calcitriol meets some goals, side effects such as nephrocalcinosis limit their use. Thus in 2018 the FDA approved Burosumab as a human anti-FGF23 monoclonal antibody for adults.

**Case Description:** We discuss the case of a 39-year-old woman with history of hypophosphatemic vitamin D resistant rickets diagnosed at 18 months. She has been followed by adult nephrology since age 19. At that time, she had lab work notable for 1, 25 Vitamin D level 61 pg/mL and PTH 134 pg/mL. Her urinary phosphate was inappropriately high at 0.6 g/24 hours despite hypophosphatemia of 1.8 mg/dL. As a child she was on phosphate supplementation but this was stopped due to nephrocalcinosis. She was maintained on dietary phosphate and calcitriol for the past twenty years with stable severe hypophosphatemia resulting in profound fatigue. Recently she completed genetic testing for PHEX gene mutation and FGF23[RR1]. Her FGF23 was normal at 140 RU/mL and her PHEX gene mutation was heterozygous positive for the pathogenic c.1715G>A (p.Gly572Asp) variant. She has a symptomatic son and a healthy daughter. Given her symptoms of fatigue and bone pain in setting of hypophosphatemia, she was started on Burosumab at 60 mg q4 weeks. Her phosphate improved to 3.2 mg/dL from 1.5 mg/dL with increase in total calcium to 10.3 mg/dL and ionized calcium 1.41 mmol/L. Her dose was decreased to 40 mg monthly with repeat labs showing normal calcium and phosphorous of 2.6 mg/dL with improved symptoms. On this dose her phosphate levels remained between 2.3-3.2 mg/dL and calcium levels 9.9-10.2 mg/dL until she was unfortunately lost to follow up resulting in need for cessation of Burosumab therapy with return of her symptoms of fatigue, bone/joint pain, and severe hypophosphatemia of 1.3 mg/dL. She has now been restarted on Burosumab therapy

**Discussion:** This case is emblematic of the benefits of Burosumab therapy for adults with XLH. In keeping with clinical trials, treatment with Burosumab resulted in increased activity levels and overall quality of life along with improved phosphorus levels. Thus, we hold that it should be offered to symptomatic adults with XLH

## SA-PO206

**Idiopathic Hypokalemia in a Patient With Autosomal Dominant Hypocalcemia (ADH) Type 2 With a GNA11 Point Mutation**

Rachael A. Silverberg, Maurice I. Khayat. *Madigan Army Medical Center, Tacoma, WA.*

**Introduction:** Calcium-sensing receptors (CaSR) expressed on parathyroid and renal tubule cells contribute to calcium homeostasis through negative-feedback. Activating mutations of the CaSR or downstream signaling components may result in Autosomal Dominant Hypocalcemia (ADH) Types 1 and 2. These rare disorders are characterized by hypocalcemia, hyperphosphatemia, and low PTH. While hypokalemia and metabolic alkalosis are reported among patients with ADH Type 1, this is not well established in ADH Type 2.

**Case Description:** A 22-year-old male presented with headaches, irritability, lethargy, perioral paresthesia, muscle and facial spasms progressive over several years with recurrent evaluations in the Emergency Department. Serial labs revealed hypocalcemia, hyperphosphatemia, and low iPTH as well as hypokalemia, hypomagnesemia, and metabolic alkalosis. Treatment comprised oral calcitriol and daily supplementation with calcium citrate, cholecalciferol, potassium chloride, and magnesium citrate. Genetic testing revealed a heterozygous likely pathogenic variant in the GNA11 gene (c.178C>T) associated with ADH Type 2. Testing for Gitelman Syndrome, ADH Type 1, and 22q11.2 deletion were negative. Despite daily supplementation and a high potassium diet, he reported continued symptomatic episodes of hypokalemia characterized by palpitations, headaches, nausea, and irritability. His aldosterone and plasma renin activity were within normal limits. A 24-hour urine study showed high renal excretion of potassium, calcium, and phosphorus.

**Discussion:** ADH type 2 results from a gain-of-function mutation in the GNA11 gene encoding a G-protein in the CaSR signaling pathway. Increased activation of this pathway reduces calcium reabsorption in the renal tubule and inhibits PTH synthesis and secretion. Hypokalemia from a Bartter's like syndrome has been reported in ADH Type 1 suspected from an inhibitory effect of the CaSR on the sodium-potassium-chloride (NKCC2) cotransporter. To our knowledge this is the first described case of hypokalemia in ADH type 2. While it may be due to similar downstream constitutive activation of the CaSR signaling pathway, his normal aldosterone and renin activity may suggest an alternative etiology. The views expressed above are those of the authors and do not reflect the official policy of the Army, Department of Defense, or US Government.

## SA-PO207

**Antibiotic Exposure and Kidney Stone Disease Across the Life Course**

Michelle Denburg,<sup>1,2</sup> Zeyu N. Li,<sup>2,1</sup> Jing Huang,<sup>2,1</sup> Lauren E. Parlett,<sup>3</sup> Kevin Haynes,<sup>4</sup> John R. Asplin,<sup>5</sup> Ingrid Y. Luna,<sup>1</sup> Charles Bailey,<sup>1,2</sup> Gregory E. Tasian.<sup>1,2</sup> *The Children's Hospital of Philadelphia, Philadelphia, PA; <sup>2</sup>University of Pennsylvania, Philadelphia, PA; <sup>3</sup>HealthCore, Wilmington, DE; <sup>4</sup>Janssen Global Services LLC, Titusville, NJ; <sup>5</sup>LithoLink Corp, Chicago, IL.*

**Background:** Kidney stone disease (KSD) is increasingly common and associated with considerable morbidity. Antibiotic (ABX) exposure may be a risk factor for KSD.

**Methods:** We examined the association between 12 classes of oral ABX and KSD in a case-control study nested in the HealthCore Integrated Research Database (HIRD) of longitudinally integrated medical and pharmacy claims from healthcare encounters of members with ≥6 months of continuous enrollment in commercial health plans across the United States from Jan 2006 to Jan 2020. Incidence density sampling was used to match cases 4-65 years of age at initial KSD diagnosis to up to 5 controls on year of birth, index date, pre-index enrollment time, sex, and geographic region. Exclusion criteria were inflammatory bowel disease, celiac disease, urinary obstruction, bariatric surgery, malignancy, cystic fibrosis, immobility, and neurogenic bladder. Conditional logistic regression models were stratified at age 18 and adjusted for other ABX use, healthcare utilization, comorbidities, UTI, thiazide and loop diuretics, H2 blockers, proton-pump inhibitors, statins, corticosteroids, and certain anti-epileptic agents.

**Results:** 69,793 children (11,622 cases/58,171 controls; 59.9% female) and 2,990,207 adults (498,393 cases/2,491,814 controls; 43.6% female) were included. Exposure to any of the 12 ABX classes in adults and 8 different ABX classes in children within 3-12 months prior to index was associated with KSD at the Bonferroni adjusted significance threshold (Table). The magnitude of association was greatest for fluoroquinolone, nitrofurantoin, and sulfa ABX with adjusted OR of 1.37-1.66 and similar effect estimates in sensitivity analyses excluding those with UTI during the exposure window and restricting to cases who had KSD surgery on or after index and their controls.

**Conclusions:** Leveraging a large claims database, we confirmed that exposure to oral ABX is associated with KSD diagnosis in children and adults.

**Funding:** NIDDK Support

Antibiotic class	Pediatric <12 years						Adult ≥18 years					
	Model A		Model B		Model C		Model A		Model B		Model C	
	OR	OR	OR	OR	OR	OR	OR	OR	OR	OR	OR	
Cephalosporin 1 <sup>st</sup> generation	1.25*	1.24*	1.17	1.14*	1.14*	1.14*	1.17	1.17*	1.17*	1.17*	1.17*	
	(1.13, 1.37)	(1.12, 1.36)	(0.91, 1.49)	(1.12, 1.17)	(1.12, 1.17)	(1.12, 1.17)	(1.12, 1.17)	(1.12, 1.17)	(1.12, 1.17)	(1.12, 1.17)	(1.12, 1.17)	
	OR	OR	OR	OR	OR	OR	OR	OR	OR	OR	OR	
Cephalosporin 2 <sup>nd</sup> generation	1.18	1.15	1.54*	1.33*	1.33*	1.33*	1.33*	1.33*	1.33*	1.33*	1.33*	
	(1.04, 1.33)	(0.96, 1.35)	(1.05, 2.07)	(1.28, 1.39)	(1.28, 1.39)	(1.28, 1.39)	(1.28, 1.39)	(1.28, 1.39)	(1.28, 1.39)	(1.28, 1.39)	(1.28, 1.39)	
	OR	OR	OR	OR	OR	OR	OR	OR	OR	OR	OR	
Cephalosporin 3 <sup>rd</sup> generation	1.29*	1.28*	1.68*	1.58*	1.58*	1.58*	1.58*	1.58*	1.58*	1.58*	1.58*	
	(1.17, 1.42)	(1.16, 1.41)	(1.30, 2.11)	(1.29, 1.39)	(1.29, 1.39)	(1.29, 1.39)	(1.29, 1.39)	(1.29, 1.39)	(1.29, 1.39)	(1.29, 1.39)	(1.29, 1.39)	
	OR	OR	OR	OR	OR	OR	OR	OR	OR	OR	OR	
Fluoroquinolone	1.66*	1.69*	1.47	1.48*	1.48*	1.48*	1.48*	1.48*	1.48*	1.48*	1.48*	
	(1.39, 1.98)	(1.40, 2.01)	(0.99, 2.17)	(1.46, 1.51)	(1.46, 1.51)	(1.46, 1.51)	(1.46, 1.51)	(1.46, 1.51)	(1.46, 1.51)	(1.46, 1.51)	(1.46, 1.51)	
	OR	OR	OR	OR	OR	OR	OR	OR	OR	OR	OR	
Trimethoprim	0.66	0.65	0.80	1.17*	1.17*	1.17*	1.17*	1.17*	1.17*	1.17*	1.17*	
	(0.66, 1.16)	(0.67, 1.28)	(0.56, 1.85)	(1.13, 1.21)	(1.13, 1.21)	(1.13, 1.21)	(1.13, 1.21)	(1.13, 1.21)	(1.13, 1.21)	(1.13, 1.21)	(1.13, 1.21)	
	OR	OR	OR	OR	OR	OR	OR	OR	OR	OR	OR	
Macrolide	1.33*	1.34*	1.47*	1.26*	1.26*	1.26*	1.26*	1.26*	1.26*	1.26*	1.26*	
	(1.24, 1.40)	(1.26, 1.42)	(1.26, 1.71)	(1.24, 1.27)	(1.24, 1.27)	(1.24, 1.27)	(1.24, 1.27)	(1.24, 1.27)	(1.24, 1.27)	(1.24, 1.27)	(1.24, 1.27)	
	OR	OR	OR	OR	OR	OR	OR	OR	OR	OR	OR	
Mentriazolin	1.09	1.11	1.33	1.09*	1.09*	1.09*	1.09*	1.09*	1.09*	1.09*	1.09*	
	(0.81, 1.40)	(0.89, 1.49)	(0.67, 2.84)	(1.05, 1.15)	(1.04, 1.1)	(1.04, 1.1)	(1.04, 1.1)	(1.04, 1.1)	(1.04, 1.1)	(1.04, 1.1)	(1.04, 1.1)	
	OR	OR	OR	OR	OR	OR	OR	OR	OR	OR	OR	
Nitrofurantoin	1.51*	1.51*	1.51*	1.51*	1.51*	1.51*	1.51*	1.51*	1.51*	1.51*	1.51*	
	(1.38, 1.63)	(1.40, 2.24)	(1.35, 3.93)	(1.54, 1.64)	(1.62, 1.74)	(1.62, 1.74)	(1.62, 1.74)	(1.62, 1.74)	(1.62, 1.74)	(1.62, 1.74)	(1.62, 1.74)	
	OR	OR	OR	OR	OR	OR	OR	OR	OR	OR	OR	
Penicillin broad spectrum	1.16*	1.16*	1.40*	1.24*	1.24*	1.24*	1.24*	1.24*	1.24*	1.24*	1.24*	
	(1.07, 1.26)	(1.08, 1.26)	(1.14, 1.73)	(1.22, 1.26)	(1.22, 1.26)	(1.22, 1.26)	(1.22, 1.26)	(1.22, 1.26)	(1.22, 1.26)	(1.22, 1.26)	(1.22, 1.26)	
	OR	OR	OR	OR	OR	OR	OR	OR	OR	OR	OR	
Penicillin	1.11	1.11	1.19	1.19*	1.19*	1.19*	1.19*	1.19*	1.19*	1.19*	1.19*	
	(1.16, 1.13)	(1.15, 1.30)	(1.06, 1.44)	(1.15, 1.18)	(1.15, 1.18)	(1.15, 1.18)	(1.15, 1.18)	(1.15, 1.18)	(1.15, 1.18)	(1.15, 1.18)	(1.15, 1.18)	
	OR	OR	OR	OR	OR	OR	OR	OR	OR	OR	OR	
Sulfis	1.42*	1.43*	1.68*	1.37*	1.37*	1.37*	1.37*	1.37*	1.37*	1.37*	1.37*	
	(1.29, 1.57)	(1.30, 1.61)	(1.30, 2.13)	(1.24, 1.40)	(1.24, 1.40)	(1.24, 1.40)	(1.24, 1.40)	(1.24, 1.40)	(1.24, 1.40)	(1.24, 1.40)	(1.24, 1.40)	
	OR	OR	OR	OR	OR	OR	OR	OR	OR	OR	OR	
Tetracycline	1.11	1.11	1.19	1.19*	1.19*	1.19*	1.19*	1.19*	1.19*	1.19*	1.19*	
	(1.01, 1.22)	(1.01, 1.22)	(0.94, 1.31)	(1.08, 1.12)	(1.08, 1.12)	(1.08, 1.12)	(1.08, 1.12)	(1.08, 1.12)	(1.08, 1.12)	(1.08, 1.12)	(1.08, 1.12)	
	OR	OR	OR	OR	OR	OR	OR	OR	OR	OR	OR	

\* Significant at Bonferroni adjusted p < 0.0045.  
 Model A: Primary results  
 Model B: Excluding those with UTI within 9-12 month exposure window  
 Model C: Limited to cases (and their controls) who had laboratory stone procedures at time of or prior date of follow-up.

Odds of KSD according to ABX class in children and adults

SA-PO208

Hypercalciuria and Risk for Hypercalcemia Among Veterans With Urinary Stone Disease

Calyani Ganesan,<sup>1</sup> I-Chun Thomas,<sup>2</sup> Carolyn D. Seib,<sup>1,2</sup> Simon Conti,<sup>1</sup> John Leppert,<sup>1,2</sup> Alan C. Pao,<sup>1,2</sup> <sup>1</sup>Stanford University School of Medicine, Stanford, CA; <sup>2</sup>VA Palo Alto Health Care System, Palo Alto, CA.

**Background:** Approximately 70-80% of patients with urinary stone disease form calcium-based stones. The most common abnormality detected in the urine of these patients is hypercalciuria. At the time of their stone diagnosis and urine calcium measurement, most patients have a normal serum calcium concentration. It remains unknown whether the level of urine calcium excretion associates with higher risk for developing hypercalcemia.

**Methods:** We used national Veterans Health Administration data to define patients with urinary stone disease as those with one or more inpatient or two or more outpatient encounters for urinary stone disease or one or more stone procedures between 2007 and 2019. We then selected patients who had a 24-hour urine measurement within 6 months of their stone diagnosis. We defined normocalcemia as a measured or albumin-corrected serum calcium measurement ≤ 10.2 mg/dL. We defined the primary outcome hypercalcemia as a measured or albumin-corrected serum calcium measurement > 10.2 mg/dL. We performed Cox proportional hazards regression to identify the risk of developing hypercalcemia by level of 24-hour urine calcium excretion.

**Results:** We identified 11,926 Veterans with urinary stone disease, normocalcemia, and a 24-hour urine calcium measurement. Within this cohort 23.8% (2841 individuals) had an elevated 24-hour urine calcium measurement ≥200mg/day and 4.6% (546 individuals) developed hypercalcemia. We found that level of 24-hour urine calcium excretion did not associate with risk of developing hypercalcemia.

**Conclusions:** Patients with urinary stone disease and normal serum calcium concentration are not at higher risk for developing hypercalcemia even if they have higher levels of 24-hour urine calcium excretion. Therefore, initial treatment should be aimed at correcting urinary risk factors. Further research is needed to clarify the utility of PTH measurement to guide further evaluation and surveillance in this population.

**Funding:** NIDDK Support, Veterans Affairs Support

SA-PO209

Effects of Consistently Strict Phosphate Control on Vascular and Valvular Calcification in Incident Hemodialysis Patients

Mao Shimizu, Hideki Fujii, Keiji Kono, Kentaro Watanabe, Kazuo Sakamoto, Shunsuke Goto, Shinichi Nishi. *Division of Nephrology and Kidney Center, Kobe University Graduate School of Medicine, Kobe, Japan.*

**Background:** Vascular calcification (VC) is a critical complication associated with cardiovascular disease in hemodialysis (HD) patients. The progression of VC is multifactorial, and serum phosphate control is particularly important. A recent randomized controlled trial (RCT) in maintenance HD patients showed that strict phosphate control slowed the progression of VC. Therefore, we investigated the effects of strict phosphate control on vascular and valvular calcification in incident HD patients.

**Methods:** This study was a post hoc analysis of our previous RCT regarding the effects of phosphate binders on VC in the incident hemodialysis (HD) patients. Computed tomography (CT) and ultrasoundcardiography (UCG) were performed at baseline and 18 months after initiation of HD, and we evaluated coronary artery calcium score (CACS) and cardiac valve calcification score (CVCS). Subsequently, the absolute changes in CACS (ΔCACS) and CVCS (ΔCVCS), and the percent change in CACS (%ΔCACS) and CVCS (%ΔCVCS) were calculated. Serum phosphate levels (serum P) were measured at 6, 12, and 18 months after initiation of HD, and phosphate control status was evaluated using the data as follows:(1) area under the curve (AUC) by multiplying the time spent with the extent to which serum P exceeded 4.5mg/dL, and (2) the number of times which serum P exceeded 4.5 mg/dL. The association of serum phosphate control with CACS and CVCS were investigated in this study.

**Results:** This study included 64 patients and they were divided into two groups depending on the median of AUC for serum P, both ΔCACS and %ΔCACS were significantly lower in the low AUC group (L-AUC) than in the high AUC group (H-AUC) (p < 0.05). ΔCVCS and %ΔCVCS was also significantly lower in the L-AUC group than in the H-AUC group. Furthermore, ΔCACS and %ΔCACS were significantly lower, and ΔCVCS and %ΔCVCS tended to be lower in patients whose serum P were consistently below 4.5mg/dL than in those whose serum P were consistently over 4.5 mg/dl.

**Conclusions:** This study suggests that the consistently strict phosphate control could slow the progression of vascular and valvular calcification in incident HD patients.

**Funding:** Commercial Support - Bayer Yakuhin, Ltd., Private Foundation Support

SA-PO210

Effects of Lanthanum Carbonate on Whole-Body Calcium Balance, Vascular Function, and Mineral Metabolites in Adults With CKD 3b-4 and Normophosphatemia

Anna Jovanovich,<sup>1</sup> Zhiying You,<sup>2</sup> Tyson J. Marden,<sup>2</sup> Moshe Levi,<sup>3,2</sup> Gregory G. Schwartz,<sup>1</sup> Michel Chonchol,<sup>2</sup> Kathleen M. Hill Gallant,<sup>4</sup> <sup>1</sup>VA Eastern Colorado Health Care System, Aurora, CO; <sup>2</sup>University of Colorado Health, Aurora, CO; <sup>3</sup>Georgetown University, Washington, DC; <sup>4</sup>University of Minnesota Twin Cities, Minneapolis, MN.

**Background:** We previously showed long-term treatment with the phosphate binder lanthanum carbonate (LC) may reduce whole-body phosphorus (P) balance in adults with CKD 3b-4 and normophosphatemia (ASN '21 PO-0543). Long-term effects of LC on total body calcium (Ca) balance, vascular function, and mineral metabolites are unknown. We determined Ca balance in normophosphatemic adults with CKD 3b-4 after a 12w RCT of LC v. placebo, and relationships of Ca and P balance with vascular function and mineral metabolites.

**Methods:** A subset of 15 subjects with CKD 3b-4 were randomized to receive 12w of LC or placebo investigating effects of phosphate lowering on vascular function, assessed by brachial artery flow-mediated dilation (FMD), (NCT02209636) volunteered to participate in this ancillary aim. At the end of 12w, subjects consumed a control diet (1000 mg/d phosphorus and 800 mg/d calcium) for 9d and continued their randomized treatment (n=7 LC, n=8 placebo). Fasting AM blood samples and stool and urine were collected during a 48h inpatient balance study on day 8-9 of the controlled diet. Ca balance (mg/d) was determined by values averaged over the 48h period: dietary Ca intake – urine Ca – fecal Ca. We used T-tests to compare means, correlation coefficients to examine relationships between P and Ca balance with FMD, and fixed effects models to examine mineral metabolites change within groups.

**Results:** Subjects were 65±7y with eGFR 33±6 mL/min/1.73m<sup>2</sup>. We excluded 1 LC subject from balance results due to insufficient stool. 24h urine Ca was similar with LC and placebo (46±28 v. 40±32 mg, p=0.73). Fecal Ca was higher with LC compared with placebo (737±446 v. 317±138 mg, p=0.03), and whole-body Ca balance was lower with LC compared with placebo (-46±410 v. 410 ±131 mg, p=0.01). Neither P nor Ca balance correlated with FMD in either group (all p>0.05). FGF-23 decreased over the study with LC (p=0.03), but 25D, 1,25D, and PTH did not change.

**Conclusions:** Long-term treatment with LC may reduce whole-body Ca balance in adults with CKD 3b-4 and normophosphatemia, but neither P nor Ca balance correlated with FMD. FGF23 decreased with LC, which coincided with negative Ca balance and a trend towards negative P balance.

**Funding:** Veterans Affairs Support

SA-PO211

Etelcalcetide Improves Bone Turnover in Renal Osteodystrophy Possibly Through Regulation of Bone Immunity and Inflammation

Zheng Cai-Mei,<sup>1</sup> Kuo-Cheng Lu,<sup>2</sup> Yi-Chou Hou,<sup>2</sup> Chien-Lin Lu,<sup>2</sup> Hui-Wen Chiu,<sup>1</sup> <sup>1</sup>Taipei Medical University College of Medicine, Taipei, Taiwan; <sup>2</sup>Fu-Jen Catholic University, Taipei, Taiwan.

**Background:** Etelcalcetide, a new calcimimetic agent, allosterically binds the extracellular N terminal domain of calcium-sensing receptor (CaSR) and consequently decreases PTH secretion. As such, it is approved to use in chronic kidney disease-mineral and bone disorder (CKD-MBD) among dialysis patients. We hypothesized that the direct protective effects of etelcalcetide on bone exist in these patients and might be explained by direct anti-oxidant and/or anti-inflammatory effects on bone cells other than lowering PTH levels.

**Methods:** Osteoclasts (OC) and osteoblasts (OB) were differentiated by the mice macrophage cell line RAW264.7 and mouse muscle myoblast C2C12, respectively. OC differentiation was analyzed by tartrate resistant acid phosphatase (TRAP). OB proliferation was evaluated by ALP activity. Furthermore, RNA-Sequencing (RNA-seq) was determined by next-generation sequencing (NGS). Genes with a 1.5-Fold change threshold are uploaded to the Ingenuity Pathway Analysis (IPA) in RAW264.7 cells. In addition, PCR analysis on RAW264.7 cells confirm these IPA-based molecular mechanisms underlying etelcalcetide on osteoclast differentiation.

**Results:** Etelcalcetide dose-dependently inhibited OC differentiation as indicated by decreased TRAP levels. On the other hand, etelcalcetide dose-dependently increases OB proliferation as indicated by increased ALP activity. It also affects several pathways in RANKL-induced differentiation of macrophages to osteoclasts. Possible molecular mechanisms as expressed by IPA analysis include: etelcalcetide induced activation of interferon regulatory factor IRF-7/IFN-alpha/beta dependent inhibition of NF-kB related RANK-L induced osteoclastogenesis. On the other hand, it possibly inhibited

the TRIM24/IRF3-STAT signaling pathways to inhibit osteoclastogenesis. PCR analysis revealed an increase in IRF7 expression but had no significant effect on TRIM24.

**Conclusions:** We found the beneficial roles of etelcalcetide in improving bone anabolism by a dual mechanism on bone cells, inhibiting osteoclast differentiation and increasing osteoblast maturation and differentiation. The underlying novel pathways might be through regulation of the cellular energy metabolism, immunity and inflammatory pathways in CKD-MBD-related bone loss.

**SA-PO212**

**AKI Promotes Osteoid Formation Through Increased PTH Secretion in Rats**

Yosuke Nakagawa, Hirotaka Komaba, Naoto Hamano, Kaichiro Sawada, Takehiko Wada, Michio Nakamura, Masafumi Fukagawa. *Tokai Daigaku Igakubu Jin Naibunpi Taisha Naika, Isehara, Japan.*

**Background:** Acute kidney injury (AKI) can induce alterations in mineral metabolism, but little is known about the longitudinal changes in bone morphology in the course of AKI and renal recovery. The purpose of this study was to determine the effect of AKI on mineral and bone metabolism and the underlying mechanism in a rat model of ischemia reperfusion injury (IRI).

**Methods:** Six-week-old male Sprague-Dawley rats were subjected to 35-min bilateral IRI or sham surgery. We evaluated the time course of changes in kidney function and mineral metabolism after surgery and assessed bone morphology at 3 days and 4 weeks by bone histomorphometry. We also repeated the experiment after performing parathyroidectomy followed by continuous infusion of 1-34PTH at a physiological dose.

**Results:** Rats with IRI exhibited acute hyperphosphatemia, decreased 1,25-dihydroxyvitamin D, and progressively increasing FGF23 and PTH levels, and demonstrated a striking increase in osteoid volume on day 3. During renal recovery, alterations in mineral metabolism and bone morphology normalized almost completely by week 4. To investigate the mechanism of the transient induction of osteoid formation after IRI, we performed qPCR of RNA isolated from femurs at 24 hours after surgery and found increased expression of *secretory leukocyte protease inhibitor (SLPI)*, a downstream mediator of PTH-induced bone formation, suggesting a causal role of PTH in the osteoid formation after IRI. Supporting this possibility, we confirmed that parathyroidectomy prevented the induction of osteoid formation at 3 days after IRI.

**Conclusions:** AKI induces a transient, but marked increase of osteoid formation in association with alterations in mineral metabolism and increased PTH. The induction of osteoid formation after AKI can be attributed to the anabolic effect of PTH on bone.

**SA-PO213**

**Increased Expression of DKK-1 in an Adynamic Bone Disease Model: Role of Phosphate**

Tania P. Truys, Juliana C. Ferreira, Katia R. Neves, Ivone B. Oliveira, Wagner Dominguez, Vanda Jorgetti, Rosa M. Moyses, Luciene dos Reis. *Universidade de Sao Paulo, Sao Paulo, Brazil.*

**Background:** Adynamic Bone Disease (ABD) is a common complication of Chronic Kidney Disease (CKD). We have previously shown that the Wnt/ $\beta$ catenin signalling pathway is inhibited in the early stages of CKD, in association with an increased bone expression of sclerostin. DKK1 is also increased in CKD in a high-turnover animal model characterized by high phosphate (P) and PTH levels. Here we tested whether DKK1 expression is increased in an ABD model, trying to identify the isolated effects of P on this pathway.

**Methods:** Wistar rats were submitted to 5/6 nephrectomy (NX) and Parathyroidectomy (PTX). They were divided into 3 groups that underwent pair-feeding with different concentrations of P. Bone expression of sclerostin, Dkk1 and  $\beta$ Catenin was evaluated using mRNA levels and immunohistochemistry (IH), whereas FGF23 was evaluated by IH.

**Results:** NX animals presented higher levels of creatinine and P, but lower serum FGF23 (figure). Compared with SHAM, a high-P diet was associated with an increase in SOST and DKK1 mRNA levels, which was corrected by a decrease in P content in the diet. In IH, a high-P diet was associated with increased osteocytic expression of FGF23 and DKK1, but not sclerostin. A low-P diet increased active  $\beta$ catenin IH expression. A significant correlation between bone FGF23 and DKK1 expression ( $r=0.5628$ ;  $p=0.0028$ ) was observed.

**Conclusions:** ABD is associated with a high bone expression of DKK1 and FGF23, which was normalized by P diet restriction. Our results suggest that in a low PTH environment, decreasing P content in the diet can stimulate the Wnt/ $\beta$ catenin pathway. These findings have to be confirmed in a clinical scenario.

**Funding:** Government Support - Non-U.S.

	SHAM 0.6%P (n=10)	NX+PTX 0.6%P (n=8)	NX+PTX 1.2%P (n=8)
<b>Biochemical</b>			
Creat mg/dl	0.7(0.5;0.8) <sup>a</sup>	1.1(0.7;3.2)	1.4(0.97;1.7)
P mg/dl	5.3(4.9;6.7) <sup>a</sup>	12.3(9.6;16)	12.6(8.6;13.9)
iCa mmol/L	1.2(1.0;1.3) <sup>a</sup>	0.5(0.4;0.6)	0.5(0.4;0.6)
FGF23 pg/ml	285±95 <sup>b</sup>	180.3±23.9	119±104
iPTH pg/ml	124.2(49.5;353.8)	24.8(6.7;176.1)	29.1(3;279.6)
Sclerostin ng/ml	0.8(0.1;3.8)	0.2(0.02;1.6)	1.05(0.3;2.7)
<b>Gene expression analysis (mRNA levels)</b>			
SOST	1.2±0.9	0.5±0.2	4.1±0.6
DKK1	1.2±0.7	0.9±0.4	2.9±0.7
$\beta$ -Catenin	1.1±0.4	1.4±0.5	0.9±0.1
<b>Immunohistochemistry</b>			
ScI%	0(0;0.4)	0.1(0;0.5)	0.2(0;2.3)
FGF23%	2.3(1.1;3.8)	2.0(1.5;4.6)	8.2(3.4;14.4) <sup>c</sup>
$\beta$ -Catenin%	4.3(1.9;6.6)	9.2(5.1;19.3) <sup>d</sup>	6.1(1.7;11.8)
DKK1%	0.5(0;2.9)	0.7(0;2.2)	5.4(1.7;15.4) <sup>e</sup>

<sup>a</sup> p<0.01 vs NX+PTX 0.6%P and NX+PTX 1.2%P. <sup>b</sup> p<0.05 vs NX+PTX 0.6%P and NX+PTX 1.2%P. <sup>c</sup> p<0.01 vs SHAM 0.6%P and NX+PTX 0.6%P. <sup>d</sup> p<0.01 vs SHAM 0.6%P.

**SA-PO214**

**Severe Bone Loss Occurs in Slow but Not in Fast CKD Progression**

Hao-Hsuan Tsai, Dominik Kentrup, Xueyan Wang, Bridget Hunt-Tobey, Jadeah J. Spindler, John C. Von Drasek, Valentin David, Aline Martin. *Northwestern University Feinberg School of Medicine, Chicago, IL.*

**Background:** Alterations in mineral metabolism contribute to bone fragility and increased mortality in chronic kidney disease (CKD). The pathogenic mechanisms of CKD-associated bone disease are unclear.

**Methods:** We studied the Col4a3 knockout model of progressive CKD on two genetic backgrounds: the fast progressing 129X1/SvJ (129Sv-CKD) mice (lifespan: 11 weeks) and the slow progressing C57BL/6J (B6-CKD) mice (lifespan: 23 weeks) and age-matched wild-type (WT) littermates. In all mice, we assessed markers of kidney function, mineral metabolism and 3D bone microarchitecture every 2 weeks in 129Sv mice, and every 4 weeks in B6 mice.

**Results:** 129Sv-CKD mice showed a rapid decline in kidney function from 6 to 10 weeks of age shown by a progressive increase in blood urea nitrogen (BUN) levels ( $p<0.05$  vs. WT at 8 and 10 weeks). At 6 weeks, 129Sv-CKD mice showed mild elevations of fibroblast growth factor 23 (FGF23) and parathyroid hormone (PTH) levels that severely worsened as kidney function declined ( $p<0.05$  at 6, 8 and 10 weeks). Overt hyperphosphatemia developed only at 10 weeks ( $p<0.05$ ). Starting at 8 weeks, 129Sv-CKD mice showed mild bone loss (-3% in bone mineral density (BMD), +8% in cortical bone porosity (Ct.Po)) ( $p<0.05$ ). Compared to 129Sv-CKD mice, B6-CKD mice showed a delayed and slow decline in kidney function marked by rising BUN levels starting only at 12 weeks ( $p<0.05$  vs. WT at 16, 20 and 23 weeks). Of note, BUN levels were similar in 10 week-old 129Sv-CKD and 23 week-old B6-CKD mice. In B6-CKD mice, FGF23 and PTH levels started to increase also at 12 weeks ( $p<0.05$  vs. WT at 16, 20 and 23 weeks). Despite a severe increase in PTH levels, FGF23 increase was milder in B6-CKD than in 129Sv-CKD mice, resulting in more pronounced hyperphosphatemia ( $p<0.05$  vs. WT at 20 and 23 weeks). In contrast with 129Sv-CKD mice, B6-CKD mice showed severe bone loss from 12 weeks of age, and reaching dramatic reductions in trabecular bone volume (-40%) and BMD (-15%), cortical thickness (-26%) and BMD (-6%), and increased Ct.Po (+60%) at 23 weeks ( $p<0.05$  vs. WT from 12 to 23 weeks).

**Conclusions:** To conclude, sustained alterations in mineral metabolism and kidney function induce severe bone loss in CKD.

**Funding:** NIDDK Support

**SA-PO215**

**The Cross-Talk Between Bone and Iron Overload in Hemodialysis Patients**

Hanna Karla A. Guapyassu Machado,<sup>1</sup> Luciene dos Reis,<sup>1</sup> Lucas A. Nunes,<sup>1,2</sup> Ivone B. Oliveira,<sup>1</sup> Cleonice Silva,<sup>1</sup> Wagner Dominguez,<sup>1</sup> Rosa M. Moyses,<sup>1</sup> Melani Custodio,<sup>1</sup> Vanda Jorgetti.<sup>1</sup> <sup>1</sup>Laboratorio de Fisiopatologia Renal, LIM16, Hospital das Clinicas HCFMUSP, Faculdade de Medicina, Universidade de Sao Paulo, Sao Paulo, Brazil; <sup>2</sup>Hospital Universitario Joao de Barros Barreto, Belem, Brazil.

**Background:** Chronic kidney disease (CKD) has several complications, including mineral and bone disorder (MBD) and anemia, whose correction can favor iron overload. Little is known about the effects of iron overload on bone, as well as of Deferoxamine (DFO) treatment.

**Methods:** We prospectively evaluated the effects of 12-month of DFO therapy on CKD-MBD markers and bone histomorphometry in 18 hemodialysis patients. Osteocytic proteins expression was quantified through immunohistochemistry (DMPI1, MEPE,

Sclerostin, FGF23, OPG, RANKL, DKK1 and CD44), and bone marrow iron positive cells (CellsFe+) were counted. During follow-up, we maintained CKD-MBD therapy to keep serum PTH in the target range.

**Results:** DFO decreased markers of iron overload, as well as CellsFe+. Few changes in CKD-MBD markers were seen (Image). Bone histomorphometry showed an increase in trabecular separation and a decrease in the osteoblast surface. Mineralization defect was present in most patients (67%), which was not corrected with DFO (61%). We found a significant increase in DMP1 and a decrease in DKK1 expression after DFO. No significant changes were seen in the other proteins.

**Conclusions:** Although few histomorphometric changes were seen after DFO therapy, it seems that bone marrow iron overload is associated with a suppression in DMP1, a protein involved in bone mineralization. In addition, the reduction in CellsFe+ might be involved with the decreased DKK1 expression, suggesting that iron accumulation in bone marrow might affect the osteocytic expression of proteins that are involved and bone mineralization and formation. Therefore, iron supplementation must be done cautiously in CKD patients.

**Funding:** Government Support - Non-U.S.

	Baseline	12 months	p
<b>Biochemical data</b>			
Hemoglobin(g/dl)	11.75(9.8-13.7)	11.6(10.2-12.3)	0.61
Iron(µg/dl)	107.5(79-135)	68(55-83)	0.001
Transferrin(%)	43.5(37-54)	27.5(23-36)	0.001
Ferritin(ng/ml)	1279(1114-1977)	490(384-1244)	0.002
Calcium(mg/dl)	9.7(9.3-10.1)	9(8.3-9.6)	0.001
Alk phosphatase(U/L)	135(103-184)	171(122-278)	0.007
PTH(pg/ml)	282.5(171-741)	451(230-660)	0.15
<b>Immunohistochemistry</b>			
DMP1(n/mm <sup>2</sup> )	3.5(0.9-8)	10.5(4.7-16.5)	0.0056
DKK1(n/mm <sup>2</sup> )	1.49(0.75-2.47)	0.28(0.13-0.92)	0.017
<b>Histomorphometry</b>			
BV/TV(%)	18.9(14.5-26.3)	17.3(12.4-20.9)	0.34
Tb.Sp(µm)	503(357-603)	590(493-771)	0.038
Tb.N(mm)	1.5(1.3-1.9)	1.4(1.2-1.7)	0.09
Ob.S/BS(%)	11.3(4.5-19.3)	7.6(3.5-13.1)	0.04
B.Ar(mm <sup>2</sup> )	6.4(4.9-8.5)	6.5(4.9-7.9)	0.51
Cell Fe <sup>+</sup> /Ma.Ar(n/mm <sup>2</sup> )	203(125-288)	9.5(1.3-26.3)	<0.0001

**SA-PO216**

**Comparison of Cat to Human Calcium Oxalate Monohydrate Kidney Stone Matrix Proteomes**

**Jeffrey Wesson**,<sup>1,2</sup> <sup>1</sup>Department of Veterans Affairs, Milwaukee, WI; <sup>2</sup>Medical College of Wisconsin, Milwaukee, WI.

**Background:** Despite its critical nature, the role of matrix in calcium oxalate stone formation is poorly understood. The wide diversity of proteins comprising matrix has contributed to the ambiguity. Because cats share many clinical characteristics of their stone disease with humans, we have compared the protein distributions measured by mass spectrometry in human calcium oxalate stone matrix to that observed in cat stone matrix.

**Methods:** Raw data from previously published proteomic studies of human urine and calcium oxalate monohydrate stone matrix were acquired and re-analyzed with similarly acquired proteomic data for calcium oxalate monohydrate stones obtained from cats. All data were analyzed using in house developed algorithms at the Mayo Clinic Proteomic Facility using the human or cat protein databases as appropriate. The observed protein distributions were analyzed in the context of a recent model of stone formation based on the aggregation of strongly anionic and strongly cationic proteins which includes selective adsorption of other proteins based on total charge.

**Results:** Matrix protein distributions shared many common features between humans and cats, including enrichment of both strongly anionic and strongly cationic proteins, increased total charge in matrix proteins compared to urine proteins, and a high degree of similarity of prominent strongly anionic proteins in the matrix of both species. However, there was weaker overlap of the specific dominant proteins in other regions of the net charge distribution.

**Conclusions:** Collectively, these observations support the conceptual model where the strongly anionic proteins associate most strongly with the calcium oxalate crystal surfaces, while the other proteins associate with the strongly anionic proteins through nonspecific, charge interactions with each other to create stones. Also, cats appear to be the best animal model of human stone disease identified to date based on these similarities.

**Funding:** Veterans Affairs Support

**SA-PO217**

**To Study the Association of Bone Mineral Density With Clinical Activity in Adult-Onset Nephrotic Syndrome**

**Arun Prabhakar**, Prabhjot K. Johal, Joyita Bharati, Vinod Kumar, Raja Ramachandran. *Post Graduate Institute of Medical Education and Research, Chandigarh, India.*

**Background:** Nephrotic syndrome and its treatment culminate in multifarious bone and mineral metabolism abnormalities. Dual Energy X-ray Absorptiometry (DEXA) scan predicts bone mineral density (BMD) alterations in children with Nephrotic syndrome. Bioavailable 25(OH)-vitamin D (free plus albumin-bound) is a better measurement of vitamin D status than total 25(OH)-Vitamin D. There is a paucity of clinical studies evaluating BMD and bioavailable 25(OH)-vitamin D and its association with clinical activity in patients with adult-onset nephrotic syndrome.

**Methods:** We partook in a prospective observational study in adult-onset nephrotic syndrome (podocytopathy or primary membranous nephropathy) followed-up for 1-year. Patients underwent bioavailable 25(OH)-Vitamin D levels and DEXA (Dual Energy X-ray Absorptiometry) scan before and after 1-year of immunosuppressive therapy. We determined the bioavailable 25 (OH)-Vitamin D using modified Vermeulen Equations. All patients received steroid-based therapy consistent with the current standard of care along with vitamin D and calcium supplementation. Remission was defined as per the latest KDIGO 2021 clinical practice guideline for the management of Glomerular disease.

**Results:** We enrolled a total of 30 patients in the study. The median proteinuria, serum albumin and creatinine at baseline were 7.1 gm/day (5.25, 15.5), 2.34 gm/dl (2, 2.26) and 0.945 mg/dl (0.70, 1.25), respectively. The median bio-available 25(OH)-Vitamin D significantly increased from 3.67 ng/mL (1.29, 6.44) to 16.86 ng/mL (8.24, 28.16) (p<0.001). But, the BMD of the lumbar spine and the hip did not change significantly from the baseline (0.91±0.12 g/cm<sup>2</sup> and 0.94 ± 0.14 g/cm<sup>2</sup> to 0.89± 0.12 g/cm<sup>2</sup> and 0.91 ± 0.11 g/cm<sup>2</sup> respectively). No significant change was observed in bio-available 25(OH)-Vitamin D and BMD (both hip and lumbar spine) between those who achieved remission and those who did not.

**Conclusions:** Treatment of nephrotic syndrome with immunosuppressive therapy is not associated with BMD decline. Reduction in proteinuria along with calcium and vitamin D supplementation probably mitigates the deleterious impact of steroids on BMD in patients with nephrotic syndrome.

**Funding:** Government Support - Non-U.S.

**SA-PO218**

**Low Bone Density as a Risk Factor for Depressive Symptoms in Elderly Patients With Non-Dialysis Dependent CKD**

**Dong-Young Lee**, *Seoul Veterans Hospital, Gangdong-gu, Seoul, Republic of Korea.*

**Background:** Chronic kidney disease (CKD) is a common disease especially among older people. Moreover, major depressive disorder is one of the most common comorbid conditions in patients with CKD. Both conditions can predispose morbidity and mortality. We aimed to evaluate the etiology of CKD and comorbid depression by investigating bone disorders that are observed in persons affected by both CKD and depression.

**Methods:** We conducted a cross-sectional study with a total of 646 patients with CKD. Depressive symptoms were defined as a score on the K-BDI II greater than 11. We compared the sociodemographic factors, kidney function, markers for CKD-Mineral and Bone Disorder and bone mineral density according to the depressive symptoms. We conducted a multivariate logistic regression analysis to calculate adjusted odd ratios and 95% confidence interval for depressive symptoms in patients with CKD.

**Results:** Individuals with CKD and depressive symptoms was associated with lower level of education attained, living alone, exercising less, low 24-hour urine phosphorus, and low bone density. Depressive symptoms were significantly associated with low bone density in lowest parts (1.55 [1.06-2.29]) and in total hip (1.72 [1.17-2.53]) even after adjusting for diabetes mellitus, hypertension, kidney function, proteinuria, age, sex, smoking, and body mass index.

**Conclusions:** Low bone density was identified as a risk factor for depressive symptoms in elderly patients with non-dialysis chronic kidney disease.

	Crude ORs (95%CI)	Model 1 ORs (95%CI)	Model 2 ORs (95%CI)	Model 3 ORs (95%CI)
Lowest T score <-1.0	1.54 (1.08-2.20)	1.58 (1.09-2.28)	1.55 (1.07-2.25)	1.55 (1.06-2.29)
Total hip T score <-1.0	1.67 (1.17-2.39)	1.73 (1.19-2.51)	1.71 (1.18-2.49)	1.72 (1.17-2.53)

Model 1: Adjusted for Age, Sex, BMI, smoking.

Model 2: Adjusted for DM, HTN.

Model 3: Adjusted eGFR, 24hr urine albuminuria

OR, Odds ratio; CI, Confidence Interval; BMI, Body mass index; HTN, hypertension

ORs and 95% CI between depressive symptoms and low bone density in participants with non-dialysis-dependent CKD



SA-PO219

Association of Vitamin D Levels and Bone Mineral Density in Elderly CKD Patients With Hip Fracture

Debajyoti M. Roy, Chee Yong Ng, Wenxiang Yeon, Sreekanth Koduri. *Changi General Hospital, Singapore, Singapore.*

**Background:** Vitamin D deficiency is common in chronic kidney disease (CKD) and is associated with lower bone mineral density (BMD), decreased muscle strength, and increased hip fracture risk. Guidelines have suggested optimal Vitamin D levels between 20-30ng/ml. However, Vitamin D metabolism is altered in CKD, and optimal levels are unknown.

**Methods:** We included 1097 patients with hip fractures. CKD was defined as estimated glomerular filtration rate <60ml/min/1.73m2, and low BMD defined as T score ≤-2.5 at femoral neck. We assessed the utility of using a 25-Vitamin D (25(OH)D) threshold of 30ng/dl, as well as a new threshold, to predict low BMD, in patients with, and without CKD.

**Results:** CKD was present in 479 (44%) patients. Using threshold of 25(OH)D <30ng/ml, there was no significant differences in patients with CKD and low BMD, compared to the other groups. We identified 27ng/ml as a better threshold with the Youden index. Using 25(OH)D<27ng/ml as a threshold, 360 of 482 patients (74.7%) with low Vitamin D had low BMD, compared to only 185/276 (67%) of patients with adequate Vitamin D, p=0.02, which was irrespective of presence or absence of CKD. Furthermore, patients with CKD and 25(OH)D <27ng/ml had a higher odds ratio of mortality upon follow-up, 1.61, 95% CI: 1.08 - 2.39, compared to those with CKD and 25(OH)D ≥ 27ng/ml.

**Conclusions:** Vitamin D <27ng/ml is associated with low BMD in patients with, and without, CKD. Further prospective studies targeting Vitamin D repletion to at least 27ng/ml, and outcome of hip fractures will be useful to validate these findings.

Table 1: Demographic characteristics of patients based on CKD status

Characteristics	CKD (n=479)	Non CKD (n=678)
Age (years)	82.5(± 7.64)	78.2(± 8.5)
Women	340(71%)	399(64.6%)
Race: Chinese	348 (74.4%)	459(75.9%)
Vit D levels ≤ 30 ng/ml	211(44%)	268(39.5%)
CKD G3a	222(47.3%)	—
CKD G3b	141(30.1%)	—
CKD G4	76(16.2%)	—
CKD G5	30(6.4%)	—
Diabetes	298 (62.2%)	386(62.5%)
BMD (T score)*	-3.0 (1.06)	-3 (1.03)
Died	123(25.7%)	124 (20.1%)
Duration from discharge to death(years)	2.3(±0.98)	2.4(±0.93)

SA-PO220

Bone Marrow-Derived C5aR Contributes to Kidney Inflammation and Tubulointerstitial Fibrosis in Streptozotocin (STZ)-Induced Diabetic Nephropathy

Jingyuan Ma, Wai Han Yiu, Sarah W.Y. Lok, Yixin Zou, Loretta Y.Y. Chan, Sydney C. Tang. *The University of Hong Kong, Hong Kong, Hong Kong.*

**Background:** Emerging evidence shows a pathogenic role of C5a in the progression of diabetic nephropathy (DN). However, the contribution of C5aR signaling from circulating leukocytes and resident kidney cells to the progression of DN has not yet been investigated.

**Methods:** Bone marrow chimeras were generated by transplanting GFP-expressing bone marrow cells from donor mice (GFP-C5aR<sup>+/+</sup> WT or GFP-C5aR<sup>-/-</sup> KO) into irradiated recipient mice (C5aR<sup>+/+</sup> WT or C5aR<sup>-/-</sup> KO) via intravenous injection. They were: 1) GFP-C5aR<sup>+/+</sup> to C5aR<sup>+/+</sup> (WT→WT), 2) GFP-C5aR<sup>+/+</sup> to C5aR<sup>-/-</sup> KO (WT→KO), 3) GFP-C5aR<sup>-/-</sup> to C5aR<sup>+/+</sup> (KO→WT) and 4) GFP-C5aR<sup>-/-</sup> to C5aR<sup>-/-</sup> KO (KO→KO). Peripheral blood and bone marrow samples from the chimeras were used for engraftment analysis by flow cytometry. Six weeks after transplantation, all chimeric mice were subjected to low-dose (50 mg/kg; 5 consecutive days) streptozotocin (STZ)-induced diabetes for 12 weeks. Blood samples and kidneys were harvested for determination of kidney function, inflammation and fibrosis.

**Results:** Chimerism was confirmed with more than 97% of bone marrow cells and 95% of circulating CD45+ cells being GFP positive. At 12 weeks after STZ injection, blood glucose levels were significantly increased which were not different among all diabetic groups. Serum creatinine in diabetic WT→WT recipients was elevated while that from diabetic WT→KO, KO→WT and KO→KO recipients was lower. Kidney expression levels of MCP-1, TNF-α and fibronectin were also significantly increased in diabetic WT→WT recipients, but they were only suppressed in the diabetic KO→WT and KO→KO groups.

**Conclusions:** Diabetic chimeric mice reconstituted with C5aR<sup>-/-</sup> bone marrow cells were protected from kidney inflammation and fibrosis, suggesting that C5aR signaling in bone marrow-derived cells is a key driver in STZ-induced DN.

**Funding:** National Natural Science Foundation of China (grant number: 81870496); Mr & Mrs Tam Yung Fan Edmund Renal Research Fund

SA-PO221

Comparison of Renal and Metabolic Effects of Empagliflozin and Dapagliflozin on Type 2 Diabetes-Induced Rats

Nadir Emre Herdan, Meltem Gursu, Sahabettin Selek, Ganime Coban, Rumez Kazancioglu. *Bezmialem Vakif Universitesi Tıp Fakultesi, Istanbul, Turkey.*

**Background:** Diabetes mellitus is a disease that affects millions of people worldwide. Extensive clinical studies are ongoing on Empagliflozin and Dapagliflozin, in patients with heart failure and chronic renal failure. The aim of this study is to investigate the equivalence and superiority of different SGLT2 inhibitors by comparing the metabolic and renal effects.

**Methods:** 44 Sprague-Dawley rats were divided into four groups, which had unrestricted access to food and water (ad libitum). Following a three-week high-fat diet, streptozotocin was administered, and groups were randomly divided based on mean glucose levels. Treatment was applied for one month. Serum and urine samples were collected before and after 1 month of the treatment. Urine samples were analysed with NMR and confirmed with Mass Spectrometry. Kidneys were collected at the end of the experiment for histological analysis.

**Results:** The Empa-treated group had considerably decreased blood glucose levels as compared to the Dapa group (p<0.001). While treatment groups did not exhibit a meaningful increase in plasma insulin levels, the placebo group did (p=0.027). The placebo group had a significant increase in BUN levels (p=0.006), but the treatment groups did not exhibit this change. Both Empa and Dapa-treated groups ameliorated interstitial inflammation, mesangial expansion, and basal membrane thickening equally well.

**Conclusions:** In conclusion, different molecules from the SGLT2-inhibitors are not equally effective on various parameters. In terms of blood and urine parameters, Empagliflozin outperformed Dapagliflozin, while both medicines showed equal improvement in terms of kidney histology. Our research demonstrates that SGLT2 inhibitors' renoprotective effects extend beyond their glucose-lowering properties.

**Funding:** Commercial Support - The Scientific and Technological Research Council of Turkey (TUBITAK)

Table 1. Urinary Parameters

	Control Group	Placebo Group	Empa Group	Dapa Group	P
	Mean±SD Min-Max (Median)	Mean ±SD Min-Max (Median)	Mean ±SD Min-Max (Median)	Mean ±SD Min-Max (Median)	
<b>Microalbuminuria</b>					
Dm	41,8±28,1	14,1±10,7	28,7±23,7	36,6±33,9	0,419*
	9,8-62,6 (53,1)	0,7-37,2 (11)	5,3-69 (26)	4,8-95 (20,1)	
Last	57,8±68,0	164,0±107,7	94,5±116,0	141,5±151,3	0,085*
	11,4-173,6 (20,9)	3,8-354,2 (186,9)	0-336,4 (47,9)	17-367,8 (108,85)	
p	1,000*	0,002*	0,066*	0,06*	
<b>Urine Na</b>					
Dm	202,5±59,1	53,8±31,3	101,3±58,5	89,2±64,1	0,042*
	152-267,5 (188)	23-128 (52)	23-190 (101)	15-198 (84)	
Last	110,8±44,2	91,4±57,4	102,2±35,1	67,3±21,2	0,078*
	81-189 (92)	15-157 (99)	37-174 (107)	38-120 (66,5)	
p	0,068*	0,314*	0,859*	0,276*	
<b>Urine K</b>					
Dm	260,3±100,0	115,1±74,4	195,8±92,8	163,3±108,9	0,090*
	145-322 (314)	48,8-299,6 (101,1)	71,2-321,2 (211)	31,7-319 (114,4)	
Last	230,6±78,6	204,3±130,6	195,1±52,8	140,9±40,1	0,0056*
	168-367 (204,2)	32-346,4 (238,6)	91,5-287,5 (202)	82,3-249,9 (135,8)	
p	0,389*	0,374*	0,745*	0,393*	

\*One Way ANOVA, \*Kruskal Wallis Test, \*\*Repeated Measurements Variance Analysis, \*Friedman Test, \*Paired t Test

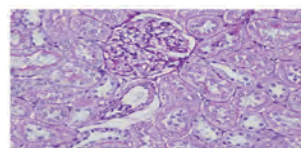

Fig.1.1 Placebo Group Mesangial Expansion and Basal Membrane Thickening with PAS Stain

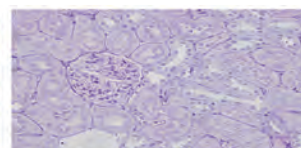

Fig.1.2 Empa Group with PAS Stain

SA-PO222

Nephroprotective Effects of Semaglutide in a Mouse Model of Hypertension-Accelerated Diabetic Kidney Disease

Stine T. Bak,<sup>1</sup> Louise Dalbøge,<sup>1</sup> Michael Christensen,<sup>1</sup> Thomas Secher,<sup>1</sup> Nicole Endlich,<sup>2</sup> Vedran Drenic,<sup>2</sup> Martin R. Madsen,<sup>1</sup> Henrik H. Hansen,<sup>1</sup> Ida Rune,<sup>1</sup> Lisbeth N. Fink,<sup>1</sup> Mette V. Østergaard.<sup>1</sup> *<sup>1</sup>Gubra, Hoersholm, Denmark; <sup>2</sup>NIPOKA GmbH, Greifswald, Germany.*

**Background:** Obesity, hyperglycemia and hypertension are critical risk factors for development of diabetic kidney disease (DKD). Emerging evidence suggests that glucagon-like peptide-1 receptor (GLP-1R) agonists improve cardiovascular and renal outcomes in type 2 diabetes patients. Here, we characterized the effect of long-acting GLP-1R agonist semaglutide alone and in combination with an ACE inhibitor in a model of hypertension-accelerated, advanced DKD facilitated by adeno-associated virus-mediated renin overexpression (ReninAAV) in uninephrectomized (Unx) female *db/db* mice.

**Methods:** Seven weeks after ReninAAV administration and six weeks post-Unx, *db/db* Unx-ReninAAV mice were administered (q.d.) vehicle, semaglutide (30 nmol/kg, s.c.) or semaglutide (30 nmol/kg, s.c.) + lisinopril (30 mg/kg, p.o.) for 11 weeks. Endpoints included blood pressure, plasma/urine biochemistry, kidney histopathology and RNA sequencing.

**Results:** Semaglutide robustly reduced hyperglycemia, hypertension and albuminuria concurrent with notable improvements in glomerulosclerosis severity, podocyte filtration slit density, urine/renal kidney injury molecule-1 (KIM-1) levels and gene expression markers of inflammation and fibrogenesis. Co-administration of lisinopril further ameliorated hypertension and glomerulosclerosis.

**Conclusions:** Semaglutide improves disease hallmarks in the db/db UNX-ReninAAV mouse model of advanced DKD. Renal outcomes were further improved by combined antihypertensive standard-of-care.

### SA-PO223

#### Declining GFR and Advanced Pathology in a Translational Mouse Model of Diabetic Kidney Disease

Arianne Van Koppen,<sup>1</sup> Andrea R. Nawrocki,<sup>2</sup> Tri Q. Nguyen,<sup>3</sup> Simon A. Hinke,<sup>2</sup> Reinout Stoop,<sup>1</sup> <sup>1</sup>TNO, Leiden, Netherlands; <sup>2</sup>Janssen Research and Development LLC, Raritan, NJ; <sup>3</sup>Universitair Medisch Centrum Utrecht Afdeling Pathologie, Utrecht, Netherlands.

**Background:** The incidence of diabetic kidney disease is increasing world wide. Development of novel therapeutics is hampered by the lack of animal models since most models only resemble the early phases of the disease. We developed a translational diet-induced mouse model. To evaluate which phases of diabetic nephropathy could be reached, we investigated decline of renal function over time and quantitatively measured histopathological damage.

**Methods:** Male KKAY mice underwent uninephrectomy (UNX). After a recovery mice were fed a high fat diet (45% LARD) and received 50 mg/L LNNA in the drinking water. Body weight, food and water intake were measured weekly. Retro orbital injection with FITC-inulin were used to measure GFR transdermal over time. UACR was also evaluated over time. Mice were terminated after 20 weeks and kidney damage was quantitatively scored by a team of renal pathologists.

**Results:** We previously showed that using a dietary intervention in combination with a vasoconstrictor in the drinking water, male KKAY develop hyperglycemia, hyperlipidemia and hypertension. Hyperfiltration was detected as early as 2 weeks after diet induction after which GFR continuously declined until termination (week 20). UACR was strongly increased and reached a plateau phase around week 12. Pathological evaluation revealed that only 18% of the glomeruli were healthy and scoring showed diffuse and nodular mesangial expansion and global glomerulosclerosis, interstitial fibrosis and tubular atrophy and tubulo-interstitial fibrosis.

**Conclusions:** Time course GFR measurements showed that in male KKAY mice on a HFD and LNNA (50 mg/L) the kidney goes through a period of hyperfiltration followed by continuous decline resulting in significant renal pathology. Together with a maximized UACR this indicated that the model reached the overt phase (4) of disease development and can be used to studied the more advanced stages of the disease as well as the early phases.

**Funding:** Commercial Support - Janssen, BPM

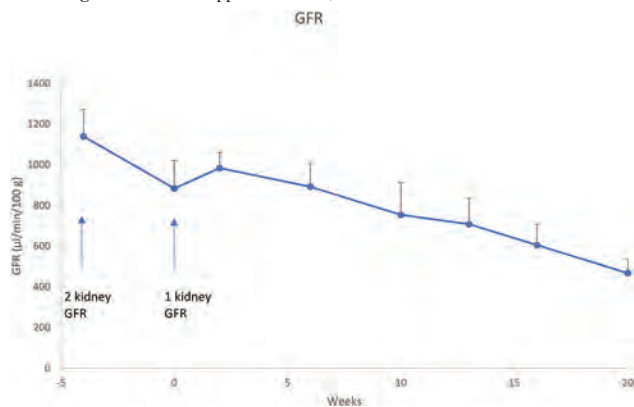

### SA-PO224

#### Gender Affects Diabetes and Diabetic Nephropathy Development in KKAY Mice

Arianne Van Koppen,<sup>1</sup> Andrea R. Nawrocki,<sup>2</sup> Tri Q. Nguyen,<sup>3</sup> Simon A. Hinke,<sup>2</sup> Reinout Stoop,<sup>1</sup> <sup>1</sup>TNO, Leiden, Netherlands; <sup>2</sup>Janssen Global Services LLC, Titusville, NJ; <sup>3</sup>Universitair Medisch Centrum Utrecht Afdeling Pathologie, Utrecht, Netherlands.

**Background:** We are developing a translational mouse model of advanced diabetic nephropathy which resembles both pathophysiology and pathology of the human situation. Diabetes affects men and women differently but treatment guidelines remains equal. Understanding gender differences is key to develop personalized therapeutics. We aim to study how gender influences diabetes induction and development of diabetic nephropathy in mice.

**Methods:** Male and female KKAY mice of 8 weeks underwent a uninephrectomy. After recovery, all mice were fed a high fat diet (HFD). Females received 100 mg/L LNNA in drinking water. Males were split in two groups and received either 50 or 100mg/L LNNA in drinking water. Body weight, food and water and blood glucose were monitored regularly. GFR by FITC-inulin clearance was measured transdermal. Albuminuria, BUN and organ weights were measured terminally. Pathology was scored by renal pathologists. KK females were used as non-induced control mice.

**Results:** Despite equal starting weights, females ate less but gained more weight on HFD compared to males. Blood glucose did not increase in females compared to controls but increased in males (12 vs 20 mmol/L). Initial (2-kidney) GFR was 1.6x higher females compared to males (554±73 vs 371±64 µL/min) and 1.5x after UNX. GFR in the females dropped towards the males GFR 4 weeks after diet initiation. UACR increased from 600 µg/mg towards 41200 µg/mg in all groups. BUN was highest in males on 100 mg/L LNNA (40 mg/dL) followed by males on 50 mg/L LNNA (28 mg/dL) and females on 100 mg/L LNNA (23 mg/dL). Kidneys of males (50 mg/L LNNA) were significant heavier than the females (100 mg/L LNNA). Pathology showed extensive glomerular and mild tubular damage with arteriolar hyalinosis in males (50 and 100 mg/L LNNA). Females showed moderate glomerular damage and very mild tubular damage with sporadic arteriolar hyalinosis.

**Conclusions:** Males and females respond different to a diabetes-inducing diet. Females has larger initial kidney function, comparable UACR, lower BUN and lower kidney weight and showed less renal damage compared to male mice. Despite the same dietary induction, females stayed metabolic healthy whereas males developed more pronounced diabetes and kidney damage. This is in accordance with clinical data and indicates the need for adjusted treatment guidelines for men and woman.

**Funding:** Commercial Support - Janssen, BPM, Government Support - Non-U.S.

### SA-PO225

#### Role of Ceruloplasmin in Diabetic Nephropathy

Sharma S. Prabhakar, Hemalata Deshmukh. Texas Tech University Health Sciences Center, Lubbock, TX.

**Background:** We have previously demonstrated that diabetic nephropathy (DN) is associated with oxidative stress and decreased renal nitric oxide (NO) levels (Prabhakar et al JASN 2007). While many factors such as hyperglycemia, reactive oxygen species and angiotensin may account for inhibition of NO in DN, the exact mechanism remains unclear. Ceruloplasmin (Cp) is a copper-transporting protein that was incriminated in many glomerular diseases including Lupus nephritis and Ig A nephropathy. Increased urinary excretion of Cp has been proposed as an early biomarker of DN but the precise role of Cp in DN has not been studied. We hypothesized that diabetic kidneys may overexpress Cp which might play a role in the pathogenesis of DN.

**Methods:** To test our hypothesis we used ZSF rats, an established rat model of nephropathy of diabetes. They were studied from 8<sup>th</sup> week until 40 weeks. Both male and female rats were used while CD rats were used as non-diabetic controls. ZSF rats were fed a high fat high calorie (Purina 5008) diet, to maintain hyperglycemia while CD rats were fed normal rat chow. At 40 weeks all rats were euthanized, kidneys harvested, and homogenates used to examine the expression of Cp by western blot technique. Blood and urine samples were collected at the start and end of the study to evaluate the kidney function.

**Results:** By 12 weeks of age ZSF rats developed obesity, diabetes, hypertriglyceridemia, hypertension and proteinuric renal failure while CD rats remained nondiabetic without hypertension, obesity or kidney involvement. Male ZSF rats were heavier than females (650 gm vs 510 gm) and more hyperglycemic (295 mg/dl vs.210 mg/dl) while proteinuria and azotemia were also more severe in male ZSF rats. Expression of Cp was increased in the kidneys of ZSF rats (male more than female) compared to CD rats.

**Conclusions:** We conclude that rat kidneys with experimental DN overexpress Cp. Since Cp is involved in metabolizing NO to nitrosothiols, Cp may contribute to oxidative/nitrosative stress and progression of DN. Additional studies are in progress to further explore the role of Cp in our model. Cp could play a pathogenic role in and could also be a biomarker of DN.

**Funding:** Private Foundation Support

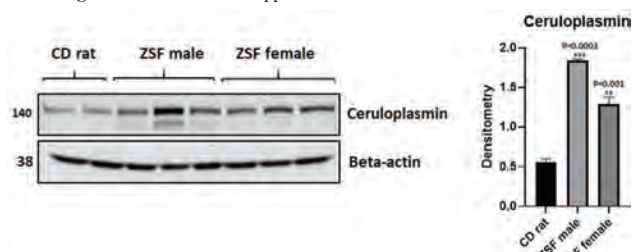

## SA-PO226

## Abstract Withdrawn

## SA-PO227

### Sex Differences in Renal Physiological Parameters and Kidney Expression of NOX-4, TGF- $\beta$ , and Fibronectin in Mice With Streptozotocin (STZ)-Induced Diabetes Mellitus

Alexis A. Gonzalez, Geraldine M. Lazcano-Páez, Pilar Cárdenas, Felipe S. Casado-Barragán. Group of Renal Physiology and Biochemistry Pontificia Universidad Católica de Valparaíso, Valparaíso, Chile.

**Background:** A hallmark of DM is the hyperglycemia but also hyperglycosuria, along with the presence of proteinuria and signs of renal damage that includes deposition of extracellular matrix, glomerular damage and tubulointerstitial fibrosis. All these aspects are usually observed during advanced stages of the disease. Among the markers observed in chronic DM in experimental animal models, the profibrotic factors transforming growth factor-beta 1 (TGF- $\beta$ 1), fibronectin and renal NADPH oxidase (NOX)-4 which contributes to increased reactive oxygen species (ROS) generation, are mostly responsible for the profibrotic phenotype in tubular cells enhancing the proliferation of fibroblasts and collagen deposition. Most of the diabetic animal models described in the literature analyzed the effects of chronic DM on renal physiology or kidney injury markers. Sex differences in glucose metabolism in animal models of DM have been described. Furthermore, it is known that women and men with DM have alterations in sex hormones. Our aim was to evaluate the physiological parameters and kidney expression of TGF- $\beta$ 1, fibronectin and NOX-4 in male and female mice with streptozotocin (STZ)-induced DM during 6 days.

**Methods:** CF-1 male or female mice were injected with or without STZ (150 mg/kg) in a single dose. Levels of fasting blood glucose (FBG), sodium excretion and urine protein/creatinine were measured at 0, 3 and 6 days. After 6 days of treatment the animals were euthanized and kidneys were removed to evaluate TGF- $\beta$ 1, fibronectin and NOX-4 expression by immunoblotting, qRT-PCR and immunofluorescence.

**Results:** Despite the augmentation in FBG in STZ male and female mice, males showed significantly higher levels than females at day 3. STZ males also showed higher urinary protein vs. creatinine levels that STZ females. Males showed a slight but significant sodium retention. STZ males showed higher expression of fibronectin as compared to control mice and also compared to females STZ. By contrast, STZ female mice showed higher expression of TGF- $\beta$  and NOX-4.

**Conclusions:** Our data suggest that there are sex differences on the induction of the expression of TGF- $\beta$ , fibronectin and NOX-4 in mice subjected to (STZ)-induced DM as early as 6 days.

## SA-PO228

### Placental Growth Factor Deficiency Aggravates Diabetic Nephropathy Through AMP-Activated Protein Kinase-Dependent Pathway

Yaeni Kim, Ji Hee Lim, Eun Nim Kim, Cheol Whee Park. The Catholic University of Korea, Seoul, Republic of Korea.

**Background:** Reduced angiogenesis is implicated in the progression of diabetic kidney disease (DKD). Placental growth factor (PlGF) is a member of the vascular endothelial growth factor (VEGF) family, that promotes angiogenesis through VEGF receptor (VEGF-R) and AMP-activated protein kinase (AMPK) in hypoxic tissues under pathologic condition. We aimed to investigate the role of PlGF in the development of DKD.

**Methods:** Diabetes was induced by a low-dose streptozotocin injection in 9-week-old male C57BL/6J PlGF-KO and wild-type mice and biochemical and morphological parameters were examined at 12 weeks later.

**Results:** Streptozotocin-induced PlGF-KO diabetic mice showed aggravation of albuminuria and pathognomic phenotypes of DKD due to decreases in the expression of VEGF-receptor2 (VEGF-R2) and CaMKK/phosphorylation of LKB1 and AMPK and their downstream signaling pathways including PI3K/phospho-Akt/FoxO3a/phospho-eNOS and PPAR $\alpha$ /PGC-1 $\alpha$ /ERR $\alpha$ /ChREBP/SREBP-1c, which caused endothelial dysfunction and lipotoxicity-induced renal inflammation (M1 polarization), oxidative stress, and apoptosis in the kidney. PlGF expression in glomerular endothelial cells (GECs) and PDGFR-B-positive-mesangial cells was significantly decreased in diabetic PlGF-KO compared to non-diabetic PlGF-KO mice in association with vascular rarefaction as demonstrated by reduced PECAM-1 expression. In cultured human GECs and mesangial cells in high-glucose condition, PlGF-deficiency induced by siPlGF decreased the expression of VEGF-R2 and AMPK-PI3K-Akt phosphorylation/eNOS and suppressed PGC-1 $\alpha$ /PPAR $\alpha$ , which ultimately led to increased level of oxidative stress and apoptosis.

**Conclusions:** This study provides a new insight into the role of PlGF in renal damage and that PlGF activation may be a promising therapeutic target for DKD.

### Expression of PlGF, PDGFR- $\beta$ and PECAM-1

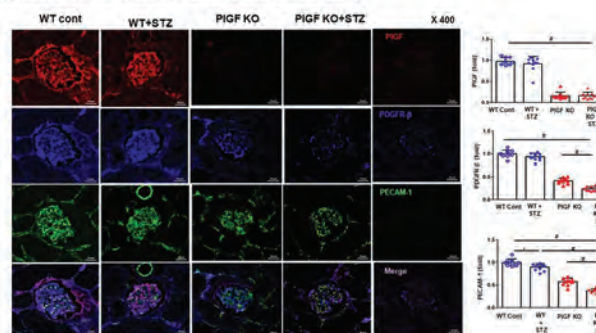

## SA-PO229

### Diabetes-Induced Renal Inflammation Is Facilitated by Expression of the Stress Response Protein REDD1

Siddharth Sunilkumar, Esma I. Yerlikaya, Michael D. Dennis. Penn State College of Medicine, Hershey, PA.

**Background:** Diabetic nephropathy (DN) results in chronic loss of kidney function and is the leading cause of end-stage renal disease. Hyperglycemia is a key mediator of DN pathophysiology; promoting oxidative stress and inflammation associated injury. Presently, much remains unknown regarding the molecular events that contribute to chronic inflammation in the context of DN. Herein, we investigated the hypothesis that hyperglycemia-induced expression of the stress response protein REDD1 acts to exacerbate renal inflammation in response to the diabetes.

**Methods:** Wild-type (WT) and REDD1 knockout (KO) mice were administered streptozotocin to induce diabetes. Kidneys were isolated after 16 weeks of diabetes and analyzed for protein and RNA expression. Urinary albumin and creatinine levels were determined. Kidneys were fixed and renal sections were examined by immunofluorescence labeling. Similar analyses were performed on human podocyte cultures. GSK3 $\beta$  inhibition was carried out using VP3.15. Activation of the transcription factor nuclear factor kappa B (NF- $\kappa$ B) was assayed using a luciferase-based assay.

**Results:** REDD1 expression in the kidney of diabetic mice correlated with albuminuria and renal hypertrophy. Diabetes induction also increased NF- $\kappa$ B activation, pro-inflammatory gene transcript and IL-1 $\beta$  cytokine expression in the kidney of diabetic wild-type mice. In contrast, REDD1 KO mice failed to exhibit a diabetes-induced renal inflammatory response. Macrophage infiltration was observed in kidneys of diabetic WT mice but not in diabetic REDD1 KO mice. In cultured human podocytes, exposure to hyperglycemic conditions elevated REDD1 expression concomitant with increased inflammatory signaling. Pro-inflammatory gene transcript expression and IL1 $\beta$  release were not observed in podocyte cultures upon REDD1 deletion. Prior studies support that REDD1 acts via an Akt-GSK3 $\beta$  signaling axis. Indeed, inhibition of GSK3 $\beta$  prevented NF- $\kappa$ B mediated inflammation and reduced podocyte apoptosis associated renal injury in diabetic mice.

**Conclusions:** These findings provide new insights into how diabetes contributes to development of renal inflammation and support the possibility that therapeutics targeting REDD1 could be beneficial in the context of DN.

**Funding:** Other NIH Support - R01 EY029702, R01 EY032879, Private Foundation Support

## SA-PO230

### Integrative Transcriptome Analysis Reveals TEKT2 and PIAS2 Involvement in Diabetic Nephropathy

Yuanqing Li,<sup>1</sup> Hongchun Lin,<sup>1</sup> Shuangshuang Shu,<sup>1</sup> Yuxiang Sun,<sup>1</sup> Weiyan Lai,<sup>1</sup> Zhaoyong Hu,<sup>2</sup> Hui Peng.<sup>1</sup> <sup>1</sup>Nephrology Division, the Third Affiliated Hospital of Sun Yat-sen University, Guangzhou, China; <sup>2</sup>Nephrology Division, Department of Medicine, Baylor College of Medicine, Houston, TX.

**Background:** Cell heterogeneity has impeded the accurate interpretation of the bulk transcriptome data from patients with diabetic nephropathy (DN). We performed an analysis by integrating bulk and single-cell transcriptome datasets to uncover novel mechanisms leading to DN, especially in the podocytes.

**Methods:** Microdissected glomeruli and tubules transcriptome datasets were selected from Gene Expression Omnibus (GEO). Then the consistency between datasets was evaluated. The analysis of bulk dataset and single-nucleus RNA dataset was integrated to reveal the cell type-specific responses to DN. The candidate genes were validated in kidney tissues from DN patients and diabetic mice.

**Results:** We compared 4 glomerular and 4 tubular datasets and found considerable discrepancies among datasets regarding the differentially expressed genes (DEGs), involved signaling pathways, and the hallmark enrichment profiles. Deconvolution of the bulk data revealed that the variations in cell-type proportion contributed greatly to this discrepancy. Integrative analysis uncovered that the dysregulation of spermatogenesis-related genes, including *TEKT2* and *PIAS2* was involved in the development of DN. Importantly, the mRNA level of *TEKT2* was negatively correlated with the mRNA levels of *NPHS1* ( $r = -0.66$ ,  $p < 0.0001$ ) and *NPHS2* ( $r = -0.85$ ,  $p < 0.0001$ ) in human diabetic glomeruli. Immunostaining confirmed that the expression of *TEKT2* and *PIAS2* were up-

regulated in podocytes of DN patients and diabetic mice. Knocking down *TEKT2* resisted high glucose-induced cytoskeletal remodeling and down-regulation of NPHS1 in cultured podocyte.

**Conclusions:** The integrative strategy can help us to efficiently use the publicly available transcriptomics resources. Using this approach and combining with classical research methods, we identified *TEKT2* and *PIAS2*, two spermatogenesis-related genes involved in the pathogenesis of DN. Furthermore, *TEKT2* is involved in this pathogenesis by regulating the podocyte cytoskeleton.

**Funding:** Government Support - Non-U.S.

#### SA-PO231

##### Long Non-Coding RNA DANCR Synergizes With IGF2BP2 to Attenuate Diabetic Kidney Disease Induced Glomerulosclerosis by Negatively Regulating the TGF- $\beta$ /Smad3 Pathway

Feng Liu, Chun Zhang. Department of Nephrology, Union Hospital, Tongji Medical College, Huazhong University of Science and Technology, Wuhan, China.

**Background:** Diabetic kidney disease (DKD) is a major microvascular complication of diabetes mellitus and the leading cause of end-stage kidney disease. Despite transforming growth factor- $\beta$  (TGF- $\beta$ ) has been implicated as a major pathogenic factor in the development of glomerulosclerosis in DKD, clinical trials with monoclonal antibodies to TGF- $\beta$  have failed to demonstrate therapeutic benefit. Thus, developing alternative therapeutic strategies to effectively block the TGF- $\beta$ /Smad signaling could be of paramount importance for the treatment of DKD. To date, whether lncRNAs can regulate the TGF- $\beta$ /SMAD signaling in the development of DKD-associated glomerulosclerosis is still unknown.

**Methods:** Through integrating analysis of a public RNA sequencing dataset of 61 DKD glomerular cases, RNA fluorescence in situ hybridization, RNA pull-down assay, and mass spectrometry analysis, DANCR was identified and its interaction with insulin-like growth factor 2 mRNA-binding protein 2 (IGF2BP2) was confirmed. Biological implications of DANCR and IGF2BP2 in human renal mesangial cells (HRMCs) under high glucose (HG) or TGF- $\beta$  stimulus were explored by flow cytometry and western blot analysis. Weighted gene co-expression network analysis and real-time quantitative RT-PCR (qRT-PCR) verification were performed to identify candidate target genes for DANCR in DKD. RNA immunoprecipitation (RIP), dual-luciferase assay, qRT-PCR and western blot assays were used to investigate the molecular mechanisms underlying the functions of DANCR and IGF2BP2.

**Results:** DANCR was predominantly detected in the cytoplasm, and was downregulated in DKD glomerular tissues and HG stimulated HRMCs. Ectopic expression of DANCR abolished the synthesis of fibronectin, Col I, and  $\alpha$ -SMA induced by the HG or TGF- $\beta$ 1 stimulation and restored the expression of NLK. Mechanistically, DANCR functioned to stabilize nemo-like kinase (NLK) mRNA through interaction with IGF2BP2, resulting in enhanced phosphorylation on the linker region of activated Smad2/3 that blocked TGF- $\beta$ /Smad signaling.

**Conclusions:** This study identifies long non-coding RNA DANCR as a new TGF- $\beta$ /Smad signaling blocker that inhibits the development of glomerulosclerosis in DKD through interacting with IGF2BP2 to stabilize NLK mRNA, indicating a potential therapeutic target for treatment of glomerulosclerosis in DKD.

#### SA-PO232

##### Inhibition of Xanthine Oxidase Protects Diabetic Nephropathy Through Amelioration of Oxidative Stress via VEGF-NOX-FoxO3a Signaling Pathway

Yu Ah Hong,<sup>1,2</sup> Keum-Jin Yang,<sup>2</sup> Wonjung Choi,<sup>1,2</sup> Yoon-Kyung Chang,<sup>1,2</sup> Suk young Kim,<sup>1,2</sup> Cheol Whee Park.<sup>1</sup> <sup>1</sup>Catholic University of Korea School of Medicine, Seoul, Republic of Korea; <sup>2</sup>Catholic University of Korea Daejeon St Mary's Hospital, Daejeon, Republic of Korea.

**Background:** Xanthine oxidase (XO) is one of major source of reactive oxygen species, and a XO inhibitor, febuxostat has been reported to the protection of kidney diseases. We investigated whether febuxostat exerts renoprotective effects against diabetic kidney disease (DKD).

**Methods:** Febuxostat (5 mg/kg) was administered to 8-week Male C57BL/6 mice via intraperitoneal route for 8 weeks in streptozotocin (STZ)-treated diabetic mice. We also evaluated the antioxidant effects of febuxostat and its mechanism using high glucose (HG)-treated cultured human glomerular endothelial cells (HGECs).

**Results:** Serum cystatin C, albuminuria and mesangial matrix expansion were significantly decreased in febuxostat-treated diabetic mice. Febuxostat also reduced serum uric acid, kidney XO and xanthine dehydrogenase levels in diabetic mice. Febuxostat suppressed the expression of vascular endothelial growth factor (VEGF) mRNA, VEGF receptor (VEGFR)1 and 3, NADPH oxidase (NOX)1, 2, and 4, and the levels of their catalytic subunit mRNA in diabetic mice. Febuxostat was accompanied by the downregulation of Akt phosphorylation, followed by the suppression of transcription factor forkhead box O3a (FoxO3a) phosphorylation and the enhancement of endothelial nitric oxide synthase (eNOS). In addition, the blockade of VEGFR1 or VEGFR3 abolished the antioxidant effects of febuxostat via NOXs-FoxO3a-eNOS signaling in HG-treated cultured HGECs. Finally, febuxostat improved oxidative stress in both *in vivo* and *in vitro* models of DKD.

**Conclusions:** The inhibition of XO by febuxostat was associated with the inhibition of VEGF, which consequently ameliorated oxidative stress related to NOXs-FoxO3a-eNOS signaling in DKD.

**Funding:** Government Support - Non-U.S.

#### SA-PO233

##### The Insulin/Insulin-Like Growth Factor Axis Is Critically Important in the Podocyte and Controls Gene Transcription and Spliceosome Function

Jenny Hurcombe,<sup>1</sup> Lusyan Dayalan,<sup>1</sup> Fern Barrington,<sup>1</sup> Lan Ni,<sup>1</sup> Paul T. Brinkkoetter,<sup>2</sup> Martin Holzenberger,<sup>3</sup> Gavin I. Welsh,<sup>1</sup> Richard Coward.<sup>1</sup> <sup>1</sup>University of Bristol, Bristol, United Kingdom; <sup>2</sup>University Hospital Cologne, Cologne, Germany; <sup>3</sup>Sorbonne University, INSERM, Paris, France.

**Background:** Insulin signalling to the podocyte via the cognate insulin receptor (IR) is crucial for kidney function and insulin-like growth factor 1 (IGF1) signalling through the structurally related insulin-like growth factor 1 receptor (IGF1R) is also known to directly affect the podocyte. Since the IR and IGF1R may act redundantly in some contexts, this study sought to elucidate the role of the insulin/IGF1 axis in podocyte function using mouse and cell culture models deficient in both receptors.

**Methods:** To examine the effects of combined receptor loss *in vivo*, a transgenic mouse model with conditional inactivation of podocyte IR and IGF1R was generated. *In vitro*, conditionally immortalized genetic IR/IGF1R dual knockout podocytes were characterised using proteomic, transcriptomic and metabolomic analysis.

**Results:** Podocyte specific IR/IGF1R knockout mice developed significant albuminuria and a severe renal phenotype with global sclerosis, renal failure and death occurring between 4 and 24 weeks. >90% loss of the IR and IGF1R in cultured mouse podocytes was also detrimental resulting in >50% cell death 7 days after receptor gene excision. Enrichment analysis of total proteomic data revealed a striking downregulation of gene ontology terms associated with splicing and RNA processing activity in IR/IGF1R deficient cells. Genome-wide and targeted long-read RNA sequencing was performed to further explore the effect of dual receptor suppression on spliceosome function alongside metabolomic studies to elucidate key metabolic pathways regulated by these receptors.

**Conclusions:** This work underlines the critical importance of podocyte insulin/IGF signalling and reveals a novel role for this signalling axis in RNA processing by regulating spliceosome activity.

**Funding:** Government Support - Non-U.S.

#### SA-PO234

##### Decoy Receptor 2 Mediates the Apoptosis-Resistant Phenotype of Senescent Renal Tubular Cells and Accelerates Renal Fibrosis in Diabetic Nephropathy

Jia Chen. Army Medical Center of PLA, Chongqing, China.

**Background:** Apoptotic resistance leads to persistent accumulation of senescent cells and sustained expression of a senescence-associated secretory phenotype, playing an essential role in the progression of tissue fibrosis. However, whether senescent renal tubular epithelial cells (RTECs) exhibit an apoptosis-resistant phenotype and the mechanism remain unclear.

**Methods:** A total of 241 DN patients diagnosed by biopsy in our hospital from January 2012 to December 2019 were included. The STZ-induced DN mouse model was constructed. DcR2-siRNA and DcR2 overexpression plasmids were transfected into the kidney using ultrasonic microbubble technology. TECs senescence was constructed by high glucose treatment. The co-localization of DcR2 and apoptosis-related markers (FLIP, Bcl-2, caspase-3, caspase-8, TUNel) and fibrotic markers ( $\alpha$ -SMA, collagen IV, fibronectin) were analyzed. DcR2 interacting proteins were screened and analyzed by co-immunoprecipitation combined with quantitative proteomics in renal tissue from DN patients and TECs.

**Results:** DcR2 was co-localized with fibrotic markers, and anti-apoptotic proteins FLIP and Bcl2 but rarely co-localized with caspase 3 or TUNEL. DcR2 overexpression promoted renal fibrosis in mice with STZ-induced DN, as evidenced by augmented Masson staining and upregulated expression of fibrotic markers. DcR2 overexpression also enhanced FLIP expression while reducing the expression of pro-apoptotic proteins, resulting in apoptotic resistance. In contrast, DcR2 knockdown produced the opposite effects *in vitro* and *in vivo*. Moreover, quantitative proteomics demonstrated that DcR2 interacted with GRP78, which has been shown to promote apoptotic resistance in cancer. GRP78 exhibited co-localization with senescent and anti-apoptotic markers but was rarely co-expressed with caspase 3 or TUNEL. Additionally, GRP78 knockdown decreased the apoptosis resistance of HG-induced senescent RTECs with upregulated cleaved caspase 3 and increased the percentage of apoptotic RTECs. Mechanistically, DcR2 mediated apoptotic resistance in senescent RTECs by enhancing GRP78-caspase 7 interactions and promoting Akt phosphorylation.

**Conclusions:** DcR2 mediated the apoptotic resistance of senescent RTECs and renal fibrosis by interacting with GRP78, indicating that targeting the DcR2-GRP78 axis represents a promising therapeutic strategy for DN.

#### SA-PO235

##### Tyro3 Agonist as a Novel Therapy for Glomerular Disease

Fang Zhong, Hong Cai, Kyung Lee, John C. He. Icahn School of Medicine at Mount Sinai, New York, NY.

**Background:** Drugs directly targeting podocytes as a therapy for glomerular disease are still lacking. Our previous studies suggest that Tyro3 is a podocyte-specific TAM (Tyro3, Axl, Mertk) tyrosine kinase receptor. In human, glomerular Tyro3 expression negatively correlates with the progression of primary glomerular disease and diabetic kidney disease (DKD). Knockout of Tyro3 aggravates podocyte injury in Adriamycin-induced nephropathy (ARDN) and DKD mice while induction of Tyro3 expression in

podocytes ameliorates kidney injury in these two animal models. These data suggest a protective role of Tyro3 against podocyte injury in glomerular disease. Here, we liked to further dissect the mechanisms of Tyro3 in podocytes and develop Tyro3 agonists as potential drugs to treat glomerular disease.

**Methods:** In vitro studies: culture of human podocytes with overexpression or knockdown of Tyro3, western blot, co-immunoprecipitation, and mass spectrometry. In vivo studies: OVE26 diabetic mice and ARDN treated with Tyro3 agonists or vehicle. Kidney histology, albuminuria, and renal function will be assessed in these mice.

**Results:** By immunoprecipitation combined with mass spectrometry analysis we identified TCTP and nicalin as the top Tyro3-interacted proteins. Nicalin is a member of the  $\gamma$ -secretase complex. TCTP is known to inhibit apoptosis through interaction with multiple partners such as p53 and Bax. We showed that Tyro3 interacted with TPTC to induce its phosphorylation and thereby inhibiting apoptosis of podocytes. Tyro3 also interacted with nicalin to induce the cleavage of Tyro3 into a soluble form. Overexpression of soluble Tyro3 inhibits its protective effects of Tyro3 in podocytes. Circulating Tyro3 increased in DKD patients. Therefore, our data suggest that increased soluble Tyro3 in DKD patients could suppress the protective effects of Tyro3 in podocytes, leading to more podocyte injury. In addition, we screened and identified a specific Tyro3 agonist (C10) which induced phosphorylation in Tyro3 but not in other TMA receptors. This Tyro3-specific agonist reduced apoptosis of human podocytes cultured in high glucose condition and ameliorated podocyte loss and glomerular injury in mice with ARDN and DKD.

**Conclusions:** In conclusion, we reveal a novel protective mechanism of Tyro3 in podocytes and develop a novel class of podocyte-specific drugs which could be potentially developed to treat glomerular disease.

**Funding:** Veterans Affairs Support

## SA-PO236

### Alterations of the Kidney Inflammatory Landscape in Patients With Diabetic Nephropathy

Martina Chirra,<sup>1</sup> Ameet A. Chimote,<sup>1</sup> Arya Dahal,<sup>1</sup> Sonia Bhati,<sup>1,2</sup> Heather Duncan,<sup>1</sup> Kotagal S. Kant,<sup>1</sup> Laura Conforti,<sup>1</sup> <sup>1</sup>University of Cincinnati, Cincinnati, OH; <sup>2</sup>University of Kentucky College of Medicine, Lexington, KY.

**Background:** Diabetic nephropathy (DN) is the leading cause of chronic kidney disease in the USA. Inflammation has a crucial role in the pathogenesis of DN and a deeper knowledge of the inflammatory state of DN kidneys could provide rationales for new treatments. Our aim was to investigate the transcriptomic immune signature of kidney biopsies from patients with DN, in comparison with healthy kidney (NK) biopsies and kidney biopsies of patients affected by lupus nephritis (LN), a well-known example of immune-related kidney disease.

**Methods:** We performed a transcriptomic analysis of formalin-fixed paraffin-embedded kidney biopsies from NK (n=7), DN (n=7) and LN (n=4) using the NanoString nCounter MAX system and the nCounter Human Autoimmune Profiling Panel. Gene expression and pathway score data analyses were performed with the nSolver 4.0 Data Analysis Software, the Advanced Analysis 2.0 plug-in (NanoString Technologies) and the ROSALIND® platform. All the LN patients were receiving immunosuppressant drugs during the sample collection.

**Results:** 31% (239/750) of the genes defining autoimmune and autoinflammatory disorders were upregulated (fold increase  $\geq 1.5$ , adjusted P-value  $\leq 0.05$ ) in DN compared to NK. When comparing DN with LN, there were 159 differentially expressed genes (fold increase  $\geq 1.5$  or fold decrease  $\leq 1.5$ , adjusted P-value  $\leq 0.05$ ) and 140/159 were upregulated in DN compared to LN. Almost all the pathways (34/35) associated with autoimmune and chronic inflammatory disorders were significantly increased in DN (n=5) compared to NK (n=7). The majority of these pathways (19/35) were still increased in DN (n=2) compared to LN (n=4).

**Conclusions:** Transcriptomic profiling of DN kidney biopsies reveals an increase of the pathways associated with autoimmune and chronic inflammatory disorders, potentially identifying new therapeutic targets.

**Funding:** Other NIH Support - Dr. Chirra was supported by R38HL155775-01., Private Foundation Support

## SA-PO237

### The Molecular Effect of Empagliflozin (SGLT2i) on the Autophagy Pathway in Type 2 Diabetic Mice Model With Diabetic Nephropathy

Farid M. Nakhoul,<sup>1,3</sup> Offir Ertracht,<sup>5</sup> Nakhoul Nakhoul,<sup>2,3</sup> Hagar Tadmor,<sup>4</sup> <sup>1</sup>Cardiovascular research lab The Galilee Medical Center, Nahariya, Israel; <sup>2</sup>Ophthalmology Division, baruch Padeh Poriya medical Center, Lower galilee, Israel; <sup>3</sup>Faculty of Medicine Bar Ilan University, Tsfat, Israel; <sup>4</sup>Diabetes and Metabolism Lab, Baruch Padeh Poriya Medical Center, Tiberias, Israel; <sup>5</sup>Cardiovascular research institute The galilee medical Center, Nahariya, Israel.

**Background:** Diabetes mellitus (DM) type II (Hyperglycemia), is associated with increased glucose cell toxicity and inflammation leading to irreversible damage to the kidney cells. Autophagy plays a key role in the degradation of damaged intracellular proteins in order to maintain intracellular homeostasis and cell integrity. During DM, their is decreased in the autophagy with consequent development & progression of diabetic nephropathy (DN). Our aim is to investigate the molecular effect of SGLT2i (EMPA) on the expression of ATG5 and its downstream collaborator LC3-II in DM mice model

**Methods:** The 8 weeksold male type II DM mice were used: 20 C57BL/6J Wild Type (C57), 20 BTBR ob/ob vehicles (DM), 20 BTBR ob/ob that were reared with EMPA in drinking water Body weight, urinary & blood glucose were measured at basal & 1 and 2 months. Lysates from murine renal cortex were subjected to histological,

immunohistochemically, western blot analysis (WB) and fibrosis (Fibronectin). All mice were sacrificed 13 week after the beginning of the experiment.

**Results:** At two months, the DM and DM+EMPA mice groups gain weight considerably vs C57/Bl (P>.0.01). Urine output increased as soon as 1 & 2 month of treatment (TX) in DM & DM+EMPA group VS control (P<0.001). Western blots (WB) significant reduction in ATG5 level in renal lysate of DM mice compared with C57/Bl mice (P< 0.01). Quantification of the WB indicate significant reduction in ATG5 level in renal lysate of DM mice compared with C57/Bl mice (P< 0.01), and moderate yet non-significant increased by the EMPA TX (P>0.05). ATG5 immunostaining was significantly decreased in DM mice compared with C57/Bl (P<0.001), and significant increased in DM+EMPA mice compared with DM mice (P<0.001). Renal LC3-II protein level & immunostaining were significantly reduced in DM mice compared with C57/Bl (P<0.001), and increased levels in DM+EMPA group VS untreated DM mice (P<0.001). Fibronectin level was reduced in DM mice compared to control and restored toward normal with EMPA TX.

**Conclusions:** Decrease in ATG5 & LC3-II proteins levels during chronic hyperglycemia (DM) contributes to deficiencies in the autophagy process, with development and progression of DN. EMPA TX significantly reduce the development & progression of DN in people with type II DM and should be recommended in early stages of the disease.

**Funding:** Government Support - Non-U.S.

## SA-PO238

### Endurance Exercise Training Prevented the Progression of Diabetic Kidney Disease With Muscle Weakness in Type 2 Diabetic Animal Models With Obesity, Hypertension, and Hyperlipidemia

Hitoshi Kotake, Takeshi Sugaya, Yugo Shibagaki, Atsuko Ikemori. *Sr. Marianna University School of Medicine, Kawasaki, Japan.*

**Background:** The aim of this present study was to evaluate protective effects of endurance exercise training against diabetic kidney disease (DKD) with muscle weakness by using male spontaneously diabetic Torii (SDT) fatty rats as type 2 diabetic animal models with obesity, hypertension, and hyperlipidemia.

**Methods:** Eight-week-old SDT fatty rats (n = 12) and Sprague-Dawley (SD) rats (n = 10) were randomly divided into exercise (Ex; SDT-Ex: n = 6, SD-Ex: n = 5) and sedentary groups (SDT-Cont: n = 6, SD-Cont: n = 5), respectively. Each group underwent regular treadmill exercise four times a week from ages 8 to 16 weeks. After finishing the exercise protocol, the kidneys were isolated and leg muscle tissue was removed. The extracted muscle specimens were categorized as slow (soleus) or fast (EDL) muscle.

**Results:** The exercise attenuated hypertension and hyperlipidemia and prevented increases in renal parameters levels without affecting of blood glucose levels. In the SDT fatty rats, it ameliorated renal morphological abnormalities in the interstitium of the surface and intermediate layers of the cortex. Downregulated expression of endothelial nitric oxide synthase in the glomerulus of the SDT fatty rats was significantly upregulated by the exercise. The exercise upregulated the renal expressions of both medium-chain acyl-CoA dehydrogenase and peroxisome proliferator-activated receptor  $\gamma$  coactivator-1 $\alpha$  related to fatty acid metabolism. In addition, the exercise training increased the muscle strength and cross-sectional area of the type IIb muscle fibers in the EDL muscle, but not soleus muscle. The exercise training upregulated the protein expression of CD31, insulin receptor substrate-2, and phosphorylated endothelial nitric oxide synthase in the EDL muscle, suggesting acceleration of angiogenesis.

**Conclusions:** Endurance exercise training exerts protective effects by preventing glomerular endothelial abnormality and enhancing renal fatty acid metabolism, and suppresses muscle weakness by acceleration of angiogenesis of EDL muscle, in type 2 diabetes with obesity, hypertension, and hyperlipidemia, independently of blood glucose.

## SA-PO239

### Deletion of iPLA2 $\gamma$ Protects Mice From Diabetic Nephropathy

Andrew V. Cybulsky,<sup>1</sup> Julie Guillemette,<sup>1</sup> Joan Papillon,<sup>1</sup> José R. Navarro-Betancourt,<sup>1</sup> Hanan Elimam,<sup>1,2</sup> Ivan G. Fantus.<sup>1</sup> <sup>1</sup>McGill University Health Centre, Montreal, QC, Canada; <sup>2</sup>University of Sadat City, Sadat City, Egypt.

**Background:** Calcium-independent phospholipase A2 $\gamma$  (iPLA2 $\gamma$ ) is localized in glomerular epithelial cells (GECs)/podocytes at the mitochondria and endoplasmic reticulum, and can mediate release of arachidonic acid and prostanoids. Global knockout (KO) of iPLA2 $\gamma$  in mice did not cause albuminuria, but resulted in mitochondrial structural abnormalities and enhanced autophagy in podocytes. In acute glomerulonephritis (GN); anti-glomerular basement membrane GN and adriamycin nephrosis), deletion of iPLA2 $\gamma$  exacerbated albuminuria and podocyte injury. This study addresses the role of iPLA2 $\gamma$  in diabetic nephropathy.

**Methods:** Hyperglycemia was induced in male mice (mean age 6.5 months) with streptozotocin (STZ). Cultured GECs were produced from control and iPLA2 $\gamma$  KO mice; the GECs express synaptopodin and nephrin.

**Results:** STZ induced progressive albuminuria in control (Ctrl) mice (~5 mg/mg creatinine at 21 weeks), while albuminuria did not increase in iPLA2 $\gamma$  KO mice (~0.5 mg/mg creatinine), remaining comparable to untreated groups (9-15 mice/group). Despite similar exposure to STZ, the STZ-KO mice developed a lower level of hyperglycemia compared to STZ-Ctrl. However, there was no significant correlation between the degree of hyperglycemia and albuminuria, and even KO mice with greatest hyperglycemia did not develop significant albuminuria. Mortality at 21 weeks was greatest in STZ-Ctrl mice (20%). Sclerotic glomeruli and enlarged glomerular capillary loops were increased significantly in Ctrl-STZ compared to KO-STZ mice. Glomerular LC3-II (a marker of autophagy) was increased in KO and KO-STZ mice compared to respective Ctrl groups.

Key: TH - Thursday; FR - Friday; SA - Saturday; OR - Oral; PO - Poster; PUB - Publication Only

Underline represents presenting author.

Glomerular matrix was expanded in both Ctrl-STZ and KO-STZ groups. STZ did not alter podocyte number, nor amounts of glomerular synaptopodin, nephrin, podocalyxin, F-actin, and macrophages. Treatment of cultured GECs with H<sub>2</sub>O<sub>2</sub> resulted in increased cell death in Ctrl GECs compared to iPLA2 $\gamma$  KO, and the increase was slightly greater in medium with 18 mM glucose compared to 8 mM. H<sub>2</sub>O<sub>2</sub>-induced cell death was not affected by inhibition of prostanoid production with indomethacin.

**Conclusions:** In contrast to acute GN, mice with global deletion of iPLA2 $\gamma$  are protected from developing chronic glomerular injury in diabetic nephropathy. This may be related at least in part to increased glomerular autophagy.

**Funding:** Private Foundation Support, Government Support - Non-U.S.

#### SA-PO240

##### Human Translational Data and Preclinical Models Support LPAR1 Antagonist as a Candidate Treatment for Diabetic Kidney Disease

Monika Sharma, Swati Kaushik, David Lopez, Katie Kassa, Wesley Minto, Thomas E. Hudson, Shushil Pandit, Shawn S. Badal, John T. Liles, Anna Zagorska. *Gilead Sciences Inc, Foster City, CA.*

**Background:** LPA-LPAR1 signaling has been implicated in kidney fibrosis. LPAR1 activation promotes epithelial cell injury and myofibroblast proliferation. *Lpar1*<sup>-/-</sup> mice are protected from fibrosis in kidney injury models. Here we evaluate LPAR1 pathway in human DKD and effect of a small molecule antagonist of LPAR1 *in vitro* and in two distinct models of kidney injury.

**Methods:** European Renal cDNA Bank DKD datasets were used to evaluate *LPAR1* expression. Small molecule LPAR1 antagonist, GS-1148569, was evaluated *in vitro* in kidney fibroblasts, mesangial cells, tubular epithelial cells, and *in vivo* in a) rat adenine model of tubulointerstitial injury (8 weeks 0.25% adenine in diet, 6 week of treatment, PO, BID) and b) a mouse *db/db eNos*<sup>-/-</sup> mouse model of glomerulosclerosis (10 weeks of treatment starting from week 10, PO, BID).

**Results:** *LPAR1* mRNA expression is elevated in DKD kidney biopsies compared to healthy donors and negatively correlates with eGFR. In fibroblasts, mesangial cells and tubular epithelial cells, LPAR1 antagonist, GS-1148569 blocked LPA-induced Myocardin Related Transcription Factor A (MRTFA) nuclear translocation and profibrotic gene expression. In the rat adenine model, GS-1148569 significantly reduced plasma creatinine (1.0 ± 0.08 mg/dL vs 2.2 ± 0.22 mg/dL in vehicle), plasma BUN (37 ± 4.9 mg/dL vs 80 ± 6.8 mg/dL in vehicle), and plasma tubular injury markers, KIM1 (3.0 ± 1.3 ng/mL vs 9.6 ± 4.6 ng/mL vehicle) and NGAL (0.61 ± 0.43 µg/mL vs 1.1 ± 0.3 µg/mL in vehicle). GS-1148569 reduced tubulointerstitial fibrosis measured by Picrosirius Red (PSR) (12.5 ± 1.7 % area vs 21.7 ± 2.1% area in vehicle). In *db/db eNos*<sup>-/-</sup> mouse model, GS-1148569 reduced global glomerular sclerosis (6.5 ± 2.4 % glomeruli vs 26 ± 13.4 % glomeruli in vehicle) and increased GFR as assessed by FITC-sinistrin half-life change from week 10 to week 20 (-3.2 ± 3.3 min vs 2.2 ± 6.8 min in vehicle).

**Conclusions:** LPAR1 expression increases in DKD in correlation with disease severity. LPAR1 antagonism blocks profibrotic gene expression in fibroblasts and mesangial cells. LPAR1 antagonism preserves kidney function and halts fibrosis progression in adenine model and reduces global glomerular sclerosis in *db/db eNos*<sup>-/-</sup>. Altogether, LPAR1 is a promising therapeutic target for DKD.

**Funding:** Commercial Support - Gilead Sciences

#### SA-PO241

##### Nuclear Receptor Coactivator 3 Deficiency Damages Podocyte Injury Through Targeting Fyn/AMPK/mTOR Signaling Pathway

Xie Yaru. *Wuhan Union Hospital Department of Neurology, Wuhan, China.*

**Background:** Diabetic kidney disease (DKD) is one of the most common chronic complications of diabetes and has become the main cause of end-stage renal disease. Podocytes, the visceral epithelial cells of the renal capsule, adhere to the outer surface of the glomerular basement membrane (GBM), and form the glomerular filtration barrier with vascular endothelial cells and GBM. Podocytes are terminally differentiated cells that cannot efficiently proliferate and renew after damage. Therefore, once the podocytes are damaged to a certain extent, it will lead to damaged capillary loops and glomerulosclerosis. It is well known that high glucose is closely related to intercellular interactions and apoptosis of podocytes. However, the exact mechanism in high glucose-mediated podocyte injury has not been fully elucidated. Therefore, the study of podocyte injury and protection mechanisms is the key to the treatment of DKD.

**Methods:** C57 male mice were injected with STZ intraperitoneally to establish a diabetic nephropathy model, and the changes of NCOA3 and downstream indicators Fyn/AMPK/mTOR/autophagy were detected; at the same time, podocytes were stimulated with high glucose to verify the changes of the above indicators *in vitro*. The NCOA3 podocyte-specific knockout mice were constructed and STZ was injected. The blood and urine biochemical levels, renal pathological changes and the downstream indicators of Fyn/AMPK/mTOR/autophagy were detected. C57 male mice were injected with NCOA3 overexpressing virus via tail vein and intraperitoneally injected with STZ to establish a diabetic nephropathy model. Biochemical levels of blood and urine, renal pathological changes and downstream indicators of Fyn/AMPK/mTOR/autophagy were detected.

**Results:** This study found that NCOA3 expression was down-regulated in DKD. Knockout of NCOA3 in renal podocytes leads to renal pathological changes in mice, and upregulation of NCOA3 promotes the Fyn/AMPK/mTOR/autophagy pathway to inhibit the progression of diabetic nephropathy

**Conclusions:** The current findings suggest that NCOA3 is a key molecule in the development of diabetic nephropathy. NCOA3 can activate autophagy, thereby inhibiting disease progression, providing new ideas and targets for the treatment of diabetic nephropathy.

#### SA-PO242

##### Effects of Non-Steroidal Mineralocorticoid Antagonist (Finerenone) in Western Diet-Induced Kidney Disease

Komuraiah Myakala, Patricia de Carvalho Ribeiro, Xiaoxin Wang, Kyle E. Korolowicz, Olga C. Rodriguez, Chris Albanese, Moshe Levi. *Georgetown University Medical Center, Washington, DC.*

**Background:** Mineralocorticoid receptor (MR) overactivation plays a crucial role in the pathogenesis of chronic kidney disease, several cardiovascular and arterial diseases. Clinical studies demonstrated the beneficial effects of steroidal MR antagonists (MRAs) spironolactone and eplerenone on kidney disease. However, long term usage of MRAs increases the risk of hyperkalemia with reduced kidney function. We aim to test the non-steroidal MR antagonist Finerenone as a novel treatment of kidney disease in a mouse model of diet induced obesity and insulin resistance.

**Methods:** 2-month old C57BL/6J mice fed on low fat (LF) or western diet (WD) were treated with vehicle or FINERENONE for 6-months until they were 8 months old. Food intake and body weight was measured for every week during the entire study period. At the end of the study, 24-hour urine collected and serum and tissues were harvested for further evaluation. Blood pressure also measured via tail cuff. To assess the kidney function, dynamic contrast-enhanced (DCE) magnetic resonance imaging (MRI) was performed using Gadoxetate disodium (Eovist).

**Results:** The body weight and kidney weight were increased significantly in mice fed WD compared to LF fed mice (N=12), which were significantly reduced with Finerenone administration although the blood glucose levels did not change between all the groups. The WD fed mice exhibited significantly increased albuminuria, which was decreased with Finerenone treatment. In kidney of mice fed WD, we detected increased expression levels of pro-inflammatory cytokines MCP1 and TNF $\alpha$ , innate immunity pathways TLR2, STING and STAT3, and senescence marker p21. Their expression was significantly decreased with Finerenone. The DCE-MRI indicated that mice fed WD showed a more rapid and sustained uptake of Eovist in the kidney compared to mice fed LF, suggestive of reduced clearance capacity. In contrast, finerenone treatment in WD fed mice exhibited Eovist uptake and clearance rates more similar to those seen in the LF diet control mice.

**Conclusions:** Our data shows that administration of Finerenone exhibits renal protective role and prevent the progression of kidney disease in a mouse model of diet induced obesity and insulin resistance.

**Funding:** Commercial Support - BAYER

#### SA-PO243

##### High Glucose Stimulates Basolateral Secretion of Semaphorin 3G by Proximal Tubule Cells: Role in Anti-Angiogenesis

Paulo S. Caceres.<sup>1,2</sup> <sup>1</sup>Henry Ford Health System, Detroit, MI; <sup>2</sup>Wayne State University School of Medicine, Detroit, MI.

**Background:** Hyperglycemia in the diabetic kidney causes tubular and microvascular abnormalities that eventually lead to kidney damage. Given the close association between the proximal tubule and peritubular capillaries, a thorough understanding of their interaction could help identify mechanisms of diabetic kidney disease. Microvascular abnormalities are known to occur in diabetic patients and animal models. Despite known growth factors produced by the proximal tubule that could potentially target neighboring endothelial cells, it is not well understood whether the proximal tubule regulates angiogenesis. Here we propose that proximal tubule secretes Semaphorin-3G (Sema3G), an anti-angiogenic protein. We hypothesize, that high glucose stimulates Sema3G secretion by proximal tubule cells and inhibits angiogenesis.

**Methods:** We utilized co-cultures of RPTEC proximal tubule and HUVEC endothelial cell lines. We analyzed angiogenesis *via* tubulogenesis assays in Matrigel and cell migration *via* wound-healing assays. We assessed kidney angiogenesis in primary cultures of mouse kidney endothelial cells and sprouting angiogenesis in cortex explants from diabetic Akita mice.

**Results:** We observed decreased sprouting angiogenesis (baseline and VEGF-stimulated) in kidney cortex explants of diabetic Akita mice vs. C57BL counterparts. To identify a potential proximal tubule anti-angiogenic factor, we measured release of Sema3G from polarized RPTEC cells. We found that RPTEC cells secreted Sema3G basolaterally and this was stimulated by high glucose (25 mM). Conversely, RPTEC cells pre-grown on high glucose lost their ability to stimulate angiogenesis in co-cultured HUVEC endothelial cells. When we administered recombinant Sema3G to endothelial cells in culture, we found that Sema3G had little effect in baseline angiogenesis, but it inhibited VEGF-stimulated angiogenesis in HUVEC and primary culture of kidney endothelial cells. Finally, when we silenced the semaphorin receptor Plexin-D1 *via* shRNAs in endothelial cells, we observed accelerated cell migration in the absence or presence of co-cultured RPTEC cells, confirming the inhibitory role of semaphorin signaling in endothelial cells.

**Conclusions:** We conclude that RPTEC proximal tubule cells secrete Sema3G, which is stimulated by high glucose, and this anti-angiogenic factor inhibits angiogenesis in HUVEC and mouse kidney endothelial cells.

**Funding:** Private Foundation Support

## SA-PO244

## Developing a Small Molecule Therapeutic to Treat Diabetic Kidney Disease

Hassan Al-Ali,<sup>1</sup> Javier T. Varona Santos,<sup>1</sup> Haley M. Donow,<sup>2</sup> Marc Giulianotti,<sup>2</sup> Judith T. Molina David,<sup>1</sup> Alessia Fornoni,<sup>1</sup> Sandra M. Merscher,<sup>1</sup> Katz Center Drug Discovery <sup>1</sup>University of Miami School of Medicine, Miami, FL; <sup>2</sup>Florida International University, Miami, FL.

**Background:** Injury and loss of podocytes underly the development and progression of DKD. We previously showed that accumulation of lipid droplets (LDs) in podocytes is associated with increased lipotoxicity and cell death, and that reducing LD accumulation in podocytes combats DKD. We hypothesize that a targeted small molecule that directly blocks LD accumulation in podocytes can halt or reverse the progression of DKD.

**Methods:** A robust phenotypic screening assay utilizing immortalized human podocytes was developed to identify compounds that reduce LD accumulation in these cells. A combinatorial chemical library from the Torrey Pines Institute for Molecular Studies (TPIMS) containing over 45 million molecules was screened in the assay. Hits were identified based on their ability to reduce LD accumulation and rescue podocytes from cell death. RNAseq libraries from podocytes treated with one of the identified hits in the presence of sera from subjects with or without DKD were generated and analyzed.

**Results:** The assay identified several hits from the FIU library. Preliminary structure activity relationship (SAR) studies showed strong feasibility for hit-to-lead optimization of one series. A representative compound reduced the expression of genes related to TNF-signaling, a pathway associated with LD accumulation and podocyte injury, and the expression of lysosome-associated membrane glycoprotein (LAMP), which correlates with improved autophagy/lipophagy. Follow up mechanistic studies confirmed that the compound induces autophagic flux in podocytes, including strong induction of lipophagy, providing a candidate mechanism by which the compound protects these cells from lipotoxic stress. Our initial medicinal chemistry efforts have generated lead-like analogs that are appropriate for *in vivo* testing.

**Conclusions:** Our screen identified a promising molecular series that strongly reverses features of podocyte toxicity and death in DKD. We have launched a medicinal chemistry campaign to extend the SAR studies and have generated optimized compounds for *in vivo* validation in a mouse model of DKD. The compounds are currently being tested in db/db mice. Our results will enable the identification of novel drug targets and initiate the development of a therapeutic candidate for DKD.

**Funding:** NIDDK Support

## SA-PO245

## L-Lysine Dietary Supplementation Attenuates Hyperglycemia in Type 2 Diabetic Nephropathy Rats

Olha Kravtsova,<sup>1</sup> Elena Isaeva,<sup>3</sup> Oleg Palygin,<sup>2</sup> Alexander Staruschenko,<sup>1,4</sup> <sup>1</sup>University of South Florida, Tampa, FL; <sup>2</sup>Medical University of South Carolina Department of Medicine, Charleston, SC; <sup>3</sup>Medical College of Wisconsin, Milwaukee, WI; <sup>4</sup>VA James A Haley Hospital, Tampa, FL.

**Background:** Diabetic kidney disease (DKD) is one of the main complications of diabetes, leading to the progression of end-stage kidney failure. Recent studies provide evidence that dietary supplementation of the essential amino acid lysine significantly attenuates proximal tubule reabsorption and is critical for the regulation of kidney function. To explore the effect of lysine on hyperglycemia in the late stage of DKD progression, we used Type 2 Diabetic Nephropathy (T2DN) rats, a non-obese model of spontaneous development of diabetes, and similar renal injuries to clinical manifestation of DKD in humans.

**Methods:** Male T2DN rats (>48 weeks old) were kept on a Purina diet. L-lysine chloride or L-lysine acetate (91 mol/l) was supplied ad libitum in drinking water for 10 days. Fasting blood was collected from the tail vein, and glucose levels were determined with a glucometer. pH and electrolytes were measured with a blood gas analyzer. Plasma and kidney tissue were collected at the end of the experiment. RT-PCR and Western blotting were performed for mRNA and protein expression analysis.

**Results:** We found that L-lysine administration (chloride or acetate) attenuates hyperglycemia (197 ± 53 to 119 ± 10 after L-lysine chloride & 121 ± 6 to 73 ± 15 after L-lysine acetate, mg/dL glucose, *p*<0.01) in T2DN rats. mRNA expression of *Slc5a2*, the gene that encodes SGLT2, did not differ in both groups compared to untreated controls. Interestingly, chloride salt of lysine leads to acidosis compared to acetate (7.25 ± 0.02 vs. 7.46 ± 0.02 blood pH, respectively), probably due to increased Cl<sup>-</sup> supplementation. In comparison with untreated diabetic rats, lysine supplement leads to a lower abundance of transporters responsible for pH homeostasis. In particular, the expression of NHE3, and NBCe1 (only chloride group), mostly abandoned in proximal tubule cells, were decreased. Similarly, cortical collecting duct expression of V-ATPase B1/2 was reduced.

**Conclusions:** Our data suggest that essential dietary lysine supplementation results in a marked reduction of blood glucose in T2DN rats. That indicates that simple amino acid administration could be used for the treatment of hyperglycemia and type 2 diabetes complications.

**Funding:** Other NIH Support - R35 HL135749, Veterans Affairs Support

## SA-PO246

## Reno-Protective Effect of Liraglutide in Type 1 Diabetes Mellitus (T1DM): Shifting Macrophage Polarization Towards the M2 Anti-Inflammatory Phenotype Through NADPH/TRP Dual Inhibition

Natalie Youssef, Mohamad Nourledein, Fuad N. Ziyadeh, Assaad Antoine Eid. American University of Beirut, Beirut, Lebanon.

**Background:** Diabetic kidney disease (DKD) is a major complication of diabetes. It is speculated that macrophages may be involved in the initiation as well as the progression of the immune response in DKD. After infiltrating the glomeruli, macrophages can polarize into an M1 pro-inflammatory phenotype or an M2 anti-inflammatory one. In addition to inflammation, extensive data from the literature highlight the deleterious effects of reactive oxygen species (ROS) over-production as well as dysregulation of calcium signaling on progression of DKD. Several hypoglycemic agents such as liraglutide, a GLP-1RA, have been investigated for their reno-protective effects. However, their exact mechanism of action still needs to be elucidated. Herein, we aim to investigate the reno-protective effect of liraglutide in type 1 diabetes mellitus (T1DM) by regulating macrophage polarization through the NADPH/TRP signaling pathway.

**Methods:** Functional, histopathological, biochemical and molecular parameters were assessed in control, T1DM, and T1DM C57/BL6J mice treated with liraglutide (0.3 mg/kg body weight) for 13 weeks.

**Results:** Liraglutide treatment improves kidney injury as assessed by improved BUN, urinary albumin to creatinine ratio (ACR), and proteinuria. This reno-protective effect of liraglutide was further confirmed using histopathology analysis exhibited by reduced glomerular hypertrophy, decreased glomerulosclerotic index and collagen deposition. Of interest, these results were associated with decreased mRNA expression of inflammatory cytokines, as well as the M1 phenotype specific markers STAT1, CCL5, CXCL9, and CXCL10. This was paralleled by an increase in the mRNA expression of anti-inflammatory cytokines, as well as the M2 phenotype specific markers ARG-1, CD206, Retna, CCL17 and CCL22. In addition, liraglutide treatment attenuated ROS overproduction by reducing NADPH oxidase activity by decreasing DUOX-1 and DUOX-2 levels. These observations were paralleled by a decrease in diabetes-induced TRPC6 and TRPM2 protein expression and mRNA levels.

**Conclusions:** To our knowledge, this is the first study to show an anti-inflammatory reno-protective effect of liraglutide in T1DM manifested by a shift in macrophage polarization towards the M2 phenotype possibly through NADPH/TRP dual inhibition.

**Funding:** Private Foundation Support

## SA-PO247

## Runcaciguat, a Novel Soluble Guanylate Cyclase (sGC) Activator, Shows Kidney Protection in Models of CKD

Jan R. Kraehling,<sup>1</sup> Tibor Schomber,<sup>1,3</sup> Agnes M. Benardeau,<sup>1,2</sup> Antje Kahnert,<sup>1</sup> Laura Popp,<sup>1</sup> Julia Vienenkoetter,<sup>1</sup> Heidrun C. Ellinger-Ziegelbauer,<sup>1</sup> Mira Pavkovic,<sup>1</sup> Axel Kretschmer,<sup>1</sup> Bettina Lawrenz,<sup>1</sup> Elke Hartmann,<sup>1</sup> Krystyna Siudak,<sup>1</sup> Alexius Freyberger,<sup>1</sup> Ina Hagelschuer,<sup>1</sup> Ilka Mathar,<sup>1</sup> Jörg Hüser,<sup>1</sup> Michael G. Hahn,<sup>1</sup> Johannes-Peter Stasch,<sup>1</sup> Volker Geiss,<sup>1</sup> Frank Eitner,<sup>1</sup> Peter Sandner.<sup>1</sup> <sup>1</sup>Bayer AG, Leverkusen, Germany; <sup>2</sup>Novo Nordisk AS Gøbal Research, Malov, Denmark; <sup>3</sup>Vincex Pharma, Leverkusen, Germany.

**Background:** The novel sGC activator runcaciguat is currently being studied in a Phase II trial in proteinuric CKD patients (NCT04507061) and targets the oxidized and heme-free form of sGC, restoring cGMP production under oxidative stress.

**Methods:** Runcaciguat was tested in hypertensive rats, the renin transgenic (RenTG) rat, and angiotensin-supplemented (ANG-SD) rat as well as in rats with diabetic and metabolic CKD, Zucker diabetic fatty (ZDF), and ZSF-1 rats. The model specific treatment duration ranged up to 42 wks Runcaciguat was applied orally in doses of 1, 3, and 10 mg/kg/bid.

**Results:** In all four rat CKD models, runcaciguat significantly and dose-dependently reduced proteinuria by 40% to 55% (Table 1, Figure 1). Long-term, 42 wks treatment of ZDF rats demonstrated additional improvements in GFR decline as well as improvements in tubular degeneration, glomerulopathy, protein casts, and fibrosis.

**Conclusions:** Runcaciguat exhibits kidney protection in a broad range of CKD models with hypertensive as well as diabetic and metabolic etiologies that justifies its further exploration in proteinuric CKD patients.

uPCR reduction

	RenTG	ANG-SD	ZDF	ZSF-1
uPCR	39.4%	56.6%*	49.8%*	53.7%*

\*, statistical significant difference at 3 mg/kg bid compared to placebo

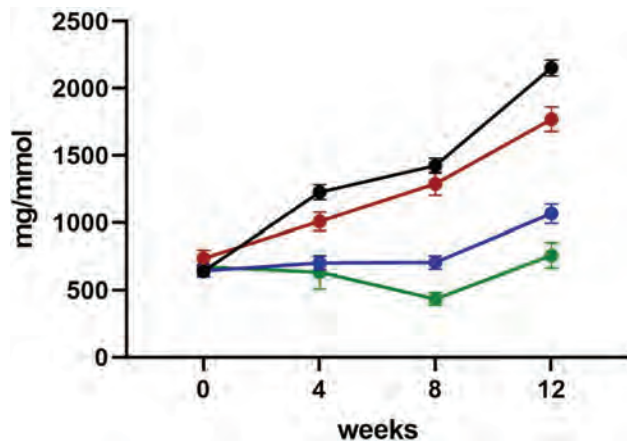

#### Proteinuria (uPCR) in ZSF1 obese rats

black, placebo; red, 1 mg/kg/bid; blue, 3mg/kg/bid; green, 10 mg/kg/bid

At weeks 4 and at 12 of treatment, all three doses lower proteinuria significantly. At week 8, 3 mg/kg/bid and 10 mg/kg/bid lower proteinuria significantly.

Data are mean  $\pm$  SEM. Statistics determined by one-way ANOVA followed by Tukey's multiple comparison test.

#### SA-PO248

##### The Novel, Clinical Stage Soluble Guanylate Cyclase Activator BI 685509 Slows the Progression of Diabetic Nephropathy in db/db Mice

Nisha Sharma,<sup>1</sup> Wenjin Liu,<sup>1</sup> Anna Tang,<sup>1</sup> Michael P. Pieper,<sup>2</sup> Glenn A. Reinhart,<sup>2</sup> Yufeng Huang.<sup>1</sup> <sup>1</sup>University of Utah Health, Salt Lake City, UT; <sup>2</sup>Boehringer Ingelheim International GmbH, Ingelheim, Germany.

**Background:** Activation of soluble guanylate cyclase (sGC) to restore cyclic guanosine monophosphate (cGMP) and improve functionality of nitric oxide (NO) pathways impaired by oxidative stress is a potential treatment for chronic and diabetic kidney disease (CKD and DKD). Administration of BI-685509, a novel, orally active small molecule sGC activator has been shown to reduce tubulointerstitial fibrosis in the rat UUO model. This study sought to determine whether administration of BI-685509 could slow the progression of glomerulosclerosis in db/db mouse, a model of type 2 diabetes often characterized by relative NO deficiency.

**Methods:** Five groups of 10 mice including normal control, diabetic db/db mice without treatment but being terminated at 14 weeks and 20 weeks respectively, diabetic db/db mice treated with one of two doses of BI-685509 (30 and 100 mpk/day mixed in mouse diet) from weeks 14 to 20. All mice received uninephrectomy at 8 weeks of age to accelerate the development of kidney disease.

**Results:** Untreated db/db mice that had obesity, hyperglycemia, and hypertriglyceridemia (TG), developed progressive albuminuria and glomerular mesangial matrix expansion between weeks 14 and 20, linked with increased renal production of fibronectin (FN) and type IV collagen (Col-IV); renal oxidative stress was evident by increased Nox4 expression and urinary malondialdehyde (MDA) secretion. Although body weight was comparable in diabetic groups, BI-685509 at the two doses reduced both blood HbA1c (10.4 $\pm$ 1.4%, 9.7 $\pm$ 1.9% respectively, vs. 11.8 $\pm$ 1.6% of untreated db/db at 20 weeks, P<0.05) and TG levels (41.2 $\pm$ 14.9, 22.7 $\pm$ 12.6 mg/dL respectively, vs. 64.1 $\pm$ 21.6 mg/dL of untreated db/db at weeks, P<0.05). Importantly, high dose of BI-685509 slowed the progression of albuminuria. BI-685509 at both doses markedly retarded the increases in glomerular matrix accumulation similarly (by 33%, P<0.05) seen in db/db mice. However, high dose of BI-685509 markedly reduced the renal FN and Col-IV production and renal oxidative stress markers.

**Conclusions:** These results suggest that treatment with BI-685509 for 6 weeks slow the progression of diabetic nephropathy in db/db mice via multiple actions and underscores its therapeutic potential in CKD and DKD. Currently, BI-685509 is in Phase II clinical trial to be tested for CKD and DKD.

**Funding:** Commercial Support - Boehringer Ingelheim Pharma GmbH & Co. KG

#### SA-PO249

##### High Glucose Induces Podocyte Dedifferentiation and Morphological Modification in Kidney Organoids

Giulia Spennati,<sup>1</sup> Heather H. Ward,<sup>2</sup> Anil K. Karihaloo,<sup>2</sup> Benjamin S. Freedman.<sup>1</sup> <sup>1</sup>University of Washington, Seattle, WA; <sup>2</sup>Novo Nordisk Inc Seattle, Seattle, WA.

**Background:** Human kidney organoids are self-assembled 3-dimensional structures containing nephron components. Healthy organoids exhibit distal and proximal tubules interconnected with podocytes organized in a sphere. Kidney organoids represent a valid platform to study disease mechanisms due to the ability to replicate pathway aberration and altered cell-cell interaction to mimic human disease. Nevertheless, the impact of high glucose in these cultures is not yet known. We compared the effects of high and low glucose on kidney organoids with the aim of building a model for diabetic nephropathy.

**Methods:** Organoids were differentiated under standard glucose until maturation, then cultured 6 days under glucose ranging from 0 to 100 mM. Equivalent mannose concentrations evaluated the osmotic effect. At days 0, 3, and 6 each whole well was imaged and organoids scored, along with morphologic and metabolic analysis (LDH, lactate). Immunofluorescent analysis and live and dead assay were performed on day 6.

**Results:** Data showed reduction of organoid number and increased metabolism under high glucose. Surprisingly, the effect of high glucose did not correlate with cell death but organoids appeared to be changing in structure and marker expression. Mannose culture indicated a non-osmotic cause of injury. Under high glucose, we observed increased numbers of podocytes that appeared to be dedifferentiating and undergoing epithelial to mesenchymal transition. This observation was supported by Zo1 staining indicating an interconnection of podocytes migrating out from the main glomerular area.

**Conclusions:** We have induced a diabetic-like phenotype in kidney organoids under high glucose conditions, indicating that this platform may represent a valid model to study diabetic nephropathy. The dedifferentiation of podocytes is of particular interest, given that glomerular function is often compromised in patients. Future work will be directed to further develop this model with the aim of screening novel therapeutics.

**Funding:** Commercial Support - Novo Nordisk

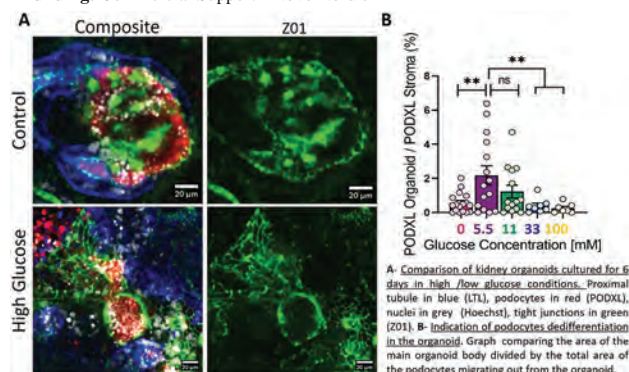

#### SA-PO250

##### Histone Deacetylase Inhibitors Enhance the Urinary Tract's Immune Response in Diabetic Mice

Aaron A. Simoni,<sup>1</sup> Laura Schwartz,<sup>1</sup> M. Skye N. Bochter,<sup>1</sup> Kristin Bender,<sup>1</sup> John D. Spencer.<sup>1,2</sup> <sup>1</sup>Abigail Wexner Research Institute at Nationwide Children's Hospital, Columbus, OH; <sup>2</sup>The Ohio State University College of Medicine, Columbus, OH.

**Background:** People with diabetes mellitus (DM) have an increased risk for developing urinary tract infection (UTI). With UTI, people with DM are more likely to experience acute kidney injury and develop chronic kidney disease. Epigenetic mechanisms such as histone and protein acetylation have emerged as factors contributing to DM and may impact UTI risk. Recently, a class of drugs called histone deacetylase inhibitors (HDACi) have been shown to improve glucose sensitivity as well as decrease infection risk. To investigate the role of HDACi on UTI antibacterial defenses, we treated diabetic mice with MS-275, a class I HDACi.

**Methods:** Type 2 DM db/db mice, which have increased UTI susceptibility, were treated with 10mg/kg intraperitoneal (i.p.) MS-275 every 48 hours for a total of 8 doses. Weight, blood glucose, urine glucose, and serum insulin concentrations were measured after MS-275 or vehicle treatment. We also assessed insulin sensitivity by performing a glucose tolerance test in which mice were fasted for 6 hours and given i.p. glucose (1g/kg) prior to obtaining serial blood glucose measurements. Quantitative real-time PCR (qRT-PCR) was used to quantify innate immune genes that prevent UTI, including urothelial barrier genes that prevent bacterial invasion and antimicrobial peptides (AMP) which kill invading pathogens.

**Results:** After 4 doses of MS-275, serum glucose and insulin concentrations in diabetic mice normalized and decreased 7-fold. MS-275 treated mice also had significantly lower glucosuria, showing an 8-fold reduction compared to vehicle treated mice. MS-275 treatment improved glucose tolerance while vehicle treated mice showed minimal glucose clearance. qRT-PCR showed suppressed bladder HDAC expression with MS-275 treatment. Importantly, we observed an induction of bladder urothelial barrier genes (*Tjp1*, *Cldn2*, *Cldn4*, *Upk1a*, and *Upk2*) and AMPs (*Camp*, *Defb1*, *Lcn2*, *Rnase4*, *Sipi*) in MS-275 treated mice compared to vehicle.

**Conclusions:** These results suggest that histone acetylation status may play a role in DM-mediated UTI defense. By increasing bladder barrier strength and AMP production using MS-275, the kidneys may be shielded from the deleterious effects of DM and UTI. Further studies are needed to assess the effectiveness of using MS-275 in individuals with DM to reduce UTI susceptibility and protect the kidneys.

**Funding:** NIDDK Support



## SA-PO251

**FRMD3/Protein 4.1O Splice Variants Regulate Hippo Signaling and Cell Migration**

Eva Koenigshausen,<sup>1</sup> Timo Reisewitz,<sup>1</sup> Larissa Matten,<sup>1</sup> Theresia Vienken,<sup>1</sup> Thorsten Wiech,<sup>2</sup> Lars C. Rump,<sup>1</sup> Lorenz Sellin.<sup>1</sup> <sup>1</sup>Heinrich-Heine-Universität Düsseldorf, Düsseldorf, Germany; <sup>2</sup>University Hospital Hamburg-Eppendorf Department of Pathology, Hamburg, Germany.

**Background:** FRMD3 has been identified as a candidate gene for diabetic nephropathy and encodes for protein 4.1O. Different protein 4.1O splice variants have been identified. In diabetic kidney disease Hippo signaling (key effectors Yes-associated kinase (YAP) and its paralogue TAZ) is increased. Unphosphorylated YAP/TAZ activates target genes via different transcription factors (e. g. c-myc). Phosphorylated YAP/TAZ remains within the cytoplasm and is degraded. Activation of YAP/TAZ is increased by Myosin light chain kinase (MLCK). C-myc, YAP/TAZ and growth factors, e. g. EGF, have been shown to promote cell migration.

**Methods:** Human kidney biopsy samples from healthy and diabetic patients were stained for protein 4.1O. HEK293T cells were stimulated with low (5 mM), high (25 mM) glucose concentrations or an osmotic control (5mM glucose + 19.5 mM mannitol). RNA was isolated and PCR performed. A c-myc reporter assay was analyzed. HEK293T cells expressed protein 4.1O splice variants or the control and were stimulated with low, high glucose or mannitol. After cell lysis, western blot was performed for phospho-YAP, myosin light chain (MLC), phospho-MLC and actin. Human podocytes were stably transduced with 4.1O splice variants. For migration assays, human podocytes were stimulated with FCS or EGF.

**Results:** Protein 4.1O expression is detected in healthy human glomeruli. In diabetic patients with CKD stage 3b to 5 and gross proteinuria protein 4.1O expression seems to be increased in podocytes. High glucose leads to enhanced transcription of FRMD3. Under high glucose condition protein 4.1O significantly increases YAP phosphorylation. This effect is abrogated if a splice variant lacking a c-terminal domain is expressed. In line with this finding, protein 4.1O decreases c-myc transactivation. MLC phosphorylation is not altered by 4.1O splice variants in high, low glucose or mannitol. Protein 4.1O (lacking the FERD domain and a c-terminal domain) reduces podocyte migration.

**Conclusions:** Expression of protein 4.1O is increased in human diabetic kidney disease and under high glucose conditions. Protein 4.1O splice variants have differential effects on c-myc transactivation, YAP/TAZ activation and migration. This improved understanding of protein 4.1O splice variant function helps to better understand its role in diabetic nephropathy.

## SA-PO252

**Gene-Based Burden Analysis of De Novo Sphingolipid Pathway Genes Identifies CERS3 as a Potential Risk Gene in Advanced Diabetic Kidney Disease**

Christopher A. Simeone,<sup>1,2</sup> Joseph L. Wilkerson,<sup>3</sup> Scott Summers,<sup>3</sup> Marcus G. Pezzolesi.<sup>1,2</sup> <sup>1</sup>University of Utah, Department of Human Genetics, Salt Lake City, UT; <sup>2</sup>University of Utah, Nephrology & Hypertension, Salt Lake City, UT; <sup>3</sup>University of Utah, Department of Nutrition and Integrative Physiology, Salt Lake City, UT.

**Background:** Identifying the genetic factors influencing diabetic kidney disease (DKD) susceptibility remains challenging. Recent studies have demonstrated that ceramides, a class of sphingolipids, are antagonists for insulin signaling and drivers of DKD progression. Sphingolipid profiles have been explored in DKD, although little is known about the genetic architecture underlying aberrant sphingolipid levels in DKD. Here, we investigated the burden of rare, pathogenic variants in genes within the *de novo* sphingolipid pathway in patients with advanced DKD.

**Methods:** We examined 33 genes in two cohorts with advanced DKD (eGFR < 30): The Chronic Renal Insufficiency Cohort (CRIC, n=656) and the Utah Kidney Study (UKS, n=185). Genotype data from CRIC was imputed ( $R^2 \geq 0.4$ ) using the Michigan Imputation Server and variants localized to genes of interest were selected, while targeted sequencing of these same genes was performed for participants of the UKS. Using summary data from gnomAD (71,702 control genomes), we performed a two-stage, gene-based burden analysis of rare variants (gnomAD global AF filter < 0.01) using the TRAPD software package to identify reproducible candidate genes across cohorts. We performed immunofluorescence in kidneys and functional analyses of the top candidate gene identified in these analyses.

**Results:** Gene-based burden analyses identified *CERS3* as a significant, reproducible candidate gene in both the CRIC and UKS cohorts. Nominal significance was observed in two *ORMDL* genes after filtering variants for CADD score  $\geq 20$ . Immunofluorescence demonstrated the presence of *CERS3* in the tubules of mouse and human kidney tissues. Additionally, metabolic flux assays suggest that genetic variation in *CERS3* reduces Cer d18:1/26:0 produced in HEK293T cells.

**Conclusions:** *CERS3* is a ceramide synthase that produces longer acyl chain ceramides ( $\geq C26$ ). Interestingly, common variants in a similar family member, *CERS2*, have also been associated with renal phenotypes in patients with diabetes, suggesting that this family of enzymes may play a role in DKD susceptibility. Further examination is necessary to fully characterize the influence of *CERS3* on DKD progression.

**Funding:** NIDDK Support

## SA-PO253

**Exosomal or Non-Exosomal Profiles: Origin of Circulating miRNAs Associated With ESKD in Diabetes**

Eiichiro Satake,<sup>1,2</sup> Natalia Z. Nowak,<sup>1,3</sup> Zaipul I Md Dom,<sup>1,2</sup> Hiroki Kobayashi,<sup>1,4</sup> Joseph Ricca,<sup>1</sup> Bozenna Krolewski,<sup>1,2</sup> Marcus G. Pezzolesi,<sup>5</sup> Ronald Kahn,<sup>1,2</sup> Andrzej S. Krolewski,<sup>1,2</sup> <sup>1</sup>Joslin Diabetes Center, Boston, MA; <sup>2</sup>Harvard Medical School, Boston, MA; <sup>3</sup>Trinity College Dublin School of Medicine, Dublin, Ireland; <sup>4</sup>Nihon Daigaku Igakubu Daigakuin Igaku Kenkyuka, Itabashi-ku, Japan; <sup>5</sup>University of Utah, Salt Lake City, UT.

**Background:** microRNAs (miRNAs) are 22 nt non-coding RNA molecules that can regulate gene and protein expression both in the cells that produce them and, potentially, in distant cells acting via secretion into the circulation. Previously, we identified 17 miRNAs in plasma that were either positively (risk) or negatively (protection) associated with progression to ESKD (*JASN* 2021). To elucidate possible mechanisms of transport of these miRNAs in the circulation, we compared levels of these miRNAs in plasma with their levels in exosomes.

**Methods:** Plasma from 55 T1D patients was divided into 11 pools (5 patients per pool), and exosomes isolated using size exclusion chromatography. miRNA levels in the 11 plasma and exosome pools were then assessed using the HTG EdgeSeq platform. The data were quantile normalized and analyzed using the R packages edgeR and limma.

**Results:** Out of 2083 miRNAs on the HTG platform, 463 (22%) were detected only in plasma, 72 (3%) were only in exosome, while 1358 were detected in both specimens. Of these, 437 (21%) had significantly higher (fold-change >2 and  $p < 3.7 \times 10^{-5}$ ) concentrations in exosomes than in plasma, 402 miRNAs (19%) were higher in plasma than in exosomes, and 519 (25%) were similar in both specimens. All of the 17 ESKD-associated miRNAs were detected in both specimens, however, the relationship between concentration in exosomes and plasma were different between protective and risk miRNAs. Among the 9 protective miRNAs, 4 had similar concentration in plasma and exosomes, and 5 were significantly higher in plasma than in exosomes. Among the 8 risk miRNAs, all had low concentrations in exosomes and dramatically higher (5–400 fold) in plasma.

**Conclusions:** This study shows that the majority of the ESKD-associated miRNAs have low concentrations in exosomes but very high in plasma, indicating that the ESKD-associated miRNAs are present mainly in non-exosomal plasma fraction. Mechanisms of their release into circulation and uptake by target tissue(s) are unknown but differ from those for the miRNAs transported mainly in exosomes. Understanding how these non-exosomal miRNAs are secreted and act on the kidney should provide new insights into the mechanism of the progression of diabetic kidney disease to ESKD and its possible treatment.

**Funding:** NIDDK Support, Private Foundation Support

## SA-PO254

**Characterising the Pro-Oxidant Enzyme NOX5 as a Potential Therapeutic Target for Diabetic Kidney Disease**

Jay C. Jha,<sup>1</sup> Aozhi Dai,<sup>1</sup> Vincent Jaquet,<sup>2</sup> Mark E. Cooper,<sup>1</sup> Karin Jandeleit-Dahm.<sup>1</sup> Diabetic Kidney Disease Lab. <sup>1</sup>Monash University Department of Diabetes, Melbourne, VIC, Australia; <sup>2</sup>Universite de Geneve, Geneva, Switzerland.

**Background:** Diabetic kidney disease (DKD) is the leading cause of end stage renal failure. Enhanced level of renal reactive oxygen species (ROS) produced by the pro-oxidant enzyme NADPH oxidase-NOX5 is considered a major contributor in aggravating renal injury in DKD. We aim to characterise the pathogenic role of NOX5 and associated ROS-sensitive pathways in DKD using various experimental models including human diabetic kidney biopsies, human diabetic renal organoids and cells as well as humanised NOX5 transgenic diabetic mice models.

**Methods:** We examined the expression of NOX5 in association with ROS-sensitive factors including a transcription factor, EGR1 (early growth response 1), a protein kinase, PKC- $\alpha$  and a key metabolic gene involved in redox balance, TXNIP (thioredoxin-interacting protein), as well as ROS production in human kidney biopsies as well as in human renal organoids and cells. We assessed the effect of NOX5 inhibition using genetic manipulation and pharmacological inhibition approaches in human renal cells and organoids exposed to diabetic milieu environment. In vivo, we also assessed the effect of Nox5 overexpression independent of NOX4 in humanised Nox5 transgenic mice in the presence or absence of diabetes.

**Results:** We identified increased expression of renal NOX5 in diabetic patients in association with upregulation of EGR-1, PKC- $\alpha$  and TXNIP. Silencing of Nox5 attenuated high glucose induced gene expression of markers of fibrosis and inflammation as well as downregulation of EGR-1, PKC- $\alpha$  and TXNIP. Our data also suggest that Nox5 appears to be upstream of Nox4 and that Nox5 inhibition also downregulates Nox4, but not vice versa. In vivo, overexpression of Nox5 independent of NOX4 pathways demonstrated an increase in albuminuria, renal fibrosis and inflammation in association with upregulation of EGR-1, ERK1/2, PKC- $\alpha$ , PKC- $\epsilon$  and TXNIP via enhanced ROS production in comparison to diabetic mice not expressing Nox5.

**Conclusions:** These findings suggest that NOX5 plays a key pathogenic dominant role in human DKD, thereby providing the fast track validation of NOX5 specific inhibitors to combat DKD in humans.

## SA-PO255

**Mechanistic Role of Renal Tubular Mitochondrial AKT1 in Metabolic Syndrome-Induced Renal Injuries**

Hugo Y. Lin,<sup>1,2</sup> Chia-Hung Yen,<sup>5</sup> Yi-Siao Chen,<sup>5</sup> I-Ya Chen,<sup>3</sup> Jee-Fu Huang,<sup>5,2</sup> Tzongshih Lu,<sup>4</sup> <sup>1</sup>Kaohsiung municipal Ta-Tung Hospital, Kaohsiung, Taiwan; <sup>2</sup>Kaohsiung Medical University Chung Ho Memorial Hospital, Kaohsiung, Taiwan; <sup>3</sup>Chang Gung University, Taoyuan, Taiwan; <sup>4</sup>Brigham and Women's Hospital Department of Medicine, Boston, MA; <sup>5</sup>Kaohsiung Medical University, Kaohsiung, Taiwan.

**Background:** Metabolic syndrome (MetS) is associated with kidney diseases, but the etiology is inconclusive. Recent evidence suggests that mitochondrial dysfunction, which can be modulated by AKT1, may play a critical role in kidney injury. We hypothesized that renal tubular mitochondrial AKT1 signaling plays a mechanistic role in the pathogenesis of kidney injuries in MetS.

**Methods:** We executed the study with 8-week C57BL/6 male mice fed with high fat diet (21.1% fat, 41% sucrose, and 1.25% cholesterol by weight) and a high sugar solution (23.1g/L d-fructose, and 18.9g/L d-glucose) for six months, compared with mice fed with normal chow diet and normal tap water.

**Results:** In our murine MetS model, the body weight was raised ( $p < 0.001$ ). The kidney size as a percentage of body weight was similar ( $p = 0.765$ ). For the glucose tolerance test, the fasting glucose level was significantly higher in MetS mice as compared to normal diet mice ( $p = 0.003$ ). From 15 to 120 minutes, the glucose levels were significantly elevated ( $p = 0.022$ ). The shape of the intraperitoneal glucose tolerance test curve at three months was dissimilar to that at six months, and the AUC value at six months was higher ( $p = 0.013$ ). The fasting hyperinsulinemia ( $p = 0.017$ ) and insulin resistance measured by Homeostatic Model Assessment for Insulin Resistance was elevated ( $p = 0.003$ ). For renal function, although serum BUN ( $p = 0.785$ ) and creatinine ( $p = 0.654$ ) in MetS mice were not changed, the proteinuria ( $p = 0.023$ ), and the urine KIM-1 ( $p = 0.014$ ) were raised. There were prominent glomerulosclerosis index ( $p = 0.032$ ), tubulointerstitial fibrosis score ( $p = 0.015$ ), tubular dilatation score ( $p = 0.038$ ), tubular vacuolation score ( $p = 0.028$ ), and tubular casts ( $p = 0.031$ ) of renal histology. To further dissect the role of mitochondrial AKT1 signaling during MetS in the renal tubules, we have examined the mitochondrial AKT1 protein. There was increasing accumulation of phosphorylated AKT1 ( $p = 0.030$ ) in the mitochondria at proximal tubule after MetS. AKT1 translocation was confirmed with immunohistochemistry stain and western blots of mitochondria proteins.

**Conclusions:** These findings shed new light on the mechanistic role of renal tubular mitochondrial AKT1 in MetS-induced kidney injuries and may be used to develop new strategies for the prevention and treatment of kidney diseases.

**Funding:** Government Support - Non-U.S.

## SA-PO256

**Store-Operated Ca<sup>2+</sup> Entry Inhibition Ameliorated High Glucose- and Ang2-Induced Podocyte Apoptosis and Mitochondria Damage**

Yu Tao,<sup>1</sup> Parisa Yazdizadeh Shotorbani,<sup>1</sup> Zhenglan Chen,<sup>1</sup> Denise M. Inman,<sup>2</sup> Rong Ma,<sup>1</sup> <sup>1</sup>University of North Texas Health Science Center, Department of Physiology and Anatomy, Fort Worth, TX; <sup>2</sup>University of North Texas Health Science Center, North Texas Eye Research Institute, Pharmaceutical Science, Fort Worth, TX.

**Background:** Diabetic Nephropathy (DN) is the most common cause of end stage renal disease. Podocyte apoptosis is one of early features of the disease and mitochondria impairment is a contributor to podocyte injury in diabetic kidney. Hyperglycemia and increased renal angiotensin II (ANG II) are two pathogenic stimuli for onset and progression of podocyte pathology in DN. However, the mechanism of the podocyte injury induced by the diabetes-related stress is not fully understood. Store-operated Ca<sup>2+</sup> entry (SOCE) has multiple functions in both excitable and non-excitable cells. It is known that ANG II activates SOCE by releasing endoplasmic reticulum Ca<sup>2+</sup>. Our previous study demonstrated that high glucose (HG) treatment enhanced SOCE by increasing Orai1 protein abundance in podocyte. However, the role of SOCE in podocyte apoptosis and mitochondria dysfunction in the setting of diabetes remains unclear. The present study was carried out to test the hypothesis that enhanced SOCE mediated HG- and ANG II-induced podocyte apoptosis and mitochondria damage.

**Methods:** All experiments were performed using cultured human podocytes. BTP2 (4  $\mu$ M) was used as the SOCE inhibitor. Podocyte apoptosis was determined by flow cytometry using Annexin V/Propidium iodide (PI) staining. Mitochondria function was evaluated by measuring: 1) the mitochondria membrane potential (MMP) using TMRE fluorescence, 2) generation of mitochondria reactive oxygen species (ROS) using MitoSox Red Mitochondrial Superoxide Indicator, 3) ATP production using ATP assay kit, and 4) mitochondria respiratory function [oxygen consumption rate (OCR)] and mitochondria ATP production by Seahorse analysis.

**Results:** Both HG (25 mM) and ANG II (1  $\mu$ M) treatments for 24 hours significantly increased podocyte apoptosis. All responses were significantly blunted by BTP2 (4  $\mu$ M). HG (25 mM) treatment significantly decreased podocyte MMP, ATP production and increased mitochondrial ROS generation, all of which were significantly inhibited by BTP2 treatment. Furthermore, HG (25 mM) and ANG II (1  $\mu$ M) treatment for 24 hours significantly reduced podocyte OCR and mitochondria ATP production, which were significantly blunted by BTP2.

**Conclusions:** SOCE contributed to HG- and ANG II-induced podocyte apoptosis and mitochondria damage.

**Funding:** NIDDK Support

## SA-PO257

**SGLT2 Inhibitors Attenuate Hypoxia and HIF1A Expression in Young Persons With Type 2 Diabetes**

Jennifer A. Schaub,<sup>1</sup> Viji Nair,<sup>1</sup> Fadhl Alakwaa,<sup>1</sup> Phillip J. McCown,<sup>1</sup> Abhijit S. Naik,<sup>1</sup> Patricia E. Ladd,<sup>2</sup> Roger K. Harned,<sup>2</sup> Helen C. Looker,<sup>4</sup> Pottumarthi V. Prasad,<sup>3</sup> Luping Li,<sup>3</sup> Laura Pyle,<sup>2</sup> Frank C. Brosius,<sup>5</sup> Robert G. Nelson,<sup>4</sup> Matthias Kretzler,<sup>1</sup> Petter Bjornstad.<sup>2</sup> <sup>1</sup>University of Michigan, Ann Arbor, MI; <sup>2</sup>Children's Hospital Colorado, Aurora, CO; <sup>3</sup>NorthShore University HealthSystem, Evanston, IL; <sup>4</sup>National Institute of Diabetes and Digestive and Kidney Diseases, Bethesda, MD; <sup>5</sup>The University of Arizona College of Medicine Tucson, Tucson, AZ.

**Background:** SGLT2 inhibitors (SGLT2i) are protective in diabetic kidney disease. Their potential impact on kidney oxygenation and transcriptional responses to hypoxia were assessed.

**Methods:** Blood oxygen level dependent-MRI data were available in young persons with type 2 diabetes (T2D, n=22, 13 on SGLT2i). Single-cell RNA sequencing data were generated from research kidney biopsies in a subset of T2D (n=16, 10 on SGLT2i) and healthy controls (HC, n=6) and compared to tubulointerstitial microarray data from kidney biopsies of American Indians with T2D (n=47). The transcriptional profile of Hypoxia Response Genes (HRG), comprising 172 target genes of Hypoxia Inducible Factor-1A (HIF1A), were examined in HC and T2D, with and without SGLT2i.

**Results:** The average (SD) age of participants with T2D was 16±2 years and median (IQR) measured GFR was 185 (160-242) ml/min. Higher cortical and medullary oxygen availability was associated with SGLT2i treatment (Fig.1). Increased HIF1A expression in T2D (without SGLT2i) compared to HC in proximal tubules (PT) was suppressed with SGLT2i. Correspondingly, 27% of HRG was suppressed with SGLT2i in PT, with glycolytic enzymes including phosphoglycerate kinase (PGK1) and phosphofructokinase (PFKL) as major contributors. PGK1 ( $r = 0.53$ ,  $p < 0.05$ ) and PFKL ( $r = 0.58$ ,  $p < 0.05$ ) expression, rather than HIF1A, in PT cells correlated with increased cortical hypoxia (higher R2\*). In American Indians with T2D, increased HIF1A expression was associated with increased interstitial fibrosis ( $r = 0.47$ ,  $p < 0.05$ ) and future loss of kidney function ( $r = -0.44$ ,  $p < 0.05$ ).

**Conclusions:** SGLT2i associate with improved kidney oxygenation, which may mitigate the deleterious morphometric and clinical outcomes associated with high kidney HIF1A expression and contribute to the beneficial kidney effects of SGLT2i.

**Funding:** NIDDK Support

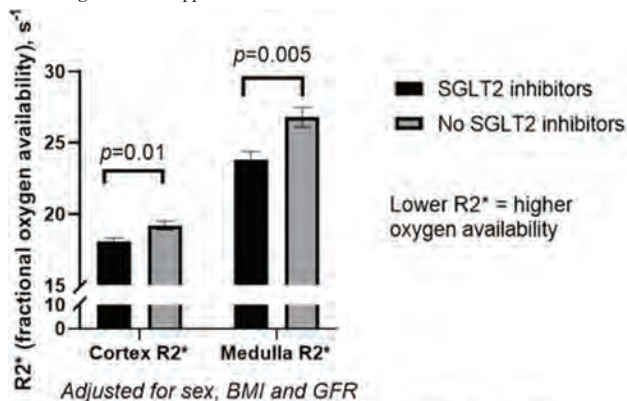

Fig.1. Lower hypoxia in kidneys with SGLT2 inhibitor treatment

## SA-PO258

**Nephron Segment Specific Response to SGLT2 Inhibitors in Young Persons With Type 2 Diabetes**

Petter Bjornstad,<sup>1</sup> Fadhl Alakwaa,<sup>2</sup> Phillip J. McCown,<sup>2</sup> Jennifer A. Schaub,<sup>2</sup> Abhijit S. Naik,<sup>2</sup> Sean Eddy,<sup>2</sup> Viji Nair,<sup>2</sup> Roger K. Harned,<sup>1</sup> Patricia E. Ladd,<sup>1</sup> Laura Pyle,<sup>1</sup> Jeffrey B. Hodgin,<sup>2</sup> Frank C. Brosius,<sup>2</sup> Robert G. Nelson,<sup>3</sup> Matthias Kretzler.<sup>2</sup> <sup>1</sup>University of Colorado Denver School of Medicine, Aurora, CO; <sup>2</sup>University of Michigan, Ann Arbor, MI; <sup>3</sup>National Institute of Diabetes and Digestive and Kidney Diseases Division of Intramural Research, Phoenix, AZ.

**Background:** Youth-onset type 2 diabetes (T2D) carries a higher risk of diabetic kidney disease (DKD) than type 1 and adult-onset type 2 diabetes of similar duration, with few treatment options. SGLT2 inhibitors (SGLT2i) are protective against DKD, but the mechanisms of nephroprotection are incompletely understood.

**Methods:** Single-cell RNA sequencing (scRNAseq) data and morphometrics were obtained from protocol kidney biopsies in healthy controls (HC, n=6) and participants ranging from 12-21 years with T2D (n=16), either treated with SGLT2i (T2Di+, n=6) or not (T2Di-, n=10). Transcripts elevated in T2D vs. HC but reduced in T2Di+ vs. T2Di- were considered "suppressed", similarly transcripts depressed in T2Di- but elevated in T2Di+ were termed "enhanced". mTOR activity scores were calculated based on expression of 39 reactome pathway genes.

Results: T2D participants were more obese and had higher measured GFR than HC. Morphometric evaluation showed higher mesangial and glomerular volumes in T2D vs. HC. scRNAseq profiles of 40,353 kidney cells formed 18 cell clusters representing all major cell types in the nephron. Despite SGLT2 expression exclusively in proximal tubules (PT), transcripts in the distal nephron were most altered with SGLT2i. In PT, transcripts in central carbon metabolism, including glycolysis, gluconeogenesis, TCA cycle and beta oxidation were suppressed with SGLT2i. In contrast, these pathways in thick ascending limb (TAL) were enhanced with the inhibitor (Fig). Notably, mTOR pathway activity score in T2D+ reverted towards the level seen in HC than T2Di-.

Conclusions: The transcriptional profiles of many metabolic pathways were favorably altered with SGLT2i in a nephron segment-specific manner in young persons with T2D. mTOR may be an important mediator of SGLT2i treatment effects in the kidney.

Funding: NIDDK Support

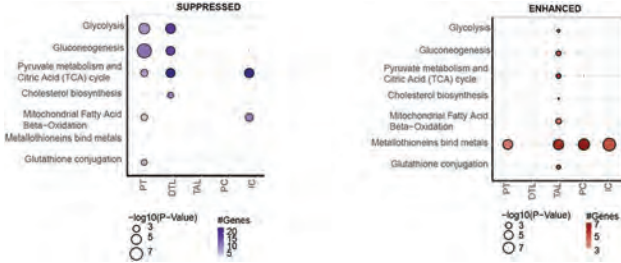

SA-PO259

Empagliflozin Use and the Risk of Nephrolithiasis in Patients With Type 2 Diabetes

Julie M. Paik,<sup>1</sup> Helen Tesfaye,<sup>1</sup> Heidi Zakoul,<sup>1</sup> Niklas Schmedt,<sup>2</sup> Lisette Koenen,<sup>3</sup> Leo Seman,<sup>4</sup> Gary C. Curhan,<sup>1</sup> Deborah J. Wexler,<sup>5</sup> Elisabetta Patorno.<sup>1</sup> <sup>1</sup>Brigham and Women's Hospital, Boston, MA; <sup>2</sup>Boehringer Ingelheim International GmbH, Ingelheim, Germany; <sup>3</sup>Lilly Deutschland GmbH, Bad Homburg, Germany; <sup>4</sup>Boehringer Ingelheim Pharmaceuticals Inc, Ridgefield, CT; <sup>5</sup>Massachusetts General Hospital, Boston, MA.

Background: Type 2 diabetes (T2D) is associated with an increased risk of kidney stones. Empagliflozin is a sodium-glucose cotransporter-2 inhibitor (SGLT2i) which might lower the risk of nephrolithiasis, potentially by increasing urinary flow. We investigated the association between empagliflozin use and the risk of nephrolithiasis in routine practice.

Methods: Using claims data from 2 private health plans and Medicare (2013-2019), we identified 102,275 pairs of 1:1 propensity score (PS)-matched adults with T2D initiating empagliflozin or a DPP4 inhibitor (DPP4i), and 115,489 pairs initiating empagliflozin or a GLP1 receptor agonist (GLP1RA). Our primary outcome was nephrolithiasis diagnosed by ICD codes in the inpatient or outpatient setting. We estimated hazard ratios (HRs), rate differences (RD) and 95% confidence intervals (CI), adjusting for 148 baseline covariates in the PS model.

Results: Over a mean follow-up of ~8 months on treatment, the risk of nephrolithiasis was lower in the empagliflozin group compared with the DPP4i group (HR 0.72 [95%CI 0.67-0.78]; RD/1,000 person-years -6.2 [95%CI -7.6, -4.8]) and the GLP1RA group (HR 0.73 [95%CI 0.68-0.79]; RD/1,000 person-years -6.0 [95%CI -7.4, -4.6]) (see Table). Secondary definitions of the outcome based on a hospital discharge diagnosis produced consistent results.

Conclusions: In routine care, empagliflozin use was associated with a reduced risk of nephrolithiasis, compared to DPP4i and GLP1RA use in patients with T2D.

Funding: Commercial Support - Boehringer Ingelheim

Table with 7 columns: Patient patient characteristics, Empagliflozin, DPP4i, GLP1RA, and HR (95%CI), RD (95%CI), N events (100,000 PY), HR (95%CI), RD (95%CI). Rows include Age, mean (SD), Glucose levels, Diabetes, Chronic kidney disease, Medication use, Insulin use, and Primary Outcome (Nephrolithiasis).

HR, hazard ratio; SD, standard deviation; DPP4i, dipeptidyl peptidase-4 inhibitor; SGLT2i, sodium-glucose cotransporter-2 inhibitor; GLP1RA, glucagon-like peptide-1 receptor agonist; PY, person-years; CI, confidence interval.

SA-PO260

Safety of Sodium-Glucose Cotransporter-2 Inhibitors in Patients With CKD and Type 2 Diabetes

Edouard Fu,<sup>1,2</sup> Elvira D'Andrea,<sup>1,2</sup> Deborah J. Wexler,<sup>3,2</sup> Elisabetta Patorno,<sup>1,2</sup> Julie M. Paik.<sup>1,2</sup> <sup>1</sup>Brigham and Women's Hospital, Boston, MA; <sup>2</sup>Harvard Medical School, Boston, MA; <sup>3</sup>Massachusetts General Hospital, Boston, MA.

Background: CRENDENCE and DAPA-CKD showed the renal and cardiovascular efficacy of sodium-glucose cotransporter 2 inhibitors (SGLT2i) in patients with chronic kidney disease (CKD). However, limited information exists about the safety of SGLT2i in routine clinical practice, which may contribute to their slow uptake. We evaluated the comparative safety of SGLT2i versus glucagon-like peptide 1 receptor agonist (GLP-1RA) or the dipeptidyl peptidase 4 (DPP-4) inhibitor sitagliptin among patients with CKD and type 2 diabetes (T2D) in routine care.

Methods: We conducted a population-based cohort study using two commercial and Medicare claims databases (April 2013-December 2021). We included patients with a diagnosis of stage 3-4 CKD and T2D initiating a SGLT2i or a comparator, i.e., GLP-1RA or sitagliptin. New users of SGLT2i were 1:1 propensity score matched to new users of GLP-1RA (cohort 1) or sitagliptin (cohort 2) in two pairwise comparisons, accounting for more than 120 baseline characteristics. Safety outcomes were diabetic ketoacidosis hospitalization, lower limb amputations, genital infections, hyperkalemia, acute kidney injury (AKI), non-vertebral fractures, hypovolemia, severe hypoglycemia, and severe urinary tract infections (UTI).

Results: Cohort 1 included 28,847 matched pairs initiating SGLT2i or GLP-1RA (mean age 72 years, 44% female). Compared with GLP-1RA, SGLT2i had similar risks for diabetic ketoacidosis, hypovolemia, hypoglycemia and severe UTI, increased risks for lower limb amputation and genital infections, and lower risks for hyperkalemia and AKI (Table). We observed similar findings in cohort 2 among 19,342 matched pairs of patients initiating SGLT2i or sitagliptin.

Conclusions: In U.S. patients with CKD and T2D from routine care, with older mean age than those in RCTs, SGLT2i are associated with increased risks of lower limb amputations, genital infections, and potentially non-vertebral fractures, and with lower risks of hyperkalemia and acute kidney injury. No differences were observed for diabetic ketoacidosis, hypovolemia, and hypoglycemia.

Funding: Other U.S. Government Support

Table. Adjusted hazard ratios and rate differences in the 1:1 propensity score matched population of patients with CKD and type 2 diabetes initiating SGLT2i vs. GLP-1RA or sitagliptin

Table with 5 columns: Outcome, SGLT2i vs. GLP-1RA (Hazard ratios, 95% CI, Rate difference/1000py), SGLT2i vs. Sitagliptin (Hazard ratios, 95% CI, Rate difference/1000py). Rows include Diabetic ketoacidosis, Lower limb amputations, Genital infections, Hyperkalemia, Acute kidney injury, Fractures, Hypovolemia, Severe hypoglycemia, Severe urinary tract infections.

Hazard ratios and rate differences were adjusted via propensity score matching for more than 120 baseline characteristics including demographics, lifestyle factors, diabetes complications, diabetes and other medications, comorbidities, healthcare utilization, laboratory tests and calendar year

SA-PO261

Effect of Canagliflozin on Markers of Hepatic Steatosis and Fibrosis in Patients With Type 2 Diabetes and CKD

Akihiko Koshino,<sup>1,2</sup> Megumi Oshima,<sup>2,3</sup> Clare G. Arnott,<sup>3</sup> Robert A. Fletcher,<sup>3</sup> Vlado Perkovic,<sup>3</sup> Hiddo J. L. Heerspink,<sup>1,3</sup> Brendon L. Neuen.<sup>3</sup> <sup>1</sup>Rijksuniversiteit Groningen, Groningen, Netherlands; <sup>2</sup>Kanazawa Daigaku, Kanazawa, Japan; <sup>3</sup>The George Institute for Global Health, Newtown, NSW, Australia.

Background: Few treatments are available for nonalcoholic fatty liver disease (NAFLD), which occurs commonly in people with diabetes and chronic kidney disease (CKD) and is associated with adverse outcomes. This post-hoc analysis of the CRENDENCE trial evaluated the effects of canagliflozin (Cana) on NAFLD risk scores in patients with diabetes and CKD, as well as their association with clinical outcomes.

Methods: Hepatic steatosis index, NAFLD fibrosis score and fibrosis-4 (FIB-4) index were calculated at baseline and during follow-up. The effects of Cana versus placebo on these NAFLD risk scores were assessed with linear mixed models. Multivariable cox regression models were used to assess associations between baseline NAFLD risk scores and clinical outcomes.

Results: 4387 (99.6%) participants had data available to evaluate baseline NAFLD risk scores. During a median 2.6 years follow-up, Cana lowered hepatic steatosis index -0.28 (95%CI -0.18, -0.39; p<0.001) and attenuated increases in NAFLD fibrosis score -0.06 (-0.03, -0.10; p=0.001) (Figure). Cana did not affect FIB4-index (Figure). After adjusting for cardiometabolic risk factors, higher NAFLD fibrosis score and FIB-4 index were associated with increased risk of mortality (HR 1.51, 95%CI 1.12, 2.03, p=0.007; HR 2.04, 95%CI 1.17-3.61, p=0.01, respectively). NAFLD risk scores were not associated with CKD progression.

Conclusions: In patients with type 2 diabetes and CKD, Cana may improve hepatic steatosis and attenuate fibrosis. Further evaluation of the effects of sodium-glucose cotransporter 2 inhibition in individuals with NAFLD is warranted.

Funding: Commercial Support - Janssen Research & Development.

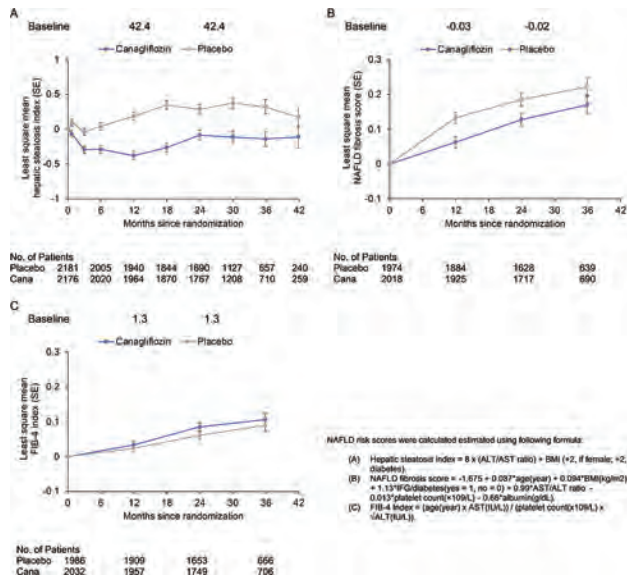

Effects of canagliflozin on (A) hepatic steatosis index, (B) NAFLD fibrosis score, and (C) FIB-4 index

SA-PO262

Effects of Canagliflozin (CANA) on Cardiovascular (CV), Kidney, and Albuminuria Outcomes by Diabetes Duration: Pooled Analysis From the CANVAS Program and CREDENCE

Sheldon W. Tobe,<sup>1</sup> Harpreet S. Bajaj,<sup>2</sup> Adeera Levin,<sup>3</sup> Thomas Mavrakanas,<sup>4</sup> Navdeep Tangri,<sup>5</sup> April E. Slee,<sup>6</sup> Wally Raptopati,<sup>7</sup> Fernando G. Ang,<sup>7</sup> <sup>1</sup>Sunnybrook Research Institute, Toronto, ON, Canada; <sup>2</sup>LMC Healthcare, Toronto, ON, Canada; <sup>3</sup>Division of Nephrology, University of British Columbia, Vancouver, BC, Canada; <sup>4</sup>Division of Nephrology, Department of Medicine, McGill University Health Centre, Montreal, QC, Canada; <sup>5</sup>Max Rady College of Medicine, University of Manitoba, Winnipeg, MB, Canada; <sup>6</sup>New Arch Consulting, Seattle, WA; <sup>7</sup>Janssen, Inc, Toronto, ON, Canada.

**Background:** Type 2 diabetes (T2DM) is a progressive disease and increasing duration is associated with heightened risk of morbidity and mortality. CANA reduced CV and kidney events in patients (pts) with T2DM and CV risk or nephropathy. We assessed the effects of CANA on CV and kidney outcomes and albuminuria progression by disease duration.

**Methods:** This post hoc analysis pooled patient-level data from the CANVAS Program (N=10,142) and the CREDENCE trial (N=4401) to examine the effect of CANA vs placebo on CV events (major adverse cardiovascular events [MACE] and CV death or hospitalization for heart failure), kidney events (doubling of serum creatinine [dScr] and end-stage kidney disease or dESK), a composite of CV and kidney events, and albuminuria progression and regression (change in albuminuria class [normo-, micro-, macro-] plus ≥30% urinary albumin to creatinine ratio change) in pts with diabetes duration of <5, ≥5 to ≤10, >10 to ≤15, and >15y. HRs and 95% CIs were estimated using a Cox proportional hazards model, stratified by duration of diabetes.

**Results:** Overall, there were 1528, 3333, 4148, and 5523 pts with diabetes duration of <5, ≥5 to ≤10, >10 to ≤15, and >15y. CANA reduced the risk of CV, kidney, composite cardiorenal outcomes, with no statistical heterogeneity amongst subgroups by diabetes duration. Similarly, CANA reduced the rate of albuminuria progression and increased rate of albuminuria regression across diabetes duration subgroups (Figure).

**Conclusions:** CANA reduced the risk of CV, kidney, and composite cardiorenal events consistently, regardless of diabetes duration. Results show within 5 years of developing T2DM, CANA positively impacts on albuminuria, an important consideration in primary care setting.

Figure. Effects of CANA vs PBO on CV and kidney outcomes by diabetes duration.

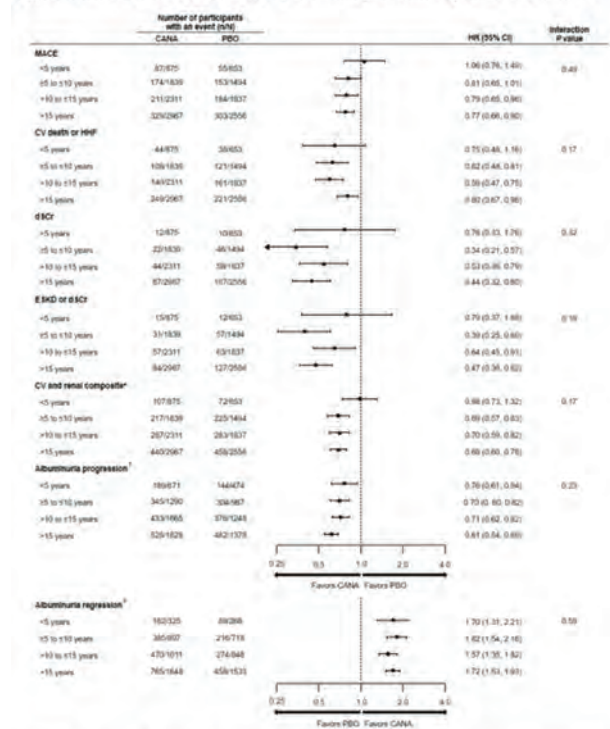

PBO, placebo; HHF, hospitalization for heart failure; ESKD, end-stage kidney disease; UACR, urinary albumin to creatinine ratio.  
 \*Composite that includes MACE, HHF, dScr, or ESKD.  
 †≥1 step increase in UACR category along with an increase in ACR ≥30% from baseline.  
 ‡≥1 step decrease in UACR category along with a decrease in UACR ≥30% from baseline.

SA-PO263

Sotagliflozin, a Dual SGLT1 and SGLT2 Inhibitor, Reduces the Risk of Cardiovascular and Renal Disease as Assessed by Steno Risk Engines in Adults With Type 1 Diabetes

Elisabeth B. Stougaard,<sup>1</sup> Peter Rossing,<sup>1,2</sup> Dorte Vistisen,<sup>1,3</sup> Phillip Banks,<sup>4</sup> Manon Girard,<sup>4</sup> Michael J. Davies,<sup>4</sup> Frederik Persson.<sup>1</sup> <sup>1</sup>Steno Diabetes Center Copenhagen, Herlev, Denmark; <sup>2</sup>Department of Clinical Medicine, University of Copenhagen, Copenhagen, Denmark; <sup>3</sup>Department of public health, University of Copenhagen, Copenhagen, Denmark; <sup>4</sup>Lexicon Pharmaceuticals, Inc., The Woodlands, TX.

**Background:** Sotagliflozin (SOTA) demonstrated cardiovascular and renal benefits in high-risk adults with type 2 diabetes. No studies have shown whether this can be demonstrated in type 1 diabetes (T1D). Treatment with SOTA is associated with increased risk of diabetic ketoacidosis (DKA). The potential cardiorenal benefits may outweigh the risk of DKA when evaluating SOTA for T1D. This analysis estimated the risk of cardiovascular disease (CVD) and end-stage kidney disease (ESKD) in adults with T1D treated with SOTA.

**Methods:** Participant-level data were used from the inTandem trials evaluating 2977 adults with T1D randomized to once-daily placebo, SOTA 200 mg or SOTA 400 mg for 24 weeks. For each participant, the cumulative risks of developing CVD and ESKD were estimated using the Steno T1 Risk Engines, which are prediction models for the 5- and 10-year risk of CVD and 5-year risk of ESKD. The estimated risk was calculated at baseline and week 24. The difference in least-square mean percent change in estimated risk from baseline (95% CI and p-value) was compared between groups using a mixed model with percent change from baseline as dependent and including the treatment group as fixed effect, and the baseline value as covariate.

**Results:** SOTA significantly reduced 5- and 10-year CVD risk scores by approximately 4 to 7% compared to placebo (Table). ESKD risk score was numerically reduced with SOTA 200 mg and significantly reduced with SOTA 400 mg relative to placebo. Similar results were observed with SOTA pooled.

**Conclusions:** Using the Steno T1 Risk Engines, the estimated risk of CVD and ESKD was significantly reduced with SOTA compared to placebo. This provides additional results that may positively enhance the benefit/risk assessment of SOTA use in T1D.

**Funding:** Commercial Support - Lexicon Pharmaceuticals, Inc. funded the inTandem studies

Table. Effect of sotagliflozin on CVD and ESKD Risk Score using Steno T1 Risk Engines

	Sotagliflozin 200 mg N = 524		Placebo N = 525		Difference in LSM % change (95% CI)
	BL mean (SD)	Mean % change from baseline (SD)	BL mean (SD)	Mean % change from baseline (SD)	
5-yr CVD risk	7.5% (5.6)	-3.5 (18.5)	6.8% (6.4)	1.5 (17.3)	-4.5 (-6.6, -2.5)*
10-yr CVD risk	14.0% (11.4)	-3.4 (17.7)	12.7% (11.0)	1.4 (16.6)	-4.4 (-6.5, -2.4)*
5-yr ESKD risk	0.9% (0.9)	6.2 (44.5)	0.9% (0.9)	11.4 (66.7)	-5.2 (-12.1, 1.7)
		Sotagliflozin 400 mg N = 1225		Placebo N = 1231	
5-yr CVD risk	7.6% (7.2)	-6.3 (18.0)	7.0% (6.7)	1.0 (20.2)	-7.1 (-8.6, -5.5)*
10-yr CVD risk	14.1% (12.0)	-6.0 (17.3)	13.1% (11.5)	0.9 (19.4)	-6.8 (-8.2, -5.3)*
5-yr ESKD risk	0.9% (0.9)	5.0 (42.7)	1.0% (1.2)	12.8 (62.8)	-7.8 (-12.1, -3.5)*

\*P < 0.003; BL = baseline; SD = standard deviation; LSM = least square means

SA-PO264

Effect of Sotagliflozin (SOTA) on Albuminuria in Patients With Type 2 Diabetes (T2D) and CKD

David Cherney,<sup>1</sup> Deepak L. Bhatt,<sup>2</sup> Michael Szarek,<sup>3</sup> Franklin W. Sun,<sup>4</sup> Michael J. Davies,<sup>4</sup> Bertram Pitt,<sup>5</sup> Philippe Gabriel Steg,<sup>6</sup> The SCORED Investigators <sup>1</sup>Toronto General Hospital, Toronto, ON, Canada; <sup>2</sup>Brigham and Women's Hospital, Boston, MA; <sup>3</sup>University of Colorado Anschutz, Aurora, CO; <sup>4</sup>Lexicon Pharmaceuticals Inc, The Woodlands, TX; <sup>5</sup>University of Michigan, Ann Arbor, MI; <sup>6</sup>Hôpital Bichat, Assistance Publique - Hôpitaux de Paris, Paris, France.

**Background:** Albuminuria in patients with/without diabetes presents a higher risk for adverse renal and cardiovascular (CV) outcomes. SGLT inhibitors demonstrate improved albuminuria. The study observed the impact of the SGLT1/SGLT2 inhibitor SOTA on urine albumin-to-creatinine ratio (UACR).

**Methods:** SCORED—a Phase 3, multicenter, double-blind, placebo-controlled, parallel-group study—randomized 10,584 patients with T2D, CKD, and other CV risk factors to SOTA or placebo. Kidney inclusion criteria were eGFR 25-60mL/min/1.73m<sup>2</sup> and any UACR. Percentage treatment difference was estimated by geometric mean ratio for the overall cohort and by eGFR and UACR subgroups. Progression/regression of UACR were assessed. Hazard ratios, 95% confidence intervals (CI), and p-values were estimated by Cox proportional hazards model.

**Results:** Median baseline eGFR was 44.5mL/min/1.73m<sup>2</sup>, with 8% at <30mL/min/1.73m<sup>2</sup>. At baseline, median UACR was 82mg/g, and 1/3 of patients had normoalbuminuria, 1/3 had micro, and 1/3 had macro. Median follow up was 16 months. The UACR difference for SOTA vs placebo was -21.3% (95% CI -23.4, -19.1; p<0.0001). Reductions were similar across eGFRs. In UACR 30-299mg/g and ≥300mg/g, reductions were significant in SOTA (p<0.0001; Fig 1). Progression risk was lower and regression risk higher in SOTA vs placebo (p<0.0001; Fig 2).

**Conclusions:** SOTA significantly reduced UACR and had favorable effects on UACR progression and regression.

**Funding:** Commercial Support - Sanofi and Lexicon Pharmaceuticals

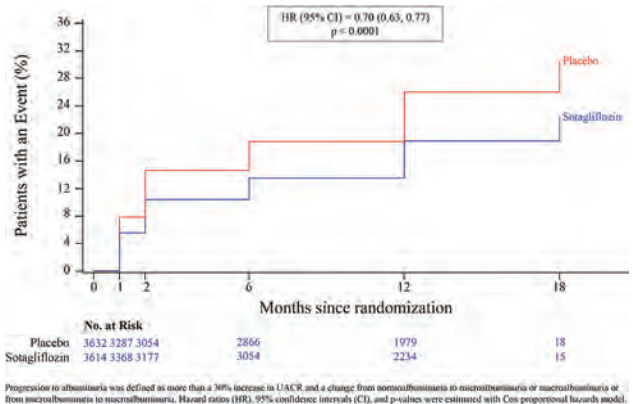
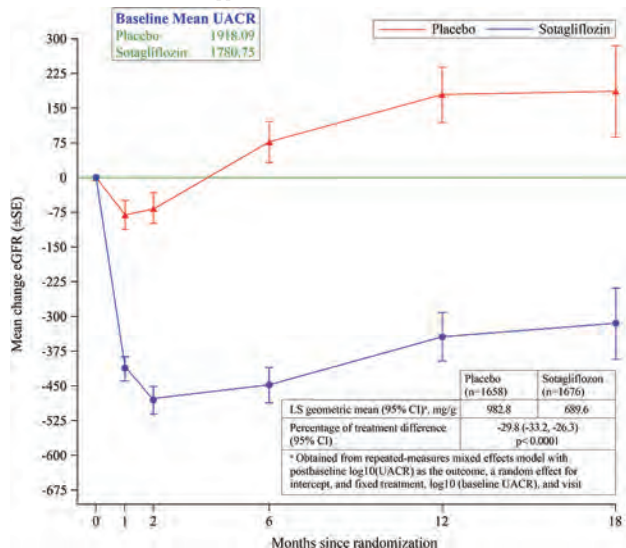

SA-PO265

Semaglutide Improves eGFR Slope vs. Placebo Regardless of Baseline HbA1c and Blood Pressure in People With Type 2 Diabetes: A Post Hoc Analysis of SUSTAIN 6 and PIONEER 6

David Cherney,<sup>1</sup> Heidrun Bosch-Traber,<sup>2</sup> Samy Hadjadj,<sup>3</sup> Anja B. Kuhlman,<sup>2</sup> Soren Rasmussen,<sup>2</sup> Katherine R. Tuttle,<sup>5,6</sup> Hidde J. L. Heerspink,<sup>4</sup> <sup>1</sup>University Health Network, Toronto, ON, Canada; <sup>2</sup>Novo Nordisk AS, Søborg, Denmark; <sup>3</sup>L'institut du thorax, Nantes, France; <sup>4</sup>University Medical Center Groningen, Groningen, Netherlands; <sup>5</sup>University of Washington, Spokane, WA; <sup>6</sup>Providence Washington, Spokane, WA.

**Background:** Previous analyses of SUSTAIN 6 and PIONEER 6 cardiovascular (CV) outcome trials indicate that semaglutide (respectively, subcutaneous and oral) reduces the decline rate (slope) of estimated glomerular filtration rate (eGFR) vs placebo in people with type 2 diabetes on standard of care antidiabetes medication at high CV risk. The effect was more pronounced in those with a comparatively lower eGFR (<60 mL/min/1.73 m<sup>2</sup>). This *post hoc* analysis evaluated whether the effect of semaglutide vs placebo on eGFR slope was consistent across different levels of glycemic control (HbA<sub>1c</sub>) or blood pressure (BP) at baseline.

**Methods:** Pooled SUSTAIN 6 and PIONEER 6 data were analyzed for change in eGFR slope from baseline in HbA<sub>1c</sub> (<8 and ≥8%) and BP (<140/90 and ≥140/90 mmHg) subgroups. A sensitivity analysis was performed adjusting for age, sex, diabetes duration, antidiabetes medication, smoking status, prior CV events, geographic region, and eGFR at baseline. Groups were also analyzed by baseline eGFR (<60 and ≥60 mL/min/1.73 m<sup>2</sup>).

**Results:** Baseline characteristics were similar across HbA<sub>1c</sub> and BP subgroups. The mean urine albumin:creatinine ratio, measured in SUSTAIN 6 only, was higher in HbA<sub>1c</sub> ≥8% and BP ≥140/90 mmHg subgroups (29.6 and 39.1 mg/g, respectively) than the HbA<sub>1c</sub> <8% and BP <140/90 mmHg subgroups (17.2 and 17.0 mg/g, respectively). Semaglutide consistently reduced eGFR slope decline vs placebo in all subgroups (Figure), as supported by the sensitivity and eGFR subgroup analyses.

**Conclusions:** Semaglutide reduces eGFR slope decline vs placebo regardless of glycemic control or BP level, suggesting a consistent effect of semaglutide on eGFR preservation.

**Funding:** Commercial Support - Novo Nordisk A/S

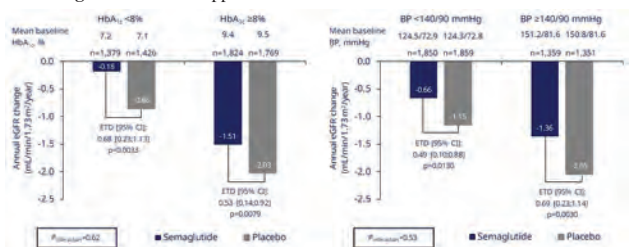

Data shown are at 1 year (all data points across visits from SUSTAIN 6 and PIONEER 6 are used in the analyses), for the full analysis set in subjects with baseline and at least one post-baseline measurement. Random slope model of repeated eGFR measures analyzed with eGFR values as dependent variable adjusted by baseline value, and time interacting with treatment and subgroup. Intercept and slopes of effect of time are assumed to vary randomly amongst subjects based on a two-dimensional normal distribution. All subjects in the SUSTAIN 6 trial had a HbA<sub>1c</sub> ≥7.0 at screening to be eligible in the trial. No HbA<sub>1c</sub> requirements were defined for subject inclusion in the PIONEER 6 trial. BP, blood pressure; CI, confidence interval; eGFR, estimated glomerular filtration rate; ETO, estimated treatment difference.

Estimated annual eGFR slopes according to treatment, and HbA<sub>1c</sub> and BP subgroups at baseline

SA-PO266

**Long-Term Use of Empagliflozin vs. DPP4 Inhibitors Mitigates eGFR Slopes in Patients With Type 2 Diabetes: Real-World Evidence**

Ofri Mosenzon,<sup>1,2</sup> Cheli Melzer Cohen,<sup>3</sup> Ilan Yanuv,<sup>1,2</sup> Aliza Rozenberg,<sup>1,2</sup> Gabriel Chodick,<sup>3,5</sup> Meir Schechter,<sup>1,2</sup> Avraham Karasik,<sup>3,4</sup> <sup>1</sup>Diabetes Unit, Department of Endocrinology and Metabolism, Hadassah Medical Center, Jerusalem, Israel; <sup>2</sup>Faculty of Medicine, Hebrew University of Jerusalem, Jerusalem, Israel; <sup>3</sup>Maccabi Institute for Research and Innovation, Maccabi Healthcare Services, Tel Aviv, Israel; <sup>4</sup>Tel Aviv University, Tel Aviv, Israel; <sup>5</sup>School of Public Health Sackler, Faculty of Medicine, Tel Aviv University, Tel Aviv, Israel.

**Background:** Randomized controlled studies showed that sodium-glucose cotransporter 2 inhibitors (SGLT2i) mitigate kidney function loss in patients with type 2 diabetes (T2D) at high cardiovascular (CV) and kidney risk. However, long-term efficacy studies in general population with T2D are lacking.

**Methods:** In Maccabi Healthcare Services, a large Israeli database (2015-2021), we compared the change in eGFR in patients with T2D who initiated empagliflozin (EMPA) or any SGLT2i, vs dipeptidyl peptidase-4 inhibitor (DPP4i). Treatment arms were propensity score-matched by 96 baseline characteristics. Subjects were followed until death, end of data availability, exposure discontinuation, initiation of the comparator drug, after 5 years, or October 2021. In a previous analysis we showed that compared to DPP4i, EMPA and any SGLT2i reduce the risk of the primary kidney outcome (≥40% eGFR declined or end-stage kidney disease). In this secondary analysis, we compared the change in eGFR overtime between arms.

**Results:** The matched population included overall 15992 initiators of EMPA or DPP4i (1:1 ratio), of them 12781 (79.9%) had eGFR measurement at follow-up. Median [IQR] follow-up was 17.9 [9.5-33.5] months, and 4924 (38.5%) were followed for ≥2 years. Mean eGFR slope were less steep with EMPA compared to DPP4i (-1.33 vs -2.26 mL/min/1.73m<sup>2</sup>/year) with mean absolute between-arms difference in favor of EMPA of 0.93 mL/min/1.73m<sup>2</sup>/year (95%CI 0.67-1.18; both p<0.001). Mitigation of eGFR slope with EMPA continued to increase with longer treatment (figure). Similar significant effects were obtained when comparing initiators of any SGLT2i to DPP4i.

**Conclusions:** Compared with DPP4i, long-term use of EMPA or any SGLT2i is associated with mitigation of kidney function loss in a general population with T2D.

**Funding:** Commercial Support - Boehringer Ingelheim

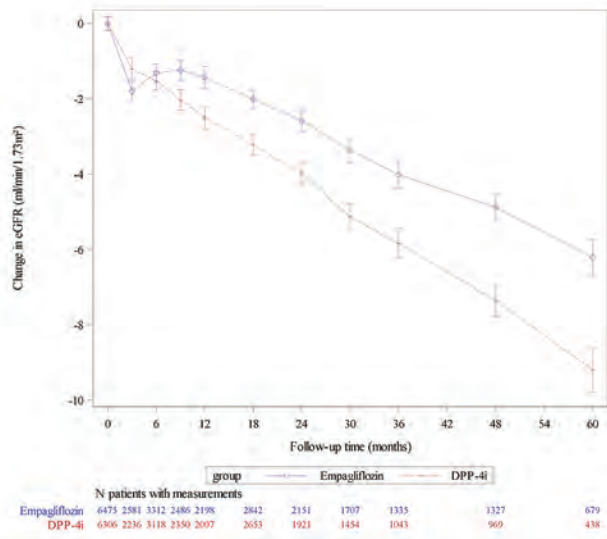

SA-PO267

**Perceived Barriers to SGLT2i Prescription in Primary Care vs. Nephrology Providers: Findings From the Michigan Kidney Improvement Collaborative**

Michael Heung, Rajiv Saran, Julie A. Wright Nunes, Jacob E. Reiss, Katherine L. Khosrovaneh, Jacqueline Rau. Michigan Kidney Improvement Collaborative University of Michigan, Ann Arbor, MI.

**Background:** Newer medications such as SGLT2i's and GLP1a's reduce cardiovascular, renal, and metabolic complications in patients with type 2 diabetes, yet studies suggest slow uptake in prescribing among eligible populations. Here we report initial findings from the Michigan Kidney Improvement Collaborative (MKIC), a statewide nephrology initiative launched in 2021 to improve care of diabetic kidney disease. MKIC is embedded within the Michigan Collaborative for Type 2 Diabetes (MCT2D) which focuses on primary care physicians (PCPs).

**Methods:** 11 nephrology practices (37% of all Michigan nephrologists) and 238 PCP practices were recruited. An initial joint MKIC/MCT2D goal is to increase use of SGLT2i's and GLP-1a's. To assist in these efforts, a baseline practice readiness assessment survey was completed to identify barriers to SGLT2i and GLP1a prescribing.

**Results:** Nephrology practices had more experience prescribing SGLT2i's than GLP1a's (73% vs 27%). Despite this, 73% of nephrology practices responded that they were "Very" or "Mostly" confident about implementing measures to improve prescribing of these medications, similar to the response from PCPs (68%, p=0.70). More PCP than nephrology practices worked with an affiliated pharmacist (33% vs 18%, p=0.355). Differences in perceived barriers to prescribing are shown in the Table. Both nephrology and PCP practices had high level of concerns related to cost and insurance coverage. However, PCP practices identified greater educational needs and higher concern about patient acceptance of injections.

**Conclusions:** PCPs and nephrologists perceive different barriers to increasing usage of newer diabetes medications and may have differential access to resources. Population health-based strategies to promote uptake of these medications need to be tailored to the specific audience. Initial such efforts by MKIC/MCT2D have been well-received, and subsequent analyses will assess impact on medication prescription rates.

Perceived Barrier	Nephrology Practice (n=11)	Primary Care Practice (n=196)	p-value
Cost of medication	7 (64%)	174 (89%)	0.63
Insurance coverage challenges	11 (100%)	163 (83%)	0.83
Patient injectable hesitancy	1 (9%)	83 (42%)	0.19
Insufficient provider knowledge regarding medications	0	117 (60%)	<0.001

SA-PO268

**Consistent Kidney Benefits With Semaglutide vs. Placebo Regardless of Baseline Urine Albumin Creatinine Ratio in Subjects With Type 2 Diabetes at High Cardiovascular Risk: A Post Hoc Analysis of SUSTAIN 6**

Hiddo J. L. Heerspink,<sup>1</sup> Anja B. Kuhlman,<sup>2</sup> Johannes F. Mann,<sup>3</sup> Soren Rasmussen,<sup>2</sup> Peter Rossing,<sup>4,5</sup> Blaz Vrhnjak,<sup>2</sup> David Cherney,<sup>6</sup> <sup>1</sup>University Medical Center Groningen, Groningen, Netherlands; <sup>2</sup>Novo Nordisk A/S, Søborg, Denmark; <sup>3</sup>KfH Kidney Center, München, Germany; <sup>4</sup>Steno Diabetes Center Copenhagen, Herlev, Denmark; <sup>5</sup>University of Copenhagen, Copenhagen, Denmark; <sup>6</sup>University Health Network, Toronto, ON, Canada.

**Background:** In a previous analysis of SUSTAIN 6 and PIONEER 6 (cardiovascular [CV] outcomes trials in subjects with type 2 diabetes [T2D] at high CV risk), semaglutide reduced estimated glomerular filtration rate (eGFR) slope vs placebo, both in addition to standard of care antidiabetes medication. This was most pronounced in those with eGFR <60 mL/min/1.73 m<sup>2</sup>; it is of clinical interest to understand if this benefit is consistent across urine albumin:creatinine ratio (UACR) groups. The aim of this *post hoc* analysis was to investigate the effects of semaglutide on eGFR slopes in subjects with different albuminuria levels at baseline in SUSTAIN 6 (PIONEER 6 was excluded as UACR was not collected in this trial).

**Methods:** eGFR slope estimated by a random effect model was compared in subjects by baseline UACR: <30/≥30-≤300/>300 mg/g. To account for potential differences in baseline characteristics, a sensitivity analysis was performed. These subgroups were also compared in those with baseline eGFR ≥30-≤60 or ≥60 mL/min/1.73 m<sup>2</sup>.

**Results:** Across the three subgroups (N=3,232), baseline characteristics were similar, except for higher blood pressure and lower eGFR in subjects with UACR >300 mg/g vs other subgroups. Overall, subjects receiving semaglutide had a slower decline in eGFR at 2 years vs placebo, an effect that was consistent across the three subgroups (p-value for interaction: 0.99; Figure). Results were consistent in the sensitivity analysis and those with eGFR ≥30-≤60 vs ≥60 mL/min/1.73 m<sup>2</sup>.

**Conclusions:** Semaglutide appears to slow eGFR decline vs placebo in subjects with T2D at high CV risk regardless of baseline albuminuria status.

**Funding:** Commercial Support - Novo Nordisk A/S

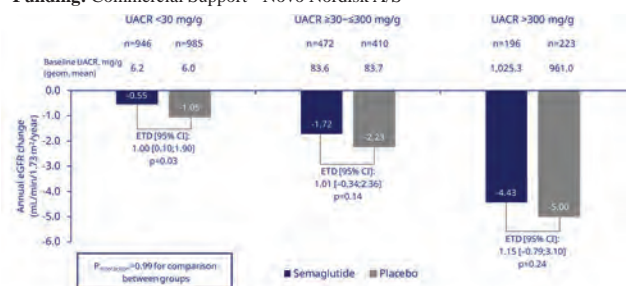

ETDs are shown as values at 2 years from the full analysis set. Random slope model of repeated eGFR measures analyzed with eGFR value as dependent variable adjusted by baseline value, and time interacting with treatment and subgroup. Intercept and slopes of effect of time are assumed to vary randomly among subjects based on a 2-dimensional normal distribution. CI, confidence interval; eGFR, estimated glomerular filtration rate; ETD, estimated treatment difference; geom., geometric; UACR, urine albumin:creatinine ratio.

Estimated annual eGFR slopes according to treatment and UACR groups at baseline

SA-PO269

Effects of Tirzepatide vs. Insulin Glargine on Kidney Function Evaluated by Cystatin C-Based eGFR: A Post Hoc Analysis From the SURPASS-4 Trial

Hiddo J. L. Heerspink,<sup>1</sup> Naveed Sattar,<sup>2</sup> Imre Pavo,<sup>3</sup> Axel Haupt,<sup>3</sup> Kevin L. Duffin,<sup>3</sup> Zhengyu Yang,<sup>3</sup> Russell J. Wiese,<sup>3</sup> Jonathan M. Wilson,<sup>3</sup> Andrea Hemmingway,<sup>3</sup> David Cherney,<sup>4</sup> Katherine R. Tuttle.<sup>5</sup> <sup>1</sup>Rijksuniversiteit Groningen, Groningen, Netherlands; <sup>2</sup>University of Glasgow, Glasgow, United Kingdom; <sup>3</sup>Eli Lilly and Company, Indianapolis, IN; <sup>4</sup>Toronto General Hospital, Toronto, ON, Canada; <sup>5</sup>Providence Washington, Seattle, WA.

**Background:** In patients with type 2 diabetes and increased cardiovascular risk (SURPASS-4 trial, N=1995; mean age 64 years, HbA1c 8.5%, BMI 33 kg/m<sup>2</sup>, eGFR [CKD-EPI-creatinine] 81.3 ± 21 mL/min/1.73m<sup>2</sup>), including 707 (35%) with UACR>30 mg/g and 342 (17%) with eGFR<60 mL/min/1.73m<sup>2</sup>, tirzepatide (TZP) treatment markedly reduced weight and slowed creatinine-based eGFR (eGFR<sub>creatinine</sub>) decline vs. insulin glargine (iGLAR). As weight reduction affects muscle mass, eGFR<sub>creatinine</sub> may change independently of kidney function, while cystatin C-based eGFR (eGFR<sub>cystatin C</sub>) is not similarly affected. The aim of this analysis was to determine whether the effect of TZP on kidney function was confirmed by eGFR<sub>cystatin C</sub>.

**Methods:** Mixed model for repeated measurements over time was used to analyze on-treatment eGFR data.

**Results:** After 1-year in the overall study population, the decline from baseline in eGFR<sub>cystatin C</sub> was significantly less with TZP vs. iGLAR (Table). No statistically significant interaction was observed in subgroup analyses by baseline UACR, eGFR<sub>creatinine</sub>, BMI, smoking status, or SGLT2i treatment (Table). Baseline (r=0.765, p<0.0001), 1-year (r=0.771, p<0.0001), and 1-year change from baseline (r=0.326, p<0.0001) values correlated between cystatin- and creatinine-based eGFR. eGFR<sub>cystatin C</sub> reductions at 1 year were dose dependent (between group difference vs. iGLAR 1.2 [-0.2, 2.7], 2.1 [0.7, 3.6] and 2.0 [0.6, 3.5] mL/min/1.73m<sup>2</sup> with 5, 10, and 15 mg, respectively). 1-year changes in body weight did not correlate with changes in eGFR<sub>cystatin C</sub> (r=0.054, p=0.125) or eGFR<sub>creatinine</sub> (r=0.012, p=0.728).

**Conclusions:** The effect of TZP on the slowing of eGFR decline is confirmed by cystatin C-based measurements, supporting the concept of a kidney-protective effect.

**Funding:** Commercial Support - Eli Lilly and Company

	N	Cystatin C-based eGFR LS mean change (TZP vs. iGLAR)		N	Creatinine-based eGFR LS mean change (TZP vs. iGLAR)	
		Week 24	Week 52		Week 24	Week 52
Overall	1770	1.4 (0.3, 2.4)*	1.8 (0.8, 2.8)*	1918	0.2 (-0.7, 1.2)	1.4 (0.3, 2.4)*
UACR <30 mg/g	1118	0.7 (0.6, 2.0)	1.4 (0.2, 2.7)*	1207	-0.1 (-1.2, 1.0)	1.7 (0.5, 3.0)*
UACR ≥30 mg/g	628	2.3 (0.4, 4.2)*	2.3 (0.4, 4.2)*	674	0.9 (-0.3, 2.6)	0.7 (-1.3, 2.6)
eGFR <60 CKD-EPI-creatinine mL/min/1.73m <sup>2</sup>	295	2.4 (0.2, 4.6)*	2.6 (0.3, 4.9)*	320	1.4 (-0.9, 3.8)	3.6 (0.5, 6.6)*
eGFR ≥60 CKD-EPI-creatinine mL/min/1.73m <sup>2</sup>	1475	1.2 (0.0, 2.4)*	1.7 (0.5, 2.8)*	1598	0.0 (-1.0, 1.0)	3.0 (-0.1, 2.1)
SGLT2i yes	445	1.6 (0.4, 3.0)	0.5 (-1.5, 2.4)	482	0.2 (-1.7, 1.3)	0.2 (-1.7, 1.3)
SGLT2i no	1325	1.3 (0.1, 2.5)*	2.2 (1.0, 3.5)*	1436	0.2 (-0.9, 1.3)	1.7 (0.5, 3.0)*
Smoking yes	952	2.0 (0.6, 3.5)*	2.2 (0.5, 3.6)*	1000	0.3 (-1.0, 1.6)	1.0 (-0.4, 2.4)
Smoking no	817	0.7 (-0.9, 2.2)	1.3 (-0.2, 2.9)	887	0.1 (-1.3, 1.5)	1.8 (0.2, 3.4)*
BMI <30 kg/m <sup>2</sup>	631	1.7 (-0.1, 3.5)	1.9 (0.1, 3.8)*	678	1.5 (-0.1, 3.1)	3.0 (1.2, 4.9)*
BMI ≥30 kg/m <sup>2</sup>	1139	1.2 (-0.1, 2.5)	1.8 (0.6, 3.0)*	1240	-0.5 (-1.7, 0.7)	0.4 (-0.9, 1.7)

Data are between group differences of LS mean change from baseline (tirzepatide vs. insulin glargine) with 95% confidence interval. \*p<0.05. BMI=body mass index; CKD-EPI=CKD-EPI-Creatinine; eGFR=estimated glomerular filtration rate; iGLAR=insulin glargine; LS=least squares; N=number of patients; SGLT2i=sodium-glucose co-transporter 2 inhibitors; TZP=tirzepatide; UACR=urine albumin-creatinine ratio vs. creatinine.

SA-PO270

Improvement of Albuminuria by the Endothelin Receptor Antagonist Atrasentan Correlates to PCSK9 Reduction in Type 2 Diabetic Nephropathy Patients

Pragvi Shrestha, Tanja R. Zijp, Michelle Pena, Robin P. Dullaart, Hiddo J. L. Heerspink, Jacob van den Born. *Universitair Medisch Centrum Groningen, Groningen, Netherlands.*

**Background:** The endothelin receptor antagonist atrasentan reduces albuminuria. This effect coincides with striking reductions in LDLc and triglycerides. Albuminuria has been shown to increase proprotein convertase subtilisin kexin type 9 (PCSK9), syndecan-1 shedding, and/or PCSK9-syndecan-1 interaction, leading to impaired hepatic lipoprotein clearance. Here, we investigated whether reduction of albuminuria and lipids with atrasentan, reduces PCSK9 and/or syndecan-1 shedding.

**Methods:** Patients with type 2 diabetes and chronic kidney disease (CKD) participating in a phase II clinical trial (RADAR; NCT01356849) were randomized to placebo (N=26) or atrasentan (0.75mg/d or 1.25mg/d) (N=94) treatment for 12 weeks. Patients were stabilized to a maximum labeled dose of RAAS inhibitor. Urine albumin creatinine ratio (UACR), serum lipids, PCSK9 and syndecan-1 were measured at baseline and week 12.

**Results:** Atrasentan treatment reduced UACR by 37.1% (95% CI 30.1, 43.4; p<0.01), LDLc by 17.12 mg/dL (95%CI 8.8, 25.4; p<0.01), triglycerides by 47.4 mg/dL (95% CI 40.4, 90.5; p<0.01) and PCSK9 by -25.9 ng/mL (95% CI -52.7, 1.0; p=0.061) compared to placebo. No effects were observed on HDLc and syndecan-1. Multivariate analysis, adjusted for baseline demographics, lipid and kidney function parameters revealed that achieved albuminuria levels during atrasentan treatment correlated with achieved PCSK9 levels (β 0.00227 per unit increment in PCSK9; P=0.0094).

**Conclusions:** In patients with type 2 diabetes and CKD, atrasentan reduces albuminuria, LDLc and triglycerides. At 12 weeks of atrasentan treatment, achieved albuminuria correlated with achieved PCSK9. Our study might suggest a mechanism by which atrasentan provides cardio-protection in high-risk patients with type 2 diabetes and CKD.

**Funding:** Government Support - Non-U.S.

SA-PO271

Safety and Efficacy of Maximally Tolerated RAS Therapy Alone or in Combination With Spironolactone in Diabetic Kidney Disease: Effect on Proteinuria and eGFR in the MRA-ACE Trial

James A. Tumlin,<sup>1,2</sup> Nelson P. Kopyt,<sup>1</sup> Daniel J. Wilson,<sup>1</sup> NephroNet Clinical Trials Consortium <sup>1</sup>NephroNet Clinical Trials Consortium, Atlanta, GA; <sup>2</sup>Emory University School of Medicine, Atlanta, GA.

**Background:** DKD is generally characterized by proteinuria and progressive of CKD. Although RAS inhibitors reduce proteinuria and slow the progression there is a high residual risk for ESRD at 8-10 years. Despite these benefits, few studies have examined the combination of mineralocorticoid receptor antagonists (MRA) with maximally tolerated RAS therapy (maxRAS). Herein we present the results of the MRA-ACE trial; a prospective, randomized, open labeled study investigating the safety/efficacy of spironolactone in combination with (maxRAS) therapy on proteinuria, delta eGFR and hyperkalemia (HK).

**Methods:** Thirty-two pts with T2D and DKD were randomized to (maxRAS) alone or in combination with spironolactone 25 mg/day (Spiro). Pts developing HK (K+ > 5.5 mmol/L) during therapy received patiomer 8.4 gm Q MWF and titrated as needed. Twenty-seven (85%) of the 32 pts had biopsies confirming DKD. At entry all patients were 1) receiving insulin or oral agents, 2) BP <140/90 mm/Hg on max tolerated ACE or ARB, 3) two consecutive, pre-study UP/Cr >500 mg/gm, 4) CKD-Epi eGFR >20 mL/min/1.73M<sup>2</sup>. The primary endpoint was reduction in proteinuria at 24 months. A complete response was as defined UP/Cr <500 mg/gm, while a partial response was >50% reduction from baseline. Mean follow-up was 29 months.

**Results:** Results appear in Table-1. Addition of Spiro to RAS reduced UP/Cr at 24 months (p<0.028). The rate of complete/partial response was significantly higher with Spiro (76.6%) vs. maxRAS (38.8%) (P<0.025). HK occurred in 22.2% maxRAS and 57.1% Spiro pts (p<0.027). There were no withdrawals due to HK. ESRD developed in 8 pts; maxRAS-(6) and Spiro-(2). There was 3 deaths; 2-controls and 1-Spiro group; none due to HK. All HK patients were successfully controlled with Patiomer.

**Conclusions:** Combination therapy with Spironolactone and max-RAS was more effective than max RAS alone in reducing nephrotic range proteinuria and slowing eGFR decline DKD, with a trend to fewer cases of ESRD. Patiomer was effective in management of HK in both groups, and enabled continuous therapy.

**Funding:** Commercial Support - Vifor Pharmaceuticals, Private Foundation Support, Clinical Revenue Support

Table-1

	Pt-#	Age	Gender	Pre-UP/Cr mg/gm	Post-UP/Cr mg/gm	>90% Red	>75% Red	>50% Red	% Patim	eGFR-24Mths	#ESRD	Death
Total Patients	32	62.3	56.2%M	3.71±0.5	2.21±0.5	14.2%	28.1%	34.2%	37.5%	34.3 mL/min	8	3
Spironolactone	14	61.3	62.5%M	3.96±7	1.87±0.7*	14.2%	42.8%	50.9%	57.1%	39.4 mL/min*	2	1
RAAS-Control	18	63.0	47.1%M	3.10±0.7	2.49±0.6	0.0%	21.4%	21.4%	22.2%	28.6 mL/min*	6	±

\*=Significance P value <0.05

SA-PO272

Effect of Spironolactone Wash-Out on Albuminuria After Long-Term Treatment: The AFTER-PRIORITY Study

Victor Wasehuus,<sup>1</sup> Viktor Rotbain Curovic,<sup>1</sup> Nete Tofte,<sup>1</sup> Morten Lindhardt,<sup>1,2</sup> Christian Delles,<sup>3</sup> Marie Frimodt-Moller,<sup>4</sup> Harald Mischak,<sup>4</sup> Frederik Persson,<sup>1</sup> Heiko von der Leyen,<sup>5</sup> Tine Hansen,<sup>5</sup> Peter Rossing,<sup>1</sup> PRIORITY Study Group <sup>1</sup>Steno Diabetes Center Copenhagen, Herlev, Denmark; <sup>2</sup>Department of Medicine, Holbæk Hospital, Holbæk, Denmark; <sup>3</sup>University of Glasgow Institute of Cardiovascular and Medical Sciences, Glasgow, United Kingdom; <sup>4</sup>Mosaïques Diagnostica, Hannover, Germany; <sup>5</sup>Hannover Clinical Trial Center Hannover Medical School, Hannover, Germany.

**Background:** The PRIORITY study showed that treatment with spironolactone did not prevent progression to microalbuminuria in high kidney risk individuals as classified by the urinary proteomic risk classifier – CKD273. As spironolactone has previously shown to significantly lower albuminuria levels in chronic kidney disease, we have investigated the difference in albuminuria and kidney risk markers 6 weeks after spironolactone discontinuation.

**Methods:** Observational study following the nested randomized clinical trial in the PRIORITY study. A total of 115 individuals with type 2 diabetes and normoalbuminuria but high-risk for progression based on urinary proteomics, previously randomized to daily

spironolactone or placebo were seen 6±2 weeks after the final visit in PRIORITY. The primary endpoint was change in urinary albumin-creatinine ratio (UACR) between the final visit in PRIORITY (baseline) and follow-up. Secondary endpoints were change in estimated glomerular filtration rate (eGFR), systolic and diastolic blood pressure (BP), and serum potassium. Statistical analysis was done using paired t-test to assess the change between baseline and follow-up and unpaired t-test for between-group analysis of end-to-end results.

**Results:** The mean age of the study subjects was 66±6 years and 90 (78.3%) were male. Baseline HbA1c was 56±17 mmol/mol, and eGFR was 78±19 ml/min/1.73m<sup>2</sup>. No change in UACR was observed in neither the spironolactone group (Median change: 33%, IQR -37;104, p=0.28) nor the placebo group (9%, -27;81, p=0.63) at follow-up. No difference between the groups was observed at end of study (Log difference: 0.05 mg/g, -0.22;0.13, p=0.60). Assessing the secondary endpoints, eGFR and systolic BP are seen increasing after discontinuation of spironolactone, and for systolic BP after placebo discontinuation as well. Potassium levels were lower after discontinuation of spironolactone, but higher after placebo discontinuation (all p<0.05).

**Conclusions:** This study supports the findings of the PRIORITY trial, that spironolactone exerted no effect on UACR in a high-risk kidney population, as classified by CKD273 score. Our findings do not support the use of spironolactone for preventing progression to microalbuminuria in high kidney risk individuals.

**Funding:** Government Support - Non-U.S.

SA-PO273

**Effect of Finerenone on CKD Outcomes in Type 2 Diabetes: A Chinese Subgroup Analysis of the FIDELIO-DKD Study**

Haitao Zhang,<sup>1</sup> Jingyuan Xie,<sup>2</sup> Chuanming Hao,<sup>3</sup> Xuemei Li,<sup>4</sup> Dalong Zhu,<sup>5</sup> Hongguang Zheng,<sup>6</sup> Xudong Xu,<sup>13</sup> Zhaohui Mo,<sup>7</sup> Weiping Lu,<sup>8</sup> Yibing Lu,<sup>9</sup> Chaoqing Wu,<sup>10</sup> Nanwei Tong,<sup>11</sup> Li Wang,<sup>12</sup> Zhihong Liu.<sup>1</sup> <sup>1</sup>National Clinical Research Center of Kidney Diseases, Jinling Hospital, Nanjing University School of Medicine, Nanjing, China; <sup>2</sup>Ruijin Hospital, Shanghai Jiao Tong University School of Medicine, Shanghai, China; <sup>3</sup>Huashan Hospital Fudan University, Shanghai, China; <sup>4</sup>Peking Union Medical College Hospital, Dongcheng-qu, China; <sup>5</sup>Nanjing University Medical School Affiliated Nanjing Drum Tower Hospital, Nanjing, China; <sup>6</sup>General Hospital of Northern Theater Command, Shenyang, China; <sup>7</sup>The Third Xiangya Hospital of Central South University, Changsha, China; <sup>8</sup>The Affiliated Huaian No.1 People's Hospital of Nanjing Medical University, Huaian, China; <sup>9</sup>The Second Affiliated Hospital of Nanjing Medical University, Nanjing, China; <sup>10</sup>The People's Hospital of Guangxi Zhuang Autonomous Regio, Guangxi, China; <sup>11</sup>Sichuan University West China Hospital, Chengdu, China; <sup>12</sup>Bayer Healthcare Company, Beijing, China; <sup>13</sup>Fudan University Minhang Hospital, Shanghai, China.

**Background:** This subgroup analysis of FIDELIO-DKD trial aimed to evaluate the efficacy and safety of finerenone in chronic kidney disease (CKD) patients with type 2 diabetes mellitus (T2DM) in China.

**Methods:** Three hundred and seventy-two participants who were recruited from 67 centers in China were randomized 1:1 to oral finerenone or placebo with standard therapy for diabetes. The primary outcome was a composite of kidney failure, sustained decrease of estimated glomerular filtration rate (eGFR) ≥40% from baseline over at least 4 weeks, or renal death. The key secondary composite outcome was a composite of death from cardiovascular causes, nonfatal myocardial infarction, nonfatal stroke, or hospitalization for heart failure.

**Results:** After a median follow-up of 30 months, the finerenone group showed a relative risk reduction (RRR) of 41% (hazard ratio [HR]=0.59, 95% confidence interval [CI], 0.39 to 0.88; p=0.009) for the primary composite outcome compared to the placebo group, and was consistent across its components with treatment benefit in finerenone group. For the key secondary composite outcome, the finerenone group showed a RRR of 25% (HR=0.75, 95% CI, 0.38 to 1.48; p=0.408), while the global results showed significant differences in favor of finerenone with a RRR of 14% (HR=0.86, 95% CI, 0.75 to 0.99; p=0.03). Adverse events were similar between the two groups. Hyperkalemia leading to discontinuation occurred in 8 (4.3%) and 2 (1.1%) participants in the finerenone and control groups, respectively.

**Conclusions:** Finerenone resulted in lower risks of CKD progression than placebo and a balanced safety profile in Chinese CKD patients with T2DM.

**Funding:** Commercial Support - Bayer AG

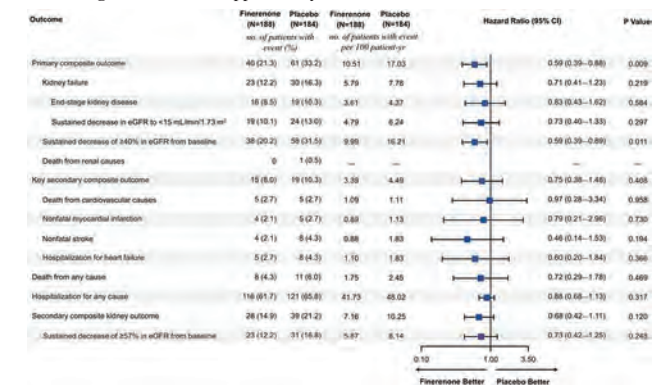

SA-PO274

**Cardiorenal Outcomes With Finerenone in Asian Patients With CKD and Type 2 Diabetes: Post Hoc Analysis From FIDELIO-DKD**

Daisuke Koya,<sup>1,2</sup> Stefan D. Anker,<sup>3</sup> Luis M. Ruilope,<sup>4,5</sup> Peter Rossing,<sup>6,7</sup> Byung-Wan Lee,<sup>8</sup> Chien-Te Lee,<sup>9</sup> Zhi Hong Liu,<sup>10</sup> Charlie Scott,<sup>11</sup> Peter Kolkhof,<sup>12</sup> Robert Lawatscheck,<sup>13</sup> Lili Wang,<sup>14</sup> Amer Joseph,<sup>15</sup> Bertram Pitt.<sup>16</sup> On behalf of the FIDELIO-DKD Investigators <sup>1</sup>Department of Diabetology and Endocrinology, and the Division of Anticipatory Molecular Food Science, Kanazawa Medical University, Kanazawa, Japan; <sup>2</sup>Department of General Internal Medicine, Omi Medical Center, Kanazawa, Japan; <sup>3</sup>Department of Cardiology (CVK) and Berlin Institute of Health Center for Regenerative Therapies, German Centre for Cardiovascular Research Partner Site Berlin, Charité Universitätsmedizin, Berlin, Germany; <sup>4</sup>Cardiorenal translational Laboratory and Hypertension Unit, Institute of Research imas12, Madrid, Spain; <sup>5</sup>CIBER-CV, Hospital Universitario 12 de Octubre, Madrid, Spain; <sup>6</sup>Steno Diabetes Center Copenhagen, Herlev, Denmark; <sup>7</sup>Department of Clinical Medicine, University of Copenhagen, Copenhagen, Denmark; <sup>8</sup>Yonsei University College of Medicine, Seodaemun-gu, Seoul, Republic of Korea; <sup>9</sup>Division of Nephrology, Department of Internal Medicine, Kaohsiung Chang-Gung Memorial Hospital, College of Medicine, Chang-Gung University, Nanjing, Taiwan; <sup>10</sup>National Clinical Research Center of Kidney Diseases, Jinling Hospital, Nanjing University School of Medicine, Nanjing, China; <sup>11</sup>Data Science and Analytics, Bayer PLC, Reading, United Kingdom; <sup>12</sup>Research and Development, Cardiovascular Precision Medicines, Bayer AG, Wuppertal, Germany; <sup>13</sup>Clinical Research, Bayer AG, Berlin, Germany; <sup>14</sup>Bayer Pte Ltd, Singapore, Singapore; <sup>15</sup>Research and Development, Cardiology and Nephrology Clinical Development, Bayer AG, Berlin, Germany; <sup>16</sup>Department of Medicine, University of Michigan School of Medicine, Ann Arbor, MI.

**Background:** In FIDELIO-DKD, finerenone significantly improved cardiorenal outcomes in patients with chronic kidney disease (CKD) and type 2 diabetes (T2D). A post hoc analysis of FIDELIO-DKD data was conducted to explore the cardiorenal effects of finerenone in patients from the Asian region.

**Methods:** In FIDELIO-DKD (NCT02540993), 5674 patients were randomized to receive finerenone or placebo, of whom 1327 were from 10 Asian countries and territories. Eligible patients had T2D, and either urine albumin-to-creatinine ratio (UACR) ≥30 to <300 mg/g and estimated glomerular filtration rate (eGFR) ≥25 to <60 mL/min/1.73 m<sup>2</sup>, or UACR ≥300 to ≤5000 mg/g and eGFR ≥25 to <75 mL/min/1.73 m<sup>2</sup>, and were treated with optimized renin-angiotensin system blockade. The primary efficacy outcome was a kidney composite outcome (time to kidney failure, death from renal causes, and sustained decrease of ≥40% in eGFR from baseline). Secondary efficacy outcomes included both kidney (time to kidney failure, death from renal causes, and sustained decrease of ≥57% in eGFR from baseline) and cardiovascular (CV; time to CV death, nonfatal myocardial infarction, nonfatal stroke, or hospitalization for heart failure) composite outcomes.

**Results:** In the Asian subgroup, 665/1327 (50%) patients received finerenone. The finerenone cohort of the Asian subgroup showed reduced ≥40% and ≥57% eGFR kidney composite outcomes and CV composite outcome vs the placebo group (hazard ratio [HR] 0.70, 95% confidence interval [CI] 0.56-0.87; HR=0.73, 95% CI 0.55-0.97; and HR=0.85, 95% CI 0.59-1.21, respectively). No apparent differences were observed between the Asian subgroup and patients from the rest of the world for these outcomes (HR=0.88, 95% CI 0.77-1.02 [P<sub>interaction</sub>=0.09]; HR=0.78; 95% CI 0.64-0.95 [P<sub>interaction</sub>=0.71]; and HR=0.86, 95% CI 0.74-1.00 [P<sub>interaction</sub>=0.95], respectively). Finerenone demonstrated similar safety across subgroups.

**Conclusions:** The beneficial effect of finerenone on cardiorenal outcomes in the Asian population are comparable to the overall results observed in FIDELIO-DKD.

**Funding:** Commercial Support - Bayer AG



## SA-PO275

## Abstract Withdrawn

## SA-PO276

**The Effect of Magnesium Supplementation on Albuminuria in Patient With Type 2 Diabetic Mellitus in Phramongkutklao Hospital: A Randomized Double-Blinded Controlled Trial**

Sriladda Santhitsate, Narittaya Varothai. *Phramongkutklao Hospital, Bangkok, Thailand.*

**Background:** Hypomagnesemia is associated with the development of microvascular complications including albuminuria in type 2 diabetes mellitus patients. It can also worsen glycemic control by promoting insulin resistance. Although there are several studies showed benefits of magnesium in patients with type 2 diabetes mellitus, there is no recommendation in recent guidelines that dietary mineral supplementation can improve outcomes in patients who do not have underlying deficiencies. This study was aimed to compare the effect of magnesium supplementation on albuminuria in type 2 diabetes mellitus patients.

**Methods:** This randomized double-blinded controlled trial included 26 patients who have moderately or severely increased albuminuria and normomagnesemia. Subjects were randomly divided in two groups to receive either 200 mg magnesium oxide or placebo daily for 6 months. Urine albumin-to-creatinine ratio, fasting plasma glucose, HbA1c, lipid profiles, kidney function were recorded at baseline and after the intervention. Magnesium intake was also assessed by 3-day food record.

**Results:** Every patients in this study had inadequate magnesium intake (lower than 30% of recommended daily allowance). Mean urine albumin-to-creatinine ratio were 143.61 +/- 115.87 mg/g in magnesium group and 466.36 +/- 989.28 mg/g in placebo group (p-value 0.247). Mean serum magnesium were 1.88 +/- 0.16 mg/dL in magnesium group and 1.77 +/- 0.10 mg/dL in placebo group (p-value 0.052). After 6-month treatment, there was no significant difference in degree of albuminuria between two groups (-47.48 +/- 89.05 vs 127.05 +/- 859.45, p-value 0.511). Fasting plasma glucose, HbA1c, lipid profiles and kidney function were also no significant differences except serum cholesterol level. Serum cholesterol were increased in both groups but significantly higher in placebo group (5.07 +/- 26.43 vs 24.25 +/- 18.68, p-value 0.049).

**Conclusions:** Magnesium supplementation showed no significant effect in albuminuria among patients with type 2 diabetes mellitus.

## SA-PO277

**Vacuolar Tubular Necrosis Caused by Hyperglycemia in a Diabetic Patient**

Sua Lee, Jaehyun Jun, Jeongwoo Kim. *Eulji University College of Medicine, Daejeon, Republic of Korea.*

**Introduction:** Acute tubular necrosis (ATN) is a disease in which the epithelial cells of the renal tubules are necrotic, accounting for about 45 % of acute renal injury, and the main causes are nephrotoxic drugs and lowering of blood pressure. Vacuolar ATN is a rare form of ATN known to be caused by hyperosmolar substances such as contrast agents, immunoglobulins, and mannitol. We reported a rare case of vacuolar ATN caused by temporary hyperglycemia in a diabetic patient.

**Case Description:** A 45-year-old man had symptoms of abdominal pain and vomiting for 5 days and a decrease renal function at a primary medical institution. He diagnosed hypertension and type 2 diabetes 5 years ago and was taking medications. He had a feeling of lethargy, general edema and abruptly decreased urine volume 3 weeks ago. On physical examination, blood pressure was 138/80 mmHg, and pretibial pitting edema was observed. In blood chemistry, serum urea/creatinine (Cr) was 78/19.52 mg/dL, and estimated glomerular filtration rate (eGFR) was 2.62 ml/1.73m<sup>2</sup>/min. serum albumin and spot urine protein-creatinine ratio were 4.5 g/dL and 4.628 g/mg. Glycated hemoglobin A1c and blood glucose level were 8.3 % and 133 mg/dL. Emergent hemodialysis was performed and kidney biopsy was done to identify the cause of acute kidney injury. The vacuolar degeneration and necrosis of renal tubular epithelial cells were observed on light microscopy, and thickening of the glomerular basement membrane was observed on electron microscopy. At 3 months after treatment, renal function was maintained with serum Cr 1.13 mg/dL and eGFR as 70.18 ml/1.73m<sup>2</sup>/min.

**Discussion:** Vacuolar ATN may be the cause of acute renal injury in diabetic patient, so it is necessary to differentiate the cause through renal biopsy when there is abrupt renal function decline in diabetic patients.

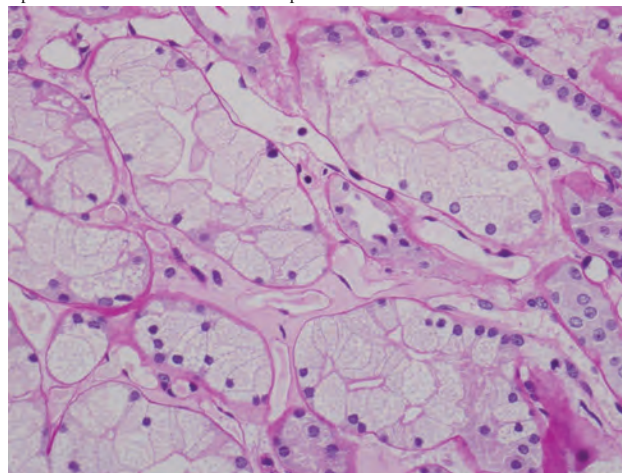

## SA-PO278

**Improving Daily Physical Activity in Patients Undergoing Hemodialysis Using Plantar Electrical Nerve Stimulation: A Randomized Double-Blinded Controlled Trial**

Myeounggon Lee,<sup>1</sup> Abdullah I. Hamad,<sup>2</sup> Rania A. Ibrahim,<sup>2</sup> Heba M. Ateya,<sup>2</sup> Mincy Mathew,<sup>2</sup> Anmol S. Momin,<sup>1</sup> Bijan Najafi,<sup>1</sup> Fadwa S. Al-Ali,<sup>2</sup> <sup>1</sup>Interdisciplinary Consortium on Advanced Motion Performance (iCAMP), Michael E. DeBakey Department of Surgery, Baylor College of Medicine, Houston, TX; <sup>2</sup>Hamad Medical Corporation, Doha, Qatar.

**Background:** Physical inactivity among patients undergoing hemodialysis (HD) is a persistent clinical problem. Intradialytic electrical stimulation (E-stim) can be a practical solution as it can be used by patients during lying down or sitting, and does not require any effort in the patients. Especially, E-stim to the plantar region of the feet can have the benefit of activating lower limb muscles and enhance the sensitivity for the somatosensory signal from the foot, which may improve the stability and increase the physical activities in HD patients.

**Methods:** Participants were randomized into either an intervention group (IG: n=24, age=55.8 ± 13.4 years, BMI = 30.2 ± 5.9 kg/m<sup>2</sup>, female = 28.0%) receiving PENS or a control group (CG: n=25, age = 57.28 ± 12.2 years, BMI = 30.8 ± 5.9 kg/m<sup>2</sup>, female = 40.0%). The IG received 1-hour PENS during the routine HD (3 sessions/week) for 12 weeks. The CG received an identical but non-functional device for the same period.

**Results:** All participants in the IG tolerated the PENS and completed all therapy sessions, indicating the feasibility of incorporating PENS during clinic visit. As an IG, there was a significant increase in standing duration between baseline and 12-weeks ( $d = 0.91$ ,  $p = 0.036$ ); and there were also increase trends, but not significant, in walking duration ( $d = 0.79$ ,  $p = 0.071$ ) and daily step count ( $d = 0.82$ ,  $p = 0.063$ ) in those periods (Figure 1). As a CG, there was no significance in those periods.

**Conclusions:** Findings suggest PENS during the routine HD process may improve mobility in daily life of HD patients. We recommend this practical therapy as an alternative way for the patients who can not do regular exercise if the results will be held with a larger sample.

**Funding:** Government Support - Non-U.S.

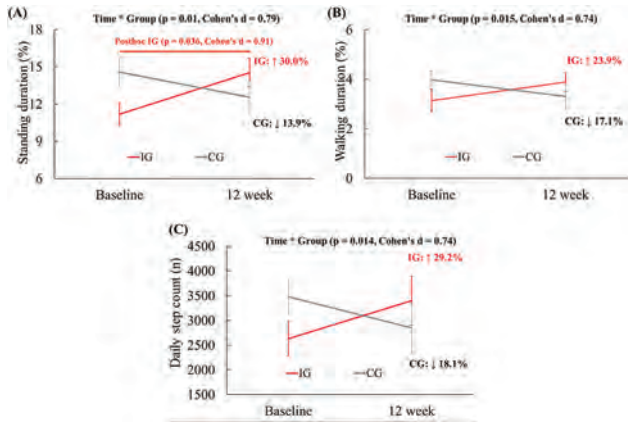

Figure (A) Participants in the intervention group (IG) showed significant improvement

SA-PO279

**Fasting Blood Glucose and the Risk of Cause-Specific Death in Hemodialysis Patients with Diabetes**

Soo-Young Yoon,<sup>1</sup> Sojin Lim,<sup>1</sup> Geon Woo Kim,<sup>1</sup> Jongho Kim,<sup>1</sup> Gang Jee Ko,<sup>2</sup> Jin sug Kim,<sup>1</sup> Ju young Moon,<sup>1</sup> Kyung hwan Jeong,<sup>1</sup> Hyeon Seok Hwang,<sup>1</sup>

<sup>1</sup>Kyung Hee University Medical Center, Dongdaemun-gu, Seoul, Republic of Korea; <sup>2</sup>Korea University College of Medicine and School of Medicine, Seoul, Republic of Korea.

**Background:** Glycemic control is fundamental to optimize the care of hemodialysis patients (HD) with diabetes. Most relevant studies focused on hemoglobin A1c values as an representative marker in general population. Therefore, current guidelines could not suggest any clear target of fasting blood glucose (FBG). The aim of the study is to examine the association between FBG and the risk of mortality and to sort out the HD patients who may benefit from strict FBG control.

**Methods:** Through reviewing the National Health Insurance Database of Korea, a total of 6,605 patients starting HD treatment with diabetes were included between 2002 and 2018. The participants were grouped into six following FBG categories: (1) <80 mg/dL, (2) 80-100 mg/dL, (3) 100-125 mg/dL, (4) 125-150 mg/dL, (5) 150-180 mg/dL, and (6) ≥180 mg/dL. Conventional and time-varying Cox regression models evaluated the association between FBG and all-cause mortality. We conducted baseline covariate-adjusted subsequent subgroup analyses.

**Results:** In a conventional Cox model compared to patients with FBG 80-100 mg/dL, adjusted hazard ratios (aHR) for all-cause mortality were significantly higher in patients with FBG 100-125 (aHR, 1.21 [95% confidence interval (CI), 1.07-1.36]), 125-150 (aHR, 1.20 [95% CI, 1.05-1.38]), 150-180 (aHR, 1.38 [95% CI, 1.19-1.61]), and ≥180 mg/dL (aHR, 1.46 [95% CI, 1.27-1.68]) except for patients with FBG <80 mg/dL. According to a time-varying Cox regression analysis, the mortality risks increased in participants with FBG <80 (aHR, 1.17 [95% CI, 1.08-1.27]), 100-125 (aHR, 1.08 [95% CI, 1.02-1.15]), 125-150 (aHR, 1.18 [95% CI, 1.10-1.28]), 150-180 (aHR, 1.31 [95% CI, 1.20-1.43]), and ≥180 mg/dL (aHR, 1.30 [95% CI, 1.21-1.39]). Compared with patients grouped into FBG 80-100 mg/dL, patients who were younger than 65, female, belonged to both normal and over body mass index, and low Charlson comorbidity index score were at a relatively higher mortality risk in case of FBG ≥100 mg/dL.

**Conclusions:** Targeting FBG from 80 to 100 mg/dL significantly alleviated the risk of all-cause mortality in diabetic HD patients when compared to those with FBG <80 mg/dL or ≥ 100 mg/dL. Further research needs to be done to elucidate the target level of FBG to minimize the mortality risk in subgroup of HD patients with diabetes.

SA-PO280

**Cost-Effectiveness Analysis of a Prognostic Risk Assessment Test for Diabetic Kidney Disease G1-G3b in the United States**

Jacie T. Cooper,<sup>1</sup> Karen Beltran,<sup>1</sup> Steven G. Coca,<sup>2</sup> John E. Schneider,<sup>1</sup>  
<sup>1</sup>Avalon Health Economics LLC, Morristown, NJ; <sup>2</sup>Icahn School of Medicine at Mount Sinai, New York, NY.

**Background:** KidneyIntelX™ was developed and validated to predict rapid progressive decline in kidney function in patients with early-stage diabetic kidney disease (DKD). KidneyIntelX can assist primary care providers to guide resource utilization and prescription of new therapeutic agents, and improve efficiency of care among physicians. We sought to develop a model that estimates the incremental cost-effectiveness of KidneyIntelX compared to risk stratification using eGFR and UACR (GAC).

**Methods:** We modeled a hypothetical cohort of 100,000 patients with DKD in stages G1/G2 with A2/A3, or G3a/G3b with A1-A3 that received a prognostic test (GAC vs. KidneyIntelX) one time at the start of the model and cardiorenal agents for treatment. We employed a 10-state Markov state transition structure, made up of the following states: Stages G1 through G5, dialysis, kidney transplant, cardiovascular death, and non-cardiovascular death. The model projects outcomes, including cardiovascular events, over a lifetime time horizon with a maximum patient age of 100 years old and presents results for both Medicare and Commercial payer perspectives.

**Results:** Our results showed that the average Medicare patient population would experience fewer dialysis starts and kidney transplants, increased life span, and increased quality adjusted life-span by using KidneyIntelX compared to GAC. Medicare patients would incur incremental costs of approximately -\$428 per patient and incremental QALYs of 0.09. In the commercial scenario analyses, cost savings were about \$14,116 per patient and QALY gains of 0.15, indicating that KidneyIntelX is a dominant strategy in comparison to GAC (Figure).

**Conclusions:** This analysis demonstrated that population-based KidneyIntelX testing for the prognosis of progression in a DKD G1-G3b population is a dominant strategy for both Medicare and commercial populations in comparison to prognosis relying on eGFR and UACR alone.

**Funding:** Commercial Support - Renalytix

Figure. Incremental benefit vs. incremental costs in Base Case/Medicare Scenario (Panel A) and Commercial Scenario (Panel B)



SA-PO281

**Percutaneous Renal Biopsy Is Associated With Higher Bleeding Risks in Diabetics: A National Population Based Study**

Vijaya Chelikani,<sup>1</sup> Nisshit Baral,<sup>1</sup> Arvind R. Kunadi,<sup>1</sup> McLaren Flint Hospital, Flint, MI.

**Background:** Percutaneous renal biopsy (PRB) is required in the diagnosis of glomerular, vascular and tubulointerstitial diseases of the kidney, providing essential information regarding prognosis and management, especially in diabetic nephropathy with atypical features. However, there are complications that develop after a renal biopsy, most commonly in the form of bleeding. The association between diabetes and major bleeding post PRB is not well studied.

**Methods:** This is a retrospective cohort study from PRB hospitalizations between January 1, 2016, and December 31, 2019, using the National Inpatient Sample (NIS). Our study sample included any hospitalizations with PRB procedure with valid information on DM, age 18 years or older, using the ICD 10 procedural and diagnostic codes validated in previous studies. Our outcome of interest is major bleeding requiring transfusion post procedure.

**Results:** From 2016 to 2019, a total of 40,177 (weighted N=190,720) hospitalizations with principal or secondary PRB procedure were identified. Among them, 44% (n= 17670) were females and 33% (n=13,318) were diabetics. Mean age was 56.81 ± 15.9 years. Moreover, 57.7% of total PRB were performed in Whites, 20.5% in Blacks, 14.2% in Hispanics, and 3.7% in Asians. Compared to non-DM, those who had DM, were older in age (mean age: 59.6 vs. 54.3;  $p < 0.001$ ), had higher post procedural major bleeding (15% vs 11%,  $p < 0.001$ ) and had similar in-hospital mortality (1% vs 1%,  $p = 0.469$ ). Multivariate regression analysis showed that, compared with non-DM, DM had a significantly increased odds of post procedural major bleeding (aOR: 1.26; 95% CI: 1.18, 1.34;  $p < 0.001$ ) after controlling for age, race, regional location of the hospital, income, and insurance provider. The annual number of PRB procedures done per 100,000 hospitalizations has been increasing at 135.6 in 2016, 138.6 in 2017, 143.9 in 2018 and 146.2 in 2019 ( $p$ -trend<0.001).

**Conclusions:** The number of PRB procedures performed has been increasing over recent years. DM is associated with high bleeding risk after the procedure.

SA-PO282

Development in eGFR Trajectories in People With Diabetic Nephropathy

Christina G. Poulsen,<sup>1</sup> Kristin Jesse,<sup>1</sup> Bendix Carstensen,<sup>1</sup> Marie Frimodt-Moller,<sup>1</sup> Tine Hansen,<sup>1</sup> Frederik Persson,<sup>1</sup> Dorte Vistisen,<sup>1,2</sup> Peter Rossing,<sup>1,2</sup> <sup>1</sup>Steno Diabetes Center Copenhagen, Herlev, Denmark; <sup>2</sup>Kobenhavns Universitet, Kobenhavn, Denmark.

**Background:** Diabetic nephropathy (DN) is a frequent and serious complication to type 1 diabetes (T1D) and type 2 diabetes (T2D). The effect of advancing diabetes care over the past decades on progression in DN requires update. We analyzed the development over calendar time in eGFR trajectories from time of DN diagnosis.

**Methods:** Retrospective cohort study, with data collected from electronic health records from persons attending the outpatient clinic at Steno Diabetes Center Copenhagen, Denmark between 2001-2020. Inclusion criteria were: T1D/T2D and DN, defined as urine albumin to creatinine ratio > 300 mg/g or urine albumin excretion rate > 300 mg/24h in two occasions > 60 days apart. Individual eGFR trajectories were calculated separately for T1D and T2D, using mixed-effects models with fixed effects of age and interactions of splines of DN duration and date of diagnosis.

**Results:** The T1D cohort included 888 persons, 59.7% male and median (IQR) age at DN diagnosis was 50 (38-62) years. Figure 1A shows estimated trajectories for eGFR for a person with T1D diagnosed with DN at age 50 in 2000, 2005, 2010 or 2015. eGFR at time of DN diagnosis increased with 1.8 ml/min/1.73m<sup>2</sup>/year. Improvement in eGFR trajectories with calendar time was not evident, but with a tendency toward attenuating decline after 2010. The T2D cohort included 1480 persons, 71.9% male and median (IQR) age at DN diagnosis was 65 (58-72) years. Figure 1B shows estimated trajectories for eGFR for a person with T2D diagnosed with DN at age 65 in 2000, 2005, 2010 or 2015. eGFR at time of DN diagnosis increased with 0.7 ml/min/1.73m<sup>2</sup>/year. Most pronounced increase was between 2000 and 2005. The eGFR trajectories for T2D were similar across calendar time.

**Conclusions:** Kidney function at time of DN diagnoses has increased over the past 20 years, most pronounced in T1D, where eGFR decline appears attenuating in most recent years. This may be explained by improved awareness and treatment.

**Funding:** Private Foundation Support

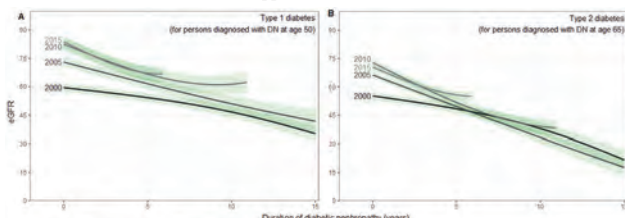

Figure 1. Average trajectories for eGFR for persons diagnosed with DN in 2000, 2005, 2010, or 2015. A. T1D, diagnosed with DN at age 50. B. T2D, diagnosed with DN at age 65.

SA-PO283

A Global Validation of a Minimal-Resource Pre-Screening Model for Reduced Kidney Function in Patients With Type 2 Diabetes

Rose Sisk,<sup>1</sup> Camilla Sammut-Powell,<sup>1</sup> Jayne Budd,<sup>1</sup> Rory S. Cameron,<sup>1</sup> Mark P. Edge,<sup>1</sup> Estefania Vazquez Mendez,<sup>2</sup> Aleksandr Bedenkov,<sup>3</sup> Hardik Vasawala,<sup>5</sup> Susana Goncalves,<sup>4</sup> <sup>1</sup>Gendius Ltd, Macclesfield, United Kingdom; <sup>2</sup>AstraZeneca, Mexico City, Mexico; <sup>3</sup>AstraZeneca, Cambridge, United Kingdom; <sup>4</sup>AstraZeneca, Buenos Aires, Argentina; <sup>5</sup>AstraZeneca, Bangalore, India.

**Background:** A minimal-resource (MR) pre-screening model has been developed in UK data for people with type 2 diabetes (T2DM) with no previous diagnosis of chronic kidney disease (CKD). It identifies those at higher risk of having reduced kidney function (eGFR < 60ml/min/1.73m<sup>2</sup>) using readily available non-clinical inputs. The model was developed to support prioritization of CKD screening resource, particularly where resources are limited. The model has previously been validated in global study data and whilst strong performance was observed, the data were limited in volume and collected prior to 2018. The goal of this study is to test the performance of the model in up-to-date data, reflective of the application setting.

**Methods:** The model was applied to the observational iCaReMe registry data covering 21 countries in 7 regions globally from 2018. We evaluated the global and regional positive predictive values (PPV) at thresholds that ensured a sensitivity of at least 80%. We compared the PPV of the MR model against current practice (i.e. "screen all", testing the entire T2DM population).

**Results:** 5618 patients with a valid eGFR measurement were included. The MR model resulted in a PPV of 28.0% [95% CI: 26.5% - 29.6%] with a sensitivity of 82.4% [95% CI: 80.2% - 84.7%] - a relative improvement of 44.8% compared with the screen all approach (PPV 19.3% [95% CI: 18.3% - 20.4%]). Regional variation in performance was observed (Figure 1, PPV range of 23.8% - 34.9%), but the improvement remained significant in regions with sufficient sample size.

**Conclusions:** The MR model can be used globally to identify people with T2DM that are likely to have kidney function impairment, but should be adapted to regional populations. The model can be used to conduct targeted screening where resources are limited. Prioritized screening of high-risk individuals could help to address the backlog in routine care provision due to the COVID-19 pandemic.

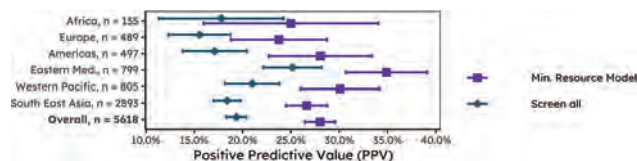

A forest plot of the performance of the MR model. Positive predictive value of the model is compared against the "screen all" approach, overall and by region.

SA-PO284

Transition Probabilities of Diabetic Kidney Disease (DKD) and Death in a Multi-Ethnic Asian Population

Charumathi Sabanayagam,<sup>1,2</sup> Feng He,<sup>1</sup> Kavita Venkataraman,<sup>3</sup> Cynthia C. Lim,<sup>4</sup> Gavin Tan.<sup>1,2</sup> <sup>1</sup>Singapore Eye Research Institute, Singapore, Singapore; <sup>2</sup>Duke-NUS Medical School, Singapore, Singapore; <sup>3</sup>National University of Singapore, Singapore, Singapore; <sup>4</sup>Singapore General Hospital, Singapore, Singapore.

**Background:** The severity and rate of progression/regression of diabetic kidney disease (DKD) are important for making clinical decisions. We examined the transitions in DKD severity stages over time in an Asian population.

**Methods:** We analysed 17,081 clinic visits by 6,453 Chinese, Malay and Indian adults with type 2 diabetes who attended the annual DKD screening visits in primary care clinics from 2010-2015 with death data until 2020. CKD stage transition was defined as change in estimated glomerular filtration rate (eGFR) categories: ≥60, 30-60 and <30 mL/min/1.73 m<sup>2</sup> (corresponding to G1-G2, G3, G4-5)+ eGFR decline ≥25% from the previous visit. A multistate Markov model was used to estimate the annual transition probabilities between 4 consecutive stages (G1-G2, G3, G4-5 and death) and the expected waiting (sojourn) time in each state adjusted for risk factors including age, gender, ethnicity, duration of diabetes, HbA1c %, systolic blood pressure (SBP), LDL-cholesterol, and diabetic retinopathy (DR) status.

**Results:** The median (interquartile range) follow-up duration was 2.68 (1.08-4.29) years, and most patients had at least 3 assessments. The annual transition probability from G1-2 to G3, G3 to G4-5 in the adjusted model were 1.4%, and 1.7%, and of death from each state were 2.4%, 5.9%, and 16.4%; mean sojourn time in each state were 25.15, 5.41, and 3.93 years. Probability of regression from G3 to G1-2, and G4-5 to G3 were 9.1%, and 5.6%; DKD progression was significantly associated with older age, Malay ethnicity, DR, higher levels of HbA1c and SBP, and lower LDL-cholesterol, while regression with younger age, female gender, and lower HbA1c; Death was significantly associated with older age, male gender, longer duration of diabetes, DR, and higher levels of HbA1c and LDL-cholesterol.

**Conclusions:** Progression of DKD in people with diabetes is a gradual but steady process. Surveillance and control of blood pressure, glucose, cholesterol and DR may facilitate the management of DKD.

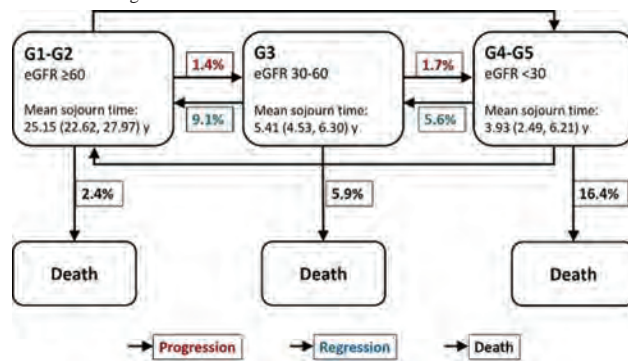

SA-PO285

CKD-Associated Pruritus (CKD-aP) in Hemodialysis (HD) Patients: Comparison of Instruments Used to Measure Self-Reported Itch Severity

Angelo Karoboyas,<sup>1</sup> Charlotte Tu,<sup>1</sup> Nidhi Sukul,<sup>2,3</sup> Elham Asgari,<sup>6</sup> Fitsum Guebre Egziabher,<sup>5</sup> Sebastian Walpen,<sup>4</sup> Thilo Schaufner,<sup>4</sup> Bruce M. Robinson,<sup>1,2</sup> Ronald L. Pisoni.<sup>1</sup> <sup>1</sup>Arbor Research Collaborative for Health, Ann Arbor, MI; <sup>2</sup>University of Michigan Department of Internal Medicine, Ann Arbor, MI; <sup>3</sup>VA Ann Arbor Healthcare System, Ann Arbor, MI; <sup>4</sup>Vifor Pharma Ltd, Glattbrugg, Switzerland; <sup>5</sup>Hospices Civils de Lyon, Lyon, France; <sup>6</sup>Guy's and St Thomas' NHS Foundation Trust, London, United Kingdom.

**Background:** The associations between self-reported CKD-aP and patient reported outcomes (PROs) have been well reported, but have generally been limited to a single baseline CKD-aP assessment. Collection of multiple CKD-aP instruments allows for

evaluation of different domains and approaches to measure CKD-aP burden, and may further help tailor data capture for future research or clinical care.

**Methods:** An electronic PRO (ePRO) survey was distributed to HD patients enrolled in the Dialysis Outcomes and Practice Patterns Study (DOPPS) in 2021-2022, and included 4 CKD-aP instruments: (1) a single question from the KDQOL-36 about the extent patients were bothered by itchy skin; (2) the 5-D itch, which assesses five dimensions of itch; and questions about the (3) worst itch [WI-NRS] and (4) average itch [AI-NRS] experienced. We calculated the Spearman correlation between each instrument, and stratified mean 5-D itch and NRS scores by response to the single KDQOL-36 question.

**Results:** Data collection is ongoing; 250 patients from 24 HD facilities in 4 countries (France, Germany, Spain, UK) have thus far completed the baseline survey. Patients 'not at all' bothered by itchy skin (N=104; 41%) were not asked to complete other CKD-aP instruments. Among the remaining 146 patients, the KDQOL-36 response was correlated with the WI-NRS (0.49), AI-NRS (0.52), and 5-D itch (0.56) – more so with the degree (0.67) and duration (0.55) domains than the distribution (0.42), disability (0.32), and direction (0.21) domains. Across response levels (somewhat, moderately, very much, extremely) of the KDQOL-36 question, the respective mean scores of other CKD-aP instruments were 10.0, 11.7, 14.7, 20.8 for 5-D itch; 2.7, 3.7, 5.6, 8.3 for AI-NRS; and 3.0, 4.1, 6.1, 8.4 for WI-NRS.

**Conclusions:** Correlation between CKD-aP instruments was relatively high; differences can be partially attributed to the recall period for the KDQOL-36 (4 weeks) vs. the 5-D itch (2 weeks) and NRS (24 hours). Understanding the relationships between CKD-aP instruments will help us interpret and link findings across observational and randomized studies that use different approaches to measure CKD-aP.

**Funding:** Commercial Support - The DOPPS is supported by Amgen Inc (since 1996, founding sponsor), Astellas Pharma Inc, AstraZeneca Pharmaceuticals LP, Bard Peripheral Vascular, Inc., Baxter Healthcare Corp, Bayer Yakuhin, Ltd, Cara Therapeutics, Inc., Chugai Pharmaceutical CO., LTD, GlaxoSmithKline LLC, Horizon Therapeutics USA, Inc., Japanese Society for Peritoneal Dialysis (JSPD), JMS Co., Ltd., Kidney Foundation Japan (KFJ), Kissei Pharmaceutical Co., Ltd, Kyowa Kirin Co., Ltd. (since 1999 for Japan DOPPS), Merck Sharp & Dohme Corp, Nikkiso Co., Ltd., ONO Pharmaceutical Co., Ltd, Terumo Corporation, Torii Pharmaceutical Co., Ltd, Vifor-Fresenius Medical Care Renal Pharma Ltd. All support is provided to Arbor Research Collaborative for Health, without restriction on publication, and not to individual coauthors.

SA-PO286

Improvement of Itch With Difelikefalin in CKD Patients on Dialysis by Baseline Itch Severity

Daniel E. Weiner,<sup>1</sup> Marc G. Vervloet,<sup>2</sup> Frederique Menzaghi,<sup>3</sup> Warren Wen,<sup>3</sup> Sebastian Walpen,<sup>4</sup> Thilo Schaufler,<sup>4</sup> Isabelle Morin,<sup>4</sup> Michael J. Germain.<sup>5</sup> <sup>1</sup>Tufts Medical Center, Boston, MA; <sup>2</sup>Amsterdam University Medical Center, Amsterdam, Netherlands; <sup>3</sup>Cara Therapeutics Inc, Stamford, CT; <sup>4</sup>Vifor Pharma Ltd, Glatbrug, Switzerland; <sup>5</sup>Baystate Medical Center, Springfield, MA.

**Background:** Difelikefalin (DFK) is a peripherally restricted κ-opioid receptor agonist that reduces itch severity in patients with chronic kidney disease-associated pruritus (CKD-aP) undergoing hemodialysis (HD). The purpose of this analysis was to determine if baseline severity of itch impacts the efficacy of DFK.

**Methods:** This was a secondary analysis of a multicenter, open-label study (3105) of intravenous DFK treatment (0.5 µg/kg, 3x per week) in patients on HD with moderate-to-severe CKD-aP (worst itch numerical rating scale [WI-NRS] ≥5). Participants were categorized based on itch severity at baseline as assessed by WI-NRS scores as either moderate (WI-NRS <7) or severe (WI-NRS ≥7). Patients were treated for 12 weeks and mean change in WI-NRS from baseline to the end of week 12 was determined.

**Results:** Among 222 participants, 70 patients had moderate pruritus (mean ±standard deviation WI-NRS: 6.0 ±0.5) and 152 patients had severe pruritus (8.3 ±0.9) at baseline. Patients with moderate and severe itch at baseline reported on average mild pruritus (WI-NRS <4) at Week 12 (2.9 ±2.2 and 3.1 ±2.3) following an improvement of -3.0 ±2.0 and -5.2 ±2.4 points, respectively, with similar relative improvements in the means from baseline of 51.7% and 62.7%, respectively (Figure).

**Conclusions:** Following 12 weeks' treatment with DFK, itch was on average reduced to mild intensity in patients with both moderate and severe disease at baseline. Together, these data suggest that DFK effectively reduces itch severity in patients with CKD-aP on HD, irrespective of baseline itch severity.

**Funding:** Commercial Support - Vifor Pharma

Figure: Reduction in itch by baseline itch severity following 12 weeks' treatment with difelikefalin

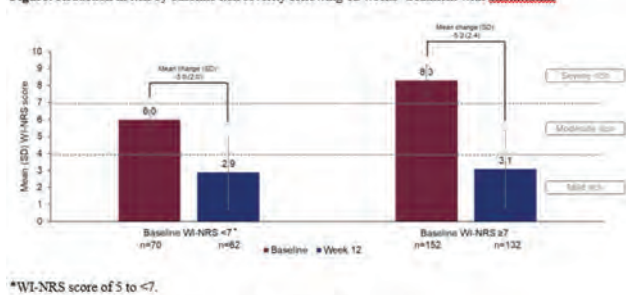

\*WI-NRS score of 5 to <7.

WI-NRS, worst itch numerical rating scale; SD, standard deviation.

SA-PO287

Pruritus in Patients With ESKD on Hemodialysis: Initial Results From a Prospective Patient Survey Study

Jeffrey Thompson,<sup>1</sup> Jennifer A. Kammerer,<sup>2</sup> Juliana H. Oliveira,<sup>2</sup> Lauren L. Ashka,<sup>1</sup> Kirsten L. Johansen,<sup>3</sup> Gil Yosipovitch.<sup>4</sup> <sup>1</sup>Cerner Enviva, North Kansas City, MO; <sup>2</sup>Vifor Pharma Ltd., Redwood City, CA; <sup>3</sup>Hennepin Healthcare Research Institute, Minneapolis, MN; <sup>4</sup>University of Miami School of Medicine, Miami, FL.

**Background:** Chronic kidney disease-associated pruritus (CKD-aP) is common in patients on hemodialysis (HD). Real-world assessment of the patient's perspective of pruritus is needed. A US-based patient survey assessed treatment, and the humanistic and economic burden of CKD-aP.

**Methods:** Eligible participants were ≥18 years old with healthcare provider (HCP) diagnosed ESKD on 3 times/week HD. They self-reported itch assessed on a modified 28-day recall period using the worst itch numerical rating scale (WI-NRS; 0=no itch to 10=worst itch), from which they were stratified into mild (1-3), moderate (4-6), and severe (7-10) cohorts. Sleep quality was assessed on a 0-10 scale (10=itch completely interfered with sleep in the past 24 hours).

**Results:** Of 299 completed surveys (2/3 planned population) from December 2021 to May 2022: 50, 126, and 123 were stratified into mild, moderate, and severe itch cohorts, respectively. Overall participants were 53% female, 53% white/non-Hispanic, 43% on Medicare plans, and 70% on in-center HD. Proportions of patients who had discussed chronic itch with an HCP, were diagnosed with CKD-aP, received HCP-recommended treatment, or were currently taking itch treatment increased with itch severity (Figure). Greater itch severity was associated with high/extremely high self-reported itch burden (mild=4.0%, moderate=26.2%, severe=39.8%), and sleep disruption (mild=2.3, moderate=4.6, and severe=6.4). Topical treatment was ubiquitous in all cohorts (100%) while systemic treatment was limited even in moderate to severe itch cohorts (24-40%).

**Conclusions:** More severe itch scores were associated with a greater likelihood of patient-HCP engagement about itch and related treatment, and poorer sleep quality. A gap in addressing itch is suggested by a lower rate of HCP-recommended treatment (57%) or HCP-diagnosed CKD-aP (56%) vs patients reporting itch to HCPs (69%), and limited use of systemic treatment in moderate to severe itch cohorts.

**Funding:** Commercial Support - Vifor Pharma

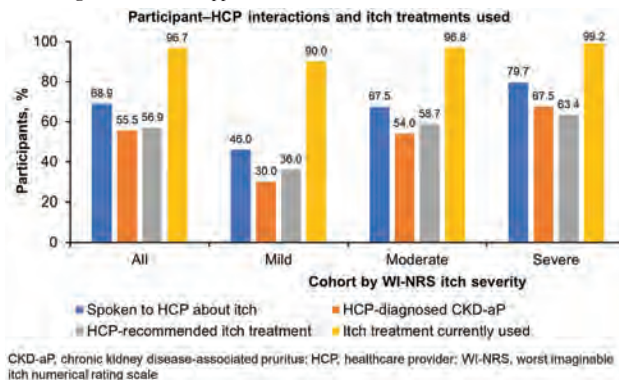

SA-PO288

Impact of Difelikefalin on 5D-Itch Domains in Patients With CKD-Associated Pruritus

Anjay Rastogi,<sup>1</sup> Joel M. Topf,<sup>2</sup> Thilo Schaufler,<sup>3</sup> Isabelle Morin,<sup>3</sup> Frederique Menzaghi,<sup>4</sup> Warren Wen,<sup>4</sup> Kieran McCafferty,<sup>5</sup> David Geffen School of Medicine, Los Angeles, CA; <sup>2</sup>Oakland University, William Beaumont School of Medicine, Rochester, MI; <sup>3</sup>Vifor Pharma Ltd, Glatbrug, Switzerland; <sup>4</sup>Cara Therapeutics Inc, Stamford, CT; <sup>5</sup>Barts Health NHS Trust, London, United Kingdom.

**Background:** Chronic kidney disease-associated pruritus (CKD-aP) is common in hemodialysis (HD) patients, impacting quality of life (QoL). In the Phase 3 KALM studies, difelikefalin (DFK), a selective kappa opioid receptor agonist approved in the United States and Europe for the treatment of moderate-severe pruritus in adults undergoing HD, improved itch intensity and QoL. The impact of DFK treatment on the subdomains of the 5D-itch scale (a multidimensional questionnaire validated in patients with chronic pruritus) were explored.

**Methods:** In this pooled KALM-1 and KALM-2 analysis (n=712), HD patients with moderate-severe CKD-aP were randomized 1:1 to receive intravenous DFK 0.5 µg/kg or placebo (PBO) 3 times/week (Wk) for 12 Wks (double-blind [DB], PBO-controlled phase), followed by an up to 52-Wk open-label extension ([OLE] all patients receiving DFK). The change from DB baseline (BL) in 5D-itch scale domains was assessed including duration, degree, direction, and body distribution of itch and disability (sleep and daily activities) with a 2-Wk recall period.

**Results:** In the DB phase, patients on DFK reported greater improvements than PBO in all domains. Throughout the OLE, patients reported ongoing improvements: Duration of itch (~6 h/day at OLE Wk 52 vs ~12-18 h/day at BL); Degree ("mild-moderate" vs "moderate-severe" at BL); Direction ("a little/much better" vs

“unchanged” at BL); Disability, (“rarely” affected daily activities [including sleep] vs “frequently/occasionally” affected at BL); and Distribution (3–5 body parts affected vs 6–10 at BL).

**Conclusions:** In the 12-wk DB period patient-reported improvements in 5D-itch scale domains were greater with DFK than PBO. In the OLE, with all patients receiving DFK up to 52 wks, further improvements were observed across all domains.

**Funding:** Commercial Support - Vifor Pharma

**Figure:** Impact of DFK treatment on the subdomains of the 5D-itch scale: duration, degree, direction, disability, and distribution

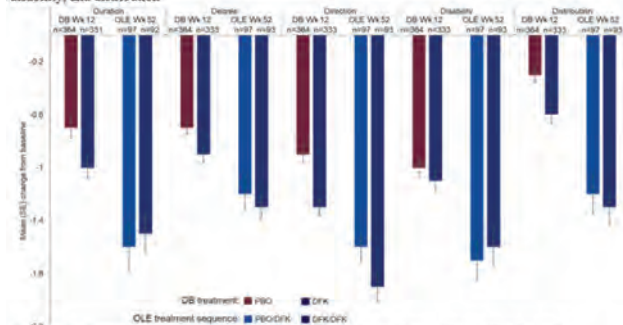

Patients in the placebo-difelikefalin arm were on placebo for a 12-week DB period, then switched to difelikefalin for the OLE. Patients in the difelikefalin/difelikefalin arm received difelikefalin for both the DB period and OLE. For the distribution domain, the number of affected body parts is tallied (potential sum 0–16) and the sum is sorted into five scoring bins: sum of 0–2 = score of 1, sum of 3–5 = score of 2, sum of 6–10 = score of 3, sum of 11–13 = score of 4, and sum of 14–16 = score of 5. For the disability domain, daily activities include sleep, leisure social, housework/errands, and work/school. DB=double-blind; DFK= difelikefalin; OLE= open-label extension; PBO= placebo; SE= standard error; WK= week.

SA-PO289

**Insights Into Current Practices and Unmet Needs Relating to CKD-Associated Pruritus: Results From a Canadian Nephrologist Survey**

Daniel Schwartz,<sup>1</sup> Gerald Miciak,<sup>2</sup> Arthur Magnaye.<sup>2</sup> <sup>1</sup>The University of British Columbia Faculty of Medicine, Vancouver, BC, Canada; <sup>2</sup>Otsuka Canada Pharmaceutical Inc., Saint-Laurent, QC, Canada.

**Background:** Chronic kidney disease-associated pruritus (CKD-aP) is a common condition in patients with CKD undergoing hemodialysis (HD). In this real-world study, Canadian nephrologists were surveyed to gain insight into current practices and unmet needs related to the treatment of CKD-aP.

**Methods:** Quantitative data regarding the perception of current treatment practices for CKD-aP were collected in November and December 2021 by a 20-minute survey completed by 62 nephrologists across Canada. Respondents’ level of agreement was assessed using a 7-point scale.

**Results:** In current practice, the mean perceived prevalence of CKD-aP in HD patients was 30.5%. Of these, 33.6% and 18.3%, respectively, experience moderate or severe CKD-aP. CKD-aP was most frequently identified (75.8% of cases) through patients complaining of itch to the multidisciplinary health care team. In clinical practice 63% of respondents currently do not use formal scales to diagnose and assess CKD-aP. Treatments used for severe and moderate CKD-aP are shown in the table. Nephrologists used topical moisturizers / emollients (85%), oral antihistamines (14%), and gabapentinoids (2%) as first-line treatments. Nephrologists reported 42% of patients with severe CKD-aP and 41% with moderate CKD-aP do not respond to treatment. Most nephrologists (94%) agreed there is a need for new treatments specifically designed to address CKD-aP, 68% agreed they do not expect to resolve a patient’s CKD-aP with currently available treatments, 89% agreed CKD-aP is challenging to treat, and 69% agreed there is a need for guidelines for the treatment of CKD-aP.

**Conclusions:** This real-world Canadian study of nephrologists showed that CKD-aP is challenging to treat and many patients do not respond to currently-available treatments. There is an urgent unmet need for new, more effective treatments and for guidelines to aid nephrologists in selecting therapy for their patients with CKD-aP.

**Funding:** Commercial Support - Otsuka

Treatment Choices

Treatment	Reported use in severe CKD-aP (%)	Reported use in moderate CKD-aP (%)
Topical moisturizers / emollients	78	69
Oral antihistamines	58	37
Gabapentinoids	51	31
Topical corticosteroids	38	20
UVB therapy	22	8
Antidepressants / anxiolytics / sedatives	14	5

SA-PO290

**Quantifying Physical Activity Behavior Among Adults Undergoing Hemodialysis Using a Gait Assistive Device: A Prospective Observational Study**

Ram kinker Mishra,<sup>1</sup> Fadwa S. Al-Ali,<sup>2</sup> Myeounggon Lee,<sup>1</sup> Rania A. Ibrahim,<sup>2</sup> Mincy Mathew,<sup>2</sup> Heba M. Ateya,<sup>2</sup> Bijan Najafi,<sup>1</sup> Abdullah I. Hamad.<sup>2</sup> <sup>1</sup>Interdisciplinary Consortium on Advanced Motion Performance (iCAMP), Michael E. DeBakey Department of Surgery, Baylor College of Medicine, Houston, TX; <sup>2</sup>Hamad Medical Corporation, Doha, Qatar.

**Background:** People undergoing Hemodialysis (HD) have a higher burden of frailty and physical inactivity. This study aimed to quantify physical activity, strength, depression, and fall risk in people undergoing HD using gait assistive devices (GADs).

**Methods:** Participants undergoing routine HD were grouped based on the use of any GADs. Physical activity was measured over two consecutive days using a validated pendant sensor. Grip strength, concerns for falling and depression were assessed on FES-I and Center for Epidemiological Studies-Depression Scales.

**Results:** 136 participants were grouped into those prescribed GADs (n = 39, age = 55.7 ± 1.3 years, female = 40.6%) and no GAD (n = 97, age = 68.6 ± 1.4 years, female = 61.5%). The proportion with cognitive impairment (40% vs. 23%), depression (51% vs. 16%), and concern of falling (84% vs. 38%) were greater in the GAD vs. NGAD group. Furthermore, number of postural transitions was negatively correlated with FES-I (ρ = -0.33, p < 0.01) and CES-D (ρ = -0.22, p = 0.025) scores.

**Conclusions:** People undergoing routine HD and using GADs showed high fear of falling, depression, and cognitive decline. Furthermore, reduced postural transition was associated with heightened fear of falling and depression level.

**Funding:** Government Support - Non-U.S.

**Table 1. Demographic, clinical, patient reported outcomes of the subject using and not using GAD. Continuous parameters are reported as mean ± standard error and categorical outcomes are reported as Number of subjects with the condition/Total subject (percentage).**

	NGAD (n = 97)	GAD (n = 39)	p-value	Effect Size
<b>Demographics</b>				
Age, years	55.7 ± 1.3	68.6 ± 1.4	< 0.01	1.10
Gender (Female), %	40.6	61.5	0.027	0.19
Body Mass Index, kg/m <sup>2</sup>	30.3 ± 0.7	32.0 ± 1.1	0.19	0.25
<b>Clinical characteristics</b>				
History of falls in past year, %	16.5	31.6	0.052	0.17
History foot ulcer, %	13.4	7.7	0.35	0.08
HbA1c, %	7.1 ± 0.2	6.7 ± 0.2	0.17	0.27
Duration of Diabetes, years	18.7 ± 0.8	17.6 ± 0.6	0.40	0.16
VPT, volts	26.5 ± 1.4	31.8 ± 2.9	0.07	0.35
Presence of Neuropathy, %	43.3	56.4	0.09	0.19
Grip Strength, kg	19.0 ± 0.8	15.7 ± 1.6	0.05	0.38
<b>Patient-Reported Outcomes</b>				
MoCA, score	25.9 ± 0.5	24.7 ± 0.7	0.09	0.30
Cognitive impairment ≤ 25, %	23	39.5	0.06	0.17
CES-D, score	10.2 ± 0.7	17.3 ± 1.7	< 0.01	0.82
Depression ≥ 16, %	16	51	< 0.01	0.36
Short FES-I, score	9.5 ± 0.4	15.9 ± 1.0	< 0.01	1.50
High concern for falling > 10, %	38	84	< 0.01	0.41
<b>Frailty</b>				
Robust, %	22	5	0.02	0.21
Pre-frailty, %	45	44.7	0.96	< 0.01
Frailty, %	32	50	0.06	0.17

**Table 2. Comparison of mobility performance metrics after controlling for age, gender, and BMI. The outcomes were reported as Mean ± Standard Error.**

	NGAD (N=73)	GAD (N=30)	p-value	Cohen's d
<b>Cumulative Postures</b>				
Standing + Walking %	17.2 ± 0.9	14.4 ± 1.7	0.19	0.26
Sitting + Lying, %	82.8 ± 0.9	86.3 ± 1.7	0.19	0.26
<b>Locomotion</b>				
Daily Step Counts, n	2683 ± 287	1106 ± 240	0.09	0.34
Cadence, steps per minutes	73 ± 1.8	68 ± 2.3	0.38	0.18
<b>Postural Transitions</b>				
Sit to Stand Transition Duration, sec	3.03 ± 0.03	3.02 ± 0.04	0.56	0.11
Sit to Stand Duration Variability, sec	1.24 ± 0.06	1.20 ± 0.09	0.72	0.06
Sit to Stand Transitions, n	106 ± 7	90 ± 10	0.15	0.29
Sit to Walk Transitions, n	12 ± 1	6 ± 1	<b>0.04</b>	<b>0.42</b>
Lying to Sit Transitions, n	31 ± 2	36 ± 6	0.22	0.25
Stand to Walk Transition, n	96 ± 9	32 ± 7	<b>0.01</b>	<b>0.51</b>
Number of Postural Transitions, n	463 ± 25	303 ± 24	<b>0.01</b>	<b>0.52</b>

GAD, Gait assistive device; NGAD, No gait assistive device; nu, no unit; Bold font highlights significant group differences

SA-PO291

**Cognitive and Physical Functioning in Relation to Survival in Patients on Chronic Hemodialysis**

Robert Ekart,<sup>1,2</sup> Sebastjan Bevc,<sup>1,2</sup> Nejc Piko,<sup>1</sup> Tadej Petreski,<sup>1,2</sup> Luka Varda,<sup>1</sup> Radovan Hojs,<sup>1,2</sup> <sup>1</sup>Univerzitetni Klinični Center Maribor, Maribor, Slovenia; <sup>2</sup>Univerza v Mariboru, Maribor, Slovenia.

**Background:** Little is known about the relationship between cognitive and physical function and survival of patients on chronic hemodialysis (HD). The Mini-Mental State Examination (MMSE) is an instrument that can help quickly diagnose whether a person has mild cognitive impairment by answering questions in several cognitive domains. The Barthel Index (BI) is an ordinal scale that measures performance in activities of daily living (ADL). The aim of the present study was to determine whether the MMSE and the BI score are predictors of mortality in patients on chronic HD.

**Methods:** Eighty-eight patients (mean age: 63.7±13.1 years, 61.4% male) on chronic HD (dialysis vintage 62±64 months) were studied cross-sectionally and longitudinally. Their cognitive function was assessed with the MMSE and physical function with the BI questionnaire at baseline. The MMSE and BI were performed during a midweek HD session, avoiding the beginning and end of each treatment. A MMSE score ≤23 was considered to indicate cognitive impairment, and a BI score ≤15 was considered to indicate physical impairment. Demographic, clinical, and laboratory parameters were recorded for each patient.

**Results:** The mean (SD) MMSE score was 24.7±4.5, and the mean BI score was 19.2±2.5. Patients with a MMSE score ≤23 had a higher dialysis vintage (82.6 vs. 52.4 months; p=0.039), patients with a BI score ≤15 had lower serum albumin (39 vs. 35 g/L; p=0.031). After a mean follow-up of 1334±640 days (range: 21-2149 days), 47 (53.4%) patients died and 3 were transplanted. None of the patients were lost or transferred to another department. The deceased patients were statistically significantly older (p<0.001), had lower serum albumin (p=0.025) and lower BI score (p=0.036). Kaplan-Meier analysis showed that survival was significantly lower in patients with a BI score ≤15 (log rank  $\chi^2$ :13.15; p<0.001). We found no difference in survival with a MMSE score regardless of the MMSE score. According to the adjusted Cox regression analysis, mortality was associated with higher age (HR 1.06, 95% CI: 1.03-1.09, p<0.001) and inversely associated with BI score (HR 0.86, 95% CI 0.78-0.94, p=0.001).

**Conclusions:** The BI score is associated with an increased risk of death in HD patients and it should be routinely assessed to predict survival of HD patients.

SA-PO292

**Physical Activity and Sleep Levels in Hemodialysis Patients as Quantified by a Wearable Device**

Maggie Han,<sup>1</sup> Ohnmar Thwin,<sup>1</sup> Xia Tao,<sup>1</sup> Lemuel Rivera Fuentes,<sup>1</sup> Amrith U. Patel,<sup>1</sup> Peter Kotanko.<sup>1,2</sup> <sup>1</sup>Renal Research Institute, New York, NY; <sup>2</sup>Icahn School of Medicine at Mount Sinai, New York, NY.

**Background:** Hemodialysis (HD) patients have a high prevalence of sedentary lifestyle and poor sleep. Decreased physical activity level (PAL) and sleep are associated with negative outcomes. Wearable activity trackers (WAT) allow the remote monitoring of PAL and sleep parameters. We aimed to objectively quantify PAL and sleep using a WAT in HD patients.

**Methods:** HD patients from 4 New York City clinics were enrolled starting June 2018 and followed for up to 1 year. Ambulatory patients ≥18 years, on maintenance HD, and owning a mobile device were included. Each patient was provided with and taught how to use the Fitbit Charge 2. The 1<sup>st</sup> month of the study was the baseline period. PAL was measured by steps/day (s/d). Sleep duration was measured by total time asleep; sleep efficiency was calculated as (total time asleep)/(total time in bed). PAL were categorized based on average number of s/d: sedentary: < 5K s/d; fairly active: 5-10k s/d; active: 10-15k s/d; very active: > 15k s/d. Sleep duration of ≥ 7 hrs were categorized as having good sleep.

**Results:** We enrolled 119 patients (age 54±12 years; 59% Black; 37% lived alone; 54% had an education level of college and above). 1,561 and 1,066 patient days PAL and sleep data, respectively, from the baseline period were included in the analysis. Results of the PAL and sleep data are shown in Fig. 1. On average, patients walked 6,120 s/d, slept 292 minutes/day, and had a sleep efficiency of 93%.

**Conclusions:** Most patients walked less than the daily recommended 10k s/d and slept less than 7 hrs. However, they had high sleep efficiency indicating that though they have shortened sleep durations, their time in bed is mostly spent asleep. Barriers to PAL and good sleep should be explored to improve these factors which attribute greatly to a patient's quality of life and health outcomes.

**Funding:** Commercial Support - Renal Research Institute

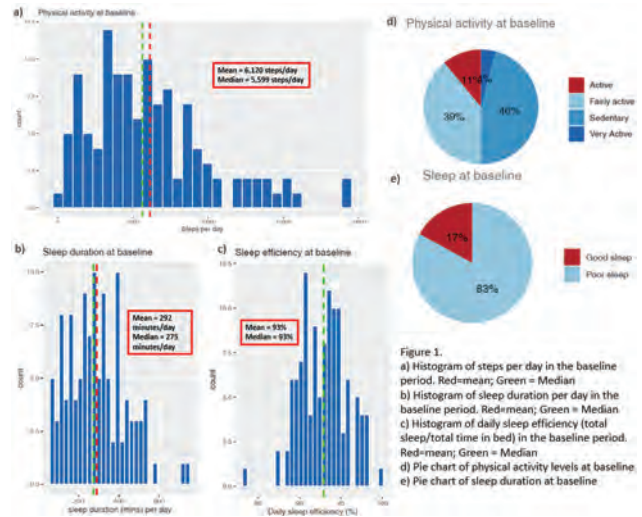

Figure 1. a) Histogram of steps per day in the baseline period. Red=mean; Green = Median b) Histogram of sleep duration per day in the baseline period. Red=mean; Green = Median c) Histogram of daily sleep efficiency (total sleep/total time in bed) in the baseline period. Red=mean; Green = Median d) Pie chart of physical activity levels at baseline. e) Pie chart of sleep duration at baseline

SA-PO293

Abstract Withdrawn

SA-PO294

**Short Physical Performance Battery, Mortality, and Hospitalization in Patients on Hemodialysis**

Juri Uchida,<sup>1</sup> Yuta Suzuki,<sup>2</sup> Keigo Imamura,<sup>1,4</sup> Shun Yoshikoshi,<sup>1,3</sup> Takuya Nakajima,<sup>1</sup> Narumi Fukuzaki,<sup>1</sup> Manae Harada,<sup>3</sup> Atsuhiko Matsunaga.<sup>1</sup> <sup>1</sup>Kitasato University Graduate School of Medical Sciences, Sagamihara, Japan; <sup>2</sup>National Institute of Public Health, Saitama, Japan; <sup>3</sup>Sagami Circulatory Organ Clinic, Sagamihara, Japan; <sup>4</sup>Tokyo Metropolitan Institute of Gerontology, Tokyo, Japan.

**Background:** Patients on hemodialysis (HD) are more frail compared with the general old population. Frailty increases vulnerability to stressors; however, appropriate intervention can restore the robust state. Hence, regularly evaluating the physical functions of patients on HD to detect frailty at an early stage is critical. Short Physical Performance Battery (SPPB) is a widely known practical tool for assessing physical functions in patients on HD. However, there is limited clear clinical data examining the association between SPPB and long-term health outcomes in patients on HD. This study examined the association between SPPB and adverse health outcomes in patients on HD.

**Methods:** A retrospective cohort study involving 326 outpatients (mean age: 68 years; 62% men) who received maintenance HD was conducted. They were categorized into two groups: low SPPB (≤ 9) or high SPPB (> 9). We examined the association of SPPB score with all-cause death, all-cause hospitalization, and cardiovascular hospitalization using the Cox proportional hazards model. In addition, we calculated the population attributable fraction (PAF) to estimate the attributable fraction of low SPPB to health outcomes.

**Results:** Patients in the low SPPB group demonstrated a higher risk of all-cause death (hazard ratio (HR): 3.19; 95% confidence interval (CI), 1.89–5.38), all-cause hospitalization (HR: 2.01; 95% CI, 1.44–2.82), and cardiovascular hospitalizations (HR: 2.20; 95% CI, 1.45–3.35). PAF suggested that 42.1% of all-cause deaths, 19.8% of all-cause hospitalizations, and 28.5% of cardiovascular hospitalizations were attributable to low SPPB.

**Conclusions:** Low SPPB was associated with a higher risk for all-cause death, all-cause hospitalization, and cardiovascular hospitalization in patients on HD. SPPB is useful for assessing physical frailty and prognostic management. Treatments to prevent low SPPB may be an effective disease management strategy to control the high mortality and admission rates in patients on HD.

## SA-PO295

**Understanding the Personal Experiences of Patients on Hemodialysis**

Wen Qing Wendy Ye,<sup>1</sup> Jinbaek Kim,<sup>1</sup> Azim S. Gangji,<sup>1,2</sup> *McMaster University Faculty of Health Sciences, Hamilton, ON, Canada; <sup>2</sup>St. Joseph's Healthcare Hamilton, Hamilton, ON, Canada.*

**Background:** Patients with end stage kidney disease on hemodialysis (HD) have complex medical, social, and emotional needs. The symptom burden of patients on HD is well documented; however, literature has not fully described the holistic patient experience, such as the social and emotional impact of HD. The objective of this study is to capture the lived experiences of patients on HD, including effects on their emotional health, relationships, and quality of life.

**Methods:** This is a qualitative study. Patients on chronic HD in Hamilton, Ontario were invited to participate. Semi-structured interviews were conducted to understand the effect of HD on their emotional and mental health, and quality of life. Interviews were transcribed and coded to identify emerging themes. A framework of the impact of HD was developed using constructivist grounded theory.

**Results:** 16 interviews were completed as of January 2022. Three themes were identified: 1) expectations of HD, 2) personal and professional impacts, and 3) changes in personal identity (Figure 1). Participants felt their experiences on HD were different from their expectations based on counselling provided by healthcare staff. This included positive and negative experiences. Participants experienced loss of employment opportunities, intimate relationships, and hobbies since starting HD. Some participants noted the emergence of a new identity anchored to HD due to the significant role it played in their lives.

**Conclusions:** Initiating HD leads to unanticipated losses for patients both personally and professionally. This requires them to undergo a number of complex changes to accommodate HD in their lives. The impact of these changes are far reaching, resulting in patients taking new identities as they cope with their chronic health concerns. Overall, this data provides new insight on the patient experience, and can be used to engage in meaningful conversations about initiation of HD.

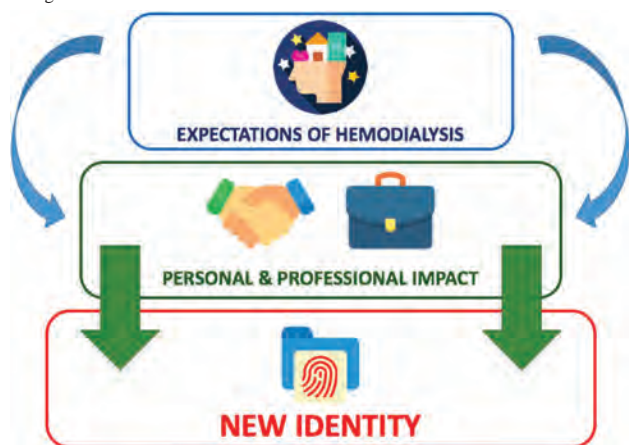

Figure 1: Professional and personal impact of hemodialysis on identity formation.

## SA-PO296

**Starting Hemodialysis: A Qualitative Study of Patients' Experiences and Perspectives**

Kshama R. Mehta,<sup>1</sup> Kerstin Leuther,<sup>1</sup> Alexandra L. Fegler,<sup>1</sup> Brigitte Schiller,<sup>1,3</sup> Paul N. Bennett,<sup>1,2</sup> Wael F. Hussein,<sup>1,3</sup> *Satellite Health Care <sup>1</sup>Satellite Healthcare, San Jose, CA; <sup>2</sup>University of South Australia, Adelaide, SA, Australia; <sup>3</sup>Stanford University School of Medicine, Stanford, CA.*

**Background:** People commencing dialysis experience anxiety, depression and hospitalizations. Limited qualitative data is available to describe the experience and perspectives of people starting dialysis.

**Methods:** Adult English speaking patients within 90 days of starting in-center hemodialysis (HD) at centers of a nonprofit dialysis provider in Northern California were invited to join the study using a convenience based sampling method until theme saturation was reached. Audio-recorded, individual, semi-structured interviews conducted by trained qualitative researchers were de-identified and transcribed verbatim before being inductively coded into Level 1 codes, Level 2 categories, and Level 3 themes.

**Results:** Three overarching themes emerged from twenty participants (55% male, 45% Caucasian, mean age 63, 66% with some college education, median HD vintage of 2 months). Theme 1, *Being overwhelmed when starting dialysis*, realizes the emotional unpreparedness of patients starting dialysis, dialysis side effects, the all-encompassing lifestyle changes and how trust and confidence in the dialysis center staff decreases anxiety to enable a positive dialysis start experience. Theme 2, *Making sense of it all (for better or for worse)*, covers how impressions of the dialysis environment (waiting and treatment areas) and building a community with other patients/staff contributes to a positive start. Theme 3, *Moving forward*, describes how the right education at the right time supports optimal informed decision-making and positions patients for success by increasing hope for a longer and better life.

**Conclusions:** Understanding the life-changing experience that patients encounter when starting dialysis can benefit hemodialysis clinicians in individualizing patient care to help patients adjust and develop long-term coping strategies. Improved patient experience is realized by: improving the center's physical environment, developing peer support programs, providing lifestyle support, implementing more person-centered care models, offering learning style-tailored education, providing care focused on individual patient goals, and enabling shared decision-making.

**Funding:** Commercial Support - Satellite Dialysis

## SA-PO297

**The Safety of Driving Among Patients With ESRD on Hemodialysis: How to Stop Burying Our Head in the Sand and Start Saving Patients**

Abdulkareem Alsuwaida,<sup>1</sup> Ghada Ankawi,<sup>2</sup> Anas A. Alsuwaida,<sup>1</sup> Ali E. Shehadah,<sup>1</sup> Mohammed T. Alzahrani,<sup>1</sup> *King Saud University, Riyadh, Saudi Arabia; <sup>2</sup>King Abdulaziz University, Jeddah, Saudi Arabia.*

**Background:** Human error is the main cause of car accidents and whether specific cognitive impairments related to dialysis session and/or comorbid medical conditions increase the risk of car accidents is still unclarified. Our objective is to explore patient's perceptions and experiences in driving to the dialysis unit.

**Methods:** A cross sectional questionnaire survey done in two university hospitals in Saudi Arabia. All adults' patients on in center hemodialysis more than 3 months were included in the study.

**Results:** Data were collected from 88 adults (39.7% women) enrolled in the Study. Among participants 46.6% were diabetic, 73.9% with hypertension and 25.0% with coronary artery disease. Forty eight patients stopped driving after starting dialysis. The most frequent cause for stop driving were fatigability, blurred vision and dizziness. Thirteen patients noted significant impact of dialysis session on their capacity to drive post treatment. Twenty participants continued to drive with 4 patients (25%) sustained a road traffic accidents since starting dialysis.

**Conclusions:** Most of dialysis patients felt continuing driving after starting dialysis was unsafe and stopped driving. Those continue to drive were likely they could not afford public transportation or do not want to burden their family. However, driving is not without its dangers. Those continued to drive are at higher risk of road traffic accidents. Creating a safe transportation program is critical for patients on in-center hemodialysis as part of comprehensive care to patients with end stage renal disease. Otherwise, bigger studies are needed to develop screening programs for patients on dialysis to periodically assess suitability to drive.

**Funding:** Government Support - Non-U.S.

## SA-PO298

**Prevalence of Depression in an Urban, Predominantly Black ESKD Population During the COVID-19 Pandemic**

Chijioke K. Ofoche,<sup>1</sup> Matthew A. Brown,<sup>1</sup> Terry Klemensen,<sup>1</sup> Clifford Collins,<sup>2</sup> Winnfred L. Timmons,<sup>3</sup> Janice P. Lea,<sup>1</sup> Laura Plantinga,<sup>1</sup> Jason Cobb,<sup>1</sup> *Emory University School of Medicine, Atlanta, GA; <sup>2</sup>American University of the Caribbean School of Medicine BV, Cupecoy, Sint Maarten (Dutch part); <sup>3</sup>Emory Healthcare, Atlanta, GA.*

**Background:** The COVID-19 pandemic has had far-reaching implications in terms of physical and mental health ramifications, and minority communities have been disproportionately impacted; particularly, prevalence of depression increased. Throughout the pandemic, ESKD patients have continued thrice-weekly in-center hemodialysis sessions or home therapies. We explored whether there was an increase in depression prevalence after the start of the pandemic in our urban predominantly Black ESKD population.

**Methods:** We used data from social worker-administered PHQ-2 questionnaire depression screenings (required by Centers for Medicare & Medicaid Services) in eligible patients treated at four Emory University affiliated in-center dialysis units and three home dialysis units from 2018-2019 (pre-pandemic) to 2020-2021 (pandemic). Excluded from this study were patients with no assessments or incomplete assessments. Data were analyzed using chi-square tests comparing the prevalence of depression in pre-pandemic versus pandemic period.

**Results:** In 2021, 91.5% of our patients were Black. There were 2433 in-center patient depression scores and 586 home dialysis patient depression scores. Excluded from the study were 1045 patients in the in-center and 214 patients in the home population. Of the 2433 patient scores analyzed in the in-center group, 1289 were pre-pandemic and 1144 were in the pandemic period. 155 (12%) in-center patient scores in the pre-pandemic period were classified as depressed while 128 (11.2%) in-center patient scores during the pandemic were classified as depressed (two-sided p-value 0.5272). Of the 586 home dialysis patient scores, 325 were pre-pandemic and 261 in the pandemic period. 71 (21.8%) patient scores in the pre-pandemic period had a positive depression screening while 29 (11.1%) patient scores during the pandemic period had depression (two-sided p-value 0.0006).

**Conclusions:** We did not observe an increase in depression prevalence during the COVID-19 pandemic in in-center dialysis patients, and surprisingly observed a statistically significant decrease in depression among our home dialysis patients. The decrease in depression in our home dialysis patients during the pandemic may reflect being at home is a protective mechanism, and this observation should be further investigated.

Key: TH - Thursday; FR - Friday; SA - Saturday; OR - Oral; PO - Poster; PUB - Publication Only

Underline represents presenting author.

## SA-PO299

**Regional Differences in Quality of Life in a Large Multinational Population of Chronic Hemodialysis Patients**

Carla Alexandra R. Santos Araujo,<sup>1,2</sup> Eliana M. Silva,<sup>1</sup> Mathias Haarhaus,<sup>1</sup> Israel P. Silva,<sup>1</sup> Suzanne H. Pearce,<sup>1</sup> Carlos Lucas,<sup>1</sup> Fernando Macario.<sup>1</sup>  
<sup>1</sup>*Diaverum Renal Services Group, Lund, Sweden;* <sup>2</sup>*UnIC@RISE, Department of Surgery and Physiology, Faculty of Medicine of the University of Porto, Porto, Portugal.*

**Background:** Health-related quality of life (QoL) is increasingly recognized as an important patient-centered outcome in hemodialysis (HD). Relevant differences between countries may exist, despite high standardization in HD care. We aimed to evaluate the effect of regional location in QoL in a large, multinational population of HD patients.

**Methods:** This was a multicenter prospective observational study using a quality database from a large HD organization. All adult patients that voluntarily responded to KDQOL-36 were included. Six months after the survey, demographic (age, gender and country) and clinical data (diabetes, comorbidity index, type of vascular access, death) were collected. Patients were allocated to different regions, according to the country of origin: Western and East Europe, Euroasia, Latin America and Iberia. Various domains of KDQOL-36 (2 generic and 3 kidney specific) were analyzed and related to the different covariates using multiple linear regression (results presented as hazard ratios and 95% confidence intervals).

**Results:** 30 614 HD patients with valid responses to KDQOL-36 were included. The majority reported poor QoL: this was particularly evident for Burden of kidney disease (46.57±26.68) and Mental (MCS) (45.29±10.31) and Physical Composite Scales (PCS) (37.80±9.40). In multivariate analysis, female gender and comorbidity index were independently associated with a poorer QoL in all domains. Older age was an independent predictor of lower PCS, but of a higher MCS, whereas time on HD was positively correlated with both MCS (1.36 [0.90–1.82],  $p<0.01$ ) and PCS (0.73 [0.34–1.12],  $p<0.01$ ). Six-month mortality was independently associated with worst scores in all levels of QoL. Western Europe patients presented significantly worst scores, particularly in MCS (–3.37 [–3.81]–(–2.92)],  $p<0.01$ ) and general scales, when compared to kidney specific domains.

**Conclusions:** In our population, we have documented a lower QoL in Western Europe patients, more evident in general and social than in kidney specific domains. These results may reflect the high level of standardization of HD care worldwide and prompt the adoption of region specific QoL strategies, oriented to the particular necessities of HD patients in certain locations of the globe.

## SA-PO300

**Quality of Life and Outcome in Patients on Hemodialysis: The Role of Dialysis Shift**

Amgad E. El Agroudy. *Arabian Gulf University, Manama, Bahrain.*

**Background:** Patients with end-stage renal disease (ESRD) undergo hemodialysis (HD) during the morning, afternoon or at night, with time of treatment generally based on space availability or patient preference. This report examines the extent to which hemodialysis treatment time of day was associated with morbidity and quality of life.

**Methods:** Dialysis start time defined dialysis shift: morning beginning between shift 1 (7am and 11am) (n = 38); shift 2 (12pm and 4pm) (n = 38); shift 3 (5pm and 9pm) (n = 43) and shift 4 (10pm and 2am) (n = 56). Outcome measures included quality of life parameters, morbidities, dialysis care or hospitalization.

**Results:** Out of 300 patients dialyzed at the Dialysis Facility, 175 (116 males and 59 females) met the inclusion criteria (adult patients aged between 18 and 90 years, on maintenance hemodialysis for more than 3 months and with no psychiatric or severe disabling diseases) were studied. Of these patients, shift 4 patients had a significant higher mean age compared to other shifts ( $p=0.001$ ) and significant higher number of widows (8.6%,  $P=0.007$ ). Most of the patients in all shifts were high school educated but with significant trend to loss of their jobs due to employer attitude in shift 4 (28.6% compared to 13.2%, 10.5% and 9.3% in shifts 1-3,  $p=0.001$ ). The patients in all four groups are comparable in terms of transportation methods, travel abroad, number of missed sessions weekly, nursing vascular access care, hemodialysis session related complications, exercise performance. Shift 4 was associated with more flexible social life,  $p=0.020$ ). Shifts 1 and 2 have high admission rates to the hospital (31.1% and 26.3%, respectively) compared to (9.3% and 7.2%, in shift 3 and 4,  $p=0.004$ ) with no significant difference in the causes of admission being the infections and cardiovascular morbidities are commonest causes. Physician care was significantly missed in shift 4 (28.6%) compared to other shifts ( $p=0.0001$ ). Shift 4 patients' spouses are more affected by losing their jobs (18%) compared to other groups ( $p=0.017$ ).

**Conclusions:** The time of the hemodialysis schedule could affect the social life, social relationships, and income of the patients by losing their jobs. The physician care was not adequate in the evening shifts. Our results of the study provide evidence for medical professionals to prioritize healthcare and effective treatment plans

## SA-PO301

**Psychometric Properties of the Kidney Disease Quality of Life Short Form 36 (KDQOL-36) Scale for the Evaluation of Quality of Life in Colombian Chronic Dialysis Patients**

Martha C. Valderrama Rios,<sup>1</sup> Ricardo Sanchez,<sup>1</sup> Mauricio Sanabria.<sup>2</sup>  
<sup>1</sup>*Universidad Nacional de Colombia, Bogota, Colombia;* <sup>2</sup>*Baxter Renal Care Services, Deerfield, IL.*

**Background:** Quality of life is one of the most important health outcomes during kidney failure treatment. The quality of the results obtained through PROMs depends on the psychometric properties with which the instrument quantifies the construct of interest in each population. **Objective** To establish the psychometric properties of the KDQOL-36 instrument in Colombian dialysis patients.

**Methods:** Scale validation study carried out in adult hemodialysis or peritoneal dialysis patients treated at Baxter Renal Care Services (BRCS) network, in Bogotá, Colombia to whom the KDQOL-36 instrument was applied. The clinimetric properties assessed were content validity, internal consistency, reliability analysis through test-retest method, applying the instrument in a second moment, 8-10 days after, criterion validity through concurrent validity, with the application of the Kidney Disease Questionnaire (KDQ) at the same time; and the sensitivity to change, applying the instrument in a second moment, after an event that could generate a change in the construct.

**Results:** A sample of 506 patients were included (table 1). Regarding content validity, the exploratory factor analysis confirmed an adequate adjustment of the model (figure 1). Item 28 did not obtain an adequate factorial load in any of the three domains. For internal consistency the McDonald's  $\omega$ , GLB and Cronbach's alpha coefficients showed values  $\geq 0.89$ . Adequate test-retest reliability was confirmed with a Lin's correlation-concordance coefficients  $\geq 0.77$  and Bland and Altman plots evidencing a high level of concordance (figure 2). Spearman correlation values significantly different from zero ( $> 0.50$ ) were found between KDQOL-36 scale and the KDQ instrument domains. And adequate sensitivity to change was confirmed with a  $p$  value for Friedman test equal to 0.0000.

**Conclusions:** The validation of the KDQOL-36 instrument for the evaluation of quality of life in Colombian population showed it has an adequate reliability, validity, and sensitivity to change.

**Funding:** Private Foundation Support

## SA-PO302

**Effects of the Long Interdialytic Period on Physical Performance in Patients on Hemodialysis**

Elliott Arroyo,<sup>1</sup> Andrew R. Coggan,<sup>2</sup> Sharon L. Karp,<sup>1</sup> Sharon M. Moe,<sup>1</sup> Kenneth Lim.<sup>1</sup> *<sup>1</sup>Indiana University School of Medicine, Indianapolis, IN;* *<sup>2</sup>Indiana University Purdue University Indianapolis, Indianapolis, IN.*

**Background:** Reduced physical function in patients on hemodialysis (HD) is strongly associated with increased risk of falls, fractures, disability, morbidity, and mortality. The long (3-day) interdialytic period is linked to fluid overload, metabolic acidosis, electrolyte imbalances, and cardiac and skeletal muscle failure—physiologic alterations that can impair physical function. Despite this, the effects of interdialytic periods on metrics of physical performance are largely unknown. Herein, we sought to determine whether physical performance is impaired following the long interdialytic period.

**Methods:** We analyzed data from the ongoing, "Effects of long interdialytic intervals on Cardiovascular Functional Capacity (ECON)" study, a randomized crossover trial of patients on conventional HD. Comprehensive assessment of mobility and performance capacity were performed on three study visits: post-HD (baseline; BL), and at the end of the 2-day and 3-day interdialytic intervals. Fluid status was assessed via bioelectrical impedance spectroscopy.

**Results:** A total of 17 patients (n=12 men, age=52±11 years, dialysis vintage=76±68 months) were included in this analysis. Body weight (BL=79.8±20.2 kg; 2-day=81.1±20.6 kg; 3-day=82.1±21.0 kg;  $p<0.001$ ), total body fluid (TBF;  $p<0.001$ ), extracellular fluid (ECF;  $p<0.001$ ), and fluid overload ( $p<0.001$ ) were significantly higher at 3-day intervals compared to both 2-day and BL. Both usual gait speed (BL=1.1±0.2 m/s; 2-day=1.0±0.1 m/s; 3-day=0.9±0.2 m/s;  $p=0.02$ ) and fast gait speed (BL=1.5±0.4 m/s; 2-day=1.4±0.3 m/s; 3-day=1.3±0.3 m/s;  $p=0.033$ ) were significantly slower in 3-day compared to BL, while no significant differences were observed between 2-day and BL. Usual gait speed was significantly correlated with TBF% ( $r=0.39$ ,  $p=0.005$ ) and ECF% ( $r=-0.42$ ,  $p=0.002$ ). Fast gait speed was significantly correlated with TBF% ( $r=0.52$ ,  $p<0.001$ ), ECF% ( $r=-0.49$ ,  $p<0.001$ ) as well as body weight ( $r=-0.39$ ,  $p=0.004$ ).

**Conclusions:** Our preliminary findings indicate that the 3-day interdialytic interval is associated with impaired physical performance. We postulate that excess volume accumulation during the 3-day interdialytic period may be a major contributor to impaired physical function.

**Funding:** Private Foundation Support



SA-PO303

**Tailoring a Pain Coping Skills Training Intervention for Patients Receiving Maintenance Hemodialysis for Kidney Failure With Chronic Pain**

Daniel Cukor,<sup>1</sup> Carrie E. Brintz,<sup>2</sup> Alicia Heapy,<sup>9</sup> Francis J. Keefe,<sup>3</sup> Jennifer L. Steel,<sup>4</sup> Manisha Jhamb,<sup>4</sup> Martin Cheate,<sup>8</sup> Daniel W. Mcneil,<sup>5</sup> Amanda J. Shallock,<sup>6</sup> Paul L. Kimmel,<sup>7</sup> Laura M. Dember.<sup>8</sup> HOPE Consortium <sup>1</sup>Rogosin Institute, New York, NY; <sup>2</sup>Vanderbilt University Medical Center, Nashville, TN; <sup>3</sup>Duke University School of Medicine, Durham, NC; <sup>4</sup>University of Pittsburgh, Pittsburgh, PA; <sup>5</sup>West Virginia University, Morgantown, WV; <sup>6</sup>New York University, New York, NY; <sup>7</sup>National Institute of Diabetes and Digestive and Kidney Diseases, Bethesda, MD; <sup>8</sup>University of Pennsylvania Perelman School of Medicine, Philadelphia, PA; <sup>9</sup>VA Connecticut Healthcare System - West Haven Campus, West Haven, CT.

**Background:** Patients with kidney failure undergoing maintenance hemodialysis (HD) have a substantial burden of pain symptoms that are consistently identified as underdiagnosed and undertreated. Pain Coping Skills Training (PCST) is a first-line behavioral treatment for pain, but there are unique challenges in applying these skills to patients treated with in-center HD. We describe PCST adaptations that address these challenges as part of an ongoing multi-center clinical trial (HOPE study) designed to evaluate the effectiveness of telehealth PCST compared to usual care for reducing pain interference among patients treated with HD.

**Methods:** Prior to initiating the trial, a team of psychologists specializing in psychosocial treatments for kidney disease or chronic pain adapted the intervention protocol from standard PCST with input from patient representatives. PCST adaptations were based on unique considerations for HD patients (e.g., treatment demands, unique pain complaints, psychiatric comorbidity, and diverse socioeconomic and health literacy levels). PCST was adapted for remote delivery with flexible options so patients could complete sessions using video or audio, with their own or a provided device, and at dialysis or another location. Content adaptations included pain coping skills applied to disease/treatment-related pain, addressing pain-related depression, sleep difficulty and anxiety, and incorporating motivational interviewing to facilitate desired opioid reduction or other individual value-based goals. Patient-facing materials used patient-centered language with input from patient representatives. Participants were recruited from dialysis facilities across the United States and those randomized to PCST received 12 weekly, 45-minute sessions via telemedicine.

**Results:** Among the 139 participants who had, as of May 18, 2022, reached Week 12 of PCST study participation a total of over 1330 PCST sessions have been completed, and the mean number of sessions conducted was 11 with 93.5% (n=130) completing the minimum target of ≥8 sessions.

**Conclusions:** The high level of engagement to date supports the acceptability of a tailored, scalable nonpharmacologic treatment for reducing pain burden in patients on HD.

**Funding:** NIDDK Support

SA-PO304

**Medication Utilization Among US Veterans With Advanced CKD Receiving Conservative Management vs. Dialysis**

Yoko Narasaki,<sup>1</sup> Kamyar Kalantar-Zadeh,<sup>1</sup> Susan T. Crowley,<sup>2</sup> Csaba P. Kovacs,<sup>3</sup> Dana B. Mukamel,<sup>1</sup> Amy S. You,<sup>1</sup> Ji Hoon Yoon,<sup>1</sup> Danh V. Nguyen,<sup>1</sup> Connie Rhee.<sup>1</sup> <sup>1</sup>University of California Irvine, Irvine, CA; <sup>2</sup>Yale University, New Haven, CT; <sup>3</sup>The University of Tennessee Health Science Center, Memphis, TN.

**Background:** Within the Veterans Health Administration, the largest integrated healthcare system in the US, 1.1 million Veterans (16%) have CKD among whom ~10% annually progress to ESKD requiring dialysis or transplant. While dialysis has been the prevailing paradigm in this population, there has been growing interest in non-dialytic conservative management (CM) as an alternative patient-centered treatment strategy for advanced CKD. We sought to examine medication utilization patterns among Veterans with advanced CKD treated with CM vs. dialysis.

**Methods:** In a national cohort of US Veterans, we examined patients with advanced CKD (≥2 eGFRs <25ml/min/1.73m<sup>2</sup> separated by ≥90 days) from 10/2010-9/2019. Using linked USRDS and Medicare (CMS) data, we compared medication utilization within 1-year prior to the index eGFR (1<sup>st</sup> eGFR <25ml/min/1.73m<sup>2</sup>) among patients categorized according to 1) receipt of CM, defined as those who did not receive dialysis within 2-years of the index eGFR, vs. 2) receipt of dialysis within 2-years of the index eGFR.

**Results:** Among 106,089 advanced CKD patients who met eligibility criteria, 25% (N=26,113) and 75% (N=79,956) were treated with dialysis vs. CM, respectively. Compared to the CM group, the dialysis group had higher utilization of anticoagulation/antiplatelet, anemia, analgesic, psychiatric, diuretic, anti-diabetes, and calcium/vitamin D agents (Fig); however, there was a similar prevalence of anti-HTN, phosphate binder, and GI medications.

**Conclusions:** Among US Veterans with advanced CKD, there tended to be higher utilization of most medication classes in the dialysis group as compared with CM patients. Further studies are needed to define the optimal pharmacotherapeutic management strategies among advanced CKD patients treated with CM vs. dialysis.

**Funding:** NIDDK Support

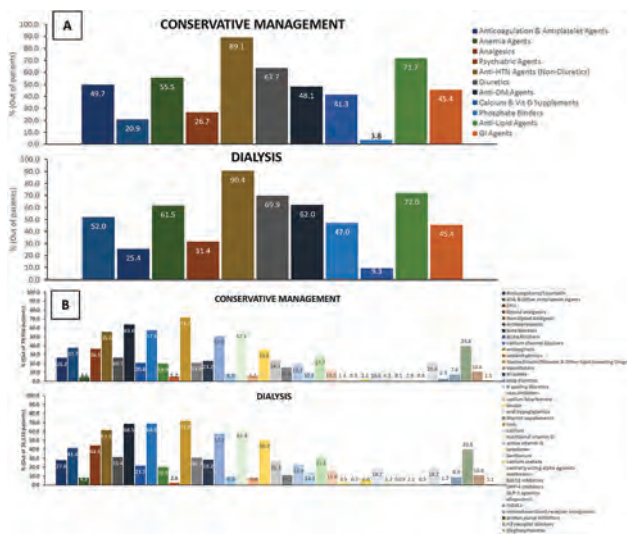

SA-PO305

**A “Best Fit” Framework Synthesis to Guide Adherence Interventions for Patients on Hemodialysis**

Kathryn Taylor,<sup>1</sup> Ebele M. Umeukeje,<sup>2</sup> Sydney Santos,<sup>3</sup> Katherine C. McNabb,<sup>1</sup> Deidra C. Crews,<sup>4</sup> Melissa D. Hladek.<sup>1</sup> <sup>1</sup>Johns Hopkins University School of Nursing, Baltimore, MD; <sup>2</sup>Vanderbilt University Medical Center, Nashville, TN; <sup>3</sup>Johns Hopkins University, Baltimore, MD; <sup>4</sup>Johns Hopkins Medicine, Baltimore, MD.

**Background:** Patients with end-stage kidney disease (ESKD) treated with hemodialysis in the U.S. have higher rates of nonadherence compared to patients in other countries. Published adherence interventions demonstrate limited efficacy. Qualitative research that explores patient perspectives about adherence may point to gaps in existing interventions. The aim of this review was to synthesize qualitative data about adherence to hemodialysis treatment, medications, or fluid and dietary restrictions to inform development of patient-centered adherence interventions.

**Methods:** We conducted a “best fit” framework synthesis of qualitative studies on adherence to hemodialysis treatment, medications, and fluid and dietary restrictions. We searched PubMed, CINAHL, PsychInfo, Embase, and Web of Science for relevant literature. We analyzed qualitative data via thematic analysis, initially identifying codes from the World Health Organization’s adherence framework.

**Results:** We screened 1775 articles and extracted qualitative data from 12. The data revealed 20 factors unique to hemodialysis treatment across the World Health Organization’s five dimensions of adherence. Two themes emerged from the data: (1) adherence in the context of patients’ whole lives and (2) dialysis treatment as a double-edged sword. Patients described a profound grieving process over loss of their “old self”. They navigated complex challenges as they balanced ESKD treatment, life tasks, and social roles.

**Conclusions:** One-size-fits-all approaches to improving adherence among patients on hemodialysis are inadequate. Adherence may improve when care incorporates patient context and provides ongoing support to patients and families as they navigate the logistical, physical, and psychological hardships of living with dialysis.

**Funding:** NIDDK Support, Other NIH Support - Kathryn Taylor was supported by National Institute of Nursing Research F31NR109461. Ebele Umeukeje was supported by National Institute of Diabetes and Digestive and Kidney Diseases 1K23DK114566-01A1 and National Institutes of Health 1 R03 DK129626-01. Katherine McNabb was supported by National Institute of Allergy and Infectious Diseases F30AI165167. Deidra Crews was supported by National Heart, Lung, and Blood Institute K24HL148181. Melissa Hladek was supported by the Johns Hopkins University Older Americans Independence Center of the National Institute on Aging, award number P30AG021334.



SA-PO306

**Effect of Hemodialysis on Lamina Cribrosa of Optic Nerve Head Measured by Swept-Source Optical Coherence Tomography**

Won June Lee. Hanyang University, Seongdong-gu, Seoul, Republic of Korea.

**Background:** The eyes and kidneys have numerous common structural, developmental, and physiologic pathways, suggesting that eye and kidney disease may be interlinked. Hemodynamic changes due to hemodialysis (HD) may affect the blood flow to the eyes, which may influence many structures of the eye. In this study, we investigated the effect of HD on lamina cribrosa (LC) of optic nerve head (ONH) by swept-source optical coherence (SS-OCT) and other ophthalmologic parameters in patients with end-stage kidney disease (ESKD).

**Methods:** A prospective observational study was performed on 28 patients who underwent HD for ESKD. Detailed ophthalmologic examinations and SS-OCT were performed immediately before and after HD. The ONH parameters including the LC position, were measured using built-in software. Changes in ONH parameters before and after HD were statistically analyzed.

**Results:** The mean anterior LC depth (LCD) significantly decreased from 441.6 ± 139.8 μm before HD to 413.5 ± 141.7 μm after HD (P=0.001). Mean neural canal diameter and mean papillary vertical height did not show significant change after HD (P=0.841, P=0.574, respectively). Significant correlation was found between changes in LCD and changes in mean ocular perfusion pressure (rho=0.397, P=0.036).

**Conclusions:** We observed significant decrease in anterior LCD after HD. Our study suggest that HD can give influence on the ONH, especially in LC.

**Funding:** Government Support - Non-U.S.

SA-PO307

**Treatment Response and Dosing of Patiromer in Veterans With Dialysis-Dependent ESKD and Hyperkalemia**

Csaba P. Kovessy,<sup>1</sup> Navdeep Tangri,<sup>2</sup> Derek Pinnell,<sup>3</sup> Steven D. Woods,<sup>4</sup> Sylvie Boutin,<sup>5</sup> Brian C. Sauer.<sup>5</sup> <sup>1</sup>The University of Tennessee Health Science Center, Memphis, TN; <sup>2</sup>University of Manitoba, Winnipeg, MB, Canada; <sup>3</sup>Salt Lake City VA Medical Center (IDEAS), Salt Lake City, UT; <sup>4</sup>Vifor Pharma Inc., Redwood City, CA; <sup>5</sup>Otsuka Canada Pharmaceutical Inc, Saint Laurent, QC, Canada.

**Background:** Hyperkalemia (HK) is a common, potentially life-threatening metabolic disorder that presents a challenge for clinicians caring for dialysis patients with end-stage kidney disease (ESKD). Patiromer is a non-absorbed, sodium-free potassium (K<sup>+</sup>)-binding polymer approved for HK treatment. This historical cohort study aimed to describe patiromer utilization and associated serum K<sup>+</sup> (sK<sup>+</sup>) changes in veterans with ESKD and HK on dialysis.

**Methods:** Patiromer utilization and sK<sup>+</sup> changes were evaluated using the National VA Corporate Data Warehouse between 1/1/16 and 2/28/21. Inclusion criteria were adults aged ≥18 years old, receiving patiromer, with at least 2 ICD codes for ESKD, on dialysis, and a sK<sup>+</sup> ≥5.1 mEq/L recorded within 91 days of the index date (date of first patiromer dispensing). sK<sup>+</sup> was assessed at baseline (BL) and 1-, 3-, and 6-months follow-up (FU) from index date. sK<sup>+</sup> change from BL to each FU timepoint was assessed by paired t-test.

**Results:** 1,267 patiromer users were identified with ESKD based on ICD code during the BL period; 458 meet the inclusion criteria and had a sK<sup>+</sup> available for evaluation during the 3 months pre-index. BL characteristics included mean age 66 years old, 97% male,

45% African American, and mean sK<sup>+</sup> 5.91 mEq/L. Comorbidities of interest included 72% diabetes, 50% heart failure, and 45% coronary artery disease. Dosing of patiromer was daily in 87% of cases with an average daily dose of 8.4 g. A dose increase was observed in 11% (n=52) and dose decrease in 5% (n=24) during the FU period. Following patiromer initiation, significant reductions (P<0.01) in mean sK<sup>+</sup> concentrations from BL were observed within 1 month (-1.02 mEq/L; n=307), 3 months (-1.04 mEq/L; n=351), and 6 months (-1.05 mEq/L; n=351; **Figure**).

**Conclusions:** Among US veterans with ESKD and HK on dialysis, patiromer use was associated with clinically relevant reductions in sK<sup>+</sup> concentrations at all study timepoints.

**Funding:** Commercial Support - Otsuka Pharmaceuticals Canada

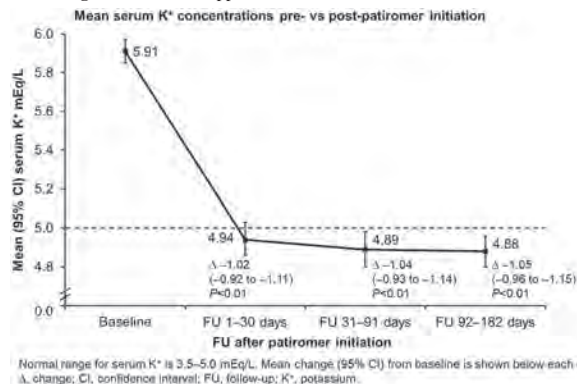

SA-PO308

**Research Participation Rates by Hemodialysis Shift and Schedule**

Vladimir Rigodon,<sup>1</sup> Yue Jiao,<sup>2</sup> John W. Larkin,<sup>2</sup> Len A. Usvyat,<sup>2</sup> Michael S. Anger,<sup>1</sup> Franklin W. Maddux,<sup>3</sup> Russell Smith.<sup>4</sup> <sup>1</sup>Fresenius Medical Care North America, Waltham, MA; <sup>2</sup>Fresenius Medical Care, Global Medical Office, Waltham, MA; <sup>3</sup>Fresenius Medical Care AG & Co KGaA, Bad Homburg, Germany; <sup>4</sup>Frenova Renal Research, Waltham, MA.

**Background:** Trial conduct is fundamental to the development of better therapeutics/devices that maintain health and treat the ailments of mankind. In kidney failure, most patients are treated by in-center hemodialysis (HD) for 240 minutes thrice weekly, which offers ample opportunities to invite patients to participate in trials. HD occurs in shifts through the day that are typically performed on Monday, Wednesday, Friday (MWF) or Tuesday, Thursday, Saturday (TTS) schedules. Many clinics are involved in trials, however, there have been questions on the equivalence of offerings and participation rates by HD shifts and schedules. To start to understand this, we assessed trial participation rates by HD shift and weekday at a clinic network.

**Methods:** We used data from all adults at HD clinics that participated in industry-sponsored trials and enrolled ≥1 participant during Oct 2018-2021. We computed the proportion of research participants (i.e. enrolled in ≥1 trial) to non-research patients per HD shift and per weekday.

**Results:** Among 218 HD clinics, 2.0% of patients (1,274/63,014) were enrolled into ≥1 trial during the 3 years. The greatest % of patients enrolled were treated in the 1<sup>st</sup> shift on a MWF schedule and participation rates decreased with each later shift (**Figure 1**). Consistent signals were seen in shifts 1-5 for patients treated on a TTS schedule, however, the highest % of patients were enrolled in the 6<sup>th</sup> shift (nocturnal HD).

**Conclusions:** Findings identified disparities in research enrollment by HD shift and schedule, with the most trial participants receiving HD in the 1<sup>st</sup> shift of the morning on an MWF schedule. These findings are likely showing research staff resourcing patterns and representative of when the largest subset of patients is treated. Nonetheless, it suggests there may be less opportunities afforded to patients in certain shifts and schedules. Given patient characteristics (e.g. age, comorbidities) are often distinct between shifts these observations will be important to be considered.

**Funding:** Commercial Support - Fresenius Medical Care

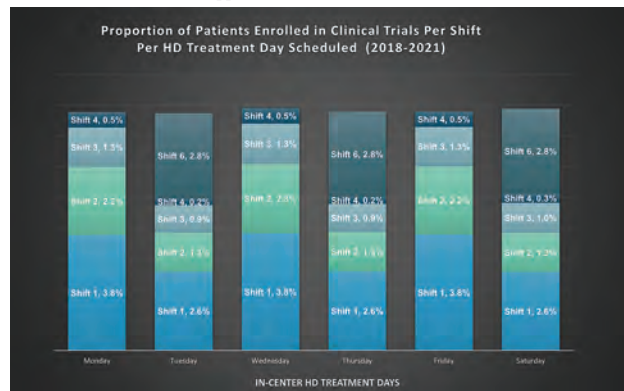

## SA-PO309

## Does Sodium Magnetic Resonance Imaging Help for Initiation of Incremental Dialysis?

Sandrine Lemoine,<sup>1,2</sup> Alireza Akbari,<sup>2</sup> Jarrin D. Penny,<sup>2</sup> Christopher W. McIntyre.<sup>2</sup>  
<sup>1</sup>Université de Lyon, Lyon, France; <sup>2</sup>Lawson Health Research Institute, London, ON, Canada.

**Background:** Incremental HD (twice a week) can be proposed to some patients who had a significant residual renal function (RRF) when hemodialysis (HD) is initiated. However renal urea clearance is a very limited tool to assess the totality of crucial functions of the kidney, such as ability of the kidney to control salt and water excretion. We hypothesized that corticomedullary gradient (CMG) measurement with <sup>23</sup>NaMRI could provide a new tool to select HD patients potentially suitable for incremental dialysis.

**Methods:** We conducted a prospective observational study to better characterize CMG in HD patient with <sup>23</sup>NaMRI. We performed CMG measurement with <sup>23</sup>NaMRI in fasting patients. All MR experiments were carried out on a GE MR750 3T (GE Healthcare, WI). A custom-built two-loop (18cm in diameter) butterfly radiofrequency surface coil tuned for <sup>23</sup>Na frequency (33.786 MHz) was used to acquire renal <sup>23</sup>Na images. We compared CMG in healthy controls (n=15) and HD patients (n=10) with or without conventionally assessed RRF.

**Results:** For healthy controls, median (IQR) age was 50 (32-60), years old, 46% men, eGFR 103 (84-108) mL/min/1.73m<sup>2</sup>, urinary osmolality (osmU) 786 (587-938) osm/L. For HD patients, median(IQR) age was 50 (32-60) years old, 40 % men, urinary osmolality (osmU) 313 (193-317) osm/L, with residual renal function (RRF). Corticomedullary gradient for controls (1,53 (1,47-1,61)), was significantly different to HD 1,32 (1,24-1,36) (p=0.001). There was a significant correlation between osmolality and CMG (r=0.92, p<0.001). We were able to see a difference in salt repartition between HD patient with RRF and control. Anuric HD patients had lost medullary sodium entirely. Figure 1 shows difference in corticomedullary pictures (A) control; (B) HD patients with RRF; (C) HD patients with no RRF

**Conclusions:** We showed that it is possible to assess corticomedullary gradient in HD patients. Additional study is justified to explore the ability to the <sup>23</sup>NaMRI to discriminate patients who might benefit best from an incremental dialysis approach.

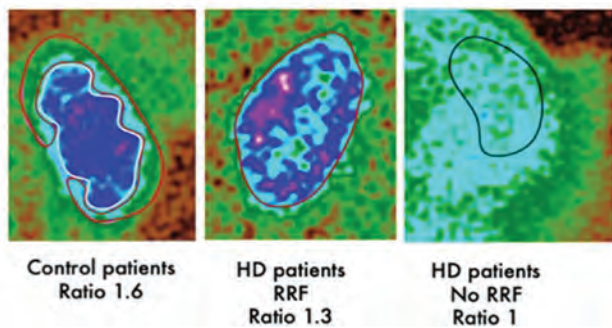

## SA-PO310

## Establishing a Standardized Central Venous Catheter Rate

Thomas P. Deluca,<sup>1</sup> Caitlin Monaghan,<sup>1</sup> Kathleen Belmonte,<sup>1</sup> John W. Larkin,<sup>1</sup> Len A. Usvyat,<sup>1</sup> Jeffrey L. Hymes,<sup>1</sup> Franklin W. Maddux.<sup>2</sup>  
<sup>1</sup>Fresenius Medical Care, Global Medical Office, Waltham, MA; <sup>2</sup>Fresenius Medical Care AG & Co KGaA, Bad Homburg, Germany.

**Background:** High central venous catheter (CVC) rates negatively affect dialysis patients around the world, with ailments such as CR-BSIs and thrombosis (Sohail, EKIR 2021). The process for getting a patient ready for AV access can be complex, thus catheter rates at clinics may be higher than expected. This model will be used as a tool to identify clinics that are performing worse than expected with CVC rates and aid to improve them.

**Methods:** The analysis was conducted on a sample of 143,411 active hemodialysis dialysis patients as of March 1<sup>st</sup>, 2022, with end stage kidney disease. Patients must have had a CVC for greater than 90 days to be included in the study. A stepwise logistic regression model was trained on the data, with outcome as CVC or not. The model used BMI, age, location (Rural or Urban), sex, vintage, comorbidities, and nursing home residence.

**Results:** Using a nationwide catheter prevalence threshold of 19% for classifying predictions as having a CVC or not, the model performance on a test dataset showed balanced accuracy=61% and area under the curve=0.68. Predicted probabilities for clinics of size greater than 25 patients, had similar predictions to the actual rates (Figure 1). The top 3 most important predictors are vintage, age, and BMI.

**Conclusions:** The standardized CVC rate model gives clinics a tool to identify patients that look like they may be a good candidate for AV access but currently have a CVC. This tool will allow direct intervention into the practices of clinics to reduce their catheter rates. The model is in early development and a pilot will be initiated to continue validation of the model.

**Funding:** Commercial Support - Fresenius Medical Care

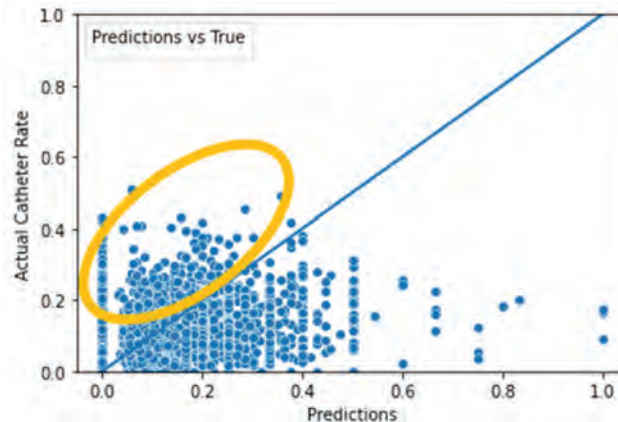

**Figure 1:** Prediction of clinic's catheter rates on the x axis vs their true catheter rates on the y axis. The oval highlights the clinics that are targeted for intervention.

## SA-PO311

## Hyperkalemia Disease Burden and Dialysis Patterns in Chinese Hemodialysis Patients: An Interim Analysis of the Precede-K Study

Zhaohui Ni,<sup>1</sup> Haijiao Jin,<sup>1</sup> Renhua Lu,<sup>1</sup> Lihong Zhang,<sup>2</sup> Li Yao,<sup>3</sup> Guojian Shao,<sup>4</sup> Li Zuo,<sup>5</sup> Shuguang Qin,<sup>6</sup> Xinzhou Zhang,<sup>7</sup> Qinghong Zhang,<sup>8</sup> Weimin Yu,<sup>9</sup> Qun Luo,<sup>10</sup> Yuqing Ren,<sup>11</sup> Hui Peng,<sup>12</sup> Jie Xiao,<sup>13</sup> Qiongqiong Yang,<sup>14</sup> Qinkai Chen,<sup>15</sup> Yifan Shi.<sup>16</sup>  
 PRECEDE-K study team  
<sup>1</sup>Department of Nephrology, Ren Ji Hospital, Shanghai Jiao Tong University School of Medicine, Shanghai, China; <sup>2</sup>Department of Nephrology, The First Hospital of Hebei Medical University, Shijiazhuang, China; <sup>3</sup>Department of Nephrology, The first hospital of China Medical University, Shenyang, China; <sup>4</sup>Department of Nephrology, Wenzhou Central Hospital, Wenzhou, China; <sup>5</sup>Department of Nephrology, Peking University People's Hospital, Beijing, China; <sup>6</sup>Department of Nephrology, Guangzhou First People's Hospital, Guangzhou, China; <sup>7</sup>Department of Nephrology, Shenzhen People's Hospital, Shenzhen, China; <sup>8</sup>Department of Nephrology, Taihe Hospital, Shiyan, China; <sup>9</sup>Department of Nephrology, Shanxi Bethune Hospital, Taiyuan, China; <sup>10</sup>Department of Nephrology, Hwa Mei Hospital, University of Chinese Academy of Sciences, Ningbo, China; <sup>11</sup>Department of Nephrology, Yangquan Coal Industry (Group) General Hospital, Yangquan, China; <sup>12</sup>Department of Nephrology, Third Affiliated Hospital of Sun Yat-Sen University, Guangzhou, China; <sup>13</sup>Department of Nephrology, The First Affiliated Hospital of Guangzhou Medical University, Guangzhou, China; <sup>14</sup>Department of Nephrology, Sun Yat-Sen Memorial Hospital, Sun Yat-Sen University, Guangzhou, China; <sup>15</sup>Department of Nephrology, First Affiliated Hospital of Nanchang University, Nanchang, China; <sup>16</sup>Medical Affairs, AstraZeneca Investment China Co, Shanghai, China.

**Background:** Hyperkalemia (HK); common in hemodialysis (HD) patients, is a life-threatening electrolyte imbalance disorder. Studies have shown that long-term control of serum potassium (sK<sup>+</sup>) in HD patients cannot be achieved. However, data on the disease burden and dialysis pattern of HK in Chinese patients on HD is scarce.

**Methods:** In this prospective, multicenter, observational cohort study (NCT04799067), dialysis prescription, sK<sup>+</sup> and other biochemistry measurements data of HD patients was collected. Data was collected on occurrence of HK, sK<sup>+</sup> fluctuation, and dialysis patterns to analyze the disease burden of HK and dialysis patterns in Chinese HD population.

**Results:** In total, 600 patients (67.2% male, 54 years mean age) were enrolled, and 60% of HD patients had heavy disease burden and medical history of HK (sK<sup>+</sup>>5.0 mmol/L) in last 6 months. At baseline visit, the prevalence of HK was 40%, proportions of sK<sup>+</sup>>5.5 mmol/L, >6.0 mmol/L and >6.5 mmol/L [17%, 6%, and 3%, respectively]. Dialysate potassium concentration mostly used was 2.0mmol/L (97.7%). Mean HD duration was 4 hours with thrice a week dialysis frequency in 86% of patients. The dialysis adequacy was standard, with average urea reduction ratio of 68% and Kt/V of 1.45. The sK<sup>+</sup> fluctuation between pre- and post-dialysis was 1.4 mmol/L, with fluctuation proportions of [0 - < 1], [1 - < 2], [2 - < 3], [≥3] were 24%, 62%, 13% and 1%, respectively. Potassium gradient between serum and dialysate was 2.8 mmol/L, with gradient proportion of [1 - < 2], [2 - < 3], [3 - < 4], [≥4] were 14%, 45%, 36% and 5%, respectively.

**Conclusions:** Prevalence of HK in Chinese HD patients was high. Rebound of sK<sup>+</sup> during the inter-dialytic period cannot be controlled under standard dialysis mode. The previous research confirmed that the potassium fluctuation > 1 mmol/l and the potassium gradient ≥ 3 mmol/L is associated with the acute clinical events. Hence, effective potassium-lowering treatments on non-dialysis days to control potassium level and fluctuation requires exploration and further validation.

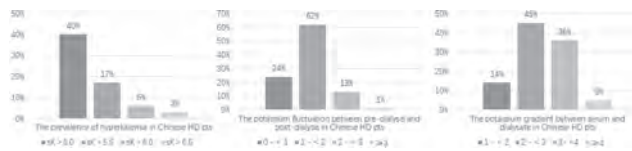

Disease burden of HK

SA-PO312

**A Comparison of Mortality Between Unplanned and Planned Hemodialysis Initiation in Incident ESKD Patients: A Long-Term Observational Study**

Keisuke Okamoto, Masahiro Eriguchi, Ken-ichi Samejima, Kazuhiko Tsuruya, Nara Kenritsu Ika Daigaku, Kashihara, Japan.

**Background:** Planned hemodialysis (HD) initiation with a matured vascular access is recommended in terms of patients' survival compared to unplanned HD initiation with a temporary vascular catheter in several guidelines across the world. This is based on several short-term observational studies, whereas long-term outcomes have been rarely evaluated.

**Methods:** We consecutively assessed newly declared ESKD patients who started HD between 1/1/2007 and 12/31/2014 at Nara Medical University Hospital. We excluded patients who had dialysis-dependent acute kidney injury (AKI) leading to ESKD, recovered from AKI, underwent continuous kidney replacement therapy as the only dialysis modality, or had HD for extra-renal indication. We stratified patients into 2 groups (unplanned vs planned HD initiation) and compared survival using the Kaplan-Meier method with or without a propensity score matching. The primary outcome was all-cause mortality during the observational period until 12/31/2020.

**Results:** Of the 460 newly declared ESKD patients who were assessed for eligibility, 345 patients (172 unplanned and 173 planned HD initiation) were included in this study. The median follow-up duration of the entire cohort was 4.59 years (range, 1.45-7.84 years). Figure 1 showed Kaplan-Meier survival curves which presented no statistically significant difference in crude survival between unplanned and planned HD initiation (Figure 1A, Log-rank P = 0.235), however, revealed a statistically significant difference in survival in the propensity score-matched cohort (Figure 1B, Log-rank P = 0.046). The hazard ratio for mortality in the unplanned HD initiation group was 1.515 [95% confidence interval 1.005-2.282] in the propensity score-matched cohort.

**Conclusions:** In this cohort of newly declared ESKD patients who started HD, those who were in the planned HD initiation group had better long-term survival in the propensity score-matched cohort. This finding supports the usefulness of creating permanent vascular access before starting HD for not only short-term but also long-term survival.

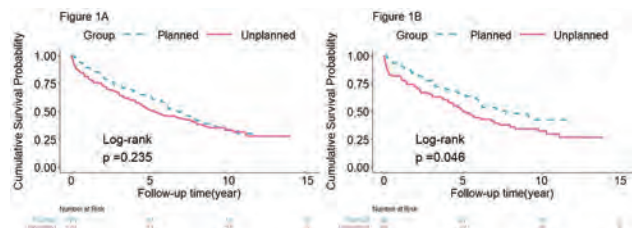

Figure 1

SA-PO313

**How Does the United States Compare With Europe in ESRD?**

Ivan Cancarevic,<sup>1,2</sup> Mahmoud Nassar,<sup>1,2</sup> Ismail Omran,<sup>1,2</sup> <sup>1</sup>Icahn School of Medicine at Mount Sinai, New York, NY; <sup>2</sup>New York City Health and Hospitals Corporation, New York, NY.

**Background:** End-stage renal disease (ESRD) requiring renal replacement therapy (RRT) due to renal disease or secondary to another disorder, predisposes to numerous complications. In the United States (US), ESRD patients are on Medicare. Europe has public systems. We aimed to find out if either does better at managing ESRD.

**Methods:** Data for 2015 and 2019 was extracted from the United States Renal Data System (USRDS) and the European Renal Association (ERA) registry. We analyzed ESRD incidence, management and survival.

**Results:** ESRD incidence in the US rose from 402 to 412, while in Europe from 119 to 132. In Europe, 26-27% of patients are over 75, while in the US >40%. Diabetes was the most common cause in both populations. 75 in a million Americans got transplants, while 35 Europeans did (from 3 in the East to 73 in Spain). The 5-year survival on dialysis was higher in Europe (47% vs 42%). Among 40-50 years olds, Europeans lived 2 years longer on dialysis. Survival after transplant was 24-30 years in the US, 22-27 in Europe.

**Conclusions:** Older Americans are more likely to be started on dialysis. Survival differences may be explained by better management and adherence among Europeans on dialysis, while the inclusion of developing countries affects survival post-transplant. Analysis of prescribing patterns would be helpful.

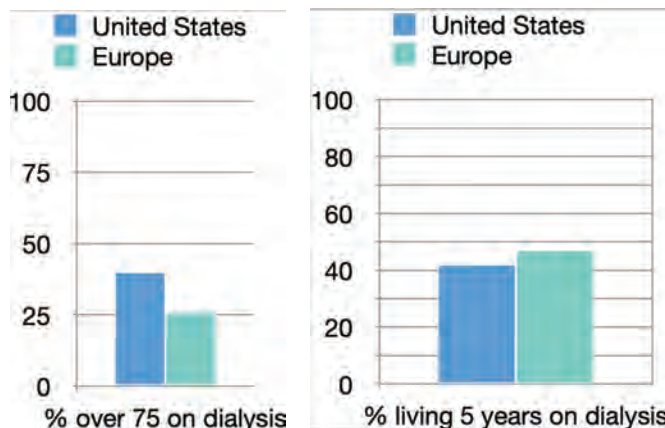

SA-PO314

Survival After Transplant Allograft Failure (TAF) and Return to Dialysis in Latin America

Adrian M. Guinsburg, Maria Ines Diaz Bessone, Juan Carlos Berbessi, Benjamin E. Hippen. *Fresenius Medical Care Global Medical Office, Waltham, MA.*

**Background:** Dialysis initiation with a permanent access and in-target clinical parameters for patients (pts) returning to dialysis after TAF are less frequently achieved than in incident dialysis population, even though transplanted pts usually enjoy specialist care. We aimed to compare rates of hospitalization (hosp) and survival between pts incident to dialysis after TAF or native kidney failure (NKF) in Fresenius Medical Care clinics in Latin America

**Methods:** We selected all incident dialysis pts between Jan 2017 and Dec 2021. Pts were classified as TAF or NKF according to ESRD cause reported. Baseline parameters were collected within first 30 days after dialysis initiation and Hosp were observed during 6 months. Pts were tracked until death, lost-to-follow-up, or end of study. Three models were fitted: Model 1 (KM): univariate, Model 2 (Cox): case-mix adjusted (age, gender, diabetes) and Model 3 (Cox): fully adjusted (model 2 + vascular access + baseline labs)

**Results:** 34,630 incident pts to dialysis were selected: 630 (1.8%) TAF and 34,000 (98.2%) NKF. Hosp (6 months) showed no significant difference in model 1. However, TAF showed Hosp HR 1.35, p<0.005 and HR 1.45, p<0.005 in model 2 and 3 respectively. Mortality risk was lower for TAF in model 1 (fig 1A, left), invert to TAF HR 1.23, p 0.03 in model 2, and no difference was found in model 3 (fig 1B, right)

**Conclusions:** In the first 6 months after dialysis initiation, risk of hosp for pts with ESRD after TAF was not significantly different from ESRD after NKF in univariate analysis, but after full multivariate adjustment, HR for hosp for TAF increased to 1.45. TAF pts showed higher survival in univariate analysis, with no significant mortality differences after full multivariate adjustment. Observed survival differences may be ameliorated by attention to CVC prevalence, Ca, P, Hb, and albumin for pts with ESRD after TAF

Group	Variable	Allograft failure	Native kidney failure	p	N
	N	630	34000		34630
Demographics	Age (years)	46.2±16.2	59.2±16.3	<0.0001	34596
	Gender, male (%)	56	59.2	0.1	34614
	White (%)	61.8	35.9	<0.0001	9173
Ethnicity	Black (%)	4.8	5.1	0.8	1292
	Asian (%)	0.9	0.8	0.9	203
	Mixed (%)	29.4	48.4	<0.0001	12101
Comorbidity	Diabetes (%)	10.3	36.8	<0.0001	12585
	Hypertension (%)	10.5	10.1	0.8	3499
Dialysis modality	HD (%)	85.7	89.3	0.004	30907
	PD (%)	14.3	10.7	0.004	3710
	HD with PD catheter (%)	6.8	3	<0.0001	1071
RRF	Creatinine (mg/dl)	7.1 ± 3.0	6.7 ± 3.1	0.02	27816
	eGFR (ml/min/1.73m2)	9.6 ± 4.4	9.7 ± 4.8	0.3	27240
Labs	Hemoglobin (g/dl)	8.9 ± 1.9	9.4 ± 1.8	<0.0001	30633
	Ferritin (ng/ml)	787.2 ± 602.9	461.4 ± 466.8	<0.0001	29989
	TSAT (%)	26.9 ± 15.6	24 ± 12.9	<0.0001	29027
	Corrected Ca (mg/dl)	9 ± 0.8	8.9 ± 0.9	0.004	29650
	Phosphate (mg/dl)	4.4 ± 1.4	4.4 ± 1.5	0.3	30372
	iPTH (pg/ml)	533.2 ± 552.3	306.1 ± 337.4	0.01	31141
	Albumin (g/dl)	3.6 ± 0.5	3.6 ± 0.6	0.3	30990
CRP (mg/l)	22.2 ± 22.7	18.8 ± 22.1	0.01	3461	
Cholesterol (mg/dl)		163.3 ± 45.5	166.5 ± 48.6	0.09	20026
	SBP (mmHg)	140 ± 25.8	147.3 ± 27.3	<0.0001	28292
BP	DBP (mmHg)	76.4 ± 16.4	75 ± 15.4	0.03	28292
	ESA therapy (%)	47.8	54.2	0.002	15895
Therapy	Iron therapy (%)	25.2	36.9	<0.0001	21918
	AVF (%)	62.6	21.5	<0.0001	5610
Access type used	AVG (%)	6.7	1.3	<0.0001	343
	CVC (%)	30.7	77.2	<0.0001	19395
Outcomes	Hosp rate (%)	30.2	28.1	0.3	9727
	Death rate (%)	18.6	23.6	0.004	8123

Table 1

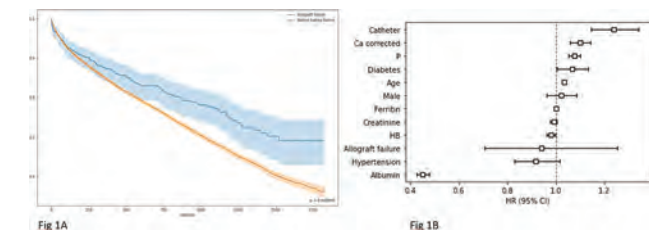

Fig1A: Mortality risk for patients with ESRD after TAF and NKF, univariate analysis. Fig2A: Hazard ratio for death in patients with ESRD after TAF, full multivariate adjustment

SA-PO315

Clinical Conditions After Transplant Allograft Failure (TAF) and Return to Dialysis in Latin America: Can We Do Better?

Adrian M. Guinsburg, Maria Ines Diaz Bessone, Juan Carlos Berbessi, Benjamin E. Hippen. *Fresenius Medical Care Global Medical Office, Waltham, MA.*

**Background:** Dialysis (dial) initiation with permanent access and in-target clinical parameters for patients (pts) returning to dial after TAF are less frequently achieved than in incident dial population, even though transplanted pts usually enjoy specialist care. We aimed to compare baseline characteristics between TAF and native kidney failure pts (NKF) incident to dial in Fresenius Medical Care Latin America clinics

**Methods:** We selected all incident pts between Jan 2017 and Dec 2021. Pts were classified as TAF or NKF according to ESRD cause reported. Baseline parameters were collected within 30 days of dial initiation. Values expressed as mean±SD. Means compared using Student t-test for normal or Mann-Whitney for non-normal distributed variables

**Results:** We selected 56,247 new pts from which 34,630 were incident to dial: NKF 34,000 (98.2%), TAF 630 (1.8%). TAF were younger (46.2±16 vs 59.2±16 yrs; p<0.0001), had lower diabetes prevalence (10.3% vs 36.8%; p<0.0001), were more likely to start PD and had lower CVC prevalence. TAF had higher creatinine (Cr) (7.1±3.0 vs 6.7±3.1 mg/dl; p 0.02) at start, lower hb (8.9±1.9 vs 9.4±1.8 g/dl), higher ferritin (787±603 vs 461±466 ng/ml; p<0.0001), TSAT (26.9±15.6 vs. 24±12.9%), CRP (22.2±22.7 vs 18.8±22.2 mg/l; p 0.01) and iPTH (533±552 vs 306±337 pg/ml), and were less likely to use ESA or iron therapy. AVF/AVG prevalence was higher in TAF but 30.7% started dial with a CVC (Table 1)

**Conclusions:** In our cohort, pts with TAF were younger and had lower prevalence of diabetes. At initiation, Cr was higher and Hb was lower in TAF group, indicative of delay in dial initiation and suboptimal pre-ESRD anemia management. Despite lower observed CVC prevalence in TAF, nearly one-third of pts with TAF started dial with a CVC

SA-PO316

Patient Survival Analysis on Hemodialysis: A Mexican Cohort

Edgar Solis, Sergio Hernández-Estrada, Víctor M. Hernandez Mora, Juan C. Rodriguez, Juan M. Ardivin Ituarte. *Medica Santa Carmen, San Miguel de Allende, Mexico.*

**Background:** 5-year cumulative survival on HD patients is variable: 41% USRDS, 45% ERA-EDTA, 65% ANZDATA. Survival of patients on HD modality in Mexico is scarce: median survival 700 d.

**Methods:** We did a retrospective cohort analysis from Nov 2015-Nov 2021 on HD pts from a network of 6 facilities across Mexico. Death was registered as the interest event, time to event was expressed in days and used to estimate survival. Clinical and laboratory data were considered in a comparative analysis between groups and as explanatory variables. Survival analysis with K-M method and Cox hazards were used.

**Results:** Total 1165 pts included, 246 (21%) died, 919 (79%) censored. 401 (44%) were lost (facility or modality change or KTR) and 518 (56%) continue alive. 5 year cumulative survival was 73%, median survival 3463 d. Multivariate analysis showed significantly increased risk of death for KtV <1.2 (HR 1.73, IC1.16-2.58), Na <135 (1.63, 1.09-2.43), Creat <10 (1.83, 1.14-2.94), Non-tunneled VA (3.32, (1.85-5.96) and age (1.02, 1.01-1.03).

**Conclusions:** We report higher survival rates compared with other series, which might be partly explained by selection and survival biases; also a high proportion of patients lost to follow up. National kidney disease register is needed.

**Funding:** Private Foundation Support

N (%)	Censored	Deaths	Total	p value
Total	919	246	1165	
Age (y) ± SD	50.6 ± 18.5	56.8 ± 16	51.9 ± 18.2	0.001
<22	54 (6)	4 (2)	58 (5)	0.001
22 - 44	289 (32)	46 (19)	335 (29)	
45 - 64	339 (37)	108 (44)	447 (38)	
65 - 74	161 (17)	59 (24)	220 (19)	
>75	74 (8)	26 (11)	100 (9)	
Male	544 (59)	144 (59)	688 (59)	0.85
Affiliation				
Non-insurance	401 (44)	111 (45)	512 (44)	0.78
Insurance	508 (56)	135 (55)	643 (56)	
Other disease				
Hypertension	304 (33)	73 (30)	377 (32)	0.31
DM2	378 (41)	129 (52)	507 (44)	0.0015
Access type				
AVF	250 (28)	35 (14)	285 (25)	<0.001
Tunneled	334 (38)	94 (38)	428 (38)	
Non-tunneled	302 (34)	116 (47)	418 (37)	
Sessions /week				
1	15 (3)	18 (13)	32 (5)	<0.001
2	133 (23)	43 (31)	176 (25)	
3	423 (74)	73 (55)	496 (70)	
Blood analysis				
Hemoglobin (g/dl)	9.9 ± 2.0	9.1 ± 2.1	9.8 ± 2.0	<0.001
WBC (mil/uL)	6.1 ± 2.1	7.2 ± 3.5	6.3 ± 2.5	<0.001
Platelets (x1000/mm3)	222.6 ± 77.5	247.1 ± 123.6	227.6 ± 89.3	0.008
Albumin (g/dl)	3.6 ± 0.6	3.3 ± 0.8	3.5 ± 0.6	0.007
Sodium (mEq/l)	136.5 ± 4.0	135.3 ± 5.4	136.3 ± 4.3	0.001
Cholesterol (mg/dl)	145.2 ± 58.7	149.1 ± 46.8	152.5 ± 55.7	0.71
KtV	1.3 ± 0.4	1.2 ± 0.4	1.3 ± 0.4	0.06
Creatinine (mg/dl)	10.1 ± 3.9	8.8 ± 3.5	9.8 ± 3.8	0.009
BUN (mmol/L)	68.2 ± 23.9	69.4 ± 25.2	68.5 ± 24.1	0.543
Phosphorus (mg/dl)	5.2 ± 1.9	5.0 ± 1.9	5.1 ± 1.9	0.26

Variable	Mean ± SE (days)	Log Rank	p-value
<b>Diabetes</b>			
DM	2150 ± 60	15.9	<0.0001
Non-DM	2778 ± 59		
<b>Access</b>			
AVF	2591 ± 58	31.9	<0.0001
Tunneled C.	2561 ± 80		
Non-tunneled	1302 ± 33		
<b>Sesion p/w</b>			
1	813 ± 101	86.1	<0.0001
2	1969 ± 96		
3	2521 ± 47		
<b>Hemoglobin (g/dl)</b>			
<10 g/dl	2337 ± 176	17.2	<0.0001
> 10 g/dl	2801 ± 551		
<b>WBCs (mil/uL)</b>			
<4.5	2646 ± 68	14.7	<0.0001
4.5-10	2769 ± 113		
>10	1600 ± 193		
<b>Platelets (x1000/mm3)</b>			
<175	2719 ± 96	8.27	<0.0001
175-250	2668 ± 89		
>250	2243 ± 106		
<b>KtV</b>			
<1.2	2308 ± 120.2	12.05	<0.0001
>1.2	2726 ± 78.0		
<b>Creatinine (mg/dl)</b>			
>10 g/dl	2850 ± 108	28.81	<0.0001
<10 g/dl	2201 ± 105		
<b>Sodium (mEq/l)</b>			
<135	2359 ± 105	25.83	<0.0001
135-145	2822 ± 71		
>145	1828 ± 335		

SA-PO317

**Ornithine Transcarbamylase Deficiency in the Time of Pregnancy: The Role of Hemodialysis in Promoting Protein Nutrition**  
Michelle Tran, Anubhav Kumar. *UVA Health, Charlottesville, VA.*

**Introduction:** Ornithine transcarbamylase deficiency (OTC-d) is a rare X-linked urea cycle disorder leading to hyperammonemia. It is exacerbated by periods of catabolic stress, including pregnancy, with treatments including protein restriction. We describe a case of a patient with OTC-d who developed hyperammonemia in her third trimester of pregnancy, complicated by protein malnutrition, for which dialysis was initiated to improve nutritional status.

**Case Description:** A 30-year-old female with OTC-d diagnosed at 27 weeks gestation presented with acute encephalopathy and ammonia level of 205 umol/L. Mentation and ammonia levels initially improved with sodium phenylacetate-sodium benzoate, arginine supplementation, and nutritional protein restriction until stable for discharge. She re-presented five days later with serum ammonia of 338 umol/L, nausea, vomiting, and worsening encephalopathy requiring intubation. While mental status improved with the therapies above, her ammonia level remained persistently elevated above the goal of <75 umol/L despite holding feeds, suggestive of protein malnutrition and muscle catabolism. Nephrology was consulted. Intermittent hemodialysis at typical flow rates was initiated for ten sessions, eight sequential, allowing the patient's dietary protein intake to be liberalized as ammonia levels and symptoms improved. No ultrafiltration was prescribed. She underwent planned Caesarian section complicated by emergency hysterectomy about one month after her final hemodialysis session. She did not require dialysis post-operatively. During her hospitalization, a multidisciplinary team consisting of Nephrology, Medical Genetics, Nutrition, High Risk Obstetrics, and Critical Care were involved in her management.

**Discussion:** Patients with OTC-d must be maintained in delicate metabolic homeostasis. We describe the complex management of a patient with OTC-d in the inherently catabolic state of late pregnancy. In this patient refractory to initial drug therapy and demonstrating muscle catabolism, hemodialysis improved her ammonia levels thus allowing for improved protein intake. This case further highlighted the degree of multidisciplinary collaboration required to achieve therapeutic goals when caring for these medically complex patients.

SA-PO318

**The Prevalence of Thrombocytopenia in Chronic Hemodialysis Patients Using Low-Molecular-Weight Heparin (Enoxaparin Sodium) vs. Standard Unfractionated Heparin for Hemodialysis Anticoagulation**

James A. Sobremisana, Rafael Montepio. *Armed Forces of the Philippines Medical Center, Diliman, Quezon City, Philippines.*

**Background:** Anticoagulation is essential for the prevention of blood clots in the extracorporeal circuit during hemodialysis. For decades, unfractionated heparin has been used for this purpose, however there were noted several disadvantages, hence the search for other anticoagulants with better effects have been studied. One of the effects of anticoagulation during hemodialysis is thrombocytopenia. This study aims to determine the prevalence of thrombocytopenia in chronic kidney disease patients on hemodialysis using unfractionated heparin and using low molecular weight heparin.

**Methods:** This study used a cross-sectional study design of hemodialysis patients comparing the prevalence of thrombocytopenia from the Enoxaparin arm with the Unfractionated Heparin arm of the study. Low molecular weight heparin was given at 0.2cc as bolus 30 minutes to 1 hour prior to hemodialysis. Unfractionated heparin was administered at 50 IU/kg bolus then at 1000 IU per hour. Thrombocytopenia was defined as decrease of 50% from baseline platelet count prior to usage or <150 x 10<sup>9</sup>/L.

**Results:** The total number of patients recruited that was currently on hemodialysis were 161 patients. A total of 127 patients were included in the study due to exclusion criteria. The Heparin arm (n1=119 patients), and Enoxaparin arm (n2= 42 patients) were included and compared. Overall mean age of the included patients is 48.2 ± 15.2 years. Majority were males and the most common reason for dialysis was Chronic Glomerulonephritis. The age, marital status, cause and reason for HD were homogenous. Among the 127 patients, 22 patients had thrombocytopenia, 16 patients (17.2%; 95% CI: 10.6 to 25.8) were under the heparin group, while 6 patients (17.6%; 95% CI: 7.7 to 32.8) were under the enoxaparin group.

**Conclusions:** It is observed in this study that there is a high prevalence of thrombocytopenia in these study population (17.2-17.6%), compared to the known incidence of hemodialysis-related thrombocytopenia (0.2-12%). Although data is not sufficient to conclude that thrombocytopenia among these patients can be solely attributed to heparin use. Thrombocytopenia occurrence in patients who use unfractionated heparin and low-molecular weight heparin was not statistically significant between the two groups.

SA-PO319

**Hemodialysis-Associated Increase in Plasma Glial Fibrillary Acidic Protein, an Acute Brain Injury Biomarker**

Lin-Chun Wang,<sup>1</sup> Ohnmar Thwin,<sup>1</sup> Amrish U. Patel,<sup>1</sup> Hanjie Zhang,<sup>1</sup> Ludovic Debure,<sup>2</sup> Xin Wang,<sup>1</sup> Nadja Grobe,<sup>1</sup> Xia Tao,<sup>1</sup> Stephan Thijssen,<sup>1</sup> Thomas Wisniewski,<sup>2</sup> Peter Kotanko.<sup>1,3</sup> <sup>1</sup>Renal Research Institute, New York, NY; <sup>2</sup>NYU Langone Health, New York, NY; <sup>3</sup>Icahn School of Medicine at Mount Sinai, New York, NY.

**Background:** Structural and functional brain pathologies (e.g., cerebral hypoperfusion, silent cerebral infarcts, leukoariosis, osmotic stress, edema) are common in hemodialysis (HD) patients, but their etiologies are poorly understood. The acute effect of HD on blood biomarkers of brain injury has not yet been studied. We measured biomarkers for astroglial injury (GFAP, glial fibrillary acidic protein), axonal injury (NF-L, neurofilament-light), post-injury neurodegeneration (T-Tau, total Tau protein), and neuronal cell body injury (UCH-L1, ubiquitin C-terminal hydrolase-L1).

**Methods:** Three chronic HD patients (age 36±9 years; dialysis vintage 7±4 years) were enrolled in this one-week pilot study and dialyzed for 4 hours each on Monday, Wednesday, and Friday. Plasma samples were collected 6 times throughout each HD session. One study subject did not proceed after Monday HD and was withdrawn. A total of seven HD treatments were completed. GFAP, NF-L, T-Tau, and UCH-L1 were quantified by Neuro 4-Plex SIMOA assays (Quanterix, MA, USA). For biomarkers larger than 50kDa (GFAP, NF-L, and T-Tau), levels were corrected for hemoconcentration using total plasma protein levels.

**Results:** GFAP increased 2.1-fold by the end of HD (Fig 1a, p<0.001). NF-L (Fig 1b) and T-Tau (Fig 1c) results showed no conclusive change throughout HD. UCH-L1 decreased 0.8-fold by the end of HD (Fig 1d, p=0.03).

**Conclusions:** We report, for the first time, an increase of GFAP, a biomarker that is associated with astroglial injury, during routine HD. The results of our pilot study provide motivation to further explore the dynamics of brain injury biomarkers in HD patients to elucidate underlying mechanisms and aid research into neuro-protective interventions.

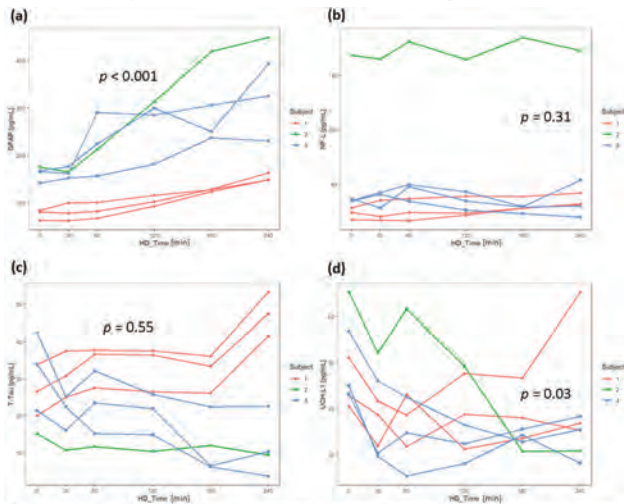

**Figure 1.** Intradialytic plasma levels of brain injury biomarkers from three study subjects (seven hemodialysis treatments in total): (a) GFAP, glial fibrillary acidic protein; (b) NF-L, neurofilament-light; (c) T-Tau, total Tau protein; and (d) UCH-L1, ubiquitin C-terminal hydrolase-L1. Data were corrected by total protein levels for biomarkers larger than 50kDa (GFAP, NF-L, and T-Tau) to account for hemoconcentration. Analysis was done by linear mixed-effects model, considering random effects over time throughout the hemodialysis treatments.

SA-PO320

**Temporal Relationship Between Prior Estimated Glomerular Filtration Rate Testing and Dialysis Initiation in a Real-World Population of Incident Dialysis Patients**

Steph Karpinski, Adam G. Walker, Carey Colson, Scott Sibbel, Francesca Tentori, Steven M. Brunelli. Davita Clinical Research, Minneapolis, MN.

**Background:** Properly preparing for dialysis initiation can lead to better short and long-term outcomes for new dialysis patients. These preparation activities usually require ≥6 months lead time and knowledge of the severity of a patient’s kidney disease. We sought to describe the patterns of dialysis starts with respect to timing and severity of prior estimated glomerular filtration rate (eGFR) testing.

**Methods:** For this analysis, we used the Optum® de-identified Integrated Dataset that links administrative claims and clinical data from providers across the continuum of care. We examined 5,900 adults who initiated dialysis across multiple outpatient provider networks between 2012 and 2019. Patients without continual insurance coverage for at least 61 days prior to dialysis start were excluded. All eGFR test results were obtained in outpatient settings prior to the start of dialysis.

**Results:** External data results show that 34.8% of patients who start dialysis did not have an ambulatory eGFR measured 6 months or more prior to initiation of dialysis. This includes 23.9% of subjects with no documented eGFR before starting outpatient dialysis

and an additional 10.9% with less than 6 months between 1<sup>st</sup> eGFR and dialysis start. Only 55.9% of patients have had a documented eGFR less than 60 mL/min/1.73m<sup>2</sup>, 6 months or more prior to arrival at a dialysis clinic.

**Conclusions:** Increased surveillance of eGFR prior to dialysis start will lead to better outcomes for patients.

SA-PO321

**The Mechanisms That Shape the Care Trajectory Leading to an Emergency Dialysis Start: Crossing Patients’, General Practitioners’, and Nephrologists’ Perspectives**

Maxime Raffray,<sup>1</sup> Sahar Bayat,<sup>1</sup> Cecile M. Vigneau.<sup>2</sup> <sup>1</sup>Univ Rennes, EHESP, CNRS, Inserm, Arènes - UMR 6051, RSMS (Recherche sur les Services et Management en Santé) - U 1309, Rennes, France; <sup>2</sup>Univ Rennes, CHU Rennes, Inserm, EHESP, Irset (Institut de recherche en santé, environnement et travail) - UMR\_S 1085, Rennes, France.

**Background:** Emergency dialysis start (EDS) is an important issue to understand and tackle in CKD care. Late referral, absent previous nephrology care and higher comorbidity scores have been associated with EDS. However, how those quantitative risk factors happen and contribute to EDS remains unexplored. We conducted a qualitative study in France to identify and describe the mechanisms that shape the trajectories that lead to EDS, using patients, GPs and nephrologists perspectives.

**Methods:** Three groups of participants were recruited in Brittany, north-west France: Patients who started dialysis in emergency between 2017 and 2019, GPs and nephrologists. Maximum variation sampling approach was used based on patients’ socio-economic profiles and GPs’ and nephrologists’ years and settings of practice. Semi-structured interviews were conducted between 2017 and 2020. A crossed thematic analysis between the 3 groups of transcripts was performed, informing how EDS trajectories come to be.

**Results:** Twenty patients, 12 GPs and 18 nephrologists were interviewed. Five main themes were identified: 1) Learning about dialysis, 2) Dialysis and nephrology care representations: a) an unacceptable biographical disruption, b) a dreadful invasive machinery, c) a straw that breaks the camel’s back, 3) The gap between the “illness” perceived and the “disease” treated, 4) Slipping through the primary care prevention net, 5) the unavoidable unpredictability of CKD course.

**Conclusions:** This study shows how quantitative risk factors of EDS such as low or absent previous nephrology care are, in part, the results of an interplay between patients’ constructed representations of dialysis, relation with the medical sphere and CKD physiopathology. The results suggests a need for evaluation of kidney replacement therapy education programs and reinforcement of psychological care. Finally, results also support ambitious mass prevention campaign focused on kidney health to counter the persistent negative representation of dialysis and seal off prevention cracks younger patients slip through.

**Funding:** Government Support - Non-U.S.

SA-PO322

**Rethinking Potentially Preventable Emergency Department Use Among People Receiving Dialysis: A Population-Based Study**

Meghan J. Elliott,<sup>1</sup> Jennifer M. MacRae,<sup>1</sup> Eddy Lang,<sup>1</sup> Andrew Mcrae,<sup>1</sup> Maoliosa Donald,<sup>1</sup> Brenda Hemmelgarn,<sup>2</sup> Paul E. Ronksley.<sup>1</sup> <sup>1</sup>University of Calgary, Calgary, AB, Canada; <sup>2</sup>University of Alberta, Edmonton, AB, Canada.

**Background:** People with kidney failure receiving maintenance dialysis visit the emergency department (ED) 3 times per year on average, which is 3- to 8-fold higher than the general population. Little is known about the clinical and socio-demographic factors that contribute to potentially preventable ED use.

**Methods:** In this retrospective cohort study, we used administrative data to identify adults receiving maintenance dialysis for >3 months between April 1, 2010 and March 31, 2019 in Alberta, Canada. We captured clinical characteristics and rates of ED use and followed patients until death or end of study (March 31, 2019). We determined age- and sex-adjusted rates of all-cause and potentially preventable ED use (defined by kidney disease-specific ambulatory care sensitive conditions: hyperkalemia, heart failure, volume overload, and malignant hypertension). We examined the association between clinical and socio-demographic factors and rates of potentially preventable ED encounters using multivariable negative binomial regression models.

**Results:** Our cohort included 4,402 people with kidney failure (2,781 hemodialysis; 1,621 peritoneal dialysis) followed for a mean of 2.8 years. 3,440 patients had 29,927 all-cause ED encounters (adjusted rate 3,065/1,000 person years). Of these, 654 patients had 1,153 potentially preventable ED encounters (adjusted rate 107/1,000 person years). Potentially preventable ED encounters were more likely in those who were socioeconomically disadvantaged, had higher comorbidity burden, and had longer dialysis vintage. Multivariable regression identified that preventable ED use was significantly higher for younger adults (age <45 years; IRR: 1.37 [95% CI 1.08-1.75]) and those with chronic pain (IRR: 1.33 [95% CI 1.06-1.66]), greatest material deprivation (IRR: 1.39 [95% CI 1.02-1.90]), and a history of hyperkalemia (IRR: 1.34 [95% CI 1.11-1.63]).

**Conclusions:** We identified that potentially preventable ED use among people receiving dialysis is related to both socio-demographic and clinical factors. Our findings underscore the need to implement and test strategies that address social determinants of health to avert potentially preventable ED use in this population.

SA-PO323

Primary Causes of ESRD in the US Cystic Fibrosis Population

Mirjana Stevanovic,<sup>1</sup> Martha L. Graber.<sup>2</sup> <sup>1</sup>Dartmouth Guarini School of Graduate and Advanced Studies, Hanover, NH; <sup>2</sup>Dartmouth College Geisel School of Medicine, Hanover, NH.

**Background:** We have previously shown that individuals with with cystic fibrosis (CF) have a greater than ten fold risk of end stage renal disease (ESRD) relative to the general population. Persons with CF have higher rates of AKI and CKD, higher rates of lung and other organ transplantation, and an approximately 40% risk of developing diabetes. However, the roles of diabetes and other possible etiologic risk factors for ESRD in CF are not defined

**Methods:** We analyzed data from the US Renal Data System (USRDS) 2014-2018 inclusive

**Results:** Non-type I diabetes was the leading cause of ESRD in the age-adjusted CF population, but was significantly less frequent compared to the general ESRD population. There was no difference in the age-adjusted frequency of type I diabetes as a cause of ESRD. The second and third most frequent causes of ESRD in CF were complications of lung transplant, and nephropathy due to drugs and other agents respectively. Hypertension was significantly less frequent in the CF population. There was no difference in the rates of glomerulonephritis and cystic diseases.

**Conclusions:** Individuals with CF have a greater than ten-fold risk of developing ESRD compared to the general US population. Non-type I diabetes mellitus is the leading cause of ESRD in CF, however diabetes is approximately 50% less frequent an etiology than in the general ESRD population. Complications of lung transplantation and medication toxicities are additional important etiologies in CF, rarely identified in the non-CF population. Glomerulonephritis was no more common as an etiology amongst CF individuals than those without CF, and hypertension was significantly less frequently identified as the cause of ESRD. Our future studies aim to identify more specificity within these categories and to evaluate the impact of CFTR activating agents. Demographic characteristics of CF persons with ESRD are described in a separate abstract submission to this meeting

**Funding:** NIDDK Support

Table 1. Primary Causes of End Stage Renal Disease in the US Cystic Fibrosis Population

Primary-disease causing ESRD	CF (N=879)	Non-CF (N=953,824)	OR <sup>1</sup>	Univariable		Age-adjusted		
				95% CI	p-value	OR <sup>2</sup>	95% CI	p-value
All causes	92 (24.3%)	403,053 (42.3%)	0.428	(0.346, 0.524)	<0.001	0.502	(0.443, 0.712)	<0.001
All Type I diabetes	32 (8.4%)	14,115 (1.7%)	1.89	(1.41, 2.71)	<0.001	1.18	(0.821, 1.71)	0.266
All Type II diabetes	60 (15.8%)	358,640 (37.6%)	0.312	(0.237, 0.414)	<0.001	0.449	(0.340, 0.594)	<0.001
Complications of transplantation lung	64 (16.9%)	317 (0.03%)	611	(437, 817)	<0.001	682	(500, 929)	<0.001
Other transplant complications	13 (3.7%)	3,789 (0.3%)	8.02	(5.05, 16.4)	<0.001	6.58	(3.85, 11.3)	<0.001
Nephropathy due to drug/other agents	29 (7.7%)	4,361 (0.5%)	16.0	(12.5, 20.4)	<0.001	26.3	(14.6, 29.7)	<0.001
Chronic interstitial nephritis	8 (2.1%)	6,286 (0.7%)	3.25	(1.61, 6.55)	<0.001	2.10	(1.07, 4.30)	0.031
Tubular necrosis	12 (3.1%)	39,000 (4.0%)	1.75	(1.01, 3.04)	0.046	2.55	(1.42, 4.40)	0.00106
Glomerulonephritis	30 (7.8%)	33,980 (3.5%)	0.889	(0.728, 1.07)	0.278	0.853	(0.625, 0.716)	<0.001
Cystic kidney disease	7 (1.8%)	31,117 (3.2%)	0.528	(0.284, 1.18)	0.126	0.405	(0.139, 0.855)	0.0175
Hypertension	5 (1.3%)	30,827 (3.2%)	0.400	(0.166, 0.967)	0.010	0.217	(0.060, 0.525)	<0.001

<sup>1</sup>Odds ratio from logistic regression.

SA-PO324

Characteristics of US Individuals With Cystic Fibrosis and ESRD

Mirjana Stevanovic,<sup>1</sup> Martha L. Graber.<sup>2</sup> <sup>1</sup>Dartmouth Guarini School of Graduate and Advanced Studies, Hanover, NH; <sup>2</sup>Dartmouth College Geisel School of Medicine, Hanover, NH.

**Background:** Persons with cystic fibrosis (CF) have increased rates of diabetes, lung transplantation, acute kidney injury (AKI), and chronic kidney disease (CKD). Data are lacking concerning the prevalence and outcomes of end stage renal disease (ESRD) in this population

**Methods:** We analyzed data from the US Renal Data System (USRDS) for the years 2014-2018 inclusive

**Results:** Based on population prevalence individuals with CF have a 10-20 fold rate of ESRD compared with the general population (USRDS 2016 data). Prevalent individuals with CF and ESRD were significantly younger (41.8 vs 59.5 years), had lower BMI, were more likely to be White and female, to initiate renal replacement therapy with peritoneal dialysis or transplantation, and to receive a living donor kidney. There was no significantly increased risk of death in a five year period.

**Conclusions:** The characteristics of US individuals with CF and ESRD have not been previously described. Relative to the general US population persons with CF have a markedly increased (10-20-fold) risk of developing ESRD. We describe the demographic characteristics of these individuals, who are younger, more likely to be White and female and more likely to start renal replacement therapy with peritoneal dialysis or transplantation and to receive a living donor kidney than those without CF. These findings have important implications for awareness, management, and prevention of AKI and CKD in this vulnerable population. Details of etiologies of ESRD in CF are submitted in a separate abstract.

**Funding:** NIDDK Support

Table 1. Characteristics of US Individuals with Cystic Fibrosis and End Stage Renal Disease

	CF (N=879)	Non-CF (N=953,824)	Univariable				Age-adjusted			
			OR <sup>1</sup>	95% CI	p-value	Coefficient/OR <sup>2</sup>	95% CI	p-value	Coefficient/OR <sup>2</sup>	95% CI
Female Sex	191 (21.7%)	410,702 (43.1%)	1.20	(1.03, 1.39)	0.0017	1.00	(1.00, 1.00)	<0.001		
Age at first ESRD event (Mean ± SD)	41.8 ± 9.84	59.5 ± 17.4	0.62	(0.64, 0.64)	<0.001	-6.47	(-5.28, -5.65)	<0.001		
BMI (Mean ± SD)	23.0 ± 6.30	29.4 ± 7.30	0.28	(0.28, 0.28)	<0.001	-0.47	(-0.47, -0.47)	<0.001		
Race										
White	301 (37.4%)	615,544 (64.6%)	1.74	(1.70, 1.80)	<0.001	0.79	(0.53, 0.77)	<0.001		
Black/African American	41 (10.8%)	216,234 (22.6%)	0.907	(0.73, 0.91)	<0.001	0.330	(0.330, 0.330)	<0.001		
Asian	4 (0.6%)	15,307 (1.6%)	0.294	(0.06, 0.28)	0.0023	0.236	(0.09, 0.68)	0.0029		
Hispanic ethnicity	30 (7.0%)	132,291 (13.9%)	0.538	(0.309, 0.779)	0.0010	0.141	(0.08, 0.48)	<0.001		
Pre-ESRD cause for a nephrologist	228 (68.2%)	457,287 (98.9%)	1.91	(0.99, 1.71)	0.001	1.52	(1.50, 1.90)	0.013		
Flow ESRD event modality type										
Hemodialysis	397 (73.7%)	800,000 (84.0%)	0.900	(0.899, 0.900)	<0.001	0.022	(0.001, 0.001)	0.111		
Peritoneal dialysis	49 (12.1%)	60,782 (6.4%)	1.21	(0.999, 1.46)	0.073	0.024	(0.000, 1.16)	0.221		
Transplant	44 (10.2%)	31,114 (3.2%)	2.44	(1.53, 4.23)	<0.001	2.10	(1.18, 2.60)	<0.001		
First Kidney Transplant	40 (10.7%)	290,839 (30.1%)	2.01	(1.53, 2.64)	<0.001	1.05	(0.828, 1.22)	0.711		
First Kidney Transplant Living Donor (n)	10	6,281	1.01	(0.75, 1.34)	<0.001	2.23	(1.18, 2.95)	<0.001		
Death during this period	40 (12.7%)	441,772 (45.6%)	1.11	(0.79, 1.57)	0.517	1.01	(0.854, 0.89)	0.215		

<sup>1</sup>Linear regression coefficient for Age at first ESRD event; OR<sup>2</sup> and 95% CI are from logistic regression for all other variables.

For all ORs, non-CF patients were used as the reference group.

SA-PO325

Calcimimetics Adherence and Preference in the Management of Uremic Secondary Hyperparathyroidism (SHPT) in Europe

Chidozie U. Nduka,<sup>1</sup> Karly S. Louie,<sup>2</sup> Matt Hall,<sup>3</sup> Filippo Aucella,<sup>4</sup> Pablo A. Urena Torres,<sup>5,6</sup> Laura Labriola,<sup>7</sup> Pieter Evenepoel,<sup>8</sup> Junjie Ma,<sup>12</sup> Najma Saleem,<sup>12</sup> Ronald L. Pisoni,<sup>9</sup> Bruno L. Fouqueray,<sup>10</sup> Robert Horne.<sup>11</sup> <sup>1</sup>Amgen, Uxbridge, United Kingdom; <sup>2</sup>Dorset County Hospital NHS Foundation Trust, Dorchester, United Kingdom; <sup>3</sup>Nottingham University Hospitals NHS Trust, Nottingham, United Kingdom; <sup>4</sup>Fondazione IRCCS "Casa Sollievo della Sofferenza", San Giovanni Rotondo, Italy; <sup>5</sup>AURA Paris-Nord, Saint-Ouen, France; <sup>6</sup>Necker Hospital, University of Paris Descartes, Paris, France; <sup>7</sup>Department of Nephrology, Cliniques Universitaires Saint-Luc, Université Catholique de Louvain, Brussels, Belgium; <sup>8</sup>Department of Immunology and Microbiology, Division of Nephrology, University Hospitals Leuven, Leuven, Belgium; <sup>9</sup>Arbor Research Collaborative for Health, Ann Arbor, MI; <sup>10</sup>Amgen GmbH, Rotkreuz, Switzerland; <sup>11</sup>University College London School of Pharmacy, London, United Kingdom; <sup>12</sup>Amgen, Thousand Oaks, CA.

**Background:** Oral cinacalcet (CIN) and intravenous etelcalcetide (ETEL) are approved for treating hemodialysis (HD) patients with SHPT. Data on patient-reported outcomes and calcimimetic preference from nephrologists/nurses' perspectives are provided in this cross-sectional study.

**Methods:** Patient questionnaires assessed CIN adherence (Medication Adherence Report Scale [MARS]), calcimimetic perceptions [Beliefs about Medicines Questionnaire (BMQ) and Treatment Intrusiveness Scale (TIS)] and gastrointestinal (GI) symptom experience in the month before enrolment. Nephrologists/nurse questionnaires assessed calcimimetic preference (CIN vs ETEL) based on effectiveness, side effects, patient burden and quality of life (QoL).

**Results:** 414 patients (204 CIN & 210 ETEL) responded to the surveys. Patient characteristics were similar between CIN vs ETEL: mean age 65 vs 64yrs; men 57% vs 61%; mean no. of medications 9 vs 8. CIN adherence was high (mean MARS 4.8), and 78% of patients reported using all CIN prescribed in the month before enrolment. There were no significant differences in perceptions of Calcimimetic Necessity (mean BMQ-Necessity CIN vs ETEL = 3.5±0.7 vs 3.6±0.5, p=0.49), Calcimimetic Concerns (mean BMQ-Concerns CIN vs ETEL = 2.3±0.6 vs 2.3±0.9, p=0.17), or treatment intrusiveness (mean TIS CIN vs ETEL = 1.6±0.7 vs 1.8±0.9). ETEL and CIN patients attributed GI symptoms to calcimimetic use at similar rates: nausea (ETEL 23%; CIN 21%); vomiting (ETEL 26%; CIN 24%) and Diarrhea (ETEL 21%; CIN 21%). Nephrologists (n=111) and nurses (n=113) preferred ETEL for patient adherence (Nephrologist 89%; Nurses 78%); reducing patient burden (Nephrologist 87%; Nurses 86%); minimizing side effects (Nephrologist 78%; Nurses 66%); improving QoL (Nephrologist 72%; Nurses 75%); and effectiveness (Nephrologist 60%; Nurses 74%).

**Conclusions:** Nephrologists/nurses preferred ETEL for encouraging patient adherence, reducing patient burden, minimizing side effects, improving QoL, and effectiveness. High levels of patient engagement were observed for ETEL and CIN.

**Funding:** Commercial Support - Amgen

SA-PO326

Market Competition and Anemia Management in the United States Following Dialysis Payment Reform

Anshul Bhatnagar, Wolfgang C. Winkelmayer, Kevin F. Erickson. Baylor College of Medicine, Houston, TX.

**Background:** Hemodialysis markets are highly concentrated. It is unknown whether market competition influences how dialysis providers respond to reimbursement reforms. We examined whether changes in anemia management following the 2011 expansion of Medicare's Prospective Payment System (PPS) for end-stage kidney disease varied with market competition.

**Methods:** From the US dialysis registry, we identified patients undergoing in-center hemodialysis in 2009 and 2012, representing periods before and after reimbursement reform. We used a difference-in-differences (DID) study design to estimate the independent associations among market competition and changes in erythropoiesis stimulating agents (ESAs) and intravenous iron dosage, the probability of having a hemoglobin <9 g/dl, and hospitalizations. We also examined serum ferritin concentrations, an indicator of the body's iron stores, in 2012 to understand patient management practices. Market competition was represented as a dichotomous variable, with less competitive areas defined as with those with ≤2 competing dialysis providers.



**Results:** Among 326,150 patients identified, 39% received dialysis in less competitive areas. Compared to areas with more competition, patients in less competitive areas had slightly more pronounced declines in ESA dose (60% versus 57%) following reimbursement reform (DID estimate: -3%; 95% Confidence Interval (CI) -5% to -1%) and less pronounced declines in intravenous iron dose (-14% versus -19%; DID estimate: 5%; 95% CI 1% to 9%). The estimated likelihoods of hemoglobin <9 g/dl, mortality, and hospitalization did not vary with market competition. Serum ferritin concentrations in 2012 were 4% (95% CI 3% to 6%) higher in less competitive areas.

**Conclusions:** Following expansion of the ESRD PPS, ESA use declined by slightly more and intravenous iron use declined by less in less competitive markets. These changes reflected a shift in anemia management towards more intensive use of intravenous iron relative to ESA and higher serum ferritin concentrations in areas with less market competition. While this suggests greater changes in cost management occurred in less competitive markets, there were no associated adverse effects on observed health outcomes.

**Funding:** NIDDK Support

### SA-PO327

#### Patient Views Regarding Cannabis Use in CKD and Kidney Failure: A Survey Study

David T. Collister,<sup>1</sup> Reid Whitlock,<sup>2</sup> Karthik K. Tennankore,<sup>3</sup> Navdeep Tangri,<sup>2</sup> Remi Goupil,<sup>4</sup> Annie-Claire Nadeau-Fredette,<sup>4</sup> Sara N. Davison,<sup>1</sup> Ron Wald,<sup>5</sup> Michael Walsh,<sup>6</sup> <sup>1</sup>University of Alberta Faculty of Medicine & Dentistry, Edmonton, AB, Canada; <sup>2</sup>University of Manitoba Max Rady College of Medicine, Winnipeg, MB, Canada; <sup>3</sup>Dalhousie University Faculty of Medicine, Halifax, NS, Canada; <sup>4</sup>Universite de Montreal, Montreal, QC, Canada; <sup>5</sup>University of Toronto Temerty Faculty of Medicine, Toronto, ON, Canada; <sup>6</sup>McMaster University, Hamilton, ON, Canada.

**Background:** Cannabis is frequently used recreationally and medicinally including for symptom management in patients with kidney disease.

**Methods:** We elicited the views of Canadian adults with kidney disease regarding their cannabis use. Participants were asked whether they would try cannabis for anxiety, depression, restless legs, itchiness, fatigue, chronic pain, decreased appetite, nausea/vomiting, sleep, cramps and other symptoms. The degree to which respondents considered cannabis for each symptom was assessed with a modified Likert scale ranging from 1-5 (anchored at 1 "definitely would not" and 5 being "definitely would"). Multilevel multivariable linear regression was used to identify respondent characteristics associated with considering cannabis for symptom control.

**Results:** Of 320 respondents, 290 (90.6%) were from in-person recruitment (27.3% response rate) and 30 (9.4%) responses were from online recruitment. 160/320 respondents (50.2%) had previously used cannabis including smoking (140, 87.5%), oils (69, 43.1%) and edibles (92, 57.5%). The most common reasons for previous cannabis use were recreation (84/160, 52.5%), pain alleviation (63/160, 39.4%) and sleep enhancement (56/160, 35.0%). Only 33.8% of previous cannabis users thought their physicians were aware of their cannabis use. >50% of respondents probably would or definitely would try cannabis for symptom control for all 10 symptoms. Characteristics independently associated with interest in trying cannabis for symptom control included symptom type (pain, sleep, restless legs), online respondent ( $\beta$  0.7, 95% CI 0.1-1.4) and previous cannabis use ( $\beta$  1.2, 95% CI 0.9, 1.5).

**Conclusions:** Many patients with kidney disease use cannabis and there is interest in trying cannabis for symptom control.

### SA-PO328

#### Coordination of Pharmaceutical Care in Dialysis Patients Is Associated With Lower Hospital Admission Rates

Hao Han,<sup>1</sup> David Hart,<sup>2</sup> Sheetal Chaudhuri,<sup>1</sup> Terrell W. Fox,<sup>2</sup> Len A. Usvyat,<sup>1</sup> <sup>1</sup>Fresenius Medical Care North America, Waltham, MA; <sup>2</sup>FreseniusRx, Franklin, TN.

**Background:** It is estimated in the literature that >50% of ESRD patients do not take their phosphate binders as prescribed. The renal pharmacy FreseniusRx provides coordinated mineral and bone disorder (MBD) medication delivery and adherence support for enrolled patients. We investigated whether coordinated MBD pharmaceutical care is associated with improvements in hospital admission in dialysis patients.

**Methods:** We included all hemodialysis patients who received  $\geq 2$  BMM shipments from FreseniusRx pharmacy in Q1 and Q2 2018 and did not have any shipments from FreseniusRx in 2 years prior to 1/1/2018. We identified control patients not enrolled in the pharmacy by nearest neighbor 1:1 matching on the logit of the propensity score for demographics, comorbidities, state, insurance type, as well as, baseline lab values, vintage, treatment rates and hospitalization rates in baseline period, and hospital admission rate in 1 year prior to enrollment. We compared hospital admission rates in 6 and 12 months after the end of Q2 2018. Then the same analysis was repeated for Q1-Q2 2019.

**Results:** For the Q1-Q2 2018 analysis, we analyzed data on 16898 patients (8449 in Rx and 8449 matched patients not in Rx). Rx patients had lower hospital admission rates per patient year (non-Rx vs Rx at 6 and 12 months: 1.63 vs 1.53, 1.68 vs 1.63). For the Q1-Q2 2019 analysis, we analyzed data on 12184 patients (6092 in Rx and 6092 matched patients not in Rx). Rx patients had lower hospital admission rates per patient year (non-Rx vs Rx at 6 and 12 months: 1.64 vs 1.55, 1.59 vs 1.46).

**Conclusions:** Coordinated pharmaceutical care is associated with lower hospital admission in the hemodialysis patient population. Further analyses are needed to understand the outstanding characteristics of the pharmaceutical patient population and what elements of this coordinated care are associated with improvements.

**Funding:** Commercial Support - Fresenius Medical Care North America

### SA-PO329

#### RNA Interference (RNAi) Treatment in Patients With Primary Hyperoxaluria Type 1 on Dialysis: How to Prove Treatment Success?

Cristina Martin Higuera,<sup>1</sup> Armando Torres,<sup>2</sup> Constantinos J. Stefanidis,<sup>4</sup> Bodo B. Beck,<sup>3</sup> Bernd Hoppe.<sup>1</sup> <sup>1</sup>German Hyperoxaluria Center, Bonn, Germany; <sup>2</sup>Universidad de La Laguna Facultad de Humanidades, La Laguna, Spain; <sup>3</sup>Uniklinik Köln, Köln, Germany; <sup>4</sup>Mitera Children's Hospital, Athens, Greece.

**Background:** Primary hyperoxaluria type 1 is a rare genetic disease of glyoxalate metabolism, leading to massively elevated oxalate production in the liver. Concomitant hyperoxaluria induces recurrent kidney stones, or progressive nephrocalcinosis and eventually (early) end stage kidney failure. Two RNA interference medication selectively block endogenous oxalate production. Oxlumo (Alynlam Pharmaceuticals, USA), is authorized for treatment. It blocks glycolate oxidase, reducing oxalate, but increasing glycolate production. Nedosiran (Dicerna/NovoNordisk, Denmark, compassionate use) blocks liver specific LDHA, the final step of oxalate production.

**Methods:** We treated seven patients (age 9-54 years, 4 female) for up to 20 months, with 5 receiving Oxlumo and 2 (the child and a 40-year-old woman) receiving Nedosiran. Dosages provided were according to companies' recommendations. All but one patient received vitamin B6 (VB6), hemodialysis (HD) regimens were constant. Plasma oxalate (Pox) and glycolate (PGlyc) were measured by ion-chromatography/mass spectrometry at baseline and before every dosage. Speckle echocardiography and bone MRI (3Tesla, left knee) were done at baseline and repeated every 6-8 months.

**Results:** Pox and PGlyc showed different follow ups: in 2 Oxlumo/VB6 and one Nedosiran/VB6 treated patients Pox was stable, or declined, meanwhile PGlyc increased only in one Oxlumo/VB6 patient (360  $\mu\text{mol/l}$  before 6<sup>th</sup> dose, normal < 10.3). They only showed, if any, minor systemic oxalate deposits. In all other patients, Pox first decreased, but later fluctuated at high levels (70-130  $\mu\text{mol/l}$ , normal < 7.4). PGlyc increased significantly in all but one Oxlumo, and intermittently in the Nedosiran patient. Lactic acidosis was diagnosed before the 6<sup>th</sup> Oxlumo dose in the patient without VB6 (PGlyc 1.04 mmol/l). PGlyc further increased to 4.14 mmol/l after the 7<sup>th</sup> dose. Speckle Echo and bone MRI ameliorated in all, but more rapidly under Nedosiran treatment.

**Conclusions:** Pox and PGlyc values should be repeatedly controlled in PH 1 HD patients on RNAi treatment. Lactic acidosis can appear in Oxlumo-treated patients with PGlyc values comparable to ethylene glycol intoxication. Pox values remaining elevated do not preclude, that treatment is failing. Imaging procedures then give better evidence of treatment success.

**Funding:** Commercial Support - Dicerna Pharmaceuticals provided compassionate use medication

### SA-PO330

#### Different Modes of Action of Two Hypoxia-Inducible Factor Prolyl Hydroxylase (HIF-PH) Inhibitors, Roxadustat (Rox) and Daprodustat (Dap), in the Treatment of Anemia in Hemodialysis (HD) Patients

Satoshi Funakoshi,<sup>1</sup> Mineaki Kitamura,<sup>1</sup> Kosei Yamaguchi,<sup>1</sup> Tomoya Nishino,<sup>2</sup> <sup>1</sup>Nagasaki Kidney Center, Nagasaki, Japan; <sup>2</sup>Nagasaki Daigaku Igakubu Daigakuin Ishiyakugaku Sogo Kenkyuka, Nagasaki, Japan.

**Background:** Several types of HIF-PH inhibitors are now available for the treatment of anemia in HD patients, but there are no reports comparing each drug so far. In this study the effects of two HIF-PH inhibitors with separate launch dates in Japan, Rox and Dap, on anemia were compared in HD patients at a single institution.

**Methods:** To determine hematopoietic effect and iron metabolism of Rox and Dap, this study involved 64 HD patients who were initially treated with epoetin alfa (EPO), and then switched to Rox on January of 2020. Then, 61 patients were also converted from EPO to daprodustat (Dap) on September of 2020. We measured erythrocyte and iron-related factors at every two weeks after the treatment switch.

**Results:** As shown in Figure, in the Rox group treated three times a week at a dose of 100 mg, Hb levels significantly increased early after administration, whereas Dap group treated daily dose of 6 mg, no such early and rapid increase of Hb levels was observed. Total iron binding capacity (TIBC) values were significantly increased in both drugs, and transferrin saturation (TSAT) levels significantly increased in Rox but not Dap.

**Conclusions:** These results suggest that Rox may promote faster hematopoiesis by improving iron metabolism earlier than Dap after administration.

**Funding:** Private Foundation Support

Changes in hemoglobin level and iron-related factors over time

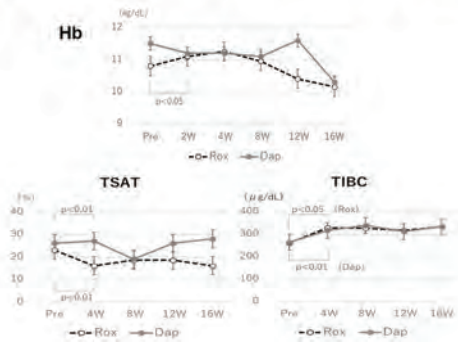

SA-PO331

**Risk Factors of Acute Dialysis Initiation in CKD Patients Followed in Multidisciplinary Low Clearance Clinics: A Retrospective Cohort Study**  
 Tarek A. Ghonimi,<sup>1</sup> Abdullah I. Hamad,<sup>1</sup> Mohamed T. Abdellatif,<sup>2</sup> <sup>1</sup>Hamad Medical Corporation, Doha, Qatar; <sup>2</sup>Misr University for Science and Technology College of Medicine, 6th of October City, Egypt.

**Background:** A significant proportion of advanced CKD patients followed in multidisciplinary clinics (MDCs) still initiate dialysis in an unplanned fashion rather than electively started. The aim of the present study is to identify risk factors that could help predict the need for unplanned dialysis initiation among patients with advanced CKD.

**Methods:** We performed a retrospective study involving advanced CKD patients followed in MDCs for the last 2 years. Patients were classified as having an acute unplanned dialysis start or electively started dialysis.

**Results:** 378 patients are included in the study. 100 patient started acute dialysis while 75 patients started dialysis electively. CHF, CAD were significantly more in patients with acute start (p = 0.05 and p=0.000 respectively). Patients with acute start had less educations, less numbers of clinic visits and less seen in vascular clinic (p = 0.000, p = 0.000 and p = 0.002 respectively). Patients with acute dialysis start had significant hospital stay and significant high icu admission (=0.003 and P = 0.00). In regression analysis, absence of diabetes and CHF significantly reduce the odds for acute dialysis start (OR 0.452, 95% CI 0.212–0.965 I, P=0.04), (OR 0.120, 95% CI 0.037–0.388, p = 0.000 respectively). Also, Patient not seen in vascular clinic have significant risk factor for acute dialysis start (OR 24.675, 95% CI 6.856–88.811, p = 0.000)

**Conclusions:** Acute dialysis initiation is common among advanced CKD patients, even if they are followed in a multidisciplinary chronic kidney disease clinic. Timely education, follow up and access creation for patients at risk may lower hospital admission, hospital stay, ICU admission, decrease cost and morbidity in those type of patients.

Characteristic	Acute dialysis: No 100 (%)	elective dialysis: No 75 (%)	p
Age (year)	57.0 ± 1.5	53.0 ± 1.6	0.079
Co-morbidities:			
Diabetes	77 (77)	48 (64)	0.060
Hypertension	96 (96)	71 (94.6)	0.676
Coronary artery disease	27 (27)	11 (14.6)	0.050
Congestive heart failure	30 (30)	4 (5.3)	0.000
Cerebrovascular disease	11 (11)	6 (8)	0.365
Dyslipidemia	60 (60)	49 (65.3)	0.471
Covid-19 infection	22 (22)	15 (20)	0.644
ICU admission	18 (18)	1 (1.3)	0.000
Mortality during Admission	5 (5)	1 (1.3)	0.187
Follow up clinic days	109.5 ± 104	163.7 ± 140.7	0.002
Hospital stay (days)	17.2 ± 24.5	0.88 ± 1.9	0.003
Education before dialysis	69 (69)	72 (96)	0.000
Seen in vascular clinic	42 (42)	72 (96)	0.000
Laboratory tests at first visit:			
Creatinine Umol/l (SD)	473.3 ± 167.2	536.4 ± 174.4	0.016
Urea Umol/l (SD)	23.2 ± 8.0	23.9 ± 7.3	0.543
GFR (ml/min/1.73m2)	12.2 ± 5.1	10.3 ± 3.9	0.010
Albumin g/l	29.2 ± 6.6	32.5 ± 5.9	0.001
K+ mmol/l (SD)	4.9 ± 2.9	4.5 ± 0.5	0.298
Hb g/dl (SD)	9.9 ± 3.5	10.2 ± 1.5	0.468
Protein/Creatinine ratio mg/mmol (SD)	617.9 ± 1021	495.1 ± 565.5	0.350
GFR 6 months before dialysis start ml/min/1.73m2 (SD)	12.5 ± 5.4	10.2 ± 4.0	0.002

SA-PO332

**Machine Learning Approach for Hemodialysis Prescription: Model Development and Validation Study**  
 Xueqin Bian, Yang Zhou, Hong Ye, Junwei Yang. *Second Affiliated Hospital of Nanjing Medical University, Nanjing, China.*

**Background:** The prediction model of hemodialysis prescription is established based on machine learning to achieve precise hemodialysis treatment.

**Methods:** We obtained 108,638 hemodialysis sessions in 965 independent maintenance hemodialysis(MHD)patients in our hospital from October 1, 2020 to June 31, 2021 using random sampling. The sessions were randomly divided into training (70%), calibration (10%), and testing (20%) sets. Apply XGBoost to analyze and extract effective feature data. XGBoost, Random Forest Regression, K-Nearest Neighbor, Support Vector

Regression and Linear Regression were used to develop the prescription model and model fusion. Training and update the model using reinforcement learning. The area under the receiver operating characteristic curves, the area under the precision-recall curves, F1 scores and MSE obtained to assess model stability and accuracy.

**Results:** There were 108,638 dialysis records in 965 patients, of whom 62.2 were male, the average age was 59.3±13.2 years, the median dialysis age was 102.3 months, BMI was 23.8±3.9, and the primary disease was diabetic nephropathy (38.6%). There are 13 labels in the hemodialysis prescription, of which 6 labels are continuous variables and the regression model is used, and 7 labels are discontinuous variables. The average accuracy is greater than 0.88, and the mean square error is less than 0.067. The average compliance rate of dialysis prescriptions was 86%.

**Conclusions:** The artificial intelligence dialysis prescription established based on machine learning has better stability and accuracy.

**Funding:** Government Support - Non-U.S.

SA-PO333

**Obesity in Patients on Haemodialysis: Looking Beyond BMI**  
 Sarah Cooney,<sup>1,2</sup> Peter J. Conlon,<sup>1</sup> Carel W. le Roux.<sup>2</sup> *<sup>1</sup>Beaumont Hospital, Dublin, Ireland; <sup>2</sup>University College Dublin, Dublin, Ireland.*

**Background:** Obesity has important implications for patients on dialysis for a number of reasons- from making them more complex to treat, to affecting the likelihood of transplantation. The WHO has changed the clinical definition of obesity from BMI >30kg/m2 to “abnormal or excessive fat that presents a risk to health”. While BMI, similar to eGFR, is useful as a screening tool, it does not always reflect health status in individuals and thus neither BMI nor eGFR are diagnostic tools. In clinical practice the King’s Obesity Staging Criteria can be used to diagnose obesity by identifying complications of obesity to determine whether a patient would benefit from obesity treatment. Using the new WHO definition, patients who were previously classed as overweight (BMI >25kg/m2) who have a complication related to excess adipose tissue can be classed as having obesity and as such may benefit from obesity treatment. Equally some patients with a BMI >30kg/m2 may not have clinically definable obesity.

**Methods:** This was a retrospective, cross-sectional audit of the prevalence of obesity in patients on haemodialysis in Beaumont Hospital, Dublin. Weight and height were extracted from the renal electronic database, which was used as a screening tool to determine patients with a BMI >25kg/m2. The King’s Obesity Staging criteria was then used to define if they had any complications of obesity.

**Results:** BMI was used as a screening tool on the current patients on haemodialysis (n=196). This identified 34.1% of patients as having obesity by the older definition of BMI >30kg/m2. In our series 62.5% of patients over BMI 25kg/m2 had a non-kidney disease related obesity complication and therefore using the new WHO definition 49.4% of the total patients on dialysis have obesity. Mean BMI was 28.4kg/m2. The most common complication was type two diabetes (n=58).

**Conclusions:** The disease of obesity affects 49.4% of patients on dialysis in Beaumont hospital. Evidence is now required to show whether treating obesity in this population will result in substantial health gain.

BMI and obesity

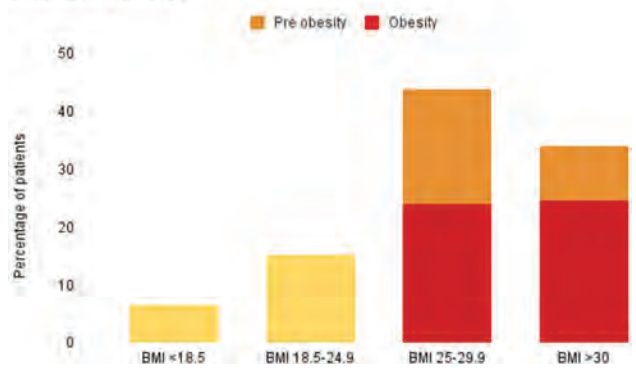

SA-PO334

**Impedance-Derived Phase Angle Is Associated With Muscle Strength and Physical Performance in Maintenance Hemodialysis Patients**  
 Xin Li, Chen Yu. *Department of Nephrology, Tongji Hospital, School of Medicine, Tongji University, Shanghai, China.*

**Background:** Phase angle (PhA) derived by bioelectrical impedance analysis (BIA) is an index of cellular health and cell membrane integrity. In maintenance hemodialysis (MHD) patients, PhA has been proposed as a predictor for protein-energy wasting (PEW). Declining in physical function is common in MHD patients, due to a variety of factors such as PEW and sarcopenia. It remains unclear if PhA is a valid marker to detect muscle function in MHD patients. The aim of this study was to identify the association between PhA and muscle function (muscle strength and physical performance) in MHD patients.

**Methods:** This was a multi-center, cross-sectional study included 864 (61% males; mean age 61.5±12.6 years) MHD patients from seven dialysis centers in Shanghai of China from 2020 to 2021. Muscle strength was measured by handgrip strength (HGS), and physical performance was measured via Short Physical Performance Battery (SPPB),

Key: TH - Thursday; FR - Friday; SA - Saturday; OR - Oral; PO - Poster; PUB - Publication Only

Underline represents presenting author.

4-meter gait speed and Timed Up and Go Test (TUGT). Nutritional status was assessed by Malnutrition inflammation score (MIS). Body composition, including PhA at 50kHz, was measured by BIA. Linear regression models were performed to determine the associations between PhA and muscle function.

**Results:** PhA (4.6±0.9) was negatively associated with age, MIS, extracellular water/total body water, visceral fat area and TUGT, and positively associated with hemoglobin, serum albumin, body mass index (BMI), skeletal muscle mass index, SPPB, 4-meter gait speed and HGS. PhA values of five body segments- right arm, left arm, trunk, right leg and left leg – also correlated well with muscle strength and physical performance. In the linear regression model further adjustments for age, gender, spKt/v, dialysis vintage, Charlson comorbidity index, MIS and BMI, PhA was positively correlated with SPPB ( $\beta=0.37$ , p-value <0.001), gait speed ( $\beta=0.32$ , p-value <0.001), HGS ( $\beta=0.32$ , p-value <0.001), and negatively associated with TUGT ( $\beta=-0.24$ , p-value <0.001).

**Conclusions:** Higher PhA was independently associated with better muscle strength and physical performance in MHD patients. Our study suggest that PhA can be used as a good marker to determine muscle function.

### SA-PO335

#### Early Body Weight Change During Continuous Renal Replacement Therapy and Subsequent Mortality in Critically Ill Patients

Sung Bin Yoon, Seongwon Han, Sungmi Kim, Minsuk Seo, Hye Ryoung Jang, Jung eun Lee, Woosung Huh, Yoon-Goo Kim, Junseok Jeon. *Samsung Medical Center, Sungkyunkwan University School of Medicine, Seoul, Republic of Korea.*

**Background:** Fluid overload in critically ill patients is associated with adverse outcome. It has been reported that negative fluid balance during continuous renal replacement therapy (CRRT) was associated with better mortality. However, measured fluid balance often does not match body weight change. We evaluated the association between early weight change during CRRT and patient outcome.

**Methods:** This retrospective study included 1694 adult patients undergoing CRRT for 3 or more days from 2009 to 2017. The day of CRRT initiation was expressed as D0. Because weight change in D0 can be significantly influenced by initial resuscitation rather than fluid control by CRRT, we divided patients according to weight change from D0 to D1: group 1 (<-1 kg, 407 patients), group 2 (-1 to 0 kg, 409 patients), group 3 (0 to 1 kg, 398 patients) and group 4 (> 1 kg, 480 patients). Early weight change (kg) during CRRT was defined as D3 weight - D1 weight. Primary outcome was 90-days mortality.

**Results:** Overall, weight increased during the first day of CRRT and decreased thereafter, and weight gain from D0 to D3 was associated with higher mortality. Early weight change during CRRT was positively associated with higher mortality in group 4 (OR 1.14, 95% CI 1.03-1.25,  $P < 0.01$ ), but not in group 1, 2 and 3. In subgroup analyses of group 4, early weight change during CRRT was positively associated with higher mortality in the surgical and cardiac ICU (OR 1.25, 95% CI 1.09-1.44,  $P = 0.001$  and OR 1.20, 95% CI 1.00-1.36,  $P = 0.007$ , respectively), but not in the medical ICU.

**Conclusions:** Early weight reduction during CRRT, especially in patients who gain weight > 1 kg on first day of CRRT, may be beneficial. However, medical ICU patients may require more careful decisions for fluid balance management.

**Funding:** Government Support - Non-U.S.

### SA-PO336

#### Lab Abnormalities Can Be Seen as Early as 3 Months Prior to Hospitalization and Mortality Among Malaysian Dialysis Patients

Yusuke Ozawa,<sup>1,3</sup> Tze L. Ting,<sup>1</sup> Pao Kuen Koh,<sup>1</sup> Rosnawati Yahya,<sup>4</sup> Li Ping Tan.<sup>1,2</sup> *<sup>1</sup>Davita Malaysia, Kuala Lumpur, Malaysia; <sup>2</sup>Ramsay Sime Darby Health Care, Selangor, Malaysia; <sup>3</sup>Mitsui Bussan Kabushiki Kaisha, Chiyoda-ku, Japan; <sup>4</sup>General Hospital Kuala Lumpur, Kuala Lumpur, Malaysia.*

**Background:** Data on associations between lab parameters with death and hospitalization among dialysis patients in Malaysia are limited. This study attempted to identify the blood test items with the highest impact on hospitalization and death.

**Methods:** We hypothesized that blood test monitoring parameters would affect the risk of being hospitalized and / or dying due to cardio/cerebrovascular events, fluid overload and infections. Patient data was extracted from 40 Davita dialysis clinics across Malaysia from January to December 2021. Variables of interest were Hemoglobin, Phosphate, Albumin, Calcium, Potassium, and Sodium. Data was analysed using 1. Sample Variance test, 2. Sample T-Test, and 3. One way Anova analysis. Regression analysis was done in order to devise a model that would predict mortality.

**Results:** A total of 774 patients were identified with data available for analysis, 515 patients were not hospitalized. 259 patients were hospitalized with 341 hospitalization events. Of the 259 hospitalized patients, 131 patients died within three months of admission giving a yearly mortality rate of 16.9%. Significant differences in mean values were observed in hospitalized patients and death as early as 3 months predating their hospitalization. These were seen in hemoglobin, albumin, calcium, potassium values. A model incorporating hemoglobin, albumin and calcium values was formulated that was able to predict the risk of mortality in 3 months.

**Conclusions:** Lab abnormalities were prevalent as early as 3 months prior to hospitalization events and were associated with hospitalization and death. Variables that were significantly different were hemoglobin, albumin, calcium and potassium. Sodium values were significantly different only when death was analyzed as the outcome. A model that incorporated hemoglobin, albumin and calcium was able to predict the risk of death.

**Funding:** Commercial Support - Davita Malaysia

Differences between hospitalized and non-hospitalized patients and Death

Category	HB(P-value)	Phos(P-value)	Alb(P-value)	Ca(P-value)	Kr(P-value)	Na(P-value)
Non-hospitalized patients	10.85	1.8232	30.195	2.244	5.25	136.2
Hospitalized patients	9.87(0.00)	1.781(0.25)	39.371(0.00)	2.1716(0.00)	5.01(0.01)	136.3(0.67)
Death	-9.283(0.00)	1.7383(0.08)	36.80(0.00)	2.090(0.00)	4.78(0.00)	135.6(0.06)

### Regression Equation

$$\text{Mortality Risk} = -3.836 + 1.4063 \text{ Alb} + 1.3692 \text{ HB} + 1.927 \text{ Ca}$$

### SA-PO337

#### Comparative Effect of Pre-Dialysis Nephrologic Care on Long-Term Mortality and Hospitalization After Dialysis Initiation

Mathias Haarhaus,<sup>1,2</sup> Lavinia O. Bratescu,<sup>3</sup> Nicolae Pana,<sup>3,4</sup> Emanuela M. Gemene,<sup>3</sup> Olivera Stojceva,<sup>5</sup> Eliana M. Silva,<sup>1</sup> Carla Alexandra R. Santos Araujo,<sup>1,6</sup> Fernando Macario.<sup>1</sup> *<sup>1</sup>Diaverum, Malmö, Sweden; <sup>2</sup>Karolinska Institutet Institutionen for klinisk vetenskap intervention och teknik, Huddinge, Sweden; <sup>3</sup>Diaverum Romania, Bucharest, Romania; <sup>4</sup>Universitatea de Medicina si Farmacie Carol Davila, Bucuresti, Romania; <sup>5</sup>Diaverum North Macedonia, Skopje, Macedonia (the former Yugoslav Republic of); <sup>6</sup>Faculty of Medicine, Cardiovascular Research and Development Unit, Porto, Portugal.*

**Background:** A structured pre-dialysis nephrologic care model may impact on patient outcome after dialysis initiation. We aimed to determine the effect of a structured nephrologic care program on mortality and hospitalizations during the first 5 years after dialysis initiation.

**Methods:** Between January 2015 and July 2018, 349 patients with end-stage renal disease who started dialysis in 9 Romanian dialysis clinics were included. In a retrospective analysis, patients followed by a nephrologist prior to dialysis initiation (N=124) were compared to patients followed in primary care (N=225). The observational period ended December 2020 or at death or loss to follow-up. anonymized clinical and laboratory data were retrieved from the dialysis provider's quality database. Patients followed for at least 1 month after dialysis initiation were included in the data analyses. Missing data were imputed using multiple imputations.

**Results:** Patients were followed for a median (25-75%) of 42 (26-50) months. Baseline age was 64 (54-70) years, there were 42.2% females and 34.9% diabetics with no significant differences between groups. At dialysis start, patients followed by a nephrologist had higher hemoglobin (9.9 (9.1-10.6) g/dL vs. 8.4 (7.8-9.4)g/L,  $p < 0.001$ ) and higher albumin (3.5 (3.2-4.1) g/dL,  $p < 0.001$ ) than patients followed in primary care, whereas Charlson Comorbidity Index was comparable between groups (6 (4-7) vs. 6 (4-7),  $p=0.9$ ). Logistic regression analysis, correcting for age, gender, hemoglobin, albumin, mean arterial pressure (MAP), and Charlson Comorbidity Score, demonstrated a lower risk for an annual hospitalization rate >1 for patients followed by a nephrologist (Exp(B) 0.30 (confidence interval 0.13-0.67),  $p=0.005$ ). A Cox regression model, correcting for the same covariables, revealed a lower mortality risk in patients followed by a nephrologist (Exp(B) 0.45 (CI 0.27-0.74),  $p=0.002$ ).

**Conclusions:** Our structured pre-dialysis care model was associated with improve survival and lower hospitalization rate during a median follow-up period of more than 3 years after dialysis initiation, compared to patients followed in primary care. These results may impact on the design of pre-dialysis care models for patients with advanced CKD. Note: This presentation will include updated results.

**Funding:** Commercial Support - Diaverum

### SA-PO338

#### Improvement of Calcinosis Cutis With Sodium Thiosulfate Infusion in a Peritoneal Dialysis Patient

Panupong Hansrivijit,<sup>1,2</sup> Viswanathan S. Iyer.<sup>2</sup> *<sup>1</sup>Brigham and Women's Hospital, Boston, MA; <sup>2</sup>UPMC Pinnacle Harrisburg, Harrisburg, PA.*

**Introduction:** Calcinosis cutis, defined by calcifications of the skin, and soft tissue is a rare disease. One subtype, calciphylaxis, defined as calcified blood vessels, can be most seen in hemodialysis patients. However, subcutaneous calcification form is extremely rare especially in peritoneal dialysis (PD) and the treatment is unknown.

**Case Description:** A 49-year-old Caucasian female with end-stage kidney disease from membranous nephropathy on PD for 3 years was evaluated in clinic for chronic bilateral leg pain. Her past medical history included essential hypertension, and history of right chronic deep vein thrombosis in 2009 with resolution of thrombosis from a repeated venous Doppler ultrasound 2 years prior to current presentation. Physical examination is remarkable for lumpy nodular swelling in circumferential pattern with local tenderness in both legs, right more than left. Serum creatinine 6.3 mg/dL, blood urea nitrogen 52 mg/dL, calcium 9.3 mg/dL, phosphorus 5.5 mg/dL, CaP product 51.2 mg<sup>2</sup>/dL<sup>2</sup>, parathyroid hormone 772 pg/mL. Radiographic imaging of both legs shown in Figure 1A. A diagnosis of calcinosis cutis was made. She was started on sodium thiosulfate infusion 12.5 g three times weekly for 5 months then 25 g weekly as well as cinacalcet and sevelamer. Eight months after treatment, patient reported significant improvement in pain and radiological findings (Figure 1B). Patient tolerated treatment well.

**Discussion:** This case provided some key learning points. First, calcinosis cutis without calciphylaxis in this patient is unusual especially with PD and normal CaP product. Second, sodium thiosulfate might be helpful in treatment of extra-vascular

calcification. However, the efficacy, dosage and duration of treatment require further investigation.

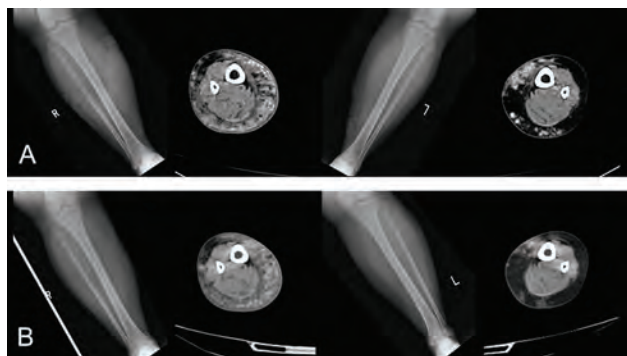

Figure 1. A) extensive bilateral subcutaneous lower leg calcifications from mid tibia to ankle, with absence of vascular calcifications; B) near resolution of calcifications on the left side, and improved calcification density on the right side.

### SA-PO339

#### Managing Sickle Cell Patients on Renal Replacement: The Struggle Is Real

Sri Vibhavari Guntupalli, Jonathan Keyes, Pooja D. Amarapurkar. *Emory University School of Medicine, Atlanta, GA.*

**Background:** Hemodialysis (HD) and peritoneal dialysis (PD) have been successfully performed in patients with sickle cell disease (SCD) and trait (SCT). However, mortality in this group remains high. Kidney transplantation is a preferred modality of renal replacement therapy (RRT) but poses great challenges. The data on longitudinal outcomes in this group varies immensely. We describe our experience with sickle cell patients on various RRT.

**Methods:** This is a retrospective analysis of data from 2004-2021, across 4 dialysis units. 29 (3.99%) out of 726 patients with sickle cell were identified. Age, gender, race, genotype, type of RRT, RRT vintage, blood pressures, transplant referral, graft function duration, hemoglobin (Hb) and Kt/v were evaluated. Patients were grouped into SCD and SCT for comparison. Statistical analysis was performed.

**Results:** All 29 patients were African American with at least 3 years of pre-dialysis nephrology care. 27.5% (8) were on PD and 72.4% (21) were on HD. 51.7% (15) patients had SCD and 48.2% (14) had SC trait. Among the SCD patient, 60% (9) started dialysis between 20-40 years of age and 40% (6) between 45-70 years of age. The patients who started dialysis at a later age had a higher Hb. 85.7% (13) SCT patients started dialysis between 45-70 years of age. 66.7% (10) patients with SCD and 28.5% (4 patients) of SCT expired and only 50% (7) of all patients survived greater than 5 years after initiation of dialysis. The average intradialytic blood pressure in patients who survived < 5 years was lower when compared to those who survived > 5 years. There was no difference in Kt/V in SCD and SCT patients who survived < or > 5 years. Of the 8 PD patients 50% (4) from each group (SCD and SCT) expired in < 5 years. 20.6% (6) of all patients received transplant. 83.3% (5) of which failed at 10-year mark with 60% (3) from BK virus and 40% (2) from rejection.

**Conclusions:** The mortality in patient with SCD and SCT on RRT is extremely high. Intradialytic hypotension is a significant co-morbidity. Graft survival is also limited. A multi-disciplinary approach is required to care for these complex patients to improve outcomes. We aim to collaborate with other centres to improve access to care and data reporting in this population.

### SA-PO340

#### End-of-Life Care Planning Among Dialysis Patients: A Mixed-Methods Study

Ania Filus, Katie T. Harmeyer, Steven M. Brunelli, Francesca Tentori. *Davita Clinical Research, Minneapolis, MN.*

**Background:** Despite high mortality rate for older adults with end-stage kidney disease, little is known about the end-of-life (EoL) care needs and preferences among patients on chronic dialysis. In an effort to better understand patient comprehension of the EoL planning process and their preferences, we elicited insight from a cohort of dialysis patients using a mixed methods approach.

**Methods:** In step one we conducted semi-structured qualitative interviews with in-center dialysis patients in January-February 2021. The results from the qualitative part informed design of the online follow-up survey (step two). The online survey data was collected from in-center and home dialysis patients from August-September 2021.

**Results:** In step one a total of 14 patients were interviewed. The average time on dialysis was 4.7 years. Results showed that patients had low understanding of EoL care terminology such as advance directive, health-care proxy, or hospice. Most patients reported that EoL conversations with their family members focused predominantly on practical issues related to dying (i.e., assets, burial) rather than EoL care (Figure 1). Common barriers to EoL care planning were: fear of death and belief that the best timing for EoL care planning are final months of one's life. In step two, online survey data was collected from 796 patients. In the survey, a majority of patients reported that preparing

and planning for their death was important to them. And 74% of patients reported that they gave some or a great deal of thought to their wishes about EoL care. Additionally, 64% of patients had discussed preferences with a family member, but only 22% discussed these with their doctor, social worker or nurse. Only 28% reported having completed a legal document that states their EoL preferences.

**Conclusions:** Dialysis patients have little awareness and understanding of steps involved in EoL care planning, and typically do not engage in EoL care conversations with their health care team. This study emphasizes the need for better patient education regarding the necessity of legal formalization of EoL preferences.

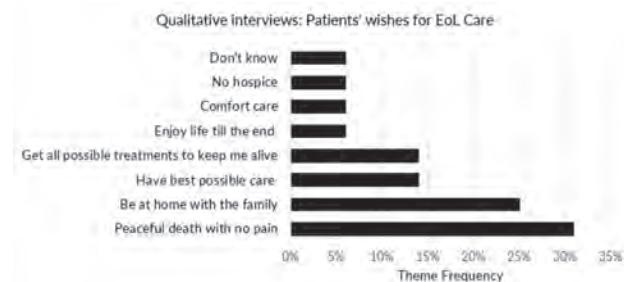

### SA-PO341

#### Differences in Demographic and Clinical Outcomes Between Modalities for Patients 60 Days Post-Transitional Care Unit Initiation

Derek M. Blankenship, Michael A. Kraus, Dinesh K. Chathoth, Rachel A. Lasky, Len A. Usvyat, Franklin W. Maddux. *Fresenius Medical Care, Global Medical Office, Waltham, MA.*

**Background:** Transitional Care Units (TCUs) are designed to enhance patient support at time of dialysis initiation and provide comprehensive education on renal replacement therapies. Much remains to be learned about TCUs and their performance. As an initial step, the purpose of this study is to describe and compare the demographics and clinical characteristics by patients' modality at 60 days post TCU enrollment.

**Methods:** This retrospective study identified Fresenius Kidney Care (FKC) patients new to dialysis and starting in-center hemodialysis (ICHD) within a TCU between Oct. 1<sup>st</sup>, 2019 and Sept. 30<sup>th</sup>, 2020. Patients less than 18 years of age and with Acute Kidney Injury preceding End Stage Kidney Disease were excluded. Demographic and clinical outcomes were measured 60 days post TCU enrollment. Tests for differences among modalities were conducted using Kruskal-Wallis and Chi-Square tests.

**Results:** 725 patients who initiated treatment at one of 57 TCUs were studied. After 60 days, 9.5%, 10.5%, 70.1%, and 9.9% were on peritoneal dialysis (PD), home hemodialysis (HHD), ICHD, or remained within a TCU, respectively. Gender, race, US region, educational status, albumin, BMI, and vascular access type were statistically significant between modalities (p<0.10). Of note, ICHD and PD had a higher proportion of female patients than HHD and those remaining in a TCU (42 vs 29%). Similarly, ICHD and PD had a higher patient proportion who live in the south (22 vs 8%). ICHD had a lower proportion with college or higher education (36 vs 49-52%) and higher proportion of blacks (45 vs 26-41%). Lastly, HHD had a higher mean BMI than other modalities (33 vs 27-29). Age, ethnicity, primary cause of ESRD, and history of diabetes, heart failure, and coronary heart disease were not statistically significant.

**Conclusions:** This preliminary study identified several demographic and clinical differences between modalities and could be used for TCU enhancements. Selection bias for patients referred to a TCU is likely. In the future, TCUs should be available for all patients and long-term follow-up of clinical outcomes should be assessed.

**Funding:** Commercial Support - Fresenius Medical Care

### SA-PO342

#### Diagnosis of Obstructive Sleep Apnea (OSA) Using NightOne (Nite1) and Crit-Line (CLD) Devices During In-Center Hemodialysis

Hassaan Iftikhar, Katherine P. Newberry, Frank J. O'Brien, Daniel W. Coyne. *Washington University in St Louis, St Louis, MO.*

**Background:** OSA is highly prevalent and underdiagnosed in in-center hemodialysis patients (ICHD). Diagnosis of OSA by simultaneous utilization of CLD monitor and portable sleep apnea testing devices has not been well studied. The CLD detects changes in relative blood volume and continuous arterial O<sub>2</sub> saturation (SaO<sub>2</sub>) data during ICHD. We conducted a study to compare SaO<sub>2</sub> changes on CLD to a validated OSA monitor, Alice NightOne (Nite1).

**Methods:** This single center study performed a protocolized, nurse-supervised sleep study using simultaneous Nite1 and CLD at a single ICHD in 6 patients with known OSA, 8 high and 10 low-suspicion OSA patients based on screening survey. Data from Nite1 was used to diagnose OSA based on a respiratory event index of ≥5/hr, and compared to the SaO<sub>2</sub> oscillation pattern on CLD (figure 1).

**Results:** 21 patients had valid results from both devices during their in-center sleep/dialysis. Mean duration of dialysis was 3.5 ± 0.5 hours. Graphs representing various degrees of suspected OSA on CLD are in figure 1. Using Nite1 as the standard, all 6 known OSA patients had a positive ICHD sleep study, and the CLD SaO<sub>2</sub> curves supported OSA. Among those with high suspicion for OSA, 4 of 6 had OSA, and CLD

curve was discordant in 2 of the 6 (1 false positive, 1 false negative). In the low suspicion group, 6 of 9 had OSA and only those 6 had Crit-line curves supporting OSA.

**Conclusions:** The recordings on Crit-Line can provide presumptive evidence of OSA, but validated device confirmation is needed. A protocolized sleep study during ICHD using NiteOne can diagnose OSA.

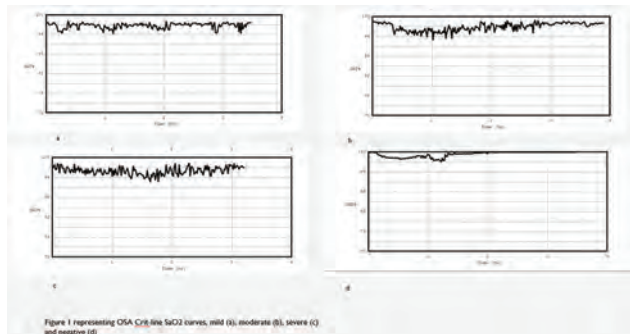

SA-PO343

**A Retrospective Analysis of All-Cause Hospitalization and 30-Day Readmission in Clinics Participating in ESRD Seamless Care Organizations**

Benjamin E. Hippen, Rachel A. Lasky, Linda Ficociello, Len A. Usvyat, Terry L. Ketchersid. *Fresenius Medical Care, Waltham, MA.*

**Background:** In 2015, the Center for Medicare and Medicaid Innovation (CMMI) implemented a pilot program known as ESRD Seamless Care Organizations (ESCOs) to reduce costs and maintain/improve care. This retrospective data analysis aims to evaluate hospitalizations in ESCO-eligible patients who received dialysis at ESCO vs non-ESCO clinics.

**Methods:** Adult, Fresenius Kidney Care (FKC) hemodialysis pts who met ESCO eligibility criteria between 10/2015-3/2017 were included. ESCO pts received dialysis at 1 of 6 FKC ESCO markets. The Non-ESCO pts were dialyzed at nearby FKC facilities that were propensity score matched on the following: number of ESCO eligible pts, mean dialysis vintage, mean pt age, %pts with diabetes, %pts with dual-eligibility, median income by zip code, and geographical proximity. Pts were further stratified by central venous catheter (CVC) use. Hospitalizations were identified using electronic medical records. Crude and adjusted Poisson regression models and chi-square testing were used.

**Results:** 13,994 pts (7,398 ESCO and 6,596 non-ESCO) were included. Pts attending ESCO clinics had 0.97 times the rate of hospitalization when compared to non-ESCO clinics (p=0.013). In the multivariate model, ESCO clinic pts had 0.95 times the rate of hospitalization when compared to pts attending non-ESCO clinics (p=0.001). The difference between groups was narrowed when controlling for CVC; thus we stratified by CVC use (table). ESCO CVC pts had 0.90 the rate of hospitalization (p=0.0004) compared to non-ESCO CVC pts. There was no significant difference in the non-CVC subgroup. 30-day readmission rate did not differ between groups (p=0.59).

**Conclusions:** ESCO-eligible pts that received hemodialysis in FKC ESCO clinics experienced a lower rate of all-cause hospitalizations when compared to pts in non-ESCO clinics, a benefit primarily associated with pts that dialyzed using a CVC.

**Funding:** Commercial Support - Fresenius Medical Care

	ESCO (n=7,398)	Non-ESCO (n=6,596)	Model Type	Rate Ratio	95% CI	p value	
Total # hospitalizations admissions / patient year	11,467 / 10,049 (1.14)	10,364 / 6,692 (1.17)	Univariate	0.97	0.94 - 0.99	0.013	
			Multivariate <sup>1</sup>	0.95	0.92 - 0.98	0.001	
			Multivariate <sup>2</sup>	0.90	0.84 - 1.01	0.205	
<b>CVC (n=3,125) vs No CVC (n=5,675)</b>							
Model Type	RR	95% CI	p value	Model Type	RR	95% CI	p value
Univariate	0.93	0.88 - 0.97	0.003	Univariate	1.08	1.03 - 1.12	0.0007
Multivariate <sup>1</sup>	0.90	0.85 - 0.95	0.0004	Multivariate <sup>2</sup>	1.04	0.99 - 1.01	0.139

<sup>1</sup>Multivariate model was adjusted for race, ethnicity, diagnosis of diabetes, history of myocardial infarction, albumin, phosphorus, calcium, hemoglobin, and intact PTH levels at baseline.  
<sup>2</sup>Multivariate model was adjusted for CVC use, race, ethnicity, diagnosis of diabetes, history of myocardial infarction, albumin, phosphorus, calcium, hemoglobin, and intact PTH levels at baseline.

SA-PO344

**Association Between Intradialytic Central Venous Oxygen Saturation and Relative Blood Volume in Chronic Hemodialysis Patients**

Hanjie Zhang,<sup>1</sup> Priscila Preciado,<sup>4</sup> Laura Rosales,<sup>1</sup> Jeroen Kooman,<sup>3</sup> Frank van der Sande,<sup>3</sup> Peter Kotanko,<sup>1,2</sup> *Renal Research Institute, New York, NY;* <sup>2</sup>*Icahn School of Medicine at Mount Sinai, New York, NY;* <sup>3</sup>*Maastricht University Medical Center, Maastricht, Netherlands;* <sup>4</sup>*Traverse Therapeutics Inc, San Diego, CA.*

**Background:** Central venous oxygen saturation (ScvO<sub>2</sub>) is correlated with upper body blood flow and usually declines during hemodialysis (HD). While relative blood volume (RBV) monitoring is widely used to guide ultrafiltration, little is known about the relationship between intradialytic changes of ScvO<sub>2</sub> and RBV.

**Methods:** We conducted a retrospective study in maintenance HD patients with central venous catheter as vascular access. Crit-Line (Fresenius Medical Care, Waltham, MA) was used to measure intradialytic ScvO<sub>2</sub> and hematocrit (hct). RBV was calculated from hct changes. We applied linear mixed effects models to assess the association between intradialytic changes of ScvO<sub>2</sub> and RBV at the end of dialysis.

**Results:** We studied 5,231 dialysis sessions in 216 patients (age 62.2±15.7 years; 47% males, UFR 7.1±2.7 mL/kg/h). We observed a significant, direct relationship between intradialytic changes of ScvO<sub>2</sub> and RBV with slope of 0.8 (Fig. 1). Results were materially identical in sessions with an UFR >13 or ≤13 mL/kg/h, respectively.

**Conclusions:** Our study shows that ScvO<sub>2</sub> declines in parallel with RBV in most patients. We posit that this relationship is driven by a decrease in cardiac preload due to intradialytic blood volume decline. The decrease in cardiac preload would then result in a lower cardiac output, hemodynamic stress, and decreased tissue perfusion. Further studies should evaluate the instantaneous, contemporaneous changes of ScvO<sub>2</sub> and RBV during HD.

**Funding:** Commercial Support - Renal Research Institute

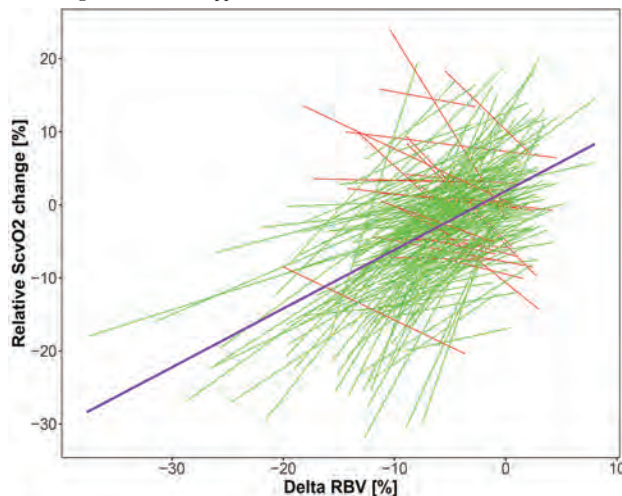

**Figure 1.** Relationship between ScvO<sub>2</sub> and RBV changes. Light lines represent individual patients. Green lines indicate a positive (N=187) and red ones (N=29) indicate a negative relationship. The heavy, purple line shows the population-level fixed-effect slope estimated from the linear mixed model.

SA-PO345

**Extracellular Volume Overload Is Associated With Increased Endothelin-1 in Hypertensive Hemodialysis Patients**

Peter N. Van Buren,<sup>1,2</sup> Bethany A. Roehm,<sup>1</sup> Kamalanathan K. Sambandam,<sup>1</sup> *The University of Texas Southwestern Medical Center Department of Internal Medicine, Dallas, TX;* <sup>2</sup>*Dallas Veterans Affairs Medical Center, Dallas, TX.*

**Background:** Extracellular volume (ECV) overload contributes to hypertension in hemodialysis (HD) patients and is associated with increased mortality. The potent vasoconstrictor endothelin-1 (ET-1) is associated with both high HD-unit blood pressure (BP) as well as morbidity and mortality. It is unclear if ECV and ET-1 are related. We sought to determine if ECV predicted ET-1 levels in hypertensive HD patients.

**Methods:** In a cohort of hypertensive HD patients, we obtained measurements of pre-HD plasma ET-1 and ECV using whole-body multifrequency bioimpedance spectroscopy. We determined the Pearson correlation coefficient between ET-1 and ratio of ECV to body weight (ECV/Wt). We then used linear regression analysis with ET-1 as the outcome and ECV/Wt as the predictor variable to determine the independent association between these variables in univariate models as well as models controlling for demographics, interdialytic weight gain, pre-HD systolic BP, and diabetes.

**Results:** There were 64 participants with a mean age of 48.9 (12) years including 38 men, 56 that were Black or Hispanic, and 37 with diabetes. All had hypertension with mean pre-HD systolic BP 157 (20) mmHg. The mean pre-HD ECV/Wt and ET-1 were 0.26 (0.05) L/kg and 2.38 (1.5) pg/mL, and there was significant correlation between these variables (r=0.3, p=.03). In a model controlling for demographics, there was a significant association between ECV/Wt and ET-1 (β=0.15, p=.002; both variables underwent reciprocal transformation). This significant association was unchanged when controlling for BP, weight gain, and diabetes.

**Conclusions:** Higher pre-HD ECV/Wt is independently associated with higher ET-1 levels in hypertensive HD patients. This association requires further investigation to establish a potentially novel mechanism related to volume induced hypertension as well as well as therapeutic strategies to consider for patients with hypertension and refractory volume overload.

**Funding:** NIDDK Support, Veterans Affairs Support

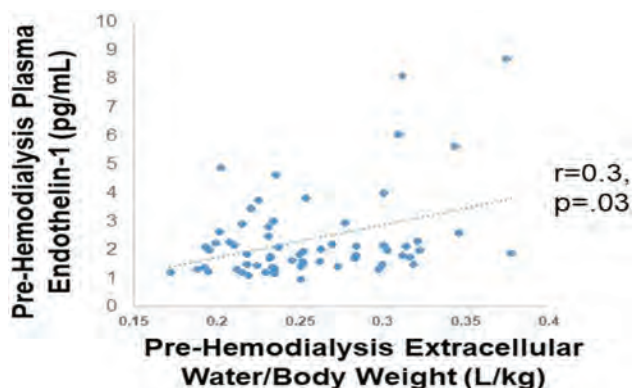

There is a significant correlation between pre-HD ECV/Wt and ET-1 (r=0.3, p=.03)

SA-PO346

**Bio-Impedance-Guided Target Weight Correction Improves Fluid Overload in Hemodialysis Patients: A Feasibility Study**

Branko Braam, Anna de Ruyter, Judy A. Ukrainetz. *University of Alberta Faculty of Medicine & Dentistry, Edmonton, AB, Canada.*

**Background:** Fluid overload in hemodialysis (HD) patients is highly prevalent and is associated with adverse cardiovascular outcomes. The hypothesis of this study was to implement a target weight correction protocol overseen by nursing staff in a hemodialysis unit to reduce fluid overload. This was successfully tested in a feasibility study. Arterial stiffness was measured in response to the intervention.

**Methods:** Of the 16 patients included in the study, 10 were subjected to the intervention (in center 1) and 6 served as time controls (in center 2). Time-average fluid overload (TAFO = pre-dialysis fluid overload - 1/2 of the one-week averaged interdialytic weight gain) was used as fluid overload parameter. Fluid status was assessed at baseline and then monthly for 2 months before the start of mid-week dialysis run using multi-frequency bioimpedance (Body Composition Monitor, BCM, Fresenius Medical Care) and arterial stiffness using (Arteriograph24™, Budapest, Hungary). In the intervention group, target weight was adjusted every two weeks based on the BCM measurements. No adjustment of target weight was performed in the control group and the treatment team was blinded from the results.

**Results:** At baseline, groups were comparable. After two months, TAFO had significantly decreased in the intervention group by 40% from 2.8±1.2 to 1.6±1.2 L (P<0.012), no change was seen in the control group (2.9±1.4 to 2.5±2.0 L, NS). With that, traditional pre-dialysis fluid overload decreased from 3.8±1.2 to 2.7±1.2 L (P<0.009) in the intervention group and no change was observed in the control group (3.6±1.3 to 3.6±2.2L, NS). Blood pressure after two months did not significantly differ in both groups (P>0.05). Arterial stiffness (PWV and AIX) remained unchanged in both groups.

**Conclusions:** This feasibility study clearly demonstrates that fluid management using a target weight correction protocol based on TAFO assessed by BCM measurements can improve fluid status in HD patients. It did not coincide in this short study with changes in arterial stiffness.

SA-PO347

**Use of Bioimpedance Techniques in Patients With CKD: A Meta-Analysis**

Laura Horowitz, Oliver A. Karadjian, Thomas Mavrakanas, Catherine L. Weber. *McGill University, Montreal, QC, Canada.*

**Background:** Bioimpedance technologies are increasingly used to determine extracellular volume status in patients with chronic kidney disease (CKD). We aimed to determine if this technology improves clinical outcomes as compared to usual care.

**Methods:** We performed a systematic review and meta-analysis of trials comparing fluid management guided by Body-Composition Monitoring or Bioimpedance analysis to standard care in patients with CKD, including patients on dialysis. Our primary outcome was all-cause mortality. Secondary outcomes included blood pressure (BP) control, all-cause hospitalization, major adverse cardiovascular events (MACE), change in left ventricular mass index (LVMI), and residual renal function. The relative risk (RR) or Hedges' g standardized mean difference (SMD) were estimated using a random-effects model.

**Results:** Our search identified 819 citations of which 12 randomized-controlled trials (RCTs) and one observational study were included (2670 patients with 1046 on peritoneal dialysis). No studies of non-dialysis dependent CKD patients met inclusion criteria. Mean age was 56 years and mean follow up was one year. There was no difference in all-cause mortality between the bioimpedance and the standard of care arms (RR 0.72, 95% confidence interval [CI] 0.47-1.11). Better diastolic BP control was observed in the bioimpedance arm of RCTs (SMD -0.18, 95% CI -0.34 to -0.02). No difference was observed between the two arms for MACE (RR 0.73, 95% CI 0.49-1.10) or LVMI (SMD -0.17, 95% CI -0.39 to 0.05). All-cause hospitalizations were not significantly different between the two groups (RR 1.08, 95% CI 0.92-1.26). Residual renal function could not be assessed.

**Conclusions:** Amongst patients on dialysis, bioimpedance-guided volume management showed improved diastolic BP control but no significant difference in all-cause mortality, MACE, and LVMI. Moreover, our study identified a knowledge gap in the use of this technology in non-dialysis dependent CKD patients and the possible effect it may have on clinical outcomes in this population.

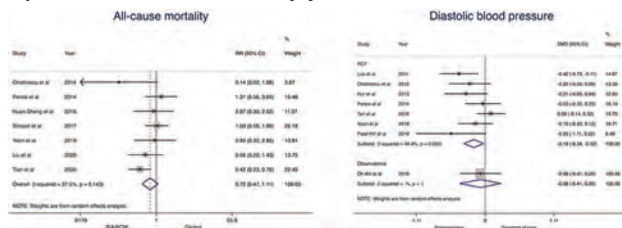

SA-PO348

**Impact of Phase Angle and Sarcopenia Estimated by Bioimpedance Analysis on Clinical Prognosis in Patients Undergoing Hemodialysis: A Retrospective Study**

Tae won Lee,<sup>1</sup> Eunjin Bae,<sup>1</sup> Dong Jun Park.<sup>1,2</sup> *<sup>1</sup>Gyeongsang National University Changwon Hospital, Changwon, Gyeongsangnam-do, Republic of Korea; <sup>2</sup>Gyeongsang National University, Jinju, Gyeongsangnam-do, Republic of Korea.*

**Background:** Bioimpedance analysis (BIA) has been widely used in the evaluation of body composition in patients undergoing maintenance hemodialysis (MHD). We conducted this study to evaluate impact of PA and sarcopenia measured by BIA on clinical prognosis in these patients.

**Methods:** This longitudinal retrospective study enrolled patients who underwent hemodialysis between January 2016 and March 2019. The patients were stratified into higher (>4°) and lower (≤4.0°) PA groups. Sarcopenia was defined when the appendicular skeletal muscle mass (ASM) was < 20 kg in men and < 15 kg in women.

**Results:** Of the 191 patients, 63.4% were men. The mean age was 64.2 ± 12.4 years. The lower PA group was older, had a higher proportion of women, a lower BMI, lower albumin, cholesterol, uric acid, and phosphorus levels, and a higher incidence of history of coronary artery disease (CAD) than the higher PA group. Linear regression analysis revealed that PA was significantly associated with BMI (B=0.18, p=0.005), serum albumin (B=-0.23, p=0.001), and creatinine levels (B=0.32, p<0.001). During a median follow-up of 16.7 months, 14.1% (n = 27) of patients experienced MACE and 11.0% (n = 21) died. Kaplan-Meier survival analysis showed that the higher PA group had significantly better survival, regardless of sarcopenia. Multivariate Cox analyses revealed that lower PA (0.51 [0.31-0.85], p=0.010), higher IDWG (1.06 [1.01-1.12], p=0.028) and C-reactive protein level (1.01 [1.01-1.02], p<0.001), and a history of CAD (3.02 [1.04-8.77], p=0.042) were significantly related to all-cause mortality after adjusting for other covariates.

**Conclusions:** PA measured by BIA was an independent factor in the prediction of mortality in MHD patients, regardless of sarcopenia. Intervention studies are needed to confirm if the improvement in PA is associated with better clinical outcome.

SA-PO349

**Non-Invasive Hemodynamic Monitoring in Hemodialysis Using Electrical Impedance Tomography**

Tongin Oh,<sup>1</sup> Jinwon Mok,<sup>1</sup> Ju young Moon,<sup>2</sup> Yang gyun Kim,<sup>2</sup> Sangho Lee,<sup>2</sup> Su Woong Jung.<sup>2</sup> *<sup>1</sup>Kyung Hee University, Seoul, Republic of Korea; <sup>2</sup>Kyung Hee University Hospital at Gangdong, Gangdong-gu, Seoul, Republic of Korea.*

**Background:** Intradialytic hypotension (IDH) is the most common complication in 20-30% of patients during hemodialysis (HD). Although blood pressure is monitored intermittently, it is insufficient to detect an IDH in real-time due to the rapidly changing hemodynamic status. Electrical impedance tomography (EIT) obtained from the thorax could simultaneously measure air-volume and blood-volume changes. We monitored the hemodynamic parameters from high-speed EIT images during HD.

**Methods:** In this clinical trial (IRB No.: KHNMC2020-08-006), 75 measurements were performed on 19 patients who had IDH in the past 3 months. An E-pad including 16 electrodes was attached to the surface of the thorax. Impedance images were acquired at 100 frames/s using a high-speed EIT system (AirTom-R, BiLab, Korea). Additionally, blood pressure was periodically obtained every 15 minutes using the NIBP unit in a hemodialysis machine. Extracted cardiac volume signal (CVS) from EIT images was used to calculate hemodynamic parameters like stroke volume (SV) and so on. Additionally, we obtained the thoracic fluid content (TFC) from the electrical admittivity changes at the end-expiration points. The equivalence of processed hemodynamic variables before and after the IDH occurrence or interventions was examined using the paired t-test.

**Results:** When various hemodynamic parameters were observed from 10 minutes before the onset of IDH to IDH time, we found that the SV significantly decreased by about 40-50%. As analyzing the type of clinical interventions during HD, SV was about 20-30% increase after 150 seconds of reducing the ultrafiltration rate (UF-) and about 50-60% increase after 180 seconds of injection of normal saline (S+) in Figure 1(a) and (b).

**Conclusions:** In this paper, real-time EIT images were non-invasively collected from patients during HD, and they could monitor hemodynamic changes caused by IDH and

clinical interventions. In the future study, we will apply this hemodynamic information to predict IDH, which allows personalized treatment based on real-time monitoring of hemodynamic indicators.

**Funding:** Government Support - Non-U.S.

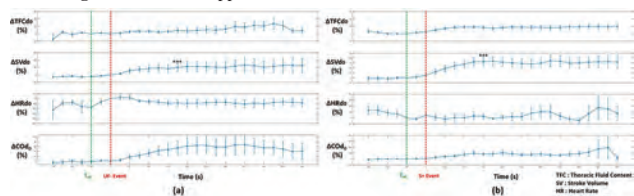

Figure 1. Relative percentile changes of TFC, SV, HR, and CO when applying (a) UF and (b) S+.

SA-PO350

**The Application of a Wearable Diffuse Reflectance Spectroscopy Monitor in the Assessment of Volume in Haemodialysis Patients**

Vicki K. Sandys,<sup>1</sup> Lavleen Bhat,<sup>1</sup> Anna Ninan,<sup>1</sup> Colin Edwards,<sup>1</sup> Donal J. Sexton,<sup>2</sup> Conall M. O’Seaghdha.<sup>1</sup> Haemodialysis Outcomes & Patient Empowerment group <sup>1</sup>Royal College of Surgeons in Ireland, Dublin, Ireland; <sup>2</sup>The University of Dublin Trinity College, Dublin, Ireland.

**Background:** The 2019 Kidney Health Initiative identified a need for solutions addressing fluid management in-between dialysis sessions. We aimed to assess the validity and reproducibility of a wearable hydration monitor in maintenance dialysis patients.

**Methods:** Prospective, single-arm observational study on 20 haemodialysis patients between January-June 2021 in a single haemodialysis centre. Participants wore a prototype wearable infrared spectroscopy device on their forearm during dialysis and nocturnally, termed the Sixty device. Bioimpedance measurements were performed 4 times using the body composition monitor (BCM) over 3 weeks. Sixty outputs a scale concordant with hydration level whereby 1 is euvoolemia. Values in kg are calculated from this scale. Sixty measurements were compared with the BCM overhydration (OH) index pre and post dialysis and with standard haemodialysis parameters.

**Results:** 12 out of 20 patients had usable data. 55% female, 80% white. Mean age was 52 ± 12.4 years. The overall accuracy for predicting pre-dialysis categories of fluid status using Sixty was 0.56 [κ = 0.01; 95% CI -0.39 – 0.42]. The accuracy for the prediction of post-dialysis categories of volume status was low [accuracy= 0.33, κ= 0.07; 95% CI= -0.14 to 0.27]. Agreement using Bland-Altman plots is shown in Figure 1. Sixty outputs at the start and end of dialysis were weakly correlated with pre and post dialysis weights (r= 0.27 and r= 0.27, respectively), as well as weight loss during dialysis (r= 0.31), but not ultrafiltration volume (r= 0.12). There was no difference between the change in Sixty readings during an overnight session, and the change in Sixty readings during a dialysis session [mean difference 0.09kg, t(39)= 0.38, p= 0.71].

**Conclusions:** A prototype wearable infrared spectroscopy device was unable to accurately assess changes in fluid status during or between dialysis sessions. In the future, hardware development and advances in photonics may enable the tracking of interdialytic fluid status.

**Funding:** Commercial Support - Enterprise Ireland Disruptive Technologies Innovation Fund grant DTIF 2019\_86

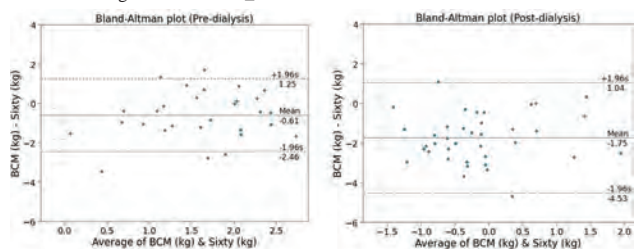

Figure 1. Bland Altman plots showing the mean bias, limits of agreement and CI for limits of agreement between Sixty OH and BCM OH pre-dialysis and Sixty OH and BCM OH post-dialysis.

SA-PO351

**Proof-of-Concept Model for the Prediction of Dry Weight in Hemodialysis Patients**

Vicki K. Sandys,<sup>1</sup> Lavleen Bhat,<sup>1</sup> Donal J. Sexton,<sup>2</sup> Conall M. O’Seaghdha.<sup>1</sup> Haemodialysis Outcomes & Patient Empowerment group <sup>1</sup>Royal College of Surgeons in Ireland, Dublin, Ireland; <sup>2</sup>The University of Dublin Trinity College, Dublin, Ireland.

**Background:** An automated, accurate and periodic assessment of dry weight using hemodialysis data would be a clinically useful, low cost, and rapidly scalable method of assessing fluid status.

**Methods:** A post-hoc analysis of a 3 week observational study in 20 patients (HOPE-02, ClinicalTrials.gov: NCT04623281). 143 features were created using clinical and calculated parameters over 1 or 2 weeks prior to the targeted session including variability

measures, differences, confidence intervals and interdialytic calculations. Averaged data was combined with single-session data. Dry weight was defined as the mean of BCM normohydration weights. Data was split 70:30 into training and testing sets. The algorithm was trained to predict overhydration (OH) index pre and post-dialysis as determined by the Fresenius Body Composition Monitor (BCM). Dry weight was derived by subtracting OH status from pre or post-dialysis weight. Model performance was evaluated using adjusted R<sup>2</sup>. The error metrics used were mean absolute error (MAE) and root mean squared error (RMSE). Accuracy was calculated using categories of fluid status defined as overhydration > 1.1 L, normohydration 1.1 - 1.1 L and underhydration < 1.1 L.

**Results:** 20 subjects involving 44 haemodialysis sessions were used. A linear regression (LR) model combining single-session data with moving averages of data from the preceding 1 or 2 weeks was created. The final model had 9 features (Figure 1). The LR model predicting post-dialysis OH status outperformed a pre-dialysis OH model. Adjusted R<sup>2</sup> for the model was 0.719. Training RMSE for post-dialysis OH= 1.12 kg, testing RMSE= 1.21 kg. The training RMSE for dry weight= 1.21 kg, the testing RMSE= 1.13 kg. The model had a classification accuracy of 81.8%.

**Conclusions:** This model represents an initial step in the creation of an automated assessment of dry weight. Work has begun on external validation and further development of this algorithm in a large dialysis dataset. A final model could potentially be embedded in a clinical decision support system for dry weight management.

**Funding:** Commercial Support - Enterprise Ireland Disruptive Technologies Innovation Fund grant DTIF 2019\_86

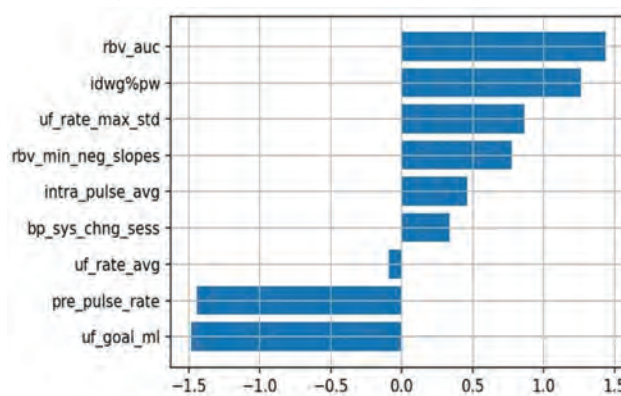

Figure 1. Feature list

SA-PO352

**When Is It Most Appropriate to Estimate Pulmonary Congestion Using Lung Ultrasound in Hemodialysis Patients?**

Saleh Kaysi, Frederic Collart, Bakhtar Pacha, Joelle L. Nortier. UVC Brugmann, Brussels, Belgium.

**Background:** Lung ultrasound (LUS) helps detecting pulmonary congestion (PC) among hemodialysis (HD) patients, even when it is clinically asymptomatic. However, the best moment to measure PC in order to obtain the most useful and significant value is not clear. We conducted a longitudinal study comparing PC measured by LUS before and after the 1<sup>st</sup> and the 2<sup>nd</sup> HD session of the week.

**Methods:** Eighteen adult patients on maintenance HD for at least 6 months in our high care unit were included in this observational prospective study. Those diagnosed with interstitial lung disease or recent pneumonia, with previous lung surgery, and those with active cancer were excluded. B-lines scores were obtained by the same investigator using the 8-sites method by LUS, performed in near supine position before and after the regularly scheduled 1<sup>st</sup> and 2<sup>nd</sup> HD sessions of the week. The cut-off for B-lines scores was fixed to 0.54 line per zone. Total body volume using Bio-electrical Impedance Analysis (BIA) was measured before both HD sessions in each patient.

**Results:** Mean ultrafiltration (UF) volumes were not statistically different between both HD sessions (2,044 ± 927 vs 1,820 ± 865 mL). Mean B-lines scores pre-HD N<sup>o</sup>1 (16 ± 5.53) were quite similar to those post-HD N<sup>o</sup>1 (15.3 ± 6.63) but were statistically different before and after HD session N<sup>o</sup>2 (16.2 ± 5.26 vs 13.6 ± 5.83, P=0.03). Mean B-lines scores measured before both HD sessions were unrelated to the inter-dialytic interval (72h vs 48h) but were strongly correlated together (R<sup>2</sup>= 0.688, P<0.0001). A significant correlation was found between B-lines scores and BIA only before HD session N<sup>o</sup>2 (R<sup>2</sup>=0.372, P=0.007).

**Conclusions:** Our data suggest that PC, even if it decreased after HD session where UF was applied, remains quite frequent. The liquid shift from extra- to intra-vascular compartments performed at mid-week is probably more effective in reducing alveolar water to the point that might be detected as a significant lower level by LUS. Due to a shorter inter-dialysis interval, a reduced level of uremic toxins on mid-week HD session could also impact the pulmonary endothelium and capillary permeability. Consequently, we think that PC is most well correlated with dry weight when measured after the 2<sup>nd</sup> HD session of the week.

SA-PO353

**Estimated Dry Weight: The Elusive Target**

Juliet Gatiba, Momen Alsayed. *Hennepin Healthcare, Minneapolis, MN.*

**Introduction:** Volume assessment and management in end stage kidney disease (ESKD) has been shown to have a significant effect on intradialytic morbidity and long-term cardiovascular complication. In this report, we hope to elucidate the effects of volume management on cardiac function in dialysis patients and the importance of non-invasive imaging in volume assessment.

**Case Description:** A 40-year-old female with a history of ESKD on dialysis and heart failure with reduced ejection fraction of 45-50%, as well as other comorbidity was admitted for optimization of volume status prior to arteriovenous graft placement. She had been consistently above her estimated dry weight (EDW) of 52 kg and had failed outpatient volume optimization. On admission, she weighed 56 kg. She underwent hemodialysis on hospital days 1 and 2, with a total of 8 kg of ultrafiltration. Her weight decreased to 51.4kg. After achieving her EDW, a dobutamine stress echocardiogram done on day 3, showed severe biventricular systolic dysfunction with an ejection fraction of 27%. Cardiology evaluated the patient and recommended continued volume optimization followed by coronary angiography to evaluate for underlying coronary artery disease. She had 3 additional days of ultrafiltration of 10kg. Her weight decreased to 46.5kg. A repeat transthoracic echocardiogram on day 5, showed significant improvement in cardiac function as shown in Table 1. Coronary angiogram was deferred, and an arteriovenous graft was placed.

**Discussion:** This case reinforces the importance of assessing volume status in patients with ESKD on dialysis with underlying heart failure with reduced ejection fraction. It specifically points out the importance of using non-invasive imaging like transthoracic echocardiograms rather than solely depending on clinical picture and EDW for volume assessment. It also highlights how volume management can mitigate an elemental constituent of mortality in renal patients, cardiac function, and recovering ejection fraction with ultrafiltration.

Table 1

	Dobutamine Echo (Hospital day 3)	TTE (Hospital Day 5)
Left ventricular EF	27%	50%
Right ventricular EF	Severely decreased	Normal
Estimated RA pressure	17mmHg	13mmHg
Tricuspid valve insufficiency	++ to ++	I+

SA-PO354

**Is Interdialytic Weight Gain Really All Fluid? A Longitudinal Study on Short Term Variability of Bioimpedance-Derived Normohydration Weight in Hemodialysis Patients**

Maximilian Waller,<sup>1,2</sup> Simon Krenn,<sup>3</sup> Sebastian Mussnig,<sup>2</sup> Manfred Hecking,<sup>2</sup> HD Research & Co. <sup>1</sup>Klinik Favoriten, Wien, Austria; <sup>2</sup>Medizinische Universität Wien, Wien, Austria; <sup>3</sup>Austrian Institute of Technology GmbH, Wien, Austria.

**Background:** Hemodialysis (HD) aims at reaching normohydration. The patient's weight measured predialysis and the desired target weight postdialysis usually determine the ultrafiltration volume, following the assumption that weight gain from the previous HD session (IDWG) consists of excess fluid.

**Methods:** Longitudinal bioimpedance spectroscopy (BIS) measurements with the Body Composition Monitor (BCM, Fresenius Medical Care Germany, v3.2) were obtained predialysis in 14 consecutive HD-sessions from 25 patients treated at the Chronic Hemodialysis Unit of Vienna General Hospital between October and December 2021. Short term variability of BIS derived parameters of fluid status was analyzed in an explorative fashion.

**Results:** The normohydration weight was 78.4±13.9 kg on average ± standard deviation (SD) and varied longitudinally for each patient, with the intra-patient SD ranging from 0.36 to 2.24kg (average: 0.8 kg). When the predialysis weight increased from one HD session to the next, the normohydration weight increased also, indicating that the patient had not only gained fluid (Figure 1).

**Conclusions:** Under the assumption that the BCM yields adequate results, and even if the target weight was set to perfect normohydration with 0L fluid overload remaining postdialysis, any weight gain above the previous predialysis weight will likely not consist of fluid alone. These results suggest that the target weight should not be fixed.

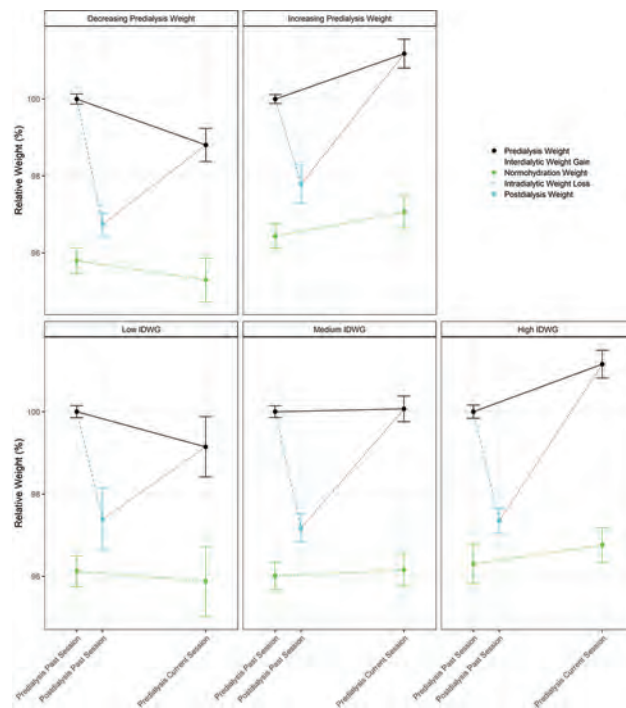

Figure 1

SA-PO355

**Percent of Patients That Exceed Candidate Ultrafiltration Rate (UFR) Warning Levels Based on 3 Different Scaling Approaches (Unscaled UFR, UFR per kg, or UFR per kg<sup>0.4</sup>)**

Ariella E. Mermelstein,<sup>1</sup> John T. Daugirdas,<sup>2</sup> Jochen G. Raimann,<sup>1</sup> Yuedong Wang,<sup>3</sup> Peter Kotanko.<sup>1</sup> <sup>1</sup>Renal Research Institute, New York, NY; <sup>2</sup>University of Illinois Chicago College of Medicine, Chicago, IL; <sup>3</sup>University of California Santa Barbara, Santa Barbara, CA.

**Background:** Exceeding a UFR warning level of 13 ml/h per kg is associated with higher mortality hazard ratios (MHR) in large patients (*KI Reports*, 2022) while exceeding UFR warning levels not scaled to body size is less affected by body weight. UFRs associated with an MHR of 1.0 (average risk) can be estimated as 105 x kg<sup>0.40</sup> ml/hr. Thus, a new candidate UFR warning level might be set 33% (140/105) higher: 140 x kg<sup>0.40</sup> (ml/hr).

**Methods:** This retrospective cohort study was performed on 2542 incident U.S. hemodialysis (HD) patients. We examined the prevalence (12-mo average) of exceeded UFR warning levels: 800 ml/h, 10 ml/h per kg, or 140 x kg<sup>0.40</sup>. Each warning level was associated with an MHR of 1.2 for an 80 kg patient.

**Results:** The estimated MHRs when exceeding each warning level are shown in the Table. The percent patients exceeding each warning level by weight decile is shown in the figure. Most patients exceeding the UFR/kg warning were smaller, while patients exceeding 800 ml/h were larger. A UFR warning based on 40 x kg<sup>0.4</sup> ml/hr was exceeded in about 15% of patients across a broad spectrum of body weight.

**Conclusions:** The percentage of patients exceeding unscaled UFR or UFR/kg warning levels is highly dependent on body weight. Warnings scaled by UFR/kg<sup>0.4</sup> may be more practical to implement, as they are exceeded by similar percentages of patients of different sizes; however, MHRs associated with exceeding UFR/kg<sup>0.4</sup> scaled warning levels still vary somewhat with body weight.

Weight (kg)	4-h max. weight removal (kg)			Mortality Hazard Ratio (MHR)		
	800 ml/h	140 x kg <sup>0.4</sup>	10 ml/h per kg	800 ml/h	140 x kg <sup>0.4</sup>	10 ml/h per kg
60	3.2	2.9	2.8	1.16	1.12	1.05
80	3.2	3.2	3.2	1.20	1.23	1.20
100	3.2	3.5	4.0	1.20	1.30	1.45
120	3.2	3.6	4.8	1.16	1.45	1.90



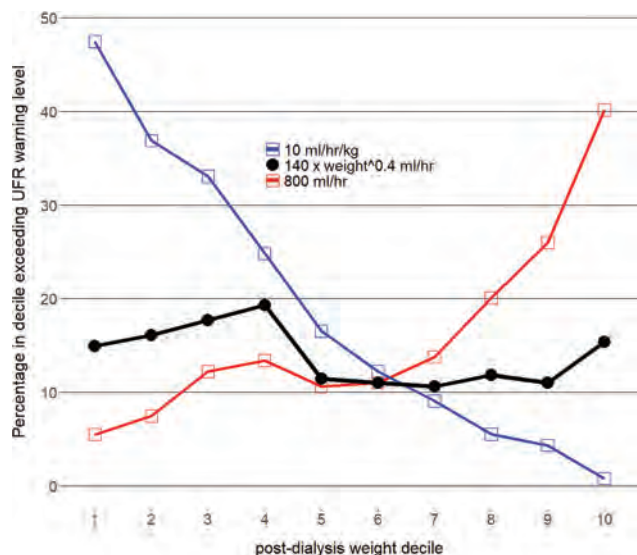

SA-PO356

**Awareness, Understanding, and Self-Reported Adherence to Fluid and Salt Restriction Amongst a Maintenance Haemodialysis Population: A Survey Study**

Yimeng Zhang, Mohammed A. Hameed, Khai Ping Ng, *University Hospitals Birmingham NHS Foundation Trust, Birmingham, United Kingdom.*

**Background:** Fluid overload is a common complication amongst haemodialysis (HD) population and a major risk factor for cardiovascular and all-cause mortality. The majority of maintenance HD population are oligo-anuric, thus patients' consistent adherence to salt and fluid restrictions are critical. However, low or non-adherence is not uncommon. This study aimed to (1) examine awareness of salt restriction (SR) and fluid restriction (FR); (2) evaluate self-reported adherence to SR/FR and (3) their effect on clinical recorded interdialytic weight gain (IDWG) in HD population.

**Methods:** It was a survey study of maintenance HD patients in two HD centres in Birmingham, UK, conducted in October 2021. The self-administered survey consists of 21 questions, focusing on participants' awareness and adherence to SR/FR. Retrospective patient data were obtained from an electronic patient database (PROTON) on demographics, dialysis vintage and clinical recorded IDWG (mean of most recent six dialysis sessions). The data is analysed using SPSS version 27 and Microsoft Excel.

**Results:** In total, 81 patients completed the questionnaires. The median age was 65 (SD=14) years, 33 (41%) were females, mean dialysis vintage of 4 (SD=4) years and mean IDWG of 1.8 (SD=0.9) kg. Majority (70%) recalled being informed about FR but less so about SR (59%). Dialysis nurse was reported to be their key source of advice (57%), followed by dialysis doctor (43%), and renal dietician (27%). One in 5 did not recall advice on either restriction. Although the majority reported adherence to SR/FR as 'very often' (82%) or 'always' (67%), most have limited understanding on reasons of restriction with 21% not knowing the rationale. There was no significant difference in IDWG between participants who were aware of fluid restriction compared to those who were not (1.9kg vs 1.7kg, p=0.31). There was also no significant correlation between self-reported fluid intake, compliance to restriction IDWG and their clinical recorded IDWG.

**Conclusions:** A significant proportion of HD patients reported to have limited awareness and understanding of SR/FR despite dedicated renal dietitian input in each HD centres. Dialysis nurses played a key role in educating HD patients. Self-reported awareness or adherence to SR/FR did not appear to be correlated with clinical IDWG in this HD cohort.

SA-PO357

**Does Dialysis Drive Patients to Drink?**

Anamika Adwaney, *Imperial College Healthcare NHS Trust, London, United Kingdom.*

**Background:** Greater fluid intake clearly leads to greater fluid removal. But reverse causality is also possible: greater fluid removal could lead to increased thirst, causing greater fluid intake. This study uses a within-patient analysis, to examine the relationship between ultrafiltration during dialysis sessions, and weight gained during the subsequent inter-dialytic interval.

**Methods:** In a urban dialysis centre, a random sample of patients was selected and stratified by unit, gender and access type. Patients were eligible if they had been receiving thrice-weekly dialysis for >1yr, and were clinically stable during this period, with no hospitalisations >14days. Data were analysed within patients, as well as between patient averages. Correlations were sought between variables within patients: the number of patients with a significant within-patient linear association (p<0.05) is reported, as well as the significance of this number, as an observation from a binomial distribution with N=100,p=0.05.

**Results:** From 100 patients, median(IQR) age 67(53-75) years, observed over a year, complete records were available for 15263 (98%) dialysis sessions with the subsequent inter-dialytic interval. Mean(±within-patient sd) pre-dialysis weight was 2.71(±1.15)% above target weight. Larger ultrafiltration volume was associated with greater subsequent inter-dialytic weight gain in 87/100 patients (p<0.001), and 15% of the within-patient variation in inter-dialytic weight gain was explained by variation in ultrafiltration volume at the previous dialysis session. Lower post-dialysis weight (relative to target weight) was also associated with greater subsequent inter-dialytic weight gain in 77/100 patients (p<0.001). In addition, the rate of weight gain was dependent on the duration of the inter-dialytic interval, being 1.21(±0.53)%/day during 2-day gaps, and 1.11(±0.38)%/day during 3-day gaps (p<0.001), suggesting a non-linear pattern of fluid intake, greatest immediately after dialysis and diminishing over the course of the inter-dialytic interval.

**Conclusions:** Fluid intake in haemodialysis patients is determined by the ultrafiltration volume and end-weight of the most recent dialysis session, and diminishes during the inter-dialytic interval. Greater fluid intake is therefore a consequence, as well as a cause, of larger ultrafiltration volumes. This bidirectional relationship suggests the need to re-examine protocols for fluid removal in haemodialysis patients.

SA-PO358

**Dialysate Sodium and the Risk of Intradialytic Hypertension: A Post Hoc Analysis of a Randomized Controlled Trial**

Daniel S. Del Castillo Rix,<sup>1,2</sup> Despina Georgiadis,<sup>1,2</sup> Anika T. Singh,<sup>1,2</sup> Finnian R. McCausland,<sup>1,2</sup> *Brigham and Women's Hospital, Boston, MA; <sup>2</sup>Harvard Medical School, Boston, MA.*

**Background:** Higher dialysate sodium (DNa) concentrations are sometimes utilized to manage intradialytic hypotension. However, higher DNa has also been associated with thirst, inter-dialytic weight gain, and higher blood pressure (BP). Few studies have evaluated the risk of intra-dialytic hypertension (IDHyper) with higher DNa, especially among hospitalized hemodialysis (HD) patients.

**Methods:** We performed a post-hoc analysis of a double-blinded single center, randomized controlled trial (NCT02145260) in hospitalized patients on maintenance hemodialysis (N=139) that randomized patients to higher (142 mmol/L) vs. lower (138 mmol/L) DNa for up to six sessions. BP was measured pre-HD, every 15 minutes intra-HD, and post-HD. Mixed effects Poisson regression models were fit to assess the effect of higher vs. lower DNa on the rate of IDHyper, defined as any increase in systolic BP (SBP) from pre-HD to post-HD. Additional models were considered that adjusted for imbalances in baseline characteristics (SBP, sex, heart failure and pre-HD weight).

**Results:** 139 patients (305 study visits) were included in the present analyses. A total of 125 (41%) sessions were complicated by IDHyper. Using an intention-to-treat approach, there was no significant difference in rates of IDH for higher vs. lower DNa arms (IRR 1.17; 95% confidence interval (CI) 0.82,1.66). Effect estimates were accentuated in the adjusted models but did not reach statistical significance (IRR 1.60; 95% CI 0.95,2.70). A sensitivity analysis, where IDHyper was defined as SBP increase ≥10 mmHg from pre- to post-HD had similar patterns of association in the intent-to-treat (IRR 1.16; 95% CI 0.71,1.92) and adjusted analyses (1.50; 95% CI 0.74,3.04).

**Conclusions:** In this post-hoc analysis of a DNa trial in hospitalized HD patients, we found no significant difference in rates of IDHyper for higher vs. lower DNa. As effect estimates were accentuated in fully adjusted analyses, larger studies are needed to investigate the possible association of higher DNa with IDHyper in this population.

**Funding:** NIDDK Support

SA-PO359

**The Unresolved Quest: The Higher the Dialysate Sodium, the Better?**

Julie Pinter,<sup>1,2</sup> Hemodialysis registry working group from European Clinical Database 5 <sup>1</sup>*Universitätsklinikum Würzburg, Würzburg, Germany;* <sup>2</sup>*University of Oxford, Oxford, United Kingdom.*

**Background:** Half of all people receiving maintenance dialysis die within 5-years of treatment. Mortality is largely driven by cardiovascular disease. A key contributor to cardiovascular disease in dialysis recipients is persistent fluid and sodium overload. During dialysis, sodium removal occurs largely via convective (ultrafiltration, weight loss) but also through diffusive losses (dialysate-plasma sodium gradient), the latter being largely dependent on the difference between serum and dialysate sodium concentration. Whether a higher or lower dialysate sodium influences survival is unknown, recognizing that other factors (i.e.; volume status, hemodynamic conditions) may influence the outcome.

**Methods:** We conducted an observational time-to-event analysis in a large international database of incident hemodialysis patients to assess the relation between dialysate sodium and all-cause mortality. We utilized the European Clinical Database 5 from Fresenius Medical Care, which is a real-time electronic health record repository for hemodialysis patient care management. From 72,163 incident hemodialysis patients in 25 countries dialysate sodium measurements were retrieved over a period of ten years. The cox regression model for time to death assessed dialysate sodium concentrations and serum sodium concentrations (< 137 mmol/l, 137-139.9 mmol/l, ≥140 mmol/l). Age, sex, ethnicity, body mass index, comorbid conditions, laboratory values, treatment variables and mediators were adjusted for before the final model accounted for fluid overload, ultrafiltration, antihypertensive medication, diuretics and overweight.

**Results:** A dialysate sodium concentration of > 140 mmol/l (21,705 observations) was consistently associated with lower all-cause mortality risk (adjusted HR 0,58 (0.46-0.73), <0.001), as compared to 137-139.9 mmol/l, (adjusted HR 0,74 (0.61-0.90), 0.003; 49,470 observations). We observed a lower mortality risk in iso-, and hyponatremic patients dialyzed against higher dialysate sodium prescriptions (> 140 mmol/l).

**Conclusions:** Higher dialysate sodium concentrations are independently associated with better survival. This observational finding clearly delineates the need for high quality randomized evidence. The Randomised Evaluation of Dialysate Sodium on Vascular Events Study is currently underway to evaluate the practice of default dialysate sodium concentrations to guide policy development and improve hemodialysis outcomes.

**Funding:** Commercial Support - Fresenius Medical Care

**SA-PO360**

**Muscle Sodium (Na<sup>+</sup>) Reduction by 2-Month Low-Na<sup>+</sup> Diet in Hemodialysis (HD) Patients**

**Hsin-Yu Fang, Kwan-Jin Jung, Shu H. Kwan, Ashley Morgan, Bailey J. Damore, Kenneth R. Wilund. University of Illinois System, Urbana, IL.**

**Background:** Skeletal muscle is a tissue Na<sup>+</sup> reservoir. Higher muscle Na<sup>+</sup> concentration ([Na<sup>+</sup>]) is associated with pathological conditions in HD patients. This study aimed to test if 2 months of low-Na<sup>+</sup> intervention reduces muscle [Na<sup>+</sup>] in HD patients.

**Methods:** Eight HD patients (75% male; 61±11 yr) received commercial low-Na<sup>+</sup> meals and dietary counseling for 2 months. Meal provision frequencies for month 1 and 2 were 2 and 1 meal/day, respectively. Pre- and post-meal muscle [Na<sup>+</sup>] were assessed by 3T <sup>23</sup>Na-MRI on non-HD days in 6 muscles: tibialis anterior (TA), extensor digitorum longus (EDL), peronei (PER), soleus (SOL), and lateral (LG) and medial (MG) gastrocnemius. Total <sup>23</sup>Na-MRI signals were split into intracellular (IC) and extracellular (EC)-weighted signals by biexponential fitting for further analysis. Changes in variables were tested by paired t-test or nonparametric equivalents.

**Results:** Muscle [Na<sup>+</sup>] was reduced in LG (P=.008) and MG (P=.02) but unchanged (P>.05) in other muscles from pre- to post-intervention (Fig. 1). IC-weighted <sup>23</sup>Na-MRI signal was reduced after intervention in 50% of muscles, while EC-weighted signal remained stable in all muscles tested (P-values shown in Fig. 2).

**Conclusions:** We found that the [Na<sup>+</sup>] in some muscles were decreased after the 2-month low-Na<sup>+</sup> diet, which may reflect more of the change in IC-weighted <sup>23</sup>Na signal. More studies are needed to confirm this and to determine its clinical implication.

**Funding:** Private Foundation Support

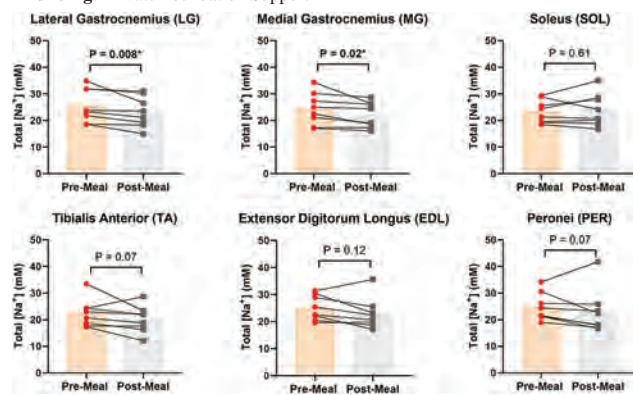

Fig 1. Pre- to Post-Meal Changes in Muscle [Na<sup>+</sup>].

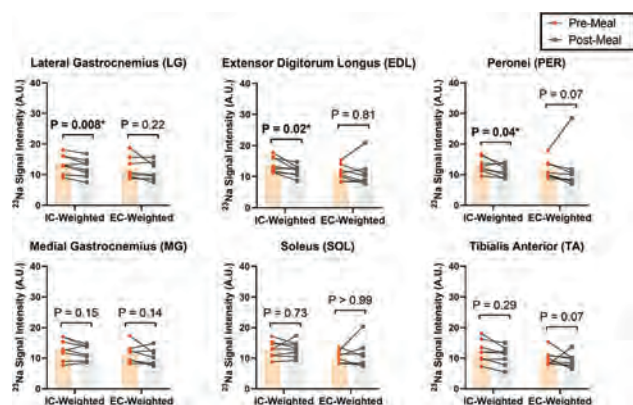

Fig 2. Changes in Intracellular (IC) and Extracellular (EC)-Weighted <sup>23</sup>Na-MRI Signals in Muscles.

**SA-PO361**

**Measured Serum Osmolality, Patient Symptoms, and Blood Pressure During Hemodialysis**

**Timothy E. Yen,<sup>1,2</sup> Despina Georgiadis,<sup>1</sup> Daniel S. Del Castillo Rix,<sup>1</sup> Finnian R. McCausland,<sup>1,2</sup> Brigham and Women's Hospital, Boston, MA; <sup>2</sup>Harvard Medical School, Boston, MA.**

**Background:** End stage kidney disease (ESKD) is accompanied by accumulation of uremic solutes in the blood. Many of these are rapidly cleared during hemodialysis (HD), leading some to postulate that rapid decline in serum osmolality may be associated with development of adverse symptoms and intra-dialytic hypotension (IDH).

**Methods:** We performed a prospective cohort study of 50 hospitalized adult patients with ESKD receiving thrice-weekly HD. Measured Osmolality (mOsm) and intradialytic symptoms (ascertained by SMARTRD questionnaire) were measured at three time points during a single inpatient HD session (pre-HD, 60 minutes, and post-HD). Blood pressure was measured every 15 minutes during HD. Spearman correlations were used to compare the pre-HD mOsm with patient reported outcome symptom scores; logistic regression was used to assess the association of mOsm with IDH (any decline in SBP <90 mmHg).

**Results:** Mean age was 65±15 years; 42% were female. The calculated Osm was an average of 1 unit higher than the mOsm, but varied widely (median difference 1 [-1, 4] milliOsm/kg). Mean mOsm decreased from 292±9mOsm/kg pre-HD, to 286±6 at 60 mins, 284±5 post-HD. The mean total symptom score was 14.8±3 pre-HD, 14.5±2.8 at 60mins, 15.1±3.4 post-HD. Correlations between pre-HD mOsm and symptom scores are shown in Table 1. IDH occurred in 9 of 50 (18%) sessions; each 5 unit increase in mOsm was associated with 43% higher risk of IDH (OR 1.43; 95%CI 0.95 to 2.14). Similar estimates were noted upon adjustment for age, sex, and pre-HD SBP (OR 1.44; 95%CI 0.90 to 2.32).

**Conclusions:** This prospective cohort study in hospitalized HD patients found substantial variability between measured and calculated Osm. Minimal correlation between mOsm and symptoms were noted, but may have been limited by minimal symptom scores overall. Signals for association of higher pre-HD mOsm with higher risk of IDH require investigation in larger studies.

**Funding:** NIDDK Support, Commercial Support - Advanced Instruments

Table 1. Correlations between pre-HD mOsm and patient symptoms

	Pre-HD	60-min	Post-HD
	Spearman's Rho (p-value)		
Muscle Cramps	0.24 (0.09)	-0.20 (0.16)	-0.07 (0.65)
Nausea	0.07 (0.65)	-0.04 (0.77)	-0.12 (0.41)
Vomiting	-0.12 (0.39)	-0.12 (0.39)	-0.25 (0.08)
Dizziness	0.02 (0.87)	0.07 (0.65)	-0.04 (0.77)
Palpitations	-0.10 (0.49)	0.11 (0.45)	-0.02 (0.87)
Chest Pain	0.02 (0.89)	0.01 (0.93)	-0.04 (0.78)
Shortness of Breath	0.18 (0.22)	0.17 (0.23)	-0.03 (0.81)
Thirst	0.13 (0.36)	0.13 (0.36)	0.10 (0.51)
Headache	-0.09 (0.53)	-0.02 (0.87)	0.02 (0.87)
Itching	0.01 (0.95)	-0.14 (0.32)	-0.13 (0.38)
Restlessness	-0.23 (0.12)	-0.28 (0.05)	-0.13 (0.38)
Tingling	0.11 (0.44)	-0.01 (0.93)	0.11 (0.43)
Total Symptoms	0.05 (0.75)	-0.01 (0.96)	-0.10 (0.48)

**SA-PO362**

**Telehealth-Assisted Home Blood Pressure (BP) Monitoring for In-Center Hemodialysis Patients**

**Yoshitsugu Obi, Yunxi Zhang, Saurabh Chandra, Maria Clarissa Tio, Catherine C. Wells, Neville R. Dossabhoy, Tariq Shafi. The University of Mississippi Medical Center, Jackson, MS.**

**Background:** Home BP monitoring is essential to guide BP management for in-center hemodialysis (HD) patients but is exceedingly difficult to obtain in clinical practice. We designed a pragmatic feasibility study of a telehealth-assisted protocolized home BP monitoring program (TH-BP) at an academic dialysis clinic.

**Methods:** From 02/03/22 to 05/13/22, we referred 37 in-center HD patients to the TH-BP, of which 25 started monitoring. All patients were provided a BP monitor with an appropriately sized cuff and a connected iPad. We averaged pre-HD sitting systolic BP (preSBP) over 30 days before and after TH-BP initiation and compared them with home SBP from the TH-BP.

**Results:** Patients had a mean age of 50 years and had been on dialysis for 6.5 years; 52% were females. The median (IQR) number of antihypertensives was 2 (1, 3). During a median follow-up of 63 days, the mean±SD frequencies of TH-BP measurements (per day) were 1.1±0.4 and 1.4±0.9 on HD days and non-HD days, respectively. After TH-BP initiation, the 30-day preSBP was 146±15 mmHg (p=NS vs. the pre-TH-BP period; **Table**). Home SBP was significantly lower than preSBP by 12±18 mmHg (p=0.005; **Figure**). Similar results were observed with diastolic BP (**Table**). Baseline patient characteristics did not predict patient willingness to participate in the TH-BP or the differences between preSBP and home SBP.

**Conclusions:** This is the first report to demonstrate successful pragmatic implementation of home BP monitoring for in-center HD patients in a routine clinical setting. Our findings of lower home SBPs suggest that BP management based on dialysis BPs alone may over treat.

**Funding:** Other U.S. Government Support

Comparison of 30-day pre- and post-TH-BP pre-HD BP and home BP

	Systolic BP			Diastolic BP		
	Pre-HD	Home	P-value	Pre-HD	Home	P-value
Before TH-BP	149±18	—	—	95±15	—	—
After TH-BP	146±15	134±26	<0.005	92±14	80±15	<0.001

Values are expressed as mean±SD, mmHg.

P-values were calculated using the paired sample t-test.

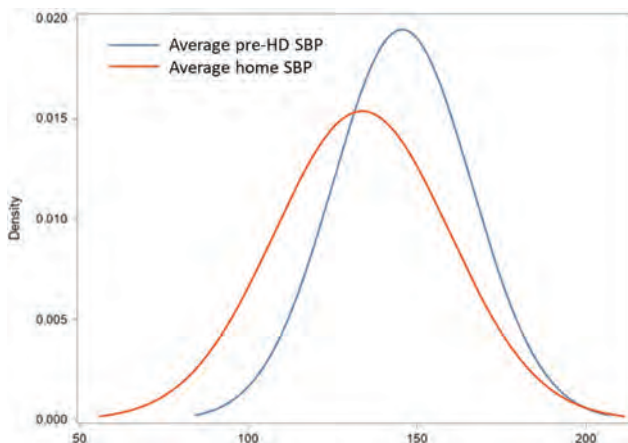

SA-PO363

The Clinical Outcomes of Blood Pressure in Maintenance Hemodialysis Patients: A Single Center Study

Yuan Luo, Bing Zhuang, Guiling Wei, Hong Ye, Junwei Yang. *The Second Affiliated Hospital of Nanjing Medical University, Nanjing, China.*

**Background:** The prevalence of hypertension among patients on dialysis and the degree to which it is controlled is difficult to ascertain, and the relationship between blood pressure (BP) and clinical outcomes among hemodialysis patients is complex and incompletely understood. This study sought to assess the relationship between interdialytic blood pressure and clinical outcomes.

**Methods:** We enrolled 456 maintenance hemodialysis patients from January to May 2022 in our center, measured interdialytic office blood pressure and volume load, and the demographic characteristics, duration of dialysis, laboratory tests, as well as the cardiac function were collected and analyzed.

**Results:** A total of 456 patients were included in the investigation with the mean age of 58.3±12.1 years old and 58.5% were male. The most common cause of dialysis was diabetic nephropathy (32.3%) and the second was hypertensive nephropathy (21.8%). Only 30.1% of the population blood pressure was controlled, under 140/90mmHg and over 100/60mmHg. 29.4% of the patients BP was more than 140/90mmHg. 59.2% of the study population used 1-2 antihypertensive drugs, and the most commonly used antihypertensive drugs were calcium antagonists. We observed the relationship between blood pressure and duration of dialysis and found a positive correlation with blood pressure with dialysis age (P<0.0001). There is also a positive correlation between LV wall thickness and systolic blood pressure, with thicker LV walls in patients with high systolic blood pressure. We measured the blood pressure of the patients before and after the six-minute walk test. We found that after the exercise, most of the patients had an increase in blood pressure, but 33.8% of the patients had a decrease in blood pressure. 59.8% of patients with a decrease in blood pressure used calcium antagonists (P<0.0001).

**Conclusions:** Although most hypertensive patients were on antihypertensive drugs, the proportion of patients with interdialytic blood pressure under 140/90mmHg is low. Hypertension is also associated with cardiac remodeling, with thicker left ventricular wall in patients with higher blood pressure.

**Funding:** Government Support - Non-U.S.

SA-PO364

Associations of Iron Sucrose and Intradialytic Blood Pressure

Anika T. Singh,<sup>1,2</sup> Timothy E. Yen,<sup>1,2</sup> Suraj Sarvode Mothi,<sup>3</sup> Sushrut S. Waikar,<sup>4,5</sup> Finnian R. McCausland,<sup>1,2</sup> <sup>1</sup>Brigham and Women's Hospital, Boston, MA; <sup>2</sup>Harvard Medical School, Boston, MA; <sup>3</sup>St Jude Children's Research Hospital, Memphis, TN; <sup>4</sup>Boston Medical Center, Boston, MA; <sup>5</sup>Boston University School of Medicine, Boston, MA.

**Background:** Intradialytic hypotension (IDH) and intra-HD hypertension (IDHyper) are associated with higher morbidity and mortality in hemodialysis (HD). Many factors can contribute to intra-HD blood pressure (BP) changes, such as drugs with vasoactive properties that could destabilize already tenuous BP. Intravenous iron sucrose (IS) is commonly administered to correct iron deficiency, however, associations with altered hemodynamics are not consistent.

**Methods:** Using the DaVita Biorepository (n=950), unadjusted and adjusted Poisson and linear repeated measures models were fit to assess the association of IS administration

with IDH, IDHyper, and systolic BP (SBP) parameters. Model 1 was adjusted for age, sex, race, access, pre-HD SBP, Model 2; same as model 1, plus ultrafiltration (UF) rate, diabetes, heart failure, ischemic heart disease, peripheral vascular disease, lung disease, and erythropoietin (ESA) dose. Exploratory models were additionally adjusted for hemoglobin and endothelin-1 concentrations.

**Results:** Mean age was 56 ±20 years, 43% were females, and 38% were Black. Mean pre-HD SBP was 152 ±26 mmHg. Patients who received IS were younger, diabetic, had higher UF rate, and higher frequency of ESA use than those who did not. In fully adjusted models, the risk of IDH was 4% lower (incidence rate ratio [IRR] 0.96; 95%CI 0.93 to 0.99) in HD sessions where IS was administered. There was no association of IS with the risk of IDHyper (IRR 1.02; 95%CI 1.00 to 1.04). Further, in adjusted models, IS was associated with a 1.2 (95%CI 1.0 to 1.5) mmHg higher pre-HD systolic BP, 0.6 (95%CI 0.4 to 0.8) mmHg higher nadir SBP, and 0.7 (95%CI 0.5 to 1.0) mmHg higher post-HD SBP.

**Conclusions:** We observed an independent association of intravenous IS administration with a lower risk of IDH and higher intra-HD SBP parameters. Future studies to better understand the mechanisms underlying this pattern are warranted.

Association of iron sucrose administration with intradialytic hypotension and hypertension

	IRR Ratio (95% CI) for Iron Sucrose administration versus not				
	Unadjusted	Model 1	Model 2	Model 2 +Hb	Model 2 +Hb, +ET-1
IDH	0.93 (0.90 to 0.96)	0.94 (0.91 to 0.98)	0.96 (0.93 to 0.99)	0.96 (0.93 to 0.99)	0.95 (0.92 to 0.99)
IDHyper	1.00 (0.98 to 1.03)	1.04 (1.02 to 1.06)	1.02 (1.00 to 1.04)	1.02 (1.00 to 1.04)	1.02 (1.00 to 1.04)

Abbreviations: IDH, intradialytic hypotension; IDHyper, intradialytic hypertension; Hb, hemoglobin; ET-1, endothelin-1

SA-PO365

Development of a Deep Learning Model for Predicting Intradialytic Hypotension Using Multicenter Clinical Data Warehouse

Hanbi Lee,<sup>1</sup> Sungjin Chung,<sup>2</sup> Chul Woo Yang,<sup>1</sup> Eun Sil Koh,<sup>2</sup> Byung ha Chung,<sup>1</sup> <sup>1</sup>Seoul Saint Mary's Hospital, Seocho-gu, Seoul, Republic of Korea; <sup>2</sup>Catholic University of Korea Yeouido Saint Mary's Hospital, Yeongdeungpo-gu, Seoul, Republic of Korea.

**Background:** Intradialytic hypotension (IDH) is a serious complication of hemodialysis, and is associated with subsequent vascular access thrombosis, inadequate dialysis dose, cardiovascular morbidity, and mortality. Since the mechanism of IDH is multifactorial, its prediction is a clinical challenge. This study aims to develop a deep learning model to predict the occurrence of IDH using data from multicenter clinical data warehouse.

**Methods:** Data from 2,008 patients who underwent a total of 928,070 hemodialysis sessions at seven university hospitals in South Korea between Mar 2009 and Dec 2019 was used in this study. IDH was defined according to the following criteria: (i) nadir systolic blood pressure (SBP)<100mmHg when the initial SBP≥160mmHg, (ii) nadir SBP<90mmHg when the initial 90≤SBP<160mmHg, or (iii) ≥20mmHg intradialytic SBP fall when initial SBP<90mmHg. Patients were randomly divided into training, validation and test sets. The importance of features in the occurrence of IDH was calculated from logistic regression, random forest, and XGBoost models. A deep 1-dimensional convolutional neural network model was constructed to predict IDH and the prediction performance was compared with other machine learning models.

**Results:** The machine learning classifiers demonstrated that the important common features associated with IDH were the occurrence of IDH and the mean SBP of last hemodialysis session. The deep convolutional neural network model with medical records of the last session predicted IDH with recall of 51.2%, F1 score of 44.6%, and negative predictive value of 97.2%, underperforming than other machine learning classifiers. However, combining the medical records of last 3 sessions boosted the prediction performance by recall to 60.6% and F1 score to 58.3% with negative predictive value of 97.2%, outperforming all other classifiers.

**Conclusions:** The past hemodialysis information enables stronger classification performances on predicting IDH occurrences. Our deep learning model would be a reliable screening tool of IDH and allow clinicians to adjust hemodialysis settings before hemodialysis treatment to prevent IDH.

SA-PO366

Combined Impact of Mean and Variability of Non-HDL-Cholesterol on Cardiovascular Risk in Patients Undergoing Hemodialysis

Hanbi Lee, Chul Woo Yang, Byung ha Chung. *Seoul Saint Mary's Hospital, Seocho-gu, Seoul, Republic of Korea.*

**Background:** Non-HDL-cholesterol (non-HDL-C) is considered as a predictor of cardiovascular risk and outcomes in general population. However, dialysis patients show inconsistent association between serum cholesterol and mortality due to the presence of protein energy wasting and inflammation. Recently, a high visit-to-visit variability in cholesterol suggested to lead to the fluctuations in the composition of atherosclerotic plaques and link to cardiovascular events. This study is aimed to stratify cardiovascular risk with the mean and variability of non-HDL-C in patients undergoing hemodialysis.

**Methods:** A total of 457 hemodialysis patients who had no history of myocardial infarction (MI) or stroke and who underwent ≥5 lipid profile at the seven university hospitals in South Korea between Mar 2009 and Dec 2019 were included. Sex-specific quartiles of non-HDL-C mean were used. Visit-to-visit non-HDL-C variability was

calculated using the coefficient of variation, variability independent of the mean and average real variability. The low mean and high variability groups were defined as the lowest and highest quartiles of non-HDL-C mean and variability, respectively. The endpoints of the study were newly diagnosed MI, stroke, or all-cause death.

**Results:** The incidence of MI was significantly higher in the low mean/high variability group than in other 3 groups. In addition, multivariable cox regression analysis demonstrated that age (hazard ratio (HR) 1.053, 95% confidence interval (CI) 1.024-1.082) and low mean/high variability group were independent risk factor for MI (HR 3.311, 95% CI 1.380-7.944). When the subjects were divided into quartile groups, neither mean nor variability of non-HDL-C was associated with MI, stroke, and all-cause mortality.

**Conclusions:** Our results suggested that the combination of low mean and high variability of non-HDL-C is associated with an increased risk of MI in hemodialysis patients, while the mean and variability *per se* could not stratify cardiovascular risk.

**SA-PO367**

**Deep Learning Model for Predicting Intradialytic Hypotension Without Privacy Infringement: A Retrospective Two-Center Study**

**Hyung Woo Kim,<sup>1</sup> Seok-Jae Heo,<sup>2</sup> Minseok Kim,<sup>2</sup> Jakyung Lee,<sup>2</sup> Keun Hyung Park,<sup>1</sup> Gongmyung Lee,<sup>1</sup> Song in Baeg,<sup>3</sup> Young Eun Kwon,<sup>3</sup> Hye Min Choi,<sup>3</sup> Dong-jin Oh,<sup>3</sup> Chung-Mo Nam,<sup>2,4</sup> Beom Seok Kim.<sup>1</sup>** <sup>1</sup>Department of Internal Medicine, Yonsei University College of Medicine, Seoul, Republic of Korea; <sup>2</sup>Department of Biostatistics and Computing, Yonsei University Graduate School, Seoul, Republic of Korea; <sup>3</sup>Department of Internal Medicine, Hanyang University College of Medicine, Myongji Hospital, Goyang, Republic of Korea; <sup>4</sup>Division of Biostatistics, Department of Biomedical Systems Informatics, Yonsei University College of Medicine, Seoul, Republic of Korea.

**Background:** Previously developed Intradialytic hypotension (IDH) prediction models utilize clinical variables with potential privacy protection issues. We developed an IDH prediction model using minimal variables, without the risk of privacy infringement.

**Methods:** Unidentifiable data from 63,640 hemodialysis sessions (26,746 of 79 patients for internal validation, 36,894 of 255 patients for external validation) from two Korean hospital hemodialysis databases were finally analyzed, using three IDH definitions: (1) systolic blood pressure (SBP) nadir <90 mmHg (Nadir90); (2) SBP decrease ≥20 mmHg from baseline (Fall20); and (3) SBP decrease ≥20 mmHg and/or mean arterial pressure decrease ≥10 mmHg (Fall20/MAP10). To predict the IDH event after 10 minutes, segments for the previous 40 minutes from 10 minutes before each time points at which blood pressure was created. Areas under receiver operating characteristic (AUROCs) and precision-recall curves were used to compare machine learning and deep learning models by logistic regression, XGBoost, and convolutional neural networks.

**Results:** Among 344,714 segments, 9,154 (2.7%), 134,988 (39.2%), and 149,674 (43.4%) IDH events occurred according to three different IDH definitions (Nadir90, Fall20, and Fall20/MAP10, respectively). Compared with models including logistic regression, random forest, and XGBoost, the deep learning model achieved the best performance in predicting IDH (AUROCs: Nadir90, 0.905; Fall20, 0.864; Fall20/MAP10, 0.863) only using measurements from hemodialysis machine during dialysis session.

**Conclusions:** The deep learning model performed well only using monitoring measurement of hemodialysis machine in predicting IDH without any personal information that could risk privacy infringement.

**SA-PO368**

**Rescue Therapy for an Old Challenging Problem: Droxidopa in the Management of Intradialytic Hypotension**

**Lakshna Sankar, Kartik Kalra. Geisinger Health, Danville, PA.**

**Introduction:** Intradialytic hypotension (IDH) is a common complication affecting 20-30% of hemodialysis (HD) sessions resulting in adverse outcomes. Here we describe the effect of droxidopa in our patient with resistant IDH.

**Case Description:** 72-year-old woman with past medical history of end stage kidney disease on HD since 2003, previous failed 2 kidney transplants, failed peritoneal dialysis, aortic and mitral valve replacement, atrial fibrillation on chronic anticoagulation. Her HD sessions were complicated by episodes of symptomatic hypotension for the last 1 - 2 years. Systolic blood pressure (SBP) ranging in between 60 - 70 mm Hg pre-dialysis. As a result, her HD sessions were cut short, and she was often symptomatic with altered mental status requiring multiple hospitalizations. Her symptoms during inter dialytic period were fatigue and exhaustion despite pharmacological measures such as midodrine 15 mg TID and fludrocortisone 0.2 mg on HD. To counter this, her intradialytic temperature was adjusted (cool dialysate), ultrafiltration (UF) goal was limited (different UF profiles were attempted), counseling on interdialytic weight gain and dietary sodium intake, blood flow and dialysate flow were reduced, dry weight was continuously reassessed, time on HD was increased. Despite above measures, she developed symptoms of volume overload as her HD sessions were continuously interrupted by IDH requiring multiple fluid boluses. Her cardiology and neurology evaluation were unremarkable. No evidence of adrenal insufficiency noted. Eventually she was prescribed droxidopa 100 mg TID and gradually escalated to 300 mg TID. Patient overall felt better (SBP improved to 110-120s mm Hg) and is currently tolerating UF removal without further interruptions in HD sessions and no further hospitalizations in the last 6 months.

**Discussion:** Management strategies for treatment and prevention of IDH is challenging. Droxidopa, a synthetic amino acid analogue metabolized to norepinephrine by dopa-decarboxylase increases blood pressure through peripheral arterial and venous

vasoconstriction. It is currently approved for neurogenic orthostatic hypotension. We propose that Droxidopa can be considered for off label use for symptomatic IDH after work up for other etiologies of hypotension is ruled out, potentially as a rescue therapy failing other pharmacological and conservative measures.

**SA-PO369**

**Higher NT-ProBNP Levels and the Risk of Intradialytic Hypotension at Hemodialysis Initiation**

**Katherine Curtis,<sup>1,2</sup> Sushrut S. Waikar,<sup>3</sup> Finnian R. McCausland.<sup>1,2</sup> Mc Causland Lab <sup>1</sup>Brigham and Women's Hospital, Boston, MA; <sup>2</sup>Harvard Medical School, Boston, MA; <sup>3</sup>Boston University School of Medicine, Boston, MA.**

**Background:** Elevated N-terminal pro B-type natriuretic peptide (NT-proBNP) accompanies cardiac dysfunction and hypervolemia and is a potent predictor of adverse outcomes in patients initiating hemodialysis (HD). These patients often experience intradialytic hypotension (IDH), which may partially reflect cardiac dysfunction, but the association of NT-proBNP with IDH is not clear.

**Methods:** We performed a post-hoc analysis of a double-blind, placebo-controlled, randomized trial that tested mannitol vs. placebo in 52 patients initiating HD (NCT01520207). Pre-HD NT-proBNP was measured in samples obtained prior to the 1<sup>st</sup> and 3<sup>rd</sup> sessions (n=87). Mixed-effects models (adjusting for randomized treatment, sex, Black race, age, diabetes, heart failure (HF), catheter use, pre-HD systolic blood pressure (SBP), pre-HD weight, ultrafiltration (UF) volume, sodium, bicarbonate, serum urea nitrogen, phosphate, albumin, and hemoglobin) were fit to examine the association of NT-proBNP with intradialytic SBP decline (pre-HD minus nadir SBP). Additionally, mixed-effects Poisson regressions were fit to determine the association with IDH (≥20 mmHg decline in SBP from pre-HD SBP).

**Results:** Mean age of patients was 55±16 years and 32% had baseline HF. The median pre-HD NT-proBNP across all sessions was 5498 [2011, 14790] pg/mL. A total of 26 sessions were complicated by IDH. In adjusted models, each unit higher log-NT-proBNP was associated with 5.8mmHg less decline in intra-dialytic SBP (95%CI -9.2 to -2.5, P=0.001). Higher pre-HD NT-proBNP was associated with a 54% lower risk of IDH per log unit NT-proBNP (IRR 0.46, 95%CI 0.23-0.92, P=0.03). There was no evidence for effect modification by randomized treatment (P-interaction=0.68).

**Conclusions:** In patients initiating HD, higher pre-HD NT-proBNP is associated with less decline in intradialytic SBP and lower risk of developing IDH. Future studies should investigate if higher pre-HD NT-proBNP levels can help identify hypervolemic patients who might tolerate more aggressive UF.

**Funding:** NIDDK Support

**Baseline SBP characteristics according to tertiles of NT-proBNP**

Characteristic	NT-proBNP tertiles (pg/mL)			P-trend
	Tertile 1 N = 16	Tertile 2 N = 12	Tertile 3 N = 15	
Pre-HD SBP	141 ± 20 138 [126, 158]	148 ± 24 142 [129, 160]	151 ± 30 153 [124, 178]	0.25 0.23
Minimum SBP	119 ± 21 120 [110, 126]	134 ± 15 136 [124, 141]	139 ± 30 137 [116, 168]	0.02 0.03
Post-HD SBP	143 ± 18 147 [133, 156]	148 ± 18 146 [140, 159]	161 ± 29 164 [144, 182]	0.03 0.06
SBP drop	23 ± 22 19 [11, 23]	14 ± 17 8 [2, 27]	13 ± 14 11 [7, 13]	0.12 0.06

Abbreviations: NT-proBNP: N-terminal pro brain natriuretic peptide, SBP: systolic blood pressure  
Note: Presented as mean ± standard deviation and median [25th-75th percentiles].

Baseline SBP characteristics across NT-proBNP tertiles

**SA-PO370**

**Associations of Body Compositions, Intradialytic Hypotension, and Mortality in Hemodialysis Patients**

**Sonoo Mizuiri,<sup>1</sup> Yoshiko Nishizawa,<sup>1</sup> Toshiaki Doi,<sup>1,5</sup> Kazuomi Yamashita,<sup>1</sup> Kenichiro Shigemoto,<sup>1</sup> Koji Usui,<sup>2</sup> Takayuki Naito,<sup>3</sup> Michiko Arita,<sup>4</sup> Takao Masaki.<sup>3</sup>** <sup>1</sup>Iryo Hojin Ichiyokai Harada Byoin, Hiroshima, Japan; <sup>2</sup>Ichiyokai Ichiyokai Clinic, Hiroshima, Japan; <sup>3</sup>Ichiyokai Yagowaga Clinic, Hiroshima, Japan; <sup>4</sup>Ichiyokai East Clinic, Hiroshima, Japan; <sup>5</sup>Hiroshima Daigaku Byoin, Hiroshima, Japan.

**Background:** Intradialytic hypotension (IDH) is a serious complication of hemodialysis. We studied the relationship among body composition, intradialytic hypotension, and mortality in dialysis patients.

**Methods:** Subjects were maintenance hemodialysis (HD) patients. The study timeline included the baseline (day 1), exposure assessment period (days 1-22), and outcome assessment period (day 23-3 years). IDH was defined as a nadir systolic blood pressure (SBP) <90 mmHg for at least two of ten HD sessions during the exposure assessment period. Clinical data at baseline and post-dialysis body composition parameters using bioimpedance spectroscopy in days 1-22 were assessed. Patients were divided into IDH and non-IDH groups. Kaplan-Meier curves and Cox proportional hazard models were used to assess patient survival.

**Results:** Overall (n=306), age, dialysis duration, and diabetes (DM) prevalence were 65±12 years, 108±100 months, and 42%, respectively. The IDH group (n=30) showed significantly (P <0.05) lower serum albumin and intracellular water (ICW) (14.7±3.6 vs. 16.2±3.7 L) levels and lower lean tissue index (LTI) (11.7±2.7 vs. 12.3±2.6 kg/m<sup>2</sup>,

P=0.06) but higher extracellular/intracellular (E/I) water (0.96±0.17 vs. 0.92±0.13, P=0.16) compared with those in the non-IDH group (n=276). Fifty all-cause deaths and 11 cardiovascular (CV) deaths occurred over 3 years. ICW (odds ratio [OR] 0.78), LTI (OR 0.79), and E/I (OR 27.52) were significant predictors for IDH, independent of age, pre-dialysis SBP, and ultrafiltration volume (P <0.05). Patients were also grouped based on the mortality cut-off values for ICW, LTI and E/I. Patients with ICW ≥13.6 L, LTI ≥15.5 kg/m<sup>2</sup>, and E/I <0.90 showed significantly higher 3-year Kaplan–Meier survival curves than those in the other groups (P <0.05). Cox models (adjusted for DM and dialysis duration) showed that ICW, LTI, E/I, and IDH were significant predictors for all-cause mortality (P <0.01). After adjusting for DM, dialysis duration, age, sex, CV diseases, serum albumin, C-reactive protein, phosphate, and magnesium levels, only IDH was a significant predictor for 3-year all-cause and CV mortality (P <0.05).

**Conclusions:** Associations between IDH, body composition, and mortality were confirmed, and an optimal body composition to prevent IDH needs to be determined.

**Funding:** Private Foundation Support

SA-PO371

**Impact of Intradialytic Hypotension Following Transition From Continuous Renal Replacement Therapy to Intermittent Hemodialysis on Mortality**

Seong Geun Kim, Donghwan Yun, Jinwoo Lee, Yong Chul Kim, Dong Ki Kim, Kook-Hwan Oh, Kwon Wook Joo, Yon Su Kim, Seung Seok Han. Seoul National University College of Medicine, Seoul, Republic of Korea.

**Background:** Transition of dialysis modalities from continuous renal replacement therapy (CRRT) to intermittent hemodialysis (iHD) is frequently conducted during a recovery phase of critically ill patients with acute kidney injury. Herein, we addressed the occurrence of intradialytic hypotension (IDH) after transition, and its association with the risk of mortality.

**Methods:** A total of 541 patients with acute kidney injury who attempted transition from CRRT to iHD were retrospectively collected from 2010 to 2020 at Seoul National University Hospital, Korea. IDH was defined as a discontinuation of dialysis because of hemodynamic instability plus when nadir systolic blood pressure was less than 90 mmHg or a decrease in systolic blood pressure ≥20 mmHg occurred during the 1<sup>st</sup> session of iHD. Odds ratios (ORs) of outcomes, such as in-hospital mortality and weaning from RRT, were measured using logistic regression model after adjusting multiple variables.

**Results:** IDH occurred in 197 (36%) patients, and their mortality rate (44%) was higher than 19% in those without IDH (OR, 2.64 [1.70–4.08]). The iHD sessions with IDH delayed a successful weaning from RRT with a OR of 0.62 [0.43–0.90] compared with those without IDH. Factors, such as low blood pressure, high pulse rate, low urine output, use of mechanical ventilator and vasopressors, and hypoalbuminemia, were associated with the IDH risk.

**Conclusions:** The IDH occurrence following transition from CRRT to iHD is associated with high mortality and delayed weaning from RRT.

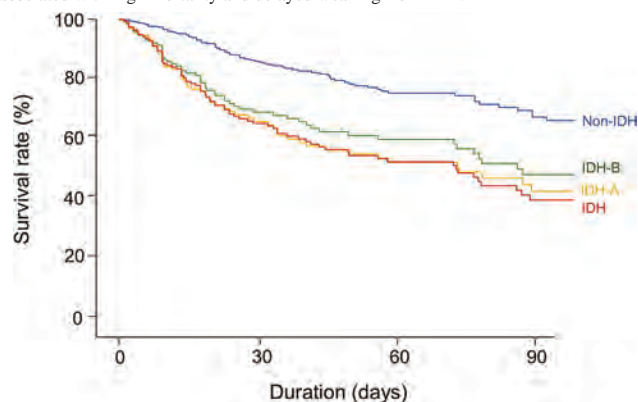

SA-PO372

**Proteomic Biomarker to Predict Intradialytic Hypotension During Hemodialysis**

Hyung Eun Son,<sup>1</sup> Seokwoo Park,<sup>2</sup> Ho Jun Chin.<sup>2</sup> <sup>1</sup>Chung-Ang University Gwangmyeong Hospital, Gwangmyeong, Gyeonggi-do, Republic of Korea; <sup>2</sup>Seoul National University Bundang Hospital, Seongnam, Republic of Korea.

**Background:** Predicting intradialytic hypotension would be beneficial for the survival of patients on HD. Yet, previous studies on proteomic approach to novel biomarkers are rare.

**Methods:** 150 patients undergoing maintenance hemodialysis were enrolled. Proteomic analysis was done using liquid chromatography-tandem mass spectrometry in serum samples. We also attained clinical information, laboratory tests, and body composition by bioimpedance analysis. The main outcome was IDH over 3 months following the enrollment. IDH was defined as more than 2 episodes of hypotension requiring intervention. Patients were divided into two groups according to the development of IDH. After data processing, differentially expressed protein (DEP)s according to

the development of IDH were obtained. Feature selection was done by least absolute shrinkage and selection operator (LASSO) analysis.

**Results:** Among 150 patients, 35 patients developed IDH. Comparing to those without IDH, they were older, obese, diabetic, and had low skeletal muscle mass per body weight. Among 18 DEPs according to the development of IDH (p<0.05), ITIH4 was remained as a DEP cut by FDR < 5%. Comparing with DEPs by 2 quantiles of skeletal muscle mass per weight, 8 DEPs were overlapped: C4BPA, VWF, VTN, IGFBP2, PROS1, LGALS3BP, CHI3L1, and DAG1. In feature selection, 9 proteins including ITIH1, C4BPA, ATRN, ITIH4, VWF, VTN, CP, FCN3, IGFBP2 as gene names, were important as much as clinical factors. In additional analysis, no DEPs were selected except skeletal muscle mass per weight.

**Conclusions:** In this study, we suggested biomarkers that showed feature importance as much as well-known clinical variables influencing intradialytic hypotension. Measurement of novel serum biomarkers would be useful to predict intradialytic hypotension.

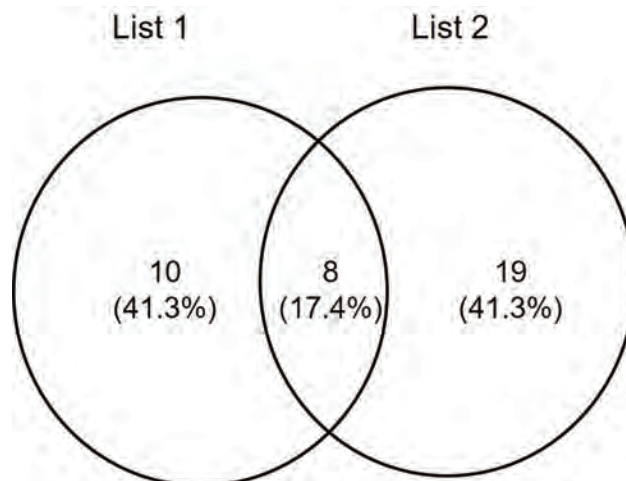

Diagrams of DEPs indicating overlapping proteins among DEPs to IDH (List 1) or skeletal muscle mass by body weight (List 2), analyzed by student's t test

SA-PO373

**Intradialytic Exercise on Cardiac Response to Hemodialysis**

Lisa Hur,<sup>1</sup> Jarrin D. Penny,<sup>2</sup> Justin R. Dorie,<sup>2</sup> Christopher W. McIntyre.<sup>2</sup> <sup>1</sup>Western University, London, ON, Canada; <sup>2</sup>London Health Sciences Centre London Kidney Clinical Research Unit, London, ON, Canada.

**Background:** Hemodialysis (HD) is associated with high rates of cardiovascular mortality due to recurrent cardiac ischemia-reperfusion injury during each HD session. Intradialytic exercise (IDE) can improve intradialytic hemodynamic tolerability, although its mechanisms remain elusive. The objective of the present study was to use intradialytic CT perfusion imaging and echocardiography to evaluate cardiac injury during HD with and without exercise.

**Methods:** 10 participants underwent two intradialytic imaging sessions: (1) the control visit (no IDE) and (2) the IDE visit, cycling on a stationary ergometer during the first 30 mins of HD treatment. In both visits, dynamic contrast-enhanced CT scans (Revolution CT, GE) were conducted at baseline, peak HD stress, and 30 mins post HD. Following each dynamic CT scan, apical 4-chamber and 2-chamber views of the heart were acquired with 2D echocardiography (Vivid Q, GE). The dynamic CT images were analyzed using the Johnson-Wilson-Lee tracer kinetic model to quantify global myocardial perfusion (MP) of the left ventricle. Using echocardiography, systolic function was evaluated by measuring segmental longitudinal strain (LS) using commercially available software (EchoPAC, GE). Myocardial segments demonstrating >20% reduction in LS compared to baseline were defined as regional wall motion abnormalities (RWMA).

**Results:** During the control visit, MP significantly dropped from baseline to peak HD stress (1.0 ± 0.4 to 0.8 ± 0.2 ml/min/g, p=0.02, Fig 1A), followed by partial recovery post HD (0.9 ± 0.2 ml/min/g, p=0.5, Fig 1A). Similar results were found during the exercise visit (baseline: 0.9 ± 0.3 ml/min/g, peak HD: 0.7 ± 0.1 ml/min/g, post HD: 0.8 ± 0.2 ml/min/g, p=0.05, Fig 1B). MP of control and exercise visits were not significantly different. The number of myocardial segments experiencing RWMA at peak stress were comparable between the two visits (5 segments, Fig 2). However, fewer RWMA post HD were observed with intradialytic exercise compared to no exercise (p=0.2).

**Conclusions:** Preliminary results indicate that MP response to HD remain unaffected by the IDE. A decrease in the number of RWMA post-HD with exercise suggests potential exercise-associated cardiac resilience to HD-induced cardiac injury.

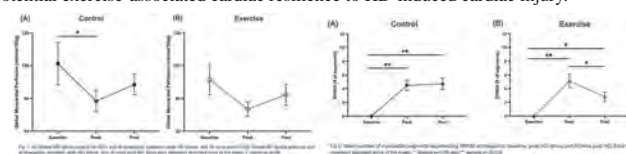

SA-PO374

**The Effect of Coronary Artery Status on Myocardial Perfusion Response to Hemodialysis**

Lisa Hur,<sup>1</sup> Ali Islam,<sup>3</sup> Jarrin D. Penny,<sup>2</sup> Justin R. Dorie,<sup>2</sup> Christopher W. McIntyre.<sup>2</sup> <sup>1</sup>Western University, London, ON, Canada; <sup>2</sup>London Health Sciences Centre London Kidney Clinical Research Unit, London, ON, Canada; <sup>3</sup>Saint Joseph's Health Care London, London, ON, Canada.

**Background:** Hemodialysis (HD) is associated with repetitive ischemia-reperfusion cardiac injury occurring during each treatment that accumulates with subsequent treatments. Conventional cardiovascular therapies effective in patients with atherosclerotic disease or myocardial infarction have been largely ineffective in treating HD-induced injuries. The objective of the present study was to use coronary CT angiography (CCTA) and intradialytic CT perfusion imaging to noninvasively evaluate the myocardial perfusion response during HD in patients with and without significant coronary artery stenosis.

**Methods:** CCTA images were acquired prior to HD (baseline) on ten patients and assessed by an experienced radiologist for clinically significant stenoses. In addition, dynamic contrast-enhanced CT scans (Revolution CT, GE) were conducted at baseline, peak HD stress, and 30 mins post HD. The dynamic CT images were analyzed using the Johnson-Wilson-Lee tracer kinetic model to quantify global myocardial perfusion (MP) of the left ventricle.

**Results:** Three patients were identified with clinically significant stenoses. In all patients, MP decreased from baseline to peak HD. However, MP response to HD was not significantly different between patients with clinically significant stenoses and those with no stenosis (Fig 1).

**Conclusions:** Preliminary results indicate that the coronary artery status does not affect the myocardial perfusion response to HD. This suggests that the decrease in MP during HD is caused by the treatment itself, rather than by coronary artery stenosis.

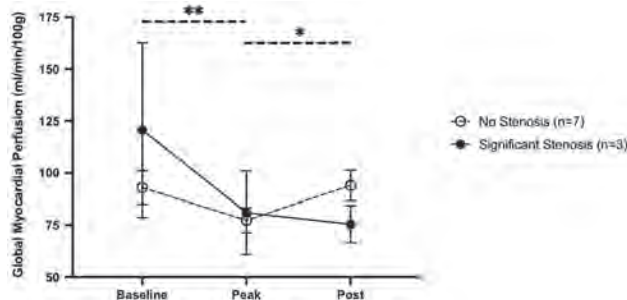

Fig 1. Mean global MP at baseline, peak HD stress, and 30 mins post HD in patients with no stenosis and with significant stenosis. Error bars represent standard error of the mean. Significance of \*\* and \* in no stenosis group denote p < 0.01 and p < 0.05, respectively.

SA-PO375

**Residual Kidney Function and Sudden Cardiac Death Among Incident Hemodialysis Patients**

Masaki Okazaki,<sup>1,2</sup> Yoshitsugu Obi,<sup>3</sup> Tariq Shafi,<sup>3</sup> Connie Rhee,<sup>1</sup> Kamyar Kalantar-Zadeh.<sup>1</sup> <sup>1</sup>University of California Irvine, Irvine, CA; <sup>2</sup>Nagoya University Graduate School of Medicine, Nagoya, Japan; <sup>3</sup>The University of Mississippi Medical Center, Jackson, MS.

**Background:** The survival benefit of residual kidney function (RKF) in hemodialysis patients is likely tied to advantages in fluid and electrolyte management. However, data have been lacking on the relationship between the RKF and sudden cardiac death (SCD). We therefore conducted a nationally representative cohort study to examine the association of RKF with SCD in patients initiating thrice-weekly in-center hemodialysis.

**Methods:** We analyzed a longitudinal data from a retrospective cohort study examining incident dialysis patients at a facility operated by a large dialysis organization in the U.S. from 2007 to 2011. The predictor was RKF measured by renal urea clearance (CL<sub>urea</sub>) at baseline and 6 months after initiating hemodialysis. Multivariable cause-specific proportional hazards models were fitted for primary analysis, and restricted cubic splines were fitted for secondary analysis for change in RKF to estimate SCD mortality.

**Results:** Baseline cohort of 39,749 patients were categorized into five groups according to baseline renal CL<sub>urea</sub> (<1.5, 1.5 to <3.0, 3.0 to <4.5, 4.5 to <6.0, and ≥6.0 mL/min/1.73 m<sup>2</sup>). The mean age was 61.6 years, and the median baseline renal CL<sub>urea</sub> was 3.1 mL/min/1.73 m<sup>2</sup>. Among a total of 7,737 all-cause deaths, 1,909 SCDs (24.7%) with the incidence rate of 34.0 per 1,000 person-years were observed. Compared with patients who had baseline renal CL<sub>urea</sub> of >6.0, those of <1.5 was associated with higher risk of SCD: case-mix adjusted hazard ratio was 1.47 (95% CI, 1.27–1.73). Of 12,169 patients with available data on change in renal CL<sub>urea</sub>, a decline in renal CL<sub>urea</sub> during the first 6 months of hemodialysis also showed a gradient association with increased SCD mortality.

**Conclusions:** Lower RKF and loss of RKF were associated with higher SCD mortality in patients starting thrice-weekly in-center hemodialysis.

**Sudden Cardiac Death**

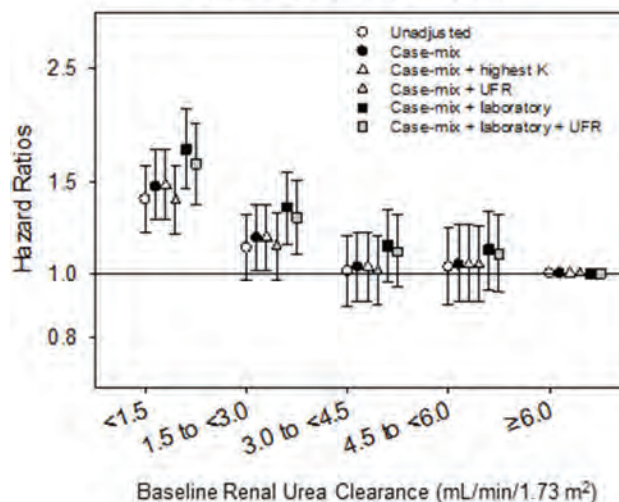

SA-PO376

**Dietary Protein Intake and Coronary Artery Calcification Changes Over Time in a Prospective Hemodialysis Cohort**

Masaki Okazaki,<sup>1,2</sup> Yoko Narasaki,<sup>1</sup> Connie Rhee,<sup>1</sup> Kamyar Kalantar-Zadeh.<sup>1</sup> <sup>1</sup>University of California Irvine, Irvine, CA; <sup>2</sup>Nagoya University Graduate School of Medicine, Nagoya, Japan.

**Background:** Hemodialysis (HD) patients are recommended a targeted protein intake of 1.0-1.2 g/kg/day. Increasing dietary protein intake while maintaining total daily food intake can be compensated by increasing the ratio of total protein per energy, and a higher ratio may be sought to achieve by increasing animal protein content. This study aimed to examine the relationship between dietary protein intake as a percentage to daily energy intake and their association with coronary artery calcification (CAC) and its changes over time in HD patients.

**Methods:** In a secondary analysis of 93 participants from the Anti-Inflammatory and Anti-Oxidative Nutrition in Hypoalbuminemic Dialysis Patients (AIONID) trial, we examined the association of total dietary protein to energy percentage assessed by 3-day food records with log-transformed annualized change in Agatston CAC score. Linear regression model was used for the comparison of tertile groups, and restricted cubic splines were fitted for continuous model.

**Results:** Analytic cohort of 70 patients with 2-point CAC measurements were categorized into tertiles according to the percentage of total protein to energy intake. Mean±SD age was 59.1±12.8 years. There were statistically significant trends toward higher plant protein proportion across lower total protein to energy proportion. Compared to the reference of the lowest tertile protein ratio group, middle tertile protein group exhibited a positive slope of ln[CAC score+1] (β=0.93, 95% CI: 0.18 to 1.56, p=0.007). In continuous spline models, we observed reverse U-shaped association of protein to energy proportion with CAC progression.

**Conclusions:** Compared to the group with the lowest tertile of dietary protein to energy intake ratio, the middle tertile group was associated with a higher risk of CAC progression. Our findings may indicate that the modulating dietary protein intake by increasing quantity without modulating quality including proportion of animal vs plant protein may not achieve the goal of preventing vascular calcification.

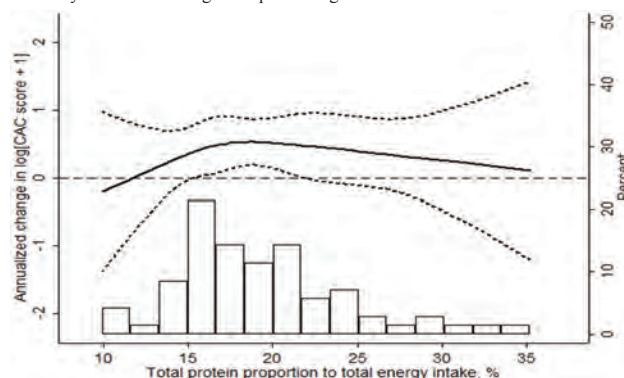

SA-PO377

**Predictors of Accelerated Residual Kidney Function Loss on Incremental Hemodialysis**

Joana Medeiros, Bárbara Ribeiro, Renata Carvalho, José M. Bastos, Rui M. Costa, Antonio Ramalheiro. *Hospital de Braga, Braga, Portugal.*

**Background:** Preservation of residual kidney function (RKF) has been the driving impetus for incremental hemodialysis (IHD). Factors such primary renal disease, comorbidities and haemodialysis prescription may predispose to an earlier loss of residual renal function.

**Methods:** Retrospective analysis of 37 patients who begun twice-weekly IHD from March 2017 to May 2022 at Braga's Hospital Dialysis Unit (Portugal). RKF was assessed monthly by residual renal urea clearance and normo-hydrated weight (NHW) was evaluated quarterly by bioelectrical impedance analysis. Inclusion criteria to IHD were: urea clearance  $\geq 3\text{mL}/\text{min}/1.73\text{m}^2$ , absence of advanced heart/liver failure and absence of active cancer. Transition on low-flux to high-flux dialysis/haemodiafiltration occurred according to the RKF loss and a maximum ultrafiltration rate of  $10\text{mL}/\text{kg}/\text{hour}$  was determined. An accelerated RKF loss was defined as a loss of at least 25% in the first 3 months.

**Results:** The mean age was  $58 \pm 13$  years, 54.1% were male, and 97% were Caucasian. Diabetic nephropathy (32.4%) was the most common cause of ESRD and arteriovenous fistula was the primary vascular access (54.1%). The Charlson comorbidity index was  $4.7 \pm 2.2$  with 89.2% of patients having hypertension and 40.5% diabetes. Baseline measured glomerular filtration rate (GFR) was  $7.5 \pm 2.3\text{mL}/\text{min}/1.72\text{m}^2$  and 93.3% had a urinary output greater than  $1000\text{mL}/\text{day}$ . During the first trimester, accelerated RKF loss occurred in 30% of patients, mainly those with older age, diabetes, Charlson comorbidity index higher than 6 and lower GFR at the baseline. Association with first month intradialytic symptomatic hypovolemia events and dry weigh exceeding NHW ( $>1\text{kg}$ ) was also found. In multivariate analysis, only baseline GFR  $<7\text{mL}/\text{min}/1.73\text{m}^2$  was a predictor of accelerated decline in RKF (OR 25.4, CI 95% 1.2-530). Loss of RKF at 3 months was significantly associated with lower IHD survival during the first year (28% vs 69%, log Rank test  $p=0.04$ ).

**Conclusions:** Factors such as age, comorbidities, first month intradialytic complications and unadjusted dry weigh prescription may influence the rate of RKF loss. Moreover, lower baseline GFR was an independent predictor of accelerated decline in RKF. Late referral to IHD or accelerated loss RKF trend that begun in pre dialysis stages may explain these findings.

SA-PO378

**A Retrospective Analysis of Fluid and Infection-Related Hospitalizations in Clinics Participating in ESRD Seamless Care Organizations**

Rachel A. Lasky, Linda Ficociello, Len A. Usvyat, Terry L. Ketchersid, Benjamin E. Hippen. *Fresenius Medical Care, Waltham, MA.*

**Background:** In a pilot program aimed at controlling costs and improving care for patients (pts) with end-stage renal disease (ESRD), the Center for Medicare and Medicaid Innovation (CMMI) created ESRD Seamless Care Organizations (ESCOs) in 2015. We conducted a retrospective data analysis to evaluate potentially preventable hospitalizations, namely fluid-related and infection-related, in ESCO-eligible pts who received dialysis at ESCO vs non-ESCO clinics.

**Methods:** Adult, Fresenius Kidney Care (FKC) hemodialysis pts who met ESCO eligibility criteria between 10/2015-3/2017 were included. ESCO pts received dialysis at 1 of 6 FKC ESCO markets, while non-ESCO pts were dialyzed at nearby FKC facilities propensity score matched on: # ESCO eligible pts, mean dialysis vintage, mean pt age, %pts with diabetes, %pts with dual-eligibility, median income by zip code, and geographical proximity. Fluid and infection-related hospitalizations were identified using ICD codes from electronic medical records. Crude and adjusted Poisson regression models were used to compare the risk of fluid- and infection-related hospitalizations between ESCO and non-ESCO groups, overall and stratified by the presence of catheters (CVC).

**Results:** 13,994 pts (7,398 ESCO and 6,596 non-ESCO) were included. Compared to pts attending non-ESCO clinics, pts attending ESCO clinics had 0.88 ( $p=0.0001$ ) and 0.85 ( $p < 0.0001$ ) times the rate of infection-related and fluid-related hospitalizations, respectively (table). With multivariate adjustment, only fluid-related hospitalizations remained statistically significant (RR:0.84,  $p=0.0002$ ). The stratified analysis demonstrates that the pts with most reduced risk of infection and fluid-related hospitalizations are the pts being dialyzed with CVC (table).

**Conclusions:** Pts that received hemodialysis in FKC ESCO clinics experienced a lower rate of fluid-related hospitalizations when compared to pts in non-ESCO clinics, a benefit primarily realized by patients dialyzing with a CVC.

**Funding:** Commercial Support - Fresenius Medical Care

	ESCO (n=7,398)	Non-ESCO (n=6,596)	Model Type	Rate Ratio	95% CI	p value
Total # infection-related admissions / patient year	1,446/ 10,049 (0.14)	1,427/ 8,892 (0.16)	Univariate	0.88	0.822 - 0.951	0.0010
			Multivariate <sup>1</sup>	0.93	0.858 - 1.014	0.1026
Total # fluid-related admissions / patient year	1,463/ 10,049 (0.14)	1,443/ 8,892 (0.16)	Univariate	0.85	0.785 - 0.915	<0.0001
			Multivariate <sup>2</sup>	0.84	0.775 - 0.924	0.0002

CVC (n=3,125)				No CVC (n=5,673)			
Infection-related admissions				Infection-related admissions			
Model Type	RR	95% CI	p value	Model Type	RR	95% CI	p value
Univariate	0.86	0.76 - 0.98	0.019	Univariate	0.99	0.85 - 1.11	0.835
Multivariate <sup>1</sup>	0.88	0.75 - 1.02	0.088	Multivariate <sup>2</sup>	1.02	0.85 - 1.17	0.796
Fluid-related admissions				Fluid-related admissions			
Univariate	0.72	0.62 - 0.83	<0.0001	Univariate	0.92	0.82 - 1.03	0.166
Multivariate <sup>1</sup>	0.69	0.55 - 0.83	<0.0001	Multivariate <sup>2</sup>	0.90	0.78 - 1.03	0.130

<sup>1</sup> Multivariate model was adjusted for race, ethnicity, dialysis vintage, M, cardiac arrhythmias, diabetes, hypertension, CVD, CHF, albumin, intact PTH, calcium, phosphorus, hemoglobin, BMI, and median income  
<sup>2</sup> Multivariate model was adjusted for gender, age, ethnicity, vintage, M, cardiac arrhythmias, diabetes, hypertension, CVD, CHF, albumin, intact PTH, calcium, phosphorus, hemoglobin, BMI, and median income

SA-PO379

**Circulating Follistatin-Like Protein-1 Levels Predicts the Risk of Cardiovascular Events and Death in Hemodialysis Patients**

Dae Kyu Kim,<sup>1</sup> Seok hui Kang,<sup>2</sup> Jin sug Kim,<sup>3</sup> Yang gyun Kim,<sup>1</sup> Yu ho Lee,<sup>4</sup> Dong-Young Lee,<sup>5</sup> Ju young Moon,<sup>1</sup> Sangho Lee,<sup>1</sup> Kyung hwan Jeong,<sup>3</sup> Hyeon Seok Hwang,<sup>3</sup> <sup>1</sup>Kyung Hee University Hospital at Gangdong, Seoul, Republic of Korea; <sup>2</sup>Yeungnam University Medical Center, Daegu, Republic of Korea; <sup>3</sup>Kyung Hee University Medical Center, Seoul, Republic of Korea; <sup>4</sup>CHA Bundang Medical Center, Seongnam, Republic of Korea; <sup>5</sup>Korea Veterans Health Service, Wonju, Republic of Korea.

**Background:** Follistatin-like protein-1 (FSTL-1) is cardiokine which are involved in the induction of angiogenesis, stimulation of cardiomyocyte proliferation and improvement of endothelial function. However, the clinical significance of circulating FSTL-1 levels remains unclear in hemodialysis patients.

**Methods:** A total 376 HD patients from the K-cohort were prospectively enrolled from June 2016 to March 2020. Plasma FSTL-1 level, plasma concentration of biomarkers and echocardiographic findings at baseline were examined. The primary endpoint was defined as a composite of CV events and death.

**Results:** Plasma FSTL-1 level had positive correlation with circulating cardiac remodeling (matrix metalloproteinase-2) and inflammatory markers (TNF- $\alpha$ , MCP-1). In multivariate linear regression analysis, FSTL-1 level was negatively associated with left ventricular ejection fraction ( $\beta = -0.36$ ;  $P = 0.011$ ). The cumulative event rate of the composite of CV event and death was significantly greater in FSTL-1 tertile 3 ( $P = 0.037$ ). FSTL-1 tertile 3 was also associated with an increased cumulative event rate of CV events ( $P = 0.048$ ). In Cox regression analysis, FSTL-1 tertile 3 was associated with a 1.80-fold risk for the composite of CV events and death (95% confidence interval [CI], 1.06-3.08), and a 2.29-fold risk for CV events (95% CI, 1.15-4.54) after adjustment for multiple variables.

**Conclusions:** Plasma level of FSTL-1 levels were independently associated with left ventricular systolic dysfunction and higher circulating FSTL-1 levels independently predicted the composite of CV events in HD patients.

SA-PO380

**Evaluation of Myocardial Ischemia in Maintenance Hemodialysis Patients**

Bing Zhuang, Yuan Luo, Guiling Wei, Hong Ye, Junwei Yang. *The Second Affiliated Hospital of Nanjing Medical University, Nanjing, China.*

**Background:** Myocardial ischemia is a common and complex phenomenon in maintenance hemodialysis patients; however, their clinical manifestations are very insidious. The main purpose of this study was to analysis and evaluate myocardial ischemia in in our dialysis center, explore the influencing factors and propose effective intervention measures.

**Methods:** This study is a prospective study. From January 2022 to April 2022, 306 patients on maintenance hemodialysis were enrolled the research in our center. The patients completed cardiovascular assessment, including: data collection of hemodialysis, six-minute walk test(6-MWT), electrocardiogram before and after 6-MWT, and body composition analysis and noninvasive hemodynamic assessment. One third patients received coronary computed tomography angiography(CTA) and fraction flow reservation(CT-FFR).

**Results:** Among the 306 hemodialysis patients, 44% had abnormal electrocardiogram, manifested as abnormal ST segment, abnormal T wave, abnormal Q wave and arrhythmia. 8.8% of the patients had obvious myocardial ischemia after 6-minute walk test. 59% of patients had more severe coronary artery disease with coronary artery disease-reporting and data system (CAD-RADS) score of 3 and 4. Only 13% of the patients had chest pain symptoms, and 88.4% of the patients denied the history of coronary heart disease. Coronary stenosis was mainly in the right coronary artery and left anterior descending artery. Severe stenosis was mainly positively correlated with age ( $R=0.19$ ,  $P=0.00$ ), calcium score ( $R=0.27$ ,  $p<0.00$ ), and six-minute walking distance ( $R=0.13$ ,  $P=0.00$ ) was negatively correlated. FFR showed that the fraction of coronary flow reserve in the left anterior descending artery decreased the most, which was mainly related to left ventricular septal hypertrophy ( $r=0.10$ ,  $P=0.01$ ), systolic blood pressure ( $r=0.15$ ,  $P=0.00$ ), cards score ( $r=0.31$ ,  $P<0.00$ ) and calcification score ( $r=0.34$ ,  $P<0.00$ ).

**Conclusions:** The incidence of myocardial ischemia patients in our dialysis center is common and insidious, however, the incidence of coronary stenosis is high. The stenosis

was mainly in the right coronary artery and the left anterior descending artery, and the decrease of the coronary flow reserve was mainly in the left anterior descending artery. Both coronary stenosis and decreased fractional flow reserve were associated with higher coronary calcium scores.

**Funding:** Government Support - Non-U.S.

**SA-PO381**

**Impact of the Platelet Distribution Width on Mortality and Cardiovascular Events in ESKD Patients**

Young Woo Song, Seok Joon Shin, Sang Hun Eum, Joo Eun Lee, Jin Ah Park, Hye Eun Yoon, Yeonhee Lee. *Catholic University of Korea Incheon Saint Mary's Hospital, Incheon, Incheon, Republic of Korea.*

**Background:** Platelet distribution width (PDW) was known to a risk factor and an indicator of a variety of diseases. We evaluated impact of PDW on the all-cause mortality and cardiovascular(CV) event in end-stage kidney disease (ESKD) patients who started dialysis.

**Methods:** The medical records of 386 ESKD patients who started maintenance dialysis between January 2006 and July 2017 were reviewed. Patients were divided into three groups; low, median and high groups based on the tertile PDW value. The primary outcome was a comparison of all-cause mortality and CV events among the PDW tertile groups. The secondary outcome is the possibility of PDW as an independent risk factor for all-cause mortality and CV event.

**Results:** Overall death event was 83 cases; 17 in the low PDW group, 13 in the median PDW group, and 53 in the high PDW group. CV event was 110 cases; 20 in the low PDW group, 34 in the median PDW group, and 56 in the high PDW group. The all-cause mortality was significantly higher in the high PDW group compared to the low PDW group (40.2% vs. 14.5%,  $P = 0.012$ ). The CV event rate was also higher in the high PDW group compared to the low PDW group (42.4% vs. 17.1%,  $P = 0.027$ ). In multivariate Cox regression analysis, high PDW was an independent predictor for all cause death before adjustment(HR 1.138, 95% CI, 1.062-1.220;  $P=0.000$ ), and even after adjustment for age, smoking, diabetes, body mass index, C-reactive protein, and previous CV disease (HR 1.120, 95% CI, 1.035-1.213;  $P=0.005$ ).

**Conclusions:** PDW value at the time of initiating dialysis in the ESKD patients may be a simple and useful method for predicting all-cause mortality and CV event.

**SA-PO382**

**Monocyte-to-High-Density Lipoprotein (HDL) Ratio, an Independent Risk Factor of Survival in Hemodialysis Patients: Results From the International MONDO Consortium**

Xiaoling Ye,<sup>1</sup> Rupert B. Bright,<sup>2</sup> Kevin Woollard,<sup>2</sup> Charles D. Pusey,<sup>2</sup> Peter Kotanko,<sup>1</sup> Neill D. Duncan.<sup>2</sup> The MONDO Initiative <sup>1</sup>Renal Research Institute, New York, NY; <sup>2</sup>Imperial College Renal and Transplant Centre, London, United Kingdom.

**Background:** Previous studies had demonstrated that elevated monocyte count to high-density lipoprotein cholesterol ratio (MHR), a novel marker of inflammation, was associated with higher mortality in patients with CKD, on peritoneal dialysis, and deceased donor kidney transplant recipients. However, the association between MHR and mortality in patients undergoing hemodialysis (HD) has received little attention. We aimed to study the relationship between MHR and mortality in a diverse HD population.

**Methods:** Four cohorts were identified:1) acute phase: first 90 days on HD as the baseline period with the subsequent 9 months as the follow-up, 2) early-stable phase: 91 days to the end of 1st year as the baseline followed with 1 year's follow-up, 3) mid-stable phase: 2nd year as the baseline and the following 1 year as the follow-up, and 4) late-stable phase: 3rd year as the baseline followed by a 7-year follow-up. All-cause & CVD mortalities were recorded during the 4 phases. Kaplan-Meier curves were constructed to explore the association between MHR quartiles and mortalities.

**Results:** 21,059 patients were included in the acute phase cohort, 19,776 in the early-stable phase cohort, 16,680 patients in the mid-stable cohort, and 13,893 patients in the late-stable phase cohort. Notably, patients in the higher baseline MHR quartile had higher levels of NLR, MLR, CRP, platelets, and ferritin and lower albumin and phosphate in all phases. All-cause (Fig. 1) and CVD mortalities were higher in patients in higher MLR quartiles in all cohorts.

**Conclusions:** A higher MHR was an independent risk factor for all-cause and CV mortality in this large and ethnically diverse HD population. MHR may be a reliable biomarker due to the connection between HDL and monocytes. This work corroborates previous findings in more restricted cohorts and warrants further mechanistic investigation.

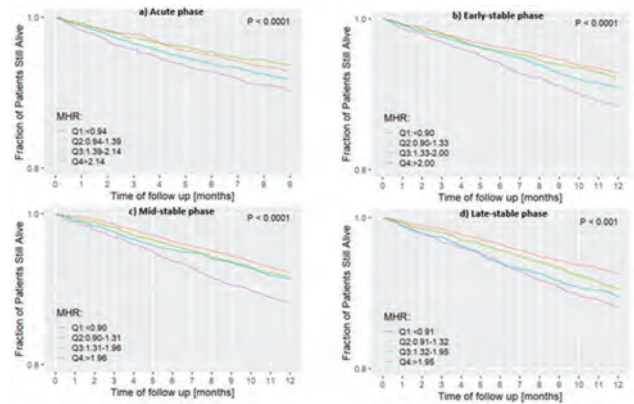

**SA-PO383**

**Leptin-to-Adiponectin Ratio and Survival in a Prospective Hemodialysis Cohort**

Thuy-Anh Bui, Amy S. You, Yoko Narasaki, Ji Hoon Yoon, Yalitzi Guerrero, Sara S. Kalantar, Ria Arora, Tracy Nakata, Danh V. Nguyen, Kamyar Kalantar-Zadeh, Connie Rhee. *University of California Irvine, Irvine, CA.*

**Background:** Leptin and adiponectin are two major adipocytokines believed to play key roles in the regulation of CV and metabolic status. While animal studies show leptin and adiponectin have inverse effects on the CV system (leptin promotes atherosclerosis, while adiponectin reduces vascular injury), it is suggested that the leptin-to-adiponectin (L/A) ratio may be an important predictor of CV disease and death. Despite their exceedingly high CV risk, no studies have examined the association between the L/A ratio and mortality in HD patients.

**Methods:** In a multicenter prospective cohort of 448 HD patients from the NIH “Malnutrition, Diet, and Racial Disparities in Kidney Disease” Study who underwent protocolized serum leptin/adiponectin measures, we examined the association of L/A ratio (categorized as tertiles) with all-cause mortality in unadjusted, case-mix, and case-mix+laboratory (adjusted for serum albumin, creatinine, nPCR, and IL-6) Cox models. We additionally examined clinical characteristics associated with high leptin and adiponectin levels (defined as the highest tertile) using logistic regression.

**Results:** We observed that increasingly higher L/A ratio tertiles were associated with incrementally lower death risk across all Cox models (ref. lowest tertile): HR (95%CI) 0.37 (0.18, 0.76) and 0.18 (0.07, 0.46), respectively for the middle and highest tertiles, respectively, in case-mix+laboratory models (Fig). In case-mix+laboratory logistic regression models, female sex, diabetes, AV access use, and lower serum albumin were associated with higher leptin, whereas female sex, Black race, and longer vintage were associated with higher adiponectin.

**Conclusions:** In a multicenter prospective cohort of HD patients, higher L/A ratios were associated with lower mortality. Further studies are needed to determine mechanistic pathways underlying the relationship between adipocytokines, CV health, and survival in HD.

**Funding:** NIDDK Support

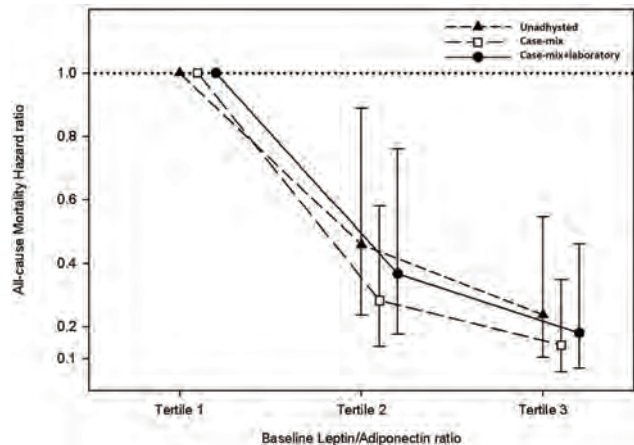



## SA-PO384

**Serum GDF-15/Albumin Ratio Is a Survival Marker of CKD Patients Initiating Maintenance Hemodialysis**

Youngrok Ham, Eu Jin Lee, Soo hyun Han, Kang Wook Lee, Kiryang Na, Dae Eun Choi. *Chungnam National University Hospital, Daejeon, Republic of Korea.*

**Background:** It is valuable to identify risk factors related to mortality in chronic kidney disease (CKD) patients starting renal replacement therapy. Recently, several studies proposed that growth-differentiation factor-15 (GDF-15) is a possible biomarker for the prognosis of patients on maintenance hemodialysis. Here, we investigated the predictive value of serum GDF-15/Albumin ratio on two-year mortality in ESRD patients initiating maintenance hemodialysis.

**Methods:** The study was a single center, retrospective study on CKD patients starting maintenance hemodialysis with a follow-up of two years. We reviewed the medical records of the patients who were diagnosed with CKD, naive to renal replacement therapy and prescribed to start maintenance hemodialysis from May 2014 to August 2019. 159 patients were eligible for analysis. The biospecimens and data used for further analysis on GDF-15 were provided by the Biobank of Chungnam National University Hospital, a member of the Korea Biobank Network.

**Results:** The patients were stratified into quartiles according to the quartiles of serum GDF-15/Albumin ratio. Among the 159 patients, the mean age was  $61.78 \pm 12.52$  years and median survival was  $20.03 \pm 7.73$  months. The highest GDF-15/Albumin quartile was significantly more associated with the increased risk of all-cause mortality than other quartiles (unadjusted hazard ratio (HR): 8.468, 95% CI 2.981–24.054,  $p < 0.001$ ). Older age and a higher overhydration state were associated with GDF-15/Albumin ratio. The ROC analysis confirmed that the ability of the GDF-15/Albumin ratio to predict mortality was superior to GDF-15 or albumin alone.

**Conclusions:** The GDF-15/Albumin ratio measured at the initial maintenance hemodialysis is an independent prognostic marker of two-year mortality in CKD patients.

**Funding:** Government Support - Non-U.S.

## SA-PO386

**Comparison of Performance of an Artificial Intelligence Risk Prediction Model and Surprise Question: A Prospective Study**

Huan-Sheng Chen,<sup>1</sup> Chen-Chou Lei,<sup>2</sup> Ming-Hsien Chou,<sup>3</sup> Chu-Cheng Lin,<sup>4</sup> Hsueh-Wen Lu,<sup>5</sup> Wen-Chieh Wu,<sup>6</sup> Tsai-Ying Lin,<sup>7</sup> Tsuan-Shih Yu,<sup>8</sup> Hung-Hsiang Liou,<sup>9</sup> Chen-Ting Cheng,<sup>10</sup> Lim Paik Seong,<sup>11</sup> Hanjie Zhang,<sup>12</sup> Weihao Tan,<sup>13</sup> Kakiu Ho,<sup>13</sup> Margaret Li,<sup>13</sup> Carmen So.<sup>13</sup> <sup>1</sup>An Hsin Qing Shui Clinic, Taichung, Taiwan; <sup>2</sup>An Hsin Nan Zi Clinic, Kaohsiung, Taiwan; <sup>3</sup>He Tai Clinic, Taipei, Taiwan; <sup>4</sup>Ho Hospital, Changhua, Taiwan; <sup>5</sup>An Hsin Da Se Clinic, Taoyuan, Taiwan; <sup>6</sup>Shin Loong Clinic, New Taipei, Taiwan; <sup>7</sup>An Hui Clinic, Taoyuan, Taiwan; <sup>8</sup>He Yang Clinic, Taoyuan, Taiwan; <sup>9</sup>Hsing-Jen Hospital, New Taipei, Taiwan; <sup>10</sup>Saint Paul's Hospital, Taoyuan, Taiwan; <sup>11</sup>Tungs' Taichung MetroHarbor Hospital, Taichung, Taiwan; <sup>12</sup>Renal Research Institute, New York, NY; <sup>13</sup>Fresenius Medical Care Asia Pacific Ltd, Hong Kong, Hong Kong.

**Background:** Hemodialysis (HD) patients encounter a significantly high risk of morbidity and mortality. The surprise question (SQ) ("Would you be surprised if this patient were still alive in 6 or 12 months?") is used as a mortality prognostication tool in HD patients. We aimed to apply a risk prediction model (RPM) and compare its performance with SQ on 6- and 12-month mortality prediction for HD patients in Taiwan.

**Methods:** We conducted a 1-year prospective observational study in 422 chronic HD patients from 8 dialysis clinics. Demographic, clinical, laboratory and dialysis treatment indicators (158 features) were used to model 6- and 12-month mortality probability using logistic regression. All patients were assessed by SQ upon enrollment and, subsequently, by RPM every month. The performance of RPM against SQ was evaluated independently using area under the receiver operating characteristics curve (AUC). We compared sensitivities and specificities of RPM and SQ.

**Results:** A total of 207 high-risk patients were identified. During the 12-month follow-up, 47 patients died. For 6-months mortality prediction, AUC for SQ and RPM were 0.56 (95%CI 0.48, 0.63) and 0.70 (95%CI 0.62, 0.79), respectively ( $p=0.006$ ). For 12-month mortality prediction, AUC for SQ and RPM were 0.56 (95%CI 0.51, 0.62) and 0.73 (95%CI 0.68, 0.78) respectively ( $p<0.0001$ ). Sensitivities of the 6- and 12-month RPM were 0.88 (95%CI 0.73, 1) and 0.89 (95%CI 0.81, 0.98), respectively. The sensitivities of the 6- and 12-month SQ were 0.12 (95%CI 0, 0.27) and 0.17 (95%CI 0.063, 0.28), respectively. The specificities of 6- and 12-month RPM were 0.53 (95%CI 0.48, 0.57) and 0.56 (95%CI 0.51, 0.61), respectively. The 6- and 12-month SQ specificities were 0.99 (95%CI 0.98, 1) and 0.95 (95%CI 0.93, 0.97), respectively.

**Conclusions:** RPM is a more reliable predictor of mortality in HD patients compared to SQ. Sensitivity of SQ was rather low in this HD patient population.

**Funding:** Commercial Support - Fresenius Medical Care Asia Pacific Ltd.

## SA-PO387

**Predictors of Urgent Dialysis and Hospitalization Following Ambulance Transport to the Emergency Department**

Aran Thanamayooran,<sup>1</sup> Megi Nallbani,<sup>1</sup> Amanda J. Vinson,<sup>1,2</sup> David Clark,<sup>1,2</sup> Patrick T. Fok,<sup>1,2</sup> Judah Goldstein,<sup>1</sup> Keigan More,<sup>1,2</sup> Janel M. Swain,<sup>1</sup> Hana Wiemer,<sup>1,2</sup> Karthik K. Tennankore,<sup>1,2</sup> <sup>1</sup>Nova Scotia Health Authority, Halifax, NS, Canada; <sup>2</sup>Dalhousie University, Halifax, NS, Canada.

**Background:** Dialysis patients may require timely, monitored dialysis (urgent dialysis) or hospitalization after ambulance transport to the emergency department (ambulance-ED). We developed and internally validated risk prediction models for urgent dialysis and hospitalization for ambulance-ED in a cohort of chronic dialysis patients.

**Methods:** We included all ambulance-ED transports for hemodialysis patients affiliated with a large regional program from 2014-2018. "Urgent dialysis" was defined as dialysis within 24 hours of ED arrival in a monitored setting or with the first ED patient blood potassium level  $>6.5$ mmol/L. Predictors included categorized vital signs prior to ambulance transport (taken by paramedics) and time from last dialysis. Logistic regression models were used to predict urgent dialysis and hospitalization and internally validated using bootstrapping. Model discrimination was evaluated using the C-statistic and calibration using the Hosmer-Lemeshow test.

**Results:** A total of 271 dialysis patients experienced 878 ambulance-ED transports. 63 transports (7.2%) required urgent dialysis and 299 (34.0%) resulted in hospitalization. Hypoxemia (odds ratio; OR: 4.04, 95% CI: 1.75-9.33) and a time from last dialysis of 24-48 hours (OR: 3.43, 95% CI: 1.05-11.9) and  $>48$  hours (OR: 9.22, 95% CI: 3.37-25.23) were associated with urgent dialysis. A risk prediction model for urgent dialysis had good discrimination (C-statistic: 0.83) and calibration (Hosmer-Lemeshow: 0.89). The prediction model for hospitalization had no individually significant predictors of hospitalization and moderate discrimination (C-statistic: 0.67) but good calibration (Hosmer-Lemeshow: 0.74).

**Conclusions:** This study highlights the possibility of predicting certain short-term outcomes in dialysis patients using information available to paramedics during ambulance-ED transport.

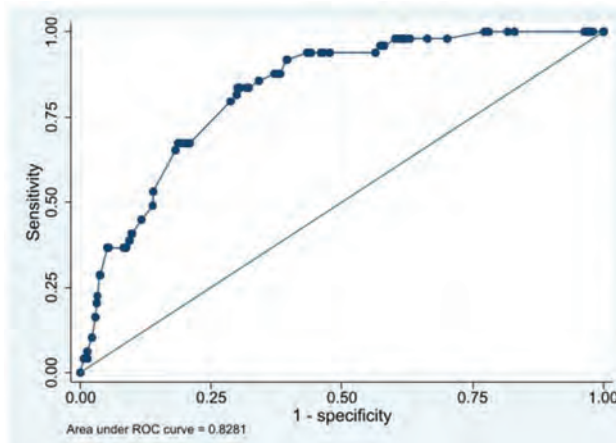

## SA-PO388

**Risk Factors of Unplanned Intensive Care Unit Admission Among Hospitalized Patients With Maintenance Hemodialysis**

Nozomi Kadota, Takuya Fujimaru, Kotaro Shimoyama, Kasumi Konishi, Yugo Ito, Fumika Taki, Masahiko Nagahama, Masaaki Nakayama. *St. Luke's International Hospital, Tokyo, Japan.*

**Background:** In general, 6.4% of hospitalized patients were admitted to intensive care unit (ICU) due to deterioration of the clinical condition, and about 40% of these patients die. For all patients, the risk factors of deterioration of the clinical condition were male, older age, complication of diabetes or chronic heart failure, and abnormal vital signs on hospitalization. However, although hemodialysis (HD) patients have higher in-hospital mortality rate than general population, the factors that predict the deterioration of the clinical condition of these patients are not understood.

**Methods:** We conducted a retrospective study in a single hospital (520 beds, including 25 intensive care beds) in Tokyo, Japan. We investigated the adult patients with maintenance HD who admitted to general ward during January 2003 to November 2022. The patients who discharged within 7 days were excluded. The primary outcome is unplanned ICU admission between 72 hours and 30 days after hospitalization. The secondary outcomes are an unplanned ICU admission or death in the same duration. We used cox proportional regression model for statistical analysis adjusted for age, sex, comorbid conditions, positive blood culture and serum albumin value on hospitalization.

**Results:** Of the 492 eligible patients, 318 (64%) were male, mean age was 73 years old, mean length of hospital stay was 36.7 days, and 44 (8.9%) patients were admitted to ICU due to deterioration of the clinical condition. Multivariate analysis with Cox proportional regression model showed that patients with cardiovascular disease on hospitalization were significantly admitted to ICU (HR 2.99 (95%CI, 1.54-5.81)

P=0.0012). Additionally, ICU admission or in-hospital death was associated with low serum albumin on hospitalization (HR 0.45 (95% CI, 0.31-0.67) P<0.001).

**Conclusions:** For maintenance HD patients, complication of cardiovascular disease could be the risk factor of deterioration of the clinical condition during hospitalization.

Patient Characteristics on Hospitalization (n=492)	n (%) or mean ± SD	Primary Outcome		Secondary Outcome	
		Hazard Ratio (95%CI)	p-value	Hazard Ratio (95%CI)	p-value
Male	318 (65)	0.9623 (0.497 - 1.863)	0.6104	0.7990 (0.5017 - 1.2726)	0.3448
Age (year)	73.08 ± 11.98	1.0076 (0.979 - 1.037)	0.9092	1.0126 (0.9915 - 1.0342)	0.2427
Scheduled hospitalization	132 (27)	1.3332 (0.697 - 2.550)	0.3846	1.1011 (0.6944 - 1.7458)	0.6823
Positive blood culture	34 (7)	1.1251 (0.399 - 3.177)	0.8238	0.6840 (0.2761 - 1.6947)	0.4120
Albumin [g/dl]	3.24 ± 0.62	0.8010 (0.464 - 1.384)	0.4267	0.4541 (0.3094 - 0.6666)	<0.001
<b>Comorbidities</b>					
Diabetes Mellitus	293 (60)	1.1716 (0.607 - 2.262)	0.6371	1.3096 (0.8256 - 2.0774)	0.2518
Cardio Vascular Disease	207 (42)	2.9949 (1.544 - 5.809)	0.0012	1.5025 (0.9702 - 2.3266)	0.0683
Cancer	174 (35)	0.9539 (0.505 - 1.801)	0.8844	1.3556 (0.8795 - 2.0895)	0.1681
Intradialytic hypotension	116 (24)	0.7782 (0.365 - 1.660)	0.5164	1.3121 (0.8069 - 2.1335)	0.2735

SA-PO389

The Prognostic Value of Objective Nutritional Scores in Patients Undergoing Maintenance Hemodialysis

Qian Wang, Zengchun Ye, Hui Peng. The Third Affiliated Hospital of Sun Yat-Sen University Lingnan Hospital, Guangzhou, China.

**Background:** Malnutrition is one of the common complications in patients undergoing maintenance hemodialysis (MHD), which affects their life quality and expectancy. But there is lack of simple and effective nutritional screening tools for MHD patients.

**Methods:** A retrospective cohort of 831 patients on MHD were enrolled from three hospitals. We applied three objective nutritional scores including prognostic nutritional index (PNI), controlling nutritional states scores (CONUT), geriatric nutritional risk index (GNRI) to longitudinally assess the nutritional status of MHD patients and its relationship with prognosis, and to compare the predictive value of the three scores by using the concordance index (C-index), the integrated discrimination improvement (IDI), and net reclassification improvement (NRI); to explore the relationship of changes in nutritional status of MHD patients with their prognosis. The primary and secondary endpoint events were all-cause and cardiovascular mortality, respectively.

**Results:** During a median follow-up period of 31.13 months, 195 patients (23.5%) died, and 116 (14%) of them died from cardiovascular events. There was no significant difference in the risk of all-cause and cardiovascular mortality between the normal nutrition and malnutrition groups before hemodialysis in our cohort. The risk of all-cause mortality or cardiovascular mortality was greater in the malnutrition group at 6th, 12th and 18th months of dialysis. None of the PNI, GNRI, and CONUT score during pre-hemodialysis status was independent factor for both all-cause mortality and cardiovascular mortality of the cohort. The mortality predictability of the GNRI was similar to the PNI, and both GNRI and PNI score are better than the CONUT score. Patients with decreased PNI or GNRI scores had a significantly increased risk of all-cause and cardiovascular mortality compared with patients with higher PNI or GNRI scores. Meanwhile, patients with increased CONUT scores had a greater risk of all-cause mortality.

**Conclusions:** Each of the three nutritional screening tools was significantly associated with an increased risk for all-cause and cardiovascular mortality at 6th, 12th, and 18th month of hemodialysis. The predictive value of both GNRI and PNI score are better than the CONUT score

SA-PO390

Prediction of Gastrointestinal Bleeding Hospitalization in Hemodialysis

Suman K. Lama,<sup>1</sup> John W. Larkin,<sup>1</sup> Sheetal Chaudhuri,<sup>1</sup> Joanna Willetts,<sup>1</sup> Anke Winter,<sup>2</sup> Yue Jiao,<sup>1</sup> Manuela Stauss-Grabo,<sup>2</sup> Len A. Usvyat,<sup>1</sup> Jeffrey L. Hymes,<sup>1</sup> Franklin W. Maddux,<sup>4</sup> Peter Stenvinkel,<sup>5</sup> Jürgen Floege.<sup>3</sup> on behalf of the INSPIRE Core Group <sup>1</sup>Fresenius Medical Care, Global Medical Office, Waltham, MA; <sup>2</sup>Fresenius Medical Care, Global Medical Office, Bad Homburg, Germany; <sup>3</sup>University Hospital Aachen, Division of Nephrology and Clinical Immunology, Aachen, Germany; <sup>4</sup>Fresenius Medical Care AG & Co KGaA, Bad Homburg, Germany; <sup>5</sup>Karolinska Institutet, Stockholm, Sweden.

**Background:** INItiativeS on advancing Patients' outcomes In REnal disease (INSPIRE) is a collaboration set forth to conduct investigations fundamental to advancing nephrology. Early detection of gastrointestinal (GI) bleeding events was chosen as a priority and the group built a machine learning model to identify a hemodialysis (HD) patient's 180-day GI bleed hospitalization risk.

**Methods:** Data from adult HD patients in the United States (Jan 2016-Dec 2020) were randomly split for training (50%), validation (30%), and testing (20%). Model (XGBoost) was built with >400 exposures, and refined to top 50 exposures, for classification of 180-day GI bleed hospitalization risk. Unseen testing data determined model performance and effect sizes.

**Results:** Among 27,796 HD patients in the test data, 322 had a GI bleed hospitalization. Model showed an area under the curve=0.70, sensitivity=56.2%, specificity=70.7%, and accuracy=70.6%. Exposures with largest effect size per Shapley values were older age (68±13 years GI bleed event vs 63±14 years no event), higher serum 25 hydroxyvitamin D level (25OH Vit D) (33.4±17.0 ng/mL GI bleed event vs 30.5±16.1 ng/mL no event), shorter days since all-cause hospitalization (203±246 days GI bleed event vs 253±269 days no event). Other important exposures included days since GI bleed hospitalization, hemoglobin and iron, time since known GI bleed, and heparin dose (**Figure 1**).

**Conclusions:** Model appears to be suitable for early detection of HD patients at risk of a GI bleed requiring hospitalization within 180 days. Prospective testing is needed with hopes of timely actions to avoid events. The association between higher 25OH Vit D and GI bleeding was unexpected and needs to be explored further in HD patients. Similar signals have been seen in warfarin users without kidney disease at 25OH Vit D levels >30 ng/mL (Keskin U, 2019).

**Funding:** Commercial Support - Fresenius Medical Care

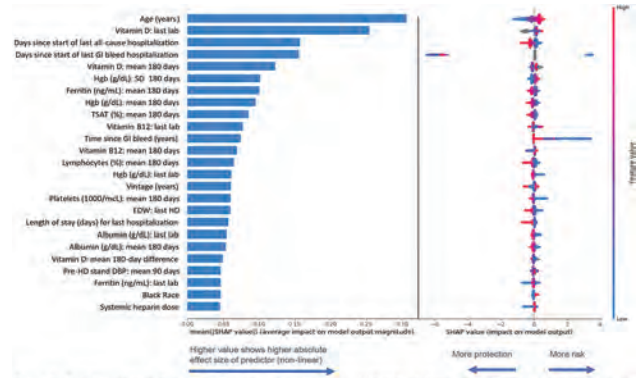

Figure 1: Top 25 predictors of 180-day GI bleed hospitalization in descending order. Bar plot on the left panel show the mean absolute SHAP values that estimate the average effect size of each exposure variable's contribution to predicting the outcome on the x-axis (calculated from the average absolute value for all patients). SHAP value plots on the right panels show the size and direction (more positive=higher risk or more negative=lower risk) of each variable's influence on the outcome for each unique patient on the x-axis, with warmer colors representing higher observed values for that measurement, color colors indicating lower values for that measurement, and gray representing a missing value for that measurement. SHAP values are presented in the unit of log odds (i.e. logarithm of the odds ratio). Hgb: hemoglobin; TSAT: transferrin saturation; EDW: estimated dry weight; DBP: diastolic blood pressure.

SA-PO391

Thromboinflammatory Biomarkers and Their Relationship With Circulating Glycosaminoglycans in ESRD Patients

Vinod K. Bansal, Madeline T. Allen, Fakiha Siddiqui, Debra Hoppensteadt, Emily G. Krupa, Bulent Kantarcioglu, Jawed Fareed. Loyola University Health System, Maywood, IL.

**Background:** End stage renal disease (ESRD) is a complex progressive medical condition that affects multiple organ systems. Given the high risk of morbidity and mortality of ESRD as well as its rising incidence, it is critical to understand the relevance of thromboinflammatory biomarkers in disease development and progression of kidney dysfunction. The purpose of this study is to profile the levels of thromboinflammatory biomarkers in ESRD patients including D-Dimer, C-reactive protein (CRP), von Willebrand factor (vWF), plasminogen activator inhibitor 1 (PAI-1), and thrombin activatable fibrinolysis inhibitor (TAFI). In addition, the levels of anti-PF4 IgG and endogenous circulating glycosaminoglycans (GAGs) were measured.

**Methods:** Citrated plasma samples were collected from seventy-three ESRD patients. Control plasma samples (NHP) from healthy, non-smoking adults aged 19 to 53 were obtained commercially. Validated ELISA methods have been used to profile each of the biomarkers. The levels of endogenous GAGs were determined (Redprobes UG, Germany). To compare the levels of thromboinflammatory biomarkers, anti-PF4 IgG, and endogenous GAGs in different groups, appropriate statistical methods included Mann-Whitney U, t-tests, Kruskal-Wallis ANOVA and experiment correlation analysis methods were performed.

**Results:** All of the biomarkers and GAGs were significantly elevated in the ESRD patients, with the exception of TAFI (p < 0.05). The ESRD patients exhibited varying levels of increase in the D-Dimer, CRP, vWF, PAI-1, anti-PF4 IgG, and GAG levels (p < 0.05). D-Dimer showed the most pronounced increase (1075%) followed by PAI-1 (361.31%), anti-PF4 IgG (209.78%), CRP (101.77%) and endogenous GAGs (17.29%). The correlation analysis revealed varying degrees of association among these biomarker levels, in particular the endogenous GAGs and PAI-1.

**Conclusions:** These results suggest that thromboinflammatory biomarkers offer the potential utility of identifying inflammation in end-stage renal disease. Marked increase in thromboinflammatory mediators due to endothelial damage may result in the upregulation of glycosaminoglycans and may contribute to platelet activation and vascular dysregulation.

**Funding:** Clinical Revenue Support

SA-PO392

**Nephrologist Ownership of Dialysis Facilities and Dialysis Outcomes**

Eugene Lin,<sup>1</sup> Genevieve Kanter,<sup>2</sup> Matthew S. Mccoy,<sup>2</sup> Kristina I. Lung,<sup>4</sup> Derick Rapista,<sup>3</sup> Jeffrey S. Berns.<sup>2</sup> <sup>1</sup>University of Southern California Keck School of Medicine, Los Angeles, CA; <sup>2</sup>University of Pennsylvania Perelman School of Medicine, Philadelphia, PA; <sup>3</sup>Duke University School of Medicine, Durham, NC; <sup>4</sup>University of Southern California, Los Angeles, CA.

**Background:** Nephrologist ownership of dialysis facilities presents a financial conflict of interest because owners can change dialysis prescriptions to increase profitability. Alternatively, facility owners could be more motivated to provide patient-centered care. In this study, we investigated the association between the ownership of dialysis facilities and dialysis outcomes.

**Methods:** Through a Freedom of Information Act request, we obtained a list of freestanding dialysis facilities' owners in 2018 from the Centers for Medicare and Medicaid Services (CMS), which we linked to a 100% sample of adults with fee-for-service Medicare receiving dialysis for end-stage kidney disease from January 2017 to November 2017 at freestanding facilities. In a multivariable analysis at the patient-month level, we studied the association between outcomes and facility ownership. We conducted a difference-in-differences analysis to mitigate selection bias. For each outcome, we compared patients managed by nephrologist owners at their own facilities versus at other facilities. To eliminate systematic differences between facilities owned by nephrologists and owned by non-nephrologists, we conducted the same comparison for patients managed by nephrologist non-owners. The difference between these comparisons (difference-in-differences) is the change in outcome associated with nephrologist ownership. We adjusted for patient, facility, and geographic confounders.

**Results:** Nephrologist ownership was associated with a 2.6 percentage point increase (95% CI: 1.4%, 3.8%, p=0.0005) of home dialysis use over a baseline rate of 9.7% (a 27% relative increase). We observed no statistically significant differences in other outcomes, including mortality, transplantation or waitlisting, hospitalizations or 30-day readmissions, missed dialysis treatments, receipt of an erythropoietin-stimulating agent, blood transfusions, use of a fistula or a catheter, or dialysis adequacy (p > 0.05 for all other outcomes).

**Conclusions:** Nephrologist ownership was associated with a large increase in home dialysis use. We did not observe adverse events associated with a profit motive. However, because it was difficult to obtain ownership data, our analysis was limited to a cross-sectional analysis of nephrologist owners. CMS should make nephrologist ownership of dialysis facilities more transparent.

**Funding:** NIDDK Support, Private Foundation Support

SA-PO393

**Risk of Death in Hospital-Based vs. Free-Standing Dialysis Facilities in the United States**

Lucy Zhang,<sup>1</sup> Sandra Amaral,<sup>2</sup> Charles E. Mcculloch,<sup>1</sup> Barbara A. Grimes,<sup>1</sup> Elaine Ku.<sup>1</sup> <sup>1</sup>University of California San Francisco School of Medicine, San Francisco, CA; <sup>2</sup>The Children's Hospital of Philadelphia, Philadelphia, PA.

**Background:** Prior studies have shown that dialysis facility type is associated with differential patient outcomes, including access to transplantation and mortality risk. It is unclear whether there are any differences in survival in patients receiving care at dialysis facilities that are affiliated with a hospital versus free-standing, and whether such mortality risk varies by race/ethnicity.

**Methods:** We included adults >18 years who started dialysis between 2014-2018 who were registered in the USRDS and examined the association between dialysis facility affiliation (hospital-based versus free-standing) and risk of death using Cox models and adjusting for age, race, sex, region, cause of kidney disease, dialysis facility network, insurance, county size, co-morbidities, distance to dialysis facility, year of dialysis initiation, and dialysis modality. We then tested for interaction between facility type and race/ethnicity and performed subgroup analysis due to the presence of an interaction (p<0.05).

**Results:** We included a total of 283,957 patients with a mean age of 55 years. Approximately 59% were men and 30% were Black patients (Table 1). Patients receiving dialysis from hospital-affiliated dialysis facilities had a 12.1% higher risk of death than those receiving dialysis at free-standing facilities (95% CI 7-17%). We detected an interaction between type of dialysis facility and race/ethnicity (p<0.05). Black patients showed a higher differential between hospital and free-standing than other races (Table 2).

**Conclusions:** Hospital-affiliation (vs. free-standing status) was associated with higher risk of death in dialysis facilities, but findings varied by race. This finding may be due to different patient mix, with hospital-affiliated facilities treating sicker patients. Further studies are needed to further explore drivers of these findings.

**Funding:** NIDDK Support

**Table 1:** Baseline Characteristics at dialysis initiation by type of dialysis facility

Variable*	Free-Standing	Hospital-Based
Total patients (N)	269,890	14,067
Age	55 ± 11.2	55.1 ± 11.6
Sex (% male)	158372 (58.7%)	8935 (63.5%)
Modality (% hemodialysis)	242317 (89.8%)	12489 (88.8%)
Race		
Black	81995 (30.4%)	4195 (29.8%)
Hispanic	47155 (17.5%)	2331 (16.6%)
White	123,771 (45.9%)	6391 (45.4%)
Other race	16969 (6.3%)	1150 (8.2%)

\*All characteristics are statistically significantly different comparing patients treated at hospital-affiliated versus free-standing facilities.

**Table 2:** Risk of death by type of dialysis facility and race/ethnicity.

Hospital-based versus free-standing dialysis facility	Adjusted Hazard Ratio (95% CI)
Black	1.23 (1.13-1.34)
Hispanic	1.01 (0.88-1.16)
White	1.09 (1.03-1.16)
Other	1.19 (1.01-1.42)

SA-PO394

**Parameters Influencing Survival After Hemodialysis Withdrawal: An Experience From a Single Center**

Kosei Yamaguchi,<sup>1,2</sup> Mineaki Kitamura,<sup>1,2</sup> Satoshi Funakoshi,<sup>1</sup> Tomoya Nishino.<sup>2</sup> <sup>1</sup>Nagasaki Renal Center, Nagasaki, Japan; <sup>2</sup>Nagasaki University School of Medicine, Nagasaki, Japan.

**Background:** Withdrawal from maintenance hemodialysis is unavoidable in some patients who have a poor general condition; however, their survival rate varies. The factors associated with survival prognosis in the terminal phase of patients undergoing hemodialysis remain unclear.

**Methods:** This study included patients who died after withdrawal from hemodialysis between 2011 and 2021 at Nagasaki Renal Center. Patient background data were collected, and the associations between the patients' clinical features and survival duration were analyzed.

**Results:** The withdrawal group included 174 patients (79.8±10.8 years old; 50.6% men; median dialysis vintage, 3.6 years). The most common (95%) reason for withdrawal was that hemodialysis was more harmful than beneficial because of the patient's poor general condition. The median time from withdrawal to death was 4 days (interquartile range: 3-10 days). Multivariable Cox proportional regression analysis showed that oral nutrition (hazard ratio (HR), 1.98; 95% confidence interval (CI), 1.12-3.50; P=0.03), hypoxemia (HR, 2.32; 95% CI, 1.55-3.47; P<0.01), ventilator use (HR, 0.26; 95% CI, 0.11-0.58; P<0.01), and pleural effusion (HR, 1.54; CI, 1.01-2.37; P=0.04) were associated with increased survival. In contrast, antibiotics and vasopressor administration were not associated with survival.

**Conclusions:** We clarified the parameters affecting the survival of patients who withdrew from hemodialysis. Physicians may use our results to establish more accurate predictions, which in turn will help patients and their families emotionally accept and implement the desired care plan.

SA-PO395

**A Predictive Model of the Time to ESKD Using Machine Learning**

Jun Okita,<sup>1</sup> Takeshi Nakata,<sup>1</sup> Emiko Noguchi,<sup>1</sup> Nobuchika Koumatsu,<sup>1</sup> Ayako Tasaki,<sup>1</sup> Hiroki Uchida,<sup>1</sup> Akiko Kudo,<sup>1</sup> Akihiro Fukuda,<sup>1</sup> Tsuyoshi Shimomura,<sup>2</sup> Masato Tanigawa,<sup>3</sup> Hirotaka Shibata.<sup>1</sup> <sup>1</sup>Department of Endocrinology, Metabolism, Rheumatology and Nephrology, Faculty of Medicine, Oita University, Yufu, Japan; <sup>2</sup>Hospital informatics center, Oita Medical University Hospital, Yuhu, Japan; <sup>3</sup>Department of Biophysics, Faculty of Medicine, Oita University, Yuhu, Japan.

**Background:** Predicting the risk of end-stage kidney disease (ESKD) and the time to renal replacement therapy (RRT) is useful not only for healthcare providers to treat CKD and prepare for renal replacement therapy (RRT) but also for patients to plan their life. Many studies have assessed the risk for ESKD using machine learning, but none have focused on the time to RRT. In this study, we investigated how to predict the time to RRT using machine learning.

**Methods:** This study was a retrospective cohort study. Patients who started RRT between April 2016 and March 2021 at Oita University Hospital were enrolled. A total of 13,323 data groups were extracted from the electronic medical records, including 34 laboratory data items (e.g., BUN and creatinine [Cr]) and 8 patient background items (e.g., age and gender) from the start of follow-up to the start of RRT. Items with missing values of more than 30% were excluded. The residual 9,838 data groups without missing values were trained by the machine; 80% of the data were randomly divided for training and 20% for testing, and supervised learning was performed with multiple algorithms

(mainly nonlinear regression models, such as Random Forest and gradient-boosted decision trees) to create predictive models and evaluate the accuracy of the test data.

**Results:** In all, 147 patients (99 males) were enrolled with a mean age of 60.8 years. The most common ESRD etiology was diabetic nephropathy (44%). The mean Cr was  $7.6 \pm 2.0$  mg/dL, and the estimated glomerular filtration rate (eGFR) was  $6.1 \pm 1.7$  mL/min/1.73 m<sup>2</sup> at induction. The optimal algorithm was the Random Forest regression, which created a predictive model that used six identical time variables (age, gender, height, weight, Cr, and eGFR). The model was highly accurate with a coefficient of determination (R<sup>2</sup>) of 0.96 and a mean absolute error of 159 days. The values predicted from the test data strongly correlated with the true values.

**Conclusions:** We predicted the time to start RRT with high accuracy using machine learning. Predicting the time to start RRT is useful for CKD treatment, and we plan to improve the accuracy of the model and consider its application to actual clinical practice in the future.

## SA-PO396

### Novel Risk Score to Predict 3-Year Mortality in Patients on Hemodialysis

Aiko Okubo,<sup>1</sup> Toshiki Doi,<sup>1,2</sup> Kenichi Morii,<sup>1,2</sup> Yoshiko Nishizawa,<sup>1</sup> Kazuomi Yamashita,<sup>1</sup> Kenichiro Shigemoto,<sup>1</sup> Sonoo Mizuiri,<sup>1</sup> Takao Masaki,<sup>2</sup> <sup>1</sup>Iryo Hojin Ichiyokai Harada Byoin, Hiroshima, Japan; <sup>2</sup>Hiroshima Daigaku Byoin, Hiroshima, Japan.

**Background:** The risk of death in patients on hemodialysis (HD) is high. Therefore, identifying patients at a high risk of death at the induction of HD is essential in clinical practice. However, few reports have examined the models predicting all-cause mortality in patients on HD using clinical factors, including electrocardiographic findings. This study aimed to investigate the clinical factors that have the most effect on the mid-term prognosis in patients on HD and to evaluate a novel risk model using these risk factors for predicting all-cause death.

**Methods:** We analyzed 385 patients with initiated HD at our four facilities from November 2008 to February 2019. We investigated demographics, medical history, laboratory data, and electrocardiographic findings at the initiation of HD therapy. We used the logistic regression model to predict 3-year all-cause mortality and evaluated it by cross-validation.

**Results:** During the 3-year follow-up, 86 (24.2%) patients died. Age ( $P < 0.01$ ), prior stroke ( $P < 0.01$ ), and the corrected QT interval ( $P = 0.03$ ) were identified as independent predictors of all-cause death by a multivariate logistic regression analysis. The predictive model was constructed using all these parameters with good discrimination of all-cause death (area under the curve: 0.80, with 80.1% sensitivity and 76.7% specificity). The area under the curve based on the 10-fold cross-validation was 0.82, with 78.2% sensitivity and 70.9% specificity, which suggested a good model. Patients above the cut-off value of the risk model were more likely to have a significantly higher risk of all-cause death than those below the cut-off value (hazard ratio: 9.13, 95% confidence interval: 5.16–16.16,  $P < 0.001$ ).

**Conclusions:** This novel risk model composed of age, prior stroke, and the corrected QT interval can stratify high-risk patients and be useful in predicting 3-year all-cause death in patients on HD. Our new risk score is easily measured at the bedside and provides good prediction of the mortality risk of patients on HD.

## SA-PO397

### Prediction of Death in Dialysis Patients Using Artificial Intelligence

Sungmin Kim, Jung Nam An, Dong Hee Lee, Jwa-kyung Kim, Sung Gyun Kim. *Hallym University Sacred Heart Hospital, Anyang, Gyeonggi-do, Republic of Korea.*

**Background:** It is very important to predict the death and to detect and manage risk factors in dialysis patients. In this study, we aimed to build a prognostic prediction model that can predict the death of dialysis patients through a deep learning technique using dialysis-related clinical variables and vital signs during dialysis that change in real time in addition to traditional risk factors.

**Methods:** Data of patients who underwent maintenance dialysis at Hallym University Sacred Heart Hospital from January 2015 to December 2019 were extracted from electronic medical record. Changes in vital signs (before dialysis, during dialysis, immediately after dialysis), dry weight, weight gain between dialysis, ultrafiltration amount, blood test results, and in-hospital deaths were investigated. Out-of-hospital deaths were investigated using data from the National Statistical Office. Using refined data, a recurrent neural network-based long short-term memory deep learning model that can predict death from vital signs was trained.

**Results:** Of a total of 1,772 patients, 322 died in-hospital and 337 died out-of-hospital. Among these, patients with vital signs measured during dialysis within 72 hours were included. When learning with 4-fold cross validation for the prediction of death within 72 hours from each vital sign measurement time during dialysis (including both out-of-hospital and in-hospital death), the performance was AUROC  $0.9591 \pm 0.0115$  and AUPRC  $0.2408 \pm 0.0290$ . Afterwards, the test set was composed of only 16 patients who died out of hospital within 100 hours from the time of the last vital sign measurement. As a result of checking the predictive performance, it was AUROC 0.8714 and AUPRC 0.1440.

**Conclusions:** In this study, a death prediction model using a deep learning technique that maximizes the correlation between data was constructed using vital signs and test results during dialysis, which are regularly measured in hemodialysis patients. A prospective study will be needed.

## SA-PO398

### eGFR Trajectory Pre-Dialysis Initiation Predicts 90-Day Hospitalization and Mortality Risk

Michael A. Kraus,<sup>1</sup> Yuedong Wang,<sup>2</sup> Catherine Y. Wang,<sup>4</sup> Carly Hahn Contino,<sup>1</sup> Len A. Usvyat,<sup>1</sup> Peter Kotanko,<sup>3,5</sup> Robert J. Kossmann,<sup>1</sup> Harvey W. Kaufman,<sup>6</sup> <sup>1</sup>Fresenius Medical Care North America, Waltham, MA; <sup>2</sup>University of California System, Oakland, CA; <sup>3</sup>Renal Research Institute, New York, NY; <sup>4</sup>Carnegie Mellon University, Pittsburgh, PA; <sup>5</sup>Icahn School of Medicine at Mount Sinai, New York, NY; <sup>6</sup>Quest Diagnostics Inc, Secaucus, NJ.

**Background:** Previous VA study<sup>1</sup> showed 1-year hospitalization and mortality in ESRD patients was linked to eGFR rate decline in 2 yrs pre-dialysis. This study evaluated males and females and applied the CKD-EPI 2021 eGFR equation to define clusters that estimate risk of hospitalization and death within 90 days after dialysis initiation.

**Methods:** Patients initiated on dialysis at Fresenius Medical Care with matched Quest Diagnostics clinical testing, 1/1/2015 - 9/30/2020 were included and deidentified. Inclusion criteria: a) 2 yrs of lab data; b)  $\geq 10$  serum creatinine (Scr) measurements; c)  $\geq 1$  Scr within 45 days; d)  $\geq 2$  Scr distributed over 2 quarters. Exclusion criteria were sudden eGFR increase  $> 20$  mL/min/1.73 m<sup>2</sup>, or mean eGFR  $> 30$  mL/min/1.73 m<sup>2</sup> within 45 days of dialysis. The revised CKD-EPI 2021 eGFR calculation was applied. A cubic spline was fitted to eGFRs from each patient followed by functional data clustering methods to learn patterns of eGFR trajectories. Both K-mean and functional principal component analysis were used. One-way ANOVA and  $\chi^2$  tests were used to compare the trajectory groups for continuous and categorical variables.

**Results:** 2341 patients: 42% female, mean age 64.9  $\pm$  12.3 years, 62.7% White, non-Hispanic, 15.7% Black non-Hispanic, 15.0% Hispanic. Patients grouped into 4 clusters of eGFR progression velocity: 1076 stable low cluster (slc); 920 slow decay cluster (sdc); 285 fast decay cluster (fdc), and 60 in the very fast decay cluster (vfdc). Comparing clinical laboratory test measures, faster decay groups tended to have lower levels of 25-Vit D, iPTH, and albumin; higher uACR, and slightly higher hgb A1C. Vfdc had higher WBC. 90-day mortality rates: 0.034 (slc), 0.043 (sdc), 0.084 (fdc), and 0.117 (vfdc). 90-day hospitalization rates: 0.219 (slc), 0.252 (sdc), 0.295 (fdc), and 0.500 (vfdc). Mortality HR compared to the slc was 2.98 fdc and 4.53 vfdc. Hospitalization odds ratio compared to slc 1.57 fdc and 3.84 vfdc. Cluster category was significantly associated with hospitalization and mortality, even after adjusting for demographic variables.

**Conclusions:** fdc and vfdc were associated with higher risk of hospitalization and mortality within 90-days after dialysis initiation. 1. O'Hare AM, et al. Am J Kidney Dis 2012 April; 59(4): 513-522

**Funding:** Private Foundation Support

## SA-PO399

### Glycated Albumin to Glycated Hemoglobin Ratio and Mortality in Diabetic Patients on Dialysis

Junichi Hoshino,<sup>1,2</sup> Masanori Abe,<sup>3,2</sup> Takayuki Hamano,<sup>4,2</sup> Takeshi Hasegawa,<sup>5,2</sup> Atsushi Wada,<sup>6,2</sup> Shigeru Nakai,<sup>7,2</sup> Norio Hanafusa,<sup>1,2</sup> Ikuto Masakane,<sup>8,2</sup> Kosaku Nitta.<sup>1,2</sup> <sup>1</sup>Tokyo Joshi Ika Daigaku, Shinjuku-ku, Japan; <sup>2</sup>the Japanese Society for Dialysis Therapy, Tokyo, Japan; <sup>3</sup>Nihon Daigaku Igakubu Daigakuin Igaku Kenkyuka, Itabashi-ku, Japan; <sup>4</sup>Nagoya Shiritsu Daigaku Daigakuin Igaku Kenkyuka Igakubu, Nagoya, Japan; <sup>5</sup>Showa Daigaku, Shinagawa-ku, Japan; <sup>6</sup>Kitasaito Byoin, Asahikawa, Japan; <sup>7</sup>Fujita Ika Daigaku, Toyoake, Japan; <sup>8</sup>Yabuki Hospital, Yamagata, Japan.

**Background:** Hemoglobin A1c (A1c) and glycated albumin (GA) are two blood glycated proteins commonly used to monitor glycemic control in dialysis patients with diabetes. However, little is known about the association between the GA/A1c ratio and mortality in these populations. Here, we examine these associations using a nationwide cohort.

**Methods:** We enrolled 28,994 dialysis patients with diabetes who met our inclusion criteria (female, 32.9%; mean age, 67.4  $\pm$  11.6 years; mean dialysis duration, 6.3  $\pm$  5.8 years). After dividing the patients into groups based on GA/A1c quantiles and adjusting for 18 potential confounders, adjusted hazard ratios and 95% confidence limits were calculated for 3-year mortality and cause-specific mortalities. Additionally, propensity score matching analyses were used to compare mortalities between the low and high GA/A1c groups.

**Results:** After adjusting for possible confounders, significantly worse mortality was found in patients with GA/A1c ratios of 3.6–4.0 (HR 1.21 (1.10–1.34)) or higher (HR 1.43 (1.30–1.58)) than in those with GA/A1c ratios of 3.0–3.3. The risks of infectious and cardiovascular death were higher in these patients regardless of their nutritional status. In the propensity score matching analyses, significantly worse mortality was consistently found in those with a higher ratio ( $\geq 3.3$ ) (HR 1.23 (1.14–1.33)) than in those with a lower ratio.

**Conclusions:** The GA/A1c ratio was significantly associated with 3-year mortality, especially infectious and cardiovascular mortality, in dialysis patients with diabetes. It is a promising new clinical indicator of survival in these patients, independent of their current glycemic control and nutritional markers.

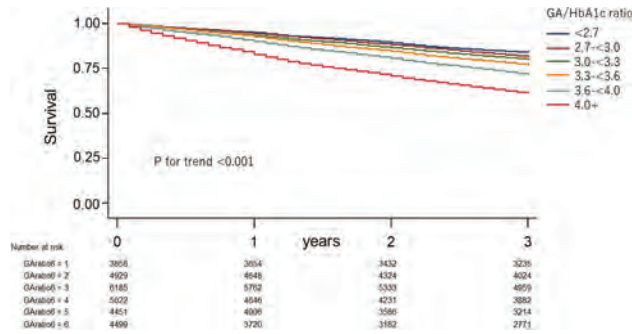

SA-PO400

**Tenapanor Plus Phosphate Binder Reduces Interdialytic Weight Gain (IDWG) in Patients With CKD on Hemodialysis (HD): Post Hoc Analysis of the AMPLIFY Study**

Steven Fishbane,<sup>1</sup> Stephen Z. Fadem,<sup>2</sup> Yang Yang,<sup>3</sup> Susan A. Edelstein,<sup>3</sup> David M. Spiegel,<sup>3</sup> <sup>1</sup>Zucker School of Medicine, Great Neck, NY; <sup>2</sup>Kidney Associates, PLLC/Baylor College of Medicine, Houston, TX; <sup>3</sup>Ardelyx, Inc., Waltham, MA.

**Background:** Excessive IDWG in patients with CKD on HD is associated with poor outcomes. Tenapanor, a novel investigational phosphate absorption inhibitor (PAI), inhibits intestinal NHE3 and increases stool Na and water content. To assess whether tenapanor might decrease IDWG and allow patients to achieve target dry weight, we performed post hoc analysis of pre-HD weights from the phase 3 AMPLIFY study (NCT03824587). We hypothesized that, compared to phosphate binder treatment alone, CKD patients treated with tenapanor and phosphate binder would have decreased IDWG and more easily approach target dry weight as reflected by a pre-HD weight decrease.

**Methods:** In AMPLIFY, patients with CKD on dialysis with high serum phosphorus (despite phosphate binder treatment) were randomized to add tenapanor 30 mg bid or placebo to their treatment regimen for 4 weeks. Pre-HD weights were recorded at baseline and week 4 after a short interdialytic interval. We evaluated the impact of tenapanor on pre-HD weight over the 4-week study.

**Results:** At week 4, mean pre-HD weight decreased with tenapanor and increased with placebo (Table), and weight percent change differed significantly between tenapanor and placebo groups (LS mean difference: -0.81%, P=0.0284; Table). At week 4, pre-HD weight decreased by a greater percentage in the tenapanor vs placebo groups (Table), and pre-HD weights decreased in a greater number of patients from the tenapanor group and increased in a greater number from the placebo group (Figure).

**Conclusions:** These results suggest that tenapanor may reduce IDWG. The potential to control serum phosphorus while helping patients achieve target weight may be beneficial for patients on HD.

**Funding:** Commercial Support - Ardelyx, Inc.

Treatment group	Baseline mean (SD) pre-HD weight, kg	Week 4 mean (SD) pre-HD weight, kg	LS mean (SE) pre-HD weight percent change, %	LS mean difference (SE) in percent change, ANCOVA P value*	Patients with any decrease in pre-HD weight at week 4, n (%)	Odds ratio, CMH test P value**
Tenapanor + phosphate binder (n=103)	96.2 (23.0)	95.8 (23.0)	-0.24 (0.27)	-0.81 (0.37) P=0.0284	58 (56.3)	2.06 P=0.0126
Placebo + phosphate binder (n=107)	90.0 (26.6)	90.2 (26.3)	0.57 (0.29)		45 (42.1)	

\*P value, LS means, and SEs were obtained from an ANCOVA model with sex, phosphate binder type, and treatment as factors and baseline pre-HD weight as a covariate.  
\*\*P value was obtained from CMH test controlling for sex and phosphate binder type.  
ANCOVA, analysis of covariance; CMH, Cochran-Mantel-Haenszel; HD, hemodialysis; LS, least squares; SD, standard deviation; SE, standard error.

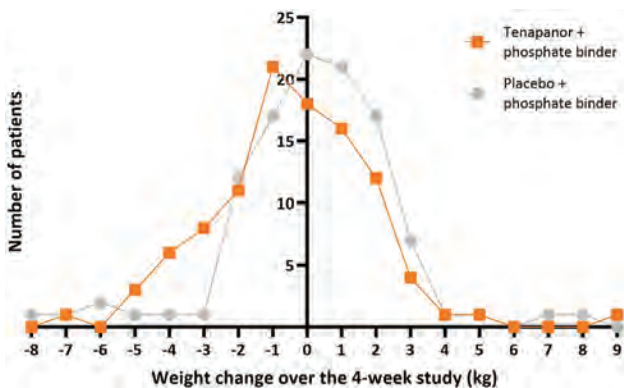

SA-PO401

**Correlation of Serum Phosphate With Pruritus Severity and Response to Difelikefalin**

Geoffrey A. Block,<sup>1</sup> Pieter Evenepoel,<sup>2</sup> Steven Fishbane,<sup>3</sup> Jeffrey J. Budden,<sup>4</sup> Isabelle Morin,<sup>4</sup> Frederique Menzaghi,<sup>5</sup> Warren Wen,<sup>5</sup> Edgar V. Lerma,<sup>6</sup> <sup>1</sup>Denver Nephrology, Denver, CO; <sup>2</sup>University Hospitals Leuven, Leuven, Belgium; <sup>3</sup>Northwell Health, Great Neck, New York, NY; <sup>4</sup>Vifor Pharma Ltd, Glattpburg, Switzerland; <sup>5</sup>Cara Therapeutics Inc, Stamford, CT; <sup>6</sup>University of Illinois at Chicago College of Medicine, Chicago, IL.

**Background:** Chronic kidney disease-associated pruritus (CKD-aP) is often reported by hemodialysis (HD) patients, thought to result from inadequate serum phosphate (sP) control, but recent studies refute this. Difelikefalin (DFK) is a selective kappa opioid receptor agonist approved in the United States and Europe for treatment of moderate-to-severe pruritus in adults undergoing HD. DFK significantly reduced itch in the Phase 3 KALM-1 and -2 trials. This analysis determined the correlation of sP to pruritus severity and response to DFK.

**Methods:** The KALM trials enrolled HD patients with moderate-to-severe CKD-aP (mean weekly worst itch numerical rating scale (WI-NRS) >4 [KALM-1] or ≥5 [KALM-2]). Patients were randomized 1:1 to intravenous DFK 0.5 µg/kg or placebo (PBO) 3 times/week (Wk) for 12 wks. Correlation between sP and WI-NRS at baseline and Wk 12 was assessed, as well as response to DFK in patients with and without hyperphosphatemia (sP ≤5.5 vs >5.5 mg/dL) at baseline.

**Results:** In pooled data (DFK and PBO), patients with baseline sP ≤5.5 mg/dL (N=438) had similar baseline characteristics to patients with sP >5.5 mg/dL (N=407). Baseline WI-NRS (7.1±1.4 vs 7.2±1.5) and anti-itch medication use (37.9% vs 38.1%) were similar. No correlation was observed between WI-NRS and sP values at baseline (p=0.54) [Figure] or Wk 12 (p=0.27). Clinically relevant improvement in WI-NRS following DFK treatment was similar in sP subgroups ≤5.5 vs >5.5 mg/dL (39.3% vs 40.2% for ≥4-point improvement; 51.1% vs 57.6% for ≥3-point improvement) and a significantly higher proportion of patients in the DFK group vs placebo reported a ≥4-point improvement in both sP subgroups (p≤0.017).

**Conclusions:** sP did not correlate with pruritus severity or response to DFK in patients with CKD-aP.

**Funding:** Commercial Support - Vifor Pharma

**Figure:** Correlation of baseline worst itch numerical rating scale score by baseline phosphate value (Intent-to-treat population for pooled difelikefalin and placebo patients)

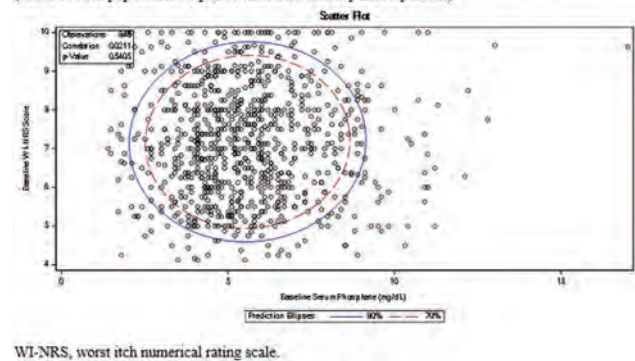

SA-PO402

**Implementation of a Nationwide Online Exercise Program in Hemodialysis Patients**

Diogo V. Leal,<sup>1</sup> Pedro M. Martins,<sup>1,2</sup> Daniela F. Cardoso,<sup>1</sup> Manuel A. Ferreira,<sup>2,3</sup> Kenneth R. Wilund,<sup>4</sup> Joao L. Viana,<sup>1</sup> <sup>1</sup>Research Center in Sports Sciences, Health Sciences and Human Development (CIDESD), University of Maia, Maia, Portugal; <sup>2</sup>Nephrocare Portugal SA, Lisbon, Portugal; <sup>3</sup>Nova Medical School, Faculdade de Ciências Médicas, Lisbon, Portugal; <sup>4</sup>University of Illinois Urbana-Champaign Department of Kinesiology and Community Health, Champaign, IL.

**Background:** Physical inactivity of HD patients was aggravated during the COVID-19 pandemic due to the imposed lockdown and suspension of ongoing intradialytic exercise program (IDE). To address this, we have developed an online exercise program (OLEP). The aim of this study was to analyze its implementation over a 12-weeks period.

**Methods:** Implementation study based on retrospective analysis using the RE-AIM framework (reach, effectiveness, adoption, implementation, maintenance). OLEP was proposed to 24 HD units previously offering IDE and included live online exercise sessions (3 times/week) led by 2 exercise physiologists via Zoom®. For each RE-AIM dimension specific implementation outcomes were adapted to OLEP. Effectiveness measures included safety (adverse events during exercise sessions) and in-clinic physical function tests (sit-to-stand 5 and 30, 8-foot up and go (8UG), handgrip strength and single leg stance) performed at baseline and 12 weeks in a group of OLEP participants and a group of patients who refused to participate.

**Results:** OLEP was adopted by 16 units (66.7%). Among 2063 patients of these units, 313 (15.2%) were eligible. Of those, 84 accepted to participate in OLEP (4.1% reach of all patients). Compared to refusals, OLEP participants had higher female proportion

( $p=0.009$ ), higher education level ( $p<0.001$ ), lower lean tissue index and handgrip strength (both  $p<0.001$ ), and completed less steps/day ( $p=0.008$ ). Maintenance in OLEP over the 12 weeks was 59.5%, i.e., 40.5% drop-out – of which 65% were voluntary. Implementation fidelity (patient’s adherence to exercise sessions) was  $73.1\pm 18.8\%$ , and implementation dose was  $2.2\pm 0.6$  exercise sessions/week. Effectiveness: OLEP participants improved performance in all physical function measures ( $p<0.05$ ), except in 8UG ( $p=0.677$ ), whilst refusals did not ( $p>0.05$ ); no severe adverse events were reported.

**Conclusions:** Our data suggests that an OLEP is realistic, safe and may improve physical function. Therefore, its applicability may subsist beyond the pandemic and be used to complement IDE. However, strategies to increase proficiency to use mobile health technology may be needed to reach more patients.

**Funding:** Government Support - Non-U.S.

SA-PO403

**Blood Pressure Changes After Arteriovenous Fistula Creation in Hemodialysis Patients**

Juan C. Duque, Karen Manzur-Pineda, Laisel Martinez, Adriana Dejman, Marwan Tabbara, Roberto I. Vazquez-Padron. University of Miami School of Medicine, Miami, FL.

**Background:** Hypertension (HTN) is highly prevalent in patients with end stage kidney disease (ESKD), reporting a rate of up to 86%. However, accepted definitions of HTN and blood pressure (BP) targets have not been established. Initiation of HD may impact the management of HTN. In addition, an arteriovenous fistula (AVF) creation poses significant hemodynamic changes. Studies have shown reduction in 24-hour ambulatory BP after a central AVF creation in patients with severe HTN and preserved renal function. We evaluate the effect of an AVF creation for dialysis on BP changes.

**Methods:** Retrospective study from 2019 to 2020 evaluated 159 patients who underwent a hemodialysis AVF creation. Vital signs were recorded by the same clinic staff and using the same equipment at five different time points: vein mapping, surgical creation, first post-surgical follow-up, second surgery (AVF transposition), and last follow-up before AVF is ready for cannulation. Demographic data, comorbidities, and pharmacological antihypertensive regimen were also collected.

**Results:** The mean age at AVF creation was  $58 \pm 13$  years with a BMI average of  $23.9 \pm 5.3$  kg/m<sup>2</sup>. A 56.7% of the cohort were Hispanic, 37.1% African American, and 6.2% Caucasian. HTN was present in (74.2%) and diabetes (40.2%). 96 patients were on HD using a dialysis catheter, and the rest were CKD stage 5 not on HD. A 52.7% were on CCB, Beta blockers in 50.2%, loop diuretics in 31.4%, hydralazine in 21.3%, ACEI/ARBs in 16.9%, clonidine in 10.6%, and isosorbide in 4.4%. Average BP during the vein mapping was  $137.78/76.3 \pm 25.9/12.5$  mmHg with heart rate (HR) of  $84.4 \pm 7.5$ ; at the AVF creation  $134.7/73.1 \pm 24/12.7$  mmHg with HR of  $73.2 \pm 11.8$ ; at the first follow-up  $135.4/71.6 \pm 23.1/11.7$  mmHg with HR of  $80.8 \pm 12$ ; at the second surgical intervention  $132.4/72.8 \pm 21.4/11.7$  mmHg with HR of  $74.3 \pm 11$ ; and last follow-up  $158.3/74 \pm 18/12.7$  mmHg with HR of  $81.8 \pm 13$ . No correlation was found between collected covariates and BP changes, and no improvement in BP was found.

**Conclusions:** Hypertension is highly prevalent in CKD 5 and ESKD patients requiring multipharmacological management. An AVF creation did not improve BP control in the short-term follow-up in our population. Moreover, we can conclude that other comorbid conditions do not correlate with hemodialysis AVF creation and BP control.

**Funding:** NIDDK Support, Other NIH Support - R01-DK121227, K08-HL151747

SA-PO404

**Disruption of the Blood Brain Barrier in ESKD: A Novel Mechanism of Cognitive Impairment**

Archana Gautam, Rebecca J. Lepping, William M. Brooks, Kate J. Young, Joseph Donald, Branden W. Comfort, Md Omar Faruque, Neal Montgomery, Alan S. Yu, Aditi Gupta. The University of Kansas Medical Center, Kansas City, KS.

**Background:** Cognitive impairment is common in end stage kidney disease (ESKD). Although disruption of blood brain barrier (BBB) integrity is an early biomarker of cognitive impairment and dementia, BBB has not been assessed in ESKD since gadolinium-based contrast-enhanced MRI used to measure BBB is impractical in ESKD.

**Methods:** In this novel single-center cross-sectional pilot study, we used single-photon emission computed tomography (SPECT-CT) with <sup>99m</sup>Tc labelled DTPA to assess BBB integrity in ESKD. We enrolled 7 ESKD patients and 6 healthy controls (without chronic kidney disease). All participants underwent brain SPECT-CT and cognitive assessments. Cohens D was calculated to compare the SPECT-CT standardized uptake values (SUV) between ESKD and controls.

**Results:** Despite the ESKD group being younger ( $50.6 \pm 13.3$  years) than the control group ( $57.7 \pm 5.9$  years), the ESKD group had a higher SUV ( $0.241 \pm 0.034$ ) indicating a greater disruption of BBB integrity than the control group ( $0.161 \pm 0.033$ ). Cohens D (measure of standard deviations between two means) = 2.35. Figure 1 shows the distribution of SUVs. The ESKD group performed worse on neuropsychological tests, in particular tests of verbal fluency, delayed recall, and Trail making B, than the control group.

**Conclusions:** This is the first report demonstrating that BBB integrity is severely disrupted in ESKD patients compared with controls. The association of BBB disruption with cognitive impairment in ESKD suggests that BBB should be further studied as a novel mechanism underlying cognitive impairment in ESKD.

**Funding:** Other NIH Support - National Institute of Ageing

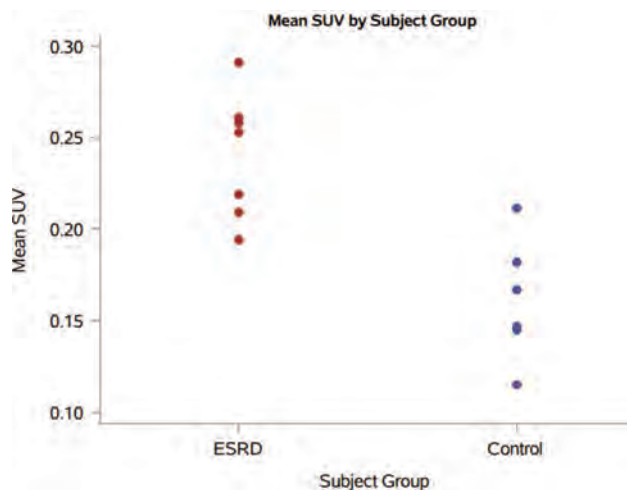

SA-PO405

**On the Removal of Middle Molecules and Albumin Loss: An Ex Vivo Evaluation of Commercial Dialyzers**

Franziska Hagemann, Hannah Roth, John Linkhorst, Matthias Wessling. Rheinisch-Westfälische Technische Hochschule Aachen, Aachen, Germany.

**Background:** An improved removal of middle-molecular-weight uremic toxins in hemodialysis treatments is essential for the patient’s health. Tailoring the membrane’s molecular weight cut off increases the removal of the toxins. However, an undesirable albumin loss is an often associated side effect and a potential concern for clinical use. A narrower pore size distribution counteracts the unwanted albumin loss. This study presents data on clearance and albumin loss at different blood and dialysate flow rates using novel dialyzers.

**Methods:** This study investigates the clearances for middle molecules in four commercial dialyzers with comparable surface areas. Simulated dialysis treatments were conducted using human plasma. The concentrations of the molecules were analyzed during 60min. The albumin loss was evaluated for 4h in a simulated hemodialysis treatment with bovine blood.

**Results:** The size dependent clearance shows the same trend for all dialyzers. The larger the middle molecule the less the impact of increasing blood flow on clearance. Theranova achieves the most elevated clearance results for small and Phylther for large middle-molecules, cf. Tab 1. However, Phylther showed the highest albumin loss during a 4h treatment compared to the investigated dialyzers, cf. Tab 1.

**Conclusions:** Novel dialyzers with extended permeability enable the removal of middle molecules when used in chronic and acute settings. Phylther stands out with higher removal of the middle molecule YKL-40, compared to the other dialyzers but exhibits a significant albumin loss. Theranova demonstrates the best trade-off between low albumin loss and good clearances of middle molecules.

**Funding:** Commercial Support - Baxter Int., Inc., supported the work.

	Molecule	Cb/Ob/Uf (ml/min)	Theranova500 (Baxter)	PhyltherHF20SD (Medtronic)	VitabranWE-21X (Asahi)	Elise19HX (Nipro)
Clearance Mean (SD) [ml/min]	β2-M	200/500/10	102.6 (2.8) <sup>a</sup>	88.1 (8.9) <sup>a</sup>	96.1 (0.8) <sup>ab</sup>	86.8 (5.9) <sup>a</sup>
	11.8kDa	300/500/10	106.3 (5.4)	87.1 (6.4) <sup>a</sup>	96.8 (3.1) <sup>ab</sup>	92.5 (3.3) <sup>ab</sup>
	400/600/10	119.5 (7.5)	100.5 (5.8) <sup>a</sup>	103.3 (3.1) <sup>a</sup>	90.6 (1.7) <sup>ab</sup>	90.6 (1.7) <sup>ab</sup>
Myoglobin Mean (SD) [ml/min]	200/500/10	64.3 (2.1)	56.8 (2.2)	55.0 (1.9) <sup>a</sup>	40.6 (1.8) <sup>ab</sup>	40.4 (2.0) <sup>ab</sup>
	300/500/10	64.4 (2.6)	63.2 (4.8)	54.8 (1.1) <sup>a</sup>	40.4 (2.0) <sup>ab</sup>	40.4 (2.0) <sup>ab</sup>
	400/600/10	69.0 (4.3)	65.1 (2.9)	55.3 (2.6) <sup>ab</sup>	35.3 (2.1) <sup>ab</sup>	35.3 (2.1) <sup>ab</sup>
YKL-40 Loss (SD) [µg/4h]	200/500/10	31.2 (1.2)	41.8 (1.1) <sup>a</sup>	23.2 (0.9) <sup>ab</sup>	13.9 (0.3) <sup>ab</sup>	13.9 (0.3) <sup>ab</sup>
	300/500/10	30.9 (1.1)	44.6 (1.0) <sup>a</sup>	23.4 (1.5) <sup>ab</sup>	15.8 (1.0) <sup>ab</sup>	15.8 (1.0) <sup>ab</sup>
	400/600/10	32.6 (2.7)	48.0 (2.1) <sup>a</sup>	23.1 (1.5) <sup>ab</sup>	13.7 (0.9) <sup>ab</sup>	13.7 (0.9) <sup>ab</sup>
Albumin	300/500/10	2.1 (0.4)	5.6 (0.8) <sup>a</sup>	2.6 (0.4) <sup>a</sup>	0.3 (0.1) <sup>ab</sup>	0.3 (0.1) <sup>ab</sup>

Tab 1: Clearance and albumin loss results <sup>a</sup> vs. Theranova <sup>b</sup>vs. Phylther <sup>c</sup>vs. Vitabran;  $p < 0.05$

SA-PO406

**Comparative Effectiveness in Removing Uremic Toxins Between Hemodialysis With Reuse and Single-Use Super High-Flux Dialyzer**

Piyaporn Prapunwatana,<sup>1</sup> Pajaree Chariyavilaskul,<sup>2</sup> Paweena Susantitaphong,<sup>1</sup> Yingyos Avihingsanon,<sup>1</sup> Somchai Eiam-Ong,<sup>1</sup> Khajohn Tirananathanagul.<sup>1</sup>  
<sup>1</sup>Chulalongkorn University Faculty of Medicine, Bangkok, Thailand; <sup>2</sup>Clinical Pharmacokinetics and Pharmacogenomics Research Unit, Department of Pharmacology, Faculty of Medicine, Chulalongkorn University, Bangkok, Thailand.

**Background:** Although hemodialysis (HD) with single use super high-flux dialyzer (SHF) provided comparable uremic toxin removing efficacy of both small (such as β2-microglobulin, β2M) and large (for example λ-free light chain, FLC) middle molecules to high volume post-dilution online hemodiafiltration, the single use SHF is expensive. The

present study was conducted to compare uremic toxin removing effectiveness between HD with reuse SHF and single-use SHF.

**Methods:** In this single center prospective study, 5 stable thrice-a-week HD patients underwent 3 periods of HD with reuse SHF dialyzer (ELISIO-21 HX), reprocessed with peracetic acid. In each period, one SHF dialyzer was maximally reused for 15 times and each patient utilized 2-4 SHF dialyzers for the whole study. The RR values of  $\beta$ 2M and  $\lambda$ -FLC were compared between the 1<sup>st</sup> use and the 2<sup>nd</sup>, 5<sup>th</sup>, 10<sup>th</sup>, and 15<sup>th</sup> use. The 1<sup>st</sup> use of each SHF dialyzer was utilized to represent the single-use SHF dialyzer. Dialysate albumin lost and serum albumin were assessed.

**Results:** A total of 15 dialyzers were analyzed. The RR of  $\beta$ 2M (should be  $\geq$  80%) was comparable between the 1<sup>st</sup> use and 15<sup>th</sup> use ( $85.5 \pm 5.9\%$  vs  $82.5 \pm 3.5\%$ ). The  $\lambda$ -FLC RR (should be  $\geq$  40%) was  $50.4 \pm 4.9\%$  at the 1<sup>st</sup> use which was significantly dropped to  $40.0 \pm 5.8\%$  and  $32.3 \pm 5.5\%$  at the 5<sup>th</sup> and 15<sup>th</sup> use, respectively ( $p < 0.001$ ). Dialysate albumin loss was significantly decreased from 1.01 g at the 1<sup>st</sup> use to 0.19 and 0.06 g at the 2<sup>nd</sup> and 5<sup>th</sup> use and undetectable after the 10<sup>th</sup> use. No statistically significant changes in serum albumin and Kt/V were found.

**Conclusions:** HD with reuse SHF dialyzer provided comparable ability to remove  $\beta$ 2M to single use SHF while the effectiveness in removing  $\lambda$ -FLC was gradually reduced after reuse. The removal of  $\lambda$ -FLC in the 5<sup>th</sup> use SHF was still comparable to high-volume online HDF. In conclusion, HD with reuse SHF dialyzer reprocessed with peracetic acid can be an alternative method to single use SHF with similar efficacy to high-volume online HDF at the 5<sup>th</sup> use.

**Funding:** Private Foundation Support

#### SA-PO407

##### The Efficacy of Post-Dilution Online Hemodiafiltration and Medium Cut-Off Dialyzer on the Removal of Protein-Bound Uremic Toxins

Ju young Moon,<sup>1</sup> Yang gyun Kim,<sup>1</sup> Su Woong Jung,<sup>1</sup> Dae Kyu Kim,<sup>1</sup> Sangho Lee,<sup>1</sup> Gun Tae Jung,<sup>4</sup> Kwang Pyo Kim,<sup>4,5</sup> Young-Il Jo,<sup>3</sup> Kyubok Jin,<sup>2</sup> Yaerim Kim,<sup>2</sup> <sup>1</sup>Kyung Hee University School of Medicine, Seoul, Republic of Korea; <sup>2</sup>Keimyung University Dongsan Medical Center, Daegu, Republic of Korea; <sup>3</sup>Konkuk University Medical Center, Gwangjin-gu, Seoul, Republic of Korea; <sup>4</sup>Department of Applied Chemistry, Institute of Natural Science, Global Center for Pharmaceutical Ingredient Materials, Kyung Hee University, Seoul, Republic of Korea; <sup>5</sup>Department of Biomedical Science and Technology, Kyung Hee Medical Science Research Institute, Kyung Hee University, Seoul, Republic of Korea.

**Background:** The accumulation of protein-bound uremic toxins (PBUT), which is not easily removed in conventional hemodialysis (HD), is associated with increased cardiovascular outcomes in dialysis patients. High-efficiency HD is known to eliminate uremic toxins more efficiently, but data regarding PBUTs and dialysis modalities, especially medium cut-off (MCO) membrane, is scarce. Therefore, this study was designed to assess the efficacy of PBUTs clearance according to dialysis modalities.

**Methods:** In this prospective cross over multicenter study, dialysis removal of uremic toxins including urea, lambda free light chain( $\lambda$ -FLC), beta 2-microglobulin( $\beta$ 2MG), indoxyl sulfate(IS), and p-cresyl sulfate(pCS) were measured in the 22 HD patients on high-flux HD (HF-HD) with FX CorDiax80, post-dilution online hemodiafiltration (Post-OL-HDF) with Fx CorDiax800, MCO-HD with TheraNova 500 over three weeks each (Figure 1).

**Results:** The average convection volume in Post-OL-HDF was  $21.4 \pm 1.8$ L per session. The reduction rate(RR) of middle-molecular weight uremic toxins was significantly higher in MCO-HD and Post-OL-HDF than in HF-HD. The RR of  $\lambda$ -FLC was higher ( $p=0.001$ ), while the RR of  $\beta$ 2MG was lower ( $p=0.004$ ) in MCO-HD than in Post-OL-HDF. The dialysate albumin was highest in MCO-HD ( $2547.3 \pm 968.3$ mg/session), followed by Post-OL-HDF ( $778.3 \pm 313.2$ mg/session) and HF-HD ( $59.9 \pm 70.8$ mg/session). Post dialysis serum levels of IS (HF-HD:  $15.3 \pm 10.4$  mg/L, Post-OL-HDF:  $12.9 \pm 6.8$  mg/L in, MCO-HD:  $13.1 \pm 7.1$  mg/L) and pCS (HF-HD:  $26.6 \pm 12.3$  mg/L, Post-OL-HDF:  $24.8 \pm 14.1$  mg/L, MCO-HD:  $23.4 \pm 13.7$  mg/L) were not statistically different. Total solute removal of IS (HF-HD:  $95.0 \pm 96.0$  mg, Post-OL-HDF:  $83.6 \pm 13.0$  mg, MCO-HD:  $74.3 \pm 66.8$  mg), pCS (HF-HD:  $114.6 \pm 58.1$  mg, Post-OL-HDF:  $126.2 \pm 69.5$ mg, MCO-HD:  $101.7 \pm 57.4$  mg), and dialytic clearance of IS (HF-HD:  $22.1 \pm 19.9$  mL/min, Post-OL-HDF:  $19.5 \pm 17.2$  mL/min, MCO-HD:  $19.6 \pm 15.8$  mL/min), pCS (HF-HD:  $13.6 \pm 2.8$  mL/min, Post-OL-HDF:  $15.3 \pm 3.2$  mL/min, MCO-HD:  $14.1 \pm 3.9$  mL/min) also did not show a significant difference.

**Conclusions:** This study shows no significant difference in the removal of PBUTs according to three dialysis modalities, even though albumin removal was the highest in MCO-HD.

#### SA-PO408

##### Combined Hemodialysis or Hemodiafiltration With Hemoperfusion Treatment for Removal of Uremic Toxins

Aglaia Chalkia, Dimitris Kourmiotis, Zoi Alexakou, Margarita Mpora, Emelina Stambolliu, Athanasia Kapota, Dimitrios I. Petras. *Nephrology Department, Hippokraton General Hospital, Athens, Greece.*

**Background:** The combination of hemodialysis-hemoperfusion (HDHP) has been proved to be superior to hemodialysis (HD) in eliminating uremic toxins. The optimal prescription is not fully elucidated.

**Methods:** 28 patients with end-stage renal disease were divided into 3 groups. We prescribed in group A hemodialysis (HD) and hemoperfusion (HP) sessions (HDHP), group B only HD and group C hemodiafiltration (HDF) and HP sessions (HDFHP). The

reduction ratio (RR) of targeted uremic toxins (low and medium) for each session was assessed. We used the HA-130 adsorption cartridge.

**Results:** The patients presented median age  $71 \pm 12$  years and median time on HD  $12 \pm 2$  months. We prescribed the HP session once biweekly (for the 1st month) and once monthly (for 11 months) during the first 2H of a regular HD or HDF. After 12 months of this intervention, both HDHP (n=12) and HDFHP (n=8) showed a significant removal of small water-soluble solutes, like urea (HDHP PR  $37 \pm 1$ ,  $p=0.03$ ; HDFHP  $25 \pm 6$ ,  $p=0.034$ ), compared to HD (n=8) (PR  $1 \pm 0.5$ ,  $p=0.09$ ). Regarding middle-sized molecules, HDHP and HDFHP also showed a significant increase in removal of  $\beta$ 2-microglobulin (HDHP PR  $6 \pm 0.7$ ,  $p=0.023$ ; HDFHP  $16.7 \pm 0.2$ ,  $p=0.037$ ) but not for iPTH, compared to HD (PR  $1.2 \pm 0.7$ ,  $p=0.098$ ). As far as safety, we only reported low intradialytic blood pressure at 5% of the patients to whom HP was added.

**Conclusions:** We demonstrated that a combination of hemodialysis or hemodiafiltration and hemoperfusion for 12 months helped efficaciously to reduce low and middle uremic toxins.

#### SA-PO409

##### Comparison of High-Flux, Super High-Flux, Medium Cut-Off Hemodialysis and Online Hemodiafiltration on the Removal of Uremic Toxins

Mohamed Belmouaz, Guillaume Goussard, Florent Joly, Betous Thomas, Frank Bridoux. *Universite de Poitiers UFR Medecine et Pharmacie, Poitiers, France.*

**Background:** Middle molecules (MM) that are inadequately removed by high-flux (HF) hemodialysis (HD) strategies are thought to contribute to the high morbidity and mortality of HD patients. On-line hemodiafiltration (OL-HDF) and HD using high-performance membranes such as adsorptive, medium cut-off (MCO), super high-flux (SHF) or protein permeable dialyzers have been implemented to enhance the removal of MM. The aim of this study was to compare the efficacy of these dialyzers used under different dialysis strategies on small solutes and MM reduction ratio (RR) and mass removal.

**Methods:** We performed a prospective study in 8 HD patients. Each patient underwent 9 dialysis sessions: seven sessions on HD using either TheraNova 500<sup>TM</sup>, Elisio 21H<sup>TM</sup>, Renak PS-2.0W<sup>TM</sup>, Filtrizer BK-2.1F<sup>TM</sup>, Vie 21X<sup>TM</sup>, TS-2.1UL<sup>TM</sup> or FDY 210-GW<sup>TM</sup> dialyzers and two sessions on OL-HDF using Elisio 21H<sup>TM</sup> or Renak PS-2.0W<sup>TM</sup> dialyzers.

**Results:** Urea mass removal and RR were similar between all dialysis strategies. The lowest beta2-microglobulin RR was achieved with Filtrizer BK-2.1F<sup>TM</sup> HD ( $p < 0.05$ ). Compared to Elisio 21H<sup>TM</sup> HD, Renak PS-2.0W<sup>TM</sup> OL-HDF produced higher beta2-microglobulin mass removal ( $181 \pm 46$  vs  $317 \pm 161$  mg,  $p < 0.05$ ). TheraNova 500<sup>TM</sup> HD, Vie 21X<sup>TM</sup> HD, FDY 210-GW<sup>TM</sup> HD, Elisio 21H<sup>TM</sup> OL-HDF and Renak PS-2.0W<sup>TM</sup> OL-HDF induced higher RR for kappa and lambda FLC, as compared to Elisio 21H<sup>TM</sup> HD and Filtrizer BK-2.1F<sup>TM</sup> HD ( $p < 0.05$ ). TS-2.1UL<sup>TM</sup> HD and Renak PS-2.0W<sup>TM</sup> HD produced higher lambda FLC RR compared to Elisio 21H<sup>TM</sup> HD ( $p < 0.05$ ). Renak PS-2.0W<sup>TM</sup> OL-HDF achieved higher kappa FLC mass removal compared to Elisio 21H<sup>TM</sup> HD ( $563 \pm 515$  vs  $141 \pm 47$  mg,  $p < 0.01$ ) and to Renak PS-2.0W<sup>TM</sup> HD ( $563 \pm 515$  vs  $153 \pm 25$  mg,  $p < 0.05$ ). Albumin loss varied from  $0.02 \pm 0.05$  to  $7.6 \pm 3.8$  g/session with Elisio 21H<sup>TM</sup> HD and Renak PS-2.0W<sup>TM</sup> OL-HDF, respectively. Compared to all other strategies, Renak PS-2.0W<sup>TM</sup> OL-HDF induced a significantly higher albumin loss ( $p < 0.05$ ).

**Conclusions:** This study confirms that albumin loss and the removal of MM, are similar using conventional Elisio 21H<sup>TM</sup> OL-HDF, MCO-HD (TheraNova 500) and SHF type V dialyzers (Vie 21X and FDY 210-GW). Although Renak PS-2.0W<sup>TM</sup> OL-HDF provides high performance for MM depuration, this protein-permeable dialyzer should not be used in post-dilution OL-HDF because of albumin loss exceeding the theoretical acceptable limit of 5 g per session.

#### SA-PO410

##### Improved Removal of Free Light Chains by Hemodialysis With Medium Cut-Off Dialyzer

Jung eun Lee, Jong Hyun Jhee, Hyeong cheon Park. *Yonsei University College of Medicine, Seodaemun-gu, Seoul, Republic of Korea.*

**Background:** Free light chains (FLCs), well known middle molecular uremic toxins, are frequently elevated in patients with renal impairment. They are associated with chronic inflammation and vascular calcification and often elevated FLCs lead to increased morbidity and mortality. Recent studies suggest that middle to large molecules are more efficiently removed by medium cut-off (MCO) dialyzers than high-flux dialyzer. This study aimed to investigate the efficacy of MCO dialyzer on elimination of FLC compared to high-flux dialyzer in patients undergoing hemodialysis.

**Methods:** A randomized prospective study was performed with 68 participants, divided into MCO dialyzer group (n = 34) and high-flux dialyzer group (n = 34). Serum levels of middle to large molecules including kappa and lambda FLCs, and beta-2 microglobulin, and their reduction ratios were measured at baseline and after 6 months, and compared between two groups.

**Results:** Baseline serum levels of albumin, calcium, inorganic phosphate and hemoglobin, and Kt/V did not differ between two groups. After 6 months, Kappa FLCs (from  $354.4 \pm 509.7$  to  $304.7 \pm 401.8$  mg/L, vs. from  $236.7 \pm 73.8$  to  $248.2 \pm 73.8$  mg/L;  $p = 0.016$ ), lambda FLCs (from  $204.9 \pm 60.3$  to  $183.4 \pm 57.8$  mg/L, vs. from  $190.1 \pm 52.0$  to  $198.8 \pm 79.4$  mg/L;  $p = 0.001$ ), and beta-2 microglobulin levels (from  $29.5 \pm 5.8$  to  $25.6 \pm 3.4$  mcg/mL, vs. from  $26.9 \pm 5.7$  to  $26.4 \pm 5.2$  mcg/mL;  $p = 0.019$ ) of MCO dialyzer group were significantly decreased, and while those of high-flux group were increased. The reduction ratios of kappa and lambda FLCs, and beta-2 microglobulin in MCO group were higher than those of high-flux group ( $10.5$  vs.  $-5.3\%$ ,  $11.1$  vs.  $-3\%$ , and  $10.6$  vs.  $-1\%$ , respectively). After 6 months, there was no change in serum albumin levels between two groups.

Key: TH - Thursday; FR - Friday; SA - Saturday; OR - Oral; PO - Poster; PUB - Publication Only

Underline represents presenting author.

**Conclusions:** Hemodialysis with MCO dialyzer shows better removal of FLCs, with preserved dialysis adequacy and serum albumin. Further studies are needed to establish the long-term effects of using MCO dialyzer on clinical outcome.

Figure 1. Difference between high-flux group and MCO group in reduction ratios of the middle molecule levels

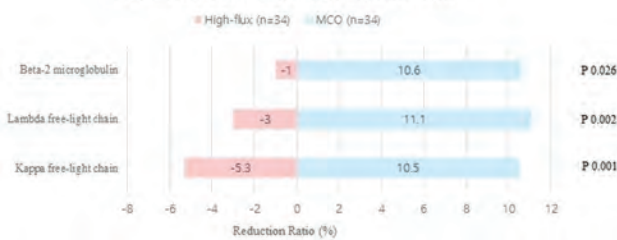

SA-PO411

**Improved Serum Phosphorous and Small Molecule Removal With Expanded Hemodialysis and Hemodiafiltration vs. Conventional Hemodialysis: A Cross-Over Randomized Clinical Trial**

Olyinka Vega, Adrián Esteban Caballero-Islas, Noemi Del Toro-Cisneros, Mauricio Arvizu Hernández, Armando Jezael Martínez-Rueda, Diana Camacho, Ricardo Correa-Rotter. *Instituto Nacional de Ciencias Medicas y Nutricion Salvador Zubiran, Ciudad de Mexico, Mexico.*

**Background:** Expanded hemodialysis (HDx) with medium cut-off dialyzers is expected to provide enhanced permeability to medium sized molecules, selective solute retention, and better internal retrofiltration. The objective of our study was to compare clearance of different size molecules in 3 modalities: conventional hemodialysis (cHD), hemodiafiltration (HDF), and HDx.

**Methods:** A single-center cross-over study was conducted in prevalent hemodialysis. Patients were randomized to determine the initial modality of treatment (Figure 1). Blood samples were taken on the first and last session in each modality and pre and post treatment. We performed ANOVA to compare groups.

**Results:** Twenty-seven stable patients were randomized, 5 were excluded (Figure 1). Twenty-two patients completed the study and were included in the analysis. The removal of small solutes (BUN) was similar in HDF and HDx and less effective in cHD (p=0.048). There was no difference in reduction ratios for medium-sized molecules (CRP, IL6, IL10, TNF $\alpha$ ), or in protein-bound p-cresol. We observed a decrease in serum phosphorous (P) in the HDx and HDF periods, contrary to what happened with cHD: (HDx 4.78 vs 3.99, HDF 5.09 vs 4.07, and cHD 4.51 vs 4.62) (Figure 2). There was no decrease in serum albumin in any of the modalities. The most frequent adverse event was intradialytic hypotension, without differences between groups.

**Conclusions:** HDF and HDx were more effective to remove small molecules vs cHD. In addition serum P values were lower in the end of period determination with HDF and HDx, which reflect a better removal of total body P with these two modalities.

**Funding:** Commercial Support - Baxter

Figure 1. Overall study design

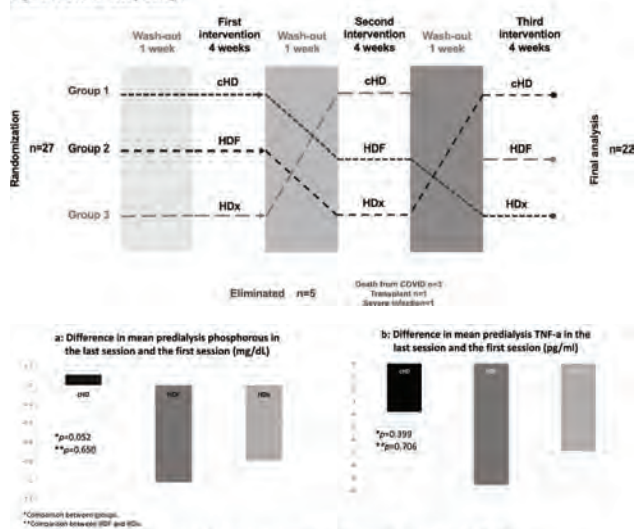

Figure 2. a: difference in predialysis phosphorous. b: difference in predialysis TNF- $\alpha$ .

SA-PO412

**A Randomized, Open-Label, Crossover Clinical Study to Compare the Effect of Hemodialysis Performed With a Medium Cut-Off Membrane vs. That With a High-Flux Membrane on Endothelial Function**

Rachel G. Armani, Aluizio B. Carvalho, Monique V. Rocha e Silva, Maria Eugenia F. Canziani. *Universidade Federal de Sao Paulo, Sao Paulo, Brazil.*

**Background:** Endothelial dysfunction (ED) is considered a marker of vascular complications, especially in patients with chronic kidney disease (CKD). Inflammation and the uremic state contribute to ED in hemodialysis (HD) patients. Recently, the medium cut-off (MCO) HD membrane has been proposed to efficiently remove inflammatory cytokines and higher molecular weight uremic toxins. The aim of this study was to compare the effect of dialysis with medium cut-off (MCO) or high-flux (HF) membranes on endothelial function of patients on chronic HD.

**Methods:** A prospective, randomized, crossover study in which 32 patients with CKD were dialyzed for 12 weeks with each membrane, including a 4-week washout period between treatments. Endothelial function was assessed by flow-mediated dilation (FMD) using brachial artery ultrasound at weeks 1, 12, 16, and 28.

**Results:** The population consisted of 59% men, 52.7 $\pm$ 13.4 years, 16% non-black, on HD for 8.8(4.1-15.1) years, 72% with arteriovenous fistula. Hypertension was the most common etiology of CKD and 34% of patients had previous cardiovascular disease. Patients were grouped, regardless of treatment sequence, into MCO or HF groups, since no carry-over (p=0.634) or sequence (p=0.998) effects were observed in the FMD assessment. The ANOVA model with repeated measures showed no effects of treatment (p=0.426), time (p=0.972) or interaction (p=0.413) in the comparison of FMD, between the MCO and HF groups. Figure 1 shows mean and respective 95% confidence interval of FMD (%) per treatment, according to evaluation moments.

**Conclusions:** Dialysis performed with MCO or HF membranes did not influence endothelial function in patients undergoing chronic HD.

**Funding:** Commercial Support - Baxter Company

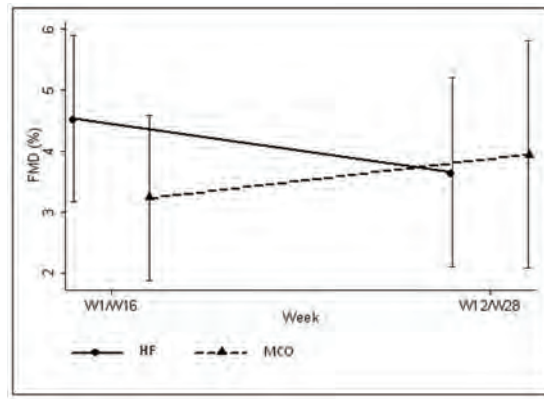

Figure 1 - Mean and respective 95% confidence interval of FMD (%) per treatment, according to evaluation moments.

SA-PO414

**Expanded Dialysis With TheraNova Compared to Conventional High-Flux Hemodialysis: A Randomized Prospective 12-Month Study**

Maggie ming yee Mok,<sup>1,2</sup> Sing-Leung Lui,<sup>1,2</sup> Tak Mao D. Chan,<sup>3,2</sup> *Tung Wah Hospital, Hong Kong, Hong Kong; <sup>2</sup>The University of Hong Kong Li Ka Shing Faculty of Medicine, Hong Kong, Hong Kong; <sup>3</sup>Queen Mary Hospital, Hong Kong, Hong Kong.*

**Background:** Hemodialysis (HD) using medium cut-off (MCO) TheraNova enables enhanced clearance of middle molecules. This study investigated the clinical effects of MCO dialysis compared with conventional HD, in Hong Kong where a significant proportion of patients were on twice-weekly HD.

**Methods:** Adult chronic HD patients were recruited from two HD units. All patients received high-flux HD over a 6-week run-in period, then were randomized (1:1) to receive high-flux HD or MCO-HD for 12 months. Primary outcomes included nutritional indexes measured by body composition monitor (BCM), and patient-reported symptom parameters. Blood parameters related to nutrition, inflammation, and cardiovascular health were also measured.

**Results:** Sixty patients were included (30 in each group) with similar baseline characteristics. Body mass index, lean and fat tissue indexes remained stable throughout within and between groups. Serum albumin in the MCO-HD group showed a significant decrease at 6-month (36.23 $\pm$ 3.36 g/L) compared with baseline (37.93 $\pm$ 2.80 g/L, p=0.043), which was significantly lower than that in controls (38.44 $\pm$ 3.43 g/L, p=0.024) at this time-point, but the level increased afterwards and the differences were not sustained. At 12-month, measured serum parameters were similar in the two groups (Tab). Symptoms related to sleep quality, appetite, itchiness, and quality of life as measured by KDQOL-SFT<sup>TM</sup> V1.3 showed no between-group difference. The incidence rates of all adverse events and hospitalizations were similar in the two groups, including events related to fluid



status. Overhydration as measured by BCM was not increased in patients on MCO-HD compared with controls, while ultrafiltration was only used in the latter.

**Conclusions:** MCO-HD with TheraNova over 12 months was safe and well tolerated, resulting in similar morphometric and biochemical parameters of nutritional status compared with patients on high-flux HD. Patients treated with MCO-HD showed an initial decrease in serum albumin which returned to prior levels after 6 months.

**Funding:** Commercial Support - Baxter Healthcare Limited

	MCO-HD	High-flux HD	p value
Hb (g/dl)	10.27±1.59	10.25±1.22	0.968
PO <sub>4</sub> (mmol/l)	2.02±0.49	1.87±0.65	0.387
Kt/V <sub>urea</sub>	4.52±0.77	4.85±0.59	0.120
β2 microglobulin (ug/ml)	29.12±7.33	27.90±5.96	0.550
FLC kappa (mg/L)	42.69 (29.92-57.25)	35.87 (21.40-51.87)	0.302
FLC lambda (mg/L)	40.91 (31.53-54.33)	32.87 (21.95-53.42)	0.134
Pentraxin-3 (ng/ml)	1.59 (0.97-2.33)	1.33 (0.60-2.29)	0.247
hs-CRP (mg/L)	2.14 (1.01-6.19)	2.70 (0.91-7.06)	0.819
hs-IL6 (pg/ml)	8.08 (3.55-15.05)	10.84 (7.59-19.95)	0.173
NT-proBNP (pg/ml)	847.45 (398.77-1399.23)	537.08 (206.71-1037.92)	0.285
FGF-23 (pg/ml)	8700.30(5516.43-15113.87)	6743.40(4404.73-11984.29)	0.337
Thrombomodulin (pg/ml)	51.08±24.20	50.52±22.81	0.938
ADMA (ng/ml)	54.21 (33.12-58.45)	46.83 (36.97-53.83)	0.521
sST2 (ng/ml)	23.11 (15.19-36.09)	11.42 (21.04-35.34)	0.808
Leptin (ng/ml)	8.40 (2.75-47.30)	7.50 (2.85-17.21)	0.602

Tab

SA-PO415

**Evaluation of VIE-X Filter Performances vs. Medium Cut-Off Dialyzer and High-Flux Dialyzers on Protein Loss and Inflammatory Status of Chronic Hemodialysis Patients**

Matteo Marcello,<sup>1,2</sup> Anna Lorenzin,<sup>3,2</sup> Claudio Ronco,<sup>3,2</sup> Monica Zanella.<sup>3,2</sup>  
<sup>1</sup>IRCCS Ospedale San Raffaele, Milano, Italy; <sup>2</sup>Fondazione IRRIV, Vicenza, Italy; <sup>3</sup>Ospedale San Bortolo di Vicenza, Vicenza, Italy.

**Background:** In ESKD there is retention of a wide range of uremic toxins. The identification middle molecular weight toxins, has promoted interest in the development of alternative techniques in order to remove larger solutes. Hemodiafiltration (HDF) has produced some results, although large convective volume, optimal vascular access and strict water quality management are required. A new class of membrane has been recently developed with a cut off (MWCO) close to the molecular weight of albumin and a very high retention onset (MWRO), allowing convective movement of large uremic solutes even in conventional HD. The aim of this study was to evaluate the safety and efficacy of ASAHI new membrane Vie-X, comparing its performance with MCO membranes and HDF treatments.

**Methods:** A longitudinal single-center device study was conducted for 3 months among 18 chronic HD patients afferents to our center. Patients were randomly assigned to either online HDF, HDx with MCO membrane, or HD with Asahi Vie-X. Blood samples, as well as dialytic effluent, were collected during 4 dialysis sessions (T0, T1, T2, T3). The primary goal was to assess albumin loss among the three types of dialyzers.

**Results:** All dialyzers had an albumin loss lower than 5 grams per HD session. We found a greater albumin loss in patients undergoing HD with MCO membrane with a significant difference in comparison to Vie-X and online HDF, p=0.003 (Figure 1). We didn't find any statistical difference in the clearance of middle molecules such as myoglobin between the three dialyzers (p=0.22). Clearance of IL-6 was higher in patients undergoing online HDF (p<0.001).

**Conclusions:** Vie-X is a polysulfone, vitamin E-interactive membrane with presumed cut-off valued of 60kD allowing advanced sieving profiles and increased internal filtration. In our study we find Vie-X to have a safe albumin loss, comparable to that of online HDF, maintaining clearance for middle molecular weight molecules similar to MCO dialyzer and online HDF.

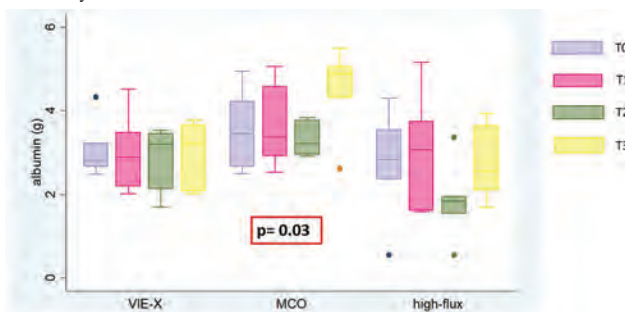

SA-PO416

**Safety and Performance of the Clearum™ High Flux Hemodialyzer**

Thilo Krueger,<sup>1</sup> Frank Dellanna,<sup>1</sup> Werner Kleophas,<sup>1</sup> Candace McClure,<sup>2</sup> Silvia Manfredini,<sup>3</sup> *DaVita Clinical Research Deutschland GmbH, Düsseldorf, Germany; <sup>2</sup>North American Science Associates Inc, Northwood, OH; <sup>3</sup>Medtronic Inc, Mirandola, Italy.*

**Background:** Clearum™ is a new high flux steam sterilized (HS) dialyzer for treatment of end stage renal disease (ESRD) patients with hemodialysis (HD) or hemodiafiltration (HDF) online. A clinical study was conducted to evaluate the safety and performance of the Clearum HS hemodialyzer in the removal of small and middle-sized uremic toxins.

**Methods:** A prospective, interventional, non-randomized study enrolled twenty (20) ESRD patients undergoing HD. The Clearum HS dialyzer was compared to Fresenius FX-series of dialyzers for a baseline (control) comparison. The duration of the trial was 2 weeks for the FX control dialyzer + 6 weeks with the Clearum HS dialyzer used for 3x weekly high flux hemodialysis.

**Results:** Nineteen (19) of 20 subjects completed the study. The primary objective of mean urea reduction ratio (URR) >65% was met. No significant difference in mean URR between the Clearum HS and Fresenius FX-series of dialyzers (p=0.97) was observed. No dialyzer-related adverse events were reported in the study. β-2-microglobulin (B2M) reduction with the Clearum HS dialyzer was statistically higher than the FX-series dialyzer (67.0% versus 54.1%; p<0.0001). Pre-dialysis interleukin-6 (IL6) and C-reactive protein (CRP) concentrations, blood-rest scores and thrombin-anti-thrombin (TAT) were comparable among the Clearum HS and FX-series of dialyzers. Finally, albumin remained at a stable level over the course of the 6 weeks of Clearum HS dialyzer use with no appreciable differences when compared to the Fresenius FX-series of dialyzers.

**Conclusions:** Overall, the Clearum HS dialyzer performed effectively in this post market study and with no reported dialyzer-related adverse events.

**Funding:** Commercial Support - Medtronic

SA-PO417

**β2-Microglobulin and α1-Microglobulin Reduction Ratios and Survival in Prevalent Dialysis Patients**

Sonoo Mizuiri,<sup>1</sup> Yoshiko Nishizawa,<sup>1</sup> Toshiaki Doi,<sup>1,2</sup> Aiko Okubo,<sup>1,2</sup> Kenichi Morii,<sup>1,2</sup> Kazuomi Yamashita,<sup>1</sup> Kenichiro Shigemoto,<sup>1</sup> Takao Masaki.<sup>2</sup>  
<sup>1</sup>Ichiyokai Harada Hospital <sup>1</sup>Iryo Hojin Ichiyokai Harada Byoin, Hiroshima, Japan; <sup>2</sup>Hiroshima Daigaku Byoin, Hiroshima, Japan.

**Background:** The β2-microglobulin (β2-MG) and α1-microglobulin (α1-MG) molecular weights are 11,800 and 33,000 Da. There are several important middle molecules including fibroblast growth factor 23 around α1-MG. β2-MG and α1-MG reduction ratios (RRs) and dialysis patient survival were studied.

**Methods:** Subjects were prevalent dialysis patients (247 predilution online hemodiafiltration [Pre-OL-HDF] and 61 hemodialysis [HD] patients). Clinical data including β2-MG and α1-MG RRs were assessed at baseline. Kaplan-Meier curves, logistic regression analyses and Cox proportional hazard models were used to assess patient survival.

**Results:** Age, dialysis duration, and diabetes prevalence in all patients (n=308) were 67±12 years, 70 (42–140) months, and 47.4%, respectively. Over 450 days, 33 patients died. The mortality cut-off values for β2-MG RR and α1-MG RR using receiver operating characteristic curves were 78% and 20%, respectively. Patients with β2-MG RR ≥78% (n=131) showed significantly higher serum albumin (3.6±0.4 vs. 3.5±0.4 g/dL) and magnesium levels and Pre-OL-HDF frequency, but a significantly lower age and C-reactive protein levels than in patients with β2-MG RR <78% (n=177) (P<0.05). These differences were observed between patients with α1-MG RR ≥20% (n=134) and α1-MG RR <20% (n=174) (P<0.05). Kaplan-Meier survival rates were significantly higher in patients with β2-MG RR ≥78% than in patients with β2-MG RR <78% and in patients with α1-MG RR ≥20% than in patients with α1-MG RR <20% (P<0.05). In unadjusted Cox models, the β2-MG RR (hazard ratio [HR] 0.97, P<0.01) and α1-MG RR (HR 0.97, P<0.05) but not HDF were predictors of all-cause mortality. After adjusting for age, sex, diabetes, dialysis duration, C-reactive protein, and normalized protein catabolic rate, the β2-MG RR (HR 0.92, P<0.01) but not the α1-MG RR remained a significant predictor for mortality. α1-MG RRs were significantly correlated with β2-MG RRs (p=0.71, P<0.0001) and serum albumin levels (p=0.21, P<0.001). β2-MG RRs were significantly correlated with serum albumin levels (p=0.23, P<0.0001).

**Conclusions:** In patients on Pre-OL-HDF or HD, higher β2-MG and α1-MG RRs showed better survival, and the β2-MG RRs was a significant determinant for mortality. Higher β2-MG and α1-MG RRs were not related to lower serum albumin levels.

**Funding:** Private Foundation Support

SA-PO418

**Molecular Sieving via Conformational Flexing During Frictionless Flow in Slippery Carbon Nanotube Membranes for Hemodialysis**

Piran Kidambi,<sup>1</sup> Peifu Cheng,<sup>1</sup> Nicholas J. Ferrell,<sup>5</sup> Carl M. Öberg,<sup>6</sup> Steven F. Buchsbaum,<sup>3</sup> Melinda L. Jue,<sup>3</sup> Dan Wang,<sup>5</sup> Shuvo Roy,<sup>4</sup> Francesco Fornasiero,<sup>3</sup> William H. Fissell,<sup>2</sup> <sup>1</sup>Vanderbilt University, Nashville, TN; <sup>2</sup>Vanderbilt University Medical Center, Nashville, TN; <sup>3</sup>Lawrence Livermore National Laboratory, Livermore, CA; <sup>4</sup>University of California San Francisco, San Francisco, CA; <sup>5</sup>The Ohio State University, Columbus, OH; <sup>6</sup>Lunds Universitet, Lund, Sweden.

**Background:** Size selective molecular separation offer transformative advances in hemodialysis. The classic trade-off between selectivity and permeability necessitates larger membrane areas (larger kits) and high pressures in conventional dialysis membranes, which limits progress towards implantable/wearable alternatives. Here, vertically aligned nanoscale capillaries embedded in a polymer matrix present new possibilities.

**Methods:** Vertically aligned carbon nanotubes (CNTs) forests were synthesized via chemical vapor deposition with precise diameter control via catalyst engineering and the space between was filled with paralyene. A microporous silicon support was used as a backing plate and the membranes mounted into a custom-built filtration cell. Hydraulic permeability was assessed via gravimetric flow rates at different transmembrane pressures. The transport of fluorescently labeled polydisperse Ficoll, either in phosphate-buffered saline (PBS) or bovine blood plasma was used to evaluate the size-selectivity. Ficoll concentrations were analyzed using size-exclusion chromatography.

**Results:** The synthesized CNT membranes membrane exhibited a cut-off ~6nm for Ficoll in PBS as well as bovine blood plasma. We measured a hydraulic permeability ~102.3 ml h<sup>-1</sup> m<sup>2</sup> mm Hg<sup>-1</sup> in comparison to ~30 ml h<sup>-1</sup> m<sup>2</sup> mm Hg<sup>-1</sup> reported in the literature for conventional high flux dialyzers. The CNT membranes allow for near complete passage of ~2 nm Ficoll molecules (Figure), which is similar to the approximate size of hemodialysis relevant small/middle molecules, e.g. b<sub>2</sub> microglobulin, while maintain clinically acceptable levels of Albumin loss.

**Conclusions:** The synthesized CNT membranes showed enhanced middle molecule clearance as well as higher hydraulic permeability compared to conventional hemodialysis membranes.

**Funding:** Other U.S. Government Support

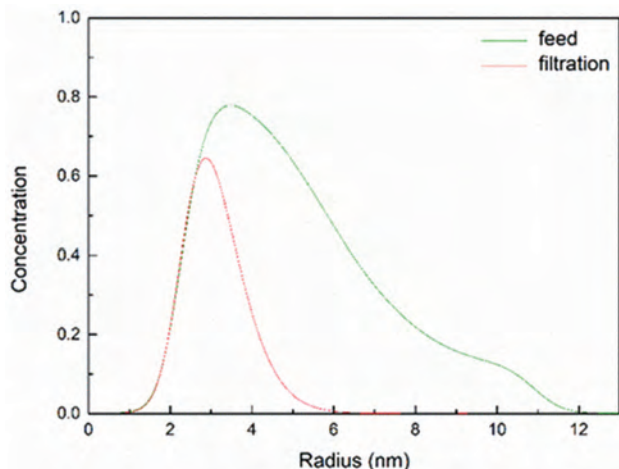

SA-PO419

**Auto Flow Feature Reduces Dialysate Use While Maintaining Dialysis Adequacy Among In-Center Hemodialysis (HD) Patients**

Meijiao Zhou, Linda Ficociello, Claudy Mullon, Michael S. Anger. *Fresenius Medical Care, Waltham, MA.*

**Background:** Adjustment of dialysate flow rate (Qd) as a proportion of blood flow rate (Qb) may lower dialysate consumption. The Auto Flow (AF) feature on Fresenius Medical Care 2008T dialysis machines can make these adjustments automatically. Using real-world data, we investigated the use of the AF feature and its impact on dialysis adequacy among in-center HD patients.

**Methods:** Adult in-center HD patients converting from manual to AF (either 1.5 or 2.0 times the Qb) during 2021 at Renal Research Institute clinics were included. All patients had Kt/V measured 3 months before and after switching to AF and no change in vascular access, dialyzer types or prescribed Qb. Parameters were averaged over each 3-month period before and after switch, and comparisons between time periods were made using paired t-tests.

**Results:** At AF switch, patients (n=48) had mean age of 64 years and vintage of 7 years. Most patients had a fistula (63%) and used Optiflux 180NRe (85%). 46% and 54% patients were switched to AF 1.5 and AF 2.0, respectively. After switch, on average, actual Qd reduced by 37 mL/min; based on the treatment time and actual Qd, we calculated that

8.6 L dialysate volume could be saved per patient per treatment (p<.0001). There was no statistically significant change in mean spKt/V, although there was a numeric increase after switch (table). Sub-analysis by AF 1.5 and 2.0, showed no change in spKt/V among patients switched to AF 1.5 (1.67) and an increase from 1.55 to 1.61 (p=0.06) among those switched to AF 2.0.

**Conclusions:** Use of the Auto Flow feature during HD maintained patients' dialysis adequacy. Based upon actual Qd and treatment time, we can estimate that this would save, on average, 8.6 L of dialysate per patient per treatment (p<0.0001).

**Funding:** Commercial Support - Fresenius Medical Care

Parameters	3-month before switch to AF	3-month after switch to AF	Mean difference	P value
UKM spKt/V	1.60	1.64	+0.03	0.12
% UKM spKt/V ≥ 1.2	100%	100%	0	/
Prescribed Qb, mL/min	428	428	0	/
Actual Qb, mL/min	418	419	+1.4	0.17
Prescribed Qd, mL/min	767	758	-8.7	0.61
Actual Qd, mL/min	737	700	-37	<.0001
Prescribed treatment time, min	211	212	+0.8	0.14
Actual treatment time, min	211	210	-1.1	0.32

SA-PO420

**The Effect of Hemodiafiltration vs. High-Flux Dialysis on Middle- and Large-Sized Molecules' Reduction and Its Relation to Albumin Loss Using Big Surface-Area Dialyzer 2.6 m<sup>2</sup>**

Hesham M. Elsayed, Magdy ElSharkawy, Hayam M. Aref, Waleed A. Abdelmohsen, Abdelrahman N. Khedr, Hussein S. Abdallah, Shaimaa Z. Abdallah, Reem A. Sultan, Mohamed F. Radwan, Aya M. Magdi, Khalid G. Abdelwahab, Abdelrahman A. Elbraky, Ahmed Emara. *Ain Shams University Faculty of Medicine, Cairo, Egypt.*

**Background:** Uremic toxins are classified into small, middle-sized, and protein-bound solutes. Removal of middle-sized molecules with minimal albumin loss is needed. This study assessed different molecules' removal using 2.6m<sup>2</sup> surface area (SA) dialyzer on high-flux haemodialysis (HF-HD) vs. hemodiafiltration (HDF) and its relation to albumin loss

**Methods:** A crossover study included 25 patients, underwent HF-HD followed by online post-dilution HDF using dialyzer; BIOPURE (*Biorema*) 260 HF (with a SA 2.6 m<sup>2</sup>, High-flux hollow Fiber Hemodialysis membrane with steam sterilization, myoglobin SC 0.7, membrane cutoff value 40 KDa.), with 2-weeks washout period. All patients were subjected to single session assessment of cumulative dialysate albumin loss, and to measurement of pre-post dialysis Reduction values of Kappa and Lambda free light chains (FLC), α-1-microglobulin (MG), IL-6 and procalcitonin by ELISA.

**Results:** There was significant reduction in post-dialysis levels of all molecules in HF-HD and HDF compared to pre-dialysis levels (P<0.001). HDF showed higher post dialysis reduction ratio of kappa and lambda FLC, α 1-MG, IL-6 and procalcitonin (P<0.001). Total dialysate albumin loss on HDF was higher compared to HF-HD with median of 2.46 (1.7 – 2.8 IQR), 0.65 (0.48 – 1.1 IQR) respectively. Maximum albumin loss on HDF was in the first hour with a median of 1.20 (0.77 – 1.3 IQR). Transmembrane pressure was positively correlated with total albumin loss in both modalities.

**Conclusions:** BIOPURE (*Biorema*) 260 HF, 2.6 m<sup>2</sup> SA, may be effective in medium-sized molecules' removal especially with online post-dilution HDF with acceptable albumin loss

**Funding:** Private Foundation Support

Different molecules (Reduction Ratio %)	HD (n = 25)	HDF (n = 25)	P
<b>Kappa (ng/ml)</b>			
Mean ± SD.	29.52 ± 6.38	45.16 ± 6.53	<0.001*
<b>Lambda (ng/ml)</b>			
Mean ± SD.	19.48 ± 1.96	28.68 ± 4.36	<0.001*
<b>Alpha 1 Microglobulin (mg/L)</b>			
Mean ± SD.	27.12 ± 7.65	41.90 ± 7.93	<0.001*
<b>IL-6 (ng/ml)</b>			
Mean ± SD.	32.48 ± 5.72	44.92 ± 5.11	<0.001*
<b>Procalcitonin (pg/ml)</b>			
Mean ± SD.	41.80 ± 4.32	50.32 ± 3.94	<0.001*

RR% of different molecules in HD vs HDF

SA-PO421

**Clinical Efficacy of Fractionated Plasma Separation and Adsorption Integrated with Continuous Veno-Venous Hemofiltration in Patients With Liver Failure**

Jianhua Dong, Li Huang, Wenjing Fan, Yongchun Ge. *JinLing Hospital, Nanjing, China.*

**Background:** To observe the clinical efficacy and safety of fractionated plasma separation and adsorption integrated with continuous veno-venous hemofiltration (FPSA-CVVH) treatment on patients with liver failure.

**Methods:** In this retrospective study, we enrolled patients with acute or acute-on-chronic liver failure (serum total bilirubin > 171.0 μmol/L or MELD Score > 18) hospitalized from 2015 to 2021. All patients received the treatment of FPSA-CVVH. The extracorporeal circulation connection is shown in Figure 1. Anticoagulation was provided with LMWH or citrate. The main efficacy evaluation index was bilirubin reduction ratios per session (RRs).

**Results:** 78 patients with acute (n=74) or acute-on-chronic (n=4) liver failure were enrolled. Total bilirubin at baseline was 377.0 ± 101.6 μmol/L, direct bilirubin was 279.3 ± 78.7 μmol/L and indirect bilirubin was 59.7 ± 27.4 μmol/L. 187 sessions of FPSA-CVVH treatment were performed. After a single session total bilirubin (364.8 ± 104.5 μmol/L vs 170.8 ± 57.3 μmol/L), direct bilirubin (262.4 ± 86.5 μmol/L vs 102.5 ± 46.4 μmol/L) and indirect bilirubin (62.3 ± 27.7 μmol/L vs 35.9 ± 14.8 μmol/L) significantly decreased. RRs was 52.0 ± 7.6% for total bilirubin, 59.4 ± 13.0% for direct bilirubin and 36.9 ± 15.4% for indirect bilirubin. Mean arterial pressure and heart rate remained stable during the treatment. 2 patients changed the filters due to blood coagulation. And another 2 patients exhibited bleeding (gastrointestinal bleeding and oozing bleeding). 29 patients (37.2%) survived in discharging from hospital, 12 patients had recovered liver function, and the remaining 17 patients still needed intermittent artificial liver support therapy.

**Conclusions:** FPSA-CVVH treatment was a novel and effective artificial liver support therapy in patients with liver failure. Thus, it may be considered as a "bridge technique" to the recovery of liver and renal function in critical ill patients with liver failure.

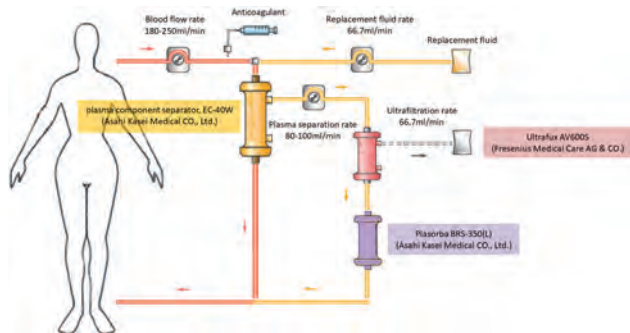

Figure 1. Schematic diagram of combined continuous veno-venous hemofiltration-bilirubin adsorption

SA-PO422

**Standard Addition Method to Analyze Bisphenols in Dialyzers**

Zahin S. Haq,<sup>1</sup> Xin Wang,<sup>1</sup> Xiaoling Wang,<sup>1</sup> Gabriela Ferreira Dias,<sup>1</sup> Joann Cheng,<sup>5</sup> Chih-Hu Ho,<sup>4</sup> Hannah-Madeleine Breitwieser,<sup>3</sup> Nadja Grobe,<sup>1</sup> Peter Kotanko.<sup>1,2</sup> <sup>1</sup>Renal Research Institute, New York, NY; <sup>2</sup>Icahn School of Medicine at Mount Sinai, New York, NY; <sup>3</sup>Fresenius Medical Care Deutschland GmbH, Bad Homburg, Germany; <sup>4</sup>Fresenius Medical Care North America, Ogden, UT; <sup>5</sup>Fresenius Medical Care North America, Waltham, MA.

**Background:** Bisphenol A (BPA), a high-volume industrial chemical, has been associated with health risks. Materials made with alternative chemicals such as Bisphenol S (BPS) have been produced, but toxicity concerns were also raised. BPA-containing materials have been used to manufacture dialyzers. Hemodialysis patients' exposure to BPA/BPS can be measured in dialyzer extractables (E) and leachables (L). However, analytical challenges are E/L complexity, matrix effects, and lack of appropriate blank specimen. We propose Standard Addition Method (SAM) as a good choice for accurate quantification of BPA/BPS in E/L.

**Methods:** BPA/BPS extracted from dialyzers in exaggerated (95% EtOH, E) and simulated-use (17.2% EtOH, L) conditions were subjected to tandem liquid chromatography-mass spectrometry. For SAM, unspiked E/L and five diluted, authentic BPA/BPS spiked E/L were run. <sup>13</sup>C<sub>12</sub>-labeled BPA/BPS served as internal standards. MassHunter Quantitative Analysis was used for quantification (Fig. 1A).

**Results:** Concentrations were reported when quality thresholds were met, including repeatable retention time, Q/Q ratio of 100% ± 20, correlation coefficient > 0.99, accuracy and recovery within 100% ± 20. Figure 1B shows two types of dialyzers made from BPA/BPS-containing material (Type A) and BPA/BPS-free material (Type B). With the measured BPA/BPS level in E/L, patient exposure can be estimated.

**Conclusions:** SAM is a good quantitation method for analyzing BPA/BPS in E/L. Analytical challenges such as matrix complexity and effects and lack of appropriate blank specimen can be overcome. With the measured concentration of BPA/BPS in E/L,

patient exposure to BPA/BPS can be estimated, and the toxicological risk assessment on hemodialysis-associated BPA/BPS exposure can be performed.

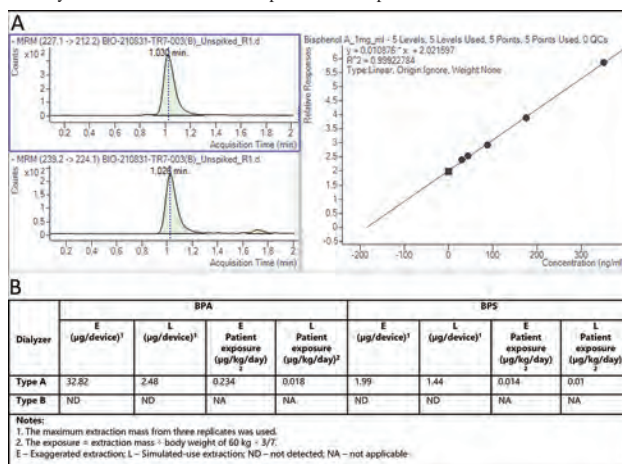

Figure 1A: BPA/<sup>13</sup>C<sub>12</sub> BPA chromatograms and calibration curve for Type A sample. Figure 1B: BPA/BPS levels per device and estimated patient exposure.

SA-PO423

**Allo-Hemodialysis Feasibility Study in a Porcine Model of AKI**

Xin Wang,<sup>1</sup> Amrith U. Patel,<sup>1</sup> Anil K. Gothi,<sup>2</sup> Dejan Nikolic,<sup>3</sup> Alexander Heide,<sup>3</sup> Jiaming Dong,<sup>4</sup> Vaibhav Maheshwari,<sup>1</sup> Nadja Grobe,<sup>1</sup> K s Nayak,<sup>5</sup> Peter Kotanko.<sup>1,6</sup> <sup>1</sup>Renal Research Institute, New York, NY; <sup>2</sup>Vivo Bio Tech, Hyderabad, India; <sup>3</sup>Fresenius Medical Care Deutschland GmbH, Bad Homburg, Germany; <sup>4</sup>Fresenius Medical Care R&D (Shanghai) Co., Ltd, Shanghai, China; <sup>5</sup>Virinchi Hospitals, Hyderabad, India; <sup>6</sup>Icahn School of Medicine at Mount Sinai, New York, NY.

**Background:** Annually, millions of kidney patients, predominantly in low and low-middle income countries, die prematurely because of lacking access to affordable kidney replacement therapy. Previously (ASN Kidney Week, 2021), we have demonstrated in healthy pigs the technical feasibility of allo-hemodialysis (alloHD), an alternative, low-cost dialysis treatment where the blood of a kidney failure patient flows counter-current to the blood of a healthy subject through the dialyzer. Here we report first results from an alloHD feasibility study in a porcine acute kidney injury (AKI) model.

**Methods:** The protocol was approved by the Committee for the Purpose of Control and Supervision of Experiments on Animals (CPCSEA), New Delhi, India. We studied four female Yorkshire pigs (weight 30 to 80 kg) with central venous catheter as vascular access. Under general anesthesia, AKI was induced in two pigs (AKI1; AKI2) through ligation of renal blood vessels. AKI pigs were then dialyzed for 4 hours against healthy pigs (H1; H2). AKI and healthy pigs were connected to the dialysate and blood compartments, respectively, of a Nipro Cellentia 17H dialyzer and anticoagulated with heparin (5,000 IU/h). Blood samples were collected before, during, and after alloHD for measurements of blood urea nitrogen (BUN) and creatinine.

**Results:** We performed one alloHD session each in two pig pairs (AKI1 & H1; AKI2 & H2). During alloHD, BUN and creatinine levels declined in the AKI animals and - as expected - transiently increased in the healthy animals and declined in the second half of the dialysis (Fig. 1). We found no indication of hemolysis or dialyzer coagulation.

**Conclusions:** In our feasibility studies in a porcine AKI model, alloHD performed as expected. Studies exploring extended outcomes are underway.

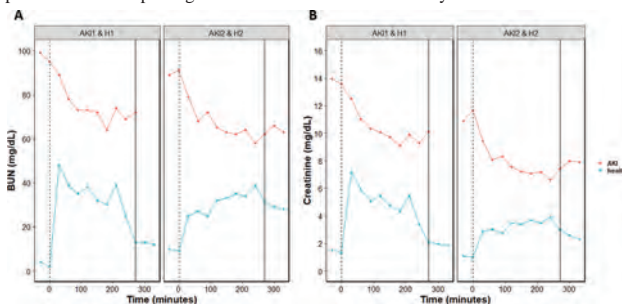

Fig. 1. Dynamics of BUN (panel A) and serum creatinine (panel B) in healthy (blue) and AKI (red) pigs.

SA-PO424

**Therapeutic Plasma Exchange for Severe Hypertriglyceridemia**

Zachary Drury, Josephine Abraham. *University of Utah Health, Salt Lake City, UT.*

**Introduction:** Severe hypertriglyceridemia (HTG) can result in significant acute and chronic conditions including pancreatitis and major cardiac adverse events. Early recognition and treatment is imperative to avoid complications. We report a case of severe hypertriglyceridemia incidentally discovered during therapeutic plasma exchange (TPE) for paraneoplastic syndrome with subsequent improvement of severe HTG with TPE.

**Case Description:** A 61 year old man with past medical history of CAD presented with ataxia and vision changes and was found to have Hodgkins lymphoma and anti-Tr antibody associated paraneoplastic syndrome. He was started on chemotherapy with doxorubicin, bleomycin, vinblastine, dacarbazine, and decadron. His paraneoplastic syndrome was treated with corticosteroids, intravenous immunoglobulin and TPE with subsequent improvement in gait and vision. He developed a recurrence of neurologic symptoms and returned for a second course of TPE. His effluent was noted to be white and Triglyceride (TG) levels were obtained that notable for levels of 1503 mg/dl. After third session of TPE a 71.4% reduction in the serum TG (1368 mg/dl to 390 mg/dl) was observed. TPE was then continued for a total of five sessions. At the completion of five sessions of TPE triglycerides had improved to 370 mg/dl. The etiology of HTG was likely undiagnosed diabetes in the setting of high dose corticosteroids for paraneoplastic syndrome and chemotherapy. The patients Hemoglobin A1C was increased at 9.1%. He was started on empagliflozen and insulin with improvement in blood sugar. On his follow up visit his A1C had decreased to 6.7% and his TG improved to 437 mg/dl.

**Discussion:** Severe HTG can have life threatening acute and chronic complications. Severe HTG was incidentally found due to workup of white effluent during TPE. It is reasonable to consider TPE as a therapy for severe hypertriglyceridemia pending evaluation and treatment to avoid complication from elevated triglycerides.

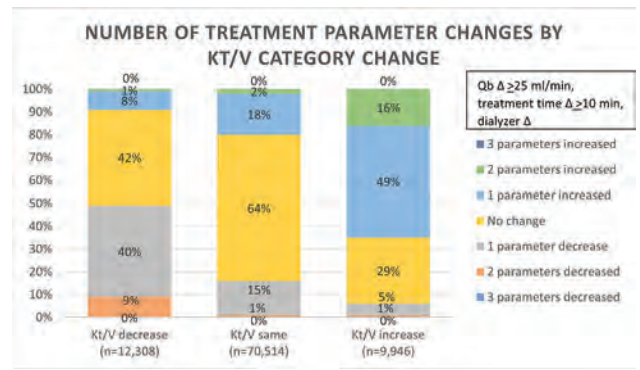

SA-PO426

**Comparison of Mid and Conventional Dialysate Flow in Critically Ill Patients Undergoing Intermittent Dialysis**

Sevag Demirjian, Anne M. Huml, Michael W. George, Matthew Layne, Jonathan J. Taliercio. *Cleveland Clinic, Cleveland, OH.*

**Background:** Conventional dialysis is a water hungry medical procedure where potential savings in consumption and waste are feasible without compromise in patient care. Kinetic modeling of urea has shown that dialysate flow rates ( $Q_d$ ) of 300 ml/min incur lower urea reduction ratio (URR) compared to conventional rates. We sought to compare urea clearance between mid and conventional flow rates, and the effect of filter size in real life clinical setting.

**Methods:** A retrospective observational study of critically ill patients requiring bedside intermittent dialysis. The study included dialysis treatments with prescribed and completed 4 hr treatments with achieved blood flow rate of 400 ml/min. ANOVA with p value of < .05 was used to compare URRs between 300 and 600 ml/min  $Q_d$  and type of dialyzer use (Optiflux High Flux 160 vs 250).

**Results:** The three groups ( $Q_d=300/F160$ ,  $Q_d=300/F250$ , and  $Q_d=600/F160$ ) were statistically different in post dialysis BUN, and URR achieved (Table). The mean URR was significantly different between  $Q_d=300/F160$  and  $Q_d=600/F160$  groups (.69 vs. .72,  $p=.03$ ), but was similar between  $Q_d=300/F250$  and  $Q_d=600/F160$  (.71 vs. .72,  $p=.17$ ).

**Conclusions:** Small solute clearance represented by URR delivered in critically ill patients was higher in dialysis treatments with  $Q_d$  of 300 vs 600 ml/min. However, this difference was offset by the use of larger dialyzer. The current findings may have implications in hospital settings where water preservation is of priority.

	$Q_d=300/F160$ (n=51)	$Q_d=300/F250$ (n=102)	$Q_d=600/F160$ (n=4019)	p value
Age (yrs)	60 (55, 72)	57 (49, 69)	61 (52, 69)	.06
Weight (kg)	83 (73, 92)	84 (76, 111)	86 (74, 106)	.28
Dialysis duration (min)	240 (235, 240)	240 (235, 240)	240 (235, 240)	.10
BUN pre (mg/dL)	57 (40, 74)	50 (37, 70)	51 (36, 71)	.29
BUN post (mg/dL)	16 (12, 23)	13 (10, 19)	14 (9, 20)	.03
Urea reduction ratio	0.69 (0.64, 0.75)	0.71 (0.63, 0.77)	0.72 (0.67, 0.78)	.01

\*Blood flow rate = 400 ml/min

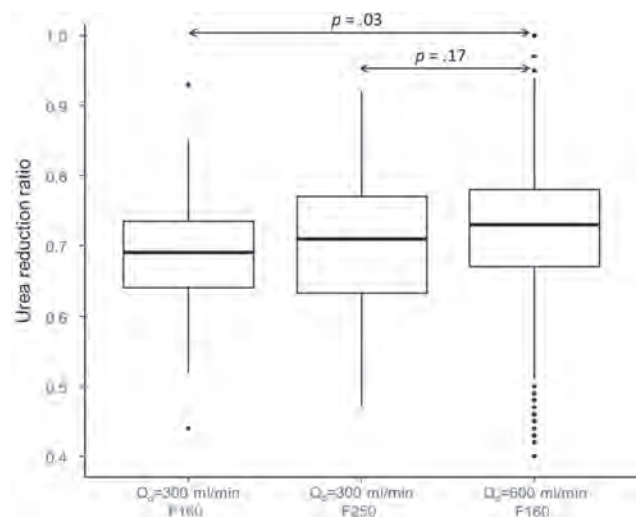

SA-PO425

**Reductions in Dialysate Flow Rates Among a Large Cohort of Hemodialysis (HD) Patients and Impacts on Dialysis Adequacy**

Linda Ficociello, Brooks E. Rogers, Amanda Stennett, Marcy E. Goldberg, Paul Smith, Kathleen Belmonte, Jeffrey L. Hymes. *Fresenius Medical Care, Waltham, MA.*

**Background:** National shortages of dialysate have led to measures to optimize therapy while conserving dialysate in US dialysis clinics. Dialysis adequacy >1.2 is a major indicator of therapy achievement. The current analysis aimed to assess whether lowering of dialysate flow (Qd) to 500 ml/min was accompanied by changes in dialysis adequacy or changes in other HD prescription parameters.

**Methods:** Included in the analysis were Fresenius Kidney Care HD patients dialyzed 1/21/22-1/22/22 and had their Qd set to 500 ml/min at the discretion of the treating physician by 2/25/22-2/26/22. Approximately 30% of patients were not included because their Qd remained >500 ml/min. Patients were categorized into the following categories based on dialysis adequacy (based on dialysis machine online clearance): <1.2, 1.2-1.4, >1.4. Changes in delivered treatment parameters were counted, including changing treatment time ≥10 minutes, blood flow (Qb) by ≥25 ml/min, or dialyzer size.

**Results:** Patients (n=92,768) were, on average, aged 64 years with 4.5 years dialysis vintage and 43% were women. On average patients' Qd was lowered from 687 to 500 ml/min. As shown in Figure, 76% of patients remained in their adequacy category despite reducing Qd to 500 ml/min, while 13% and 11% decreased or increased adequacy category, respectively. For those remaining in the same category, the majority achieve this without changes to dialysis prescriptions (64%) where 20% increased time, Qb, or dialyzer size. Among the patients who lowered adequacy, 91% had treatment parameters stay the same or decrease.

**Conclusions:** Reductions in Qd to 500 ml/min were not accompanied by decreases in dialysis adequacy in 87% of patients. In the 13% of patients with decreases, no increases in HD prescriptions were observed for 91% of patients. An algorithm outlining steps to adjust HD prescriptions when it is necessary to lower Qd may need to be developed as part of preparedness plans.

**Funding:** Commercial Support - Fresenius Medical Care

SA-PO427

**Feasibility of Crit-Line®-Based Estimation of Pre-Dialysis Hemoglobin in Hemodialysis Patients**

Ohnmar Thwin,<sup>1</sup> Lin-Chun Wang,<sup>1</sup> Xia Tao,<sup>1</sup> Zahin S. Haq,<sup>1</sup> Xin Wang,<sup>1</sup> Xiaoling Wang,<sup>1</sup> Hanjie Zhang,<sup>1</sup> Lemuel Rivera Fuentes,<sup>1</sup> Nadja Grobe,<sup>1</sup> Stephan Thijssen,<sup>1</sup> Peter Kotanko.<sup>1,2</sup> <sup>1</sup>Renal Research Institute, New York, NY; <sup>2</sup>Icahn School of Medicine at Mount Sinai, New York, NY.

**Background:** Most patients on hemodialysis (HD) have renal anemia. Anemia management involves periodic collection of pre-dialysis blood samples for measurement of hemoglobin (Hgb) concentration. Replacing these blood draws by non-invasive measurements with the Crit-Line® Monitor (CLM) would be desirable but requires adjusting the measurements to reflect the customary pre-HD laboratory values. We explored whether such an adjustment is feasible.

**Methods:** Chronic HD patients were studied on up to 3 occasions each. Pre-HD blood was collected, and the mean of 20 repeated Hgb measurements was used as a highly accurate estimate of true Hgb concentration. CLM hematocrit was obtained 3.5 min into HD, converted into Hgb using a conversion factor of 0.322, and adjusted as per Equation 1 (patent app. WO2015/179523 A1). Blood volume was estimated using the Nadler equation, and the saline half-life was estimated to be 25 min.

**Results:** We studied 14 subjects (age 56.7 ± 16 years, 50% males) during a total of 27 HD treatments. The difference between adjusted CLM Hgb and pre-HD laboratory Hgb was -0.05 ± 0.55 g/dL (Figure 1; N = 25; CLM data unavailable for 2 visits).

**Conclusions:** Infusion of the extracorporeal priming fluid into the patient causes initial hemodilution. Equation 1 yields adjusted CLM Hgb values that are on average virtually identical to pre-HD laboratory measurements of Hgb. The observed variability may be due to inaccuracies in anthropometric blood volume assessment and variability in saline extravasation rate.

**Equation 1.** Adjusting early intradialytic CLM hemoglobin concentration to reflect pre-dialysis Hgb concentration. <sup>®</sup>

$$Hgb_{CLM}^{adjusted} = Hgb_{CLM} + (V_{saline} \cdot 0.5)^{\left(\frac{t_{CLM}}{t_{1/2}^{saline}}\right)} - V_{UF}(t_0, t_{CLM}) \cdot \frac{Hgb_{CLM}}{BV}$$

$Hgb_{CLM}$ : Hgb obtained from CLM;  $V_{saline}$ : volume of infused priming solution (saline);  $t_{CLM}$ : elapsed time of HD when CLM Hgb was obtained;  $t_{1/2}^{saline}$ : intravascular half-life of infused saline;  $V_{UF}(t_0, t_{CLM})$ : cumulative ultrafiltration volume at  $t_{CLM}$ ;  $BV$ : pre-HD blood volume

**Figure 1.** Difference between adjusted CLM Hgb and pre-HD laboratory Hgb (25 study visits from 14 subjects). Vertical line denotes average.

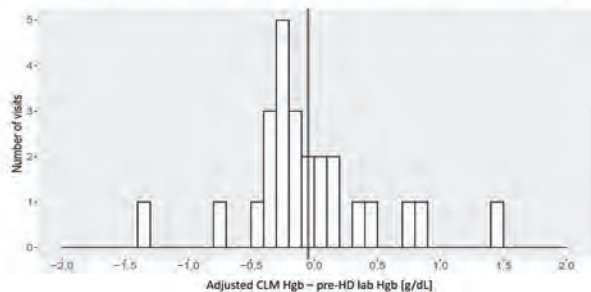

SA-PO428

**Human Factors Validation of the Tablo Hemodialysis System With Health Care Practitioners**

Brittany Lim, Cynthia J. D’Alessandri-Silva, Elise Edson, Josh Schumacher, Michael A. Aragon. *Outset Medical, San Jose, CA.*

**Background:** Hemodialysis is a lifesaving treatment warranting extensive training to perform safely and effectively in different use environments. Shortages in nurse staffing due to the COVID 19 pandemic caused a desire to innovate systems that can be safely and effectively used by healthcare professionals (HCPs). The Tablo® Hemodialysis System (“Tablo”) is easy-to-learn, indicated for clinic, hospital, and home settings. Features include a simplified user interface, interactive touchscreen GUI coupled with videos to assist users. Prior usability testing of Tablo had a use error rate of 1.5%. Here we report on the results of simulated use human factors validation testing on recent software version of the Tablo® Hemodialysis System (“Tablo”) with HCPs in the clinic setting.

**Methods:** HCPs tested the Tablo in a simulated clinic environment to validate safety and usability. HCPs underwent training on all aspects of device operation; including setup, takedown, monitoring, routine maintenance, and alarm resolution. After a decay of at least one hour, HCPs performed tasks without the trainer. Task performance to use errors, close calls, and difficulties were recorded along with interview data.

**Results:** Fifteen (15) HCPs were recruited, consisting of 9 RNs with prior HD experience and 6 dialysis technicians. A total of 7365 tasks were performed, with the use error rate across all tasks less than <1%, with most use errors related to Manual Blood Return. 100% of HCPs reported that they felt they could use Tablo safely and effectively. Summary of user task assessments shown in Figure 1.

**Conclusions:** After standard 3-hour training, HCPs were able to safely and effectively operate Tablo in a simulated use clinic setting. HF testing of this more recent software shows further reduction in Tablo’s already low use error rate. This supports prior data regarding the ability of HCPs to easily learn and use Tablo and the device’s ability to facilitate expansion of available dialysis nursing staff while increasing the quality and safety of dialysis treatments across the care continuum.

**Funding:** Veterans Affairs Support

Figure 1 User task assessments

Use Scenario	Scenario Title	Difficulty	Close Call	Use Error	Total Tasks
1	Prepare the System	10 (0.4%)	0 (0%)	16 (0.6%)	2610
2	Connect to the patient	0 (0%)	0 (0%)	0 (0%)	180
3	Perform treatment	6 (0.5%)	0 (0%)	8 (0.7%)	1170
4	Complete treatment and disconnect patient	4 (0.5%)	0 (0%)	1 (0.1%)	825
5	Perform manual blood return	5 (2.1%)	0 (0%)	5 (2.1%)	240
6	Cleaning, Disinfection, and Routine Maintenance	6 (0.4%)	0 (0%)	6 (0.4%)	1530
7	Respond to alarms	1 (0.3%)	0 (0%)	0 (0%)	330
8	User Manual Comprehension	0 (0%)	0 (0%)	0 (0%)	360
9	Service and Miscellaneous	0 (0%)	0 (0%)	0 (0%)	120
	<b>Total</b>	<b>32 (0.4%)</b>	<b>0 (0%)</b>	<b>35 (0.5%)</b>	<b>7365</b>

SA-PO429

**Interventions Required for Use of a Wearable Device in Hemodialysis Patients**

Maggie Han,<sup>1</sup> Ohnmar Thwin,<sup>1</sup> Xia Tao,<sup>1</sup> Lemuel Rivera Fuentes,<sup>1</sup> Amrith U. Patel,<sup>1</sup> Peter Kotanko.<sup>1,2</sup> <sup>1</sup>Renal Research Institute, New York, NY; <sup>2</sup>Icahn School of Medicine at Mount Sinai, New York, NY.

**Background:** Increased physical activity (PA) is associated with reduced risk of cardiovascular disease, which is prevalent in hemodialysis (HD) patients. Wearable activity trackers (WAT) allow the remote monitoring of PA. We aimed to explore what kinds of interventions are required to maintain use of WAT in a HD population

**Methods:** HD patients from 4 New York City clinics were enrolled on a rolling basis starting June 2018 and followed for up to 1 year. Ambulatory patients ≥18 years, on maintenance HD, and owning a mobile device were included. Each patient was provided with and taught how to use the Fitbit Charge 2. A stepwise intervention plan was used to assess feasibility (Figure 1). Patients were deemed non-compliant if they were withdrawn for non-compliance and patients who completed the 1-year follow up period were deemed compliant.

**Results:** 119 patients were enrolled into the study. Patients were 54±12 years old, 59% African American, 37% lived alone, and 54% had an education level of college and above. 74 patients completed the study, 17 patients were withdrawn for non-compliance, 6 patients passed away, 12 patients were withdrawn due to kidney transplants, and 10 patients were withdrawn for other reasons. Results of the interventions deployed to compliant and non-compliant patients are shown in figure 2.

**Conclusions:** Patients who were non-compliant required a greater proportion of phone calls and in-person meetings, both interventions that cannot be automated, compared to their compliant counterparts. Patients who are more likely to be compliant, can maintain use of their wearable devices with automated text message reminders. When considering implementing a program using WAT in the HD population, an intervention-based program is necessary to guarantee adequate device usage and data collection.

**Funding:** Commercial Support - Renal Research Institute

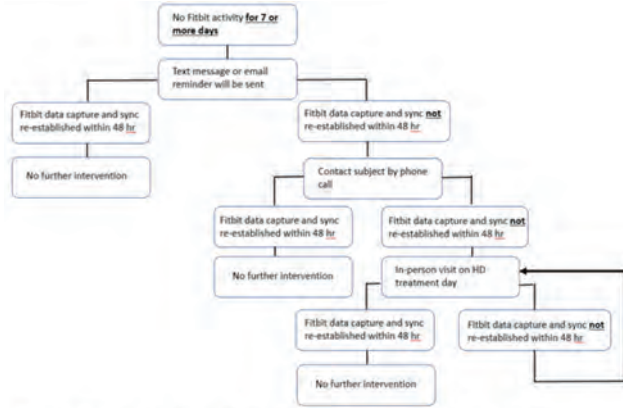

Figure 1. Stepwise intervention scheme. If a patient required more than 3 in-person visits, then they were withdrawn for non-compliance.

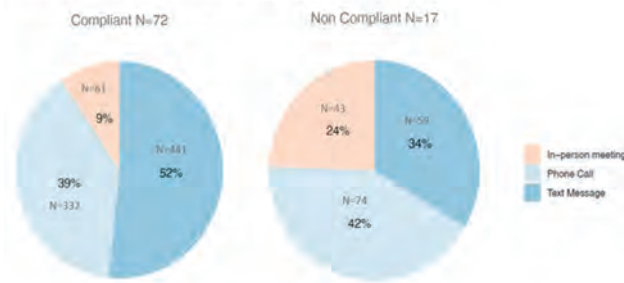

Figure 2. Interventions deployed in compliant and non-compliant patients

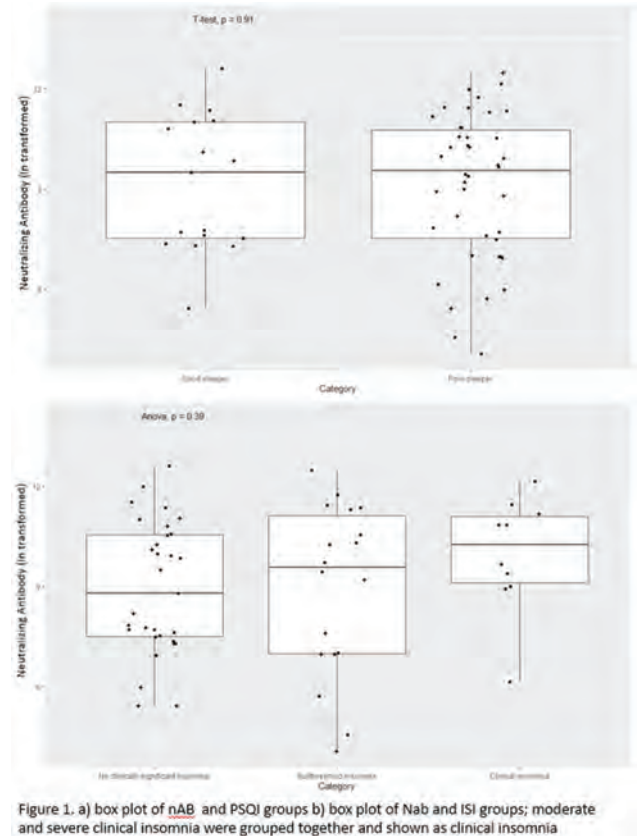

Figure 1. a) box plot of nAB and PSQI groups b) box plot of Nab and ISI groups; moderate and severe clinical insomnia were grouped together and shown as clinical insomnia

SA-PO430

Association Between Sleep and COVID-19 Vaccination Response in Hemodialysis Patients

Maggie Han,<sup>1</sup> Xiaoling Wang,<sup>1</sup> Xiaoling Ye,<sup>1</sup> Zijun Dong,<sup>1</sup> Ohnmar Thwin,<sup>1</sup> Amrith U. Patel,<sup>1</sup> Lela Tisdale,<sup>1</sup> Lin-Chun Wang,<sup>1</sup> Sarah Ren,<sup>1</sup> Lemuel Rivera Fuentes,<sup>1</sup> Hanjie Zhang,<sup>1</sup> Peter Kotanko.<sup>1,2</sup> <sup>1</sup>Renal Research Institute, New York, NY; <sup>2</sup>Icahn School of Medicine at Mount Sinai, New York, NY.

**Background:** Hemodialysis (HD) patients are less likely to mount a response to the COVID-19 vaccination (CoVac). Poor sleep is associated with blunted vaccination response in the general population. We aim to explore the association between CoVac and sleep quality (SQ) in HD patients.

**Methods:** Patients from 3 HD clinics were enrolled if they were ≥18 years and able to give written consent. Patients were administered the Insomnia Severity Index (ISI) and the Pittsburgh Sleep Quality Index (PSQI). Blood specimen were collected after the primary series of COVID-19 vaccination. SARS-CoV-2 neutralization antibodies (nAB) were assayed using the GenScript SARS-CoV-2 Surrogate Virus Neutralization Test Kit (Cat#L00847-A). nAB titers are presented as Unit/ml on a natural log scale. PSQI scores of >5 were categorized as poor SQ and ≤5 as good SQ. ISI scores were grouped as no clinically significant insomnia (NI; score 0-7), subthreshold insomnia (SI; score 8-14), and clinical insomnia (CI; score 14-28). T-test and ANOVA analysis were performed on PSQI and ISI scores, respectively, to determine the statistical association between SQ and nAB levels

**Results:** 58 patients were included (60±9 years old, HD vintage 4.7±4.5 years, 62% male, 66% Black, 21% Hispanic). In the PSQI, 72% (n=42) had poor SQ. In the ISI, 52% = NI, 31% = SI, and 17% CI. Box plots of nAB levels with median and IQR are shown in Fig. 1. There is no association between SQ and nAB levels.

**Conclusions:** There is no association between SQ and CoVac response. Given the immune dysfunction in this population, any modifying effect SQ has on CoVac, as observed in the general population, is unlikely. Other methods of improving CoVac response in this vulnerable population should be explored.

**Funding:** Commercial Support - Renal Research Institute

SA-PO431

Post-Bilateral Orthotopic Lung Transplant Dual Dialysis

Aniruddha Bhattacharyya,<sup>1</sup> Yani Zhang,<sup>2</sup> Girma M. Ayele.<sup>3</sup> <sup>1</sup>University of Maryland Medical System, Baltimore, MD; <sup>2</sup>MedStar Union Memorial Hospital, Baltimore, MD; <sup>3</sup>Howard University College of Medicine, Washington, DC.

**Introduction:** Hyperammonemia (HA) is a metabolic disorder characterized by an elevated concentration of serum ammonia (NH3). It is a complication of Bilateral Orthotopic Lung Transplants (BOLT) befalling 4.1% of patients, with a 75% mortality rate. Opportunistic infections of Ureaplasma are implicated as culprits of HA. Renal replacement therapy (RRT) is the treatment of choice for HA with neurologic symptoms. NH3 is a small molecule whose clearance mirrors urea in RRT. Intermittent hemodialysis (IHD) clears NH3 faster than continuous hemodialysis (CHD), though CHD is better tolerated in people with hemodynamic instability. There are few studies comparing IHD vs CHD for treating HA in adults.

**Case Description:** We report a case of a 64-year-old man with new encephalopathy, 1 day after extubation following BOLT. Initial imaging was negative for stroke, and later CT scans showed cerebral edema. Concurrent metabolic workup found an elevated NH3 of 526 umol/L. PCR assays of bronchial fluid after BOLT found the 16S ribosomal RNA sequence of Ureaplasma species. Soon after developing HA, the patient had hemodynamic instability requiring 3 pressors. While critically ill, we treated his HA with a novel regimen of alternating CHD and IHD. RRT was done via a dialysis catheter placed non-emergently in the right femoral vein. The CHD was prescribed with a blood flow (Q<sub>B</sub>) of 300ml/min, and a dialysate flow (Q<sub>D</sub>) of 7800ml/h. The first 2 hours of IHD had a Q<sub>B</sub> of 200ml/min, and a Q<sub>D</sub> of 400ml/min. The 2nd and 3rd rounds of IHD had respective Q<sub>B</sub> of 300 and 350ml/min, and respective Q<sub>D</sub> of 500 and 600ml/min. The patient's NH3 was reduced by 95% over 45 hours by our unique RRT protocol, and he survived this highly fatal condition.

**Discussion:** Adult patients after BOLT can develop HA as a rare and deadly complication. Opportunistic infections of urease-producing bacteria like Ureaplasma may play a role in increased NH3 production. While the ideal RRT regimen for HA after BOLT is unknown, our case shows the combination of IHD and CHD can quickly lower NH3 levels and limit its expected rebound in such patients.

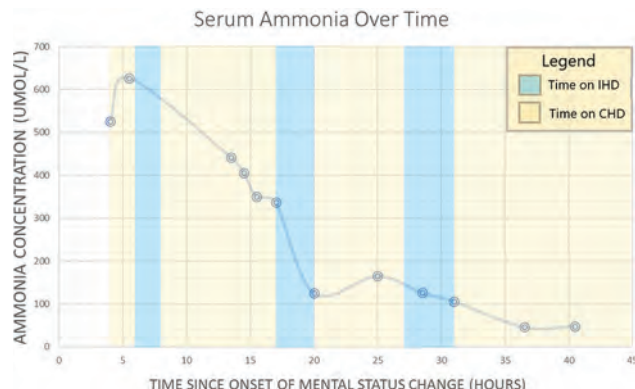

SA-PO432

**Single Center Experience: Conversion From Conventional Continuous Renal Replacement Therapy to Tablo Adaptive Dialysis**  
 Tara E. Greenleaf Nichols, Sandy Rowe, Debra M. Dutton, Toni Yurcso, Senthil P. Ramaiyah. *Covenant HealthCare, Saginaw, MI.*

**Background:** Since the advent of the COVID-19 pandemic in March 2020, the ability to provide high quality, cost efficient care in the ICU has been challenged by nursing shortages, increased acuity, patient volumes and higher incidence of AKI requiring dialysis. CRRT typically requires 1:1 nursing support and specialized devices. Here we describe Covenant Healthcare, a 372 acute bed hospital that converted from conventional CRRT model (“Non-Tablo”) to an adaptive dialysis model with the Tablo® Hemodialysis System (“Tablo”).

**Methods:** A retrospective chart review of extended therapy treatments over six months after transition to Tablo. All Tablo treatments performed in the ICU that met the previous hospital criteria for CRRT were included. Nurse to patient ratio during dialysis was 1:1 and 1:2 when not on therapy. Demographics, COVID status, treatment duration and time off therapy, defined as hours within each 24-hr period where the patient was not on dialysis was recorded. Treatment success was defined as achieving at least 90% of prescribed treatment time.

**Results:** A total of 228 treatments were completed in 60 ICU patients with 60% COVID positive. Mean age was 62 yrs (range, 29-88). Total treatment success was 96% with 4% ending early due to alarms. Figure 1 shows total treatment by time; 0-6 hrs, >6-12, >12-24 hrs with success rates. Total time off therapy compared to a Non-Tablo continuous model was 2299 hrs equating to approximately 1.2 FTE (\$100k) in labor productivity.

**Conclusions:** At Covenant Healthcare, conversion to Tablo adaptive therapy model successfully delivered treatments up to 24 hrs to critically ill patients who would otherwise be on CRRT. Adaptive therapy improved nurse staffing efficiency while reducing cost and patient time off dialysis. Application of this model allows a more individualized approach to ICU patient care without increasing the burden on the ICU or acute hospitals.

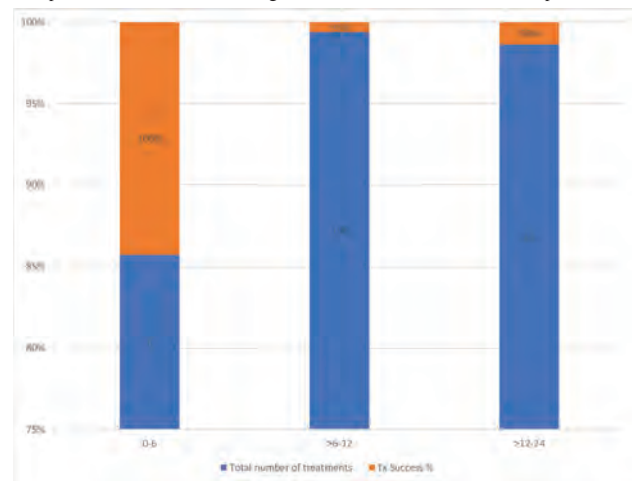

SA-PO433

**Use of Remote Dielectric Sensing (ReDS) in Hemodialysis Patients**  
 Gessica Sabrina Braga Barbosa, Eduardo d. Valle, Carolina M. Lima, João Lucas M. Gorzoni, Daniela C. Favarato, Ana Teresa P. Vieira, Vinicius V. Sobral, Camila F. Assis, Rayra G. Ribeiro, Igor Smolentzov, Lucia Andrade, Camila E. Rodrigues, Jose M. Vieira Jr.. *Universidade de Sao Paulo, Sao Paulo, Brazil.*

**Background:** New tools are being developed to assess volume status in fluid overload risk patients. The ReDS system is a non-invasive device built from military technology “see through-walls” indicated to assess hypervolemic status represented by pulmonary congestion. There are studies demonstrating an optimal correlation between ReDS and high-resolution chest tomography and invasive hemodynamic monitoring, mostly in heart failure patients. Our aim is to evaluate the use of ReDS in hemodialysis (HD) population.

**Methods:** We enrolled 23 patients under three times per week HD treatment. The fluid status was evaluated before and after dialysis by physical examination, lung ultrasound (LUS) and ReDS. The study was performed for four weeks (ReDS device availability period). Clinical parameters include weight and blood pressure. Degree of pulmonary congestion was evaluated according to B lines number visualized by LUS and percentage of fluid in lung tissue from ReDS (value > 35% is associated to hypervolemic status).

**Results:** The analysis was performed in 41 HD sessions. There is linear correlation between ReDS and LUS especially in cases of severe pulmonary congestion according to LUS degree ( $r=0,393$ , Spearman’s test,  $p < 0.05$ ). There was no difference between blood pressure values and ReDS or LUS results. There was no difference between the assessment before and after HD sessions.

**Conclusions:** ReDS system is a promising tool that can be used to assess fluid status in hemodialysis patients.

**Funding:** Commercial Support - <https://www.bragenix.com.br/>

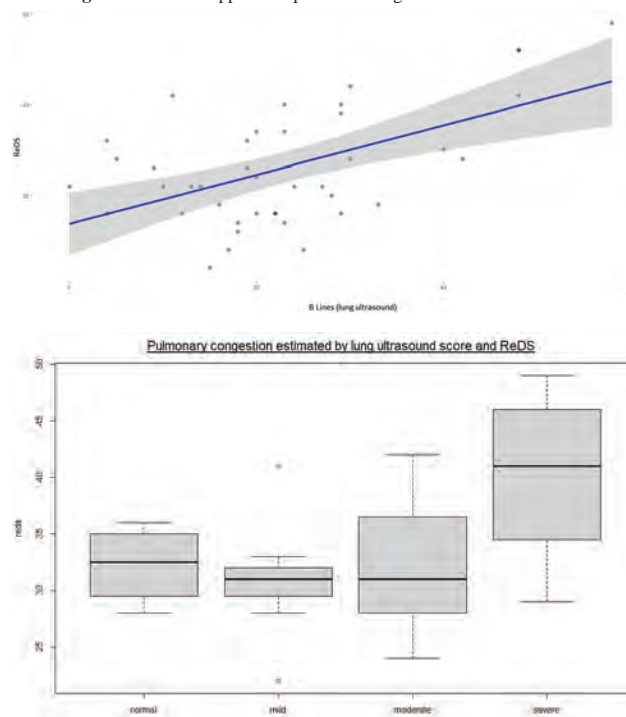

SA-PO434

**Water Smarter: Exploring the Potential to Recycle Reverse Osmosis Reject Water**  
 Keerat Dhatt, Andrew I. Chin. *University of California Davis, Davis, CA.*

**Background:** Water is possibly the most precious resource on the planet, and water conservation has become of increasing concern over the past few years. Opportunities for conservation in hemodialysis (HD) units should be explored. An efficient reverse osmosis (RO) system has an approximate 5% water reject rate. The aim of this study was to assess whether the reject water could be repurposed, rather than wasted.

**Methods:** In July 2021, we tested both the RO product water as well as the RO reject water from a 24 station dialysis center in Sacramento, California as part of routine clinic water testing. We compared the constituents that are tested and regulated by the city of Sacramento in the RO reject water to the levels considered safe by the city.

**Results:** We found that the RO system reject water from our HD clinic is well within the standards put forth by the city of Sacramento for acceptable drinking water. Notably, fluoride is added to the city water, and even this element was within acceptable limits in the RO reject water. See table 1 for these details. Our clinic uses over 176,000 gallons of water each month, even with a standard HD dialysate flow rate of 600 mL/min. Assuming

conservatively that 85% of our water is used to produce product water and a 5% RO reject rate, we estimate that about 7500 gallons of potable water is wasted every month.

**Conclusions:** Our RO reject water is well within the safe standards for drinking water. Differences may be noticed in other cities, depending on the source of the water. However, it is likely that millions of gallons of potable water are wasted by dialysis clinics across the country. As water conservation continues to be of rising concern, municipalities should provide incentives for dialysis providers to repurpose their RO reject water.

	Units	Dialysis RO product test result	Dialysis RO reject test result	Reference for product water test*	City water*	Maximum Contaminant Level (MCL)
Aluminum	ppm	<0.0050	0.0793	<0.010	ND	0.2
Antimony	ppm	<0.0010	<0.0010	<0.006	ND	0.006
Arsenic	ppm	<0.0010	0.0015	<0.005	0.0028	0.01
Barium	ppm	<0.0100	0.0187	<0.100	0.03	1
Beryllium	ppm	<0.0002	<0.0002	<0.0004	ND	0.004
Cadmium	ppm	<0.0005	<0.0005	<0.001	ND	0.005
Calcium	ppm	<0.5000	10.5189	<2.000	28	no established MCL
Chromium	ppm	<0.0050	<0.0050	<0.014	ND	0.05
Copper	ppm	<0.0050	<0.0050	<0.100	ND	1
Fluoride	ppm	<0.2000	0.7943**	<0.200	0.7** (added to water)	2
Lead	ppm	<0.0010	<0.0010	<0.0050	ND	0.0015
Magnesium	ppm	<0.5000	5.4306	<4.000	18	no established MCL
Mercury	ppm	<0.0002	<0.0002	<0.0002	ND	0.002
Nitrate	ppm	<0.2000	<0.2000	<2.000	ND	10
Potassium	ppm	<0.5000	1.1703	<8.000	no data	no established MCL
Selenium	ppm	<0.0010	<0.0010	<0.090	ND	0.05
Silver	ppm	<0.0010	<0.0010	<0.005	ND	0.1
Sodium	ppm	<0.8142	13.3219	<70.00	26	no established MCL
Sulfate	ppm	<0.1000	0.009	<100.0	11	500
Thallium	ppm	<0.0010	<0.0010	<0.002	ND	0.002
Zinc	ppm	<0.0050	0.009	<0.100	ND	5
Conductance	µS/cm@25C	4	165		405	

\*2020 averaged data available online at: [cityofarramento.org/Utilities/Water/Water-Quality](http://cityofarramento.org/Utilities/Water/Water-Quality), accessed on 5/9/2022  
 \*\*City water is fluorinated  
 RD values for RO reject water exceed references for dialysis water but are all within limits for city drinking water

SA-PO435

Different Modalities of Dialysis for Hyperammonemia Treatment

Ahmed S. Sbaih,<sup>1</sup> Moh'd Sharshir,<sup>1</sup> Farah Harasis.<sup>2</sup> <sup>1</sup>Tulane University School of Medicine, New Orleans, LA; <sup>2</sup>Islamic Hospital, Amman, Jordan.

**Introduction:** Hyperammonemia (HA) is a life-threatening condition and can lead to irreversible cerebral damage and death if not treated in a proper way. A Few studies found in literature about the treatment of HA by dialysis in adults. Here, we describe two cases of acute encephalopathy due HA with different causes. Treated successfully with different modalities of dialysis.

**Case Description: Case 1:** A 23-year-old female presented with altered mental status. Laboratory workups showed ammonia level of 581 (reference value 11 -32) micromol/l with normal lactate, creatinine, and liver enzymes. Brain image showed a cerebral edema. Urea cycle disorder was suspected. Along with medical treatment, Dialysis was initiated using Sustained low efficiency dialysis for 48 hours, Ammonia level decreased to 74. She completely recovered after that and did not need dialysis, ammonia level returned to normal level and discharged without neurological deficit. **Case 2:** A 67-year-old female with liver cirrhosis presented with altered mental status and gastrointestinal bleeding. Laboratory data revealed ammonia level of 263. Intermittent hemodialysis (iHD) was performed for 3 hours then switch to Continuous venovenous hemofiltration (CVVHD) for 24 hours. Level returned to normal, and patient improved then discharged without neurological deficit.

**Discussion:** HA can occur in patients with liver failure, urea cycle defects, inborn errors of metabolism (IEM), post-chemotherapy, toxins exposure or drugs. Management should be started immediately to avoid life threatening consequences. However, there are no specific guidelines about when to start dialysis or which techniques are more appropriate. Generally, the primary goals of dialysis are to rapidly reduce ammonia level and achieve resolution of symptoms. It has been proposed that, when the blood ammonia level is three times greater than the upper limit of normal or encephalopathy, it is worth considering dialysis. Among adult patients, the goal to provide continuous removal of ammonia by performing daily HD and CVVH in between sessions of HD to prevent ammonia rebound as what we did in the second case. If cerebral edema is present as in the first case, we would elect a continuous technique (CVVHD or SLED) to avoid worsening the edema with iHD.

SA-PO436

Mathematical Modeling of Allo-Hemodialysis as Acute Treatment for Urea Cycle Disorders

Vaibhav Maheshwari,<sup>1</sup> Guido Filler,<sup>2</sup> Akash Deep,<sup>3</sup> Rasha H. Hussein,<sup>4,5</sup> Maria E. Ferris,<sup>6</sup> Xin Wang,<sup>1</sup> Amrsh U. Patel,<sup>1</sup> Peter Kotanko.<sup>1,7</sup> <sup>1</sup>Renal Research Institute, New York, NY; <sup>2</sup>London Health Sciences Centre, London, ON, Canada; <sup>3</sup>King's College Hospital, London, United Kingdom; <sup>4</sup>Pontificia Universidade Catolica do Parana, Curitiba, Brazil; <sup>5</sup>Soba University Hospital, Khartoum, Sudan; <sup>6</sup>University of North Carolina System, Chapel Hill, NC; <sup>7</sup>Icahn School of Medicine at Mount Sinai, New York, NY.

**Background:** Urea cycle disorders (UCD) are inborn errors of metabolism characterized by a reduced activity of enzymes that convert nitrogenous waste to urea, resulting in accumulation of ammonia (NH<sub>3</sub>). UCDs can result in neonatal death or severe neurological complications. Clinically, swift reduction of NH<sub>3</sub> levels towards the normal range is key to prevent sequelae. Previously, we have developed allo-hemodialysis (alloHD), a simple extracorporeal dialytic modality where a patient is dialyzed against a healthy subject (buddy) [Maheshwari (2020) KIR 5, S29]. Here, we model alloHD as a treatment for UCD.

**Methods:** We adapted a model of human NH<sub>3</sub> metabolism [Griffin (2019) Theor Biol Med Model 16, 11]. The model considers constant NH<sub>3</sub> absorption, renal excretion, and the activities of key urea cycle enzymes (glutamine synthase, glutaminase, carbamoyl phosphate synthetase I). To simulate UCD, neonate enzyme function was set to 5% of healthy capacity. For alloHD simulation, a mini dialyzer with surface area 0.075 m<sup>2</sup> was used. Neonate and buddy blood flow rates were 15 and 30 mL/min, respectively, ultrafiltration was zero.

**Results:** The NH<sub>3</sub> concentration gradient results in rapid diffusion of NH<sub>3</sub> and glutamine from the neonate to the buddy (Fig.1). Within 60 min of alloHD, the neonate NH<sub>3</sub> plasma concentration drops to around 50%. The subsequent steady state NH<sub>3</sub> is still above normal levels because in our simulations the neonate's NH<sub>3</sub> production is kept unchanged. However, in clinical practice, the UCD patients' protein intake is reduced to zero, which lowers the NH<sub>3</sub> production rate.

**Conclusions:** Our simulations indicate that alloHD is a potential option for the initial, emergency treatment of UCD.

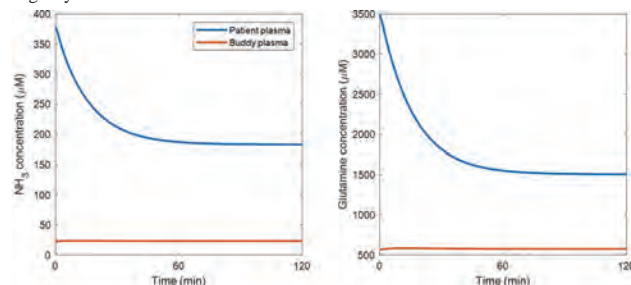

Fig. 1: AlloHD treatment simulation for UCD.

SA-PO437

Anaphylaxis From Ethylene Oxide Sterilized Dialysis Tubing and Needles

Clarkson Crane, Robyn A. Cunard, Nicholas Scanlon, Taylor Doherty, O. Alison Potok. University of California San Diego, La Jolla, CA.

**Introduction:** Hypersensitivity reactions to ethylene oxide (EtO) sterilized dialyzers have been described. While EtO is no longer used to sterilize most dialyzers, it is used on other pieces of dialysis equipment. We present a case of dialysis-related anaphylaxis attributed to an IgE-mediated allergy to EtO-sterilized dialysis tubing and needles.

**Case Description:** A 78-year-old male with end stage kidney disease (ESKD) was maintained on hemodialysis (HD) for 3 years without complications. Access was a tunneled dialysis catheter (TDC) then transitioned to an arteriovenous fistula (AVF). Subsequent treatments were complicated by intradialytic hypotension and syncope within minutes of starting HD. Symptoms also included pruritis (no hives), and a throat closure sensation; Labs showed WBC of 11.3 k/uL, of which 2.4 k/uL eosinophils. Differential diagnosis included idiopathic hyperesoinophilic syndrome (HES), mastocytosis with eosinophilia, mast cell activation syndrome (MCAS), and type 1 hypersensitivity reaction to ethylene oxide (EtO). Workup showed normal cardiac evaluation, negative D816V mutation, negative FIP1L1-PDGFR, elevated tryptase 28 mcg/L, total IgE >3000 IU/mL, and anti-EtO IgE >100 kU/L. Access was transitioned back to the TDC and a Revaclear dialyzer (polyaryl sulfone) was used with normal saline rinses of dialysis tubing. He was given prednisone and anti-histamines and tolerated subsequent HD treatments. Prednisone was tapered and omalizumab (anti-IgE Fc) was started.

**Discussion:** This case is an example of dialysis-associated anaphylaxis initially presenting as intradialytic hypotension. Upon recognition of the hyperesoinophilia, it was noted this was chronic since HD initiation 3 years prior. Previous work-up was negative for parasite infections and malignancy, making mastocytosis less likely. We hypothesize the patient's eosinophilia and hypersensitivity began upon his initial exposure to EtO and HD equipment. While using a TDC, chronic eosinophilia may have been related to the low-level EtO exposure from saline-rinsed tubing. When use of the AVF with EtO-sterilized needles was resumed, he was exposed to a higher "dose" of EtO. This triggered a more robust type 1 hypersensitivity leading to mast cell degranulation and repeated anaphylactic episodes that were overcome by pretreating with steroids, anti-histamines, and anti-IgE Fc monoclonal, omalizumab.

SA-PO438

A Bubbly Catastrophe: A Case of Air Embolism Presenting as Ischemic Stroke in a Hemodialysis Patient

Randa Abd algayoum, Tyler Andrea, Kalathil K. Sureshkumar. Allegheny Health Network, Pittsburgh, PA.

**Introduction:** Air embolism is a rare but potentially catastrophic complication and can often be fatal. In humans, a volume of 100-300 mL air is considered fatal. Due to the technological safeguards implemented in hemodialysis machines, symptomatic air embolisms are now exceedingly rare. We present a case of ischemic stroke and cerebral edema due to air embolism in a hemodialysis patient.

**Case Description:** A 76-year old male with history of multiple myeloma, lung cancer, and end-stage kidney disease on hemodialysis through tunneled dialysis catheter, presented for evaluation of stroke symptoms. Patient developed right gaze preference, left hemiparesis and dysarthria at his dialysis center after rinse back. No significant



hemodynamic compromise and no alarms reported. Admission CT angiogram of head and neck revealed no acute intracranial abnormalities or infarct on perfusion imaging. Deemed not a candidate for thrombolytic therapy. MRI brain showed no acute intracranial abnormalities, markedly motion degraded. On the following hospital day, patient developed worsening lethargy and weakness. Follow-up CT head revealed cerebral edema involving the middle cerebral and anterior communicating artery territories on the right side with small focus of air in the right vertex sulcus which was also present on initial head CT scan (figure) consistent with air embolism, not previously reported but commented on in retrospect. Patient underwent emergent hyperbaric oxygen treatments. Following 3 sessions, patient experienced significant improvement in symptoms and was subsequently discharged to a rehabilitation facility.

**Discussion:** Despite the technological safeguards in new hemodialysis machines, though rare air embolism can still occur during hemodialysis nowadays mostly due to human error. Our case highlights the importance of implementing preventative measures, ensuring adequate staff training and the need for high level of vigilance required for early diagnosis and prompt management.

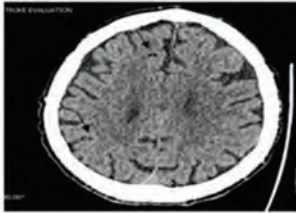

Figure 1: Initial CT

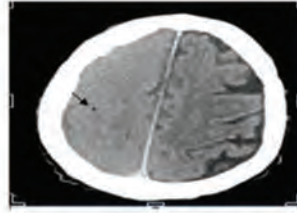

Figure 2: Follow up CT

Black arrows pointing to the air embolisms in figure 1 and figure 2, imaging obtained on initial presentation and the following day respectively.

SA-PO439

Comparison Between Incremental and Conventional Hemodialysis in a Single Center

Sehyun Jung,<sup>1</sup> Seunghye Lee,<sup>1</sup> Ha nee Jang,<sup>1,2</sup> Se-Ho Chang,<sup>1,2</sup> Hyun-Jung Kim.<sup>1,2</sup> <sup>1</sup>Gyeongsang National University Hospital, Jinju, Republic of Korea; <sup>2</sup>Gyeongsang National University Graduate School of Medicine, Jinju, Gyeongsangnam-do, Republic of Korea.

**Background:** Residual kidney function (RKF) in dialysis patients contributes to removing body fluids and salts, improving blood pressure, and enhancing middle molecules clearance. According to retrospective data, incremental hemodialysis (HD) may preserve RKF. However, its efficacy and safety are controversial compared to conventional HD.

**Methods:** This was a single-center retrospective study for comparison between incremental and conventional HD for one year. Inclusion criteria of incremental HD were urine output above 600ml/day and residual renal urea clearance (Kru) above 3ml/min/1.73m<sup>2</sup>. Among already maintenance HD patients, 21 patients changed to incremental HD (one or two times a week) and 54 patients maintained conventional HD (three times a week).

**Results:** There were three deaths in incremental HD group. Blood pressure and blood chemistry data at selected time points are shown in Table 1. Study arm between both groups in mixed effect models did not show significant parameters that were blood pressure, serum sodium, potassium, calcium, phosphate, protein, albumin, total cholesterol, glucose, and C-reactive protein. However, serum total CO<sub>2</sub> decreased significantly, and serum chloride was significantly higher in the incremental HD than in the conventional HD (Figure.1).

**Conclusions:** Incremental HD was not inferior to conventional HD. But, serum bicarbonate and chloride can be under-dialysis in the incremental HD, so careful observation is required in this group.

Table 1. Blood pressure and blood chemistry data

Parameter	Group	Time point after randomization, mo <sup>a</sup>				
		1	3	6	9	12
Predialysis SBP, mmHg	Conventional	146.3 ± 20.8	144.3 ± 19.7	146.9 ± 20.1	145.3 ± 20	148.6 ± 21.5
	Incremental	132.1 ± 24.3	141.4 ± 22.1	143.5 ± 20.2	139.9 ± 22	134.6 ± 17.1
Predialysis DBP, mmHg	Conventional	75.9 ± 11.9	74.3 ± 12.5	78.4 ± 15.1	73.8 ± 11.1	74.5 ± 11.6
	Incremental	71.5 ± 14.4	73 ± 14.2	76 ± 13.1	74.1 ± 13.7	70.6 ± 10.9
Postdialysis SBP, mmHg	Conventional	144.1 ± 20.7	141.4 ± 15.6	141.2 ± 19.5	144.1 ± 19.2	145.3 ± 22.4
	Incremental	140.9 ± 22.9	142.4 ± 17.7	145.9 ± 22.4	138.9 ± 27.6	139.4 ± 25.1
Postdialysis DBP, mmHg	Conventional	75.8 ± 12.4	73.7 ± 10.3	74.4 ± 12.2	75.8 ± 11.1	73.7 ± 12.1
	Incremental	75.5 ± 11.4	77.1 ± 11	76.9 ± 9.7	75.2 ± 12.8	70.8 ± 7.9
Sodium, mmol/L	Conventional	137.1 ± 4.2	137.6 ± 3.3	136.4 ± 3.1	137.1 ± 3.1	137.1 ± 3.5
	Incremental	138.2 ± 3.1	136.9 ± 2.9	137.1 ± 3.1	137.1 ± 4.1	137.5 ± 1.8
Potassium, mmol/L	Conventional	4.6 ± 0.6	4.7 ± 0.6	4.9 ± 0.7	4.9 ± 0.7	4.9 ± 0.8
	Incremental	4.7 ± 0.8	4.7 ± 0.7	4.8 ± 0.9	4.7 ± 0.7	4.7 ± 1
Chloride, mmol/L	Conventional	97.9 ± 4.7	99.3 ± 3.9	97.6 ± 4.3	99.5 ± 3.8	99.2 ± 4
	Incremental	102.8 ± 3.9	102.3 ± 5.1	103.8 ± 5.4	104 ± 5.2	104.2 ± 5.7
Total CO <sub>2</sub> , mmol/L	Conventional	23.4 ± 3.1	23.4 ± 3.3	23.9 ± 2.9	23 ± 3	23.9 ± 2.9
	Incremental	21.3 ± 3.4	20.4 ± 4	20 ± 4.3	19.7 ± 4.2	18.4 ± 3.2
Glucose, mg/dL	Conventional	140.6 ± 55.6	145.1 ± 57.8	139.5 ± 47.7	139.3 ± 50.5	144.4 ± 73.3
	Incremental	136.8 ± 41.5	151.5 ± 47.3	145.8 ± 55.9	143.7 ± 52.7	116.1 ± 22.8
Cholesterol, mg/dL	Conventional	135.3 ± 37.6	135.6 ± 33	130.2 ± 33.8	130.1 ± 36.4	132.2 ± 33.7
	Incremental	155.3 ± 49	155.3 ± 44.6	158.7 ± 34.3	154.5 ± 32.5	148.9 ± 33.7
Protein, g/dL	Conventional	6.7 ± 0.8	6.8 ± 0.6	6.9 ± 0.6	6.8 ± 0.5	6.8 ± 0.5
	Incremental	6.7 ± 0.7	6.7 ± 0.6	6.6 ± 0.5	6.4 ± 0.5	6.5 ± 0.6
Albumin, g/dL	Conventional	3.9 ± 0.5	4 ± 0.4	4.1 ± 0.5	4.1 ± 0.4	4.1 ± 0.4
	Incremental	4.1 ± 0.6	4.1 ± 0.5	4.1 ± 0.4	3.9 ± 0.4	4.1 ± 0.3
CRP, mg/L	Conventional	5.6 ± 10	4.5 ± 11.2	3.4 ± 5.9	8.2 ± 19.4	2.5 ± 4
	Incremental	3.1 ± 4.1	2.9 ± 4.8	2.8 ± 3	2.4 ± 3.2	2.1 ± 2

Data are presented as the mean (1 standard deviation) SBP, systolic blood pressure; DBP, diastolic blood pressure; CRP, C-reactive protein  
<sup>a</sup>Not all time points are shown for brevity.

Table 1. Blood pressure and blood chemistry data

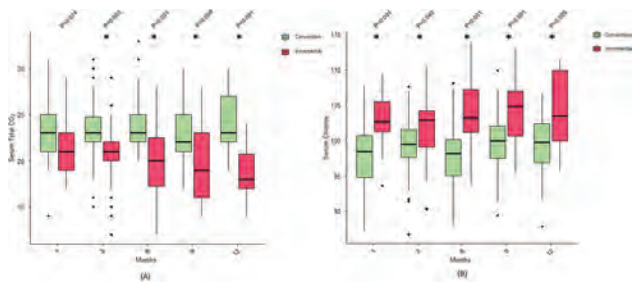

Figure 1. Serum total CO<sub>2</sub> (A), serum chloride (B) during study.

SA-PO440

Case Series of Continuous Venovenous Hemofiltration With Severe Hyponatremia and Acidosis

Kasumi Konishi, Takuya Fujimaru, Kotaro Shimoyama, Nozomi Kadota, Yugo Ito, Fumika Taki, Masahiko Nagahama, Shutaro Isokawa, Toru Hifumi, Norio Otani, Masaaki Nakayama. *St.Luke's International Hospital, Tokyo, Japan.*

**Introduction:** For the patients with anuric acute kidney injury (AKI) and severe hyponatremia, we previously reported “Flex Na” method, which involved flexible adjustment of the sodium concentration using continuous venovenous hemofiltration(CVVH). However the weak point of this methods is the management of severe acidosis. In this case series, we had performed “Flex Na” added on intravenous 1.26% NaHCO<sub>3</sub> and improved severe acidemia and hyponatremia.

**Case Description:** case1 A 57 year-old man admitted to the hospital with bacterial meningitis and AKI due to acute tubular necrosis. The blood test showed sodium 121 mEq/L, potassium 3.6 mEq/L, chloride 84 mEq/L, urea nitrogen 68.8mg/dL, creatinine 4.84 mg/dL. Arterial blood gas analysis showed pH 7.04, PaCO<sub>2</sub> of 37.4mmHg, PaO<sub>2</sub> of 103.0 mmHg, bicarbonate level of 9.6 mEq/L, lactate 10.9 mmol/L. We started Flex Na using the 5% dextrose solution(D5W) infusion and available replacement fluid(Sublood-BSG), which has a sodium concentration of 140 mEq/L as 1.26% NaHCO<sub>3</sub> was infused intravenously. After 48 hours, acidosis was improved. After another 24hours, serum sodium reached 130 mEq/L, and we changed intermittent hemodialysis(IHD). case2 A 48 year-old man with stage 5 chronic kidney injury admitted to hospital with unconsciousness due to uremia. The laboratory data showed sodium 108 mEq/L, potassium 6.0 mEq/L, chloride 78 mEq/L, urea nitrogen 139.3 mg/dL, creatinine, 17.85 mg/dL. Arterial blood gas analysis showed pH 6.8, PaCO<sub>2</sub> of 33.3mmHg, PaO<sub>2</sub> of 43.3 mmHg, bicarbonate level of 5.5 mEq/L, Lactate of 4.10mmol/L. We started “Flex Na” method with continuous infusion of D5W and 1.26% NaHCO<sub>3</sub> intravenously for the additional filtration. After 48 hours treatment, acidosis was improved and we changed IHD for maintenance renal replacement therapy.

**Discussion:** In general, adverse effects of acute metabolic acidosis include decreased cardiac output, arterial dilatation with hypotension, altered oxygen delivery, and impairment of the immune response. Therefore, the patients with severe metabolic acidosis need bicarbonate therapy or dialysis. However, CVVH had slower clearance than IHD. From this case report, Flex Na with intravenous NaHCO<sub>3</sub> infusion could be the optimal tool for the patients with severe hyponatremia and acidosis who require dialysis.

SA-PO441

**Fatal Systemic Air Embolism From Arteriovenous Fistula During Hemodialysis: A Case Report**

Arturo Peñaloza, Manuel A. Marquez. *Instituto Mexicano del Seguro Social, Tampico, Mexico.*

**Introduction:** We report a case of a Mexican woman diagnosed with end-stage CKD on regular hemodialysis with a left brachiocephalic (BC) arteriovenous fistula (AVF) who presented systemic air embolism during her HD session

**Case Description:** A 59-year-old woman with a ten years history of CKD on HD with a left BC AVF. She attended her scheduled HD session with no symptoms; minutes after the start of her session, she presented dyspnea, hypoxemia, hypotension, and sudden neurological deterioration requiring mechanical ventilation. A non-contrasted head CT demonstrated air embolism in the cortical veins of the bilateral parietal region. Our center had no hyperbaric oxygen therapy chamber, so FiO2 was increased to 1.0 and continued supportive care. TTE reported dilatation of the right atrium and ventricle, severe tricuspid insufficiency, and pulmonary hypertension. Patent foramen ovale was ruled out. 48 hours after, there was no neurological improvement, so a new head CT was ordered, finding parietal ischemic areas and no evidence of air embolism. Ventilator-associated pneumonia and non-ST elevation myocardial infarction complicated her hospitalization. On her fifth day, she developed VF with a subsequent cardiac arrest that did not respond to resuscitation maneuvers

**Discussion:** Due to the current safety mechanisms in hemodialysis units, such as air traps, a systemic air embolism is an infrequent event. Few cases in patients with AVF with fatal outcomes have been reported in contemporary literature. This case demonstrates the importance of maintaining a high index of suspicion to recognize this clinical entity in patients who present sudden cardiopulmonary and neurological alterations during HD. Alarms in hemodialysis units may not detect the unnoticed passage of air to the patient.

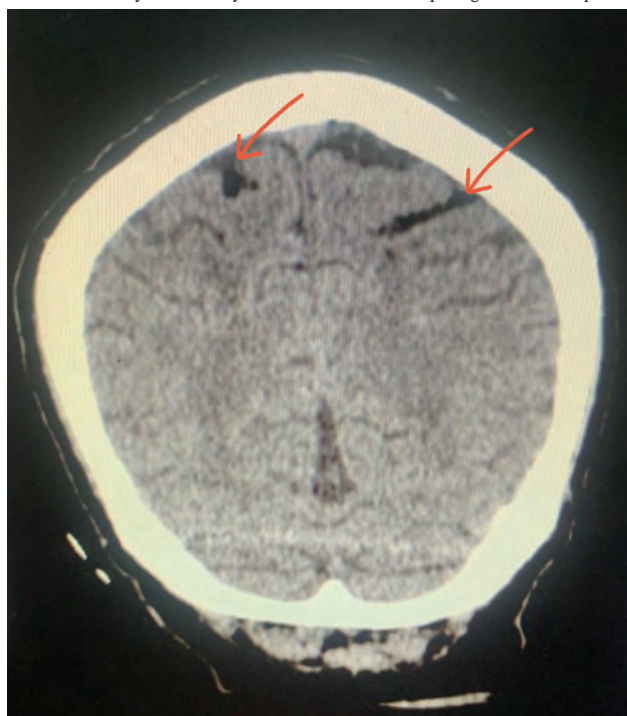

SA-PO442

**Euglycemic Ketoacidosis: An Underrecognized Complication of Continuous Renal Replacement Therapy**

Joel O. Adewuyi, Jusong Choi, Amir Kazory. *University of Florida, Gainesville, FL.*

**Introduction:** Euglycemic Ketoacidosis (EKA) is a rare presentation of diabetic ketoacidosis in patients with reduced caloric intake and those using newer antidiabetic medications. It is also seen in other settings where the body has to go to a ketogenic state due to reduced available glucose.

**Case Description:** A 52-year-old woman with a history of hypertension and diabetes was admitted for necrotizing soft tissue infection of the lower extremity. Hospital course was complicated by septic shock and oliguric acute kidney injury. Continuous renal replacement therapy (CRRT) was started with a conventional solution leading to gradual improvement in patient’s biochemical profile (Day 0). Nutrition was provided with low-glycemic carbohydrate along with intravenous insulin infusion. Two days later, CRRT solution was changed to a phosphate-containing solution to reduce the need for phosphate supplementation. This was followed by an unexplained progressive drop in serum bicarbonate levels in the face of normal serum lactate levels (anion gap metabolic acidosis [AGMA]) (Day 2). Since the phosphate-containing solution is glucose-free, there was a

suspicion for development of ketosis; serum beta hydroxybutyrate was found to be as high as 6.6 mmol/L (normal:  $\leq 0.27$ ) with stable glycemia confirming the diagnosis of EKA. CRRT solution was changed back to a conventional glucose-containing solution leading to a gradual reduction in the level of ketones and normalization of serum bicarbonate concentrations (Day 4).

**Discussion:** Since most patients on CRRT are critically ill and several of their biochemical parameters not within the normal range, EKA may remain unrecognized unless patients are screened for it. The diagnosis should be considered once there is progressive AGMA despite ongoing CRRT, in the absence of lactic acidosis, especially if a glucose-free solution is used.



SA-PO443

**Evaluation of Bacteriology of Bicarbonate Dialysis Solution (BDS) From Hemodialysis (HD) Clinics That Have Adopted Ferric Pyrophosphate Citrate (FPC; Triferic)**

Helen Currier,<sup>1</sup> Julie Zaleski,<sup>2</sup> Marc L. Hoffman.<sup>1</sup> *Rockwell Medical Inc, Wixom, MI;* <sup>2</sup>*Ascend Clinical, Redwood City, CA.*

**Background:** Despite broad advocacy in clinical guidelines, concerns remain that intravenous iron may increase the risk of infection by promoting pathogen growth and predisposing patients to infection (Shah, 2021). FPC is an iron (III)-citrate-pyrophosphate oligomeric complex that does not contain a carbohydrate shell and that delivers iron directly to transferrin via BDS. FPC experience at 98+ hemodialysis clinics and over 500 months (mos.) of exposure has not been associated with any report of bacterial growth from the BDS exceeding the Association for the Advancement of Medical Instrumentation (AAMI) standards.

**Methods:** As a quality assurance project evaluating the risk of bacterial growth and to supplement FPC safety data, the bacteriology of conventional BDS from 8 independent HD clinics was evaluated for positive evidence. These microbiological cultures of HD water and fluid are routine safety measures in US HD clinics. Collection is standardized by “clean-catch” and sent out by expedited mail. Permissions were obtained from individual dialysis facility medical directors to use their proprietary data in the analysis. The data was collected from a single clinical laboratory that exclusively provides ESRD services. The 8 FPC user clinics represented rural/urban areas from 4 states. Deidentified Water Analysis Reports collected and reported for routine Quality Assessment Performance Improvement surveillance [Total Viable Microbial Count (CFU/mL) and Limulus Amebocyte Lysate (LAL)] were analyzed for potential microbial growth pre- and post-adoption of FPC. Data included 12 mos. pre-FPC adoption to present. CMS regulations reference AAMI RD62:2006 for maximum allowable levels (MAL) in both culture and endotoxin. The MAL in water used for HD is 200 CFU/mL and 2 endotoxin unit (EU)/mL.

**Results:** Neither cohort of BDS cultures exceeded MALs. One LAL pre-FPC exposure exceeded the MAL.

**Conclusions:** This retrospective analysis demonstrates that FPC delivered in its different form *does not* contribute to microbial growth in the BDS. Shah AA, Donovan K, Seeley C, et al. Risk of infection associated with administration of intravenous iron: a systematic review and meta-analysis. *JAMA Netw Open.* 2021;4(11):e2133935.

Water Analysis Reports (n=254)	Pre FPC mos. (n=96) exceeding MAL	Post FPC mos. (n=154) exceeding MAL
CFU/ml	0	0
LAL EU/ml	1	0

Water Analysis Reports’ Results

SA-PO444

**Effect of Cytokine Adsorption on Mortality: A Meta-Analysis**

Bernhard M. Schmidt,<sup>1</sup> Hannah Lang,<sup>1</sup> Clara Vollmer Barbosa,<sup>1</sup> Zhejia Tian,<sup>1</sup> Anette Melk,<sup>2</sup> <sup>1</sup>Department of Nephrology and Hypertension, Hannover Medical School, Hannover, Germany; <sup>2</sup>Department of Pediatric Kidney, Liver and Metabolic Diseases, Hannover Medical School, Hannover, Germany.

**Background:** Cytokine adsorption using the CytoSorb® device had been proposed to be beneficial in various clinical settings including sepsis, ARDS, hyperinflammatory syndromes, cardiac surgery or recovery after cardiac arrest. The aim of this analysis was to provide evidence for the efficacy of the CytoSorb® device with regard to mortality in these settings.

**Methods:** We searched Medline, Cochrane Library database and used the database provided by Cytosorbents™. Central Register of Controlled Trials and clinicaltrials.gov for randomized, controlled studies (01.1.2010-28.2.22). We considered randomized controlled trials and observational studies with a control group. The longest reported mortality (30 days-, hospital- or ICU-mortality) was defined as primary endpoint. For analyzing the data we computed risk ratios and 95%-confidence intervals and used DerSimonian and Lairds random effects model (R 4.1). We analysed all studies together and separated in the subgroups sepsis, cardiac surgery, SARS-CoV-2 infection, recovery from cardiac arrest, other severe illness. The meta-analysis was registered in advance (PROSPERO: CRD4202290334).

**Results:** Of initial 1249 publications, 37 trials were found eligible, in total including 1256 patients treated with CytoSorb® and 1230 controls. Concerning the primary endpoint mortality Cytosorb® did not show a positive effect in all studies together 1.10 [0.92; 1.33] RR [95%-CI], in sepsis 1.03 [0.81; 1.31], CPB surgery 0.85 [0.51; 1.44], severe illness 1.05 [0.79; 1.39], SARS-CoV-2 1.58 [0.50; 4.94], and recovery from cardiac arrest 1.22 [1.02; 1.46] (figure). Likewise we did not find significant difference in ICU length of stay, lactate levels, or norepinephrine after treatment.

**Conclusions:** To date there is no evidence for a positive effect of the CytoSorb® adsorber on mortality across a bunch of indications that justifies its widespread use in intensive care medicine.

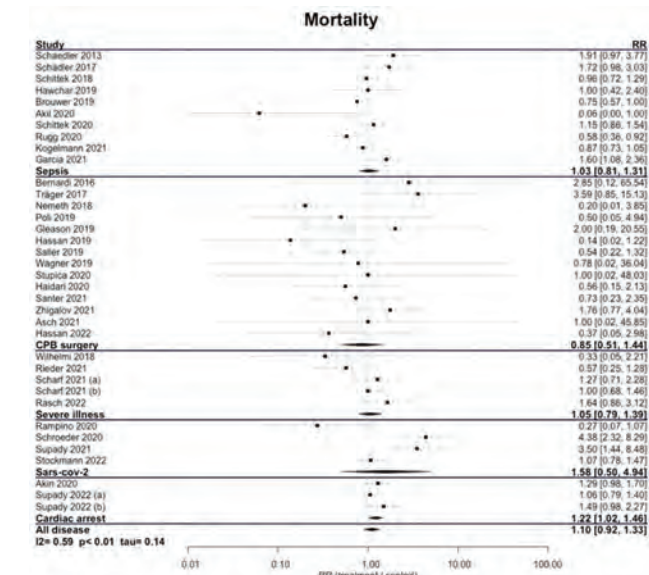

SA-PO445

**Incidence Rates of Bleeding Events With Heparin Administration in Chronic Hemodialysis Patients: A Systematic Review and Meta-Analysis**

Jochen G. Raimann,<sup>1</sup> Adelheid Gauly,<sup>2</sup> Joanna Willetts,<sup>3</sup> Suman K. Lama,<sup>3</sup> Derek M. Blankenship,<sup>3</sup> Thomas P. Deluca,<sup>3</sup> Jonathan Chavez,<sup>4</sup> Netzahualpilli Delgado Figueroa,<sup>4</sup> Guillermo Garcia-Garcia,<sup>4</sup> <sup>1</sup>Renal Research Institute, New York, NY; <sup>2</sup>Fresenius Medical Care Global Medical Office, Bad Homburg, Germany; <sup>3</sup>Fresenius Medical Care Global Medical Office, Waltham, MA; <sup>4</sup>Hospital Civil de Guadalajara Unidad Hospitalaria Fray Antonio Alcalde, Guadalajara, Mexico.

**Background:** To ensure patency of the extracorporeal circuit and vascular access, anticoagulation by systemic heparinization is usually performed during hemodialysis (HD). Heparin may have adverse effects such as bleeding, heparin-induced thrombocytopenia, and others, which may be a burden to the HD patients, to health care providers and to health care systems. The aim of this systematic literature review and meta-analysis was to provide a comprehensive overview of the incidence of bleeding events in heparinized HD patients and to estimate the variation associated with different types of heparins.

**Methods:** We searched PubMed, Embase, and the Cochrane Central Register of Controlled Trials (CENTRAL) database for English-language articles from January 1, 2000, to DATE. We included prospective, randomized, controlled trials and observational

studies that include chronic HD patients in whom unfractionated heparin (UFH) or low-molecular-weight heparin (LMWH), was used for systemic anticoagulation, and in which adverse effects of heparin as primary or secondary end points were reported. A random intercept Poisson regression model with maximum likelihood estimation was applied to estimate incidence rates. All articles were screened by two reviewers; discrepant assessments were cross-checked by a third reviewer. The detailed methodology has been published as PROSPERO Registration no. 239695.

**Results:** Screening of 3764 articles resulted in 20 articles with data that could be used for our meta-analysis. The incidence rate of minor and major bleeding events per 100 patient years for LMWH was 13.8 (95% CI 4.0 to 47.3) and for UFH was 6.2 (95% CI 2.5 to 15.5). Regional variability and a period effect associated with changes in practice patterns is being subject of additional research.

**Conclusions:** Our research quantified the incidence rates of bleeding associated with heparin administration in HD patients. Differences between the types of heparins need to be appreciated and should be subject of further research. A clear difference of heparin estimates to populations with no heparin administration, emphasizes the need for improvements allowing for minimization of the need for heparin administration.

SA-PO446

**Recurrent Clotting of the Filter in Home Hemodialysis With NxStage System One: A Case Report**

Dhayanithi Dhavalan, Sharon G. Adler, Tiane Dai. Harbor-UCLA Medical Center, Torrance, CA.

**Introduction:** Clotting of the dialyzer is one complication in home hemodialysis. Recurrent filter clotting without pro-thrombotic factors is relatively uncommon. We report an adult male with recurrent clotting of the venous header of the filter in NxStage System One during home hemodialysis.

**Case Description:** A 60-year-old African American male with end stage renal disease from obstructive nephropathy due to prostate cancer was in remission after radiation therapy. He started on in-center hemodialysis via a tunneled internal jugular catheter. Two years later, he transitioned to home hemodialysis due to uncontrolled blood pressure and phosphorus levels. He was on apixaban for anticoagulation due to a history of paroxysmal atrial fibrillation. Patient did well on home hemodialysis via a right brachiocephalic fistula prior to his hospitalization for bladder bleeding that was attributed to radiation cystitis. Apixaban was temporarily discontinued. After discharge, patient started experiencing recurrent clotting of the venous header of the NxStage System One filter, which did not resolve with restarting Apixaban, changing the blood flow rate, increasing the heparin bolus dose, and adding a heparin infusion or saline flush hourly. He had no history of recurrent thrombosis of his vascular access nor identifiable pro-thrombotic risk factors. The clotting issue did not occur when he received in-center or in-hospital dialysis, where a standard (Fresenius) dialysis machine and high flux dialyzer were used. Clotting appeared to resolve with a combination of: 1) Flushing the dialyzer with at least one liter of saline; 2) Administration of apixaban 5mg one hour prior to dialysis; and 3) Using a higher heparin bolus dose 50units/kg (4,000units) with a supplemental 1,000 unit/hr infusion. The patient now experiences prolonged post-dialysis bleeding time and the AVF requires a careful pressure dressing.

**Discussion:** Dialyzer clotting during home hemodialysis is one of the complications. Recurrent clotting of the filter in the NxStage System One is uncommon but can occur in home hemodialysis patients with no identifiable pro-thrombotic factors. Clotting may be prevented by an increase in anticoagulant dosing. Higher bleeding risk is one of the precautions.

SA-PO447

**Sodium-Induced Microcirculatory Dysfunction During Hemodialysis**

Lisa Hur,<sup>1</sup> Yanmin Zhang,<sup>1</sup> Barry Janssen,<sup>1</sup> Christopher W. McIntyre,<sup>2</sup> <sup>1</sup>Western University, London, ON, Canada; <sup>2</sup>London Health Sciences Centre London Kidney Clinical Research Unit, London, ON, Canada.

**Background:** Hemodialysis (HD) results in microcirculatory dysfunction (MD) leading to recurrent cardiac ischemia. Endothelial glycocalyx is vulnerable to circulatory and oncotic stress (predominantly Na<sup>+</sup> mediated)- inducing shedding of syndecan-1 (syn1), a transmembrane heparan sulfate proteoglycan. The glycocalyx binds Na<sup>+</sup>, buffering sudden serum Na<sup>+</sup> shifts, and can be damaged with acute changes in Na<sup>+</sup> concentration ([Na<sup>+</sup>]). The aim of this study is to investigate the effects of [Na<sup>+</sup>] dialysate on endothelial cell injury and MD during HD. We hypothesize that avoidance of higher [Na<sup>+</sup>] dialysate would have a direct protective effect on the endothelial glycocalyx and minimize directly observed HD-associated microcirculatory disturbance.

**Methods:** 8 healthy male Wistar Kyoto rats underwent HD: 4 were exposed to a higher dialysate [Na<sup>+</sup>] (140mM) and 4 were exposed to dialysate [Na<sup>+</sup>] below typical rat plasma Na<sup>+</sup> level (hyponatremic-130mM). Throughout HD, intravital microscopy (IVM) was used to image skeletal muscle microvasculature at baseline, during extracorporeal circulation with no dialysate flow ("Sham"), at 1 hr into HD, at 2 hrs into HD, and post HD ("Final"). The IVM images were processed to automatically derive the number of identified intersecting points, to quantify microcirculatory blood flow and observe the change in perfusion index at each timepoint. Blood samples were collected at the same timepoints corresponding to the IVM image acquisitions to measure syn1 and quantify glycocalyx shedding during HD. Continuous BP recordings were made from carotid artery cannulation.

**Results:** BP response to HD was comparable between the two groups. We observed progressive increase in syn1 concentration in blood plasma sampled throughout the duration of the experiment in both groups (Fig 1A). The hyponatremic group demonstrated a consistent trend of lower perfusion index at all timepoints relative to the comparator group (ns, Fig 1B).

Key: TH - Thursday; FR - Friday; SA - Saturday; OR - Oral; PO - Poster; PUB - Publication Only

Underline represents presenting author.

**Conclusions:** Preliminary data in healthy rats suggests that a single HD session results in syn1 release from the vasculature- indicating acute HD-associated endothelial injury. Limiting exposure to intradialytic Na<sup>+</sup> may reduce MD under the stress of HD, despite equivalent systemic hemodynamic response.

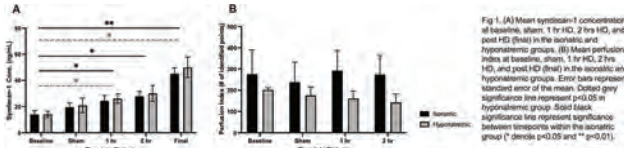

SA-PO448

**Microbacterium Sepsis due to an Insufficiently Sterilized Dialyzer**

Mark D. Kilpatrick, Jason M. Kidd. Virginia Commonwealth University School of Medicine, Richmond, VA.

**Introduction:** Water treatment systems and dialysis machines are susceptible to growth of microorganisms if not sufficiently disinfected. We present a case of *Microbacterium* sepsis related to insufficient sterilization of a hemodialysis machine when brought back into circulation.

**Case Description:** A 45-year-old man with ESKD presented to the emergency department after chills and vomiting during hemodialysis. Earlier in the day, a patient using the same hemodialysis machine, which had just been returned to use, developed similar symptoms and was admitted to the ICU. In the ED, our patient was tachycardic and tachypneic with a leukocyte count of 7.0x10<sup>9</sup>/L. Blood cultures were collected in the dialysis unit and ED and he was started on vancomycin and piperacillin-tazobactam empirically. On hospital day 3, cultures grew gram positive rods which later speciated to *Microbacterium*. Repeat cultures yielded no growth and our patient's tunneled dialysis catheter was replaced. He was treated with intravenous vancomycin for a 14-day course. Blood cultures in the patient dialyzed before our patient were also positive for *Microbacterium*. Cultures obtained from the dialysis machine yielded no growth.

**Discussion:** This rare case of hemodialysis-associated *Microbacterium* bacteremia demonstrates the importance of proper hemodialysis machine sterilization. *Microbacterium* are gram positive rods that rarely cause human infection [1]. Given our patient's history and the prior patient's similar history on the same machine, the origin of our patient's bacteremia is presumably the hemodialysis machine, likely either the tubing or dialysate. These two sources are the most common sites of microbial contamination [2]. *Microbacterium* bacteremia is also associated with catheter and port access and has been cultured from direct catheter sampling in an infected patient [1]. Although dialysis facilities have varying sterilization procedures, they adhere to strict contamination and monitoring standards for patient benefit. In our case, it is not known if there was a lapse in cleaning protocol or inadvertent material contamination, but thankfully our patient improved with prompt administration of empiric antibiotics and permacath replacement. [A] Chorost M, et al. 2018. [B] Pontoriero G, et al. 2003.

SA-PO449

**The World Prevalence, Associated Risk Factors, and Mortality of Hepatitis C Virus Infection in Hemodialysis Patients: A Meta-Analysis**

Tanat Lertussavavivat, Primploy Greeviroj, Thana Thongsricome, Kullaya Takkavatakarn, Jeerath Phannajit, Yingyos Avihingsanon, Kearkiat Praditpornsilpa, Somchai Eiam-Ong, Paweena Susantitaphong. Chulalongkorn University Faculty of Medicine, Bangkok, Thailand.

**Background:** Hemodialysis patients constitute high-risk population for HCV infection. The world burden of HCV infection among hemodialysis patients has not been systematically examined.

**Methods:** A systematic literature search was conducted in MEDLINE and Scopus to determine the world prevalence of HCV infection, risk factors, and outcomes among hemodialysis patients. Random-effect models and meta-regressions were used to generate pooled estimates and assess heterogeneity.

**Results:** Four hundred and seven studies with 1,302,167 participants were analyzed. The pooled prevalence of HCV infection was 21%. The highest prevalence was observed in Africa (28%) and low-income countries (48.5%). A significant prevalence was declined following the publication year and was also inversely related to GDP spent on total health expenditure and total population of each country. The most common HCV genotype was genotype 1b (33.5%), followed by genotype 1a (22.8%), 3 (8.2%), 2 (6%), 4 (5%), and 6 (2.4%). Factors associated with HCV positivity included younger age, longer dialysis duration, more blood transfusions, and dialyzer reuse. The pooled unadjusted HR for all-cause mortality was 1.12 (95%CI 1.03 to 1.22), and the adjusted HR was 1.21 (95%CI 1.12 to 1.30) in HCV-infected relative to non-HCV infected patients. There was significantly higher HCV-associated mortality from infection and malignancy.

**Conclusions:** HCV infection among hemodialysis patients is a shared burden worldwide and is associated with a higher risk of death.

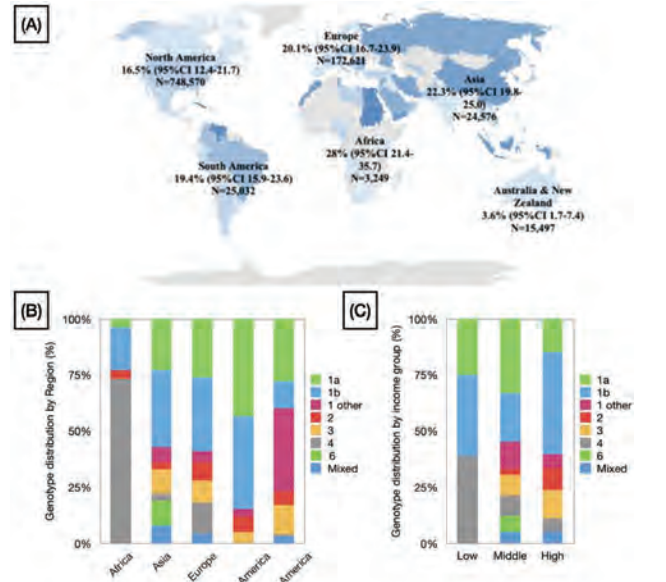

Pooled prevalence of HCV infection among hemodialysis patients (A) by world zones and HCV genotype distribution (B) by regions and (C) country's income

SA-PO450

**Favorable Prognosis in Patients Undergoing Hemodialysis Who Received a 23-Valent Pneumococcal Polysaccharide Vaccine Compared With Those Who Received a 13-Valent Pneumococcal Protein-Conjugate**

Kosei Yamaguchi,<sup>1,2</sup> Mineaki Kitamura,<sup>1,2</sup> Satoshi Funakoshi,<sup>1</sup> Tomoya Nishino.<sup>2</sup> <sup>1</sup>Nagasaki Renal Center, Nagasaki, Japan; <sup>2</sup>Nagasaki University School of Medicine, Nagasaki, Japan.

**Background:** Infectious diseases are one of the main causes of death in patients undergoing hemodialysis (HD). Routine pneumococcal vaccination for the older population began in 2014 in Japan. Currently, the 23-valent pneumococcal polysaccharide vaccine (PPSV23), alone or in combination with a 13-valent pneumococcal protein conjugate vaccine (PCV13), is recommended for older patients. However, the efficacy of these two vaccines in patients undergoing HD remains unknown. We aimed to evaluate the prognosis of patients undergoing HD who were vaccinated with only PPSV23 compared with those vaccinated with PCV13.

**Methods:** Patients undergoing HD who were vaccinated with PPSV23 alone (PPSV23 group) or PCV13 (PCV13 group) between 2014 and 2016 were included, and the observation period was three years from the first injection. Patients who underwent HD between 2011 and 2012 were included as controls and observed for three years. The patients did not receive any pneumococcal vaccines during this period. After propensity score matching using age, sex, dialysis vintage, diabetes history, pneumonia history, and serum albumin and creatinine levels, survival analysis was performed.

**Results:** The study included 89 patients in the PPSV23 group (70.0±10.7 years old; 65.2% male; median dialysis vintage, 3.6 years), 98 patients in the PCV13 group (76.6±8.0 years old; 48.0% male; median dialysis vintage, 3.1 years), and 339 patients as controls (67.4±13.3 years old; 57.2% male; median dialysis vintage, 4.6 years). After propensity score matching, the PPSV23 and control groups (81 patients each), and the PCV13 and control groups (76 patients each) were evaluated. Significant differences in the survival rate between the PPSV23 group and controls were observed (P=0.04), but no significant difference was observed between the PCV13 group and controls. The incidence of pneumonia in the PPSV23, PCV13, and control groups did not differ significantly during the observation period.

**Conclusions:** The patients vaccinated with PPSV23 had favorable outcomes; however, the efficacy of PCV13 was limited in older patients who were undergoing HD. Further studies are needed to clarify the mechanisms affecting the prognostic relevance of pneumococcal vaccines and the differences between them.

SA-PO451

**Observations of Infection Prevention and Control Practices in US Outpatient Hemodialysis Clinics, 2015-2018**

Nicole Gualandi, Stephanie Hsu, Shannon Novosad, Priti R. Patel. National Dialysis ICAR Implementation Working Group Centers for Disease Control and Prevention, Atlanta, GA.

**Background:** Pandemics have highlighted the need for robust infection prevention and control (IPC) in dialysis clinics to prevent spread of infections. In 2015, public health departments were funded to assess and improve IPC in hemodialysis clinics. We present results of observations performed during these assessments.

**Methods:** A standardized Infection Control Assessment and Response (ICAR) form was developed by IPC experts at a federal public health agency. The form included observations of practice using published tools for 7 different IPC processes. A process was considered successful if all recommended steps were completed. Health department staff selected clinics for assessment and were trained on use of the observation tools. Cross-sectional assessments occurred from March 2015-March 2018. We pooled jurisdictions' aggregate numerator and denominator data and calculated the percent of observed processes successfully completed.

**Results:** In all, 70,288 IPC observations were made in 764 dialysis clinics in 29 jurisdictions. Of 42,642 hand hygiene opportunities observed, 89.5% were successful (Figure). Among injection processes, 82.1% of 3,802 injection preparations and 87.3% of 3,550 injection administrations were successful. Among vascular access processes, 77.3% of 6,688 arteriovenous access connections, 82.0% of 4,061 catheter connection/disconnections, and 65.8% of 2,350 catheter exit site processes were successful. For routine disinfection of dialysis stations, 62.4% of 7,195 observed processes were successful.

**Conclusions:** In a large-scale evaluation of dialysis IPC practices, observed adherence to hand hygiene and injection safety was high. But infrequent, serious errors could have occurred. Important areas for improvement may exist for vascular access care and dialysis station disinfection. Increased attention to routine IPC practice will likely lessen the impact of emerging infections.

**Funding:** Other U.S. Government Support

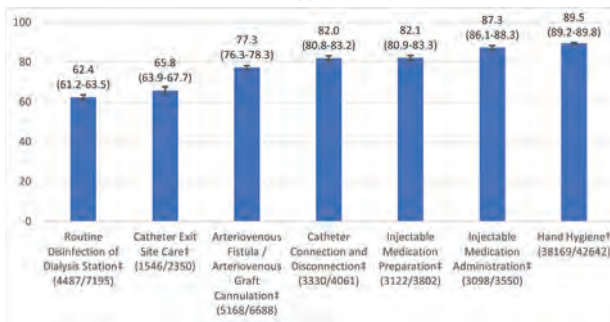

SA-PO452

**Characteristics and Outcomes Among Hospitalized Patients With Gram-Negative Bacteremia (GNB) Who Require Kidney Replacement Therapy (KRT)**

Matthew R. Sinclair,<sup>1,2</sup> Joshua T. Thaden,<sup>1</sup> Felicia Ruffin,<sup>5</sup> Lawrence Park,<sup>1,3</sup> Michael M. Dagher,<sup>4</sup> Emily Eichenberger,<sup>1</sup> Christina M. Wyatt,<sup>1,2</sup> Vance Fowler.<sup>1,2</sup> <sup>1</sup>Duke University School of Medicine, Durham, NC; <sup>2</sup>Duke Clinical Research Institute, Durham, NC; <sup>3</sup>Duke Global Health Institute, Durham, NC; <sup>4</sup>Duke University Health System, Durham, NC; <sup>5</sup>Duke University Medical Center, Durham, NC.

**Background:** GNB is a common cause of sepsis in patients requiring KRT, and is associated with morbidity and mortality. These adverse outcomes are partially the result of increasing antibiotic-resistant bacterial strains, but other contributing patient and bacterial factors are unclear. Further, it is unknown if patients hospitalized with GNB who develop acute kidney injury (AKI) requiring KRT prior to bacteremia have disparate outcomes compared to patients on maintenance hemodialysis (HD) hospitalized with GNB. We evaluated differences in characteristics and outcomes in hospitalized patients with GNB with AKI requiring KRT vs those on maintenance HD and assessed associations between clinical and bacterial characteristics and outcomes.

**Methods:** Hospitalized, non-neutropenic adults with GNB who required KRT were prospectively enrolled from Jan 1, 2002 to December 31, 2016 (n=185). Clinical and bacterial characteristics and outcomes between groups were evaluated with Mann-Whitney-U or Fisher's Exact test. Associations with outcomes were estimated using logistic regression.

**Results:** Among hospitalized patients with GNB, those patients with AKI requiring KRT (n=38) compared to patients on maintenance HD (n=147) were more acutely ill (Acute Physiology Score, median (APS) 13.0 vs APS 9.0; p=0.03), more likely to be a transplant recipient (44.7% vs 18.4%; p=0.001), less likely to identify as Black race (18.4% vs 67.3%; p<0.001), and more likely to have a multi-drug resistant (MDR) bacterial strain (47.4% vs 27.1%; p=0.02). Additionally, patients with AKI requiring KRT were more likely to have clinical complications (65.8% vs 40.1%; p=0.006) and to die (57.9% vs 24.5%; p<0.001) compared to patients on maintenance HD. Among all patients, MDR bacterial strains and non-vascular source of infection were associated with all-cause mortality (Odds Ratio (OR) 4.36, 95% Confidence Interval (CI) 1.83-11.00 and OR 6.94, 95% CI 2.11-28.48, respectively).

**Conclusions:** Hospitalized patients with GNB and HD-dependence are at significant risk for adverse outcomes. Both clinical and bacterial characteristics contribute to these outcomes, with clinical complications and mortality rates highest among patients who develop AKI requiring KRT.

**Funding:** Other NIH Support - K24-AI093969

SA-PO453

**Outcomes and Costs of Central Venous Catheter (CVC)-Related Staphylococcus aureus Bloodstream Infections (SA-BSI) in Hemodialysis (HD) Patients (Pts) With SA Nares Colonization (SA-NC) and Diabetes Mellitus (DM)**

Nimish Patel,<sup>1</sup> Jamie P. Dwyer,<sup>2</sup> Lynda Berne,<sup>3</sup> Clarence L. Young,<sup>4</sup> Matthew Callahan,<sup>4</sup> Anthony G. Robinson,<sup>4</sup> Thomas P. Lodise.<sup>5</sup> <sup>1</sup>Skaggs School of Pharmacy and Pharmaceutical Sciences, University of California San Diego, San Diego, CA; <sup>2</sup>University of Utah Health, Salt Lake City, UT; <sup>3</sup>BAL Pharma Consulting, Princeton, NJ; <sup>4</sup>Botanix Pharmaceuticals Limited, North Perth, WA, Australia; <sup>5</sup>Albany College of Pharmacy and Health Sciences, Albany, NY.

**Background:** The rate of SA-BSIs in pts who start in-center HD with a CVC is estimated to be ~1 cases per 100-person months (PMID: 28663227), with higher rates observed in CVC-HD pts with SA-NC and DM. This study estimated the yearly outcomes and costs attributable to CVC-related SA-BSIs in adult CVC-HD pts with SA-NC and DM who start in-center HD.

**Methods:** A probabilistic model from the US Healthcare Perspective (1-year time horizon) was developed. The study population consisted of ~45,000 pts with DM as primary cause of ESRD who start in-center CVC-HD each year. Markov modeling (4 12-week cycles) was used to simulate the transitions between the different health-related dynamic states of CVC-HD pts with SA-NC and DM and estimate the yearly CVC-related SA-BSI-related outcomes and costs. Time on CVC, prevalence of SA-NC, CVC-related SA-BSI rates, CVC-related SA-BSI re-infection rates, 12-week SA-BSI costs (first episode and re-infections), and CVC-related SA-BSI death rates were identified in comprehensive literature review (Figure 1).

**Results:** Data indicate that 18,000 of the 45,000 annual incident CVC-HD pts with DM have SA-NC. Among CVC-HD pts with SA-NC and DM, the model estimates that there are 3,690 CVC-related SA-BSIs, 720 SA-BSI-related re-infections, and 900 SA-BSI-related deaths annually. Attributable yearly mean (SD) costs are projected to be 229 (51) million USD.

**Conclusions:** The estimated annual incidence of CVC-related SA-BSIs in CVC-HD pts with DM who start in-center HD that is attributable to SA-NC is high, resulting in considerable morbidity, mortality, and healthcare costs. New technologies are needed to prevent CVC-related SA-BSIs in this population.

**Funding:** Commercial Support - Botanix

Figure 1. Primary References to Support Model Inputs

Model Covariate	Primary References*	Input for Model	Range for Monte Carlo Simulation
Number of Patients with DM as Primary Cause of ESRD who Start in-Center CVC-HD Each Year in the US	USDRS 2019 and 2020 Data Annual Reports <a href="https://afip.unhcr.org/70200/med-stare.html?stare=2-vaporlic-acorn">https://afip.unhcr.org/70200/med-stare.html?stare=2-vaporlic-acorn</a> <a href="https://unhcr.org/media/2317/2019-executive-summary.pdf">https://unhcr.org/media/2317/2019-executive-summary.pdf</a>	45,000 patients	NA
Time on CVC and Transitions Between Health-Related Dynamic States Across Four 12-Week Model Cycles	USDRS 2020 Annual Data Report <a href="https://afip.unhcr.org/70200/med-stare.html?stare=2-vaporlic-acorn">https://afip.unhcr.org/70200/med-stare.html?stare=2-vaporlic-acorn</a>	Cycle 1 (CVC-retained): 100-68% Cycle 2 (CVC-retained): 88-46% Cycle 3 (CVC-retained): 46-28% Cycle 4 (CVC-retained): 28-17%	NA
SA-Colonization	Schuch M et al. BMC Nephrol. 2019 May 6;20(1):153  Martin K et al. Open Forum Infect Dis. 2020 Apr 14;7(6):ofaa117. doi: 10.1093/ofid/ofaa117.	Overall: 40% at start of each cycle 15% persistently colonized 25% intermittently colonized	30-50% overall 10-20% for persistent 20-30% for intermittent Triangular distribution
SA CVC-Related BSIs Among SA-Colonized Patients with DM as Primary Cause of ESRD	Chaudry MS et al. Hemodialy. 2019 Apr;23(2):230-238. doi: 10.1111/hdi.12728  Sedlcock M et al. Am J Kidney Dis. 2007 Mar;49(3):401-8.  Taylor G et al. Am J Infect Control. 2004 May;32(5):555-60. doi: 10.1016/j.ajic.2003.05.007.	3.1 SA-BSI per 100 person-months  9.3% of SA-nares colonized pts with DM will have a CVC-related SA-BSI each cycle	5-10% (Triangular distribution)
CVC-Related SA-BSI Re-Infection Rate Among SA-BSI Survivors	Choi SH et al. Clin Infect Dis. 2021 Jun 1;72(11):1891-1899  Engemann JJ et al. Infect Control Hosp Epidemiol. 2005 Jun;26(6):534-9.	15%	NA
12-Week Costs for First CVC-Related SA-BSI and CVC-Related SA-BSI Re-infections	Reed SD et al. Infect Control Hosp Epidemiol. 2005 Feb;26(2):175-83.  Touat M et al. J Infect. 2021 Mar;22(3):339-345.  Tian W. <a href="http://www.hospira.com/gov/reports/statberfs/eb-205-Hospital-Discharge-Postdischarge.pdf">http://www.hospira.com/gov/reports/statberfs/eb-205-Hospital-Discharge-Postdischarge.pdf</a>	Weighted 12-week cost of \$47,285 for Primary CVC-HD-Related SA-BSI  Weighted 12-week cost of \$42,352* for CVC-HD-Related SA-BSI Re-infections	Applied normal distribution with fixed lower bound of \$5,000 (initial hospitalization with readmission) and upper bound 2 times the mean to capture cost distribution
Mortality at 12 Weeks for First CVC-Related SA-BSI and CVC-Related SA-BSI Re-infections	Engemann JJ et al. Infect Control Hosp Epidemiol. 2005 Jun;26(6):534-9.	19%	NA

\*These were the primary references to support its model input. Additional references (not shown) were supportive of each input.

## SA-PO454

## Clinician and Patient Support Through Supply Chain Innovation During the COVID-19 Pandemic

Ramnik S. Khangura, Kulwant Sandhu, Cynthia J. D'Alessandri-Silva, Michael A. Aragon. *Outset Medical, San Jose, CA.*

**Background:** Since March 2020, the COVID-19 Pandemic has critically impacted the global supply chain from raw materials to devices and supplies. As a result, many hospitals' and dialysis providers' capacity to provide care for patients in ICUs and dialysis units was materially impacted. To ensure patients received the necessary life-saving dialysis treatments from the ICU to Home with Tablo, it was critical to implement a new, long term global supply chain strategy. Here we report the impact of an innovative supply chain initiative to meet these challenges.

**Methods:** Retrospective analysis of supply chain performance metrics from Dec 2020-Dec 2021 assessed monthly for on-time delivery, inventory, allocation events and overall parts shipped. During March and April of 2020, Outset's supply chain team implemented 3 strategic initiatives aimed at improving risk analysis, upstream sourcing and logistics management. Risk analysis improvements included investment in software analytics and application of AI to improve transparency for rapid decisions. Upstream sourcing developed expertise in the full life cycle of every component and category of the device to secure supplies with methods including dual source or near source. Logistics focused on long term stability and localization of goods by partnering with third party distribution and logistics providers to utilize a wider range of supply transport options.

**Results:** Over the 13 months period, total treatments delivered increased by 125%. The mean On Time Delivery performance over the same period was 96% (min 92%, max 98%), better than the internal target of 95%. (Fig 1) There were no occurrences of delivery interruption or implementation of supply allocation to any hospitals, clinics or home dialysis patients.

**Conclusions:** Sustainable innovation in Tablo's console and cartridge supply chain successfully supported the increased demand for dialysis equipment and supplies and ensured reliable delivery of critically needed treatment related supplies for clinicians and patients using Tablo throughout the peak of the pandemic.

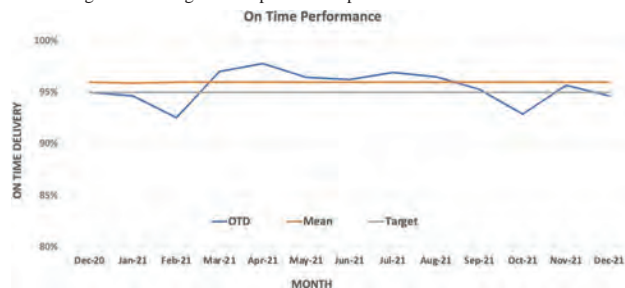

## SA-PO455

## Pandemic Effects on Stability of Goals-of-Care Congruence Between Dialysis Patients and Their Surrogates: A Natural Experiment Study

Mi-Kyung Song, Sudeshna Paul, Jordan L. Pelkmans. *Emory University, Atlanta, GA.*

**Background:** The COVID pandemic has brought fear and uncertainty to all aspects of life and to medical care in particular. This study was to assess the effects of a disaster on the stability of dialysis patients' end-of-life care preferences and dyad congruence on goals of care after an evidence-based advance care planning (ACP) intervention, SPIRIT (Sharing Patient's Illness Representations to Increase Trust).

**Methods:** In an on-going parent study, a pragmatic trial of SPIRIT included 151 patient-surrogate dyads who completed the baseline (T1) and post-intervention assessment (T2), including goals-of-care preferences (asking patient's values in specific scenarios), prior to the pandemic lockdown. Of those, 110 dyads (59 intervention and 52 usual care) consented to be in this natural experimental study during the pandemic and completed the measures 2 additional times, at enrollment (T3) and again 6 months later (T4), along with the COVID Stress Scale. Dyad congruence was measured by comparing patients' and surrogates' responses to the goals-of-care document.

**Results:** The sample included 83% non-White. In general, most patients' goals-of-care preferences and dyad congruence were stable over time. GEE analyses showed a time and pandemic interaction in dyad congruence on goals of care ( $p=0.04$ ): both groups' dyad congruence sharply improved at T2 from T1 but more so in intervention dyads before the pandemic (significant treatment effect,  $p=0.01$ ), and the congruence levels remained stable until T3 during the pandemic followed by an increase in dyads' congruence at T4 (Fig 1). But group difference during the pandemic (T3, T4) was not significant.

**Conclusions:** After the ACP intervention, intervention dyads' congruence was significantly better than controls, but the intervention did not make intervention dyads' congruence more stable than controls' during the pandemic.

**Funding:** Other NIH Support - NINR

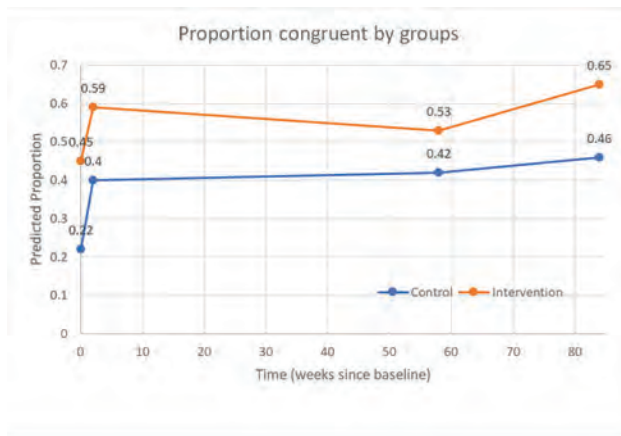

Dyad Congruence By Group

## SA-PO456

## Long-Term SARS-CoV-2 Antibody Titers After mRNA Vaccination in Patients Undergoing Hemodialysis in Japan

Daisuke Kanai,<sup>1</sup> Tatsuya Haze,<sup>1</sup> Hiromichi Wakui,<sup>1</sup> Masaaki Hanaoka,<sup>3</sup> Eriko Abe,<sup>1</sup> Kengo Azushima,<sup>1</sup> Nobuhito Hirawa,<sup>2</sup> Kouichi Tamura,<sup>1</sup> <sup>1</sup>Yokohama Shiritsu Daigaku Igakubu Daigakuin Igaku Kenkyuka, Yokohama, Japan; <sup>2</sup>Yokohama Shiritsu Daigaku Fuzoku Shimin Sogo Iryo Center, Yokohama, Japan; <sup>3</sup>Iryo Hojin Shadan Kohsaikai Kamioooka Jinsei Clinic, Yokohama, Japan.

**Background:** Severe acute respiratory syndrome coronavirus 2 (SARS-CoV-2) vaccination is shown to prevent severe illness and death in hemodialysis (HD) patients, but the immune response to vaccines is reduced in this population. This study compares SARS-CoV-2 spike protein antibody titers between HD patients and healthy controls in Japan for up to 6 months following vaccination.

**Methods:** A multi-institutional retrospective study at five clinics in Japan was conducted using 412 HD patients and 156 healthy controls who received two doses of the BNT162b2 (Pfizer-BioNTech) mRNA vaccine. Anti-SARS-CoV-2 spike protein S1 IgG antibody titers were measured at 1, 3, and 6 months after the second dose. The attenuation speed was calculated as slope (i.e., -b) by using a linear mixed-effects model toward the log-transformed antibody titers.

**Results:** The HD group had significantly lower month 1 antibody titers (Ab-titer-1) than the controls, and these remained lower through month 6 (95% CI: 2617.1 (1296.7, 5240.8) vs. 7285.4 (4403.9, 11000.0) AU/mL at Ab-titer-1, and 353.4 (178.4, 656.3) vs. 812.0 (498.3, 1342.7) AU/mL at Ab-titer-6 ( $p < 0.001$ , respectively)). Lower log Ab-titer-1 levels in the HD group were significantly associated with a lower log Ab-titer-6 (0.90 [0.83, 0.97],  $p < 0.001$ ). The -b values in the HD patients and healthy controls were  $-4.7 \pm 1.1$  and  $-4.7 \pm 1.4$  (year<sup>-1</sup>), respectively. In the HD patient group, age, serum albumin level, and hemoglobin level showed a negative correlation with Ab-titer-1, and the use of vitamin D preparation showed a positive correlation. In addition, the lower peak antibody titer contributed to the lower Ab-titer-6.

**Conclusions:** SARS-CoV-2 spike protein antibody titers were significantly lower in HD patients than in healthy controls at 1 (peak) and 6 months after the second vaccination. Low peak antibody titers contributed to low 6-month antibody titers.

## SA-PO457

## Better Anti-Spike IgG Antibody Response to SARS-CoV-2 Vaccine in Patients on Hemodiafiltration Than on Hemodialysis

Fernando Carrera,<sup>1</sup> Stefan H. Jacobson,<sup>2</sup> Joana Costa,<sup>1</sup> Marco A. Marques,<sup>3</sup> Francisco Ferrer.<sup>1</sup> <sup>1</sup>DaVita, Leiria, Portugal; <sup>2</sup>Danderyd Hospital, Stockholm, Sweden; <sup>3</sup>Affidea Laboratory, Lisbon, Portugal.

**Background:** The antibody response to SARS-CoV-2 vaccine in hemodialysis (HD) patients is diminished compared to healthy subjects. The aim of this study was to compare the presence of reactive SARS-CoV-2 antibodies in patients with high-flux HD and on-line hemodiafiltration (HDF) three and six months after the second dose of SARS-CoV-2 vaccine since previous studies indicate that a sustained antibody response correlate with protection from disease.

**Methods:** We included 216 HD patients of which 157 had on-line HDF and 59 high-flux HD and 46 health care workers as controls and studied the presence of reactive anti-spike IgG antibodies three and six months after the second dose of SARS-CoV-2 vaccine. Clinical features between the patient groups were similar, but patients with on-line HDF had significantly higher Kt/V.

**Results:** The percentage of participants with reactive antibodies was significantly lower in patients compared to controls, both three and six months after the second dose of vaccine. Furthermore, the proportion of patients with reactive anti-spike IgG  $\geq 1.0$  six months after the second dose of vaccine was significantly higher in patients with on-line HDF compared to in patients with high-flux HD. In logistic regression analyses

adjusted for several clinical features, the variables associated with presence of reactive anti-spike IgG at three months after the second dose of vaccine were lower age, HDF treatment, not being obese and not having a previous solid organ transplant. The two variables with the strongest influence on the presence of reactive anti-spike IgG levels six months after the second dose of vaccine were treatment with on-line HDF and not having immunosuppressive therapy.

**Conclusions:** This is the first study to show that on-line HDF preserves the antibody response better than high-flux HD after vaccination with SARS-CoV-2 vaccine. Treatment strategies that sustain the vaccine response are essential to apply in this vulnerable group of patients.

**Funding:** Private Foundation Support

**SA-PO458**

**Outcome Study Among Hospitalized Symptomatic COVID-19 Patients Who Required Chronic vs. Acute Hemodialysis (HD)**

Phuong-Chi T. Pham,<sup>1</sup> Mohammad S. Alghussein,<sup>1</sup> Svetlana O. Villano,<sup>1</sup> Nisha M. Singh,<sup>1</sup> Susana M. Mendoza,<sup>1</sup> Golriz Jafari,<sup>1</sup> Anita Kamarzarian,<sup>1</sup> Phuong-Thu T. Pham.<sup>2</sup> <sup>1</sup>UCLA Medical Center Olive View, Sylmar, CA; <sup>2</sup>University of California Los Angeles David Geffen School of Medicine, Los Angeles, CA.

**Background:** Mortality among patients admitted for COVID19 infections who develop acute kidney injury (AKI) and require dialysis support has been reported to be >60-70%. Data are lacking regarding how chronic HD patients with an impaired immune system may: 1) mount an inflammatory response to COVID19 infection and 2) survive the infection compared with those who require acute HD for AKI. We evaluated ferritin levels, hospital length of stay (LOS), and mortality rates among chronic HD patients and those who required acute HD during hospitalization for COVID19-related symptoms.

**Methods:** Inclusion: All patients hospitalized for COVID19-related symptoms who received HD at OV-UCLA Medical Center from January to December 2020. Data collection: Baseline characteristics: age, gender, body mass index (BMI), comorbidities (diabetes mellitus, hypertension, underlying chronic obstructive lung disease or asthma, history of malignancy, and heart failure). Medications: use of any inhibitor of the renin angiotensin aldosterone system. Lab studies: albumin, ferritin, basic chemistry. Hospital LOS and death from any cause. Data analysis: Ferritin levels, hospital LOS, and mortality among chronic and acute HD patients.

**Results:** See Figure

**Conclusions:** Among our hospitalized symptomatic COVID19 patients requiring HD support: 1. Ferritin levels were comparable between chronic HD and previously nondialysis patients who required acute HD support. 2. Chronic HD patients had shorter hospital LOS compared with those requiring acute HD (6.2 ± 5.7d vs. 35.3 ± 31.3d). The 2 groups had similar serum sodium, albumin, and ferritin levels. 3. Mortality was <5% (compared with 1.5% for the US population).among chronic HD patients and 58% among those who developed AKI requiring acute HD. 4. Incidentally, BMI among current COVID19 cohort was 30.6 ± 8.8 compared with 26.4 ± 5.8 Kg/m<sup>2</sup> from our 70 non-COVID dialysis patients included in a different study (p-value <0.001).

<sup>1</sup>Baseline Characteristics and Outcomes Among Hospitalized Symptomatic COVID-19 Patients Requiring Hemodialysis Support During the COVID-19 Pandemic (January to December 2020) At Olive View-UCLA Medical Center

	<sup>1</sup> Chronic HD	<sup>2</sup> Acute HD	p-value
Number of patients specifically admitted for COVID-symptoms	23	31	---
Age (years)	37.9 ± 31.5	48.3 ± 21.9	0.16
Percent male	78.3	80.6	NS
Body mass index (Kg/m <sup>2</sup> )	28.1 ± 6.9	33.7 ± 9.7	0.02
Number of comorbidities (hypertension, diabetes mellitus, chronic obstructive pulmonary disease, cancer) per patient	2.82	1.39	---
Percentage of patients receiving angiotensin converting enzyme inhibitor or angiotensin receptor blocker prior to COVID diagnosis	69.6	25.8	0.00138
Average sodium concentration (mmol/L)	133.4 ± 3.3	133.6 ± 4.9	0.86
Albumin (g/dL)	3.1 ± 0.5	3.1 ± 0.6	0.72
Highest ferritin level recorded (mcg/L)	3264 ± 2369	3138 ± 3986	0.89
Hospital length of stay (days)	6.2 ± 5.7	35.3 ± 31.3	<0.0001
Percent mortality	4.4	58.1	<0.0001

<sup>1</sup>All data herein pertain to patients admitted specifically for COVID-19 related symptoms. <sup>2</sup>Chronic HD refers to patients with established need for HD prior to COVID-19 infection; Acute HD refers to HD support for acute kidney injury during COVID-19 related admission. Abbreviations: HD, hemodialysis

**SA-PO459**

**An Anuric and Hyperkalemic Patient During the COVID-19 Pandemic Without Access to Dialysis due to Social Protests in a Small Municipality in Colombia: What Can I Do?**

Roberto Ramirez Marmolejo,<sup>1,2</sup> Sofia Ramirez Isaza,<sup>3</sup> <sup>1</sup>Universidad Santiago de Cali Facultad de Salud, Cali, Colombia; <sup>2</sup>DaVita Inc, Denver, CO; <sup>3</sup>Pontificia Universidad Javeriana, Cali, Colombia.

**Introduction:** Due to the expenses generated by the pandemic, the Colombian government (image 1) propose raising taxes. This led to a social claim that led to the start of a national strike for several months in Cali city and its small nearby municipalities (Yumbo), indigenous people and other radical groups block main roads into and out of the city (images 2, 3, 4). The blockades prevented the passage of patients to be able to dialyze in Cali. In Yumbo there were no dialysis clinics, since the local hospital only has primary care. We present the case of an anuric patient who, due to lack of dialysis, presented pulmonary edema and hyperkalemia, and who could not be treated in a renal center, but in a small regional hospital and how his life was maintained with a totally alternative protocol.

**Case Description:** A 69y patient, presented pulmonary edema on the fourth day without dialysis, see Table 1, electrocardiogram showing peak T waves. Telephone communication was maintained. Management: Nebulizations with β stimulants, oral nifedipine and minoxidil. The patient persists hypervolemic on the second day, raises potassium to 8.8mEq/L and begins to present oxygen desaturation, a protocol is proposed as a vital emergency: enemas every 15 minutes, for 3. Oral castor oil, one ounce every 12 hours. (first dose assumed as zero hour of the protocol). See evolution in table No. 1. Potassium and pulmonary edema were finally controlled.

**Discussion:** In the history of humanity, there are countless moments where violence causes medical missions to take measures that are not recommended in theory, but have saved lives. This protocol is clearly a desperate measure, but it can be of support in cases of pulmonary edema or hyperkalemia.

time	Weight Kg	SaO <sub>2</sub>	K mEq/L	AP mmHG	EKG
-24	82	92%	7.9	198/112	T picudas V1-V2 + sokoloff +
0	83	76%	8.8	212/116	
12	81	84%		186/110	
20	80				
24		86%	7.4	174/106	
30	78	94%	6.4	168/94	Sokoloff +

Table N°1: Summary of temporal evolution before and after the start of the protocol, electrocardiogram (EKG), potassium (K), arterial pressure (AP)

Image N° 3. Map of the department of Valle del Cauca, with the municipalities, communication routes and blocking points marked in red lines, in the district of Cali (the regional capital)



Image N° 4. Explosión en el municipio de Yumbo, Valle del Cauca



**SA-PO460**

**Impact of Inpatient Tele-Nephrology Treatment Outcomes in Rural Alabama**

Norman W. Seay, Katie Bean, Arun Rajasekaran, Takamitsu Saigusa, Vinay Narasimha Krishna, Ashlee Chatham, Alicia S. Cole, Eric L. Wallace. UAB Hospital, Birmingham, AL.

**Background:** Access to nephrology care including dialysis in rural Alabama (AL) hospitals is lacking. The University of Alabama at Birmingham (UAB) with Sanderling Inc. started inpatient tele-nephrology (TN) services in 2019 and currently serves 3 rural AL hospitals. Since the COVID-19 pandemic, transfer to TN-equipped hospitals in AL played a pivotal role for patients needing nephrology services when primary referral centers were at capacity.

**Methods:** TN services were 100% virtual and video-based. Consults were completed by UAB nephrology faculty. Home hemodialysis machine (HHD) was used to provide kidney replacement therapy (KRT) in the hospital, with aid of inpatient dialysis technicians supervised remotely by TN dialysis nurses. TN consults were evaluated from Jun 2019 to Dec 2021. Retrospective chart review for pre-defined outcomes was performed and analyzed.

**Results:** There were 694 inpatient TN encounters. Mean age was 64 (18-96) yr. 74% of consultations involved black patients. Mean stay was 6 d. 44% were ICU patients; 18% were COVID-19 positive. AKI and known ESKD patients contributed to 48% and 44% consults, respectively. 11% had AKI necessitating KRT. 20% and 13% of consults involved hyperkalemia and dysnatremias, respectively. 792 dialysis treatments were performed with 11% complicated by intradialytic hypotension (IDH). Patients were discharged 64% and transferred to higher level of care 18% of the time. 90 patients expired. 66% of deaths were attributable to COVID-19. Preliminary economics analysis at the hospital with the most consults showed increase in case-mix index and higher census since implementation of TN services.

**Conclusions:** Inpatient TN in community hospitals in rural AL provided essential nephrology care to underserved populations amidst a pandemic limiting transfer to nephrology-staffed medical centers at capacity. Most patient encounters resulted in discharge without need for transfer to bigger centers thus saving vital time and resources. Dialysis safety was favorable with low IDH prevalence likely given HHD use. TN services can be beneficial for nephrology care in remote community hospitals with further studies warranted.

SA-PO461

**In-Center Hemodialysis Patient Perspectives on Telenephrology**

Mariam Charkviani, Lagu A. Androga, Priya Ramar, Rachel H. Amundson, Ziad Zoghby, Robert C. Albright. *Mayo Clinic Minnesota, Rochester, MN.*

**Background:** Telenephrology has gained popularity in various medical specialties, including nephrology. CMS allows its limited use for in-center dialysis rounds but there remains a lack of objective data on patient perceptions on its use as a health care delivery modality. In this study we evaluated in-center hemodialysis patients' perspectives on care received via telenephrology

**Methods:** We retrospectively studied adults who received telenephrology care in three remote dialysis centers at Mayo Clinic Health System from March 22, 2021 to July 22, 2021. We used a standardized survey methodology to evaluate patient satisfaction and their perspectives on access to their nephrologist, relationship with care provider, their opinions on the telenephrology technology, and their overall assessment of the care received.

**Results:** Overall, 130 in-center dialysis patients received telenephrology care through video visits at three remote dialysis centers. Survey response rate was 62% (n=81). Surveyed patients had favorable perception about care they received via telenephrology. 64% felt a personal connection with their telehealth providers and 94% expressed that most of their questions were answered during the video visits. 86% of survey responders did not have any technical difficulties. 9.2% patients reported poor sound quality. Surprisingly, 67% of patients felt video visits provided them with more time than face-to-face visits with their providers, 90% thought that their video visits were successful. 81% of patients would be comfortable using video for least half or more of their visits, 9% preferred using video for all their visits, and 9% preferred no telenephrology visits at all.

**Conclusions:** Patient satisfaction was high among patients seen via telenephrology. Telenephrology can become valuable tool to fill the gaps in patient care especially in remote dialysis areas.

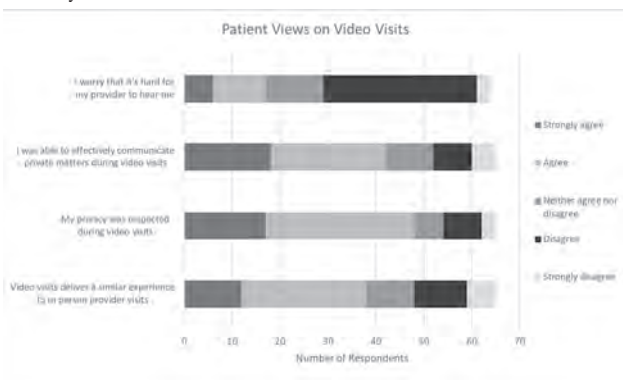

Patient Views on Video Visit (n=81)

SA-PO462

**Metabolites Associated With Uremic Symptoms in Hemodialysis Patients**

Leslie Myint,<sup>1</sup> Eugene P. Rhee,<sup>2</sup> Kendra E. Wulczyn,<sup>2</sup> Sahir Kalim,<sup>2</sup> Dorry L. Segev,<sup>3</sup> Mara McAdams-DeMarco,<sup>3</sup> Ravi I. Thadhani,<sup>2</sup> Sharon M. Moe,<sup>4</sup> Ranjani N. Moorthi,<sup>4</sup> Thomas H. Hostetter,<sup>5</sup> Jonathan Himmelfarb,<sup>6</sup> Timothy W. Meyer,<sup>7</sup> Neil R. Powe,<sup>8</sup> Marcello Tonelli,<sup>9</sup> Tariq Shafi.<sup>10</sup> <sup>1</sup>Macalaster College, St. Paul, MN; <sup>2</sup>Massachusetts General Hospital, Boston, MA; <sup>3</sup>NYU Langone Health, New York, NY; <sup>4</sup>Indiana University School of Medicine, Indianapolis, IN; <sup>5</sup>University of North Carolina System, Chapel Hill, NC; <sup>6</sup>University of Washington School of Medicine, Seattle, WA; <sup>7</sup>Stanford University School of Medicine, Stanford, CA; <sup>8</sup>University of California San Francisco, San Francisco, CA; <sup>9</sup>University of Calgary, Calgary, AB, Canada; <sup>10</sup>University of Mississippi Medical Center, Jackson, MS.

**Background:** The specific substances causing uremic symptoms are unknown. We used untargeted metabolomics to identify metabolite markers associated with uremic symptoms in hemodialysis patients.

**Methods:** We profiled 29,591 plasma metabolites (Broad Institute) in 517 Longitudinal US/Canada Incident Dialysis (LUCID) study participants at baseline (discovery) and subset at year 1 (validation). We concurrently assessed uremic symptoms (KDQOL-36; fatigue, pruritus, anorexia, nausea/vomiting, daytime sleepiness, difficulty concentrating, and pain) and investigated demographic- and clinical covariate-adjusted associations using: a) metabolite-wise linear models with empirical Bayesian inference, accounting for multiple testing; b) LASSO; c) random forest (RF) models. We defined robust symptom-metabolite associations if significant in linear models and at least medium importance in both LASSO and RF models.

**Results:** The mean age was 61 years, 80% were male, and mean duration from dialysis initiation was 62 days. We identified several metabolites robustly associated with uremic symptoms; 3 metabolites associated with anorexia, 8 with pruritus, and 1 each with pain, sleepiness, and concentration (Table). Higher levels of 2-hydroxy-3-methylpentanoate/hydroxyisocaproate were linked to higher severity of anorexia, bodily pain, and difficulty concentrating. Lower levels of indoxyl sulfate were associated with higher severity of daytime sleepiness. No metabolites were significantly associated with fatigue or nausea/vomiting.

**Conclusions:** We identified several metabolites associated with uremic symptoms, which could be targeted for future interventions if replicated in other studies.

**Funding:** Other NIH Support - NINR

Metabolites robustly associated with uremic symptoms in the LUCID study

Symptom	Metabolite	Baseline			Year 1		
		Adjusted Fold Change		Relative Importance	Adjusted Fold Change		Relative Importance
		High vs. Low <sup>a</sup>	LASSO <sup>b</sup>	RF <sup>c</sup>	High vs. Low <sup>a</sup>	LASSO <sup>b</sup>	RF <sup>c</sup>
Anorexia	gentisate	0.67	High	Low	0.47	High	Medium
	2-hydroxy-3-methylpentanoate/hydroxyisocaproate	1.82	High	High	1.76	Low	Medium
	AMP	2.31	Medium	High	0.72	Low	High
	C54-10/TAD	0.93	Low	Low	0.78	High	High
Pruritus	C36:0 PC	0.94	Low	Low	0.73	High	High
	C36:5 PE plasmalogen	0.95	Low	High	0.62	High	Medium
	C34:5 PC plasmalogen	0.99	Low	Low	0.59	Medium	Medium
	C14:0 SM	0.97	Low	Medium	0.73	High	High
	C36:5 PC plasmalogen-B	1	Low	Medium	0.76	High	High
	C34:1 PC plasmalogen-B	0.99	Medium	Low	0.77	Medium	Medium
	C36:3 PC plasmalogen	1.01	Low	Low	0.81	Medium	Medium
	C36:3 PC plasmalogen	1.01	Low	Low	0.81	Medium	Medium
Bodily Pain	2-hydroxy-3-methylpentanoate/hydroxyisocaproate	1.33	High	High	1.66	Medium	Low
Daytime Sleepiness	indoxylsulfate	0.68	Medium	High	0.46	Medium	Low
Difficulty Concentrating	2-hydroxy-3-methylpentanoate/hydroxyisocaproate	1.02	Low	Medium	2.26	High	High

<sup>a</sup> Adjusted fold change in metabolite abundance when comparing patients with high symptom severity to low severity  
<sup>b</sup> Relative importance of the metabolite in LASSO (b) and random forest (c) models for the symptom outcome  
<sup>c</sup> Covariates included in all models: age, gender, height, weight, cardiovascular disease, and diabetes  
<sup>d</sup> Significant adjusted fold change associations at a false discovery rate threshold of 0.1 are in bold

SA-PO463

**Impact of CKD-Associated Pruritus Relief on Mood and Emotional Distress**

Sonja Ständer,<sup>1</sup> Steven Fishbane,<sup>2</sup> Thilo Schaeffler,<sup>3</sup> Isabelle Morin,<sup>3</sup> Frederic Menzaghi,<sup>4</sup> Warren Wen,<sup>4</sup> Kamyar Kalantar-Zadeh.<sup>5</sup> <sup>1</sup>Center for Chronic Pruritus, University of Münster, Münster, Germany; <sup>2</sup>Northwell Health, Great Neck, New York, NY; <sup>3</sup>Vifor Pharma Ltd, Glattpburg, Switzerland; <sup>4</sup>Cara Therapeutics Inc, Stamford, CT; <sup>5</sup>University of California Irvine, Irvine, CA.

**Background:** Chronic kidney disease-associated pruritus (CKD-aP) is a frequent, unpleasant symptom and a cause of suffering in patients undergoing hemodialysis (HD). The aim of this analysis was to assess the impact of itch relief on mood and depression in patients with CKD-aP based on data from clinical trials with difelikefalin (DFK).

**Methods:** DFK studies enrolled HD patients with moderate-to-severe CKD-aP (mean worst itching numerical rating scale [WI-NRS] score >4 [KALM-1] or ≥5 [KALM-2 and 3105]). Patients were randomized 1:1 to intravenous DFK 0.5 µg/kg or placebo (KALM) or received open-label DFK (3105) 3 times/week for 12 weeks. The present analysis reports data from all patients completing the studies irrespective of study drug exposure; data were pooled for patients receiving DFK and placebo from the KALM trials. Change from baseline of the mood and depression sub-domain of Skindex-10 was assessed.

**Results:** Skindex-10 scores were available for 549 patients in KALM and 194 patients in 3105. Patients reporting clinically relevant (≥3-point) change in itch (KALM: n=305; 3105: n=143) reported a corresponding improvement of 72% (3105) and 67% (KALM) in the mood/emotional distress domain of Skindex-10, compared with 33% and 26% for patients with <3-point improvement (KALM: n=244; 3105: n=51) in WI-NRS.

**Conclusions:** In this study we found that achieving clinically meaningful reductions in itch severity to be associated with significantly greater improvements in mood and depression, as well as in overall itch-related quality of life, for patients with CKD-aP.

**Funding:** Commercial Support - Vifor Pharma



**Figure:** Relative percentage change in the mean from baseline to week 12 in Skindex-10 question scores for patients reporting  $\geq 3$ -point vs  $< 3$ -point improvement in worst-itching numerical rating scale in (A) Study 3105 and (B) KALM studies.

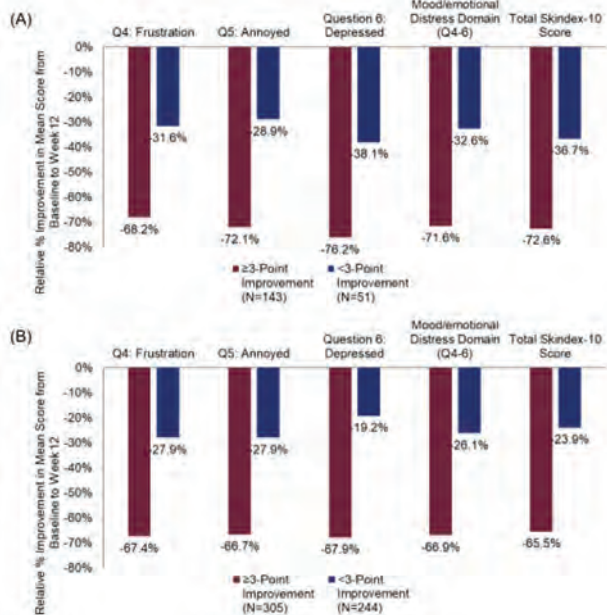

**Fig. 3** The relationship of Regional citrate anticoagulant dose and time.

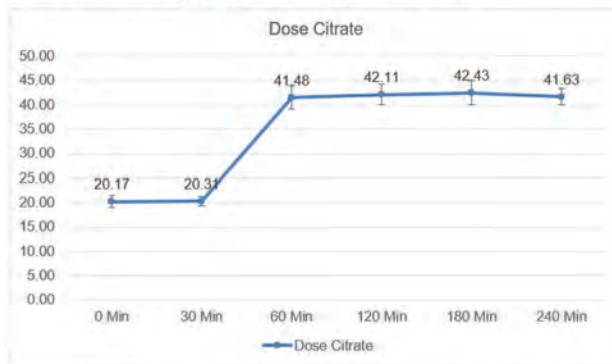

**SA-PO464**

**Efficacy of Regional Citrate Anticoagulation vs. Saline Flushing During Intermittent Hemodialysis on Blood Circuit Clotting Prevention: A Randomized Clinical Trial (The Citra-Saline-IHD)**  
 Suree Yoowannakul, Theerapun Boonsayomphu. *Bhumibol Adulyadej Hospital, Bangkok, Thailand.*

**Background:** Conventional hemodialysis requires anticoagulation to prevent clotting in the extracorporeal circuit. For patients who unable to receive heparin anticoagulation during hemodialysis, saline flushing technique is a common practice but clots have been found. Regional citrate anticoagulation (RCA) is effective but not routinely use in dialysis unit. We wished to evaluate the efficacy and safety of regional citrate anticoagulation (RCA) for low flux intermittent hemodialysis using with 1.75 mEq/L dialysate calcium compared to saline flushing technique.

**Methods:** A prospective randomized, open label, cross over study on 144 sessions of 72 HD patients was conducted in hemodialysis unit of Bhumibol Adulyadej hospital. Patients were allocated to RCA group and saline group. Citrate was infused and adjusted according to the degree of anticoagulation and level of ionized calcium within the systemic circuit. Assessment of clot formation in dialysis circuit, blood electrolyte, acid-base balance, treatment time and adverse events were evaluated compared between RCA group and saline group.

**Results:** No clotting event in the RCA group while 25% (18 of 72 sessions) of saline group had circuit clots and resulted in early termination of dialysis. The citrate infusion rate was  $41.6 \pm 1.6$  mmol/l/min with using 1.75 mEq/L dialysate calcium and infuse post-filter of 10% calcium gluconate rate 30 ml/hr. No incidence of hypernatremia, hypocalcemia and metabolic alkalosis in RCA group.

**Conclusions:** RCA is safe and more effective for preventing dialysis circuit clots than saline flushing technique. We demonstrated the protocol optimal dose of RCA for low flux hemodialysis with using 1.75 mEq/L dialysate calcium can imply to be the protocol for patients who are contraindicated to the use of heparin anticoagulants in the intermittent hemodialysis.

**Funding:** Government Support - Non-U.S.

**SA-PO465**

**Parkinson Disease-Induced Cerebral Salt Wasting**  
 Zachary A. Hansen, Adrian J. Baudy, Jing Chen. *Tulane University, New Orleans, LA.*

**Introduction:** Cerebral salt wasting (CSW) primarily occurs in cerebral hemorrhage but can be caused by any neurologic disease. It is due to renal salt wasting and subsequent volume contraction, but the exact mechanism is unclear. It has many overlapping features with SIADH and distinguishing the two is important as treatment differs drastically. Here, we present a case of hyponatremia and our treatment approach.

**Case Description:** 76-year-old man with Parkinson Disease, neurogenic bladder and suprapubic catheter presented for abdominal pain and altered mental status. He was found to be volume depleted with a serum sodium (Na) of 119 that increased to 122 with 500mL of normal saline (NS). His serum osmolality (S<sub>osm</sub>) was 249, urine osmolality (U<sub>osm</sub>) 421 and urine sodium (Ur Na) <12. He received 13 liters of NS over the next few days and repeat labs showed Na 127, S<sub>osm</sub> 127, U<sub>osm</sub> 264, Ur Na 59 and Fractional excretion of Uric Acid (FE Uric Acid) 14%. His sodium dropped when IV hydration was discontinued, raising concern for cerebral salt wasting (CSW). CT head showed no acute changes, but Parkinson’s disease remained a possible cause. After more NS, his Na was 128, increasing suspicion for CSW. NS was stopped and Na again dropped to 124 further indicating CSW. To assess this, we measured Ur Na, and U<sub>osm</sub> before and after giving NS. Ur Na went from 88 to 128, U<sub>osm</sub> increased, and FE uric acid remained elevated at 22%. He was still clinically hypovolemic suggesting that he was still losing Na. After the addition of salt tablets, his Na slowly began to improve, and he was discharged.

**Discussion:** To our knowledge, this is the first case of CSW in a patient with chronic idiopathic Parkinson’s disease. CSW is a rare disorder usually associated with vascular or traumatic cerebral injury. Its pathogenesis is unclear but may be due to natriuretic peptides that result in renal salt wasting with resulting volume contraction. CSW is a challenging diagnosis and is often mistaken for SIADH early in the disease course. This can affect treatment and delay accurate diagnosis. CSW tends to have high Ur Na and severe volume depletion due to sodium wasting and high urine output. Patients will have a net negative Na balance and high FE Uric Acid. Careful assessment can help differentiate this disorder from SIADH. Patients with SIADH are euvolemic and initially have high FE Uric Acid that drops with improvement of Na.

**SA-PO466**

**Cisplatin Induced Renal Salt Wasting Syndrome: An Uncommon Diagnostic Distinction**  
 Sharmil Suma Kumaran, Muhammad F. Habib, Metlapalli Venkata Sravanthi, Ramya Bhargava. *SUNY Upstate Medical University Hospital, Syracuse, NY.*

**Introduction:** Platinum-based chemotherapy is commonly associated with nephrotoxicity and electrolyte imbalances including hyponatremia. The mechanism of hyponatremia in such cases is either syndrome of inappropriate antidiuretic hormone secretion (SIADH) or renal salt wasting syndrome (RSWS). The latter is scarcely reported. We describe a case of RSWS induced by cisplatin.

**Case Description:** A 20-year-old male with nonseminomatous germ cell testicular cancer for which he underwent right orchiectomy, presented with one-week history of abdominal pain, polyuria, and unintentional 15 lbs weight loss after he was initiated on adjuvant BEP (bleomycin, etoposide, cisplatin) chemotherapy. Orthostatic hypotension was noted. He appeared hypovolemic on physical examination. His urine output in the first 24 hours of monitoring was more than 5 L. Pertinent labs include low serum Na 123 mmol/L, high urine Na 173 mmol/L, and normal serum creatinine. His Fractional Na excretion (FeNa) was calculated to be 2.1%. A diagnosis of RSWS was made and he was commenced on intravenous 0.9% saline and salt tablets. His serum Na gradually normalized over two days. Considering his young age and high likelihood of cure, cisplatin was continued although subsequent chemotherapy cycles were completed inpatient with close monitoring of serum and urine sodium. RSWS did not recur on rechallenge with Cisplatin.

**Discussion:** Hyponatremia is a serious complication of platinum-based chemotherapy. Understanding the mechanism of hyponatremia is important as the treatments are distinct—salt supplementation in RSWS and fluid restriction in SIADH. The mechanism of RSWS is thought to be cisplatin-induced inflammation, alteration of solute transport, and apoptosis

in proximal and distal tubular epithelium with preference to the former, thus causing a net sodium excretion. These patients present with hypotonic hyponatremia, polyuria, and hypovolemia. In contrast, SIADH patients are euvolemic and normouric. A high FeNa despite volume depletion helps delineate RSWs further from SIADH. Treatment consists of salt and water replenishment, and recovery is the rule although recurrence is common. While carboplatin is less toxic, cisplatin has unequivocal superiority in most of the cancers in which it is used, making it difficult to replace it, especially when there is realistic curative intent.

**SA-PO467**

**Syndrome of Inappropriate Antidiuresis (SIAD): A Clue to a Rare Diagnosis**

Amara Sarwal, Sarah Gilligan, Nirupama Ramkumar, Josephine Abraham. *University of Utah Health, Salt Lake City, UT.*

**Introduction:** Syndrome of inappropriate antidiuresis (SIAD) was first described by Schwartz and Bartter in 1967. Small cell lung cancer is the malignancy most often associated with ectopic ADH release, however extrapulmonary small cell cancers, medications and other pulmonary disease can also be associated with SIAD. SIAD is rarely associated with prostate cancer. We report a case of SIAD with small cell carcinoma of the prostate.

**Case Description:** A 74-year-old man with history of cardiomyopathy, hypertension and left renal cancer with partial nephrectomy presented to our facility due to an irregular heartbeat. Upon further questioning, it was discovered that he had a 2 month history of gait unsteadiness, confusion and fatigue. He denied increased thirst or recent medication changes. He denied use of NSAIDs, PPIs, diuretics, SSRIs, or anti-epileptic medications. He is a former smoker with a 40 pack year history and is a social drinker. During initial workup in the emergency room, a sodium level of 125 mmol/L was discovered. He was initially treated with furosemide and 4 gram salt tabs daily however eventually transferred to the critical care unit for hypertonic saline when his sodium dropped to 115 mmol/L within 72 hours. Further workup revealed a TSH of 1.25 mU/L, morning cortisol of 19 ug/dL, serum osmolality of 236 mOsm/kg with urine osmolality of 500 mOsm/kg and urinary sodium level of 155 mmol/L. MRI brain and CT chest were unrevealing, however his CT abdomen revealed an enlarged prostate with a heterogeneously enhancing large nodule and an enlarged right pelvic lymph node, concerning for metastatic prostate cancer despite a normal prostate specific antigen (PSA) at 0.5 ng/mL. Biopsy revealed small cell carcinoma of the prostate. Radiotherapy as well as chemotherapy with cisplatin and etoposide was initiated. He continued treatment with salt tablets and furosemide with stabilization of his sodium at 130-136 mmol/L.

**Discussion:** Small cell carcinoma of the prostate is rare and accounts for <1% of all patients afflicted with prostate cancer. It is usually diagnosed at an advanced stage and PSA can be disproportionately low compared to conventional adenocarcinoma of the prostate. This case illustrates the need for diligent investigation when patients present with hyponatremia and SIAD.

**SA-PO468**

**Syndrome of Inappropriate Antidiuretic Hormone Secretion (SIADH) Secondary to Untreated Parkinson Disease**

Najjar Yaseen, Mina Awad, Geovani Faddoul. *Albany Medical Center, Albany, NY.*

**Introduction:** Hyponatremia is the most common electrolyte disorder associated with neurological conditions and is mediated by excess release of antidiuretic hormone. The etiology can range from a straightforward SIADH to the poorly understood mechanism of cerebral salt wasting. Whereas acute intracranial process such as acute stroke, intracranial bleeding or tumor are typical etiologies of SIADH, neurodegenerative diseases such as Parkinson's disease or ALS have not been known to be associated SIADH. However, SIADH has been reported as a side effect of anti-Parkinson medication e.g. Levodopa/Carbidopa. Parkinson's disease per se has not been known to be associated by SIADH and hyponatremia. We present a case of hyponatremia due of SIADH in the setting of untreated Parkinson.

**Case Description:** A 71-yo male patient with DM II and hypothyroidism presented to the hospital with progressive confusion, slow speech and severe fatigue over las few days accompanied with sluggish body movements for few months. On exam, he appeared to be euvolemic. Neurological exam revealed mild arm rigidity, bradykinesia, resting tremors, and stiff gait. Initial blood work showed hypo-osmolar hyponatremia (sodium 122 mEq/L, serum osmolality 275 mOsm/Kg, uric acid 2.3 mg/L, TSH 3.5 UIU/mL, AM cortisol 24 UG/dL). Urine studies showed (urine sodium: 92 mEq/L, osmolality 672 mOsm/Kg). A Brain MRI did not show any structural abnormality. CT chest showed localized infiltrate. Initially SIADH was thought to be due to pulmonary process. After starting him on fluid restriction of 1.5L/day and urea 15 mg BID, sodium improved gradually to 133 mEq/L on discharge. Urine osmolality continued to ranges 700-800 mOsm/Kg. Active pulmonary process was ruled out by pulmonologist. Parkinsonism was confirmed by outpatient neurology who started Carbidopa/Levodopa. As extrapyramidal symptoms improved with Carbidopa/Levodopa, urine osmolality improved to 400 mOsm/Kg. Successfully, sodium level was maintained between 135-137 while being off urea and fluid restriction. He was diagnosed with new-onset SIADH and extrapyramidal symptom.

**Discussion:** This case demonstrated an association of SIADH and untreated Parkinson's disease. In contrary to literature, SIADH resolved with anti-Parkinson treatment which supports Parkinson's disease as a causal mechanism. As dose increased of anti-Parkinson's agent, urine osmolality improved and extrapyramidal symptoms resolved.

**SA-PO469**

**Dual Paraneoplastic Syndrome in Small Cell Lung Cancer**

Kamil Sardarli, Austin M. Morris, Jamal Abu-Khaled. *BHSH Beaumont Health, Royal Oak, MI.*

**Introduction:** Small cell lung cancer (SCLC) is an aggressive neuroendocrine lung cancer associated with paraneoplastic syndromes – syndrome of inappropriate ADH (SIADH) in 7-16% of cases and Ectopic ACTH Syndrome (EAS) in 3.5-4.3% of cases. Both syndromes are associated with a poor prognosis in patients with SCLC. We describe a patient who presented with SIADH, leading to a diagnosis of SCLC who subsequently developed EAS.

**Case Description:** A 71-year-old female with a past medical history of hypertension, depression, and tobacco use presented with lethargy. She noted headache, but otherwise was unable to provide history due to altered mentation. Per her family, the patient recently had pneumonia treated with antibiotics and steroids and was complicated by hyponatremia. Upon evaluation, our patient was hemodynamically stable, with labs revealing Na 106 mmol/L, K 3.9 mmol/L, Cl 74 mmol/L, BUN 6 mg/dl, and creatinine 0.52 mg/dl. Serum osmolality was 232 mOsmol/kg, urine osmolality 543 mOsmol/kg, urine Na 130 mmol/l and urine Chloride 128 mmol/l. TSH was within normal limits and random cortisol level was 63.4 mcg/dl. She was managed in ICU with a DDAVP clamp and 3% saline. She was discharged on Urea therapy, which was later change to furosemide and sodium chloride tablets due to cost. At discharge, the etiology of her hyponatremia was most consistent with SIADH. CT scan of the chest followed by PET scan showed multiple enlarged mediastinal lymph nodes that were considered suspicious for malignancy. Lymph node biopsy confirmed metastatic SCLC. Our patient was started on concurrent chemotherapy and radiotherapy. Upon follow up, progression of her cancer was seen, prompting additional chemotherapy with carboplatin, etoposide, and atezolizumab. She was admitted 11 months after her first presentation due to hypernatremia and hypokalemia. She had metabolic alkalosis with a bicarbonate of 36 mmol/L, Na level 146 mmol/L, and K 2.7 mmol/L. Morning cortisol level was 54.2 mcg/dl and ACTH was 63 pg/ml. Cortisol level after low dose dexamethasone suppression test remained elevated at 66.6 mcg/dl. In the setting of active SCLC, findings were most suggestive of ectopic ACTH secretion.

**Discussion:** There are only 8 cases reported in literature with simultaneous or sequential EAS and SIADH. Cortisol and ADH have opposite effects on kidney sodium excretion. This may lead to masking of EAS by SIADH, leading to underdiagnosis.

**SA-PO470**

**SIADH Escape or Tolvaptan Resistance in Progressive Small Cell Lung Cancer**

Sunny Mandal,<sup>1</sup> Lakshmi Kannan.<sup>2</sup> *<sup>1</sup>University of Pikeville Kentucky College of Osteopathic Medicine, Pikeville, KY; <sup>2</sup>Pikeville Medical Center, Pikeville, KY.*

**Introduction:** Syndrome of inappropriate antidiuretic hormone(SIADH) occurs in 11-15% of patients with small-cell lung cancer. The pathophysiology is through direct tumor secretion, enhanced secretion of ADH from adrenal metastases, chemotherapy, opioids, NSAIDs, or side effects of treatment like nausea, vomiting, stress, and pain. We report a patient with small-cell lung cancer initially managed with tolvaptan but developed resistance to the aquaretic effects of the drug.

**Case Description:** A 61-year-old male with small cell lung cancer and chronic hyponatremia on tolvaptan presented with unsteady gait and weakness. Workup showed serum sodium of 111 mEq/L(baseline-122-125 mEq/L), serum osmolality of 236 mOsm/Kg H<sub>2</sub>O, urine osmolality of 589 mOsm/Kg H<sub>2</sub>O, and urine sodium of 62 mEq/L. The patient was admitted for 3% hypertonic saline for SIADH. His sodium improved to 120 mEq/L with the resolution of symptoms. Reviewing his records, the patient was diagnosed with T3N3 I1IC small cell lung cancer 11 months prior to this admission. He underwent two cycles of cisplatin and etoposide. In a span of 3 months, the patient had four hospitalizations for acute on chronic hyponatremia despite being on tolvaptan as his surveillance CT abdomen/pelvis revealed multiple new liver metastases. The timeline of events is shown in Figure 2.

**Discussion:** Syndrome of inappropriate antidiuretic hormone is characterized by euvolemic hypotonic hyponatremia where tolvaptan has been used since 2009. The first two cases of resistance to tolvaptan therapy were described in 2018 in patients with small-cell lung cancer and this is the third report of SIADH escape to tolvaptan. The possible cause of resistance to the aquaretic effects of the drug is due to extraordinarily high ADH levels from the progression of lung cancer. In these cases, successful treatment of the malignancy will eliminate or reduce the inappropriate ADH secretion. One key factor to consider is the search for new metastasis when patients present with recurrent acute or acute on chronic hyponatremia.

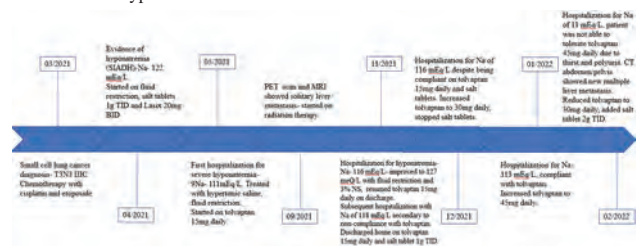

## SA-PO471

**One Not So Salty Lady**

Melanie Wanigatunga, Jerald L. Taggart, Adrian J. Baudy, Katherine A. Peacock. Tulane University School of Medicine, New Orleans, LA.

**Introduction:** This is unique because it discusses a patient with many episodes of hyponatremia with different etiologies in the same hospitalization. This is important because it emphasizes the significance of physiology in evaluating hyponatremia. Objectives: 1. Develop an approach to hyponatremia 2. See roles of aldosterone and ADH in fluid balance

**Case Description:** A 69-year-old woman with CLL presented with weakness, poor oral intake, and was profoundly hyponatremic to 105 mEq/L with altered mental status. WBC was 160k/uL, serum osmolality 231mOsm/kg, urine osmolality 513mOsm/Kg and urine sodium <12mEq/L. Sodium improved with infusions of normal saline but she developed decompensated heart failure and nausea. She was diuresed. Sodium recovered to normal ranges after about one month, yet after fluoxetine was resumed, sodium decreased to 126 mEq/L and was refractory to normal saline. Her studies were: serum osmolality 273 mOsm/kg, urine osmolality 365 mOsm/kg, urine sodium 38 mEq/L. Fluoxetine was stopped and mirtazapine was started for depression. Sodium improved with 1.5 L/day fluid restriction as well. She was discharged to physical rehabilitation with resolution of her mental status to baseline, and lab studies within normal ranges.

**Discussion:** At first, there was concern our patient had pseudohyponatremia from increased WBC in her blood falsely diluting her serum sodium. In CLL, patients can have pseudohyponatremia due to hyperglobulinemia. Hospital machinery is now able to separate the serum electrolytes from other blood elements to measure them properly, ruling out pseudohyponatremia for this patient from CLL. She had hypotonic hypovolemic hyponatremia on admission; her serum osmolality was truly low and her urine sodium showed that aldosterone was increased, trying to increase total body sodium. Urine osmolality was high, showing ADH was working to increase total body water. She improved with appropriate treatment: normal saline. Her re-development of hyponatremia was more complex. Given her nausea and decompensated heart failure, she likely had increased ADH (Sahay & Sahay, 2014). Lab studies were not consistent with SIADH, but improved with treatment for SIADH. It is important to understand the balance of aldosterone and ADH in a patient with hyponatremia as it guides treatment. References Sahay, M., & Sahay, R. (2014). Hyponatremia: A practical approach. Indian journal of endocrinology and metabolism, 18(6), 760-771.

## SA-PO472

**High Urinary Sodium Is Not Always SIADH**

Sahar Amin, Neeharika Mettupalli, Alice Chedid. The University of Tennessee Health Science Center College of Medicine, Memphis, TN.

**Introduction:** Cisplatin nephrotoxicity has been well described in the literature. However, renal salt wasting (RSW) is relatively uncommon. We present an interesting case of severe hyponatremia secondary to Cisplatin that mimicked SIADH but improved with administration of IV fluids.

**Case Description:** A 39-year-old AA male with newly diagnosed small cell lung cancer was admitted for induction chemotherapy. Initial physical exam was unremarkable. Vital signs were normal, BP 120/77 mm Hg and HR 85. Laboratory: Na 132 mEq/l with normal creatinine at 0.6 mg/dl. Patient was given Cisplatin 80mg/m<sup>2</sup> x1. Day 2, Na at 128 meq/l. Day 3, Na dropped to 123 meq/l. Further workup: Serum osm 246 mOsm, TSH and cortisol WNL. MRI negative for brain metastases. Urine osmolality at 726 mOsm with urine sodium of 222 mEq/l. Given malignancy concern, patient was treated as SIADH with fluid restriction. Na continued to drop, down to 117 meq/l (graph below). Upon rechecking vitals, patient was orthostatic and was complaining of dizziness. Given hypovolemia, RSW 2/2 cisplatin was suspected. Patient was started on NS infusion with slow and gradual improvement of his serum Na to normal. NS was eventually stopped, and patient was transitioned to salt tablets. Patient was not rechallenged with cisplatin. Graph 1: Sodium Trend

**Discussion:** Renal salt wasting is a rare side effect of Cisplatin that manifests as hypovolemic hyponatremia. Given the clinical and laboratory similarities, it is often misdiagnosed as SIADH. We want to shed light on the importance of recognizing this entity because restoration of intravascular volume is of the essence.

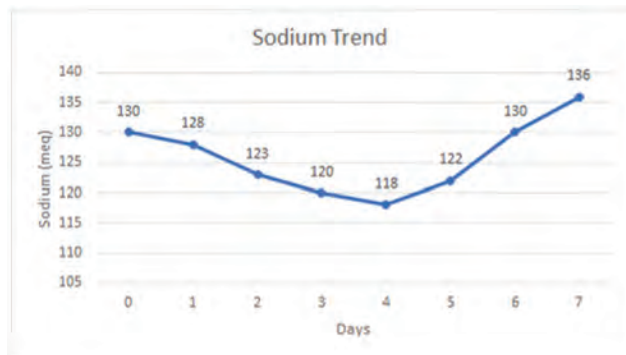

## SA-PO473

**A Severe Case of Cyclophosphamide Induced Hyponatremia**

Shawn Alonso,<sup>1,2</sup> Chavely Valdes Sanchez,<sup>1,2</sup> Raman Anam,<sup>1,2</sup> Ahmed A. Waheed.<sup>1,2</sup> <sup>1</sup>University of Miami School of Medicine, Miami, FL; <sup>2</sup>Holy Cross Hospital, Ft. Lauderdale, FL.

**Introduction:** Mild to moderate hyponatremia is a known complication of cyclophosphamide (CY) which has been reported in numerous case reports<sup>2,3</sup> and retrospective analysis.<sup>1</sup> Here we present a case of CY-induced acute severe hyponatremia in a patient with diffuse large B-cell lymphoma.

**Case Description:** Patient is a 37-year-old female with a recent diagnosis of diffuse large B cell lymphoma on etoposide, prednisone, oncovin, cyclophosphamide-hydroxydaunorubicin (EPOCH). After the EPOCH, she received 20mg/kg of intravenous CY and instructions to drink copious amounts of water. The following day, the patient was lethargic with a headache and nausea. Labs revealed sodium of 118mmol/L down from 140mmol/L the day before, with a serum osmolality of 231mOsm/L, urine osmolality of 541mOsm/L, and urine sodium of 175mmol/L. Hypertonic saline was initiated nevertheless the patient suffered a seizure and was taken to the ICU. Despite multiple hypertonic saline boluses, the sodium continued to drop to a nadir of 110mmol/L. Conivaptan was initiated, and the sodium gradually increased to 127mmol/L. The patient was discharged neurologically intact on salt tabs.

**Discussion:** Severe hyponatremia is a life-threatening complication of CY and it can develop rapidly. The potential mechanisms behind this complication may be either a substantial release of antidiuretic hormone (ADH), the enhanced action of ADH on the kidneys, or both. However, more recent studies have reported direct toxic effect of CY metabolites on the collecting tubules, as opposed to an increase in endogenous ADH.<sup>4</sup> Prior reports have also concluded that this adverse effect can occur with both high (>40 mg/kg) and low dose (<20 mg/kg) CY.<sup>1,2,3</sup> The degree of hyponatremia is also likely influenced by an increased free water intake, which is recommended prior to CY administration to reduce the risk of cystitis. Symptoms like pain and nausea which are known to increase the release of endogenous ADH can also contribute to the degree of hyponatremia.<sup>5</sup> This case not only highlights the importance of being aware of this adverse effect but also suggests that there may be a potential need for a standardized protocol to monitor these patients given the danger of acute hyponatremia. The protocol could include patient education, frequent monitoring of serum sodium following the administration of CY, as well as treating any symptoms known to promote ADH release.

## SA-PO474

**Isavuconazonium Sulfate Associated Acute Hyponatremia**

Boonyanuth N. Maturstrakul, Abhishek Nimkar, Tanazul T. Pariswala, Hitesh H. Shah. Donald and Barbara Zucker School of Medicine at Hofstra/Northwell, Great Neck, NY.

**Introduction:** Isavuconazonium sulfate is an azole antifungal agent approved by the US FDA for the treatment of invasive aspergillosis and mucormycosis. Isavuconazonium sulfate has been associated with several electrolyte disorders including hypokalemia and hypomagnesemia. Hyponatremia has rarely been associated with Isavuconazonium sulfate in clinical trials. Here, we present an interesting case of isavuconazonium associated acute hyponatremia

**Case Description:** 72-year-old male with history of liver and kidney transplantation, on immunosuppressives presented to the hospital because of painless mono-ocular vision loss and chronic headache. Pt. was subsequently found to have aspergillus infection of the left cavernous sinus (that was confirmed by tissue biopsy). Mycophenolate mofetil was held in view of active aspergillus infection. Pt. was initially started on amphotericin B treatment but was later switched to intravenous isavuconazonium sulfate (for his invasive fungal infection). Before initiation of isavuconazonium sulfate, serum sodium (SNa) was in normal range at 136 mmol/L. After initiating isavuconazonium sulfate, SNa progressively decreased to 121 mmol/L over the next 10 days. Pt. was clinically euvolemic on exam. Work-up for hyponatremia showed low serum osmolality of 273 mosm/kg, urine sodium of 163 mmol/L and urine osmolality of 484 mosm/kg. Both TSH and AM serum cortisol levels were in normal range. Pt. was initiated on oral salt tablets and fluid restriction. Isavuconazonium sulfate was discontinued for severe hyponatremia and patient was initiated on intravenous voriconazole. SNa progressively improved to 134 mmol/L, 10 days after discontinuation of isavuconazonium sulfate.

**Discussion:** Solid organ transplant recipients are at increased risk for serious bacterial, viral, and fungal infections. Our patient presented with invasive aspergillosis. Treatment with isavuconazonium sulfate, a systemic antifungal medication resulted in acute severe euvolemic hyponatremia. Hyponatremia has shown to be an uncommon adverse effect (<5%) of this agent in clinical trials. While the exact mechanism of isavuconazonium sulfate associated hyponatremia is unknown, serum sodium levels progressively improved in our patient after discontinuation of this agent. Clinicians should be aware of this potential and reversible adverse effect of this agent.

## SA-PO475

**Hyponatremia vs. Pseudohyponatremia: Sodium Measurement in a Patient With a Hematologic Malignancy**

Sarah Haeger, Nervik Roy, Sarah E. Young. University of Colorado Denver School of Medicine, Aurora, CO.

**Introduction:** Hyponatremia is an electrolyte disturbance that can portend great morbidity. Once identified, hyponatremia must be confirmed as a true finding and not a laboratory artifact known as "pseudohyponatremia." Delayed confirmation leads to a

Key: TH - Thursday; FR - Friday; SA - Saturday; OR - Oral; PO - Poster; PUB - Publication Only

Underline represents presenting author.

lag in treatment. Here we report a case of apparent pseudohyponatremia in a patient with chronic lymphocytic leukemia (CLL), subsequently found to have true hyponatremia due to the syndrome of inappropriate anti-diuretic hormone (SIADH).

**Case Description:** A 73 year old with a history of CLL presented with confusion and nausea. Initial laboratory tests revealed a white blood cell count of  $71.4 \times 10^9$  cells/L and a serum sodium concentration of 110mmol/L. Initial measured serum osmolality was normal (284 mOsm/kg) raising concern for pseudohyponatremia. The patient had no paraprotein gap (total protein 6.0g/dL, albumin 3.3g/dL) and a normal triglyceride concentration (98 mg/dL). Repeat laboratory testing revealed true hyponatremia with a serum sodium concentration 108mmol/L, whole blood sodium concentration 108mmol/L, and serum osmolality 227mOsm/kg. Further testing revealed a diagnosis of SIADH. CT scan revealed new lung nodules concerning for malignancy. The patient's hospital course was prolonged due to refractory hyponatremia despite treatment with hypertonic saline, urea and tolvaptan.

**Discussion:** Serum sodium concentration, obtained on the basic metabolic panel, is routinely measured by indirect ion-selective electrode (ISE) methods which assumes that plasma contains 93% water. Serum sodium measurements using this method may be inaccurate when a patient has increased lipid, protein, or other non-aqueous substances in their blood. In contrast, whole blood sodium concentration is measured by direct ISE methods which does not make a plasma water content assumption. Serum osmolality is used as a surrogate for whole blood sodium concentration. Serum osmolality should be low in true hyponatremia, and if normal identifies pseudohyponatremia. We described a case where initial testing was misleading and delayed the diagnosis and treatment of true hyponatremia. For patients presenting with suspected hyponatremia, but with risk factors for pseudohyponatremia, we suggest repeat testing with serum sodium, whole blood sodium, and serum osmolality to verify the diagnosis of pseudohyponatremia.

#### SA-PO476

##### A Case Report on Unusual Idiopathic Central Diabetes Insipidus During the Polyuric Phase of AKI

Omar N. Elhawary,<sup>1,2</sup> Syeda S. Bukhari,<sup>1,2</sup> Isha Puri,<sup>1,2</sup> Mary C. Mallappalli,<sup>1,2</sup> Sonalika Agarwal.<sup>1,2</sup> Nephrology KCH <sup>1</sup>SUNY Downstate Health Sciences University, New York City, NY; <sup>2</sup>Kings County Hospital Center, Brooklyn, NY.

**Introduction:** Historically, classic Acute tubular injury (ATN) goes through an oliguric phase with urine output (UOP)  $\leq 400$  mL/24 hours for 1–2 weeks followed by a non-oliguric phase with UOP  $> 400$  mL/24 hours for 10–14 days with eventual recovery of the kidney functions. Central diabetes insipidus (CDI) is caused by impairment in either the synthesis, transport, or release of antidiuretic hormone (ADH). Clinically, the patient with CDI presents with volume depletion, polyuria, and elevated serum sodium. We usually tend to consider polyuria following AKI as polyuric phase until proven otherwise. In our case the patient had diabetes insipidus that improved with desmopressin, so measuring the urine and serum osmolality in patients developing polyuria post ATN should be considered.

**Case Description:** 75 y/o man with medical history of hypertension was admitted for encephalopathy and hypoxemia. He was found to have anuric ATN secondary to volume depletion complicated with hyperkalemia. The patient was treated with aggressive hydration and electrolyte repletion. A week later he was hemodynamically stable, kidney functions improved without dialysis. As expected, he developed polyuria but surprisingly there was progressive increase in serum sodium despite aggressive free water replacement via the nasogastric tube and intravenous hypotonic fluids. We ordered urine and serum osmolality and serum Na. Labs were significant for serum Na 170, Serum osmolality 363 mOsm/kg, urine osmolality 203 mOsm/kg, therefore diabetes insipidus was highly suspected. Primary polydipsia was ruled out as patient was not conscious enough to drink water by himself. Subcutaneous desmopressin 2 mcg was administered. Diagnosis of CDI was confirmed since urine osmolality doubled at the end of 2 hours. He was started on desmopressin nasal spray and serum Na was checked twice daily. Serum Na improved from 170 to 144. MRI brain did not show pituitary/hypothalamic lesion. Additional diagnostic work up for CDI could not be performed as the patient passed away few days later.

**Discussion:** In cases with Acute Kidney Injury that present with persistent hypernatremia during polyuric phase, other causes should be considered. They should be screened for Diabetes Insipidus by measuring both serum and urine osmolality and a trial of desmopressin can be given if required.

#### SA-PO477

##### Phenytoin: A Rare Cause of Central Diabetes Insipidus

Muhammad Rawala, Anand Kumar, Shancy Jacob. *The University of Texas Medical Branch at Galveston, Galveston, TX.*

**Introduction:** Drug-induced electrolyte abnormalities have been increasingly reported and may be associated with considerable morbidity and mortality. In clinical practice, hypernatremia (serum sodium higher than 145 mmol/L) is usually of multifactorial etiology, and drug therapy not infrequently is disregarded as a contributing factor to increased serum sodium concentration. Phenytoin is a commonly used antiepileptic but is rarely associated with hypernatremia in adults. Our case reminds the value of monitoring renal tubular function and electrolytes, especially in the severely neurologically impaired population on this medication.

**Case Description:** A 31-year-old non-verbal male with a history of seizure disorder, traumatic brain injury with right frontotemporal lobectomy, and renal cell carcinoma status post radical nephrectomy presented to the hospital with failure to thrive. The patient presented with mild hypernatremia (146 mmol/L) and intravenous fluids were administered as volume depletion was considered the etiology. The patient had been non-

compliant with phenytoin at home based on undetectable phenytoin levels; however, he was dosed with phenytoin appropriately in the hospital to achieve a therapeutic level. The hypernatremia worsened (161mmol/L-170 mmol/L); further workup revealed a serum osmolality (Osm) of 354 and a urine Osm of 120. The diagnosis was consistent with central diabetes insipidus (DI). After ruling out possible common etiologies of DI, phenytoin was the only medication attributed to DI. Therefore, the patient was treated by switching phenytoin to levetiracetam, and desmopressin was initiated. The patient responded to desmopressin with the resolution of hypernatremia and normalization of serum and urine Osm.

**Discussion:** The reported frequency of hypernatremia in a general hospital population range from 0.3% to 3.5%. We believe this case merits discussion for two reasons. Firstly, to highlight the difficulties encountered in unraveling the etiology of hypernatremia, and secondly, to describe an unusual side effect of a commonly used antiepileptic drug, phenytoin. Our case had a new-onset DI after therapeutically dosing phenytoin. Phenytoin is a rare but recognized cause of central DI, with few cases reported in the literature.

#### SA-PO478

##### A Rare Case of Methotrexate-Induced Nephrogenic Diabetes Insipidus

Brian Bustos, Soo H. Kae, Chris Dipollina, Eduardo M. Padrao. *University of Connecticut School of Medicine, Farmington, CT.*

**Introduction:** Methotrexate (MTX) is used for several medical conditions, particularly cancers and rheumatologic conditions. High dose MTX is a widely used regimen in malignancies and known to cause renal toxicity. To our knowledge, there has been only one other case report published of methotrexate induced nephrogenic diabetes insipidus (DI).

**Case Description:** 68 year-old male with a history of Burkitt's Lymphoma with CNS involvement (on standard chemotherapy and high dose MTX) presented to the hospital for MTX infusion. He received high dose MTX the day following admission, and subsequently had an elevated MTX level of 10.61 micromoles/L. The nephrology service was consulted 9 days later due to polyuria. He has no history of renal disease and creatinine was unremarkable. Urinalysis on admission revealed a specific gravity of 1.020. He was net negative 8.5 L since admission and had urinated 4.0 L in 24 hours. However, he was being given a D5-100mEq bicarbonate infusion due to elevated MTX level. On the day of consult, urine osmolality was 156 mOsm/kg, raising the possibility of DI. Serum sodium was 144 mmol/L and serum osmolality was 292 mOsm/kg. Glucose and BUN were normal. His intravenous fluids were stopped. The MTX levels declined to 0.09 micromoles/L and urine osmolality increased, eventually reaching 432 mOsm/kg. His sodium levels decreased from the upper limit of normal to 138 mmol/L. His urine appeared more grossly concentrated and urine output slowed.

**Discussion:** Nephrogenic DI as a result of medication use has been seen in a number of different therapies. It is suspected that our patient's polyuria was secondary to methotrexate induced DI. His urinalysis on admission suggested he was able to concentrate his urine. On the day of consult, his urine osmolality could have suggested DI. His glucose and BUN were normal and would not favor osmotic diuresis. He did have serum sodium in the upper limit of normal as well as serum osmolality slightly less than 295 mOsm/kg, which could be due to the bicarbonate infusion lowering his true serum values. In the setting of increasing urinary concentration and decreasing urine output as MTX levels decrease, we can suspect that our patient suffered from methotrexate induced DI, of which has only been reported in one other published case report. Our patient case may contribute to the knowledge of the safety profile of MTX.

#### SA-PO479

##### Nineteen Liters of Urine Output as a Consequence of Concomitant Use of Extracorporeal Membrane Oxygenation and Tolvaptan

Sri Vibhavari Guntupalli, Frederic F. Rahbari-Oskoui. *Emory University School of Medicine, Atlanta, GA.*

**Introduction:** Tolvaptan (TVP), an oral vasopressin (V2) receptor antagonist, has been used in heart failure patients to increase aquaresis, without evidence on improved long-term or all-cause mortality. Veno-arterial ECMO (VA-ECMO) is a new modality to improve tissue oxygenation in cardiogenic shock. We present the first reported case of massive polyuria in a patient who was on TVP and then started VA-ECMO.

**Case Description:** 31 YO male was transferred from an outside hospital with new onset heart failure (LVEF=15%), ventricular tachycardia and cardiogenic shock. After high dose furosemide, he received 4 doses of TVP 30 mg/d and an additional 60 mg on the day of transfer. Urine output (UOP) increased from 1-2 to 4-7L/day and serum sodium ([Na]) from 122-123 to 126-130 mmol/L temporarily. VA-ECMO was started at [Na] of 119 mmol/L. UOP increased to 19L over the next 24h with a rise of [Na] by 12 mmol. His urine Na and osmolality were 75 mmol/L and 150 mOsm/Kg respectively. Desmopressin at 2 mcg/day was administered over 2 days and UOP decreased to 11, 9, 5.5 and 3L/day over the next 4 days. Despite 1:1 replacement of free water losses, [Na] continued to rise. His mental status was originally unchanged until his heart failure and overall condition started to deteriorate. His urine output was responsive to loop diuretics but [Na] increased to 147 mmol/L. Unfortunately, he passed away within 2 weeks.

**Discussion:** TVP was used to improve hyponatremia (due to non-osmotic release of ADH observed in heart failure) and cause aquaresis. UOP on TVP is typically around 6+/-2 L in 24h, as originally seen in this case. ECMO can also cause polyuria by increased perfusion of the renal arteries. Effect of TVP on [Na] is unpredictable with overcorrection in 40% of patients [1], [Na] increased with TVP but overcorrected by 12 mmol/day once ECMO was started. His urine Na was elevated with low osmolality. This rapid [Na] rise suggests a residual effect of Tolvaptan administered several days ago combined to the ECMO-induced pressure diuresis. The washout period for tolvaptan should be 5 times

Key: TH - Thursday; FR - Friday; SA - Saturday; OR - Oral; PO - Poster; PUB - Publication Only

Underline represents presenting author.

the half-life of elimination (12h), which may be prolonged in case of passive hepatic congestion or use of CYP43A inducers. Concomitant use of tolvaptan and VA-ECMO should be avoided under penalty of causing massive polyuria and rapid overcorrection of hyponatremia.

#### SA-PO480

##### A Surprising Complication Following Immunoglobulin G Therapy: Osmotic Diuresis

Jesus D. Vega-Colon, Maria E. Rivera, Alexis Rivera Gonzalez, Carlos G. Rivera-Bermudez, Krystahl Z. Andujar-Rivera, Ileana E. Ocasio Melendez. *University of Puerto Rico Medical Sciences Campus, San Juan, Puerto Rico.*

**Introduction:** Polyuria is defined as a urine output greater than 3 liters in 24 hours. The differential diagnosis can be classified into osmotic and water diuresis causes. Osmotic diuresis is characterized by an excess of urinary solute with an osmolar excretion rate more than 1,000 mOsm/Day. Elevated urea, resolving acute tubular necrosis and hyperglycemia must be considered as potential triggers. Few cases on literature described the occurrence of immunoglobulin G induced osmotic diuresis in a patient with Pemphigus Vulgaris exacerbation, thus making the diagnosis challenging.

**Case Description:** We report a 52-year-old Puerto Rican female with Pemphigus Vulgaris complaining of recurrent painful blisters in the mouth and chest in the past 5 days. During the initial evaluation patient was started on immunoglobulin G IV therapy. Throughout hospital stay, nephrology service was consulted for persistent polyuria of 6.60 liters/24 hours and hypernatremia of 153 meq/L. No history of diuretics use reported. Renal function was stable with serum creatinine levels on baseline (BUN:19 Scr:0.65 mg/dl). Further workup showed elevated urine osmolality results of 391 mOsm/Kg. To differentiate between osmotic and water diuresis, 24-Hour Osmolar Excretion Rate was calculated multiplying urine output times urine osmolality. Results revealed evidence of 2,580 mOsm/Day indicating osmotic diuresis as the cause of severe polyuria. Typical causes of polyuria were absent leaving recent administration of immunoglobulin G containing maltose as the culprit of osmotic diuresis. Following discontinuation of immunoglobulin G therapy urine output reached normal values of 1.0-1.5 liters/Day.

**Discussion:** This case illustrates a not well-known cause of osmotic diuresis that should be included on the differential diagnosis. Increased awareness of this uncommon side effect will help clinicians recognize and address it early to prevent life-threatening electrolyte disorders. The uniqueness of this case lies on the rarity of this therapy causing osmotic diuresis with only a small percentage of hyperosmolar maltose found on the immunoglobulin G product that led to massive urinary solute loss. Our patient successfully responded after discontinuation of the potential trigger reaching adequate uremia.

#### SA-PO481

##### A Salty Goodbye to Cardiorenal and Hepatorenal Syndromes: Hypertonic Saline Diuresis

Sean Barnett. *United States Air Force, San Antonio, TX.*

**Introduction:** Diuresis and anti-diuresis are the most pivotal aspects of the cardiovascular system. The pathology of Cardiorenal Syndrome (CRS) and Hepatorenal Syndrome (HRS) are due in large part to a lack of diuresis. The lack of diuresis is due to the Renin Angiotensin Aldosterone System (RAAS) and Antidiuretic Hormone (ADH). The cardiac output, renal perfusion pressure, and neurohormonal controls of diuresis can be accentuated physiologically with 3% Saline to aid in treating this pathophysiology.

**Case Description:** 30 patients with CRS, HRS, CHF or ARDS were treated using 100mL of 3% Saline. 28 patients (93%) responded appropriately and only 2 patients (7%) had no response. Of the responders, 25 (89%) demonstrated a significant change in clinical course within 24 hours. No patient experienced any complications associated with this treatment. No patient experienced hypernatremia.

**Discussion:** Hypertonic Saline, specifically 3% Saline, is the best diuretic adjunct we have in medicine. It is well studied in heart failure and many diverse settings, 3% Saline is a safe and effective way to ensure adequate diuresis while protecting both the heart and the kidneys. In the setting of CRS or HRS, 3% Saline can function as a better adjunct for diuresis and as a diagnostic test in most settings. Physiologically, CRS and HRS arise primarily from poor renal perfusion and excessive activation of RAAS and ADH, with decreased activation or response to ANP and BNP. The urinary evaluation will generally demonstrate a low sodium, high potassium, and high osmolality. Combining physiology with evidence-based medicine, the goal would be a higher urine sodium (>50meq/L), a high urinary sodium to potassium ratio, and a low urine osmolality. This exact situation is achieved by 3% Saline. 3% Saline functions to improve preload, stimulate ANP in the Right Atrium, decrease pulmonary vascular resistance, improve cardiac output, inhibit RAAS (directly and indirectly) and inhibit ADH (directly and indirectly). 3% Saline can be used as a safe and effective treatment for most diuresis. Fortunately, the overall concentration of 3% appears to be the perfect balance of effect without complications. 3% can be given through a peripheral IV at rates under 50mL/hr, 3% can be given outside the ICU, and small amounts of 3% have almost no significant complications in all medical literature.

#### SA-PO482

##### An Uncommon Case of Liddle Syndrome

Elizabeth Pabon-Vazquez, Jessica Castillo, Jan Paul Rosaly Martinez, Jose Rivera Sepulveda, Bryan L. Pagan Rivera. *Mayaguez Medical Center, Mayaguez, Puerto Rico.*

**Introduction:** Hypertension is a medical condition affecting the population globally. Most of the patients are not aware of this disease until organ damage is present. Misdiagnosis of hypertension's etiology will lead to poorly treated patients and increase risk of medical complications. For this reason, diagnosing and management of hypertension are fundamental in the primary and secondary prevention steps.

**Case Description:** A 52y/o male patient with a past medical history of hypertension. Whom had previously visited multiple physicians due to resistant hypertension. During endocrinologist evaluation, he was found with low potassium levels. However, patient denied any symptoms including weakness, fatigue, muscle cramps or palpitations. Patient has been treated for the past three years with oral potassium replacement. New laboratory bloodwork for secondary causes of hypertension were ordered. At follow up evaluation, patient was found with metabolic alkalosis, normal magnesium levels (2.0mg/dL), normal aldosterone and low renin levels, normal ACTH and cortisol, and normal catecholamines levels. Although, patient had been complaint with oral potassium replacement, he continued with asymptomatic hypokalemia. For this reason, patient was referred to nephrology services. Bloodwork was re-assed and results yield urine potassium spot of 27mmol/L. Since, He was started on amiloride 5mg daily. In the past 2 months for the first time, potassium levels have been between 3.0-3.1, without including potassium replacement. Patient responded successfully to therapy. Abdominal CT-scan was negative for adrenal mass. Genetic studies are under study, but patient's clinical presentation and response behave as Liddle's syndrome.

**Discussion:** Secondary causes of hypertension are medical condition that contributes to elevated blood pressure. Liddle syndrome is a rare genetic condition associated with abnormalities on the epithelial sodium channel (ENaC) at the collecting tubule. Classical presentation is young onset hypertension, associated with hypokalemia and metabolic alkalosis. Usually, a strong family history will lead the work-up and diagnosis. But, as in this case, no family history was relevant. Managing hypertension will require out of the box thinking. Controlling elevated blood pressure with medications, without identifying its etiology is not enough if patient's wellbeing is the priority.

#### SA-PO483

##### Gitelman-Like Syndrome Associated With Chemotherapy With Cisplatin

Juan D. Diaz Garcia, Mario Alamilla Sanchez, Julio C. Nieto, Irving G. Ramirez, Claudia B. López, Valeria Yanez Salguero, Jose L. Ortega, Martin B. Yama Estrella, Enrique F. Morales Lopez, Francisco Velasco Garcia Lascuiran. *Centro Medico Nacional 20 de Noviembre, Mexico City, Mexico.*

**Introduction:** Gitelman-like or acquired syndrome is a rare salt-losing tubulopathy similar to thiazides, characterized by severe and chronic hypokalemia associated with metabolic alkalosis and secondary hyperaldosteronism, it is also characteristic of hypomagnesemia and hypocalciuria without a defect in the ability to concentrate urine. Cisplatin is the most widely used antineoplastic agent for the treatment of solid tumors and is a well-known cause of nephrotoxicity.

**Case Description:** A 38-year-old female with a history of gastric adenocarcinoma was treated with surgery and 12 cycles of cisplatin, adriamycin, and cyclophosphamide, with no history of taking loop diuretics and thiazides. On hospital admission, her vital signs were normal with stable blood pressure and presence of paresthesias in the extremities. Serum creatinine 0.6 mg/dl, BUN 15 mg/dl, hypokalaemia (2.2 mEq/l) and hypomagnesaemia (0.5 mg/dl), with a venous blood gas analysis that reported a pure metabolic alkalosis with pH 7.52, bicarbonate 32 mEq/l, PCO2 38 mmHg, PO2 82 mmHg. Urinary electrolyte levels were requested in 24 hours, demonstrating urinary losses of potassium with hypocalciuria. He required daily treatment with 20 to 80 mEq of KCl orally, 2000 mg of magnesium oxide and 200 mg of spironolactone to maintain his electrolytes within the normal range. Cisplatin was suspended and chemotherapy was changed. Three months after Cisplatin suspension, the patient reported serum electrolytes within normal limits.

**Discussion:** The mechanism of cisplatin nephrotoxicity remains uncertain, it is believed that cisplatin can cause DNA damage in the NCCT gene and DCT epithelial apoptosis producing Gitelman-like syndrome. Although this syndrome occurs infrequently, cisplatin causes frequent renal dysfunction. Cisplatin administration in divided doses or as a continuous infusion reduces nephrotoxicity. Immediate replacement of magnesium and potassium deficits reduces the risk of adverse effects. This case demonstrates that cisplatin can have permanent effects on tubular function and can cause significant morbidity. This syndrome should be considered in patients with unexplained electrolyte abnormalities and a history of distant therapy for malignancies.

#### SA-PO484

##### Pregnancy and Gitelman Syndrome

Daniel Gomez, Ursula C. Brewster. *Yale University Department of Internal Medicine, New Haven, CT.*

**Introduction:** Gitelman Syndrome (GS) is a rare genetic tubulopathy resulting in hypokalemia and hypomagnesemia through renal wasting that is caused by a mutation in the SLC12A3 gene that codes for NCC in the Distal convoluted tubule. We present a

case of a pregnant patient with GS and discuss management challenges. The physiologic increase in GFR due to pregnancy, increases potassium/magnesium wasting causing a challenge.

**Case Description:** A 33-year old female with GS presented to nephrology clinic 10 weeks pregnant. She was diagnosed as a teen when routine blood work showed hypokalemia and hypomagnesemia. She previously took KCl 40 mEq four times per day and MgOx 400mg twice a day. She refused sequencing. Blood Pressure was 105/67 mmHg Heart Rate 84/min with normal exam. Initial labs notable for Na 138 mEq/L, K 2.4 mEq/L, HCO<sub>3</sub> 23 mEq/L, Ca 9.4 mg/dL, Cr 0.5 mg/dL, BUN 11 mg/dL, Mg 1.3 mg/dL. A 24 hour urine study showed volume of 3 L, potassium of 285 mmol/24h, Magnesium 134 mg/g Cr and Creatinine 1.44 g/24h. Increase in supplementation didn't substantially increase levels. In an attempt to downregulate the renin angiotensin aldosterone system due to hypovolemia, 1g NaCl tablets three times daily was added and Magnesium oxide was changed to Magnesium lactate for better absorption and lower side effects. Repeat 24 hour urine post salt tablets, showed the potassium dropped to 249 mmol/24h, with no change in Mg. Supplements were titrated up and ultimately she was placed on KCL 200 mEq/24h and 2,672 mg MgLac/24h. On this regimen her labs were Na 136 mEq, K 2.9 mEq, HCO<sub>3</sub> 27 mEq, Mg 1.3 mg/dL stayed throughout the pregnancy, delivering without complications a normokalemic baby. She remained asymptomatic. Her regimen had 21 pills per day, but she never required IV supplementation. She struggled with anxiety and frustration from pill burden and constant monitoring.

**Discussion:** This case illustrates the difficulties that patients with GS face when they become pregnant. Successful pregnancies are possible with close monitoring. GFR increases in pregnancy, increasing K/Mg wasting. Hypokalemia and hypomagnesemia can be treated with high salt diet, oral potassium and magnesium supplementation to achieve adequate electrolyte levels. It is important to understand various Mg preparations available and their side effect profile to aggressively replete orally. Despite the challenges, patients with GS can successfully carry pregnancies with careful monitoring.

#### SA-PO485

##### Hypokalemia in Pregnancy Concerning for a Masked Renal Tubulopathy

Soumya V. Rajendren, Woojin Ahn. *Columbia University Irving Medical Center, New York, NY.*

**Introduction:** Pregnancy causes many physiologic alterations in fluid and electrolyte balance. Increased progesterone-mediated systemic vasodilation results in hypotension. RAAS upregulation increases renal K secretion. K loss is counteracted by progesterone's inhibition of kaliuresis, protecting the pregnant woman against hypokalemia. GFR rises, increasing proximal tubular K reabsorption. All of these maintain normokalemia in pregnancy. Hypokalemia in pregnancy therefore may be the first clue to an underlying renal tubulopathy in an otherwise healthy patient.

**Case Description:** A 37 year old asymptomatic G5P4 at 28 weeks gestation with no significant history was referred for hypokalemia to 3.0-3.2 mmol/L. She was mildly hypotensive (93/58). A pre-pregnancy BMP showed serum Na 144 mmol/L, K 3.3 mmol/L, Cl 113 mmol/L, bicarbonate 17 mmol/L and Ca 8.7 mg/dL. During this pregnancy, serum Cl 103-107 mmol/L, bicarbonate 17-22 mmol/L, Ca 8.1-8.7 mg/dL with ionized Ca 1.16 mmol/L and Mg 1.8-2.0 mg/dL. All blood gases were drawn during pregnancy with pH 7.31-7.39 and pCO<sub>2</sub> 32-39 mmHg. Urine pH ranged 5.5-7.0 during this pregnancy and was 6.0-7.0 prior. Urine AG during this pregnancy was 38 mmol/L and TTKG 7 evidenced renal K wasting. There was no nephrocalcinosis, although calcium oxalate crystals were seen on a prior UA. She was given 10 mEq KCl daily with improvement and referred for genetic testing.

**Discussion:** This case demonstrates the challenges in diagnosing renal tubulopathies in pregnancy, as the classic abnormalities may masquerade as normal pregnancy physiology. Scant pre-pregnancy data in these otherwise healthy patients makes accurate diagnoses even harder. Here, the challenge is differentiating a primary NAGMA with respiratory compensation from a physiologic progesterone-mediated respiratory alkalosis with metabolic compensation. Borderline hypocalcemia and questionable hypercalciuria could suggest a type 1 RTA or Bartter Syndrome. Hypotension could be physiologic or suggestive of a tubulopathy like Gitelman or Bartter. And while the absence of an obvious metabolic alkalosis argues against these, the very mild acidosis and correction with a just 10 mEq KCl daily is atypical of a pure type 1 RTA, raising concern for a mixed acid-base disorder. Accurate diagnosis in this population is essential for the prevention of adverse maternal and fetal outcomes, and renal genetic testing may play a key diagnostic role.

#### SA-PO486

##### A Case of Licorice Root Toxicity With Hypokalemia-Induced Bradycardia and Hypotension

Judy Sakya, Alexander Pennekamp. *Christ Hospital, Cincinnati, OH.*

**Introduction:** Licorice (glycyrrhethinic acid) toxicity causes hypertension along with hypokalemia by mimicking a state of hyperaldosteronism. It inhibits type 2 11-beta-hydroxysteroid dehydrogenase and binds to mineralocorticoid receptors.

**Case Description:** A 75-year-old male with a past medical history significant for controlled hypertension, hyperlipidemia, coronary artery disease presented with progressive fatigue and dyspnea on exertion. In the ED, he was hypotensive and bradycardic, hypokalemic with ST-depressions and U-waves on EKG; his troponins were elevated. His medications prior to admission included: losartan, chlorthalidone. Serum Creatinine: 1.4 mg/dL (reference: 0.50 - 1.30 mg/dL) Serum potassium: 1.2 (reference: 3.5 - 5.1 mmol/L) Urine potassium: 50 (reference: 12.0 - 129.0 mmol/L; inappropriately high) Urine creatinine: 128.5 mg/dL (reference: 30 - 310 mg/dL) Fractional excretion of potassium: 45.4% (Renal potassium wasting) Upon further questioning, patient revealed

that he had been taking licorice root extract (glycyrrhethinic acid) for the past three weeks to treat his fatigue. He stated that a provider had mentioned that his fatigue may be a result of possible adrenal insufficiency. To intervene with a natural supplement, he was recommended to take the licorice root extract from an online store. The patient's blood pressure normalized with electrolyte correction, licorice discontinuation and supportive care.

**Discussion:** Licorice (glycyrrhethinic acid) is a common addition to many candies, gums, and beverages and small amount of consumption poses minimal risk. Ingestion high enough to produce hypermineralocorticoid effects is possible when consumed as a licorice concentrate - a "health supplementation" that is readily accessible to patients without regulation. Interestingly, in our case, the expected hypertension due to overactivation of the renin-angiotensin-aldosterone system was masked by reduced cardiac output from hypokalemia-induced bradycardia. A detailed history was the key to exploring further urine studies, and an inappropriately high urine potassium and high fractional excretion of potassium confirmed the diagnosis.

#### SA-PO487

##### Unusual Case of Hypokalemia After Gastric Band

Elise Ewing, Hassan N. Ibrahim. *Houston Methodist Hospital, Houston, TX.*

**Introduction:** 55 year old woman with prior laparoscopic gastric band 10 years ago presented to primary care for new onset fatigue, concentration difficulty, and cold intolerance. She also has severe heartburn for the past few years and takes over-the-counter calcium carbonate multiple times per day. She has hypokalemia worsening over the past 3 years and several other metabolic disturbances, and was referred to nephrology clinic.

**Case Description:** Lab results included low potassium 3.0 mmol/L (3.5-5.3), elevated serum bicarbonate 30 mmol/L (20-32), BUN 12 mg/dL, creatinine 0.98 mg/dL, elevated serum calcium 10.4 mg/dL (8.3-10.2) and PTH 21 pg/dL (15-65). VBG revealed pH 7.36, pCO<sub>2</sub> 57mmHg (45-51), and bicarbonate 32 mmol/L (21-28). Hemoglobin was 10.2 g/dL (11.7-15.5) with microcytosis (MCV 82). Serum iron level was 11 mcg/dL (45-160), with 3% iron saturation (16-45). Urine studies indicated renal wasting with random U<sub>Na</sub> 60 mEq/L, U<sub>Cr</sub> 41 mEq/L, U<sub>K</sub> 28 mEq/L and U<sub>Ca</sub> 22 mEq/L. CT scan of the abdomen revealed a significantly dilated esophagus above the gastric band with excessive restriction. The electrolyte disturbances were likely sequelae of this with frequent calcium carbonate intake leading to hypercalcemia, suppressed PTH, and metabolic alkalosis. The metabolic alkalosis induces kaliuresis and intracellular shift of potassium resulting in hypokalemia. She was advised to discontinue calcium carbonate and instead use Esomeprazole 40mg daily for GERD, and to discuss gastric band adjustment with bariatric surgeon. At a 1 month follow-up visit, there was normalization of potassium 3.7 mmol/L, bicarbonate 25 mmol/L, and calcium 9.5 mg/dL. She also received two IV iron infusions and hemoglobin increased to 13.2 g/dL within 2 months. Energy level, concentration, and cold tolerance all improved.

**Discussion:** Milk Alkali syndrome includes a triad of hypercalcemia, metabolic alkalosis, and acute kidney injury. Discontinuing the offending agent usually results in rapid resolution. Calcium carbonate can also impact iron absorption. Typically iron is conjugated within gastric acid and absorbed in the upper gastrointestinal tract. If this process is impaired and iron reaches the alkaline secretions in the proximal jejunum, it is converted to ferric hydroxide and cannot be absorbed. Excess calcium can impair iron absorption. Also since an acidic gastric environment is needed, medications such as PPIs or antacids can decrease iron absorption.

#### SA-PO488

##### To Kayexalate or Not to Kayexalate

Yahya Al-Yousif, Amenah Al-Juboori, Nitin Behl, Aditya Bansal. *AtlantiCare Regional Medical Center, Atlantic City, NJ.*

**Introduction:** Although rare, it is important to consider colon necrosis, ulceration, and perforation in the management of patients with abdominal pain following kayexalate administration. We present a critically ill patient requiring partial hemicolectomy following kayexalate for hyperkalemia.

**Case Description:** A 43-year-old male presented to the ER via EMS after being intubated emergently in the field. Was found to be COVID-19 positive and admitted to the ICU. Creatinine and potassium started trending up after day 5, requiring multiple doses of calcium gluconate, insulin, and dextrose, along with 4 doses of kayexalate 30 g over the second week. On the 10th day, he started spiking fever, having abdominal distention, and continued desaturating. Abdominal x-ray showed a large amount of free intraperitoneal air warranting emergent ex lap with partial right hemicolectomy and end ileostomy. Unfortunately, he was pronounced dead after a lengthy hospital stay of 55 days. The specimen showed perforation, mucosal necrosis, and acute serositis. It also showed Amorphophilic crystals suggesting a diagnosis of kayexalate-induced colon ischemia and necrosis.

**Discussion:** Kayexalate was approved by the FDA in 1958 and has been used to treat hyperkalemia. It can bind intraluminal calcium, leading to bowel obstruction or perforation, with a reported incidence of 0.14-1.8%. The identification of rhomboid or triangular, basophilic crystals with a mosaic pattern on H&E stain is pathognomonic for the presence of kayexalate. We present this case as a reminder of the rare yet devastating complications of kayexalate. For that reason, clinical suspicion should be raised in patients with abdominal pain following kayexalate. Kayexalate should only be used in patients who have life-threatening hyperkalemia where dialysis or newer cation exchangers (ie, patiromer or Lokelma) are not available, and other therapies to remove potassium have failed or are not possible.

Key: TH - Thursday; FR - Friday; SA - Saturday; OR - Oral; PO - Poster; PUB - Publication Only

Underline represents presenting author.

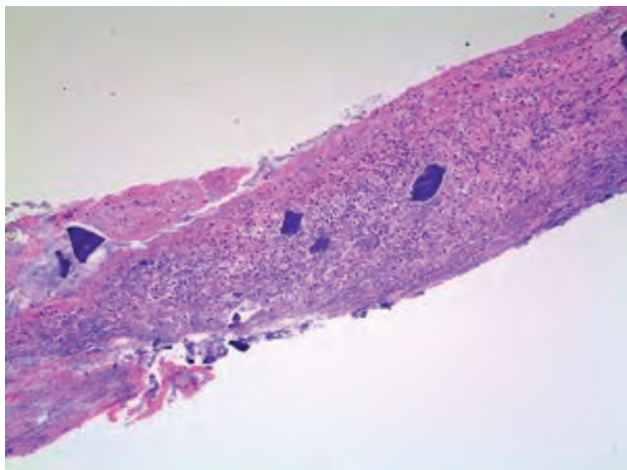

Microscopic Image of the right colon.

SA-PO489

**Empagliflozin-Induced Fanconi Syndrome in a Patient With COVID-19**  
 Nicole Fernandez, Gilad S. Guez, Edgar R. Escasinas. *LewisGale Medical Center, Salem, VA.*

**Introduction:** Fanconi syndrome is a renal tubular acidosis type 2 that also presents with phosphaturia, renal glucosuria, aminoaciduria, and tubular proteinuria. Etiologies of fanconi syndrome include wilson’s disease, inborn errors of metabolism, type 1 glycogen storage disorders, multiple myeloma, heavy metal toxicity, and medications. While a variety of drugs can lead to fanconi syndrome, there are only 4 published cases due to an SGLT-2 inhibitor, all of which were associated with canagliflozin. Based on our literature review, this is the first reported case of fanconi syndrome due to empagliflozin use.

**Case Description:** 61 year-old female with history of type II diabetes mellitus and rheumatoid arthritis. She had been taking empagliflozin-metformin 12.5 mg-1,000 mg, twice a day for 1.5 years and A1C was 7%. She had covid, and was admitted for severe fatigue and nonanion gap metabolic acidosis. Empagliflozin-metformin was held on admission. Metabolic panel showed bicarbonate 11 mmol/L, phosphate 1.2 mg/dL, magnesium 1.5 mg/dl and potassium 2.7 mmol/L. She required a lot of replacement over the course of 9 days before returning to normal electrolyte levels (table 2).

**Discussion:** Urine studies (table 1) including aminoaciduria also demonstrated that patient had an underlying Fanconi Syndrome. The severe fatigue was exacerbated by Covid infection, but was multifactorial due to low levels of serum electrolytes as well. Fanconi syndrome is a rare form of renal tubular acidosis type II, historically associated with a variety of medications. Some notable drugs include aminoglycosides, cisplatin, valproic acid, tetracyclines, ifosfamide, and tenofovir, as well as heavy metal toxicity. Currently, fanconi syndrome is not a known adverse effect for SGLT 2 inhibitors as there are only 4 previously reported cases. Due to recent emerging data supporting the use of this medication class in diabetes mellitus, especially complicated by congestive heart failure and chronic kidney disease, more data is needed in order to evaluate the benefits of these medications compared to the increasingly growing body of reported complications.

Urine Studies	
Ur Na	76 mmol/L
Ur Phos	46.5 mg/dL
Ur K	31 mmol/L
Ur Protein/Cr Ratio	4.07
Ur Cystine	720 umol/g Cr
Ur Lysine	2,093.2 umol/g Cr
Ur Serine	5,432.9 umol/g Cr
Ur Glycine	11,890.3 umol/g Cr
Ur Histidine	2,973.5 umol/g Cr

(Table 1)

Electrolyte Replacement Totals in 9 days	
IV Na Bicarbonate	750 mEq
PO Na Bicarbonate	13,000 mg
IV K Phosphate	150 mmol
IV Potassium Cl	250 mEq
PO Potassium Cl	3,780 mEq
IV Magnesium	2 gm

(Table 2)

SA-PO490

**Cadmium Toxicity From Cigarettes Causing Proximal Renal Tubular Acidosis and Severe Symptomatic Hypokalemia**

Lyle W. Baker. *Mayo Clinic, Jacksonville, FL.*

**Introduction:** Heavy metal toxicity is an underrecognized cause of proximal renal tubular acidosis (RTA). Acquired proximal RTA is commonly caused by paraprotein disease, autoimmune disease, & medications. Heavy metals like cadmium can cause proximal RTA. This author presents two cases of cadmium toxicity from cigarette smoking causing proximal RTA and severe hypokalemia presenting as muscle weakness.

**Case Description:** Case 1: 57-year-old female with COPD and >40 pack-year smoking history, admitted for general weakness. She actively smoked 2 packs per day (PPD). Case 2: 66-year-old female with COPD and >50 pack-year smoking history, admitted for lower extremity weakness. She actively smoked 1 PPD. Both patients denied diarrhea, vomiting, and use of laxatives or diuretics. Both patients had unremarkable vitals & exam was significant for 4/5 muscle strength of extremities. Admission labs (Table 1)

revealed severe hypokalemia, hypophosphatemia, & non-anion gap metabolic acidosis. Urine studies (Table 1) including urine potassium-to-creatinine ratio,  $\beta$ 2-microglobulin, & retinol-binding protein-to-creatinine ratio were suggestive of renal potassium wasting, proximal tubulopathy, & RTA. Testing for paraprotein & autoimmune disease was unremarkable. Review of medications did not identify an offending agent. Heavy metals screen in both patients revealed elevated urinary cadmium confirming cadmium toxicity.

**Discussion:** The kidneys are a primary target organ for chronic cadmium toxicity. Inhalation of tobacco smoke is the main source of cadmium exposure in smokers; inhalation from smoking 1 PPD is between 1-3  $\mu$ g. The critical urinary cadmium-creatinine ratio associated with renal tubular injury is 2-10  $\mu$ g/g. These two cases highlight the importance of recognizing chronic cadmium toxicity from cigarette smoking as a rare cause of proximal RTA.

Table 1: Labs

	Case #1	Case #2	Reference
Potassium (mmol/L), serum	<1.5	1.6	3.6-5.2
Phosphorus (mg/dL), serum	1.0	0.9	2.5-4.5
Bicarbonate (mmol/L), serum	20	17	22-29
Serum Anion Gap	11	9	7-15
Urine Anion Gap	-9.1	22	
24 Hour Urine Potassium (mEq)	108	-	>30 suggestive of renal potassium wasting in setting of hypokalemia
Urine Potassium-to-Creatinine Ratio (mEq/g)	153	55.9	>13 suggestive of renal potassium wasting in setting of hypokalemia
$\beta$ 2-Microglobulin ( $\mu$ g/L), urine	>20,000	>20,000	<300
Retinol-Binding Protein-to-Creatinine Ratio ( $\mu$ g/g), urine	173,200	178,800	$\leq$ 1100
Cadmium-to-Creatinine Ratio ( $\mu$ g/g), urine	6.2	9.0	<0.6

SA-PO491

**Immune Checkpoint Inhibitor-Induced “Pantubulopathy”**

Kelly E. Schlotman, Muhammad A. Shahzad, Casey N. Gashti, Roger A. Rodby. *Rush University Medical Center, Chicago, IL.*

**Introduction:** Immune checkpoint inhibitors (CPI’s) are widely used, effective cancer therapy agents that utilize the body’s natural immune system to destroy cancer cells. Unfortunately, the immune-mediated cellular damage is not limited to malignant cells and can also occur in healthy tissues including the kidneys. Tubulointerstitial nephritis (TIN) is the most common pathology seen on kidney biopsy in patients with AKI due to CPI’s. Here we present a case of CPI-induced interstitial nephritis which resulted in functional defects throughout the entire nephron.

**Case Description:** A 67 yo F w/ PMH of HTN, CKD3b (baseline SCr 1.3-1.6 from previous nephrotoxic exposure to carboplatin and bevacizumab), and metastatic endometrial cancer being treated with pembrolizumab (PD-1 inhibitor), lenvatinib (TK inhibitor), and zoledronic acid presented with a SCr of 3.2 mg/dl, hypokalemia (2.5 mmol/L), hypophosphatemia (1.9 mg/dl), hypomagnesemia (1.3 mg/dl), and a non-anion gap metabolic acidosis with  $[HCO_3^-]$  14 mmol/L and arterial blood pH of 7.18. Her urinalysis had a pH of 6.5, 3+ glucosuria (serum blood glucose of 98 mg/dl), 1+ blood, 1+ protein, and 5 WBC’s. Her urine P/C ratio was 3.8 g/g and urine A/C ratio was 530 mg/g. The fractional excretion of potassium (FEK) and phosphorus (FEPhos) were elevated (FEK 77% and FEPhos 52%) consistent with potassium and phosphorus wasting. The urine osmole gap was low (28) and urine anion gap was positive (+11), both consistent with a distal renal tubular acidosis. Her severe electrolyte disturbances required aggressive supplementation. Renal biopsy showed acute on chronic interstitial nephritis with acute tubular necrosis and 20% IFTA. She received 40 mg prednisone with improvement in electrolyte disturbances and SCr to baseline.

**Discussion:** CPI’s can cause acute interstitial nephritis leading to AKI and a number of tubular defects. Our case had evidence of 1) proximal tubular defects manifested as Fanconi syndrome with non-albuminuric proteinuria as well as renal K,  $PO_4$ , and glucose wasting 2) a loop of Henle defect with Mg wasting and 3) a distal tubular defect manifested as a distal RTA. While each of these have been reported with CPI’s, we are unaware of a prior case of “pantubulopathy” in which every segment of the nephron was affected by the CPI-induced AIN. Prompt diagnosis and treatment led to complete resolution of AKI and tubular defects.

SA-PO492

**A Novel Form of Renal Tubular Acidosis (RTA) Associated With Immune Checkpoint Inhibitors: A Case Report and Literature Review**

L. D. Weiner,<sup>1,2</sup> Hyun-Wook Lee,<sup>2</sup> William L. Clapp,<sup>2</sup> Chintan V. Shah.<sup>2</sup> <sup>1</sup>Gainesville VAMC, Gainesville, FL; <sup>2</sup>University of Florida College of Medicine, Gainesville, FL.

**Introduction:** Immune checkpoint inhibitors (ICI) are increasingly being used as anti-neoplastic therapy. This report describes a case linking ICI therapy to a novel form of RTA, which we term Type V RTA.

**Case Description:** A 46 yo female with metastatic cancer was treated with Carboplatin-Paclitaxel-Pembrolizumab followed by maintenance pembrolizumab. Three months after starting maintenance pembrolizumab, she developed hypokalemic (K, 3.2 mM) normal-gap metabolic acidosis (tCO<sub>2</sub>, 15 mM). Renal function was preserved (creatinine, 0.6 mg/dl), and the urine pH was 6.0. Urinary ammonia, estimated using urine anion gap (+27 mM) and urine osmole gap (83 mOsmol/kg H<sub>2</sub>O), was not elevated. Urinary citrate in a 24-hour collection was undetectable. A diagnosis of ICI-associated RTA was made, and pembrolizumab was held. A kidney biopsy showed proximal tubule vacuolization but no tubulitis, tubular necrosis, or interstitial nephritis. K-citrate treatment

normalized the acidosis and hypokalemia; urine pH remained 6.0 during therapy. The RTA spontaneously resolved over four months. Immunohistochemistry of the biopsy specimen for key acid-base transporters, NBCe1, H-ATPase, and Rhesus C Glycoprotein, showed normal expression and localization compared to control tissue. Ultrastructural analysis showed proximal tubule apical and basolateral vacuolization. A review of medical literature identified 7 previous cases of RTA associated with PD-1 therapy. Urine pH was 6.0 in 3, 6.3 in one case, 6.5 in two, and 6.7 in one case.

**Discussion:** This case represents a novel form of RTA, which we term Type V RTA. Type II (proximal) RTA is excluded given the persistent urine acidification during alkali therapy and undetectable urinary citrate. Intact urine acidification excludes Type I (distal) RTA. The absence of hyperkalemia excludes Type IV (hyperkalemic) RTA. Instead, we postulate that this case represents a novel form of RTA, Type V RTA, which is characterized by normal gap metabolic acidosis, impaired ammonia excretion despite intact urine acidification, the absence of hyperkalemia, and intact ability to decrease urinary citrate. A case review identifies several similar cases, all associated with anti-PD1 therapy. We suggest the etiology is impaired proximal tubule ammonia generation, which may be related to the proximal tubule vacuolization observed.

### SA-PO493

#### Metabolic Acidosis in a Patient With Polycystic Ovary Syndrome Taking Oral Contraceptives and Antipsychotics

Renuka Tolani, *Palmetto General Hospital, Hialeah, FL.*

**Introduction:** Patients with insulin resistance such as with polycystic ovarian syndrome (PCOS) who are on oral contraceptives (OCPs) and antipsychotics, may be at an increased risk for hypertriglyceridemia as a side effect. Lipolysis of triglycerides may increase free fatty acid production and therefore contribute to HAGMA. When there is severe hypertriglyceridemia, then plasmapheresis and dialysis play an important role in resolution.

**Case Description:** An 18 year old female with a past medical history of PCOS, diabetes, and depression presented to the ED with lower abdominal pain. Her home medications included lurasidone, sertraline, ethinyl estradiol-norgestimate, metformin, and insulin. Patient complained of associated dysuria. In the ED patient was found with tachycardia and tachypnea, but normotensive and afebrile. Labs were notable for leukocytosis of 15.7, glucose 252, bicarb 6, anion gap 23, and sodium 128. BUN was 4 and creatinine was 0.6. There was not a significant osmolality gap. Lactic acid was not elevated. Acetaminophen, ethanol, and salicylate levels were negative. UA was significant for leukocyte esterase, protein, glucose, and ketones. Urine culture grew *E. coli*. Blood gas on room air showed pH of 7.028, pCO<sub>2</sub> 10.3, bicarb 5, and pO<sub>2</sub> 130. Lipid panel showed cholesterol of 1,062, LDL < 472, and triglycerides > 2625. Lipase was 431, without findings of pancreatic pathology on CT abdomen. Hemoglobin A1C was found to be 9.81. The patient received a dialysis and plasmapheresis session. She was started on insulin drip, statin, omega and fenofibrate. She received 5 amps of bicarb and was started on a bicarb drip. She was given a course of antibiotics for her UTI. Over a course of 24 hours the acidosis resolved and the anion gap closed. Triglycerides reduced to the 400s by the next day. Trialysis catheter was removed. Psychiatry and internal medicine decided to discontinue antipsychotic and continue sertraline. She was discharged with OCP containing less estrogen, insulin, statin, omega-3 and fenofibrate.

**Discussion:** In patients with hypermetabolic syndrome who have HAGMA on labs, it is important to check for elevated triglycerides and treat based on severity. After plasmapheresis and hemodialysis with reduction of triglyceride levels, our patient's HAGMA resolved. There have been a few cases reported of oral contraception-induced hypertriglyceridemia particularly with estrogen, but requires further research.

### SA-PO494

#### L-Arginine-Induced Non-Anion Gap Metabolic Acidosis in a Patient With MELAS Syndrome

Daniel Rechlin, Catherine A. Moore. *University of Rochester Medical Center, Rochester, NY.*

**Introduction:** MELAS syndrome (Mitochondrial myopathy, encephalopathy, lactic acidosis, and stroke-like episodes) is a rare disorder of mitochondrial DNA manifesting across multiple body systems, including with episodic lactic acidosis. Primary treatment of flares is with L-arginine. This medication has been shown to inhibit proximal renal tubule bicarbonate reabsorption, and we present a complicated case of this known but rare side effect.

**Case Description:** Our patient was a 40 year old male with a history of MELAS syndrome with subsequent seizures, hearing and visual loss, and previous stroke-like episodes; hypertension; and type 2 diabetes mellitus treated with Empagliflozin. He presented to the hospital with 2-3 days of abdominal pain and malaise, with acute onset encephalopathy. Initial workup revealed an anion gap metabolic acidosis (AGMA), with evidence of lactic acidosis and DKA, and concurrent respiratory acidosis. He initially responded to IV fluids, insulin infusion, and mechanical ventilation. On hospital day 2 he was started on IV L-Arginine for suspected MELAS flare. The next day there was recurrence of AGMA, with additional non-anion gap metabolic acidosis (NAGMA). AGMA, attributed to recurrence of euglycemic DKA vs. starvation ketosis, resolved with additional IV fluids and insulin infusion. Given the timeline, and urine labs consistent with type II renal tubular acidosis, his Arginine infusions were felt to be the most likely culprit for his NAGMA. He was treated with temporary bicarbonate supplementation, and with completion of his course of L-Arginine his acidosis resolved.

**Discussion:** This is a case of L-arginine induced non anion gap metabolic acidosis in a patient with MELAS syndrome. Although there have been occasional reports of this phenomenon, there is very little literature on this topic. This patient's case was also

complicated by multiple other sources of metabolic, and respiratory, acidosis. Patients with MELAS syndrome are prone to complicated acid-base disturbances by nature of their disease. NAGMA from L-arginine is a medication side effect peculiar to this combination of therapy and disease process. Because of the multiple potential pitfalls in diagnosis illustrated by this case, it is important to bear this in mind when caring for patients with this rare disease.

### SA-PO495

#### Unexplained Metabolic Acidosis: Look for Acetaminophen!

Sriram Sriperumbuduri, Lilia Harris, Uma Mahesh R. Avula, Safa Osman, Carter V. Schwartz, Maria Clarissa Tio. *The University of Mississippi Medical Center, Jackson, MS.*

**Introduction:** High anion gap metabolic acidosis (HAGMA) is a common clinical scenario and often presents as a diagnostic challenge. We present an often-overlooked etiology of HAGMA in a hospitalized patient.

**Case Description:** A 65-year-old-female with atrophic right kidney and hypertension was referred to our hospital for management of a recently diagnosed urothelial bladder malignancy. She had multiple hospitalizations for urosepsis in the past 3 months. Labs showed low serum albumin of 2.3 mg/dl and serum creatinine of 0.65 mg/dl at the time of current admission. She underwent radical cystectomy and open right nephroureterectomy (for recurrent urosepsis). Post operatively she developed ileus and was started on total parenteral nutrition (TPN). One week later, she developed progressively worsening HAGMA. Initial evaluation at the onset of acidosis showed high blood glucose with normal serum beta hydroxybutyrate (BHB) level. Insulin infusion was started and TPN was held. Despite giving sodium bicarbonate, HAGMA continued to worsen with decline in serum bicarbonate up to 10 mEq/l and increase in anion gap (AG) to 36 mEq/l by post operative day 17. Serum lactate was normal and there was no exposure to salicylates or alcohol. Serum creatinine was 0.9 mg/dl indicating mild acute kidney injury. Chart review showed a cumulative exposure of 49.7 grams to Acetaminophen over 19 days after the surgery. Urine 5-oxoproline was ordered and it was elevated at 1401 mmol/mol of creatinine. Liver function tests remained normal. Acetaminophen was held and intravenous N-Acetyl cysteine (NAC) was given for a total dose of 300 mg/kg over one day. Serum AG normalized after 3 days of NAC to 12 mEq/L and bicarbonate improved to 23 mEq/L after one week.

**Discussion:** This case highlights 5-oxoproline as a differential for HAGMA in a hospitalized patient with chronic acetaminophen exposure. Exposure to high cumulative doses of acetaminophen in patients with predisposing factors (elderly, females, malnutrition, sepsis, chronic acetaminophen exposure) should raise concern for this condition.

### SA-PO496

#### Case of Increased Anion Gap Metabolic Acidosis From Acquired Glutathione Deficiency Secondary to Acetaminophen

Hussain A. Karimi,<sup>1</sup> Hoda Kaldas,<sup>1</sup> Mariya Asghar,<sup>2</sup> *UPMC, Pittsburgh, PA;* <sup>2</sup>*Liaquat National Hospital and Medical College, Karachi, Pakistan.*

**Introduction:** We describe a case of a 31-year-old female with prolonged hospitalization who had high anion gap metabolic acidosis (HAGMA) secondary to Acetaminophen-induced pyroglutamate excretion.

**Case Description:** 31 y/o F with a past medical history significant for traumatic brain injury secondary to a motor vehicle accident, seizure disorder, bowel perforation status post ileostomy who presented with Pneumonia and UTI (Urinary tract infection) from MDR (multidrug-resistant) organisms, also found to have HAGMA for which Nephrology was consulted. The patient had a very prolonged hospitalization which was met with multiple complications. She was noted to have HAGMA of 26 and a serum bicarbonate level of 12. Her VBG showed a pH of 7.17, PCO<sub>2</sub> of 36, and HCO<sub>3</sub> of 13, her delta gap was 1.16 indicating pure HAGMA. Appropriate workup was done which showed negative ACTH stimulation test, creatine phosphokinase levels <10, Lactic acid at 2.0 mmol/L, beta-hydroxybutyrate levels were 0.27 mmol/L, free valproic acid at 4.7 (4.8-17.3 ug/ml), topiramate levels at 6.8 (5-20 ug/ml), Acetaminophen and aspirin levels were undetectable. Ethanol levels were not checked but she had no exposure to it due to the prolonged hospitalization, all medications were reviewed, and propylene glycol was not used as a solvent in any of the meds. Her renal function showed serum creatinine of 0.3 mg/dl, but it was unreliable as she was severely malnourished, urine anion gap was positive. She was started on sodium bicarbonate tablets 650 mg q 8 hours and then transitioned to a bicarbonate drip with 150 meq/L in 1 L of sterile water. Upon further review, it was noted that she had been getting oral acetaminophen 650 mg every 6 hours as needed intermittently for pain, this prompted us to send serum and urine organic acid panel using gas chromatography/mass spectrometry which revealed massive excretion of pyroglutamate in the urine. Her Acetaminophen was stopped and a week later her serum bicarbonate levels improved to 24 without needing any further NaHCO<sub>3</sub> tablets.

**Discussion:** High anion gap metabolic acidosis due to acquired deficiency of glutathione in malnourished patients who are exposed chronically to Acetaminophen is underinvestigated and underreported. This should be considered as a differential, especially in women with prolonged hospitalization and sepsis when evaluating HAGMA.



## SA-PO497

**Case of Chronic Lactic Acidosis in an Adult Female**

Violeta Alvarez Retamales, Charles W. Heilig. *University of Florida College of Medicine, Jacksonville, FL.*

**Introduction:** Sengers syndrome (SS) is a rare autosomal recessive disorder due to mutations in acylglycerol kinase (AGK) gene. We report a case of an adult female referred to the nephrology clinic with chronic lactic acidosis, diagnosed clinically and undergoing genetic work up for SS.

**Case Description:** 30 y/o F, born of consanguineous parents, with history of chronic myalgias, asthenia, exercise intolerance, open angle glaucoma, and congenital cataracts is found to have chronic lactic acidosis. Her serologies are remarkable for AST at 55 U/L, ALT at 41 U/L, aldolase at 13.4 U/L, lactic acid at 7.6 mmol/L, LDH at 220 U/L, CK at 504 U/L. Urine lactic acid at 92 mmol/mol creat. Echocardiogram (TTE) revealed mild concentric left ventricular hypertrophy but otherwise unremarkable. She has two younger twin brothers, one of them share her symptoms along with cardiomyopathy. No one else in the family has similar symptoms. Her 24 y/o brother has been recently diagnosed with SS. Patient is currently undergoing further genetic workup to confirm SS.

**Discussion:** SS is caused by homozygous or compound heterozygous mutation in the AGK gene on chromosome 7q34. It is an autosomal recessive mitochondrial disorder characterized by congenital cataracts, hypertrophic cardiomyopathy, skeletal myopathy, exercise intolerance, and lactic acidosis. SS is usually diagnosed in infancy yet that is not the case with this patient. Being a very rare disease, its phenotype/genotype is still uncertain. AGK is involved in the synthesis of phosphatidic acid which acts as a second messenger regulating several cellular processes and plays an important role in the synthesis of phospholipids. Multiple studies found oxidative phosphorylation defects in SS and suggested that mitochondrial respiration and metabolism are affected in the absence of AGK. SS can have high mortality rate due to hypertrophic cardiomyopathy, yet in our patient TTE showed only mild hypertrophy. SS can be differentiated from other hypertrophic cardiomyopathy associated genetic disorders by its high incidence of ocular lesions. A distinctive feature is the development of marked lactic acidosis on slight muscular exercise for which our patient has been told to avoid any strenuous activity. Much is still to be understood about SS, yet strong clinical suspicion is needed when a patient presents with ocular lesions, lactic acidosis, muscle weakness and cardiomyopathy clinical features.

## SA-PO498

**Anion Gap Metabolic Acidosis due to Lactate Production in the Setting of Metformin Poisoning**

Nazish Khan,<sup>1,2</sup> John Manllo,<sup>3</sup> Roberto Manllo-Karim.<sup>3,1</sup> *The University of Texas Rio Grande Valley, Edinburg, TX; <sup>2</sup>Knapp Medical Center, Weslaco, TX; <sup>3</sup>South Texas Kidney Specialists, McAllen, TX.*

**Introduction:** We present a case of anion gap metabolic acidosis (AGMA) secondary to severe lactate production due to metformin overdose in an 18-year-old woman, highlighting metabolic derangements ensuing the need for hemodialysis.

**Case Description:** An 18 y/o woman with past medical history of depression and recently diagnosed diabetes mellitus presented to us two hours after attempting suicide by ingesting over a hundred Metformin 1000mg tablets. On evaluation, she reported two episodes of emesis prior to arrival. Physical examination revealed a somnolent yet arousable, tachypneic and depressed young woman. Initial labs were remarkable for serum HCO<sub>3</sub> of 10 mmol/L, anion gap of 19 and a lactic acid level of 6.3 mmol/L. Admission arterial blood gases showed: pH of 7.17, PCO<sub>2</sub> 23.9, PO<sub>2</sub> 126 and HCO<sub>3</sub> 8.5. Urine drug screen, acetaminophen and salicylates level were negative. She received a bolus of isotonic saline and 200 mEq of IV sodium bicarbonate in the ED and was admitted to the ICU for closer monitoring. Within seven hours of ingestion, her lactic acid trended up to 28 mmol/L, serum HCO<sub>3</sub> dropped to < 5 mEq/L and the anion gap rose to 40. Arterial blood pH dropped to 6.811 and she was started on IV sodium bicarbonate infusion. The patient became hypotensive with intractable acidosis and required sustained low-efficiency dialysis. Despite severe tachypnea, the patient did not require intubation. She received two six-hour SLED sessions in 24 hours and 1750 mEq of IV sodium bicarbonate supplementation as infusion and boluses in 48 hours which resolved the AGMA and improved lactic acid to 2.3 mmol/L. No cardiac arrhythmias were recorded. Her symptoms significantly improved with pH correction and she was discharged home after psychiatry consultation.

**Discussion:** Metformin associated lactic acidosis carries a high mortality rate, even higher in cases of overdose. Patients initially have relatively normal labs and the severity of acidosis may not be apparent on presentation. However, as seen in this case, they can rapidly decompensate. Patients with reported or suspected metformin toxicity should be monitored closely with frequent ABG, electrolytes and lactic acid checks for initial 12 hours (two metformin half-lives). Lastly, although metformin has no antidote, its toxicity can be managed with early nephrology consultation and pH correction with sodium bicarbonate and dialysis.

## SA-PO499

**MALA: Surviving Extreme Metformin Toxicity**

Raad B. Chowdhury,<sup>1</sup> Paul M. Palevsky.<sup>2</sup> *UPMC, Pittsburgh, PA; <sup>2</sup>University of Pittsburgh, Pittsburgh, PA.*

**Introduction:** Metformin (MET) induced lactic acidosis (MALA) is a potentially life-threatening complication of MET associated with decreased kidney function characterized by a profound type B lactic acidosis with vasoplegia and circulatory

collapse. Management requires drug removal using kidney replacement therapy. In 2019, close to 90 million prescriptions of metformin were filled. MALA is rare in absence of kidney dysfunction and MET is contraindicated at eGFR < 30 mL/min/1.73 m<sup>2</sup>. MALA. Serum MET levels are important in distinguishing these cases from other causes of lactic acidosis. We describe a case of MALA with one of the highest serum levels reported, in a patient with no prior history of renal disease.

**Case Description:** A 33-year-old female with unknown past medical history presented as a transfer from an outside hospital after ingestion of 90 grams of MET. On initial presentation her lactate was 11 mmol/L, with rapid clinical decompensation and minimal responsiveness. On transfer, her pH was 6.86, HCO<sub>3</sub>- 7 mmol/L, AG 24 mmol/L, lactate 18.3 mmol/L, BUN 18 mg/dl, Cr. 1.1 mg/dl, K+ 5.1 mmol/L, and Posm 348 mOsm/kg. High flux hemodialysis (HD) was initiated for presumed MALA while awaiting pre-HD MET levels. She received hemodialysis for 47.25 hours until her lactate was <3 mmol/L and pH >7.35. Her admission MET level was ultimately reported as 470 mcg/ml. She was discharged from the hospital after 40 days and was HD independent.

**Discussion:** We describe a young female with no prior history of kidney disease who developed MALA associated with one of the highest MET levels reported after massive ingestion who survived after prolonged extracorporeal drug removal. In a systematic review by Yeh et al<sup>2</sup>, the highest reported MET level was 380.0 mcg/ml with a correlation between levels and ingested drug, consistent with our case. In our review of the literature MET levels of >200 mcg/mL were generally fatal. Although MALA is commonly associated with decreased kidney function, this case illustrates that massive MET ingestion can cause MALA independent of other risk factors including presence of kidney disease. In conclusion, we report a case of MALA with a substantial ingestion burden and arguably one of the highest reported levels of metformin who survived after early and prolonged hemodialysis.

## SA-PO500

**Continues Renal Replacement Therapy as a Cause of Euglycemic Diabetic Ketoacidosis**

Hisham N. Abu Farsak, Purnima Kabir, Saba Salem. *Hamilton Medical Center, Dalton, GA.*

**Introduction:** Ketoacidosis occurs when absolute or relative insulin deficiency inhibits the ability of glucose to enter cells for utilization as metabolic fuel, the result being that the liver rapidly breaks down fat into ketones to employ as a fuel source. The overproduction of ketones ensues, causing them to accumulate in the blood and urine and turn the blood acidic. Ketoacidosis is not commonly recognized as a cause for anion gap metabolic acidosis in patients who are on continuous renal replacement therapy (CRRT). We present a case for a patient with acute kidney injury who developed euglycemic diabetic ketoacidosis (EDKA) on CRRT.

**Case Description:** A 78 year-old Caucasian female patient with past medical history significant for diabetes mellitus type 2, chronic kidney disease stage 3, and dementia, who was admitted to the ICU for altered mental status secondary to septic shock presumed secondary to urinary tract infection. Patient was intubated for airway protection. She became hypotensive after intubation and required vasopressors continuously. Patient started to develop oliguric acute kidney injury which required CRRT initiation for hyperkalemia and volume removal after 5 days of her hospitalization. Three days after starting CRRT, her serum bicarbonate level was 14 mEq/L, her anion gap worsened to 22 mEq/L. Her lactate level was normal. Her blood glucose levels were 100-220 mg/dL since admission. Uremia was unlikely with normal serum urea and close-to-normal creatinine while on CRRT. She was not on any drugs known to cause metabolic acidosis. Ketoacidosis was suspected and confirmed by high serum b-hydroxybutyrate level. She was started on glucose and insulin infusions. After 24 hours, her bicarbonate improved to 26 mEq/L, with a significant decrease in b-hydroxybutyrate level.

**Discussion:** EDKA is diagnosed in patients with normoglycemia, wide anion gap metabolic acidosis, and ketonemia. CRRT theoretically may be complicated with EDKA because of potentially compromised caloric intake and increased metabolic demands and stress from underlying critical illness, which may lead to a decrease in endogenous insulin production and a simultaneous increase in glucagon levels, which subsequently leads to lipolysis and ketogenesis. CRRT is an under-recognized etiology of euglycemic DKA which requires early recognition and treatment to avoid catastrophic outcomes.

## SA-PO501

**Persistent Euglycemic Ketoacidosis During Continuous Renal Replacement Therapy Despite IV Insulin Infusion**

Oyintayo Ajiboye,<sup>1</sup> Pooja D. Amarapurkar,<sup>1,2</sup> Michael J. Connor.<sup>1,2</sup> *Emory University School of Medicine, Atlanta, GA; <sup>2</sup>Grady Memorial Hospital, Atlanta, GA.*

**Introduction:** Euglycemic diabetic ketoacidosis (DKA) is an uncommon, known complication of continuous renal replacement therapy (CRRT) when using dextrose-free CRRT solutions with insulin-dependent diabetics at higher risk. Typically, CRRT-related euglycemic DKA resolves with increased insulin & dextrose exposure. Here we describe a case of euglycemic DKA which did not resolve with insulin administration & only improved after stopping CRRT.

**Case Description:** 73-year-old female with CKD 3aA1, insulin-dependent diabetes, & lung adenocarcinoma admitted for septic shock from empyema & post-obstructive pneumonia, respiratory failure, & anion-gap metabolic acidosis secondary to lactic acidosis & DKA with initial Beta-hydroxybutyrate (BHB) 1.7 mmol/L & glucose 727 mg/dl. She was placed on vasopressors, antibiotics, & an insulin infusion. However, she progressed to anuric acute kidney injury requiring CRRT using our standard phosphorus-containing, dextrose-free solution which improved the metabolic acidosis. Subsequently,

Key: TH - Thursday; FR - Friday; SA - Saturday; OR - Oral; PO - Poster; PUB - Publication Only

Underline represents presenting author.

developed recurrent anion-gap metabolic acidosis on CRRT day 3 & evaluation revealed recurrence of elevated BHB to 1.38 mmol/L which steadily increased to 5.9 mmol/L on CRRT day 6 despite increased insulin infusion & escalating exposure to IV & enteral dextrose with bicarbonate levels remaining 14-21 meq/L & glucose 142-229 mg/dl on insulin infusion at peak > 5 units/hour. CRRT was stopped on day 6 due to persistent euglycemic DKA with rapid normalization of serum bicarbonate & decrease BHB to 0.78 mmol/L over 12 hours.

**Discussion:** CRRT with dextrose-free solutions results in net glucose loss leading to lower serum glucose levels & decreased insulin requirements in ICU patients. In a patient with impaired endogenous insulin production, this decreased insulin exposure can precipitate ketogenesis leading to euglycemic DKA. In prior case descriptions & our local experience, CRRT-related euglycemic DKA typically resolves with increased insulin dose facilitated by a deliberate increase in exogenous dextrose sources. However, in this case, the DKA did not resolve despite a significant increase in hourly insulin dose & only improved with cessation CRRT. Clinicians should be cognizant of, and alert to, euglycemic DKA as a complication of dextrose-free CRRT solutions. CRRT cessation or change to dextrose-containing solutions may be required when conservative management fails.

## SA-PO502

### A Case of Severe Alcoholic Ketoacidosis and Hyperlactatemia

Benjamin Wooden, Raphael J. Rosen, Woojin Ahn. *Columbia University Irving Medical Center, New York, NY.*

**Introduction:** Alcoholic ketoacidosis is a cause of metabolic acidosis in patients with heavy alcohol use and poor nutrition. We report a case of alcoholic ketoacidosis notable for severe acidemia and hyperlactatemia, which resolved with dextrose administration.

**Case Description:** A 37 year-old woman with alcohol use disorder presented with abdominal pain in the setting of 1 week of heavy alcohol use. She was tachycardic but normotensive. Mental status was normal. Labs showed serum bicarbonate <6 mmol/L and an anion gap of >52. Blood gas revealed pH 6.85 and pCO<sub>2</sub> 18 mm Hg. Venous lactate was 16 mmol/L. She was dosed 25 mEq IV bicarbonate, and subsequent blood gas showed pH 7.05 and pCO<sub>2</sub> 16. Ethanol level was 79 mg/dL, beta-hydroxybutyrate 8.47 mmol/L, AST 253, ALT 54, total bilirubin 0.8, INR 1.1, and serum osmolality 336 mOsm/kg. Calculated osmolality was 301, indicating an osmolal gap of 35. The patient denied ingesting any substances apart from store-bought whiskey. She admitted to poor food intake. She was treated with thiamine and a dextrose infusion, without further bicarbonate. Within 3 hours, her serum bicarbonate increased to 9 mmol/L, and rose to 23 mmol/L less than 18 hours after dextrose was initiated. The hyperlactatemia resolved as well, though it took 3 days to fully normalize. She was stable for discharge on hospital day 4.

**Discussion:** Alcoholic ketoacidosis is the result of disturbed metabolism that occurs with heavy alcohol use and malnutrition. Notable features include a relatively normal mental status (vs. diabetic ketoacidosis of similar metabolic severity), and typically prominent GI symptoms including nausea and pain. Labs show anion gap metabolic acidosis and elevated serum ketones. Serum osmolality is elevated due to accumulation of ketones and ethanol. Lactate elevation can occur (due to NADH accumulation favoring conversion of pyruvate to lactate), but is typically not severe. In our patient, she had a severe hyperlactatemia for which no alternative cause was found, illustrating that alcoholic ketoacidosis should be kept on the differential in alcohol-using patients with anion gap metabolic acidosis and osmolar gap, even in the setting of marked hyperlactatemia. Preserved mental status and normotension, despite severe acidemia, may be clues to the diagnosis. Dextrose administration (with thiamine to protect against Wernicke encephalopathy) can rapidly reverse the acidosis.

## SA-PO503

### Transient Vision Loss From Alcohol Associated Lactic Acidosis

Muhammad A. Monk, Jordan Torres, Krina Viroliya, Ndifreke Ekpa, Junaid M. Alam, Sowmya Puthalappattu. *HCA Houston Kingwood/University of Houston, Kingwood, TX.*

**Introduction:** Lactic Acidosis is a common finding in critically ill patients and can cause a variety of complications. We present a case of reversible blindness caused by ethanol induced lactic acidosis

**Case Description:** A 53-year-old male with PMH of hypertension, type 2 Diabetes, and alcohol abuse presented with acute binocular vision loss, altered mental status, facial droop, and slurred speech. He reported heavy ethanol use and denied any toxic ingestion. The patient had a blood pressure of 206/96 mmHg and respiratory rate of 40/min. Labs were notable for CO<sub>2</sub> of <5, K of 6.1, glucose of 123, lactate of 9.5, and BUN/Creatinine of 73/5.2. ABG showed pH of 6.66, and anion gap of 27. Osmolar gap was found to be 35.5, serum alcohol was 19, and testing for ketones, salicylates, methanol, and ethylene glycol was negative. The patient received TPA, and an IV nicardipine drip was started in the ICU. Vision was restored after receiving IV sodium bicarbonate, and hemodialysis took place 24 hours post TPA. MRI showed small right middle frontal gyrus infarct. Symptoms improved over time, and patient was discharged without residual deficits after removal of dialysis catheter on day 12

**Discussion:** Metabolic Acidosis is known to cause vision loss, and is commonly associated with organic alcohol ingestion. Several cases involving metformin associated lactic acidosis and alcoholic/diabetic ketoacidosis presenting with reversible blindness have also been reported. It is hypothesized that retinal horizontal cells are disrupted in response to severe acidemia. Ethanol use can cause Type B lactic acidosis by altering the NADH/NAD ratio in the liver and increasing metabolism of pyruvate to lactate. Lactic acidosis is a likely cause in this case given that our patient had a history of alcohol abuse and presented with high anion and osmolar gaps, elevated lactate and alcohol, and

negative ketone and organic alcohol levels Though our patient had a frontal stroke on MRI, those are not usually associated with vision loss. Other considered causes include amaurosis fugax, PRES, and hypertensive emergency, though based on negative MRI, and symptom resolution after acid/base correction, lactic acidosis was deemed to be a likely cause Although rare, severe acidosis should be ruled out in cases of acute blindness, and correction of acidosis should take place while investigating other causes

## SA-PO504

### Post-Operative Severe Hypercalcemia: A Tale of Two Patients

Amer A. Belal, Sanaa Badour, Joel O. Adewuyi, Amir Kazory. *University of Florida College of Medicine, Gainesville, FL.*

**Introduction:** Calcium sulfate beads are increasingly used as a means for delivery of local antibiotics in periprosthetic joint infections. Hypercalcemia is an emerging complication after placement of the beads that is poorly characterized. Certain subset of patients (e.g. those with chronic kidney disease [CKD]) seem to be particularly susceptible and need to be risk stratified prior to surgery.

**Case Description:** A 72-year-old woman with a medical history significant for CKD and metastatic papillary thyroid cancer to the right femur was admitted for second revision of right total hip arthroplasty. Her serum calcium (Ca) was noted to rise rapidly from 9.1 mg/dL preoperatively to 11.1 mg/dL on postoperative day (POD) 3. She underwent workup for causes of hypercalcemia with PTH that was appropriately suppressed at 4 pg/mL, ionized Ca elevated at 2.0 mmol/L, VitD(25)OH within normal range at 30.65 ng/mL as was VitD(1,25)OH at 25.3 pg/mL. PTHrP was unremarkable at 4 pmol/L, as was Angiotensin Converting Enzyme at 80 U/L. Labs were inconsistent with multiple myeloma. Her serum creatinine (Cr) remained relatively stable at 4 mg/dL during this time. Further investigation revealed that she had insertion of calcium sulfate beads during surgery. Her Ca continued to rise and peaked on POD 7 at 15.8 mg/dL despite medical management including aggressive hydration with 150-200 cc/hour of normal saline, 8 doses of calcitonin, as well as pamidronate on POD 5. Only after 23 days, did her Ca return to a normal level below 10 mg/dL. Contrast this with the case of a 77-year-old woman with normal renal function (Cr 0.7 mg/dL) that was admitted due to prosthetic joint infection of the knee, also with intraoperative placement of calcium sulfate antibiotic eluting beads. Her serum Ca preoperatively was 8.3 mg/dL and rose to 14.1 mg/dL on POD 2, but responded to conventional medical therapy with steady decline and return to normal range of less than 10 mg/dL within 7 days.

**Discussion:** These two cases serve to raise awareness regarding post-operative hypercalcemia that can result from calcium sulfate beads used for local antibiotic therapy. Of note, in patients with advanced CKD, hypercalcemia can be prolonged despite appropriate medical therapy leading to increased morbidity. With increasing use of calcium-eluting beads, we propose that this point needs to be included in pre-operative risk stratification

## SA-PO505

### Paracoccidioides brasiliensis Infection, a Tropical Disease Causing Severe Hypercalcemia and AKI: A Case Report

Renan G. Diniz, Lucia Andrade, Luciana G. Lutf, Fernando L. Strufaldi. *Universidade de Sao Paulo Hospital das Clinicas, Sao Paulo, Brazil.*

**Introduction:** Paracoccidioidomycosis is a systemic fungal disease that is prevalent in Brazil. Although it can affect multiple organs, the renal and electrolytic effects are not well known.

**Case Description:** A 30-year-old man from an urban area of the state of São Paulo presented with disseminated papular and nodular skin lesions, some with fistulation and purulent discharge, together with lymph node enlargement, right hypochondrium pain, fever, night sweats, anorexia and weight loss (25 kg). Direct microscopic analysis of the lesions revealed fungal yeast consistent with *Paracoccidioides brasiliensis*. The patient showed normocytic, normochromic anemia (hemoglobin 7.7 mg/dL) and the following: urea 55 mg/dL; creatinine 1.43 mg/dL; sodium 134 mEq/L; potassium 4.2 mEq/L; total calcium (TCa) 12.6 mg/dL; ionic calcium (iCa) 7.3 mg/dL; phosphorus 3.2 mg/dL; parathyroid hormone <6 pg/mL; 25-hydroxy-vitamin D 17 ng/mL; and alkaline phosphatase 596 U/L. Bilirubin, TSH and urinalysis were all normal. Serology for viruses, syphilis and toxoplasmosis were all negative. His 1,25-dihydroxyvitamin D was elevated (94 ng/dL). A CT scan showed no bone lesions. He received intravenous pamidronate 60 mg and saline infusion. Amphotericin B deoxycholate was prescribed but later switched to amphotericin B lipid complex because the clinical profile had improved. On postadmission day 20, creatinine was 0.77 mg/dL, iCa was 5.82 mg/dL and TCa was 10.2 mg/dL. He was discharged on day 49 with significant improvement of the skin lesions, creatinine of 0.7 mg/dL, iCa of 5.03 mg/dL and TCa of 9.4 mg/dL.

**Discussion:** We suggest that the hypercalcemia was associated with endogenous release of 1,25-dihydroxyvitamin D from paracoccidioidomycosis lesions. To our knowledge, this is only the third reported case of paracoccidioidomycosis accompanied by hypercalcemia and the only one in which the patient had a high 1,25-dihydroxyvitamin D level. Although a wide spectrum of neglected tropical diseases are still under investigation, we cannot neglect new findings in this field, given the complexity and peculiarities of this group of diseases. Such findings can allow earlier diagnosis, new discoveries and better treatments.

## SA-PO506

**Chronic Hypercalcemia Secondary to Granulomatous Formation After Buttock Augmentation: Case Report**

Christopher A. Dorizas, Brianna Conte, Anushka Chadha, Desiree Garcia Anton. *University of Miami School of Medicine, Miami, FL.*

**Introduction:** Hypercalcemia is a medical condition often encountered in the clinical setting. While common causes of hypercalcemia include hyperparathyroidism, malignancies, and medications, granulomatous-mediated hypercalcemia from previous cosmetic silicon injections is a rare cause that should be considered.

**Case Description:** A 65-year-old female with hypertension, diabetes mellitus type 2, and recent diagnosis of hypercalcemia of unknown etiology presented to the ED after a syncopal episode from symptomatic hypercalcemia. Vital signs were stable. Physical exam was remarkable for altered mental status. Initial labs showed calcium 17.8 mg/dL, ionized 1.74 mmol/L, normal albumin, PTH 12.8 pg/mL, BUN 46 mg/dL and Cr 2.66 mg/dL, with unknown baseline. Renal ultrasound showed echogenic parenchyma. Intravenous fluids and calcitonin 4 units/kg BID were initiated. PTHrP was negative ( $< 2$  pmol/L) and vitamin D 1,25 dihydroxy was at the upper limit of normal (71.8 nG/mL). Additional workup for sarcoidosis, lymphoma, thyrotoxicosis, and multiple myeloma was unrevealing. The patient noted a history of gluteal silicone injections 10 years ago. PET scan (low level FDG uptake in the subcutaneous tissues of the gluteal regions and proximal thigh) and inguinal lymph node biopsy (granulomatous lymphadenitis) confirmed granulomatous-mediated hypercalcemia. Surgical intervention was not recommended given dissemination. Zoledronic acid 4 mg IV was added along with prednisone 20 mg with taper and Hydroxychloroquine (HCQ) 200 mg daily. Calcium improved to 9.9 mg/dL and creatinine to 1.9 mg/dL.

**Discussion:** Hypercalcemia secondary to cosmetic silicone injections is a rare entity, only about two dozen cases have been reported in the literature. Unfortunately, no definitive therapies exist for this calcitriol-mediated hypercalcemia. Additionally, it carries a significant morbidity burden including lifelong side effects, chronic steroid exposure and development of CKD. HCQ could be a potential treatment option to lower the steroid burden. Awareness must be raised about this disease and clinicians should consider it as a cause of hypercalcemia, especially in an era of increasingly frequent cosmetic procedures.

## SA-PO507

**Hypercalcemia, It's Not Always Cancer: Unique Case of Sarcoidosis Presenting as a Testicular Mass**

Azkaa Zaman, Navkiran Randhawa, Suraj Marwaha, Norhan Elsayed, Ramier J. Lehne, Mohammad H. Wadud, Sunil Patel, James J. Siegert, April Brill, Tauseef A. Sarguroh. *Franciscan Health Inc, Mishawaka, IN.*

**Introduction:** Sarcoidosis is a multi-system disease typically seen in young adults with a prevalence of about 50 to 160 per 100,000 population worldwide. The disease pathology is thought to involve the accumulation of T lymphocytes, mononuclear phagocytes and noncaseating granulomas in the lungs, eyes, skin and lymph nodes. We report a unique case of systemic sarcoidosis in a patient with severe hypercalcemia, acute renal failure and a testicular mass.

**Case Description:** A 44 year old male with history of Hypertension, Type 2 Diabetes, Obesity presented with a painless left testicular mass and 70 pound weight loss over five months. On admission he was noted to have a serum creatinine of 4.6 mg/dL, serum calcium of 17.2 mg/dL with appropriately suppressed intact PTH of 7 pg/mL and an elevated vitamin D 1,25-dihydroxy of 80.2 pg/mL. A kidney biopsy showed acute tubular necrosis with no immune complex deposition or paraprotein mediated disease. CT chest, abdomen and pelvis revealed several bilateral pulmonary nodules and diffuse lymphadenopathy including mediastinal, periaortic and bilateral inguinal chains. A scrotal ultrasound revealed a solid calcified mass lateral to the left testis. Urology performed a left inguino femoral lymph node dissection and a left partial orchiectomy. Frozen section was negative for malignancy and final pathology showed granulomatous lymphadenitis consistent with sarcoidosis. The patient was treated medically for hypercalcemia and discharged on oral corticosteroids.

**Discussion:** Typically, sarcoidosis presents with pulmonary symptoms. This is a rare presentation of severe hypercalcemia in a patient with a testicular mass which emphasizes that physicians should be aware of extrapulmonary manifestations of sarcoidosis when evaluating a patient presenting with hypercalcemia and renal failure.

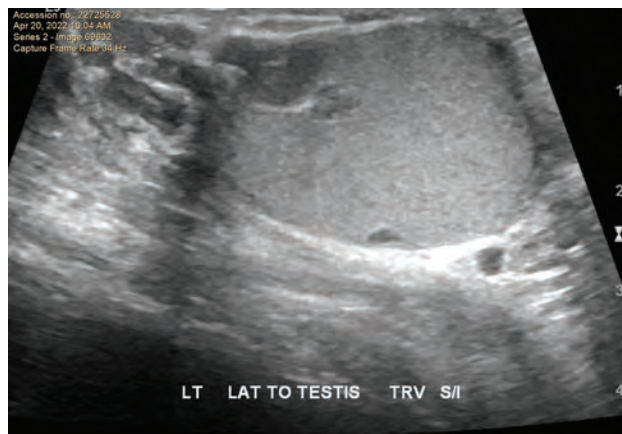

Calcified mass superior to left testis on ultrasound

## SA-PO508

**Bad to the Bone: Refractory Hypercalcemia due to Limited Bone Marrow Sarcoidosis**

Kaushika Kondragunta, Erin Townsley, Phillip Madonia, Uday Vemulapalli. *Brookwood Baptist Health, Birmingham, AL.*

**Introduction:** Sarcoidosis limited to the bone marrow is a rare diagnosis.

**Case Description:** A 69 y.o. white woman with history of osteoporosis, chronic kidney disease stage 3, silicone breast implants presented with nausea, vomiting, and malaise. Vital signs on admission were stable. Labs were significant for an albumin of 3.3 g/dL, calcium of 14.1 mg/dL (corrected to 14.7mg/dL). She had two prior hospitalizations for volume depletion, with hypercalcemia to a level of 12-13mg/dL, and acute kidney injury which rapidly corrected with IV fluids. However, the recurrence of severe hypercalcemia necessitated further investigation. On admission, parathyroid hormone (PTH) was 55 pg/mL, PTH-related protein was 22 pg/mL, so PTH mediated hypercalcemia was unlikely. Vitamin D 25 level was 35 pg/mL, and angiotensin converting enzyme (ACE) levels were  $< 5$ . Urine calcium was not low. Serum cortisol was normal. Mildly elevated vitamin D1,25 at a level of 81 pg/mL was noted. Differential diagnoses included sarcoidosis, multiple myeloma, foreign body granuloma and infectious granulomatosis. Skeletal survey showed no bony lesions. Myeloma panel showed an M spike of 0.5g/dL, immunofixation with IgM lambda, elevation of kappa/lambda light chains 5.12, and 9.19 mg/dl respectively, but total IgM kappa/lambda ratio was normal. A normal PET scan ruled out a silicone granuloma associated with her breast implants. Sarcoidosis was the final diagnosis considered. A bone marrow biopsy was performed, which was negative for polyclonal cells, malignancies, acid fast bacteria, and fungi. It showed scattered deep-seated non caseating granulomas consistent with sarcoidosis. She had complete resolution of hypercalcemia with 60 mg prednisone, tapered over 3 months.

**Discussion:** Diagnosing sarcoidosis from only hypercalcemia and elevated vitamin1,25 D without any other findings on imaging made this diagnosis clinically challenging. The step wise approach to rule out other etiologies led to a bone marrow biopsy, confirming the diagnosis. Chest X-ray and ACE levels are often used to screen for sarcoidosis, but are not very sensitive. Physicians should consider a bone marrow biopsy when there is high suspicion for granulomatous hypercalcemia. The tissue would need to be evaluated for infectious, hematologic, allergic, and other auto immune disorders causing granulomatous lesions.

## SA-PO509

**A Rare Case of Calcium Tartrate Nephrolithiasis**

Madeline S. Chung, Amy Yau. *The Ohio State University Wexner Medical Center, Columbus, OH.*

**Introduction:** Calcium tartrate tetrahydrate nephrolithiasis is rare with only a handful of cases noted in the literature. Initially reported in rats with a high tartrate diet, the stone spectra was later identified in 6% of previously unidentified human kidney stones with a general incidence of 0.007%.

**Case Description:** We present a 39-year-old woman with no significant past medical history who presented with flank pain due to a 5 mm distal left ureteral stone at the ureterovesical junction. She underwent uncomplicated ureteroscopy with basket stone extraction with removal of two kidney stones (2mm and 5mm in diameter). Stone analysis was significant for 50% calcium tartrate tetrahydrate, 30% calcium oxalate monohydrate, and 20% calcium phosphate. Metabolic evaluation was unremarkable with normal 25-OH vitamin D, intact parathyroid hormone, and calcium levels. 24-hour urine samples were significant for low urine volume and hypercalciuria (Table 1). She had no previous history of kidney stones. Upon further questioning, she admitted to consuming 1-2 scoops of Spark energy drink mix daily for the past 5 years. Each scoop of this drink mix contains 10mg of L-carnitine as tartrate and 500mg of choline as bitartrate and citrate. She denied any other supplements nor high consumption of tartrate-containing substances such as wine or free baking powder. She was encouraged to avoid AdvoCare Spark, increase her fluid intake and re-assess hypercalciuria in 6 months.

**Discussion:** This is the fourth reported case of a calcium tartrate tetrahydrate stone with an associated history. The first was a patient in Africa with unknown history. Later retrospective analysis of the Mayo Clinic database revealed 35 stones consistent with calcium tartrate tetrahydrate in 27 unique patients, but only three had available history. All three also consumed AdvoCare Spark energy drink mix regularly. We believe that excessive tartrate intake via the Spark Energy Drink mix is what precipitated the kidney stone in our patient. Her case is a cautious reminder to obtain a full social and dietary history in patients with unknown or rare stone profile and those with or recurrent stones despite appropriate risk factor modification.

Table 1

Date	Vol 24	Ca 24	Ox 24	Cr 24	pH	UA 24	Na 24	Mg 24
11/30/21	2.00	452	16	646	5.638	0.580	149	115
12/1/21	1.76	373	23	794	5.889	0.648	140	101
Ref Range	0.5-4L	<200 mg	20-40 mg	>50 mg	5.8-6.2	<0.750 g	50-150 mmol	30-120 mg

## SA-PO510

### A Case of Hypercalcemia Exacerbated by Ectopic 1,25(OH)<sub>2</sub>D Expressed in Post-Transplant Lymphoproliferative Disorder (PTLD) 13 Years After Kidney Transplantation

**Kazumi Kozuka**, Yosuke Nakagawa, Konomi Isozumi, Masahiro Koizumi, Hiroataka Komaba, Takehiko Wada, Masafumi Fukagawa. *Tokai Daigaku Igakubu Jin Naibunpi Taisha Naika, Isehara, Japan.*

**Introduction:** Post-transplant lymphoproliferative disorder (PTLD) develops in 1-3% of kidney transplant recipients. Paraneoplastic hypercalcemia is frequently seen in patients with malignant lymphoma, but is rarely seen in patients with PTLD. Here, we report a case of PTLD presenting with progressive hypercalcemia associated with ectopic calcitriol synthesis at 13 years following deceased donor kidney transplantation.

**Case Description:** A 59-year-old man was admitted to our hospital with a 6-week history of generalized weakness, appetite loss, and extremities edema. He had been on hemodialysis for 23 years and had received a deceased donor kidney transplant 13 years before presentation. He showed no evidence of rejection with immunosuppressants, and his serum creatinine persisted 1.5 to 1.6 mg/dL thereafter. He also had secondary hyperparathyroidism which was well controlled by oral calcimimetics. On examination, he showed severe pitting edema of extremities particularly in the left leg and swollen left knee joint. His serum calcium increased from 10.6 to 15.6 mg/dL for 6 weeks, with suppressed parathyroid hormone (PTH) level (58 pg/mL) and undetectable PTH-related peptide level. Further investigations revealed an increased 1,25(OH)<sub>2</sub>D level of 122 pg/mL (normal range 20-60). Analysis of the knee joint fluid showed atypical lymphocyte infiltration, and flow cytometry revealed a monoclonal lambda-restricted B-cell population, suggesting B cell lymphoma. He was treated with intravenous normal saline and subsequently with a dose of denosumab, but he developed severe acidemia with worsening kidney function and became hemodynamically unstable. Continuous hemodialysis was started on hospital day 2. He underwent R-CHOP treatment, but the lymphoma did not respond to the treatment, and he died on hospital day 6. Autopsy showed massive lymphoma infiltration in iliopsoas muscle, residual kidneys, large and small intestine, and the patient was finally diagnosed as diffuse large B-cell lymphoma. An increased level of 1,25(OH)<sub>2</sub>D suggested ectopic calcitriol synthesis in the lymphoma.

**Discussion:** PTLD should be considered as a differential diagnosis of unexplained hypercalcemia in kidney transplant recipients.

## SA-PO511

### Severe Hypercalcemia due to Hypervitaminosis D

**Kuldeep Lohano**, Sharma S. Prabhakar. *Texas Tech University Health Sciences Center, Lubbock, TX.*

**Introduction:** Hypercalcemia is not an uncommon clinical problem but hypervitaminosis D causing hypercalcemia is very uncommon. We are reporting a patient who presented with this unusual condition.

**Case Description:** A 71 year old frail Caucasian male, presented to ER secondary to a fall. The past medical history was significant for coronary heart disease, hypertension, CHF, COPD, rheumatoid arthritis (on prednisone), right femoral fracture and no history of CKD. A CT scan with contrast on admission revealed a left intertrochanteric fracture and multiple vertebral fractures. On admission, laboratory studies were remarkable for hypercalcemia (14.2 mg/dl), HB: 12.9 g, platelet count of 446k and IWBC count of 33k. Serum Cr was 0.9 mg/dl, albumin 3.9 g/dl, and, BUN: 39 mg/dl. On examination, patient was hypovolemic, confused, chronic RA changes in hands. Diagnostic work up was negative for Multiple myeloma and malignancy. Further interrogation revealed a history of high dose of vitamin D (10,000 IU daily) for a long period which correlated with a vitamin D level of 200 ng/ml and PTH of 16 pg/ml. He was started on IV fluids and calcitonin and furosemide. The hypercalcemia improved on 3rd day while renal function continued to worsen after second day (Scr 1.3 to 2.0 mg/dl) possibly due to contrast induced renal injury. Subsequent course in the hospital was notable for return of calcium levels to 9.5mg/dl and improving renal function on discharge.

**Discussion:** The purpose for reporting this case is two-fold. 1. Vitamin D is rare cause of hypercalcemia, often resulting from prolonged over consumption of vitamin D and calcium supplements without monitoring the serum levels. 2. Consequences of hypercalcemia include dehydration, risk of acute kidney injury, and increased risk of bone fracture. The cause of hypercalcemia in this patient initially was not obvious as hyperparathyroidism, malignancy (multiple myeloma), hyper-thyroidism and adrenal insufficiency were excluded but finally it was narrowed down to hyper-vitaminosis D.

Initial hemoconcentration due to hypovolemia, was confirmed by normalization of many lab abnormalities after IV fluids. Hypercalcemia could be a contributory factor to AKI (caused by the radio-contrast) as well as to bone fracture by decreased bone turn over due to low PTH and cumulative steroid use. To conclude this case exemplifies how hypercalcemia can result from an usual cause and lead to multiple complications.

## SA-PO512

### Man of Steel: Calcitriol-Mediated Hypercalcemia From Subcutaneous Injection of Vitamin D3 in Sesame Oil

**Anushka Chadha**,<sup>1,2</sup> Efren Chavez.<sup>2,1</sup> *Jackson Memorial Hospital, Miami, FL;*  
<sup>2</sup>*University of Miami School of Medicine, Miami, FL.*

**Introduction:** Parathyroid hormone (PTH) independent hypercalcemia in young patients is rare. Differential diagnosis include malignancy, granulomatous diseases, adrenal insufficiency and drug-induced hypercalcemia. We report a case of a young athlete who developed calcitriol-mediated hypercalcemia due to granulomatous disease from oil-based subcutaneous (SQ) injections.

**Case Description:** A 31 year-old male, professional Jiu-jitsu player with no prior history, presented to the ED with worsening nausea, headaches, night sweats and weight loss over several weeks. He just completed a 3 month physician-supervised body building program, taking multiple drugs to increase strength and muscle mass- including daily oral danazol 100 mg, anastrozole 1 mg, DHEA 100 mg, clomiphene citrate 50 mg, bi-weekly intramuscular HCG 10,000 IU and weekly SQ injections of vitamin D3 in sesame oil 100,000 units/mL. On admission, vital signs were stable. Labs with elevated corrected calcium 12.4 mg/dL, ionized calcium 1.97 mmol/L, and acute kidney injury (AKI) with creatinine 4.2 mg/dL (baseline creatinine 0.95 mg/dL). He was initially treated with normal saline, calcitonin and zoledronic acid 3 mcg infusion. On further work up, he had low intact PTH 5.58 pg/mL, undetectable PTH related peptide but elevated 1,25 (OH)<sub>2</sub> Vitamin D 146 pg/mL. Screening for sarcoidosis, tuberculosis and fungal infections was negative. Imaging did not show masses, lymphadenopathy or organomegaly. However, a whole body FDG PET/CT scan had hypermetabolic uptake with skin thickening in the right thigh and anterior pelvic wall, corresponding to areas of administered SQ Vitamin D3. He was treated with oral prednisone, achieving and sustaining resolution of hypercalcemia and AKI.

**Discussion:** Hypercalcemia with suppressed PTH has been attributed to use of cosmetic body fillers- silicone and methyl methacrylate injections. Bodybuilders and athletes similarly use oil-based injections to augment muscle size. Biopsies from those areas demonstrate a foreign body reaction with granuloma formation and express 1 $\alpha$ -hydroxylase activity; this suggests hypercalcemia is due to increased calcitriol synthesis and intestinal calcium absorption. Our case demonstrates the dangers of abusing improper medications for body building and how providers should be vigilant to identify use of oil-based injections and its association with hypercalcemia

## SA-PO513

### A Not So Clear Case of Hypercalcemia

**Andrei Felipe S. Carvalho**, Shawn Alonso, Kara Alcegueire, Ahmed A. Waheed. *University of Miami Health System, Miami, FL.*

**Introduction:** Hypercalcemia is a frequent finding in clinical practice and is most commonly due to primary hyperparathyroidism or an underlying malignancy.<sup>1</sup> Therefore, it is generally recommended that the initial workup begin with determining whether the cause is either parathyroid hormone (PTH)-dependent or independent.<sup>1,2</sup> Although this approach is helpful in most cases, here we present a case where the cause is not quite so clear.

**Case Description:** A 67-year-old woman with a history of hypertension and chronic kidney disease stage 3a, presented with one week of abdominal pain and constipation. On arrival, her vitals were normal, and her exam was notable for mild abdominal tenderness. Initial labs revealed hypercalcemia with a calcium 12.6mg/dL, albumin 3.9g/dL, phosphorous 2.4mg/dL, hemoglobin 9.7g/dL and an elevated creatinine of 2.8mg/dL, with a baseline 1.8mg/dL. Serum PTH was elevated at 677pg/mL, and 25-OH vitamin D was low-normal at 31ng/mL. Imaging showed an 11mm parathyroid mass suspicious for an adenoma, which was presumed to be the cause of the hypercalcemia. However, despite adequate intravenous fluids, the patient's kidney function did not improve as expected, which in addition to the patient's age and the anemia, prompted further workup. The patient was then found to have an IgG-kappa monoclonal gammopathy, which led to a bone marrow biopsy revealing 20% plasma cells. The patient was diagnosed with multiple myeloma.

**Discussion:** Although the hypercalcemia was likely driven by the parathyroid adenoma given the degree of PTH elevation, we suspect that the multiple myeloma was also likely contributing. Interestingly, although the exact mechanism remains unknown, there are numerous case reports, dating back decades, and even a small prospective study describing an association between monoclonal gammopathies, including multiple myeloma, and primary hyperparathyroidism.<sup>3,4,5</sup> Given the prevalence of reported cases, some authors suggest ruling out a coexisting monoclonal gammopathy at the time of diagnosis of primary hyperparathyroidism, particularly in the elderly and those with difficult to control hypercalcemia.<sup>5,6,7</sup> As seen in this case, had it not been for the additional lab abnormalities the diagnosis of myeloma would have likely been delayed. Thus, this case gives us an opportunity to highlight a clinically important association between primary hyperparathyroidism and monoclonal gammopathies.

## SA-PO514

**Hypercalcemia: A Harbinger of Recovery From Rhabdomyolysis?**

Dawn Maldonado, Joseph Guadalupe, Temi-Ete I. Ediale, Cora O. Ogbolu, Maritza Brown, Aaron S. Stern. *Mount Sinai Health System, New York, NY.*

**Introduction:** Hypercalcemia occasionally develops following renal recovery from rhabdomyolysis. We describe a case of hypercalcemia developing just prior to renal recovery. This case suggests that not only can hypercalcemia develop after rhabdomyolysis, but that it can sometimes be a sign of imminent recovery.

**Case Description:** We present a case of a 65-year-old man with a past medical history of hepatitis C who was brought to the emergency department after prolonged cold exposure. He was hypothermic at 30.4 Celsius and had frostbite of multiple digits. Laboratory results were significant for a markedly elevated serum creatine kinase level >22,000 units/L and serum creatinine 4 mg/dL with unknown baseline. He did not respond to aggressive fluid resuscitation; hence dialysis was initiated. Corrected serum calcium was 5.8 mEq/L on hospital day 2, and remained low until it started to rise beyond normal levels on hospital day 28, peaking at 14.4 meq/L on hospital day 41 (table 1). Therapy was initiated with calcitonin and lower calcium dialysate. On hospital day 43 he began making urine, so dialysis was held. Hypercalcemia work-up revealed parathyroid hormone 9.9 pg/mL, vitamin D-25 9 ng/mL, vitamin D1-25 <5 ng/mL, fractional excretion of calcium 0.05, parathyroid-related hormone <2 pg/mL, and alkaline phosphatase 79 U/L – thus ruling out more common causes of hypercalcemia. N-telopeptide/creatinine ratio was 54 (normal 0-62), which ruled out hypercalcemia of immobilization. These results led us to the conclusion that the hypercalcemia was due to recovery from rhabdomyolysis.

**Discussion:** Hypercalcemia can be seen in the setting of recovery from rhabdomyolysis. The mechanism remains unclear, but it is postulated that it is from mobilization of calcium deposits that are sequestered in damaged muscle tissue. We present a case where the patient started developing hypercalcemia shortly before other signs of kidney recovery. Our case suggests that hypercalcemia may at times be the first indication of renal recovery from rhabdomyolysis.



## SA-PO515

**Bones, Groans, and Thyroid Hormones: A Rare Case of Hyperthyroidism-Induced Hypercalcemic Crisis**

Neha Siddiqui,<sup>1</sup> Ram Sinha,<sup>1</sup> Jatinder Kohli.<sup>1,2</sup> <sup>1</sup>AtlantiCare Regional Medical Center, Atlantic City, NJ; <sup>2</sup>Shore Medical Center, Somers Point, NJ.

**Introduction:** Mild to moderate hypercalcemia can be seen in patients with hyperthyroidism, but serum calcium levels rarely exceed more than 12mg/dl. The mechanism of hyperthyroidism-induced hypercalcemia is not fully understood. However, it is proposed that an elevation in thyroid hormone can stimulate bone turnover and, therefore, cause an increase in serum and urine calcium levels with subsequent suppression of PTH levels.

**Case Description:** A 36-year-old male with a past medical history of IV drug use, hypertension, and untreated hyperthyroidism presented to the emergency department with increasing dyspnea, non-productive cough, dizziness, nausea and vomiting for three days. The patient also endorsed palpitations, hot flashes, and weight loss over the last few months. No known family history of thyroid disease, hypercalcemia, or malignancy. Physical examination was remarkable for tachycardia and tremors. His labs were significant for a corrected calcium of 12.2mg/dl and TSH <0.005. Serum creatinine was within normal limits. UDS was unremarkable, PTH was suppressed, the PTHrP was normal, vitamin D levels were low, and SPEP was unremarkable. The patient received a 2L fluid bolus in the emergency department and was started on maintenance IVF. Upon further investigation, the patient had T3 of >20, elevated free T4 >7.77, Thyroxine (T4) of 23.8, TSIG, and thyroid receptor antibody were positive. NM bone scan showed no osteolytic or osteoblastic lesions. The patient received calcitonin for two days while conducting hypercalcemia workup. The patient was on IV steroids for a brief period of time as treatment for possible thyroid storm. The patient was started on methimazole and propranolol, both of which were continued upon discharge. Serum calcium levels and symptoms responded to treatment.

**Discussion:** To the best of our knowledge, there are four reported cases of hyperthyroidism-induced hypercalcemic crises with a serum calcium level of 12mg/dl (3mmol/dl) or more. We present a case of a 36-year-old male with symptomatic hypercalcemia with a calcium level of 12.2 upon arrival. Although rare, hyperthyroidism should be considered a cause when all other etiologies of hypercalcemic crisis have been ruled out. Immediate volume expansion and treatment with anti-thyroid medications are the mainstay of management of hyperthyroidism-induced hypercalcemia.

## SA-PO516

**Hypercalcemic Crisis as a Presentation of Parathyroid Adenoma: An Atypical Clinical Case Study**

Alexandra Rosario Aulet, Yolanda I. Hidalgo-Hernandez. *Sistema de Salud Episcopal San Lucas, Ponce, Puerto Rico.*

**Introduction:** Hypercalcemia is a common electrolyte disturbance seen in both outpatient and inpatient setting. Normal calcium levels range between 8.6 -10.3mg/dL. Mechanism of hypercalcemia vary in association to the cause, from increase gastrointestinal absorption and bone resorption associated to hypervitaminosis D, to increased bone resorption with tubular reabsorption associated to hyperparathyroidism. Primary hyperparathyroidism and malignancy are the most common causes of hypercalcemia. Primary hyperparathyroidism levels usually elevated but less than 11mg/dL in more rare but severe cases >12mg/dL, levels >13mg/dL usually seen with malignancy and less commonly seen in primary hyperparathyroidism.

**Case Description:** Case of a 69 y/o female patient with a PMHx of alcohol use disorder, peptic ulcer disease, active smoker being work up as outpatient due to a thyroid nodule which presents to the ED due to disorientation, epigastric pain, constipation associated to 30lbs of unintentional weight loss that has been progressing over the last month. During evaluation patient found oriented x2, GCS 14/15, with unstable gait and benign abdominal examination. Laboratory work up noted for a severe hypercalcemia of 18.4md/dL. Symptoms were refractory to medical treatment with IVF and bisphosphonates requiring renal replacement therapy. Work up done reported primary hyperparathyroidism, which FNA biopsy confirmed parathyroid adenoma. ENT was consulted and left parathyroidectomy and left lobe hemithyroidectomy was performed.

**Discussion:** Parathyroid crisis is a rare presentation to a parathyroid adenoma. Seen in 1-2% patient with known primary hyperparathyroidism. Parathyroid crisis presents with severe hypercalcemia associated central nervous system dysfunction like changes in mental status, bone disease, nephrolithiasis, or severe abdominal pain. We want to bring awareness to the medical community about diagnosis and treatment since this could be a rare but fatal endocrinology emergency.

## SA-PO517

**Ogilvie Syndrome: Treatment of Hypokalemia With Amiloride Unmasked Hypercalcemia and Hyperparathyroidism**

Alexa Golbus, Natalie T. Freidin. *Medical University of South Carolina, Charleston, SC.*

**Introduction:** Colonic pseudo-obstruction, also called Ogilvie's syndrome, occurs due to impaired intestinal propulsion and is often caused by hypokalemia and some endocrine disorders such as hyperparathyroidism. Additionally, secretory diarrhea due to intestinal pseudo-obstruction can cause hypokalemia. Diuretics such as amiloride can be used to treat hypokalemia in this condition. Amiloride is used to decrease excretion of sodium without increasing reabsorption of calcium, however in our case, we believe that amiloride induced hypercalcemia by unmasking hyperparathyroidism.

**Case Description:** We present a 73-year-old female with a history of hypertension and parathyroid adenoma, presenting with colonic pseudo-obstruction and hypokalemia. She has refused decompression of her pseudo-obstruction. Given concern for Liddle's syndrome based on her chronic hypertension, low plasma aldosterone and renin, and hypokalemia, we treated her hypokalemia with amiloride. This caused hypercalcemia to 14.4 mg/dL and altered mental status. The amiloride was subsequently discontinued with improvement in her symptoms and her primary hyperparathyroidism was treated with cinacalcet.

**Discussion:** Amiloride inhibits sodium reabsorption at the ENaC channel (epithelial sodium channel) in the late distal convoluted tubule, which causes a decreased negative potential in the lumen, resulting in decreased potassium excretion and thus an increase in serum potassium. In our patient, however, this caused an increase in serum calcium. Amiloride is theorized to induce hypercalcemia by increasing calcium reabsorption in the late distal convoluted tubule and the connecting tubule. While the mechanism is not fully known, it is thought that diuretic induced cellular hyperpolarization results in an increased electrical gradient that favors calcium reabsorption. Although our patient's parathyroid hormone level was normal prior to treatment with amiloride, her PTH became elevated with treatment with amiloride. We believe that amiloride unmasked her hyperparathyroidism and induced hypercalcemia.

## SA-PO518

**Platinum Based Chemotherapy Related Hypomagnesemia Treated With Sodium Glucose Cotransporter 2 (SGLT2) Inhibitors in Non-Diabetic Cancer Patients**

Nour Hammad, Arash Rashidi. *University Hospitals, Cleveland, OH.*

**Introduction:** Platinum based chemotherapy, such as cisplatin and carboplatin, is known to cause hypomagnesemia by renal magnesium wasting. Sodium glucose co-transporter 2 (SGLT2) inhibitors are new class of type 2 diabetes drugs with growing popularity because of their renal and heart benefits beside their diabetes indication. This class of medications was found to elevate serum magnesium levels by 0.15-0.24 mg/dl in prior meta-analysis. We present three patients with refractory hypomagnesemia related to cisplatin/carboplatin who were treated with SGLT2 inhibitors with marked improvement in serum magnesium levels.

**Case Description:** Case 1: 75 year old female with history of stage 3C serous ovarian cancer status post debulking procedure and chemotherapy with docetaxol and carboplatin. She had multiple electrolyte abnormalities including hypokalemia and hypomagnesemia that partially improved after ostomy closure. She continued to have refractory hypomagnesemia treated with oral and intravenous magnesium. Case

Key: TH - Thursday; FR - Friday; SA - Saturday; OR - Oral; PO - Poster; PUB - Publication Only

Underline represents presenting author.

2 57 year old female with history of stage 3C endothelial ovarian cancer status post debulking procedure and chemotherapy with carboplatin and docetaxol. She developed hypomagnesemia requiring intravenous and oral magnesium replacements. Case 3: 57 year old male with T2N3M0 left supraglottic cancer treated with cisplatin, 5-fluorouracil, and pembrolizumab. He was noted to have hypokalemia and hypomagnesemia which was dependent on oral and intravenous magnesium. All three patients were later started on amiloride, however continued to be dependent on oral and intravenous magnesium despite increasing amiloride dose. They were later started on dapagliflozin and had normalization of serum magnesium off intravenous supplementation.

**Discussion:** Hypomagnesemia can occur at any time with platinum based chemotherapy and can last after discontinuation of the drug. Our patients developed refractory hypomagnesemia on oral and intravenous magnesium supplementation in addition to incremental doses of amiloride. Dapagliflozin was started and patient had improved magnesium level with discontinuation of intravenous supplementation.

### SA-PO519

#### The Dominant Cause of Cramping Muscles

Christina L. Blum, Maura A. Watson, Megha R. Joshi. *Walter Reed National Military Medical Center, Bethesda, MD.*

**Introduction:** Magnesium ( $Mg^{2+}$ ) is the second most abundant intracellular cation. The human body contains about 24g of  $Mg^{2+}$  with normal serum concentration 1.7-2.5mg/dL.  $Mg^{2+}$  influences neuromuscular excitability, mitochondrial function and cellular proliferation. Clinical hypomagnesemia (hypo $Mg^{2+}$ ) ranges from asymptomatic to cramping, seizures and death. Investigating the cause of hypo $Mg^{2+}$  assists prompt management and prevents life threatening complications.

**Case Description:** A 37 year-old male with no significant medical or family history was hospitalized in 2015 for fatigue, profound diarrhea and dehydration. Labs revealed hypo $Mg^{2+}$  and supplementation was started; an extensive workup did not reveal an etiology. He continued to have muscle fasciculation, fatigue, cramping and decreased stamina despite taking  $Mg^{2+}$  1064mg and two Phos-Nak packets twice daily (phos 8mmol/packet). Calcium was 8.9mg/dL, (alb 3.9g/dL),  $Mg^{2+}$  1.1mg/dL, phosphorous 3.1mg/dL, urine calcium <5mg/dL and  $Mg^{2+}$  8.2mg/dL with fractional excretion of Mg 13%. After a trial of amiloride 20mg daily; his  $Mg^{2+}$  remained 1.1mg/dL, potassium 3.5, and phos 2.9. He discontinued amiloride and resumed high dose  $Mg^{2+}$  supplements. Genetic testing revealed a pathogenic variant on gene *FXYD2* c.121G>A, p.Gly41Arg.

**Discussion:** Isolated dominant hypo $Mg^{2+}$ , *FXYD2* c.121G>A, p.Gly41Arg, an autosomal dominant Gitelman-like hypo $Mg^{2+}$ , is a rare genetic cause of hypo $Mg^{2+}$  affecting the subunit of  $Na^{+}-K^{+}-ATPase$  protein of the distal convoluted tubule. The  $\gamma$ -subunit is misrouted and the  $\alpha$ - and  $\beta$ -subunit of the  $Na^{+}-K^{+}-ATPase$  cannot form, resulting in reduction of  $Na^{+}-K^{+}-ATPase$  activity decreasing  $Mg^{2+}$  uptake and increasing renal  $Mg^{2+}$  losses. The average  $Mg^{2+}$  concentration with this mutation is of 1.142mg/dL (0.47mM). Incidence unknown. The gene was discovered in 2000 in 3 Dutch families (29 patients) who presented with tetany, muscle weakness, chondrocalcinosis, excessive thirst, polyuria and less commonly epilepsy, kidney failure, or arrhythmias. Treatment is  $Mg^{2+}$  supplementation. Genetic testing is an important tool for early diagnosis and prompt management. Ongoing research in hereditary hypo $Mg^{2+}$  is needed to further our understanding of *FXYD2* mutations. The views expressed are those of the authors and do not reflect the official policy of the Department of the Army/Navy/Air Force, the Department of Defense, or the United States government.

### SA-PO520

#### Rare Co-Existence of Osteogenesis Imperfecta and Familial Renal Phosphorus Wasting

Sidrah Abid, Krishnakumar D. Hongalgi, Kelly H. Beers. *Albany Medical Center, Albany, NY.*

**Introduction:** Osteogenesis imperfecta (OI) is a severe disease with a wide spectrum of presentations depending upon the genetic abnormality. Known as a pure collagen abnormality, co-existence with an electrolyte abnormality such as hypophosphatemia is rarely reported. It could be indicative of multiple genetic abnormalities and may have worsening effect on overall prognosis.

**Case Description:** Our patient is a 35-year-old female with past medical history of severe scoliosis, blue eyes, and OI diagnosed at birth. Patient was referred to nephrology office for low serum phosphorus level after extensive work up done by endocrinology was non-revealing. Urine dipstick was negative for glucose, protein, blood, ketones, and bilirubin. Renal panel was unremarkable except serum phosphorus level of 1.7 mg/dL. Remaining labs showed serum magnesium 2.2 mg/dL, intact parathyroid hormone 27 pg/ml (15-65pg/ml), thyroid stimulating hormone (TSH) 1.850 uIU/ml (0.450-4.5), 24-hour urine phosphorus 0.7gm/day, 24-hour urine calcium 26 mg/day, 24-hour urine creatinine 1.2g/day, urine dipstick was negative for glucose and proteins. Patient was started on calcitriol and oral phosphate supplements. In view of elevated urine phosphorus excretion in the setting of hypophosphatemia, genetic testing was obtained that reported a variant of *ALPL* gene and *SLC34A4* gene. The *ALPL* gene variant is associated with autosomal recessive and autosomal dominant hypophosphatemia. The *SLC34A3* gene variant is associated with autosomal recessive hereditary hypophosphatemic rickets with hypercalciuria. Hence, our patient was kept on oral phosphorus and calcitriol supplements with close monitoring of serum electrolytes.

**Discussion:** Osteogenesis imperfecta is a disease with severe clinical manifestations and while treatment options are only limited to symptomatic management, coexistence of another electrolyte abnormality further worsens the prognosis. These patients should undergo timely genetic counselling along with a multidisciplinary approach for management.

TEST	RESULT	Reference values
Fibroblast growth factor-23	102 RU/ml	< 180 RU/ml
ALPL gene	Heterozygous	
SLC34A3 gene	Heterozygous	
25-hydroxy vitamin D	29.0 ng/ml	30.0-100.0

### SA-PO521

#### Isolated Hypophosphatemia due to Renal Phosphorous Wasting in Association With ENPP1 Mutations

Jusong Choi, Gajapathiraju Chamarthi, Dayan Ojeda Damas. *University of Florida, Gainesville, FL.*

**Introduction:** Biallelic mutations in the ecto-nucleotide pyrophosphatase/phosphodiesterase 1 gene is known to cause generalized arterial calcification of infancy or autosomal-recessive hypophosphatemic rickets in humans. We report a case with renal phosphorous wasting syndrome with normal FGF-23 level in a patient with heterozygous variants on ENPP1 c.1798T>C.

**Case Description:** A 38-year-old Caucasian male with refractory bitemporal epilepsy diagnosed in 2012 and status post response neurostimulation implantation in 2020 was referred for evaluation of hypophosphatemia incidentally found during the periods of seizure activity... patient underwent workup for hypophosphatemia. 24 hours urine studies were conducted while the patient was on phosphorus supplement because of concerns of possible breakthrough seizures due to supplementation cessation. 24 hours urine study revealed phosphorus excretion was approximately 800mg per day, serum phosphorus at 2.61 mg/dL and serum creatinine at 1.22mg /dl with eGFR greater than 59 ml. His Fractional excretion of phosphate was greater than 10 percent on different occasions despite serum phosphorus being low at 2.5 while being on phosphorus supplements. Renal wasting was suspected and further work up was pursued. Pertinent labs include FGF 23 level of 27 pg/mL, PTH of 47 pg/ml, vitamin D 25-OH of 36.13 ng/mL, and 1,25-dihydroxy of 69 pg/mL. A genetic test was performed which revealed heterozygous variants on ENPP1 c.1798T>C but of uncertain significance as it has not been reported in literature. Interesting patient endorses some bone mineralization problems with daughter and is currently undergoing evaluation. His low phosphorus checked during the seizure activity was attributed to redistribution.

**Discussion:** Heterozygous mutations in the ENPP1 leading to hypophosphatemia, mildly increased FGF23 have been reported in the literature. The Genetic associations of ARHR2 is thought to enhance the activity or levels of FGF-23 which is the key phosphaturic hormone. Our patient's mutation sequence change replaces the neutral and polar tyrosine with the basic and polar histidine at codon 600 of the ENPP1 protein. This variant has not been reported in literatures of individuals affected with ENPP1-related conditions. Moreover, there are currently insufficient available evidence to determine the role of this variant in the disease.

### SA-PO522

#### Injury-Induced DNA Re-Replication Leads to Tubular Cell Polyploidization in FAN1-Deficient Kidneys

Merlin Airik, Amy B. Huynh, Rannar Airik. *University of Pittsburgh, Pittsburgh, PA.*

**Background:** Karyomegalic interstitial nephritis (KIN) is a biopsy-based diagnosis in which the nuclei of the kidney proximal tubule cells (PTECs) appear abnormally enlarged or karyomegalic. Nuclear enlargement in KIN results from increased chromosomal numbers due to a mitotic failure. However, the molecular mechanism responsible for polyploidization has not been identified. Here we show that karyomegaly is caused in *FAN1*-deficient kidney tubular cells by aberrant DNA re-replication induced by failed DNA repair in the preceding S-phase.

**Methods:** KIN was induced in *Fan1* KO kidneys by low dose cisplatin administration (5 weekly injections of 2 mg/kg). Histological analysis was performed using HE and PAS staining. RNA-seq analysis was performed on cisplatin-treated kidneys to identify molecular changes. *FAN1* KO human PTECs were used to monitor changes in cell cycle progression with FUCCI(SA) and FUCCI(CA) probes, and to perform biochemical studies with the p21 inhibitor UC2288.

**Results:** Chronic treatment with low dose cisplatin induced tubular karyomegaly (KIN) in *Fan1* KO kidneys but not in control mice. Marker analysis showed that the karyomegalic cells were arrested in G2. This finding was independently confirmed by RNAseq analysis, which revealed overrepresentation of G2/M checkpoint genes and upregulation of *Cdkn1a* in injured *Fan1* KO kidneys. Unexpectedly, the G2-arrested cells displayed increased DNA replication activity and upregulation of DNA replication licensing factors (RLFs) CDT1 and CDC6 in KIN. *In vitro* assays in PTECs showed that CDT1/CDC6 upregulation and stabilization was triggered by p21 accumulation in cells with DNA damage. Treatment with UC2288 abolished CDT1/CDC6 accumulation in *FAN1* KO PTECs and prevented their polyploidization. Cell cycle analysis with FUCCI probes revealed that karyomegaly leads to irreversible G2 cell cycle exit.

**Conclusions:** Our data show that karyomegaly arises in *FAN1*-deficient tubular epithelial cells through aberrant polyploidization due to DNA re-replication and coincides with p21 upregulation and G2 arrest. Inhibiting p21 blocks upregulation of RLFs and nuclear enlargement, suggesting that p21 may be a therapeutic target to mitigate KIN.

**Funding:** NIDDK Support

Key: TH - Thursday; FR - Friday; SA - Saturday; OR - Oral; PO - Poster; PUB - Publication Only

Underline represents presenting author.

## SA-PO523

**A Novel Pathogenic Mutation in Alström Syndrome Causing CKD**

Jordana Yahr,<sup>1</sup> Mohamed Hassanein,<sup>2</sup> Hernan Rincon-Choles,<sup>1</sup> <sup>1</sup>Cleveland Clinic, Cleveland, OH; <sup>2</sup>University of Mississippi Medical Center, Jackson, MS.

**Introduction:** Alström Syndrome is a rare progressive multi-system disorder caused by mutations in the *ALMS1* gene. It is inherited in an autosomal recessive fashion. It is estimated to occur in 1 of every 1,000,000 live births. The disease is characterized by visual defects (rod-cone dystrophy), sensorineural hearing loss, insulin resistance, cardiomyopathy, nonalcoholic fatty liver disease, and chronic kidney disease (CKD). We present a case of progressive kidney dysfunction in a patient with Alström syndrome due to a novel mutation in the *ALMS1* gene.

**Case Description:** A 21-year-old female patient was referred to the nephrology clinic for evaluation of CKD. Her medical history included obesity, developmental delay in childhood, precocious puberty at age 7, hearing loss, and vision impairment. Genetic testing for Alström syndrome was performed and showed a compound heterozygous finding of c.5166dupA and c.7126dupA in the *ALMS1* gene, both novel pathogenic mutations, resulting in a frameshift mutation with premature protein termination. She eventually developed CKD, hepatic steatosis, and type II diabetes mellitus, all consistent with Alström syndrome. Her brother demonstrated a similar clinical syndrome. Her CKD workup included normal complement levels, negative antinuclear antibody, negative viral hepatitis testing, urinalysis with intermittent microscopic hematuria, protein to creatinine ratio 0.4 g/g, albumin/creatinine ratio 204 mg/g, and structurally normal kidneys on ultrasound. Over the next 8 years, her CKD progressed to stage IIIb with a baseline creatinine of 2.0-2.4 mg/dL. She was treated with aggressive glucose and blood pressure control including an angiotensin receptor blocker and a sodium-glucose cotransporter-2 (SGLT2) inhibitor.

**Discussion:** Alström syndrome is a rare cause of CKD but should be considered in those presenting with consistent features. Kidney impairment is characterized by decreased glomerular filtration rate, microalbuminuria without overt proteinuria, interstitial fibrosis, glomerular hyalinosis, and tubular atrophy. Genetic testing has become the hallmark of diagnosis. We report a novel mutation in the *ALMS1* gene resulting in Alström syndrome. While no specific treatment exists, treatment should be targeted at organ specific complications of the disease.

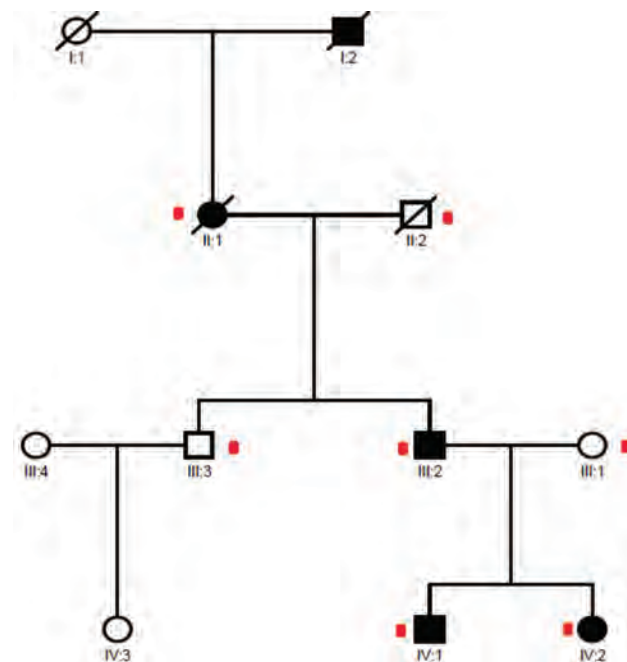

## SA-PO524

**Unusual Autosomal Dominant Transmission of NPHS2 Variant**

Edoardo La Porta, Gianluca Caridi, Andrea Angeletti, Francesca Lugani. IRCCS Istituto Giannina Gaslini Istituto Giannina Gaslini, Genova, Italy.

**Introduction:** *NPHS2* encodes for podocin, a protein necessary to the structure of the slit diaphragm. *NPHS2* variants are associated with autosomal recessive SRNS. C-terminal part of podocin is responsible for the protein oligomerization (DOI: 10.1007/s10157-016-1331-39) and heterozygous LoF variants of this region can lead to protein retention in the cell cytoplasm, causing a dominant-negative effect similar to the recessive condition. Two families with AD glomerulopathy and C-terminal LoF of the podocin have been described (Seidl, D. Nephrol Dial Transplant 2022 37:suppl3; MO044). We identified a family with a heterozygous frameshift variant of *NPHS2* on exon 8 segregating in all affected members tested.

**Case Description:** A 4 years old male was investigated for proteinuria. Family history underlined 4 generations of affected family members following an AD transmission. Father (III:2) was diagnosed with Minimal Change Disease at 15 years old, and he later developed end stage kidney disease (ESKD). Paternal grandmother (II:1) and great-grandfather (I:2) were affected by ESKD. We also found proteinuria in the sister; after few years she and her brother developed ESKD. We performed exome sequencing in III:1, III:2, IV:1, and IV:2 and we filtered a panel of 388 genes identifying a unique heterozygous variant segregating in all the affected members of *NPHS2* (NM\_014625:c.984del; p. Q328Hfs\*20). Sanger sequencing validated it and revealed the same variant in II:1, therefore it was absent in III:3.

**Discussion:** We presented a tree family supporting the AD transmission of *NPHS2*-related glomerulopathy due to a LoF at the -C terminal. This underlines the importance of the variant itself in the genetic counseling and should point out the necessity of a periodic pipeline revision of the molecular diagnosis of the kidney disease.

## SA-PO525

**Assessing the Allelic Spectrum and Pathogenicity of Novel Variants in NPHS2 in 238 Individuals With Steroid-Resistant Nephrotic Syndrome**

Camille H. Nicolas Frank, Florian Buerger, Nils D. Mertens, Shirlee Shril, Friedhelm Hildebrandt. Boston Children's Hospital, Boston, MA.

**Background:** Recessive variants in *NPHS2* are the second most frequent cause of steroid-resistant nephrotic syndrome (SRNS) and show a wide spectrum of age of onset. There is no well-established loss-of-function screening assay and clinical databases such as ClinVar are insufficient to determine the deleteriousness of newly detected *NPHS2* variants. It was suggested that *in silico* scores can substitute for the lack of high-throughput functional assays. In addition to homozygous variants, specific compound heterozygosity with the common variant R229Q has been described in Tory, Nat Genet 46:299, 2014. We tested the hypothesis, that R229Q variant is only pathogenic when combined with a compound heterozygote variant encoding for an amino acid in the C-terminal domain (residue 124-383).

**Methods:** We re-examined an international cohort of 2,300 individuals with SRNS in whom we had performed exome sequencing and multiplex PCR sequencing (Fluidigm) with a specific emphasis on likely-causative, homozygous missense and compound-heterozygous (in combination with R229Q) variants in *NPHS2*. We generated *in silico* scores (REVEL, EVE) for homozygous missenses *NPHS2* likely causative variants identified in this cohort.

**Results:** Likely causative *NPHS2* variants were identified in 238/2,300 individuals (10%). In 113/238 (47%) individuals, one among 27 different homozygous missense variants was detected. EVE and REVEL scores, calculated for the 27 variants, were plotted to the corresponding individual's median age of onset. Higher REVEL scores negatively correlated with median age of onset ( $p < 0.03$ ), whereas EVE scores did not ( $p = 0.23$ ). 37 out of 238 individuals (15%) with SRNS had a R229Q variant combined with one of 16 different likely causative variants as the alternative allele (in trans). 8 were previously published, whereas we identified 5 new missense variants, and 3 undescribed C-terminal truncating variants. Interestingly, all 16 mapped onto the C-terminal protein domain.

**Conclusions:** In *NPHS2*, we detected a correlation between REVEL deleteriousness score and age of SRNS onset. We confirmed that R229Q is only pathogenic when combined with a variant encoding for an amino acid in the C-terminal domain of podocin (residue 124-383).

**Funding:** NIDDK Support

## SA-PO526

**Late-Onset Schwannomatosis in Two Unrelated Patients With Peripheral Neuropathy and Focal Segmental Glomerulosclerosis due to INF2 Mutations**

Linh N. Tran,<sup>1</sup> Huong Quynh Tran Thuy,<sup>1</sup> Yoshinori Sato,<sup>2</sup> Hiroyasu Tsukaguchi,<sup>1</sup> <sup>1</sup>Kansai Ika Daigaku Fuzoku Hirakata Byoin, Hirakata, Japan; <sup>2</sup>Showa Daigaku Fujigaoka Byoin, Yokohama, Japan.

**Introduction:** INF2, a member of actin assembly factor formin, is implicated in fundamental biological processes, including maintenance of cell shape, polarity, and migration. Mutations in the extreme N-terminus of INF2 cause peripheral neuropathy of Charcot-Marie-Tooth (CMT) type, in addition to focal segmental glomerulosclerosis

Key: TH - Thursday; FR - Friday; SA - Saturday; OR - Oral; PO - Poster; PUB - Publication Only

Underline represents presenting author.

(FSGS). These two disorders are likely ascribed to progressive degeneration through actin dysregulation in podocytes and Schwann cells. Here we report two unrelated patients with CMT and FSGS due to *INF2* mutations manifested schwannomatosis in later clinical course.

**Case Description:** **Case 1** A 12-year female has a heterozygous *INF2* p.G73D variant and had difficulty in walking since childhood, first noticed proteinuria. She showed steppage gait with asymmetric atrophy and weakness in the lower limb muscles and hearing disability. *Pes cavus* deformity was surgically corrected at age 11. At age 14, she developed nephrotic syndrome diagnosed as FSGS. The renal disease was resistant to steroids and progressed into ESRD at age 16. At around age 30, she noticed multiple subcutaneous nodules. A spinal MRI revealed schwannomatosis in the caudal nerves. **Case 2** A 10-year boy has a heterozygous *INF2* p.V108D variant, first noticed walking disability, developed nephrotic syndrome with FSGS at age 14 and progression to ESRD at age 17. Since age around 20, he noticed subcutaneous nodules in his neck, spine, pelvic cavity, and left lower extremity. Biopsy of peroneal nerve revealed degeneration in large myelinated fibers with onion bulb formation. A spine MRI revealed schwannomatosis in the caudal nerves. Histology of biopsied cervical tumors at age 29 revealed schwannomas with a biphasic pattern of mixed hypercellular (Antoni A) and hypocellular (Antoni B) components.

**Discussion:** This report first demonstrated, to our knowledge, multi-focal schwannomatosis development of peripheral neurons in later course of two CMT/FSGS cases with the *INF2* mutations. Our observations shed a light on previously underrecognized, proliferative natures of *INF2* mutations, thereby broadening a phenotypic spectrum of CMT/FSGS mutation that typically leads to cell degeneration. Further study is necessary to clarify the cellular mechanisms by which the CMT/FSGS type *INF2* mutations could accelerate the proliferation in Schwann cells.

### SA-PO527

#### Challenges in Diagnosis of Mitochondrial Mutations in Patients With Diabetes and Kidney Disease: A Case Report

Sukhdeep S. Sahi, Sarwat Gilani, Alessia Buglioni, Marie C. Hogan, Lihong Bu, Aleksandra Kukla, Yogish C. Kudva. *Mayo Clinic Minnesota, Rochester, MN.*

**Introduction:** Determining etiology of diabetes may be challenging due to high genetic and phenotypic heterogeneity. Mitochondrial diseases, including “MELAS” (mitochondrial encephalopathy with lactic acidosis and stroke-like episodes) have been associated with maternally inherited diabetes, as well as deafness and kidney disease. We report a case of women diagnosed with mitochondrial disease later in life who initially presented with diabetes.

**Case Description:** A 46 yo woman developed gestational type 2 diabetes at age 30. Family history was positive for maternal diabetes. She was treated with insulin due to her poor tolerance to other anti-diabetic agents. Creatinine had gradually increased from 0.8 mg to 1.3 mg. She reported hearing loss 2 years prior to her diagnosis of mitochondrial disease. Lactate was checked due to the combination of diabetes and deafness and suspicion of mitochondrial etiology. Lactate was abnormal 3.7 mmol/ml (n 0.5-2.2 mmol/ml). There were no other clinical symptoms. Mitochondrial Full Genome Analysis by Next Generation Sequencing (NGS) identified m.3243A>G in MT-TL1 with a heteroplasmy level of 12%. Kidney biopsy showed diffuse mesangial expansion, focal segmental glomerulosclerosis with moderate foot process effacement, and mitochondriopathy with abnormal mitochondria of variable sizes and shapes (Fig), consistent with the dual diagnosis of mitochondrial and diabetic kidney disease. Heteroplasmy was evident in 75% of kidney cells.

**Discussion:** Our case highlights the challenges inherent in diagnosing mitochondrial diseases as the presenting symptoms may vary. Providers should consider mitochondrial etiology when, in addition to diabetes, other systemic symptoms are present. A multidisciplinary approach is necessary to establish diagnosis.

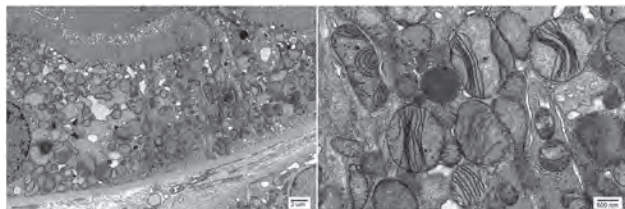

Figure legend: Native kidney biopsy electron microscopy findings of MT-TL1 associated mitochondriopathy, showing dysmorphic mitochondria in proximal tubular epithelial cells. Original magnification (a) x2500 and (b) x6000.

### SA-PO528

#### Autosomal Dominant Fanconi Syndrome and CKD Associated With Glycine Amidinotransferase Mutation: A Rare Genetic Syndrome

Ignacio A. Portales Castillo,<sup>1</sup> Patrick Hanna,<sup>1</sup> Andrew L. Lundquist,<sup>1</sup> Harald Jüppner,<sup>1</sup> Avi Traum,<sup>2</sup> Andrew S. Allegretti.<sup>1</sup> *<sup>1</sup>Massachusetts General Hospital, Boston, MA; <sup>2</sup>Boston Children's Hospital, Boston, MA.*

**Introduction:** Chronic kidney disease (CKD) secondary to monoallelic mutations in the gene *glycine amidinotransferase (GATM)* was reported in 2018, without subsequent patients published in the literature. We now present the case of a female with hereditary Fanconi syndrome, nephrolithiasis and mild CKD, found with a heterozygous *GATM* mutation.

**Case Description:** A 27 year-old female from Ecuador presented to the adult nephrology clinic for evaluation of renal tubular acidosis (RTA) and CKD. She was first seen at the pediatric nephrology clinic 10 years earlier for a non-anion gap metabolic acidosis (serum bicarbonate 19 mmol/L) and nephrolithiasis. Work-up at that time revealed CKD stage 2 (GFR of ~60 mL/min), hypokalemia at 3.3 mEq/L and low-normal serum phosphate at ~3.5 mg/dl. Urine pH was 7 with glucosuria, amino aciduria, moderately increased phosphate (FePO<sub>4</sub> 27%) and calcium excretion (300 mg calcium/24 hours). At the time, potassium citrate was prescribed for suspected type 2 RTA. During our evaluation at the adult nephrology clinic, serum and urine parameters remained unchanged, except for worsening hypophosphatemia (2.2 mg/dL) with normal 1,25(OH)<sub>2</sub> vitamin D of 44 pg/mL and PTH 28 pg/mL. Her family history was notable for a younger sister with RTA and her father with ESRD at age 30. She was referred to the Massachusetts General Hospital Renal Genetics Clinic with a diagnosis of hereditary Fanconi syndrome. Genetic testing revealed a heterozygous variant of uncertain significance (VUS) in the *GATM* gene (Pro341Leu). In multidisciplinary review, this VUS was strongly suspected to be causative, and was genetically confirmed in her father and sister.

**Discussion:** Fanconi syndrome and CKD in association with heterozygous mutations in *GATM* have been described thus far in a single research study. Using a proximal tubular cell model, pathologic *GATM* mutations caused fibrillary aggregates in the mitochondria, also present in patients' kidney biopsies. Our patient presents with Fanconi syndrome and nephrolithiasis which was not previously associated with variants in this gene. This case illustrates the value of genetic testing, the importance of access to genetic expertise for interpretation of a VUS and the results hold promise for personalized treatment targeting expression of *GATM* with creatine.

### SA-PO529

#### A Clinical Workflow for Selection of Patients and Efficient Diagnosis of Genetic Kidney Diseases

Francesca Becherucci,<sup>1</sup> Samuela Landini,<sup>1</sup> Viviana Palazzo,<sup>1</sup> Valentina Raglianti,<sup>1,3</sup> Luigi Cirillo,<sup>1,3</sup> Gianmarco Lugli,<sup>1,3</sup> Benedetta Mazzinghi,<sup>2</sup> Paola Romagnani,<sup>1,3</sup> *<sup>1</sup>Meyer Children's Hospital, Florence, Italy; <sup>2</sup>Ludwig-Maximilians-Universität Munchen, Munchen, Germany; <sup>3</sup>Università degli Studi di Firenze, Firenze, Italy.*

**Background:** The advent of whole-exome sequencing (WES) has been making inherited kidney disorders (IKD) increasingly recognized across all age groups. Accessibility to genetic testing, interpretation of results and cost concerns limit the widespread use of genomic medicine in daily clinical practice. We explored feasibility and diagnostic performance of a service delivery model for patient selection, WES, results interpretation and counseling.

**Methods:** We set-up a multi-step diagnostic workflow based on the application of WES and reverse phenotyping performed by a multidisciplinary team of experts to adult and pediatric patients selected with simple clinical criteria, through a regional network of nephrology and pediatric centers working in close collaboration with a tertiary center for rare kidney diseases. We included all consecutive patients with a clinical picture suggestive of IKD belonging to 8 different clinical categories. We recorded clinical-laboratory-radiological information. We performed a cost-analysis of the diagnostic workflow modelling potential economic savings of a genomic-first approach to the diagnosis of IKD.

**Results:** By applying this workflow to a cohort of 474 pediatric and adult patients, we obtained a global diagnostic yield of 66.9%, with category-specific diagnostic rates ranging from 46% to 87%. Reverse phenotyping performed in patients or family members allowed us to reclassify the clinical diagnosis in 90/317 (28.4%) patients, thus increasing diagnostic accuracy. Disease reclassification encompassed the entire spectrum of IKD. Diagnostic yield was independent on the age at onset of kidney disease. We offered genetic testing as cascade screening to 67 families, providing a genetic diagnosis in 67 family members with previously unsuspected or unspecified kidney disorders. The clinical work-up was redirected in an average of 50% of patients. In 11.5% of patients, the results of genetic testing helped in guiding kidney transplant decisions. Finally, cost-analysis showed that our workflow is efficient enabling to potentially save a mean of 1360 euros per patient.

**Conclusions:** Ordering genetic testing, interpreting results, providing counseling and tailoring clinical management (i.e., personalized nephrology) is feasible and saves costs in a real-world setting.

### SA-PO530

#### Incorporating a Renal Genetics Clinic Into Clinical Practice: The Cleveland Clinic Experience

Xin Yee Tan,<sup>1</sup> Chloe Borden,<sup>3</sup> Xiangling Wang,<sup>2,1</sup> *<sup>1</sup>Cleveland Clinic, Cleveland, OH; <sup>2</sup>Cleveland Clinic Genomic Medicine Institute, Cleveland, OH; <sup>3</sup>Cleveland Clinic Lerner Research Institute, Cleveland, OH.*

**Background:** The perceived need for timely diagnoses of genetic kidney diseases to allow multifaceted disease-specific patient care led to the establishment of our Renal Genetics Clinic (RGC) in 2018 which has since been rapidly growing.

**Methods:** A retrospective review was conducted to evaluate the diagnostic yield of available genetic testing modalities and its diagnostic and therapeutic implications among the patients who were referred to our RGC from January 2019 to March 2022.

**Results:** 309 patients from 299 pedigrees including 118 males and 191 females aged 35.1±20.3 years old were seen in our RGC during this period, 292 of whom were recommended for genetic testing and 252 had results available. Presentations were variable comprising mainly of glomerular diseases (33%), cystic kidney diseases (25.2%),



electrolyte disorders(24.9%), congenital anomalies of kidneys and urinary tract(6.5%) and nephrolithiasis/ nephrocalcinosis(3.2%). A tiered testing algorithm was utilized which encompassed single gene panel(SGP), multigene panel(MGP), chromosomal microarray(CMA) and whole exome sequencing(WES). Among patients with results available, 44.8%(113) had a positive result, 25.4%(64)had variant(s) of undetermined significance(VUS),8.3%(21) were identified as heterozygous carriers, and 21.4%(54) tested negative. The diagnostic yield of different testing modalities is illustrated in **Figure 1**. The majority of positive results in our patients were achieved by MGP(71.7%), followed by SGP(18.6%), WES(8.9%) and CMA(0.9%). The positive results brought about a new diagnosis or a change in diagnosis in 67.3%(76) of patients and confirmed a priori diagnoses in 32.7%(37). Consequently, this has resulted in a change in management including change in medications in 27.4%(31) of patients.

**Conclusions:** As genetic testing becomes increasingly accessible, we have demonstrated compelling benefits of incorporating a specialized RGC into nephrology practice with quantifiable diagnostic and therapeutic impacts.

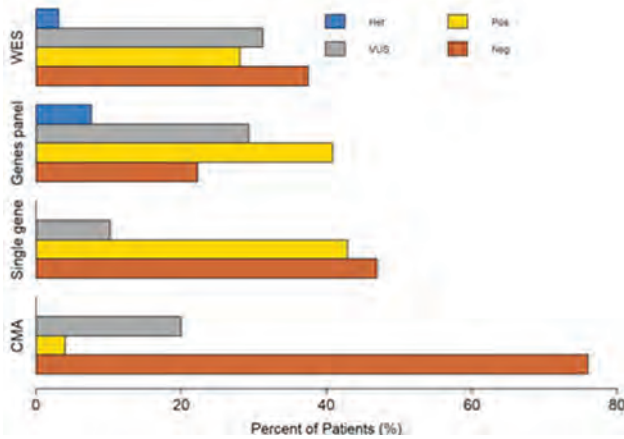

**SA-PO531**

**Whole Exome Sequencing (WES) Increases Diagnostic Yield in Renal Genetics Clinic (RGC) Patients With Previously Negative Multi-Gene Panel (MGP) Results**

Xin Yee Tan,<sup>1</sup> Chloe Borden,<sup>2</sup> Xiangling Wang.<sup>3,1</sup> <sup>1</sup>Cleveland Clinic, Cleveland, OH; <sup>2</sup>Cleveland Clinic Lerner Research Institute, Cleveland, OH; <sup>3</sup>Cleveland Clinic Genomic Medicine Institute, Cleveland, OH.

**Background:** Genetic testings have been increasingly accessible to patients with kidney diseases. MGP covering up to hundreds of disease-related genes has been frequently used in clinical practice with high diagnostic yield. WES has been valuable in research settings but its utility in clinical setting has not been assessed.

**Methods:** Clinical characteristics and genetic findings of a cohort of patients referred to the Cleveland Clinic RGC who had WES performed in clinical setting were analyzed.

**Results:** From January 2019 to March 2022,292 patients were evaluated in the RGC. Among these, 54(18.5%) were suggested to have WES, including 33females and 21males aged 22.4±18.5 years old. WES was recommended as first tier testing for 23(42.6%)patients and last tier testing after nondiagnostic precedent tests for 31(57.4%) patients. Clinical presentations included electrolyte disorders(25.9%), glomerular diseases(22.2%), cystic kidney diseases(20.4%), congenital anomalies of kidney and urinary tract(16.7%), tubulointerstitial diseases (5.6%), multisystemic diseases(5.6%) and nephrolithiasis/ nephrocalcinosis(2.7%).50% reported a positive family history and 24.1% had dysmorphic features.9 patients did not proceed due to denial/lack of insurance coverage and 34out of 43patients who proceeded had results available(**Figure1**),of which 29.4%(10)had a positive result, 29.4%(10) were found to have variant(s) of undetermined significance(VUS),5.9%(2)were identified as heterozygote carriers, and 22.2%(12)tested negative.7 out of 10 patients with positive results received a new or change in diagnosis. When performed as last tier testing after nondiagnostic precedent tests, WES had a diagnostic yield of 13%.

**Conclusions:** This study supports the clinical utility of WES in patients with suspected genetic kidney diseases as it evidently increases the diagnostic yield in patients with previous negative tests results.

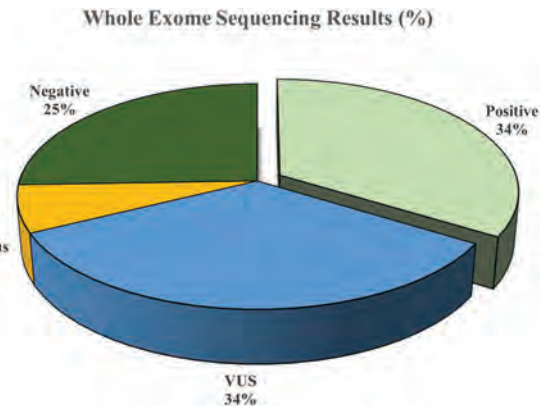

**SA-PO532**

**Electronic Health Record-Based Nephrotic Syndrome Genomic Discovery Using the Mass General Brigham (MGB) Biobank**

Janewit Wongboonsin,<sup>1,3</sup> Sagar U. Nigwekar,<sup>2</sup> Matt G. Sampson.<sup>3</sup> <sup>1</sup>Brigham and Women's Hospital, Boston, MA; <sup>2</sup>Massachusetts General Hospital, Boston, MA; <sup>3</sup>Boston Children's Hospital, Boston, MA.

**Background:** Published studies demonstrating the value of genetic stratification in nephrotic syndrome (NS) have often focused on children or research cohorts selected for specific characteristics, such as having steroid resistant NS. The prevalence and clinical correlates of known genetic forms of NS in adult patients are less well understood but may have important clinical implications. The EHR-linked Biobank of the MGB, which has enrolled > 130,000 patients and conducted SNP genotyping and exome sequencing on most of them, provides a unique opportunity to identify patients with NS for subsequent genomic discovery.

**Methods:** We used the following strategies to identify all NS patients in the biobank. 1) Screened with ICD-10 diagnosis code of 'nephrotic syndrome.' 2) Applied a published computational phenotype for primary NS consisting of 8 inclusion codes and 87 exclusion codes. 3) Reviewed patients with kidney pathology data and the diagnosis code of 'proteinuria.' 4) Reviewed patients with kidney pathology data, regardless of diagnosis.

**Results:** Strategy 1 identified 558 patients and performed manual chart reviews. The mean age was 60±15 years, and 70% of the cohort were Caucasian. 90.7% of patients had proteinuric kidney disease. Focal segmental glomerulosclerosis (FSGS) was the most common diagnosis (28.1%). Strategy 2 identified 86 patients, 22 of whom had validated diagnoses through chart review. This approach lacked specificity for primary NS as 23% of patients (5/22) did not have NS. Strategy 3 identified 819 patients, 291 of whom had validated diagnoses from strategy 1. 271/291 (93.1%) had pathology reports of native kidney disease confirming the diagnosis. Given the high yield of capturing patients with glomerular diseases through kidney pathology data, we then proceed with strategy 4, reviewing the kidney pathology data from all patients. We obtained additional 1648 patients, 334 of whom have either minimal change disease, FSGS, or membranous nephropathy. The total number of unique NS from these efforts is 564 patients.

**Conclusions:** This EHR-link biobank provided a unique opportunity for genomic discovery for nephrotic syndrome in adults. The kidney pathology data was the key to ensuring that we captured all patients with glomerular disease from the Biobank. Manual adjudication is still required to provide the correct diagnosis.

**Funding:** Private Foundation Support

**SA-PO533**

**Clinical Utility of Genetic Testing in Kidney Transplant Evaluation**

Anshul Bhalla,<sup>1</sup> Darbey Raible,<sup>2</sup> Vasanthi Balaraman,<sup>1</sup> Manish Talwar.<sup>1</sup> <sup>1</sup>James D. Eason Transplant Institute, Memphis, TN; <sup>2</sup>Natera, Inc., Austin, TX.

**Background:** Genetic testing is an emerging tool in kidney transplant (KT) evaluation. We present examples of diagnostic and clinical utility resulting from broad-panel genetic testing in pre- and post-KT settings at an academic transplant center.

**Methods:** Selection criteria for genetic testing included: pre-KT patients with early-onset end stage kidney disease (ESKD), ESKD of unclear etiology or positive family history of ESKD, and post-KT patients with suspected recurrent disease or poor graft function. Patients were tested using a Next-Generation Sequencing (NGS) panel of 385 genes (the Renasight™ Test) associated with isolated or syndromic chronic kidney disease (CKD). Positive results included at least one pathogenic (P) or likely pathogenic (LP) variant in an autosomal dominant or X-linked gene, two P/LP variants in an autosomal recessive gene, or the presence of two APOLI risk alleles.

**Results:** This study included 132 patients (pre-KT=98, post-KT=34). The median age was 42 years (range: 21-77) and most (78%) were African American. Overall, 62 patients (47%) received a positive result in at least one panel gene. Hypertensive nephrosclerosis was the most common diagnosis (68%, n=90) at the time of referral for KT evaluation. Genetic findings established a new diagnosis in 57% (n=51/90) of these patients. Genetic testing confirmed the diagnosis for 2 of 36 patients with an established a priori clinical diagnosis other than hypertensive nephrosclerosis and led to further delineation of disease origin in 6 (17%) of these patients. Surveillance changes were indicated for 27% of

patients, based on risk for recurrence post-KT (n=11) and/or extrarenal features (n=6) delineated via genetic testing. Significant alterations to treatment were indicated for 2 (unrelated) patients with previously undiagnosed Adenine Phosphoribosyltransferase (APRT) Deficiency, for whom treatment with xanthine oxidase inhibitor was initiated to reduce risk of graft damage and loss.

**Conclusions:** In KT, genetic diagnosis can facilitate personalized prognostication of disease recurrence and changes in management to optimize graft survival. Demonstration of real-world clinical benefits is important for establishing evidence-based guidelines and best practices for integration of genetic testing into KT evaluation.

SA-PO534

**The Clinical Impact of Genetic Testing in Outpatient General and Transplant Nephrology: A Tertiary Centre Experience**

Lakshna Sankar,<sup>1</sup> Pooja Sanghi,<sup>1</sup> Gurmukteshwar Singh,<sup>1</sup> Prince M. Anand,<sup>2</sup> Kartik Kalra,<sup>1</sup> Alex R. Chang.<sup>1</sup> <sup>1</sup>Geisinger Health, Danville, PA; <sup>2</sup>Medical University of South Carolina, Charleston, SC.

**Background:** Monogenic diseases account for 10-15% of kidney diseases. The impact of clinical genetic testing in real-world nephrology is not well-characterized.

**Methods:** A retrospective study was conducted at Geisinger from June 2020 to April 2022. Patients with suspicion for inherited kidney disease underwent genetic testing. We classified positive finding as having a pathogenic (P) or likely pathogenic (LP) variant in a gene consistent with the clinical phenotype or presence of two apolipoprotein L1 (APO1L) risk alleles. The number of variants of unknown significance (VUS) that matched the clinical phenotype were quantified.

**Results:** Positive genetic diagnoses were obtained in 42 patients (P/LP variants n=36; 2 APO1L risk alleles n=6) encompassing 19 genes. Among those without a genetic diagnosis, 17 patients had a VUS that was consistent with the renal phenotype. The mean number of VUS was 4.8 ± 2.6. 92% of the patients (136/147) had at least 1 VUS. Diagnostic yield of genetic testing in CKD of unknown cause was 28% (Figure 1). Among potential kidney donors, 1/9 (11%) had a positive variant (CFI gene). 28% of the patients (15/53) with positive genetic diagnoses underwent kidney transplant workup. Family testing was done in 6 families confirming 2 genetic diagnoses in 2 relatives who were referred to genetic counseling.

**Conclusions:** Nephrologist-driven use of genetic testing can provide molecular diagnoses influencing management in CKD/ESKD patients. Family testing provides insights that help identify appropriate living donors, refer those with a positive diagnosis to genetics clinic and re-classify VUS as disease causing variants. Our study represents real - world application and utilization of renal genetic testing.

Outcome of Genetic Testing by Pre-test Diagnosis

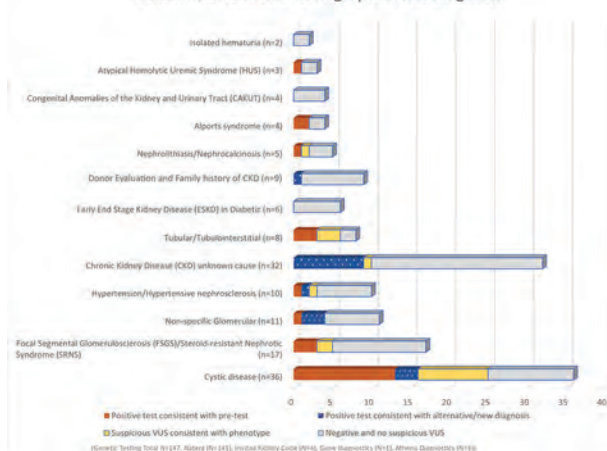

SA-PO535

**African American Kidney Disease Patients Experience Reduced Access to Genetic Testing Compared With White Patients**

Chloe Borden,<sup>1</sup> Xin Yee Tan,<sup>1,2</sup> Xiangling Wang.<sup>1,2</sup> <sup>1</sup>Cleveland Clinic Lerner College of Medicine of Case Western Reserve University, Cleveland, OH; <sup>2</sup>Cleveland Clinic, Cleveland, OH.

**Background:** African Americans are almost four times as likely as White Americans to develop kidney failure. In the last decade, significant advancements in the diagnosis and management of patients with genetic kidney diseases have been made. Whether disparities in access to genetic testing between racial groups exists has not been previously examined.

**Methods:** A retrospective review of patients referred to the Cleveland Clinic Renal Genetics Clinic (RGC) from January 2019 to March 2022 was conducted. Patient demographics, clinical characteristics, insurance coverage, referring providers, diagnostic modality, and diagnostic yield were collected for comparison.

**Results:** 309 patients from 299 pedigrees including 118 males and 191 females aged 35.1 ± 20.3 years were seen at the RGC from January 2019 to March 2022. 49 African American patients, 232 White patients, 24 patients who were neither White nor African

American, and 4 patients who declined to provide race were seen. African American patients were significantly more likely to be in end stage renal disease (ESRD) at the time of referral compared with White patients (OR = 3.7, p = 0.003). African American patients were additionally more likely to be covered by Medicaid (OR = 1.4, p = 1.4e-5) and less likely to have private insurance (OR = 0.3, p = 3.3e-4). Further, African American patients were more likely to exhibit nonadherence (OR = 3.4, p = 0.003). No differences in referring providers, family history, diagnostic yield, Medicare coverage, eGFR at first visit, and age at first visit between groups were noted.

**Conclusions:** This study suggested inequitable access to genetic testing amongst African American kidney disease patients. As personalized genetic healthcare becomes increasingly prevalent, steps will need to be taken to ensure equitable access for all persons.

Table 1. Patient demographic information

Factor	African American (N=49)	White (N=232)	Other (N=24)	Total (N=309)
Age (at 1 <sup>st</sup> visit), Mean ± SD	35.4 ± 19.0	36.5 ± 20.2	24.3 ± 19.4	35.1 ± 20.3
Males, No. (%)	28 (57.1)	76 (32.8)	13 (54.2)	118 (38.2)
Females, No. (%)	21 (42.9)	156 (67.2)	11 (54.8)	191 (61.8)
eGFR (at 1 <sup>st</sup> visit), Mean ± SD	79.3 ± 44.4	87.7 ± 43.6	109 ± 59.9	88.6 ± 45.6
Family History, No. (%)	25 (51.0)	125 (53.9)	11 (47.8)	163 (52.8)
Nonadherence*, No. (%)	13 (23.6)	20 (8.3)	2 (8.0)	36 (11.2)
End stage renal disease (ESRD), No. (%)	11 (22.4)	17 (7.3)	4 (16.7)	33 (10.7)
Dysmorphic Features, No. (%)	7 (14.3)	18 (7.8)	2 (8.3)	27 (8.7)
Medicaid, No. (%)	22 (44.9)	34 (14.7)	5 (20.8)	64 (20.7)
Medicare, No. (%)	9 (18.4)	39 (16.8)	2 (8.3)	50 (16.2)
Private insurance, No. (%)	18 (36.7)	152 (65.5)	13 (54.2)	184 (59.5)
Military insurance, No. (%)	0 (0)	5 (2.2)	0 (0)	5 (1.6)
International insurance, No. (%)	0 (0)	1 (0.4)	2 (8.3)	3 (1.0)

\*13 additional patients who did not show for appointments included in analysis.

SA-PO536

**Diagnostic Yield of Massively Parallel Sequencing in Patients With CKD of Unknown Etiology: The Dutch Nationwide Prospective VARIETY Cohort Study**

Amber de Haan,<sup>1</sup> Mark Eijgelsheim,<sup>1</sup> Liffert Vogt,<sup>2</sup> Ewout J. Hoorn,<sup>3</sup> Joris I. Rotmans,<sup>4</sup> Albertien M. van Eerde,<sup>5</sup> Nine V. Knoers,<sup>1</sup> Martin H. De Borst.<sup>1</sup> <sup>1</sup>Universitair Medisch Centrum Groningen, Groningen, Netherlands; <sup>2</sup>Amsterdam UMC Locatie AMC, Amsterdam, Netherlands; <sup>3</sup>Erasmus MC, Rotterdam, Netherlands; <sup>4</sup>Leids Universitair Medisch Centrum, Leiden, Netherlands; <sup>5</sup>Universitair Medisch Centrum Utrecht, Utrecht, Netherlands.

**Background:** The cause of chronic kidney disease (CKD) remains unknown in at least 20% of patients. While retrospective studies, most in research setting, indicate that massively parallel sequencing (MPS) may lead to a genetic diagnosis in 12-56% of patients with unexplained CKD, the diagnostic yield in clinical practice is unclear. Here, we aimed to determine the diagnostic yield of MPS-based gene panel testing in patients with unexplained CKD in a routine healthcare setting.

**Methods:** A prospective nationwide observational cohort study was conducted in 13 hospitals throughout the Netherlands. Patients with unexplained CKD who had an eGFR <60mL/min/1.73 m<sup>2</sup> before the age of 50 years were included. Informed consent was obtained from all participants. Diagnostic genetic testing was performed using the whole-exome sequencing (WES) based CKD-Y (Chronic Kidney Disease in Young patients; 256 genes) or broad hereditary kidney disease (495 genes) multi-gene panels at the University Medical Center Utrecht.

**Results:** As of May 2022, 370 patients have been included (>90% of the target inclusion, n=400). In an interim analysis involving 233 patients with complete data available, mean age was 44±12 years, mean age at diagnosis CKD was 31±12 years, 39% were female, 62% had proteinuria, 24% had hematuria, 84% had hypertension, 68% had undergone kidney transplantation and 37% reported a positive family history for CKD. A diagnostic variant, defined as (likely) pathogenic variants explaining the clinical phenotype, was identified in 45/233 participants (19%). Most diagnostic variants were identified in *NPH1* (N=12), *COL4A3* (N=7), *COL4A4* (N=5), *COL4A5* (N=4), and *PAX2* (N=3). A genetic diagnosis subsequently led to at least one clinical consequence (e.g. change in therapy, search for extrarenal features, implications for transplantation, family planning/counseling,) in 75% of patients.

**Conclusions:** In this study, WES-based panel testing yielded a genetic diagnosis in 19% of cases, highlighting the relevance of MPS as a tool in the diagnostic workup of adult patients with CKD of unknown origin. Most common genetic diagnoses in this population were nephronophthisis and Alport spectrum disease. Complete data analysis (n=400) is expected by October 2022.

**Funding:** Commercial Support - Sanofi Genzyme, Government Support - Non-U.S.

## SA-PO537

**Diagnostic Yield Among Patients With Diabetic Nephropathy and/or Hypertension: Genetic Testing in Kidney Transplant Waitlist Patients**

David B. Leiser,<sup>1</sup> Karen E. Kennamer,<sup>1</sup> Laurel Kartchner,<sup>2</sup> Margaret M. Romine,<sup>1</sup> Ashley E. Aaron,<sup>1</sup> Kristel J. McLawhorn,<sup>1</sup> Heather Jones,<sup>1</sup> William Irish.<sup>1</sup> <sup>1</sup>Vidant Transplant Center, Greenville, NC; <sup>2</sup>Natera, Inc., Austin, TX.

**Background:** Diabetes and hypertension (HTN) are common causes of end-stage renal disease (ESRD) in the general population. Studies have shown that ESRD often has a genetic cause. Although diabetes and HTN can have a hereditary component in some cases, recommendations for genetic testing in ESRD typically exclude patients with presumed diabetic nephropathy or HTN. We describe a single-center approach to using genetic testing in patients presenting for renal transplant evaluation, including those whose clinical diagnosis was diabetic nephropathy or HTN.

**Methods:** As part of the initial work-up process, all potential transplant patients were tested to determine cause of original kidney disease, ancestry, diabetes (y/n), and hypertension (y/n). Patients then underwent testing with a panel consisting of >380 genes associated with kidney disease (the Renasight™ test). Positive results included those with pathogenic or likely pathogenic variants, or with the G1 or G2 *APOL1* risk alleles. Results were then stratified based on patient clinical diagnosis.

**Results:** Among the 189 patients tested, 31.7% (n=60) had positive results spanning 14 genes. Six patients were identified as having positive results in >1 gene. At the time of transplant evaluation, diabetic nephropathy or HTN were the most common causes of ESRD. Other causes of ESRD that often are hereditary, such as focal segmental glomerulosclerosis and polycystic kidney disease were highly prevalent among the cohort. Genetic findings were identified in patients whose ESRD was due to diabetic nephropathy (21.7%, 18/83), HTN (34.5%, 19/55), FSGS (66.7%, 6/9), PKD (88.9%, 8/9), and "Other" (27.3%, 9/33).

**Conclusions:** Despite published protocols excluding genetic testing in patients with presumed diabetic nephropathy, this analysis suggests that patients with ESRD caused by diabetes and/or hypertension may have a high diagnostic yield spanning a wide variety of genetic causes.

## Common Positive Genetic Findings

Clinical Diagnosis (Cause of ESRD)	Diagnostic yield Genes (# patients)
Diabetic nephropathy at time of KT evaluation (n=83)	21.7% (n=18) APOL1 (13), CFH (1), COL4A4 (1), HNF4A (1), PKD2 (1), SLC7A9 (1), TTR (1)
HTN at time of KT evaluation (n=55)	34.5% (n=19) APOL1 (12), COL4A3 (1), COL4A4 (5), COL4A5 (1), GLI3 (1), MG2R (1), PKD1 (1), TTR (2)
Focal segmental glomerulosclerosis (FSGS) (n=9)	66.7% (n=6) APOL1 (6)
Polycystic kidney disease (PKD) (n=9)	88.9% (n=8) APOL1 (1), PKD1 (6), PKD2 (1), TTR (1)
Other (n=33)	27.3% (n=9) APOL1 (6: lupus, covid, cong renal anomaly, IgAN (2)), COL4A5 (2 GN), PGR21 (solitary kidney), NPH1 (1: medullary cystic kidney disease), TTR (1)

## SA-PO538

**Copy Number Variation Analysis in 138 Families With Steroid-Resistant Nephrotic Syndrome Identifies Homozygous Causal Deletions in *PLCE1* and *NPHS2* in Two Families**

Dalia Pantel,<sup>1,2</sup> Nils D. Mertens,<sup>1</sup> Ronen Schneider,<sup>1</sup> Jameela A. Kari,<sup>3</sup> Sherif M. El desoky,<sup>3</sup> Arvind Bagga,<sup>4</sup> Tze Yin Lim,<sup>5</sup> Shirlee Shril,<sup>1</sup> Friedhelm Hildebrandt.<sup>1</sup> <sup>1</sup>Boston Children's Hospital, Boston, MA; <sup>2</sup>Institute of Human Genetics, Heidelberg University, Heidelberg, Germany; <sup>3</sup>King Abdulaziz University, Faculty of Medicine, Jeddah, Saudi Arabia; <sup>4</sup>Division of Nephrology, Department of Pediatrics, All India Institute of Medical Sciences, New Delhi, India; <sup>5</sup>Division of Nephrology, Columbia University, New York City, NY.

**Background:** Steroid-resistant nephrotic syndrome (SRNS) is the second most common cause of end-stage renal disease in children and adults under the age of 20 years. Previously, we were able to detect by whole-exome sequencing (WES) a known monogenic cause of SRNS in 25% of affected families (Warejko *CJASN* 13:53, 2018), supporting the indispensable role of WES in uncovering genetic causation of the syndrome. However, WES falls short of detecting copy number variations (CNV) due to technical challenges. We therefore hypothesized that causal CNVs could be detected in a large SRNS cohort.

**Methods:** We performed genome-wide single nucleotide polymorphism (SNP)-based CNV analysis on a cohort of 138 SRNS families, in which we previously did not identify a genetic cause through WES. We evaluated WES and CNV data for variants in 61 known SRNS genes and in 12 genes, in which variants are known to cause a phenocopy of SRNS. We applied previously published, predefined criteria to evaluate and classify the CNVs.

**Results:** In a cohort of 138 families with SRNS, we detected a novel CNV in two genes in two families (2/138 families, 1.5%) after having excluded competing variants by genome-wide WES and CNV analysis. Both CNVs are homozygous deletions: We detected a deletion of 9,670 bp in the *PLCE1* gene and a deletion of 6,790 bp in the *NPHS2* gene. The deletions were confirmed across breakpoint using PCR and Sanger sequencing.

**Conclusions:** This study shows that CNV analysis can identify the genetic cause in families with SRNS in which a genetic cause was not found through WES, though the rate of detected CNVs lies below the one found in other monogenic kidney diseases, like congenital anomalies of the kidneys and urinary tract.

**Funding:** Other NIH Support - 5RC2DK122397-02 and 5R01DK076683-16

## SA-PO539

**Biallelic Variants in *NUP85* Causes Pediatric Steroid Resistant Nephrotic Syndrome**

Rini Rossanti,<sup>1,2</sup> Dany Hilmanto,<sup>1,2</sup> Tomoko Horinouchi,<sup>1</sup> Nana Sakakibara,<sup>1</sup> China Nagano,<sup>1</sup> Tomohiko Yamamura,<sup>1</sup> Shinya Ishiko,<sup>1</sup> Yuya Aoto,<sup>1</sup> Atsushi Kondo,<sup>1</sup> Kazumoto Iijima,<sup>3,4</sup> Kandai Nozu.<sup>1</sup> <sup>1</sup>Department of Pediatrics, Kobe University Graduate School of Medicine, Kobe, Japan; <sup>2</sup>Department of Child Health, Nephrology Division, Dr. Hasan Sadikin General Hospital/Faculty of Medicine, Universitas Padjadjaran, Bandung, Indonesia; <sup>3</sup>Hyogo Prefectural Kobe Children's Hospital, Kobe, Japan; <sup>4</sup>Department of Advanced Paediatric Medicine, Kobe University Graduate School of Medicine, Kobe, Japan.

**Introduction:** Steroid resistant nephrotic syndrome consistently progressed to end-stage renal disease. Despite the fact that more than 50 monogenic causes of steroid resistant nephrotic syndrome (SRNS) have been identified, a large proportion of SRNS remains unexplained. Nucleoporin 85, a protein encoded by the inner ring subunit of the nuclear pore complex (NPC), has recently been found to cause SRNS. Here we describe a *NUP85* compound heterozygous mutation in a child with focal segmental glomerulosclerosis (FSGS). Although one was a large deletion variant with obvious pathogenicity, another was a novel heterozygous variant which pathogenicity was unknown. To verify the pathogenicity of the missense variant, we conducted *in vitro* protein expression analyses.

**Case Description:** A 9-year-old girl with learning disorder and low vision was diagnosed with SRNS at 3 years old without any history of kidney disease in the family. The histological finding was FSGS. Pre-emptive kidney transplantation was conducted at 9 years-old. Patient harbored 2 novel heterozygous mutations in *NUP85*, c.1379G>A (p.Arg460Gln) in exon 14 by next generation sequencing, and a large deletion straddling from intron 11 of *NUP85* to *GGA3* gene by copy number variant analysis and custom array CGH. The *in vitro* protein expression analysis showed abnormal localization of *NUP85* in cytoplasm with the particle formation by the missense variant.

**Discussion:** In this study we defined the pathogenicity of a very rare missense variant in *NUP85*. This finding can help identifying more variants in this rare form of SRNS.

## SA-PO540

**Genomic Sequencing Is Associated With a High Diagnostic Yield in Hospitalized Children With Both Congenital Heart Defects and Congenital Anomalies of the Kidney and Urinary Tract System**

Erika Allred,<sup>1,2</sup> Elliot Perens.<sup>1,3</sup> <sup>1</sup>University of California San Diego, La Jolla, CA; <sup>2</sup>Rady Children's Institute for Genomic Medicine, San Diego, CA; <sup>3</sup>Rady Children's Hospital San Diego, San Diego, CA.

**Background:** Congenital heart defects (CHD) and congenital anomalies of the kidney and urinary tract (CAKUT) account for significant morbidity and mortality in childhood. Dozens of monogenic causes of anomalies in each organ system have been identified. However, even though 30% of CHD patients (pts) also have a CAKUT and both organs arise from the lateral mesoderm, there is sparse overlap of the genes implicated in the congenital anomalies of each organ system. We sought to determine whether pts with both CAKUT and CHD have a monogenic etiology, with the long term goal of guiding future diagnostic work up and improving outcomes.

**Methods:** Retrospective review identifying patients with both CAKUT and CHD and either whole genome sequencing or whole exome sequencing, admitted to Rady Children's Hospital between January 2015 and July 2020. Demographic information, presenting phenotype, and genetic results were collected, along with the mother's pregnancy history. WGS results were reanalyzed using the CAKUT and CHD phenotype as a primary filter. Genetic results were reviewed to identify causative, candidate, and novel genes for the CAKUT and CHD phenotype. Associated additional structural malformations were identified and categorized.

**Results:** 32 patients were identified. 8 patients had causative variants, 3 patients had candidate variants, and 3 patients had potential novel variants. 5 patients had variants in genes not associated with the CAKUT/CHD phenotype, and 13 patients had no variant identified. Of these, 8 patients were identified as having possible alternative causes for their CHD/CAKUT phenotype. 88% of all CAKUT/CHD patients had at least one additional organ system with a structural malformation.

**Conclusions:** Overall, our study demonstrated a high rate of monogenic etiologies in hospitalized pts with both CHD and CAKUT, with a diagnostic rate of 44%. Thus, physicians should have a high suspicion for genetic disease in this population. Together, these data provide valuable information on how to approach acutely ill pts with CAKUT and CHD, including guiding diagnostic work up for associated phenotypes, as well as novel insights into the genetics of CAKUT and CHD overlap syndromes in hospitalized children.

**Funding:** NIDDK Support

## SA-PO541

**Barriers to Genetic Testing for Determining Cause of Kidney Disease Among Healthcare Providers**

Michael Spigler, Jemetra Collins, Melanie Paris, Ryan Woolley. *American Kidney Fund, Rockville, MD.*

**Background:** Studies estimate between 5 and 10 percent of cases of kidney disease have an unknown etiology, and that a subset of these unknown designations may be attributable to genetic conditions. Identifying the cause of patients' chronic kidney disease (CKD) is important for informing tailored treatment plans to mitigate or slow disease progression. Genetic testing can also inform patients of any genetic based susceptibility for family members, helps to identify appropriate clinical trials for the advancement of treatment, and remove the feeling of blame for the disease. To identify opportunities for addressing barriers around CKD diagnosis and determining CKD cause, the American Kidney Fund conducted a survey of US-based healthcare providers (HCPs) who treat CKD patients.

**Methods:** An online survey was fielded between January 14-25, 2022, to 300 US-based HCPs, including 105 primary care providers (PCPs), 81 nurse practitioners/physician assistants (NP/PAs), 83 nephrologists, and 31 kidney transplant surgeons who treated 20 or more CKD patients in the previous month.

**Results:** HCPs reported using genetic testing in an average of 8% of their patients with suspected CKD and 25% have never used genetic testing for determining CKD cause. Among those who use genetic testing less frequently (n=198), 50% were not very familiar with genetic testing for kidney disease. PCPs, NPs, and PAs were most likely to see patient out-of-pocket costs (73% and 70%, respectively) and connecting patients with a genetic counselor (57%, and 44%, respectively) as barriers to genetic testing compared to other HCPs. Lastly, after learning more about genetic testing, providers reported an 18% increased likelihood to use it to determine primary cause of CKD.

**Conclusions:** Genetic testing is not widely used among HCPs for determining cause of kidney disease. Cost and coverage, as well as connecting with a genetic counselor appear to be the most challenging aspects of utilizing genetic testing. Additionally, these results demonstrate a notable increase in HCPs likelihood to use genetic testing once presented with the benefits of a definitive diagnosis. With these findings, stakeholders should continue to raise awareness of genetic testing benefits among HCPs and identify policies to address the challenges shared across the kidney community.

**Funding:** Commercial Support - Natera, Vertex, Alexion, Otsuka, Travele Therapeutics

## SA-PO542

**Next Generation Sequencing to Determine Etiology of Renal Disease: A Canadian Prospective Cohort Study**

Logan R. Van Nynatten,<sup>1,2</sup> Cadence Baker,<sup>1</sup> Dervla M. Connaughton,<sup>1,2</sup> <sup>1</sup>London Health Sciences Centre University Hospital, London, ON, Canada; <sup>2</sup>Western University Schulich School of Medicine & Dentistry, London, ON, Canada.

**Background:** Recent data suggest that monogenic (single gene) diseases are underestimated in chronic kidney disease (CKD), particularly in adults with CKD of unknown etiology (CKDu). Retrospective research-based studies show that up to 70% pediatric and 30% adult-onset CKD is monogenic. Prospective studies are needed to help guide nephrologists on the integrating next generation sequencing into routine clinical settings.

**Methods:** This study is an ongoing prospective, cohort study to evaluate the diagnostic yield of next generation sequencing testing in a Canadian clinic. The secondary objective is to determine the outcomes following establishment of a genetic diagnosis, to help guide physicians and policymakers on implementation of next generation sequencing diagnostic into routine clinical care. A targeted phenotype driven gene panel was performed if the subtype of CKD was evident at time of presentation. Exome sequencing was utilized for patients with non-diagnostic panels or in whom the subtype of CKD was unknown (i.e. CKDu).

**Results:** To date, 148 families (209 individuals) have been recruited. We report on 72 families with CKD in whom next generation sequencing testing results are currently available. The median age of onset of CKD was 44 years (IQR 35-52). In 55% the subtype of CKD was unknown. A genetic diagnosis was confirmed in 42% of families. Exome sequencing yielded a genetic diagnosis in a further 10% who had a negative phenotype driven gene panel or had CKDu.

**Conclusions:** This is the first study to prospectively characterize monogenic causation of CKD in a Canadian cohort. Genetic sequencing demonstrates a high prevalence of monogenic disease in CKD. Both gene-panel and exome sequencing identified pathogenic mutations associated with renal disease. Genetic sequencing informed prognosis and resolved diagnostic confusion in all positive cases, while in some cases help guide management or facilitate decision making in biologically related living donors.

## SA-PO543

**Genetic Glomerular Disorders Are Associated With Worse Outcomes in CureGN**

Mark Elliott,<sup>1,2</sup> Natalie Vena,<sup>1</sup> Enrico Cocchi,<sup>1,4</sup> Maddalena Marasa,<sup>1</sup> Hila Milo Rasouly,<sup>1</sup> Matthias Kretzler,<sup>3</sup> Krzysztof Kiryluk,<sup>1</sup> Ali G. Gharavi.<sup>1</sup> CureGN Consortium <sup>1</sup>Columbia University Irving Medical Center, New York, NY; <sup>2</sup>University of Calgary Cumming School of Medicine, Calgary, AB, Canada; <sup>3</sup>University of Michigan, Ann Arbor, MI; <sup>4</sup>Universita' degli Studi di Torino, Torino, Italy.

**Background:** The true prevalence of monogenic glomerular disease is not known. Prognosis and treatment response may differ between genetic and sporadic forms of disease thus identifying a genetic etiology can have clinical significance in this patient population.

**Methods:** 2018 individuals enrolled in the international, multicenter Cure Glomerulonephropathy Network (CureGN) underwent genome sequencing. 513 with focal segmental glomerulosclerosis (FSGS), 465 with minimal change disease (MCD), 476 with membranous nephropathy (MN), and 564 with IgA nephropathy. Cases with a strong suspicion of a genetic diagnosis and those with kidney failure were excluded prior to enrolment. Variants in 180 genes with glomerular phenotypes were classified per ACMG/AMP guidelines. Pathogenic and likely pathogenic variants consistent with the inheritance pattern and patient phenotype were considered diagnostic. *APOL1* high risk genotypes were evaluated. The risk of immunosuppression resistance and kidney failure, defined by chronic dialysis or transplantation, was determined over a median of 4.3 years of follow-up, adjusted for demographic, clinical and biopsy characteristics.

**Results:** 14 different monogenic glomerular disorders were detected in 42 individuals (2% diagnostic rate): 28 with FSGS (5.4% diagnostic rate), 8 with MCD (1.7% diagnostic rate), 6 with IgAN (1.1% diagnostic rate), and 0 in MN. Over half were due to variants in *NPHS2* (16 variants in 10 individuals) and *Alport* spectrum disorder genes (18 variants in 18 individuals). 124 individuals have high-risk *APOL1* genotypes, including 3 with Mendelian diagnostic variants. On logistic regression, individuals with monogenic glomerular disease and those with high-risk *APOL1* genotypes were more likely to have immunosuppression resistant disease (OR=4.46, P=7x10<sup>-4</sup>; OR=1.83, P=0.02, respectively), particularly resistance to two or more therapies (OR=3.40, P=0.002; OR=2.19, P=0.003, respectively), and were also at increased risk of kidney failure (Cox proportional hazards OR=2.03, P=0.02; OR=1.88, P=0.002, respectively).

**Conclusions:** Monogenic glomerular diseases were identified in 42 subjects, with the highest diagnostic rate among FSGS cases. Individuals with monogenic disorders and those with high risk *APOL1* genotypes had an increased risk of multidrug resistant disease and kidney failure.

**Funding:** NIDDK Support

## SA-PO544

**Designing a Protocol for Return of Research Genetic Results to Adult and Pediatric Patients in NEPTUNE: A Multicenter Nephrotic Syndrome Cohort**

Jennifer Fishbein,<sup>1</sup> Chrysta C. Lienczewski,<sup>2</sup> Wendy R. Uhlmann,<sup>2</sup> J. Scott Roberts,<sup>2</sup> Matt G. Sampson.<sup>1,3</sup> NEPTUNE, University of Michigan <sup>1</sup>Boston Children's Hospital, Boston, MA; <sup>2</sup>University of Michigan, Ann Arbor, MI; <sup>3</sup>Broad Institute, Cambridge, MA.

**Background:** The Nephrotic Syndrome Study Network (NEPTUNE), an observational cohort study of proteinuric kidney disease, is identifying patients with variants in Mendelian nephrotic syndrome genes. Return of research genetic results may have clinical benefits for participants. However, there is limited literature on how to return results in pediatric and multicenter studies. Some challenges and unanswered questions include returning secondary findings, communicating with patients, involving providers and paying for the process. Here we describe an initial protocol for return of results (ROR) for NEPTUNE.

**Methods:** We determined that only putative pathogenic, monogenic causes of nephrotic syndrome and high-risk *APOL1* genotype will be returned to patients. We conducted a needs assessment of all principal investigators in NEPTUNE (n=29) using an online survey, to understand the levels of expertise and resources across recruitment sites in order to operationalize ROR at each one. We asked about current presence of genetics clinics, use and comfort level with clinical genetic testing, and whom they would like to return results. To support clinicians, we created genetic information sheets and templates for communicating results in the chart and to patients.

**Results:** 27 sites completed the needs assessment. 82% (n=22) have a genetics clinic at their institution and among those, 32% (n=7) have a nephrology specific genetics clinic. 88.9% (n=24) of divisions have providers that already regularly order genetic testing, most commonly kidney genetics panel (n=23). 59% (n=16) of institutions can handle ROR independently. The remaining sites requested counseling and educational support through NEPTUNE. We created templates for a letter to notify patients, telephone script to follow-up with patients, a genetic counseling clinic note, and a family letter to be given to patients.

**Conclusions:** We have created a protocol to return genetic results to patients in NEPTUNE that addresses the unique challenges of a multicenter cohort including pediatric patients. The variability in resources and knowledge about genetic testing amongst nephrology divisions highlighted a need for support for ROR. Our protocol is generalizable to other research studies that aim to implement return of research genetic results.

SA-PO545

**Diagnostic Yield of Exome Sequencing in Early Onset Hypertensive Nephropathy in Adults**

Justine Serre,<sup>1,3</sup> Alice Doreille,<sup>1</sup> Marine Serveaux Dancer,<sup>2</sup> Laure Raymond,<sup>2</sup> Cedric Rafat,<sup>1</sup> Laurent Mesnard,<sup>1,3</sup> Service de néphrologie Hôpital Tenon <sup>1</sup>Assistance Publique - Hôpitaux de Paris, Paris, France; <sup>2</sup>Eurofins Biomnis Lyon, Lyon, France; <sup>3</sup>INSERM UMRS 1155, Paris, France.

**Background:** Hypertensive nephropathy (HN) is one of the most frequent causes of chronic kidney disease (CKD). However, the very existence of HN has been called into question. Its diagnostic framework is based on non-specific criteria. Next generation sequencing with exome sequencing (ES) has emerged as a comprehensive tool to detect Mendelian diseases in nephrology. ES has yet to be consistently incorporated in the diagnostic workup of patients with presumed HN.

**Methods:** We retrospectively collected the ES performed in the context of HN between September 2018 and February 2021. The diagnosis of HN was established if patients had an eGFR of less than 60ml/min/1.73m2, combined with hypertension, if no other cause of kidney disease could be identified, and a urinary protein to creatinine ratio of less than 2.5 was required.

**Results:** A total of 128 patients (Table 1) were sequenced in the context of HN. We detected pathogenic / likely pathogenic variants in 20 of the 128 patients (16%) encompassing 14 different monogenic disorders with Nephronophthisis and Alport syndrome accounting for more than half of it. Consanguinity and extra-renal disease possibly linked to the renal phenotype were significantly associated with ES positivity. The diagnostic yield of ES was lower in patients of African ancestry (8% versus 30% in non-African ancestry patients, p<0.01). There were significantly more variant of uncertain significance in patients with African (56%) compared to non-African ancestry (22%) (p=0.04) but less co-segregation data, with significantly more ES performed in solo, only proband (96%, compared to 80% in non-African ancestry patients, p<0.01).

**Conclusions:** The high diagnostic yield of ES (16%) in a population of patients thought to have HN casts further doubts on the validity of the existing diagnosis criteria. Our results argue for more consistent implementation of ES in patients supposed to have HN.

Patient characteristics and diagnostic yield

	All patients n = 128	Positive results n = 20	Negative results n = 108	p
Age, median [Q25-75]	41.5 [35.0; 51.0]	40.0 [31.8; 47.5]	42.0 [36.0; 51.0]	0.37
Sex (male), n (%)	99 (77)	13 (65)	86 (80)	0.16
CKD Stage V - Transplanted, n (%)	86 (67)	17 (81)	69 (64)	0.4
First-degree nephropathy, n (%)	38 (30)	9 (45)	29 (27)	0.1
Consanguinity, n (%)	8 (6.3)	4 (20)	4 (3.7)	0.021
Extra-Renal diseases, n (%)	30 (23)	11 (55)	19 (18)	<0.001
African ancestry, n (%)	84 (66)	7 (35)	77 (71)	<0.01

SA-PO546

**Whole Genome Sequencing-Based Rare Copy-Number Variation Analysis in Patients With Proteinuric Kidney Disease**

Jihoon Yoon,<sup>1,3</sup> Anya Greenberg,<sup>1</sup> Ana C. Onuchic-Whitford,<sup>1,4</sup> Michelle McNulty,<sup>1</sup> Dongwon Lee,<sup>1,2</sup> Matt G. Sampson,<sup>1,2</sup> NEPTUNE <sup>1</sup>Boston Children's Hospital Department of Pediatrics, Boston, MA; <sup>2</sup>Harvard Medical School, Boston, MA; <sup>3</sup>Seoul National University College of Medicine, Seoul, Republic of Korea; <sup>4</sup>Brigham and Women's Hospital Department of Medicine, Boston, MA.

**Background:** Copy-number variants (CNVs), which have relatively larger effects than single nucleotide variants, are major drivers of diverse diseases and phenotypes, including congenital anomalies of the kidney and urinary tract. However, their contributions to nephrotic syndrome (NS) have not been systematically investigated. We addressed this through a whole genome sequence (WGS) based analysis of CNV in 619 pediatric and adult patients enrolled in the Nephrotic Syndrome Study Network (NEPTUNE).

**Methods:** WGS was performed at a depth of 30x. High-confidence CNV in coding regions were identified by integrating multiple detection methods. We used ACMG/ClinGen criteria to identify pathogenic CNV. We selected ancestry-matched controls from putatively healthy controls from the 1000 Genome Project (1KGP) by performing PCA analysis. We assessed the genome-wide distribution of rare (MAF < 0.1%) CNVs in cases and controls. We annotated CNV for the presence of known Mendelian steroid resistant nephrotic syndrome (SRNS) genes and those in the Online Mendelian Inheritance in Man (OMIM) database.

**Results:** There were no CNV (>1kb) impacting coding regions of Mendelian SRNS genes. There were 10 large CNVs (>100 kb) in 9 patients (1.4%) predicted as pathogenic/likely pathogenic based on the ACMG/ClinGen criteria. Case-control analyses revealed no difference in rare CNV burden (MAF < 0.1%). However, NEPTUNE patients had a 1.2x increased burden of coding CNV than controls (1.23 folds, P=0.02). Gene Ontology (GO) analysis of OMIM genes in case-only CNVs, identified enrichment in the lipid metabolism processes, particularly "lipase activity" (GO:0016298, FDR=4.6x10<sup>-3</sup>).

**Conclusions:** CNV impacting known Mendelian SRNS genes do not appear to be a major form of disease-associate genetic architecture. The relevance to NS of the pathogenic CNV detected in these patients needs to be determined. Preliminary case-control analysis suggests that CNV located in genes related to lipid metabolism may contribute to proteinuric kidney disease. Further characterization of these CNVs and expansion to non-coding regions is required.

**Funding:** NIDDK Support, Other NIH Support - DRDR1

SA-PO547

**Diagnostic Utility of the Targeted Next-Generation Sequencing Panel Test for Suspicious Genetic Glomerular Diseases**

Ji Hye Kim, Hajeong Lee. Seoul National University Hospital, Jongno-gu, Seoul, Republic of Korea.

**Background:** A substantial proportion of glomerular diseases has genetic background, but there is no solid guideline concerning genetic work-up. The targeted next-generation sequencing (NGS) gene panel can identify possible mutations causing genetic glomerulopathies. We evaluated the diagnostic utility of targeted NGS panel for glomerular diseases.

**Methods:** Patients who received targeted NGS panel from 2017 to 2021 were included. Our NGS panel covered 23 variants causing genetic glomerulopathies including collagenopathies (COL4A3, COL4A4, COL4A5, and MYH9), genetic nephrotic syndrome (ACTN4, ADCK4, ANLN, COQ2, COQ6, EMP2, INF2, NPHS2, NUP107, PLCE1, and TRPC6), and other syndromic diseases (NPHS1, LAMB2, LCAT, LMX1B, PAX2, SMARCAL1, WDR73, and WT1). Variants were classified according to American College of Medical Genetics and Genomics 2015 guideline. Diagnostic yield was calculated as positivity rate of pathogenic or likely pathogenic variants.

**Results:** A total of 111 patients were included. The median age of disease onset and of receiving test was 9.0 [3.0;22.5] and 17.0 [7.5;33.0] years. Among them, 50 had family history of kidney disease and 3 had congenital anomalies. Seventy-three patients received percutaneous kidney biopsy for their pathologic diagnosis. Overall diagnostic yield of targeted NGS panel was 36% and higher in patients with younger onset age (<18 years) than those older [44.7% vs 17.1%, p=0.03]. It was associated with previous kidney biopsy (adjusted odds ratio (aOR), 6.23; 95% confidence interval (CI), 1.21-32.06), hematuria (aOR, 4.68; 95% CI, 1.32-16.56), systolic blood pressure (aOR, 0.94; 95% CI, 0.88-0.99) and absence of edema (aOR, 0.05; 95% CI, 0-0.66) even after covariate adjustment. Among 40 patients with positive gene test results, 16 changed their diagnosis from initial pathologic diagnosis and 13 patients received new genetic diagnosis.

**Conclusions:** Targeted NGS panel test for genetic glomerular diseases was useful in genetic diagnosis with a modest diagnostic yield of 36%. Previous kidney biopsy, hematuria, low systolic blood pressure and absence of edema were associated with higher positivity rate.

SA-PO548

**Genetic Variances in Mesoamerican and Undocumented Immigrant ESRD Patients**

Mobolaji A. Obayomi, Jessie C. Fullmer, Henry J. Fan, George N. Coritsidis. Westchester Medical Center, Valhalla, NY.

**Background:** Dialysis clinics in the New York area treat a large population of undocumented immigrants (UIs) who originate or have heritage from Central and Northern South America, where renal failure includes the not yet understood Mesoamerican Nephropathy. Many are in the US for up to 6 years before awareness of CKD, often too late for proper diagnosis of pathogenesis. We were interested to see if certain underlying genetic mutations were more commonly found in UIs.

**Methods:** Patients were recruited prospectively from 5 dialysis units in New York from 2/1/22 focusing on patients whose heritage was from Latin America. Patients' buccal swabs were processed via Renasight genetic screening kits, which looks at 385 different genes related to kidney disease. The test is performed via buccal swab. Results are logged as pathogenic, carriers, or variants of unknown significance (VUS).

**Results:** Of 89 patients screened, 94.6% were UI's and 27.6% were under age 40. Overall positivity for pathogenic genes was 14% and 42% identified as carriers. There was an average of 6.9 VUS in each patient. The most common pathogenic gene was COL4A3 & 4 (8.62%) while the most common VUS genes were CACNA1H (13.4%), FRAS1 (8.6%), and TNS2 (8.6%).

**Conclusions:** An underlying pathologic genetic component that may be tied to patients of Latin American descent was seen at greater frequency in our UI population (14%) than that of the general public (10%). These patients had a multitude of different genetic abnormalities which may play a role in the early presentation and currently unknown origin of Mesoamerican Nephropathy. It is clear that further study of these genes are required.

**Funding:** Commercial Support - Natera

SA-PO549

**Underlying Genetic Causes of Adult Patients With ESKD Undergoing Hemodialysis Therapy**

Takuya Fujimaru,<sup>1</sup> Takayasu Mori,<sup>1</sup> Motoko Chiga,<sup>1</sup> Shintaro Mandai,<sup>1</sup> Fumiaki Ando,<sup>1</sup> Yutaro Mori,<sup>1</sup> Koichiro Susa,<sup>1</sup> Yuta Nakano,<sup>1</sup> Takao Shoji,<sup>2</sup> Yuichiro Fukudome,<sup>3</sup> Naoto Inaba,<sup>4</sup> Kenichiro Kitamura,<sup>4</sup> Taichi Nakanishi,<sup>4</sup> Toshihiro Kimura,<sup>5</sup> Teiichi Tamura,<sup>5</sup> Kiyoshi Ozawa,<sup>5</sup> Shinichi Uchida,<sup>1</sup> Eisei Sohara.<sup>1</sup> <sup>1</sup>Tokyo Medical and Dental University, Tokyo, Japan; <sup>2</sup>Miura Seaside Clinic, Kanagawa, Japan; <sup>3</sup>Zushi Sakurayama Clinic, Kanagawa, Japan; <sup>4</sup>Kitakurihama Takuchi Clinic, Kanagawa, Japan; <sup>5</sup>Yokosuka Clinic, Kanagawa, Japan.

**Background:** Recent progress of genetic studies gradually reveals true causes of chronic kidney disease (CKD). In the general CKD population, it has become clear that about 10% of patients carry some responsible genetic variants, and further most of them are limited genes such as PKD1, PKD2, or COL4As. End-stage kidney disease (ESKD)

is the ultimate phenotype of CKD, and conducting genetic analysis focusing on the population undergoing hemodialysis leads to the evaluation of key genes that have an influence on ESKD. To clarify underlying true cause of adult patients with ESKD, we performed panel-based comprehensive genetic analysis on hemodialysis patients.

**Methods:** Four dialysis clinics in Japan were included. The study was limited to patients who were introduced to hemodialysis during adulthood between the ages of 20 and 49. Of the 238 patients, the patients with a clear diagnosis of primary disease for ESKD were excluded, and 114 patients were included our study. Comprehensive genetic testing was performed using capture-based next-generation sequencing for 212 genes responsible for hereditary kidney diseases.

**Results:** Eleven patients (12%) out of the 92 were elucidated to have responsible gene variants, leading to definite genetic diagnosis. Of them, 6 and 1 patients carried causal pathogenic variants in *PKD1* and *NPHP1*, respectively. One of the patients with the *PKD1* variant also had the *COL4A4* pathogenic variant. All with *PKD1* variants did not have family history of kidney cysts. In addition, 4 patients, FSGS due to *WT1* variant, ADTKD due to *UMOD* variant, Alport syndrome due to *COL4A3* and *COL4A4* variants, and Fabry disease due to *GLA* variant were included. With the exception of polycystic kidney disease, these diagnoses had not been clinically obtained.

**Conclusions:** Focusing on ESKD patients, the proportion of those with a genetic cause was high. Among the patients who have been introduced to dialysis in adulthood, there are various kinds of undiagnosed hereditary renal diseases. From the viewpoint of genetic counseling and complication management, accurate diagnosis by comprehensive genetic analysis is extremely important.

**Funding:** Government Support - Non-U.S.

## SA-PO550

### Korean Cohort of Genetic Kidney Diseases

Hyeon Ah Woo,<sup>1</sup> Hee Gyung Kang,<sup>1</sup> Yo Han Ahn,<sup>1</sup> Jeesu Min,<sup>1</sup> Naye Choi,<sup>1</sup> Hyeonju Lee,<sup>1</sup> Haemin Kang,<sup>1</sup> Seon Hee Lim,<sup>3</sup> Ji hyun Kim,<sup>2</sup> <sup>1</sup>Seoul National University Hospital, Jongno-gu, Seoul, Republic of Korea; <sup>2</sup>Seoul National University Bundang Hospital, Seongnam, GyeongGi, Republic of Korea; <sup>3</sup>The Korean Society of Nephrology, Seoul, Republic of Korea.

**Background:** Genetic causes comprise a significant proportion of chronic kidney diseases (CKD). According to ethnicity, the composition can vary. Here, we report on Korea's nationwide composition of genetic kidney diseases in Korea.

**Methods:** In this multicenter cohort study, we investigated the genetic diagnosis of Korean patients with known or putative genetic kidney diseases and CKD of unknown origin. For known genetic kidney disease patients, clinical information, causative genes, and their responsible variants were collected, and for those without a genetic diagnosis, whole-exome sequencing was applied for genetic diagnosis.

**Results:** Genetic causes were identified in 1040 patients (male:female=1.3:1). Clinical diagnosis of genetic kidney diseases of Korea were as follows. Glomerulonephritis (24.9% of 1040 patients), tubulopathy (24.4%), cystic kidney disease (4.8%), and others (45.9%) including hypophosphatemic rickets or renal glycosuria. 118 genes were identified and the most common causative genes of Korean genetic kidney diseases were as follows. In glomerulonephritis: *COL4A5* (53.7% of glomerulonephritis), *NPHS1* (5.0%), *NUP107* (5.0%), *COL4A4* (4.6%), *WT1* (4.6%), *COL4A3* (4.2%), and others. In tubulopathy: *SLC12A3* (33% of tubulopathy), *AVPR2* (15%) *CLCN5* (15%), *CLCNKB* (11.4%), *OCRL* (11%), and others. In cystic kidney disease: *PKD1* (20% of cystic kidney disease), *PKHD1* (16%), and others. In others: *PHEX* (10% of others), *SLC5A2* (6.9%), and others. For 201 cases of CKD with unknown origin, 71 cases (35.3% of the unknown origin CKD patients) obtained genetic diagnosis using whole-exome sequencing, identifying pathogenic or likely-pathogenic variants in *COL4A5* (n=11, 15.5% of 71 cases), *COL4A4* (n=10), *PAX2* (n=5), *COL4A3* (n=4), *CUBN* (n=3), *NPHS1* (n=3), *WT1* (n=3), and others. Compared to the literature, prevalence of NPHP2 was lower than the reports of Caucasian, and distal renal-tubular acidosis was lower than the reports of Southern Asia.

**Conclusions:** Identifying the characteristics of genetic kidney diseases of a certain ethnicity through establishing a national registry would facilitate early diagnoses and proper management of these rare kidney diseases.

**Funding:** Government Support - Non-U.S.

## SA-PO551

### Biallelic Variants in TULP3 Cause Variable Onset Liver Cirrhosis and Kidney Failure With Defective Ciliary Cargo Composition and DNA Damage Repair

John A. Sayer,<sup>1,2</sup> John Devane,<sup>3</sup> Elisabeth B. Ott,<sup>3</sup> Daniel Epting,<sup>3</sup> Eric G. Olinger,<sup>1</sup> Carsten Bergmann,<sup>3,4</sup> <sup>1</sup>Newcastle University Faculty of Medical Sciences, Newcastle upon Tyne, United Kingdom; <sup>2</sup>Freeman Hospital, Newcastle upon Tyne, United Kingdom; <sup>3</sup>Albert-Ludwigs-Universität Freiburg Medizinische Fakultät, Freiburg, Germany; <sup>4</sup>Medizinische Genetik Mainz, Mainz, Germany.

**Background:** Several pathways governed by the primary cilium have been linked to human disease. Among them is autosomal recessive polycystic kidney disease (ARPKD), characterized by early-onset kidney failure in association with ductal plate malformation and hepatic fibrosis. So far, only two ciliary genes have been implicated in the ARPKD spectrum.

**Methods:** We used a combination of massive parallel sequencing with clinical, imaging and histopathological analysis in unsolved patients with features of ARPKD. Mechanistic studies were conducted in different cell models including patient-derived primary cells. This research was made possible through access to the data and findings

generated by the 100,000 Genomes Project (100kGP) (<http://www.genomicsengland.co.uk>).

**Results:** We report a 68-year-old female with a history of liver transplantation (aged 41 years) due to biliary cirrhosis and chronic kidney disease with multiple small cortical and medullary kidney cysts. Through whole genome sequencing analysis, we identified a homozygous missense variant affecting a functionally relevant amino acid in *TULP3*, encoding tubby-like protein 3 implicated in ciliary trafficking of various membrane proteins. Through 100kGP and international collaborators, a further 7 families with matching phenotypes and biallelic *TULP3* variants were detected. Patients (n=15) showed a wide range of disease onset (4-33 years) and presented with progressive liver fibrosis, fibrocystic kidney disease and histologically atypical hypertrophic cardiomyopathy. End-stage liver and kidney disease mostly occurred in adulthood. In several patient-derived cell systems, we identified disrupted ciliary cargo composition, including several proteins previously linked with hepatic fibrosis and cystic kidneys in humans and mice. *Ex vivo* pathway analyses demonstrated aberrant DNA damage repair and upregulation of profibrotic pathways with gene clusters for hypertrophic cardiomyopathy, WNT and TGF- $\beta$  signalling.

**Conclusions:** These findings identify a novel monogenic cause for a recessive progressive degenerative disease of major organs including the kidney in which affected individuals may benefit from early detection and improved clinical management.

## SA-PO552

### Underrecognition and Treatment of Autosomal Dominant Alport Syndrome in a Health System-Based Research Cohort

Kaushal V. Solanki,<sup>1</sup> Bryn S. Moore,<sup>1</sup> Natasha T. Strande,<sup>1</sup> Ion D. Bucaloiu,<sup>1</sup> Alex R. Chang,<sup>1</sup> *Geisinger Health, Danville, PA.*

**Background:** Autosomal Dominant (AD) Alport Syndrome (AS) is increasingly recognized as a cause of chronic kidney disease and end-stage kidney disease (ESKD). It is unknown to what extent patients with ADAS are undiagnosed and whether they may benefit from diagnosis early in the disease course. We sought to assess whether a genetic diagnosis for ADAS was made and whether there were missed opportunities for treatment in a research cohort of participants with whole-exome sequencing data.

**Methods:** We used data from Geisinger MyCode-DiscovEHR, an unselected health system-based cohort with exome sequencing data linked to electronic health records (EHR). We identified participants heterozygous for rare (minor allele frequency <0.001) *COL4A3* pathogenic (P) or likely pathogenic (LP) variants listed in ClinVar. Chart reviews were performed focusing on the diagnosis of ADAS, AS-related features and diagnoses, genetic testing, renal biopsy pathology, treatment with angiotensin-converting enzyme inhibitors (ACEis) or angiotensin receptor blockers (ARBs), urologic workup for hematuria, family history (AS, thin basement membrane disease, and hereditary nephritis).

**Results:** There were a total of 402/174,418 patients heterozygous for P/LP *COL4A3* variants. Mean age was 59 (SD 18.7) years, 64% were female, 56% had ICD-code diagnoses for hypertension, 22% had diabetes, 7.2% had eGFR <30 ml/min/1.73m<sup>2</sup>, and 5.7% had ESKD. Over a median follow-up time of 15 years, only 118 (29%) had quantitative albuminuria testing. Only 4 patients had a clinical diagnosis of AD Alport Syndrome, 5 had documented family history, and 4 had history of kidney biopsy. Among the 338 (84%) who had urinalysis data available, 166 (49%) had trace or greater hematuria. 81 individuals had undergone urologic workup for hematuria. Of the 118 (29%) with albuminuria data, 42% had albuminuria  $\geq$ 30mg/g and 17% had albuminuria  $\geq$ 300 mg/g. ACEi/ARBs were underutilized in the overall population (24.5%), and even for those with hypertension (39.3%), and those with albuminuria (32.4%).

**Conclusions:** Very few patients with AD Alport Syndrome in a large health system-based research cohort had a diagnosis of ADAS, and a minority of patients were receiving guideline-recommended treatment with ACEis. Future studies should examine the benefits vs. risks of early diagnosis of ADAS.

**Funding:** NIDDK Support

## SA-PO553

### Refractory Focal Segmental Glomerulosclerosis: A Presentation of Alport Syndrome

Kenan M. Alrejjal,<sup>1,2</sup> Umayma Abdullatif,<sup>1</sup> Lauren Beretich,<sup>4</sup> Michelle Bloom,<sup>4</sup> Sumit Punj,<sup>4</sup> Abdul A. Abdellatif.<sup>3,1</sup> <sup>1</sup>CLS Health, Houston, TX; <sup>2</sup>MedStar Georgetown University Hospital MedStar Washington Hospital Center Internal Medicine Residency Program, Washington, DC; <sup>3</sup>Baylor College of Medicine, Houston, TX; <sup>4</sup>Natera, Inc., Austin, TX.

**Introduction:** Alport syndrome (AS) is a genetic condition caused by variants in the *COL4A3/4/5* genes. While classically characterized by progressive kidney disease, hearing loss, and ocular abnormalities, the use of genetic testing has expanded our understanding of the AS phenotype. Individuals with AS, notably autosomal dominant, are also known to present with benign hematuria, thin basement membrane nephropathy, and focal segmental glomerulosclerosis (FSGS) with or without extrarenal manifestations. The purpose of this study was to describe a case of FSGS refractory to multiple immunosuppressive regimens that was later diagnosed as AS.

**Case Description:** A 38-year-old Caucasian female with a history of biopsy-proven FSGS at 19 years of age with severe nephrotic syndrome. The patient was refractory to multiple lines of immunosuppressive therapy. Furthermore, an eye exam revealed keratoconus. These findings along with her family history of kidney conditions prompted genetic testing with a panel of 385 genes (the Renasight™ test) to help understand the etiology of her renal presentation and to determine further management. Genetic testing identified a heterozygous, likely pathogenic variant (c.1565G>A, p.Trp522\*) in *COL4A4*, associated with AS. This variant is predicted to result in a stop-gain in exon 22 of the

Key: TH - Thursday; FR - Friday; SA - Saturday; OR - Oral; PO - Poster; PUB - Publication Only

Underline represents presenting author.

*COL4A4* gene. While c.1565G>A (p.Trp522\*) is private to this family, other putative loss-of-function variants downstream of this position have been reported to be pathogenic. The patient's 10 year old daughter was also found to have hematuria, and was subsequently found to have the familial variant in *COL4A4*.

**Discussion:** This case exemplifies the variable presentation of AS and the value of genetic testing for the proband and their family. The patient's condition was reclassified, enabling appropriate intervention, treatment resistance assessment and family testing. In addition, the patient's daughter received an early diagnosis, guiding future treatment plans and options while avoiding unnecessary risk exposure. The family's genetic diagnosis allowed for accurate genetic risk assessment and may increase access to targeted treatments or clinical trials in the future. Ultimately, genetic testing should be considered for individuals with FSGS, given the association with AS and other genetic conditions.

## SA-PO554

### Elucidating the Genetic Architecture of Microscopic Hematuria

Aditi Mhaske, Omid Sadeghi-Alavijeh, Mallory L. Downie, Melanie M. Chan, Daniel P. Gale. *University College London Department of Renal Medicine, London, United Kingdom.*

**Background:** Microscopic hematuria is commonly found during routine urine analysis and may be unrelated to exercise, trauma to the urogenital tract and menstruation. The most common glomerulopathies associated with this finding are IgA nephropathy and type IV collagen defects including Alport syndrome (AS). To elucidate the genetic architecture and identify potential disease-causing variants we used the whole genome sequencing and the phenotypic information from the 100,000 Genomes Project (100KGP) database.

**Methods:** Genome wide association studies (GWAS) were performed on two cohorts. Cohort one represent the 137 probands recruited with familial hematuria, cohort two comprised 3459 patients with hospital episode statistics (HES) data coding for at least one episode of microscopic hematuria. Both cohorts were ancestry matched to ~45,000 controls inclusive of individuals with diverse genetic ancestry. Enrichment of common, low-frequency (minor allele frequency [MAF] > 0.1%) and rare (MAF < 0.1%) single-nucleotide variant (SNV), indel and rare structural variant (SV) alleles on a genome-wide and per-gene basis was sought using a generalised linear mixed model approach to account for population structure.

**Results:** In the gene-based analyses we identified *COL4A4* ( $p=6.21E-10$ ,  $MAF=0.00040$ ) as significantly associated with hematuria. This signal was driven by a stop gain variant that exhibits a founder effect in collagenopathies (rs35138315). The genome wide variant analysis of over 9 million variants in both cohorts did not reveal any statistically significant loci.

**Conclusions:** This study provides insights on the genetic landscape of hematuria in a national health system. The pathogenic rs35138315 mutation in *COL4A4* was also reported recently in a larger cohort of hematuria patients from the UK Biobank. Variants in *COL4A4* account for a large proportion of microscopic hematuria at the population level.

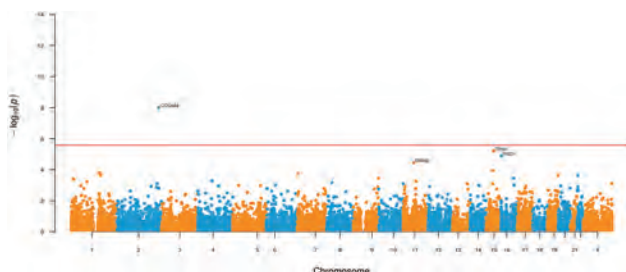

Figure 1 - Rare variant Manhattan showing *COL4A4* as being significantly associated with hematuria

## SA-PO555

### Clinical and Diagnostic Utility of Genetic Sequencing for Children With Microscopic Haematuria in a Kidney Genomics Clinic

Josiah Shanks,<sup>1</sup> Catherine Quinlan,<sup>1,2</sup> <sup>1</sup>Department of Nephrology, Royal Children's Hospital, Melbourne, VIC, Australia; <sup>2</sup>Kidney Flagship, Murdoch Children's Research Institute, Melbourne, VIC, Australia.

**Background:** Microscopic haematuria (MH) in children is associated with the risk of progression to chronic kidney disease. Genetic disease including Alport syndrome is an important potential aetiology.

**Methods:** We conducted a retrospective review of the electronic medical records of patients referred to a Kidney Genomics Clinic (KGC) with MH from 2016 to 2021; this period covers both pre- and post-government funded genomic sequencing for MH. Data were collected including demographics, investigations and diagnosis prior to referral, tests undertaken by the clinic, and the diagnostic and clinical utility of these genetic tests.

**Results:** Sixty patients were referred to the KGC with MH over a six-year period. Mean age at referral was 8.8 years and most (73%) were referred for diagnosis of an undifferentiated disease. At time of review, 10 (17%) patients' genetic results were outstanding. Of those with results, 26 (52%) received a genetic diagnosis for their haematuria. The most common diagnosis was X-linked Alport Syndrome (12/26, 46%), followed by Autosomal Dominant Alport Syndrome (10/26, 38%), and two cases each of

Autosomal Recessive Alport Syndrome and Dent's disease. 11/50 (22%) had a variant of uncertain significance (VUS) in a phenotypically concordant gene. The diagnostic yield dropped from 74% to 36% after the introduction of government-funded genomic sequencing for paediatric MH. The average degree of haematuria and proteinuria also decreased after the introduction of government-funding for genomic sequencing suggesting the bar for testing has been lowered. We found a higher diagnostic yield of 54% amongst male patients compared to 28% amongst female patients, despite females being affected twice as often by X-linked disease than males.

**Conclusions:** Our KGC review highlights the substantial clinical utility of genetic analysis for microscopic haematuria in paediatric patients and the important role that government-funded genomic sequencing can play in providing equitable and early access to gold standard testing. The testing is non-invasive and has a high diagnostic yield. A multidisciplinary team including appropriate genetic counselling can help ensure these patients are followed up meaningfully.

## SA-PO556

### New Insights on the Clinical Manifestations of *COL4A4* Genetic Variants: A UK Biobank Analysis

Silvia M. Titan,<sup>1</sup> Alexandre da Costa Pereira,<sup>2</sup> <sup>1</sup>Nephrology Division, Sao Paulo University Medical School, Sao Paulo, Brazil; <sup>2</sup>Harvard Medical School, Boston, MA.

**Background:** The spectrum of clinical manifestations of *COL4A4* is wide, with mutations in this gene being reported to be associated with Alport, thin membrane disease, and no kidney disease. Current literature is largely derived from phenotype-centered analysis but genetic data from population studies offer us the opportunity to investigate the associations of genotypes and phenotypes in an unbiased manner. In this study, we aimed at describing the association of *COL4A4* variants with albuminuria and other phenotypes in a large population study.

**Methods:** We used data from 200,069 UK-Biobank (UKB) participants with WES data to establish the prevalence of coding variants in *COL4A4*. We conducted burden analysis using SAIGE-GENE and WES and albuminuria data from 60,699 individuals adjusting for age and sex. Multiple iterations of conditional adjustment were applied to derive a set of independently associated genetic variants. Associated variants were annotated for their current ACMG classification using the ClinVar database. Finally, we explored other trait associations for selected variants.

**Results:** Of the 2988 unique variants within the *COL4A4* gene region, 1091 were coding: 56 LOF, 720 missense (434 damaging missense), and 315 synonymous. Rare variants in the coding region of *COL4A4* were significantly associated with albuminuria in burden analysis ( $p$ -value =  $8e-22$  for LOF, and  $2e-10$  for missense). Most burden signals for albuminuria at the population level could be explained by only 3 variants: rs35138315 (a stop-gain variant seen in 1:1000 individuals), rs36121515 (a missense variant seen in 1:300 individuals), and rs79143859 (a missense variant seen in 1:300 individuals). While rs35138315 is classified in ClinVar as pathogenic for recessive Alport disease, both rs36121515 and rs79143859 are currently classified as benign. In addition, rs36121515 was significantly associated with hearing-related phenotypes and rs79143859 with eye-related phenotypes, suggesting potentially pleiotropic manifestations of Alport disease.

**Conclusions:** Based on the findings of this large-scale population study, we suggest that rs35138315, rs36121515, and rs79143859 can be disease-modifying variants and should be further characterized regarding pathogenicity.

## SA-PO557

### Immunohistochemistry Staining of Type-4 Collagen Does Not Predict the Expression of *COL4A3/4/5* in a Genomic Variant of Focal Segmental Glomerulosclerosis

Suramath Isaranuwatchai,<sup>1,2</sup> Pongpratch Puapatanakul,<sup>1</sup> Jerasit Surintprantont,<sup>1</sup> Koonpong Iampenkhae,<sup>1</sup> Jutamad Makyoo,<sup>1</sup> Thiamjit Chaichana,<sup>1</sup> Ankanee Chanakul,<sup>1</sup> Talerngsak Kanjanabuch,<sup>1</sup> Kearkiat Praditpornsilpa,<sup>1</sup> <sup>1</sup>Chulalongkorn University, Bangkok, Thailand; <sup>2</sup>Chulabhorn Hospital, Bangkok, Thailand.

**Background:** Focal segmental glomerulosclerosis (FSGS) is one of the kidney diseases with high rate of monogenic mutation. Variants in *COL4A3*, *COL4A4*, and *COL4A5* genes were reported to be the most common cause of FSGS. We conducted an immunohistochemistry (IHC) staining of  $\alpha3(IV)$  and  $\alpha5(IV)$  collagen to see the correlation with the expression of *COL4A3/4/5* and genetic variants of FSGS patients.

**Methods:** Whole-exome sequencing of FSGS patients were analyzed for *COL4A3/4/5* variants and classified by American College of Medical Genetics guideline. Paraffin blocks of FSGS patients with variants in *COL4A3/4/5* genes were recruited and went through IHC staining protocol. We used normal allograft kidney as positive control and confirmed Alport's syndrome case as negative control.

**Results:** Eighteen FSGS patients with variants in *COL4A3/4/5* genes were identified. One patient had a novel pathogenic variant (c.905delG, p.Gly302ValfsTer23) in *COL4A4* gene. Another patient had a known likely pathogenic variant (c.2752G>A, p.Gly918Arg) in *COL4A4* gene. Both of them had positive staining of  $\alpha3(IV)$  and  $\alpha5(IV)$  collagen, which means both patients express  $\alpha3(IV)$  and  $\alpha5(IV)$  collagen in their glomerular basement membrane (GBM), contradicting with our hypothesis that pathogenic variants should result in negative staining. Ten patients had variants of uncertain significance which six of them had positive staining and four of them had equivocal staining. Six patients had benign or likely benign variants in *COL4A3/4/5* genes which four of them had positive staining and two of them had equivocal staining.

**Conclusions:** FSGS patients with COL4A3/4/5 genes variants all had  $\alpha 3(IV)$  and  $\alpha 5(IV)$  collagen expression in their GBM. The expression of  $\alpha 3(IV)$  and  $\alpha 5(IV)$  collagen by IHC staining was not correlated with COL4A3/4/5 genes variant classified by ACMG criteria.

**Funding:** Government Support - Non-U.S.

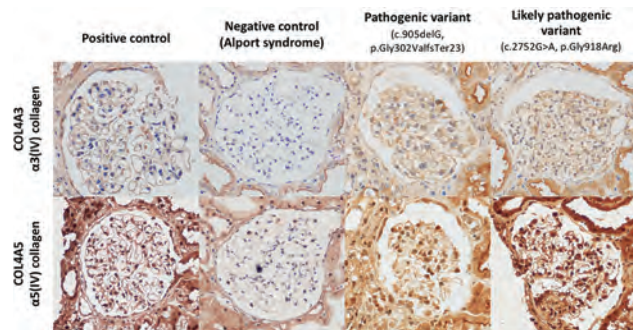

Figure 1: Immunohistochemistry staining of  $\alpha 3(IV)$  and  $\alpha 5(IV)$  collagen

SA-PO558

**Potentially Clinically Relevant Variant of Uncertain Significance in the COL4A5 Gene**

Teresa Trinka,<sup>1</sup> Kerry Gaj,<sup>3</sup> Quinn P. Stein,<sup>3</sup> Sumit Punj,<sup>3</sup> Mohammed Khurram Faizan.<sup>2,1</sup> <sup>1</sup>The Warren Alpert Medical School at Brown University, Providence, RI; <sup>2</sup>Hasbro Children's Hospital, Providence, RI; <sup>3</sup>Natera, Inc., Austin, TX.

**Introduction:** Genetic testing is an emerging tool for patient management in the field of Nephrology. Numerous studies highlight the benefits of using broad, unbiased genetic panels compared to smaller, targeted panels based on the clinical presentation of the disease, due to the often complex and variable presentation of many renal disorders. Alport syndrome (AS) is an inherited disease caused by pathogenic variants in the COL4A3/4/5 genes that encode collagen IV components respectively. In AS, a spectrum of phenotypes ranging from isolated hematuria with non-progressive renal disease to progressive renal disease with extrarenal abnormalities is observed. Here we report our findings of a variant of uncertain significance (VUS) in the COL4A5 gene in four family members.

**Case Description:** Patient 0 was a 16 y/o female, initially presenting with microscopic hematuria and marginally elevated urine protein to creatinine ratio. The patient's physical exam was unremarkable with normal blood pressure and SCr levels. However, the patient's mother and maternal aunt both had a lifelong history of microscopic hematuria. The maternal grandfather had lifelong kidney disease, for which he received a kidney transplant at the age of 50. All four patients underwent genetic testing with a next generation sequencing (NGS)-based panel consisting of 385 genes associated with kidney disease (the Renasight™ test). No positive genetic findings were identified in the patients; however, a VUS, c.276+2dup, in the COL4A5 gene was identified in all four members.

**Discussion:** In the family presented here, genetic testing provided an intimation of a possible cause and inheritance pattern for kidney disease and hematuria. Genetic testing for Patient 0 gave rise to cascade testing in 3 additional family members to date, with the potential for testing of other affected family members. The VUS identified is predicted to affect the highly conserved splice donor site for exon 4. Functional studies are necessary to determine the impact of this variant and to invoke stronger evidence for reclassification. To our knowledge, this variant has not been reported to be associated with AS and is absent from population databases. However, based on the clinical presentation of these patients and the lack of other positive genetic findings, this VUS is suspicious and warrants further investigations.

SA-PO559

**Clinical and Genetic Features of Autosomal Dominant Alport Syndrome: A Cohort Study in China**

Ningning Hu,<sup>1</sup> Dai Xuantong,<sup>1,2</sup> Fujun Lin,<sup>1,2</sup> Gengru Jiang.<sup>1,2</sup> <sup>1</sup>Shanghai Jiaotong University School of Medicine Xinhua Hospital, Shanghai, China; <sup>2</sup>Centre for Rare Disease, Shanghai, China.

**Background:** Patients carrying pathogenic heterozygous COL4A3 /COL4A4 mutations, considered to have autosomal dominant Alport syndrome (ADAS), account for nearly 1% of the population. ADAS patients show a wide spectrum of disease, extending from familial isolated microscopic hematuria to end-stage renal disease (ESRD). The aim of this study was to evaluate the clinical and genetic spectrum of Chinese ADAS patients.

**Methods:** 106 families with ADAS referred from 11 Chinese hospitals between 2006 and 2022 were retrospectively studied. Clinical, genetic, laboratory, and pathological data were collected.

**Results:** Of the cohort of 221 patients, 66 (29.9%) patients were under the age of 18. Microhematuria was present in 98.2% patients, and extrarenal features were rare. 118 (53.4%) patients developed proteinuria [mean age 24.39±16.64 years], 58 (26.2%) with progression toward chronic kidney disease (CKD) 2 and more advanced CKD stages at a mean age of 41.07±13.62 years (22 required kidney replacement therapy at the mean age of 48.05±11.92 years). 49 patients underwent kidney biopsy: findings were consistent

with classic Alport syndrome in 12 cases, with diffuse thin basement membrane in 12 cases and with focal segmental sclerosis in 10 cases. 90 pathogenic heterozygous COL4A3 /COL4A4 mutations were identified and 45 (50%) were Glycine substitution missense mutations. Genotype-phenotype correlation analysis only revealed a significant difference regarding progression toward CKD2 when comparing patients with Glycine mutation located in exons 1-20 and in exons 21 to carboxy terminus (P = 0.006).

**Conclusions:** Among Chinese patients carrying pathogenic heterozygous COL4A3 /COL4A4 mutations, a significant percentage is at risk for disease progression defined by the onset of proteinuria and renal function impairment. Thus, enhancing early diagnosis and timely intervention of ADAS must be considered to achieve optimal outcomes.

**Funding:** Government Support - Non-U.S.

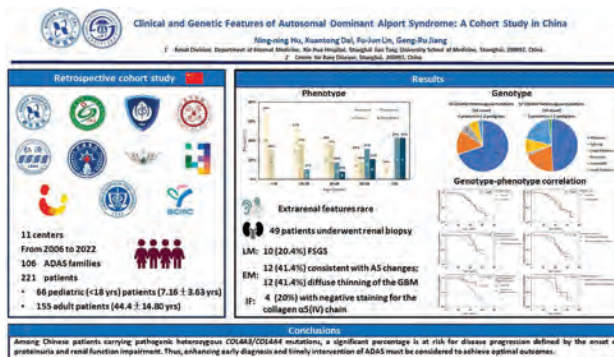

SA-PO560

**Genotype and Renal Outcomes in Alport Syndrome: A Retrospective Cohort Study Using National Registry of Rare Kidney Diseases (RaDaR) Data**

Katie Wong,<sup>1</sup> David Pitcher,<sup>1</sup> A. Neil Turner,<sup>4</sup> Kate Bramham,<sup>3</sup> Daniel P. Gale.<sup>2</sup> <sup>1</sup>UK Renal Registry, Bristol, United Kingdom; <sup>2</sup>University College London, London, United Kingdom; <sup>3</sup>King's College London, London, United Kingdom; <sup>4</sup>University of Edinburgh, Edinburgh, United Kingdom.

**Background:** Alport syndrome (AS) is the second commonest cause of inherited kidney failure, resulting from pathogenic variants in COL4A3, COL4A4, and COL4A5 genes. This study investigated the renal outcomes associated with pathogenic variant types in a UK cohort of patients diagnosed with AS.

**Methods:** RaDaR data is linked with the UK Renal Registry for renal outcomes and Regional Genetics hubs for genetics reports. Pathogenic variants were classified into 1) Non-protein length altering 2)Protein length altering. Kaplan-Meier analysis and the log rank statistic were used to compare survival curves, stratified by pathogenic variant type, for a) time between last eGFR  $\geq 90$  and last eGFR  $\geq 30$  ("therapeutic window") b) age at KRT start c) kidney transplant graft survival, censored for death. Analyses were run comparing variant type for 1) COL4A5 males 2) COL4A5 females 3) Heterozygous COL4A3 or COL4A4 variants 4) Homozygous or 2 COL4A3 or COL4A4 variants.

**Results:** Genetic report data were available for 182/914 (20%) AS patients recruited to RaDaR (Figure 1). 167/182 had a detected pathogenic mutation (92%). 46 (25%) underwent kidney transplantation. No significant difference in time to KRT by variant type was observed in males or females with COL4A5 variants (p=0.17, p=0.06 respectively). Graft survival and time in therapeutic window were not significantly different between variant type for any group.

**Conclusions:** We did not observe the previously reported correlation between variant type and renal outcomes in males with COL4A5 variants. Linkage of the RaDaR AS cohort with genetic report data is actively ongoing; further correlations may be observed with larger numbers.

Figure 1: RaDaR AS cohort genetic variants

	n	%
<b>Pathogenic variant type</b>		
<b>Protein length altering</b>		
Splice site	28	15
Stop gain	12	7
Frameshift	18	10
Deletions, insertions or deletion/insertion	12	7
Exon duplication/deletion	12	7
<b>Non protein length altering</b>		
Glycine substitution	69	38
Non glycine substitution	32	17
<b>Gene</b>		
<b>COL4A5 variants</b>		
Male	50	30
Female	40	24
<b>COL4A3 and COL4A4 variants</b>		
Heterozygous: 1 COL4A3 or COL4A4 variant	60	36
Homozygous or 2 COL4A3 or COL4A4 variants	16	10
<b>Digenic/Other</b>	1	1

Key: TH - Thursday; FR - Friday; SA - Saturday; OR - Oral; PO - Poster; PUB - Publication Only

Underline represents presenting author.



SA-PO561

**Heterogeneity in Electronic Health Record (HER) Phenotype Concepts in Collagen Type IV-Associated Nephropathies**

Jordan G. Nestor, Krzysztof Kiryluk, Chunhua Weng. *Columbia University, New York, NY.*

**Background:** Limited appreciation for the full spectrum of disease manifestations of collagen type IV-associated nephropathies (COL4A-AN) contributes to delays in diagnosis. Understanding the diversity of phenotypes is compounded by the heterogeneity of terms used to describe phenotype concepts in the EHR.

**Methods:** We extracted terms from published COL4A-AN case series and mapped them to concept unique identifiers (CUIs) in the Unified Medical Language System (UMLS). We identified 100 exome sequenced Columbia Biobank participants with diagnostic variant(s) in COL4A3/4/5 and performed a heuristic manual chart review. We counted the total number of unique concepts identified across structured (e.g., ICD9/10 and SNOMED-CT codes, etc.) and unstructured (e.g., clinical narratives, raw laboratory values, etc.) formats. Each encoded data element was mapped to standardized terminologies of the OMOP-Common Data Model. Then, we analyzed the diversity of codes used and conducted qualitative interviews with providers on billing practices.

**Results:** Most of the rich descriptions were documented within the text of clinical narratives written by kidney experts. In addition, a review of the raw urinalysis data revealed temporal, diagnostic evidence of hematuria in nearly half the cohort. Across structured data formats, we found numerous billing codes used to document particular concepts, such as hematuria and hearing loss. Through qualitative interviews, we found that nephrologists selected codes that reflected the primary disease addressed in the visit and ones that demonstrated the medical complexity of the patient's disease to maximize reimbursement.

**Conclusions:** EHR data heterogeneity is an obstacle to the development of accurate and valid phenotype algorithms for COL4A-AN and should be accounted for in EHR phenotyping. Extracting concepts from clinical text using natural language processing techniques, in addition to structured data elements like billing codes, may prove useful.

**Funding:** Other NIH Support - KL2TR001874

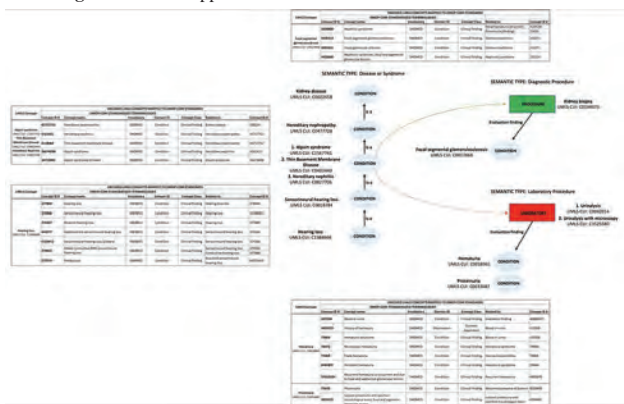

UMLS Concept Map for COL4A-AN

SA-PO562

**Aberrant Splicing Affected by Single Nucleotide Variants Positioned at the Second and Third to the End of Exons in COL4A5 Gene**

Eri Okada, Yuya Aoto, Tomoko Horinouchi, Tomohiko Yamamura, Kandai Nozu. *Kobe Daigaku, Kobe, Japan.*

**Background:** As it has become more evident that male patients with X-linked Alport Syndrome show obvious genotype-phenotype correlation, it has been of great importance to clarify the impact on aberrant splicing caused by identified variants. We previously reported that single nucleotide variants (SNVs) at the last nucleotide of exons in COL4A5 gene highly cause aberrant splicing. It is generally considered that the 2nd and 3rd to the last nucleotides of exons can also play an important role in the first step of splicing process. The aim of the recent study is to investigate aberrant splicing affected by SNVs positioned at 2nd or 3rd to the last nucleotide of exons in COL4A5 gene.

**Methods:** We selected 8 candidate variants: 6 from Human Gene Mutation Database Professional and 2 from our cohort. We performed in vitro splicing reporter assay and reverse transcription polymerase chain reaction (RT-PCR) for messenger RNA obtained from the patients if available.

**Results:** Initial classification of the candidate variants was as follows: 3 nonsense, 2 missense and 3 synonymous. Splicing reporter assay and RT-PCR for messenger RNA revealed that 6 of 8 variants caused aberrant splicing. Four variants initially assessed as non-truncating variants were revealed to be truncating variants. One variant (No.7, c.685A>T, p.Lys229\*) generated not only normal transcript but also aberrant transcript, which resulting in in-frame deletion.

**Conclusions:** We revealed that exonic SNVs positioned at the 2nd and 3rd to the last nucleotide of exon in COL4A5 gene can highly cause aberrant splicing. Minigene splicing assay is useful to confirm the effect of variants on aberrant splicing especially for genes

that genotype-phenotype correlation is evident like COL4A5 gene to predict the patients' prognosis.

No.	Variant			cDNA analysis (patients' sample)	Minigene splicing reporter assay		
	Exon (bp)	Nucleotide	Protein		splicing outcome	Protein effect	
<b>2nd to the last nucleotide</b>							
1	27 (105)	c.2145A>G	p.Lys715=	/	exon27 skipping	p.[Asp682_Gly716del]	
2	29 (151)	c.2394A>T	p.Lys798Asn		exon29 skipping	p.[Gly749Valfs*20]	
3		c.2394A>G	p.Lys798=	exon29 skipping	p.[Gly749Valfs*20]		
4	48 (178)	c.4687C>T	p.Arg1563*	normal splicing	normal splicing	p.[Arg1563*]	
5	50 (173)	c.4975A>G	p.Ser1659Gly	/	exon50 skipping	p.[His1602*]	
<b>3rd to the last nucleotide</b>							
6	9 (81)	c.544C>T	p.Gln182*	/	normal splicing	p.[Gln182*]	
7	12 (42)	c.685A>T	p.Lys229*	/	normal splicing	p.[Lys229*]	
				exon2 skipping	p.[Asn217_Gly230del]		
8	50 (173)	c.4974C>T	p.Phe1658=	exon50 skipping	exon50 skipping	p.[His1602*]	

Candidate variants and splicing outcome

SA-PO563

**Podocalyxin (PODXL) Nonsense Variant in Patients With Atypical Adult-Onset Focal Segmental Glomerulosclerosis (FSGS)**

Monica Arnaldi, Dervla M. Connaughton. *Nephrology Division at Schulich School of Medicine & Dentistry, Western University Western University, London, ON, Canada.*

**Introduction:** Genetic kidney disease has been the focus of many investigative efforts, particularly in patients with adult-onset chronic kidney disease (CKD) and positive family history. FSGS is a podocyte-driven disease, that is the most frequent cause of CKD worldwide and regularly progresses to end-stage kidney disease (ESKD). The PODXL-encoded podocalyxin is a podocyte protein and a member of the CD34 family of stem cell sialomucins. It has recently been described in families with both recessive (compound heterozygous variants) and dominant forms of familial nephropathies. We detected a novel heterozygous nonsense variant in the PODXL gene c.1048C>T, p.(Arg350\*) in a family with atypical FSGS.

**Case Description:** We detected a novel heterozygous nonsense variant in the PODXL gene c.1048C>T, p.(Arg350\*) in a family with atypical FSGS. This variant was segregated in this family with 3 affected individuals with CKD all carrying the same variant. The patient is a 43-year-old woman, who was first diagnosed 29 years with proteinuria, peripheral edema, and normal creatinine level. A kidney biopsy raised the suspicion of FSGS with patchy podocyte effacement but no definite segmental sclerotic glomerular lesions were identified. There were some areas of thickening of the glomerular basement membranes and mild tubular atrophy and interstitial fibrosis. Initially, she commenced prednisone but had no response, treatment switched to mycophenolate but no response, then started on cyclosporine with low dose prednisone with a complete response followed by relapse. She was later switched to tacrolimus with partial response.

**Discussion:** Next-generation sequencing (NGS) technology can reveal the underlying etiology of disease in patients, where other diagnostic strategies have failed to confirm the diagnosis. In this case, histopathology following kidney biopsy raised the suspicion of FSGS but diagnosis could not be confirmed. Increased utilization of NGS is expected to increase diagnostic efficiency in patients with CKD, especially in patients with positive family history and/or young-onset ESKD. A definitive genetic diagnosis has important prognostic value to help understand these atypical subtypes of disease which may in turn impact treatment strategies for patients carrying particular genetic variants.

SA-PO564

**Genome-Wide Association Study (GWAS) Uncovers Novel Mechanisms and Potential Therapeutic Targets for IgA Vasculitis**

Lili Liu,<sup>1</sup> Li Zhu,<sup>2</sup> Sara Monteiro-Martins,<sup>3</sup> Francesca Zanoni,<sup>1</sup> Francesca Lugani,<sup>4</sup> Krzysztof Mucha,<sup>5</sup> Malgorzata Mizerska-wasiak,<sup>5</sup> Laureline Berthelot,<sup>6</sup> Jan Novak,<sup>7</sup> William E. Smoyer,<sup>8</sup> Robert J. Wyatt,<sup>9</sup> Raoul D. Nelson,<sup>10</sup> Anna Kottgen,<sup>3</sup> Ali G. Gharavi,<sup>1</sup> Hong Zhang,<sup>2</sup> Krzysztof Kiryluk,<sup>1</sup> <sup>1</sup>Columbia University Irving Medical Center, New York, NY; <sup>2</sup>Peking University First Hospital, Beijing, China; <sup>3</sup>Albert-Ludwigs-Universitat Freiburg, Freiburg im Breisgau, Germany; <sup>4</sup>The Giannina Gaslini Children's Hospital, Genova, Italy; <sup>5</sup>Warsaw University Medical Center, Warsaw, Poland; <sup>6</sup>INSERM, Paris, France; <sup>7</sup>The University of Alabama at Birmingham Department of Cell Developmental and Integrative Biology, Birmingham, AL; <sup>8</sup>Nationwide Children's Hospital, Columbus, OH; <sup>9</sup>The University of Memphis, Memphis, TN; <sup>10</sup>University of Utah Health, Salt Lake City, UT.

**Background:** IgA vasculitis (IgAV) is an immune complex-mediated leukocytoclastic vasculitis characterized by vascular deposition of IgA-containing immune complexes in the skin, gastrointestinal and glomerular capillaries. The exact pathogenic mechanisms of IgAV remain unclear and thus there are presently no targeted treatments.

**Methods:** We conducted a GWAS for IgAV in 8,098 individuals of European and East Asian ancestries including 2,170 IgAV cases and 5,928 controls. We performed

meta-analysis with dense imputation and fine-mapping of significant loci, followed by proteome-wide association studies (PWAS) and transcriptome-wide association studies. Whole blood RNA-seq data from 255 IgAV cases with matched genotype data were used for genome-wide expression QTL (eQTL) mapping. By integrative analysis of genetic and transcriptomic data, we investigated the consequences of IgAV risk alleles on gene function and regulation.

**Results:** In GWAS, we detected 3 genome-wide significant loci for IgAV. We confirmed a strong effect of the *HLA* locus (OR=1.55, P= 1.1x10<sup>-25</sup>) and we identified two novel non-*HLA* loci at chr.19q13.42 (OR=1.51, P=1.0x10<sup>-20</sup>) and chr.2q37.1 (OR=1.34, P= 2.2x10<sup>-09</sup>) loci. The *HLA* fine-mapping identified *HLA-DRB1* as the most likely culprit gene, with amino-acid position 11 conveying the greatest risk. The chr.19q13.42 locus colocalized with the eQTL for *FCAR* (PP4=0.95), encoding the Fc  $\alpha$  IgA receptor (CD89), with the risk allele being associated with increased *FCAR* expression in myeloid cells (P<sub>fold-adjusted</sub> = 1.6x10<sup>-09</sup>). Blood mRNA levels of *FCAR* in IgAV patients were 1.5-fold higher vs. controls (P=5.1x10<sup>-09</sup>). Four upstream regulators for *FCAR* differentially activated in IgAV cases vs. controls were identified using ARACNe3-based master regulator analysis. By PWAS, we additionally identified a distinct proteome-wide significant signal at the 1q21.3 locus that was suggestive in GWAS, and for which the risk allele was associated with increased blood levels of soluble IL6R.

**Conclusions:** Our genetic findings implicate roles for CD89 and IL6R in the pathogenesis of IgAV and nominate these genes and related pathways for future therapeutic targeting.

## SA-PO565

### Familial IgA Glomerulonephritis Is Commonly Caused by Pathogenic Variants Associated With Other Genetic Kidney Diseases

Philip A. Harraka,<sup>1</sup> Khalid Mahmood,<sup>2,3</sup> Heather G. Mack,<sup>4,5</sup> David Barit,<sup>1</sup> David Langsford,<sup>1</sup> Timothy J. Pianta,<sup>6,7</sup> Deb J. Colville,<sup>1</sup> Judith A. Savage.<sup>1</sup>  
<sup>1</sup>The University of Melbourne Department of Medicine, Northern Health, Melbourne, VIC, Australia; <sup>2</sup>Melbourne Bioinformatics, Melbourne, VIC, Australia; <sup>3</sup>The University of Melbourne Department of Clinical Pathology, Melbourne, VIC, Australia; <sup>4</sup>The University of Melbourne Department of Surgery in Ophthalmology, East Melbourne, VIC, Australia; <sup>5</sup>Department of Ophthalmology, Melbourne Health, Melbourne, VIC, Australia; <sup>6</sup>Department of Medical Education, University of Melbourne, Melbourne, VIC, Australia; <sup>7</sup>Renal Medicine, Northern Health, Melbourne, VIC, Australia.

**Background:** Genetic studies of families with IgA glomerulonephritis have implicated pathogenic variants in *COL4A3-5* and *SPRY2* but in few other genes. We have recently identified retinal drusen in IgA glomerulonephritis which is further evidence for complement activation. This study investigated familial IgA disease for pathogenic variants in five candidate gene lists including those reported in IgA nephropathy (102 genes), the complement system (56), drusen in macular degeneration (46), Alport syndrome (3) and FSGS (47).

**Methods:** Eight unrelated individuals with familial IgA nephropathy were recruited. Family members were examined for haematuria, proteinuria and eGFR. IgA nephropathy was biopsy-proven in the index case and some relatives. Whole exome sequencing of available members in each family was performed and variants curated using the GATK Best Practices pipeline. Variants were examined for a CADD score  $\geq 10$  and a minor allele frequency  $< 0.05$  in gnomAD, and pathogenic assessments made according to the ACMG criteria. Assessments included pathogenic features in in-silico prediction algorithms ( $\geq 2$  of PolyPhen-2, SIFT, MutationTaster) and conservation of the affected residue in vertebrates (UCSC Genomics Institute).

**Results:** Damaging variants were identified in four families (50%) consistent with Alport syndrome in two (*COL4A3*, *COL4A5*), Renal Cysts And Diabetes syndrome (*HNF1B*) in one and C9 deficiency (*C9*) in one. The *COL4A3* variant (p.Gly395Glu) was Likely pathogenic (PP5, PM1, PM2, PP2, PP3) and previously associated with AD Alport syndrome and haematuria. The *COL4A5* variant (p.Gly624Asp) is a common hypomorphic variant (PP5, PM1, PM5, PP2, PP3) causing late onset X-linked Alport syndrome. The *HNF1B* variant (p.Pro437Leu) is Likely Pathogenic (PM2, PP2, PP3, PP5) and previously reported in Renal Cysts And Diabetes syndrome. The *C9* (p.Cys54Ter) variant is a Pathogenic nonsense change (PVS1, PP5, PM2, PP3) in a drusen-risk gene associated with a partial C9 complement deficiency.

**Conclusions:** Half the families with IgA nephropathy examined here had another explanation for their genetic kidney disease. Since IgA deposits occur in up to 20% of normal individuals, apparent familial IgA nephropathy may be secondary to another, concurrent, genetic kidney disease.

## SA-PO566

### OXGR1 Is a Candidate Disease Gene for Human Calcium Oxalate Nephrolithiasis

Amar J. Majmundar,<sup>1</sup> Eugen Widmeier,<sup>1</sup> John F. Heneghan,<sup>2</sup> Ankana Daga,<sup>1</sup> Hannah Hugo,<sup>1</sup> Ali Amar,<sup>1,3</sup> Tilman Jobst-Schwan,<sup>1,4</sup> Caleb Nelson,<sup>5</sup> Jan Halbritter,<sup>6,7</sup> John A. Sayer,<sup>8,9</sup> Hanan Fathy,<sup>10</sup> Michelle A. Baum,<sup>1</sup> Shirlee Shril,<sup>1</sup> Shrikant M. Mane,<sup>11</sup> Seth L. Alper,<sup>2</sup> Friedhelm Hildebrandt.<sup>1</sup>  
<sup>1</sup>Division of Nephrology, Department of Medicine, Boston Children's Hospital, Harvard Medical School, Boston, MA; <sup>2</sup>Division of Nephrology, Department of Medicine, Beth Israel Deaconess Medical Center, Harvard Medical School, Boston, MA; <sup>3</sup>Department of Human Genetics and Molecular Biology, University of Health Sciences, Lahore, Pakistan; <sup>4</sup>Department of Nephrology and Hypertension, Friedrich-Alexander-Universität Erlangen-Nürnberg, Erlangen, Germany; <sup>5</sup>Department of Urology, Boston Children's Hospital and Department of Surgery, Harvard Medical School, Boston, MA; <sup>6</sup>Division of Nephrology, Department of Internal Medicine, University of Leipzig, Leipzig, Germany; <sup>7</sup>Department of Nephrology and Medical Intensive Care, Charité Universitätsmedizin Berlin, Berlin, Germany; <sup>8</sup>Institute of Genetic Medicine, Newcastle University, Newcastle, United Kingdom; <sup>9</sup>The Newcastle upon Tyne Hospitals NHS Foundation Trust, Newcastle, United Kingdom; <sup>10</sup>Pediatric Nephrology Unit, Alexandria University, Alexandria, Egypt; <sup>11</sup>Department of Genetics, Yale University School of Medicine, New Haven, CT.

**Background:** Nephrolithiasis (NL) affects 1 in 11 individuals worldwide. Causative genetic variants are detected in 11-28% of NL and/or associated nephrocalcinosis (NC) (Halbritter *JASN* 2015; Braun *cJASN* 2016; Daga *KI* 2018). *OXGR1* encodes 2-oxoglutarate receptor 1, which is expressed in collecting duct Type B intercalated cells. *OXGR1* mediates cellular Ca<sup>2+</sup> uptake in response to  $\alpha$ -ketoglutarate (AKG) (He *Nature* 2004), a renally excreted metabolite derived from the NL treatment citrate (Krebs *Biochem J* 1938; Coe *Nat Rev Neph* 2016). Genetic inactivation in mice of the *Oxgr1* effector Pendrin leads to hypercalciuria, a risk factor for NL/NC (Tokonami *JCI* 2013; Amlal *AJPCP* 2010; Barone *NDT* 2016).

**Methods:** Exome and targeted sequencing of the *OXGR1* locus was performed in a worldwide NL/NC cohort. Putatively deleterious rare *OXGR1* variants were functionally characterized.

**Results:** A heterozygous missense *OXGR1* variant (c.371T>G, p.L124R) co-segregated with calcium oxalate NL/NC in an autosomal dominant inheritance pattern within a multi-generational family with five affected individuals. Strong amino acid conservation in orthologues and paralogues, severe *in silico* prediction scores (SIFT, PolyPhen2.0, CADD), and extreme rarity in exome/genome population databases suggested the variant was deleterious. Interrogation of the *OXGR1* locus in 1107 NL/NC families identified five additional dominant alleles (p.Ser56Profs\*7, p.Tyr93His, p.Cys217Arg, p.Ser233Arg, p.Ser287Phe) in five families with calcium oxalate NL/NC. All were rare variants ( $< 5$  alleles in ExAC,  $< 10$  alleles in gnomAD) with multiple severe prediction scores. Rare, potentially deleterious *OXGR1* variants were enriched in NL/NC subjects relative to ExAC controls (0.54% versus 0.16%; X<sup>2</sup>=7.117, p=0.0076). Wildtype *OXGR1*-expressing *Xenopus* oocytes exhibited AKG-responsive Ca<sup>2+</sup> uptake. Four of five NL/NC-associated missense variants revealed impaired AKG-dependent Ca<sup>2+</sup> uptake at pH 5 and/or 7.4, demonstrating loss-of-function.

**Conclusions:** Rare, dominant *OXGR1* variants are a candidate etiology of NL/NC, suggesting a novel mechanism for human NL/NC disease.

**Funding:** NIDDK Support, Private Foundation Support

## SA-PO567

### Rare Kidney Stone, Potassium Magnesium Pyrophosphate Pentahydrate Calculi, in Hypophosphatasia

Tariku T. Gudura, Korey Bartolomeo, Xiangling Wang, Cleveland Clinic Cleveland Clinic, Cleveland, OH.

**Introduction:** Hypophosphatasia (HPP) is a rare inherited disorder caused by loss of function mutation of ALPL that encodes tissue nonspecific alkaline phosphatase (TNSALP), characterized by impaired mineralization of bones and teeth in the presence of low activity of serum and bone alkaline phosphatase. Kidney stones and nephrocalcinosis have been reported in some cases and most of the stones are calcium containing. Late diagnosis of hypophosphatasia is not uncommon. Here we present a case of a new diagnosis of hypophosphatasia for a 61 year old man after passing pure potassium magnesium pyrophosphate pentahydrate stones, which is very rare.

**Case Description:** A 61-year-old with history of hypertension, diabetes, premature tooth loss, skeletal fractures and over 10 symptomatic nephrolithiasis since age 20 was sent for genetic evaluation. His most recent serum labs were relevant for creatinine 1.4 mg/dl, alkaline phosphatase (ALP) 6 U/L (40-130), bone specific ALP 1.6  $\mu$ g/ml (6.5-20.1), vitamin B6 1,594.2 nmol/L (20-125), PTH 39 pg/ml (15-65) and 25-vitamin D 69.6 ng/ml (31-80). Calcium and phosphate were within normal lab limits. Urines studies were unremarkable with 24-hour urine protein 480 mg, presumed to be related to diabetic nephropathy or possible tubular injury from recurrent nephrolithiasis. His most recent stone analysis showed 100% potassium magnesium pyrophosphate pentahydrate (PMPP). Family history was significant for short stature and a mechanical fall related wrist fracture in his mother, and kidney stones and color blindness in his 2 nephews. Genetic test showed two heterozygous pathogenic variants, c.1240C>A (p. Leu414Met) and c.407G>A (p. Arg136His), in the ALPL gene confirming the diagnosis of HPP. Parental testing is pending to clarify its inheritance pattern. The patient was started on recombinant human TNSALP.

**Discussion:** Patients with HPP tend to have hypercalciuria with or without hypercalcemia from impaired bone uptake of calcium and phosphorus. This increases risk of nephrocalcinosis and calcium containing kidney stones. Our patient developed pure potassium magnesium pyrophosphate pentahydrate stone, which is very rare, and has not been reported in human beings. Its association with HPP is unclear and deserves further investigation.

**SA-PO568**

**Genotype-Phenotype Correlation in Cystinuria**

Mohammad D. Hossain,<sup>1</sup> Andrea G. Cogal,<sup>1</sup> Ivan E. Porter,<sup>2</sup> David S. Goldfarb,<sup>3</sup> Peter C. Harris,<sup>1</sup> John C. Lieske.<sup>1</sup> <sup>1</sup>Mayo Clinic Minnesota, Rochester, MN; <sup>2</sup>Mayo Clinic in Florida, Jacksonville, FL; <sup>3</sup>NYU Langone Health, New York, NY.

**Background:** Cystinuria is an autosomal recessive disorder characterized by impaired proximal renal tubular absorption of cystine. To date no clear genotype-phenotype relationship has been established. This study reviewed genetic and clinical data of a large cohort of suspected cystinuric patients in the Rare Kidney Stone Consortium (RKSC) cystinuria registry.

**Methods:** Subjects with suspected cystinuria (n=76) were genotyped either by Sanger sequencing or a targeted next generation sequencing (tNGS) panel that includes the 2 cystinuria genes. Clinical data were abstracted from the RKSC cystinuria registry.

**Results:** Biallelic mutations in *SLC3A1* were found in 50 individuals, biallelic mutations in *SLC7A9* in 21 individuals, and 1 mutation in each gene in 1 individual. Four individuals had a clear cystinuria phenotype with only a single monoallelic change in *SLC3A1* or *SLC7A9* detected. Median (IQR) urinary cystine was 706 (460-848) mg/day. The Table depicts clinical details of participants with disease due to *SLC3A1* and *SLC7A9* mutations. Urinary cystine excretion and other clinical outcomes did not differ by genotype. Patients with *SLC7A9*-related disease more commonly had 2 nontruncating mutations and *SLC3A1*-related disease more commonly had 2 truncating mutations. Multi-exon duplications were common for *SLC3A1*, found in 14 instances. A total of 16 novel, 32 known *SLC3A1* and 12 novel, 12 known *SLC7A9* mutations were detected.

**Conclusions:** The vast majority of cystinuria patients have biallelic disease due to 2 changes in either *SLC3A1* or *SLC7A9*, and not one of each. Cystine excretion and other clinical manifestations did not differ by genotype. Further study is needed to understand genotype-phenotype correlation and the variable outcomes seen in patients with cystinuria.

**Funding:** NIDDK Support

	With <i>SLC3A1</i> Mutations (N=52)	With <i>SLC7A9</i> Mutations (N=23)	p value
Individuals (%)	69.3	30.3	
Pedigrees (%)	67.1	27.6	
Female Sex	16 (50.0%)	7 (43.8%)	<b>0.7</b>
Urinary Cystine (mg/day)	706.0 (509.0, 831.5)	662.0 (407.5, 887.2)	<b>0.6</b>
Age of 1 <sup>st</sup> Stone Episode (years)	16.0 (10.0, 20.0)	7.75 (3.0, 14.7)	<b>0.2</b>
Total number of stone episodes requiring procedures, lifetime	4.0 (1.5, 10.0)	3.5 (1.0, 10.0)	<b>0.8</b>
Procedural burden/year	0.3 (0.2, 0.5)	0.07 (0.03, 0.1)	<b>0.6</b>
Allele Variants			<b>0.04</b>
- 2 Nontruncating	10 (30.3%)	12 (66.7%)	
- 2 Truncating	11 (33.3%)	2 (11.1%)	
Truncating + Nontruncating	12 (36.4%)	4 (22.2%)	
Copy Number Variation (CNV)			<b>0.09</b>
- Heterozygous Duplication	8 (16.7%)	0 (0.0%)	
- Homozygous Duplication	3 (6.2%)	0 (0.0%)	
- Heterozygous Deletion	3 (6.2%)	0 (0.0%)	
- Compound heterozygous duplications	2 (4.2%)	0 (0.0%)	
- Compound heterozygous duplication and deletion	1 (2.1%)	0 (0.0%)	
Chronic Kidney Disease (CKD)			<b>0.7</b>
- Stage 1	5 (31.2%)	4 (33.3%)	
- Stage 2	10 (62.5%)	6 (50.0%)	
- Stage 3a	1 (6.2%)	1 (8.3%)	
- Stage 3b	0 (0.0%)	1 (8.3%)	
Serum Creatinine (mg/dl)	0.9 (0.8, 1.2)	1.00 (0.8, 1.2)	<b>0.1</b>
Estimated GFR (ml/min/1.73m <sup>2</sup> )	80.1 (74.2, 93.1)	76.8 (64.4, 95.1)	<b>0.7</b>

All numerical values are reported as median with interquartile range (Q1, Q3).  
Kruskal-Wallis rank sum test and Pearson's Chi-squared test were used to calculate p-values for numerical and categorical variables, respectively.

**SA-PO569**

**Novel KCNJ1 Mutations Responsible for Adult Bartter Syndrome With Hypocalcemia**

Chien-Chou Chen,<sup>1</sup> Chih-Chien Sung,<sup>1</sup> Min-hua Tseng,<sup>2</sup> Shih-Hua P. Lin.<sup>1</sup> Division of Nephrology, Tri-Service General Hospital <sup>1</sup>Tri-Service General Hospital, Taipei, Taiwan; <sup>2</sup>Chang Gung Memorial Hospital, Taoyuan, Taiwan.

**Introduction:** Bartter syndrome (BS) is a rare, autosomal recessive disease, caused by gene mutations of the transporters or channels of thick ascending loop of Henle (LOH) responsible for sodium chloride (NaCl), potassium (K<sup>+</sup>) and calcium (Ca<sup>++</sup>) reabsorption. Accordingly, it is characterized by persistent renal salt wasting with secondary hyperreninemia and hyperaldosteronism, renal K<sup>+</sup> wasting with hypokalemic metabolic alkalosis with renal K<sup>+</sup> wasting, and hypercalciuria with nephrocalcinosis and/or nephrolithiasis. The clinical manifestations of genetic BS vary dramatically from

asymptomatic, polyuria, polydipsia, premature delivery, polyhydramnios and failure to thrive, but usually presenting at antenatal and neonatal period other than adulthood.

**Case Description:** A 28-year-old Chinese female was referred for the evaluation for chronic hypocalcemia, medullary nephrocalcinosis, and hypokalemia. Two years ago, she first presented with severe symmetrical general muscle weakness, muscle tetany, spasm, and polyuria and was found to have moderate hypokalemia with metabolic alkalosis and renal potassium (K<sup>+</sup>) wasting, hypocalcemia (7.0 mg/dl) with an increased serum parathyroid hormone, hypercalciuria and bilateral medullary nephrocalcinosis. A thorough search for the identifiable causes such as autoimmune disorders, inflammation, malignancy, and use of diuretics was non-revealing. Genetic sequencing of calcium sensing receptor (CaSR) was negative. Using next generation sequencing based mutation screening with Sanger sequencing in her family, compound heterozygous mutations c.346\_357del (p.116\_119del) and c.1074 C>A (p.C358X) in *KCNJ1* inherited from her parents was identified. These two *KCNJ1* mutations were novel and pathogenic variants. Treatment with cyclooxygenase-2 (COX2) inhibitor, K<sup>+</sup> and calcium supplementation achieved a remarkable improvement in her clinical feature and laboratory abnormality.

**Discussion:** Although hypercalciuria in the presence of persisted renal salt wasting, metabolic alkalosis and medullary nephrocalcinosis are the landmark findings for BS, serum calcium, phosphate and PTH may help differentiate between type I/II and V. Genetic form of late or adult BS, albeit rare, should be kept in mind as a cause of chronic hypokalemia with salt wasting and nephrocalcinosis/ nephrolithiasis, even in the presence of hypocalcemia.

**SA-PO570**

**Monogenic Forms of Kidney Stone Disease in 841 Adult Kidney Stone Formers From the Bern Kidney Stone Registry**

Manuel A. Anderegg,<sup>1</sup> Eric G. Olinger,<sup>2</sup> Robert M. Geraghty,<sup>2</sup> André Schaller,<sup>4</sup> Matteo Bargagli,<sup>1</sup> Lea Pohlmeier,<sup>3</sup> John A. Sayer,<sup>2,3</sup> Daniel G. Fuster.<sup>1</sup> <sup>1</sup>Department of Nephrology and Hypertension, Inselspital, Bern University Hospital, University of Bern, Bern, Switzerland; <sup>2</sup>Newcastle University Translational and Clinical Research Institute, Newcastle upon Tyne, United Kingdom; <sup>3</sup>Renal Services, The Newcastle upon Tyne Hospitals NHS Foundation Trust, Newcastle upon Tyne, United Kingdom; <sup>4</sup>Department of Medical Genetics, Inselspital, Bern University Hospital, University of Bern, Bern, Switzerland; <sup>5</sup>Interfaculty Bioinformatics Unit, University of Bern, Bern, Switzerland.

**Background:** Kidney stone disease is increasing worldwide, leads to high morbidity and represents a substantial economic burden to health systems. The detection of monogenic forms of kidney stone disease provides crucial pathophysiological insights and enables precision medicine approaches in affected patients. Previous genetic analysis by whole exome sequencing (WES) or kidney stone disease gene panels in relatively small cohorts of selected, mostly pediatric stone formers detected monogenic forms of kidney stone disease in 10-30% of patients studied. Larger studies using WES in well-characterized unselected cohorts of adult kidney stone formers are missing.

**Methods:** We conducted WES in 841 adult kidney stone formers participating in the Bern Kidney Stone Registry (BKSR). The BKSR is an unselected cohort of kidney stone formers with detailed phenotypic data available. Inclusion criteria are: ≥ 1 stone episode and age ≥ 18 years. For the initial analysis, we applied a virtual panel of 33 genes previously implicated in monogenic kidney stone disease. Variants in the 33 genes were filtered according to gnomAD allele frequencies (MAF <1%) and predicted consequence on the canonical transcript and were then curated against in silico pathogenicity tools, variant databases and previously reported modes of inheritance.

**Results:** We detected 184 distinct predicted pathogenic variants in 19 of 33 analyzed genes. Taking into account likely mode of inheritance, this led to a molecular diagnosis for 12.1% of all patients. 30% of the detected variants with predicted pathogenicity have not been previously reported. 70 % of the kidney stone formers with likely monogenic etiology showed monoallelic inheritance, fitting with previous data showing more frequent recessive inheritance of kidney stone disease in children, but more dominant inheritance patterns in adults.

**Conclusions:** In an unselected cohort of adult kidney stone formers, we identified a surprisingly high prevalence of monogenic forms of kidney stone disease. The next steps will include genotype/phenotype correlations of solved individuals. Furthermore, using the detailed phenotypic dataset of the BKSR, we aim to investigate potential multiallelic inheritance patterns and extend the genetic analysis to candidate genes.

**Funding:** Government Support - Non-U.S.

**SA-PO571**

**Quantification of Oxalate in Human Plasma by Novel Liquid Chromatography-Tandem Mass Spectrometry: Method Development, Validation, and Application in Lumasiran Clinical Trials**

Valerie Clausen, Karen H. Cao, John M. Gansner, Gabriel Robbie, Jing-Tao Wu. Alnylam Pharmaceuticals Inc, Cambridge, MA.

**Background:** Primary hyperoxaluria type 1 (PH1) is a rare autosomal recessive genetic disease characterized by hepatic oxalate overproduction. Oxalate is excreted primarily by the kidneys, where it can cause kidney stones and/or nephrocalcinosis, leading to progressive kidney damage. PH1 is characterized by increases in both urinary and plasma oxalate (POx). In PH1 patients with compromised kidney function, POx is monitored. However, measuring POx is challenging due to its intrinsic chemical property and nonenzymatic conversion of ascorbate to oxalate in vitro. We present the development

and validation of a novel liquid chromatography-tandem mass spectrometry (LC-MS/MS) assay to determine oxalate concentration in human K<sub>2</sub>EDTA plasma.

**Methods:** A validated LC-MS/MS assay capable of measuring oxalate in 100  $\mu$ L of K<sub>2</sub>EDTA plasma was developed. Samples were spiked with internal standard (<sup>13</sup>C<sub>2</sub>-labeled oxalic acid), acidified, and extracted by protein precipitation prior to analysis using anion exchange high-performance liquid chromatography with electrospray ionization MS/MS detection. The method was assessed for linearity, sensitivity, accuracy, precision, selectivity, hemolyzed plasma, lipemic plasma, interference, recovery, matrix effect, and stability. The validated LC-MS/MS assay was used to quantify POx in the lumasiran clinical trials.

**Results:** The LC-MS/MS assay was developed and validated successfully with a quantitation range of 0.500-50.0  $\mu$ g/mL (5.55-555  $\mu$ mol/L). The validation met acceptance criteria of 15% (20% at the lower limit of quantitation) for accuracy, precision, and other parameters tested. Oxalate was shown to be stable in K<sub>2</sub>EDTA human plasma for 125 days and for 5 freeze/thaw cycles at -20°C and -70°C. Analysis of POx levels in 75 healthy adults indicated the normal range to be 1.71-12.11  $\mu$ mol/L.

**Conclusions:** A novel LC-MS/MS assay was developed and validated successfully and in accordance with regulatory guidelines. The required sample volume was only 100  $\mu$ L of K<sub>2</sub>EDTA plasma, which is especially favorable in the pediatric population, and there is no need to acidify blood before processing. The assay accurately determines POx levels, which were used as an efficacy endpoint in the clinical development of lumasiran.

**Funding:** Commercial Support - Alynham Pharmaceuticals

## SA-PO572

### Detection of X-Linked Variations in SHROOM4 in Four Families With Syndromic Congenital Anomalies of the Kidney and Urinary Tract (CAKUT)

Caroline M. Kolvenbach,<sup>1,2</sup> Tim Felger,<sup>1</sup> Luca M. Schierbaum,<sup>1</sup> Isabelle Thiffault,<sup>6</sup> Marcin Zaniew,<sup>3</sup> Friedhelm Hildebrandt,<sup>2</sup> Phillip Grote,<sup>4</sup> Benjamin Odermatt,<sup>1</sup> Heiko M. Reutter,<sup>5</sup> Gabriel C. Dworschak.<sup>1</sup> <sup>1</sup>Rheinische Friedrich-Wilhelms-Universität Bonn, Bonn, Germany; <sup>2</sup>Boston Children's Hospital, Boston, MA; <sup>3</sup>Uniwersytet Zielonogorski, Zielona Gora, Poland; <sup>4</sup>Institut für Tumorphysiologie und experimentelle Therapie, Frankfurt am Main, Germany; <sup>5</sup>Universitätsklinikum Erlangen, Erlangen, Germany; <sup>6</sup>Children's Mercy Hospitals and Clinics, Kansas City, MO.

**Background:** SHROOM4 plays an important role in cytoskeletal modification and development of the early nervous system. Previously, single nucleotide variants (SNVs) or copy number variations (CNVs) in SHROOM4 were shown to cause the X-linked neurodevelopmental disorder Stocco dos Santos syndrome (MIM 300434). However, no congenital anomalies of the kidney and the urinary tract (CAKUT), the intestinal, or cardiovascular system have been described in Stocco dos Santos syndrome.

**Methods:** Here, we performed exome sequencing (ES) and CNV analyses to detect further variants, and expression studies and gene knockdown experiments in zebrafish to study the role of SHROOM4 during embryonic development.

**Results:** In a family with two affected individuals with CAKUT, anorectal, cardiovascular, and central nervous system anomalies, we identified by ES a putative disease-causing SNV in SHROOM4 (c.940G>A; p.Glu314Lys). Analysis of 666 CAKUT ES samples revealed no further allele carriers. Through GeneMatcher, one family with a SNV (c.3942+1G>A; p.?) and two families with two different CNVs (chrX:g.49,369,600-50,447,320 and chrX:g.49,375,617-52,838,206) in SHROOM4 were contributed with a matching syndromic CAKUT phenotype. Upon embryonic mouse and zebrafish *in situ* mRNA expression studies we showed Shroom4 expression in the urinary tract, cloaca, heart, and cerebral central nervous system. Knockdown studies in zebrafish larvae using a splice blocking Morpholino revealed pronephric cysts, anomalies of the cloaca and the heart, decreased eye-to-head size ratio, and higher mortality compared to controls. These findings replicate the phenotypic spectrum of the affected individuals with genetic variations in SHROOM4 reported here. Co-injection of human wild-type SHROOM4 mRNA and Morpholino rescued the observed phenotypes.

**Conclusions:** The identified SNVs and CNVs in four families with syndromic CAKUT and embryonic mouse and zebrafish studies suggest functional deleteriousness of SHROOM4. We therefore propose that SHROOM4 plays an important role in the development of several principal organ structures.

**Funding:** Government Support - Non-U.S.

## SA-PO573

### Trio Whole Exome Sequencing Analysis Reveals PRPF8 as a Potential Ciliopathy Candidate Gene Phenocopying Congenital Anomalies of the Kidney and Urinary Tract (CAKUT)

Lea M. Merz,<sup>1</sup> Tucker J. Carrocci,<sup>4</sup> Nils D. Mertens,<sup>2</sup> Florian Buerger,<sup>2</sup> Heiko M. Reutter,<sup>3</sup> Aaron Hoskins,<sup>4</sup> Shirlee Shril,<sup>2</sup> Friedhelm Hildebrandt.<sup>2</sup> <sup>1</sup>Department of Pediatrics, University Hospital, Leipzig, Germany; <sup>2</sup>Department of Pediatric Nephrology, Boston Children's Hospital & Harvard Medical School, Boston, MA; <sup>3</sup>Department of Neonatology, University Hospital, Erlangen, Germany; <sup>4</sup>Department of Biochemistry, University of Wisconsin - Madison, Madison, WI.

**Background:** Congenital abnormalities of the kidneys and urinary tract (CAKUT) represent the most frequent birth defect. The discovery of  $\geq 45$  monogenic causes of CAKUT in humans has generated novel insights into its pathogenesis. PRPF8 is a core component of the spliceosome and was recently shown to be localized at the distal end

of the mother centriole (Shen, *J Cell Biol.* 3;221(1):e202105092, 2022). It functions as receptor for the linear ubiquitin assembly complex, facilitating the removal of CP110 from the mother centriole and promoting ciliogenesis.

**Methods:** We performed whole exome sequencing in 136 trios of children with CAKUT and identified *de novo* variants in 38 different genes. To identify the most likely pathogenic variants, we ranked those 38 *de novo* variants using the following criteria: constraint and prediction scores, absence from the gnomAD control database, number of additional *de novo* variants, and whether a mouse model with CAKUT existed. Since CAKUT-linked mutations occurred at positions that are highly conserved between yeast and human spliceosomes, we are using *S. cerevisiae* (growth and ACT1-CUP1 reporter assays) as a model system to test their impact on aspects of the splicing reaction.

**Results:** Following those criteria, PRPF8 scored highest as a potential new candidate gene for CAKUT. We identified two additional CAKUT families with heterozygous *de novo* missense variants (Reutter, *Current Genomics* 16(999):1-1, 2015, Lei, 40(10):1290-1299, 2020) and 8 further heterozygous missense mutations that were inherited or of unknown mode of inheritance. All three *de novo* variants are positioned in highly conserved regions within the linker and endonuclease domains, including one amino acid residue that was previously shown to impact the catalytic steps of splicing in *S. cerevisiae* (human PRPF8 residue R1681). Using splicing assays, we found that PRPF8 mutants do not impact the splicing at the consensus splice sites. Two mutants showed an altered splicing effect at the non-consensus splice with a potential inhibition of the exon ligation.

**Conclusions:** We generated initial evidence that PRPF8 mutations may represent a novel ciliopathy gene, phenocopying CAKUT.

**Funding:** NIDDK Support

## SA-PO574

### Clinical Characterization of a Dent Disease-1 Cohort Including

#### Genotype-Phenotype Correlations

Muhammad G. Arnous,<sup>1</sup> Andrea G. Cogal,<sup>1</sup> Jennifer Arroyo,<sup>1</sup> Franca Anglani,<sup>2</sup> Peter C. Harris,<sup>1</sup> John C. Lieske.<sup>1</sup> <sup>1</sup>Mayo Clinic Minnesota, Rochester, MN; <sup>2</sup>Università degli Studi di Padova, Padova, Italy.

**Background:** Dent disease is an X-linked recessive renal disorder associated with Low molecular weight proteinuria, kidney stones, nephrocalcinosis, and kidney failure in the 3<sup>rd</sup> to 5<sup>th</sup> decade. Dent-1 is caused by mutations in the CLCN5 gene and Dent-2 mutations in the OCLRL2 gene. DD-1 accounts for 60% of diagnosed patients

**Methods:** Review of 134 patients from (RKSC) DD Registry (65 unique mutations). CLCN5 variants were assessed for pathogenicity using ACMG guidelines and categorized as truncating (nonsense, frameshift, large deletions, and canonical splice-site mutations) and nontruncating (missense and non-frame mutations). Correlations were analyzed using observational statistics and survival analysis methods.

**Results:** Missense mutations were the most prevalent (37%), followed by frameshift (23%) and nonsense (23%). Overall truncating (65%) were more common than non-truncating (35%) mutations. Patients with truncating mutations had more prevalent nephrocalcinosis, experienced stone events earlier in life, and manifested a higher albumin excretion rate than the non-truncating group. Patients with non-truncating mutations developed hematuria more often. No statistically significant difference between the 2 groups regarding CKD evolution. 24h urine Ca was positively associated with lifetime stone events and CKD evolution among the whole cohort. 24h urine protein was positively associated with CKD evolution but not associated with nephrolithiasis. Stratifying the cohort by mutation type, Lifetime stone events positively correlated with CKD evolution within the truncating group.

**Conclusions:** DD-1 patients with truncating mutations tended to have a more severe disease course compared to those with non-truncating mutations. Functional studies of the effect of specific mutations on intracellular processes and function, and overall renal physiology, may help to elucidate the underlying reasons.

**Funding:** NIDDK Support

#### Genotype-phenotype correlations

Patients' category Total N:134	Truncating 92	Non-truncating 42	P-value
Prevalent nephrocalcinosis	66%	50%	0.031
Hematuria	18%	45%	0.000
Age at 1st stone event	14(10-20)	27(21-27)	0.014
Total Urine Protein g/24h	1.60(0.68-2.1)	0.91(0.59-1.93)	0.004
Urine Albumin (mg/24h urine)	180.6 (119.15-279.5)	106.6 (74.45-176.95)	0.019
LMWP: alpha-1mg/24h	502.5 (321.5-602)	157 (71-522)	0.268

## SA-PO575

### Dent Disease Presenting as Night Blindness

Robin Miller,<sup>1,2</sup> Justin J. Arnett,<sup>3</sup> Katayoon Shayan,<sup>1</sup> Shyamanga R. Borooah,<sup>3</sup> Caitlin E. Carter.<sup>1,2</sup> <sup>1</sup>Rady Children's Hospital San Diego, San Diego, CA; <sup>2</sup>University of California San Diego, La Jolla, CA; <sup>3</sup>University of California at San Diego Department of Ophthalmology at the Shiley Eye Institute, La Jolla, CA.

**Introduction:** Dent Disease is an X-linked inherited tubulopathy that results in low molecular weight proteinuria, hypercalciuria, nephrocalcinosis, and progressive kidney dysfunction. Typical clinical manifestations in children include rickets, polyuria, and nephrolithiasis. We report a case of night blindness as the initial presentation of Dent Disease.

**Case Description:** A 16 yo healthy male with no family history of kidney disease presented with progressive night blindness and peripheral vision loss. He was found to have vitamin A deficiency and visual symptoms improved with vitamin A supplementation. Evaluation for underlying causes of vitamin A deficiency revealed renal dysfunction (serum creatinine 1.2 mg/dL, eGFR 65 ml/min by Schwartz 2) and nephrotic range proteinuria (3.5 gm/day). Urinary retinol binding protein to creatinine ratio was markedly elevated at >6667mcg/g (normal <190 mcg/g), suggestive of loss of retinol binding protein as the etiology of his vitamin A deficiency. Kidney biopsy demonstrated fibrous glomerular crescents, glomerulosclerosis, and tubular atrophy with moderate interstitial fibrosis. Evaluation for immunologic and genetic causes of glomerular disease was unrevealing. Genetic testing confirmed a pathogenic mutation in CLCN5, one of the two genes known to cause Dent Disease. The patient was subsequently found to have low bone mineral density by DEXA and hypercalciuria.

**Discussion:** Dent Disease due to CLCN5 mutation results in the inability of the proximal tubule to reabsorb low molecular weight proteins from the glomerular filtrate. This includes retinol binding protein, and vitamin A deficiency is a known sequelae of Dent Disease, however resultant vision loss has not previously been reported as the presenting finding in Dent Disease. In addition, while Dent Disease is typically considered a primarily tubular disorder, our patient had significant glomerular pathology including fibrous and fibrocellular crescents, which are rarely reported manifestations of Dent Disease but may play a role in its progression. Identifying early symptoms of Dent Disease allows for prompt treatment which could limit morbidity and mortality.

#### SA-PO576

#### Outcome of Atypical Hemolytic Uremic Syndrome (aHUS) Treated With C5-Inhibition, Primary vs. Secondary vs. Idiopathic: Results From the ItalKid-HUS Network

Gianluigi Ardisino,<sup>1</sup> Marianna Tangredi,<sup>4</sup> Valentina Capone,<sup>1</sup> Luigi Porcaro,<sup>3</sup> Massimo Cugno,<sup>2</sup> Brigida Brezzi,<sup>5</sup> Olga Crendino,<sup>6</sup> Lino C. Cirami,<sup>7</sup> Giuseppe Castellano,<sup>4</sup> Federica Ravera,<sup>8</sup> Donata C. Cresseri.<sup>4</sup> ItalKid HUS Network <sup>1</sup>Center for HUS Prevention, Control and Management at Pediatric Nephrology, Dialysis and Transplant Unit, Fondazione IRCCS Ca' Granda, Ospedale Maggiore Policlinico, Milano, Italy; <sup>2</sup>Medicina Interna, Dipartimento di Fisiopatologia Medico Chirurgica e dei Trapianti, Fondazione IRCCS Ca' Granda, Ospedale Maggiore Policlinico, Università Degli Studi, Milano, Italy; <sup>3</sup>Medical Genetics Laboratory, Fondazione IRCCS Ca' Granda, Ospedale Maggiore Policlinico, Milano, Italy; <sup>4</sup>Nephrology, Dialysis and Transplant Unit, Fondazione IRCCS Ca' Granda, Ospedale Maggiore Policlinico, Milano, Italy; <sup>5</sup>Presidio Ospedaliero SS Antonio e Biagio, Alessandria, Italy; <sup>6</sup>Azienda Ospedaliera di Rilievo Nazionale Antonio Cardarelli, Napoli, Italy; <sup>7</sup>Ospedale Careggi, Firenze, Italy; <sup>8</sup>Azienda Socio Sanitaria Territoriale Grande Ospedale Metropolitan Niguarda, Milano, Italy.

**Background:** Atypical Hemolytic Uremic Syndrome is a Thrombotic Microangiopathy related to complement abnormalities (genetic or acquired) in 50-60% of cases. The remaining cases may involve unknown genes, but may also be due to coexisting complement over-activating conditions acting as triggers. Based on the presence of complement abnormalities and of specific triggers, 3 groups can be identified: 1. Primary (with complement abnormality), 2. Secondary (trigger only), 3. Idiopathic (neither complement abnormality nor trigger). This approach to aHUS classification may have important drawbacks in the management of patients particularly with regards to C5 inhibition (C5i) as to treatment initiation, discontinuation and response rate.

**Methods:** The case series of aHUS treated or referred to our Center between 2000 and 2021 was analyzed according to the mentioned classification criteria. Response rate (RR), case-fatality rate, frequency of ESKD and relapse rate were compared between C5i and conventional treatment.

**Results:** Out of 240 patients, 150 (62.5%) had Primary aHUS, 55 (22.9%) Secondary aHUS and 35 (14.6%) Idiopathic aHUS. In patients treated with C5i (n:143) RR was higher within all groups (82.7% for Primary, 76.1% for Secondary and 59.1% for Idiopathic aHUS) compared to conventional treatment (38.7%, 55.6% and 53.9%, respectively). The frequency of ESKD was lower after C5i in all groups (Primary 15.7 vs 59.6%; Secondary 14.8 vs 40.4%; Idiopathic 36.0 vs 40.0%). Similarly, case-fatality rate was lower with C5i in all groups compared to conventional treatment (Primary 5.7 vs 9.5%; Secondary 8.5 vs 20.0%; Idiopathic 4.0 vs 13.0%). Among patients who discontinued C5i (n:83) the relapse rate was significantly higher in those with complement dysregulation compared to patients without complement abnormalities (68.6% for Primary and 0% for both Secondary and Idiopathic aHUS).

**Conclusions:** Based on our results and given that aHUS patient can't be correctly classified *a priori*, C5i should be promptly started in all patients meeting the criteria for aHUS. When complement dysregulation workup is available, patients can be better stratified and managed accordingly as to treatment discontinuation.

#### SA-PO577

#### Rare Cause of Nephrotic Range Proteinuria During Pregnancy: Genetic C3 Nephropathy (C3N) Presenting During Pregnancy

Harshil Fichadiya,<sup>1</sup> Richa Dua,<sup>1</sup> Poorva P. Bhide,<sup>1</sup> Adhithya Rajamohan,<sup>1</sup> Spiros M. Arbes,<sup>1,2</sup> <sup>1</sup>Rutgers Health Monmouth Medical Center, Long Branch, NJ; <sup>2</sup>Hypertension & Nephrology Association, Eatontown, NJ.

**Introduction:** Causes of proteinuria during pregnancy include isolated gestational proteinuria, pre-eclampsia, UTI, pre-existing CKD or denovo glomerular disease. We report a case of genetic C3N presenting with new onset proteinuria during pregnancy. C3N is a very rare cause of MGPN and is more commonly seen as an acquired disease due to formation of C3 Nephric factor (autoantibodies against regulatory proteins of complement pathway) than as inherited disease due to defect in C3 gene leading to abnormal activation of alternate complement pathway. It is associated with monoclonal gammopathy in elderly.

**Case Description:** 30-year-old Caucasian female presented with pedal and periorbital edema with 3+ proteinuria at the end of first trimester of pregnancy. She had normal BP, no recent infection or vaccination, history of IV drug or medication use, known malignancy, hepatitis of HIV infection, diabetes mellitus, no family history of nephrotic syndrome, negative PLA2R Ab, normal C3, C4 level and no gammopathy disease. UPr/Cr ratio at 21 weeks was 1.6g/mg. At 35 weeks her UPr/Cr. ratio ratio worsened to nephrotic range proteinuria 6.1g. Proteinuria was managed with non pharmacological measures during pregnancy. Postpartum her kidney biopsy revealed MPGN with C3 deposits. Genetic testing revealed pathogenic autosomal dominant variant of C3 gene associated with C3N and atypical HUS and carrier variant of NPHS2 gene. ADAMTS13 level were normal. She was enrolled in a clinical trial at a higher center.

**Discussion:** To our knowledge this is the first case of genetic C3N presenting during pregnancy. A case of atypical HUS which involves similar gene defect and pathogenesis has been reported in a one month postpartum female. Our patient like a few other cases of C3N presented with nephrotic range proteinuria, hematuria and normal serum complement level. Treatment of mild disease (normal kidney function with proteinuria <1.5g/day) includes supportive measures while moderate to severe disease (proteinuria >1.5g/day and abnormal renal function) includes glucocorticoid and immunosuppression therapy. Trials have reported benefit with eculizumab (C5 inhibitor). Iptacopan (selective factor B inhibitor) is being studied in an ongoing clinical trial. While the genetic disease is autosomal dominant it presents with incomplete penetrance.

#### SA-PO578

#### X-Linked Recessive Variants in X-Prolyl Aminopeptidase 2 (XPNPEP2) as a Potential New Cause of Nephrotic Syndrome

Bshara Mansour,<sup>1</sup> Ronen Schneider,<sup>1</sup> Florian Buerger,<sup>1</sup> Katharina Lemberg,<sup>1</sup> Camille H. Nicolas Frank,<sup>1</sup> Kirolos Yousef,<sup>1</sup> Dervla M. Connaughton,<sup>5</sup> Peter J. Conlon,<sup>3</sup> Sevcana A. Bakkaloglu,<sup>4</sup> Sherif M. El desoky,<sup>2</sup> Jameela A. Kari,<sup>2</sup> Shirlee Shril,<sup>1</sup> Friedhelm Hildebrandt,<sup>1</sup> <sup>1</sup>Boston Children's Hospital, Boston, MA; <sup>2</sup>King Abdulaziz University, Jeddah, Saudi Arabia; <sup>3</sup>Beaumont Hospital, Dublin, Ireland; <sup>4</sup>Gazi Universitesi, Ankara, Turkey; <sup>5</sup>London Health Sciences Centre, London, ON, Canada.

**Background:** Steroid-resistant nephrotic syndrome (SRNS) is the second most frequent cause of chronic kidney disease in children and young adults. Major insights into its pathogenesis came from the discovery of ~68 monogenic causes, contributing to ~11-30% of SRNS with onset <25 years of age. However, a significant proportion remains without a genetic diagnosis.

**Methods:** To identify novel potential monogenic causes of SRNS, we performed whole-exome sequencing (WES) in a worldwide cohort of individuals with SRNS from 1,285 different families. We evaluated potential pathogenicity of bi-allelic hemizygous genetic variants by *in-silico* prediction scores, evolutionary conservation, and allele frequency in public genome sequencing databases.

**Results:** We discovered, 3 different X-linked recessive, likely deleterious variants in *XPNPEP2* (X-Prolyl Aminopeptidase 2) in unrelated male individuals. Individual A4966\_21 had missense variant: c.346C>T, p.(Arg116Cys), which changes an arginine residue as part of a highly conserved DXRY motif that is important for the enzyme activity. This variant is deemed as likely disease-causing by SIFT, MutTaster, and PolyPhen2 prediction programs. Individual A222\_21 had a nonsense variant c.670C>T, p.(Arg224\*). Individual D\_10382\_21 had an obligatory splice variant c.1107+1G>A. The ages of SRNS onset were 3, 15, and 2-year-old, respectively. All variants were absent hemizygosally from the gnomAD database. No extra-renal manifestations were reported. Upon renal biopsy, individuals A4966\_21 and D\_10382\_21 both showed focal segmental glomerulosclerosis, and A222\_21 showed membranoproliferative glomerulonephritis. *XPNPEP2* encodes a membrane-bound isoform of aminopeptidase P (APP2), a widely distributed hydrolase that cleaves N-terminal imido bonds. One of the substrates for APP2 is Bradykinin (BK). We consider *XPNPEP2* a candidate gene for SRNS/FSGS because BK has been shown to play a role in the pathogenesis of FSGS, operating through B1 receptor signaling in a mouse model (Pereira *Kidney Int.* 79:1217, 2011).

**Conclusions:** By WES, we identify X-linked recessive variants in the gene *XPNPEP2* in 3 affected individuals, as a potential novel monogenic cause of SRNS.

**Funding:** Other NIH Support - 5R01DK068306-18

## SA-PO579

## UPLC-MS/MS-Based Plasma Assay for Therapeutic Monitoring in Patients With APRT Deficiency

Ummur A. Thorsteinsdottir,<sup>1</sup> Hrafnhildur L. Runolfsson,<sup>2</sup> Vidar O. Edvardsson,<sup>2,1</sup> Runolfur Palsson,<sup>2,1</sup> Margret Thorsteinsdottir,<sup>1</sup> APRT Deficiency Research Program of the Rare Kidney Stone Consortium <sup>1</sup>Heilbrigdisvisindasvid - Haskoli Island, Reykjavik, Iceland; <sup>2</sup>Landspítali, Reykjavik, Iceland.

**Background:** Adenine phosphoribosyltransferase deficiency (APRTd) is a rare disorder of purine metabolism characterized by urinary excretion of poorly soluble 2,8-dihydroxyadenine (DHA), nephrolithiasis and chronic kidney disease (CKD). Treatment with allopurinol or febuxostat, reduces DHA excretion and slows CKD progression. The aim was to optimize a UPLC-MS/MS method for simultaneous quantification of DHA, adenine, allopurinol, oxypurinol and febuxostat in plasma, utilizing the chemometric approach design of experiments (DoE).

**Methods:** The UPLC-MS/MS quantification method was optimized, employing the chemometric software MODDE Pro 13. Fractional factorial (FF) design was used to reveal significant experimental factors influencing peak area, retention time and resolution of all analytes using partial least square (PLS) regression. Absolute quantification of DHA, adenine, allopurinol, oxypurinol and febuxostat was performed in plasma samples from untreated and treated APRTd patients and healthy controls.

**Results:** For all analytes, accuracy and precision were within the acceptable range of  $\pm 15\%$ . Preliminary data revealed a median (range) plasma concentration of 248 (224-395) ng/mL for DHA and 194 (159-284) ng/mL for adenine, in the untreated patients, and below 50 ng/mL for DHA and 533 (339-1034) ng/mL for adenine, in those on treatment. DHA was not detected in the plasma samples from healthy controls. In patients receiving XOR inhibitor therapy, the median plasma concentration for allopurinol, oxypurinol and febuxostat was 687 (103-2901), 7945 (2199-10943) and 1628 ng/mL, respectively.

**Conclusions:** A UPLC-MS/MS assay for quantification of DHA, adenine, allopurinol, oxypurinol and febuxostat in human plasma was developed and optimized using DoE.

**Funding:** Government Support - Non-U.S.

## SA-PO580

## Dent Disease in Drosophila: Homologous Functions Between the Fly and Human Chloride Transporters

Carmen J. Reynolds,<sup>1</sup> Christopher M. Gillen,<sup>2</sup> Julian A. Dow,<sup>3</sup> Michael F. Romero,<sup>1</sup> <sup>1</sup>Mayo Foundation for Medical Education and Research, Rochester, MN; <sup>2</sup>Kenyon College, Gambier, OH; <sup>3</sup>University of Glasgow, Glasgow, United Kingdom.

**Background:** Mutations in the  $2Cl^-/H^+$  transporter CLC-5 cause Dent Disease type 1 (DD1) and lead to progressive renal failure by age 20-40. A major characteristic of DD1 is the renal mishandling of  $Ca^{2+}$  that increases urinary  $Ca^{2+}$  excretion, calcium oxalate (CaOx) kidney stones, and kidney calcification. Our laboratory has identified *Drosophila* Clc-c as the homolog of CLC-5 with conserved amino acids at DD1 mutation sites. We hypothesize that Clc-c shares functional similarities in  $Cl^-$  transport and  $Ca^{2+}$  homeostasis.

**Methods:** To determine the function of Clc-c, we assessed  $Cl^-$  transport by Clc-c and Clc-c with homologous DD1 mutations by voltage clamp assays. We then knocked-down expression of Clc-c in the renal Malpighian tubules of flies to assess evaluated crystal formation and cation secretion.

**Results:** Voltage clamp experiments in *Xenopus* oocytes show that Clc-c is electrogenic with similar outward-rectifying currents in  $Cl^-$  solutions as observed with human CLC-5. Chloride transport was decreased by acidic (pH 6.0), but not by alkaline solution (pH 8.5) when compared to the standard solution of pH 7.5. Homologous DD1 mutations S393L, R494W, and Q777x impaired  $Cl^-$  transport activity similar to previous observations for CLC-5 DD1 mutations S244L, R345W, and Q629x (Tang et al, *Physiol Rep* 4[8], 2016). RNAi knockdown of Clc-c (Clc-c-KD) in the *Drosophila* renal tubules (Malpighian tubules, MT) resulted in 50% Clc-c mRNA expression. Tubule Ca-oxalate crystals in adult anterior MT (7 days after eclosion) were present in all Clc-c-KD and were more abundant (15 $\pm$ 4 crystals per fly) compared to 5 $\pm$ 2 crystals in control flies ( $P=0.02$ ). Using MT-secretion experiments, cations secreted from MT of Clc-c KD flies contained higher concentrations of  $Ca^{2+}$  while all other ions ( $Na^+$ ,  $NH_4^+$ ,  $K^+$ ,  $Mg^{2+}$ ), and volume were the same as WT.

**Conclusions:** In conclusion, *Drosophila* Clc-c has similarities to human CLC-5 including impaired function with voltage-gated  $Cl^-$  transport, homologous DD1 mutations, increased CaOx crystal formation, and elevated  $Ca^{2+}$  in urine secretions. Thus, Clc-c has the potential to be an important model for future investigations on the effects  $Ca^{2+}$  homeostasis in DD1.

**Funding:** NIDDK Support

## SA-PO581

## Purely Coincidental CLCN5 Variants Identified in Two Patients With IgA Nephropathy

Darbey Raible,<sup>1</sup> Sumit Punj,<sup>1</sup> Padam Hirachan,<sup>2</sup> Andrew Lazar,<sup>1,3</sup> <sup>1</sup>Natera, Inc., Austin, TX; <sup>2</sup>Cenla Kidney Specialists, Alexandria, LA; <sup>3</sup>UH Ahuja Medical Center, Beachwood, OH.

**Introduction:** Many monogenic forms of chronic kidney disease (CKD) exhibit phenotypic variability, making clinical diagnosis challenging. An example is Dent disease 1 (DD1), caused by variants in the *CLCN5* gene, which can present with low molecular

weight proteinuria and variable hypercalciuria, nephrocalcinosis, nephrolithiasis, and hyperphosphaturia. While DD1 is primarily a disorder of the proximal tubules, glomerular pathology has been reported and may contribute to CKD progression. Use of broad panel-based genetic testing may improve the ability to identify monogenic disorders and/or reclassify biopsy-based diagnoses. We report two patients with biopsy-confirmed IgA nephropathy (IgAN) in whom likely pathogenic variants in *CLCN5* were identified through broad-panel genetic testing of 385 CKD associated genes (the Renasight™ test).

**Case Description:** Patient 1: a 38-year-old Caucasian male with history of progressive CKD (eGFR 30 mL/min/1.73 m<sup>2</sup>), proteinuria, hematuria, and biopsy-proven IgAN. Family history is significant for hematuria and unspecified diabetes mellitus in the maternal grandfather. Genetic testing revealed a likely pathogenic, hemizygous, frameshift variant in exon 9 that results in a truncation of *CLCN5*. The genetic diagnosis of DD1 informed counseling and prompted management changes to reduce nephrolithiasis risk. Patient 2: a 52-year-old Caucasian male with a history of persistently elevated serum creatinine (2.24 mg/dL), proteinuria, hematuria, nephrolithiasis, and biopsy-confirmed IgAN diagnosed over three decades. Genetic testing identified a likely pathogenic, hemizygous, frameshift variant in exon 8 that results in a truncation of *CLCN5*. The genetic diagnosis of DD1 prompted treatment changes including cessation of hydroxychloroquine and initiation of potassium citrate and an SGLT2 inhibitor.

**Discussion:** These cases demonstrate the clinical utility of broad renal genetic testing in patients with renal dysfunction by identifying an unexpected co-existence of DD1 with IgAN. Cases of co-occurring IgAN with type IV collagen disorders and Fabry disease have been reported, demonstrating that individuals presenting with IgAN can have a variety of monogenic forms of CKD. Further studies are needed to determine any relationship between IgAN and these monogenic conditions, or impact on disease severity or progression.

## SA-PO582

## Prevalence and Phenotypic Spectrum of Heterozygous SLC34A3 Mutations in a Large Genetic Database

Chinedu O. Nwachukwu, Gurmukteshwar Singh, Bryn S. Moore, Natasha T. Strande, Ion D. Bucaloiu, Alex R. Chang, *Geisinger Medical Center, Danville, PA.*

**Background:** Homozygous or compound heterozygous mutations in *SLC34A3*, encoding the sodium dependent inorganic phosphate cotransport proteins 2c (NPT2c), cause autosomal recessive hypophosphatemic rickets with hypercalciuria. Whether heterozygous carriers of *SLC34A3* pathogenic variants have increased risk of nephrolithiasis or other renal disorders is unknown.

**Methods:** We included participants heterozygous for *SLC34A3* S192L in the Geisinger MyCode/DiscoverEHR study, an unselected health-system-based study with exome sequencing data linked to electronic health records (EHR). We reviewed EHR for nephrolithiasis-related labs, diagnoses in progress notes or imaging, workup, nephrology and urology encounters.

**Results:** Of 174,418 MyCode participants, 238 (0.14%) were heterozygous for *SLC34A3* S192L. We excluded 3 with *SLC34A3* variants of uncertain significance and those without EHR data. Of the 217 remaining (mean age 58.6 years, 63% female), 65 (30%) had evidence of nephrolithiasis, including 13 who had incidental nephrolithiasis on imaging, and 2 had nephrocalcinosis. Only 21/65 with nephrolithiasis had urology visits for nephrolithiasis (15 had urologic procedures) and 13/65 were seen by nephrology for nephrolithiasis. Only 11 (5.5%) participants had family history of nephrolithiasis noted. Nephrolithiasis lab tests were rarely done. Of 88 participants with available serum phosphorus, 34 (39%) had hypophosphatemia  $<2.5$  mg/dL at least once. Among 9 patients who had a completed 24-hour urine risk profile, mean 24-hour urine calcium was 294 mg/d (67%  $>250$  mg/d), mean 24-hour urine phosphorus was 856 mg/d (33%  $>1100$  mg/d). Kidney stone analysis on 3 patients indicated calcium oxalate stone composition. Prescriptions potentially increasing nephrolithiasis risk included calcium supplements in 12 (6%) and vitamin D supplements in 29 (13%). No participants were taking phosphate supplements.

**Conclusions:** In our unselected EHR-based cohort, approximately 1/3 of *SLC34A3* S192L heterozygotes had evidence of nephrolithiasis. Few were comprehensively evaluated for nephrolithiasis, and many were taking potentially contraindicated medications. Further studies will help determine if personalized management could improve nephrolithiasis risk in this population.

## SA-PO583

## Rapid Detection of Heterozygous Carrier of AGT for Autosomal Recessive Renal Tubular Dysgenesis in Taiwan

Min-hua Tseng,<sup>1</sup> Shih-Hua P. Lin,<sup>2</sup> <sup>1</sup>Chang Gung Memorial Hospital Linkou, Taoyuan, Taiwan; <sup>2</sup>Tri-Service General Hospital, Taipei, Taiwan.

**Background:** Recurrent mutation of homozygous E3\_E4 del:2870bp deletion+9bp insertion in the *AGT* gene responsible for autosomal recessive renal tubular dysgenesis (ARRTD) is frequently reported in Taiwan, but the exact prevalence of heterozygosity is still unknown. The rapid detection of this mutation may help in the prevention of recurrent ARRTD.

**Methods:** This study was aimed to investigate the prevalence of heterozygosity of E3\_E4 del:2870bp deletion+9bp insertion of *AGT* in Taiwan and develop a simple and rapid method to detect this mutation. Three thousand health, ten heterozygous parents, and five homozygous Taiwanese were enrolled to define this mutation and determine their prevalence by using TaqMan probe-based real-time polymerase chain reaction (RT-PCR). We designed and validated the mutation detection plate, and tested its feasibility in newly diagnosed ARRTD patients.

Key: TH - Thursday; FR - Friday; SA - Saturday; OR - Oral; PO - Poster; PUB - Publication Only

Underline represents presenting author.

**Results:** The recurrent mutation-based TaqMan assays were fully validated with excellent sensitivity and specificity in genetic diagnosed patients and healthy subjects. The prevalence of heterozygosity of E3\_E4 del:2870bp deletion+9bp insertion of AGT is 1.27% in Taiwan. The probability that this haplotype occurred independently in all index cases was of 1.52 x10<sup>5</sup>, suggesting a founder effect.

**Conclusions:** The prevalence of heterozygosity of E3\_E4 del:2870bp deletion+9bp insertion of AGT in Taiwan is high and can be rapidly identified by TagMan probe-based RT-PCR.

**Funding:** Government Support - Non-U.S.

SA-PO584

**NephroS: Phenotypical Analysis of a Large National Nephrotic Syndrome Cohort: A Multicentre Longitudinal Study From Great Britain**

Maryam Afzal. Bristol Renal Group *University of Bristol, Bristol, United Kingdom.*

**Background:** Nephrotic Syndrome (NS) is a rare kidney disease diagnosed by the presence of proteinuria, oedema and hypoalbuminemia. The estimated global incidence of NS is 2-7 people per 100,000. The pathological processes that cause NS remain elusive. This novel multicentre longitudinal study aimed to identify the clinical and socio-demographic characteristics of a large NS cohort across Great Britain. Phenotypical analysis of such a large cohort will help understand the natural history and patterns of disease during a patient's lifetime.

**Methods:** A large multicentre longitudinal study was set up in January 2010 in 51 adult and paediatric sites across England, Scotland and Wales. Detailed prospective and retrospective clinical data was captured onto the Rare Renal Diseases Registry (RaDaR) over a period of 12 years from date of diagnosis until the cut-off point in January 2022. Patients were categorised by both their response to steroids and histological diagnoses to identify specific NS subgroups.

**Results:** Over 12 years, a total of 1974 adult and paediatric NS patients were recruited. The results show that NS is a male predominant condition (56%) and more prevalent in South Asian (13%) and African ethnicities (4%). A large proportion of patients were steroid-sensitive (48%), and the main histological diagnosis was Minimal Change Disease (MCD) (50%). Those who reached end stage renal disease (16%) were mainly aged 0 – 17 years old. A high proportion of deaths were noted in 2020/1, and caused by cancer or COVID-19.

**Conclusions:** It can be concluded that NS is dominant in males, and in South Asian and African ethnicities. A large proportion of patients were steroid-sensitive, and the main histological diagnosis was MCD. The data gathered in this study will help transform our understanding of NS. To better understand the implications of these results, future research including international collaboration will facilitate the development of translational research and evidence-based recommendations.

**Funding:** Private Foundation Support

SA-PO585

**Clinical Presentation and Management of Nephrotic Syndrome in the First Year of Life: A Report From the Pediatric Nephrology Research Consortium (PNRC)**

Yu Kamigaki,<sup>1</sup> Alexandru R. Constantinescu,<sup>2,4</sup> Tej K. Mattoo,<sup>3</sup> Larry A. Greenbaum,<sup>5</sup> Melissa A. Muff-Luett,<sup>6</sup> Ali Annaim,<sup>7</sup> Scott E. Wenderfer,<sup>8,9</sup> Emilee Plautz,<sup>10</sup> Michelle N. Rheault,<sup>11</sup> Robert L. Myette,<sup>12,13</sup> Katherine Twombly,<sup>7</sup> Mahmoud Kallash,<sup>1</sup> William E. Smoyer,<sup>1</sup> Tetyana L. Vasylyeva.<sup>14</sup> <sup>1</sup>Nationwide Children's Hospital, Columbus, OH; <sup>2</sup>Joe DiMaggio Children's Hospital, Hollywood, FL; <sup>3</sup>Wayne State University School of Medicine, Detroit, MI; <sup>4</sup>Florida Atlantic University Charles E Schmidt College of Medicine, Boca Raton, FL; <sup>5</sup>Emory University School of Medicine, Atlanta, GA; <sup>6</sup>Children's Hospital and Medical Center, Omaha, NE; <sup>7</sup>Medical University of South Carolina, Charleston, SC; <sup>8</sup>The University of British Columbia Faculty of Medicine, Vancouver, BC, Canada; <sup>9</sup>BC Children's Hospital, Vancouver, BC, Canada; <sup>10</sup>University of Minnesota, Minneapolis, MN; <sup>11</sup>University of Minnesota Masonic Children's Hospital, Minneapolis, MN; <sup>12</sup>Children's Hospital of Eastern Ontario, Ottawa, ON, Canada; <sup>13</sup>Ottawa Hospital Research Institute, Ottawa, ON, Canada; <sup>14</sup>Texas Tech University Health Sciences Center School of Medicine Amarillo, Amarillo, TX.

**Background:** Nephrotic syndrome (NS) in the first year of life is called congenital (CNS) if diagnosed between 0-3 months, or infantile (INS) if diagnosed between 3-12 months of age. The aim of this study was to determine if there were clinically meaningful differences between CNS vs. INS patients regarding clinical presentation, management, and outcomes.

**Methods:** 11 PNRC sites participated in the study, using IRB-approved retrospective chart reviews of CNS and INS patients born between 1998-2019. Data were collected on patient characteristics, pertinent laboratory tests, need and frequency of albumin infusions, and type and timing of nephrectomy and renal replacement therapy (RRT).

**Results:** The study included 69 patients, 49 with CNS and 20 with INS, median ages at diagnosis of 1 month and 6 months, respectively. Patients were similar with respect to nutrition, thyroxin supplementation, IVIG/SCIG prophylaxis, and thrombosis prophylaxis. Within the first 2 months after diagnosis, daily albumin infusions were more frequently needed in CNS vs. INS (79 vs. 30%; p=0.006), while weekly infusions were more frequently needed in INS vs. CNS (50 vs. 3%; p=0.001). Moreover, within the final

6 months preceding RRT, albumin infusions were more frequently required in CNS vs. INS (51 vs. 15%; p=0.007). Nephrectomy was also performed more frequently in CNS vs. INS (78 vs. 50%; p=0.024). Dialysis was similarly required in CNS vs. INS (73 vs. 55%; p=0.14). Pre-emptive kidney transplantations were similarly performed in CNS vs. INS patients (6% vs. 5%). Notably, management without either nephrectomy or RRT was more frequent in INS vs. CNS (40% vs. 16%; p=0.035). Sequences of interventions (i.e., Nephrectomy->RRT->Transplant [TXP]) were similar between the groups, although RRT->bilateral nephrectomy->TXP tended to occur more frequently in CNS vs. INS (61 vs. 36%; p=0.06).

**Conclusions:** Compared to children with INS, those with CNS had more severe disease courses, requiring more frequent albumin infusions, and earlier onset of RRT. In addition, almost 25% of children with CNS or INS were able to be managed without need for either nephrectomy or RRT.

SA-PO586

**Congenital Nephrotic Syndrome in the Amish and Mennonite Population of Central Pennsylvania**

Hannah Kim. Penn State Children's Hospital and Division of Pediatric Nephrology and Hypertension *Penn State College of Medicine, Hershey, PA.*

**Background:** Pennsylvania has the largest Amish/Mennonite population in the United States. The Amish/Mennonites accept beliefs that restrict participation in larger American society and thus have increased risk for certain genetic diseases including congenital nephrotic syndrome (CNS). We aim to describe the CNS population at Penn State Children's Hospital.

**Methods:** Clinical characteristics of the known CNS population at Penn State Children's Hospital were assessed using a retrospective electronic medical record review. An individual was defined as being part of, or historically part of, the Amish or Mennonite population by self-disclosure. Characteristics were summarized using medians (interquartile ranges) or proportions. Kaplan-Meier curves and Log-rank tests were used to evaluate time to end-stage kidney disease as defined by time to end-stage kidney disease (ESKD).

**Results:** 25 patients were identified at Penn State Children's Hospital over the last 30 years with a diagnosis of CNS (Table 1). Of those patients, 80% identified as Amish or Mennonite. The majority had either NPHS1 or NPHS2 mutations. The median time to ESKD was at 3 years of age (Figure 1). The median time to ESKD was faster for those with NPHS1 as compared to those with NPHS2 mutations (3 vs. 6 years, p<0.001).

**Conclusions:** The majority of children were of Amish or Mennonite background with ESKD in the first few years of life. Most had associated hypothyroidism, but the incidence of other complications including thromboses and serious bacterial infections was low.

Clinical Characteristics	Characteristic	N (%) or Median (IQR)
Amish/Mennonite (n=25)	Neither	4 (16%)
	Amish	9 (36%)
	Mennonite	11 (44%)
	Either/unknown	1 (4%)
Gene (n=21)	LAMB2	1 (4.8%)
	NPHS1	10 (47.6%)
	NPHS2	9 (42.9%)
	WT1	1 (4.8%)
Gender (n=25)	Male	14 (56%)
	Female	11 (44%)
NICU (n=24)		4 (16.7%)
	Ever dialysis use (n=24)	23 (95.8%)
Thrombosis (n=24)		1 (4.2%)
	Ever anticoagulation use (n=24)	3 (12.5%)
Ever anti-proteinuric agent use (n=24)		21 (87.5%)
	Ever NSAID use (n=24)	1 (4.2%)
Serious bacterial infections	0	16 (66.7%)
	1	6 (25%)
	2	2 (8.3%)
Ever use of infection prophylaxis (n=24)		19 (79.2%)
	Ever levothyroxine use (n=24)	21 (87.5%)
ESKD (n=25)		21 (84%)

Table 1. Clinical Characteristics

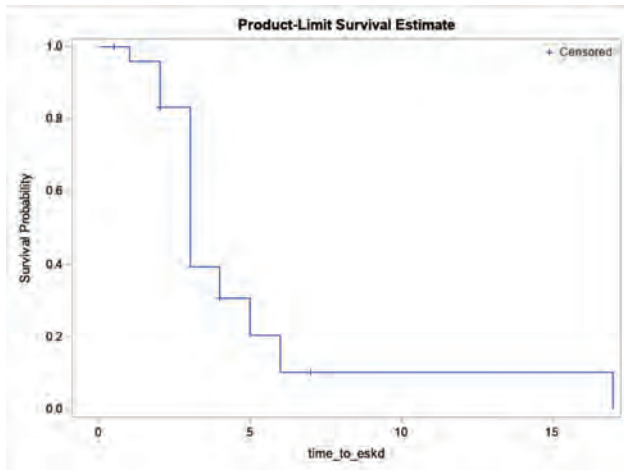

Figure 1. Time to ESKD

### SA-PO587

#### Hyperfiltration and eGFR Equations in the Pediatric NEPTUNE Study Cohort

Eloise Salmon,<sup>1</sup> Yujie Wang,<sup>1</sup> Katherine M. Dell,<sup>2</sup> Kimberly J. Reidy,<sup>3</sup> Pediatric Working Group of the NEPTUNE study <sup>1</sup>University of Michigan, Ann Arbor, MI; <sup>2</sup>Cleveland Clinic Children's Hospital, Cleveland, OH; <sup>3</sup>Children's Hospital at Montefiore, Bronx, NY.

**Background:** Hyperfiltration has been reported in nephrotic syndrome. Pediatric GFR estimating equations were developed with data primarily on children with decreased GFRs, and the accuracy of these formulas with elevated GFRs is unknown. Because hyperfiltration may be deleterious, inaccurate estimated GFRs (eGFRs) in this patient population may generate false clinical reassurance. The objectives of this study in the pediatric NEPTUNE cohort were: (1) to examine whether the variance between two pediatric eGFR estimating formulas differs by hyperfiltration status; and (2) to compare the prevalence of hyperfiltration while in first remission in this cohort.

**Methods:** eGFR was calculated using the creatinine based pediatric "bedside" Schwartz formula and the CKID U25 formula. Hyperfiltration was defined as eGFR  $\geq$  140 ml/min/1.73m<sup>2</sup>. First remission was defined as the first urine protein:creatinine (UPC)  $<$  0.3 mg/mg for which there was an available serum creatinine obtained at the same time. For Aim 1, all available serum creatinines obtained on patients 1-  $<$ 18 years of age were utilized irrespective of proteinuria status. Absolute differences between the two eGFR formulas were calculated and the difference in those with and without hyperfiltration were compared by t-test (two-sample unequal variance). For Aim 2, only the subset of pediatric patients who achieved first remission were included.

**Results:** A total of 3570 serum creatinine values from 320 unique patient with a median age of 6 years (35% minimal change disease, MCD, 20% focal segmental glomerulosclerosis, FSGS, 45% not biopsied) were available for analysis. The median [interquartile range] difference between the eGFRs using the two estimating formulas in patients with vs without hyperfiltration was 23 [16.9-28] vs. 11 [6.8-15.2] mL/min/1.73m<sup>2</sup>, respectively (p  $<$  0.001). For children who achieved first remission (n=233), 12.5% had hyperfiltration by "bedside" Schwartz vs. 7.7% by the U25 formula.

**Conclusions:** Pediatric NEPTUNE patients with hyperfiltration vs. not demonstrate higher variability in eGFRs using two common pediatric estimating equations, and rates of hyperfiltration (in remission) also vary based on the formula used. These data suggest estimating equations may be less accurate in children with nephrotic syndrome and indicate more research is needed to better refine eGFR estimation formulas for this population.

**Funding:** NIDDK Support, Other NIH Support - NCATS/ Division of Rare Diseases Research Innovation (DRDRI). Division of Rare Diseases Research Innovation (DRDRI).

### SA-PO588

#### Induction Therapy With Mycophenolate Mofetil for Steroid-Sensitive Nephrotic Syndrome in Children: A Prospective Single Center Pilot Study

Alexandra Mazo,<sup>1,2</sup> Tanya E. Pereira,<sup>1,2</sup> Sonia Solomon,<sup>1,2</sup> Dmitry V. Samsonov,<sup>1,2</sup> <sup>1</sup>Westchester Medical Center, Valhalla, NY; <sup>2</sup>New York Medical College, Valhalla, NY.

**Background:** Standard induction therapy for steroid sensitive nephrotic syndrome (SSNS) in children is steroids for 12 weeks. The purpose of this study was to evaluate whether Mycophenolate Mofetil (MMF) can replace steroids to complete the induction phase in SSNS.

**Methods:** Patients 2 to 12 years old with first diagnosis of nephrotic syndrome who achieved remission (UPC  $<$  0.3 mg/mg) within 2 weeks of steroid treatment were recruited. In MMF group (TG) treatment with steroids was stopped on day of enrollment and MMF (1200 mg/m<sup>2</sup>/day) initiated and continued for a total of 10 wks. Control group

(CG) continued standard steroid treatment. Quality of Life (QOL) was assessed by questionnaires at enrollment and in 10 weeks. The primary study outcomes were relapse rate (RR) and relapse free interval (RFI) (time in weeks from enrollment to first relapse). Secondary outcomes included side effects of MMF, steroids, and changes in QOL.

**Results:** Nine patients were in TG and 17 in CG. During induction phase 2 out of 9 patients (22%) in TG developed relapse compare with 1 out of 17 (6%) in CG (p 0.1). During the first year 6 out of 9 patients (67%) in TG and 12 out of 17 (71%) in CG developed relapse (p 1.0). Median RFI was 11 (QI 5-22) weeks in TG and 17 (QI 13-31) weeks in CG (p 0.7). Two patients in CG and none in TG required treatment for hypertension. QOL improved in both groups, not statistically significant. No difference in secondary outcomes (weight gain, leukopenia, anemia, infection rate) were seen between the groups.

**Conclusions:** Induction therapy with steroids resulted in less RR during the first 3 months of therapy and prolonged RFI. However, in our small sample data difference between the groups was not statistically significant. Larger randomized study is underway to compare MMF and steroid induction in SSNS (INTENT study).

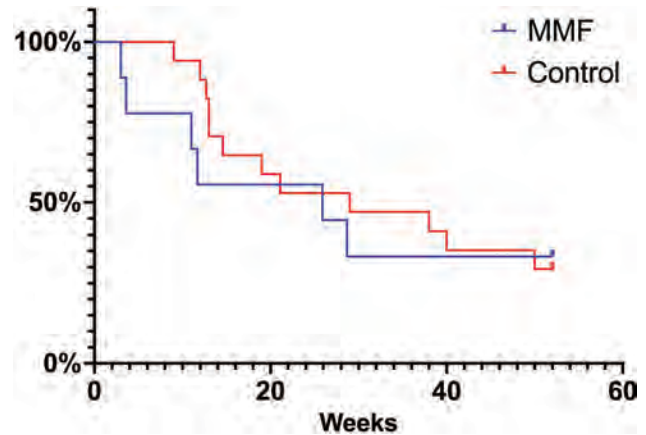

Relapse free interval by Kaplan-Meier analysis (logrank test p=0.72)

### SA-PO589

#### Significance of Remission of Proteinuria in Childhood IgA Nephropathy

Yuko Shima,<sup>1</sup> Hironobu Mukaiyama,<sup>1</sup> Yu Tanaka,<sup>1</sup> Wataru Shimabukuro,<sup>2</sup> Hiroshi Kaito,<sup>3</sup> Ryojiro Tanaka,<sup>3</sup> Kandai Nozu,<sup>4</sup> Kazumoto Iijima,<sup>4</sup> Daisuke Tokuhara,<sup>1</sup> Norishige Yoshikawa,<sup>5</sup> Koichi Nakanishi,<sup>2</sup> <sup>1</sup>Wakayama Kenritsu Ika Daigaku, Wakayama, Japan; <sup>2</sup>Ryukyuu Daigaku Igakubu Daigakuin Igaku Kenkyuka, Nakagami-gun, Japan; <sup>3</sup>Hyogo Kenritsu Kodomo Byoin, Kobe, Japan; <sup>4</sup>Kobe Daigaku, Kobe, Japan; <sup>5</sup>Shakai Iryo Hojin Aijinkai Takatsuki Byoin, Takatsuki, Japan.

**Background:** Remission of proteinuria is the most significant prognostic factor for kidney outcome in IgA nephropathy (IgAN). There is no study investigating the effect of proteinuria remission on long-term outcomes in a large cohort of pediatric IgA nephropathy. The purpose of this study is to clarify the factors for proteinuria remission and their outcomes in childhood IgAN.

**Methods:** In the retrospective analysis of 538 biopsy-proven childhood IgAN between 1976 and 2013, we evaluated clinical and pathological findings of the 309 cases (57.4% with proteinuria remission and the others).

**Results:** Although there were significant differences in onset age (median 10.3 vs. 11.9 years, p $<$ 0.0001), and follow-up period (median 7 vs. 3 years, p $<$ 0.0001) between the proteinuria remission and non-remission groups, there was no other significant difference in clinical and pathological findings. In the logistic regression analyses, onset age (OR=0.90, p=0.04), initial biopsy year before 1990 (OR=0.41, p=0.03), need for immunosuppressive treatment (OR=0.40, p=0.03), and follow-up period (OR=1.21, p $<$ 0.0001) were significantly related to proteinuria remission. Kaplan-Meier analysis showed a significantly better kidney survival rate in the proteinuria remission group than in the non-proteinuria remission group (97.0 vs 78.7% at 13 years, p $<$ 0.001). And, all patients who progressed to kidney failure in the proteinuria remission group had proteinuria relapse.

**Conclusions:** The patients with childhood IgAN were detected by annual school screening early in the disease course in Japan and they were treated according to their clinical and pathological severity. Regardless of clinical and pathological severity at biopsy, risk factors related to proteinuria remission were only onset age, the initial biopsy year before 1990 when extensive treatments began, and the need for immunosuppressive treatment in the course. Not only proteinuria remission but also the continuation of proteinuria remission is important for renal survival.



## SA-PO590

**Cerebral Venous Sinus Thrombosis in a Child With IgA Vasculitis and COVID-19 Infection**

Kayla J. Erspamer,<sup>1</sup> Ethan A. Canty,<sup>1</sup> Bronwyn Baz,<sup>1,2</sup> Abbie R. Bauer.<sup>1,1</sup> *Oregon Health & Science University Doernbecher Children's Hospital, Portland, OR;*  
<sup>2</sup>*Kaiser Permanente Sunnyside Medical Center, Clackamas, OR.*

**Introduction:** IgA vasculitis (IgAV) is a common diagnosis in children and includes purpura, and/or petechiae (without thrombocytopenia or coagulopathy) with at least one of the following: abdominal pain, joint pain, AKI, hematuria, proteinuria, or evidence of IgA deposition. Many cases are preceded by upper respiratory tract infections, including COVID-19. The incidence of cerebral venous sinus thrombosis (CVST) in the pediatric population is low (0.6/100,000 per year). We present a case of a 5 year old boy with IgA vasculitis and COVID-19 infection found to have CVST.

**Case Description:** A previously healthy 5 year old boy transferred to our institution with two weeks of intermittent, severe abdominal pain in the setting of COVID-19 infection with new-onset hematochezia, hypertension, and tachycardia. Abdominal ultrasound, abdominal x-ray, chest x-ray, ANA, C3, C4, ANCA, creatinine, electrolytes, and coagulation factors were normal. Urinalysis was significant for hematuria and a urine protein-to-creatinine ratio (UPC) of 2.02 mg/mg. Purpuric and petechial rash appeared the day after admission. UPC trended up to 4.82 mg/mg and a renal biopsy confirmed the diagnosis of IgA nephropathy. Patient was treated with 30mg/kg/day Solu-Medrol for three days and discharged home on 2mg/kg/day prednisolone daily. He was readmitted two days later with severe left frontal headache. UPC was worse at 5.98 mg/mg and mycophenolic mofetil (MMF) was initiated. Imaging revealed an occlusive thrombus of the left transverse sinus with nonocclusive thrombi in the distal portion of the left lateral sinus and posterior superior sagittal sinus. He started 21mg Lovenox twice daily and had minimal residual thrombosis after three months. His UPC peaked at 20.73 mg/mg and eventually normalized with high-dose steroids, Enalapril, and MMF.

**Discussion:** This is the first case, to our knowledge, of CVST in a patient with IgAV associated with COVID-19 infection. Multiple case reports of IgA vasculitis associated with COVID-19 infection have been published in the past two years, and this case may support a more careful approach when it comes to screening for pro-coagulation risk factors.

## SA-PO591

**A Rare Genetic Cause of Steroid Resistant Nephrotic Syndrome**

Jessamyn S. Carter,<sup>1,2</sup> John D. Spencer.<sup>1</sup> *Nationwide Children's Hospital, Columbus, OH;* <sup>2</sup>*The Ohio State University Wexner Medical Center, Columbus, OH.*

**Introduction:** MIRAGE syndrome, named for Myelodysplasia, Infection, growth Restriction, Adrenal hypoplasia, Genital phenotypes, and Enteropathy, is a rare genetic disorder caused by autosomal dominant mutations in *SAMD9* and which is sometimes associated with adaptive monosomy 7 leading to myelodysplasia. However, there is significant genotypic and phenotypic variation with an increase in identified mutations and presentations in recent years. We present here a case of focal segmental glomerulosclerosis in a patient with MIRAGE syndrome associated with a novel *SAMD9* mutation.

**Case Description:** A 3 year old boy with history of intrauterine growth restriction, cryptorchidism, and intermittent thrombocytopenia presented for persistent proteinuria (urine protein:creatinine ratio, or UPCR, of 3.4) with normal serum albumin. Renal biopsy showed segmental sclerosis in 2 out of 20 glomeruli, and he completed a prednisone course with no improvement of proteinuria. He was then started on enalapril and spironolactone with improvement of UPCR to 1 and has remained on renin-angiotensin-aldosterone system blockade since that time for management of his proteinuria. His hematologic course progressed to myelodysplastic syndrome with transient monosomy 7 and he underwent bone marrow transplant at age 8. That year, while on tacrolimus from BMT, he developed edema and hypoalbuminemia prompting repeat renal biopsy which again showed focal segmental glomerulosclerosis. Immunosuppression with curcumin was given with improvement in UPCR from 4.4 to 1.6 initially but with recurrent increase over the next two years. He has since received no other immunosuppression and maintains on lisinopril and spironolactone with variable but persistent proteinuria and intermittent episodes of edema. UPCR was 6.8 during most recent follow up at age 15.

**Discussion:** MIRAGE syndrome is a rare but increasingly recognized genetic disease impacting many organ systems. The immunologic and hematologic manifestations are most notable because of potential lethality, but scattered evidence suggests MIRAGE syndrome can be associated with glomerular disease. Though not definitive, people with MIRAGE syndrome may have structural anomalies in the endosomal system, which could trigger dysfunctional endocytosis in podocytes and lead to proteinuria.

## SA-PO592

**Revealing Complement Regulatory Functions of Thrombospondin-1 as New Potential Mechanism in Renal Disease**

Swagata Konwar,<sup>1,2</sup> Jessika Kleindienst,<sup>1</sup> Eva L. Decker,<sup>2</sup> Martin Pohl,<sup>1</sup> Christian Gorzelanny,<sup>3</sup> Todor A. Tschongov,<sup>1</sup> Karsten Häffner.<sup>1</sup> *AG Pediatric Nephrology <sup>1</sup>Universitätsklinikum Freiburg, Freiburg, Germany;* <sup>2</sup>*Albert-Ludwigs-Universität Freiburg, Freiburg im Breisgau, Germany;* <sup>3</sup>*Universitätsklinikum Hamburg-Eppendorf, Hamburg, Germany.*

**Background:** Overactivation of the complement system can lead to severe kidney and vascular diseases like atypical hemolytic uremic syndrome (aHUS) and ANCA-associated vasculitis. In recent years it is becoming clearer that coagulation,

thrombosis and extracellular matrix are deeply connected with the complement system. Thrombospondin-1 (TSP-1) is a major compound of  $\alpha$ -granules in platelets and also present in Weibel-Palade bodies of endothelial cells. TSP-1 is rapidly released after injury and involved in the regulation of clot formation and platelet aggregation. Binding of complement factor H (FH) to TSP-1 has been reported before, however, no research has examined possible intrinsic TSP-1 complement regulation.

**Methods:** Alternative pathway ELISA, Hemolysis, cofactor, decay acceleration and terminal complement complex (TCC) formation assay were performed as described previously (Michelfelder et al. JASN, 2018). Factor D inhibition assay was performed as described previously (Edwards et al. J Biol Chem, 1999) Binding assays: TSP-1 was coated on 96 well plates and incubated with increasing amounts of C3 or C5. Binding was analysed using HRP-coupled antibodies. Cell culture: HUVEC were transfected with TSP-1 siRNA using lipofectamine as instructed. Immune fluorescence staining was performed with specific antibodies against TSP-1 and C3.

**Results:** TSP-1 is able to strongly inhibit the alternative pathway (AP) in normal human and aHUS patient serum. The inhibition is only partly dependent on FH. TSP-1 binds to central complement proteins of the alternative pathway. It has no intrinsic cofactor or decay acceleration activity, but inhibits cleavage of FB and C3. Additionally, TSP-1 prevents formation of TCC. Knockdown of TSP-1 in endothelial cells leads to an increase in C3 deposition on HUVEC. This increase can be ameliorated by adding recombinant TSP-1 back into the system.

**Conclusions:** In several in vitro experiments we have found that TSP-1 directly inhibits the activation of the AP in multiple ways. We believe that TSP-1 can act as a bridge between platelets, extracellular matrix, coagulation and complement system and thereby contribute to pathomechanisms of renal diseases. This knowledge could lead to the development of new treatment strategies for complement mediated diseases in the future.

**Funding:** Commercial Support - eleva GmbH, Freiburg, Germany

## SA-PO593

**A Unique Presentation of Dense Deposit Disease**

Golnaz Sadeghiani, Amal G. Ezzaiyan, Ashley E. Rawson. *Our Lady of the Lake Regional Medical Center, Baton Rouge, LA.*

**Introduction:** Diagnosis of dense deposit disease (DDD) is made by renal bx. It has a poor prognosis and treatment remains difficult and varied. Renal bx may be confounding early in the disease process.

**Case Description:** A 14 yo female with no PMH presented to our facility with 4 weeks of progressive edema. Initial evaluation demonstrated UA with 20-50 WBCs, 10-20 RBCs, and >500 protein; serum Cr 1.54; UPCR 13000 mg/G; C3 11; and C4 11. ANA and anti-dsDNA antibodies were positive. Renal bx demonstrated a diffuse proliferative glomerulonephritis (GN) and membranous nephropathy with multiple wire loop lesions. IF showed a full house pattern with diffuse global granular mesangial and capillary loop staining for IgG (3+), IgA (trace-1+), IgM (1+), C3 (3+), C1q (2+), kappa (3+) and lambda (2+). EM revealed occasional subepithelial and intramembranous electron-dense deposits along the basement membranes. She was diagnosed with mixed class IV/V lupus nephritis and met ACR classification criteria for diagnosis of SLE. From 4/2020-2021, she was treated with high dose pulse IV steroids, oral steroids, rituximab, mycophenolate mofetil, azathioprine, and cyclophosphamide. Despite aggressive treatment, her response was moderate at best and the C3 did not increase. She underwent a second bx 12 months later due to lack of resolution of renal symptoms. IF on the second bx revealed focal and segmental granular mesangial and capillary loop staining for IgG (1+), kappa (trace) and lambda (trace) and diffuse global granular mesangial and capillary loop staining for C3 (3+). EM revealed extensive electron-dense transformation of the glomerular basement membranes and mesangium. These findings appeared more consistent with DDD. Complement pathway assessment revealed elevated SC5B-9 Level (1,048 ng/ml), C3a (454.5 ng/ml), C5a (28,616 ng/ml), C3 Nephritic Factor (171.0 unit/ml) and complement Bb (3,790 mcg/ml). She was started on eculizumab with significant improvement over the last six months. Her Cr fell from 2.52 to 1.41 and UPCR fell from 5,513 mg/G to 2,117 mg/G.

**Discussion:** GN patients present similarly in many cases and some lupus indicators such as ANA may be nonspecific. This case shows the importance of repeating a renal bx in non-responsive lupus nephritis or GN patients in general as the initial biopsy may not tell the full story. In our case repeat biopsy revealed a new diagnosis leading to different treatment options.

## SA-PO594

**Acute Renal Papillary Necrosis With New-Onset Minimal Change Disease**

Shrea Goswami,<sup>1,2</sup> Shunhua Guo,<sup>1,2</sup> Joshua Roth,<sup>1,2</sup> Andrew L. Schwaderer,<sup>1,2</sup> Myda Khalid.<sup>1,2</sup> *Riley Hospital for Children at Indiana University Health, Indianapolis, IN;* <sup>2</sup>*Indiana University School of Medicine, Indianapolis, IN.*

**Introduction:** Acute renal papillary necrosis (RPN) is a rare condition in children characterized by renal sloughing of papillae. We present a case of RPN in a healthy 4-year-old girl with new onset minimal change disease (MCD). To our knowledge, RPN as a complication of new onset MCD has not been previously reported.

**Case Description:** The patient presented with a 4-day history of generalized edema, fatigue and decreased urine output. Pertinent lab findings were albumin of 2.4 mg/dL and UPCR of 27 mg/mg. She had an elevated serum BUN and creatinine of 44 mg/dL and 1.2 mg/dL respectively. Renal bladder ultrasound showed bilateral nephromegaly without hydronephrosis. Upon hospitalization, she received albumin with furosemide overnight. However, she remained anuric and creatinine rose to 2.9 mg/dL the next day. Repeat renal bladder ultrasound demonstrated bilateral circular isoechoic foci in mid-poles of the

kidneys with bladder debris, suspicious for RPN. Double J stents were placed urgently with immediate production of urine. Retrograde pyelogram at the time of stent placement demonstrated multiple collections of contrast in bilateral kidney papillae, specific for RPN. A renal biopsy on day 6 of hospitalization revealed MCD. Common risk factors for RPN such as NSAID use were not present and a hemoglobin electrophoresis was negative. She remained on prednisolone for the MCD and entered remission in one month.

**Discussion:** To our knowledge we are not aware of any case reports describing RPN as a complication of minimal change disease. The sloughed renal papillae caused an acute bilateral ureteric obstruction. Due to sudden onset of obstruction hydronephrosis did not develop. We speculate that the intravascular volume depletion from MCD triggered a hypoxic state resulting in RPN which is similar to the pathophysiology of severe dehydration induced RPN.

Retrograde left pyelogram demonstrating central excavation of the papillae typical for papillary necrosis.

A. A "ball on tree appearance" in the upper and lower poles papillae (arrows 1, 2, and 4) and a clubbed calyx appearance in the mid pole papilla (arrow 3).

B. There is progressive filling of the papillae excavations, most severe in the mid pole (arrow).

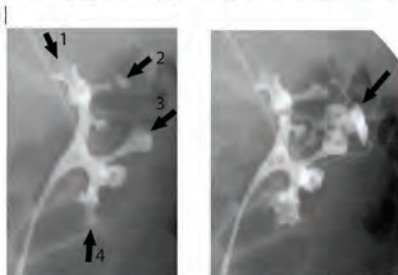

SA-PO595

The Difference of Activation Pattern of Complement System Between Pediatric and Adult Lupus Nephritis

Minji Park, Min Hyun Cho. Kyungpook National University Hospital, Daegu, Republic of Korea.

**Background:** Lupus nephritis has an etiopathogenesis caused by activation of the complement system. The purpose of this study is to investigate the differences and clinical implication of the activation pattern of complement system between pediatric and adult lupus nephritis patients.

**Methods:** We retrospectively reviewed medical records of 14 pediatric and 26 adult patients whose tissue specimens were stored among patients diagnosed with lupus nephritis through renal biopsy. The activation of complement system was evaluated by performing IHC staining for C4d (a component of the lectin pathway) and IF staining for C1q (a component of the classical pathway) and C3 (a component of the alternative pathway) in renal tissue.

**Results:** The study enrolled 14 pediatric and 26 adult patients, and the proportion of female was significantly higher in both groups. The average age at diagnosis of pediatric patients was 11.7 ± 2.9 years, and the average age of adult patients was 37.3 ± 13.5 years. Except for age and C3 level, the baseline clinical characteristics of pediatric and adult patients were similar. Age-adjusted mean C3 value were significantly lower in pediatric patients, 33.0mg/dL in pediatric patients and 50.8 mg/dL in adult patients (p=0.003). As a result of complement staining of kidney tissue, the C3 and C1q positivity rate in pediatric/adult patients were 92.9/76.9% and 85.7/80.8%, respectively and there was no significant difference. However, the C4d positivity was 35.7% in pediatric patients and 76.9% in adult patients (p=0.010), which was significantly higher in adult patients than in pediatric patients. Although there was no correlation between C4d activation and initial laboratory findings and prognosis in both groups, the C4d/C1q(+/+) group among adult patients had poor prognosis (defined as CRF, dialysis or death) than the C4d/C1q(+/-) group (82% vs 33%, p=0.027).

**Conclusions:** Pediatric lupus nephritis patients had significantly lower C4d activation compared to adult lupus nephritis patients and the co-positivity for C4d and C1q can be considered as a poor prognostic factor for lupus nephritis patients. Therefore, we conclude that the pattern of complement activation system plays an important role in determining the age difference and prognosis in lupus nephritis.

SA-PO596

Urine Complement Factor Ba Is an AKI Biomarker in Critically Ill Children

Erin K. Stenson,<sup>1,2</sup> Zhiying You,<sup>1</sup> Charles L. Edelstein,<sup>1</sup> Shinobu Miyazaki-anzai,<sup>1</sup> Joshua M. Thurman,<sup>1</sup> Bradley P. Dixon,<sup>1,2</sup> Michael Zappitelli,<sup>4</sup> Stuart Goldstein,<sup>3</sup> Jessica B. Kendrick,<sup>1</sup> <sup>1</sup>University of Colorado Denver School of Medicine, Aurora, CO; <sup>2</sup>Children's Hospital Colorado, Aurora, CO; <sup>3</sup>Cincinnati Children's Hospital Medical Center, Cincinnati, OH; <sup>4</sup>Sick Kids Foundation, Toronto, ON, Canada.

**Background:** Critically ill children with acute kidney injury (AKI) suffer from high morbidity and mortality and lack treatment options. Complement activation is implicated in AKI pathogenesis, which could potentially be treated with complement-targeted therapeutics. We assessed the association between urine Ba, an activated fragment of the alternative complement pathway, and AKI in a heterogeneous cohort of critically ill children.

**Methods:** A biorepository of critically ill children was leveraged and identified children with pRIFLE criteria AKI (stage 1 eGFR 25% decreased; stage 2 eGFR 50% decreased; stage 3 eGFR 75% decreased). ELISAs quantified urine Ba values. The log value of Ba was used in ANOVA with pairwise comparison by the Tukey method. Logistic regression tested the association between urine Ba and AKI.

**Results:** 73 patients from the original study had urine specimens available. 17 with no AKI, 26 with stage 1, 16 with stage 2, and 14 with stage 3 AKI. Ba was higher in patients with stage 3 AKI compared to all other stages, and higher in patients with stage 2 AKI versus no AKI (Figure 1; p<0.05). Multivariate analysis showed the association between urine Ba and AKI (OR 1.40, 95% CI 1.08-1.82, p = 0.002) after adjusting for PRISM (an estimate of illness severity).

**Conclusions:** Urine factor Ba levels are increased in patients with AKI compared to patients without AKI. In patients with similar illness severity on admission, a doubling of urine Ba level was associated with a 40% increase in AKI diagnosis. Further studies are needed to investigate the role of complement activation in critically ill children at risk of AKI, to help stratify patients to study complement therapeutics in.

**Funding:** NIDDK Support, Other NIH Support - National Institutes of Health Grants Eunice Kennedy Shriver Institute of Child Health & Human Development K12 HD 047349

Multivariate logistic regression

Variable	OR (95% CI)	p-value
Urine Ba	1.40 (1.08-1.82)	0.0015
Urine IL-18	1.21 (0.60-2.42)	0.60
PRISM	0.99 (0.91-1.07)	0.78

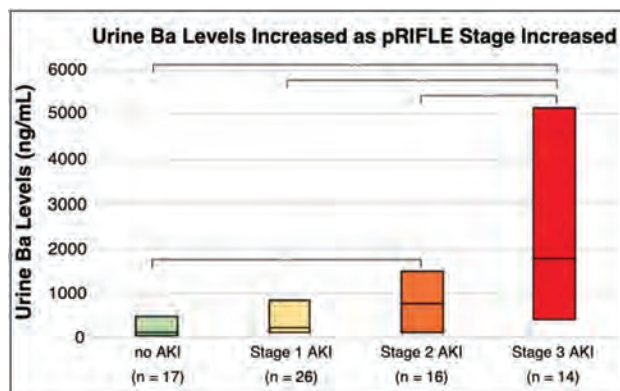

SA-PO597

Prospective Cohort Study of Pediatric AKI in Korea

Naye Choi,<sup>1,3</sup> Jeesu Min,<sup>1,3</sup> Ji hyun Kim,<sup>2,3</sup> Haemin Kang,<sup>1</sup> Hee Gyung Kang,<sup>1,3</sup> Yo Han Ahn,<sup>1,3</sup> <sup>1</sup>Seoul National University Children's Hospital, Seoul, Republic of Korea; <sup>2</sup>Seoul National University Bundang Hospital, Seongnam, Republic of Korea; <sup>3</sup>Seoul National University College of Medicine, Seoul, Republic of Korea.

**Background:** Acute kidney injury (AKI) is a common complication in pediatric patients with underlying disease, and it is associated with increased length of hospital stay and mortality. Additionally, AKI is a well-known risk factor for chronic kidney disease (CKD). Although studies about AKI in children have been increasingly conducted, there was lack of study on the longitudinal kidney outcomes after AKI. Therefore, we conducted a prospective cohort study to investigate the short- and long-term effects of AKI on kidney function in children with AKI.

**Methods:** A prospective cohort study was performed in hospitalized children who were diagnosed with AKI in Seoul National University Children's Hospital from February 2016 to July 2021. AKI was defined according to Kidney Disease: Improving Global Outcomes (KDIGO) criteria. Kidney function was assessed at 1, 3, 6, and 12 months after the AKI event and annually thereafter from 1 year

**Results:** A total of 807 children with AKI were enrolled, and 735 (male 58.2%) patients with follow-up data were analyzed. AKI occurred at the median age of 5.6 (interquartile range (IQR) 1.1-12.1) years. The 85.4% of patients had the underlying disease, including hemato-oncological disease 210 (28.6%), preterm birth 115 (15.6%), and kidney disease 74 (10.1%). Hypertension was present in 107 (14.6%) at the time of AKI. Among them, 415 (56.5%) patients were classified as stage 1, 177 (24.1%) and 143 (19.5%) were classified as stage 2 and 3, respectively. Estimated glomerular filtration rate (eGFR) declined from 102.6 (IQR 70.7-136.6) mL/min/1.73m<sup>2</sup> at baseline to 52.8 (IQR 23.9-74.4) mL/min/1.73m<sup>2</sup> at the onset of AKI. At follow-up of 1, 3, 6, 12 months, eGFR were 88.9 (IQR 63.5-119.4), 98.3 (IQR 78.2-121.2), 100.5 (IQR 82.0-121.7), and 95.9 (IQR 77.8-113.2) mL/min/1.73m<sup>2</sup>, respectively. After 12 months, the proportion of eGFR less than 90 and 60 mL/min/1.73m<sup>2</sup> were 39.8 % and 8.4%, respectively. The eGFR at follow-up of 12 months was significantly lower than that at baseline (P = 0.007). Older age and hypertension at the AKI event were the risk factors for CKD stage 3.

**Conclusions:** In this study, 8.4% of children progressed to CKD following AKI. Therefore, it is important to monitor the kidney function in children after an AKI event. Further study is needed to validate risk factors for CKD and longer outcomes.

SA-PO598

**Patient Level Factors Increase Risk of Acute Kidney Disease in Hospitalized Children With AKI**

Mital Patel,<sup>1</sup> Christoph Hornik,<sup>1</sup> Clarissa J. Diamantidis,<sup>1</sup> David T. Selewski,<sup>2</sup> Rasheed A. Gbadegesin.<sup>1</sup> <sup>1</sup>Duke University Medical Center, Durham, NC; <sup>2</sup>Medical University of South Carolina, Charleston, SC.

**Background:** Studies in adults have shown that acute kidney disease (AKD [kidney dysfunction  $\geq 7$ -90 days]) may be a better predictor of chronic kidney disease (CKD) and mortality in AKI survivors. However, in the pediatric population, little attention has been paid to the AKI-to-AKD transition and subsequent consequences. The aim of this study is to evaluate the risk factors for progression of AKI to AKD in hospitalized children and determine the incidence of CKD following AKD.

**Methods:** We quantified AKD risk using a retrospective cohort of 528 children admitted with AKI to critical care and general wards at a tertiary care children's hospital between 2015-2019. Exclusion criteria included insufficient creatinine values to evaluate for AKD, chronic dialysis, or previous kidney transplant. AKI and AKD were defined using Kidney Disease Improving Global Outcomes criteria. CKD was defined as new estimated glomerular filtration rate of  $< 60$  ml/min/1.73m<sup>2</sup> for  $> 3$  months after AKI.

**Results:** In this cohort, 297 (56.3%) of hospitalized AKI survivors developed AKD. Univariable analysis showed that there are patient level risk factors for AKD (table 1) including preexisting conditions, iatrogenic factors, and severity of kidney injury. Among children with AKD, 26.3% developed CKD compared to 13.4% in the group without AKD (OR 2.9, 95% CI 1.75-4.77).

**Conclusions:** Our data shows that AKD is extremely common among hospitalized children with AKI and that multiple patient level risk factors are associated with AKD. This study suggests that AKI survivors with AKD are at higher risk of developing CKD than those without AKD, suggesting nephrology follow up is indicated in this group.

**Funding:** NIDDK Support

Table 1: Univariable analysis comparing risk factors in patients with and without AKD

Variable	AKD (n=297)	No AKD (n=231)	p-value
Prematurity < 36 weeks	106 (35.7)	54 (23.4)	0.0026
Malignancy	37 (12.5)	15 (6.5)	0.023
Bone marrow transplant	40 (13.5)	8 (3.5)	7.38e-5
Previous AKI	39 (13.1)	16 (6.9)	0.021
Severe AKI	258 (86.9)	164 (70.1)	6.27e-6
Mechanical ventilation	152 (51.2)	75 (32.5)	1.65e-5
ECMO	26 (8.8)	10 (4.3)	0.045
Nephrotoxic medication exposure	261 (87.9)	176 (76.2)	0.00042
Suprathreshold medications	99 (33.3)	55 (23.8)	0.017
Sepsis	175 (58.9)	100 (43.3)	0.00006

Data expressed as N (%)

SA-PO599

**Neonatal Hyperoxia Contributes to Kidney Injury and Differential Kidney Gene Expression in Adult Rats**

Marissa J. Defreitas,<sup>1</sup> Augusto F. Schmidt,<sup>1</sup> Amanda Levine,<sup>1</sup> Shathiyah Kulandavelu,<sup>1</sup> Pingping Chen,<sup>1</sup> Runxia Tian,<sup>1</sup> Claudia P. Rojas,<sup>2</sup> Carolyn L. Abitbol,<sup>1</sup> Shu Wu,<sup>1</sup> Karen Young,<sup>1</sup> Merline Benny.<sup>1</sup> <sup>1</sup>University of Miami School of Medicine, Miami, FL; <sup>2</sup>Memorial Healthcare System, Hollywood, FL.

**Background:** Neonatal hyperoxia exposure causes short- and long-term kidney injury and impaired kidney development. However, the mechanisms underlying this programming are largely unknown. Here, we test the hypothesis that neonatal hyperoxia induces renal histomorphometry changes and altered kidney gene expression in adult rats.

**Methods:** Newborn rats (N=14) randomly assigned to normoxia (RA; n=8) or hyperoxia (HO; n=6) (85% O<sub>2</sub>) from postnatal day 1 to 14, were recovered in normoxic conditions until 1 year of life. At 1 year of life, kidney and body weight were measured. Renal histomorphometry was assessed for glomerular size (diameter and area) and tubular injury score. RNA-seq of the whole kidney was done (n=4/group) to assess the transcriptional effects of neonatal hyperoxia at 1 year. Data are expressed as mean  $\pm$  SD and analyzed by Student's T test.

**Results:** At 1 year, kidney weight/body weight was significantly lower in the HO compared to the RA group (1.98  $\pm$  0.57 mg/gm vs 3.99  $\pm$  2.05 mg/gm, respectively, p=0.03). There was significant glomerulomegaly (Figure 1A) and a trend towards increased tubular injury score (Figure 1B) in the HO compared to RA group. Neonatal hyperoxia exposure differentially regulated genes in 1 year old kidneys. Gene set enrichment analysis showed that the most downregulated genes were related to "kidney development" (Figure 1C) while the most upregulated included genes involved in "brush border", "extracellular matrix binding", and "glutathione peroxidase and transferase activity" (Figure 1D).

**Conclusions:** Neonatal HO exposure was associated with sustained glomerular and tubular injury and decreased nephron mass in adult rats. This was accompanied by a downregulation of kidney developmental gene expression and an upregulation of antioxidant and tissue repair gene expression. Further studies to determine how antioxidant therapies could alter the programming of kidney injury after neonatal HO exposure are important.

**Funding:** Other NIH Support - K08, KL2

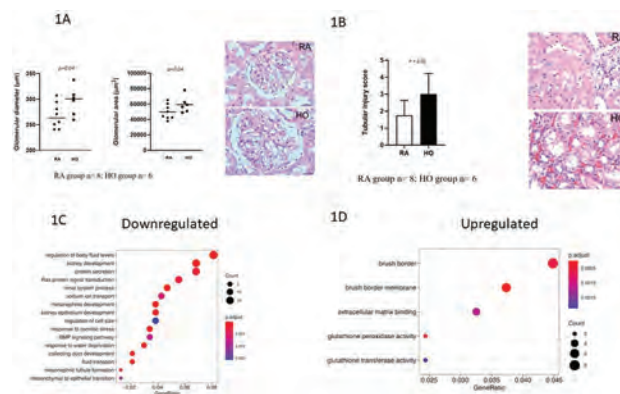

SA-PO600

**Predictive Factors of Mortality in Pediatric Patients With AKI Hospitalized in a Tertiary Hospital**

Simone Vieira, Maria Fernanda C. Carvalho, Paloma C. Gago, Eduardo F. Hatanaka, Karina M. Macedo, Ana Carolina A. Dos Santos, Pollyanna S. Pacheco, Renata L. Miranda, Paulo C. Koch Nogueira. Hospital Samaritano de Sao Paulo, Sao Paulo, Brazil.

**Background:** Retrospective analysis of risk factors associated with death in pediatric patients hospitalized in the intensive care unit (ICU) of Samaritano Higienópolis Américas Hospital from January 2016 to April 2022, with indication of dialysis, taking into account the etiology of Kidney disease, clinical and demographic characteristics.

**Methods:** We evaluated 235 patients (6 on peritoneal dialysis - PD, 102 on continuous hemodialysis - CRRT and 127 on conventional hemodialysis - HDC). The patients were grouped into: survivors and death. To evaluate the predictive factors of death, univariate logistic regression analysis was used with the outcome death, and the following risk variables: age, gender, etiology of kidney disease, Fluid overload, use of diuretics, vasoactive drugs, and time of ICU stay until consultation with nephrologist.

**Results:** Of the 235 patients included in the study, 63 (27%) died and 172 (73%) survived until hospital discharge, 176 (75%) were male, 157 (67%) had kidney disease, 51 (22%) had oncologic disease, 17 (7%) were cardiac. The median age was 5 years (interquartile range 1.4 to 10.0) and the risk factors significantly associated with the outcome death were: Fluid overload (FO%) (OR= 1.07, 95% CI 1.03-1.1, p<0.001), age (OR= 0.91, 95% CI 0.86-0.97, p 0.002), according to the underlying disease: Oncologic (OR= 8.31, 95% CI 4.18- 16.51), p <0.01), cardiac (OR= 26.56, 95%CI 5.87- 120.21, p <0.001), kidney (OR= 0.05, 95% CI 0.02- 0.11, p < 0.001), use of vasoactive drugs (OR = 13.47 95% CI 6.2- 29.28, p < 0.001) and ICU stay to initiate dialysis (OR= 1.1, 95% CI 1.05 - 1.15, p<0.001)

**Conclusions:** In this study the variables that were associated with the highest risk of death were : underlying disease, with a higher chance of death for heart disease (increased risk of death by 26.56 times) and oncological (increased risk of 8 times), patients with Kidney disease had a protective effect for death, age (each year of increase reduces the risk of death by 9%), use of vasoactive drugs (increased death by 13.5 times), ICU stay (each day the most increased the risk of death by 10%) and Fluid overload (each 1% FO increased the risk of death by 7%).

SA-PO601

**Fluid Balance and Return to Birth Weight Impact Short- and Long-Term Respiratory Outcomes in Premature Neonates**

Michelle C. Starr,<sup>1</sup> Katja M. Gist,<sup>4</sup> Jeff L. Segar,<sup>7</sup> Rupesh Raina,<sup>8</sup> Ronnie Guillet,<sup>9</sup> Saudamini Nesargi,<sup>6</sup> Shina Menon,<sup>3</sup> Nekayla Anderson,<sup>2</sup> David J. Askenazi,<sup>2</sup> David T. Selewski.<sup>5</sup> Neonatal Kidney Collaborative

<sup>1</sup>Indiana University School of Medicine, Indianapolis, IN; <sup>2</sup>The University of Alabama at Birmingham School of Medicine, Birmingham, AL; <sup>3</sup>Seattle Children's Hospital, Seattle, WA; <sup>4</sup>Cincinnati Children's Hospital Medical Center, Cincinnati, OH; <sup>5</sup>Medical University of South Carolina, Charleston, SC; <sup>6</sup>St. John's Medical College, India, India; <sup>7</sup>Medical College of Wisconsin, Milwaukee, WI; <sup>8</sup>Cleveland Clinic Akron General, Akron, OH; <sup>9</sup>Golisano Children's Hospital, Rochester, NY.

**Background:** Premature neonates are at risk of acute kidney injury (AKI) and disordered fluid balance (FB). Few data exist on association between FB and respiratory outcomes in this population.

**Methods:** We evaluated neonates born 24–27 weeks in the PENUT study, a Phase III randomized, placebo-controlled trial in 30 US NICUs from 2013-16. Primary exposure: peak FB in the first 14 postnatal days. Secondary exposures: FB postnatal day 3 and return to birthweight day. FB was calculated as percent change from birthweight. Primary outcome: mechanical ventilation (MV) on postnatal day 14. Composite secondary outcome: severe bronchopulmonary dysplasia (BPD) or death.

**Results:** 923 preterm neonates were included. Weight was available for 13,394 of 13,845 (96.7%) potential patient-days. 480/923 (53.5%) were MV on postnatal day 14 and 554/923 (60.0%) had severe BPD/death. Neonates with peak FB  $> 5\%$  had 1.75

higher odds (95% CI 1.33, 2.31,  $p < 0.0001$ ) of MV on postnatal day 14, and 1.51 higher odds (95% CI 1.11, 2.06,  $p = 0.009$ ) of severe BPD/death. After adjusting for confounding variables, for every 5% increase in peak fluid balance there was 2.21 higher odds of MV on postnatal day 14 (aOR 2.21, 95% CI: 1.61, 2.80,  $p < 0.0001$ ). (Table 1) Median return to birthweight was shorter in neonates who were MV on postnatal day 14 (7d vs. 8d;  $p < 0.0001$ ) and those with severe BPD (7d vs. 8d,  $p = .0003$ ) (Figure 1). Neonates who did not drop below their birth weight were more likely to be MV (68% vs. 59%,  $p = .0041$ ).

**Conclusions:** Peak FB was associated with MV and severe BPD/death. Time to regain birth weight and 5% fluid overload are actionable markers of poor pulmonary outcomes. Future work should determine if interventions including targeted fluid management or individualized fluid delivery guided improve patient outcomes.

**Funding:** Commercial Support - Nuwellis

**Table 1. Fluid balance stratified by the need for mechanical ventilation at postnatal day 14**

Outcome	Mechanically Ventilated at Postnatal 14		p-Value
	Yes (N = 458)	No (N = 415)	
Peak Fluid Balance First 14 d	15% (8%, 24%)	8% (2%, 14%)	<0.0001
Lowest Fluid Balance First 14 d	-10% (-15%, -5%)	-11% (-15%, -7%)	0.0380
Fluid Balance at Postnatal Day 3	-5% (-11%, 0%)	-8% (-12%, -3%)	<0.0001
Fluid Balance at Postnatal Day 7	-4% (-9%, 2%)	-1% (-7%, 7%)	<0.0001
Day Infant Regained Birth Weight (d)	7 (5, 10)	8 (6, 11)	<0.0001

\* Estimated from a Wilcoxon rank sums test.

**Figure 1. Kaplan-Meier Curves of post-natal day by which neonate regained birth weight and A) mechanical ventilation support at 14 days and B) Bronchopulmonary Dysplasia**

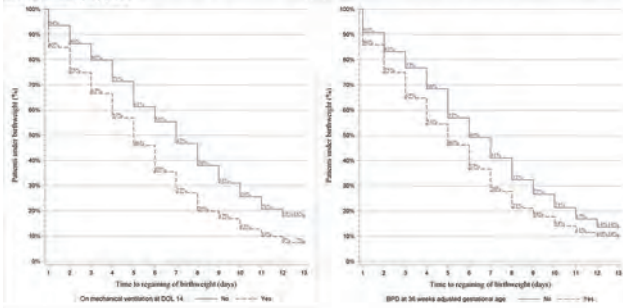

**SA-PO602**

**Clearance and Nutrition in Neonatal Continuous Kidney Support Therapy (CKST) Using the CARPEDIEM System**

Pomy T. Vuong,<sup>1,2</sup> Molly R. Vega,<sup>1,2</sup> Pamela Heise,<sup>1,2</sup> Sarah J. Swartz,<sup>1,2</sup> Poyyapakkam Srivaths,<sup>1,2</sup> Scott W. Osborne,<sup>1,2</sup> Christopher J. Rhee,<sup>1,2</sup> Ayse Akcan Arikan,<sup>1,2</sup> Catherine Joseph.<sup>1,2</sup> <sup>1</sup>Baylor College of Medicine, Houston, TX; <sup>2</sup>Texas Children's Hospital, Houston, TX.

**Background:** Improved solute clearance has been associated with improved dietary protein intake estimated by normalized protein catabolic rate (nPCR) and better nutritional status in pediatric CKST. Optimizing nutrition in neonatal CKST to ensure adequate growth can be challenging and requires appropriate clearance. The Cardio-Renal, Pediatric Dialysis Emergency Machine (CARPEDIEM™, Bellco-Medtronic, Mirandola, Italy) was designed as infant CKST with continuous veno-venous hemodialysis (CVVHD). Used in Italy since June 2013 and approved in the United States in April 2020 for infant CKST, we aimed to assess the solute clearance effect on nPCR receiving CKST with CARPEDIEM™ system.

**Methods:** Single center retrospective cohort of 8 patients who received CKST between June to December 2021. Institutional quality improvement dashboard for CKST collected real-world data for circuit characteristics prospectively. Per institutional protocol, filter performance is monitored daily with effluent urea nitrogen. Urea clearance (ml/min) was determined by the effluent rate. nPCR was calculated using the Edefonti equation for the first 5 and last 5 treatments for each patient, with goal nPCR value > 1 g urea nitrogen/kg/day.

**Results:** 8 infants received a total of 272 CKST sessions (162 using 015 filter and 110 using 025 filter) for 31.8 days (IQR 21.9 – 49.6) days CKST. At CKST start, estimated dry weight was 2.61 kg (IQR 2.52 - 3.4) and actual patient weight was 3.27 kg (IQR 3.04 – 4.60). Average filter life was 18.04h, average blood flow rate was 28.36ml/min, average effluent flow rate was 50.57ml/kg/h, and median total effluent volume per day was 6509 mL (IQR 5573-7307) per patient. Urea clearance was 34.3 (IQR 23.1-59.9). Overall median nPCR was 1.20 (IQR 0.95-1.44), with lower median nPCR during the first 5 treatments (median nPCR 1.13 with IQR 0.81-1.35) compared to the last 5 treatments (median nPCR 1.22 with IQR 1.00-1.48).

**Conclusions:** Adequate solute clearance can be achieved using the CARPEDIEM™ system which can allow for optimization of nutritional status and promote growth among critically ill neonates.

**SA-PO603**

**High Prevalence of Bone Disease in Children on Prolonged Continuous Kidney Replacement Therapy**

Mugdha Rairikar,<sup>1,2</sup> Peace D. Imani,<sup>1,2</sup> Siddharth P. Jadhav,<sup>1,2</sup> Matthew Ditzler,<sup>1,2</sup> Ayse Akcan Arikan,<sup>1,2</sup> Poyyapakkam Srivaths.<sup>1,2</sup> <sup>1</sup>Baylor College of Medicine, Houston, TX; <sup>2</sup>Texas Children's Hospital, Houston, TX.

**Background:** Acute kidney injury(AKI) with/without continuous kidney replacement therapy(CKRT) alters bone metabolism in adults, possibly increasing long term fracture risk. Few studies look at bone disease in AKI on prolonged CKRT with regional citrate anticoagulation in children. We aim to assess osteopenia and bone biomarker changes in pediatric AKI on prolonged CKRT.

**Methods:** Retrospective chart review, ≤ 21 yrs of age with AKI on CKRT ≥ 28 days, including bone markers, without chronic kidney disease/metabolic bone disease. Chest X-ray(CxR) at CKRT initiation, day 14, day 28 evaluated for osteopenia by two independent blinded radiologists.

**Results:** CxR readings(Kappa 58.7%) moderate agreement amongst radiologists. Baseline osteopenia in 17/53(32%), in 21/53(40%) by day 28. Among risk factors, acute liver failure(OddsRatio[OR]3.93,95CI:1.14–13.5, p.03), low 25-OH Vitamin D(95CI:-1.3–0.16, p.045), high PTH (95CI:0.008-0.39, p.003) associated with worsening osteopenia at day 28. Serum calcium, phosphorus, citrate rate, steroid not associated with worsening. Baseline osteopenia associated with higher fracture risk(OR5.5,95CI:1.4–21, p.013), osteopenia day 14 with even higher risk(OR10,95CI:2.2-43.7, p.002).

**Conclusions:** Baseline osteopenia present in 1/3 children at CKRT start, which persisted&/or worsened by day28. Osteopenia associated with increased risk of fracture, risk increasing with increasing days on CKRT. Targeted screening (skeletal survey/DEXA scan) likely warranted for prolonged CKRT, especially in high risk patients as liver failure. Further investigation needed to know if optimal metabolic control in prolonged CKRT will decrease future fracture risk, and to understand underlying pathophysiology.

**Table 1: Demographics and Markers of Bone disease**

Days on CKRT	Total patient (n)	Age in months (IQR)	Gender (n/%)	Weight at initiation in kg (IQR)	Fracture during hospitalization (n)	Total calcium (mg/dL) (IQR)	Serum Phosphorus level (mg/dL) (IQR)	Ionized calcium (mg/dL) (IQR)	pH (IQR)	Serum Bicarb rate (mg/dL) (IQR)	Serum PTH (pg/mL) (IQR)	Serum 25-OH Vitamin D (ng/mL) (IQR)	Blood Urea Nitrogen (mg/dL) (IQR)	Calcium infusion rate (mg/kg) (IQR)	Citrate infusion rate (mg/kg) (IQR)	Osteopenia (n)
	53	85.1(74, 102)	23(20)	3 (16, 45)	31	8.9 (7.8, 10.0)	4.7 (3.6, 5.8)	1.27 (1.20, 1.32)	7.28 (7.25, 7.31)	23 (19)	37	80 (10)	50 (10)	50 (10)	50 (10)	17
Day of initiation		10.6 (10.1, 11.8)	5 (14)	1.3 (1.26, 1.31)	7 (38)	5.14 (4.18, 5.97)	3.22 (2.81, 3.71)	3.37 (3.11, 3.64)	25.6 (24.2, 27.0)	119 (4)	142 (18)	119 (4)	105 (10)	45 (10)	140 (10)	23
Day 14		10.6 (10.1, 11.8)	4 (14)	1.3 (1.26, 1.31)	7 (38)	5.14 (4.18, 5.97)	3.22 (2.81, 3.71)	3.37 (3.11, 3.64)	25.6 (24.2, 27.0)	119 (4)	142 (18)	119 (4)	105 (10)	45 (10)	140 (10)	23
Day 28		10.6 (10.1, 11.8)	4 (14)	1.3 (1.26, 1.31)	7 (38)	5.14 (4.18, 5.97)	3.22 (2.81, 3.71)	3.37 (3.11, 3.64)	25.6 (24.2, 27.0)	119 (4)	142 (18)	119 (4)	105 (10)	45 (10)	140 (10)	23

**Figure 1: Fractures on prolonged CKRT**

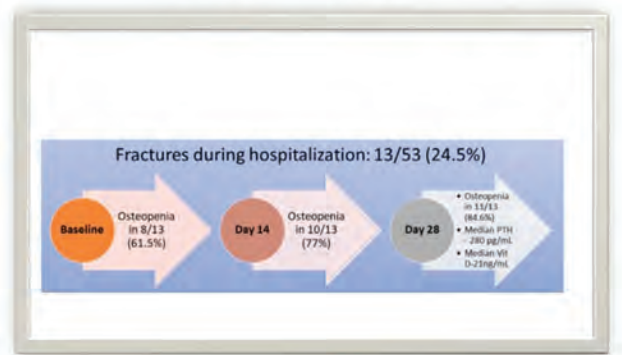

Fractures on prolonged CKRT

**SA-PO604**

**Ribonuclease 6 Is a Monocyte and Macrophage Derived Antimicrobial Peptide That Limits Urinary Tract Infection Susceptibility In Vivo**

Macie M. Kercsma,<sup>1</sup> Hanna H. Cortado,<sup>1</sup> Birong Li,<sup>1</sup> Christina B. Ching,<sup>1,3</sup> Ashley R. Jackson,<sup>1,2</sup> John D. Spencer,<sup>1,2</sup> Juan de Dios Ruiz-Rosado,<sup>1,2</sup> Brian Becknell.<sup>1,2</sup> <sup>1</sup>Kidney and Urinary Tract Center <sup>2</sup>Kidney and Urinary Tract Center, <sup>3</sup>Agigail Wexner Research Institute at Nationwide Children's Hospital, Columbus, OH; <sup>2</sup>Division of Nephrology and Hypertension, Nationwide Children's Hospital, Columbus, OH; <sup>3</sup>Department of Urology, Nationwide Children's Hospital, Columbus, OH.

**Background:** Urinary tract infections (UTI) are common, serious bacterial infections of childhood that originate in the bladder and can ascend to the kidney resulting in acute and chronic injury. Ribonuclease 6 (RNase 6) is an antimicrobial peptide that kills uropathogenic *Escherichia coli* (UPEC). Here, we studied the impact and cellular sources of RNase6 on UTI susceptibility *in vivo*.

**Methods:** To understand the impact of RNase6 on UTI susceptibility, we established humanized *RNASE6* transgenic mice and performed transurethral inoculation of UPEC. We utilized a novel *Rnase6*<sup>EGFP/+</sup> knock allele and *C33cr1*<sup>GFP/GFP</sup>; *Ccr2*<sup>RFP/RFP</sup> mice to

definitively establish the cellular sources of RNase6. The role of RNase6 in intracellular UPEC killing was identified in a gentamicin protection assay using bone marrow derived macrophages (BMDM).

**Results:** *RNASE6* transgenic mice were protected from experimental UTI, with reduced bacterial burden throughout the urinary tract, compared to non-transgenic controls. Mouse *Rnase6* and human RNase6 are expressed by resident macrophages and circulating monocytes that are recruited to the infected bladder and kidney. At baseline, these RNase6+ cells localize to the submucosa of the bladder and kidney. Following infection, these cells redistribute to the urothelium in close proximity to intracellular UPEC. Compared to non-transgenic controls, *RNASE6* transgenic macrophages are more adept at killing phagocytosed UPEC.

**Conclusions:** RNase6 is a monocyte and macrophage associated antimicrobial peptide that redistributes to the bladder and renal urothelium in the presence of UPEC to effectively limit disseminated infection *in vivo*.

**Funding:** NIDDK Support

## SA-PO605

### The Human Ribonuclease 3 Antimicrobial Peptide Reduces Urinary Tract Infection Susceptibility *In Vivo*

Hanna H. Cortado,<sup>1</sup> Macie M. Kerckmar,<sup>1</sup> Birong Li,<sup>1</sup> Sudipti Gupta,<sup>1,3</sup> Christina B. Ching,<sup>1,3</sup> Ashley R. Jackson,<sup>1,2</sup> John D. Spencer,<sup>1,2</sup> Juan de Dios Ruiz-Rosado,<sup>1,2</sup> Brian Becknell,<sup>1,2</sup> Kidney and Urinary Tract Center <sup>1</sup>Kidney and Urinary Tract Center, Abigail Wexner Research Institute at Nationwide Children's Hospital, Columbus, OH; <sup>2</sup>Division of Nephrology and Hypertension, Nationwide Children's Hospital, Columbus, OH; <sup>3</sup>Department of Urology, Nationwide Children's Hospital, Columbus, OH.

**Background:** Urinary tract infections (UTI) are common, serious bacterial infections of childhood, most often caused by uropathogenic *Escherichia coli* (UPEC). To develop innovative and effective strategies to prevent and treat UTI, we have focused our efforts toward identifying antimicrobial peptides (AMPs) that exhibit potent activity toward UPEC *in vitro* and *in vivo*. Here, we utilized a genetic approach to study the contributions of human Ribonuclease (RNase) 3 to UTI susceptibility in mice.

**Methods:** Urine RNase3 levels were measured by ELISA in females with UTI and compared to unaffected controls. Humanized *RNASE3* transgenic mice underwent transurethral inoculation of UPEC, and CFU were enumerated in urinary tract organs. We utilized immunofluorescence microscopy and intracellular flow cytometry to identify the cellular sources of RNase3. The bactericidal activity of RNase3 toward UPEC was investigated through the use of recombinant RNase3 and *RNASE3* transgenic neutrophils.

**Results:** Urine RNase3/Cr levels were elevated in patients with UTI compared to controls. RNase 3 amino-terminal peptide exhibited dose-dependent killing of UPEC. *RNASE3* transgenic mice were protected from ascending UPEC infection, with reduced upper tract bacterial burden, compared to non-transgenic controls. RNase3 protein is expressed by neutrophils that infiltrate the infected kidney and bladder and release RNase3 following UPEC exposure. Accordingly, compared to non-transgenic controls, *RNASE3* transgenic neutrophils are more adept at extracellular UPEC killing.

**Conclusions:** Our data establish that RNase3 is a neutrophil derived antimicrobial peptide induced during human UTI with potent bactericidal activity toward UPEC. Functionally, our *in vitro* and *in vivo* data in *RNASE3* transgenic mice and neutrophils establish that RNase3 effectively limits the disseminated UPEC infection.

**Funding:** NIDDK Support

## SA-PO606

### Urine Microbiota Analysis and mGWAS in Children With Urinary Tract Infections and Vesicoureteral Reflux

Miguel Verbitsky, Pavan Khosla, Heekuk Park, Yask Gupta, Atlas Khan, Iman Ghavami, Krzysztof Kiryluk, Simone Sanna-Cherchi, Jonathan M. Barasch, Cathy L. Mendelsohn, Anne-Catrin Uhlemann, Ali G. Gharavi. Columbia University, New York, NY.

**Background:** Vesicoureteral reflux (VUR), the retrograde flow of urine from the bladder into the ureters and kidney, accounts for 25-30% of pediatric ESRD worldwide. Urinary tract infections (UTI) are often associated with VUR.

**Methods:** We performed a microbiota analysis based on 16S rRNA gene sequencing from 325 urine samples of children with urinary tract infections with or without VUR from the RIVUR and CUTIE studies' cohorts, and a microbiota GWAS (mGWAS) in 278 of them, with genomic DNA available for genotyping.

**Results:** We found a significant decrease in urine microbiota alpha diversity with VUR ( $P=3 \times 10^{-8}$ ), lack of toilet training ( $P=4 \times 10^{-3}$ ), and younger age ( $P=1 \times 10^{-3}$ ). Our mGWAS identified genome-wide significant associations with zero-truncated relative abundance of *Pseudomonas* on chr10 ( $P=2 \times 10^{-9}$ ) and *Clostridia* on Chr3 ( $P=5 \times 10^{-8}$ ), and a suggestive association with *Bacillales* ( $P=3 \times 10^{-7}$ ) on the same locus as with *Pseudomonas*. Secondary analysis in female participants showed a suggestive association with *Gammaproteobacteria* on Chr11 ( $P=6 \times 10^{-8}$ ). The top SNPs in these loci were on or near genes associated with immune surveillance, inflammation, and genitourinary tract development and disease (CXCL12, ROBO1, WNT11). We also conducted phenome-wide association studies on the UK Biobank and eMERGE cohorts of the top SNPs showing suggestive associations with UTI and bladder dysfunction.

**Conclusions:** We report the first combined urine microbiota analysis and mGWAS in children with UTI and VUR, showing associations of bacterial taxa's relative abundances with clinical variables and human host genetic factors.

**Funding:** NIDDK Support

## SA-PO607

### Fundamental Role for the Urothelial Plaque in Gram-Negative Urinary Tract Infections

Birong Li,<sup>1</sup> Hanna H. Cortado,<sup>1</sup> Sudipti Gupta,<sup>1,3</sup> Christina B. Ching,<sup>1,3</sup> Ashley R. Jackson,<sup>1,2</sup> Brian Becknell,<sup>1,2</sup> Kidney and Urinary Tract Center <sup>1</sup>Kidney and Urinary Tract Center, Abigail Wexner Research Institute at Nationwide Children's Hospital, Columbus, OH; <sup>2</sup>Division of Nephrology and Hypertension, Nationwide Children's Hospital, Columbus, OH; <sup>3</sup>Department of Urology, Nationwide Children's Hospital, Columbus, OH.

**Background:** Over 90% of human urinary tract infections (UTI) are caused by Gram-negative bacteria, most commonly, uropathogenic *Escherichia coli* (UPEC). Superficial cells in the bladder produce Uroplakin (Upk) containing urothelial plaques that bind to type I fimbriae of UPEC in a mannose-dependent manner. The role of the urothelial plaque in bladder epithelial cell invasion and triggering the host inflammatory response remains unclear. We hypothesized that a functional urothelial plaque is absolutely required for Gram-negative cystitis to occur.

**Methods:** We established acute cystitis in urothelial plaque-deficient female *Upk1b*<sup>-/-</sup> and wild-type (*Upk1b*<sup>+/+</sup>) mice by transurethral inoculation of UPEC strain UT189 or *Enterococcus faecalis* strain 0852. Bacterial burden was measured by plating tissue homogenates and enumeration of bacterial CFU. Intracellular bacterial communities were detected on the basis of b-galactosidase activity and immunofluorescence microscopy. Upk protein expression was localized by immunofluorescence microscopy, and plaque ultrastructure was visualized by electron microscopy. UPEC elicitation of cytokines and chemokines was measured by qPCR.

**Results:** *Upk1b* deletion results in failure of superficial bladder epithelial cells to assemble a functional urothelial plaque, as evinced by absence of plaque ultrastructure and increased permeabilization of FITC-Dextran. In response to UPEC inoculation, *Upk1b*<sup>-/-</sup> mice exhibited reduced bacterial burden throughout the urinary tract, absence of intracellular bacterial communities, less cytokine and chemokine mRNA production induction, and decreased neutrophil infiltration, when compared to *Upk1b*<sup>+/+</sup> mice. Conversely, *Upk1b*<sup>-/-</sup> and *Upk1b*<sup>+/+</sup> mice displayed equal susceptibility to infection with *E. faecalis*.

**Conclusions:** The urothelial plaque is essential to facilitate UPEC invasion of the bladder mucosa and establishment of cystitis, but this structure is dispensable for *Enterococcus* infection. This study demonstrates the primacy of the plaque for Gram-negative UTI and further strengthens the rationale for targeted therapies such as mannosides to disrupt UPEC-plaque interaction and serve as anti-infective agents.

**Funding:** NIDDK Support

## SA-PO608

### $\alpha$ -Defensins 1-3 Gene-Dosage Drives Protection of the Urinary Tract From Uropathogenic Bacterial Challenge

Jorge J. Canas, Andrew L. Schwaderer, David S. Hains. Indiana University School of Medicine, Indianapolis, IN.

**Background:** Antimicrobial peptides (AMPs) are potent innate immune effectors with direct antimicrobial activity against a range of bacteria. The AMP  $\alpha$ -Defensin 1-3 (*DEFA1A3*) is expressed by human neutrophils granules and kidney epithelial cells. Recently, a low DNA copy number of *DEFA1A3* has been associated with increased UTI risk in children (<4 copies versus >6 per diploid genome). Due to the lack of this gene in mice, we utilize a human *DEFA1A3* gene knock-in mouse with a 4 copy gene per haploid genome to study gene-dosage interactions. This study aims to compare bacterial burden and antimicrobial gene expression between human *DEFA1A3* gene knock-in mice under a pyelonephritis model.

**Methods:** Experimental UTIs were induced by transurethral inoculation of uropathogenic *E. coli* strain CFT073 into *DEFA1A3*<sup>+/+</sup> (8 copies), *DEFA1A3*<sup>+/0</sup> (4 copies), and *DEFA1A3*<sup>0/0</sup> (0 copies) littermate mice. Following 6 hours post-infection (6-hpi), kidneys and bladders were homogenized for bacterial colony-forming unit analysis and mRNA isolation.

**Results:** Compared to *DEFA1A3*<sup>0/0</sup>, *DEFA1A3*<sup>+/+</sup> mice had a significant reduction of mean bacterial burden titers in kidneys and bladders (Figure 1). Following gene expression antimicrobial response array and qRT-PCR in *DEFA1A3*<sup>+/+</sup> and *DEFA1A3*<sup>0/0</sup> kidneys, the most significantly differentially expressed genes were *Rac1* and *Lyz2* (Figure 2).

**Conclusions:** The human *DEFA1A3* gene knock-in mouse represents a critical tool to evaluate novel  $\alpha$ -defensins 1-3 gene-immune interactions. Further studies will involve exploring gene-drug interactions under antibiotic prophylaxis settings before UTI challenge.

**Funding:** NIDDK Support

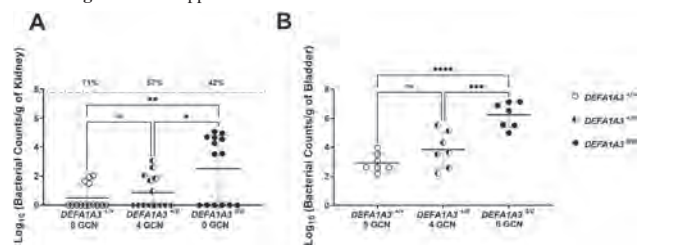

Figure 1. Bacterial titers of kidney (A) and bladders (B) comparing *DEFA1A3*<sup>+/+</sup>, *DEFA1A3*<sup>+/0</sup>, and *DEFA1A3*<sup>0/0</sup> mice. Percentages above the line are clearance rates in kidneys without bacterial growth.

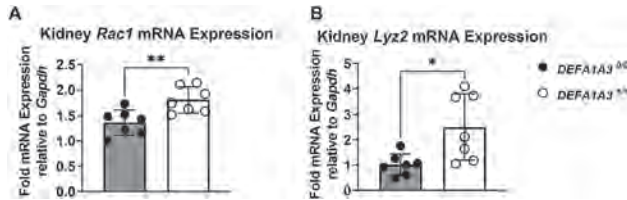

Figure 2. Kidney *DEFA1A3*<sup>+/+</sup> and *DEFA1A3*<sup>+/0</sup> mouse mRNA expression of *Rac* (A) and *Lyz2* (B) relative to *Gapdh* gene.

SA-PO609

The PPAR $\gamma$  Signaling Pathway Regulates Urothelial Adaptation During Urinary Tract Obstruction in Mice

Alexa Miehl,<sup>1,2</sup> Kelly Grounds,<sup>1</sup> Birong Li,<sup>1</sup> Macie M. Kercsmar,<sup>1</sup> Brian Becknell,<sup>1,2</sup> Ashley R. Jackson.<sup>1,2</sup> <sup>1</sup>Abigail Wexner Research Institute at Nationwide Children's Hospital, Columbus, OH; <sup>2</sup>The Ohio State University College of Medicine, Columbus, OH.

**Background:** Urinary Tract Obstruction (UTO) is a leading cause of chronic kidney disease in children. No treatments can prevent kidney injury, but heterogeneous outcomes implicate unknown protective adaptations. We previously reported that mice with UTO adapt a bladder-like urothelial lining - characterized by the acquisition of terminally differentiated plaque producing uroplakin-expressing cells (UPK-UCs) along the renal urothelium. Depletion of UPK-UCs or the urothelial plaque accelerate UTO-induced structural and functional injury, suggesting that formation of UPK-UCs is protective. The adult tissue repair progenitor, and the molecular program that governs UTO-induced renal urothelium remodeling is unknown. In the bladder, UPK-UCs function as tissue repair progenitors, and the PPAR $\gamma$  signaling pathway drives urothelial differentiation. Thus, we hypothesized that UPK-UCs to activate PPAR $\gamma$  signaling during UTO-induced renal urothelium remodeling.

**Methods:** UTO was modeled using unilateral ureteral obstruction. Lineage analysis was performed using *Upk2*<sup>CreERT2</sup>; *R26*<sup>DTT</sup> mice. Immunofluorescent localization was used to profile the PPAR $\gamma$  signaling pathway during experimental UTO. We used *Upk2*<sup>CreERT2</sup>; *R26*<sup>DTT</sup> mice to deplete UPK-UCs during UTO. We conditionally disrupted PPAR $\gamma$  signaling using *Upk*<sup>CreERT2</sup>; *Pparg*<sup>fl/fl</sup> (*Pparg*-cKO), and *Pparg*<sup>fl/fl</sup> mice during UTO.

**Results:** Lineage analysis experiments showed that adult UPK-UCs were the major contributor to UTO-induced renal urothelium remodeling. At post-operative day 7 and 10, renal urothelium expressed *de novo* PPAR $\gamma$  and FABP4 (a direct transcriptional target of PPAR $\gamma$  signaling), which co-localized to UPK-UCs. In mice where UPK-UCs were genetically depleted, we observed diminished PPAR $\gamma$  and FABP4 during UTO. Finally, we found that *Pparg*-cKOs had fewer UPK-UCs during UTO than *Pparg*<sup>fl/fl</sup> mice.

**Conclusions:** Our results indicate that UTO-induced urothelial remodeling is achieved through activation of the PPAR $\gamma$  signaling pathway in UPK-UCs. Future studies will investigate the impact of *Pparg*-cKO and PPAR $\gamma$  gain of function experiments on kidney injury/function during UTO. Altogether, our findings advance our understanding of renal adaptation to UTO, and reveal a potential mechanism with therapeutic utility for mitigating obstructive kidney disease in children.

**Funding:** NIDDK Support

SA-PO610

Stat3 May Drive Prevention of Experimental Chronic Urinary Tract Infection

Sudipti Gupta, Evan Alexander, Hanna H. Cortado, Brian Becknell, John D. Spencer, Christina B. Ching. Kidney and Urinary Tract Center Nationwide Children's Hospital, Columbus, OH.

**Background:** Our understanding of the pathogenesis of chronic urinary tract infections (UTIs) is poor. Having previously identified the importance of IL-6 in UTI susceptibility, we sought to identify the role of the downstream transcription factor, Stat3, in UTI susceptibility, particularly in chronic infection. We hypothesize that Stat3 is involved in limiting UTI development and chronicity.

**Methods:** Experimental UPEC UTI (eUTI) was induced in 6-8 weeks old female mice expressing constitutively active Stat3 (Stat3C) and FVB/N wild type controls (WT). Bladder and urine bacterial burden were evaluated at various time points up to 7 days post infection (dpi); and IBCs enumerated. Histopathologic evaluation was performed via H&E and immunofluorescent (IF) staining. qRT-PCR was used for quantification of antimicrobial peptide (AMP) expression. Results were evaluated by Mann-Whitney U test with p<0.05 being significant.

**Results:** Compared to WT, Stat3C mice demonstrated significantly decreased urine bacterial burden at 24 hours post infection (hpi) and 7dpi with bladder burden being significantly less at 7dpi. There was no significant difference in IBC phenotype at 6hpi. H&E of Stat3C bladders at 24hpi showed less inflammation and edema compared to WT. Both uninfected and infected Stat3C urothelium showed Stat3 reactivity by IF with relatively little staining in WT mice. Stat3C and WT urothelium demonstrated induction of pStat3 after infection with apparent persistence of pSTAT3 in Stat3C at 7dpi. Stat3C urothelium showed more Ki67 staining at 24hpi compared to WT. There was significantly higher induction of certain AMPs with eUTI in Stat3C vs. WT mice on qRT-PCR.

**Conclusions:** Stat3 appears significant in protecting against chronic UTI. This could be through differences in urothelial regeneration and turn over as well as through elevated AMP expression.

**Funding:** NIDDK Support

**Figure:** Stat3C mice demonstrate baseline expression of Stat3 on IF and a decrease in bladder and urine bacterial burden by 7dpi. Certain antimicrobial peptide expression is more highly induced in the bladder of Stat3C vs. WT mice after infection.

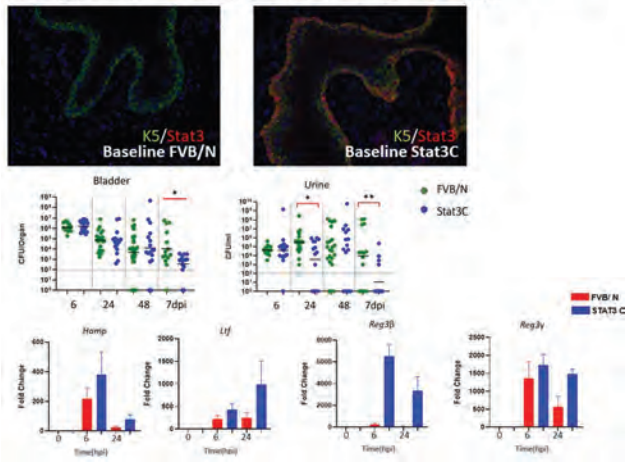

SA-PO611

Dose Vesicoureteral Reflux Increase Risk for Bacteremia in Urinary Tract Infection?

Dabin Kim,<sup>1</sup> Naye Choi,<sup>1,2</sup> Jeese Min,<sup>1,2</sup> Hee Gyung Kang,<sup>1,2</sup> Yo Han Ahn.<sup>1,2</sup> <sup>1</sup>Seoul National University Children's Hospital, Seoul, Republic of Korea; <sup>2</sup>Seoul National University College of Medicine, Seoul, Republic of Korea.

**Background:** Urinary tract infection (UTI) is one of the most common serious bacterial infections in children. During UTI episodes, concurrent bacteremia occurs in 5% to 31% of the cases. UTI accompanied by bacteremia is associated with adverse outcomes such as prolonged admission, shock, bacterial meningitis, and intensive-care unit admission. While it is known that bacteremic UTI had higher CRP, risk factors of concurrent bacteremia is not well investigated yet. Vesicoureteral reflux (VUR) is commonly found in children with UTI. While it is known that bacteremic UTI had higher CRP, DNI, and creatinine level, risk factors of concurrent bacteremia is not well investigated yet.

**Methods:** We reviewed clinical findings of UTI cases from January 2000 to December 2021 in Seoul National University Children's Hospital. To investigate if VUR is a risk factor for bacteremia, the study population was defined as those who had UTIs younger than 24 months and in whom voiding cystourethrogram (VCUG) was performed at the time of UTI. Urine culture, blood culture, and VCUG results were collected in addition to demographic findings. Only when blood culture reported the same pathogens as urine culture, the UTI episodes were considered as concurrent bacteremia.

**Results:** Among a total of 152 (male 78.3%, female 21.7%) cases who had UTI and VCUG tests, 19 patients (12.5%) had concurrent bacteremia during febrile UTI episodes. When comparing these patients with those without concurrent bacteremia (n=133), demographic findings were not statistically different, but the prevalence of high-grade VUR (VUR of grade 3 or higher) was higher in the bacteremia group (47.4%, 9/19) than in the non-bacteremia group (20.3%, 27/133, P=0.018). Patients who have VUR grade 3 or higher had a 3.53-fold increased risk for bacteremia. (95% CI: 1.307-9.554)

**Conclusions:** Children with a VUR of grade 3 or higher are more susceptible to bacteremic UTI. Therefore, concurrent bacteremia might imply the presence of high-grade VUR. On the other hand, managing VUR might reduce the risk of bacteremia in case of UTI.

SA-PO612

Spatial Transcriptomics Provides Unique Insights Into the Pathophysiology of Experimental Pyelonephritis

Gregory Ballash,<sup>1</sup> Israel Cotzomi Ortega,<sup>1</sup> Ashley R. Jackson,<sup>1,2</sup> Brian Becknell,<sup>1,2</sup> Juan de Dios Ruiz-Rosado.<sup>1,2</sup> Kidney and Urinary Tract Center <sup>1</sup>Kidney and Urinary Tract Center, Abigail Wexner Research Institute, Nationwide Children's Hospital, Columbus, OH; <sup>2</sup>Division of Nephrology and Hypertension, Nationwide Children's Hospital, Columbus, OH.

**Background:** Acute pyelonephritis (APN) is considered one of the most significant bacterial infections among young children and is associated with acute kidney injury, renal scarring, and end-stage kidney disease. The molecular mechanisms leading to alterations of tissue homeostasis and long-term sequelae during APN are poorly understood. In this study, we utilized a novel technique, spatially resolved transcriptomics, to define the molecular basis of APN pathology.

**Methods:** Immunocompetent C3H/HeOJ female mice underwent transurethral inoculation with uropathogenic *Escherichia coli* (UPEC). We performed spatial transcriptomics (Visium, 10x Genomics) in kidney sections from infected mice at 0, 7 and 28 days post-infection (dpi), to provide a spatiotemporal context of differential gene expression during UPEC-induced pyelonephritis. Transcriptomic data was spatially integrated using the 10X Space Ranger pipeline. Space Ranger output was investigated for gene expression within tissues via Loupe Browser and across tissue using the *Seurat* package in R.

**Results:** APN kidneys showed unique clustering that localized to geographic regions of the cortex and papilla corresponding to renal abscessation. The acute phase of infection witnessed the emergence of four unique clusters associated with immune response initiation, LPS tolerance, and promoting apoptosis. As infection progressed to a chronic phase, two unique clusters localized to early renal scars that prominently featured genes involved in the adaptive immune response, fibroblast migration, and extracellular matrix formation. By integrating single cell RNA-seq analysis, we identified an enrichment of neutrophils in areas of abscessation, surrounded by macrophages at 7 dpi, and an enrichment of stromal cells in regions of mononuclear inflammation at 28 dpi. Predicted pathways of inflammation thought to instigate renal fibrosis circumscribed renal lesions at both acute and chronic phases of infection.

**Conclusions:** Spatial transcriptomics is a powerful tool to superimpose transcriptional changes onto the landscape of renal pathology. This experimental approach will serve to integrate transcriptional dynamics into a pathophysiological map of the renal response to bacterial infections.

**Funding:** NIDDK Support

#### SA-PO613

##### Distinct miRNA Profiles Govern the Host Response to Bacterial Cystitis vs. Pyelonephritis

**Gregory Ballash,<sup>1</sup> Birong Li,<sup>1</sup> Hanna H. Cortado,<sup>1</sup> Israel Cotzomi Ortega,<sup>1</sup> Ashley R. Jackson,<sup>1,2</sup> Juan de Dios Ruiz-Rosado,<sup>1,2</sup> Brian Becknell.<sup>1,2</sup> Kidney and Urinary Tract Center <sup>1</sup>Kidney and Urinary Tract Center, Abigail Wexner Research Institute, Nationwide Children's Hospital, Columbus, OH; <sup>2</sup>Division of Nephrology and Hypertension, Nationwide Children's Hospital, Columbus, OH.**

**Background:** Urinary tract infections (UTIs) are one of the most common bacterial infections of childhood. The innate immune response is essential for pathogen detection and eradication, but excessive inflammation can result in urothelial remodeling that increase risk of subsequent infection and long-term sequelae. MicroRNA are small, non-coding RNA with key roles in regulating renal inflammation and tissue remodeling, but their expression and function in UTI are unknown. Here we investigate miRNA dynamics in the setting of experimental cystitis and pyelonephritis.

**Methods:** Female C3H/HeOJ mice underwent transurethral inoculation with uropathogenic *Escherichia coli* (UPEC) or carrier. Bladders and kidneys were harvested 7 days post infection for miRNA and total RNA sequencing. Transcriptome analysis was performed using GO and Ingenuity. Differential miR expression was validated by qPCR. In certain experiments, miR expression was measured in purified urothelial cells following fluorescence activated cell sorting. The kinetics of miR expression elicited by UPEC was studied in immortalized human urothelial cells.

**Results:** The kidney and bladder miRome varied markedly in response to UPEC infection, with renal miR regulating the proliferative/regenerative response, while bladder miR regulated inflammation and a Tlr4/NF-kB response to Gram-negative bacteria. qPCR validated upregulation of miR-155, -146a, and miR-21, and pathway analysis identified these miR as significant upstream regulators of mRNA expression during cystitis. We determined that a subset of miR were expressed by Upk2+ urothelial cells, and that miR-146a levels increased within this population following UPEC infection. A similar induction of miR-146a occurred in human urothelial cells following UPEC treatment *in vitro*.

**Conclusions:** Distinct miRNA are induced by UPEC during cystitis and pyelonephritis. In the bladder, the targetome of miR-155, miR-146a, and miR-21 suggests their regulatory role in reducing inflammation. Complementary studies in isolated urothelial cells establish this lineage as a source of UPEC-elicited miR *in vivo* and *in vitro*. These observations justify further studies to identify the functional significance and mechanistic properties of miRNA during UTI.

**Funding:** NIDDK Support

#### SA-PO614

##### Cell-Specific Insulin Receptor Deletion Disrupts Urothelial Barrier Integrity Increasing Urinary Tract Susceptibility to Infection

**Kristin Bender,<sup>1</sup> Laura Schwartz,<sup>1</sup> Aaron A. Simoni,<sup>1</sup> John D. Spencer.<sup>1,2,3</sup> <sup>1</sup>Abigail Wexner Research Institute at Nationwide Children's Hospital, Columbus, OH; <sup>2</sup>The Ohio State University College of Medicine, Columbus, OH.**

**Background:** Individuals with diabetes mellitus have a higher risk for urinary tract infection (UTI), which may increase their risk for kidney injury. The underlying mechanisms of infection remain undefined. During infection, the bladder urothelium acts as a barrier during bacterial attachment and invasion. To investigate the role of insulin signaling on urothelial barrier integrity and infection susceptibility, we genetically deleted the insulin receptor (IR) in the basal or intermediate/superficial cells in the murine urothelium.

**Methods:** IR knock-out mice (IRKO) were generated by crossing mice homozygous for the floxed *Insr* (insulin receptor) gene with transgenic mice that have tamoxifen-inducible Cre recombinase under the Keratin 5 (Krt5) or Uroplakin 2 (Upk2) promoter

expressed in the basal or intermediate/superficial cells, respectively. Littermates lacking the Cre transgene served as controls (IRflox). To determine if IR deletion impacts host defense, female mice were transurethral infected with uropathogenic *E. coli* (UPEC). UPEC burden was enumerated in urine and bladder post infection. To assess bladder barrier permeability, uninfected bladders were mounted in an Ussing chamber, and transepithelial resistance (TER) and radioisotope permeabilities were measured. Cell adhesion markers in isolated urothelium were assessed by qRT-PCR and western blot.

**Results:** Compared to IRflox, IRKO mice exhibit normal development, normoglycemia, and normal bladder histology. Following transurethral UPEC infection, UPK2 IRKO mice have significantly greater UPEC burden in the urine and bladder while barrier studies indicted uninfected UPK2 IRKO mice have lower transepithelial resistance and increased water and urea permeabilities. No differences are observed in Krt5 IRKO in burden. Isolated urothelium from UPK2 IRKO mice expressed lower mRNA levels of several cell adhesion markers compared to IRflox.

**Conclusions:** These results suggest that insulin signaling in the intermediate/superficial cells in the urothelium is critical for the integrity of the urothelial barrier in UTI defense. Disruption of signaling in the basal cells did not impact the bladder defenses during infection. Additional studies to evaluate how IR deletion impacts urothelial defenses.

**Funding:** NIDDK Support

#### SA-PO615

##### PTEN Deletion in the Bladder Superficial Epithelium and Kidney Tubules Enhances Bacterial Burden During Urinary Tract Infections

**M. Skye N. Bochter,<sup>1</sup> Kristin Bender,<sup>1</sup> Laura Schwartz,<sup>1</sup> John D. Spencer.<sup>1,2</sup> <sup>1</sup>Abigail Wexner Research Institute at Nationwide Children's Hospital, Columbus, OH; <sup>2</sup>The Ohio State University College of Medicine, Columbus, OH.**

**Background:** Urinary tract infections (UTI) are one of the most common types of bacterial infections, affecting more than 150 million individuals a year. Previous work from our lab identified a role for PI3K/AKT signaling regulating in the innate immune response in the bladder and kidneys. To further investigate the significance of PI3K/AKT signaling on host defense, we genetically deleted *Pten*, a PI3K/AKT antagonist, in the superficial cells of the bladder urothelium or in the epithelium of the distal nephron and collecting ducts of the kidney.

**Methods:** Mice homozygous for the floxed *Pten* gene were crossed with transgenic mice expressing the Cre recombinase under the control of the Uroplakin2 (Upk2) promoter or cadherin 16 (KSP) promoter to create bladder urothelium-specific or kidney tubule-specific *Pten* knockout (PTEN-KO) mice. PTEN-KO mice and Cre-negative littermate controls (PTENflox) were transurethral infected with uropathogenic *E. coli*. At 16 and 24hrs post infection, *E. coli* burden was quantified in the urine, bladder, and kidney.

**Results:** Upk2-Cre and KSP-Cre PTEN-KO mice showed normal phenotypes and development. PCR confirmed Cre-recombination in PTEN-KO bladders and kidneys. qRT-PCR confirmed *Pten* mRNA deletion. Compared to PTENflox littermate controls, bladder and kidney tissue from Upk2-Cre and KSP-Cre PTEN-KO mice appeared phenotypically normal by light microscopy. Following experimental UTI, Upk2-Cre and KSP-Cre PTEN-KO mice had 1-1.5-fold greater urine and bladder bacterial burden at both 16 and 48hpi compared to PTENflox control mice.

**Conclusions:** These results indicate that PI3K/AKT signaling in the bladder urothelium and kidney tubules impacts UTI susceptibility. They provided added support that the kidney tubules contribute to UTI defense. Additional studies are needed to identify the mechanisms of how PI3K/AKT signaling regulates host defenses and how PI3K/AKT hyper-activation enhances UTI susceptibility.

**Funding:** NIDDK Support

#### SA-PO616

##### NOD2 Activates Intercalated Cell Immune Defense During Uropathogenic *Escherichia coli* Infection

**Sarah C. Linn,<sup>1,2</sup> Laura Schwartz,<sup>1</sup> John D. Spencer.<sup>1,3</sup> <sup>1</sup>Abigail Wexner Research Institute at Nationwide Children's Hospital, Columbus, OH; <sup>2</sup>The Ohio State University College of Veterinary Medicine, Columbus, OH; <sup>3</sup>The Ohio State University College of Medicine, Columbus, OH.**

**Background:** Urinary tract infections (UTIs), including pyelonephritis, are frequent infections in women and children often caused by uropathogenic *Escherichia coli* (UPEC). Intercalated cells (ICs), located within the collecting duct, prevent and combat UTIs by recruiting immune cells and secreting antimicrobial peptides (AMPs) into the urine. Mechanisms of UPEC pyelonephritis pathogenesis and the IC immune response are unclear. Here, we challenged ICs *in vitro* with UPEC or bacterial membrane constituents to identify their innate immune responses.

**Methods:** Rabbit ICs (Clone C cells) were challenged with UPEC or the UPEC cell membrane components lipopolysaccharide (LPS), muramyl dipeptide (MDP) and  $\gamma$ -D-Glu-mDAP (iE-DAP). Following infection, cell lysates were obtained and an antimicrobial response PCR array or qRT-PCR were used to determine immune gene activation. Immunoblotting was performed to confirm innate immune pathway activation. Bacterial attachment and invasion assays assessed if exposure to cell membrane components prior to infection impacted IC susceptibility to UPEC.

**Results:** UPEC activated Toll-like receptor (TLR), NFKB, and Nucleotide Binding Oligomerization Domain Containing (NOD)-like receptor (NLR) signaling pathways in ICs, as determined by the antimicrobial response arrays, STRING, and Ingenuity Pathway Analysis. Immunoblotting confirmed activation of both NFKB and MAPK signaling pathways. LPS and the NOD2 agonist, MDP, stimulated NF-kB and MAPK signaling and induced AMP expression, including Len2 (NGAL), Ribonuclease 4, and Ribonuclease

Key: TH - Thursday; FR - Friday; SA - Saturday; OR - Oral; PO - Poster; PUB - Publication Only

Underline represents presenting author.

8. The NOD1 agonist, iE-DAP did not affect AMP expression. Incubation of ICs with LPS and MDP one hour prior to infection protected ICs against UPEC attachment and invasion.

**Conclusions:** In response to UPEC, ICs activate NOD2, TLR4, and the downstream NFkB and MAPK signaling pathways. Stimulation with LPS and MDP activates IC innate immune pathways and increases AMP expression to protect ICs from UPEC. Together, these data indicate NOD2 and downstream NFkB and MAPK signaling may have a role in IC innate immune defenses against UTI.

**Funding:** NIDDK Support

## SA-PO617

### Notch Signaling Regulates Renal Urothelial Cell Proliferation During Experimental Urinary Tract Obstruction

Kelly Grounds,<sup>1</sup> Alexa Miehs,<sup>1,2</sup> Birong Li,<sup>1</sup> Brian Becknell,<sup>1,2</sup> Ashley R. Jackson,<sup>1,2</sup> *Abigail Wexner Research Institute at Nationwide Children's Hospital, Columbus, OH;* <sup>2</sup>*The Ohio State University College of Medicine, Columbus, OH.*

**Background:** Urinary Tract Obstruction (UTO) is a leading cause of pediatric chronic kidney disease (CKD). While no interventions can prevent CKD progression, heterogenous outcomes suggest differences in ability of the kidney to adapt to hydrostatic pressure and pelvic/ureteral dilatation. Congenital and acquired UTO triggers protective urothelial remodeling. Basal Keratin 5 (K5)-UCs function as age-restricted progenitors, giving rise to protective apical Uroplakin (UPK)-UCs, but the molecular regulation of renal K5-UC progenitors is unknown. The Notch signaling pathway regulates progenitor proliferation and differentiation in other organ systems. Thus, we hypothesize that the Notch signaling pathway governs renal K5-UCs during UTO.

**Methods:** We profiled the expression of members of the Notch signaling pathway using RNAscope (Jag2, Notch1, Dll1), immunohistochemical (ICH) and immunofluorescent (IF) localization (Notch1, NICD, RBPJ, Hes7). We used Megabladder mice (Mgb, congenital lower UTO), and unilateral ureteral obstruction (UO, acquired upper UTO) to model UTO. We used *K5<sup>CreERT2/+</sup>;RBPJ<sup>fl/fl</sup>;R26<sup>tdT/+</sup>* mice (RBPJ-cKO) to inducibly disrupt Notch signaling in K5-UCs and compared to *RBPJ<sup>fl/fl</sup>;R26<sup>tdT/+</sup>* (control). We investigated the impact of Notch loss of function on urothelial integrity using IF (K5, UPK, Ki67).

**Results:** Renal urothelium expresses *Jag2*, *Dll1* (ligands), and *Notch1* (receptor), but low or undetectable levels of NICD (activated Notch) during homeostasis. UTO (both Mgb & UO) leads to increased NICD in K5-UCs, thus, we proceeded to disrupt Notch during UTO. After validating deletion of RBPJ (loss of Notch function) in K5-UCs, we then performed UO in RBPJ-cKO and control mice. At post-operative day 2 (peak stage of UTO-induced urothelial proliferation) RBPJ-cKOs exhibited increased Ki67 in K5-UCs compared to controls.

**Conclusions:** Our study suggests renal K5-UC progenitors are regulated by the Notch signaling pathway during UTO. Further studies are warranted to determine whether increased K5-UC proliferation in RBPJ-cKOs leads to impaired renal urothelial remodeling, and whether this impacts renal function. Nevertheless, these findings advance our understanding of renal adaptation to UTO, and implicate a potential signaling pathway with therapeutic utility for mitigating obstructive nephropathy.

**Funding:** NIDDK Support

## SA-PO618

### Novel Drug Therapy to Prevent Bladder Fibrosis in a Pre-Clinical Model of Posterior Urethral Valves

Kevin X. Cao,<sup>1</sup> Maria K. Joannou,<sup>1</sup> Cheuk Yan Man,<sup>1</sup> Navroop S. Johal,<sup>1</sup> Peter M. Cuckow,<sup>1</sup> Christopher H. Fry,<sup>2</sup> Paul Winyard,<sup>1</sup> David A. Long,<sup>1</sup> David Long - UCL Nephro-Urology <sup>1</sup>*UCL Great Ormond Street Institute of Child Health, London, United Kingdom;* <sup>2</sup>*University of Bristol, Bristol, United Kingdom.*

**Background:** Posterior Urethral Valves (PUV) remains one of the most severe paediatric conditions, responsible for most of the demand for renal replacement resources in childhood. We previously showed that excess extra-cellular matrix (ECM) in these bladders may be the pathologic culprit, so finding an anti-fibrotic therapy is a promising means to improve outcomes in this disorder. We performed a pre-clinical trial with both an animal model of PUV and human cell culture experiments with PUV bladder cells, treating both with soluble guanylate cyclase (sGC) modulators to explore the therapeutic potential of this family of drugs.

**Methods:** 8-week old male C57 mice (n=36) were used to create a PUV-analogue surgical model, through partial-ligation of the urethra, which were then orally-administered sGC modulators for two out of three weeks of the experiment. Bladders were stained with picosirius red to allow evaluation of the smooth muscle to connective tissue ratio (SM:CTR). Biomechanical assessments of the stress-strain relationship from these bladders was measured to derive elastic modulus, or stiffness from the steady-state tension (measured in kilopascals, kPa). Furthermore, primary cell cultures were established from children with PUV undergoing bladder surgery or kidney transplant and treated with the same drugs over a 7-day course to determine relative changes in both ECM proteins and changes to gene expression of ECM genes.

**Results:** Our animal model generated a PUV-like morphology, reducing SM:CTR from 1.2 in sham surgery to 0.5 in the model, indicating a greater ECM content (p<0.001), with increase in detrusor stiffness from 50kPa to 170kPa. Treatment with either sGC activator, cinaciguat or sGC stimulator, BAY 41-2272 (10mg/kg) kept both these variables in the same range as sham surgery (p<0.001). Culture of detrusor in a pro-

fibrotic 1% fetal bovine serum milieu resulted in a 20% increase in fibronectin protein and gene expression, compared to control milieu of 10% serum, relative to housekeeping gene/protein GAPDH. Treatment in 1% serum with BAY 41-2272 reduced expression of fibronectin protein by seven-fold and FN1 gene expression by 20%.

**Conclusions:** sGC modulation in an in vivo and in vitro model described here demonstrates prognosis-altering potential for this on-market drug in PUV.

**Funding:** Private Foundation Support

## SA-PO619

### Are Patients With Renal Anomalies at Risk for Müllerian Anomalies?

Laura E. Walawender, Yueyang F. Fei, Brian Becknell, Daryl J. Mcleod. *Nationwide Children's Hospital, Columbus, OH.*

**Background:** Patients with Müllerian anomalies have a 30-50% increased prevalence of congenital renal anomalies, but the prevalence of Müllerian anomalies among patients with known congenital renal anomalies is unknown. A delay in diagnosis of obstructive Müllerian anomalies can increase the risk of poor clinical outcomes including pelvic inflammatory disease, abscess, infertility, and endometriosis. The goal of this study was to describe the prevalence of Müllerian anomalies in a cohort of patients with known congenital renal anomalies.

**Methods:** A retrospective electronic medical record review was performed of patients within the Nationwide Children's Hospital system with ICD9 or ICD10 diagnostic codes for both urologic and gynecologic anomalies. Patients with complex urogenital pathology, such as, cloaca, urogenital sinus, or bladder exstrophy were excluded. Renal anomaly diagnosis, Müllerian anomaly diagnosis, reason for pelvic evaluation, type of evaluation, and age of diagnosis of both renal and Müllerian anomalies were evaluated.

**Results:** 136 patients were identified as having both urologic and gynecologic codes; 80 were excluded based on the exclusion criteria. Of the 56 eligible patients, 31 (55%) had a congenital solitary kidney. The type of and reason for pelvic evaluation was determined for 46 patients. Abdominal pain/dysmenorrhea was the most common reason for pelvic evaluation (38%), most often by ultrasound (70%), leading to the diagnosis of a Müllerian anomaly in 41 (73%) patients. Among the 38 patients with renal and Müllerian anomalies, 24 (63%) had an initial diagnosis of a renal anomaly; 6 (16%) had an initial diagnosis of Müllerian anomaly, and 8 (21%) were diagnosed with both simultaneously. 16 patients (39%) had a Müllerian obstruction, and 9 underwent urgent surgical intervention within 2 weeks of the diagnosis.

**Conclusions:** In this study, over half of the patients had a renal anomaly diagnosed before their Müllerian anomaly, which was obstructive in over one-third of instances. Given the primacy of early diagnosis for obstructive Müllerian anomalies, there is a need for a prospective study in patients with congenital renal anomalies to determine if routine pelvic ultrasound at the larche or around the age of expected menarche could reduce the rate of obstructive Müllerian anomalies presenting acutely.

## SA-PO620

### Altered UBASH3A Expression May Be Involved in Congenital Anomalies of the Kidney and Urinary Tract (CAKUT) Phenotypes of Down Syndrome

Mirela Lozic, Katarina Vukojevic. *Sveučiliste u Splitu Medicinski fakultet, Split, Croatia.*

**Background:** Congenital anomalies of the kidney and urinary tract (CAKUT) are considered to be the fourth most common major birth defects in Down syndrome (DS) and are up to 30 times more prevalent than in the general population. Due to the lack of insight into its primary pathogenesis, diagnostic and therapeutic possibilities are limited. The *UBASH3A* gene could be considered a candidate gene for the development of some DS phenotypes as it is mapped to 21q22.3, which is within the critical region for the development of DS. Previously conducted *in silico* analysis of a database obtained by whole-exome sequencing of patients with CAKUT uncovered *UBASH3A* as a novel protein-coding candidate gene. We also demonstrated the expression of *UBASH3A* in normal developing and adult kidneys. Due to the increased gene dose, established expression pattern, and possible role in renal development, altered *UBASH3A* expression could be involved in the CAKUT DS phenotypes.

**Methods:** For the immunofluorescence study of *UBASH3A* in DS, the tissue of kidneys of premature infants and adults diagnosed with DS and CAKUT, along with healthy controls, were used.

**Results:** *UBASH3A* exhibited positive expression patterns in DS but differed in intensity and distribution compared to the control samples. In DS, the signal was clearly visible only at a magnification of 100x, while in controls it was clearly visible at 40x, which indicates a significantly reduced intensity. However, in DS we could observe a granular, scattered signal within the nucleus in contrast to the control nuclei, which mostly contained a single punctate signal. This could indicate a large number of abnormal gene products and/or apoptotic processes.

**Conclusions:** Because of its expression pattern and its mapping to 21q22.3, *UBASH3A* could be involved in the CAKUT phenotypes of Down syndrome.

**Funding:** Government Support - Non-U.S.



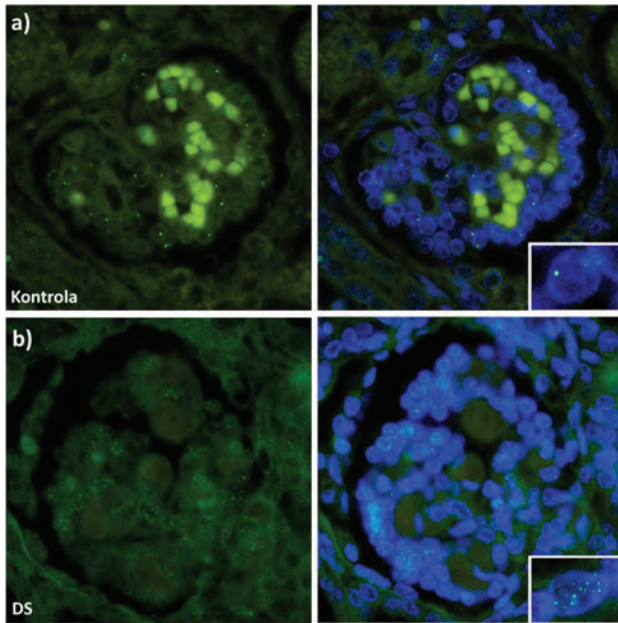

## SA-PO621

### Renal Scintigraphy in the Follow-Up of Patients With Congenital Single Functioning Kidney

Luigi Cirillo,<sup>1,2</sup> Francesca Becherucci,<sup>2</sup> Tommaso Mazzerli,<sup>1</sup> Elisa Buti,<sup>2</sup> Carmela Errichiello,<sup>2</sup> Paola Romagnani.<sup>1,2</sup> <sup>1</sup>Università degli Studi di Firenze Dipartimento di Scienze Biomediche Sperimentali e Cliniche Mario Serio, Firenze, Italy; <sup>2</sup>Meyer Children's Hospital, Firenze, Italy.

**Background:** In the last decade the association between congenital single functional kidney (cSKF) and increased risk of hypertension, proteinuria and kidney injury has become clear. Regarding CKD long-term outcome, kidney hypertrophy at ultrasound (US) in the early months of life is reported as protective. Kidney US measuring renal length (BPL) and renal scintigraphy (RS) measuring GFR (mGFR) are both useful tools for the clinical management. The follow-up is frequently based on local protocols, although clinical recommendations have been proposed recently. The aim of the present study was to assess the utility of RS and to compare it to US in gathering information on kidney function, long term outcome and the appropriate use in the follow-up of patients with cSKF.

**Methods:** Retrospective, monocentric, observational study enrolling pediatric cSKF patients. Demographic, clinical, instrumental and laboratory data were collected from medical records for all the patients included in this study. CKD was considered as composite outcome (at least one: reduced mGFR or eGFR, proteinuria in at least two different examinations, hypertension).

**Results:** 163 cSKF patients were included. The BPL showed a linear increase over time, with curve flattening after 144 months of age. Conversely, mGFR rapidly increased between 0 and 60 months, stabilizing thereafter (Fig.1) and reaching a median value over the threshold of normal function between 24 and 60 months; we observed a slight decrease after 180 months, although not statistically significant. Comparing the trend of BPL and mGFR over time, we observed a significant correlation ( $R^2=0.5$ ,  $p\text{-value}<0.05$ ) between 1 and 60 months of life, that was lost thereafter. Proteinuria, hypertension, impaired eGFR and mGFR were found in 11.7%, 18.7%, 30.4% and 39.3% patients, respectively, with overall CKD rate of 41.6%. Of note, 25% of these patients were identified only by RS, having no other considered abnormality. Moreover in this subgroup patients only one showed kidney hypertrophy at US before the age of 60 months.

**Conclusions:** RS can be as useful as US in the follow-up of cSKF. It allows to early spot a higher number of CKD patients and probably represent the best option for those with late referral in which early US is not available, to guide the clinicians in defining the risk of CKD and inform prognosis.

## SA-PO622

### Immunohistochemical Expression Pattern of RIP5, FGFR1, and FGFR2 in Normal Human Kidney Development and Congenital Anomalies of the Kidney and Urinary Tract (CAKUT)

Katarina Vukojevic,<sup>1</sup> Anita Racetin,<sup>1</sup> Nela Kelam,<sup>1</sup> Natalija Filipovic,<sup>1</sup> Violeta Soljic.<sup>2</sup> <sup>1</sup>University of Split School of Medicine, Split, Croatia; <sup>2</sup>University of Mostar School of Medicine, Mostar, Bosnia and Herzegovina.

**Background:** RIP5 plays a key role in the urinary tract development, downstream of FGF-signaling and its impairment can lead to congenital anomalies of the kidney and urinary tract (CAKUT).

**Methods:** Human kidney tissues of 16 conceptuses between 22<sup>nd</sup> and 28<sup>th</sup> developmental weeks (dw) were used as a control, in the comparison with 21 CAKUT samples. Sections were stained with the double-immunofluorescence method with RIP5 and FGFR1/FGFR2 markers.

**Results:** RIP5 expression was higher in the collecting tubules (Ct) of CAKUT samples in comparison to control ( $p<0.0001$ ), while in metanephric mesenchyme (mm) (3.5%) and glomeruli (g) (4.15%) was lower than in control ( $p<0.0001$ ). The highest expression of FGFR1 and FGFR2 was observed in the collecting ducts (Cd) of both CAKUT cases and control. Additionally, expression of FGFR1 and FGFR2 was also higher in Ct and g of controls in comparison to CAKUT cases ( $p<0.0001$ ). RIP5 and FGFR1/FGFR2 co-expressed in Cd of controls, while RIP5 and FGFR1 did not co-express in CAKUT samples. In CAKUT cases RIP5 and FGFR2 co-expressed in mm and g.

**Conclusions:** Altered RIP5, FGFR1, and FGFR2 expression pattern in CAKUT cases in comparison to normal human kidney development might indicate its significance in FGF receptor signaling and normal kidney development.

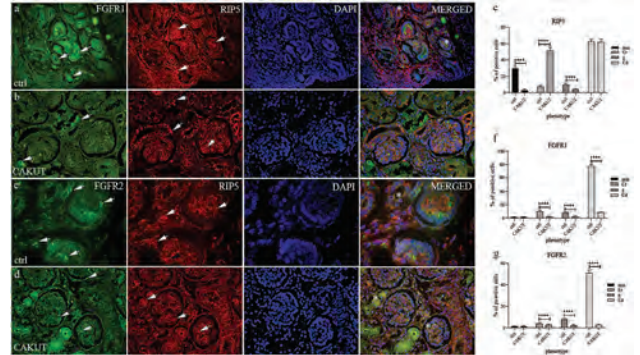

**a-d** Immunofluorescence staining of developing human kidneys and CAKUT cases with RIP5, FGFR1, FGFR2 markers (arrows), and DAPI in different kidney structures (g–glomeruli, Ct–convoluted tubules, Cd–collecting duct, mm–metanephric mesenchyme) between 22<sup>nd</sup> and 28<sup>th</sup> developmental week. Merged pictures reveal co-expression of RIP5 and FGFR1 and RIP5 and FGFR2 in the collecting duct of controls (asterisks) and RIP5 and FGFR2 in the mm and g of CAKUT cases (asterisks). **e-g** Distribution of RIP5, FGFR1 and FGFR2 positive cells in the mm, g, Cd and Ct in human kidney development and CAKUT cases. Data were shown as mean  $\pm$  SD,  $p<0.05$  (two-way ANOVA with Sidak's multiple comparisons test).

## SA-PO623

### Rapid Development of Severe Nephrolithiasis in Febrile Infection-Related Epilepsy Syndrome

Linda Wang, Sun-Young Ahn. Children's National Hospital, Washington, DC.

**Introduction:** Febrile infection-related epilepsy syndrome (FIRES) is a rare disorder characterized by new onset of refractory status epilepticus, with development of seizures within 24 hours to 2 weeks of febrile illness. Nephrolithiasis has not been previously reported with FIRES.

**Case Description:** A 5-year-old previously healthy boy presented with fever followed by refractory seizures requiring multiple antiepileptics; he was subsequently diagnosed with FIRES. Serum electrolytes, calcium (Ca), phosphorus (P), uric acid, and creatinine were normal, but urinalysis showed blood and protein. Initial renal ultrasound (US) was normal; however, an abdominal US 11 days later showed extensive multiple bilateral kidney stones, largest measuring 10 mm, resulting in pelvicalyceal dilation bilaterally, with bilateral ureteral dilation from calculi and bladder wall calcification. Stone formation was initially attributed to furosemide (given 7 days), topiramate (11 days), and ketogenic diet (1 month). However, the patient continued to form numerous bilateral stones for several months after discontinuation of all 3 factors, requiring repeated lithotripsy, stone extraction, and bilateral ureteral stenting to relieve obstruction. Initial stone analyses revealed carbonate apatite (dahlite, 100%) stones and a stone analysis 3 months later showed Ca hydrogen phosphate (brushite, 100%) stones. A 24-hour urine analysis showed hypercalciuria (4.8 mg/kg Ca,  $nl<4$ ) and phosphaturia (22.5 mg/kg P,  $nl<17$ ). He received intravenous immunoglobulin, steroids, rituximab, anakinra and tocilizumab as treatment for FIRES with improvement in his seizures; hematuria and proteinuria resolved. Oral hydrochlorothiazide was initiated resulting in decreased stone burden on abdominal CT scan.

**Discussion:** Kidney stone formation has been associated with increased expression of molecules involved in inflammatory pathways, such as osteopontin which is detected in stone organic matrix. In addition, serum osteocalcin, elevated in our patient (98.4 ng/ml,  $nl$  7.3-38.5), has been linked to development of renal calcium phosphate deposits. In our patient with possible underlying hypercalciuria, the pro-inflammatory state from FIRES may have triggered the rapid and massive kidney stone formation and bladder calcification. Further investigation is needed to delineate the association between nephrolithiasis and inflammatory conditions such as FIRES.

## SA-PO624

**Nephrocalcinosis in Children: Clinical Outcomes According to Underlying Diseases**

Jinwoon Jung,<sup>1,2</sup> Heeyeon Cho.<sup>1,2</sup> <sup>1</sup>Samsung Medical Center, Gangnam-gu, Seoul, Republic of Korea; <sup>2</sup>Sungkyunkwan University School of Medicine, Suwon, Republic of Korea.

**Background:** Nephrocalcinosis (NC) is defined as calcium deposits in renal tubules and interstitium. Often detected as an incidental finding, NC have been suggested to be caused by factors such as prematurity, metabolic and monogenic disorders. Recently, there was a few reports that NC might be a specific finding of hereditary renal disease of various outcomes. This study aimed to evaluate the risk factors and underlying diseases including genetic causes and assess clinical outcomes of Korean children with NC.

**Methods:** Total 256 children who visited Samsung Medical Center from January 2017 to December 2021 with a confirmative or suspected diagnosis of NC at age under 18 using ultrasonography were enrolled. Medical records including sex, gestational age, underlying disease, medication history, genetic analysis, and ultrasonography were retrospectively reviewed.

**Results:** Male to female ratio was 0.9:1 and the average age at first diagnosis of NC was 598.4 days after birth. One hundred eighty-one children (70.7%) were born as prematurity. Underlying disease of bronchopulmonary dysplasia (BPD) and patent ductus arteriosus (PDA) were found in 34.7 % and 25.0%, respectively. Each of 143 (55.8 %) and 107 (41.7%) of patients had medication history of furosemide and vitamin D. Incidence of BPD, PDA and taking vitamin D were remarkably high in premature group comparing with full term group. Among 142 children in whom the follow-up data were available, NC was spontaneously resolved over time averaging to 310 days in 96 children (67.6 %). Progression to chronic kidney disease (CKD) was noted in 8 (3.1%) patients. For 44 patients without the clinical risk factors, genetic studies were performed and 20 pathogenic variants including *HNF1B*, *SLC25A13*, and *PKHD1* were detected in 22 children. Among the 22 showing genetic mutations, 2 patients with *HNF1B* and *CFH* mutation progressed to CKD.

**Conclusions:** The majority of current study group had histories highly relevant with preterm birth and most of them showed spontaneous resolution of NC within a year. On the other hand, full-term born children without the known risk factors were more likely to have genetic causes and to develop CKD. Therefore, our study suggests that although the children with NC present the favorable outcomes, regular follow-up and genetic analysis are necessary for the patients without the clinical risk factors.

## SA-PO625

**First Post-Natal Screening Study to Detect Primary Hyperoxaluria Types 1 and 3**

Cristina Martin Higuera,<sup>1</sup> Bodo B. Beck,<sup>2</sup> Katharina Hohenfellner,<sup>3</sup> Bernd Hoppe.<sup>1</sup> <sup>1</sup>German Hyperoxaluria Center, Bonn, Germany; <sup>2</sup>Uniklinik Köln, Köln, Germany; <sup>3</sup>Kliniken der Stadt und des Landkreises Rosenheim GmbH, Rosenheim, Germany.

**Background:** The three primary hyperoxalurias (PH) are ultra-rare diseases of the glyoxylate metabolism, at which three specific enzyme defects induce severe endogenous overproduction of oxalate, and thus its massively elevated urinary excretion. Clinical hallmarks are recurrent urolithiasis, progressive nephrocalcinosis and eventually end stage kidney failure. Early diagnosis should be mandatory to achieve better outcome, which is even more important now, as a new treatment option is available for type 1 primary hyperoxaluria.

**Methods:** After parents have signed informed consents, we include all routine newborn-screening cards send to our screening lab for testing the presence of the most common mutations of the *AGXT* (c.508G>A, PH 1) and *HOGA1* (c700+5G>T, PH 3) genes in Europe, respectively. We expect to test > 150.000 samples. If patients are homozygous, treatment will be started promptly, and outcome will be compared to historical controls from the German PH registry (OxalGermany). If heterozygous mutations are found, repeated spot urine analysis is performed to exclude hyperoxaluria. In those new-borns with hyperoxaluria, further genetic analysis is done and, if being positive, they start treatment promptly.

**Results:** So far, we have screened 7131 newborns in the routine testing. Out of those, no patient with homozygous mutations for *AGXT* or *HOGA1* have been found. However, we found 24 heterozygous patients each for *AGXT* and *HOGA1* mutations, respectively. One other newborn was heterozygous for *AGXT* and *HOGA1*. In 19 (11 *HOGA1*, 8 *AGXT*) patients urine analysis is already available, all were normal for oxalate and PH-type specific metabolites.

**Conclusions:** This huge newborn screening program will answer multiple questions. First we can better calculate the true prevalence of two PH types in Germany, as genomic data supposes many more patients, as currently known. Secondly, we can promptly treat patients and prevent disastrous outcome. Thirdly, we will compare outcome of different treatments (standard with vitamin B6 compared to new RNAi, Oxalumo, in PH 1). Lastly, the batches of urine analyzed will provide best normative molar creatinine ratios not only for oxalate and related metabolites, but also for other lithogenic substances for the newborn period.

**Funding:** Commercial Support - Bridgebio Pharmaceuticals, Private Foundation Support

## SA-PO626

**Single Cell Immune Profiling Reveals Pro-Inflammatory Mechanisms Linked to Dysbiosis and Cardiovascular Disease in Children With CKD**

Johannes Holle,<sup>1,6</sup> Harithaa Anandakumar,<sup>1</sup> Ulrike Löber,<sup>1,7</sup> Anne Dueck,<sup>2</sup> Julia Schlender,<sup>1</sup> Hannes Sallmon,<sup>3</sup> Felix Behrens,<sup>1</sup> Jennifer A. Kirwan,<sup>4</sup> Jun Oh,<sup>5</sup> Stefan Engelhardt,<sup>2</sup> Sofia K. Forslund,<sup>1,7</sup> Dominik Müller,<sup>1</sup> Hendrik Bartolomaeus,<sup>1,6</sup> Nicola Wilck.<sup>6</sup> <sup>1</sup>Charite Universitätsmedizin Berlin, Berlin, Germany; <sup>2</sup>Technische Universität München, München, Germany; <sup>3</sup>German Heart Institute Berlin, Berlin, Germany; <sup>4</sup>Berlin Institute of Health at Charite, Berlin, Germany; <sup>5</sup>Universitätsklinikum Hamburg-Eppendorf, Hamburg, Germany; <sup>6</sup>German Centre for Cardiovascular Research, partner site Berlin, Berlin, Germany; <sup>7</sup>Max-Delbrück-Centrum für Molekulare Medizin in der Helmholtz-Gemeinschaft, Buch, Germany.

**Background:** Controlling chronic inflammatory processes as a major risk factor for cardiovascular disease (CVD) is of outstanding importance in chronic kidney disease (CKD) to reduce CKD-associated morbidity. The underlying mechanisms of inflammation in CKD are incompletely understood, but may be linked to gut dysbiosis. We aimed to characterize microbiota-immune interactions in pediatric CKD patients, thus independent of confounding comorbidities frequently seen in adult patients.

**Methods:** We analyzed the fecal microbiome, metabolites and immune phenotypes in 48 children (normal kidney function, CKD stage G3-G4, G5 treated by hemodialysis (HD) or kidney transplantation) with a mean age of  $10.6 \pm 3.8$  years. We validated and further expanded our knowledge in a second cohort of 38 patients linking cardiovascular phenotypes to single immune cell transcriptomics.

**Results:** Serum TNF- $\alpha$  and sCD14 were stage-dependently elevated, indicating inflammation, gut barrier dysfunction and endotoxemia. We observed compositional and functional alterations of the microbiome, including a diminished production of short-chain fatty acids. Plasma metabolite analysis revealed a stage-dependent increase of tryptophan metabolites of bacterial origin. Serum from HD patients activated the aryl hydrocarbon receptor and stimulated TNF- $\alpha$  production in monocytes, corresponding to a pro-inflammatory shift from classical to non-classical and intermediate monocytes. Unsupervised analysis of T cells revealed a loss of mucosa-associated invariant T (MAIT) cells and regulatory T cell subtypes in HD patients. Pro-inflammatory immune cell patterns were confirmed and further described using targeted proteomics and CITE-sequencing in the validation cohort.

**Conclusions:** Gut barrier dysfunction and microbial metabolite imbalance mediate the pro-inflammatory immune phenotype, thereby driving the susceptibility to cardiovascular disease. Thus, the data highlight the importance of the microbiota-immune axis in CKD irrespective of confounding comorbidities. Further investigations are ongoing to highlight the role of microbiome-immune interaction as an emerging treatment target in CKD patients.

**Funding:** Private Foundation Support

## SA-PO627

**Molecular Pathways Underlying Vascular Disease in Children With ESKD**

Maria Bartosova,<sup>1</sup> Julie Bernardor,<sup>1</sup> Conghui Zhang,<sup>1</sup> Rebecca Herzog,<sup>2</sup> Iva Marinovic,<sup>1</sup> Anette Melk,<sup>3</sup> Verena Peters,<sup>1</sup> Klaus Kratochwill,<sup>2</sup> Claus Peter Schmitt.<sup>1</sup> International Pediatric Peritoneal Biobank <sup>1</sup>Universitäts Klinikum Heidelberg, Heidelberg, Germany; <sup>2</sup>Medizinische Universität Wien, Wien, Austria; <sup>3</sup>Medizinische Hochschule Hannover, Hannover, Germany.

**Background:** Patients with ESKD suffer from exceedingly high cardiovascular disease. Children, devoid of life-style and aging related CVD risk factors, provide highly sensitive and specific insights in early pathomechanisms of vascular disease.

**Methods:** Arterial tissues from 95 non-CKD and 110 ESKD-children (median age 9.2 years) underwent digital histomorphometry. Omental arterioles microdissected from surrounding fat tissue underwent multi-omics, and untargeted and vascular calcification (VC) targeted GSEA/IPA. Key mechanisms were validated by quantitative immunostaining *ex vivo* and *in vitro*.

**Results:** Significant arteriolar lumen obliteration was present in children with ESKD, intima and media thickness increased, and endothelial telomeres were shorter, independent of underlying diseases and sex. Arteriolar inflammatory (CD68+) and pro-fibrotic (pSMAD2/3) activity was increased. GSEA identified top enriched pathways including telomere extension by telomerase and chromatin histone methylation. IPA cross-omics showed suppression of actin cytoskeleton, tight junction signaling, and focal adhesion. VC pathway analysis identified 30/442 pathways related to actin cytoskeleton, Wnt signaling, extracellular matrix (ECM) organization, complement activation, and osteoblast-like phenotype. In independent age-matched ESKD cohorts, endothelial methylated histone 3 was reduced and complement system activated compared to non-CKD controls. Actin cytoskeleton interacting proteins gamma actin and profilin-1 were reduced, cofilin-1 unchanged. ECM protein fibronectin-1 was reduced. *In vitro*, exposure of endothelial cells to inflammatory cytokines and reactive metabolites reduced transendothelial resistance, increased permeability and impaired sealing junction and cytoskeleton integrity. These effects were prevented by co-incubation with anserine, 3-methylhistidine and alanyl-glutamine, but not by carnosine, L-histidine, 1-methylhistidine and methyl- alanine.

**Conclusions:** ESKD results in major vascular aging already in early childhood. We provide a first comprehensive analysis of underlying molecular mechanisms and derive a novel potential therapeutic intervention, *in vitro* preserving endothelial cell barrier integrity.

**Funding:** Government Support - Non-U.S.

SA-PO628

**Variant Load in Childhood Nephrotic Syndrome Is Associated With Pattern of Therapy Response**

Rachel K. Cason, Megan Chryst-Stangl, Kinsie Huggins, Brandon M. Lane, Tiffany Tu, Alejandro Ochoa, Rasheed A. Gbadegesin. *Duke University Medical Center, Durham, NC.*

**Background:** Nephrotic syndrome (NS) is the most common glomerular disease seen in pediatric nephrology clinics. Although the etiology for most cases of NS remains unknown, several genetic loci have been associated with Steroid Sensitive NS (SSNS). It is unclear if these loci are also associated with pattern of therapy response. In the present study, we investigated the association between NS risk loci and pattern of therapy response in a large, multi-ethnic cohort of patients with NS.

**Methods:** We enrolled 1058 patients with childhood onset NS comprising of Steroid Resistant NS (SRNS) and SSNS (including Infrequently Relapsing [IFR] and Frequently Relapsing/Steroid Dependent [FR/SD]). Genotyping was done using TaqMan and Direct Sanger Sequencing for 10 childhood NS risk loci: *HLA-DQA1* (rs1129740 & rs1071630), *BTNL2* (rs9348883), *HLA-DR/DQ* (rs4642516 & rs3134996), Intergenic (rs9273371), *CALHM6* (rs2637678), *NPHS1/KIRREL* (rs56117924), *TNFSF15* (rs6478109), and *TNFRSF11A* (rs34213471). We compared the minor allele frequencies (MAF) between NS vs. controls, SRNS vs. SSNS, and IFR vs. FR/SD. Variant load analysis comparison was performed using Wilcoxon (rank sum) 2-sample test.

**Results:** All 10 risk loci were associated with NS compared with controls ( $p=0.006$  to  $<2.2e^{-16}$ ). Variant load was associated with both SRNS and FR/SD (SRNS vs. SSNS  $p=1.98e^{-15}$  and IFR vs. FR/SD  $p=0.002$ ).

**Conclusions:** Our study showed that genetic risk loci for childhood NS are associated with pattern of therapy response and may predict disease outcome.

**Funding:** NIDDK Support, Other NIH Support - Duke CTSA TL1 Training Grant

SA-PO629

**Proteomic Analysis of Complement Proteins in Glomerulonephritis**

Lilian M. Palma,<sup>1</sup> Jason D. Theis,<sup>2</sup> Fernando C. Fervenza,<sup>2</sup> Sanjeev Sethi.<sup>2</sup> <sup>1</sup>*Universidade Estadual de Campinas, Campinas, Brazil;* <sup>2</sup>*Mayo Clinic Minnesota, Rochester, MN.*

**Background:** Complement plays an important role in the pathogenesis of glomerulonephritis (GN). Even though the underlying etiology of GN might be different, complement activation results in glomerular injury and progression of disease in most GN. Routine IF includes staining for only complement proteins C3c and C1q. Therefore, with regards to evaluation of complement pathways the kidney biopsy provides limited information.

**Methods:** We performed laser microdissection of glomeruli in 60 cases of GN that included infection-related GN (IRG), lupus nephritis (LN), IgA nephropathy (IgAN), fibrillary GN (FG), membranous nephropathy (MN), ANCA-GN, C3GN, dense deposit disease (DDD), proliferative GN with monoclonal Ig deposits (PGNMID), monoclonal Ig deposition disease (MIDD) and immunotactoid glomerulopathy (ITG). This was followed by mass spectrometry (MS/MS) to analyze complement proteins and pathways involved in GN.

**Results:** MS/MS shows that C3 followed by C9 are the most abundant complement proteins in GN, indicating activation of classical/lectin/alternative and terminal pathways, either exclusive or with combination of pathways (Figure 1). C3G, IgAN, and ANCA-GN showed alternative pathway activation. Depending on the type of GN, classical/lectin pathway activation with either C4A and/or C4B was present. Thus, MN, FG and IRG showed C4A-dominant pathways while LN, PGNMID, MIDD and ITG show C4B-dominant pathways. Significant deposition of complement regulatory proteins FHR1 and FHR5 is present in most GN.

**Conclusions:** This study shows accumulation of specific complement proteins in GN. The complement proteins, complement pathways and the amount of complement protein deposition is variable in different types of GN. Selective targeting of complement pathways may be a novel option in the treatment of GN.

	IRG	LN	IgAN	FG	ANCA + GN	ANCA-GN	C3 GN	DDD	PGNMID	ITG	MIDD	MN
C3	+++	+++	+++	+++	+	+++	++	+++	+++	++	+++	+++
C4A	+	-	-	+++	+/-	+/-	-	-	++	-	-	+++
C4B	-	+++	-	-	-	-	-	-	+++	+++	+++	-
C9	++	++	++	++	-	-	+++	+++	++	++	+++	++
FHR1	+	++	+++	+++	-	-	++	+++	++	+++	++	++
FHR5	+	++	+/-	+++	-	-	++	+++	++	++	++	+

MS/MS total spectral counts in GN. + to ++++: - negative or baseline (0-2), + (low) spectral counts between 2-5, ++ (moderate) spectral counts between 6-15, +++ (high) spectral counts between 16-50, ++++ (very high) spectral counts over 50.

SA-PO630

**C3 Glomerulonephritis Has a Higher Burden of Complement Proteins Compared to Post-Infectious Glomerulonephritis**

Lilian M. Palma,<sup>1</sup> Jason D. Theis,<sup>2</sup> Maria Izabel N. de Holanda,<sup>3</sup> Fernando C. Fervenza,<sup>2</sup> Sanjeev Sethi.<sup>2</sup> <sup>1</sup>*Universidade Estadual de Campinas Faculdade de Ciencias Medicas, Campinas, Brazil;* <sup>2</sup>*Mayo Clinic Minnesota, Rochester, MN;* <sup>3</sup>*Hospital Federal de Bonsucesso, Rio de Janeiro, Brazil.*

**Background:** Complement plays an important role in Post Infectious Glomerulonephritis (PIGN) and C3 glomerulonephritis (C3GN). Both PIGN and C3GN are characterized by a proliferative GN on light microscopy and bright staining for C3 on immunofluorescence studies and are difficult to distinguish on kidney biopsy. However, the etiology, pathogenesis and treatment are different for PIGN and C3GN. Given the limitations of routine kidney biopsy, we performed laser microdissection followed by mass spectrometry (MS) analysis to determine whether glomerular complement profiles are different in PIGN and C3GN.

**Methods:** Complement protein profiles were analyzed in patients with PIGN (n=8) and C3GN (n=9). Glomeruli (8-10 per biopsy) were laser microdissected and dissected fragments were digested into tryptic peptides and analyzed by MS. For each case 2 samples were analyzed. A list of proteins was generated and peptide identifications were accepted if greater than 90% probability by the Peptide Prophet algorithm was established. The Total spectral counts (TSC) of complement proteins of the alternative and terminal pathways (C3, C5-C9), regulatory proteins (CFH, CFHR1-5) and classical/lectin pathways (C4A, C4B) were compared between the two groups.

**Results:** Mean TSC of complement proteins for PIGN vs. C3GN were as follows: C3: 35.25 vs. 129.5 ( $p<0.05$ ), C5-C9: 9.6 vs. 66.4 ( $p<0.05$ ), CFH: 0.62 vs. 14.2 ( $p<0.05$ ), CFHR1-5: 5.25 vs. 48.6 ( $p=NS$ ), C4A: 0 vs. 8.11 ( $p=NS$ ) and C4B: 1.25 vs. 11.6 ( $p<0.05$ ). Compared to PIGN, C3 was 3.7-fold higher in patients with C3GN, as was C5-C9 (7-fold), CFH (22-fold), CFHR1-5 (9.3-fold) and C4B (9.3-fold). Only C4A had similar TSC among the two groups.

**Conclusions:** Glomeruli of C3GN express significantly higher levels of C3, C5-C9, and CFH when compared to PIGN. These studies show that burden of alternative and terminal complement pathway proteins is much higher in C3GN compared to PIGN.

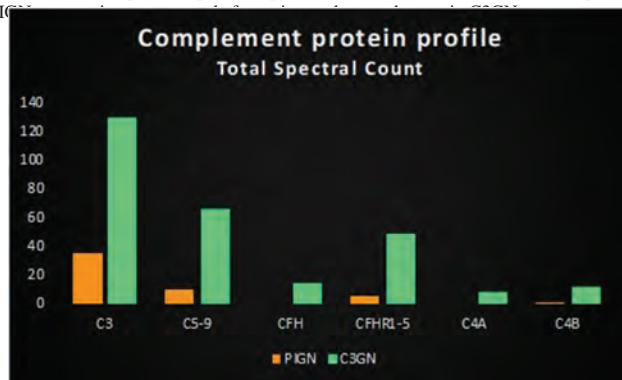

SA-PO631

**Kidney Complement Peptides Are Abundant in Patients With Kidney Disease**

Salem Almaani,<sup>1</sup> John P. Shapiro,<sup>1</sup> Sethu M. Madhavan,<sup>1</sup> Anjali A. Satoskar,<sup>1</sup> Michael Merchant,<sup>2</sup> Jon B. Klein,<sup>2</sup> Brad H. Rovin,<sup>1</sup> Samir V. Parikh,<sup>1</sup> Isabelle Ayoub.<sup>1</sup> <sup>1</sup>*The Ohio State University Wexner Medical Center, Columbus, OH;* <sup>2</sup>*University of Louisville, Louisville, KY.*

**Background:** Activation of the complement system has been observed in many immune and non-immune kidney diseases. Murine models of renal fibrosis demonstrate that targeting the complement system may be useful in slowing renal fibrosis. In previous work using an agnostic proteomics approach, the complement system was one of the top regulated pathways shared by many kidney diseases. In this study, we aimed to further identify patterns of complement involvement in a variety of kidney diseases.

**Methods:** Kidney biopsies from 58 patients across several kidney diseases and 25 controls were used. Glomeruli and tubulointerstitium (TI) were isolated using laser-capture microdissection, processed, and submitted for LC-MS/MS. Peptides were analyzed for spectral count quantitation. Spectral counts of complement pathway components were compared between disease and control samples that were analyzed in the same batch using t tests, a raw p-value<0.05 and |log2 fold change|>0.58 were considered significant.

**Results:** An increase in abundance of common and terminal pathway complement components was noted in the glomeruli and TI across all diseases. An increase in glomerular and TI C2 and C4 abundance was noted in patients with MCD and FSGS, suggestive of classical and/or lectin pathway involvement. A decrease in glomerular complement receptor 1 (CR1), which is typically expressed by podocytes, was universally observed.

**Conclusions:** Proteomic analysis of a heterogeneous population of kidney diseases identified an increase in complement pathway peptide abundance. An increase in terminal complement pathway components was universally observed and has the potential to be



of complement in the fluid phase (i.e. circulation) and/or the renal glomerulus. The latter is comprised of glomerular fenestrae, which are blanketed by extracellular matrix (ECM) and depend on circulating regulators for complement control in this microenvironment. Here we present an *in vitro* model of ECM-specific AP C3 convertase activation and regulation.

**Methods:** A human ECM substitute (MaxGel) was used as a base upon which AP C3 convertase was reconstituted. Convertase activity and regulation was validated using inhibiting (Factor H) and stabilizing (Properdin) regulators of complement activation. Once validated, we used this model to assess the effect of C3 Nephritic factors (C3Nefs) on C3 convertase activity.

**Results:** AP C3 convertase forms and decays on MaxGel in the expected manner; negative and positive regulation by FH and FP, respectively, was also observed. In the presence of IgGs derived from C3G patients positive for C3Nefs, the rate of decay of C3 convertase was significantly decreased when compared to C3 convertase alone, normal human serum IgGs, and IgGs derived from C3G patients negative for C3Nefs.

**Conclusions:** We conclude that this model of the glycomatrix offers a reliable and replicable method of evaluating various drivers of C3G in an environment similar to that of the glycomatrix. Further, we show that patient-specific assessment of C3 convertase activity and regulation is possible, thus offering an improved understanding of the effect of different disease factors on C3G pathogenesis.

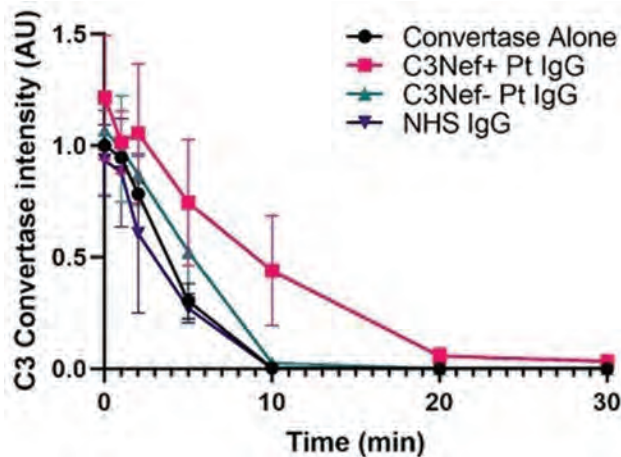

**Figure 1:** C3 convertase decay decreases in presence of IgGs from C3G patients positive for C3Nefs.

#### SA-PO636

##### SYNERGY-1: A Phase 1, First-in-Human, Safety, Tolerability, Immunogenicity, Pharmacokinetics, and Pharmacodynamics Study of KP104 in Escalating Single and Multiple Doses

Paul Wabnitz,<sup>1</sup> Xiang Gao,<sup>2</sup> Jay Ma,<sup>2</sup> Ping Tsui,<sup>2</sup> Martin Rabe,<sup>2</sup> Helen N. Fu,<sup>2</sup> Chaomei He,<sup>2</sup> Jingtao Wu,<sup>2</sup> Brian K. York,<sup>2</sup> Christina Weng,<sup>2,3</sup> Jon Rankin,<sup>4</sup> Frederick C. Beddingfield,<sup>2,5</sup> Wenru Song,<sup>2</sup> Nicholas Farinola,<sup>1</sup> Richard Lee.<sup>2</sup>  
<sup>1</sup>Cancer Research Institute, University of South Australia, Adelaide, SA, Australia; <sup>2</sup>Kira Pharmaceuticals, Cambridge, MA; <sup>3</sup>Massachusetts General Hospital - Harvard Medical School, Boston, MA; <sup>4</sup>Syneos Health Australia, Sydney, NSW, Australia; <sup>5</sup>University of California Los Angeles David Geffen School of Medicine, Los Angeles, CA.

**Background:** Glomerular diseases (GD), such as IgA nephropathy and complement (C) 3 glomerulopathy which have limited or no approved therapies, are known to be mediated by aberrant C activation. KP104 is a bi-functional C inhibitor fusion protein comprised of humanized anti-C5 monoclonal antibody fused with truncated C factor H. KP104 fusion design inhibits C5-mediated membrane attack complex formation and alternative pathway (AP) activation.

**Methods:** This is a first-in-human, randomized, double-blind, placebo-controlled, single center study of KP104 in healthy volunteers. Safety, tolerability, anti-drug antibodies (ADA) development, PK, and PD were assessed in single ascending dose (SAD) and multiple ascending dose (MAD) cohorts. At interim analysis, 48 SAD and 8 MAD have completed study assessments. SAD dose levels were 60-1200 mg; MAD was 600 mg IV QW for 5 total doses.

**Results:** Majority of subjects were Caucasian (81.3% SAD and 62.5% MAD), male (26 SAD and 6 MAD), and mean age was 30.5 and 33.6 years for SAD and MAD, respectively. No deaths, DLTs, or severe TEAEs were reported. SAD (n=38/48, 79.2%) reported 126 TEAEs in all cohorts. No dose related trend was observed. MAD (n=8/8, 100%) reported 24 TEAEs. Majority of TEAEs were Grade 1 and resolved without treatment. In SAD cohorts, 3 PD markers, rRBC (AP + terminal pathway [TP]), C3b (AP), and free C5 (TP) all showed substantial inhibition as dose increased. Maximum rRBC, C3b, and free C5 inhibition reached >85%, >90%, and >99.5% (<0.5 µg/mL) respectively, at ≥360 mg and inhibition duration was extended with higher doses. At 1200 mg, inhibition for all 3 PD markers was ≥99%. In the MAD cohort, the 3 PD markers achieved substantial inhibition during entire dosing period. ADAs were detected in 3 SAD and 4 MAD but did not appear to impact subject safety.

**Conclusions:** KP104 was safe, well tolerated, and showed proof of mechanism with potent TP and AP inhibition in the SYNERGY-1 study. Complete data will be available at ASN 2022. The data supports planned future clinical trials in C-mediated GD. To our knowledge, KP104 is the first bifunctional biologic demonstrating successful inhibition of both AP and TP.

**Funding:** Commercial Support - Kira Pharmaceuticals

#### SA-PO637

##### Analysis of Galnt14 Null Mice Link O-Glycosylation Defects With Elevated IgA Levels via Altered B-Cell Homing

Nicholas J. Steers,<sup>1</sup> Sindhuri Prakash-Polet,<sup>1</sup> Kelsey O. Stevens,<sup>1</sup> Anna Ng,<sup>1</sup> Judy Liang,<sup>1</sup> Jan Novak,<sup>2</sup> Ali G. Gharavi,<sup>1</sup> <sup>1</sup>Columbia University Irving Medical Center, New York, NY; <sup>2</sup>University of Alabama at Birmingham, Birmingham, AL.

**Background:** Defects in O-glycosylation of IgA1 are a characteristic finding in IgA Nephropathy. It is not known if aberrant O-glycosylation can impact other aspects of IgA homeostasis, such as B-cell homing and migration. In humans, up to 20 distinct acetylglucosaminyltransferases (GALNTs) can initiate O-glycosylation of proteins.

**Methods:** We studied *Galnt14* null mice and compared the circulating and mucosal IgA levels and tissue resident IgA+ B-cells in *Galnt14*<sup>-/-</sup> and *Galnt14*<sup>+/+</sup> mice by ELISA and flow cytometry.

**Results:** GALNT14 is expressed in human and murine lymphoid tissue, including the germinal centers of the spleen and lymph nodes, which are the major sites for B-cell maturation, antibody class switching and proliferation. Serum IgA levels were significantly elevated in the *Galnt14*<sup>-/-</sup> mice compared to the *Galnt14*<sup>+/+</sup> mice (1.73 ± 0.95 mg/ml, 0.84 ± 0.35 mg/ml, P-value < 0.001, respectively). Similarly elevated were mucosal IgA levels in the peritoneal cavity (PC), small intestine (SI), and the colon in *Galnt14*<sup>-/-</sup> mice. Flow cytometric analysis of IgA bound to fecal bacteria also demonstrated enhanced binding of IgA to bacteria derived from *Galnt14*<sup>-/-</sup> mice compared to the *Galnt14*<sup>+/+</sup> mice (mean fluorescence intensity 5721 ± 1028, 4006 ± 480, respectively P-value < 0.01). In addition, the percentage of IgA+ B cells in spleen and peritoneal cavity was significantly increased in *Galnt14*<sup>-/-</sup> mice. No differences in the percentage IgA+ B-cells in the SI, Peyer's patches and peripheral blood mononuclear cells were observed between the genotypes, suggesting non-mucosal tissues as the major site of abnormalities in the distribution of IgA-producing cells. Finally, reciprocal adoptive transfer experiments demonstrated that splenic derived B-cells isolated from *Galnt14*<sup>-/-</sup> mice had a reduced ability to home to the spleen, regardless of the recipient genotype.

**Conclusions:** *Galnt14*<sup>-/-</sup> mice have a defect in B-cells to home and potentially remain in mucosal and lymph tissues, partially explaining the increased number of IgA+ cells in the spleen and PC, and elevated IgA in the serum of *Galnt14*<sup>-/-</sup> mice. We are currently exploring the mechanisms of the alterations observed in B-cell recruitment to mucosal and lymphoid tissue in *Galnt14*<sup>-/-</sup> mice.

**Funding:** NIDDK Support

#### SA-PO638

##### LIF/JAK2/STAT1 Signaling Enhances Production of Galactose-Deficient IgA1 by IgA1-Producing Cell Lines Derived From Tonsils of Patients With IgA Nephropathy

Koshi Yamada,<sup>1</sup> Zhi qiang Huang,<sup>2</sup> Colin Reily,<sup>2</sup> Hitoshi Suzuki,<sup>1</sup> Jan Novak,<sup>2</sup> Yusuke Suzuki,<sup>1</sup> <sup>1</sup>Juntendo University Faculty of Medicine, Tokyo, Japan; <sup>2</sup>University of Alabama at Birmingham, Birmingham, AL.

**Background:** Galactose-deficient IgA1 (Gd-IgA1) have a key role in the pathogenesis of IgA nephropathy (IgAN). Tonsillectomy is one of the effective treatments and is prospective to reduce serum levels of Gd-IgA1. Thus, abnormal responses of the tonsil-residing B cells in pro-inflammatory condition may be involved in synthesis of Gd-IgA1. However, the mechanisms of production of Gd-IgA1 in tonsils remain unknown. In this study, we used IgA1-producing cell lines derived from tonsils of patients with IgAN and assessed the effects of cytokines, Leukemia inhibitory factor (LIF) and Oncostatin M (OSM), encoded in the Chr.22q12 IgAN-risk locus, on cellular signaling and production of Gd-IgA1.

**Methods:** IgA1-producing cell lines were derived from palatine tonsils of patients with IgAN and patients with chronic tonsillitis (CT) after EBV immortalization. Tonsillar-tissue sections were stained with antibodies specific for components of JAK-STAT pathway. Gd-IgA1 production was measured by lectin ELISA, JAK-STAT signaling in cultured cells was assessed by immunoblotting of cell lysates and validated by using siRNA gene-specific knock-down and small-molecule inhibitors.

**Results:** Staining for JAK2 was observed in the crypt epithelium and germinal center (GC) of palatine tonsils from both IgAN and CT groups. Staining for phospho-STAT1 was enhanced in GC regions of palatine tonsils from IgAN patients compared to CT groups. IgA1-producing cells derived from tonsils of patients with IgAN, compared to those of CT, exhibited enhanced STAT1 phosphorylation and elevated Gd-IgA1 production in response to LIF, but not OSM. JAK2 inhibitor and STAT1 siRNA knock-down blocked these LIF-induced effects.

**Conclusions:** In summary, palatine-tonsil-derived IgA1-producing cells exhibit dysregulation of LIF-mediated signaling resulted in Gd-IgA1 overproduction. These findings indicate that LIF-mediated abnormal mucosal immune responses may be involved in the overproduction of the main autoantigen in IgAN, Gd-IgA1.

**Funding:** NIDDK Support, Government Support - Non-U.S.

## SA-PO639

**IgA+ Plasma Cells Accumulation in Kidneys of IgA Nephropathy Model Mice and Patients**

Yoshihito Nihei, Maiko Nakayama, Yusuke Fukao, Hitoshi Suzuki, Yusuke Suzuki. *Juntendo University, Tokyo, Japan.*

**Background:** Previous studies have suggested that nephritogenic IgA are mainly produced in the bone marrow in IgA nephropathy (IgAN), whereas plasma cells (PCs) are often found in the affected kidneys in autoimmune diseases like systemic lupus erythematosus. In the present study, we evaluated the leukocytes in the kidney of IgA nephropathy model mice (gddY mice) and patients and investigated whether PCs infiltrate in the inflamed kidney.

**Methods:** GddY mice were generated through selectively mating individuals within an early-disease onset group of ddY mice for more than 20 generations. All individual gddY mice exhibit proteinuria and glomerular IgA deposition by 8 weeks of age, followed by obvious renal failure and the pathology being similar to human IgAN. Isolated leukocytes from murine kidney were analysed by flow cytometry. To check whether PCs are present in the patient's kidneys, the kidney biopsy specimens from patients with IgAN were stained with anti-human IgA and CD138 antibodies. To investigate whether the IgA+ PCs in the kidney of gddY mice are generated in T cell-dependent or independent manner, we sequenced the variable region of IgA heavy and light chains from single IgA+ PCs isolated from the kidney of gddY mice.

**Results:** We found that a significant number of IgA+ PCs accumulated in the kidneys of gddY mice. The IgA+ PCs emerge by 8 weeks of age and further increased with age in gddY mice. Immunohistochemical staining of kidney biopsy samples from IgAN patients revealed the presence of IgA+ PCs cells in the tubulointerstitial region of the kidney. Most of the heavy- and light-chain V region genes from IgA+ PCs in the kidney of gddY mice contained significant numbers of somatic mutations that replaced amino-acids, indicating that these PCs were generated in a T-cell-dependent manner through the germinal center.

**Conclusions:** We found that IgA+ PCs accumulate in the kidneys of gddY mice and IgAN patients and these IgA+ PCs are generated in T-cell-dependent manner. We will clarify the role of these IgA+ PCs in the pathogenesis of IgAN.

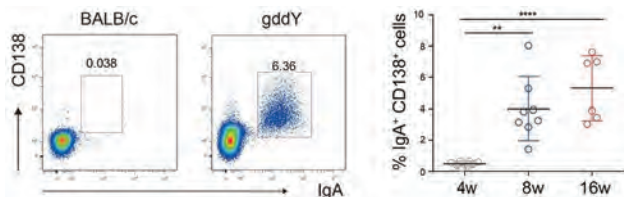

## SA-PO640

**T-Cell Receptor Repertoire Analysis in Tonsillar Tissues of Patients With IgA Nephropathy**

Kazunori Satokata, Shin Goto, Hiroki Yamaguchi, Hirofumi Watanabe, Suguru Yamamoto, Yoshikatsu Kaneko, Ichiei Narita. *Division of Clinical Nephrology and Rheumatology, Kidney Research Center, Niigata University Graduate School of Medical and Dental Sciences, Niigata, Japan.*

**Background:** Immunoglobulin A nephropathy (IgAN) is the most prevalent primary chronic glomerulonephritis. The aberrant mucosal immune response is considered to be related to the IgAN pathogenesis. However, evidence for the involvement of T-cells in mucosal immunity of IgAN is limited, and we conducted a comprehensive analysis of T-cell receptor repertoire in the tonsillar tissues in patients with IgAN.

**Methods:** 28 patients with biopsy-proven IgAN and 20 patients with recurrent tonsillitis (RT) who had undergone tonsillectomy were included in the study. After total RNA was extracted from each dissected tonsillar crypt, unbiased adaptor-ligation-PCR was carried out as library preparation. Then T cell receptor (TCR) sequencing was performed by the next-generation sequencer. We examined the usages of variable and joining regions and analyzed diversity and similarity in TCR $\alpha$  (TRA) and  $\beta$  (TRB) genes at the tonsillar crypts using bioinformatics software.

**Results:** TCR sequencing obtained an average of 74,761 in-frame reads in TRA gene and 57,163 in TRB gene per sample. Diversity indexes of repertoire in both TRA and TRB were not different between patients with IgAN and RT. Similarity indexes of TRA repertoire, but not TRB, were significantly lower in IgAN than in RT patients ( $p < 0.01$ ), and the sharing of TRA clonotypes by more than two individuals was significantly lower in IgAN patients ( $p < 0.05$ ). In shared TRA sequences, TRAV1-2 and TRAJ33, which belong to invariant TCRs, were significantly shared by RT patients ( $p < 0.01$ ). On the other hand, the relative abundance of shared TRA repertoires in IgAN patients was higher than in RT and significantly increased in shorter CDR3 lengths ( $p < 0.05$ ). TRAV41 was significantly abundant in shorter CDR3 lengths of IgAN patients.

**Conclusions:** Our data suggests that dynamic changes in the T-cell subset are involved in abnormal mucosal immune responses in the tonsils of patients with IgAN.

## SA-PO641

**Biologically Active Circulatory Immune Complexes in IgA Nephropathy Contain Polymeric IgA1, With Galactose-Deficient and Minimally Sialylated O-Glycans, IgG, and Complement C3b and iC3b**

Stacy D. Hall,<sup>1</sup> Sarah Coffee,<sup>1</sup> Zhi qiang Huang,<sup>1</sup> Nicolas Maillard,<sup>1,2</sup> Zina Moldoveanu,<sup>1</sup> Audra A. Hargett,<sup>1</sup> Dana Rizk,<sup>1</sup> Bruce A. Julian,<sup>1</sup> Matthew B. Renfrow,<sup>1</sup> Jan Novak.<sup>1</sup> <sup>1</sup>The University of Alabama at Birmingham, Birmingham, AL; <sup>2</sup>Hospital and University Jean Monnet of Saint-Etienne, Saint-Etienne, France.

**Background:** IgA nephropathy (IgAN) is an autoimmune disease wherein pathogenic immune complexes (IC) are thought to form in the circulation from IgA1 with some hinge-region O-glycans deficient in galactose (galactose-deficient IgA1; Gd-IgA1) bound by IgG autoantibodies. Some of these IC deposit in the glomeruli to induce kidney injury. The glomerular immunodeposits are enriched for Gd-IgA1 and the corresponding IgG autoantibodies. However, the composition of the circulating IC in IgAN is not fully understood.

**Methods:** We isolated different molecular forms of IgA1 from sera of 20 patients with IgAN by lectin-affinity and size-exclusion chromatography (SEC). Isolated monomeric IgA1 (mIgA1), polymeric IgA1 (pIgA1), and IgA1 bound in IC (IgA1-IC) were analyzed for their degree of galactose deficiency by a lectin ELISA performed without and with neuraminidase treatment to remove sialic acid. For assessment of biological activity, IgA1-IC were isolated by SEC directly from serum and tested for proliferation-stimulating and signaling-inducing activities in cultured primary human mesangial cells. SDS-PAGE immunoblotting was used for detection of IgA, IgG, complement C3, and phosphorylated (P-) and total ERK1/2, and P- and total Akt.

**Results:** Molecular forms of serum IgA1 included mIgA1 (~90%), pIgA1 (~9%) and IgA1-IC (<0.4%). Relative degree of galactose deficiency of the IgA1 was highest in IgA1-IC, less in pIgA1, and least in mIgA1. IgA1 in IC had minimally sialylated O-glycans. IgA1-IC isolated by SEC from sera of IgAN patients had molecular mass >700 kDa. These circulatory IC induced signaling (e.g., P-ERK1/2, P-Akt) and cellular proliferation of the mesangial cells. These biologically active IgA1-IC contained pIgA1, IgG, and complement C3b and iC3b.

**Conclusions:** Biologically active circulatory immune complexes in patients with IgAN had molecular mass >700 kDa and contained polymeric Gd-IgA1 with a high degree of galactose deficiency and minimal sialylation, IgG, C3b, and iC3b. Collectively, these findings support the pathogenic role of IgA1-containing immune complexes in IgAN.

**Funding:** NIDDK Support

## SA-PO642

**Inhibition of Platelet-Derived Growth Factor-Induced Signaling and Filopodia Formation in Cultured Human Mesangial Cells by Sheng Ping, a Chinese Herbal Medicine**

Zhi qiang Huang,<sup>1</sup> Lea Novak,<sup>1</sup> Xianwen Zhang,<sup>2</sup> Stacy D. Hall,<sup>1</sup> Lin Wang,<sup>2</sup> Yiping Chen,<sup>2</sup> Bruce A. Julian,<sup>1</sup> Jan Novak.<sup>1</sup> <sup>1</sup>The University of Alabama at Birmingham, Birmingham, AL; <sup>2</sup>Long Hua Hospital, Shanghai, China.

**Background:** Proliferation of mesangial cells is commonly observed in kidney-biopsy specimens of patients with IgA nephropathy (IgAN). This process is thought to involve several factors, such as platelet-derived growth factor (PDGF) with its corresponding receptors and downstream protein kinases, including a focal-adhesion kinase (FAK) involved in the control of cell migration. Histologically, PDGF induces formation of filopodia, slender cytoplasmic projections, in cultured mesangial cells. Here we assessed the effects of Sheng Ping, a traditional Chinese herbal medicine, on PDGF-induced signaling and filopodia formation in cultured primary human mesangial cells.

**Methods:** Quiescent primary human mesangial cells were activated with PDGF (10 ng/ml) for 15 min at 37°C. Sheng Ping, an inhibitor of FAK (PF 573288), or medium only were added to mesangial cells prior to PDGF addition. Negative control consisted of mesangial cells with medium only. After the incubation with PDGF, cells were washed, and cell lysates were analyzed by SDS-PAGE immunoblotting using antibodies specific for protein kinases and their phosphorylated variants. For imaging analyses, mesangial cells were cultured on 4-chamber glass slides and treated as described above. Then, the cells were washed, fixed, permeabilized, and stained with TRITC-phalloidin (specific for fibrillar actin) and a nuclear stain. To assess formation of filopodia, the stained cells were examined by a fluorescence microscope using 60x objective.

**Results:** Sheng Ping inhibited PDGF-induced formation of filopodia in the cultured mesangial cells, phosphorylation of FAK, extracellular signal-regulated kinase 1/2 (ERK1/2), and a serine/threonine kinase 1 (AKT1). PF 573288, a positive control for FAK inhibition, inhibited filopodia formation as well as phosphorylation of FAK, ERK1/2, and AKT1.

**Conclusions:** Sheng Ping, Chinese herbal medicine, blocked PDGF-induced formation of filopodia and phosphorylation of several proteins in cultured human mesangial cells. The clinical benefit of Sheng Ping for treatment of patients with IgA nephropathy may, in part, be based on its effect to inhibit the signaling pathways in mesangial cells activated by PDGF.

**Funding:** NIDDK Support

## SA-PO643

**Serum IgA1-IgG-Containing Immune Complexes From Patients With IgA Nephropathy Activate Cultured Human Mesangial Cells and Associate With Cellular Integrin  $\beta$ 1**

Zhi qiang Huang,<sup>1</sup> Xianwen Zhang,<sup>2</sup> Stacy D. Hall,<sup>1</sup> Lin Wang,<sup>2</sup> Yiping Chen,<sup>2</sup> Dana Rizk,<sup>1</sup> Bruce A. Julian,<sup>1</sup> Jan Novak.<sup>1</sup> <sup>1</sup>University of Alabama at Birmingham, Birmingham, AL; <sup>2</sup>Long Hua Hospital, Shanghai, China.

**Background:** Circulatory IgA1-IgG-containing immune complexes of patients with IgA nephropathy (IgAN) induce cellular proliferation of cultured human mesangial cells. This process involves activation of multiple protein-tyrosine kinases. However, whether IgA1-IgG immune complexes associate with mesangial cells and any role of integrin  $\beta$ 1 in this process are not known.

**Methods:** IgA1-IgG immune complexes were isolated from sera of patients with IgAN by size-exclusion chromatography and added to quiescent human primary mesangial cells in culture. After 15 min incubation at 37°C, with or without different inhibitors, the cells were washed and lysed. Cell lysates or immunoprecipitated products were analyzed by SDS-PAGE immunoblotting. Inhibitors of integrin  $\alpha$ 1 $\beta$ 1 (obustatin) and  $\alpha$ 5 $\beta$ 1 (Arg-Gly-Asp peptide; RGD), and protein-tyrosine kinases (dasatinib) and Sheng Ping (a herbal medicine for treatment of patients with IgAN in China), were tested for their inhibitory effects. Antibodies specific for integrin  $\alpha$ 1 $\beta$ 1, integrin  $\alpha$ 5 $\beta$ 1, or platelet-derived growth factor receptor  $\beta$  (PDGFR- $\beta$ ) were used for immunoprecipitation. Antibodies specific for IgA, IgG, different subtypes of integrins and their associated proteins, several protein-tyrosine kinases and their phosphorylated variants were used for immunoblotting.

**Results:** The mesangial cell lysates contained IgG and IgA, indicating that IgA1-IgG immune complexes associated with the cells, either bound at the surface or within the cells. Immunoprecipitation indicated that the IgA/IgG were associated with integrin  $\alpha$ 1 $\beta$ 1 and  $\alpha$ 5 $\beta$ 1. The complexes induced phosphorylation of ERK1/2, AXL, PDGFR- $\beta$ , and integrin  $\beta$ 1. Analysis of immunoprecipitated products indicated association of integrin  $\beta$ 1 with PDGFR- $\beta$ . Obustatin, RGD, dasatinib, and Sheng Ping inhibited phosphorylation of integrin  $\beta$ 1, PDGFR- $\beta$ , and ERK1/2; all inhibitors except RGD also inhibited phosphorylation of AXL.

**Conclusions:** Thus, IgA1-IgG immune complexes associated with mesangial cells and this process was, at least in part, mediated by integrin  $\alpha$ 1 $\beta$ 1 and  $\alpha$ 5 $\beta$ 1 and involved activation of multiple signaling pathways. A better understanding of the pathways activated by IgA1-IgG immune complexes may provide new therapeutic approaches for IgAN.

**Funding:** NIDDK Support

## SA-PO644

**High-Resolution Imaging Approaches to Assess Colocalization of Immunoglobulin-Component Chains in Glomerular Immunodeposits in IgA Nephropathy**

Lea Novak,<sup>1</sup> Stacy D. Hall,<sup>1</sup> Dana Rizk,<sup>1</sup> Zina Moldoveanu,<sup>1</sup> Bruce A. Julian,<sup>1</sup> Mark Haas,<sup>2</sup> Jan Novak.<sup>1</sup> <sup>1</sup>University of Alabama at Birmingham, Birmingham, AL; <sup>2</sup>Cedars-Sinai Medical Center, Los Angeles, CA.

**Background:** Routine immunofluorescence microscopy of glomerular immunodeposits in IgA nephropathy (IgAN) reveals IgA with variable amounts of IgG and/or IgM and usually complement C3. We have developed a new high-resolution confocal-microscopy approach to detect immunoglobulins in biopsy specimens. In earlier studies, we found IgG in all IgAN kidney biopsies, including those IgG-negative by routine immunofluorescence microscopy. This improved visualization of immunoglobulins enables studies of colocalization of their component light chains. Here, we evaluated our imaging approach for assessment of colocalization of IgG with kappa and lambda light chains in IgAN kidney biopsies.

**Methods:** Frozen-tissue sections (4  $\mu$ m) of remnant kidney biopsies from 20 IgAN patients (3 IgG-positive and 17 IgG-negative by routine immunofluorescence) were fixed, blocked, and stained sequentially with IgG-Fc nanobody, mouse monoclonal antibody (mAb) specific for human kappa light chain, mouse mAb specific for human lambda light chain, and a nuclear stain. Using a high-resolution confocal microscope (Nikon A1R/SIM), z-stack images were acquired (objective 60x). For each slide, 60 regions of interest were selected in areas with IgG staining. Using Advanced NIS analysis software, Pearson's correlation coefficient (PCC) and Mander's overlap coefficient (MOC) colocalization data were collected for each slide.

**Results:** IgG was detected in all 20 biopsies. Single-optical-plane images showed colocalization of IgG with kappa and lambda light chains; this finding was confirmed by line-intensity profiles. IgG was not colocalized with only one type of light chain. Colocalization for IgG with kappa or with lambda light chain exhibited variability by PCC and MOC analyses but colocalization for IgG with kappa versus IgG with lambda light chain did not significantly differ.

**Conclusions:** High-resolution confocal microscopy and the use of sensitive immunofluorescence staining are suitable for study of glomerular immunodeposits in IgAN. Colocalization of IgG with kappa and lambda light chains in all IgAN kidney biopsies is consistent with polyclonal origin of these pathogenic IgG autoantibodies.

**Funding:** NIDDK Support

## SA-PO645

**Cell-Surface Glycoprofiling of IgA1-Secreting Cells From Patients With IgA Nephropathy Reveals Subpopulations With Differential Cytokine Responses and Capacity to Produce Galactose-Deficient IgA1**

Colin Reilly,<sup>1</sup> Shigeaki Nakazawa,<sup>2</sup> Bruce A. Julian,<sup>1</sup> Jan Novak.<sup>1</sup> <sup>1</sup>The University of Alabama at Birmingham College of Arts and Sciences, Birmingham, AL; <sup>2</sup>Osaka Daigaku Daigakuin Igakukai Kenkyuka Igakubu Igaku Senko, Suita, Japan.

**Background:** Galactose-deficient IgA1 (Gd-IgA1) is the main autoantigen in IgA nephropathy (IgAN) and its elevated circulatory levels predict poor kidney outcome. As Gd-IgA1 constitutes a small fraction of total circulatory IgA1, we hypothesize that only a few IgA1-secreting cells may be involved. Moreover, cytokine stimulation can increase Gd-IgA1 production in cultured IgA1-producing cells from IgAN patients. We report here that cell-surface glycoprofiling of immortalized IgA1<sup>+</sup> cells with a GalNAc-Gal-specific lectin (peanut agglutinin, PNA) can identify subsets of cells with differential signaling and O-glycosylation of IgA1.

**Methods:** Immortalized IgA1-producing cells derived from peripheral blood mononuclear cells of healthy controls (HC) and IgAN patients were stimulated with mixture of cytokines (IL-4, IL-6, IL-21, CD40L) for 20 min, followed by cell-surface staining with PNA and IgA-specific antibody and FACS. Non-stimulated cells served as negative controls. The live-sorted cells with distinct PNA binding (low- and high-PNA-binding cells) were cultured and assessed for baseline and cytokine-mediated signaling and Gd-IgA1 production. Gd-IgA1 was determined by lectin ELISA, phosphoproteins by intracellular staining with antibodies and FACS.

**Results:** For both HC- and IgAN-derived IgA1<sup>+</sup> cells without cytokine stimulation (i.e., baseline), high-PNA-binding cells exhibited more phosphorylated (P) ERK1/2, less P-65-NF-kB, and less P-STAT1 compared to low-PNA-binding cells (p<0.01, p=0.02, p<0.01, respectively). Moreover, there was less P-65-NF-kB in HC- vs. IgAN-derived cells, but only for the low-PNA-binding cells (p=0.01). For both HC- and IgAN-derived IgA1<sup>+</sup> cells with cytokine stimulation, P-ERK1/2 was increased in PNA-high cells (p<0.01) and P-65-NF-kB was increased in PNA-low cells (p=0.01). In a pilot experiment, the high-PNA-binding cells from an IgAN patient produced more Gd-IgA1 compared to low-PNA-binding cells.

**Conclusions:** Glycoprofiling of IgA1<sup>+</sup> cells with PNA lectin revealed cells with differential cell-surface glycosylation. These distinct cell types differed in baseline and cytokine-induced cell signaling and Gd-IgA1 production.

**Funding:** NIDDK Support

## SA-PO646

**Experimental Investigation of Exacerbation of IgA Nephropathy by Exposure to Fine Particulate Matter**

Yohan Park, Se-Hee Yoon, Sung-Ro Yun, Won Min Hwang. *Konyang University Hospital, Daejeon, Republic of Korea.*

**Background:** It is known that exposure to fine particulate matter, which has recently been highlighted as an environmental problem, occurs mainly through the respiratory tract, which increases various inflammatory reactions. This increase in mucosal inflammation is thought to cause aggravation of IgA nephropathy, but no studies have been reported on the relationship between IgA nephropathy and fine particulate matter so far.

**Methods:** The HIGA (high serum IgA) mouse model was used as a spontaneous IgA nephropathy animal model. Using a sealed fine particulate matter exposure cage system, the exposure group was exposed to fine particulate matter for 1 hour at a time, 3 times a week, for a total of 8 weeks. After 8 weeks of exposure to fine particulate matter, blood, urine, lung, and kidney tissues were obtained and analyzed.

**Results:** There was no significant difference in the total IgA concentration in the blood of the exposure group and the control group. However, in the lectin binding assay (Ricinus communis agglutinin I, Sambucus nigra agglutinin), the concentration of glycosylated IgA tended to be higher in the control group. In the lung tissue of the exposure group, interstitial thickening was evident and toll like receptor (TLR)-9 expression was significantly increased. In the kidney tissue of the exposure group, mesangial proliferation and mesangial expansion were increased, and the number of glomerular scleroses were higher in the exposure group compared to the control group. Mesangial IgA deposition in the exposure group was significantly increased compared to the control group in immunofluorescence assay.

**Conclusions:** It was observed that fine particulate matter increased TLR-9 expression in lung tissue, which increased hypoglycosylated IgA, resulting in renal glomerular damage and increased mesangial IgA deposition in HIGA mouse model. This suggests that chronic exposure to high concentrations of fine particulate matter in IgA nephropathy may exacerbate the disease severity.

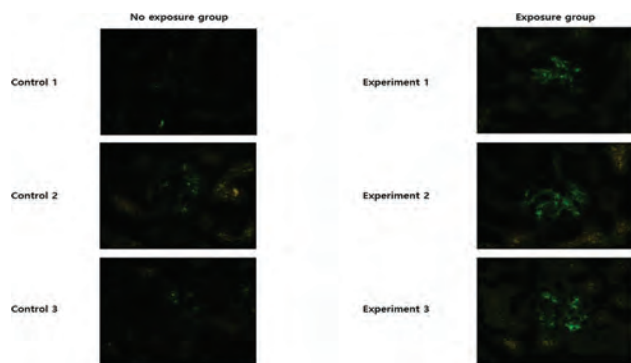

## SA-PO647

### An Epigenetically Driven Mechanism Triggered by Viral and Bacterial RNA Regulates the IL-6 Levels in IgA Nephropathy

Fabio Sallustio, Claudia Curci, Maria Teresa Cimmarusti, Angela Picerno, Alessandra Stasi, Francesco Pesce, Vincenzo Di Iorio, Loreto Gesualdo. Loreto Gesualdo's research Group *Università degli Studi di Bari Aldo Moro, Bari, Italy*.

**Background:** Recently, the role of IL-6 in IgAN pathogenesis is becoming increasingly important. A possible hypothesis emerges from our recent work on genome-wide DNA methylation screening in patients with IgAN, which identified, among other findings, a hypermethylated region comprising Vault 2-1 RNA (VTRNA2-1), a non-RNA coding also known as a precursor of miR-886 (pre-mi-RNA). Consistently, VTRNA2-1 expression was found downregulated in IgAN patients.

**Methods:** Total RNA were isolated from PBMCs of IgAN patients, transplanted IgAN patients (TP-IgAN), non-IgAN transplanted patients (TP) and healthy subjects (HS). VTRNA2-1, CREB, PKR and IL-6 were evaluated by RT-PCR and by ELISA. Poly (I:C) and Pfizer-BioNTech COVID-19 COMIRNATY vaccine were used to transfect patient PBMCs. PKR inhibitor imoxin (C16) 1  $\mu$ M was used to stimulate patient PBMCs.

**Results:** Here we confirm that VTRNA2-1 is low expressed in IgAN subjects compared to HS and we found that also in TP-IgAN, compared to TP, the VTRNA2-1 transcript was expressed at level very low. We found that in IgAN patients with downregulated VTRNA2-1, PKR is overactivated, coherently with the role of the VTRNA2-1 that binds to PKR and inhibits its phosphorylation. The loss of the VTRNA2-1 natural restraint caused the activation of CREB by PKR, a classical cAMP-inducible CRE-binding factor interacting with a region of the IL-6 promoter and leading to IL-6 production. We found higher CREB phosphorylation levels and IL-6 levels both in IgAN and in TP-IgAN patients. Since PKR is normally activated by bacterial and viral RNA, we hypothesized that these microorganisms can further activate the PKR/CREB/IL-6 pathway leading to an excess of IL-6 production, explaining both the high levels of IL-6, both infection involvement in the disease, both cases of IgAN associated with COVID-19 infection and with COVID-19 RNA-vaccination. Both the RNA poly(I:C) and the COVID-19 RNA-vaccine stimulation significantly increase the IL-6 levels in IgAN patient PBMCs.

**Conclusions:** In conclusion, the discovery of the upregulated VTRNA2-1/PKR/CREB/IL-6 pathway in IgAN patients may provide a new pathogenic mechanism in IgAN and may be useful for the development of novel therapeutic approaches, likely by modulating the VTRNA2-1 methylation level in IgAN patients.

**Funding:** Government Support - Non-U.S.

## SA-PO648

### CARD9 Risk Locus for IgA Nephropathy Plays a Dichotomous Role Between Systemic and Mucosal Immunity Mediated by Retinoic Acid

James Gleeson, Eleftheria Theodora Metallinou, Dina Rafah, Harry Sokol, Renato C. Monteiro. *INSERM, Paris, France*.

**Background:** Caspase recruitment domain family member 9 (CARD9) has been identified as a susceptibility gene for IgA nephropathy (IgAN) by genome wide association studies. CARD9 is an adaptor protein involved in innate immune response and intestinal immune homeostasis. We aimed to study CARD9 in the mucosal immune compartment and examine its role in a mouse model of IgAN.

**Methods:** Serum and intestinal immunoglobulins of *wt* and *CARD9*<sup>-/-</sup> mice were measured. Humanised a1KI-CARD9<sup>-/-</sup> mice and a1KI-CD89tg-CARD9<sup>-/-</sup> mice were generated as models of IgAN. Mesenteric lymph nodes (MLNs) and splenocytes were isolated and cultured *ex vivo*. Bone marrow derived dendritic cells (BMDCs) were exposed to 2 $\mu$ M retinoic acid (RA) to induce a mucosal phenotype. Cholera Toxin subunit B (CTB) was administered by oral gavage for mucosal immunization or subcutaneously for systemic immunisation.

**Results:** Compared to *wt* mice, *CARD9*<sup>-/-</sup> mice had higher intestinal IgA and lower serum IgA. RA increased BMDC expression of CARD9. The effect of CARD9 KO on BMDC cytokine response was inverted by RA exposure such that in the absence of RA, CARD9 KO reduced cytokine production but, in the presence of RA CARD9 KO increased cytokine production, resulting in a significant interaction between RA and *CARD9* for IL-10 (p<0.0001), IL-21 (p=0.01) and BAFF (p<0.0001). KO of CARD9 in

a1KI mice caused decreased IgA1 secretion by splenocytes (p<0.05), but increased MLN IgA1 secretion (p<0.01). After mucosal immunization with CTB, CARD9 KO enhanced IgA adaptive response (p<0.0001) and weakened IgG adaptive response (<0.01) while after systemic immunisation no effect of CARD9 was seen. In a spontaneous mouse model of IgAN (a1KI-CD89tg) CARD9 KO mice had more severe glomerulonephritis than controls with greater IgA1 mesangial deposition (p<0.05), proteinuria (p<0.001) and higher serum cystatin C (p=ns). Vitamin A (RA) free diet reversed the effect of CARD9 KO on IgAN phenotype.

**Conclusions:** Loss of CARD9 function aggravates IgAN phenotype in a mouse model through increased activity of the mucosal IgA response. The effect of CARD9 in the mucosal compartment is mediated by retinoic acid from dietary vitamin A. These results support a role of mucosal CARD9 dysregulation in the immuno-pathogenesis of IgAN.

## SA-PO649

### Intestinal Dysbiosis of Mucin-Degrading Bacteria Causes IgA Nephropathy

James Gleeson, Jonathan M. Chemouny, Nicolas Benech, Eleftheria Theodora Metallinou, Aurelie Sannier, Eric Dugas, Francois Vrtovsnik, Harry Sokol, Renato C. Monteiro. *INSERM, Paris, France*.

**Background:** IgA nephropathy (IgAN) is characterized by glomerular deposition of deglycosylated IgA1 (dg-IgA1) bound by autoreactive antibodies. Genome wide association studies and clinical observations implicate the mucosal immune system in disease pathogenesis. We sought to investigate host-microbiota interactions in IgAN.

**Methods:** Faecal samples from IgAN patients (IgAN, n=33), healthy controls (HC, n=65) and disease controls with other causes of CKD (CKD, n=20) were analysed by 16S rRNA DNA sequencing. CaCo-2 cells were used *in vitro* while C57BL/6J and humanized a1KI-CD89tg mice were used for *in vivo* experiments. Immunofluorescence microscopy quantified IgA and C3 deposition, RT-PCR quantified gene expression, ELISA quantified proteins. IgA1 glycosylation was measured by HAA lectin, dg-IgA1 specific antibody (KM55, IBL) and mass spectrometry.

**Results:** Compared to HC and CKD, the intestinal microbiota of IgAN had altered b-diversity (p=0.001, p=0.02) and increased abundance of *Akkermansia muciniphila* (p=0.001, p=0.03). *A. muciniphila* (AKK) consistently deglycosylated human IgA1 (p=0.0007); dg-IgA1 passed retrogradely from the luminal to systemic side of mucosal tissue both *in vitro* and *in vivo*. Glomerular deposits of IgA1 were found in AKK, but not *E. coli*, colonised *wt* mice after oral gavage with exogenous IgA1 (p<0.001). Colonization of a1KI-CD89tg mice with AKK induced an aggravated IgAN phenotype whereas colonisation with *E. coli* did not (p=0.001). Faecal levels of a-Defensin 6 correlated negatively with faecal AKK (p=0.02). *In vitro* growth assays and electron microscopy showed inhibition of AKK by a-Defensin 6. IgG colocalized with IgA in glomerular deposits of AKK, but not *E. coli*, colonized a1KI-CD89tg mice. Affinity of serum IgG from IgAN patients was much greater for human IgA1 incubated with AKK than for controls.

**Conclusions:** IgA1 is deglycosylated in the intestinal lumen by mucin-degrading bacteria, such as AKK, before passing by retro-transcytosis to the systemic circulation, where it is bound by autoreactive antibodies, and depositing in the mesangium. We provide mechanistic evidence for the causal role of an intestinal dysbiosis in the pathogenesis of autoimmune glomerulonephritis.

## SA-PO650

### Metabolomics Reveals Serum mTOR Signaling Activation in IgA Nephropathy Patients

Hyung Woo Kim,<sup>1</sup> Tae-Joon Park,<sup>2</sup> Jinhwa Kong,<sup>2</sup> Boyoung Nam,<sup>1</sup> Seung Hyeok Han,<sup>1</sup> Tae-Hyun Yoo,<sup>1</sup> Shin-Wook Kang,<sup>1</sup> Bong-Jo Kim,<sup>2</sup> Heun-Sik Lee,<sup>2</sup> Jung Tak Park.<sup>1</sup> <sup>1</sup>Department of Internal Medicine, College of Medicine, Institute of Kidney Disease Research, Yonsei University, Seoul, Republic of Korea; <sup>2</sup>Division of Genome Science, Department of Precision Medicine, National Institute of Health, Cheongju, Republic of Korea.

**Background:** Circulating metabolites are known to play key roles in the pathophysiology of several diseases. In Immunoglobulin A nephropathy (IgAN), the role of systemic milieu as a risk factor for progression has been reported. However, the serum metabolic profile of IgAN and its role in disease progression is not well known.

**Methods:** Twenty-five patients with IgAN and five controls without IgAN were included in this study. The capillary electrophoresis and time-of-flight mass spectrometry-based metabolomics quantification was applied for the serum metabolic profile. The concentration of each metabolite was log-transformed and scaled. To determine metabolomic differences between IgAN and controls, a principle components analysis (PCA), hierarchical cluster analysis (HCA), and univariate Welch's t-test was performed. Metabolite pathway analysis was performed to find significant disease-pathway associations. Pathway sets were obtained from the Kyoto Encyclopedia of Genes and Genomes and the Ingenuity Pathway Analysis (IPA) database.

**Results:** The mean age of the patients with IgAN was 39.4 years, and 44% were female. The mean eGFR was 89.7  $\pm$  27.6 ml/min per 1.73 m<sup>2</sup> and the median urine protein-to-creatinine ratio was 1.5 [0.9 to 2.8] g/g. The mean age of controls was 55.6 years, and 80% were female. The mean eGFR was 84.7  $\pm$  11.4 ml/min per 1.73 m<sup>2</sup>. A total 56 serum metabolites were assessed. PCA and HCA revealed significant metabolic pathway differences between IgAN and controls. Welch's t-test showed that 16 metabolites (3 and 13 metabolites in the anion and cation, respectively) concentrations were significantly higher in IgAN patients after multiple test correction. Pathway enrichment analysis showed that four pathways were associated with these 16 metabolites: Valine, leucine and isoleucine degradation, aminoacyl-tRNA biosynthesis, glyoxylate and dicarboxylate

Key: TH - Thursday; FR - Friday; SA - Saturday; OR - Oral; PO - Poster; PUB - Publication Only

Underline represents presenting author.



metabolism, and alanine, aspartate and glutamate metabolism. In addition, IPA database revealed mTOR signaling pathway to be related with the 4 metabolites among 16 metabolites.

**Conclusions:** In this metabolomics analysis, 16 metabolites were noticed as those that significantly identify IgAN. The mTOR signaling pathway activation through these metabolites may play a role in IgAN pathophysiology.

**Funding:** Government Support - Non-U.S.

#### SA-PO651

**Genome-Wide Methylation in Patients With Primary IgA Nephropathy**  
Qiuxia Wang, Wei Wang. *Sichuan Academy of Medical Sciences and Sichuan People's Hospital, Chengdu, China.*

**Background:** Methylation gene chip was used to study the pathogenesis of DNA methylation in IgAN.

**Methods:** NimbleGen 3x720K methylation gene chip was used to screen differentially methylation genes (DMGs) in patients with IgA nephropathy and healthy subjects combining with functional enrichment analysis. The mRNA expression of DMGs in peripheral blood lymphocytes was screened by RT-qPCR; the methylation level of DMGs was verified by pyrophosphate sequencing; the relationship between the methylation level of DMGs and mRNA expression level and clinical characteristics were analyzed.

**Results:** 1. 2062 differentially methylation sites and 1839 differentially methylation genes were detected by methylation gene chip. 2. Four differentially methylation genes *CLEC10A*, *ACCS*, *CFHR1* and *TNFRSF17* were screened by functional enrichment analysis. 3. RT-qPCR showed that, in peripheral blood lymphocytes of IgAN group, the mRNA expression level of *TNFRSF17* was higher than that of control group ( $P=0.03$ ). 4. Combined with the clinical data, in peripheral blood lymphocytes of patients with IgAN, the mRNA expression level of *CLEC10A* was negatively correlated with hemoglobin ( $P=0.02$ ,  $r=-0.33$ ); the mRNA expression level of *TNFRSF17* was negatively correlated with high density lipoprotein ( $P=0.04$ ,  $r=-0.33$ ); the mRNA expression level of *CFHR1* was negatively correlated with eGFR level ( $P=0.03$ ,  $r=-0.31$ ) and positively correlated with the level of serum creatinine ( $P=0.06$ ,  $r=0.27$ ). 5. According to the analysis of pathological data, the mRNA expression level of *CLEC10A* in E1 group was higher than that in E0 group, and that in S1 group was higher than that in S0 group ( $P < 0.05$ ). Compared with M0, E0 and C0, the mRNA expression level of *TNFRSF17* increased in M1, E1 and C1-2 groups, but the difference was not statistically significant. 6. In IgAN group, the methylation level of *TNFRSF17* CpG1 site was increased ( $P=0.02$ ), and it was positively correlated with the expression level of *TNFRSF17* mRNA ( $P<0.05$ ,  $r=0.39$ ).

**Conclusions:** 1. Aberrant DNA methylation of *TNFRSF17* may be involved in the pathogenesis of IgAN. 2. *CFHR1* and *CLEC10A* may be related to the disease progression of IgAN.

#### SA-PO652

**More Severe Mitochondrial Injury at the Time of Diagnosis Is Associated With Poor Prognosis in IgA Nephropathy**  
Byung chul Yu, Kyung Ho Lee, Soo Jeong Choi, Moo Yong Park, Jin kuk Kim. *Soonchunhyang University Hospital Bucheon, Bucheon, Gyeonggi-do, Republic of Korea.*

**Background:** We hypothesized that the degree of mitochondrial injury at the time of diagnosis may serve as a valuable prognostic marker in IgA nephropathy (IgAN).

**Methods:** We prospectively enrolled 52 patients with IgAN. Focusing on the stimulator of interferon genes (STING)-NF- $\kappa$ B pathway activated by mitochondrial injury, the signal intensity of immunohistochemical (IHC) staining for STING and NF- $\kappa$ B was analyzed using kidney tissue at the time of diagnosis. Proteinuria at 6 months after treatment was categorized by conventional definitions of complete ( $<0.3$  g/day) and partial remission ( $<3.5$  g/day and 50% reduction in proteinuria). Time-averaged proteinuria (TA-proteinuria) was calculated as the average of the mean of proteinuria were obtained by 24-hour urine collection every 6 months for each patient.

**Results:** Kidney tissue from 40 patients showed positive IHC staining for STING and NF- $\kappa$ B. Patients were divided into the high ( $n = 21$ ) and low ( $n = 31$ ) intensity subgroups according to the signal intensity of IHC staining for STING and NF- $\kappa$ B based on 2+ and more or less, respectively. Fewer patients achieved complete or partial remission in the high intensity group than in the low intensity group (53.3 vs 94.1%,  $p = 0.013$ ). During a median follow-up of 3.5 years, TA-proteinuria and mean annual rate of estimated glomerular filtration rate decline were higher in the high intensity group than in the low intensity group ( $0.99 \pm 0.78$  vs.  $0.49 \pm 0.32$  g/day,  $p = 0.010$ ; and  $-1.91 \pm 4.71$  vs.  $1.55 \pm 5.82$  mL/min/1.73m<sup>2</sup>/year,  $p = 0.029$ , respectively).

**Conclusions:** More severe mitochondrial injury, as represented by a high signal intensity of IHC stain for STING and NF- $\kappa$ B at the time of diagnosis, could be used as a prognostic marker to predict poor prognosis in IgAN.

**Funding:** Government Support - Non-U.S.

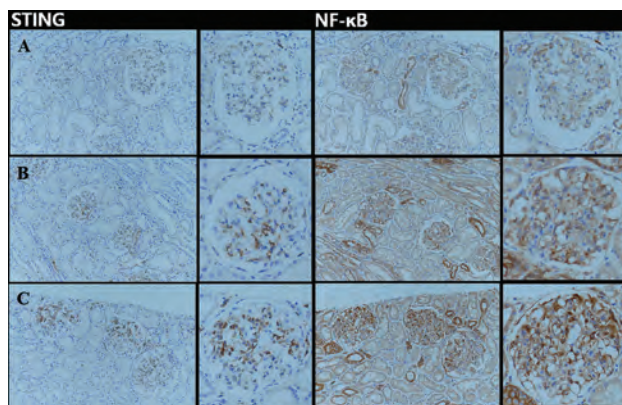

Immunohistochemical (IHC) staining of STING and NF- $\kappa$ B on kidney tissue obtained from patients. Patients were classified into 1+ (A), 2+ (B), and 3+ (C) according to the signal intensity of IHC staining.

#### SA-PO653

**A Role for Circulating MicroRNAs in the Pathogenesis of IgA Nephropathy**

Jasraj S. Bhachu, Jonathan Barratt, Izabella Z. Pawluczyk. *University of Leicester, Leicester, United Kingdom.*

**Background:** IgA nephropathy (IgAN) is considered to be a systemic disease with the kidneys being injured as innocent bystanders, therefore investigating circulating mediators as a key to its pathogenesis is well founded. Recently, the emergence of microRNAs (miRs) as negative regulators of gene expression has opened new avenues to understand their role in normal and pathological processes. The aim of this study was to investigate the role of circulating miRs in IgAN.

**Methods:** Next generation sequencing (NGS) was performed by Qiagen (Germany) on sera from patients with IgAN, idiopathic membranous nephropathy (IMN) and healthy subjects (HS). NGS data was validated using independent serum samples from each cohort by RT-qPCR. Extracellular exosomes were also isolated from the sera and urine of patients and controls and miR expression measured by RT-qPCR. MicroRNA expression was also measured in peripheral blood mononuclear cells (PBMCs). Mechanistic studies were subsequently performed using kidney cells *in vitro*.

**Results:** NGS and subsequent validation using RT-qPCR identified miRs -483-5p and -122-5p as being significantly overexpressed in those IgAN patients at high risk of future progression (IgAN-HR) compared to those at low risk of progression (IgAN-LR) and HS, but not compared to IMN. Both miRs were also significantly increased in serum exosomes of IgAN-HR compared to IgAN-LR and HS and this time also compared to IMN. Sera from IgAN-HR patients contained significantly more exosomes than sera from IgAN-LR, HS and IMN. Exosomal miR-483-5p levels correlated with proteinuria and with serum-derived tumour necrosis factor (TNF) super family analytes in IgAN. Having identified that miR-483-5p was enriched in peripheral blood CD19+ cells and in the urine, *in vitro* studies showed that exposing immortalised B cells to TNFR1 resulted in B cell activation and release of B cell-derived exosomes containing high levels of miR-483-5p. Collecting duct epithelial cells (CDECs) exposed to these miR-483-5p-enriched B cell-derived exosomes adopted a pro-inflammatory phenotype which was mediated by the transcription factor SOCS3, a known target of miR-483-5p.

**Conclusions:** This study has identified a potential novel mechanism for the TNF superfamily/B cell-axis in driving tubulointerstitial injury in IgAN.

**Funding:** Private Foundation Support

#### SA-PO654

**Treatment With Nefecon Reduces Circulating Levels of Galactose-Deficient IgA1 in Patients With IgA Nephropathy in the NefIgArd Clinical Trial**

Karen Molynse, Nadia Nawaz, Scott Taylor, Jonathan Barratt. *University of Leicester, Leicester, United Kingdom.*

**Background:** IgA nephropathy (IgAN) is characterized by mesangial accumulation of IgA1-containing immune complexes (IgA1 ICs), which generate a pro-inflammatory and pro-fibrotic glomerular microenvironment, breakdown of the glomerular filtration barrier and progressive tubulointerstitial inflammation and scarring. IgA1 IC formation in the circulation is mainly driven by increased levels of polymeric galactose-deficient IgA1 (Gd-IgA1), thought to be derived from mucosally primed B cells, mostly residing in the gut associated lymphoid tissue (GALT). The therapeutic effect of selectively targeting the GALT was first investigated in the NEFIGAN study (NCT01738035) and results have now been confirmed in the larger NefIgArd clinical trial (NCT03643965).

**Methods:** NefIgArd is a randomized, double-blind, placebo-controlled Phase 3 trial, comprising PART A (9-month treatment and 3-month follow-up period) and PART B (12 month no-treatment follow-up period). Serum samples were collected at screening (placebo  $n=81$ ; 16 mg Nefecon  $n=81$ ), Month 3 (placebo  $n=81$ ; 16 mg Nefecon  $n=81$ ), Month 6 (placebo  $n=81$ ; 16 mg Nefecon  $n=79$ ), and Month 9 (i.e. end of treatment: placebo  $n=79$ ; 16 mg Nefecon  $n=81$ ). Gd-IgA1 levels were measured with an ELISA

Key: TH - Thursday; FR - Friday; SA - Saturday; OR - Oral; PO - Poster; PUB - Publication Only

Underline represents presenting author.

using the Gd-IgA1 specific antibody, KM55 (IBL, Japan). Between-group comparisons at each time point were undertaken using unpaired t-tests (significance level = 0.05).

**Results:** 16 mg Nefecon treatment significantly reduced levels of circulating Gd-IgA1. Mean Gd-IgA1 levels fell by 21.4% (p<0.0005) at Month 3, 23.5% (p<0.0017) at Month 6 and 34% (p<0.0001) at Month 9 vs placebo.

**Conclusions:** To date, two large independent studies have shown that targeting the GALT with Nefecon results in a significant reduction in both proteinuria and a critical pathogenic biomarker in IgAN. Gd-IgA1-containing immune complexes have been shown to activate mesangial cells, promote glomerular scarring, and high levels are associated with more severe glomerular injury in kidney biopsies and worse kidney survival in clinical studies. This significant reduction in Gd-IgA1, combined with the proteinuria reduction reported in the NeflgArd trial, are consistent with Nefecon having a direct disease-modifying effect in IgAN.

**Funding:** Commercial Support - Calliditas Therapeutics AB

**SA-PO655**

**Atacicept Reduces Serum Immune Complex Levels in Patients With IgA Nephropathy (IgAN)**

Jonathan Barratt,<sup>1</sup> Celia J. Lin,<sup>2</sup> Nadia Nawaz,<sup>1</sup> Karen Molyneux,<sup>1</sup> Gerald B. Appel,<sup>3</sup> James A. Tumlin,<sup>4</sup> Yusuke Suzuki.<sup>5</sup> <sup>1</sup>University of Leicester, Leicester, United Kingdom; <sup>2</sup>Vera Therapeutics, Inc, Brisbane, CA; <sup>3</sup>Columbia University Medical Center, New York, NY; <sup>4</sup>Emory University School of Medicine, Atlanta, GA; <sup>5</sup>Juntendo University Faculty of Medicine, Tokyo, Japan.

**Background:** IgAN is an autoimmune disease thought to have a multi-hit mechanism in the inflammatory pathogenic process. Elevated serum Gd-IgA1, which plays a central role in IgAN pathogenesis is the first hit. The second hit is the antibodies that develop against Gd-IgA1 (anti-Gd IgA1) leading to formation of immune complexes (third hit). These circulating immune complexes can then deposit in the kidney and cause injury (fourth hit). The Ph2a JANUS, a randomized placebo-controlled clinical trial, showed that atacicept was the first therapeutic to decrease both circulatory Gd-IgA1 and anti-GdIgA1. This analysis investigates whether atacicept can also reduce serum immune complex levels.

**Methods:** JANUS patients were evaluated for serum IgA-IgG immune complex levels by ELISA at baseline, weeks 4, 12, 24, 48, and 72. Serum samples were normalized using 3 standard serum samples included on all plates.

**Results:** Decrease in serum IgA-IgG immune complex levels was observed in both atacicept 25 mg and 75 mg groups over time. At 24 weeks, mean percent change from baseline was 17% decrease for atacicept 25 mg, 21% decrease for atacicept 75 mg, and 3% decrease for placebo. At 72 weeks, 29% decrease for atacicept 25 mg, 26% decrease for atacicept 75 mg, and 13% decrease for placebo was observed.

**Conclusions:** Atacicept is the first therapeutic to show reduction in serum Gd-IgA1, anti-Gd-IgA1, and now immune complex levels in IgAN patients. Atacicept's ability to mitigate all of the first three hits of the multi-hit hypothesis illustrates its potential to modify the disease. The ongoing Ph2b ORIGIN trial evaluating up to atacicept 150 mg in IgAN pts, will help determine how reduction of these multiple hits translate to renal function.

**Funding:** Commercial Support - Vera Therapeutics, Inc.

**SA-PO656**

**Urinary GADD45G Protein Excretion Predicts IgA Nephropathy Progression**

Min-Jeong Lee. *Ajou University School of Medicine and Graduate School of Medicine, Suwon, Gyeonggi-do, Republic of Korea.*

**Background:** Growth arrest and DNA damage 45G (GADD45G) is a family of proteins involved in DNA damage response and cell growth arrest. In this study, we show evidence that urinary GADD45G protein is associated with progression of IgA nephropathy.

**Methods:** Patients diagnosed with IgA nephropathy without reversible acute kidney injury at study initiation and with at least one subsequent serum creatinine (SCR) measurement were included. A 50% or greater increase of SCR level was used as an endpoint of deterioration of renal function. Enzyme-linked immunosorbent assay (ELISA) was performed using a Human GADD45G ELISA kit. Renal biopsy tissues were stained with a monoclonal mouse anti-GADD45G antibody.

**Results:** Forty-five patients whose renal biopsy revealed IgA nephropathy were enrolled. Urinary GADD45G and urinary protein concentrations were 1.89 ± 1.82 µg/g and 1.47 ± 1.98 g/g, respectively. Urinary GADD45G showed significant positive correlations with SCR-slopes and urinary protein. The SCR-slope of the highest tertile group of urinary GADD45G (above 1.95 µg/g) was significantly higher than that of the lowest tertile group (below 0.90 µg/g). Univariate Cox regression analysis showed that urinary GADD45G was significantly associated with deterioration of renal function. Kaplan-Meier test showed a significant difference in event-free survival for deterioration of renal function between the highest urinary GADD45G tertile group and other tertile groups. The area under the receiver operating characteristics (ROC) curve indicated urinary GADD45G had a good performance in predicting renal outcome (cut-off point 1.67 µg/g, positive predictive value 36.8%, negative predictive value 100%). Immunohistochemistry showed that GADD45G was expressed across all pathologic grades of IgA nephropathy and mainly detected in the cytoplasm of renal tubules whereas no staining was noted in normal tissues.

**Conclusions:** In the present study, we showed that urinary GADD45G excretion is significantly associated with kidney disease progression in patients with IgA nephropathy. We also found that GADD45G was expressed in renal tubules across all pathologic grades indicating that tubular damage was an early pathogenic process of IgA nephropathy.

**SA-PO657**

**Persistence of Signs and Symptoms in Treated Patients With IgA Nephropathy: Evidence From Real-World Data**

Richard A. Lafayette,<sup>1</sup> Michel Kroes,<sup>2</sup> Carolina A. Aldworth,<sup>2</sup> Luis Prieto-Rodriguez,<sup>2</sup> Aneesh T. George,<sup>3</sup> Jonathan J. de Courcy,<sup>4</sup> Keisha J. Golden,<sup>6</sup> Emma Chatterton,<sup>6</sup> Li Yao,<sup>4</sup> Dario Roccatello.<sup>5</sup> <sup>1</sup>Stanford Medicine, Stanford, CA; <sup>2</sup>Novartis AG, Basel, Switzerland; <sup>3</sup>Novartis Healthcare Private Limited, Hyderabad, India; <sup>4</sup>The First Hospital of China Medical University, Shenyang, China; <sup>5</sup>University of Turin, Department of Clinical and Biological Sciences, Turin, Italy; <sup>6</sup>Adelphi Real World, Bollington, United Kingdom.

**Background:** Immunoglobulin A nephropathy (IgAN) is the most common form of primary glomerulonephritis worldwide, with an estimated annual incidence of 25 per million. It currently has limited treatment options. This analysis aimed to describe IgAN signs and symptoms (S&S) in treated patients.

**Methods:** The Adelphi IgAN Disease Specific Programme was a point-in-time survey of IgAN-treating nephrologists in the US, EU5 (France, Germany, Italy, Spain, UK) and Asia (China and Japan) between June and October 2021. Nephrologists completed structured online records for successive patients presenting with IgAN, including patient's demographics, IgAN treatment history, and a list of 29 current IgAN S&S.

**Results:** 295 nephrologists completed records for 1376 patients treated for a minimum of one week at time of survey. Mean patient age was 42.6 years, 59% were men. Median time since treatment initiation was 86 weeks (US 61, EU5 121, Asia 76). Despite treatment with standard of care (ACEi, ARB, Statins, Corticosteroids), most patients presented with S&S at time of survey. This was consistent in patients with longer treatment duration. Common S&S experienced were proteinuria, hematuria, hypertension, and fatigue (Table 1). A higher proportion of patients in their second year of treatment were at a better CKD stage than those in their first year of treatment or those treated for >2 years. Of those patients treated for more than two years, US 26%, EU5 31%, and Asia 24% had >1g proteinuria/day were reported.

**Conclusions:** Despite treatment, IgAN S&S persist in the majority of patients. Proteinuria persists in many patients, increasing the risk of progression to kidney failure. This shows a need for better treatment options for IgAN.

**Funding:** Commercial Support - Novartis Pharma AG

Table 1	US				EU5				Asia			
	Any n=232	<1y n=105	1-2y n=50	>2y n=77	Any n=474	<1y n=139	1-2y n=82	>2y n=253	Any n=670	<1y n=258	1-2y n=125	>2y n=287
Time since treatment initiation (years)												
Number of signs & symptoms Mean (SD)	2.2 (2.4)	2.6 (2.4)	2.0 (2.5)	2.0 (2.5)	1.8 (1.8)	2.1 (1.9)	1.9 (1.6)	1.6 (1.8)	2.6 (2.5)	2.6 (2.4)	2.2 (2.2)	2.7 (2.7)
% Currently symptomatic	78%	80%	78%	75%	75%	80%	79%	72%	79%	83%	75%	76%
<b>Top 10 signs &amp; symptoms</b>												
Proteinuria	45%	50%	46%	38%	36%	41%	33%	34%	54%	60%	53%	49%
Hematuria	30%	34%	28%	26%	20%	24%	16%	19%	30%	31%	25%	31%
Hypertension	27%	36%	18%	21%	28%	32%	33%	25%	22%	17%	15%	28%
Fatigue	22%	28%	16%	18%	16%	19%	20%	17%	22%	21%	23%	24%
Edema in extremities	16%	17%	8%	18%	9%	14%	6%	8%	18%	22%	11%	18%
High cholesterol	20%	27%	10%	17%	14%	13%	15%	14%	8%	10%	5%	9%
Discolored urine	7%	8%	4%	8%	5%	5%	6%	5%	17%	23%	11%	13%
Sleep problems	7%	7%	6%	9%	7%	5%	10%	7%	9%	8%	10%	10%
Pain in abdomen	4%	3%	10%	1%	5%	6%	7%	4%	11%	5%	10%	17%
Oliguria	1%	1%	2%	0%	4%	7%	1%	3%	9%	12%	2%	8%
<b>Current GFR</b>												
GFR ≥45 mL/min/1.73 m2	71%	68%	76%	71%	74%	73%	80%	74%	82%	89%	91%	72%
GFR <45 mL/min/1.73 m2	29%	32%	24%	29%	26%	27%	20%	26%	18%	11%	9%	28%
<b>Current Proteinuria (where reported)</b>												
>1g/day	37%	48%	36%	26%	37%	47%	41%	31%	24%	29%	16%	24%
≤1g/day	63%	52%	64%	74%	63%	53%	59%	69%	76%	71%	84%	76%

**SA-PO658**

**The Real-World Diagnostic Pathway in Patients With IgA Nephropathy**

Richard A. Lafayette,<sup>1</sup> Michel Kroes,<sup>2</sup> Carolina A. Aldworth,<sup>2</sup> Luis Prieto-Rodriguez,<sup>2</sup> Aneesh T. George,<sup>3</sup> Jonathan J. de Courcy,<sup>4</sup> Keisha J. Golden,<sup>4</sup> Emma Chatterton,<sup>4</sup> Li Yao,<sup>3</sup> Dario Roccatello.<sup>6</sup> <sup>1</sup>Stanford University School of Medicine, Stanford, CA; <sup>2</sup>Novartis AG, Basel, Switzerland; <sup>3</sup>Novartis Healthcare Private Limited, Hyderabad, India; <sup>4</sup>Adelphi Real World, Bollington, United Kingdom; <sup>5</sup>The First Hospital of China Medical University, Shenyang, China; <sup>6</sup>University of Turin Department of Clinical and Biological Sciences, Turin, Italy.

**Background:** Although rare (estimated global annual incidence of 25/million) immunoglobulin A nephropathy (IgAN) is the most common form of primary glomerulonephritis. IgAN is associated with a poor prognosis, 30% or more of patients with >1g/day of proteinuria progress to kidney failure within 10 years. Poor prognosis is partly due to delayed diagnosis (Dx). This analysis aims to better understand the diagnostic pathway of IgAN patients.

**Methods:** The Adelphi IgAN Disease Specific Programme was a point-in-time survey of IgAN-treating nephrologists in the EU5 (France, Germany, Italy, Spain, UK), US and Asia (China and Japan) from June to October 2021. Nephrologists completed structured online records for successive patients presenting with IgAN, including demographics, clinical data, and reasons for delay of Dx.

**Results:** A total of 295 nephrologists completed records for 1792 patients in the survey. Mean patient age was 43.6 years, and 59% were men. Median time from symptom onset to the patient consulting a physician was reported for 79% of patients. In the EU5 (n=456) and US (n=233), this was 4.4 weeks (IQR EU5: 0.4-9.3, IQR US: 1.3-12.4) and in Asia (n=734) 4.6 weeks (IQR: 0.7-16.3). Median time from first physician consultation to confirmed IgAN Dx was reported for 86% of patients. Half of the patients received Dx within 4-5 weeks, the top 10% experienced a much longer period (**table 1**). Reasons for a delay >4 weeks between first consultation and Dx were reported for 46% of patients (n=826). Waiting to conduct tests (44% EU5, 30% US, 43% Asia) and waiting for a referral to a specialist (47% EU5, 41% US, 22% Asia) were the most common causes. Where GFR was recorded at Dx (76%, n=1356), 20% of patients were at CKD stages 3b-5 (GFR <45 mL/min/1.73 m<sup>2</sup>), in the US this figure was 32%.

**Conclusions:** While half of IgAN patients receive a relatively quick Dx, for at least one in ten the wait was over 20 weeks. During this time patients may have progressed to later stages of CKD. Improving the diagnostic process may improve prognosis for some patients.

**Funding:** Commercial Support - Novartis Pharma AG

	EU5 (n=491)	US (n=263)	Asia (n=783)
25th percentile	2.4	0.9	1.0
Median	5.3	4.0	4.3
75th percentile	13.0	8.7	9.3
90th percentile	27.0	20.3	36.0

SA-PO659

**Compartment Specific Analysis of Leukocyte Trans-Endothelial Migration Molecular Signature in IgA Nephropathy**

Fengge Zhu,<sup>1,2</sup> Xizhao Chen,<sup>1,2</sup> Guangyan Cai,<sup>1,2</sup> Xiangmei Chen,<sup>1,2</sup> *<sup>1</sup>Chinese PLA General Hospital, Beijing, China; <sup>2</sup>State Key Laboratory of Kidney Diseases, Beijing, China.*

**Background:** The mechanism of how vascular lesions in IgA nephropathy affect renal disease progress remains unclear. Leukocyte trans-endothelium migration is an important bridge between blood vessels and tissue inflammation. This study analyzes the molecular signature of leukocyte trans-endothelial migration in IgA nephropathy based on the proteomic and the transcriptomic data of glomerulus, renal tubulointerstitium, peripheral blood mononuclear cells and peripheral CD14<sup>+</sup> monocytes of IgA nephropathy.

**Methods:** The renal proteomic data are obtained from a local cohort of 59 IgA nephropathy patients and 19 healthy controls. RNA-seq transcriptomic data of glomerulus, renal tubulointerstitium, PBMCs and peripheral CD14<sup>+</sup> monocytes in patients with IgA nephropathy are accessed from web based GEO database.

**Results:** 1. Canonical molecules related to leukocyte trans-endothelial migration, including molecules in cell adhesion, anchoring and cell deformation are analyzed in IgA nephropathy kidneys. We find that MCAM, ICAM1 and CDH5 are significantly upregulated in IgA nephropathy compared to that of paracancerous tissue, and not in membranous nephropathy. 2. Pearson correlation analysis show that the leukocyte trans-endothelial migration molecular signature is not correlated with proteinuria, renal function, hypertension or serum complement level, but had a weak correlation with decreased S score in the Oxford classification. 3. One of the trans-endothelial migration related genes - Integrin  $\alpha$  Subunit L (ITGAL) was significantly upregulated in the tubulointerstitium compartment of IgA nephropathy compared to healthy controls. However, there is no difference between IgA nephropathy and controls within the glomerulus, PBMCs, or peripheral CD14<sup>+</sup> monocyte compartments.

**Conclusions:** The leukocyte trans-endothelial migration signature molecules are significantly upregulated in the renal tubulointerstitium of IgA nephropathy, but not in the glomerulus, PBMCs, or peripheral CD14<sup>+</sup> monocytes. The leukocyte trans-endothelial migration signature is weakly correlated with decreased Oxford S score.

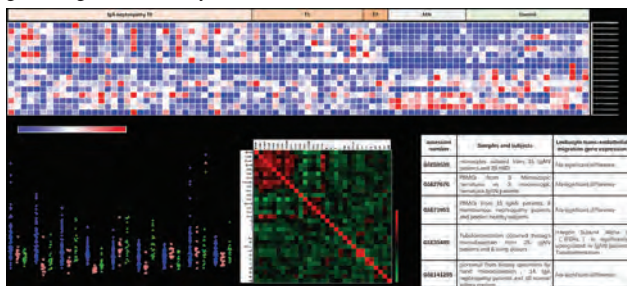

SA-PO660

**Misdiagnoses and the Impact on Disease Severity in Immunoglobulin A Nephropathy Patients: A Real-World Study**

James Jackson, Sarah Bourgeois, Mollie Lowe, Mohammed T. Khan, Muhammad Jamee. *Adelphi Real World, Bollington, United Kingdom.*

**Background:** Physicians may suspect immunoglobulin A nephropathy (IgAN) based on patient history, a physical exam, and urine and blood tests, but the only way to truly diagnose IgAN is by kidney biopsy. Data reporting on misdiagnosis of IgAN are sparse. This study aimed to understand rates of misdiagnosis and the impact on disease severity in a real-world population.

**Methods:** Data were drawn from the Adelphi IgAN Disease Specific Programme (DSP™) conducted in 2021 in France, Germany, Italy, Spain, United Kingdom (EU5), USA, China, and Japan. The DSP was a real-world, point in time survey collecting data from nephrologists and their consulting patients, including demographics, frequency of misdiagnoses, diagnostic delay, reasons for the delay, and physician perceived disease severity. Descriptive analyses were performed.

**Results:** In total, 321 physicians provided data for 1792 patients. The mean age of patients was 43.6 years, 1052 (59%) were male and 726 (44%) patients were white/Caucasian. Overall, 262 (82%) physicians reported managing patients who had been initially misdiagnosed which resulted in a delayed IgAN diagnosis. A higher proportion of misdiagnosed patients was reported in the EU5 and USA compared with, China and Japan (*Figure 1*). In total, 860 (56%) patients experienced a delay of >4 weeks from first consultation to receiving an IgAN diagnosis. In 54 (6%) of these, the reason for delay was diagnosis or suspicion of another condition. A higher proportion of patients who were misdiagnosed were moderate (57%) or severe (22%) when receiving an IgAN diagnosis than those who had not been misdiagnosed (52% moderate; 13% severe).

**Conclusions:** Our study showed that patients diagnosed earlier and without misdiagnosis were less severe at the time of their IgAN diagnosis. Prevalence of IgAN misdiagnosis is high, therefore further research is needed to understand the challenges faced by physicians when diagnosing this rare disease.

Figure 1: Distribution of % physicians who are managing misdiagnosed patients

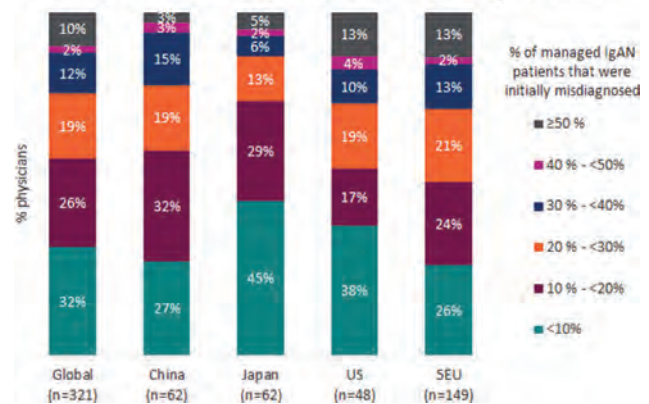

SA-PO661

**Investigating the Role of the Complement System in Paediatric Sickle Cell Disease**

Daniel Diatlov,<sup>1,2</sup> Arlette Bohorquez,<sup>2</sup> Melanie E. Jackson,<sup>4</sup> Melina Cheong,<sup>4</sup> Christoph Licht.<sup>3,2</sup> *<sup>1</sup>University of Toronto Institute of Medical Science, Toronto, ON, Canada; <sup>2</sup>The Hospital for Sick Children Research Institute Cell Biology Program, Toronto, ON, Canada; <sup>3</sup>The Hospital for Sick Children Division of Nephrology, Toronto, ON, Canada; <sup>4</sup>The Hospital for Sick Children Division of Haematology/Oncology, Toronto, ON, Canada.*

**Background:** Sickle cell disease (SCD) is one of the most common hereditary red blood cell (RBC) disorders in the world, with an estimated 300,000 infants born with the disease annually. In SCD, a mutation in the gene for  $\beta$ -globin results in rigid sickled RBCs that can form blockages in the micro-vessels within organs, such as the kidney, leading to RBC lysis, endothelial cell (EC) damage, ischemia/reperfusion injury, and extremely painful vaso-occlusive crises (VOC). SCD can give rise to a variety of renal manifestations such as hyperfiltration, microalbuminuria, and AKI. Approximately 16-18% of overall mortality in patients with SCD is ascribed to kidney disease. The complement system – a critical part of the innate immune system - is involved in a myriad of kidney and vascular disorders, and emerging research points to the involvement of complement in SCD, potentially contributing to sickle cell nephropathy (Fig. 1A).

**Methods:** Paediatric patients with SCD (HbSS or HbS/β0) were enrolled during hospital admission with diagnosed VOC or acute chest crisis (ACS) not caused by infection. Patient serum was collected during hospital admission (crisis) and during follow-up (steady state). Complement activity was measured using the WIESLAB Complement System Screen (Svar Life Science). Immunofluorescence (IF) imaging was used to measure the deposition of C3b and C5b-9 on the surface of ECs exposed to patient serum.

**Results:** There is equal classical and alternative pathway activity during disease steady state and crisis, with an interesting trend showing elevated MBL pathway activity during crisis compared to steady state (Fig. 1B). IF assay data shows significantly elevated deposition of C3b and C5b-9 proteins on ECs when comparing crisis samples and healthy controls, with a trend suggesting a potential difference in complement deposition between steady state and crisis patients (Fig. 1C).

**Conclusions:** Our preliminary data shows complement is active in SCD, resulting in elevated C3b and C5b-9 deposition on ECs during SCD crisis. Future work will focus on further quantifying complement activity, and assessing the functional consequences of this on the surface of ECs.

**Funding:** Commercial Support - Pfizer, Government Support - Non-U.S.

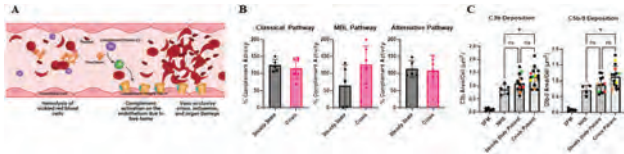

## SA-PO662

### The Characteristics of IgM Nephropathy Compared to Other Glomerular Diseases

Eun-Jeong Kwon,<sup>1</sup> Ho Jun Chin,<sup>1,2</sup> <sup>1</sup>Seoul National University Bundang Hospital Department of Internal Medicine, Seongnam, Gyeonggi-do, Republic of Korea; <sup>2</sup>Seoul National University College of Medicine Department of Internal Medicine, Seoul, Republic of Korea.

**Background:** IgM nephropathy (IgMN) is pathologically defined as diffuse deposition of IgM in the mesangium. The definition and characteristics are still unclear. In this study, we explain manifestation of IgMN according to the electron dense deposits (EDD) in mesangium and differences in the clinical feature of IgMN with minimal change disease (MCD) or focal segmental glomerulosclerosis (FSGS). Finally, we would like to compare clinical findings between IgA nephropathy (IgAN) and IgMN, which have mainly mesangial lesions.

**Methods:** We enrolled 63 adult IgMN patients with a renal biopsy from May 2003 to June 2017. IgMN was defined as 1+ or more IgM antibody deposition in mesangium which intensity is more than the other antibodies of IgG or IgA. We excluded secondary nephropathy: autoimmune diseases, monoclonal gammopathy, or pathologically proven diabetic nephropathy. We compared the characteristics of IgMN with those of 91 MCD, 103 FSGS, and 469 IgAN. The renal failure was defined as decrease of estimated GFR more than 50% at the time of renal biopsy, less than 15 ml/min/1.73 m<sup>2</sup>, or progressed to end stage renal disease during follow-up period.

**Results:** There were 13 IgMN patients with EDD and 50 IgMN without EDD. Among light microscopic findings, mesangial cellularity and matrix were increased in IgMN with EDD, more frequently. The intensity of immunofluorescent staining for IgG, IgM, IgA, and C3 were more prominent in IgMN with EDD. Diffuse podocyte effacement was found in IgMN with EDD, more frequently. There was no difference of clinical characteristics and renal outcome of IgMN according to presence of EDD. IgMN had similar clinical features to FSGS. IgMN patients had higher blood pressure, lower proteinuria, and lower level of creatinine at renal biopsy, compared to MCD. However, it is greater blood pressure, creatinine and proteinuria, and more frequent incidence of acute kidney injury at renal biopsy in IgMN compared to IgAN patients. The frequency of renal failure in IgMN (46.0%) was similar to FSGS (40.8%) (p=0.522), although it was higher than that of MCD (18.7%) or IgAN (26.4%) (p<0.001 and p=0.001, respectively).

**Conclusions:** Clinical characteristics of IgMN were not different according to the presence of EDD. Therefore, IgMN should be defined by the immunofluorescent findings. IgMN has similar characteristics to FSGS, however, has severe presentation compared to MCD and IgAN.

## SA-PO663

### Injection Heroin Use and AA-Type Renal Amyloidosis: An Underrecognized Etiology?

Jaskiran Mann,<sup>1</sup> Roberto L. Chuapoco,<sup>2</sup> Hoang Anh Nguyen,<sup>1</sup> David C. Wallace,<sup>1</sup> Kevin Yu.<sup>1</sup> Valley Hospital Medical Center <sup>1</sup>Valley Hospital Medical Center, Las Vegas, NV; <sup>2</sup>Touro College & University System, Las Vegas, NV.

**Introduction:** Serum amyloid A (SAA) renal amyloidosis is characterized by the deposition of serum amyloid A protein into renal glomeruli, tubules, and vessels. The AA amyloid proteins are misfolded aggregates derived from acute-phase reactant serum amyloid A protein. Regular injection heroin use has been linked to increased risk of secondary amyloidosis, possibly due to recurrent skin and soft tissue infections.

**Case Description:** Patient is a 40 year-old Caucasian male with history of untreated hepatitis C and daily injection heroin use who presented to the emergency department with cellulitis of bilateral hands, and was found to be septic and bacteremic with *Streptococcus pyogenes*. Patient was started on broad spectrum antibiotics. Transesophageal echocardiogram was negative for vegetations/endocarditis. Nephrology was consulted for worsening non-oliguric acute kidney injury with uprending creatinine. Urine studies notable for protein 176 mg/dL with microalbumin 110.2mg/dL. Workup included renal ultrasound showing echogenic kidneys bilaterally; SPEP and UPEP with no M-spike, but elevated free kappa and lambda chains with normal kappa/lambda ratio; negative immunofixation; and repeat urine studies showing 20,840mg protein per day and UPC 16.4g/dL. Renal biopsy showed mild interstitial fibrosis and tubular atrophy (IFTA) and acute tubular injury, proteinaceous material in gloms and tubules that stained positive with congo red and demonstrated apple green birefringence; no evidence of kappa or lambda light chains on immunofluorescence. Renal function stabilized and patient was advised to follow up outpatient to initiate ACE inhibitor for proteinuria in likely AA renal amyloidosis.

**Discussion:** AA amyloidosis is an under-recognized cause of acute kidney injury. The pathophysiology may be due to inflammation associated with recurrent skin and soft tissue infections associated with injecting heroin, versus local inflammation due to injection heroin use. Case series have demonstrated rapid progression to dialysis-dependent

renal failure and death in these patients. Greater awareness of renal amyloidosis and its complications may help reduce incidence of disease and/or slow its progression.

## SA-PO664

### AL Amyloidosis Following Johnson & Johnson COVID-19 Vaccination

Abhishek Nimkar, Tanazul T. Pariswala, Nupur N. Uppal. Northwell Health, New Hyde Park, NY.

**Introduction:** Amyloidosis is a clinical disorder that results from extracellular tissue deposition of pathogenic, misfolded proteins. Several cases of COVID-19 vaccine associated nephrotic syndrome have been described, here we report a case of AL amyloidosis following Johnson and Johnson (J & J) SARS-CoV-2 vaccine.

**Case Description:** A 76-year-old Haitian male with no past medical history was evaluated for acute kidney injury (AKI) and lower extremity (LE) swelling. Patient mentioned that he started to notice LE swelling on 13th day after receiving J & J SARS-CoV-2 vaccine, with associated presence of foamy urine and weight gain of 13 lbs since the receipt of the vaccine. He denied any rash, joint pains, change in appetite, use of NSAIDs, PPIs, antibiotics or herbal supplements. Lab work showed serum creatinine (Scr) of 2.26 mg/dl (baseline Scr was 1.19 mg/dl, 2 weeks prior to receiving vaccine), low serum albumin (2.1gm/dl), anemia (Hgb 11.4 gm/dl) and hyperlipidemia. Urine analysis revealed >600 mg/dl proteinuria, 37 RBCs with spot urine total protein/creatinine ratio (TP/Cr) elevated to 8.6. Serum immunofixation showed IgA lambda band. He was initiated on oral torsemide. Kidney biopsy revealed renal amyloidosis AL type, lambda light chain restricted with extensive glomerular and vascular deposits (26% of glomeruli obliterated by amyloid). Subsequently, bone marrow biopsy also showed lambda chain amyloidosis. Scr peaked to 4.66 mg/dl, albumin was low at 2 gm/dl and spot urine TP/Cr was elevated at 13.3. He was initiated on treatment with Daratumumab + Cyclophosphamide, Bortezomib and Dexamethasone, 8 months into therapy, Scr and spot urine TP/Cr have decreased to 2.6 mg/dl and 2.8 respectively and serum albumin had normalized to 3.6 gm/dl.

**Discussion:** Vaccination is a recognized trigger for new-onset and relapse of glomerular disease. It appears that our patient had undiagnosed amyloidosis, however the onset of nephrotic syndrome occurred after pt. received the vaccine, likely secondary to enhanced immune response causing the disease to manifest clinically. Further studies are needed to determine whether there is an association or causation between the COVID-19 viral vector vaccines and amyloidosis.

## SA-PO665

### A Membranous Case of Immunoglobulin Deposition in C3-Dominant Membranoproliferative Glomerulopathy

Abhishek Nimkar, Purva D. Sharma. Northwell Health, New Hyde Park, NY.

**Introduction:** Eculizumab/Ravulizumab is a humanized murine recombinant monoclonal antibody engineered to minimize immunogenicity and proinflammatory effects by inhibiting the terminal complement component C5 to prevent the generation of the membrane attack complex. We report a case where new immunoglobulin deposits were seen on kidney biopsy in a patient with C3 glomerulopathy following use of ravulizumab.

**Case Description:** A 20 yo male presented with hypertension, foamy urine and hematuria. Lab work showed elevated serum creatinine of 2.9 mg/dl and elevated urine protein to creatinine ratio of 5.8 gms/gm of creatinine. Serological work showed low C3 and rest was unremarkable. Kidney biopsy was performed which showed membranoproliferative glomerulonephritis (GN) with dominant C3 deposits. Work up for low complement mediated GN was unrevealing for atypical HUS. He received 4 doses of Ravulizumab for C3 glomerulopathy but couldn't continue due to insurance issues. Patient initially responded to the treatment, but later serum creatinine started rising again with significant proteinuria. Patient underwent repeat kidney biopsy which revealed C3 GN with strong IgG2/4-Kappa reactivity in glomerular deposits. Patient was resumed on complement blockade and was listed for kidney transplant evaluation.

**Discussion:** Eculizumab/Ravulizumab consists of a hybrid human IgG2 heavy chain hinge region, which does not bind Fc receptors, and the IgG4 heavy chain CH2 and CH3 regions associated with a κ light chain. The tissue deposition of IgG2, IgG4, and κ light chain has been described in literature in patients receiving this drug for C3 glomerulopathy. With the expanded use of eculizumab/ravulizumab for treatment of conditions that could benefit from terminal complement blockade, pathologists are expected to encounter more biopsy specimens with IgG2, IgG4, and κ deposits. Given its low immunogenicity and slow tissue clearance, prolonged tissue deposition of the antibody is expected, which may generate confusing results. Knowledge of this finding is important because the detection of Ig-positive monoclonal deposits in patients with clinically suspected glomerular disease could lead to misdiagnoses, especially if therapy was discontinued a while prior to the biopsy and the pathologist was not informed of antecedent eculizumab/Ravulizumab use and if IgG subclass staining is not performed.

## SA-PO666

### A Rare Cause of Thrombotic Microangiopathy (TMA)

Rama Kethineni, Sarah Gilligan, Josephine Abraham. University of Utah Health, Salt Lake City, UT.

**Introduction:** TMA can occur secondary to systemic autoimmune disorders such as SLE, Scleroderma, and APS. We present a case of TMA secondary to autoimmune myositis.

**Case Description:** A 48-year-old Hispanic female with a history of hypertension presented with headache, blurry vision, chest pain and dyspnea, with blood pressure of

Key: TH - Thursday; FR - Friday; SA - Saturday; OR - Oral; PO - Poster; PUB - Publication Only

Underline represents presenting author.

230/140 mm hg. Her creatinine worsened from 0.8 mg/dl to 2.6 mg/dl with proteinuria of 1 g/g within a week despite improvement in blood pressure. Her labs were notable for microscopic hematuria and Platelets of 96k/ul and hemoglobin 10 g/dl. She had a troponin-I of 0.26 ng/ml, CK of 995 U/L and an ECHO with EF of 43%. Serologic work-up showed positive ANA of 1:1280 with speckled pattern, SSA-60 of 76 with negative SLE and Systemic sclerosis panel. Her hemolysis labs and SPEP were normal. Her cardiac MRI showed findings of myocarditis. Renal biopsy showed TMA with scattered subendothelial immune complex deposits and acute tubular injury. Immunofluorescence showed scant capillary and mesangial staining for predominantly IgM and C1q, with scant staining for other antibodies. Creatinine worsened to 11.5 mg/dl over the course of 5 weeks and dialysis was initiated. Two months later she presented with fatigue, weakness, and diffuse muscle pain with CK of 4000 U/L and muscle biopsy showing necrotizing myopathy. She was started on high dose steroids and Cellcept with improvement of CK level. Her clinical course was complicated by bone marrow suppression, CMV viremia, and HLH with elevated ferritin of 25,527, SIL2r elevation of 19K with no response to Anakinra. She had worsening hemodynamic instability and ultimately passed away after her family opted to withdraw care.

**Discussion:** Distinguishing and treating of various causes of TMA can be very challenging especially when limited to the kidney. TMA frequently presents with hypertension, making it difficult to distinguish malignant hypertension from other causes. Literature on autoimmune myositis and TMA is rare. It can be very challenging to diagnose if TMA is caused early in the course of the disease as in our case.

#### SA-PO667

### New Onset Anti-GBM Glomerulonephritis on a Background of IgA Nephropathy Post-SARS-CoV-2 Vaccination: A Double Hit Phenomenon?

Ramsha Riaz, Danny Haddad, Marissa M. Sansone, Valentin Marian, Deepika Jain. *Jersey City Medical Center, Jersey City, NJ.*

**Introduction:** Anti-glomerular basement membrane (anti-GBM) nephritis is a rare, but potentially fatal pathology that occurs due to development of IgG autoantibodies against an autoantigen expressed in the basement membrane of kidneys. We present a case of anti-GBM nephritis as an uncommon immune-mediated adverse effect post mRNA Covid-19 vaccination.

**Case Description:** This is a 41-year-old South Asian female with a history of hypothyroidism, who was tested positive for Covid-19 in April 2021. Post-covid, she received the Pfizer-SARS-CoV vaccine in June and July 2021. Few weeks later, she presented with anemia to her primary care physician, and a couple of months after, a urinalysis revealed significant microscopic hematuria and proteinuria. Further workup revealed a blood urea nitrogen (BUN) of 70 mg/dL and serum creatinine of 9.8 mg/dL which subsequently led to hospitalization for workup of acute kidney injury. Her labs were significant for hemoglobin 6.8 g/dL, BUN/Creatinine 81/10.13 mg/dL, potassium of 5.4, metabolic acidosis (HCO<sub>3</sub> 16mmol/L), and a urinalysis showing >50 red blood cells (RBCs) per high power field (HPF) with a protein of 300 mg/dL and 24-hour protein excretion of 5.7 g/dL. Complete review of systems was unremarkable with no signs of extrarenal manifestations and negative chest imaging. Immunological workup was negative except for elevated anti-GBM titer at 4.6 (normal <1) and elevated IgG and IgA serum proteins. A renal biopsy was performed to confirm the diagnosis, which showed acute anti-GBM nephritis - crescentic glomerulonephritis with 2-3+ linear IgG staining with incidental mesangial IgA deposits. She was initiated on IV pulse steroids, plasma exchange therapy, and IV Cyclophosphamide. Renal function gradually improved on this treatment regimen.

**Discussion:** The occurrence of anti-GBM nephritis with concomitant IgA nephropathy post-SARS-CoV-2 mRNA vaccination has been rarely reported in literature. The etiology remains speculative; however, these cases highlight the need to exercise vigilance in patients presenting with symptoms or lab findings suggesting acute kidney injury with a preceding history of recent vaccination. Early identification and intervention may prevent progression of disease.

#### SA-PO668

### IgA Vasculitis Nephritis in a Patient With Alport Syndrome: An Association or a Just a Coincidence?

Uma Mahesh R. Avula,<sup>1</sup> Michelle N. Rheault,<sup>2</sup> Lilia Harris,<sup>1</sup> Michael B. Kuperman,<sup>3</sup> Safa Osman,<sup>1</sup> Mohamed Hassanein.<sup>1</sup> <sup>1</sup>The University of Mississippi Medical Center, Jackson, MS; <sup>2</sup>University of Minnesota Medical School Twin Cities, Minneapolis, MN; <sup>3</sup>Arkana Laboratories, Little Rock, AR.

**Introduction:** Alport syndrome is a rare inherited disorder manifested by persistent microscopic hematuria, nephritis, sensorineural deafness, and ocular abnormalities. IgA nephropathy has been reported in a small percentage of patients with Alport syndrome, however, IgA vasculitis nephritis (IgA-VN) has not been reported. We report a rare case of Alport syndrome with crescentic IgA-VN.

**Case Description:** A 48-year-old male with a history of deep vein thrombosis (on warfarin) was followed by nephrology clinic for chronic kidney disease (CKD). Due to concerns of risks associated with holding warfarin, genetic testing was done in lieu of kidney biopsy which was positive for a hemizygous pathogenic mutation in the X-linked COL4A5 gene for Alport Syndrome. He did not have any sensorineural deafness, ocular abnormalities, or a family history of kidney disease. He was admitted to the hospital for acute kidney injury (creatinine 14.6 mg/dL from a baseline of 2 mg/dL), nephrotic range proteinuria (microalbumin/creatinine ratio: 3.689 mg/g, normal < 200 mg/g) and microscopic hematuria. A full serological workup was unremarkable. He developed new-onset bilateral lower extremity purpura which was biopsied showing leukocytoclastic IgA

Vasculitis. Kidney biopsy showed IgA-dominant glomerulonephritis with 70% interstitial fibrosis and tubular atrophy, 80% crescents, and no electron microscopy findings suggestive of Alport Syndrome. Four days after the kidney biopsy, he was started on dialysis and immunosuppression (IV Methylprednisolone and Cyclophosphamide) after ruling out infection. He was discharged with a plan to continue immunosuppression and dialysis as an outpatient. Unfortunately, he developed COVID-19 prompting a delay in further immunosuppressive therapy.

**Discussion:** Although extremely rare, mutations in the COL4A3, COL4A4, and COL4A5 genes have been implicated in cases of familial IgA Nephropathy and Alport Syndrome. We report a novel patient with IgA-VN and COL4A5 variant. It is unclear whether his underlying COL4A5 variant contributed to his severe presentation with IgA-VN. Genome-wide association studies in patients with coexisting pathologies are needed to discover both diseases' possible common genetic connection.

#### SA-PO669

### A Case of an IgA Variant of Anti-Glomerular Basement Membrane Disease

Mairéad Hamill, Ian Harrington, Michelle Madden, Francis Ward. *Tallaght University Hospital, Dublin, Ireland.*

**Introduction:** Anti-GBM disease is a rapidly progressive glomerulonephritis. Pathogenesis is generally attributed to circulating IgG autoantibodies against cryptic epitopes in the NC1 domain of the alpha-3 chain of type IV collagen. It is a rare disease with a grave prognosis. Atypical anti-GBM disease has been described as a variant characterised by linear staining of GBM by IgG, IgM or IgA, in the absence of circulating anti-GBM autoantibodies. Here we report a case of an IgA variant of atypical anti-GBM disease.

**Case Description:** A 77-year old Caucasian female presented with malaise, and pyrexia on a background of chronic obstructive pulmonary disease. She had recently recovered from COVID-19. On presentation, she had anuric AKINIII (creatinine: 10.2 mg/dL) with previously normal function. On imaging, chest was clear and there was no obstruction. Urine microscopy revealed microhaematuria and proteinuria was quantified at 288mg/mmol. Complement studies and immunoglobulins were normal. HIV, hepatitis B and C virology were negative. Serum anti-GBM and anti-neutrophil cytoplasmic antibodies (ab) were negative. Kidney biopsy revealed extensive crescentic glomerulonephritis, with moderate interstitial fibrosis. GBM thickening was noted. On IF, linear staining for IgA (2+) and C3 was seen in capillary loops. EM did not identify immune complex deposition disease. Immunosuppression with prednisolone, cyclophosphamide and plasmapheresis was initiated without success. Serum IgA anti-GBM ab was negative. She remains dialysis dependent.

**Discussion:** The limited available literature suggests that biopsy-proven IgA variant anti-GBM disease, with undetectable serum anti-GBM ab, is an extremely rare presentation and that conventional therapies are rarely successful. Early diagnosis has an impact on prognosis in anti-GBM disease and, given widespread use of IgG anti-GBM ab assays, atypical cases may have treatment initiated later with devastating repercussions. This case illustrates the importance of prompt biopsy and need for increased awareness of atypical anti-GBM disease presentations.

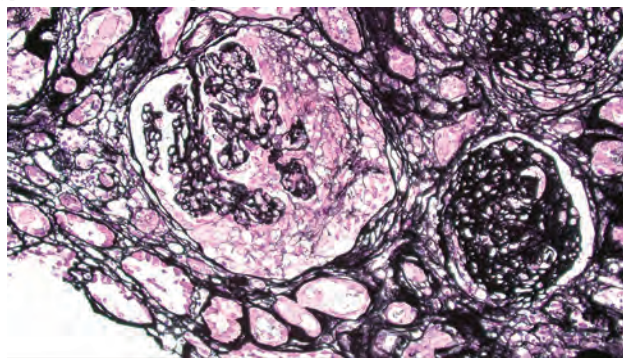

#### SA-PO670

### Crescentic IgA Nephropathy (cIgAN) in a Patient With COVID-19 Infection

Sally Chau,<sup>1</sup> Svetlana O. Villano,<sup>1</sup> Vinod K. Valluri,<sup>1</sup> Kulwant S. Bath,<sup>1</sup> Masoud Haghi,<sup>1</sup> Nisha M. Singh,<sup>1</sup> Jean Hou,<sup>2</sup> Susana M. Mendoza,<sup>1</sup> Golriz Jafari,<sup>1</sup> Anita Kamarzarian,<sup>1</sup> Phuong-Thu T. Pham,<sup>3</sup> Phuong-Chi T. Pham.<sup>1</sup> <sup>1</sup>UCLA Medical Center Olive View, Sylmar, CA; <sup>2</sup>Cedars-Sinai Medical Center, Los Angeles, CA; <sup>3</sup>University of California Los Angeles David Geffen School of Medicine, Los Angeles, CA.

**Introduction:** COVID19 infection has been linked to various glomerulonephropathies (GN) including collapsing focal segmental glomerulosclerosis, pauciimmune crescentic glomerulonephritis, and possibly minimal change disease and IgA nephropathy.

**Case Description:** A 57-year-old obese man with hypertension, hyperlipidemia, prediabetes, chronic obstructive pulmonary disease, illicit drug use, status post Pfizer COVID vaccine (1<sup>st</sup> dose 4m prior, 2<sup>nd</sup> dose 3w later), and COVID19 infection 7w prior, presented with an acute onset purpuric rash that began from bilateral hands and

feet and progressed to arms and legs. Patient denied joint pain or abdominal discomfort. Initial studies: Serum creatinine (Cr) 4.17 mg/dL (2.37 mg/dL 2w prior, baseline 0.93 mg/dL 4m prior). Urinalysis: > 50 red blood cells/high power field; Urine protein/Cr 4g/g, albumin/Cr >3g/g; Negative: HIV, ANCA, ANA, antiGBM, complements. Chest CT: Bilateral multifocal consolidative opacities concerning for aspiration, multifocal bacterial or viral pneumonia, or atypical presentation of COVID19 pneumonia. Skin biopsy: Leukocytoclastic vasculitis; No immunoreactants detected. Patient suffered from rapid respiratory deterioration, multiple hypotensive episodes, and acute kidney injury requiring mechanical ventilation and dialysis support. Kidney biopsy: IgA dominant immune complex mediated glomerulonephritis with focal/remote fibrous crescents; acute tubular injury. Treatment: Intravenous methylprednisolone 250 mg x 3d, followed by oral prednisone course. Patient recovered adequate function after 6w and was able to discontinue dialysis.

**Discussion:** COVID19 infection-related inflammatory response may precipitate GN in susceptible individuals. Crescentic IgAN is known to be associated with acute inflammatory conditions involving lungs, gastrointestinal tract, and skin. The timeline for the development of cIgAN herein raises suspicion for COVID19 infection/pneumonia as the inciting event.

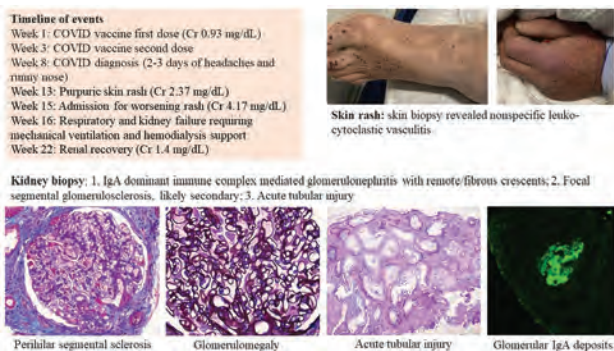

#### SA-PO671

##### A Challenging Case of C1q Nephropathy in a 62-Year-Old Man

Nidal Alhosainat, Nicole Hunter, Wajid M. Choudhry, Rochester Regional Health, Rochester, NY.

**Introduction:** C1q nephropathy is a rare form of glomerulopathy characterized by mesangial deposition of the complement component C1q, usually affects older children and young adults. We are presenting an unusual case of a 62-year-old male patient with C1q nephropathy

**Case Description:** A 62-year-old man with PMHx of hypothyroidism, diabetes mellitus, admitted with shortness of breath and anuria for 24 hours. On presentation, BP was 104/70. Physical exam was notable for positive JVD, and lower extremity edema. Labs were significant for creatinine 4.82 mg/dl (baseline 1.8), Urinalysis showed RBC casts, +2 proteinuria. Urine protein:creatinine ratio was 821 mg/d. low C3 at 23mg/dL and C4 at < 5mg/dL. ANA, ANCA, RF, anti-RNP, anti-Smith, anti-SSA/SSB, anti-histone, anti-cardiolipin, CCP, myeloperoxidase, proteinase 3, cryoglobulin, SPEP, UPEP, immunofixation, HCV, and HIV all were negative. Renal biopsy revealed proliferative glomerulonephritis with glomerular and extra glomerular IgG and C1q-containing immune complex deposits with organized substructure. Diagnosis of C1q nephropathy was made and the patient was started on prednisone with significant improvement of the kidney function.

**Discussion:** C1q nephropathy is a poorly understood entity characterized by mesangial proliferation, and prominent C1q deposits on immunofluorescence microscopy in a patient with no clinical, laboratory or histopathological evidence of systemic lupus erythematosus (SLE). The prevalence of C1q nephropathy varies from 0.2 to 16% and seems to be higher in children. Clinical presentation is diverse, and ranges from asymptomatic hematuria or proteinuria to frank nephritic or nephrotic syndrome. Light microscopic features can mimic minimal change disease (MCD), focal segmental glomerulosclerosis (FSGS), and proliferative glomerulonephritis. The main defining pathology is intense staining for C1q mainly in the mesangium, can be accompanied by IgG and IgM deposition. Corticosteroids are the mainstay of treatment, with immunosuppressive agents reserved for steroid resistant cases. Poor outcomes can be seen if nephrotic syndrome and FSGS present. **Conclusion** C1q nephropathy is a distinct clinicopathologic entity characterized by mesangial C1q deposition, it may carry poor outcomes, therefore, early detection can be vital in the management, treatment usually by steroids, addition of immunosuppressive therapy might be required in resistant cases.

#### SA-PO672

##### Bartonella Infection-Associated Glomerulonephritis and Recurrent Dense Deposit Disease in a Kidney Transplant

Yuang Chen, Ramya Krishna Velagapudi, Agnes B. Fogo, Paisit Pauksakon, Beatrice P. Concepcion, Vanderbilt University Medical Center, Nashville, TN.

**Introduction:** Dense deposit disease (DDD) is caused by dysregulation of the alternative complement pathway, leading to excessive complement activation and complement deposition in the glomerular capillary walls and mesangium. Patients with DDD are at risk to have over-activation of the complement pathway in the setting of

acute infection, and may present with initial features suggesting infection-associated glomerulonephritis (IAGN) that transform to DDD. We present a case of infection-associated trigger of recurrent DDD in a kidney transplant patient with acute bartonella infection.

**Case Description:** A 29 year old man with DDD and subsequent living unrelated kidney transplantation, maintained on tacrolimus, MMF, and prednisone, presented 1 year after transplant with headaches, fevers, diarrhea, and myalgias. He was diagnosed and treated for cat scratch disease (bartonella IgM 1:64). He was readmitted 11 days after initial presentation for neuroretinitis and non-oliguric AKI (Cr 3.5 mg/dL [baseline 1.4 mg/dL], low C3 and normal C4, UA with 89 RBC, 12 WBC, >500 protein, UPCR 1.48). Biopsy revealed diffuse endocapillary hypercellularity with neutrophils, diffuse global chunky mesangial and capillary loop staining for C3+++ and IgM++, and EM with mesangial and subendothelial deposits of usual density without hump-type subepithelial deposits. There was ribbon-like staining for C3++ along tubular basement membranes with focal dense TBM transformation by EM, indicative of IAGN transforming to DDD. Factor H autoantibodies were then detected. He was treated with high-dose prednisone, doxycycline/rifabutin, and twice-weekly plasma exchange with FFP for 8 weeks. The bartonella infection resolved and kidney function returned to baseline with resolution of proteinuria and hypocomplementemia. Repeat biopsy 3 months later confirmed resolving IAGN-like features and early recurrent DDD.

**Discussion:** The inherent dysregulation of the alternative complement pathway in our patient likely put him at risk for overactivation of the complement system in the setting of an acute infection, leading to IAGN-like acute lesions and evolution to recurrent DDD in the kidney transplant. Prompt diagnosis and management led to clinical resolution but with persistent morphological changes. More research is needed to further characterize this association.

#### SA-PO673

##### C3 Glomerulonephritis Triggered by Toxocarasis

Mona Ben m'rad,<sup>1</sup> Alexandre Beaulac,<sup>2</sup> Steven Palanchuck,<sup>1</sup> Veronique Beauvoyer,<sup>1</sup> Me Linh Luong,<sup>3</sup> <sup>1</sup>Hopital du Haut-Richelieu, Saint-Jean-sur-Richelieu, QC, Canada; <sup>2</sup>Centre integre universitaire de sante et de services sociaux de l'Estrie Centre hospitalier universitaire de Sherbrooke du Quebec, Sherbrooke, QC, Canada; <sup>3</sup>Centre Hospitalier de l'Universite de Montreal, Montreal, QC, Canada.

**Introduction:** C3 glomerulonephritis (C3GN) is a rare disease, triggered by a monoclonal gammopathy or auto-immunity or an infection resulting from the overactivation of the alternative pathway of the complement (APC), with a poor prognosis. We report a case of C3GN triggered by *Toxocara canis* (*T. canis*), a parasitic infection.

**Case Description:** An 83 year-old man was admitted for fever, rash, pruritus, eosinophilia 1600/mm<sup>3</sup> and a serum creatinine of 122 µmol/L. He had repaired a septic tank which required excavation of contaminated soil, 2 weeks prior. He was discharged with no diagnosis and readmitted 4 months later for a recurrent rash, fever, dyspnea, a nephrotic syndrome (NS), hematuria, a peak creatinine of 355 µmol/L, low C3 (0.2 U/L) and a peak eosinophilia of 2400/mm<sup>3</sup>. A *Staphylococcus aureus* bacteremia was treated with IV cefazolin for 14 days. An extensive NS and eosinophilia work-up including ANCA, ANA, electrophoresis, free light chains, viral serologies, bone marrow biopsy, genetic mutations and autoantibodies against the APC regulators was negative, except for a repeatedly highly positive *Toxocara sp* serology. The kidney biopsy showed a severe diffuse endocapillary glomerulonephritis with C3 deposits. On the basis of the strong positivity of the *T. canis* serology, the marked eosinophilia, a diagnosis of C3GN associated with an active visceral toxocarasis was made. After 3 pulses of Solumedrol 1 g IV followed by prednisone 1 mg/kg/day slowly tapered and albendazole 400 mg twice a day for 28 days, the *T. canis* infection abated. He required dialysis. Within 6 months, a second kidney biopsy showed an important decrease of the inflammation and of the C3 deposits with a lot of scarring tissue and fibrosis confirming end-stage renal disease.

**Discussion:** Toxocarasis, a highly prevalent helminthic zoonosis worldwide, has been reported as a rare cause of NS and eosinophilia both in adults and children. Here, an active infection-related C3GN was probably triggered by a visceral toxocarasis, after exposure to a contaminated soil, suggesting the role of an uncontrolled activation of the APC. The treatment goals were : 1/ eradication of *T. canis*, 2/ control of the glomerular inflammation and prevention of flairs after the destruction of the larvae with slowly tapered steroids, 3/ supportive. We suggest to consider toxocarasis as a differential diagnosis for NS and eosinophilia.

#### SA-PO674

##### Unmasking the C3ulprit

Audai Ma'ayah, Brian Benes, Kathleen Borghoff, Kirk W. Foster, Prasanth Ravipati, University of Nebraska Medical Center, Omaha, NE.

**Introduction:** C3 glomerulonephritis (C3GN) is a rare disease with kidney biopsy findings typically showing a proliferative pattern of injury with C3 deposition on immunofluorescence (IF), along with an absence of immunoglobulin (Ig) staining. However, in certain cases, it is important to pursue paraffin IF, which can unmask deposited Ig that is negative on routine IF staining. The aim of this case report is to illuminate the importance of paraffin IF to help distinguish cases of C3GN from immune complex GN.

**Case Description:** A 22-year-old man with no chronic medical history presented with complaints of arthralgias and sore throat and was found to have acute kidney injury. He was without rash, synovitis, or peripheral edema. Serum creatinine was 4.37 mg/dL, urinalysis showed numerous dysmorphic red blood cells, and spot protein to creatinine ratio was 2.5. Serologic evaluation showed low C3, low C4, and a positive

Key: TH - Thursday; FR - Friday; SA - Saturday; OR - Oral; PO - Poster; PUB - Publication Only

Underline represents presenting author.

anti-nuclear antibody. Additional antibody testing, streptococcal testing, serum protein electrophoresis with immunofixation, and infectious diseases evaluation were negative. Kidney biopsy showed mesangioproliferative glomerulonephritis involving all glomeruli, with IF staining positive only for C3 in the glomerular capillary walls. A preliminary diagnosis of C3GN was made. However, electron microscopy (EM) showed fibrillary-like substructure within subendothelial deposits and intracellular rod-like crystals, which raised suspicion for masked glomerular Ig deposits. Therefore, we performed paraffin IF which showed IgG staining with kappa restriction along the glomerular capillary wall. Serum testing revealed the presence of circulating IgG cryoglobulin. The patient was ultimately diagnosed with type 1 cryoglobulinemic glomerulonephritis.

**Discussion:** In cases of suspected C3GN, paraffin IF is important to ensure the absence of immune complex GN. Patients with paraproteinemia or EM findings of fibrillary or microtubular substructure warrant consideration for paraffin IF to avoid misdiagnosis. This is critical to inform proper clinical management, as paraprotein-related immune complex GN warrants further evaluation for lymphoproliferative disease.

**SA-PO675**

**C3 Glomerulonephritis (C3GN) in a Patient With Marginal Zone Lymphoma Responsive to Rituximab Therapy**

Mark N. Massoud, Stephen R. Sammons, Monica P. Revelo Penafiel, Josephine Abraham. *University of Utah Health, Salt Lake City, UT.*

**Introduction:** We present the case of a patient with Marginal Zone Lymphoma diagnosed later with C3GN and treated consequently with Rituximab with complete renal response

**Case Description:** An 81-year-old man was diagnosed with IgM-kappa Monoclonal Gammopathy of Undetermined Significance (MGUS) in 2016 during evaluation for peripheral neuropathy and was found to have a CD5/CD10-negative Marginal Zone Lymphoma. In 2019, microscopic hematuria and proteinuria (UPCR 904 mg/g) were identified which prompted a Nephrology referral. At this time, he was noted to have low serum C3 and C4 levels, kappa-lambda ratio of 2.2 and stable renal function (serum creatinine 1.1-1.2 mg/dL). A renal biopsy was obtained in May 2019 which was significant for focal proliferative glomerulonephritis with dominant C3 deposits and strong IgM staining of capillary loops and mesangial matrix. His proteinuria improved with ACE-I (UPCR < 115 mg/g), and he remained under surveillance for his MGUS/MZL and off any therapy directed at his C3GN until January 2021 when he developed deterioration of renal function (serum creatinine up to 1.7 mg/dL), worsening proteinuria (UPCR 960 mg/g), hypocomplementemia and elevated kappa-lambda ratio of 4.3 with pancytopenia. In March 2021, he underwent 4 weeks of rituximab therapy, after which his proteinuria, complement levels, and renal function improved. These improvements have persisted thus far for a year after his rituximab therapy.

**Discussion:** C3GN is a rare type of GN in which dysregulation of the alternative complement pathway results in deposition of C3 within the glomeruli. C3GN can be associated with monoclonal gammopathy and can lead to renal impairment. Patients usually present with hematuria, proteinuria, variable degree of renal dysfunction and hypocomplementemia. If left untreated, patients could progress to ESRD. Diagnosis is established with a renal biopsy showing glomerular C3 and monoclonal Ig deposits on IF in the kidney. Treatment of C3GN in patients with monoclonal gammopathy should be directed at the underlying clone, and targeted therapy can lead to improved renal survival.

**SA-PO676**

**C3 Glomerulonephritis After Vector COVID-19 Vaccination: A Case Report**

Akilandanayaki Angamuthu, Zahir Ali Shaikh, Imara Dissanayake, Manjula Balasubramanian, Saurabh Gupta. *Albert Einstein Medical Center, Philadelphia, PA.*

**Introduction:** Mass vaccinations for coronavirus (COVID-19) are being administered worldwide. Even though vaccine is safe and effective, rare adverse events like thrombosis with thrombocytopenia, myocarditis, Guillain barre syndrome have been reported. Renal adverse events such as IgA nephropathy and minimal change disease are reported as well. We report a case of C3 glomerulonephritis (C3 GN) after Johnson & Johnson (J&J) vector COVID-19 vaccine.

**Case Description:** 84-year-old female with history of hypertension, diabetes, and CKD stage 3 presented with fatigue, shortness of breath, leg swelling and poor oral intake. She had received J&J vector vaccine few weeks prior to presentation. Her baseline creatinine was 1.8. Home medications included amlodipine, aspirin, clonidine, coreg, hydralazine, insulin and protonix. In the emergency department, vitals were normal. She had bilateral lower extremities edema. Her labs showed creatinine 5.4 mg/dl, BUN 42 mg/dl, and CPK 167 IU/L. Urine analysis positive for dysmorphic RBCs. 24-hour urine protein was 820 mg. Hepatitis serologies, Anti-dsDNA, SPEP, UPEP, C-ANCA and PR-3 were negative. Her ANA, P-ANCA and MPO titers were positive. Her C3 was low. C4 was normal. Renal biopsy revealed C3 dominant glomerulonephritis with crescents and moderate interstitial fibrosis. C4d was negative. Hydralazine was discontinued. With worsening renal parameters, she was initiated on hemodialysis. Trial of Steroids and CellCept did not show any response and she remains on hemodialysis.

**Discussion:** The C3 glomerulopathies are a group of rare kidney diseases characterized by complement dysregulation occurring in the glomerular microenvironment, which results in prominent complement C3 deposition. Most patients are treated with steroids in combination with either cyclophosphamide or Mycophenolate mofetil. Rituximab has been used in some case reports. To our knowledge, this is the first reported case of C3 GN after receiving the COVID-19 vaccine. In our case, the temporal association suggests an immune response to vaccine as a potential trigger. 1. Lebedev L. and Wechsler

A. Minimal change disease following the Pfizer-BioNTech COVID-19 vaccine. *Am J Kidney Dis.* 2021; 78:142-145. 2. Peggy Perrin and Nicolas Bouvier. Gross hematuria following SARS-CoV-2 vaccination in patients with IgA nephropathy, *Kidney Int.* 2021 Aug; 100(2): 466-468.

**SA-PO677**

**A Heavy Heart and Grieving Kidneys: C3 Glomerulonephritis Complicated With Cardiac Tamponade**

Wilfredo M. Pedreira, Charlynn De Jesus Ramos, Jaymilitte Bosques, Carlos Cortes, Mario J. Robles-Franceschini. *VA Caribbean Healthcare System, San Juan, Puerto Rico.*

**Introduction:** C3 glomerulopathies are rare complement-mediated kidney diseases classified as Dense Deposit Disease or C3 Glomerulonephritis (GN) based on structural manifestations on electron microscopy (EM), both which result after complement cascade dysregulation. Most common clinical presentations are proteinuria, hematuria, altered kidney function & hypertension. We herein present a case of C3GN with nephrotic syndrome (NS) & a rare complication.

**Case Description:** 66 y/o man recently hospitalized due to uncontrolled hypertension, new-onset NS, atrial fibrillation, & pneumonia developed involuntary movements, hypoxemia & hypotension days after discharge. Kidney biopsy results were pending & had been started on apixaban at discharge. POCUS: large pericardial effusion with right ventricular collapse during diastole. He was intubated & pericardiocentesis performed. Pericardial fluid: blood & inflammatory cells, other laboratories negative. Serum Cr: 2.58mg/dL BUN: 59.0mg/dL Alb:2.5g/dL Urine Prot/Cr: 6.37g. Kidney biopsy's light microscopy: diffuse mesangial & endocapillary cell proliferative GN with crescents. Immunofluorescence: IgM & kappa light chains: trace, C1q: +1, C3: +2, others: negative. EM: Small sub-endothelial deposits, no sub-epithelial nor mesangial deposits, & foot process effacement. Labs: decreased C3 & C4, increased ESR & CRP, rheumatologic, hematologic (including monoclonal gammopathy) & infectious (except IgG mycoplasma) workup negative. Patient met criteria for C3GN. Patient improved & was later discharged, currently on immunosuppressive therapy.

**Discussion:** Few reports of cardiac tamponade secondary to GN are present in the literature & to our knowledge, none related to C3GN. Although no mechanism has been explained in these patients, one could elucidate that circulatory congestion from NS could lead to formation of a pericardial effusion. Although recently started on apixaban, there is no evidence of increased risk of cardiac tamponade in anticoagulated patients compared with non-anticoagulated. Timely recognition of this unusual & lethal complication of Nephrotic Syndrome may prevent deaths.

**SA-PO678**

**Reduced Dose Non-Cyclical Oral Cyclophosphamide and Prednisolone for Membranous Nephropathy**

Karppagavalli Subramaniam, Srimathi Ponnusamy, Mangalakumar Veerasamy. *KMCH, Coimbatore, India.*

**Background:** Calcineurin inhibitors, rituximab and cyclic steroid & cyclophosphamide are the main therapeutic options in membranous nephropathy (MN). We describe the effect of non-cyclical reduced dose oral cyclophosphamide/ prednisolone (nCCP) in this group.

**Methods:** Patients were given oral cyclophosphamide (1.5mg/kg body weight/day) and prednisolone (0.5mg/kg body weight/day) for 3 months. At 3 months cyclophosphamide was stopped and prednisolone was tapered over the ensuing 4-7 weeks at a decremental rate of 5mg/week.

**Results:** Patient characteristics are described in table 1. Remission rates are given in figure 1. 3 patients experienced major adverse events (pneumonia -2, zoster-1, hemorrhagic cystitis-1).

**Conclusions:** nCCP regime appears to have comparable effect in inducing proteinuria remission at 6 & 12 months in this retrospective study and it was achieved using lower dose of cyclophosphamide. The latter may help to reduce cumulative cyclophosphamide related toxicities. This regime avoids pulse steroid infusion without losing the efficacy. Corticosteroid and cyclophosphamide were used simultaneously and whether this could help to use lower doses of cyclophosphamide merits further evaluation. Despite using lower dose of cyclophosphamide (1.5mg/kg as opposed to 2mg/kg in RI-CYCLO study) 1 of our patients developed hemorrhagic cystitis raises the important safety question about the use of cytotoxic agents.

Patient characteristics (Total no = 21)

Age in years, mean (SD)	43.7(11)
Sex - Male, n (%)	12(57)
DM, n (%)	2(9.5%)
HT, n (%)	11(52)
Weight (kg), mean (SD)	66.8(10.7)
Systolic BP (mmHg), mean (SD)	127.8(16)
Diastolic BP (mmHg), mean (SD)	76.6(8)
Serum creatinine (mg/dL), mean (SD)	0.7(0.23)
Urine protein/creatinine ratio, mean (SD)	7(3.4)
Serum albumin (g/dL), mean (SD)	2.2(0.5)
Total cholesterol (mg/dL), mean (SD)	316(95)
Serum anti-PLA2R antibody positivity, n(%)	14(66.7)

Remission rate  
No of patients in remission/Total number(%)

Time	Complete remission	Complete or partial remission
3 months	2/21 (9.5)	18/21 (85.7)
6 months	4/19 (21)	16/19 (84.2)
12 months	6/16 (37.5)	13/16 (81.25)

## SA-PO679

### Safety and Efficacy of Felzartamab (MOR202) in Anti-Phospholipase A2 Receptor (PLA2R) Autoantibody-Positive Membranous Nephropathy: The M-PLACE Study

Brad H. Rovin,<sup>1</sup> Pierre M. Ronco,<sup>2,10</sup> Jack F. Wetzels,<sup>3</sup> Sharon G. Adler,<sup>4</sup> Isabelle Ayoub,<sup>1</sup> Philippe Zaoui,<sup>5</sup> Seung Hyeok Han,<sup>6</sup> Julia Jauch-Lembach,<sup>7</sup> Nicola Faulhaber,<sup>7</sup> Jie Cui,<sup>8</sup> Stefan Haertle,<sup>7</sup> Ben Sprangers.<sup>9</sup> <sup>1</sup>The Ohio State University Wexner Medical Center, Columbus, OH; <sup>2</sup>Sorbonne Université and INSERM UMRS 1155, Paris, France; <sup>3</sup>Radboud University Medical Center, Nijmegen, Netherlands; <sup>4</sup>Lundquist Research Institute at Harbor UCLA, Torrance, CA; <sup>5</sup>Centre Hospitalier Universitaire Grenoble Alpes, Grenoble, France; <sup>6</sup>Yonsei University College of Medicine, Seoul, Republic of Korea; <sup>7</sup>MorphoSys AG, Planegg, Germany; <sup>8</sup>MorphoSys US Inc., Boston, MA; <sup>9</sup>University Hospitals Leuven, Leuven, Belgium; <sup>10</sup>Centre Hospitalier Le Mans, Le Mans, France.

**Background:** Primary membranous nephropathy (MN) is an autoimmune disease. Depleting CD20-/CD38+ plasma cells, potentially a main source of autoantibodies, may be an effective treatment (Tx) strategy for MN, particularly in patients (pts) with high PLA2R Ab titers. This interim analysis reports proof-of-mechanism data for felzartamab, a fully human IgG1 anti-CD38 mAb.

**Methods:** M-PLACE (NCT0145440) is a Phase Ib/IIa, open-label, multicenter, multinational study of adults with anti-PLA2R Abs-associated MN requiring immunosuppressive therapy (IST). Cohort 1: newly diagnosed and IST-relapsed pts; Cohort 2: IST-refractory pts. Pts received 9 felzartamab infusions (16 mg/kg) over six 28-day cycles, followed by a 28-week follow-up. Primary endpoints are incidence and severity of Tx-emergent adverse events (TEAEs); key secondary endpoint is the immunologic response rate based on anti-PLA2R Ab reductions; exploratory endpoints include the effect of Tx on 24h UPCR reduction.

**Results:** By April 10, 2022, 31 pts were enrolled from 21 sites in N. America, Asia-Pacific, and Europe (Cohort 1, n=18; Cohort 2, n=13); 23 pts have completed the Tx phase (Cohort 2, n=9). Mean (SD) age was 57.5 (11.8) years and 77.4% were male. At baseline, mean circulating anti-PLA2R Ab titer was 247.1 (259.3) U/mL; mean UPCR was 6.4 (2.2) g/g; mean eGFR was 60.2 (20.0) mL/min/1.73m<sup>2</sup>. Overall, 27 pts (87%) had at least one TEAE; TEAEs were mostly mild/moderate in severity and the majority resolved. The most commonly reported TEAE was infusion-related reaction (29% of pts; one Grade 3). Five pts (16%) experienced serious TEAEs. A ≥50% reduction in anti-PLA2R Ab titer from baseline was shown in 26/31 pts (84%). Change in anti-PLA2R Ab titer was generally followed by a timely change in UPCR. At ~12 months, 4/12 pts with EOS data showed >50% reduction in UPCR, including one refractory pt.

**Conclusions:** Longer follow-up of the M-PLACE study shows safety data consistent with the safety profile previously described and as expected in this underlying population. The early and pronounced anti-PLA2R Ab responses observed with felzartamab are encouraging, including in hard-to-treat patients; long-term UPCR responses will be further evaluated.

**Funding:** Commercial Support - MorphoSys AG

## SA-PO680

### PLA2R-Membranous Nephropathy in Black Americans: A Single Center Cohort

Swetha Rani Kanduri, Vipin Varghese, Juan Carlos Q. Velez. Ochsner Nephrology Ochsner Medical Center, New Orleans, LA.

**Background:** Phospholipase A2 receptor (PLA2R) antibody-associated membranous nephropathy (PLA2R-MN) is the most common type of MN. Although PLA2R-MN has been well characterized in cohorts in Asia, Europe and North America, description of its phenotype in a predominantly black population is lacking. We hypothesize that PLA2R-MN in black individuals is associated with unique serological or clinical phenotype.

**Methods:** We retrospectively reviewed records of adult patients diagnosed with PLA2R-MN in native kidneys over the last 5 years at a single medical center. Trajectories of anti-PLA2R titers were extracted. Rates of serological remission (SR) (anti-PLA2R < 2 RU/mL), partial remission (PR) [reduction in urine protein-to-creatinine ratio (UPCR) to 0.5 to 3.0 g/g without worsening serum creatinine (sCr)] and complete remission (CR) (UPCR < 0.5 g/g) were assessed at varying time points within a 24-month interval and compared between ethnic groups

**Results:** We included 41 patients, median age 61 years, 39% women, 61% self-identified black, 29% white, 5% Hispanic, and 5% Asian. PLA2R antigen was biopsy-

verified in 30/41 (73%). Median peak anti-PLA2R titer was 269 (21 - >1500) vs 100 (24 - 850) RU/mL for black patients (n=25) and other races (n=16), respectively (p=0.01). Median sCr was 1.0 mg/dL for both groups (p=0.58), whereas the median UPCR were 5.8 g/g in black patients and 5.8 g/g in others (p=0.9). Patients receiving immunosuppression (IST) (cyclophosphamide, rituximab, tacrolimus-based regimens) included 14/25 (56%) black patients and 7/16 (44%) of other races. No patient on either race group achieved SR by 3 months. Although the overall SR rates after 24 months were comparable (52% vs 56%), SR was achieved at a later time for black patients compared to other races [5/13 (38%) vs 8/9 (88%) achieved SR by 12 months in black and non-black patients, respectively, p=0.022]. Comparable PR and CR rates were observed

**Conclusions:** Individuals of black race with PLA2R-MN present with higher peak anti-PLA2R titers and may take longer to achieve serological remission with IST. The temporal difference in achieving SR was not driven by less common use of IST. Prospective studies will be needed to expand on this observation and its potential implication on harder clinical endpoints

## SA-PO681

### Prognostic Value of Anti-PLA2R-Ab on Long Term Outcomes in Primary Membranous Nephropathy

Omar S. Ragy,<sup>1</sup> Sebastian G. Bate,<sup>2</sup> Samar Qaisera Bukhari,<sup>3</sup> Arif Khwaja,<sup>3</sup> Anirudh Rao,<sup>4</sup> Durga Anil K Kanigicherla.<sup>2</sup> <sup>1</sup>Southmead Hospital, Bristol, United Kingdom; <sup>2</sup>Manchester Metropolitan University, Manchester, United Kingdom; <sup>3</sup>The University of Sheffield, Sheffield, United Kingdom; <sup>4</sup>NHS England and NHS Improvement North West, Manchester, United Kingdom.

**Background:** Better risk prediction tools are needed to improve longer-term outcomes in Primary Membranous Nephropathy (PMN). Studies well established the diagnostic utility of the Anti-PLA2R antibody test in PMN, but its prognostic value in clinical practice remains unclear. We aimed to assess a) the prognostic value of the Anti-PLA2R-Ab and compared its performance to conventional clinical markers of disease activity and b) the impact of testing on disease outcomes compared to outcomes before its discovery.

**Methods:** 222 patients from three centres in the North of England, UK who were diagnosed with PMN from January 2003 to July 2019 and had a serum Anti-PLA2R-Ab test (contemporaneously or retrospectively) were included. Baseline markers including protein creatinine ratio (uPCR), estimated GFR (eGFR), Anti-PLA2R-Ab status (positive and negative), Ab titre (high and low), and time of test (contemporary and retrospective) were assessed for risk with outcomes. The primary outcome was time to progression (composite of doubling of serum creatinine, CKD5, and death). Secondary outcomes were time to partial remission (PR) and time to immunosuppression. Cox proportional hazard (PH) models adjusted for baseline conventional biomarkers were used.

**Results:** Cox PH tests did not show significant correlation between Anti-PLA2R-Ab status (positive vs negative) and both time to progression (aHR 0.93, p=0.71), and time to PR (aHR 0.84, p=0.13). A similar lack of association with time to progression was noted for the Ab titre, High vs Low (aHR 1.07, p=0.77); there was a trend for a longer time to PR in the high Ab titre group (aHR 0.794, p=0.08). There was a strong association between conventional clinical markers: eGFR (HRz 0.767, p<0.05) and uPCR (HRz 1.44, p<0.005) and time to progression among all patients; and eGFR (HRz 0.61 p<0.005), among PLA2R-Ab positive patients. Time to Immunosuppression was significantly shorter in both the positive (HR=1.450, p<0.05) and high titre patients (aHR=1.42, p=0.02).

**Conclusions:** Anti-PLA2R-Ab status or Ab-titres do not outperform baseline conventional markers of eGFR and proteinuria in predicting disease progression in the longer term. Further studies are needed to best harness the utility of antibody testing in predicting disease progression in PMN.

## SA-PO682

### The Clinical Significance of Circulating piRNAs in Extracellular Vesicles in Patients With Idiopathic Membranous Nephropathy

Soonhyo Kwon,<sup>1</sup> In O Sun,<sup>2</sup> <sup>1</sup>Soonchunhyang University Hospital, Yongsan-gu, Seoul, Republic of Korea; <sup>2</sup>Presbyterian Medical Center, Jeonju, Jeollabuk-do, Republic of Korea.

**Background:** PIWI-interacting RNAs (piRNAs) are a distinct group of small non coding RNAs that regulate gene expression. Although piRNAs has been studied in predicting prognosis in kidney cancer, little is known about piRNAs in glomerular disease. Therefore, we investigated the clinical significance of piRNAs in nephrotic syndrome.

**Methods:** We prospectively enrolled 60 participants, including those with idiopathic nephrotic syndrome (IMN) (n=19) and idiopathic nephrotic syndrome (INS) (n=21) and healthy volunteers (HVs; n=20) in this study. Using RNA sequencing, we assessed the serum extracellular vesicle (EV)-piRNA profiles of all participants. We investigated whether the piRNAs could be helpful to discriminate IMN from INS and predict the treatment response of patients with IMN. Based on achievement of clinical remission, IMN patients were divided in to two groups [IMN-W (n=9) vs IMN-R (n=10)].

**Results:** We found 11 piRNAs that were upregulated and 6 that were downregulated in patients with IMN when compared to HVs. There were 22 miRNAs that were upregulated and 23 that were downregulated in patients with IMN when compared to the INS. Among these miRNAs, we found 5 piRNAs, whose levels were significantly up- or downregulated in patients with IMN compared to HVs and patients with INS. There were 50 upregulated and 11 downregulated piRNAs in patients with IMN-R when compared to patients with IMN-W. Of these piRNAs, the expression level of piRNA-42775 and piRNA-36743 were found to be inversely correlated with proteinuria on kidney biopsy.

Key: TH - Thursday; FR - Friday; SA - Saturday; OR - Oral; PO - Poster; PUB - Publication Only

Underline represents presenting author.



Meanwhile, a positive correlation was observed between renal function and expression of piRNA-43108.

**Conclusions:** Patients with IMN have a distinct EV-piRNA expression profile compared with INS and HVs. In addition, circulating EV-piRNAs could be useful to predict the treatment response of IMN patients.

#### SA-PO683

##### Is Lupus Podocytopathy Always a Benign Glomerulopathy?

**Cristiane B. Dias,** Leticia Jorge, Luis Yu, Viktoria Woronik. *Universidade de Sao Paulo, Sao Paulo, Brazil.*

**Background:** The aim of the study is to evaluate the clinical and histological characteristics, as well as evolution of patients with Lupus Podocytopathy (LP). LP is defined as patients with Systemic Lupus Erythematosus (SLE) and nephrotic syndrome whose diagnostic renal biopsy showed light microscopy with normal glomeruli (MCD) or focal segmental glomerulosclerosis (FSGS) or mesangial proliferation (MP), in addition to immunofluorescence with the absence of sub-epithelial or sub-endothelial deposits. For patients with a renal biopsy compatible with FSGS, the nephrotic presentation was not required as long as there was no chronicity on the renal biopsy.

**Methods:** This is a one Center retrospective study with LP patients submitted to renal biopsies from 1994 to 2017. Patients are highly responsive to corticosteroids but relapses are very common thus the impact of long-terms outcomes is unclear in literature.

**Results:** During the study period, 31 patients met the criteria for LP and had a median age of 32 (28-40) years at the time of renal biopsy, median proteinuria of 4.9 (3.7-8.27) g/day and serum albumin of 2.18 (1.57-2.65) g/dl. Only two patients did not have nephrotic syndrome at the time of renal biopsy, in addition, 42% had CKDEPI <60 ml/min/1.73m<sup>2</sup> and 25.8% had serum low C3 complement level. The time between the diagnosis of SLE and LP was 10 (2-33) months in 28 patients, whereas in three the renal diagnosis occurred before SLE. Histological diagnosis comprised 22 FSGS, 7 MCD and 2 MP. On follow-up owing to clinical criteria of progression and/or persistent proteinuria, ten patients underwent renal rebiopsy, highlighting that 5 patients transitioned to other histological class (3 Lupus Nephritis class IV originally one FSGS and two MP while 2 MP were originally MCD), others 5 patients remained as originally (4 FSGS with increased chronicity and 1 MCD). The median of follow-up time was 84 (53-120) months, being that two patients were lost to follow-up, while five patients (17%) had CKDEPI below 60 ml/min/1.73m<sup>2</sup> and one was on dialysis.

**Conclusions:** LP has a variable course with transition to more severe histological classe of Lupus Nephritis (class IV in three patients out of 31) and evolution to chronic kidney disease in approximately 20% of patients.

#### SA-PO684

##### The Trajectory of Glomerular and Tubulointerstitial Lesions After Treatment of Lupus Nephritis

**Ana Malvar,<sup>1</sup> Valeria G. Alberton,<sup>1</sup> Bruno J. Lococo,<sup>1</sup> Maria C. Lourenco,<sup>1</sup> Joaquín Martínez,<sup>1</sup> Mauro Elencwajg,<sup>1</sup> Haikady N. Nagaraja,<sup>2</sup> Brad H. Rovin.<sup>2</sup>** *<sup>1</sup>Hospital Fernandez, Buenos Aires, Argentina; <sup>2</sup>The Ohio State University, Columbus, OH.*

**Background:** Proliferative lupus nephritis (LN) is characterized histologically by glomerular and tubulointerstitial (TI) inflammation that presumably must resolve with treatment to achieve remission. Here we sought to document the trajectory of lesion resolution using serial kidney biopsies during LN treatment.

**Methods:** A cohort of proliferative LN patients was prospectively followed during treatment with standard LN therapy. Patients had a diagnostic kidney biopsy (Bx1), a biopsy generally within the first year of treatment (Bx2), and a biopsy after at least 3 years of total immunosuppression (Bx3). The NIH activity and chronicity indices (AI, CI) were calculated at each biopsy.

**Results:** The cohort (n=110) was followed for a median (range) of 109 (34, 202) months. Patients were treated with either MMF or cyclophosphamide initially. Overall, the patients did very well. Only 2 patients developed ESKD by last follow-up and only 9 patients had CKD (eGFR <60 ml/min/1.73m<sup>2</sup>), but this was pre-existing in 4 patients. AI followed an exponential decline after starting treatment. At the time of Bx2 (an average 9.7 months after Bx1), the percent of biopsies positive for cellular crescents (CC), fibrinoid necrosis (FN), and neutrophil infiltration (NEU) fell precipitously, while the decline of endocapillary hypercellularity (EH) and hyaline deposits (HD) was more gradual. At Bx3 (an average of 42.6 months after Bx1) fewer than 5% of biopsies had residual CC, FN, NEU, or interstitial inflammation, but 25% still had EH and HD. By immunofluorescence microscopy over 90% of Bx1 biopsies had IgG and complement components C3 and C1q. At Bx3 only 30-40% of biopsies continued to show IF for complement, but IgG was still present in 66% of biopsies. The CI increased after Bx1. The rate of increase of all CI components was greatest from Bx1 to Bx2, slowed between Bx2 and Bx3, and actually declined for fibrous crescents.

**Conclusions:** These data show that the most inflammatory lesions found in proliferative LN are rapidly responsive to immunosuppression, but EH and HD are more resistant. Complement deposition resolves quickly, but IgG is present in glomeruli for a long time. Despite rapid improvement in active inflammation, kidneys sustain chronic damage early in the disease course.

**Funding:** Other NIH Support - NIAMS

#### SA-PO685

##### Feasibility and Safety of Obtaining Kidney Biopsy Research Cores in a Predominantly Black Lupus Nephritis Patient Population

**Jason Cobb,<sup>1</sup> Alton B. Farris,<sup>1</sup> Ahmad Akhgar,<sup>2</sup> Gabor G. Illei,<sup>2</sup> Dominic P. Sinibaldi,<sup>2</sup> Wendy I. White,<sup>2</sup> S. Sam Lim.<sup>1</sup>** *<sup>1</sup>Emory University School of Medicine, Atlanta, GA; <sup>2</sup>AstraZeneca Pharmaceuticals LP, Wilmington, DE.*

**Background:** Lupus nephritis (LN) occurs in >50% of patients with SLE. Black patients disproportionately suffer from LN with more severe disease. Histologic examination of kidney tissue is required for definitive diagnosis and advancing the science. We are reporting the feasibility and safety of obtaining kidney biopsy research cores in a high-risk group of LN patients as part of a study that was carried out to detect novel biomarkers associated with LN.

**Methods:** Patients suspected of having LN were referred for a diagnostic kidney biopsy, and all had estimated proteinuria >500 mg/g. Patients consented to an extra pass for the obtainment of a research core. Kidney biopsies were performed at three hospitals: Emory University Hospital, Emory University Hospital Midtown, and Grady Memorial Hospital.

**Results:** A total of 47 patients suspected of LN were enrolled from 2014-2017. All patients underwent at least 3 core passes using standard 16 cm, 18 gauge biopsy needles by interventional radiologists (CT guided) or nephrology services (ultrasound guided). A total of 46 LN patients had a kidney biopsy and 40 patients had sufficient research core samples. Standard of care for CT guided kidney biopsy is same-day hospital discharge and an overnight stay after an ultrasound guided biopsy. Patients were 82% female and 90% Black race. The mean systolic blood pressure was 135 ± 17 mmHg. The mean hemoglobin was 10±1.8 g/dL and mean platelet count 219±94 10<sup>3</sup>/mL. Only one LN patient had an adverse outcome requiring hospital admission after a CT guided biopsy and that patient required renal artery embolization but did not receive a blood transfusion.

**Conclusions:** We demonstrated that the obtainment of research core samples in addition to the usual cores needed for a diagnostic kidney biopsy is feasible and overall safe with only 1 patient requiring an unplanned hospital admission. Suspected LN patients were generally agreeable to an extra pass for research purposes, particularly notable in this sample of mostly Black patients. The obtainment of research kidney biopsy cores is a newer discussion topic in nephrology, and this study is even more unique since it was successfully carried out in SLE patients which are likely at higher risk of bleeding due to higher rates of thrombocytopenia and anemia.

**Funding:** Commercial Support - AstraZeneca

#### SA-PO686

##### Repeated Renal Flares in Lupus Nephritis Are Associated With Decreased Response to Therapy, Progression of Kidney Disease, and Patient Survival

**Sofia E. M. Macedo,<sup>1,2</sup> Abril A. Pérez Arias,<sup>1,3</sup> María F. Zavala Miranda,<sup>1,2</sup> Cristinoc Cruz,<sup>1,2</sup> Luis E. Morales-Buenrostro,<sup>1,2</sup> Juan M. Mejia-Vilet.<sup>1,2</sup>** *<sup>1</sup>Instituto Nacional de Ciencias Medicas y Nutricion Salvador Zubiran, Mexico City, Mexico; <sup>2</sup>Universidad Nacional Autonoma de Mexico, Mexico City, Mexico; <sup>3</sup>Universidad Autonoma de Baja California, Mexicali, Mexico.*

**Background:** Repeated renal flares in lupus nephritis (LN) occur in some patients with systemic lupus erythematosus and have been associated with worse long-term kidney function. This study aimed to assess the impact of repeated LN flares in response to therapy, kidney and patient prognosis.

**Methods:** All patients from a well-characterized biopsy-proven LN cohort between 2008 and 2018 were segregated into three groups according to the number of LN flare when they entered our cohort: first LN flare, second LN flare, or third LN flare. The following outcomes were evaluated by unadjusted and adjusted time-to-event analyses: complete and partial response, disease relapses, progression to decline of 30% of the eGFR, doubling of serum creatinine, end-stage kidney disease, and patient survival.

**Results:** A total of 441 patients were included: 257 (58%) in their first LN flare, 102 (23%) in their second LN flare, and 82 (19%) in their third LN flare. There were significant differences in LN flare presentation in age, eGFR, serum albumin, pyuria, and hematuria among groups. The NIH chronicity indices and the percentage of patients with vascular lesions were higher in groups at progressive LN flares. In the adjusted analyses, complete and partial response rates decreased, as well as kidney and patient survival, at a progressive number of LN flares. No differences in the dynamic course of all surveillance laboratory parameters were observed in the first year after initial therapy among LN flare groups.

**Conclusions:** A progressive number of LN flares is associated with a lower response to therapy and an adverse prognosis for kidney function and patient survival. The history of LN flares should be accounted for in clinical practice and clinical trials in lupus nephritis.

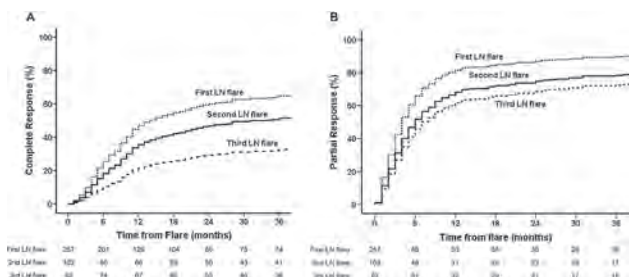

Figure 1. Complete (A) and Partial (B) response rates for lupus nephritis patients in their first, second, or third flare.

SA-PO687

Outcomes of Immunosuppressive Therapy in Lupus Nephritis

Pamela O. Tan Lim, National Kidney and Transplant Institute, Quezon City, Philippines.

**Background:** Lupus Nephritis (LN) is one of the severe manifestations of Systemic Lupus Erythematosus (SLE). Renal involvement is seen in about >50% of the patients which caused significant morbidity. Over the past decades, the survival rate of patients with LN has improved dramatically because of improvement in the classification of patients, improvement in diagnosis, more intensive treatment with the use of immunosuppressive/cytotoxic agents, high dose corticosteroid pulse therapy, and advances in the treatment of hypertension, infections and renal failure.

**Methods:** Biopsy proven LN patients, diagnosed from January 2015 to December 2019, and started on immunosuppressive therapy were included. The demographic and clinical characteristics were retrieved from electronic medical records. Laboratory results at baseline, at initiation of treatment, and at time of remission and flare were assessed.

**Results:** Fifty-five biopsy proven LN patients were included. Median age was 27 years at time of biopsy and majority were female (89.09%). Thirty one (56.36%) patients had Class IV LN; the median lupus activity score was 4 (ranging from 0-12), and chronicity score was 2 (ranging from 0-12). Complete remission was observed in 16 (29.09%) patients and partial remission was noted in 31 (56.36%) patients. There was no response in three patients, ESRD in five patients and no deaths. The time to remission is at 6 months on the average and the median time to renal flare was 18 months. The risk of renal flares increases by 2% for every one month increase in the delay between diagnosis and treatment.

**Conclusions:** Among patients diagnosed with LN, treatment with induction therapy followed by maintenance therapy ensured good efficacy. The occurrence of renal flare after initiation of treatment was 18 months. Early response to treatment on diagnosis may lessen risk of renal flares.

Outcomes in lupus nephritis

	Frequency (%); Median [95% CI]
Remission	47 (85.45)
Complete	16 (29.09)
Partial	31 (56.36)
No response	3 (5.45)
ESRD	5 (9.09)
Death	0
Time to partial or complete remission from start of treatment (months)	6 [5 to 7]
Lupus flare	15 (27.27)
Time to lupus flare from start of treatment (months)	18 [11 to 18]

SA-PO688

Voclosporin Induces Systemic Lipidomic Alterations: Implications in the Remission of Lupus Nephritis

Farsad Afshinnia,<sup>1</sup> Linda M. Rehaume,<sup>2</sup> Jennifer Cross,<sup>2</sup> Robert B. Huizinga,<sup>2</sup> Subramaniam Pennathur.<sup>1</sup> <sup>1</sup>University of Michigan, Ann Arbor, MI; <sup>2</sup>Aurinia Pharmaceuticals Inc, Victoria, BC, Canada.

**Background:** Voclosporin is a novel calcineurin inhibitor indicated for the treatment of adults with active lupus nephritis (LN). Cardiovascular disease (CVD) is a major cause of morbidity and mortality in SLE patients, and LN is an independent CVD risk factor. The AURORA 1 trial showed favorable renal clinical response and changes in traditional lipoproteins with voclosporin. We hypothesize that the beneficial therapeutic response is mediated in part by alteration in circulating lipids.

**Methods:** In a lipidomic analysis, 918 serum lipids in 14 classes from baseline and week 52 of randomly selected participants from control (placebo) (N=30) and voclosporin (N=28) arms of the AURORA 1 trial (ClinicalTrials.gov, NCT03021499; EudraCT, 2016-004045-81) were compared. All patients received MMF and low-dose steroids. The difference of lipids at week 52 from baseline was calculated, z-score standardized, and used in mixed linear models.

**Results:** The alterations of lipid class levels were assessed as a function of voclosporin effect and by achievement of either complete renal response (CRR) or partial renal response (PRR) (Table). Voclosporin and renal clinical response (CRR or PRR) contributed to decline in CERs and TAGs and increase in DCERs and PIs independent of each other. Results indicate the additive effects of voclosporin and renal clinical response on alteration of corresponding lipids. Voclosporin, CRR and PRR were independently associated with alteration of PC(C16), PIs, and TAGs. An integrative analysis showed significant correlations between saturated DAGs and MAGs (C>16), TAGs, SMs, CERs, unsaturated PEPs, and palmitoyl PCs(C16) after controlling for CRR or PRR.

**Conclusions:** CERs, DCERs, PIs, and TAGs are altered by voclosporin. Alterations of PC, PI and TAGs correlate with renal outcome independent of voclosporin. Collectively, these findings suggest that voclosporin reduces lipogenesis by decreasing incorporation of fatty acid precursors, and a favorable therapeutic response is mediated in part by promotion of change in corresponding lipid class.

**Funding:** Commercial Support - Aurinia Pharmaceuticals Inc.

Lipids	Voclosporin effect (N=28 vs N=30 in control)	CRR effect (N=14 with CRR vs N=4 with no CRR)	PRR effect (N=28 with PRR vs N=28 with no PRR)	Interaction between voclosporin and CRR	Interaction between voclosporin and PRR
Ceramides (CER)	Decreased	Decreased	Decreased	Decreased	Decreased
Dihydroceramids (DCER)	Increased	Increased	Increased	Increased	Increased
Monoglycerol (MAG) (C12-18)	Decreased	Decreased	Decreased	Decreased	Decreased
Saturated Diacylglycerol (SAG)	Decreased	Decreased	Decreased	Decreased	Decreased
Lysosphosphatidylcholine (LPC) (C14-18)	Decreased	Decreased	Decreased	Decreased	Decreased
Phosphatidylcholine (PC) (C16)	Decreased	Decreased	Decreased	Decreased	Decreased
Phosphatidylethanolamine (PE)	Increased	Increased	Increased	Increased	Increased
Sphingomyelin (SM)	Decreased	Decreased	Decreased	Decreased	Decreased
Triacylglycerol (TAG)	Decreased	Decreased	Decreased	Decreased	Decreased

Note: Each column shows the change in mean of lipid class from baseline to week 52 by the main effects of voclosporin, clinical response and their interaction. Complete renal response assessed at Week 52 was defined as using protein creatinine ratio (UPCR) < 5.5 mg/mg, stable renal function (eGFR > 60 mL/min/1.73 m<sup>2</sup> or no decrease >20% from baseline), presence of sustained, low-dose steroids (in the 8 weeks prior to assessment) and no use of rescue medication. Partial renal response defined as a 50% reduction from baseline in UPCR. P-values are < 0.02.

SA-PO689

Comparison of Clinical Efficacy of Centrifugal-Membranous Hybrid Double Filtration Plasmapheresis and Membranous Double Filtration Plasmapheresis on Severe Lupus Nephritis

Jianhua Dong, Li Huang, Wenjing Fan, Yongchun Ge. JinLing Hospital, Nanjing, China.

**Background:** The Study delves into the clinical efficacy and safety of centrifugal-Membranous Hybrid double filtration plasmapheresis (C/M hybrid DFPP) on severe lupus nephritis (LN) by comparing it with membranous DFPP (M DFPP).

**Methods:** A retrospective cohort study was conducted in 70 patients who were diagnosed with severe LN and had received DFPP treatment from 2016 to 2021. 51 patients received C/M hybrid DFPP, and 19 patients received M DFPP. The differences in clinical efficacy, vascular access, dosage of anticoagulant, treatment cost and adverse events were compared in the two types of DFPP.

**Results:** A total of 181 DFPPs (133 C/M hybrid DFPPs and 48 M DFPPs) were performed. The ANA, AdSDNA titer, quantitative urinary protein, urinary red blood cell count and serum creatinine decreased and hemoglobin increased after the DFPP treatment and at 3<sup>rd</sup> month after treatment, however, there was no significant difference between the two groups. All patients built the vascular access via the central venous catheter in M DFPP, while 8 patients built the vascular access via puncturing into the peripheral artery and vein in C/M hybrid DFPP. 34 patients (66.7%) received 4% citric acid alone for anticoagulation in C/M hybrid DFPP, the dosage of LMWH was significantly lower than that in M DFPP (1204±286 vs 4106±399IU, P<0.001). M DFPP had a significantly higher cost than C/M hybrid DFPP. 2 patients in M DFPP developed skin ectasis, epistaxis or aggravated alveolar hemorrhage, and 4 patients in C/M hybrid DFPP developed perioral numbness, numbness in distal extremities or tetany.

**Conclusions:** C/M hybrid DFPP could be a cost-effective treatment strategy applied in patients with severe LN.

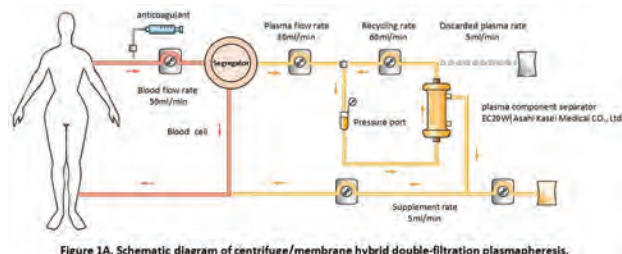

Figure 1A. Schematic diagram of centrifugal/membranous hybrid double-filtration plasmapheresis.

Schematic diagram of Centrifugal-membranous hybrid DFPP

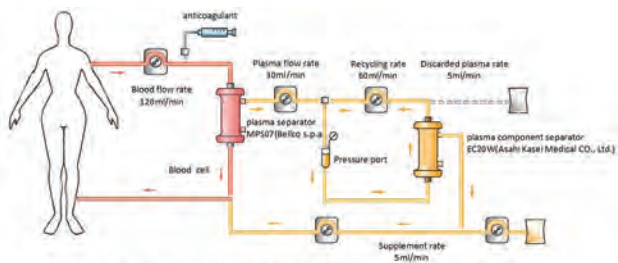

Figure 1B. Schematic diagram of membrane double-filtration plasmapheresis.

Schematic diagram of membranous hybrid DFPP

SA-PO690

Systemic Lupus Erythematosus (SLE) Nephritis and COVID-19

Lakshmi Aishwarya Pavuluri,<sup>1</sup> Venkata A. Yalamanchili,<sup>2</sup> Ram Rapur.<sup>1</sup> Nephrology, SVIMS, Tirupati <sup>1</sup>Sri Venkateswara Institute of Medical Sciences, Tirupati, India; <sup>2</sup>Dallas Nephrology Associates, Dallas, TX.

**Background:** We report the outcomes of renal biopsy proven SLE nephritis patients after COVID-19 infection from Sri Venkateswara Institute of Medical Sciences (SVIMS), a tertiary care referral center and University Hospital in Tirupati, India.

**Methods:** Our institute has been declared as State COVID-19 hospital in the last week of the March 2020. From then, till now we had admitted and managed COVID-19 patients from several districts of Andhra Pradesh and neighbour states. We collected the data of patients with biopsy proven SLE nephritis contemporaneously from admission to the outcomes on a computerised proforma. We employed the following statistics. For the data of continuous variables and categorical variables, student t test and chi square tests were used respectively. For the risk factors for mortality univariate linear regression was used. We used Medcalc free online software.

**Results:** We had identified sixteen patients of SLE nephritis admitted with COVID-19 disease. Of them fourteen were females and two were males. The mean age was 29.3 years. Out of sixteen patients, seven patients, required mechanical ventilator and dialysis and eventually died during their hospitalization. One more patient expired due to disseminated tuberculosis (50%). We identified the patients who died were of younger age, had higher serum creatinine at presentation, higher CT severity score and lower serum albumin as factors which had significant effect on mortality.

**Conclusions:** Of the more than 20 studies published on SLE patients with COVID-19, none of the studies focussed on the lupus nephritis. Our results suggested that with the approximately 50% mortality the COVID -19 disease had a calamitous effect on SLE nephritis patients.

Parameters related to systemic lupus erythematosus nephritis

Parameter	Result before COVID-19 disease	Result during/after COVID-19 disease
Anti dsDNA titre (reference range: > 40 WHO IU/mL - positive)	163.8 ± 30.3	147.6 ± 23.0
Complement C3 (reference range: 91 - 156 mg/dL)	70.9 ± 8.9	81.0 ± 7.6
Complement C4 (reference Range: 20 - 50 mg/dL)	18.4 ± 2.1	21.3 ± 4.5
Serum creatinine (mg/dL) in patients without renal failure (n=8) (mean ± SD) (range)	1.17±0.20 (0.9-1.4)	1.32 ± 0.22 (1.05-1.24)
Serum creatinine (mg/dL) in patients with renal failure (n=8) (mean ± SD) (range)	7.82 ± 3.25 (3.5-12.1)	9.0±3.0 (6.1-11.9)
Renal biopsy in SLE patients admitted with COVID-19 (n=16)	Class IV: 10 Class III+V: 4 Class V: 2	Class VI: *
Treatment of SLE nephritis	Steroids, cyclophosphamide and ACE-inhibitors	Steroids

\* A 17-year-girl, SLE nephritis Class IV diagnosed before COVID-19 presented with haematuria after the diagnosis of COVID-19. A repeat renal biopsy done during COVID-19 disease revealed crescents

SA-PO691

The First-Year Course of Urine MCP-1 Is Associated With Response to the Initial Therapy and Long-Term Prognosis

Abril A. Pérez Arias,<sup>1,2</sup> Sofia E. M. Macedo,<sup>1,3</sup> María F. Zavala Miranda,<sup>1,3</sup> Cristinoc Cruz,<sup>1,3</sup> Luis E. Morales-Buenrostro,<sup>1,3</sup> Juan M. Mejia-Vilet.<sup>1,3</sup> <sup>1</sup>Instituto Nacional de Ciencias Medicas y Nutricion Salvador Zubiran, Mexico City, Mexico; <sup>2</sup>Universidad Autonoma de Baja California, Mexicali, Mexico; <sup>3</sup>Universidad Nacional Autonoma de Mexico, Mexico City, Mexico.

**Background:** There is a need for useful biomarkers in lupus nephritis. The monocyte chemoattractant protein 1 (MCP-1) has been previously proposed as a biomarker of disease activity, however, it has been study at single timepoints and with short follow-up. We aimed o assess the course of uMCP-1 and its association with response to therapy and long-term kidney function in a prospective cohort of adults who received a kidney biopsy for suspicion of active lupus nephritis (LN).

**Methods:** Subjects were segregated into a histologically active LN group and a histologically chronic LN group. Both groups were followed for >36 months and urine were collected at flare, 3-, 6-, and 12-months of follow-up. The association between the

course of uMCP-1, response to treatment, and progression to 30% loss of the eGFR was evaluated by linear mixed models for repeated measures.

**Results:** A kidney biopsy was performed on 125 subjects. In 114 the report was consistent with histologically active LN, and in 11 with chronic LN. Urine MCP-1 levels were significantly higher in the active LN than in the chronic LN group. Urine MCP-1 levels correlated with the histological findings of cellular crescents, endocapillary hypercellularity, interstitial inflammation, glomerular sclerosis, interstitial fibrosis, and tubular atrophy. The mean estimates of uMCP-1 at flare were higher in the non-response group than in the complete response group, and decreased in the complete/partial response groups by the 3<sup>rd</sup> month, while they remained elevated in the non-response group. The mean estimates for uMCP-1 were higher at LN flare and remained elevated in patients who progressed to loss of 30% of the eGFR, while they decreased in patients with stable kidney function.

**Conclusions:** The first-year course of uMCP-1 is associated with response to therapy and kidney survival in lupus nephritis.

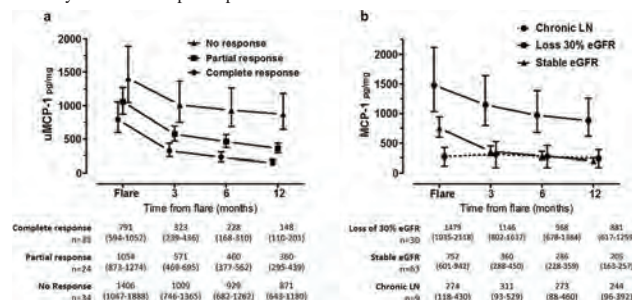

Figure 1. First-year course of urine MCP-1 levels according to response to therapy (a) and long-term kidney prognosis (b).

SA-PO692

Low Chronicity Score at Kidney Biopsy Predicts Renal Recovery From Dialysis in Patients With ANCA-Associated Vasculitis With Glomerulonephritis

Dalia Zubidat,<sup>1</sup> Marta I. Casal Moura,<sup>1</sup> Marc Patricio-Liébona,<sup>2</sup> Maria Jose Soler,<sup>2</sup> Fernanda G. Dos Santos,<sup>1</sup> Luca Nardelli,<sup>1</sup> Juan C. León Román,<sup>2</sup> Ciria L. De Sousa,<sup>1</sup> Ladan Zand,<sup>1</sup> Sanjeev Sethi,<sup>1</sup> Ulrich Specks,<sup>1</sup> Fernando C. Fervenza.<sup>1</sup> <sup>1</sup>Mayo Foundation for Medical Education and Research, Rochester, MN; <sup>2</sup>Hospital Universitari Vall d'Hebron, Barcelona, Spain.

**Background:** Predictors of renal recovery from dialysis after remission-induction therapy in patients with ANCA-associated vasculitis with glomerulonephritis (AAV-GN) are not fully characterized.

**Methods:** We conducted a retrospective cohort study of MPO- or PR3-ANCA positive patients with AAV (MPA and GPA) and active renal disease requiring dialysis followed between 1996-2021 at two tertiary care centers.

**Results:** We analyzed 110 patients that needed dialysis and had undergone kidney biopsy at the time of AAV-GN presentation. Seventy-nine patients (71.8%) remained permanently on dialysis, while 31 patients (28.2%) required dialysis only transiently (16 patients received PLEX). There were no differences in severity of the disease as assessed by BVAS/WG (8vs.8 points, p=0.990) nor in eGFR (9.7vs.9.1mL/min/1.73 m<sup>2</sup>, p=0.902). There were no differences in the activity index on kidney biopsies (assessed by the % of crescents or necrosis/total glomeruli). However, most patients who recovered from dialysis had a minimal/mild chronicity score (64.5vs.39.2%, p<0.0001), whereas patients that remained on dialysis more frequently had moderate/severe chronicity features (60.8vs.35.5%, p<0.0001). There were no differences in the remission-induction immunosuppressants, or use of i.v. methylprednisolone or PLEX. In patients who recovered from dialysis, rituximab was the most frequently used remission-maintenance treatment (42.9vs.10.0%, p=0.005). Mortality was higher in patients who remained on dialysis (35.4vs.12.9%, p=0.019). Minimal/mild scoring of the biopsy was a predictor of recovery from dialysis (OR 2.815;CI95%.1.187-6.675, p=0.019) in univariable analysis. Assuming a p<0.100, we performed a multivariable analysis, and when adjusted to the treatment with PLEX, minimal/mild scoring of the biopsy remained a predictor of recovery from dialysis (OR 2.529;CI95%.1.046-6.118, p=0.040) (Table 1).

**Conclusions:** In patients with AAV-GN, renal recovery from dialysis depends on the chronicity score of the kidney biopsy at the time of diagnosis and not on the use of PLEX.

Recovery from dialysis	Multivariable Logistic Regression	
	OR (95% CI)	P-value
Minimal / Mild grades (MCCS)	2.529 (1.046 - 6.118)	0.040
PLEX	1.701 (0.708 - 4.085)	0.235

SA-PO693

**Renal Medullary Angiitis and Arteritis in ANCA Vasculitis: Clinico-Pathologic Features and Outcomes**

Grant Kirby,<sup>1</sup> Alana Dasgupta,<sup>1</sup> Abdulrahman K. Alabdulsalam,<sup>2</sup> Avi Z. Rosenberg,<sup>1</sup> Duvuru Geetha,<sup>1</sup> Johns Hopkins Nephrology <sup>1</sup>Johns Hopkins Medicine, Baltimore, MD; <sup>2</sup>King Abdulaziz Medical City, Riyadh, Saudi Arabia.

**Background:** The hallmark of ANCA associated glomerulonephritis is a pauci-immune glomerulonephritis, with renal medullary angiitis (RMA) and arteritis (AR) reported infrequently. We sought to compare the clinico-pathologic characteristics, renal risk score (RRS) and outcomes of RMA and AR in ANCA-associated vasculitis (AAV) patients who underwent a diagnostic kidney biopsy.

**Methods:** AAV patients with a kidney biopsy diagnosis of RMA and AR were included. RMA was defined by the presence of interstitial hemorrhage in the medulla associated, polymorphonuclear leukocyte infiltrate and karyorrhectic debris. AR was defined by fibrinoid necrosis of the vessel wall and/or inflammatory infiltrate involving the media of the artery. Demographic, clinical and treatment details were extracted by record review. Descriptive statistics were analyzed to evaluate variables of interest.

**Results:** Of 136 AAV biopsies, 13 had RMA and 13 had AR. The mean (SD) age was 65 (19) yrs for RMA and 72 (9) yrs in AR. At entry all had severe disease with-eGFR of  $\leq 20$ . There were no differences in ANCA type, entry e-GFR, proteinuria or extra-renal vasculitis between the groups. All biopsies included cortex and medulla with a mean (SD) glomeruli of 9 (5) in RMA and 27 (30) in AR. There were no significant differences in the % of normal glomeruli, global sclerosis, glomerular necrosis, or crescents between RMA and RA. RRS was moderate/high in 69% of patients. All patients were treated with glucocorticoids and either cyclophosphamide or rituximab or mycophenolate. All patients with RMA achieved remission while 2 with AR had early mortality secondary to active vasculitis. Similar improvements in e-GFR were noted at 12 M in both groups.

**Conclusions:** RMA and AR was seen in 10% of biopsies in our cohort and clinically presents with severely impaired renal function. Glomerular crescents, necrosis and interstitial inflammation with less chronicity are observed in both RMA and AR. Although, majority of RMA patients respond to immunosuppression with good kidney recovery, refractory vasculitis is seen 15% of patients with AR.

**Funding:** Clinical Revenue Support

SA-PO694

**Economic Evaluation of Azathioprine vs. Rituximab in ANCA-Vasculitis in the United States**

Lexy Ehlert,<sup>1</sup> Vimal K. Derebail,<sup>1</sup> Susan L. Hogan,<sup>1</sup> Sherrie L. Aspinall,<sup>2,3</sup> Carolyn T. Thorpe,<sup>1,4</sup> <sup>1</sup>The University of North Carolina at Chapel Hill, Chapel Hill, NC; <sup>2</sup>VA Center for Health Equity Research and Promotion, Pittsburgh, PA; <sup>3</sup>University of Pittsburgh School of Pharmacy, Pittsburgh, PA; <sup>4</sup>Veterans Affairs Pittsburgh Healthcare System, Pittsburgh, PA.

**Background:** Research indicates that rituximab (RTX) is superior to azathioprine (AZA) as a maintenance therapy in preventing relapse among patients in remission for ANCA-vasculitis (AV), including granulomatosis with polyangiitis, microscopic polyangiitis, and renal-limited disease. Some guidelines recommend RTX as first-line therapy, with AZA as second-line therapy. Because RTX is 15.5 times as expensive as AZA, we sought to evaluate the cost-effectiveness of RTX vs. AZA as a maintenance therapy in AV, from a U.S. payer, or health plan, perspective.

**Methods:** We used a 10-year Markov model with a hypothetical cohort of 10,000 patients. In this model, patients moved through four health states (see Figure). Model inputs included health state transition probabilities; probabilities of infection, cancer, and cardiovascular events; costs of treatment and outcomes; health state utility weights; and cost/utility discount rates. We did not include end-stage kidney disease, likely captured by relapse/death. Model outputs were years patients spent in relapse, deaths, costs, and quality-adjusted life-years (QALYs). We conducted a one-way sensitivity analysis to account for wide variation in medication costs.

**Results:** Therapy-specific results are reported in the Table. The incremental cost of RTX treatment was \$171 million. The cost per major relapse year averted was \$63,018 and the cost per death averted was \$142,869. The cost per QALY gained was \$43,936. In our one-way sensitivity analysis, we found that if payers pay 100% of the listed drug price, then the cost per QALY gained is ~\$44,000. If drug costs can be reduced to 50% of current listed price, then the cost per QALY gained is ~\$15,000.

**Conclusions:** Though RTX is associated with better health outcomes in this population, \$44,000/QALY may be above the willingness-to-pay threshold for some U.S. payers. Efforts to reduce RTX cost can help payers stay within their WTP range and decrease overall healthcare spending.

Treatment Arm	Minor Relapse Years	Major Relapse Years	Deaths	QALYs
Azathioprine	4,993	15,530	2,103	53,065
Rituximab	5,043	12,813	904	56,963

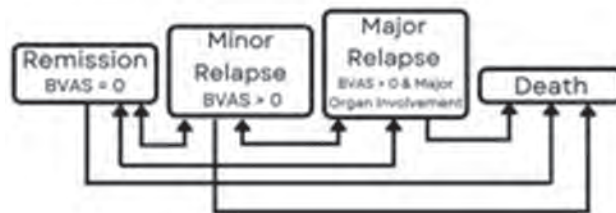

SA-PO695

**Successful Treatment With Eculizumab in Patients With Severe ANCA Vasculitis**

Miguel Uriol Rivera,<sup>1,2</sup> Gemma Arrufat Goterris,<sup>1</sup> Aina Obrador,<sup>1</sup> Angel Garcia-Alvarez,<sup>3</sup> Sonia Jimenez,<sup>1</sup> <sup>1</sup>Hospital Universitari Son Espases, Palma de Mallorca, Spain; <sup>2</sup>Fundacio Institut d'Investigacio Sanitaria Illes Balears, Palma de Mallorca, Spain; <sup>3</sup>Hospital Comarcal d'Inca, Inca, Spain.

**Background:** Severe presentation of ANCA vasculitis is a life-threatening disease despite aggressive immunosuppression therapy. Complement hyperactivation is involved in pathogenesis; thus, the effect of the C5 inhibitor (eculizumab) used in severe forms of ANCA vasculitis may be a treatment option.

**Methods:** This is a retrospective study. Nine patients were included. Period of study: from May 2017 to May 2022. All patients received at least 3 drugs (steroids, rituximab and mycophenolate or cyclophosphamide) before eculizumab. Eculizumab was indicated as an off-label indication due to lack of improvement or clinical worsening.

**Results:** Mean (SD) age: 62 (15) years. Female: 4. Three patients showed serum anti-proteinase 3 antineutrophil cytoplasmic antibody (PR3-ANCA) and 5 (myeloperoxidase: MPO-ANCA) and one was ANCA-negative. Six patients had an estimated glomerular filtration rate (eGFR) < 10 ml/min/1.73 m<sup>2</sup> at presentation. Five patients had pulmonary involvement. The mean (min-max) time of follow-up after the onset of eculizumab was 27 (1-60) months. One patient ANCA-negative microscopic polyangiitis with diffuse alveolar hemorrhage needed orotracheal intubation and had a satisfactory evolution after eculizumab; however, 20 days after, the patient developed a COVID-19 infection and died. One patient who needed urgent dialysis at presentation did not recover renal function and showed a complement factor H mutation. The evolution of the other 7 patients was as follows: the median (p25-p75) eGFR increased from baseline to the end of the follow-up: 9.1(4.8-21.7)ml/min/1.73m<sup>2</sup> to 31(13-45)ml/min/1.73m<sup>2</sup>, respectively (P=0.018) and the mild proteinuria disappeared in all patients. Alveolar hemorrhage improved in all patients within seven days after the first eculizumab administration. The median (p25-p75) doses of eculizumab administered were 1800(1800-3600) mg. One patient required eculizumab for two different periods.

**Conclusions:** One patient died due to a COVID-19 infection, and one remained in chronic renal replacement therapy. Alveolar hemorrhage was well controlled in all patients. The eGFR increased significantly in 7/9 patients, and in 4/6 patients, dialysis could be withdrawn. In severe ANCA vasculitis, eculizumab should be considered for improving outcomes.

**Funding:** Other NIH Support - none funding

SA-PO696

**Integrated Safety of Avacopan in ANCA-Associated Vasculitis**

David R. Jayne,<sup>1</sup> Pirow Bekker,<sup>2</sup> <sup>1</sup>University of Cambridge, Cambridge, United Kingdom; <sup>2</sup>ChemoCentryx Inc, San Carlos, CA.

**Background:** Avacopan (TAVNEOS®) is approved as adjunctive treatment for adults with ANCA-associated vasculitis (AAV). Integrated safety data from 2 Phase 2 and 1 Phase 3 studies in 439 AAV patients is reported.

**Methods:** In the 3 trials, all groups received background cyclophosphamide followed by azathioprine, or rituximab; control groups received full prednisone regimen (60mg tapered to 0 over 20 weeks) plus placebo. The Phase 2 CLEAR trial (Jayne et al. 2017) had 3 groups: control (N=23), avacopan 30mg twice daily (BID)+low dose prednisone (N=22), and avacopan+no prednisone (N=22). The Phase 2 CLASSIC trial (Merkel et al. 2020) had 3 groups: control (N=13), avacopan 10mg BID (N=13), and 30mg BID (N=16). The Phase 3 trial (ADVOCATE; Jayne et al. 2021) had a control group (N=164) and a 30mg avacopan group with no oral glucocorticoid taper (N=166). The treatment period was 12 weeks in Phase 2 and 52 weeks in Phase 3. Integrated exposure-adjusted adverse event (AE) rates were calculated.

**Results:** 439 patients were treated, 200 controls and 239 avacopan. The AE patient first incidence rate and AE rate, serious AE rate, infection event rate, and WBC count decrease AE rate were statistically lower in the avacopan compared to the prednisone group (see table).

**Conclusions:** In the context of avacopan's demonstrated efficacy profile, these integrated safety results provide support for avacopan's use in the treatment of patients with AAV. Refs: Jayne et al. J Am Soc Nephrol 2017;28:2756; Jayne et al. NEJM 2021;384:599; Merkel et al. ACR Open Rheumatol 2020;2:662.

**Funding:** Commercial Support - ChemoCentryx

Exposure-Adjusted Adverse Event Rates by Treatment Group

Table with 4 columns: Exposure-adjusted rate/100 patient-years, Prednisone Control Groups (N=200), Avicopan Groups (N=249), and Difference (95% CI). Rows include Total exposure, Adverse event rates, SAE rates, and discontinuation rates.

SA-PO697

Efficacy and Safety of Remission Induction Regimens in Elderly Patients With ANCA-Associated Glomerulonephritis. Lillian Xu, Faten F. Aqeel, Yumeng Wen, Duvuru Geetha. Johns Hopkins Medicine, Baltimore, MD.

Background: Induction regimens using either cyclophosphamide (CYC) or rituximab (RTX) have demonstrated comparable efficacy and adverse event rates in a randomized trial of patients with mean age of 54 years.

Methods: Patients, age 60 and above, diagnosed with ANCA GN were retrospectively identified. Baseline characteristics and outcomes across several clinical parameters were recorded and compared between CYC, RTX, and CYC+RTX groups for significance using Kruskal-Wallis test, Chi-squared test, and multivariate logistic regression as appropriate.

Results: Among 75 patients with ANCA GN with a mean (SD) age of 70 (6) years at diagnosis, there were significant differences in age at diagnosis (p=0.018), Caucasian race (p=0.01), entry eGFR (p=0.00009), dialysis at entry (p=0.009), and use of plasmapheresis (p=0.001) between the CYC (n=25), RTX (n=38), and CYC+RTX (n=12) groups.

Conclusions: CYC, RTX, and CYC+RTX are equally effective in remission induction in elderly patients with ANCA GN. Use of RTX only was associated with a lower risk of bone marrow suppression compared to CYC only.

Funding: Clinical Revenue Support

Table with 4 columns: Outcome, Treatment group, CYC, RTX, and CYC+RTX. Rows include Infection (OR), Bone marrow suppression (OR), Prednisone dose at 6 months (coefficient), GFR at 12 months (coefficient), and ESKD at 12 months (OR).

SA-PO698

Health-Related Quality of Life in ANCA-Vasculitis Patients in Ireland: A National Survey. Eithne M. Nic an Riogh, Eoin Gogarty, Alyssa M. Verrelli, Elhussein A. Elhassan, Jennifer Scott, Arthur White, Mark A. Little.

Background: Anti-neutrophil cytoplasmic antibody-associated vasculitis (AAV) is a debilitating disease that can impact on a patient's quality of life. The aim of this study was to assess longitudinal quality of life amongst patients with AAV using the EQ-5D instrument.

Methods: 343 patients with AAV were recruited from the Irish Rare Kidney Disease Registry. The EQ-5D instrument was used to evaluate the domains of mobility, self-care, usual activities, pain/discomfort, anxiety/depression and to generate an index score.

Results: A poorer quality of life was seen amongst those with AAV (median index value 0.80, UK average 0.856). The mean visual analogue scale was 75.6 (UK average 82.8). Pain and discomfort levels were most affected while self-care was least affected.

Conclusions: We have defined for the first time the EQ-5D index value over the full disease course in patients with AAV. Other studies have demonstrated a reduction in quality of life during active disease using the AAV-PRO and the Medical Outcomes Study Short Form-36.

SA-PO699

The Humanistic Burden of Rare Kidney Diseases, Understanding the Impact of Focal Segmental Glomerulosclerosis and IgA Nephropathy on Patients and Caregivers Study (HONUS): Preliminary Results for IgA Nephropathy in the United States

Justyna Szklarzewicz. On behalf of HONUS Advisory and Study team members. Leicester General Hospital, Leicester, United Kingdom.

Background: While immunoglobulin A nephropathy (IgAN) has been shown to be associated with significant clinical and economic burden, less is known about the humanistic burden associated with the disease.

Methods: HONUS is a multi-national, cross-sectional survey among adult patients, caregivers (care-partners) and parents/care-partners of youth (8-17 years) with focal segmental glomerulosclerosis (FSGS) or IgAN.

Results: The analysis included 89 adult IgAN patients. Most of them were Caucasian (88%) and 52% were female, with mean age of 37 years. Most patients (67%) were in CKD stage 3/4, and 3% in end-stage renal disease and had received transplant.

Conclusions: With US general population estimates as a reference, patients with IgAN experience impaired HRQoL and productivity, which also impacts their care-partner's mental health and productivity.

Funding: Commercial Support - Travere Therapeutics, Inc., San Diego, CA

SA-PO700

Synergistic Effect of Proteinuria on Hematuria-Related Decline in Kidney Function: The Japan Specific Health Checkups (J-SHC) Study

Hikari Tasaki, Masahiro Eriguchi, Hisako Yoshida, Takayuki Uemura, Masatoshi Nishimoto, Takaaki Kosugi, Masaru Matsui, Ken-ichi Samejima, Masato Kasahara, Kunitoshi Iseki, Koichi Asahi, Kunihito Yamagata, Tsuneo Konta, Shouichi Fujimoto, Ichiei Narita, Yugo Shibagaki, Toshiki Moriyama, Tsuyoshi Watanabe, Kazuhiko Tsuruya, Nara Kenritsu Ika Daigaku, Kashihara, Japan; Osaka Koritsu Daigaku Igakubu Daigakuin Igaku Kenkyaku, Osaka, Japan; Nara-ken Sogo Iryo Center, Nara, Japan; Steering Committee of Research on Design of the Comprehensive Health Care System for Chronic Kidney Disease (CKD) Based on the Individual Risk Assessment by Specific Health Check, Fukushima, Japan.

Background: We hypothesized that proteinuria had an effect modification on hematuria-related kidney function decline.

Methods: This is a longitudinal observational study. Participants was 40 to 74 years old and those who received multiple nationwide specific health checks between 2008 and

2014. The exposures of interest were hematuria (presence or absence) and proteinuria (3 categories: none, occasional, and persistent). Using a mixed-effects model, trajectories of eGFR decline adjusted for clinically relevant factors were examined between hematuria categories stratified by proteinuria categories.

**Results:** Among 552,951 subjects, 146,753 (26.5%) had hematuria, and 56,021 (10.1%) and 8,061 (1.5%) had occasional and persistent proteinuria, respectively. During the median follow-up of 3.0 years, annual change in eGFR decline in participants with hematuria (median [95% confidence interval]: -0.95 [-0.98 to -0.92] mL/min/1.73 m<sup>2</sup>/year) was significantly faster than those without hematuria (-0.86 [-0.87 to -0.84] mL/min/1.73 m<sup>2</sup>/year, P <0.001) in the entire cohort. The differences in eGFR decline rate between participants with and without hematuria (mean ± standard error) were 0.036±0.005, 0.027±0.013, and 0.130±0.048 mL/min/1.73 m<sup>2</sup>/year in none, occasional, and persistent proteinuria categories, respectively. Proteinuria had synergistic effect on hematuria-related eGFR decline rate (P for interaction <0.001).

**Conclusions:** Proteinuria has a synergistic effect on the hematuria-related decline in kidney function.

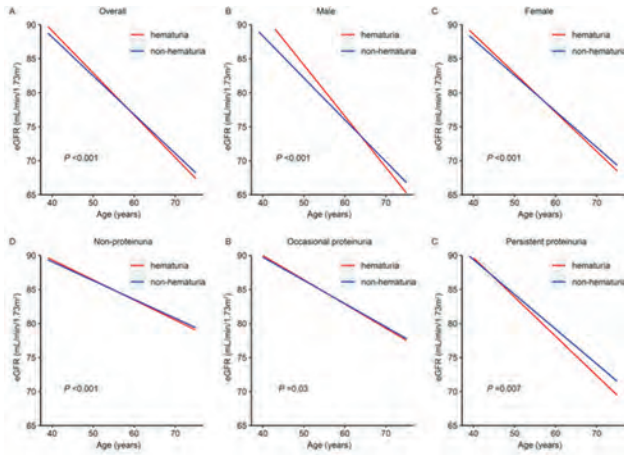

**SA-PO701**

**The Irish Rituximab Study (IRIS): A Nationwide Study of Rituximab Prescribing and Effectiveness for the Treatment of Kidney Diseases**

**Dearbhla M. Kelly,<sup>1,2</sup> Dearbhail Ni Cathain,<sup>1</sup> Blathnaid O'Connell,<sup>3</sup> James O'Hanlon,<sup>1</sup> Aislinn E. Hanahoe,<sup>4</sup> Sorcha O'Brien,<sup>5</sup> Omer Ahmed,<sup>6</sup> Raymond S. Piggott,<sup>7</sup> Laura M. Slattery,<sup>1</sup> Eoghan White,<sup>8</sup> Catherine M. Brown,<sup>3</sup> Liam F. Casserly,<sup>6</sup> Amy Hudson,<sup>1</sup> Mark A. Little,<sup>4</sup> Denise M. Sadlier,<sup>7</sup> Donal J. Sexton,<sup>5</sup> Sarah M. Moran,<sup>8</sup> Michelle M. O'Shaughnessy,<sup>8</sup> Peter J. Conlon.<sup>1</sup> IRIS Rituximab Study (IRIS) <sup>1</sup>Beaumont Hospital, Dublin, Ireland; <sup>2</sup>Massachusetts General Hospital, Boston, MA; <sup>3</sup>University Hospital Waterford, Waterford, Ireland; <sup>4</sup>Tallaght University Hospital, Dublin, Ireland; <sup>5</sup>St. James's Hospital, Dublin, Ireland; <sup>6</sup>University Hospital Limerick, Dooradoyle, Ireland; <sup>7</sup>Mater Misericordiae University Hospital, Dublin, Ireland; <sup>8</sup>Cork University Hospital, Cork, Ireland.**

**Background:** Rituximab is increasingly used to treat glomerular diseases, including ANCA-associated vasculitis (AAV), membranous nephropathy, minimal change disease (MCD), and focal segmental glomerulosclerosis (FSGS). However, strong evidence supporting its use in some of these conditions is lacking and it is also costly and potentially toxic. Using nationwide data, we examined prescribing practices and clinical outcomes in Irish patients who received Rituximab for glomerular disease.

**Methods:** All patients attending Irish Nephrology Centres who received Rituximab for glomerular disease between 01/01/13 and 31/12/21 were included in this retrospective observational study. Rituximab dosing, prior and concurrent medications, clinical presentation, and outcomes were extracted from electronic healthcare records. The primary efficacy outcome was complete or partial remission at 12 months. Descriptive statistics are herein presented.

**Results:** From 9 participating centres, we identified 405 patients (median age 55.3 years; 37.3% female), a majority (53%) of whom had AAV, **Table**. The most frequent Rituximab dose was 1g (60%) and the median cumulative dose received was 3g (IQR 2-4g). From patients with available outcome data (n=306), 259 (85%) achieved CR or PR by a median of 5 (IQR 2-10) months. During a median follow-up of 49 (IQR 31-74) months, 71 (23%) patients had disease relapses and 80 (25%) experienced adverse events: 72 (22%) infections, 40 (13%) leucopenia, 18 (9%) infusion reactions, 15 (7%) malignancies, and 12 (3%) episodes of hypogammaglobulinemia.

**Conclusions:** Based on preliminary data, Rituximab was an effective and safe treatment in the majority of Irish adults with glomerular disease who received it.

	AAV, n=210	Membranous GN, n=61	MCD, n=35	FSGS, n=15	Lupus nephritis, n=21
Male sex	128 (61%)	54 (88%)	19 (54%)	12 (80%)	8 (38%)
Age, years	61 (50-70)	54 (41-69)	40 (28-97)	38 (13-50)	34 (23-44)
Cumulative dose, g	3.0 (1.0-4.0)	2.0 (1.5-3.2)	3.0 (2.0-4.0)	5.0 (2.0-9.7)	7.0 (1.0-9.0)
Outcome data					
Follow-up, yrs	4.9 (2.8-6.5)	3.8 (2.2-4.8)	4.3 (2.2-4.8)	5.7 (10.0-8.8)	2.9 (2.0-3.5)
Complete remission	76/157 (48%)	16/54 (30%)	21/29 (72%)	1/13 (7.7%)	6/14 (43%)
Partial remission	67/257 (26%)	24/54 (44%)	7/29 (24%)	9/13 (69%)	4/14 (29%)
Relapse	44/143 (31%)	7/40 (18%)	5/28 (18%)	6/10 (60%)	1/10 (10%)

**SA-PO702**

**A Retrospective Analysis of Cardiovascular Disease (CVD) Events in Prevalent Patients With Focal Segmental Glomerulosclerosis (FSGS) in the United States**

**Juan Carlos Q. Velez,<sup>1</sup> Kamlesh M. Thakker,<sup>2,3</sup> Mark E. Bensch,<sup>2</sup> Edgar V. Lerma,<sup>4,5</sup> Richard M. Lieblich,<sup>6</sup> Martin C. Bunke,<sup>7</sup> Kaijun Wang,<sup>2</sup> David Oliveri,<sup>8</sup> Andrew Rava,<sup>8</sup> Diana T. Amari,<sup>8</sup> David Cork,<sup>9</sup> <sup>1</sup>Ochsner Medical Center, New Orleans, LA; <sup>2</sup>Traverse Therapeutics Inc, San Diego, CA; <sup>3</sup>Notting Hill Consulting LLC, Celebration, FL; <sup>4</sup>University of Illinois Chicago, Chicago, IL; <sup>5</sup>Advocate Christ Medical Center, Oak Lawn, IL; <sup>6</sup>VJA Consulting, Walnut Creek, CA; <sup>7</sup>CM Bunke Consulting, Mt. Pleasant, SC; <sup>8</sup>Genesis Research LLC, Hoboken, NJ; <sup>9</sup>Genesis Research LLC Newcastle, Newcastle upon Tyne, United Kingdom.**

**Background:** FSGS is a histologic pattern of glomerular injury with numerous causes, frequently associated with kidney disease progression and kidney failure. Although CVD events are known to be associated with end stage kidney disease (ESKD), there is a paucity of research examining this relationship in the FSGS population. We assessed the impact of baseline proteinuria and eGFR decline to ESKD on CVD event incidence and all-cause mortality.

**Methods:** A descriptive, retrospective analysis using Optum® de-identified Market Clarity and proprietary Natural Language Processed (NLP) Data (2007-2020). Inclusion criteria: Patients (≥18yo) with ≥2 FSGS ICD-10 codes (N031, N041, N051, N061, N071) and/or ≥2 FSGS NLP terms within 180 days and ≥30 days apart without associated negation terms, >6mo pre-index activity (exclusion: COVID-19). Post-index CVD events included myocardial infarction (MI), ischemic stroke/transient ischemic attack (TIA), unstable angina, congestive heart failure (CHF), percutaneous coronary intervention (PCI), or coronary artery bypass graft (CABG). All-cause mortality included patients with a death date post-index.

**Results:** Overall (n=7,974), 11.7% of patients with FSGS experienced a CVD event. Post-ESKD, and among patients with higher baseline proteinuria, CVD events and mortality were significantly elevated (p<.001; Table 1).

**Conclusions:** A significant increase in CVD events and death was associated with elevated proteinuria and progression to ESKD in patients with FSGS. New therapies for FSGS that reduce proteinuria may reduce CVD events and improve overall survival.

**Funding:** Commercial Support - Traverse Therapeutics, Inc

**Table 1: CVD Events and Mortality**

	Pre-ESKD* (n=4,478)	Post-ESKD* (n=4,934)	p value	Baseline Proteinuria <1.5 g/g (n=576)	Baseline Proteinuria ≥1.5-3.5 g/g (n=534)	Baseline Proteinuria ≥3.5 g/g (n=710)	p value
Any CVD event	313 (7.0%)	726 (14.7%)	<.001	70 (8.0%)	70 (13.1%)	107 (15.1%)	<.001
MI	6 (0.1%)	16 (0.3%)	0.09	1 (0.1%)	4 (0.7%)	6 (0.8%)	0.05
Ischemic stroke/TIA	3 (0.1%)	13 (0.3%)	0.02	1 (0.1%)	0 (0.0%)	2 (0.3%)	0.62
Unstable Angina	2 (0.0%)	7 (0.1%)	0.18	0 (0.0%)	2 (0.4%)	1 (0.1%)	0.12
CHF	23 (0.5%)	58 (1.2%)	<.001	2 (0.2%)	3 (0.6%)	17 (2.4%)	<.001
PCI	141 (3.1%)	341 (6.9%)	<.001	39 (4.5%)	35 (6.6%)	46 (6.5%)	0.12
CABG	240 (5.4%)	579 (11.7%)	<.001	63 (7.2%)	56 (10.3%)	81 (11.4%)	0.010
Mortality	160 (3.6%)	819 (16.6%)	<.001	61 (7.0%)	60 (11.2%)	119 (16.8%)	<.001

\*Patients could contribute to both pre- and post-ESKD periods based on kidney function.

**SA-PO703**

**Minimal Change Disease Management and Outcomes: Observation Over 10 Years From a Single Adult Nephrology Centre**

**Anja Oklopčić,<sup>1</sup> Corrie Bowers,<sup>1</sup> Nithin Balasubramanian,<sup>2</sup> Arif Khwaja,<sup>1</sup> Syazrah Salam.<sup>1</sup> <sup>1</sup>Sheffield Kidney Institute, Sheffield, United Kingdom; <sup>2</sup>The University of Sheffield Medical School, Sheffield, United Kingdom.**

**Background:** Minimal change disease (MCD) is one of the causes of nephrotic syndrome. Disease response to corticosteroid varies and time to disease remission and relapse is unknown. We assessed: the remission and relapse rates, time from remission to first relapse, the proportion of patients on adjunct treatment, the proportion of patients with acute kidney injury (AKI) at initial presentation, clinical outcomes.

**Methods:** Single centre service evaluation. Adult patients with diagnosis of MCD. Between 1st January 2010 and 31st December 2019. Follow up data were collected until 31st December 2020. Patients from paediatric nephrology services were excluded

**Results:** 41 patients (26 men, 15 women). All but one had histological diagnosis. Mean age 49 ± 17 years. 11 patients had AKI at presentation. 37/41 patients achieved remission; 26 had complete and 11 had partial remission. 24/37 patients relapsed but all subsequently achieved remission (21 complete and 3 partial remission). The median time from initial remission to first relapse was 168 days (IQR 71 – 327 days). 14/24 patients had a relapse within 6 months from initial remission. All patients received

**Key: TH - Thursday; FR - Friday; SA - Saturday; OR - Oral; PO - Poster; PUB - Publication Only**

**Underline represents presenting author.**

corticosteroid. Additional immunosuppression was predominantly calcineurin inhibitor (CNI, 22 patients).

**Conclusions:** Majority of MCD patients achieved remission, but over half relapsed within 6 months of initial remission. CNI is the most common adjunct treatment in our centre. Long term dialysis and death are uncommon.

**Funding:** Government Support - Non-U.S.

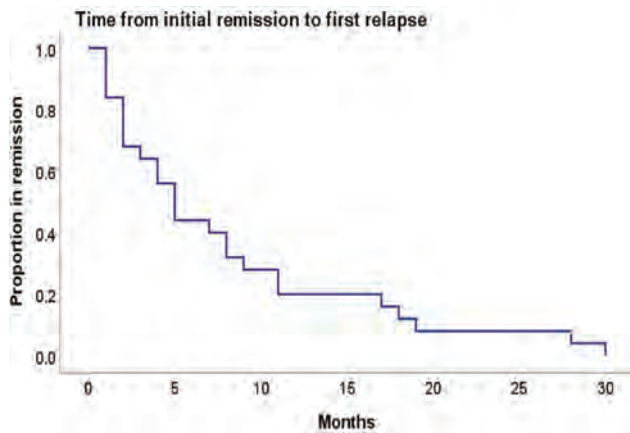
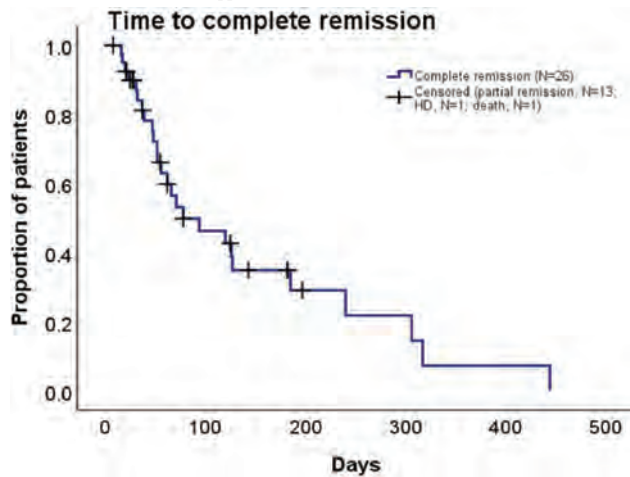

SA-PO704

**Comparing Outcomes of Patients With and Without Nephrotic Syndrome in Minimal Change Disease**

Hyung Eun Son,<sup>1</sup> Seokwoo Park,<sup>2</sup> Ho Jun Chin.<sup>2</sup> <sup>1</sup>Chung-Ang University Gwangmyeong Hospital, Gwangmyeong, Gyeonggi-do, Republic of Korea; <sup>2</sup>Seoul National University Bundang Hospital, Seongnam, Gyeonggi-do, Republic of Korea.

**Background:** Minimal change lesion (MCD) is characterized by edema, nephrotic ranged proteinuria (NS). However, the fate of MCD without nephrotic proteinuria needs to be defined in more detail.

**Methods:** We enrolled 79 adult MCD patients with the first renal biopsy in a tertiary hospital from May 2003 to June 2017. We did not include patients having any immunosuppressive treatment before renal biopsy, patients with inappropriate biopsy samples (<10 glomeruli/biopsy, any electron dense deposit, and light microscopic findings suggestive secondary causes). Remission of proteinuria was defined as urine protein to creatinine ratio (UPCR) < 0.3 g/g creatinine and relapse of proteinuria as UPCR ≥ 3.0 g/g creatinine. Clinic-pathologic features were compared between patients with and without NS. We followed up with the frequency of flare to nephrotic proteinuria, and renal outcomes such as the decrease of estimated glomerular filtration rate (GFR) over 50% compared to GFR at renal biopsy, GFR < 15 ml/min/1.73 m<sup>2</sup>, or progression to end stage renal disease during follow-up period.

**Results:** There were 3 patients with UPCR < 0.3 g/g creatinine, 17 patients with UPCR 0.3-2.9 g/g creatinine, and 59 patients with UPCR ≥ 3.0 g/g creatinine at admission for renal biopsy. Mean age at renal biopsy was 53.7 ± 19.2 (range:18.5-99.0) years, and there were 38 male patients (48.1%). Each group included 20 patients (Non-NS group), and 59 patients (NS group). Non-NS group had lower UPCR (1.36 ± 0.99 vs 10.2 ± 6.21 g/g creatinine, p<0.001) and higher GFR (98 ± 27 vs 75 ± 36 ml/min/1.73 m<sup>2</sup>, p=0.012) at renal biopsy. Non-NS group had lower frequency of AKI during follow-up period [5.0% vs 59.3%, p < 0.001]. Response rate to steroid treatment was 100 % in Non-NS group and 92.3 % in NS group (p = 1.000). There was no difference in the frequency of the first relapse and the number of relapses. At the final visit, the CR rate was 73.4 %. The eGFR during follow-up was much improved in NS group compared to Non-NS group because

of higher incidence of AKI at renal biopsy. The incidence rate of renal event, ESRD event, or mortality was not different between groups.

**Conclusions:** The adult MCD patients with nephrotic and non-nephrotic ranged proteinuria showed similar outcomes. Therefore, MCD should be paid more attention regardless of the amount of proteinuria at renal biopsy.

SA-PO705

**Preparing a Clinical Outcomes Assessment Set for Nephrotic Syndrome (Prepare-NS): A New Core Set of Clinical Outcome Assessments Focused on Fluid Overload for Nephrotic Syndrome**

Eloise Salmon,<sup>1</sup> Debbie Gipson,<sup>1</sup> Noelle E. Carozzi,<sup>1</sup> Jin-Shei Lai,<sup>5</sup> Patrick H. Nachman,<sup>3</sup> David T. Selewski,<sup>2</sup> Richard A. Lafayette,<sup>4</sup> Kelly Helm,<sup>6</sup> Cathie Spino,<sup>1</sup> Courtney N. Hurt,<sup>5</sup> Rebecca Scherr,<sup>1</sup> Vivian Kurtz,<sup>1</sup> Yujie Wang,<sup>1</sup> Daniyal Shamim,<sup>1</sup> John D. Peiper.<sup>5</sup> <sup>1</sup>University of Michigan, Ann Arbor, MI; <sup>2</sup>Medical University of South Carolina, Charleston, SC; <sup>3</sup>University of Minnesota Academic Health Center, Minneapolis, MN; <sup>4</sup>Stanford University School of Medicine, Stanford, CA; <sup>5</sup>Northwestern University Feinberg School of Medicine, Chicago, IL; <sup>6</sup>Nephcure Kidney International, King of Prussia, PA.

**Background:** Individuals with nephrotic syndrome (NS) experience fluid overload (FO). Partnering with FDA, we are creating and validating Clinical Outcome Assessments (COAs) of Patient Reported Outcomes (PRO) and Observer Reported Outcomes (ObsRO) of FO in NS for use in drug development. The initial project phase established a conceptual model, conducted a gap analysis, and assessed available data.

**Methods:** Stakeholder groups met, context of use (COU) was defined, and a scoping literature review was conducted. Analysis of existing PROMIS HRQOL data from the NEPTUNE and CureGN cohort studies estimated mean score differences (25,75 CIs) for participants with current vs past edema.

**Results:** COU includes age ≥ 2 yrs, NS etiology (Figure), persistent or relapsing/remitting NS, and edema, excluding dialysis dependence. 1337 manuscripts were reviewed; 9 met inclusion criteria. Two PROs created for FSGS or FSGS/minimal change disease (MCD) included FO items. No ObsROs identified. Secondary analysis of existing FSGS and MCD qualitative data identified edema location and severity ranges. Pooled cohort analysis showed worse HRQOL with edema in 1,678 participants (1246 adults, 432 children), e.g., adult Physical Function (-5.71 (-8.41, -3.01) and child Mobility (-3.8 (-5.86, -1.73)).

**Conclusions:** No existing PRO or ObsRO focus on assessment of FO and its impact on patients with NS. Scores on generic HRQOL scales vary with edema but do not gather detailed information on FO, making them insufficient for use in drug development. Protocols for concept elicitation and cognitive debriefing are in progress to fill the identified gaps and inform the creation COAs for FO in NS, inclusive of an ObsRO for young children and PRO for self-report for ages 8+. At project end, the final COA set will be publicly available for use as an endpoint in NS trials.

**Funding:** Other U.S. Government Support

Figure. Fluid Overload in Nephrotic Syndrome Clinical Outcomes Assessment Project Focus

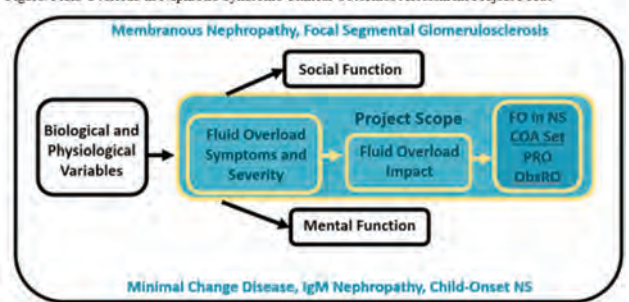

SA-PO706

**A Prospective Study to Assess Safety and Efficacy of Bone-Marrow Derived Mesenchymal Stromal Cells for Severe Frequently Relapsing or Steroid-Dependent Idiopathic Nephrotic Syndrome: The MESNEPH Study**

Marina Vivarelli,<sup>1</sup> Manuela Colucci,<sup>1</sup> Piero L. Ruggenenti,<sup>2</sup> Federica Casiraghi,<sup>2</sup> Federica Zotta,<sup>1</sup> Francesco Emma,<sup>1</sup> Giuseppe Remuzzi.<sup>2</sup> <sup>1</sup>Division of Nephrology, Bambino Gesù Pediatric Hospital IRCCS, Rome, Italy; <sup>2</sup>Istituto di Ricerche Farmacologiche "Mario Negri" IRCCS, Bergamo, Italy.

**Background:** An immune etiology of idiopathic nephrotic syndrome (INS) has been suggested by the efficacy of steroids and steroid-sparing agents, which present side effects.

**Methods:** This phase I study aimed to assess feasibility, safety and efficacy of autologous bone marrow-derived mesenchymal stromal cells (BM-MSC) in children and young adults (5-40 age years old) with steroid-dependent or multirelapsing INS. Following BM-MSC infusions, oral immunosuppression (IS) was gradually tapered. Safety, efficacy and immunomodulatory effects on different B and T cell subsets *in vivo* were monitored for 12 months.

**Results:** A total of 16 patients (10 children, 6 adults) were enrolled. A sufficient amount of autologous BM-MSC was obtained for all. Infusions were well tolerated.

Key: TH - Thursday; FR - Friday; SA - Saturday; OR - Oral; PO - Poster; PUB - Publication Only

Underline represents presenting author.

Adverse events were limited and not reconducibile to BM-MSc infusion. At baseline, all patients were on steroids and most were on 1-2 steroid-sparing agents. At the end of the study, the number of required IS was significantly reduced in children ( $p=0.022$ ) but not in adults. Whereas all patients relapsed during the 12-month follow-up, with a mean time of 8,5 months, the median number of relapses was significantly reduced in children (1 [IQR 1-1] vs 2 [IQR 2-3.25] compared to the previous 12 months, ( $p<0.001$ ) but not in adults. Among B and T cell subsets, a significant but transient reduction of total CD19+, mature and switched memory B cells and an increase of transitional B cells and regulatory T cells ( $p<0.05$ ) was observed *in vivo* between 1 and 3 months following BM-MSc infusion, despite the tapering of immunosuppression, especially in children.

**Conclusions:** Infusion of autologous BM-MSc was safe. A significant reduction of number of IS drugs and of relapses was found in children but not in young adults. The immunomodulatory effect of a cycle of autologous BM-MSc infusions on specific B and T cell subsets was transient.

**Funding:** Government Support - Non-U.S.

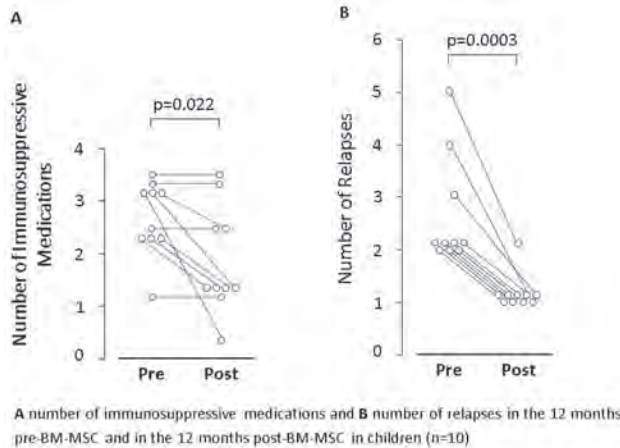

**SA-PO707**

**Rituximab and a Short Course of Corticosteroids for Initial Management of Adult-Onset Minimal Change Disease**

Ayotunde Ositelu, Fatmah N. Yamani, Kana R. Amari, Yashpal S. Kanwar, Vikram Aggarwal. *Northwestern University Feinberg School of Medicine, Chicago, IL.*

**Background:** Minimal change disease (MCD) accounts for 10-25 % of adult nephrotic syndrome (NS). Despite corticosteroid (CS) sensitive course of NS in MCD, high doses and prolonged exposure lead to many CS-related adverse effects. Rituximab (RTX) has proven to be effective in frequently relapsing (FR) and CS-dependent (SD) MCD. We report our experience of using RTX and a short course of CS for the initial management of the first episode of adult-onset MCD with the intention to curtail the duration and cumulative dose of CS.

**Methods:** Our series includes 5 adult patients with biopsy-proven MCD from February 2018 to March 2022 at Northwestern Memorial Hospital, Chicago, Illinois. Management plans were based on shared decisions with patients regarding the risks and benefits of various treatment options, the evolution of adverse effects, and the course of NS. All patients were initially treated with high-dose prednisone (1mg/kg/day) and two infusions of RTX (2-4 week intervals). Relapse, partial and complete remission (PR, CR) were defined per the KDIGO 2021 Glomerular Diseases Guideline.

**Results:** The mean age of the patients was 46 years (range 32-79), all females. The mean duration of initial high-dose CS was 3.2 weeks and followed by CS taper. The total mean duration of CS use was 8.6 weeks (range 6-12 weeks). All patients received the first dose of RTX within 4 weeks of CS initiation. CR was achieved in all patients at a mean time of 9.4 weeks (range 2-24 weeks, Figure 1). All patients expressed reluctance to a long duration of CS as per KDIGO as they experienced CS-related adverse events. All patients maintained CR for one year. Only 2 patients had relapsed after 1 year and responded to a single dose of Rituximab alone. No patient experienced severe adverse events from RTX.

**Conclusions:** Our study is promising and indicates that RTX may be a viable candidate as first-line therapy for treating MCD in adults. This approach limits the cumulative dose of CS and maintains remission at 1 year with overall limited side effects and better patient-reported outcomes.

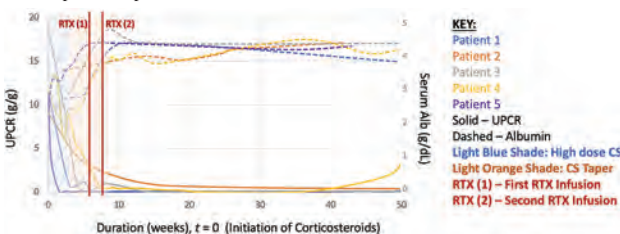

Course of Adult-Onset MCD for Five Patients Over 1 Year

**SA-PO708**

**The ACTION (AT1R and CCR2 Targets for Inflammatory Nephrosis) Program in Focal Segmental Glomerulosclerosis**

Simon D. Roger,<sup>1</sup> David W. Mudge,<sup>2</sup> Craig L. Nelson,<sup>3</sup> Muh Geot Wong,<sup>4</sup> Robert Shepherd,<sup>5</sup> Alisha J. Smith,<sup>5</sup> David K. Packham,<sup>6</sup> ACTION-FSGS <sup>1</sup>Gosford Hospital, Gosford, NSW, Australia; <sup>2</sup>Princess Alexandra Hospital, Woolloongabba, QLD, Australia; <sup>3</sup>Western Health, Footscray, VIC, Australia; <sup>4</sup>Concord Repatriation General Hospital, Concord, NSW, Australia; <sup>5</sup>Dimerix Bioscience, Melbourne, VIC, Australia; <sup>6</sup>Melbourne Renal Research Group, Melbourne, VIC, Australia.

**Background:** Focal segmental glomerulosclerosis (FSGS) is a disease of podocytes. Complications include nephrotic syndrome and progressive kidney failure. There is no approved treatment. The angiotensin II receptor type 1 (AT1R) and chemokine receptor 2 (CCR2) are G protein coupled receptors that form functional heteromers. Simultaneous antagonism of these receptors demonstrated synergistic renoprotective effects in preclinical models. In a Phase 2a study of 27 patients with proteinuric chronic kidney disease, 25% of patients achieved > 50% reduction in proteinuria with combination of DMX-200 (propagermanium, a CCR2 antagonist) and irbesartan, an angiotensin receptor blocker (ARB). Proteinuria reduction is a positive prognostic sign for preserving kidney function.

**Methods:** ACTION is a Phase 2a randomised, placebo-controlled, 2-way crossover study in primary FSGS patients receiving ARB, exploring the safety and efficacy of DMX-200 in reducing proteinuria. Patients were randomised to receive DMX-200 240mg daily or placebo for 16 weeks, followed by 6-week washout, then crossed over to the alternate treatment for a further 16 weeks. Eligible patients were aged 18-80 with biopsy-proven primary FSGS. Patients received stable dose of irbesartan 300 mg/day throughout the study. Screening urine protein/creatinine ratio (UPCR) was  $\geq 150$  mg/mmol and eGFR  $\geq 25$  ml/min/1.73m<sup>2</sup>. Exclusion criteria included secondary FSGS and diabetes mellitus.

**Results:** 8 patients were enrolled and completed the study. DMX-200 for 16 weeks demonstrated a safety profile similar to placebo, with no safety concerns associated with combined DMX-200 and irbesartan. The study was not powered for efficacy but greater reduction in UPCR (-84.3 mg/mmol vs -5.1mg/mmol) from baseline was observed with DMX-200 compared with placebo. Mixed model for repeated measures (MMRM) analysis showed placebo-corrected ratio was < 1, indicating a greater reduction in UPCR with DMX-200 vs placebo.

**Conclusions:** These encouraging data suggest that DMX-200 may result in clinically meaningful reduction in proteinuria when added to ARB in patients with primary FSGS. This has led to the initiation of an international Phase 2/3 randomised double-blind, placebo-controlled study (ACTION3) to further evaluate the efficacy of DMX-200 in patients with FSGS receiving an ARB.

**Funding:** Commercial Support - Dimerix Bioscience Ltd

**SA-PO709**

**Repetitive Administration of Rituximab to Maintain Clinical Remission in Patients With Minimal Change Disease/Focal Segmental Glomerulosclerosis**

Thomas Osterholt, Lucas Kuehne, Franziska Grundmann, Thomas Benzing, Linus A. Volker, Paul T. Brinkkoetter. *Uniklinik Köln, Köln, Germany.*

**Background:** Minimal change disease (MCD) and focal segmental glomerulosclerosis (FSGS) are glomerulopathies that present with nephrotic syndrome and show foot process effacement on electron microscopy. Primary forms of these diseases are treated with immunosuppressive drugs such as steroids, calcineurin inhibitors, and cytotoxic agents. Particular problems are frequent relapsing or glucocorticoid-dependent forms of those diseases. A recent metaanalysis provided evidence for the efficacy of B-cell depleting agents such as rituximab (RTX) in such patients. However, there is little evidence for the efficacy of reinduction of remission after initial successful treatment with RTX.

**Methods:** We conducted a single-center retrospective case series to evaluate the efficacy of repeated induction therapies with rituximab in patients with primary minimal change disease and focal segmental glomerulosclerosis. We identified 13 patients who received more than one induction therapy with RTX from our institutions and the FORMe-registry (NCT03949972). Disease status prior to induction and after 3 and 6 months was assessed. Changes in serum creatinine, proteinuria and time to relapse were evaluated. Relapse-free survival was assessed with the cox proportional hazard and Kaplan Meier estimators and compared to previous therapy regimens.

**Results:** Through all additional cycles after the first treatment with RTX, an improvement of disease activity could be shown and led to a complete remission in 71% and partial remission in 27% after 3 ( $p<0.001$ ) and 6 months ( $p<0.001$ ) compared to the disease state before induction. Time to relapse increased from 4.5 months (95%-CI: 3-10 months) to 21 months (95%-CI: 15-32 months) ( $p<0.001$ ) compared to previous immunosuppression regimen. The estimated glomerular filtration rate remained stable through all cycles ( $p=0.53$ ). Compared to continuous B-cell depletion, an individualized relapse based approach led to a significantly reduced rituximab exposure.

**Conclusions:** Repeated administration of RTX in patients with MCD/FSGS with an initial good clinical response did not result in drug tolerance and decreased efficacy at a median follow-up of 93.5 months after the first RTX induction. Thus, reinduction therapies may provide an alternative to continuous B-cell-depletion and reduce long-term side effects of continuous immunosuppression.

**Funding:** Government Support - Non-U.S.



SA-PO710

**Direct Oral Anticoagulants vs. Warfarin for Venous Thromboembolism Prophylaxis in Patients With Nephrotic Syndrome: A Retrospective Cohort Study**

Katerina Stanilova, Aminat A. Tijani, Eric M. Coons, Ashley Casey, Britta Mizuki, Miranda Dermady, Adi Bamnolker, Muhannad Alqudsi, Juan Carlos Q. Velez. Ochsner Nephrology Ochsner Medical Center, New Orleans, LA.

**Background:** Hypercoagulability with resultant venous thromboembolism (VTE) is a common feature of nephrotic syndrome (NS). Anticoagulation with warfarin is standard of care for patients with NS and serum albumin < 2.5 g/dL, whereas the evidence supporting the use of direct oral anticoagulants (DOACs) for VTE prophylaxis in NS is mostly limited to case reports. We examined the rates of bleeding and thromboembolic event rates in patients with NS receiving DOACs or warfarin for VTE prophylaxis.

**Methods:** A retrospective cohort study was conducted in adults with NS treated with a DOAC or warfarin for VTE prophylaxis for ≥ 7 days and with ≥ 2 encounters documented within the Ochsner Health System between January 2013 and July 2021. Patients were excluded if they had a prior VTE within 6 months or had known prior exposure to a study drug. The primary outcome was the composite rate of major and clinically relevant non-major bleeding. Secondary outcomes included time to bleeding events and the rate of new thromboembolic events.

**Results:** Of 171 patients screened, 44 patients were included in the study (25 in the DOAC cohort and 19 in the warfarin cohort); median age 55 (41-64) years, 50% women, 63% self-identified black. Median follow-up was 7.8 (4.6-18.7) months. Median urine protein-to-creatinine ratio, serum albumin and serum creatinine were 8.6 (5.0-11.8) g/g, 1.6 (1.2-2.1) g/dL and 1.3 (0.8-2.1) mg/dL, respectively. The most common etiology of NS was membranous nephropathy: 14 (56%) in the DOAC group [12 of them phospholipase A2 receptor (PLA2R)+] and 9 (47%) in the warfarin group [4 of them PLA2R+]. The primary outcome occurred in 2 patients treated with a DOAC and 5 patients treated with warfarin (8% vs 26%, p=0.21). The primary outcome was driven by major bleeding (4% vs 21%, p=0.15). There was no difference in time to major bleeding (250 vs 340 days, p=1.00). One new VTE event occurred in the DOAC cohort.

**Conclusions:** Bleeding and thromboembolic events were similar in patients with NS treated with a DOAC or warfarin for VTE prophylaxis. This study adds comparative data for VTE prophylaxis in patients with NS. Larger prospective studies are still warranted.

SA-PO711

**PatchSorter Enables Efficient Digital Glomerular Classification**

Akhil Ambekar,<sup>1,2</sup> Tasneem Talawalla,<sup>3</sup> Bangchen Wang,<sup>1</sup> Clarissa A. Cassol,<sup>4</sup> Anant Madabhushi,<sup>3,5</sup> Laura Barisoni,<sup>1,6</sup> Andrew Janowczyk.<sup>3,7</sup> <sup>1</sup>Duke University Department of Pathology, Durham, NC; <sup>2</sup>Duke University, Durham, NC; <sup>3</sup>Case Western Reserve University Department of Biomedical Engineering, Cleveland, OH; <sup>4</sup>Arkana Laboratories, Little Rock, AR; <sup>5</sup>VA Northeast Ohio Healthcare System, Cleveland, OH; <sup>6</sup>Duke University Department of Medicine, Durham, NC; <sup>7</sup>Centre Hospitalier Universitaire Vaudois, Lausanne, Switzerland.

**Background:** Quantification of segmental (SS) and global glomerulosclerosis (GS) has diagnostic and prognostic relevance in kidney disease, which entails laboriously assigning SS, GS, and non-GS/SS labels to individual glomeruli. While deep learning (DL) based tools can automate this task, they require large amounts of categorized glomeruli for training. PatchSorter (PS), an open-source tool (patchsorter.com), can facilitate review and label assignment of glomeruli by grouping those with similar presentational characteristics in a 2-dimensional plot. Within this plot, as PS receives user feedback, separation between categories iteratively increases to facilitate bulk labeling, improving labeling efficiency. This study compares glomerular labeling efficiency of PS versus an un-DL-aided approach, QuickReviewer (QR).

**Methods:** 3446 segmented glomeruli from 241 NEPTUNE PAS whole slide images previously manually categorized as SS, GS, and non-SS/GS were uploaded in PS and QR for labeling by a pathologist. Labels per second (LPS) were calculated for both approaches. Concordance between PS labels and ground truth was calculated.

**Results:** All glomeruli were labeled in 4260 seconds using PS (0.808 LPS), vs 712 glomeruli in 1800 seconds using QR (0.395 LPS), yielding a 105% speed improvement for PS over QR. Concordance of PS labels with manual categorization was 95%, suggesting efficiency improvements did not come at the cost of labeling fidelity.

**Conclusions:** PS is a robust and efficient tool for glomerular classification with potential to aid in overcoming manpower limitations in generating large cohorts of labeled digital kidney biopsies.

**Funding:** NIDDK Support, Other NIH Support - NIH NCI, Veterans Affairs Support, Private Foundation Support

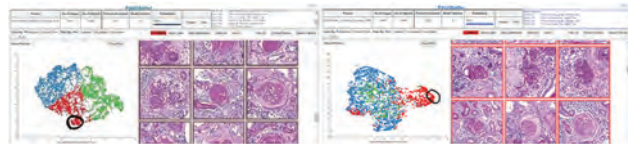

Figure 1: Left image: the user lassos areas of interest in the Cartesian plot (left) which are subsequently presented for review and bulk labeling (right). Right image: as labeling progresses, the feature space is improved, further separating predicted categories in the plot to facilitate improved labeling efficiency.

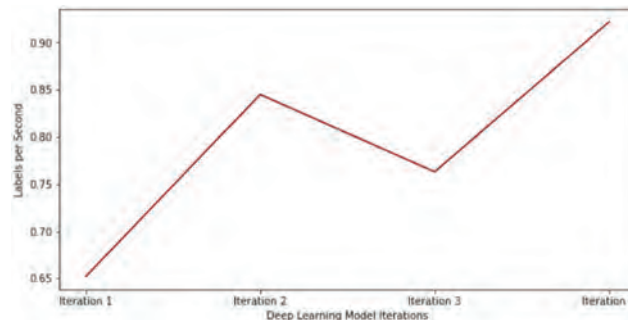

Figure 2: An upward trend in labeling efficiency is observed after each model iteration, suggesting the potential for a further improvement in labeling times when applied to larger cohorts.

SA-PO712

**A Phase 3, Multicenter, Randomized, Double-Blind, Placebo-Controlled Study to Evaluate the Efficacy and Safety of Sibeprenlimab Administered Subcutaneously in Patients With IgA Nephropathy**

Dana Rizk,<sup>1</sup> Vlado Perkovic,<sup>2</sup> Richard A. Lafayette,<sup>3</sup> Hernan Trimarchi,<sup>4</sup> Jonathan Barratt,<sup>5</sup> Kevin Carroll,<sup>6</sup> Vladimir Tesar,<sup>7</sup> Hong Zhang,<sup>8</sup> Yusuke Suzuki,<sup>9</sup> Adrian Liew,<sup>10</sup> Muh Geot Wong,<sup>11</sup> Bruce R. Leslie,<sup>12</sup> Mohit Mathur,<sup>13</sup> Jeffrey Hafkin.<sup>12</sup> <sup>1</sup>University of Alabama at Birmingham, Birmingham, AL; <sup>2</sup>University of New South Wales, Sydney, NSW, Australia; <sup>3</sup>Stanford University, Stanford, CA; <sup>4</sup>Hospital Britanico de Buenos Aires, Buenos Aires, Argentina; <sup>5</sup>University of Leicester, Leicester, United Kingdom; <sup>6</sup>KJC Statistics, London, United Kingdom; <sup>7</sup>Charles University, Prague, Czechia; <sup>8</sup>Peking University, Beijing, China; <sup>9</sup>Juntendo Daigaku, Bunkyo-ku, Japan; <sup>10</sup>Mount Elizabeth Novena Hospital, Singapore, Singapore; <sup>11</sup>Concord Repatriation General Hospital, Concord, NSW, Australia; <sup>12</sup>Otsuka Pharmaceuticals Development & Commercialization, Inc., Rockville, MD; <sup>13</sup>Visterra Inc, Boston, MA.

**Background:** IgAN is the leading primary glomerulonephritis worldwide. Up to 40% of patients develop kidney failure within ~20 years of diagnosis. Current treatment consists of optimized supportive care including renin-angiotensin aldosterone system (RAAS) blockade. New therapies targeting the underlying disease pathophysiology are needed. Emerging data suggest that the B cell growth factor, A Proliferation Inducing Ligand (APRIL), plays a key role in the pathogenesis of IgAN and may be an ideal target. Sibeprenlimab (VIS649), a humanized IgG2 monoclonal antibody (mAb) that inhibits APRIL, is being evaluated for the treatment of IgAN.

**Methods:** The VISIONARY Trial (NCT05248646) is a global Phase 3 randomized controlled trial which will assess the efficacy and safety of sibeprenlimab in adult patients with IgAN. Approximately 450 patients with biopsy-confirmed IgAN will be randomized to receive 400mg sibeprenlimab subcutaneously or placebo for 24 months, while continuing to receive standard of care. Key inclusion criteria: on maximally tolerated RAAS blockade, 24 hr uPCR ≥ 0.75 g/g or urine protein ≥ 1.0 g/day, eGFR ≥ 30 mL/min/1.73 m<sup>2</sup>. Patients with secondary IgAN, coexisting kidney disease, IgG < 600 mg/dL, MEST-C score T2 or C2 will not be included in the study. An exploratory cohort of 20 patients with eGFR 20-30 mL/min/1.73 m<sup>2</sup> will also be enrolled. The primary efficacy endpoint is to evaluate the change in 24 hr uPCR at 9 months compared with baseline. Key secondary efficacy endpoint is to evaluate the change in annualized eGFR slope over 24 months. Additional secondary endpoints include clinical remission, safety, pharmacodynamics, and anti-drug Ab. Patients completing the trial will be eligible for a 24-month open label extension study (NCT05248659).

**Results:** Results of study expected later when study is complete.  
**Conclusions:** Sibeprenlimab is a mAb that blocks APRIL, a B cell growth factor implicated in the pathogenesis of IgAN. A pivotal phase 3 trial is under way to assess the efficacy and safety of sibeprenlimab for the treatment of IgAN.

**Funding:** Commercial Support - Otsuka Pharmaceuticals Development & Commercialization, Inc.

SA-PO713

**Evolution in IgA Nephropathy Treatment: How Will SGLT2 Inhibitors, Steroid Regimens, and Experiment Therapies Change the Treatment Landscape?**

Chris Dudzinski,<sup>1</sup> Pietro A. Canetta,<sup>2</sup> Denise Foy.<sup>1</sup> <sup>1</sup>Spherix Global Insights, Exton, PA; <sup>2</sup>Columbia University Irving Medical Center, New York, NY.

**Background:** Treatment options for IgA nephropathy (IgAN) are evolving rapidly. The use of SGLT2 inhibitors (SGLT2i) has established efficacy. Other treatment options, including reduced-dose systemic steroid regimens, a recently launched oral targeted budesonide. Agents in development have the potential to continue to improve patient outcomes. Survey data is presented on U.S. nephrologists' clinical practice and expectations regarding the treatment of IgAN.

**Methods:** 907 IgAN patient records were collected in collaboration with more than 200 US nephrologists via a HIPAA-compliant, online chart review tool between Dec 20, 2020 – Feb 16, 2021 and Dec 14, 2021 – Feb 21, 2022. Launch tracking data for

delayed-release budesonide capsules was captured via an online survey fielded to 77 US nephrologists from May 4–7, 2022.

**Results:** SGLT2i use in IgAN patients more than tripled between 2021 and 2022 (from 6% to 21%) after dapagliflozin was approved in the U.S for non-diabetic CKD and sub-analysis data was published on its use in IgAN patients. 75% of nephrologists strongly agreed that SGLT2is may significantly help delay kidney disease progression in glomerular disease patients, and 73% expected to continue to increase their prescribing over the next six months. Despite awareness of the TESTING trial spreading among nephrologists, use of systemic steroids has remained stable at 14% of patients year-over-year. The availability of budesonide capsules has created another option, with nephrologists were predicting up to 13% of their diagnosed IgAN patients may be eligible candidates for this therapy. New agents in the pipeline for IgAN include sparsentan, atrasentan, and iptacopan. Nephrologists have strong awareness of these agents in development (~60% consider themselves moderately to highly familiar with sparsentan and atrasentan, this moves to 42% for iptacopan) and indicate increasing willingness to prescribe if available.

**Conclusions:** Nephrologists treating IgAN patients have significantly increased their use of SGLT2is in the past year, with utilization likely to continue to increase. However, large majority of patients remain untreated with SGLT2i. Systemic steroids, with evolving treatment regimens, continue to have a role in patient management, with the potential for more change following the recent approval of delayed-release budesonide.

#### SA-PO714

##### An Exploratory Trial of an Investigational RNA Therapeutic, IONIS-FB-LRx, for Treatment of IgA Nephropathy

Sean Barbour,<sup>1</sup> Michelle A. Hladunewich,<sup>2</sup> John Irvine,<sup>3</sup> Angela Makris,<sup>4</sup> Richard A. Robson,<sup>5</sup> Sven-Jean Tan,<sup>6</sup> Muh Geot Wong,<sup>7</sup> Ashley Frazer-Abel,<sup>8</sup> Qingqing Yang,<sup>9</sup> Lixuan Yin,<sup>9</sup> Terry Barrett,<sup>9</sup> Jon L. Ruckle,<sup>10</sup> Eugene Schneider,<sup>9</sup> Richard Geary,<sup>9</sup> Filippo Canducci,<sup>11</sup> Michael Mccaleb.<sup>9</sup>  
<sup>1</sup>The University of British Columbia Faculty of Medicine, Vancouver, BC, Canada; <sup>2</sup>University of Toronto, Sunnybrook, ON, Canada; <sup>3</sup>CDHB, Christchurch, New Zealand; <sup>4</sup>Liverpool Hosp Renal Clinic, Liverpool, NSW, Australia; <sup>5</sup>Christchurch Clinical Studies Trust Ltd, Christchurch, New Zealand; <sup>6</sup>The Royal Melbourne Hospital, Parkville, VIC, Australia; <sup>7</sup>Royal North Shore Hospital, St Leonards, NSW, Australia; <sup>8</sup>Exsera Biolabs, Denver, CO; <sup>9</sup>Ionis Pharmaceuticals Inc, Carlsbad, CA; <sup>10</sup>Pacific Pharma Grp, Tacoma, WA; <sup>11</sup>Roche, Basel, Switzerland.

**Background:** Pathogenesis of IgA nephropathy (IgAN) is known to be dependent upon multiple factors, one being the complement system. Overactivity of the complement Alternative Pathway (AP) has been proposed to be responsible in part for the renal deposition of complement C3 activation-products and subsequent renal sequelae. We sought to test the hypothesis that a reduction of systemic AP would improve proteinuria. This was accomplished by lowering the production of complement factor B (FB), a required component of the AP, using an investigational antisense oligonucleotide that targets FB mRNA in the liver.

**Methods:** An exploratory, single arm, open label Ph 2 study recruited patients with biopsy-confirmed IgAN within 12 months (C3 deposition,  $\leq 50\%$  IFTA,  $\leq 50\%$  crescents), proteinuria  $> 1.5$ g/d, eGFR  $> 45$ , hematuria, despite maximum ACEi/ARB for at least 60 d. Patients received monthly SC administration of IONIS-FB-LRx. Primary outcome was change in 24-hr proteinuria at Wk29 (4 wk after last dose) compared to baseline (BL). Secondary outcome measures included: safety, complement levels and eGFR. (NCT04014335)

**Results:** Study enrolled 10 subjects, 25-59 yr, 40% Female, 6 Asian, and 4 White. There was a selective reduction of plasma complement FB protein levels, serum AP activity and urinary Ba from BL to end of treatment (mean % change of -69%, -39% and -88%, respectively). Median proteinuria (24 hr urine collection) at BL was 2.06 g/d (IQR 1.43, 3.51 g/d). At Wk 29, the change in proteinuria was -1.09 g/d (IQR -1.68, -0.79 g/d), corresponding to a 44% reduction. There was no change in eGFR at Wk 29 compared to BL (mean  $\pm$  SD; BL 68  $\pm$  26; Wk29 69  $\pm$  21 mL/min/1.73m<sup>2</sup>). The drug demonstrated an acceptable safety profile with no Treatment Emergent SAE and the only clinically meaningful safety signal (moderate TEAE) was a reversible elevation of ALT without changes in bilirubin in one subject. All subjects completed the study (wk 29).

**Conclusions:** This Ph 2 open label study provides initial clinical evidence that IONIS-FB-LRx reduces complement and proteinuria in patients with IgAN, supporting further development to determine the potential of IONIS-FB-LRx to reduce the progression of IgA nephropathy.

**Funding:** Commercial Support - Ionis Pharmaceuticals

#### SA-PO715

##### Glomerular Transcriptomics Predicts Outcome and Identifies Therapeutic Strategies for Assumed Benign IgA Nephropathy

Mariell Rivedal,<sup>1</sup> Håvard Mikkelsen,<sup>1</sup> Hans-Peter Marti,<sup>1,2</sup> Thomas Knoop,<sup>1,2</sup> Rune Bjoerneklett,<sup>1,2</sup> Yngvar Lunde Haaskjold,<sup>1,2</sup> Jessica Furriol,<sup>1,2</sup> Sabine Leh,<sup>2</sup> Terje Apeland,<sup>4</sup> Flavia T. Paunas,<sup>3</sup> Janka Babickova,<sup>1</sup> Andreas Scherer,<sup>5,6</sup> Oystein Eikrem,<sup>1,2</sup> Philipp Strauss.<sup>1</sup>  
<sup>1</sup>Universitetet i Bergen, Bergen, Norway; <sup>2</sup>Helse Bergen HF, Bergen, Norway; <sup>3</sup>Helse Fonna HF, Haugesund, Norway; <sup>4</sup>Helse Stavanger HF, Stavanger, Norway; <sup>5</sup>Helsingin yliopisto, Helsinki, Finland; <sup>6</sup>Spheromics, Kontiolahti, Finland.

**Background:** In a previous study of patients with IgA nephropathy (IgAN) with assumed benign disease, we have shown that 18.6% of patients develop a progressive clinical course, which was not predicted by any known clinical nor histopathological parameters (Knoop 2017, *Nephrol Dial Transplant*). We aim to differentiate between future progressors and non-progressors with assumed benign IgAN by using glomerular transcriptomics from diagnostic kidney biopsies and to investigate whether this can identify drugs to be used in those patients.

**Methods:** We included adult progressive patients (n=15) and patients with remitting disease (non-progressors, n=21) from our previously reported IgAN cohort, with a mean follow-up time of 21.6 years, and assembled an internal validation cohort. Glomerular laser-capture microdissection was performed from 10 $\mu$ m archival kidney biopsy sections, RNA extracted and sequenced with the SMARTer Stranded Total RNA-Seq kit – Pico Input Mammalian (Clontech Laboratories, California, USA). Expression key results were validated in publicly available cohorts and on the protein level with immunohistochemistry in our internal cohorts.

**Results:** Based on the 1,240 differentially expressed glomerular genes from the initial kidney biopsies, we were able to identify which patients will be IgAN progressors and non-progressors using a two-component classifier. The classifier predicted disease progression with 88% accuracy, 75% sensitivity and 100% specificity (AUC=0.875), more accurate than the recommended International IgAN Prediction Tool. We identified 45 possible drug targets, including angiotensinogen, a target of sparsentan, currently investigated as therapy in IgAN (NCT03762850 and NCT04663204). The findings on upregulation of angiotensinogen, which was independent of blood pressure, were validated in an internal IgAN validation cohort. Interestingly, complement activation did not play a major role in our data.

**Conclusions:** Glomerular mRNA sequencing from diagnostic kidney biopsies from assumed benign IgAN can differentiate between future progressors and non-progressors at the time of biopsy, on average 21.6 years before progressive disease is documented.

**Funding:** Commercial Support - Alexion

#### SA-PO716

##### Machine-Learning Based Prediction Model for Prognosis of IgA Nephropathy Patients

Sehoon Park,<sup>1</sup> Eun Sil Koh,<sup>6</sup> Chung Hee Baek,<sup>5</sup> Yong Chul Kim,<sup>1</sup> Jung Pyo Lee,<sup>3</sup> Dong Ki Kim,<sup>1</sup> Seung Hyeok Han,<sup>4</sup> Ho Jun Chin,<sup>2</sup> Kwon Wook Joo,<sup>1</sup> Yon Su Kim,<sup>1</sup> Hajeong Lee.<sup>1</sup>  
<sup>1</sup>Seoul National University Hospital, Jongno-gu, Seoul, Republic of Korea; <sup>2</sup>Seoul National University Bundang Hospital, Seongnam, Republic of Korea; <sup>3</sup>Seoul National University Seoul Metropolitan Government Boramae Medical Center, Dongjak-gu, Seoul, Republic of Korea; <sup>4</sup>Severance Hospital, Seodaemun-gu, Seoul, Republic of Korea; <sup>5</sup>Asan Medical Center, Songpa-gu, Seoul, Republic of Korea; <sup>6</sup>Catholic University of Korea School of Medicine, Seoul, Republic of Korea.

**Background:** IgA nephropathy is one of the most common primary glomerulonephritis and the disease shows heterogeneous prognosis. International Risk Score system has been developed to predict the prognosis of IgA nephropathy, however, further investigation for additional prognostic modeling by machine-learning based method may further improve the prediction power.

**Methods:** We screened total of 5387 IgA nephropathy patients from 3 tertiary university hospitals in Korea. The study population was divided into development and validation cohort. Based on the collected electronic health records, CatBoost model was used for machine-learning based modeling for the adverse composite outcome, which included halving of eGFR and end-stage kidney disease. Area under curve (AUC) values for the outcomes within 1, 3, and 5 years were calculated to assess the discriminative power.

**Results:** The constructed model showed good discriminative power in the developmental cohort as the AUC values ranged from 0.94 to 0.99 for the study outcomes. In the developmental cohort, there was some attenuation particularly in the hospitals with small number of samples (AUC 0.65-0.80), however, most AUC values for the study outcomes remained in acceptable range (AUC 0.81-0.97).

**Conclusions:** Machine-learning based prediction model for IgA nephropathy prognosis may provide a valid tool to estimate the kidney failure risk in the patients.

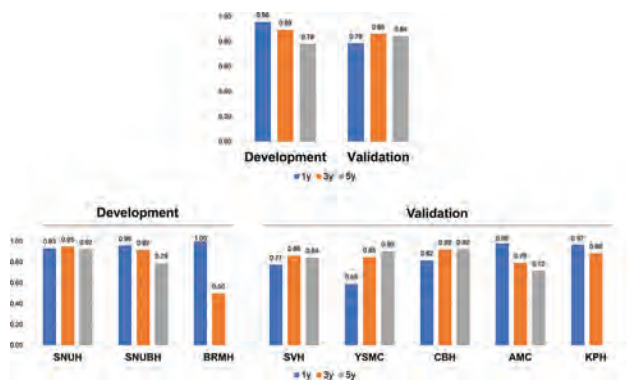

SA-PO717

**Predictors of Bleeding Following Inpatient Percutaneous Kidney Biopsy**  
 Tulayla Katmeh,<sup>1</sup> Aran Thanamayooran,<sup>1</sup> Isaac Bai,<sup>2</sup> Geraint C. Berger,<sup>2</sup> Meghan Day,<sup>1</sup> Bright Huo,<sup>2</sup> Amanda J. Vinson,<sup>1,2</sup> Karthik K. Tennankore.<sup>1,2</sup>  
<sup>1</sup>Nova Scotia Health Authority, Halifax, NS, Canada; <sup>2</sup>Dalhousie University, Halifax, NS, Canada.

**Background:** Percutaneous diagnostic kidney biopsy is important in managing kidney disease, but less is known about predictors of bleeding following biopsy. The purpose of this study was to determine clinical risk factors for minor/major bleeding following percutaneous diagnostic kidney biopsy among admitted patients.

**Methods:** We analyzed a cohort of all adults that received an in-patient diagnostic kidney biopsy at a tertiary care center from 2014-2019. Biopsies for the diagnosis of kidney tumors were excluded. Outcomes of interest were minor bleeding (any of hemoglobin drop >10 g/L within 24 hours post biopsy, macrohematuria, hematoma on ultrasound) and major bleeding (need for blood transfusion or surgical intervention post biopsy). Predictors of major bleeding were analyzed using logistic regression; those factors significantly associated with bleeding using a P<0.05 were included in a multivariable model and reported using odds ratios (OR) with 95% confidence intervals (CI).

**Results:** Between 2014-2019, a total of 380 in-patient biopsies were performed. 221 (58.2%) of the patients were male, and mean age of the population was 57.3 ± 15.8 years. A minor bleed occurred in 131 (34.5%) of patients, and a major bleed occurred in 56 (14.7%) of patients. Risk factors for major bleeding are noted in Table 1. Factors significantly associated with major bleed included: creatinine 400-600 (OR. 7.46; 95%CI. 2.13-26.14); creatinine >600 or on dialysis (OR. 13.82; 95%CI. 4.04-47.25); structural heart disease (OR. 9.40; 95%CI. 1.33-66.47) and cerebrovascular disease (OR. 6.62; 95%CI. 1.47-29.78).

**Conclusions:** This study highlights risk factors associated with bleeding after inpatient percutaneous kidney biopsy which is of clinical importance for health care professionals. In future study we will derive and validate a risk prediction model for major and minor bleeding following biopsy.

Table 1. Risk factors for major bleeding following kidney biopsy (adjusted model; N=325)

Variable	Odds ratio	95% Confidence interval
<b>Lab values</b>		
<b>Creatinine</b>		
<200 umol/L	Reference	Reference
200-400 umol/L	2.95	0.87-9.92
400-600 umol/L	7.46	2.13-26.14
>600	13.82	4.04-47.25
<b>White blood cell count</b>		
<11.00	Reference	Reference
≥11.00	1.89	0.86-4.14
<b>Platelet count</b>		
<150 uL	Reference	Reference
≥150 uL	0.57	0.26-1.29
Albumin (each 1 unit increase in g/L)	0.96	0.91-1.00
<b>Comorbidities</b>		
Anemia (Hemoglobin <100 g/L)	2.57	1.06-6.25
Active cancer	1.93	0.55-6.74
Chronic Obstructive Lung Disease	1.16	0.37-3.66
Structural heart disease	9.40	1.33-66.47
Cerebrovascular disease	6.62	1.47-29.78
Ace Inhibitor use (at baseline)	0.66	0.29-1.52
Anticoagulant (at baseline)*	1.03	0.48-2.19

\*Anticoagulants were discontinued prior to biopsy

SA-PO718

**Bacterial Infections in Patients With ESKD due to Glomerular Disease in the United States**

Vivek Charu,<sup>1</sup> Jialin Han,<sup>1</sup> Maria E. Montez-Rath,<sup>1</sup> Wolfgang C. Winkelmayr,<sup>2</sup> Michelle M. O'Shaughnessy,<sup>3</sup> <sup>1</sup>Stanford University School of Medicine, Stanford, CA; <sup>2</sup>Baylor College of Medicine, Houston, TX; <sup>3</sup>University College Cork, Cork, Ireland.

**Background:** Patients with kidney failure on dialysis are at increased risk for infection. However, whether reported cause of kidney failure associates with infection risk after dialysis initiation has been poorly studied. We quantified rates of infection-related hospitalization (IRH) by cause of kidney failure in patients newly initiated on dialysis in the US.

**Methods:** Using data from the United States Renal Data System (USRDS), we studied all adult patients (≥18 years) with kidney failure attributed to any of six selected glomerular disease subtypes, diabetic nephropathy [DN], or autosomal dominant polycystic kidney disease, who started dialysis as a first kidney failure treatment modality between 2005 and 2014. We used multivariable Prentice, Williams and Peterson (PWP) models to estimate hazard ratios for overall, 1<sup>st</sup>, 2<sup>nd</sup> and 3<sup>rd</sup> IRH for each cause of kidney failure.

**Results:** 277,173 patients were included in this analysis. Compared to patients with IgA nephropathy (IgAN), those with MPGN, lupus nephritis (LN), vasculitis, or DN had higher overall IRH rates (20 vs. 30-36 events per 100 person years; p<0.05). Multivariable PWP models demonstrate that after adjustment for demographic and clinical covariates, patients with LN, vasculitis, or DN (vs. those with IgAN) had significantly higher hazards of 1<sup>st</sup>-3<sup>rd</sup> IRHs (adjusted HRs 1.14-1.44, p<0.05; **Figure**).

**Conclusions:** In US patients with kidney failure, the risk of IRH varied by reported cause of kidney failure. Specifically, patients with LN, vasculitis, or DN were at higher risks for IRH compared to patients with IgAN. These findings can inform patient counseling as well as the design of future studies examining pathogenic mechanisms and therapeutic interventions.

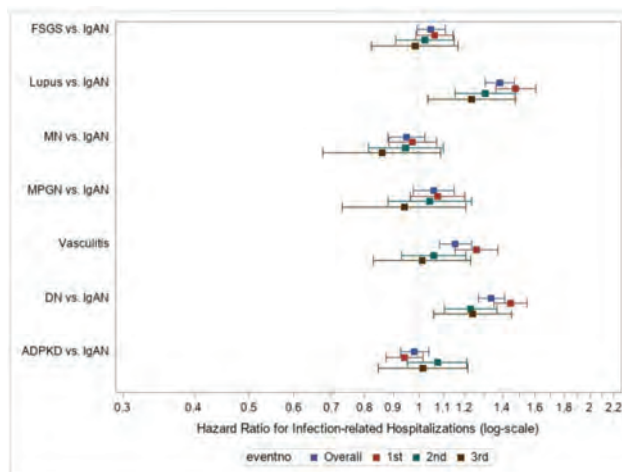

Adjusted hazards ratios for 1<sup>st</sup>-3<sup>rd</sup> infection-related hospitalization (IRH), adjusting for adjusted for demographic/clinical characteristics.

SA-PO719

**Epidemiology of Membranoproliferative Glomerulonephritis: A Single Centre Observation Over 20 Years**

Chethana Ramakrishna, Joshua Storrar, Sara Metaoy, Constantina Chrysochou, Francesco Rainone, James Ritchie, Dimitrios J. Poulidakos, Rajkumar Chinnadurai, Philip A. Kalra, Smeeta Sinha. *Salford Royal NHS Foundation Trust, Salford, United Kingdom.*

**Background:** Membranoproliferative glomerulonephritis (MPGN) is a pathological entity seen on light microscopy which represents a pattern of kidney injury characterised by an increase in intraglomerular cells and diffuse thickening of the glomerular capillary walls. MPGN accounts for about 7% -10% of all cases of confirmed glomerulonephritis on biopsy. MPGN includes immune complex mediated MPGN (ICGN) and C3 glomerulopathy (C3G). C3G in turn comprises of dense deposit disease (DDD) and C3 glomerulonephritis (C3GN). The updated classification has enabled a greater understanding of the pathophysiology and facilitated research focusing on targeted therapeutic options and trials particularly targeting the complement system

**Methods:** This is a single centre observational study was conducted on all patients who had a biopsy proven diagnosis of MPGN from our biopsy database between January 2000 and December 2020

**Results:** A total of 41 patients were diagnosed with MPGN over this 20-year period of which 28 patients had immune complex mediated MPGN and 10 patients had C3G. Of the patients with C3G, 8 had C3GN and 2 had DDD. Three patients with MPGN were not classified due to insufficient data. The mean age at diagnosis was 55.7 ± 17.6 years. Mean age at diagnosis for ICGN and C3G was 56.8 ± 16.9 years and 48 ± 17.9 years respectively. Mean blood pressure was 147/81 mmHg ± 27/11mmHg. Nephritic

range proteinuria was the presenting feature in 14 patients with ICGN and 7 patients with C3G. MPGN was associated with infections in 8 patients, connective tissue disease in 5 patients and haematological malignancies (lymphoma/leukaemia) in 5 patients. The remaining 23 patients did not have a clear aetiology for MPGN. The mean estimated glomerular filtration rate was  $40.3 \pm 27.8$  mL/min at diagnosis; 80.4% received renin-angiotensin system inhibitors (RASi) and 73.17% received immunosuppression. Twenty patients (50%) progressed to end stage kidney disease and received renal replacement therapy. Two patients underwent renal transplantation of which one developed recurrence of MPGN in the transplant kidney.

**Conclusions:** Our observation has added insights to this rare renal pathological diagnosis which has multiple aetiological factors including complement pathway dysregulation.

#### SA-PO720

### Crescentic Glomerulonephritis due to Proteinase 3 (PR3) Anti-Neutrophil Cytoplasmic Autoantibody (ANCA) and IgA Mediated Anti-Glomerular Basement Membrane (GBM) Disease: A Rare Case of Double Identity

Melody L. Siff,<sup>1</sup> Mirza S. Baig,<sup>2</sup> Jason M. Kidd,<sup>1</sup> <sup>1</sup>Virginia Commonwealth University Health System, Richmond, VA; <sup>2</sup>Richmond Nephrology Associates, Richmond, VA.

**Introduction:** Crescentic glomerulonephritis due to co-existing ANCA associated vasculitis and Anti-GBM antibody disease is rare and often referred to as “double positive” disease. Most double positive cases involve myeloperoxidase (MPO) ANCA. Furthermore, anti-GBM disease generally manifests with linear staining IgG staining. We present a case of double positive disease with both PR3-ANCA and linear IgA staining of the glomerular basement membranes.

**Case Description:** A 73-year-old female presented to the hospital with acute kidney injury with a serum creatinine of 5.7 mg/dL. She had been treated with antibiotics for mastoiditis intermittently for 3 months. She was admitted to the hospital and underwent kidney biopsy. Serologic work up was significant for elevated PR3 ANCA. Biopsy was significant for crescentic glomerulonephritis and IgA and kappa linear staining along the GBM. No immune complexes were seen on electron microscopy. There was no evidence of diffuse alveolar hemorrhage. She was started on dialysis at presentation. After tissue diagnosis, she was started on glucocorticoids, plasma exchange and plan to begin cyclophosphamide. She has shown some renal recovery and dialysis is currently on hold.

**Discussion:** Double positive ANCA and anti-GBM is rare combination with limited and conflicting data regarding treatment. Literature review revealed approximately one-third of patients with anti-GBM also had an associated ANCA, which was usually MPO and rarely PR3. We believe this is the first described case of atypical anti-GBM (linear IgA) disease with dual positive PR3-ANCA. Due to the rarity of the co-existence, there are no treatment guidelines. Due to the severity of disease presentation, we are treating the patient aggressively with high dose steroids, plasma exchange and cyclophosphamide, which then should be followed by maintenance immunosuppression to prevent relapse of ANCA, especially prevalent in PR3.

#### SA-PO721

### Treatment of Membranous Nephropathy With Crescent Nephritis by Rituximab With Corticosteroids

Fan Zhang, Yiya Yang, Yinyin Chen, Yumei Liang, Xun Luo. Hunan Provincial People's Hospital, Changsha, China.

**Introduction:** Crescent formation is rare in primary membranous nephropathy (MN). Previously reported cases of MN and crescent formation without any signs of vasculitis, lupus, or anti-GBM disease showed unfavorable therapeutic response and tended to have worse renal outcomes. Here, we presented a rare case presented with NS and kidney biopsy-proven MN.

**Case Description:** A 71-year-old female was admitted to hospital with nausea, vomiting and hypouricemia for 20 days. Serum creatinine was 539 μmol/L. Urinary sediment showed 120000 red blood cells per ml, 4+ protein. Serum albumin was 24.99 g/L. Anti-PLA2R antibodies were positive of 415.29 (<14) RU/mL. ANCA, anti-GBM antibody, anti-PR3 antibody, ANA antibody were all negative. Kidney biopsy (Fig. 1) contained 11 glomeruli, 1 of them were global sclerosis, 6 of them had crescent formation. GBM thickening and “spike and dome” appearance observed. Immunofluorescence showed granular deposits of IgG<sup>++</sup>, C3+ and IgM+ along capillary loop. The diagnosis was stage II MN combined with crescentic glomerulonephritis. She was treated with methylprednisolone 500mg per day for 3 days then reduced to 40mg per day, in combination with rituximab 600mg per week for 4 weeks (total dose 2.4mg), combined with intermittent hemodialysis (Figure 2). One month later, her serum creatinine was 139 (40–100) μmol/L. Urinary sediment showed no red blood cells, 2+ protein. Glucocorticoids were gradually reduced and the patient got complete remission 3 months later. Anti-PLA2R antibody became negative.

**Discussion:** Now there is no guideline for the treatments to MN with crescents and previously reported cases showed poor response of the therapy. Our case suggests a beneficial effect of rituximab for MN patients with crescentic glomerulonephritis. It provides that there is a pathologic feature of MN and crescents in the absence of known immunologic factors and rituximab could serve as an effective cure and could be considered in serious conditions of MN.

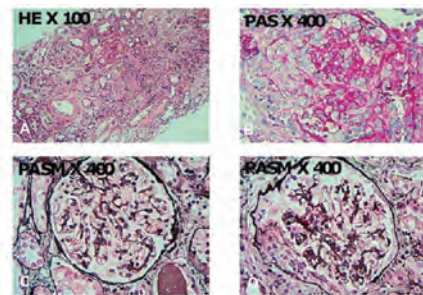

Kidney biopsy examinations.

#### SA-PO722

### Probenecid-Induced IgA Nephropathy Is Reversible

Sreyoshi F. Alam, Spencer Hodgins, Daniel L. Landry, Gregory L. Braden. Div of Nephrology UMass Chan Med School-Baystate, Springfield, MA.

**Introduction:** IgA nephropathy is usually idiopathic in nature but can have a genetic predisposition & it can also be secondary to autoimmune diseases, vasculitis, infections, liver disease, or anti-VEGF drugs like bevacizumab, & covid vaccine. We present a case of probenecid-induced IgA nephropathy.

**Case Description:** A 65-year-old male with chronic gout developed progressive chronic kidney disease over a 3-year period. He had been on probenecid 1 g twice daily for his gout for 15 yrs. His sodium iohalate clearance deteriorated to 58 mL/min, with a serum creatinine of 1.5 mg/dL. All other serologic tests were negative. His 72-hour lead level was also normal. He did not have SLE, granulomatous disease, or systemic rheumatic disorders. Surprisingly he did not have proteinuria or hematuria. Renal biopsy revealed IgA nephropathy, with segmental mesangial hypercellularity, mild arterial sclerosis, & tubular atrophy. Cytoplasmic lipofuscin pigment was noted on PAS stain capillary loops with focal thickening of the glomerular basement membrane, engorged capillary loops, & thickened tubular basement membrane. Immunofluorescence studies showed diffuse segmental paramesangial granules of IgA [3+] & fibrinogen as well as paramesangial granules of IgG [2+], Kappa & lambda. Electron microscopy showed swollen podocytes with increased cytoplasmic organelles and vacuolization, focal foot process effacement, & electron-dense deposits in the paramesangium & mesangium. His MEST score was zero. 6 months after discontinuation of probenecid, the patient's iohalate GFR significantly improved to 79 mL/min, followed by 82 mL/min 6 months later. He never had proteinuria, hematuria, or casts throughout his disease course. Five years later his GFR was 88 mL/min with a serum creatinine of 1.1 mg/dL.

**Discussion:** Probenecid has pleiotropic effects on the human immune system. It inhibits Pannexin-1 channels which are known to modulate T-cell function. Probenecid also regulates TRPV-2 channels as an agonist. These channels are also present on human immune B and T cell lymphocytes. Probenecid inhibits VEGF in retinal endothelial cells, & bevacizumab, an anti-VEGF monoclonal antibody, has been shown to cause IgA nephropathy. We conclude that probenecid can be a cause of IgA nephropathy which is reversible upon drug discontinuation.

#### SA-PO723

### Parvovirus B19 and Collapsing Glomerulopathy in a Postpartum Female

Elias S. Khazoum, Azkaa Zaman, Norhan Elsayed, Chetachi E. Odelugo, Moudi Hubeishy, Shanaz Azad, Tauseef A. Sarguroh. Franciscan Health Inc, Mishawaka, IN.

**Introduction:** Collapsing glomerulopathy (CG) is a variant of FSGS characterized by rapid onset and progression of renal failure. Interstitial fibrosis (IF), tubular atrophy (TA), entry level serum creatinine (SrCr) and degree of proteinuria have been used as predictors for progression.

**Case Description:** A 36-year-old African American female with a history of obesity reported gradual development of lower extremity edema following delivery of her second child. Her pregnancy was complicated by gestational diabetes and preeclampsia. At four months postpartum, she developed an upper respiratory infection followed by onset of exertional dyspnea, orthopnea, chest pain and worsening edema for which she presented to the hospital. Of note, she mentioned that her newborn was being treated for a rash on her face and scalp. Workup showed a SrCr of 1.0 mg/dL and a urine protein to creatinine ratio of 7.0 g/g. An echocardiogram revealed biventricular systolic dysfunction. Renal biopsy showed CG with moderate IF/TA and sclerosis of 24% of glomeruli. Serologies and HIV were negative, but parvovirus B19 (PvB19) IgM and IgG titers were elevated. Furosemide, losartan and spironolactone were started. Two weeks after discharge her repeat labs demonstrated SrCr of 1.0 mg/dL and proteinuria improved to 1.94 g/g.

**Discussion:** In one study, all CG patients with recovery of renal function had both IF and TA < 25% on biopsy. Another found IF > 20%, SrCr > 2, and proteinuria of > 8 g/day to be strong indicators of progression. A previous case report of CG in a 36-year-old intrapartum female with acute PvB19 infection and little IF/TA on initial biopsy showed rapid progression to ESRD, though she carried two APOL1 risk alleles. Our patient's preserved renal function and improved proteinuria on follow-up, despite risk factors of moderate IFTA on biopsy, may be related to a decreased genetic risk.

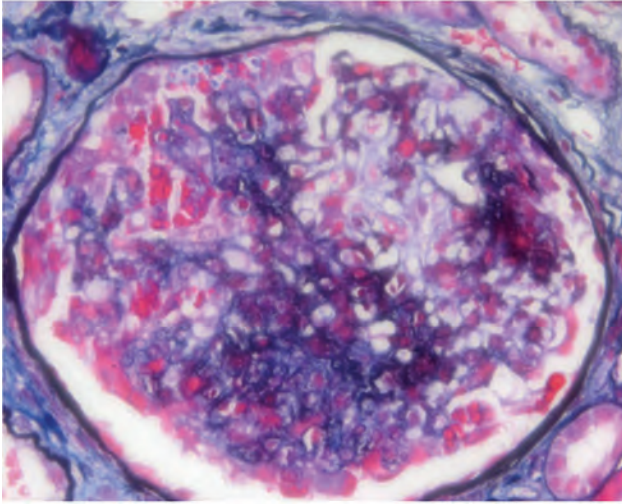

SA-PO724

#### Lupus-Like Nephritis Secondary to Non-steroidal Anti-inflammatory Drug (NSAID) Use: Case Report

Sapna Sharma,<sup>1,2</sup> Angelina Dhani Mohamed,<sup>1,2</sup> Ermias S. Greffie,<sup>1,2</sup> William M. Paredes,<sup>1,2</sup> Jamil Ibrahim,<sup>1,2</sup> Bessy Suyin Flores Chang,<sup>1,2</sup> <sup>1</sup>St Barnabas Hospital, Bronx, NY; <sup>2</sup>The City College of New York, New York, NY.

**Introduction:** Membranous nephropathy (MN) is a disorder with thickening of the glomerular capillary wall, resulting from immune complex formation on the basement membrane which leads to loss of large amounts of proteins in the urine. MN accounts for 30% of cases of nephrotic syndrome in adults of which 80% are due to primary MN and 20% are secondary to medications such as NSAID and diseases such as systemic lupus erythematosus (SLE), hepatitis B, hepatitis C and malignancies. We present a case of Lupus-like nephritis secondary to NSAID use

**Case Description:** 50-year-old male patient with diabetes, hypertension, asthma and obesity came to the hospital complaining of bilateral lower extremity swelling for 8 months. Physical exam was significant for generalized anasarca, chronic stasis changes in bilateral lower extremities, warmth and erythema of the left leg. His medications included lisinopril, hydrochlorothiazide, omeprazole, diclofenac 100 mg daily for over 8 months for joint pain. Initial serum creatinine was elevated to 9.2 mg/dl, Albumin was decreased to < 1 gm/dl. 24-hour total urine protein was 27 g and diagnosis of nephrotic syndrome was made. Extensive workup for infectious causes were negative. Autoimmune workup was negative for antinuclear antibodies, Anti-dsDNA, and rheumatoid factor. This prompted a kidney biopsy which revealed full-house immunofluorescence with focal segmental sclerosing features, diffuse acute tubular injury and moderate interstitial inflammation. He required temporary hemodialysis and was subsequently started on pulse dose steroids for 3 days with subsequent tapering along with lisinopril and albumin. Serum creatinine plateaued around 4.5 mg/dl for which dialysis was discontinued and followed up in clinic

**Discussion:** Membranous nephropathy with full-house immunofluorescence (IgG, IgA, IgM, C1q and C3) has been recently recognized in patients without features of SLE, called lupus-like nephritis. The insidious presentation of renal insufficiency with severe lower extremity edema, nephrotic syndrome and biopsy demonstrating full-house immunofluorescence, diffuse acute tubular injury and acute interstitial inflammation suggested NSAID induced MN in our patient. There are no clear guidelines on treatment for secondary MN due to NSAID use and need to be established along with awareness regarding long term effects

SA-PO725

#### A Case of Concomitant Anti-Glomerular Basement Membrane (Anti-GBM) Disease and Membranous Nephropathy

Cori O. Ogbolu, Dawn Maldonado, Temi-Ete I. Ediale, Joseph Guadalupe, Stephen C. Ward, Saad A. Bhatti, Aaron S. Stern, Maritza Brown. *Icahn School of Medicine at Mount Sinai, New York, NY.*

**Introduction:** There have been few cases of anti-glomerular basement membrane disease co-existing with membranous nephropathy (MN). We present a case of this rare dual pathology.

**Case Description:** A 56-year-old man with hypertension presented to the emergency room with dark urine and oliguria. He denied fever, dyspnea or hemoptysis. He had stable vitals, clear lungs, leg edema, and no rashes. Creatinine was 9.5 mg/dL (0.9 8 months ago).

Urine microscopy showed red blood cell casts. Anti-GBM was 194 U. ANA, ANCA, complements, and anti-PLA2r were normal. Kidney biopsy revealed cellular crescents, and immunofluorescence showed linear IgG and C3 (figure 1). Electron microscopy showed subepithelial and rare intramembranous immune deposits (figure 2). The final diagnosis was anti-GBM and MN. The patient was treated with pulse steroids, cyclophosphamide, and plasma exchange alternating with dialysis. Despite 2 weeks of plasma exchange, anti-GBM remained elevated at 46 U. He remains dialysis-dependent after 3 months.

**Discussion:** Only a few case reports have described the co-existence of anti-GBM and MN. Renal outcomes are worse than in patients with either diagnosis alone, which was the case for our patient. The fact that anti-GBM titers remained elevated despite plasmapheresis suggests that a systemic factor led to its active production. This factor may be related to the MN. This case highlights the need for elucidation of a target antigen that may trigger both diseases.

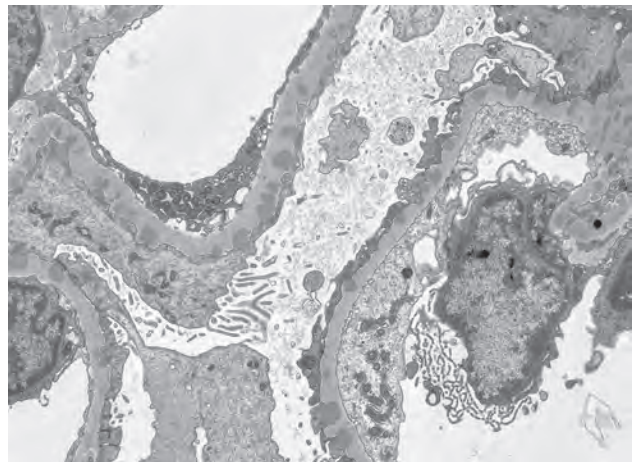
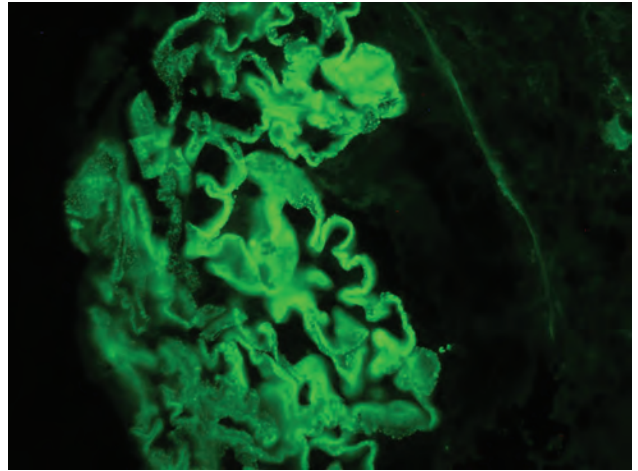

SA-PO726

#### Ovarian Carcinoma Induced NELL-1 Membranous Nephropathy With Bilateral Renal Vein Thromboses

Cynthia Contreras, Amit K. Rajput, Cesar E. Abdul-Massih, Antoine L. Samaha. *TriHealth, Cincinnati, OH.*

**Introduction:** Membranous nephropathy (MN) is one of the most common causes of nephritic syndrome in adults, accounting for nearly one-third of all cases. PLA2R, a transmembrane receptor, is the major antigen in primary MN, found in approximately 70% of cases. Neural epidermal growth factor-like 1 (NELL-1) is seen in 16% of PLA2R negative MN. NELL-1 has a high association with underlying malignancy, seen in up to one-third NELL-1 positive MN patients.

**Case Description:** A 70-year-old female with a history of myelofibrosis was admitted by her nephrologist due to an asymptomatic acute kidney injury (AKI) with nephrotic range proteinuria (UPCR 23g). Her Cr increased from 1.1mg/dL to 2.5mg/dL in less than 3 months. Extensive serologic work up was unremarkable, prompting a renal biopsy. The renal biopsy revealed NELL-1 MN with 6/27 glomeruli globally sclerosed and severe arteriosclerosis. Interestingly, the biopsy also demonstrated focal glomeruli with rare intraluminal aggregates of fibrin material and focal glomerular hypercellularity, suggesting renal vein thrombosis. During the work up, the patient was found to have a left renal vein acute thrombosis and no visualization of the right renal vein. A subsequent venogram demonstrated bilateral renal vein thrombosis, as well as thrombosis in the inferior vena cava and hepatic vein. The patient underwent multiple thrombectomies and thrombolytics, which improved her clot burden, but unfortunately was unable to salvage

Key: TH - Thursday; FR - Friday; SA - Saturday; OR - Oral; PO - Poster; PUB - Publication Only

Underline represents presenting author.

the right renal vein. The patient was started on long-term anticoagulation. Given the association with NELL-1 MN and malignancy, the patient underwent an extensive work up. She was ultimately found with bilateral ovarian masses, which were consistent with high-grade serous carcinoma of the ovaries.

**Discussion:** NELL-1 membranous nephropathy accounts for approximately 16% of all PLA2R negative MN cases. As seen with this patient, NELL-1 MN has a strong association with underlying malignancy. If diagnosed on biopsy, patients should undergo extensive cancer screening. As our understanding of this association progresses, more research is needed in guiding treatment for NELL-1 MN, especially cases with co-existing malignancies.

**SA-PO727**

**A Novel Approach in a Case of Cryoglobulinemic Glomerulonephritis**  
 Pooja Kalantri, Koba A. Lomashvili. *Emory University, Atlanta, GA.*

**Introduction:** Obinutuzumab, a fully humanized monoclonal anti CD-20 antibody, has been used for the treatment of B-cell malignancies. It is a novel and attractive treatment option in cases of glomerulonephritis, when Rituximab, a chimeric humanized murine monoclonal anti CD-20 antibody is not tolerated.

**Case Description:** A 52-year-old lady had a history of hypertension, Sjogren's disease, and mixed cryoglobulinemia complicated by glomerulonephritis and vasculitis. She reported being diagnosed with this disease in 2008 needing plasmapheresis. She relapsed in summer of 2020, with severe renal and skin manifestation and responded well to Rituximab infusion in August of 2020, achieving full remission with subsequent doses of rituximab at 4 months intervals. Unfortunately, the patient developed severe serum sickness reaction to third dose of Rituximab, requiring intubation. She relapsed again in 7/2021, and was diagnosed with monoclonal paraproteinemia of IgM kappa type with a normal bone marrow biopsy, 29% cryoglobulin levels, worsening proteinuria, AKI and purpuric rash with skin ulcers. She got pulse steroids and was started on monthly IV Cytoxin and oral steroid taper. The patient improved initially, dropping cryoglobulin level to 3%, but relapsed again when prednisone was tapered to 20 mg, while receiving IV Cytoxin. Prednisone was increased back to 60 mg daily. She later got admitted with a large left lower extremity ulcer and worsening skin rash. Her cryoglobulin level was also up to 8%. She was started on pulse dose steroids again and 1000mg Obinutuzumab given IV, with which she went into remission within 3 months. She got her second dose 5 months later on 3/2022, with prednisone completely tapered off currently. She had a healed leg ulcer, resolving purpuric rash, proteinuria of 330 mg/day, negative cryoglobulins, and an improving histopathology as of 3/2022.

**Discussion:** Rituximab is a chimeric antibody with murine and human components in it. Obinutuzumab is a fully humanized form. We believe that our patient had a reaction to the murine component of rituximab, which was not present in Obinutuzumab and hence she tolerated it well. It is a good alternative to explore. Obinutuzumab is currently not FDA approved for the treatment of cryoglobulinemic glomerulonephritis, and is being investigated for the treatment of lupus nephritis and membranous nephropathy.

**SA-PO728**

**Glomerulonephritis Following a Streptococcal Infection: Deciding Whether It's Poststreptococcal Glomerulonephritis**

Latoya N. Gayle, Alan M. Weinstein, Steven Salvatore. *New York-Presbyterian Hospital/Weill Cornell Medical Center, New York, NY.*

**Introduction:** Infection related glomerulonephritis (IRGN) was described in children as poststreptococcal glomerulonephritis (PSGN). Diagnostic kidney biopsy findings are subepithelial humps, which stain for C3 and IgG. IRGN is increasingly diagnosed in adults presenting for treatment of other infections. Ambiguity may arise when the biopsy does not display classic findings. We present a case of PSGN in an adult

**Case Description:** A 64-year-old female with hypertension and type 2 diabetes, presented to hospital with dyspnea for 1-2 days. She had a strep throat a week prior and received amoxicillin. She was saturating 86% on room air, with BP 182/90 and leg edema. Serum creatinine (Cr) = 4.68, up from 1.06 a month prior. Urine protein:Cr = 6.2, and urine sediment showed >50 RBC, >50 WBC, and RBC casts. On hospital day 1, urine output was less than 100 ml, despite bumetanide. CXR showed patchy consolidation and edema. She had worsening dyspnea with elevated systolic BP to 200 mmHg. CVVHD was started, and after net removal of 9L, systolic BP improved to 130 and BIPAP was no longer needed. Serologies included C3 = 54 (90-180mg/dl), C4 = 46.8 (12-36mg/dl), antistreptolysin O (ASLO) titre = 544 (<=200iu/mol), ANA positive 1:180, rheumatoid factor positive, ESR 83 and CRP 10. ANCA, dsDNA, MPO, PR3, hepatitis B and C were negative. Renal biopsy on day 4 revealed an exudative GN with no crescents, and IF showing only C3 and no IgG; there was widespread acute tubular injury of moderate severity. The patient received dialysis twice (days 5 and 7), as urine output reached 1.25 L on day 8. She was discharged on day 10 with Cr = 3.4. One-week later Cr = 2.9, with C3 = 118 and ASLO = 198.

**Discussion:** IRGN is often diagnosed in children based on presentation, while in adults biopsy confirmation is recommended. The finding of C3 only on our patient's kidney biopsy suggested possible C3GN. With her history, positive ASLO, and normalization of C3 within 2-3 weeks of presentation, this case was a true IRGN. However, at the time of biopsy there was ambiguity, between true PSGN and C3GN in someone who had a recent strep infection. Further studies into the evolution of IRGN in adults, with respect to the processing of glomerular immune deposits, may help address this ambiguity.

**SA-PO729**

**Gonococcal Endocarditis-Associated Glomerulonephritis: Revisiting a Forgotten Enemy**

Lillia Harris, Sriram Sriperumbuduri, Bushra Syed. *The University of Mississippi Medical Center, Jackson, MS.*

**Introduction:** Disseminated gonococcal infection is rare in the post-antibiotic era (0.5-3.0% cases) and can be complicated by infective endocarditis (IE) and glomerulonephritis (GN). We describe a unique case of rapidly progressive GN (RPGN) secondary to gonococcal IE coinciding with complement deficiency.

**Case Description:** A 61-year-old male with migratory polyarthritis, recurrent UTIs and conjunctivitis presented with diarrhea, arthralgia, and skin rash. On physical exam: purpuric rash involving forearms, thighs, nasal tip and cheeks; tenderness and swelling of the right shoulder and small joints of the right foot; bilateral chronic anterior uveitis. On initial workup (Table 1): anemia, leukocytosis, sCr of 2.98 mg/dL from baseline 0.8. Urinalysis showed proteinuria, hematuria, sterile pyuria, WBC casts. Cefepime started for empiric sepsis (Figure 1). A skin biopsy was consistent with leukocytoclastic vasculitis. Steroids were initiated due to suspected RPGN and worsened sCr. On additional workup: elevated UPCr and low C3 complement level; on renal biopsy diffuse crescentic and exudative GN with C3 deposits; favors IRGN. ECHO revealed a multi-lobular mass 1.9x2.6 cm on tricuspid valve (TV). Steroids were held due to concern for IE. Workup for culture-negative IE was unrevealing but metagenomics sequencing of microbial cell free DNA resulted positive for *Neisseria gonorrhoea*. Functional testing of the complement pathway revealed normal CH50 and decreased AH50 activity. He received 6-weeks of Ceftriaxone with resolution of the TV vegetation and partial renal recovery with sCr of 1.27 mg/dL.

**Discussion:** Complement deficient patients are highly susceptible to *Neisseria* infections. Dysregulation of complement pathway predisposed to C3 glomerulopathy and concomitant infection provided a second hit contributing to severe GN. Treatment with antibiotics and steroids led to partial renal recovery; further research needed on role of immunosuppression for course and outcome of IRGN.

Admission laboratory results	Admission laboratory results
WBC	13.7 TH/mm <sup>3</sup> (4.0 - 10.0)
Hemoglobin	5.7 g/dL (13.0 - 17.0)
ERS	111 ml/hr (0.0 - 10.0)
CRP	15.6 mg/dL (0.0 - 0.5)
sCr	2.98 mg/dL (0.67 - 1.17)
BUN	59 mg/dL (8-23)
Blood culture	No growth after 5 days
Urine culture	No growth
Complementary laboratory results	Complementary laboratory results
UPCR	3.3
Serum albumin	3 gm/dl
C3 complement	46 mg/dl (90 - 180)
C4 complement	18 mg/dl (10 - 40)
Complement total (CH50)	42 U/ml (35-70)
AH50, alternative complement pathway, functional	Low, < 10% of norm (> 46)
Mannose binding Lectin	3390 ng/ml (>51)
HIV, HCV, HbsAg, HBC, HBS	Non-reactive
Cyclic Citrullinated Peptide	Negative
Syphilis antibody (total)	Non-reactive
ASO screen	Negative
ANA	Negative
SSA and SSB antibody	< 0.2 AU (< 1.0)
Rheumatoid factor	< 10 IU/ml (< 14.0)
Glomerular Basement Membrane Antibodies	< 0.2 U (< 1.0)
Cryoglobulins	Negative
ANCA	Negative
Kappa/Lambda Free light chain (FLC) ratio	0.845 (0.26 - 1.65)
IFE (urine/serum)	Urine and serum are negative for monoclonal FLC
N. gonorrhoea, urine	Not detected
C. trachomatis, urine	Not detected
Bartonella Henselae, Quintana IgG Screen	< 1:128 (< 1:128 titer)
Bartonella Henselae, Quintana IgM Screen	< 1:20 (< 1:20 titer)
Bartonella PCR (Blood)	Not detected
Brucella Antibody IgG	Negative
Brucella Antibody IgM	Negative
Tropheryma whipplei PCR (Blood)	Not detected
Blastomycosis Antigen	None detected
Histoplasma Antigen Urine	Negative
Q Fever IgG Phase I Ab, II Ab	< 1:16 (< 1:16)
Q Fever IgM Phase I Ab, II Ab	< 1:16 (< 1:16)
Culture, AFB Blood	No Acid Fast bacilli isolated
Legionella Antigen Urine	Negative
Culture, Fungus Blood	No Grow th
Karius test: Neisseria gonorrhoeae	5309 DNA molecules/ml (< 10)

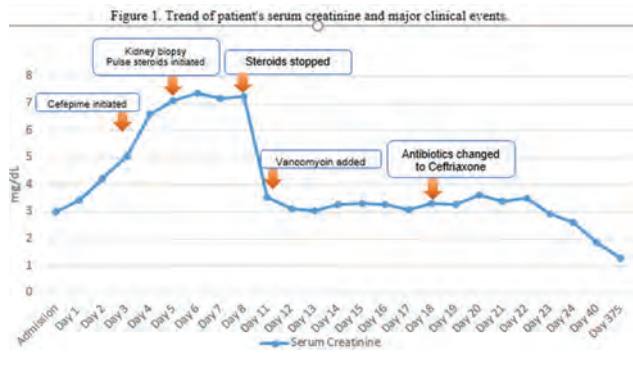

## SA-PO730

## The Maximal Consequences of Minimal Change Disease

Chris Dipollina, Brian Bustos, Soo H. Kae. University of Connecticut, Storrs, CT.

**Introduction:** Minimal change disease (MCD) is a common cause of nephrotic syndrome in children. However, it only accounts for 10-15% of nephrotic syndromes in adults. The exact pathophysiology of MCD still remains unclear. We present a case of adult-onset MCD causing nephrotic syndrome and explore the pathophysiology behind MCD.

**Case Description:** A 38-year-old male presented to the hospital with 2 weeks of lower extremity edema and 3 days of oliguria with outpatient blood work showing creatinine rise to 1.5mg/dL from a baseline of 0.7 mg/dL 4 months ago. He had gross anasarca on exam, hypoalbuminemia with albumin level of 2.0 g/dL, and significant proteinuria (>7g/24 hrs) consistent with nephrotic syndrome. He denied being started on any new medication or using illicit drugs. During admission, his creatinine rose to 2.6mg/dL and he also had hematuria on urinalysis prompting a renal biopsy, which showed findings consistent with acute tubular necrosis (ATN) and diffuse podocytopathy confirming diagnosis of MCD with concurrent ATN. ANA, ANCA, and anti-PLA2R were all negative. Patient was pulsed with IV steroids and discharged on a steroid taper with resolution of his edema and proteinuria and normalization of his creatinine.

**Discussion:** The hallmark of MCD is podocyte effacement that results in protein loss, especially albumin, subsequently causing edema and hyperlipidemia. The exact mechanism as to how the podocyte gets effaced remains unclear although there are some emerging hypotheses. One theory is that T cell dysfunction results in production of glomerular permeability factor, which is thought to affect the glomerular capillary wall and cause proteinuria and foot effacement. More recent studies have shown the presence of deposits of circulating autoantibodies targeting nephrin, an essential component of the glomerular slit diaphragm, in kidney biopsies of patients with MCD. These hypotheses point towards an autoimmune or immune dysregulatory mechanism behind MCD, which can potentially explain why patients with MCD respond to immunosuppressives agents. Although rarer in adults, MCD is a known cause of nephrotic syndrome and carries significant morbidity with nearly 20% of cases necessitating dialysis. Kidney biopsy is the only way to confirm diagnosis. Further studies are needed to identify serological markers that could aid in a more prompt diagnosis of MCD in order to pursue targeted management.

## SA-PO731

## APOL1 Extracellular Translocation: A Possible Role of Microvesicles

Prabhjot K. Johal,<sup>1</sup> Vinod Kumar,<sup>1</sup> Ashwani Malhotra,<sup>2</sup> Pravin C. Singhal.<sup>2</sup>  
<sup>1</sup>Post Graduate Institute of Medical Education and Research, Chandigarh, India; <sup>2</sup>Northwell Health Feinstein Institutes for Medical Research, Manhasset, NY.

**Background:** Podocyte expressed APOL1 (pAPOL1) is not secretory compared to the one expressed by liver cells. However, the plasma membrane integration potential of pAPOL1 is well documented, where G0 has maximum membrane penetration than G1 & G2. Presence of pAPOL1 protein in the culture medium and biological fluids is still unclear. Here, we hypothesized that APOL1 secretion in podocyte cells adopt microvesicles (MVs) secretion pathway rather than direct secretion to the medium.

**Methods:** APOL1 and its risk variants were over-expressed in human embryonic kidney (HEK) cells. After 48hr of incubation, the culture medium was collected and processed for MVs isolation by ultracentrifugation and MVs isolation kit. MVs were also isolated from podocytes expressing APOL1-G0, G1 & G2. Isolated MVs were characterized for the presence of HSP70, CD81, CD63 and absence of Calnexin by Western Blot (WB) and FACS. Size was measured using Nanosize system and Scanning Electron Microscopy. ELISA was used to detect circulating APOL1, while WB used for MVs APOL1. MVs were further incubated with non APOL1 expressing HEK cells and after 48hr HEK cell lysate was analyzed for APOL1 presence by WB.

**Results:** Nanosize & SEM measured size of isolated MVs was in between 90-125nm. These MVs stained positive for the expression of CD63, CD81, and HSP70, but were negative for the expression of calnexin. Thereby, confirming that there was no cytosolic contamination. We observed the presence of APOL1 protein only in the lysed MVs. However, the level of APOL1-G0 (intensity: 1.92±0.01) is much higher compared to Vector (0.11±0.01) G1 (0.12±0.01) and G2 (0.17±0.02) Figure 1

**Conclusions:** This preliminary study shows that Podocytes secrete APOL1 through MVs pathway

**Funding:** Government Support - Non-U.S.

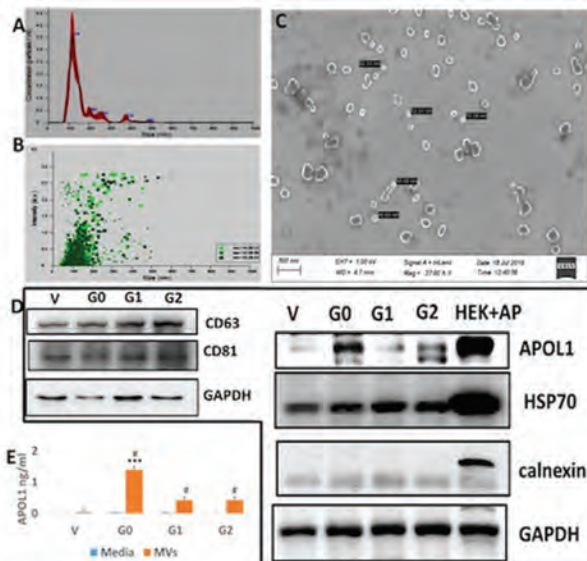

**Fig 2.** MVs size measured using Nanosize (A&B), SEM (C), expression of MVs protein marker and APOL1 (D), ELISA to detect APOL1 in media and MVs (E). P value \*\*\*p<0.001, #p<0.001 (\*G0 vs V, G1 or G2; #media vs MVs)

## SA-PO732

## Obesity-Related Glomerulopathy in the Presence of APOL1 Risk Alleles

Nang San Hti Lar Seng,<sup>1,2</sup> Ronald Valdez Imbert,<sup>1,2</sup> Belinda Jim,<sup>1,2</sup> <sup>1</sup>Jacobi Medical Center, Bronx, NY; <sup>2</sup>Albert Einstein College of Medicine, Bronx, NY.

**Introduction:** Apolipoprotein L1 (APOL1) confers protection from *Trypanosoma brucei* infections are enriched in sub-Saharan African populations. Nephropathic APOL1 risk alleles (G1/G2) have been associated with focal segmental glomerulosclerosis, HIV-associated nephropathy, SLE-associated collapsing glomerulopathy, and other glomerulonephritides. Here, we present a case of obesity-related glomerulopathy (ORG) in the setting of two APOL1 risk alleles.

**Case Description:** A 32-year-old female from Jamaica with a history of hypertension, preeclampsia, hyperlipidemia, and obesity (BMI 32 kg/m<sup>2</sup>) was referred to the nephrology clinic for the evaluation of proteinuria and lower extremity edema. An evaluation for secondary causes of HTN was unrevealing. The patient also denied a history of premature birth or low birth weight for herself, though noted frequent urinary tract infections as a child but was never further evaluated. Her family history was significant for her mother who developed hypertension in the mid-twenties, her maternal grandmother who experienced a cerebrovascular accident at the age of 40, and her maternal grandfather who died of end-stage kidney disease of unknown etiology. Physical examination revealed a blood pressure of 150/100 mmHg, clear lungs, normal cardiac and abdominal exam, but bilateral 2+ lower extremity pitting edema. Labs were significant for estimated glomerular filtration rate 65 (82-137 ml/min/1.73 m<sup>2</sup>) and urine protein creatinine ratio (uPCR) 2368 mg/g. Infectious and autoimmune workup were unremarkable. Kidney biopsy showed mild focal global glomerulosclerosis with glomerulomegaly with mild tubular atrophy and interstitial fibrosis. The findings of glomerulomegaly indicated glomerular hypertension and hyperfiltration, which may be related to obesity, hypertension, and/or reduced nephron number. We referred our patient to the weight management clinic, started her on losartan and atorvastatin. At four-month follow-up, her uPCR decreased to 1618 mg/g.

**Discussion:** Obesity may serve as a "second hit" to develop ORG. Moreover, APOL1 risk alleles may be associated with increased cardiovascular and metabolic derangements. Given the substantial morbidity and mortality from the combination of cardiovascular disease and CKD, knowledge of APOL1 risk allele status may help to better stratify cardiovascular and renal risks to help guide clinical care.

## SA-PO733

## A Case of Lupus Podocytopathy in Transition to Membranous Lupus Nephritis Class V With Positive APOL-1 Gene

Venkata Kishore R. Mukku, Marjan Afrouzian, Tina Kochar. The University of Texas Medical Branch at Galveston, Galveston, TX.

**Introduction:** Lupus podocytopathy (LP) is a glomerular lesion in systemic lupus erythematosus (SLE) patients characterized by diffuse epithelial cell foot process effacement (FPE) without immune complex deposition or with only mesangial immune complex deposition. In SLE, nephrotic syndrome in rare instances, appear as LP, mimicking minimal change disease (MCD) or primary focal segmental glomerulosclerosis (FSGS).

**Case Description:** 21-year-old African American female with a past medical history of eczema, kidney stone, COVID-19, facial rash admitted with persistent shortness of breath, lower extremity swelling with symptomatic anemia. Patient was noted to have nephrotic syndrome with positive serology for SLE and low complements. Renal biopsy

showed lupus podocytopathy with features of collapsing glomerulopathy. The absence of endocapillary proliferation, presence of collapsing features, and lack of sub-endothelial immune complexes on electron microscopy (EM) are features consistent with LP with transition to Membranous lupus nephritis (LN) Class V. Patient was started on steroids, mycophenolate mofetil, and hydroxychloroquine. Voclosporin was added at one month follow-up given persistent nephrotic syndrome. Proteinuria improved significantly to 2 g in 4 weeks and prednisone taper was started. APOL1 gene assay revealed presence of G1, G2 risk alleles.

**Discussion:** The prevalence of LP in LN biopsies is approximately 1% and is diagnosed based on clinical presentation of nephrotic syndrome with SLE and kidney biopsy findings of diffuse and severe FPE on EM, and absence of subendothelial or subepithelial immune deposits on EM. LP is further subclassified as MCD or FSGS subtypes. The MCD forms respond well to treatment with glucocorticoids as induction therapy, adding a nonglucocorticoid immunosuppressive agent only to treat or, in some cases, to avoid relapses. On the other hand, the FSGS forms with collapsing lesions have worse outcomes, progressing to end-stage renal disease in more than 50% of the cases. LP FSGS subtypes are less steroid-responsive and may benefit from initial induction treatment with glucocorticoids and another agent, such as calcineurin inhibitors. APOL1 genotyping of African American patients with SLE might help identify patients at risk for collapsing glomerulopathy, an entity with poor prognosis and resistance to treatment.

**SA-PO734**

**Human iPSC-Derived Podocytes to Study APOL1 High-Risk Variants**

Lauren Haines, Uyen Tran, John F. O'Toole, John R. Sedor, Oliver Wessely. *Cleveland Clinic, Cleveland, OH.*

**Background:** Podocytes within the glomerulus are integral to forming the filtration barrier needed for kidney function. The CDC estimates 15% of adults in the US have chronic kidney disease (CKD), but there are no curative treatment options for CKD and patients must resort to time-consuming dialysis or undergo a kidney transplant to maintain a quality of life during disease progression. The African American population of sub-Saharan descent has a 3.5-fold increased risk for end-stage kidney disease compared to populations of European descent. This incidence discrepancy is, in part, due to two pathogenic variants G1 and G2 in the apolipoprotein L1 (*APOL1*) gene. Individuals with the presence of one high-risk allele are resistant to African sleeping sickness, but the presence of two high-risk alleles significantly predisposes to kidney disease.

**Methods:** As *APOL1* is only present in humans and some higher-order primates, to model its biology we have generated a series of isogenic human induced pluripotent stem cell lines (iPSCs) genetically engineered to contain *APOL1* reference (G0) and high-risk (G1, G2) variant genotypes. In addition, the lab has also developed a protocol to directly differentiate iPSCs into pure populations of podocytes. Combined with our new iPSC cell lines, this provides a novel cellular model to study *APOL1* high-risk variants in the cell type affected in human patients. A pure population of human high-risk *APOL1* podocytes will enable additional discovery not feasible through prior means of research.

**Results:** Variant *APOL1* iPSC lines successfully differentiate into pure podocyte populations using our podocyte differentiation protocol. These podocytes robustly express FOXD1, MAFB, and WT1. They form foot process-like cytoplasmic extensions, marked by slit diaphragm proteins NPHS1 and NPHS2. Upon stimulation with IFN- $\gamma$ , the podocytes express *APOL1*. These podocytes do not demonstrate differential cell death upon induction of *APOL1*.

**Conclusions:** This research allows the integration of human-specific aspects of podocyte biology in a representative and homogenous cell population. It provides an opportunity to gain an understanding of *APOL1* and the mechanism underlying *APOL1*-mediated diseases. Data generated using this model will help to provide directly translatable and desperately needed therapeutic intervention to kidney disease injury and progression.

**Funding:** NIDDK Support

**SA-PO735**

**Progression of Focal Segmental Glomerulosclerosis in Patients With High Risk APOL1 Genotypes: A CureGN Study**

Mahmoud Kallash,<sup>1</sup> Yujie Wang,<sup>3</sup> Abigail R. Smith,<sup>3</sup> Howard Trachtman,<sup>3</sup> Carla M. Nester,<sup>4</sup> Rasheed A. Gbadegesin,<sup>6</sup> Pietro A. Canetta,<sup>7</sup> Chen Wang,<sup>7</sup> Tracy E. Hunley,<sup>14</sup> John Sperati,<sup>5</sup> David T. Selewski,<sup>2</sup> Isabelle Ayoub,<sup>8</sup> Tarak Srivastava,<sup>9</sup> Amy K. Mottl,<sup>10</sup> Jeffrey B. Kopp,<sup>11</sup> Virginia Royal,<sup>12</sup> Debbie Gipson,<sup>3</sup> Jason M. Kidd.<sup>13</sup> <sup>1</sup>Nationwide Children's Hospital, Columbus, OH; <sup>2</sup>University of South Carolina System, Columbia, SC; <sup>3</sup>University of Michigan, Ann Arbor, MI; <sup>4</sup>The University of Iowa Hospitals and Clinics Department of Pathology, Iowa City, IA; <sup>5</sup>Johns Hopkins University School of Medicine, Baltimore, MD; <sup>6</sup>Duke University Medical Center, Durham, NC; <sup>7</sup>Columbia University Irving Medical Center, New York, NY; <sup>8</sup>The Ohio State University Wexner Medical Center, Columbus, OH; <sup>9</sup>Mercy Children's Hospital Springfield, Springfield, MO; <sup>10</sup>Cincinnati Children's Hospital Medical Center James M Anderson Center for Health Systems Excellence, Cincinnati, OH; <sup>11</sup>National Institute of Diabetes and Digestive and Kidney Diseases, Bethesda, MD; <sup>12</sup>Hopital Maisonneuve-Rosemont, Montreal, QC, Canada; <sup>13</sup>VCU Medical Center Main Hospital, Richmond, VA; <sup>14</sup>Vanderbilt University Medical Center, Nashville, TN.

**Background:** Polymorphism in *APOL1* is a risk factor for disease progression in FSGS. This study evaluated the association of *APOL1* genotypes on kidney disease progression in patients with FSGS.

**Methods:** Cure Glomerulonephropathy participants with a biopsy diagnosis of FSGS were included. Whole genome sequencing was performed with 150 bp paired end reads on Illumina NovaSeq 6000 instruments targeting 30X read depth. eGFR decline was categorized as  $\leq$ -5, 0 to -5, and  $>$ 0ml/min/yr. Multivariable ordinal logistic regression was used to assess the association with *APOL1* high-risk (HR, 2 risk alleles) vs low risk (LR, 0-1 risk alleles).

**Results:** Of 650 participants, 13% were HR, 60% were LR (*APOL1* status missing for 27%, Table). HR participants' biopsies showed more collapsing FSGS ( $p<0.001$ ), greater interstitial inflammation ( $p<0.001$ ) and interstitial fibrosis and tubular atrophy ( $p=0.02$ ). The odds of rapid progression was 2.76 times higher in the HR group after adjustment. Proteinuria at biopsy was not associated with progression category, however, within the first year post-enrollment, higher nadir proteinuria (OR=1.09,  $p=0.02$ ), need for multiple immunosuppressive agents (OR=1.35,  $p=0.001$ ) and uncontrolled hypertension (OR=1.61,  $p=0.04$ ) were associated with rapid progression.

**Conclusions:** In addition to *APOL1* genotype, degree of proteinuria reduction, use of multiple immunosuppressive agents and uncontrolled hypertension are additional risk factors for rapid progression of FSGS. A better understanding of the natural history of FSGS in the context of high risk *APOL1* genotypes will improve patient care and inform the design of interventional studies.

Table: Demographic and clinical characteristics of subjects per *APOL1* status.

Character	All (N=650)	HR genotype (N=87)	LR genotype (N=389)	p
Age at kidney disease onset, median (IQR)	28 (13, 47)	31 (15, 43)	32 (14, 50)	0.42
Sex, n (%) Female	304 (47)	49 (56)	174 (45)	0.05
eGFR (ml/min/1.73m <sup>2</sup> ) at biopsy, median (IQR)	73 (43, 103)	62 (36, 81)	76 (44, 106)	<0.01
UP:C (g/g) at biopsy, median (IQR)	4.2 (2.2, 8.6)	4.7 (1.8, 9.4)	4.2 (2.3, 8.4)	0.84
Nadir UP:C (g/g) from biopsy to 1 year post enrollment, median (IQR)	0.4 (0.1, 1.8)	0.5 (0.3, 1.7)	0.4 (0.1, 1.6)	0.03
Serum albumin (g/dl) at biopsy, median (IQR)	2.9 (2.0, 3.7)	2.7 (1.9, 3.6)	2.8 (2.0, 3.8)	0.37
Number of medications up to 1 year post enrollment (Steroids, CNL, CTX, MMF, Rituximab), n (%)				0.29
0	173 (27)	21 (24)	100 (26)	
1	159 (24)	23 (26)	89 (23)	
2	184 (28)	32 (37)	109 (28)	
3	103 (16)	8 (9)	68 (17)	
4	29 (4)	3 (3)	21 (5)	
5	2 (0)	0 (0)	2 (1)	



SA-PO736

**Testican-2 Alleviates Adriamycin-Induced Podocyte Injury by Modulating Vitronectin-Integrin  $\alpha V\beta 3$  Interaction**

Donghai Wen,<sup>1</sup> Ivy A. Rosales,<sup>1</sup> Robert B. Colvin,<sup>1</sup> Sushrut S. Waikar,<sup>2</sup> Wen Zhou,<sup>1</sup> Martin Pollak,<sup>3</sup> Eugene P. Rhee.<sup>1</sup> <sup>1</sup>Massachusetts General Hospital, Boston, MA; <sup>2</sup>Boston University, Boston, MA; <sup>3</sup>Beth Israel Deaconess Medical Center, Boston, MA.

**Background:** Testican-2 is a podocyte-derived glycoprotein encoded by the gene *SPOCK2*. Its circulating levels are associated with higher estimated glomerular filtration rate (eGFR) and slower rate of subsequent eGFR decline in two large racially diverse cohorts. The biological function of testican-2 in podocytes is unknown.

**Methods:** Immortalized cultured human podocytes were treated with adriamycin with or without testican-2, and then actin cytoskeleton disruption was examined to assess podocyte injury. BALB/c male mice were treated with adriamycin together with placebo (eGFP) or *Spock2* adenovirus. Three weeks later, urine spot albumin/creatinine and glomerulosclerosis were examined. To further investigate the underlying mechanisms of testican-2 on podocyte function, immunoprecipitation-mass spectrometry (IP-MS) was utilized to examine the potential binding proteins of testican-2 in the extra-cellular matrix (ECM) of cultured human podocytes. Bio-Layer Interferometry (BLI) was utilized to further confirm their interactions. Finally, glomerular testican-2 expression levels of human kidney biopsy samples from patients with primary focal glomerulosclerosis (FSGS) and normal control subjects were examined by immunofluorescence (IF).

**Results:** Testican-2 significantly reduced adriamycin-induced podocyte actin cytoskeleton disruption. Treatment of *Spock2* adenovirus also improved adriamycin-induced albuminuria and glomerulosclerosis as compared to eGFP adenovirus. IP-MS identified vitronectin as one of the binding partners for testican-2, which was further verified by BLI. In addition, BLI showed that testican-2 inhibits the interaction between vitronectin and integrin  $\alpha V\beta 3$ , which is an anchored protein that has been shown to play an important role in podocyte injury. Administration of testican-2 also reduced adriamycin-induced activation of integrin  $\alpha V\beta 3$  in cultured human podocytes and mouse glomeruli as examined by IF. Finally, glomerular testican-2 expression was reduced in patients with FSGS as compared to normal control subjects.

**Conclusions:** Testican-2 alleviates adriamycin-induced podocyte injury, likely through modulating vitronectin-integrin  $\alpha V\beta 3$  interaction

**Funding:** NIDDK Support

SA-PO737

**Change of Integrin  $\alpha V\beta 3$  in Glomerular Diseases and Flow Shear Stress**

Jae seok Kim, Nghia T. Pham, Ji-Hee Kim, Bao T. Dang, Minseob Eom, Jun Young Lee, Jae Won Yang, Byoung Geun Han, Seung-Ok Choi, Seung-Kuy Cha. *Yonsei University Wonju College of Medicine, Wonju, Republic of Korea.*

**Background:** Podocyte and glomerular basement membrane (GBM) are main components of glomerular filtration barrier. Integrins (Itg) play a specific role in the crosstalk of podocyte and GBM under physical stress, but the renal disease-specific expression and context-dependent role of specific Itg remain elusive.

**Methods:** Here we explored disease-specific integrin (Itg  $\alpha V\beta 3$ ) expression using human kidney tissues obtained from the patients with trauma (control), membranous nephropathy (MN), and minimal change disease (MCD), and examined the (patho) physiological role of Itg  $\alpha V\beta 3$  upon mechanical stress.

**Results:** In immunohistochemical studies, Itg  $\beta 3$  was exclusively expressed in glomerulus. Itg  $\beta 3$  expression was lower in MN and MCD than that of control, while uPAR and fibronectin, a activator of Itg  $\alpha V\beta 3$ , were higher in MN and MCD. There were no differences in Itg  $\beta 3$ , uPAR, and fibronectin between MN and MCD groups (Figure 1). Functional experiments revealed that mechanical forces by fluid shear stress (FSS) upregulated Itg  $\beta 3$  activation and induced actin remodeling without affecting total Itg  $\beta 3$  expression in human podocyte. In addition, FSS increased fibronectin supporting that Itg  $\alpha V\beta 3$  might be activated in association with fibronectin under FSS (Figure 2).

**Conclusions:** Taken together, this study demonstrates that Itg  $\alpha V\beta 3$  may be implicated in the interplay of podocyte and GBM under pathological conditions. In particular, Itg  $\alpha V\beta 3$  activation by fibronectin is thought to be important step in the role of Itg  $\alpha V\beta 3$ . Our results provide new clues for therapeutic strategies for glomerular diseases. This work was supported by the National Research Foundation of Korea (NRF) grants (2021R1G1A1004360, 2017R1A5A2015369)

**Funding:** Government Support - Non-U.S.

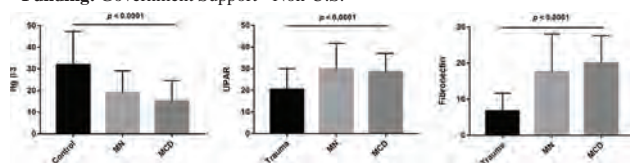

Figure 1. Immunohistochemical studies of human kidney.

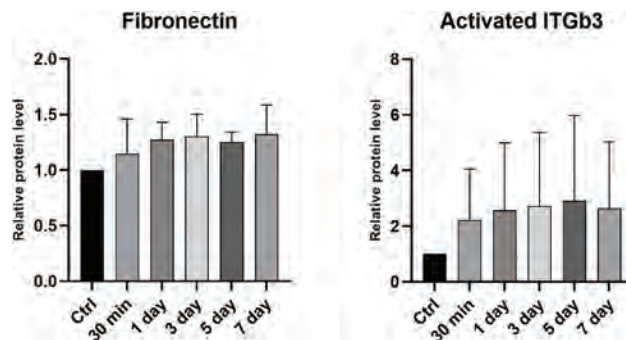

Figure 2. Change in the interaction of podocyte-glomerular basement membrane under flow shear stress (FSS).

SA-PO738

**Discovery of a Novel Podocyte Complex of Nephrotic Syndrome Disease Protein NOS1AP and Dystroglycan Complex (DGC) Component SNTA1**

David A. Ball,<sup>1</sup> Lorrin Liang,<sup>1</sup> Vineeta Sharma,<sup>1</sup> Gabrielle L. Wilson,<sup>1</sup> Florian Bueger,<sup>1</sup> Radovan Bogdanovic,<sup>2</sup> Stanley C. Froehner,<sup>3</sup> Marvin Adams,<sup>3</sup> Shirlee Shril,<sup>1</sup> Shrikant M. Mane,<sup>4</sup> Friedhelm Hildebrandt,<sup>1</sup> Amar J. Majmundar.<sup>1</sup> <sup>1</sup>Division of Nephrology, Department of Pediatrics, Boston Children's Hospital, Harvard Medical School, Boston, MA; <sup>2</sup>The Institute of Mother and Child Health Care of Serbia "Dr Vukan Cupic", Belgrade, Serbia; <sup>3</sup>University of Washington Department of Physiology and Biophysics, Seattle, WA; <sup>4</sup>Department of Genetics, Yale University School of Medicine, New Haven, CT.

**Background:** Nephrotic syndrome (NS) is a leading cause of pediatric chronic kidney disease. We discovered recessive mutations in *NOS1AP*, encoding nitric oxide synthase 1 adaptor protein, as a novel cause of NS (Majmundar *Sci Adv* 2021). We aimed to identify podocyte-specific *NOS1AP* interaction partners through which it regulates podocyte homeostasis.

**Methods:** Protein interactions were detected by co-immunoprecipitation (co-IP) assays using tagged cDNA constructs. Immunofluorescence (IF) staining and confocal microscopy were performed. Exome sequencing (ES) data from >800 NS families was analyzed.

**Results:** Of 85 putative *NOS1AP*-interacting proteins from published candidate interaction and proteomics studies, six were co-expressed (% cell expression z-score>1) with *NOS1AP* in podocyte clusters from at least three of four published kidney single cell mRNA sequencing (scRNAseq) datasets: FYN, PAK1, GSN, SPTAN1, SNTA1, HSPA12A. Upon co-overexpression in immortalized podocytes, *NOS1AP* exhibited bi-directional co-IP with only SNTA1 and HSPA12A and required its PDZ binding domain for the SNTA1 interaction. SNTA1 (syntrophin alpha 1) is an adaptor protein, which recruits other dystroglycan complex (DGC) proteins to the mouse neuromuscular junction (Adams *J Neurosci* 2010). DGC genes *DAG1* and *UTRN1* were co-expressed with *NOS1AP* and *SNTA1* in podocyte clusters from published kidney scRNAseq datasets. By IF, we found that *NOS1AP* and SNTA1 co-localized with podocyte marker nephrin and was adjacent to alpha-dystroglycan in glomeruli from human and rat kidney sections. *NOS1AP*-induced filopodia formation, an NS intermediate phenotype, was reduced by *SNTA1* knockdown in immortalized podocytes (32.8% versus 23.1%,  $X^2 = 4.4$ ,  $p = 0.035$ ). Finally, ES data was evaluated under the hypothesis that DGC genes are mutated in human NS. Candidate compound heterozygous variants in *UTRN1* (p.S623F, p.T3177C), with rare prevalence in gnomAD and multiple severe *in silico* prediction scores, were detected in a 16-year-old female F1418 with nephrotic range proteinuria resistant to corticosteroids.

**Conclusions:** Our results suggest that *NOS1AP* and SNTA1 form a complex in glomerular podocytes, which may have implications for actin remodeling and human NS.

**Funding:** NIDDK Support, Other NIH Support - NICHD, Private Foundation Support

SA-PO739

**Transcriptomic Analysis of Homozygous CLVS1 H310Y Podocytes Reveals Mechanisms Driving Disease and Corticosteroid Mediated Rescue**

Brandon M. Lane,<sup>1,2</sup> Megan Chryst-Stangl,<sup>1,2</sup> Guanghong Wu,<sup>1,2</sup> Kinsie Huggins,<sup>3,2</sup> Rasheed A. Gbadegesin.<sup>1,2</sup> <sup>1</sup>Duke University School of Medicine, Durham, NC; <sup>2</sup>Duke Molecular Physiology Institute, Durham, NC; <sup>3</sup>Duke University, Durham, NC.

**Background:** We have previously shown that the homozygous CLVS1 H310Y variant is a cause of familial steroid sensitive nephrotic syndrome (SSNS). This variant causes defects in clathrin mediated endocytosis that results in increased generation of reactive oxygen species and decreased viability in conditionally immortalized podocytes. These phenotypes were ameliorated by corticosteroid treatment, mimicking the phenotype in the affected family, however the exact mechanisms involved were unclear.

**Methods:** To identify mechanisms of disease and therapy response, we performed unbiased RNA-seq transcriptomic analysis on conditionally immortalized podocytes with WT CLVS1, homozygous CLVS1 H310Y podocytes, and corticosteroid treated homozygous H310Y podocytes (N=3 each).

**Results:** Among the most significant pathways disrupted by the CLVS1 H310Y variant according to Gene Ontology (GO) analysis is response to virus ( $p=1.26E-6$ ). Interestingly, other top downregulated pathways including focal adhesion, cell substrate adhesion, actin cytoskeleton regulation, and cell-cell adhesion in H310Y podocytes ( $p=4.51E-11$ ,  $4.34E-11$ ,  $2.73E-05$ , and  $0.000395$ ) were also among the most significantly upregulated pathways by corticosteroid treatment ( $p=7.84E-23$ ,  $7.87E-23$ ,  $1.26E-05$ , and  $0.001755$ ). Additionally, corticosteroid treatment increased intracellular vesicle transport of proteins to the cell membrane, endoplasmic reticulum, and within mitochondria ( $p=6.54E-24$ ,  $7.92E-23$ , and  $2.54E-05$ ).

**Conclusions:** The results of this study identified disruption of podocyte adhesion and cytoskeletal regulation pathways in podocytes homozygous for the CLVS1 H310Y mutation. Our findings also revealed that glucocorticoid treatments partially correct the dysregulation in these pathways. Corticosteroid treatment also increased expression of vesicle transport processes that could counteract a loss in clathrin mediated endocytosis. Taken together, this data provides valuable insight into mechanisms driving disease and corticosteroid response in SSNS due to defects in CLVS1 gene and highlights pathways that may be potential therapeutic targets.

**Funding:** NIDDK Support, Other NIH Support - NICHD

#### SA-PO740

### Nephrin-Ephrin-B1-Par6 Complex Is Crucial for Slit Diaphragm in Podocytes: Ephrin-B1 Suppresses Tight Junction Formation by Interfering With Par-6-Cdc42 Binding

Yoshiyasu Fukusumi, Ying Zhang, Hidenori Yasuda, Hiroshi Kawachi. *Department of Cell Biology, Kidney Research Center, Niigata University, Niigata, Japan.*

**Background:** We have reported that ephrin-B1 interacts with nephrin, a key molecule of slit diaphragm at the extra-cellular domain (Fukusumi et al. JASN 2018) and interacts with Par-6, a member of the Par polarity complex, at the cytoplasmic domain in podocyte (Takamura et al. Am J Pathol 2021). However, the precise role of the ephrin-B1-Par-6 interaction in the slit diaphragm is unclear. The binding of Cdc42 with Par-6 is understood to be essential for tight junction formation. Converting to slit diaphragm from pre-mature junctions is an important step in podocyte differentiation, and it is reported that the transition of slit diaphragm to tight junction appears in many nephrotic conditions. Thus, we hypothesize that ephrin-B1-Par-6 interaction contributes to the maintenance of the slit diaphragm by interfering with the binding of Par-6-Cdc42.

**Methods:** To verify the hypothesis, the interactions of ephrin-B1, Par-6 and Cdc42 were analyzed with the HEK cell expression system. The alterations of the interactions in podocyte injury models were investigated with dual-labeling immunofluorescence study.

**Results:** The interaction of Par-6 and Cdc42 was detected with immunoprecipitation techniques with HEK cells transfected with these molecules. However, if ephrin-B1 was co-transfected, Par-6 was dissociated from Cdc42 and interacted with ephrin-B1. Then, if ephrin-B1 was phosphorylated by the treatment of Eph-Fc, the interaction of Par-6 with ephrin-B1 was disrupted and Par-6 interacted with Cdc42. In anti-nephrin antibody-induced nephropathy, a rat nephrotic model, not only nephrin but also ephrin-B1 was phosphorylated, and ephrin-B1 was dissociated from Par-6.

**Conclusions:** Ephrin-B1-Par6 interaction interferes with the Par-6-Cdc42 interaction, and consequently suppresses tight junction formation. The interaction of Par-6 with ephrin-B1 instead of Cdc42 is a critical step for converting the slit diaphragm from the tight junction. In injured podocytes, ephrin-B1 is phosphorylated and dissociated from Par-6, and Par-6 interacts with Cdc42 instead of ephrin-B1. It is conceivable that dissociation of ephrin-B1 from Par-6 is one of the critical events in podocyte injury. The stabilization of ephrin-B1-Par-6 interaction could be a novel therapeutic approach for nephrotic syndrome.

**Funding:** Government Support - Non-U.S.

#### SA-PO741

### Disease-Associated Mutant Gain-of-Function Causes INF2-Related Focal Segmental Glomerulosclerosis

Balaji karthick Subramanian,<sup>1,2</sup> Martin Pollak.<sup>1,2</sup> BIDMC-Nephrology <sup>1</sup>Beth Israel Deaconess Medical Center, Boston, MA; <sup>2</sup>Harvard Medical School, Boston, MA.

**Background:** Highly penetrant Mendelian forms of Focal Segmental Glomerulosclerosis (FSGS) are rare examples where we can unequivocally say we know the cause of the disease. Inverted Formin 2 (INF2) is one of the 15 members of the formin family of proteins, which share a formin homology domain (FH2) involved in the control of actin polymerization. Missense mutations in INF2 lead to kidney disease characterized by proteinuria, progressive kidney dysfunction, and FSGS with or without Charcot-Marie-Tooth disease (CMT). Prior studies have suggested that INF2 promotes actin polymerization and modulates various cell processes such as mitochondria fission and Rho/mDia signaling. However, the mechanisms underlying kidney disease development remain unclear.

**Methods:** INF2 knock-out and INF2 R218Q knock-in mouse models were compared for their disease phenotype development. Puromycin aminonucleoside (PAN) injury was used as a stress model to compare the disease development between INF2 knock-out and knock-in mice models. Glomerular RNA sequencing analyses were performed to identify the pathways associated with the disease development. Micropatterned podocytes were used to validate the pathways driving the disease development.

**Results:** Neither the INF2 R218Q knock-in mutation nor INF2 knock-out condition impact glomerular development. However, the disease phenotype was higher with PAN injury in heterozygous and homozygous R218Q INF2 knock-in mice. In contrast, heterozygous or homozygous knock-out mice do not develop any significant kidney disease phenotype. RNA sequencing analysis showed changes in the expression of genes that regulate cell adhesion, mitochondria, and trafficking to associate with the disease phenotype. These changes were replicated in micropatterned podocytes, in which heterozygous and homozygous knock-in mice-derived podocytes exhibited disease-associated cell-adhesion (cortactin distribution) and mitochondria (fission/fusion balance) and trafficking (lipid raft recycling) defects.

**Conclusions:** INF2 mutation confers susceptibility to glomerular injury in the mouse, indicating the gain-of-function nature of INF2 mutants and presenting an important model to target for therapeutics development. Processes associated with cell adhesion, trafficking, and mitochondria may be involved in the disease.

**Funding:** NIDDK Support

#### SA-PO742

### New Mutation in the TNS2 Gene Causes a New Form of Treatable Nephrotic Syndrome

Raquel Martínez Pulleiro,<sup>1,2</sup> Manuel Fidalgo diaz,<sup>3</sup> Angel Carracedo,<sup>2</sup> Cándido D. Rodríguez,<sup>3</sup> Miguel A. Garcia-Gonzalez.<sup>1,2</sup> <sup>1</sup>Instituto de Investigación Sanitaria de Santiago de Compostela, Santiago de Compostela, Spain; <sup>2</sup>Grupo de Medicina Xenómica (GMX), Santiago de Compostela, Spain; <sup>3</sup>Hospital Clínico Universitario de Santiago de Compostela, Servicio de Nefrología, Santiago de Compostela, Spain.

**Background:** Pediatric primary nephrotic syndrome (PNS) is a renal disease characterized by the triad of proteinuria, hypoalbuminemia and edema. Treatment consists of immunosuppressive drugs and corticosteroids and, not in all cases, a satisfactory response is obtained and corticoid dependence or corticoid resistance (SRNS) may develop. Patients may progress to end-stage renal disease (ESRD) and may require dialysis and/or transplantation. In most cases its etiology is unknown, although advances in the molecular genetics of glomerular diseases have shown that single gene defects can affect podocyte structure and function being responsible for one-third or more of all pediatric cases of SRNS. In 2018, Ashraf et al. described a new entity of partially treatment-sensitive SN (pTSNS) and found an underlying genetic cause (six genes involved in the regulation of Rho GTPases in podocytes, including TNS2).

**Methods:** DNA extraction from a blood sample and mutation detection by NGS sequencing of a panel of glomerular genes. Variant filtering was done based on population and eigen frequencies, quality and functional impact parameters. Interpretation with reference to ACMG criteria.

**Results:** In our cohort we have a case of pTSNS with multiple recurrences throughout life, persisting into adulthood. All alternative therapies that were tried to limit the high doses of steroids and their respective toxicities were unsuccessful. Genetic diagnosis revealed a previously undescribed homozygous mutation in the TNS2 gene (Asn1262Ile), in a conserved residue, with interpretation of "disease-causing" given by in silico predictors and with a particular phenotype.

**Conclusions:** The homozygous mutation of the TNS2 gene is responsible for our patient's NS, being the second genetic diagnosis worldwide linking mutations in TNS2 with pathology. Although immunosuppressive treatment achieves disease remission for months, it is not able to prolong it over time. The only way to control relapses is steroids. Knowing the behavior of the SN associated with TNS2 can give the patient a better prognosis of the disease. Regarding genetic diagnosis, there is a need to constantly update the panelized study of genes causing glomerular disease due to the continuous discovery of new genes.

#### SA-PO743

### A Missense Mutation in Zinc Finger 4 of WT1 Might Lead to Focal Segmental Glomerular Sclerosis due to Its Mislocalization and Downstream Dysregulation

Toru Kanamori, Tomohiro Udagawa, Miki Murakoshi, Eriko Adachi, Mika Okutsu, Takayasu Mori, Eisei Sohara, Shinichi Uchida. *Tokyo Ika Shika Daigaku Daigakin Ishigaku Sogo Kenkyuka, Tokyo, Japan.*

**Background:** Wilms' tumor suppressor gene 1 (WT1) is associated with the development of the urogenital system and regulates genes involved in sex differentiation and determination. WT1 encodes four zinc finger domains (ZF). Inactivation in ZF2 or 3 of WT1 causes Denys-Drash syndrome (46, XY disorder of sex development [DSD] and renal disorders) and in intron 9 of WT1 causes Frasier syndrome (genital tract anomalies and focal segmental glomerulosclerosis [FSGS]). Eozenou et al. reported that mutations in ZF4 of WT1 cause 46, XX DSD (*ProNAS*. 2020, 13680). There is insufficient evidence associating ZF4 variants and nephropathy.

**Methods:** A 15-year-old boy presented with proteinuria, renal dysfunction, and undescended testis. He was diagnosed with FSGS by renal biopsy at 16 years and started hemodialysis at 20 years of age. To analyze the pathogenic mechanism of the mutations (WT1 R495Q) found in this FSGS patient, we evaluated localization of WT1 and other podocyte slit-diaphragm proteins by immunofluorescence staining using C-terminal antibodies of a kidney section. HEK293T cells were transfected with expression constructs to encode the wild type or R495Q WT1 protein. To examine the effect of WT1 R495Q on the regulation of key podocyte genes, we quantitatively assessed messenger ribonucleic acid (mRNA) expression levels isolated from wild type or mutation-expressing HEK293 cells by qPCR.

Key: TH - Thursday; FR - Friday; SA - Saturday; OR - Oral; PO - Poster; PUB - Publication Only

Underline represents presenting author.

**Results:** Immunofluorescence staining showed that in contrast to the cytoplasmic localization of *WT1* in a boy with non-genetic nephrotic syndrome, *WT1* was localized to podocyte cytoplasm and nucleus. We found less expression of the *NPHS1* gene in the case of transfection with *WT1* R495Q compared to wild types. *NPHS1* mRNA expressed approximately 25-fold whereas *NPHS* mRNA expressed approximately 10-fold compared to the control. When wild type and mutant *WT1* were transfected with the same dose, the expression of *NPHS1* was the same as when only the mutant was transfected.

**Conclusions:** We demonstrate that *WT1* R495Q mutation affects *WT1* protein localization and dysregulates *NPHS1* expression in podocytes. Our data suggests the loss of function mutation had a dominant negative effect in podocytes.

**Funding:** Government Support - Non-U.S.

#### SA-PO744

##### Single Cell RNA Sequencing Revealed Genes That Could Mediate Podocyte Injury in Genetic Podocytopathy

Vidhi Dalal,<sup>1,2</sup> Alexander J. Kula,<sup>1,2</sup> Priya S. Verghese,<sup>1,2</sup> Tomoko Hayashida,<sup>1,2</sup> Ann and Robert H Lurie Children's Hospital of Chicago, Chicago, IL; <sup>2</sup>Northwestern University Feinberg School of Medicine, Chicago, IL.

**Background:** Up to 30% of pediatric patients with steroid-resistant nephrotic syndrome carry a mutation in genes that are critical for maintaining the podocyte structure. While it is still impractical to mend individual mutation, some patients develop symptoms later in their life, providing a potential therapeutic window. However, a mechanism by which podocyte injury progress in those patients are largely unknown.

**Methods:** Single cell suspension was prepared from a portion of nephrectomized kidney of a patient with *ACTN4* and *ITGB4* mutations and subjected to single cell RNA sequencing (scRNAseq). The data was compared to a dataset from healthy adult kidney at Kidney Interactive Transcriptomics (KIT).

**Results:** A previously healthy 6-year-old girl with no family history of kidney disease presented with worsening edema. Lab results at admission included serum creatinine 1.25 and albumin 1.2, and urinalysis with 2+glucose, 3+protein, and 1+blood. Biopsy showed 70% global glomerulosclerosis with 50-60% interstitial fibrosis with negative immunofluorescence. She did not respond to 4 weeks of high dose prednisone and transitioned to tacrolimus. *CTN4* and *ITGB4* mutations were found in her nephrotic syndrome genetic panel and tacrolimus was discontinued. Her serum creatinine rose quickly to 5.8 and protein loss was uncontrollable, therefore bilateral nephrectomy was performed 8 months after presentation. The patient received a kidney from her mother 1 month later, and the graft is fully functional to date. scRNAseq revealed 15 clusters and cluster 10 was annotated as podocytes based on expression of the genes specific to podocytes described in KIT. While expression of some of the podocyte-specific genes (*NPHS2*, *PODXY*, *SRGAP2B*, *CCN2*, *CLIC5*, *ATP10A*) were preserved, other genes (*FYN*, *NTNG1*, *CDC14A*, *ALS2CL*) were not detected in the patient dataset. The diseased kidney also expressed genes that are not expressed in the healthy kidney. The most highly differentially upregulated genes only in the diseased kidney include *MGP*, *TAGLN*, *RGS5*, *TPM2* and *ADIRF*. Extracellular matrix genes were also significantly increased in diseased podocytes. Switch in classes of *GPGR* genes was also observed (Q and O in healthy and D, A, K in diseased podocytes).

**Conclusions:** Genes identified by scRNAseq implicate potential therapeutic targets for children with genetic podocytopathy.

**Funding:** NIDDK Support

#### SA-PO745

##### Reduction of Systemic Inflammation by Notch3 Inhibition in HIV-Associated Nephropathy

Mackenzie Thornton,<sup>1</sup> Nicole Sommer,<sup>1</sup> Mercedes B. McGonigle,<sup>1</sup> Johnny Dinh Phan,<sup>1</sup> Tao Wang,<sup>2</sup> Pravin C. Singhal,<sup>3</sup> Timothy A. Fields,<sup>1</sup> Madhulika Sharma,<sup>1</sup> <sup>1</sup>University of Kansas Medical Center Department of Internal Medicine, Kansas City, KS; <sup>2</sup>The University of Manchester, Manchester, United Kingdom; <sup>3</sup>Northwell Health, New Hyde Park, NY.

**Background:** Anti-retroviral therapy (ART) suppresses HIV-associated Nephropathy (HIVAN) but does not protect from continuous generation of viral proteins and inflammation. We need therapies that inhibit viral replication and inflammation simultaneously to avoid progression into chronic kidney disease (CKD). We have previously shown that pan Notch inhibition ameliorated disease progression in the Tg26 mouse model of HIVAN. Here, we determined specifically the role of Notch3 pathway in HIVAN pathogenesis.

**Methods:** We labelled renal sections from HIVAN patients and mouse model (Tg26) for Notch3 via immunohistochemistry. We determined if HIV-1 induces Notch3 activation. We generated Tg26 mice with global Notch3 knockout (Tg-N3KO) and characterized the kidneys, followed by RNA sequencing. Macrophage-podocyte interactions were then studied. Soluble TNF alpha levels were evaluated using ELISA.

**Results:** Notch3 was activated in glomerular, tubular and interstitial cells of HIVAN biopsies and Tg26 mice. Notch3 expression was induced when podocytes were transfected with HIV-1 construct. Genetic knockout of Notch3 (N3KO) in Tg26 (Tg-N3KO) mice resulted in a significant increase in the life span. This was associated with marked improvement in glomerular and tubular injury and renal function. A striking reduction in infiltrating immune cells was observed. RNA sequencing and validation data indicated a marked reduction of macrophage markers in Tg-N3KO mice versus Tg26 mice. We then isolated and cultured bone marrow derived macrophages from Tg26 and Tg-N3KO mice and found that Notch3 and Notch ligands, Jagged 1 and Delta like 4 (Dil4) were markedly upregulated in Tg26 mice. N3KO normalized them. Conditioned macrophage media

from BMDM derived from Tg26 mice resulted in Notch activation of podocytes. Finally, Notch3 deletion not only affected the kidneys but reduced the systemic expression of soluble inflammatory factor tumor necrosis factor alpha (TNF-alpha).

**Conclusions:** Notch 3 deletion in HIVAN model reduced kidney injury, improved renal function, reduced macrophage infiltration and reduced systemic TNF alpha levels which may collectively be responsible for the increase life span of the Tg26 mice. Thus, inhibition of Notch3 may constitute an attractive therapeutic strategy in HIV related CKDs.

**Funding:** NIDDK Support, Other NIH Support - P20GM103418

#### SA-PO746

##### Podocyte Expression of the Human PLA2R1 Causes Immune-Mediated Membranous Nephropathy in Mice

Nicola M. Tomas, Silke Dehde, Catherine Meyer-Schwesinger, Larissa Seifert, Renke Lucas, Sarah Köllner, Ming Huang, Tobias B. Huber, Gunther Zahner. *Universitätsklinikum Hamburg-Eppendorf, Hamburg, Germany.*

**Background:** Antibody-mediated autoimmune pathologies like membranous nephropathy (MN) are difficult to model, particularly in the absence of target antigen expression in typical model organisms such as mice and rats, which is the case for PLA2R1, the major autoantigen in this disease.

**Methods:** We generated a mouse line expressing the full-length human PLA2R1 specifically in podocytes (hPLA2R1-positive mice). Mice were characterized during the first weeks of life using urinary albumin measurements, serum analyses, light microscopic and immunofluorescence microscopy as well as electron microscopy. The mouse line was also crossed to *Rag2*<sup>-/-</sup> mice, which lack mature B and T lymphocytes.

**Results:** Human PLA2R1-positive mice were healthy after birth. Beginning from the age of three weeks, however, mice developed a nephrotic syndrome with progressive albuminuria and hyperlipidemia. This was preceded by the development of anti-PLA2R1 antibodies, which primarily bound the PLA2R1 extracellular domains that are also recognized by patient autoantibodies (CysR, CTLDI, CTLD7/8). After disease onset, histological analyses in hPLA2R1-positive mice revealed the typical morphological signs of MN with granular glomerular deposition of murine IgG in immunofluorescence and subepithelial electron-dense deposits in electron microscopy. Importantly, hPLA2R1-positive *Rag2*<sup>-/-</sup> mice did neither develop anti-PLA2R1 antibodies nor proteinuria.

**Conclusions:** Our work demonstrates that podocyte expression of human PLA2R1 in mice can induce immune-mediated, PLA2R1-associated MN.

**Funding:** Government Support - Non-U.S.

#### SA-PO747

##### THSD7A Cleavage Is Mediated by the Proprotein Convertase Furin In Vitro

Larissa Seifert, Silke Dehde, Renke Lucas, Gunther Zahner, Nicola M. Tomas. *Universitätsklinikum Hamburg-Eppendorf, Hamburg, Germany.*

**Background:** Thrombospondin type 1 domain-containing 7A (THSD7A) is a pathogenic autoantigen in membranous nephropathy (MN). It is prominently expressed on podocytes in humans and rodents, where it is located at the basal aspects of foot processes and it likely plays a role in podocyte adhesion. When expressed recombinantly e.g. in HEK cells, THSD7A is cleaved in the N-terminal region.

**Methods:** Purified, recombinantly expressed THSD7A was analyzed by mass spectrometry (MS). Following MS analysis, we applied site directed mutagenesis to further narrow down the cleavage site. We tried two additional approaches to confirm our data and identify the protease that we assumed to be responsible for the cleavage. First, we tested a specific inhibitor and second we added the recombinant commercial available protease to uncut protein, to see whether it is processed.

**Results:** Mass spectrometry revealed a cleavage of THSD7A in the polybasic region of the fourth TSP-1 domain. The cleavage site was located between two cysteines forming a disulfide bond, leading to adherence of the fragments even after cleavage of the peptide backbone. The identified site corresponded to the cleavage motif of proprotein convertases (PCs). Base substitution of one Arginine to Alanine within the cleavage site completely abolished the proteolytic processing. Adding an inhibitor, which dominantly inhibits the PC furin, to the cell culture medium of THSD7A expressing HEK cells achieved the same effect. Conversely, adding recombinant furin to uncut THSD7A led to cleavage of the protein.

**Conclusions:** The PC furin cleaves THSD7A in the fourth TSP-1 domain in vitro. Whether this processing also occurs in vivo and is related to the biological function of THSD7A needs to be investigated.

**Funding:** Government Support - Non-U.S.

#### SA-PO748

##### Podocyte Autophagy and Cell Survival Is Regulated by the Circadian Clock Gene

Lulu Wang, Lei Jiang, Junwei Yang. *Second Affiliated Hospital of Nanjing Medical University, Nanjing, China.*

**Background:** The circadian clock is a ubiquitous system in mammals which synchronizes cellular, tissue, and systemic biological functions with 24-hour environmental cycles. CLOCK (Circadian locomotor output Cycles protein kaput) is a core component of the molecular clocks. It contains a BHLH-PAS domain and forms a heterodimer with BMAL1 (Brain and Muscle Arnt-like 1), acting in the positive branch of the circadian transcription/translation feedback loop. Previous study had identified

that the intrinsic circadian clock BMAL1 in podocytes controls glomerular filtration rate. Little is known about the *Clock* and podocytes. The study aimed to explore the effects of *Clock* on podocytes.

**Methods:** *In vitro*, the primary podocyte was used to elaborate the role of *Clock* on podocytes by knockdown of *Clock* by siRNA. Chromatin immunoprecipitation (CHIP) sequence was employed to detect association between *Clock* and autophagy. *In vivo*, we made mouse sleep fragmentation to constructed circadian rhythm disorder model. The podocyte specific *Clock* knockout mice (podocyte-*Clock*<sup>-/-</sup>) were also constructed.

**Results:** Loss of *Clock* caused podocyte death. There was an increased urinary albumin excretion and podocytes injury in Podocyte-*Clock*<sup>-/-</sup> mice compared to control mice. We also found that sleep fragmentation led to the loss of circadian clock oscillation, the fusion of foot processes and albuminuria. CHIP-seq and qPCR analysis confirmed that *Clock* bonded to the promoter of *Becn1* and *Atg12*. Circadian rhythms disorder impaired autophagy, which promoted podocyte death.

**Conclusions:** Our study revealed the critical role of *Clock* circadian rhythm in podocyte. Mechanistically, *Clock* dependent circadian autophagy is indispensable for podocyte to adapt stress response or nutrient metabolism.

**Funding:** Government Support - Non-U.S.

## SA-PO749

### Oxysterol-Binding Protein Like 7 Deficiency Leads to Decreased Autophagic Flux, Increased Lipid Droplet Accumulation, and Apoptosis in Podocytes

Jeffrey D. Pressly,<sup>1,2</sup> Sandra M. Merscher,<sup>1,2</sup> Alessia Fornoni.<sup>1,2</sup> <sup>1</sup>University of Miami Katz Family Division of Nephrology and Hypertension, Miami, FL; <sup>2</sup>Peggy and Harold Katz Drug Discovery Center, Miami, FL.

**Background:** Previously we demonstrated that OSBPL7 protein levels are decreased in podocyte models of chronic kidney disease (CKD). OSBPs are involved in cholesterol transfer from the endoplasmic reticulum (ER) to the Golgi, cholesterol efflux, and autophagy. OSBPL7 is a lipid transfer protein that transfers cholesterol for PI4P at subcellular membrane sites that contains an oxysterol binding domain (OSBD), a PH domain, and an FFAT motive. It remains unknown if OSBPL7 deficiency contributes to dysregulated lipid trafficking, leading to a decrease in podocyte viability.

**Methods:** OSBPL7-V5 construct was purchased from Addgene, and mutated constructs carrying deletions in the FFAT and PH domains of OSBPL7 were generated by PCR mutagenesis. Overexpression of OSBPL7 (deletion) constructs was achieved using Eugene HD (Promega) following manufacturer-recommended transfection protocols. Whole-cell lysates were collected from siOSBPL7 and scOSBPL7 podocytes and analyzed for LC3 and GATE-16 protein expression by western blot. LD number was determined using Opera high content screening system and Columbus analysis software. Apoptosis was measured using the ApoTox-Glo Apoptosis Assay (Promega).

**Results:** OSBPL7 deficiency in siOSBPL7 podocytes leads to decreased autophagic flux with increased levels of LC3 cleavage and decreased levels of GATE-16. siOSBPL7 podocytes demonstrate increased lipid droplets compared to scOSBPL7 podocytes. Overexpression of full-length OSBPL7 is sufficient to protect siOSBPL7 podocytes from apoptosis. However, overexpression of an OSBPL7 construct with a deletion of the FFAT domain failed to rescue the effect on apoptosis, implicating the FFAT domain as imperative for the antiapoptotic effects of OSBPL7 in podocytes.

**Conclusions:** OSBPL7, i.e., the FFAT domain of OSBPL7, is necessary for the proper function of and viability of podocytes. OSBPL7 deficiency leads to decreased autophagic flux, lipid accumulation, and podocyte injury. The decreased autophagic flux may contribute to lipid droplet accumulation, resulting in lipotoxicity in podocytes deficient in OSBPL7. Future studies will address the role of OSBPL7 in lipophagy and the role of lipophagy in CKD, which may lead to the identification of novel therapeutic targets for the treatment of this prevalent and costly disease.

**Funding:** NIDDK Support

## SA-PO750

### SMPDL3b Modulates STING Activation in Podocytes

Matthew Tolerico,<sup>1,2</sup> Antonio M. Fontanella,<sup>1</sup> Shamroop Kumar Mallela,<sup>1</sup> Margaret Z. Gurumani,<sup>1,2</sup> Judith T. Molina David,<sup>1</sup> George W. Burke,<sup>3</sup> Sandra M. Merscher,<sup>1</sup> Alessia Fornoni,<sup>1</sup> Alla Mitrofanova.<sup>1,3</sup> <sup>1</sup>University of Miami Katz Family Division of Nephrology and Hypertension, Miami, FL; <sup>2</sup>University of Miami Department of Molecular and Cellular Pharmacology, Miami, FL; <sup>3</sup>University of Miami Department of Surgery, Miami, FL.

**Background:** Chronic kidney disease (CKD) is a major health problem with no definitive cure. Podocytes are specialized glomerular cells that maintain kidney filtration and are injured in CKD. Recent studies show that sphingomyelin phosphodiesterase acid-like 3b (SMPDL3b) is important for podocyte function and regulates innate immunity in macrophages. The stimulator of interferon genes (STING), a component of the innate immune system that detects cytosolic DNA, has been shown to regulate inflammation in mouse models of CKD. We tested the hypothesis that altered SMPDL3b expression leads to podocyte injury through chronic activation of STING.

**Methods:** Illumina sequencing RNA data analysis, qRT-PCR and Western blot were used to characterize immortalized human podocytes with knockdown (siSMP) or overexpression (SMP OE) of SMPDL3b. c-diAMP, a STING specific agonist, treatment (10µM) was performed for 24h. Glomeruli isolated from 8-week-old mice with podocyte specific Smpdl3b deficiency (pSMP<sup>fl/fl</sup>) or overexpression (pSMP<sup>tg</sup>) were used to evaluate STING activation. pSMP<sup>fl/fl</sup> and pSMP<sup>tg</sup> mice were injected I.P. with a single dose of c-diAMP, 25mg/kg or 5% DMSO and sacrificed 72h after injection, following by urinary

albumin-to-creatinine ratio (ACR), histological and serum analyses. Two-tailed t-test or One-Way ANOVA followed by Tukey's post-test were used to detect statistical changes.

**Results:** Illumina RNAseq analysis revealed altered DNA sensing pathways in SMP OE podocytes. siSMP podocytes have reduced phospho and total STING, while SMP OE podocytes have increased phospho and total STING compared to control podocytes. Treatment with c-diAMP resulted in increased STING phosphorylation in control and siSMP podocytes, but not in SMP OE cells. Glomerular STING was significantly decreased in pSMP<sup>fl/fl</sup> mice and increased in pSMP<sup>tg</sup> mice. While both pSMP<sup>fl/fl</sup> and pSMP<sup>tg</sup> mice do not develop proteinuria at the baseline, treatment with c-diAMP resulted in increased ACR in pSMP<sup>tg</sup>, but not in pSMP<sup>fl/fl</sup> mice.

**Conclusions:** Our data indicate that SMPDL3b overexpression leads to STING activation in podocytes *in vitro* and STING-dependent proteinuria *in vivo*. Targeting SMPDL3b in the podocytes may represent a novel approach to regulate podocyte innate immunity and to improve renal outcomes in patients with CKD.

## SA-PO751

### Steroid-Resistant Minimal Change Disease Induced by Waldenstrom Macroglobulinemia

Tin T. Pham,<sup>1,4</sup> Allison Carilli,<sup>2</sup> Christine A. Vanbeek,<sup>3</sup> Jorge I. Martinez Osorio,<sup>2</sup> <sup>1</sup>HCA Healthcare Graduate Medical Education, Orlando, FL; <sup>2</sup>Orlando VA Healthcare System, Orlando, FL; <sup>3</sup>AmeriPath Inc, Oklahoma City, OK; <sup>4</sup>University of Central Florida, Orlando, FL.

**Introduction:** Waldenstrom's macroglobulinemia (WM) is an IgM-secreting B-cell lymphoproliferative disorder associated with a variety of renal manifestations. Glomerular pathology in WM most commonly occurs because of direct monoclonal protein deposition resulting in light chain amyloidosis, cryoglobulinemic glomerulonephritis, or non-cryoglobulinemic membranoproliferative glomerulonephritis. Minimal Change Disease (MCD) rarely develops in the setting of non-Hodgkin lymphomas (NHLs) including WM. We present a case of steroid resistant MCD induced by WM requiring the use of cytotoxic agents with successful remission achieved of nephrotic syndrome.

**Case Description:** 67-year-old man, with history of hyperlipidemia was evaluated for acute onset of anasarca, asthenia, and weight gain of 40 lbs. He had heavy proteinuria (12 grams), hypoalbuminemia (1.0 grams/dL), and normal serum creatinine level (1.1 mg/dL). Serum protein electrophoresis showed 2 M spikes (one IgM kappa, one IgM lambda). Serum free light chain ratio was normal at (1.42). PCR for gene mutation was positive. Bone marrow biopsy revealed a mildly hypercellular bone marrow (60%) with involvement by a B-cell lymphoproliferative disorder. Renal biopsy showed MCD. He was started on prednisone 80 mg that was tapered to 60 mg over 4 months. However, he had persistent fatigue, lower extremity edema, and ongoing proteinuria (7 to 14 grams). On repeat renal biopsy, there was extensive podocyte foot process effacement, consistent with MCD. The treatment was transitioned to 6 cycles of rituximab, cyclophosphamide, and corticosteroids. The patient reported remarkable improvement in fatigue and lower extremity edema by the middle of his treatment. After finishing the full treatment course, he had complete resolution of proteinuria, stable serum creatinine (1.1 mg/dL), and normalization of serum albumin (3.8 g/dL).

**Discussion:** MCD is a rare renal manifestation of WM. Although the lesion is not due to direct monoclonal protein deposition, it may be related to other factors secreted by the tumor. MCD in the setting of NHL is often steroid-sensitive. However, this case demonstrates that cytotoxic agents and monoclonal antibodies may be required to achieve complete remission.

## SA-PO752

### Don't Miss Mesalamine! Mesalamine-Induced Focal Segmental Glomerulosclerosis in a Patient With Ulcerative Colitis

Andrea R. Linares. Department of Kidney Medicine Cleveland Clinic Florida, Weston, FL.

**Introduction:** Renal manifestation in UC and Crohn's disease is not uncommon. It's suggested to be a combination of genetic factors, infectious agents, bacterial endotoxins, and immune complex depositions. The most frequent renal disease in patients with IBD are nephrolithiasis, TIN, GN, and amyloidosis. Mesalamine is a 5-ASA compound which is the mainstay drug for UC. It is known to cause hypersensitivity reactions which may even cause aggravation of UC.

**Case Description:** We present a case of a 23 year old male with a history of UC for 8 years who went to the ED for worsening generalized edema for 3 days. His UA with 3+ protein and no RBCs. UPCR was 7.2 and albumin 1.6 g/dL. Nephrology was consulted for nephrotic syndrome. IV diuresis was started for anasarca. The patient had been taking mesalamine for many years and did not have recent UC flare ups. He did not have history of premature birth, hypertension, or obesity, and had normal kidney size. Urine microscopy showed oval fat bodies. Serological work up was significant for elevated ESR, + MPO and +PR3 antibodies. HIV, CMV, EBV, and parvovirus B19 were negative. A native kidney biopsy was done and it revealed negative IF findings and evidence against active immune complex mediated GN. EM confirmed diffuse podocyte effacement and ultimately glomerular tip lesion variant Focal Segmental Glomerulosclerosis. The patient was started on immunosuppression with corticosteroids, RAAS blockade with ARB, Calcium/ Vitamin D supplementation, PPI, diuretics, and salt restriction. With close outpatient monitoring and tapering of steroids, the patient's proteinuria and edema improved. He continues to follow up with GI and will pursue other treatments for UC once steroids have been completely tapered.

**Discussion:** IBD renal manifestations are usually associated with disease activity and improve with remission of bowel inflammation. Lack of viral causes or UC activity, as well as positive MPO and PR3 antibodies, was more suggestive of a drug induced reaction.

Key: TH - Thursday; FR - Friday; SA - Saturday; OR - Oral; PO - Poster; PUB - Publication Only

Underline represents presenting author.

Mesalazine is renally excreted and the most common reported kidney related adverse reactions is acute or chronic interstitial nephritis due to hypersensitivity reaction usually occurring in the first 6 months of use. Mesalazine induced FSGS must be considered in the differential early on presentation of a patient with nephrotic syndrome to ensure adequate and appropriate treatment to preserve kidney function.

#### SA-PO753

##### Effects of Hyperuricemia on the Progression of Salt-Sensitive (SS) Hypertension in Dahl SS Rats

Lashodya V. Dissanayake,<sup>1,2</sup> Adrian P. Zietara,<sup>1,2</sup> Vladislav Levchenko,<sup>1</sup> Oleg Palygin,<sup>3</sup> Alexander Staruschenko.<sup>1,4</sup> <sup>1</sup>University of South Florida, Tampa, FL; <sup>2</sup>Medical College of Wisconsin, Milwaukee, WI; <sup>3</sup>Medical University of South Carolina, Charleston, SC; <sup>4</sup>VA James A Haley Hospital, Tampa, FL.

**Background:** Uric acid (UA) is a purine metabolite that has shown both oxidative and antioxidant properties. Increased plasma levels of UA (hyperuricemia) have been associated with hypertension and chronic kidney disease. Variations in dietary salt intake affect plasma and urine UA levels and may be involved in blood pressure and renal function control. We explore conditions of induced mild hyperuricemia and a high salt diet on the development of hypertension using Dahl SS rats, a model of salt-sensitive (SS) hypertension, and chronic administration of oxonic acid. Oxonic acid is a uricase inhibitor that prevents the breakdown of UA further into more soluble allantoin.

**Methods:** 8-week-old Dahl SS male rats were implanted with telemeters. After recovery, BP measurements were collected for 4 days on a 0.4% NaCl diet and switched to either a 4% NaCl diet or a 2% oxonic acid + 4% NaCl diet (treatment, N=4-6) for 3 weeks. Rats were euthanized, and tissue, plasma, and urine were collected for the following analysis.

**Results:** Treatment with oxonic acid for 3-weeks increased plasma UA 5-fold (0.25±0.01 vs. 1.37±0.06 mg/dl, control vs. treated) while decreasing the urine UA excretion (0.33±0.01 vs. 0.19±0.01 UA/Cre). Elevated UA plasma levels were associated with significantly attenuated progression and magnitude of SS hypertension (mean arterial pressure: 159±1 vs. 137±1 mmHg, control vs. treated). Total body weight (TBW) and kidney weight/TBW ratio did not differ. The treatment group had a lower heart weight/TBW ratio (3.98±0.03 vs. 3.64±0.02). Overall, electrolyte homeostasis did not vary between the groups; however, urine Ca<sup>2+</sup> excretion was significantly lower in the treatment group (1.48±0.09 vs. 0.43±0.06 Ca<sup>2+</sup>/Cre).

**Conclusions:** The present study indicates that the increase in UA plasma levels attenuates the progression of SS hypertension. These results may suggest that UA homeostasis may be involved in the regulation of oxidative stress and has a protective effect against salt-induced hypertension.

**Funding:** Other NIH Support - R35 HL135749, Veterans Affairs Support

#### SA-PO754

##### Salt Sensitivity Is Modulated by Lanosterol Synthase rs2254524 Polymorphism

Sipontina Faienza,<sup>1,2</sup> Lorena Citterio,<sup>2</sup> Elisabetta Messaggio,<sup>3</sup> Laura Zagato,<sup>2</sup> Chiara Lanzani,<sup>2</sup> Marco Simonini,<sup>2</sup> Paolo Manunta.<sup>2</sup> Genomics of Renal Diseases and Hypertension Unit <sup>1</sup>Università Vita Salute San Raffaele, Milano, Italy; <sup>2</sup>IRCCS Ospedale San Raffaele, Milano, Italy.

**Background:** The blood pressure (BP) response to different salt intakes, the so-called salt sensitivity, is more frequent in hypertensive patients compared to the general population. Elevated levels of the steroid hormone Endogenous Ouabain (EO) have been associated with hypertension (HT) and salt sensitivity. We characterized the missense variation rs2254524 (Val642Leu; V642: C variant; L642: A variant) of the Lanosterol Synthase (*Lss*), a gene coding for a key enzyme in steroid biosynthesis, since AA patients on a low salt diet showed a greater reduction in BP compared to the LSS CC and only CC patients had an increase in plasma EO after the low salt protocol. Hence, we hypothesized that LSS could affect salt-sensitive HT by regulation of EO biosynthesis.

**Methods:** We generated a knock-in mouse model carrying the *Lss* rs2254524 SNP expression ubiquitously to test our hypothesis. Male mice were fed with a Normal Salt Diet (NSD; 0.5% NaCl), High Salt Diet (HSD; 4% NaCl), or Low Salt Diet (LSD; 0.03% Na) for 15 days and BP was measured by the BP-2000 Blood Pressure tail-cuff system, in conscious trained mice.

**Results:** *Lss* AA mice were viable, healthy, and undistinguishable phenotypically from the WT *Lss* CC. However, the *Lss* mRNA and protein levels were reduced in the adrenal glands of mutated mice at 3 months and in the kidneys at 6 months of age, whereas no differences were observed at 12 months of age. At baseline, the *Lss* AA polymorphism affected kidney weight, normalized to body weight, that was significantly enlarged at 3 and 12 months of age, compared to its WT counterpart. Moreover, the Systolic BP (SBP) in *Lss* WT mice showed a progressive increase at 9 and 12 months of age that was not observed in *Lss* AA mice. At 3 months, only the AA mice showed a significant SBP reduction after LSD compared to NSD, and upon HSD was observed an SBP increase in AA, but not in CC mice, just at 12 months of age. Moreover, the 12 months mice in HSD showed cardiac hypertrophy, a common feature in hypertensive patients.

**Conclusions:** Extensive studies are still ongoing, but the new *Lss* mouse model resembles the salt-sensitive HT together with heart hypertrophy observed in hypertensive patients and provides a good model to prove our hypothesis.

**Funding:** Government Support - Non-U.S.

#### SA-PO755

##### Dendritic Cell-Specific JAK2 Contributes to Salt-Sensitive Hypertension via the Epithelial Sodium Channel

Mohammad Saleem,<sup>1</sup> Luul Aden,<sup>1,2</sup> Ashley L. Pitzer,<sup>1</sup> Jeanne A. Ishimwe,<sup>1</sup> Fernando Elijovich,<sup>1</sup> Cheryl L. Laffer,<sup>1,2</sup> Suman Pakala,<sup>1</sup> Paul D. Kastner,<sup>1</sup> Thomas R. Kleyman,<sup>3</sup> Annet Kirabo.<sup>1</sup> <sup>1</sup>Vanderbilt University Medical Center, Nashville, TN; <sup>2</sup>Vanderbilt University, Nashville, TN; <sup>3</sup>University of Pittsburgh, Pittsburgh, PA.

**Background:** Salt-sensitivity of blood pressure is an independent predictor for death due to cardiovascular disease. We recently found that the epithelial sodium channel (ENaC) on dendritic cells mediates NADPH oxidase-dependent formation of immunogenic isolevuglandin (IsoLG)-protein adducts leading to inflammation and salt-sensitive hypertension. We hypothesized that expression of JAK2 specifically in antigen presenting myeloid cells contributes to salt-sensitive hypertension in an ENaC dependent mechanism.

**Methods:** We used both bulk and single cell transcriptome profiling using RNA-Seq analysis in human antigen presenting cells. We also performed molecular and flow cytometric immune phenotyping along with radio telemetry blood pressure and heart rate monitoring in mice with specific deletion of JAK2 in CD11c+ cells (JAK2 KO). To induce salt sensitivity of blood pressure in otherwise salt resistant C57BL/6 mice, L-NAME was given in drinking water for 2 weeks followed by 3 weeks of high salt treatment.

**Results:** Transcriptomic analyses in human myeloid antigen presenting cells revealed that high salt treatment in vitro and in vivo upregulates genes of the JAK/STAT pathway, and the downstream regulators including the suppressor of cytokine signaling (SOCS) genes. JAK2 KO mice developed blunted hypertension (124.2 vs 137.2 mmHg, SE=3.84, P=0.02) and reduced heart rate compared to the wildtype littermates during L-NAME/high salt treatment. JAK2 KO mice exhibited less infiltration of effector memory T cells (TEM) in kidney and spleen, with profound reduction in inflammatory markers IL-17a and IFN-gamma in CD4+ and CD8+ T cells in spleen. Moreover, there was less aortic infiltration of CD11c+ cells with less expression of CD86, and less production of IsoLGs and IL1-beta in JAK2 KO mice. These mice also exhibited less monocyte/macrophage infiltration in the kidneys and less volume retention in response to high salt-feeding. We also found that salt-induced expression of ENaC subunit  $\alpha$ , and serum/glucocorticoid regulated kinase 1 (SGK1) were reduced in the CD11c+ cells.

**Conclusions:** These results indicate that dendritic cell JAK2 plays an important role in salt-sensitive hypertension through an ENaC-dependent mechanism.

**Funding:** Other NIH Support - 1K01HL130497-01, 5R01HL147818-22, 1R03HL155041-01, 1R01HL144941-01A1

#### SA-PO756

##### Resident Renal Dendritic Cells Respond to Salt-Sensitive Hypertension via ToneBP, Leading to Increased Interleukin 6

Masaaki Yoshigi,<sup>1</sup> Kennedy Cunliffe-Koehler,<sup>1</sup> Amity F. Eaton,<sup>2</sup> Harini Srinivasan,<sup>1</sup> Dennis Brown,<sup>2</sup> Maria A. Battistone,<sup>2</sup> Brandi M. Wynne.<sup>1</sup> <sup>1</sup>University of Utah Health, Salt Lake City, UT; <sup>2</sup>Harvard Medical School, Boston, MA.

**Background:** During hypertension, dendritic cells (DCs) have been shown to activate immune cells and secrete cytokines, such as IL-6. DCs also form an intricate network within the renal cortex. Tonicity-Responsive Enhancer Binding Protein (ToneBP) is a transcriptional regulator of the cellular response to hypertonicity. ToneBP plays a role in the stress response in immune cells. We hypothesize that rDCs respond to increased sodium and salt-sensitive hypertension (SS HTN) via ToneBP, leading to increased IL-6 levels.

**Methods:** To test this hypothesis, mice lacking a functional CX<sub>3</sub>CR1 chemokine receptor (CX<sub>3</sub>CR1<sup>-EGFP/+</sup>) were used. CX<sub>3</sub>CR1 is required for DC localization to the kidney; thus these mice have a renal-specific DC-depletion. Mice were subjected to increased dietary salt (HS, 4%) or normal chow, in addition to a SS HTN model; 2 weeks L-NAME followed by 1-2 weeks of wash-out and then HS chow for the remainder of the study. Pro-inflammatory cytokines using meso-scale design (MSD)(n=3-8) in serum samples. Kidney tissue was used to determine IL-6 mRNA and ToneBP levels (n=4).

**Results:** Renal-dendritic cell depleted mice had a trending increase in ToneBP mRNA expression following HS (2-3weeks), which was significantly increased (2.39 fold change, p<0.0001) during SS HTN. SS HTN rDC-depleted mice had significantly reduced renal ToneBP expression (1.47 fold change, p<0.05) as compared to SS HTN Wt. When looking at IL-6 levels, we observed reductions in renal IL-6 levels (1.5 fold change) in SS HTN rDC-depleted mice compared to SS HTN Wt, with similar trending reductions in serum IL-6 levels.

**Conclusions:** Here, we show that resident renal DCs may be a primary contributor to the renal osmotic stress response by ToneBP, as shown by the considerable reductions in ToneBP mRNA following SS HTN in rDC-depleted mice. In addition, we observed similar reductions in renal and serum IL-6 levels. These data suggest that during SS HTN, DC-mediated ToneBP may contribute to the pro-inflammatory cytokine responses by innate immune cells.

**Funding:** NIDDK Support, Private Foundation Support

SA-PO757

**Kidney-Specific CAPI1/Prss8-Deficient Mice Maintain ENaC-Mediated Sodium Balance Through an Aldosterone Independent Pathway**

Elodie Ehret,<sup>1</sup> Yannick Jäger,<sup>1</sup> Frederique Ino,<sup>1</sup> Marc P. Maillard,<sup>2</sup> Edith Hummler,<sup>1</sup> Simona Frateschi.<sup>1</sup> <sup>1</sup>Université de Lausanne Faculté de biologie et de médecine, Lausanne, Switzerland; <sup>2</sup>Centre hospitalier universitaire vaudois Service de néphrologie et d'hypertension, Lausanne, Switzerland.

**Background:** The channel-activating protease 1 (CAPI1/Prss8) is a glycoposphatidylinositol-anchored protein and is part of the membrane bound serine protease family. *In vitro* studies revealed CAPI1/Prss8 as an activator of the epithelial sodium channel (ENaC). This channel, localized in the distal part and the collecting duct of the nephron, is involved in the maintenance of the electrolytic homeostasis by reabsorbing sodium from the lumen towards the blood. Na<sup>+</sup> deprivation normally results in a rise of plasma aldosterone thereby increasing ENaC activity. It is hypothesized that ENaC is proteolytically cleaved by channel-activating proteases furin and CAPI1/prostasin.

**Methods:** To test whether CAPI1/Prss8 is required for renal ENaC activation, tubular nephron-specific CAPI1/prostasin knockout mice (Prss8<sup>lox/lox</sup>;Pax8-rtTA<sup>tg/+</sup>;TRE-LC1<sup>tg/0</sup>) and control mice were exposed to a low Na<sup>+</sup> diet. Physiological parameters including urinary Na<sup>+</sup> and K<sup>+</sup>, plasma electrolytes, aldosterone levels and renin activity were measured. ENaC activity was determined by benzamil-induced natriuresis.

**Results:** Upon Na<sup>+</sup> deprivation, no changes in Na<sup>+</sup> and K<sup>+</sup> was observed in CAPI1/Prss8 knockout mice. α- or γENaC subunit cleavage pattern did not differ. Interestingly, although plasma aldosterone concentration was significantly decreased in CAPI1/Prss8 knockout mice, ENaC activity was similar between the two groups, suggesting that the production of aldosterone is uncoupled from the renin-angiotensin system in CAPI1/Prss8 knockout mice.

**Conclusions:** In summary, we were able to show that *in vivo*, CAPI1/Prss8 was not required for ENaC proteolytic activation. Our experiments revealed that the lack of CAPI1/Prss8 uncoupled ENaC activation from the classical renin-angiotensin-aldosterone stimulation on Na<sup>+</sup> restriction. This study reveals a complex regulation of ENaC function including aldosterone-dependent and independent mechanisms.

**Funding:** Government Support - Non-U.S.

SA-PO758

**High Tissue Sodium Associates With Insulin Resistance in Prehypertensive Obese Individuals**

Lale A. Ertuglu, Melis Sahinoz, Elvis A. Akwo, Andrew Guide, Thomas G. Stewart, Mindy Pike, Cassianne Robinson-Cohen, Meena S. Madhur, David G. Harrison, Talat Alp Ikizler. *Vanderbilt University Medical Center, Nashville, TN.*

**Background:** High tissue sodium (Na<sup>+</sup>) accumulation plays a role in the development of hypertension by activation of inflammatory and metabolic pathways. We sought to determine if tissue Na<sup>+</sup> content is associated with insulin sensitivity (IS) in patients with early hypertension, a known metabolic derangement commonly observed in patients with kidney and cardiovascular disease.

**Methods:** Tissue Na<sup>+</sup> accumulation and IS were assessed in 83 participants with early hypertension (SBP 120 - 139 mmHg or DBP 70 - 89 mmHg) using <sup>23</sup>NaMRI and hyperinsulinemic euglycemic clamp technique. Glucose disposal rate (GDR) was used as the marker of IS. High-sensitivity C-reactive protein (hsCRP) and interleukin 6 (IL-6) were used as markers of inflammation.

**Results:** GDR did not significantly associate with tissue Na<sup>+</sup> in the entire cohort. In subgroup analysis according to obese vs lean, GDR significantly associated with muscle and skin Na<sup>+</sup> among the obese (β=-1.11, 95% CI = -1.99, -0.24 and β=-0.45, 95% CI = -0.83, -0.07 for muscle and skin Na<sup>+</sup>, respectively) but not in lean participants. Among obese participants, there was significant effect modification by the inflammatory markers. The changes in GDR per unit changes in tissue Na<sup>+</sup> were greater at higher levels of hsCRP (p=0.03 and 0.01 for muscle and skin Na<sup>+</sup>, respectively) and IL-6 (p=0.05 and 0.01 for muscle and skin Na<sup>+</sup>, respectively). This was not observed in lean participants.

**Conclusions:** Our data show a significant negative association between muscle and skin Na<sup>+</sup> and IS in the obese, but not in lean individuals with early hypertension. Systemic inflammation may play a key role in the relationship between tissue Na<sup>+</sup> and IS.

**Funding:** NIDDK Support, Private Foundation Support

Characteristic	Overall (n=83)	Obese (n=30)	Lean (n=53)	P-value
Age (years)	48 (36,58)	49 (38, 58)	48 (34, 55)	0.44
Female, n (%)	56 (67.5)	21 (70)	35 (66)	0.81
African American origin (%)	34 (41)	15 (50)	34 (64.2)	0.25
BMI (kg/m <sup>2</sup> )	27.5 (24.4, 32.3)	33 (31.5, 36.3)	25 (23.5, 27.2)	<0.001*
SBP (mmHg)	126 (120, 132)	128 (121, 134)	124 (118, 129)	0.047*
DBP (mmHg)	77 (71, 82)	77.5 (72, 84)	74 (70, 81)	0.14
GDR (mg/kg/min)	8.4 (6, 11.5)	6.4 (4.7, 8.2)	10.6 (6.7, 13.4)	<0.001*
Muscle Na <sup>+</sup> (mmol/L)	16.6 (15, 19)	17.1 (15.6, 18.7)	15.8 (14.8, 19)	0.30
Skin Na <sup>+</sup> (mmol/L)	12.6 (11,16.7)	13.6 (12, 17.6)	12.3 (10.9, 15.5)	0.13
hsCRP (mg/dL)	1.3 (0.6, 3)	2.6 (1.1, 3.8)	1 (0.5, 2.2)	0.01*
IL-6 (pg/mL)	1.7 (1.0, 2.6)	2.1 (1.4, 2.9)	1.5 (1, 2.4)	0.04*

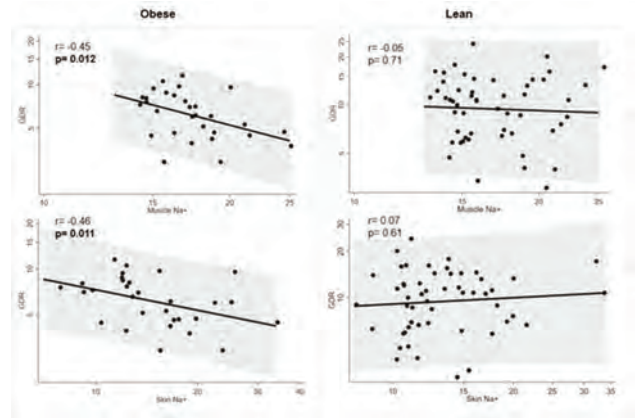

SA-PO759

**Tissue Sodium Content and Intramuscular Adipose Tissue Accumulation in Individuals With Early Hypertension**

Lale A. Ertuglu, Melis Sahinoz, Elvis A. Akwo, Andrew Guide, Thomas G. Stewart, Mindy Pike, Cassianne Robinson-Cohen, Meena S. Madhur, David G. Harrison, Talat Alp Ikizler. *Vanderbilt University Medical Center, Nashville, TN.*

**Background:** High tissue sodium (Na<sup>+</sup>) accumulation has been associated with the development of hypertension through activation of inflammatory pathways. Hypertension is also linked with increased adiposity. Whether tissue Na<sup>+</sup> plays a role in this relationship remains unknown. We hypothesized that excess tissue Na<sup>+</sup> in the muscle could lead to intramuscular adipose tissue (IMAT) deposition and that pro-inflammatory characteristics of tissue Na<sup>+</sup> mediate this effect in individuals with early hypertension.

**Methods:** IMAT and Na<sup>+</sup> accumulation in the skin and muscle were measured using <sup>1</sup>H- and <sup>23</sup>Na- MRI imaging of the calf in 83 subjects with early hypertension (systolic blood pressure between 120 and 139 mmHg, or a diastolic blood pressure 70 and 89 mmHg). Blood samples were collected for high-sensitivity C-reactive protein (hsCRP) and interleukin 6 (IL-6) measurements.

**Results:** Median age was 48, with 68% female and BMI 27.5 kg/m<sup>2</sup>. Median muscle and skin Na<sup>+</sup> were 16.6 (IQR: 14.9-19) and 12.6 (IQR: 10.9-16.6) mmol/L, respectively. Median IMAT was 1.3 mL. IMAT was positively correlated with muscle and skin Na<sup>+</sup> (r=0.38, p<0.001 and r=0.48, p<0.001, respectively). There was a significant effect modification of the relationship between IMAT and skin Na<sup>+</sup> by the inflammatory markers in models adjusted for age and sex. The effect of skin Na<sup>+</sup> on IMAT volume increased at high levels of inflammatory markers (p=0.03 and 0.01 for hsCRP and IL-6, respectively).

**Conclusions:** Our data show that high tissue Na<sup>+</sup> concentrations in both skin and muscle associate with increased IMAT, suggesting an adipogenic effect. Systemic inflammation may play a key role in the relationship between skin Na<sup>+</sup> and IMAT, potentially through high sodium-induced systemic inflammatory activation in the skin.

**Funding:** NIDDK Support, Private Foundation Support

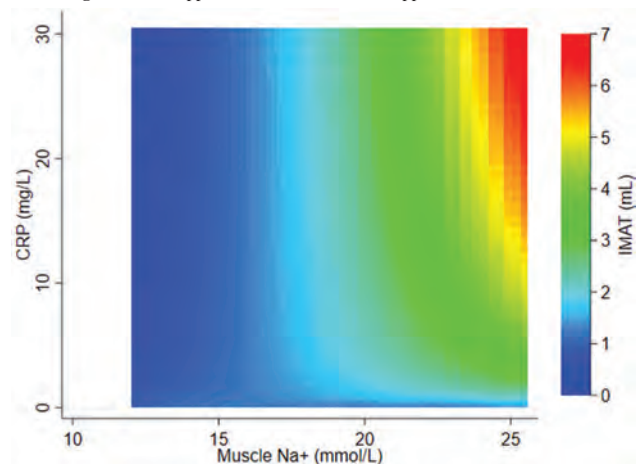

The interaction between hsCRP and muscle sodium for the association with IMAT.

## SA-PO760

**Altered Transsulfuration Metabolic Pathway Under GSTM1 Deficiency in Hypertension**

Yves T. Wang, Luojing Chen, Timothy J. Beane, Nhu Nguyen, Thu H. L. University of Rochester Medical Center, Rochester, NY.

**Background:** Glutathione S-transferase  $\mu$ -1 (GSTM1) belongs to the superfamily of GSTs that are phase II antioxidant enzymes regulated by nuclear factor erythroid 2-related factor 2 (Nrf2). In humans, homozygous carriers of the common *GSTM1(0)* null allele are deficient of the enzyme and its activity and have increased risks of chronic kidney disease (CKD) progression. Global *Gstm1* knockout (KO) mice have increased renal superoxide levels, inflammation, and kidney injury in angiotensin II-induced hypertension (Ang II-HTN). While the upstream regulation of GSTM1 has been delineated, its downstream effects are poorly understood.

**Methods:** We took a metabolomic approach using the service of Metabolon (Morrisville, NC) to perform unbiased, global metabolic profiles of kidney tissues of wild-type (WT) and *Gstm1* KO mice at baseline and after 4 weeks of Ang II-HTN via mini-osmotic pump at 1000 ng/kg/min (n=6/group). For confirmation, targeted metabolomics was performed using an LC-MS/MS in negative ion mode. Total hydrogen sulfide ( $H_2S$ ) levels were measured using the formation of methylene blue method (n $\geq$ 6/group).

**Results:** Among the 926 profiled metabolites, levels of several metabolites of the transsulfuration pathway (TSP) and downstream cysteine metabolism were different between WT and *Gstm1* KO mice. Targeted analysis of metabolites in and downstream of the TSP showed that cystathionine was significantly increased in KO vs. WT kidneys in both baseline (3.5-fold, p=0.013) and Ang II-HTN (4.3-fold, p=0.001). Metabolites upstream of cystathionine were not different. Downstream metabolites were unchanged at baseline, but were all reduced ( $\log_2$ (KO/WT)<-0.4) in Ang II-HTN, though the differences of individual metabolites were not statistically significant. Levels of  $H_2S$ , a bioactive end product of the TSP, were significantly reduced in KO kidneys (21.6 $\pm$ 2.9 vs. 28.6 $\pm$ 4.9 nmol/kidney, p<0.01).

**Conclusions:** Our preliminary data suggest that GSTM1 modulates the balance of  $H_2S$ , a gaseous molecule that has emerged as an important modulator of cell metabolism and signaling with pleiotropic effects, including potent anti-oxidant, anti-inflammatory, and vasodilatory functions. Delineation of the impact of GSTM1-TSP- $H_2S$  axis in disease states has important therapeutic implications in kidney and cardiovascular diseases in the context of precision and individualized medicine.

**Funding:** NIDDK Support

## SA-PO761

**Circulating Monocytes From Patients With Primary Aldosteronism Display Exhaustion on Lipopolysaccharide Stimulation**

Marta Kantauskaite, Blanka Duvnjak, Claudia Schmidt, Fabian Srugies, Thilo Kolb, Eva Koeningshausen, Lars C. Rump, Johannes Stegbauer. *Heinrich-Heine-Universitaet Dusseldorf, Dusseldorf, Germany.*

**Background:** Aldosterone excess present in primary aldosteronism (PA) plays a critical role in the development of endothelial dysfunction, oxidative stress and chronic inflammation, which contributes to aggravated hypertensive organ damage. According to animal studies, aldosterone-induced immune cell activation directly contributes to vascular injury. As the monocytes are the main immune cells interacting with vascular wall during the injury, we proposed that patients with PA would demonstrate activated monocytes.

**Methods:** Monocytes from patients (N=9) before and 3 months after the treatment (N=9) and healthy individuals (N=6) were seeded into 96-well plates at 200000 cell/well in RPMI 1640 Dutch-modified culture medium (PAN Biotech) with supplements. After 4 hour rest time the cells were exposed to 10 ng/ml Lipopolysaccharides (LPS) O111:B4 from E.coli for 24 hours. After the incubation supernatants were collected for cytokine, chemokine and growth factor measurements using Bio-Plex Pro Human Cytokine 17-plex Assay. Clinical and laboratory data were collected from patients records.

**Results:** Before the treatment PA patients displayed significantly higher concentrations of following cytokines and growth factors than healthy controls: G-CSF, IFN- $\gamma$ , TNF- $\alpha$ , IL-6, IL-10, IL-8, IL-17, MCP-1. Moreover, before the treatment Aldosterone-Renin-Quotient (ARQ) correlated positively with IL-6 (r 0.667, p=0.05) and MCP-1 (r 0.883, p=0.002). After the treatment was initiated, we have observed normalized blood pressure (median 139/85mmHg vs 130/80mmHg, p<0.05) and significantly lower ARQ (83 (59 - 261) vs 13(3.6 - 9.4), p<0.05). In addition, cytokine levels in monocyte supernatants normalized and reached levels similar to healthy controls. Upon the stimulation with LPS, PA patients demonstrated a blunted immune response whereas the treatment restored the cytokine response upon LPS stimulation. Moreover, lower IL-6 (r -0.766, p=0.27), TNF- $\alpha$  (r -0.802, p=0.017) and G-CSF (r -0.719, p = 0.045) concentration upon LPS stimulation was associated with higher diastolic blood pressure.

**Conclusions:** Patients with primary aldosteronism demonstrate higher cytokine levels at a steady state and a type of reversible endotoxin tolerance upon stimulation which might contribute to the increase in blood pressure.

**Funding:** Government Support - Non-U.S.

## SA-PO762

**Insights Into the Role of Atrial Natriuretic Peptide in Mitochondria-Mediated Metabolism in Salt-Sensitive (SS) Hypertension**

Aleksandra Zamaro,<sup>1</sup> Alena Cherezova,<sup>1</sup> Regina F. Sultanova,<sup>2</sup> Ryan Schibalski,<sup>1</sup> Mark Domondon,<sup>1</sup> Morgan J. Spicer,<sup>1</sup> Anna Nikiforova,<sup>2</sup> Mikhail Fomin,<sup>1</sup> Courtney J. Christopher,<sup>3</sup> Shawn R. Campagna,<sup>3</sup> Krisztian Stadler,<sup>4</sup> Daria Ilatovskaya.<sup>1</sup> <sup>1</sup>Augusta University, Augusta, GA; <sup>2</sup>Medical University of South Carolina, Charleston, SC; <sup>3</sup>University of Tennessee Knoxville, Knoxville, TN; <sup>4</sup>Pennington Biomedical Research Center, Baton Rouge, LA.

**Background:** Salt-sensitive (SS) hypertension (SS-HTN) is associated with decreased levels of Atrial Natriuretic Peptide (ANP), and is accompanied with renal mitochondrial dysfunction. Although ANP has been proposed as a modulator of mitochondrial bioenergetics, its role in renal mitochondrial function in SS hypertension is unclear. The present study was aimed at identifying renal metabolic pathways affected in the condition of ANP deficiency modeled in a Dahl SS rat.

**Methods:** Dahl SS wild type (WT) and ANP knockout (KO) rats were placed on a 0.4% NaCl normal salt (NS) diet, or a 4% NaCl high salt (HS, to induce hypertension) for 21 days. Metabolic profiles of renal cortices were generated using UHPLC-HRMS, and metabolites were identified by retention time exact mass using MAVEN and MetaboAnalyst software. IPA was used to identify pathways of interest. Mitochondrial membrane potential, production of H<sub>2</sub>O<sub>2</sub> and respiration were measured on isolated renal cortical mitochondria.

**Results:** 133 mitochondria-associated metabolites were identified in the kidney cortices. When KO and WT groups were compared on NS, in the KO we observed increased abundance of amino acids and their metabolites (p<0.01) as well as uric acid cycle metabolites (citrulline, ornithine, acetylglutamine, p<0.01). Furthermore, we report elevated products of glycolysis in the KO (phosphoenolpyruvate, p<0.01, pyruvate, p<0.05), and significantly lower abundance of purines (ADP, GMP, UMP, p<0.01). Interestingly, KO tissues exhibited low levels of NAD+ and NADP+ (p<0.01). We observed similar metabolic processes in the WT rats when HS diet rats were compared to NS diet fed rats. Studies on isolated mitochondria revealed a decrease in membrane potential accompanied with higher OCR and superoxide production in the KO animals on both NS and HS diets, vs WT groups.

**Conclusions:** It can be surmised that lack of ANP in the Dahl SS rats triggers a potential renal glycolytic shift and activation of catabolic pathways. These data support the notion that changes in ANP levels modulate mitochondrial bioenergetics in SS-HTN, and further studies of the related pathways will lead to a discovery of novel therapeutics.

**Funding:** Other NIH Support - HL148114

## SA-PO763

**Revealing Novel Signaling Pathways Affected in Glomeruli During Salt-Sensitive Hypertension**

Fabiha Anwar,<sup>1</sup> Daria Lysikova,<sup>1</sup> Ryan Schibalski,<sup>1</sup> Mark Domondon,<sup>2</sup> Margarita Shamatova,<sup>1</sup> Krisztian Stadler,<sup>3</sup> Denisha R. Spires,<sup>1</sup> Daria Ilatovskaya.<sup>1</sup> <sup>1</sup>Augusta University, Augusta, GA; <sup>2</sup>Medical University of South Carolina, Charleston, SC; <sup>3</sup>Pennington Biomedical Research Center, Baton Rouge, LA.

**Background:** Salt-sensitive hypertension (SS-HTN) is defined by an increase in blood pressure resulting from an elevated salt intake; it is characterized by the development of hypertensive glomerulosclerosis. There is a gap in knowledge regarding factors that might contribute to glomerular damage in SS-HTN. The goal of this study was to assess the transcriptomic changes that accompany glomerulosclerosis in SS-HTN.

**Methods:** 8-week-old Dahl Salt Sensitive rats were fed a normal (0.4% NaCl, NS) or high salt diet (4% NaCl, HS, to induce hypertension) for 3 weeks. At the endpoint, glomeruli were obtained from the cortex using differential sieving. Total mRNA was isolated from the glomeruli and subjected to NextGen sequencing; transcriptomic data was analyzed using IPA software. The cutoff value for the experimental fold-change (EFC) was 1.5; p value < 0.05 was considered significant.

**Results:** 149 genes were found to be differentially expressed in glomeruli from HS and NS diet fed rats (107 and 42 were down- and up-regulated). We recorded changes in several signaling pathways: GPCR signaling was suppressed, including leptin/melanocortin, AMPK/mTOR, and ERK/MAPK pathways (Elf3 (EFC 1.8); Mc4r (-5.0), Gator2 (-4.3), Azgp1 (-3.6), Lepr (-2.9), Nr4a1 (-2.4), Pki (-2.5), Rgs2 (-1.8)). We report changes in calcium regulation (Calb (1.6), Cav2.1 (-3.6), Prkce (-3.0), Carf (-2.2), Ip3kb (-1.8)), cellular metabolism (Ltc4s (2.3), Apobec1 (1.5), Sdr42e1 (1.5), Acaca (-3.2), Fads3 (-2.6), Sdhaf3 (-2.3), Ren (-1.9), Cox14 (-1.7), Cyp4f2 (-1.6), Mgl1 (-1.6) Cyp2d22 (-1.5), Ch25h (-1.5), Gnpda2 (-1.5)), immune response, apoptosis, and inflammation (Mrc1 (1.5), Nfkb (-2.8), Xiap (-2.8), Fcgr2a (-2.7), Marco (-2), Hla-a (-1.7)), as well as fibrosis and cell proliferation (Myl3 (1.7), Cend2 (1.5), Fmn13 (-3.5), c-Rel (-2.8), Cdk13 (-1.8), Cdkn1b (-1.6), Wnt5a (-1.6)), and solute transporters (Slc14a1 (2.8), Slco1a1 (-2.2), Slc2a10 (-1.7), Slc38a3 (-1.7), Slc6a6 (-1.6), Slc38a6 (-1.5)).

**Conclusions:** We revealed here novel gene networks affected in glomeruli during SS-HTN. Alignment of this data with other existing 'omics analyses is necessary to provide further insight into the development of hypertensive glomerulosclerosis.

**Funding:** Other NIH Support - HL148114

## SA-PO764

**Endothelial Cell-Specific G2APOL1 Expression Induces Hypertension via STING and NLRP3 Pathways**

Bibek Poudel, Joseph Wahba, Allison Vassalotti, Archana Raman, Junnan Wu, Katalin Susztak. *University of Pennsylvania Perelman School of Medicine, Philadelphia, PA.*

**Background:** Genetic studies showed an association between ApolipoproteinL1 (APOL1) high risk (G1/G2) genotype and hypertension (HTN) and hypertensive kidney disease (H-CKD). The causal role of APOL1 in the development of HTN and H-CKD is not fully understood.

**Methods:** In the human kidney, APOL1 is highly expressed in endothelial cells and podocytes. We generated endothelial and podocyte-specific inducible G0 and G2 APOL1 transgenic mice by crossing the TRE-G2APOL1 and TRE-G0-APOL1 mice with the endothelial-specific Cdh5tTA and podocyte-specific (NPHS1rtTA) transgenic mice. We induced APOL1 expression by doxycycline diet. In the Cdh5tTA/TRE-G2APOL1 and control mice, we performed uni-nephrectomy (UNX) at five weeks of age and kept mice on a 4% salt diet for 12 weeks. Blood pressure was monitored by the tail-cuff method. To understand the role of the inflammasome (*NLRP3* and *GSDMD*) and the cytosolic nucleotide sensor (STING) in disease development, we crossed the *STING*, *NLRP3*, and *GSDMD* knock-out mice with the Cdh5tTA/TRE-G2APOL1 animals.

**Results:** Podocyte-specific G2APOL1 transgenic mice developed severe HTN only after proteinuria and renal damage was observed, likely representing a secondary HTN. Systolic, diastolic, and mean arterial blood pressure was mildly but significantly higher in Cdh5tTA/TRE-G2APOL1 mice compared to control mice. Cdh5tTA/TRE-G2APOL1 mice also developed a slight increase in urinary albumin/creatinine ratio and renal fibrosis after the animals became hypertensive. Hypertension, renal fibrosis, and proteinuria were ameliorated in *STING*, *NLRP3*, and *GSDMD* knock-out Cdh5tTA/TRE-G2APOL1 mice compared to Cdh5tTA/TRE-G2APOL1 mice. Our preliminary data indicate an increased cytosolic leakage of mitochondrial DNA in Cdh5tTA/TRE-G2APOL1 mice, which is likely responsible for the *STING*, *NLRP3*, and *GSDMD* activation in the Cdh5tTA/TRE-G2APOL1 mice.

**Conclusions:** EC-specific G2APOL1 transgenic mice developed mild salt-sensitive hypertension and renal damage, indicating the causal role of G2APOL1 in hypertension and hypertensive kidney disease, while podocyte-specific G2APOL1 was associated with secondary hypertension. This project was supported by DK105821.

**Funding:** NIDDK Support

## SA-PO765

**The Clinical Conundrum of Secondary Hypertension in Young Adults: A Case of Extreme Renin Elevation Associated With Coarctation of the Aorta**

Rohit K. Gupta, Elizabeth Taber-Hight. *Indiana University School of Medicine, Indianapolis, IN.*

**Introduction:** Hypertension may affect 1 in 8 young adults between 20-40 years of age. In the year 2000, worldwide prevalence of hypertension was estimated as 12.7% in men and 7.4% in women between 20-29 years of age and 18.4% in men and 12.6% in women between 30-39 years of age. Uncontrolled hypertension at a young age is associated with complications such as cardiovascular disease, cerebrovascular accidents and increased mortality that persist into late adulthood. This underscores the need to evaluate hypertension, including secondary causes, in young adults.

**Case Description:** A 27 year-old woman was referred to our clinic for hypertension. She was diagnosed with hypertension at the age of 10. Her hypertension was well controlled with medications (including azilsartan and metoprolol), but no previous work up for secondary hypertension was available. Labs revealed elevated plasma renin of 11300 pg/ml, normal serum aldosterone of 11.5 ng/dl and an aldosterone-to-renin ratio of <0.1. Contrast computed tomography (CT) revealed severe coarctation of the aorta (COA) with minimal patent lumen. No renin-secreting tumor or renal artery stenosis was identified. Severe COA was confirmed by invasive aortography.

**Discussion:** This case describes an association between severe COA, extreme plasma renin elevation and hypertension. The mechanism behind renin elevation in this situation is unclear. In addition to severe COA with minimal patent lumen and elevated pressure gradients across the coarcted segment identified by CT angiography and invasive aortography, findings such as "dampened upstroke" by renal arterial doppler and moderately-to-severely reduced ankle-brachial indices suggest that renal hypoperfusion may play a role. Use of the angiotensin II receptor blocker azilsartan to control hypertension likely contributed to some degree of plasma renin elevation and relatively suppressed serum aldosterone. It is also notable that plasma renin remained extremely elevated despite concomitant use of metoprolol. Hypertension was reasonably controlled medically, but the patient ultimately underwent coarctation repair of hemodynamically significant, severe COA.

## SA-PO766

**Identification of a Mechanosensor in Juxtaglomerular Cells for the Regulation of Renin Synthesis and Secretion**

Jin Wei, Jie Zhang, Nikita S. Yadav, Jenna Chan, Kshama Patel, Anish R. Thalakola, Ridham Patel, Fady G. Attalla, Garrett D. Meredith, Ruisheng Liu. *USF Health Morsani College of Medicine, Tampa, FL.*

**Background:** Juxtaglomerular (JG) cells are a group of specialized vascular smooth muscle (VSM) cells but distinguished from VSM cells by the synthesis and secretion of renin. However, the intracellular mechanisms of renin release from JG remain elusive.

**Methods:** We performed single-cell RNA seq on a total of 9815 cells that were derived from renal cortex tissue of C57BL/6J mice.

**Results:** Unbiased clustering analysis demonstrated 12 distinct cell clusters. In particular, a cluster consisting of 284 cells was identified as VSM cells by distinct expression of Acta2 ( $\alpha$ -smooth muscle actin). Moreover, based on the co-expression of Ren1 (renin), 34 JG cells were further distinguished from this cluster of VSM cells. We profiled the transcriptome of these JG cells and correlated it with Ren1. The top 5 genes that were most positively correlated with Ren1 expression were Nr2f1, Akr1b7, Smim15, Gng11, and Sdc1. We also compared the transcriptome between JG cells and VSM cells. The top 5 genes that were most differentially expressed in JG cells vs. VSM cells were Ren1, Sfrp2, Akr1b7, Fam46a, and Sdc1. Thus, Akr1b7 and Sdc1 could be potential candidate genes that participate in the control of Ren1 expression in JG cells. In the present study, we examined the role of Sdc1 (syndecan-1) in the regulation of renin synthesis and secretion in response to perfusion pressure changes with both *in vitro* model of isolated/perfused afferent arteriole (Af-Art) and *in vivo* model of 2 kidneys 1 clip (2K1C). We found that low perfusion pressure through Af-Art increased Ren1 mRNA expression by 140.7 $\pm$ 24.8% while high perfusion pressure decreased the expression by 66.2 $\pm$ 13.1% compared to normal perfusion pressure in WT mice. However, the perfusion pressure alteration-induced changes in Ren1 expression were significantly attenuated in SDC1KO mice (n=4-5; p<0.05). Additionally, 2K1C increased renin expression in low-pressure kidney by 163.3 $\pm$ 48.7%, plasma renin and Ang II concentrations by 118.2 $\pm$ 61.4% and 162.8 $\pm$ 50.2%, and mean arterial pressure by 31.6 $\pm$ 5.7 mmHg. However, the 2K1C-induced changes were significantly reduced in SDC1KO mice (n=5-7; p<0.01).

**Conclusions:** In conclusion, this study demonstrates that syndecan-1 is a key mechano-sensor in JG cells that regulates the renin synthesis and secretion.

**Funding:** Other NIH Support - NHLBI

## SA-PO767

**Spontaneous Renal Artery Dissection**

Khaldoon Aljassani, Rimsha Ali, Taaha M. Mirza. *University of Pittsburgh Medical Center UPMC, Pittsburgh, PA.*

**Introduction:** Renal artery dissection is frequently seen as an extension of aortic dissection, but bilateral Spontaneous Renal Artery Dissection (SRAD) is an extremely rare condition that has only been described in case reports. The clinical presentation is variable and renal infarction is a frequent consequence.

**Case Description:** A 41-year-old male with insignificant past medical history presented with a sudden onset left sided sharp flank pain, 7/10 in intensity, non-radiating, no dysuria, hematuria, frequency. His routine labs on presentation were benign apart from mild elevation in white blood cell count and elevation of creatinine from baseline. CT abdomen with contrast showed left kidney infarction with large thrombus in the left renal artery. Coagulation profile and thrombophilia work up was negative. Heparin infusion was started, the patient's pain and renal function improved, discharged on apixaban. 3 days later he presented with right flank pain with hematuria, face puffiness and lower limb swelling, hypertension. Initial work up showed elevated creatinine, ESR and CRP, LDH, D dimer, mild transaminitis. CT abdomen and pelvis with contrast showed parital right kidney infarct with filling defect in the right renal artery suspicious for a dissection. Patient was started on heparin infusion, steroids and azathioprine. Further autoimmune work up was negative. Peripheral smear, bone marrow biopsy, MRI angiography of the head and neck was normal. IR angiogram of the renal arteries showed bilateral renal artery dissection. A stent was placed in the right renal artery, improving right renal blood flow to the residual right renal parenchyma. No significant flow was identified in the left renal artery.

**Discussion:** SRAD is a rare phenomenon with incidence of 0.05% of all artery dissections (1). Spontaneous bilateral renal artery dissection is an exceedingly rare condition described in case reports. (2, 3) The etiology has not been clearly defined; however Fibromuscular Muscular Dysplasia is noted to be associated with the development of SRAD, which is what we expected as the likely cause in our patient. The presentation of SRAD is variable, usually asymptomatic (C), unless it leads to renal infarction. A CT angiogram can be used to diagnose renal artery dissection as with most dissections. Treatment focused is on surgical revascularization and nephrectomy is only opted for if there is a high infarction burden.



## SA-PO768

### Deletion of AT1a Receptors Selectively in the Proximal Tubules of the Kidney Augments Glomerular Filtration in Male and Female PT-Agr1a<sup>-/-</sup> Mice

Xiao C. Li, Jia L. Zhuo. Tulane University School of Medicine, New Orleans, LA.

**Background:** It is well recognized that circulating angiotensin II (Ang II) plays a key role in the regulation of glomerular filtration via activation of AT<sub>1a</sub> (AT<sub>1a</sub>) receptors. However, whether Ang II and AT<sub>1a</sub> (AT<sub>1a</sub>) receptors in the proximal tubules play an important role in the regulation of glomerular filtration remains unknown.

**Methods:** We tested the hypothesis that deletion of AT<sub>1a</sub> receptors selectively in the proximal tubules augments glomerular filtration in male and female PT-Agr1a<sup>-/-</sup> mice. PT-Agr1a<sup>-/-</sup> mice were generated using the iL-Sgt2-Cre/Agr1a-floxed approach. Two groups of adult male and female wild-type (WT) and PT-Agr1a<sup>-/-</sup> mice were infused with or without a slow pressor dose of Ang II for 2 weeks via an osmotic minipump (~500 µg/kg body wt./day, i.p.). Whole-kidney glomerular filtration rate (GFR) was determined using the transdermal GFR monitoring technique with FITC-sinistrin (MediBeacon, 10 mg/100 g body wt. i.v.).

**Results:** In WT mice, basal systolic blood pressure was 116 ± 3 mmHg, which increased to 146 ± 5 mmHg in response to Ang II infusion (P<0.01). Basal GFR was 160.8 ± 14.4 µl/min in male (n=9) and 149.9 ± 18.4 µl/min in female mice (n.s., n=7). In response to Ang II infusion, GFR was significantly decreased by ~25% to a similar extent in male and female WT mice (P<0.01). By comparison, basal systolic blood pressure was 13 ± 2 mmHg lower in age-matched male (n=13) and female (n=10) PT-Agr1a<sup>-/-</sup> mice (P<0.01). In response to Ang II infusion, systolic blood pressure increased to 128 ± 3 mmHg in male and female PT-Agr1a<sup>-/-</sup> mice (P<0.01). Interestingly, basal GFR was ~20% higher in male (190.6 ± 11.0 µl/min, P<0.05, n=10) and ~30% higher in female PT-Agr1a<sup>-/-</sup> mice (203.8 ± 21.5 µl/min, P<0.05, n=9) than WT mice, respectively. In response to Ang II infusion, GFR was significantly decreased by ~25% in male PT-Agr1a<sup>-/-</sup> mice (155.9 ± 20.0 µl/min, P<0.01, n=10). However, Ang II infusion had no significant effect on GFR in female PT-Agr1a<sup>-/-</sup> mice (191.2 ± 18.8 µl/min, n.s., n=7).

**Conclusions:** Our findings suggest that deletion of AT<sub>1a</sub> receptors selectively in the proximal tubules inhibits AT<sub>1a</sub> receptor-mediated, Ang II-stimulated proximal tubule sodium reabsorption, which increases the end proximal tubule sodium delivery to the macula densa and impairs the tubuloglomerular feedback response in PT-Agr1a<sup>-/-</sup> mice.

**Funding:** NIDDK Support

## SA-PO769

### Regulation of Edn1 by Its Antisense Long Non-Coding RNA, Edn1-AS

Alexandria Juffre, Lauren G. Douma, Charles S. Wingo, Michelle L. Gumz. Gumz Laboratory University of Florida, Gainesville, FL.

**Background:** The peptide hormone endothelin-1 (ET-1) decreases renal sodium reabsorption by inhibiting epithelial sodium channel (ENaC) activity. Dysfunctional regulation of sodium handling can cause hypertension and ET-1 is a therapeutic target. We discovered a long non-coding RNA (lncRNA), Edn1-AS, which is antisense to the Edn1 mRNA. Using CRISPR-modified human proximal tubule cells (HK-2), we previously found that cis over-expression of Edn1-AS (expressed from the same locus as Edn1) resulted in increased ET-1 levels in cultured human proximal tubule cells (HK-2). The goal of this study was to test the effect of trans-overexpression of Edn1-AS (from an exogenous DNA construct) on Edn1 expression. Based on our previous results, we hypothesized that trans over-expressing Edn1-AS in collecting duct cells would increase ET-1 mRNA expression.

**Methods:** Inducible Edn1-AS overexpressing IMCD-3 and mpkCCD cells were generated using Tet-ONE systems (Takara Clontech), which increases Edn1-AS expression after treatment with doxycycline. Edn1-AS lncRNA and Edn1 mRNA levels were determined by strand-specific RT-PCR or qPCR.

**Results:** Similarly to cis over-expression in HK-2 cells, trans over-expression of Edn1-AS in IMCD-3 and mpkCCD cells showed increased Edn1 levels (n=3, p < 0.05 by unpaired t-test).

**Conclusions:** Consistent with our previous results in HK-2 cells, increased Edn1 expression was observed in Edn1-AS overexpressing IMCD-3 and mpkCCD cells. These data suggest that Edn1-AS is a positive regulator of Edn1, regardless of whether Edn1-AS is over-expressed in a cis or trans manner. Subsequent studies will seek to determine the mechanism of action of Edn1-AS on Edn1 expression which may involve chromatin remodeling. Future investigation of Edn1-AS's regulation of Edn1 could lead to the identification of novel therapeutic targets for treatment of hypertension.

**Funding:** NIDDK Support, Other NIH Support - NIA

## SA-PO770

### Bone Marrow Indoleamine 2, 3-Dioxygenase Deficiency Attenuates CKD Associated Atherosclerosis

Biaoxin Chai, Vetalise K. Chefor, Lixia Zeng, Dheer Patel, Max Keller, Nancy F. Roeser, Jaeman Byun, Anna V. Mathew. Mathew Lab, University of Michigan University of Michigan, Ann Arbor, MI.

**Background:** Non-traditional risk factors like inflammation and oxidative stress play an essential role in the increased cardiovascular disease (CVD) risk prevalent in chronic kidney disease (CKD). Indoleamine 2, 3-dioxygenase (IDO1) catabolizes amino acid tryptophan to kynurenine in immune cells and extrahepatic tissues. IDO1 expression and activity are linked to atherosclerosis and renal function in clinical and experimental models. However, the mechanistic link between bone marrow IDO1 expression and CKD accelerated atherosclerosis is unknown.

**Methods:** Male LDLR<sup>-/-</sup> mice underwent sham surgery or 5/6 nephrectomy (CKD) and were placed on a high-fat/high-cholesterol diet (HFD) for 16 weeks. Tryptophan and kynurenine levels were measured using targeted mass spectrometry in the plasma, urine, and tissues. We designed a metabolic flux study using intraperitoneal injection of <sup>13</sup>C<sub>11</sub> tryptophan to delineate the contribution of decreased renal excretion vs. increased production in specific tissues in CKD mice. We then created a chimeric 5/6 nephrectomized male LDLR<sup>-/-</sup> mice with bone marrow from control and IdO1<sup>-/-</sup> mice, respectively, to demonstrate the role of IDO1 in CKD atherosclerosis. We quantified atherosclerosis with Oil Red-O staining of *en face* aortic sections. We measured changes in macrophage apoptosis, phagocytosis, and cytokine profiles with IDO1 deficiency.

**Results:** CKD mice demonstrate lower circulating tryptophan and increased kynurenine to tryptophan ratio (KTR, marker of IDO activity) at baseline and the end of diet than controls. CKD mice demonstrate increased IDO expression and activity in aortic tissue and bone marrow cells. The metabolic flux study revealed that the CKD mice had increased label in kynurenine pools of vascular and bone marrow tissues confirming increased IDO1 activity in these tissues. IDO1 deficiency in the bone marrow of male CKD LDLR<sup>-/-</sup> mice decreases atherosclerosis compared to CKD mice with intact bone marrow IDO1 expression. Activated human macrophage cultures reveal that IDO1 depletion increases macrophage apoptosis and decreases phagocytosis and cytokines.

**Conclusions:** In summary, IDO1 depletion in the bone marrow of CKD mice decreased atherosclerosis by its action on macrophage apoptosis, phagocytosis, and cytokine profiles.

**Funding:** Other NIH Support - NHLBI

## SA-PO771

### Activin A Is a Potential Mediator of TGFβ1-Induced Tubulointerstitial Fibrosis

Asfia Soomro, Renzhong Li, Dan Zhang, Kian S. O'Neil, Melissa Macdonald, Bo Gao, Joan C. Krepinsky. McMaster University, Hamilton, ON, Canada.

**Background:** Chronic kidney disease (CKD) is a rising health issue in North America, characterized by progressive renal fibrosis often leading to organ failure. TGFβ1 is a central mediator of fibrosis in CKD of diverse etiology, but its direct inhibition is limited by adverse effects. We recently showed in glomerular mesangial cells (MC) that activin A (ActA) mediates TGFβ1 profibrotic effects through regulation of both canonical Smad3 and noncanonical MRTF-A signaling. Here we study the potential role of ActA in the development of tubulointerstitial fibrosis (TIF), a major determinant of kidney function decline in CKD. We further assess the promoter regulation of ActA by TGFβ1.

**Methods:** Renal fibrosis was induced in mice overexpressing (OE) TGFβ1 using 2 models: 5/6 nephrectomy (Nx) and unilateral ureteral obstruction (UUO). UUO mice were treated with a neutralizing ActA antibody to assess effects on fibrosis. Primary mouse MC, human renal proximal tubular epithelial cells (PTEC, HK2) and rat renal fibroblasts (RF) were used. ActA and Activin B (ActB) were inhibited with a neutralizing antibody or follistatin. Transcriptional activity of the ActA promoter was studied using a luciferase reporter plasmid and a series of deletion constructs.

**Results:** TGFβ1 OE augmented fibrosis and activin levels in Nx and UUO. ActA neutralization inhibited Smad3 activation and fibrosis after UUO in wild-type and TGFβ1 OE mice. In both models, ActA and B were significantly increased in tubular cells, which largely colocalized to PTEC identified by megalin. We thus studied the potential role of activins in tubular-fibroblast crosstalk. TGFβ1 increased secretion of ActA and B from HK2 cells, with a greater ActA effect. Media from HK2 treated with TGFβ1 induced RF Smad3 activation and fibrotic responses (matrix synthesis, αSMA induction). These were blocked by follistatin or ActA, but not ActB, neutralization. In MC, we found the -350bp region of the ActA promoter is required for TGFβ1 regulation. Interestingly, a novel CT microsatellite site upstream of this which suppressed promoter activity was also identified.

**Conclusions:** ActA is induced by TGFβ1 and mediates its profibrotic effects, with relevance to both glomerular and TIF. Its inhibition is being evaluated as a novel treatment for fibrosis in CKD.

## SA-PO772

### Loss of Serum and Glucocorticoid Kinase 1 (SGK) in T Cells Abrogates Memory T Cell Formation, Hypertension, and End-Organ Damage

Dina Maaliki,<sup>1</sup> Maha M. Itani,<sup>1</sup> Hala H. Jarrah,<sup>1</sup> Carla El-Mallah,<sup>1</sup> Omar Obeid,<sup>1</sup> Miran A. Jaffa,<sup>1</sup> Hana A. Itani,<sup>1,2</sup> <sup>1</sup>American University of Beirut, Beirut, Lebanon; <sup>2</sup>Vanderbilt University Medical Center, Nashville, TN.

**Background:** NaCl concentrates in tissues over time and activates immune cells including T<sub>H</sub>17 cells and dendritic cells, which are known to contribute to hypertension, in a Serum/Glucocorticoid Kinase 1 (SGK1)-dependent fashion. In addition to T<sub>H</sub>17 cells and dendritic cells, memory T cells play a vital role in hypertension genesis. Long-lived memory cells generate a systemic inflammatory response through mobilization to target organs and release of cytokines. To understand the mechanisms by which memory T cells sense salt, we tested the hypothesis that SGK1, an important intracellular sensor of Na<sup>+</sup>, in T cells is necessary for the formation of memory T cells and their mediation of salt sensitive hypertension and organ damage.

**Methods:** We employed mice with T cell-specific deletion of SGK1, SGK1<sup>fl/fl</sup> x tgCD4<sup>cre</sup> mice, and used SGK1<sup>fl/fl</sup> mice as controls. To mimic repeated exposure to hypertensive stimuli, we treated mice with L-NAME (0.5mg/ml) in drinking water for 2 weeks, allowed a 2-week washout interval, followed by a high salt(HS) diet (4% NaCl) for 3 weeks.

**Results:** L-NAME/HS significantly increased blood pressure as well as memory T cell infiltration in the kidney, aorta, and bone marrow of SGK1<sup>fl/fl</sup> mice, as compared to SGK1<sup>fl/fl</sup> x tgCD4<sup>cre</sup> mice. SGK1<sup>fl/fl</sup> mice also demonstrated caused striking albuminuria, cortical fibrosis, cortical ROS generation and increased renal IFN-γ and NGAL expression

Key: TH - Thursday; FR - Friday; SA - Saturday; OR - Oral; PO - Poster; PUB - Publication Only

Underline represents presenting author.

after L-NAME/HS. Myography studies demonstrated an impaired relaxation in response to acetylcholine but not sodium nitroprusside in mesenteric arterioles from  $SGK1^{fl/fl}$  mice, but not  $SGK1^{fl/fl} \times tg\ CD4^{cre}$  mice. T cells were sorted and adoptively transferred from the bone marrow of  $CD45.2\ SGK1^{fl/fl} \times tg\ CD4^{cre}$  mice or  $SGK1^{fl/fl}$  controls that had undergone the L-NAME/HS protocol, to recipient  $CD45.1$  mice. Recipient mice were then fed a HS diet for 3 weeks. Strikingly, mice that had received T cells from  $SGK1^{fl/fl}$  donors exhibited significantly increased blood pressure and renal memory T cell infiltration, compared to mice that had received cells from  $SGK1^{fl/fl} \times tg\ CD4^{cre}$  donors.

**Conclusions:** Our data suggest a new therapeutic target to reduce the formation of hypertension-specific memory T cells, which will protect against hypertension and end-organ damage in response to repeated hypertensive stimuli.

**Funding:** Other NIH Support - American Society of Nephrology

## SA-PO773

### Histone Deacetylase 9 Contributes to Vascular Calcification in CKD

Lin Xiong, Qiong Xiao, Chen Rong, Yun Tang, Li Wang, Yi Li, Guisen Li. *Sichuan Academy of Medical Sciences and Sichuan People's Hospital, Chengdu, China.*

**Background:** Vascular calcification (VC) is a serious complication of chronic kidney disease (CKD). Unfortunately, there is no effective therapy for VC beyond supportive care due to the complex pathogenesis of VC. Histone deacetylase 9 (HDAC9) could regulate the transdifferentiation of vascular smooth muscle cells in atherosclerotic aortic calcification. However, the role of HDAC9 in VC upon CKD is unclear. The purpose of this study was to investigate the role and mechanism of HDAC9 in VC upon CKD.

**Methods:** Rat aortic smooth muscle cells (RASMCs) were divided into control and calcification group. The calcification group was induced with  $\beta$ -glycerophosphate and  $CaCl_2$ . RASMCs were incubated with Alizarin Red S stain to detect calcification. Real-time quantitative PCR (RT-PCR) and western blotting (WB) were utilized to detect the expression level of HDAC9. 30 male wild-type Wistar rats were randomly divided into six groups (n=5): 4- and 16-week control groups, and 4-, 8-, 12-, and 16-week VC groups. The VC model of CKD in rats was established by 5/6 nephrectomy combined with high phosphorus chow. Rat aortas were collected and stained with alizarin red to detect VC. Subsequently, the expressions of HDAC9 were detected by third generation sequencing and immunohistochemical staining.

**Results:** *In vitro*, alizarin red staining showed the RASMCs in the calcified group had more calcium salt deposition compared with the control group. Both WB and RT-PCR showed the expression of HDAC9 in calcified cells was increased. *In vivo*, alizarin red staining of the aorta showed the vascular calcium deposition in the calcification group was significantly higher than that in the control group. In the third-generation full length transcriptome sequencing of rat aorta, the RNA expression of HDAC9 in calcification group increased gradually from 4 weeks to 12 weeks, and was significantly higher than that in 4- and 16-week control groups; From 12 to 16 weeks, the RNA expression of HDAC9 began to decline, but it was still higher than that of the 4-week and 16-week control groups. Moreover, immunohistochemical staining also indicated the expression of HDAC9 in the aorta of the 12-week calcification group was significantly increased, relative to the 4- and 16-week control groups.

**Conclusions:** Histone deacetylase 9 could contribute to development of vascular calcification in chronic kidney disease.

## SA-PO774

### Olfactory Receptor 558 (Olfr558) Is Required for Sex Differences in Blood Pressure

Jiaojiao Xu,<sup>1</sup> Rira Choi,<sup>1</sup> Helen R. Warren,<sup>2</sup> Kunal Gupta,<sup>1</sup> Lakshmi Santhanam,<sup>1</sup> Jennifer L. Pluznick,<sup>1</sup> <sup>1</sup>Johns Hopkins University School of Medicine, Baltimore, MD; <sup>2</sup>Queen Mary University of London Barts and The London School of Medicine and Dentistry, London, United Kingdom.

**Background:** Olfactory receptor 558 (Olfr558) is expressed in the kidney where its functional role is unknown.

**Methods:** Olfr558 was localized using RNAScope. Systolic (SBP), diastolic (DBP), and mean arterial pressure (MAP) was measured in whole-body Olfr558 wild-type (WT) and knockout (KO) via telemetry. Expression was analyzed by qPCR, plasma renin activity (PRA) was measured by ELISA, and vasoreactivity was examined *ex vivo* by wire myography (responses to potassium chloride (KCl), phenylephrine (PE), acetylcholine (ACh), and sodium nitroprusside (SNP) in aortic and mesenteric rings). In females, pulse wave velocity (PWV) and tensile testing were performed. Using UK Biobank data (N~450k), we performed genetic analyses of DBP, testing for sex-interaction effects.

**Results:** Olfr558 localizes to renal vascular smooth muscle cells, including the renal afferent arteriole. It is known that males have a higher BP than premenopausal females in both humans and mice; indeed, we find that Olfr558 WT males (M) had a higher BP than females (F, n=7-9 per group), including MAP (M:101.0±1.6 vs. F:89.0±0.9 mmHg,  $p<0.0001$ ), SBP (M:113±2 vs. F:102±1mmHg,  $p=0.003$ ), and DBP (M: 89±2 vs. F:75±0.1mmHg,  $p<0.0001$ ). These sex differences in BP were absent in Olfr558 KO (MAP M: 96±2 vs. F: 95±1mmHg; SBP M: 110±2 vs. F: 108±2mmHg; DBP M: 81±2 vs. F: 82±2mmHg). However, other sex differences (body weight) are intact in KO, and KO males and females are fertile. In male KOs (n=10-12), kidney renin mRNA was decreased (0.4±0.1 vs WT: 1±0.1  $p=0.001$ ), as was PRA (201±21 vs WT: 402±15,  $p=0.001$ ); these parameters were unchanged in female KOs. Male KO aortic rings exhibited less constriction to PE, male KO mesenterics exhibited more relaxation to SNP, and female KO aortic rings exhibited more constriction to KCl. KO females have increased PWV (KO: 4.6±0.4 vs WT: 3.2±0.2 m/s,  $p=0.007$ , n=8-11), but no changes in tensile testing. The OR51E1 (the human ortholog of Olfr558) gene region was recently reported for

association with DBP (PMID 30224653). Our UK Biobank analyses demonstrate a sex-specific effect for the lead variant rs17224476, with effects on DBP differing significantly ( $p=0.01$ ) between men vs women.

**Conclusions:** Olfr558 is required for sex differences in BP in mice. Olfr558 regulates BP in males via renin and vascular reactivity, but via arterial stiffness in females.

**Funding:** Other NIH Support - R56DK107726

## SA-PO775

### Full-Length Klotho and Secretase BACE1 Are Upregulated in Human Hearts From Patients With Advanced CKD

Gayatri Narayanan,<sup>1</sup> Arvin Halim,<sup>1</sup> Neal X. Chen,<sup>1</sup> Sharon M. Moe,<sup>1</sup> Tzongshi Lu,<sup>2,3</sup> Kenneth Lim.<sup>1</sup> <sup>1</sup>Indiana University School of Medicine, Indianapolis, IN; <sup>2</sup>Brigham and Women's Hospital, Boston, MA; <sup>3</sup>Harvard Medical School, Boston, MA.

**Background:** Klotho is an anti-aging protein that has demonstrated remarkable cardiovascular-protective effects. Klotho-deficient mice develop extensive cardiovascular disease that resembles advanced CKD patients; conversely Klotho supplementation rescues this phenotype. Klotho is cleaved into several soluble isoforms that constitute its KL1 and/or KL2 ectodomains by proteases ADAM10, ADAM17, and BACE1. To-date, the expression profile and natural history of Klotho and its regulatory enzymes locally in hearts from patients with CKD is largely undefined. Herein, we performed molecular phenotyping of the local Klotho hormonal system in explanted human donor hearts from patients with CKD.

**Methods:** We analyzed human left ventricular tissues from advanced CKD donors (hemodialysis, HD; n=19), patients with hypertension with preserved renal function (HTN; n=11), and healthy controls (CON, n=19) collected in the Cardiovascular Aging in CKD (CAIN) cohort. Hearts were subjected to gross pathologic and molecular analysis, including Masson's Trichrome staining, immunohistochemistry and immunoblotting.

**Results:** HD and HTN hearts exhibited significantly higher heart weight relative to body surface area (BSA) compared to CON hearts ( $p<0.001$ ). HD hearts had significantly thicker left ventricular walls compared to CON hearts ( $p<0.007$ ). There was greater fibrosis staining in HD hearts compared to HTN ( $p<0.008$ ) and CON hearts ( $p<0.001$ ). Significantly, HD hearts exhibited greater upregulation of full-length Klotho compared to HTN ( $p<0.008$ ) and CON hearts ( $p<0.002$ ). There was no significant difference in full-length Klotho expression between HTN and CON hearts ( $p=0.7$ ). Interestingly, we did not detect KL1 and KL2 isoforms in human hearts. Moreover, HD hearts exhibited increased BACE1 ( $p<0.02$ ) compared to HTN and CON hearts. There were no significant differences in ADAM10 or ADAM17 expression in hearts between the three groups ( $p>0.1$ ).

**Conclusions:** Full-length Klotho and BACE1 are upregulated in hearts from advanced CKD patients. These results suggest that increased local Klotho expression may be an adaptive response in advanced CKD. Cleavage of myocardial Klotho may be driven by BACE1 in diseased hearts from patients with CKD. Further studies to elucidate the mechanisms and regulation of myocardial Klotho are warranted.

**Funding:** NIDDK Support

## SA-PO776

### Novel Evidence for an Enhanced Intrarenal Machinery of Estrogen Biosynthesis in the Female Rat Kidney

Victoria L. Nasci,<sup>1</sup> Alison J. Kriegel,<sup>2</sup> Eman Y. Gohar,<sup>1</sup> <sup>1</sup>Vanderbilt University Medical Center, Nashville, TN; <sup>2</sup>Medical College of Wisconsin, Milwaukee, WI.

**Background:** Hypertension is more prevalent in men than age-matched premenopausal women. We recently showed that activation of the G-protein coupled estrogen receptor 1 in the renal medulla promotes natriuresis in female (F), but not male (M), Sprague Dawley (SD) rats. Whether renal medullary GPER1 is activated by circulating or locally produced estrogen is unknown. Some extragonadal tissues, such as the brain, express aromatase, the key enzyme in estrogen biosynthesis, which acts locally to convert testosterone to estradiol ( $E_2$ ). We hypothesized that the kidneys are capable of producing  $E_2$  and this intrarenal steroidogenic capability is enhanced in F rats.

**Methods:** To test this, we assessed the expression of elements of the estrogen biosynthesis pathway in M and F SD rat kidneys with a focus on the medulla as it plays a major role in sex-related differences in sodium handling.

**Results:** Mass spectrometry (MS) imaging of kidney sections revealed greater abundance for cholesterol sulfate, a substrate which can be used in sex steroid production, in F compared to M kidneys. This sex-specific difference in renal cholesterol abundance was driven by medullary differences (F:  $4.98 \times 10^6 \pm 0.4 \times 10^6$ ; M:  $2.2 \times 10^6 \pm 0.2 \times 10^6$  average peak intensity  $P=0.0001$ ). RNA sequencing of the renal inner medulla analyzed via Ingenuity Pathway Analysis revealed that 23% of sequenced transcripts encoding proteins within the estrogen biosynthesis pathway were greater, and 8% were lower, in F vs M rats, suggesting activation of this pathway in F kidneys. Of interest, Cyp19a1, which encodes for aromatase, was 2.7-fold higher in F compared to M inner medulla. Whereas inner medullary expression of Cyp2c11, which encodes an enzyme that converts testosterone to  $2\alpha$ -OH-testosterone, was 13-fold lower in F vs M. Increasing salt intake promoted Cyp19a1 mRNA expression in F, but not M, inner medulla ( $P=0.04$ ). Using LC-MS, we found greater levels of tissue  $E_2$  within inner medullary tissues of F kidneys compared to M ( $28.9 \pm 7.8$  vs  $9.3 \pm 2.0$  pg/ $\mu$ l/mg  $P=0.0323$ ).

**Conclusions:** Overall, our investigation of renal estrogen biosynthesis reveals greater expression of the substrate, key enzyme, and end product as well as pathway enrichment in F compared to M kidneys. This points to the kidney as an extragonadal site for  $E_2$  biosynthesis, which could provide insight into sex-differences in renal disease.

**Funding:** NIDDK Support

Key: TH - Thursday; FR - Friday; SA - Saturday; OR - Oral; PO - Poster; PUB - Publication Only

Underline represents presenting author.

## SA-PO777

**Kidney Specific BMAL1 Knockout Reveal Differences in Circadian Rhythms of Blood Pressure Following a Low Potassium/High Salt Diet**

Charles B. Drucker, G. R. Crislip, Hannah M. Costello, I. Jeanette Lynch, Charles S. Wingo, Michelle L. Gumz. *University of Florida College of Medicine, Gainesville, FL.*

**Background:** Circadian rhythms are present in various physiologic functions, with irregularities being linked to cardiovascular disease, including hypertension, in humans. Previously, we have shown that knocking out the circadian clock factor BMAL1 in renal distal nephron and collecting duct cells of male mice (KS-BMAL1 KO) led to lower systolic blood pressure (SBP) than control mice (CNTL) with no effect on daily rhythms under a normal diet. Additionally, this effect was increased following a low potassium/high salt diet (OKHS; 4% NaCl). Our goal for this study was to determine if there were any genotype differences in circadian rhythms of SBP following a OKHS diet.

**Methods:** SBP was measured via telemeter implants (N=7-8). KS-BMAL1 KO and CNTL were placed on a normal diet for 3 days, OK diet for 7 days, and then a OKHS diet for 10 days. Cosinor analysis on SBP was performed for each mouse during the last 3 days of normal and OKHS diets to calculate mesor (midline estimating statistic of rhythm), amplitude (the extent of predictable change within a cycle), period (duration of a cycle from peak to peak), and acrophase (time at which the peak of a rhythm occurs). Two-way ANOVA with post-hoc analysis to compare between genotypes following OKHS is provided.

**Results:** As expected, the mesor for SBP was lower in KS-BMAL1 KO compared to CNTL following OKHS ( $p=0.0005$ ). OKHS increased mesor compared to normal diet. There were no differences between genotypes in the period. OKHS diet also had no effect on SBP period. The period ranged from 23.0-24.9 hours. KS-BMAL1 KO had lower amplitude in SBP than CNTL following OKHS ( $p=0.04$ ). Additionally, OKHS increased amplitude compared to normal diet in both groups ( $p<0.0001$ ). There was no difference between genotypes in acrophase, however, OKHS advanced the acrophase in both groups ( $p<0.0001$ ).

**Conclusions:** Treatment with OKHS affects rhythms of SBP by increasing the amplitude and advancing the acrophase, suggesting a role for diet in causing circadian disruption. BMAL1 within distal nephron and collecting duct cells contributes to SBP regulation following OKHS and the amplitude of rhythms.

**Funding:** NIDDK Support, Veterans Affairs Support, Private Foundation Support

## SA-PO778

**Circadian Clock Provides Beneficial Effects Against the Dysfunction in Endothelial Signaling by Regulating Heme Synthesis and Heme Oxygenase-1 Expression**

Hideyuki Negoro,<sup>1,2</sup> *<sup>1</sup>Harvard Medical School, Boston, MA; <sup>2</sup>The Graduate School of Project Design, Tokyo, Japan.*

**Background:** The circadian clock is a molecular mechanism that confers 24 hours variations in gene expression and function to regulate many physiological functions. Chronic circadian clock disruption is associated with vascular stiffness and dysfunction in endothelial signaling and responses. Heme is a ligand of REV-ERB $\alpha$  and REV-ERB $\beta$  which modulate circadian rhythms by binding to the ROR region of CLOCK or BMAL1 to suppress the expression of these genes. 5-Aminolevulinic acid (ALA) is the common precursor of heme. The iron ion is inserted into PpIX to form heme in the mitochondria and incorporated into hemoproteins. Heme oxygenase-1 (HO-1) is an intracellular enzyme which catalyzes the oxidation of heme to generate ferrous iron, carbon monoxide, and biliverdin, which is subsequently converted to bilirubin. These products have anti-inflammatory, anti-apoptotic and anti-thrombotic properties. In this study, we observed if the deletion of Bmal1, a critical component of the circadian clock, can influence HO-1 which play an important part in the protection of vascular diseases.

**Methods:** Congenic 12- to 16-week-old male, wild-type and Bmal1-KO littermate mice were generated from heterozygote breeding to be used for these studies. We also knocked down Bmal1 to evaluate the protein levels of HO-1 expression in the knocked down cells. To synchronize circadian rhythms, serum stimulations were performed. Cells were also pre-incubated with or without 1 mM ALA and 0.5 mM sodium ferrous citrate (SFC).

**Results:** In aorta from Bmal1 KO mice, there was a reduction in HO-1 expression in mice with a dysfunctional circadian rhythm. Bmal1 KO mice display pre-mature aging to have a dramatic prothrombotic phenotype. This phenotype is linked to the regulation of key risk factors for cardiovascular disease. These include HO-1 which is significantly reduced in Bmal1 KO mice. ALA/SFC co-incubation affected the oscillation and phase of core clock genes and led to increase of HO-1. HO-1 levels followed a circadian pattern, and this pattern was absent in Bmal1 KO mice.

**Conclusions:** These findings indicate that circadian clock provides beneficial effects against the dysfunction in endothelial signaling to promote atherogenesis by regulating Heme synthesis and HO-1 expression. This study establishes a mechanistic connection between Bmal1 and cardiovascular phenotype.

**Funding:** Government Support - Non-U.S.

## SA-PO779

**The Circadian Clock Protein PER1 Mediates Sex-Dependent Effects on Arterial Stiffness**

Ravindra K. Sharma,<sup>1</sup> Joshua Gomes,<sup>1</sup> G. R. Crislip,<sup>1</sup> Hannah M. Costello,<sup>1</sup> Lauren G. Douma,<sup>1</sup> Suraj Krishnan,<sup>1</sup> Kityan Cheng,<sup>1</sup> Rajesh Mohandas,<sup>2</sup> Michelle L. Gumz.<sup>1,1</sup> *University of Florida, Gainesville, FL; <sup>2</sup>LSU Health New Orleans, New Orleans, LA.*

**Background:** Increased arterial stiffness is independently associated with adverse cardiovascular events and improvement in pulse wave velocity (PWV), a noninvasive clinical index of arterial stiffness, correlates with better survival. The Circadian Protein Period 1 (PER1) is important to the maintenance of circadian rhythms and regulates a wide array of physiological functions including blood pressure. Lysyl Oxidase (LOX), an extracellular cuproenzyme that mediates collagen crosslinking, is integral to maintain vascular stiffness, and exhibits a circadian pattern of expression. Thus, we hypothesize that disrupted circadian clock function and upregulation of LOX could be a key mechanism for increased vascular stiffness.

**Methods:** Male and female C57BL/6J (15-16 weeks old) global PER1 Knock-out (KO) and WT mice (n=6) subjected to echocardiographic measurement of PWV to evaluate aortic stiffness. Further, cell specific mRNA expression of LOX was assessed in aortic tissue using situ hybridization (ISH). Aortic segments were mounted in ex-vivo wire myograph to analyze changes in vascular reactivity and functions. Finally, morphometric measurements were used to assess structural changes and remodeling in H&E stained aortic sections. Comparisons between groups were made using t-test and p-value <0.05 was accepted as significant.

**Results:** Knockout of PER1 resulted in an increased PWV in male (Con:179 $\pm$ 32, PER1 KO: 306 $\pm$ 47 cm/s,  $p<0.001$ ) but not in female mice (Con:219 $\pm$ 14, PER1 KO: 225  $\pm$  23 cm/s,  $p<0.80$ ) compared to age matched WT controls. This was associated with an increased LOX mRNA expression (~2.7 fold;  $p<0.01$ ) in the aorta of PER1 KO compared to WT mice. Morphometric analysis showed an increased adventitia thickness (30%;  $p<0.05$ ) in aortas of PER1KO mice. However, vascular functions/reactivity in PER1 KO mice aorta were slightly increased but this did not reach statistical significance.

**Conclusions:** Our findings suggest that disruption of circadian rhythm by deleting PER1 increases arterial stiffness in male but not in female mice. Increased LOX mediated changes in extracellular matrix are at least in part responsible for the pathogenesis of arterial stiffness in these mice. Inhibition of excessive LOX may have therapeutic potential in alleviating pathogenic increased vascular stiffness.

**Funding:** Other NIH Support - NIH-NHLBI and Florida Department of Health, Other U.S. Government Support

## SA-PO780

**Alterations in Kidney Venous Flow in the Prognosis of Heart Failure**

Faeq Husain-Syed,<sup>1,2</sup> Sharma Singam,<sup>3</sup> Jason K. Viehman,<sup>3</sup> Philip Schulte,<sup>3</sup> Pascall Bauer,<sup>2</sup> Khodr Tello,<sup>2</sup> Manuel Richter,<sup>2</sup> Werner Seeger,<sup>2</sup> Henning Gall,<sup>2</sup> Ardeschir Ghofrani,<sup>2</sup> Horst-Walter Birk,<sup>2</sup> Kianoush Kashani,<sup>3</sup> Claudio Ronco.<sup>4,5</sup> *<sup>1</sup>University of Virginia, Charlottesville, VA; <sup>2</sup>Universitätsklinikum Giessen und Marburg GmbH, Giessen, Germany; <sup>3</sup>Mayo Clinic Minnesota, Rochester, MN; <sup>4</sup>Azienda Ospedale Università Padova, Padova, Italy; <sup>5</sup>Ospedale San Bortolo di Vicenza, Vicenza, Italy.*

**Background:** Doppler-derived kidney venous flow (KVF) has gained interest as a potential surrogate marker of kidney congestion and adverse outcomes in heart failure (HF). The clinical importance of changes in KVC from baseline remains unclear.

**Methods:** 216 inpatients with HF comprising the whole left ventricular ejection fraction spectrum and diuretic-resistant volume overload were enrolled and underwent spectral Doppler at baseline and after one month. 4 KVF patterns (i.e., continuous, pulsatile, biphasic, and monophasic venous flows) and the kidney venous stasis index (KVSI) were defined. In addition, echocardiography, intra-abdominal pressure (only baseline), kidney function, hormones, and hydration status were assessed on the day of kidney Doppler ultrasonography. We evaluated HF-related morbidity using the cause-specific Cox proportional hazard model for the composite outcome of HF progression (hospitalization for worsening HF, outpatient HF decompensation) and all-cause mortality for 18-months post-discharge.

**Results:** During follow-up, the morbidity/mortality outcome occurred in 126 patients and was independently predicted by baseline KVSI (per 0.1 increase: HR 1.18 [95% CI 1.03-1.35;  $p=0.020$ ]) and KVF patterns (per one pattern increase: HR 1.42 [95% CI 1.04-1.94;  $p=0.026$ ]), respectively. Both an increase of 0.1 in the change from Doppler 1 to 2 KVSI and a single increase in the individual KVF pattern in the change from Doppler 1 to 2 were associated with higher risk of the composite outcome (HR 2.99 [95% CI 2.08-4.32;  $p<0.0001$ ] and HR 6.73 [95% CI 3.27-13.86;  $p<0.0001$ ], respectively).

**Conclusions:** Serial assessment of KVF provides additional prognostic information on worsening HF and death risk-stratification. Changes in KVF may provide a basis for enhanced clinical making in patients with HF.

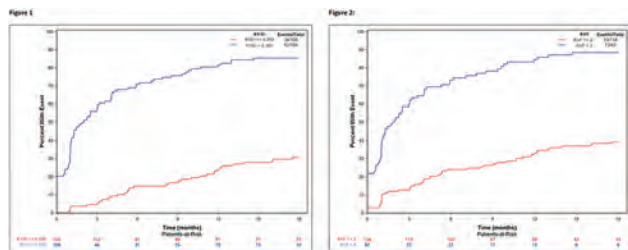

## SA-PO781

**The Activation of BK $\alpha$  Channel Inhibits Cardiac Fibrosis in CKD**

Yijin Huang,<sup>1</sup> Momar A. Diop,<sup>1</sup> Shuyang Bian,<sup>1</sup> Faten Hassounah,<sup>2</sup> John W. Calvert,<sup>2</sup> Xiaonan H. Wang,<sup>2</sup> Hui Cai.<sup>2,3</sup> <sup>1</sup>Emory University Emory College of Arts and Sciences, Atlanta, GA; <sup>2</sup>Emory University School of Medicine, Atlanta, GA; <sup>3</sup>VA Medical Center Atlanta, Decatur, GA.

**Background:** Uremic cardiomyopathy contributes to morbidity and mortality in chronic kidney disease (CKD). Our previous study found that activation of the large conductance, calcium-activated potassium channels (BK channels) attenuated renal fibrosis in mice. We hypothesized that upregulation BK channels activity suppresses cardiac fibrosis in CKD.

**Methods:** CKD mice were induced by 5/6 nephrectomy. To enhance BK channel activity, BMS-191011 (10 mg/kg BW), an opener of BK channel, was given by IP injection daily for 8 weeks. Blood pressure was measured using the tail-cuff method. Echocardiogram was used to measure cardiac size and function. Cardiac myoblast cells (H9C2) were used to assess the effects of BK opener (NS1916 10mM) on fibrotic markers and TGF- $\beta$  signaling pathway. The mRNA expression of BK was assayed by RT-PCR. The fibrotic protein markers were measured by western blots or immunohistochemistry (IHC) in the H9C2 cells and cardiac tissues.

**Results:** The expressions of BK $\alpha$  mRNA and protein were decreased and cardiac fibrosis was increased in the heart of CKD mice. Activation of BK channel by BMS-191011 significantly decreased the CKD-induced increase in systolic (116mmHg-CKD/BMS vs 135mmHg-CKD) and diastolic blood pressure (58mmHg-CKD/BMS vs 80mmHg-CKD) compared to the CKD groups. Echocardiogram showed that LV end-diastolic dimension increased in 5/6Nx mice (3.2mm-sham to 4.0mm-CKD), but back to normal after BK opener treatment (3.5mm-CKD/BMS;  $p < 0.01$  vs CKD) along with improving ejection fraction (63.9%-sham, 43.1%-CKD and 53.5%-CKD/BMS;  $p < 0.05$  vs CKD). IHC showed that fibrosis was significantly increased in CKD heart along with increased levels of fibronectin and vimentin, whereas BMS treatment attenuated these changes. In addition, TGF beta decreased BK $\alpha$  level and increased fibronectin and collagen Ia in a dose-dependent manner, whereas NS1916 inhibited the TGF $\beta$ -induced upregulation of fibronectin and collagen I in H9C2 cells.

**Conclusions:** Activation of BK channel by BK channel openers has significantly attenuated cardiac fibrosis in both CKD mice and in cardiac myoblast cells. This study could provide novel therapeutic strategies for treating uremic cardiomyopathy in chronic kidney diseases.

**Funding:** Veterans Affairs Support

## SA-PO782

**Distinct Glucose vs. Fructose-Specific Gene Regulation in Small Intestine**  
Manoocher Soleimani,<sup>1,2</sup> Sharon L. Barone,<sup>1,2</sup> Kamyar A. Zahedi,<sup>1,2</sup> Christos Argyropoulos.<sup>1</sup> <sup>1</sup>University of New Mexico Health Sciences Center, Albuquerque, NM; <sup>2</sup>New Mexico VA Health Care System, Albuquerque, NM.

**Background:** Metabolic syndrome is manifested by visceral obesity, hypertension, and insulin resistance and is highly prevalent in US population. The pathogenesis of hypertension in metabolic syndrome remains speculative. Americans are consuming >300 calories/day of sugar- mostly in the form of fructose and sucrose (a glucose/fructose disaccharide). In addition, Americans are consuming 2-3 times the recommended amount of salt. How the interaction between excessive salt, carbohydrates, and their transporters in the small intestine may lead to salt sensitivity of hypertension in metabolic syndrome remains unknown. Increased consumption of sucrose (which hydrolyzes to glucose and fructose) increases systemic blood pressure in rodents. There are distinct pathways mediating the absorption of glucose vs. fructose in the small intestine. Glucose is absorbed primarily via SGLT1; whereas, fructose is primarily absorbed via GLUT5.

**Methods:** Mice were fed a 60% glucose or fructose diet (vs. control) for 2 weeks. RNA seq analysis and expression studies were performed on RNA isolated from mouse jejunum.

**Results:** RNA seq analysis and northern hybridization on jejuna of experimental animals shows significant activation of the mineralocorticoid receptor (MR) in glucose-, but not fructose-fed mice. Glucocorticoid receptor (GR) expression did not change in glucose- or fructose-fed mice. In addition, the expression of SGK1, which regulates the expression of NHE3 and SGLT1 was increased significantly in glucose-fed, but not fructose-fed mice. The expression of 11 $\beta$ -hydroxysteroid dehydrogenase 2 (11 $\beta$ -HSD2), which inactivates glucocorticoids, is decreased in glucose-fed mice, which ensures that glucocorticoids remain active and can efficiently compete for binding with MR. GLUT5 was increased more significantly in fructose-fed, whereas SGLT1 was increased more significantly in glucose-fed mice.

**Conclusions:** Our studies demonstrate that increased glucose consumption activates the MR and SGK1, but downregulates 11 $\beta$ -HSD2 in the small intestine. The upregulation of MR and SGK1 can facilitate further salt absorption via NHE3 and SGLT1 working in parallel and stimulated by glucocorticoids. We propose that increased carbohydrate consumption (including sucrose) can stimulate salt absorption in the small intestine by distinct mechanisms.

**Funding:** Veterans Affairs Support, Private Foundation Support

## SA-PO783

**Increased Dopamine D1 Receptor (D1R) Phosphorylation due to G Protein-Coupled Receptor Kinase 4 (GRK4) Variant 65L Causes Hypertension**

Shaun C. Moore, Daniel A. Yaqub, Laureano D. Asico, Ines Armando, Pedro A. Jose. *The George Washington University, Washington, DC.*

**Background:** Activating variants of the human GRK4 (65R>L, 142A>V, and 486A>V) are involved in the desensitization of the D1R and are associated with hypertension in several ethnic groups. Although GRK4 is essential for the normal desensitization and resensitization of dopamine receptors, certain constitutively active GRK4 variants impairs dopamine D1 (D1R) function and natriuretic function. We have reported that global transgenic mice expressing hGRK4 65L have salt-sensitive hypertension.

**Methods:** We have reported that global transgenic mice expressing hGRK4 65L have salt-sensitive hypertension. To avoid the effect of protein overexpression in these transgenic mice, we generated mice globally expressing hGRK4 65L or hGRK4 wild type (WT) by crispr-cas9-mediated genome editing in C57Bl/6 mice (hGRK4 65L GE and hGRK4 WT GE).

**Results:** Systolic blood pressure (SBP) in hGRK4 65L GE mice under pentobarbital anesthesia was higher (124 $\pm$ 2 vs 101 $\pm$ 1 mmHg,  $n=5$ /group,  $P < 0.05$ ) than in their littermates not expressing the human gene (GE WT) or mice expressing hGRK4 WT GE. Renal D1R phosphorylation was higher in hGRK4 65L GE than GE WT (112 $\pm$ 2 vs 100 $\pm$ 1%,  $n=3$ /group,  $P < 0.05$ ). To determine the role of the kidney in the salt sensitivity of these mice, we generated mice with kidney-specific (KS) expression of the GRK4 65L (KS hGRK4 65L) by the bilateral ureteral infusion of adeno-associated virus (AAV) vectors carrying hGRK4 65L in GRK4 knockout mice. Mice infused with hGRK4 WT served as controls (KS hGRK4 WT). SBP (under anesthesia) before AAV was similar in both groups. SBP post AAV increased in KS hGRK4 65L (93 $\pm$ 1 vs 117 $\pm$ 4 mm Hg,  $P < 0.05$ ,  $n=4$ ) but not in KS hGRK4 WT (96 $\pm$ 2 vs 105 $\pm$ 6,  $n=5$ ). Renal D1R phosphorylation was higher (170  $\pm$  10 vs 100  $\pm$ 15%;  $n=5$ ,  $P < 0.02$ ) in KS hGRK4 65L than KS hGRK4 WT. We also studied human renal proximal tubule cells (hRPTCs) endogenously carrying GRK4 WT or GRK4 65L. In hRPTCs with GRK4 65L D1R, phosphorylation (204  $\pm$  22 vs 100 $\pm$ 24%,  $n=6$ /group;  $P < 0.05$ ), was increased, relative to hRPTCs with GRK4 WT.

**Conclusions:** Our results show across different mouse models and hRPTCs that the presence of GRK4 65L results in increased D1R phosphorylation and show the vital role of renal D1R in the regulation of blood pressure.

**Funding:** NIDDK Support, Other NIH Support - NIH R01 grants

## SA-PO784

**Afferent Neurons of the Kidney With Impaired Firing Pattern in Inflammation: Role of Sodium and Potassium Currents**

Kristina Rodionova,<sup>1</sup> Roland Veelken,<sup>1,2</sup> Karl F. Hilgers,<sup>1</sup> Peter Linz,<sup>1</sup> Christian Ott,<sup>1,2</sup> Roland E. Schmieder,<sup>1</sup> Mario Schiffer,<sup>1</sup> Kerstin U. Amann,<sup>1</sup> Tilmann Ditting.<sup>1,2</sup> <sup>1</sup>Friedrich-Alexander-Universitat Erlangen-Nurnberg Medizinische Fakultat, Erlangen, Germany; <sup>2</sup>Paracelsus Medical Private University Nuremberg, Nuremberg, Germany.

**Background:** Previously, we reported that peripheral neurons with renal afferents involved in sympathetic control exhibit a predominantly tonic firing pattern of higher frequency that is reduced to low frequencies (phasic firing pattern) in renal inflammation (and hypertension). Now, we wanted to test the hypothesis that the reduction in firing activity during inflammation is due to special tonic neurons switching from higher to low frequencies.

**Methods:** Renal subcapsular staining (DiI) for identification of neurons with renal projection (RANs). Cultivated neurons incubated with the chemokine CXCL1 (1.5 nmol/ml) for 12 hours prior to electrophysiology. Current clamp used to characterize neurons as "tonic", i.e. sustained action potential (AP) firing or "phasic", i.e. <5 APs upon stimulation. Membrane currents investigated by increasing clamp voltage. Data analyzed: renal vs. non-renal and tonic vs. phasic neurons.

**Results:** Renal neurons exposed to CXCL1 showed a decrease of tonic firing pattern compared to controls (35.6% vs. 57%,  $P < 0.05$ ). Phasic neurons exhibited higher Na<sup>+</sup> and K<sup>+</sup> currents than tonic neurons in controls resulting in shorter APs (3.7 $\pm$ 0.3 vs. 6.1 $\pm$ 0.6 ms,  $P < 0.01$ ). In neurons incubated with CXCL1, Na<sup>+</sup> and K<sup>+</sup> peak currents increased (Na<sup>+</sup>: -969 $\pm$ 47 vs. -758 $\pm$ 47 nA/pF,  $P < 0.01$ ; K<sup>+</sup>: 707 $\pm$ 22 vs. 558 $\pm$ 31 nA/pF,  $P < 0.01$ ) in phasic, but were unchanged in tonic neurons. Incubated phasic neurons showed a much broader range of Na<sup>+</sup> currents [-365 -- 1429 nA] vs. [-412 -- 4273 nA];  $P < 0.05$ ; similar to tonic neurons.

**Conclusions:** The enlarged number of renal phasic neurons incubated with CXCL1 showed significantly increased membrane currents resembling the broad range of Na<sup>+</sup> currents seen in tonic neurons. These findings suggest that a subgroup of tonic neurons switched to a phasic response pattern in inflammation while other mechanisms become less likely (e.g. recruitment of formerly silent phasic neurons).

**Funding:** Government Support - Non-U.S.

Key: TH - Thursday; FR - Friday; SA - Saturday; OR - Oral; PO - Poster; PUB - Publication Only

Underline represents presenting author.

SA-PO785

**Pericyte Detachment and Interstitial Fibrosis in Dahl Salt-Sensitive Hypertensive (DahlS) Rats**

Hiroki Ito,<sup>1,2</sup> Takuo Hirose,<sup>2,1</sup> Shigemitsu Sato,<sup>1</sup> Kazuhiro Takahashi,<sup>2</sup> Takefumi Mori.<sup>1</sup> <sup>1</sup>Tohoku Ika Yakka Daigaku, Sendai, Japan; <sup>2</sup>Tohoku Daigaku Daigakuin Igakuei Kenkyuka Igakubu, Sendai, Japan.

**Background:** Dahl salt-sensitive hypertensive (DahlS) rats have salt-sensitive hypertension and volume-overloaded renal venous congestion with heart failure. We previously reported that pericyte detachment and pericyte-myofibroblast transition (PMT) around the vasa recta were involved in interstitial injury and fibrosis in an artificially induced renal venous congestion model. In the present study, we assessed the relation of pericyte detachment around the vasa recta and PMT with interstitial fibrosis in DahlS rats.

**Methods:** Eight-week-old DahlS rats (Dahl/Mcwi) were divided into three groups: normal diet, 4% NaCl diet, and 8% NaCl diet groups, and their kidneys were analyzed after 2 weeks. Total mRNA and protein expression levels were quantified by real-time PCR and western blot, respectively. Tubulointerstitial damage and fibrosis were identified by histological analysis. Furthermore, we evaluated pericyte detachment around the vasa recta by low-vacuum scanning electron microscopy (LV-SEM).

**Results:** The expression of KIM1, a tubulointerstitial damage marker; CNN1 and  $\alpha$ SMA, interstitial fibrosis markers; and TAGLN, a PMT marker; was increased in a salt-dependent manner in DahlS rats. Pericyte detachment around the vasa recta was observed in 4% and 8% NaCl diet groups by LV-SEM.

**Conclusions:** Pericyte detachment and PMT are involved in tubulointerstitial injury and fibrosis of DahlS rats. Renal venous congestion and subsequent physiological changes could have a role in renal damage and fibrosis.

SA-PO786

**Role of Platelet-Derived Growth Factor (PDGF) in Ex Vivo Aortic Calcification Under Uremic Conditions**

Burcu Yesilyurt,<sup>1,3</sup> Li Zhang,<sup>3</sup> Barbara M. Klinkhammer,<sup>3</sup> Julia Moellmann,<sup>3</sup> Patrick Droste,<sup>3</sup> Claudia Goetsch,<sup>3</sup> Willi Jahnhen-Dechent,<sup>3</sup> Michael Lehrke,<sup>3</sup> Mathias Hohl,<sup>2</sup> Joachim Jankowski,<sup>1</sup> Dickson W. Wong,<sup>3</sup> Peter Boor.<sup>3,1</sup> <sup>1</sup>Rheinisch-Westfälische Technische Hochschule Aachen, Aachen, Germany; <sup>2</sup>Universitätsklinikum des Saarlandes und Medizinische Fakultät der Universität des Saarlandes, Homburg, Germany; <sup>3</sup>Universitätsklinikum Aachen, Aachen, Germany.

**Background:** Chronic kidney disease (CKD) is associated with an increased risk of developing vascular calcification. Platelet-derived growth factor (PDGF) is involved in vascular development and vasculopathy via effects on vascular smooth muscle cells (VSMCs). It remains unclear whether PDGF might be involved in CKD-associated vascular calcification.

**Methods:** To address this, we adapted an *ex-vivo* calcification model in murine aortas to analyze the effect of uremia and PDGF. We first examined whether aortic calcification is affected by age, sex, genetic background, incubation time-points of calcification medium (3-10days), and various aortic regions (arch, thoracic, suprarenal and infrarenal). Aortas collected from control and CKD mice (induced by an adenine-enriched diet) were calcified *ex-vivo* to examine the effect of CKD conditioning on calcification. Hemodialysate from CKD patients was added to the calcification medium to create the uremic milieu *ex-vivo*. Soluble PDGFR- $\beta$  antibody and Imatinib were used as an inhibitor of PDGFR- $\beta$ . *Ex-vivo* calcification was also performed on the transgenic aorta with tamoxifen-inducible activation of PDGFR- $\beta$  specifically in VSMCs.

**Results:** With these approaches, we observed that longer (10days) incubation in the calcification medium led to an increased calcification in all aortic regions. Aortas from older mice had higher susceptibility to calcify *ex-vivo*, whereas sex and genetic background had no effects. Aortas from CKD mice calcified significantly more than those of healthy mice. Similarly, adding hemodialysate to the calcification medium enhanced calcification, which was significantly diminished upon PDGF signaling inhibition. Additionally, aortas from mice with constitutive PDGFR- $\beta$  activation in VSMCs showed a higher calcification compared to WT mice.

**Conclusions:** Overall, our results suggested that PDGFR- $\beta$  activation in VSMCs is involved in uremic vascular calcification.

**Funding:** Private Foundation Support

SA-PO787

**Cardiac Radiation Exposure and Coronary Atherosclerosis: An Inflammatory Interplay**

Purna R. Nepali,<sup>1</sup> Mickael Mathieu,<sup>1</sup> Sebastien Monette,<sup>1</sup> Yunping Qiu,<sup>3</sup> Irwin J. Kurland,<sup>3</sup> Andreas Rimner,<sup>1</sup> Adriana Haimovitz-Friedman,<sup>1</sup> Edgar A. Jaimnes.<sup>1,2</sup> <sup>1</sup>Memorial Sloan Kettering Cancer Center, New York, NY; <sup>2</sup>Weill Cornell Medicine, New York, NY; <sup>3</sup>Albert Einstein College of Medicine, Bronx, NY.

**Background:** Cardiac radiation exposure is a known risk factor for the increased cardiovascular mortality observed in cancer patients receiving thoracic radiation therapy (RT). A better understanding of the mechanisms involved is essential to develop preventive and treatment strategies. In this study we hypothesize that the development of accelerated atherosclerosis after RT is dependent upon inflammatory mechanisms that include the activation of eicosanoid pathways.

**Methods:** Male Apolipoprotein E knockout mice on a high fat diet received 16Gy cardiac RT to the whole or partial (apical or basal) regions of the heart at 9 or 16 weeks (w) of age. Atherosclerotic lesions (H&E) and inflammatory infiltrates (IHC) were assessed 8w post RT. Eicosanoid profile was studied (liquid chromatography mass spectrometry) in the serum of 16w old mice 24 hours post radiation. RNAscope was used to assess LOX mRNA expression post RT.

**Results:** (1) At 8w follow up, mice receiving basal RT at 16w showed a greater number of atherosclerotic lesions in the basal coronary arteries (29.33  $\pm$  5.48 versus 9  $\pm$  2.70) and basal subendocardial vasculature (6.66  $\pm$  2.07 versus 0.2  $\pm$  0.2) as compared to controls. Inflammatory cells (CD45, CD3) and endothelial adhesion molecules were differentially expressed based upon the site of RT. (2) Protective oxidized EPA metabolites (5HEPE and 12HEPE) were decreased after whole RT but increased after basal irradiation compared to whole RT (Table). (3) 12LOX mRNA was significantly elevated in the cardiac lesions of mice after apical RT and there was a trend towards increased 15LOX and 5LOX mRNA expression post whole, basal and apical RT compared to controls.

**Conclusions:** Our results indicate that RT to different regions of the heart results in a distinctive variance in the systemic production of eicosanoids and vascular LOX mRNA expression profile which may mediate or be a compensatory response in the development of accelerated atherosclerosis after RT.

Eicosanoid	No RT	24h whole RT (* versus No RT)	24h Basal RT (* versus 24h Whole RT)
12HEPE	35.38 $\pm$ 6.06	6.42 $\pm$ 1.31 <sup>†</sup>	43.70 $\pm$ 17.23
12HEPE	5.99 $\pm$ 0.79	1.24 $\pm$ 0.21 <sup>†</sup>	7.25 $\pm$ 2.17 <sup>†</sup>
5HEPE	2.38 $\pm$ 0.31	0.57 $\pm$ 0.09 <sup>†</sup>	2.89 $\pm$ 0.82 <sup>†</sup>
15HEPE	3.86 $\pm$ 1.61	3.10 $\pm$ 1.05 <sup>†</sup>	12.52 $\pm$ 4.69
7HDHA	0.05 $\pm$ 0.002	0.065 $\pm$ 0.007 <sup>†</sup>	0.03 $\pm$ 0.005 <sup>†</sup>

<sup>†</sup> = p < 0.05

SA-PO788

**Mapping Tubuloglomerular and Myogenic Autoregulation Throughout the Kidney With MRI**

Edwin Baldelomar,<sup>1</sup> Jennifer R. Charlton,<sup>2</sup> Shella Keilholz,<sup>1</sup> Cihat Eldeniz,<sup>1</sup> Hongyu An,<sup>1</sup> Kevin M. Bennett.<sup>1</sup> <sup>1</sup>Washington University in St Louis School of Medicine, St Louis, MO; <sup>2</sup>University of Virginia School of Medicine, Charlottesville, VA.

**Background:** Autoregulation is a critical kidney function to protect nephrons, is disrupted in disease, and several autoregulatory mechanisms of perfusion have been observed in animal models, observed by distinct low-frequency oscillations (myogenic ~100mHz and tubuloglomerular feedback, TGF ~10mHz).

**Methods:** *Rat Kidneys* – Sprague Dawley rats (n=4) were anesthetized and left anatomical kidney externalized in three animals. MR Details: Bruker 9.4T MRI; a mouse brain receive only coil; single shot gradient echo echo planar imaging; TE/TR = 13/150ms; resolution = 0.4x0.4x0.4mm<sup>3</sup>; and 15min acquisition time. Vitals were monitored. In two animals, we compared scans with and without saturation bands over renal artery to assess oxygen sensitivity. We imaged one kidney *in situ* without externalization to determine if we could overcome motion. Imaging was repeated after euthanasia. *Human Kidney In Vivo* – A single human volunteer consented for imaging. MR Details: 3T Prisma scanner using a spine and a flex coil; FLASH sequence; TE/TR = 2.27/4.2ms; resolution = 2.5x2.5x2.5mm<sup>3</sup>; and 15min acquisition time. *Post processing* – AFNI and Matlab softwares were used to process and analyze data. Typical pre-processing methods were used.

**Results:** Resting state MRI and spectral analysis revealed spatially variable and distinct bands of frequencies consistent with myogenic and TGF autoregulatory mechanisms (Fig 1). We found evidence of other mechanisms of physiological function at lower frequencies that require further investigation. We observed evidence of spatial correlations in the time course consistent with nephrovascular coupling (Fig 1).

**Conclusions:** A simple and short, non- contrasted MRI scan can be used to detect spatially variable, low- frequency oscillatory changes that appear to be associated with autoregulation of the kidney in both rats and humans. Mapping autoregulatory spectra may be an important, unique biomarker of kidney disease, developmental processes, transplant evaluation, and response to therapies.

**Funding:** Private Foundation Support

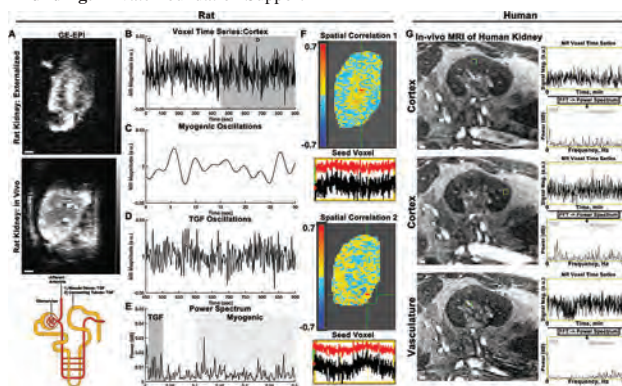

SA-PO789

**Association of Maternal Hypertension With Offspring Kidney Function in a Non-Human Primate Model of Spontaneous Hypertension**

Carol Vincent, Ashton Chen, Kylie Kavanagh, Andrew M. South. Wake Forest University School of Medicine, Winston-Salem, NC.

**Background:** Early-life exposure to adverse events can program hypertension (HTN) and kidney disease in childhood and early adulthood but the mechanism is not well understood. The spontaneously hypertensive vervet monkey may provide a novel model for investigating early HTN and related renal target organ damage development.

**Methods:** This is a pilot prospective cross-sectional study of *Chlorocebus spp.* maternal-offspring dyads. We identified 10 HTN mothers based on prior sedated blood pressure (BP) measurements, defined by the 2017 ACC/AHA Guideline using age  $\geq$ 13 years old criteria, and randomly selected offspring to complete each dyad. We 1:2 matched each maternal HTN dyad with a maternal normotension dyad by age and offspring sex. Sedated BP, weight, and labs were obtained on dyads. Our exposures were maternal HTN group and maternal BP measurements. Our outcomes were offspring serum creatinine (SCr) and blood urea nitrogen (BUN). Using generalized linear models, we estimated the associations between the exposures and outcomes.

**Results:** Age range, BP, and sex distribution were similar within the maternal and offspring groups (Table 1). Maternal HTN and BP were not significantly associated with offspring SCr ( $\beta$  0.08, 95% CL -0.1 to 0.26) or BUN ( $\beta$  2.6, 95% CL -3.0 to 8.2).

**Conclusions:** We did not observe an association between maternal HTN and offspring kidney function in maternal-offspring vervet dyads. This could be because offspring of older, less healthy mothers may be too young to show altered kidney function or be due to our small sample size in this pilot study. Next steps include investigating associations of renin-angiotensin system components with offspring BP and organ damage.

**Funding:** Other NIH Support - R01-HL146818, NHLBI K23-HL148394, L40-HL148910, Private Foundation Support

	Hypertensive Mothers N=10	Normotensive Mothers N=5	Offspring of hypertensive mothers N=10	Offspring of normotensive mothers N=5
Female sex	10 (100%)	5 (100%)	6 (60%)	3 (60%)
Age, yr	13.4 [12.0, 18.0]	16.9 [14.7, 17.4]	3.1 [2.7, 6.5]	4.8 [2.9, 7.0]
Systolic blood pressure, mmHg	118.0 [109.0, 126.5]	110.0 [107.0, 115.5]	114.3 [87.5, 122.5]	114.5 [104.0, 149.5]
Diastolic blood pressure, mmHg	63.8 [51.5, 84.0]	62.5 [56.5, 77.0]	59.0 [48.0, 66.0]	69.5 [64.0, 74.0]
MAP, mmHg	81.8 [67.0, 101.0]	78.5 [76.0, 91.0]	79.3 [65.6, 89.0]	86.0 [79.0, 100.5]
Elevated blood pressure	2 (20%)	0 (0%)	2 (20%)	0 (0%)
Stage 1 Hypertension	1 (10%)	0 (0%)	1 (10%)	0 (0%)
Stage 2 Hypertension	2 (20%)	1 (20%)	0 (0%)	2 (40%)
Maternal age at delivery, yr	10.7 [6.9, 13.0]	5.7 [4.1, 11.0]	10.6 [7.9, 11.9]	11.8 [10.6, 12.2]
Serum creatinine, mg/dL	0.7 [0.6, 0.9]	0.8 [0.7, 0.9]	0.65 [0.5, 0.8]	0.6 [0.4, 0.7]
BUN, mg/dL	17.0 [16.0, 19.0]	21.0 [15.0, 22.0]	19.5 [16.0, 25.0]	19.0 [17.0, 20.0]
ALT, U/L	68.5 [62.0, 107.0]	40.0 [37.0, 56.0]	44.0 [34.0, 64.0]	47.0 [47.0, 61.0]
HDL, mg/dL	43.5 [32.0, 56.0]	60.0 [56.0, 64.0]	61.5 [58.0, 66.0]	60.0 [57.0, 82.0]

N (%) mean (SD), or median [IQR]. <sup>1</sup>1:4 offspring ( $\alpha=2$  and  $\alpha=2$ ). Between-group differences by Wilcoxon rank-sum test with t approximation, t-test, or chi-square test.

Table: Clinical and laboratory characteristics of vervet monkeys

SA-PO790

**Association of Serum Uric Acid With Hypertension Severity and Adverse Cardiac Changes at Baseline in Youth With Primary Hypertension**

Carol Vincent, Ashton Chen, Andrew M. South. Wake Forest University School of Medicine, Winston-Salem, NC.

**Background:** Mechanisms driving hypertension (HTN)-related organ damage in youth with HTN are incompletely understood. Uric acid may be associated with HTN and related target organ damage in youth, but this relationship remains paradoxical due in part to methodological limitations.

**Methods:** This is a secondary analysis of data from a pilot prospective cohort study of youth aged 5–17 years with newly diagnosed primary HTN defined by the AAP Clinical Practice Guideline. Exclusion criteria were diabetes mellitus, chronic kidney disease, heart disease, or non-English or Spanish speaker. Our exposures were serum uric acid (SUA) and SUA standard deviation (SD) from the mean. Our outcomes were blood pressure (BP), BP z-score, left ventricular mass index (LVMI) indexed to height and BSA, and relative wall thickness (RWT). We estimated associations between exposures and outcomes with generalized linear models adjusted for gestational age, birth weight, sex, and body mass index as identified in a directed cyclic graph.

**Results:** Of the 30 participants, mean age was 13.4 years (SD 3.6) with 30% female, 27% Black or African American, and 40% Hispanic or Spanish origin ethnicity. Median SUA was 5.4 mg/dL [IQR 4.9, 7.1]. No participants had left ventricular hypertrophy. Elevated blood pressure was seen in 10%, stage 1 hypertension in 47%, and stage 2 hypertension in 27% of the population. In adjusted analyses, SUA from mean was not associated with systolic BP ( $\beta$  0.18, 95% CL -2.72 to 3.08), diastolic BP ( $\beta$  -1.72, 95% CL -4.35 to 0.92), LVMI g/m<sup>2.7</sup> ( $\beta$  -0.72, 95% CL -3.08 to 1.64), LVMI g/BSA ( $\beta$  -0.61, 95% CL -4.52 to 5.75), or RWT ( $\beta$  -1.77, 95% CL -9.62 to 6.07). SUA was associated with Diastolic BP z-score ( $\beta$  -0.38, 95% CL -0.61 to 0.15).

**Conclusions:** We did not observe associations of SUA with HTN or related heart changes on echocardiogram. Our findings could be reflect that our population did not

have LVH or our small sample size. Ongoing analyses include investigating associations of renin-angiotensin system with target organ damage.

**Funding:** Other NIH Support - NHLBI K23-HL148394, L40-HL148910, R01-HL146818

SA-PO791

**Increased Renal Inflammation in Drd5 Knockout Mice Is Associated With Peroxiredoxin-4 Dysfunction**

Bibhas Amatya,<sup>1</sup> Jacob Q. Polzin,<sup>1</sup> Laureano D. Asico,<sup>1</sup> Ines Armando,<sup>1</sup> Robin A. Felder,<sup>2</sup> Pedro A. Jose,<sup>1</sup> Hewang Lee.<sup>1</sup> <sup>1</sup>The George Washington University School of Medicine and Health Sciences, Washington, DC; <sup>2</sup>University of Virginia Health Sciences Center, Charlottesville, VA.

**Background:** The dopamine D5 receptor (D<sub>5</sub>R) suppresses inflammation in the central nervous system. However, its role in the regulation of inflammation associated with oxidative stress and hypertension in the kidney is not known.

**Methods:** Protein expression was determined by immunoblotting in D<sub>5</sub>R-expressing cells, treated with pharmacological reagents or transfected with mock or specific siRNA to silence specific genes. Protein-protein interaction was determined by co-immunoprecipitation and co-localization analysis of immunofluorescence images. *Drd5*<sup>-/-</sup> mice were generated, as previously reported.

**Results:** In D<sub>5</sub>R-HEK 293 cells, fenoldopam (FEN, 25 nM/12 hr, n=4), a D<sub>5</sub>-like receptor agonist, increased the expression (158.1±11.9% vs 100.0±6.8% basal level, n=6) of peroxiredoxin-4 (PRDX4), an endoplasmic reticulum-localized protein. By contrast, D<sub>5</sub>R protein was decreased in *PRDX4* siRNA-treated D<sub>5</sub>R-HEK293 (58.8±6.7% vs 100.0±9.6% basal level, n=4) and -human renal proximal tubule cells (hRPTCs) (60.4±5.8%, n=4). PRDX4 protein was also decreased in the kidney cortices of *Drd5*<sup>-/-</sup> mice (*Ddr5*<sup>+/-</sup>: 100±18%, n=5; *D<sub>5</sub>R*<sup>-/-</sup>: 69±14%, n=4; P<0.05). FEN increased the co-immunoprecipitation of D<sub>5</sub>R and PRDX4 and their colocalization, particularly in the endoplasmic reticulum. Moreover, silencing *PRDX4*, by its specific siRNA, increased reactive oxygen species (ROS) production and impaired the inhibitory effect of FEN on ROS production in hRPTCs. In D<sub>5</sub>R-HEK 293 cells, siRNA silencing of *PRDX4* also increased the production of tumor necrosis factor (TNF) and interleukin (IL)-1b. The increase in TNF protein in D<sub>5</sub>R-HEK293 cells with silenced *PRDX4* was attenuated by tempol, a superoxide dismutase mimetic, indicating that oxidative stress and downstream inflammation are associated with PRDX4 deficiency and consistent with the increase in NLRP3 inflammasome with PRDX4 silencing (scrambled siRNA: 100±5.0%, *PRDX4* siRNA: 150.6±6.0%). The protein expressions of TNF (*Ddr5*<sup>+/-</sup>: 100±11%, n=4; *D<sub>5</sub>R*<sup>-/-</sup>: 179±16%, n=4; P<0.05) and IL-1 $\beta$  (*Ddr5*<sup>+/-</sup>: 100±13%, n=4; *D<sub>5</sub>R*<sup>-/-</sup>: 156±14%, n=4; P<0.05) were also increased in the kidney cortices of *Drd5*<sup>-/-</sup> mice, relative to *Drd5*<sup>+/-</sup> littermates.

**Conclusions:** The increase in renal inflammation in *Drd5*<sup>-/-</sup> mice is due, in part, to oxidative stress, caused by the impaired interaction between D<sub>5</sub>R with PRDX4.

**Funding:** NIDDK Support

SA-PO792

**CXCL12 and Fractalkine Predict Heart Failure in CKD Patients: The CRIC Study**

Mariana F. Marques,<sup>1,2</sup> Marta Borges Canha,<sup>1,2</sup> Katherine S. Ravi,<sup>3</sup> Finnian R. McCausland.<sup>3</sup> <sup>1</sup>Centro Hospitalar Universitario de Sao Joao, Porto, Portugal; <sup>2</sup>Faculdade de Medicina da Universidade do Porto, Porto, Portugal; <sup>3</sup>Brigham and Women's Hospital, Boston, MA.

**Background:** Heart Failure (HF) is common and associated with higher mortality in patients with Chronic Kidney Disease (CKD). Inflammation is thought to play a role in HF development, prompting us to explore the association of CXCL12 and fractalkine (T cell and monocyte chemokines, respectively) with incident HF in the Chronic Renal Insufficiency Cohort (CRIC).

**Methods:** This study included 3478 patients with available baseline measurements of CXCL12 and Fractalkine. Multivariable Cox and logistic regression models were fit to assess the association of each biomarker (log-transformed and categories) with baseline B-type Natriuretic Peptide (BNP) levels and Left Ventricular Mass Index (LVMI) measured at year 1, both defined as categorical variables above median, and incident HF.

**Results:** In fully adjusted analyses, higher CXCL12 and fractalkine levels were associated with higher baseline BNP – Odds Ratio (OR) 1.27 [95% Confidence Interval (CI) 1.17 – 1.38] and OR 1.22 [1.11 – 1.34], respectively. Raised CXCL12 and fractalkine were associated with increased LVMI at year 1 of follow-up, independent of patient demographics and renal function – OR 95% CI 1.10 [1.01 – 1.21] and 1.13 [1.03 – 1.24], correspondingly. Both biomarkers predicted incident HF, regardless of patient demographics, renal function, comorbidities, medication and sodium and phosphate levels – Hazard Ratio (HR) 95% CI 1.21 [1.07 – 1.37] for CXCL12 and 1.15 [1.00 – 1.31] for fractalkine. Results were significant only for the highest quartiles of the biomarkers when analysed as categorical variables.

**Conclusions:** Higher levels of CXCL12 and fractalkine are independently associated with higher baseline BNP, LVMI at 1 year, and incident HF hospitalization. Whether interventions that target these pathways can reduce incident HF among patients with CKD remains to be determined.

SA-PO793

**A Role of Amphiregulin in PDE3A-Mediated Renoprotection**

Anastasiia Sholokh,<sup>1</sup> Brandon J. McMurray,<sup>2</sup> Daniele Y. Sunaga-Franze,<sup>1</sup> Fatimunnisa Qadri,<sup>1</sup> Kerstin Zuehlik,<sup>1</sup> Lajos Marko,<sup>4</sup> Minze Xu,<sup>3</sup> Andreas Patzak,<sup>3</sup> Pontus Persson,<sup>3</sup> Philipp G. Maass,<sup>2</sup> Tatiana A. Borodina,<sup>1</sup> Sylvia Bähring,<sup>4</sup> Michael Bader,<sup>1</sup> Enno Klussmann.<sup>1</sup> <sup>1</sup>Max-Delbruck-Centrum für Molekulare Medizin in der Helmholtz-Gemeinschaft, Berlin, Germany; <sup>2</sup>University of Toronto, Toronto, ON, Canada; <sup>3</sup>Charite Universitätsmedizin Berlin, Berlin, Germany; <sup>4</sup>Max Delbruck Centrum für Molekulare Medizin Experimental and Clinical Research Center, Berlin, Germany.

**Background:** A primary risk factor for chronic kidney disease (CKD) is hypertension. Autosomal-dominant hypertension with brachydactyly type E (HTNB) resembles essential hypertension, but the patients show almost no signs of end-organ damage such as CKD. HTNB is caused by mutations in the phosphodiesterase 3A (*PDE3A*) gene. Therefore, we hypothesize that HTNB-causing *PDE3A*-mutations are renoprotective and aim to gain insight into the underlying mechanisms.

**Methods:** Using CRISPR/Cas9 technology, rats expressing *PDE3A* with a 3 amino acid deletion (*PDE3A-Δ3aa*) were generated. These animals recapitulate the HTNB phenotype. Rats with a functional *PDE3A* knockout (Functional Del) were used as an additional control. Inner medulla (IM) and residual kidney (RK) were investigated using biochemical, molecular biological, histological, and physiological approaches. *Vasa recta* contractility was measured.

**Results:** The overall kidney morphology of the wild-type (WT), *PDE3A-Δ3aa*, and functional Del rats was similar. As in second-order mesenteric arteries, the media to lumen ratio of renal arteries was significantly increased in *PDE3A-Δ3aa* rats compared to wild-type. The relaxation of *Vasa recta* to forskolin was not affected in *PDE3A-Δ3aa* rats and appeared stronger in functional Del (both vs. WT). The mRNA and protein expression levels of proinflammatory cytokines and fibrosis markers remained at similar levels as in wild-type rats in both IM and RK. However, compared to wild-type animals, collagen levels in IM and RK of *PDE3A-Δ3aa* and in IM of functional Del rats were significantly increased. Amphiregulin (AREG) is a fibrosis- and thus kidney damage-inducing epidermal growth factor receptor (EGFR) agonist. The mRNA and protein expression levels of AREG were significantly decreased in IM of *PDE3A-Δ3aa* animals compared to wild-type, while its serum level remained unchanged.

**Conclusions:** Our data reveal that *PDE3A* mutations protect the kidneys from hypertension-induced damage and suggested that AREG plays a role in the underlying mechanisms.

**Funding:** Government Support - Non-U.S.

SA-PO794

**Progression of Kidney Disease in Kidney Transplant Recipients With a Failing Graft: A Matched Cohort Study**

Ngan Lam,<sup>1</sup> Robert R. Quinn,<sup>1</sup> Alix Clarke,<sup>1</sup> Huda Al-Wahsh,<sup>1</sup> Greg A. Knoll,<sup>2</sup> Fareed Kamar,<sup>1</sup> Rachel Jeong,<sup>1</sup> James A. Kiberd,<sup>1</sup> Pietro Ravani.<sup>1</sup> <sup>1</sup>University of Calgary Cumming School of Medicine, Calgary, AB, Canada; <sup>2</sup>Ottawa Hospital, Ottawa, ON, Canada.

**Background:** Renal function may decline more rapidly in kidney transplant recipients with a failing graft than in people with chronic kidney disease (CKD) of their native kidneys.

**Methods:** We conducted a retrospective, population-based cohort study using linked healthcare databases in Alberta, Canada (2002-2019) to identify kidney transplant recipients with a failing graft, defined as 2 outpatient estimated glomerular filtration rate (eGFR) measurements between 15 and 30 mL/min/1.73 m<sup>2</sup> at least 90 days apart. Recipients were compared to propensity-score matched, non-transplant controls with a similar degree of sustained kidney dysfunction who were followed by a nephrologist. We compared the change in eGFR over time (primary outcome) and the competing risks of kidney failure and death without kidney failure (secondary outcome). We used joint modelling to account for possible informative censoring and the association between time-dependent changes in eGFR (eGFR with 95% confidence limits,  $eGFR_{LCL}$ ) and the competing events (hazard ratios,  $HR_{LCL}$ ).

**Results:** We matched 575 transplant recipients to 575 non-transplant controls. For the recipients, the median age was 57 years (interquartile range [IQR] 46-67), 39% were women, and median potential follow-up time was 7.8 years (IQR 3.6-12.1). In the joint model, the eGFR decline over time was similar in the two groups (recipients vs. controls:  $-2.60_{-2.27}^{-1.94}$  vs.  $-2.52_{-2.21}^{-1.90}$  mL/min/1.73 m<sup>2</sup> per year). In the time-to-event sub-model, the hazards for both kidney failure ( $HR_{2.05}^{2.68}$ ) and death ( $HR_{1.23}^{1.61}$ ) were significantly higher for transplant recipients. eGFR decline was associated with kidney failure but not with death.

**Conclusions:** Although kidney function declines at a similar rate in transplant recipients as in non-transplant controls, people with a failing graft have a higher risk of kidney failure and death. Studies are needed to identify preventive measures to improve outcomes in kidney transplant recipients with a failing graft.

**Funding:** Government Support - Non-U.S.

SA-PO795

**Long-Term Outcomes of Living Related Kidney Donation for Alport Syndrome Spectrum: A Propensity-Score Matched Analysis**

Yasar Caliskan,<sup>1</sup> Ozgur A. Oto,<sup>2</sup> Seda Safak,<sup>2</sup> Safak Mirioglu,<sup>2</sup> Berna Yelken,<sup>3</sup> Arzu Velioglu,<sup>4</sup> Ahmet B. Dirim,<sup>2</sup> Nurana Guller,<sup>2</sup> Abdulmecit Yildiz,<sup>2</sup> Alparslan Ersoy,<sup>5</sup> Aydin Turkmen,<sup>2</sup> Halil Yazici,<sup>2</sup> Krista L. Lentine.<sup>1</sup> <sup>1</sup>Saint Louis University School of Medicine, Saint Louis, MO; <sup>2</sup>Istanbul Universitesi Istanbul Tip Fakultesi, Istanbul, Turkey; <sup>3</sup>Koc Universitesi, Istanbul, Turkey; <sup>4</sup>Marmara Universitesi, Istanbul, Turkey; <sup>5</sup>Bursa Uludag Universitesi, Bursa, Turkey.

**Background:** We examined a cohort of living related donors (LRDs) to recipients with Alport syndrome spectrum (AS) and compared their outcomes with a control group to improve understanding of the clinical course and outcomes of living donation in this context.

**Methods:** LRDs of AS recipients (ASLD group) and propensity score-matched control LDs without any family history of AS (non-ASLD group) were followed for major cardiac events (MACE), death, post-donation eGFR and proteinuria.

**Results:** Long-term outcomes over 12.5 (IQR,5.0-16.7) years were evaluated in 27 and 29 LDs from ASLD and non-ASLD groups, respectively (Table 1). During follow-up, 5 LDs (18.5%) in ASLD developed MACE after 5.5 (IQR,4.5-10.3) years, whereas only two LDs in non-ASLD group developed MACE (p=0.19) (Table 1). New-onset hypertension was higher in ASLD (51.9%) compared to the control group (24.2%) (p=0.03). Three donors in ASLD and 2 donors in non-ASLD group who developed new-onset hypertension died during follow-up (p=0.58). MACE rate was significantly higher in donors who developed hypertension after donation (0% vs 33.3%, p<0.001). There were no differences between study groups regarding last eGFR and proteinuria levels (p=0.42 and p=0.26, respectively). When long-term outcomes of donors with *COL4A3-5* variants were evaluated, of 6 ASLDs with associated variants only a donor with *COL4A3* and another donor with *COL4A4* heterozygous variant developed hypertension and MACE (Table 2).

**Conclusions:** Although the risk of kidney disease can be minimised by careful donor evaluation, our findings suggest that hypertension risk after the donation is higher than expected in related donors of recipients with AS.

Table 1. Demographic and follow up characteristics of living related donors of recipients with Alport syndrome spectrum and propensity score matched control donor group.

Characteristics	ASLD Group (n=27)	Non-ASLD Group (n=29)	P value
Age at donation (years), mean±SD	48.7(9.8)	48.4(10.4)	NS
HLA mismatch, mean±SD	2.9(1.0)	2.4(1.0)	NS
Donor's relationship to recipients, n (%)			
Mother	14 (45.2)	8 (25.8)	
Father	10 (29.6)	7 (22.6)	
Sister	5 (14.1)	3 (14.1)	NS
Grandparent	1 (3.2)	0 (0.0)	
Uncle	1 (3.2)	0 (0.0)	
LRD (spouse)	0 (0.0)	11 (35.5)	
Recipients' causal genes and inheritance pattern in the family, n (%)			
COL4A5 (XAS)	4 (12)	-	
COL4A4 (AR)	3 (9)	-	
COL4A3 (AD)	2 (6)	-	
COL4A5 (AS)	5 (15)	-	
COL4A3 (AD)	1 (3)	-	
Genetic test not performed	18 (53)	-	

Follow-up Data	ASLD Group (n=27)	Non-ASLD Group (n=29)	P value
Age at donation (years), mean±SD	48.7(9.8)	48.4(10.4)	NS
Sex (male/female), n (%)	13 (48.1) / 14 (51.9)	14 (48.3) / 15 (51.7)	NS
Duration of follow-up (years), median (IQR)	13.0 (5.0-17.0)	8.3 (1.2-12.3)	0.05
Serum creatinine at last follow-up (mg/dL), mean±SD	1.1(0.3)	1.0(0.3)	NS
eGFR at last follow-up (mL/min/1.73 m <sup>2</sup> ), median (IQR)	64.0 (55.6-77.0)	66.0 (59.5-85.0)	NS
Proteinuria at last follow-up (g/d), median (IQR)	0.1 (0.0-0.2)	0.1 (0.0-0.1)	NS
Hypertension after donation, n (%)	14 (51.9)	7 (24.1)	0.03
Diabetes mellitus after donation, n (%)	6 (22.2)	3 (10.3)	NS
Major cardiac event, n (%)	5 (18.5)	2 (6.9)	NS
Acute coronary ischemia	4 (14.8)	2 (6.9)	
Coronary heart failure	1 (3.7)	0 (0)	
Death, n (%)	3 (11.1)	2 (6.9)	NS

Abbreviations: AD, autosomal dominant; AR, autosomal recessive; AS, Alport syndrome spectrum; ASLD, living donors of recipients with Alport syndrome; HLA, human leukocyte antigen; LRD, living related donor; NS, not significant; XAS, X-linked Alport syndrome.

Table 2. Genetic test results of recipients with Alport syndrome spectrum and living related donors and outcomes.

Family	Recipient	Age at RT / sex	Gene variant	Zygosity	ACMG classification	Donor HTN	Donor MACE
Family 1	Recipient	25 / M	COL4A5 (NM_000495.5)c.142-1G>A	Hem	P (PVSL, PMA2, PPS)		
	Donor (mother)	49 / F	COL4A5 (NM_000495.5)c.142-1G>A	Hem	P (PVSL, PMA2, PPS)	No	No
Family 2	Recipient	34 / F	COL4A5 (NM_000495.5)c.546-6T>G	Hem	VUS (BPA)		
	Donor (father)	48 / M	No pathogenic variant			Yes	No
Family 3	Recipient	50 / M	COL4A4 (NM_000092.3)c.248Bdel	Hem	P (PVSL, PMA2, PPS)		
	Donor (sister)	59 / F	No pathogenic variant			Yes	No
Family 4	Recipient	30 / M	COL4A4 (NM_000092.3)c.2320G>C	Compound Het	LP (FPS, PMA2, PPS)		
	Donor (mother)	40 / F	COL4A4 (NM_000092.3)c.4394G>A COL4A4 (NM_000092.3)c.4394G>A	Hem	VUS (PMA2, PPS) VUS (PMA2, PPS)	Yes	Yes
Family 5	Recipient	24 / M	COL4A4 (NM_000092.3)c.81_86del	Hom	VUS (PMA2, PMA4, PPS)		
	Donor (mother)	56 / F	COL4A4 (NM_000092.3)c.81_86del	Hem	VUS (PMA2, PMA4, PPS)	No	No
Family 6	Recipient	35 / F	COL4A5 (NM_000091.5)c.140R>1G>C	Hem	P (PVSL, PMA2, PPS)		
	Donor (father)	67 / M	COL4A5 (NM_000091.5)c.140R>1G>C	Hem	P (PVSL, PMA2, PPS)	Yes	Yes
Family 7	Recipient	24 / F	COL4A5 (NM_000091.5)c.488T_488del	Hom	P (PVSL, PMA2, PPS)		
	Donor (father)	48 / M	COL4A5 (NM_000091.5)c.488T_488del	Hem	P (PVSL, PMA2, PPS)	No	No
Family 8	Recipient	42 / F	COL4A5 (NM_000091.5)c.2584G>A	Hem	P (PMA1, PMA2, PMA2, PPS, PPS)		
	Donor (mother)	35 / F	No pathogenic variant			Yes	No
Family 9	Recipient	18 / F	COL4A5 (NM_000091.5)c.3646G>A	Hom	P (PMA2, PMA1, PMA1, PPS)		
	Donor (mother)	38 / F	COL4A5 (NM_000091.5)c.3646G>A	Hem	P (PMA2, PMA1, PPS)	No	No

Abbreviations: ACMG, American College of Medical Genetics and Genomics; P, pathogenic; Het, heterozygous; Hom, homozygous; HTN, hypertension; RT, kidney transplantation; LP, likely pathogenic; M, male; MACE, major adverse cardiac events; P, pathogenic; VUS, variant of unknown significance.

SA-PO796

**Increasing Conversion Rates and Reducing Disparities: Determining Modifiable Predictors Associated With Donating a Kidney**

Amy D. Waterman,<sup>1</sup> John D. Peipert,<sup>2</sup> Edward A. Graviss,<sup>3</sup> Duc T. Nguyen,<sup>3</sup> Ahmed O. Gaber,<sup>1</sup> Andrea M. Meinders,<sup>1</sup> Linda W. Moore,<sup>1</sup> Francis L. Weng,<sup>4</sup>  
<sup>1</sup>Houston Methodist, Houston, TX; <sup>2</sup>Northwestern University Feinberg School of Medicine, Chicago, IL; <sup>3</sup>Houston Methodist Academic Institute, Houston, TX; <sup>4</sup>Cooperman Barnabas Medical Center, Livingston, NJ.

**Background:** Potential living donors (PLD) may present for evaluation but not donate due to modifiable factors that could be intervened upon. From a longitudinal cohort study of 5 transplant centers, we examined how many PLDs of different races/ethnicities actually donated, how many were not ruled out who might still donate, and whether any modifiable factors were predictive of actual living donation (LD).

**Methods:** From 2017-2020, we surveyed 2184 PLDs about their demographic characteristics, their educational preparedness, LD readiness, and anxiety prior to evaluation. Using EMR review, we followed 1241 PLDs for up to 12 months who were not ruled out to determine whether they donated a kidney. We used multivariable logistic regression models to identify characteristics associated with donating with variable selection conducted using the least absolute shrinkage and LASSO methods.

**Results:** Of 2184 PLDs, 943 (43.2%) were ruled out for medical reasons, 704 (32.2%) dropped out, 130 (6.0%) were ruled out for modifiable reasons, and 407 (18.6%) donated. At the univariate level, PLDs who were Black (22.8%), Hispanic (22.4%), or of other races/ethnicities (20.6%) were less likely to donate than Whites (40.3%) and Asians (43%), with multilevel modeling revealing that Hispanics [OR: 2.25; 95% CI: 1.29, 3.95] remained less likely to donate than Whites after controlling for other factors (Table). Multivariate modeling also revealed that PLDs who had spoken to the kidney patient about donating, read information, and were in the Action Stage of readiness were 1.5-2.4 times more likely to donate.

**Conclusions:** Interventions focused on increasing living donors' readiness and preparedness may reduce drop-out and increase the number of PLDs converting to actual LD.

**Funding:** Other NIH Support - NIMHD - National Institute on Minority Health and Health Disparities

**Conclusions:** Higher anxiety, particularly when the kidney recipient is a family member, was associated with a reduced likelihood of LD. PROMIS Anxiety should be considered as a screening tool for PD along with LD tailored interventions to reduce anxiety and support withdrawal from donation.

**Funding:** Other NIH Support - NIMHD

Table. Participant characteristics associated with increased levels of anxiety	Lower Anxiety: T score <55 (n=1727)	Higher Anxiety: T score >55 (n=424)	p-value
<b>Demographics</b>			
Age (years), median (IQR)	44.0 (33.0, 54.0)	42.0 (31.0, 52.0)	0.01
Gender: Female	1024 (60.0)	283 (67.5)	0.004
<b>Donor Characteristics</b>			
Close relation of recipient	878 (50.9)	252 (59.4)	0.002
Has donated blood, past year	298 (17.4)	50 (11.8)	0.01
No income possible, <6 months	587 (50.2)	191 (64.5)	<0.001
<b>Donor Motivation/Decision-Making</b>			
Found out in-person that the recipient needed a KT	1084 (62.8)	289 (68.2)	0.04
Time to make decision = 1 day (vs. decided immediately)	577 (34.7)	187 (45.5)	<0.001
Earlier readiness level vs. Being in action to pursue LD at onset	329 (19.9)	146 (36.0)	<0.001
Preference for someone else to donate	128 (7.5)	80 (19.0)	<0.001
<b>Donor Previous Education/Knowledge</b>			
<b>Actions already taken</b>			
Talk to trusted people	1017 (60.0)	206 (49.6)	<0.001
Contact transplant center	911 (54.1)	194 (47.8)	0.02
Complete forms	648 (38.5)	132 (32.0)	0.02
Considered family/work responsibilities	731 (43.3)	104 (25.3)	<0.001
<b>Knowledge about LKD</b>			
Test knowledge	1116 (65.1)	247 (59.2)	0.03
Recovery knowledge	1292 (75.3)	239 (57.5)	<0.001
Risk knowledge	1264 (74.0)	238 (57.1)	<0.001
Costs knowledge	945 (55.8)	160 (38.7)	<0.001
Benefits knowledge	1658 (96.7)	390 (92.6)	<0.001
Informed decision	1470 (86.3)	303 (72.7)	<0.001
<b>Medical Mistrust/Health Literacy</b>			
Greater medical mistrust (combined score), median (IQR)	12.0 (9.0, 15.0)	12.0 (9.0, 12.0)	<0.001
Health literacy (combined score)	2.0 (2.0, 3.0)	3.0 (2.0, 4.0)	<0.001
<b>Practical Challenges to Donation</b>			
Lack of community support for donating	495 (29.4)	164 (39.6)	<0.001
Donation-related cost barriers	258 (15.2)	96 (23.0)	<0.001
Time-off from work barriers	250 (16.5)	95 (25.3)	<0.001

Table. Factors associated with Donation within 12 months		
	Multivariable OR (95% CI)	p-value
<b>Demographics</b>		
Race/Ethnicity		
White	(reference)	
Hispanic	0.56 (0.34, 0.90)	0.02
Other/Unknown	0.46 (0.23, 0.94)	0.03
<b>Donor characteristics</b>		
Close relationship with recipient (family member or spouse)	1.76 (1.24, 2.52)	0.002
Q.13. PROMIS Bank v1.0 Anxiety T score (per 5 point increase)	0.90 (0.81, 1.01)	0.08
Q.22. Highest level of education > High School	1.87 (1.12, 3.13)	0.02
<b>Donor Motivation/Decision-Making</b>		
In Readiness Stage of Action vs. other Readiness Stages	1.59 (1.01, 2.51)	0.04
Reported that religion is important to them	0.54 (0.37, 0.78)	0.001
<b>Donor Previous Education/Knowledge</b>		
Reported that had read information about living donation	1.49 (1.00, 2.22)	0.049
Reported that had spoken to kidney patient about donating	2.37 (1.58, 3.57)	<0.001
OR, odds ratio; CI, confidence interval	AUC = 0.76	

SA-PO797

**Understanding Anxiety in Potential Living Donors and Its Association With Actual Donation**

Amy D. Waterman,<sup>1</sup> Ariella Maghen,<sup>2</sup> Wendy Balliet,<sup>3</sup> Francis L. Weng,<sup>4</sup> Edward A. Graviss,<sup>1</sup> Duc T. Nguyen,<sup>1</sup> Alexis Bobu,<sup>1</sup> Ahmed O. Gaber,<sup>1</sup> John D. Peipert,<sup>5</sup> <sup>1</sup>Houston Methodist, Houston, TX; <sup>2</sup>Community Memorial Health System, Ventura, CA; <sup>3</sup>Medical University of South Carolina, Charleston, SC; <sup>4</sup>Cooperman Barnabas Medical Center, Livingston, NJ; <sup>5</sup>Northwestern University, Evanston, IL.

**Background:** Potential donors (PDs) considering Living Kidney Donations (LD) may experience emotional distress surrounding donation and consequently drop out. Using longitudinal cohort data, we examined anxiety at onset of donor evaluation, characteristics associated with higher anxiety, and whether higher anxiety was associated with actual LD.

**Methods:** PDs from 5 transplant centers were surveyed on their attitudes, knowledge of LD, and a PROMIS@ 4-item anxiety short form (normative T score mean of 50, higher scores mean higher anxiety). Participants were followed up to 12 months from evaluation to determine if they donated. Multivariable logistic regression models were used to identify characteristics associated with mild anxiety or higher (T score ≥55) and LD.

**Results:** 2184 individuals were surveyed, of which 407 (18.6%) donated a kidney. Participants were White (50.3%), female (61.5%). The median T-score was 46.8 (IQR: 39.4, 54.8); 19.7% (n=424) had T scores ≥55. Anxiety T-scores did not vary by race/ethnicity (p=0.77). Lack of support for donation [odds ratio (OR): 2.25; 95% CI: 1.29, 3.95], having a close familial recipient (OR: 1.72; 1.07, 2.79), and other factors were associated with higher anxiety (Table 1). Compared to those with less anxiety, those patients with higher anxiety were more likely to report that they would prefer that someone else donate (19% vs. 7.5%, P<.001) and had a 39% reduction in odds of actually donating (OR: 0.61; 95% CI: 0.38, 0.97).

SA-PO798

**Prevalence and Predictors of Suboptimal Kidney Donor Profile Index (KDPI) and Estimated Post-Transplant Survival (EPTS) Mismatches in Kidney Transplant Recipients**

Sarah Chen, Barbara A. Grimes, Charles E. McCulloch, Flavio Vincenti, Elaine Ku. *University of California San Francisco, San Francisco, CA.*

**Background:** Under the current Kidney Allocation System, longevity matching of transplant candidates with deceased donor organs occurs through matching of the Kidney Donor Profile Index (KDPI) to the Estimated Post-Transplant Survival (EPTS). Our objective was to explore predictors and outcomes of population with large mismatches in KDPI and EPTS (defined in Figure).

**Methods:** Adults who received deceased donor transplantation between 2015-2019 according to the USRDS were included. Logistic regression models were used to identify predictors of a high KDPI/low EPTS or low KDPI/high EPTS match (Figure) in separate models. Candidate predictors included demographic, comorbidity, and laboratory data. To confirm if these mismatches had differential graft outcomes, we examined the risk of graft loss in each of these groups compared to those with closer categories of matching between KDPI and EPTS.

**Results:** Table 1 shows predictors of the two mismatch types. Results were similar when highly sensitized (calculated panel reactive antibody>80%) or repeat transplant recipients were excluded. In Cox models, we found the expected outcomes: higher risk of graft loss for high KDPI/low EPTS mismatched population (HR 1.62; 95% CI 1.36-1.94) and lower risk of graft loss for low KDPI/high EPTS mismatched population (HR 0.46; 95% CI 0.37-0.58).

**Conclusions:** Extreme matches in KDPI/EPTS are present in >20% of transplant recipients. Some variables, such as donor and recipient race, are consistently predictive of low-quality organs being matched to recipients with high EPTS or vice versa. Further studies are needed to understand the reasons for these mismatches given that such mismatches do associate with different risks of long-term graft outcomes.



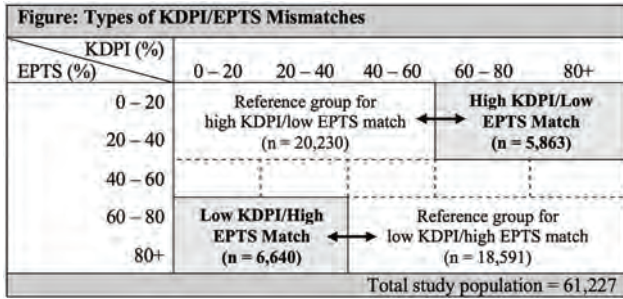

**Table 1: Predictors of Each KDPI/EPTS Mismatch**

	High KDPI/Low EPTS Match (unfavorable*)		Low KDPI/High EPTS Match (favorable†)	
	Odds Ratio	95% CI	Odds Ratio	95% CI
Factors associated with increased likelihood of mismatch	Black (vs. White) donors	2.21 [2.02 - 2.41]	On Medicare/Medicaid	1.28 [1.17 - 1.39]
	Asian donors	1.59 [1.29 - 1.95]	OPTN region 8	1.23 [1.00 - 1.51]
	OPTN region 9 (vs. region 1)	1.42 [1.15 - 1.76]		
	OPTN region 7	1.28 [1.03 - 1.59]		
	Females (vs. males)	1.23 [1.14 - 1.32]		
Factors associated with decreased likelihood of mismatch	Asian (vs. non-Hispanic White) recipients	1.23 [1.08 - 1.40]	Asian donors	0.51 [0.39 - 0.65]
	OPTN region 6	0.48 [0.36 - 0.63]	Black donors	0.57 [0.51 - 0.63]
	On Medicare/Medicaid (vs. private insurance)	0.88 [0.81 - 0.95]	OPTN region 9	0.61 [0.50 - 0.76]
			OPTN region 7	0.72 [0.58 - 0.89]
			OPTN region 5	0.73 [0.60 - 0.88]
			Hispanic recipients	0.77 [0.70 - 0.86]
			Asian recipients	0.80 [0.68 - 0.93]

\* High KDPI/low EPTS mismatch indicates the candidate received a donor kidney with relatively shorter estimated graft survival compared to the candidate's expected survival after transplant. This is an unfavorable mismatch for the recipients. We expected recipients with favorable mismatch to be associated with longer graft survival.

† Low KDPI/high EPTS mismatch indicates the candidate received a donor kidney with relatively longer estimated graft survival compared to the candidate's expected survival after transplant. This is a favorable mismatch for the recipients. We expected recipients with favorable mismatch to be associated with longer graft survival.

SA-PO799

Should “Marginal Kidneys” Be Offered for Repeat Transplantation? A Mate-Kidney Analysis

Kalathil K. Sureshkumar,<sup>1</sup> Michelle A. Josephson,<sup>2</sup> Bhavna Chopra,<sup>3</sup> Rita L. McGill.<sup>2</sup> <sup>1</sup>Allegheny Health Network, Pittsburgh, PA; <sup>2</sup>University of Chicago Pritzker School of Medicine, Chicago, IL; <sup>3</sup>Beth Israel Deaconess Medical Center, Boston, MA.

**Background:** Initial and subsequent kidney transplantation improves survival compared to continuing dialysis. Higher kidney donor profile index (KDPI) kidneys (“marginal kidneys”) generally provide inferior transplant outcomes compared to lower KDPI kidneys. Repeat kidney transplant recipients (KTRs) are biologically more complex with increasing immunologic risk. We aimed to explore whether transplantation of high-KDPI “marginal kidneys” might result in suboptimal outcomes for repeat KTRs by utilizing a mate-kidney model.

**Methods:** Deceased donors in the OPTN/UNOS database from 2000 to 2019 were extracted if one kidney was transplanted into a first time recipient and the mate-kidney was transplanted into a repeat recipient. Transplant pairs were then stratified by KDPI: 0-20% (best kidneys); 21-85% (average kidneys); 86-100% (“marginal kidneys”). Using marginal models, transplant outcomes were compared between first time and repeat mate-kidney recipients.

**Results:** During the study period, 9502 mate-kidney pairs were identified with KDPI as follows: 0-20%= 2387; 21-85%=6800; 86-100%=315. Risks for delayed graft function (DGF), graft failure, death-censored graft failure and patient death are shown for repeat KTRs compared to first time KTRs (table).

**Conclusions:** Elevated risk for DGF in repeat KTRs regardless of KDPI suggests that recipient related factors are responsible. Inferior death-censored graft survival observed when higher KDPI kidneys are received by repeat KTRs suggests that these patients may preferentially benefit from lower KDPI kidneys. Transplant teams should be cautious about accepting “marginal kidney” offers for repeat KTRs. Improved patient survival observed in repeat KTRs could possibly reflect stringent listing criteria for repeat kidney transplantation, or other factors.

Outcomes: Repeat vs. first transplant

	KDPI 0-20%		KDPI 21-85%		KDPI 86-100%	
	OR (95% CI)	P	OR (95% CI)	P	OR (95% CI)	P
Delayed graft function	1.30 (1.10-1.54)	0.002	1.15 (1.06-1.25)	0.001	1.61 (1.11-2.32)	0.01
Graft failure	1.00 (0.89-1.12)	0.90	1.02 (0.96-1.09)	0.50	0.99 (0.89-1.12)	0.90
Death-censored graft failure	1.14 (0.95-1.36)	0.20	1.24 (1.12-1.37)	<0.001	1.49 (1.06-2.09)	0.02
Patient death	0.88 (0.76-1.00)	0.05	0.85 (0.79-0.92)	<0.001	0.89 (0.69-1.14)	0.40

CI=confidence interval; HR=hazard ratio; OR=odds ratio

SA-PO800

Geographic Hot Spots of Post-Dialysis Kidney Transplant Waitlisting Are Associated With Socioeconomic Deprivation

Robert B. Buchalter, Anne M. Huml, Emilio D. Poggio, Jesse D. Schold. Cleveland Clinic, Cleveland, OH.

**Background:** Wait-listing of deceased donor kidney transplant candidates before maintenance dialysis improves outcomes. Preemptive listing disparities have not been examined with geospatial methods, so identifying hot spot areas where post-dialysis wait-listing is most prevalent is a first step towards localizing interventions and health policy. Socioeconomic deprivation is linked to post-dialysis wait-listing but has not been studied in the context of geographic hot spots, suggesting an opportunity to examine differences in deprivation between post-dialysis wait-listing hot spots and non-hot spots.

**Methods:** We used 2010-2020 zip code tabulation area-level SRTR deceased donor kidney transplant candidate data and 3 geospatial cluster analysis methods to identify statistically significant post-dialysis wait-listing hot spots. We classified ZCTAs by area deprivation index quartile derived from 2010-2019 ACS 5-year estimates and computed odds ratios and 95% confidence intervals comparing deprivation values in hot spots and non-hot spots.

**Results:** We identified hot spots in southeastern, southwestern, and California ZCTAs, with most hot spots occurring in the southeast (Figure 1). Hot spot ZCTAs were more likely to be in the highest deprivation quartile (OR: 6.76, 95%CI: 6.52-7.02) compared to non-hot spot ZCTAs.

**Conclusions:** Our results reveal novel small area post-dialysis kidney transplant wait-listing disparity patterns where clinical interventions and health policies can be targeted. Our work is the first to identify localized preemptive listing disparities and the first to identify geographic preemptive listing disparities in California. The strong link between post-dialysis wait-listing hot spots and socioeconomic deprivation reflects previous findings but sheds new light by integrating geography.

**Funding:** Other NIH Support - NIH T32CA094186, Other U.S. Government Support

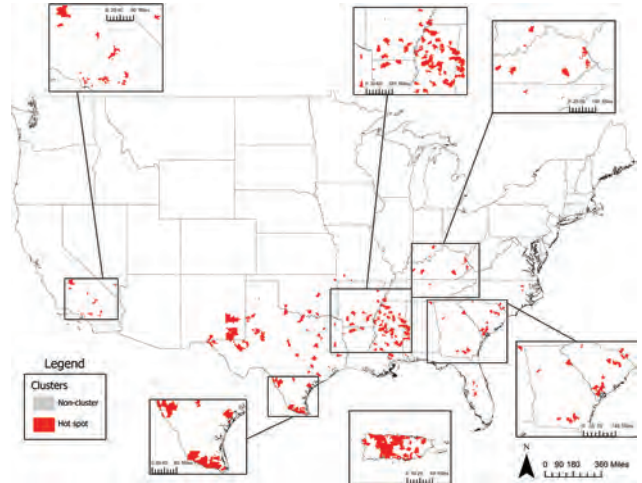

Figure 1: ZCTA hot spots of kidney transplant candidates wait-listed post-dialysis, 2010-2020

SA-PO801

Risk Prediction for Early Post-Donation Kidney Dysfunction in Live Kidney Donors Using a Common Data Model

Sehoon Park,<sup>1</sup> Eunjeong Kang,<sup>2</sup> Sejoong Kim,<sup>3</sup> Kwon Wook Joo,<sup>1</sup> Yon Su Kim,<sup>1</sup> Hajeong Lee.<sup>1</sup> <sup>1</sup>Seoul National University Hospital, Jongno-gu, Seoul, Republic of Korea; <sup>2</sup>Ewha Womans University Seoul Hospital, Seoul, Republic of Korea; <sup>3</sup>Seoul National University Bundang Hospital, Seongnam, Republic of Korea.

**Background:** Determination of the prognosis of living kidney donors is important. Impairment of early post-donation kidney function is associated with a higher risk of long-term kidney failure. Therefore, a prediction model for early post-donation kidney function in living kidney donors is warranted.

**Methods:** Common Data Model was implemented for inclusion of uniform data from three tertiary hospitals in Korea. The development cohort consisted of living kidney donors at Seoul National University Hospital (N=1074), and the two validation cohorts consisted of 2595 and 189 living kidney donors from other hospitals in Korea. Logistic regression analysis was performed for insufficient kidney function recovery, comprising estimated glomerular filtration rates (eGFRs) <60 and <50 mL/min/1.73 m<sup>2</sup>. Variables that were associated with most of these study outcomes were selected for construction of the final prediction model, a multivariable logistic regression model.

**Results:** Among the study cohorts, 10%-35% of living kidney donors had an eGFR <60 mL/min/1.73 m<sup>2</sup> and 3%-9% had an eGFR <50 mL/min/1.73 m<sup>2</sup> in the outcome-assessment period. Older age, male sex, higher body mass index, lower baseline eGFR, higher serum uric acid concentration, and the occurrence of postoperative acute kidney injury were included in the final prediction model. The model yielded acceptable

discriminative power (AUC≥0.88) in both the development and validation cohorts. The calibration results were also acceptable (Hosmer-Lemeshow test, all P values but one were >0.05). A risk calculator for the four study outcomes was developed and published online (<https://snhneurology.github.io/>).

**Conclusions:** We constructed an easily accessible and useful risk prediction calculator for early post-donation kidney function.

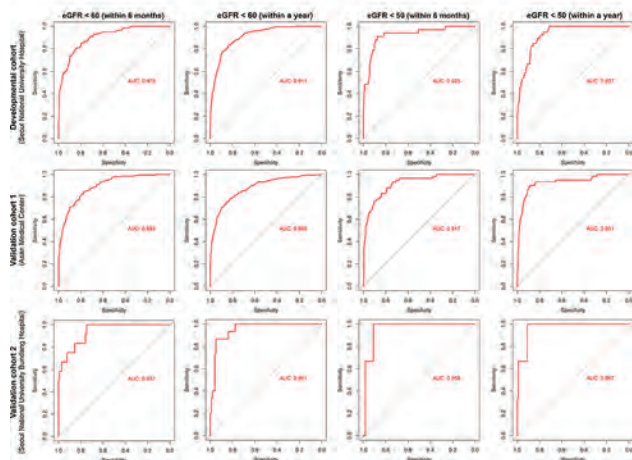
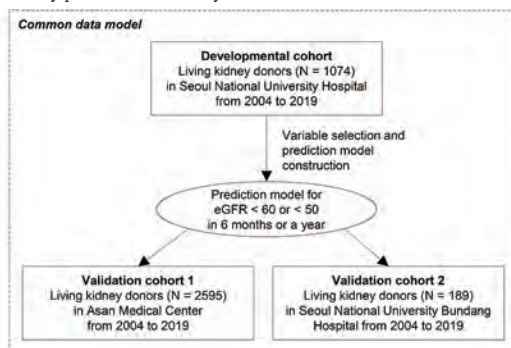

**SA-PO802**

**Death on Kidney Transplant Waitlist: Clues to Better Listing Decision Making**

Ninoshka Mendonca, Jaya Mehta, Anil S. Paramesh, Hoonbae Jeon, Mary Killackey, Adarsh Vijay. Tulane Transplant *Tulane University School of Medicine, New Orleans, LA.*

**Background:** Wait-list mortality with risk adjustment is one of the pre-transplant metrics currently used for monitoring transplant program performance. Understanding risk factors and mortality trends in wait-listed kidney transplant candidates are essential to implement better screening protocols and better listing decision making.

**Methods:** We performed a single-center five-year retrospective study of kidney transplant candidates who were accepted to the transplant wait-list between January, 2012 and December, 2016. Characteristics of transplanted recipients [TG] were compared with candidates that expired [EG] on the kidney transplant waitlist.

**Results:** A total of 266 patients on the transplant wait-list were included in our study, of which 185(70%) were transplanted and 81(30%) expired. The groups were comparable with respect to gender, ethnicity, BMI, blood type, functional status at listing, history of previous transplants and history of prior malignancy. Our analysis showed median age at listing was lower in TG in comparison to EG (47 vs 51 years; p=0.001). Average length of time spent on the transplant waitlist was higher in EG (884 vs 819 days; p=0.50). The occurrence of polypharmacy (>5 medications) was higher in EG in comparison to TG (92% vs 81%; p=0.017) along with the increased use of blood thinners in the EG group (49% vs 34%; p=0.018). We also found that 98% of patients in the EG group had a diagnosis of hypertension at the time of listing in comparison to 88% in the TG group (p=0.01). When comparing groups, 61% of the EG patients were diabetic in comparison to only 31% of TG patients. Similarly, the median HbA1c as well as the use of insulin was significantly higher in EG patients (7.1 vs 5.6; p=0.0001, 41% vs 19%; p=0.0002). A higher proportion of patients in TG had EF > 50% on pre-listing echo than patients in EG (68% vs 56%; p=0.09). 51 patients (63%) in EG underwent heart catheterization in comparison to 88 patients (48%) in TG. However, the percentage of positive heart catheterizations were higher in the TG 28% vs 21% in EG.

**Conclusions:** Our study shows greater mortality risk in wait-listed kidney transplant candidates with EF < 50%, poorly controlled diabetes, poly-pharmacy and use of blood thinners. The discrepancy in positive heart catheterization rates should alert future prospective trials to further streamline cardiac screening protocols in kidney transplant candidates.

**SA-PO803**

**Use of Peritoneal Dialysis After Kidney Transplant Failure Is Associated With Survival Advantage in a Contemporary National Cohort of ESKD Patients**

Sanjana Kapoor, Molly Fisher, Michele H. Mokrzycki, Luz E. Liriano-Ward, Enver Akalin, Tanya S. Johns. *Albert Einstein College of Medicine, Bronx, NY.*

**Background:** Kidney allograft failure (KAF) is associated with increased mortality. Prior studies suggest that peritoneal dialysis (PD) may offer short-term survival advantage over hemodialysis (HD) after KAF. We compared patient survival by dialysis modality and HD access type with mortality in patients with KAF.

**Methods:** From 2009-2019, adult (>18 years) incident dialysis patients following KAF were identified using the US Renal Data System. We excluded patients who were missing data on dialysis modality or died within 30 days of initiating dialysis. Dialysis modality was analyzed with an intention-to-treat approach in which mortality was attributed to the initial modality. Patients were censored at re-transplantation or study end. Multivariable Cox Proportional hazards models with multiple imputation for missing data were used to determine the association between dialysis modality and access type and mortality.

**Results:** Of 32,649 KAF patients, 3,201 (9.8%) were initially treated with PD and 29,448 (90.2%) with HD. Among those on HD, 11,284 (38.4%) and 18,127 (61.6%) used an arteriovenous access and central venous catheter (CVC), respectively. Compared to the HD group, the PD group was younger (median age 55 vs 51 years, p<0.001); more likely to be Caucasian (69.6% vs 63.4%, p<0.001) and received a living donor transplant (47.1% vs 33.8%, p<0.001); and less likely to have diabetes (28.6% vs 41.2%, p<0.001) and coronary artery disease (8% vs 12.2%, p<0.001). Over the study follow-up [median 6.6y(6.4-6.8y)], there were 10,534 deaths and 6,455 patients had at least one re-transplantation. Compared to HD, initiating PD after KAF was associated with a 14% lower risk of death (adjusted hazard ratio 0.86 [95% confidence interval 0.78 – 0.94]) after adjusting for demographics, donor type, comorbidities, ESKD etiology, albumin, creatinine, hemoglobin and dialysis vintage. The survival advantage was more pronounced when PD was compared to HD initiation via CVC.

**Conclusions:** Among patients with KAF, PD is associated with improved long-term survival compared to HD. CVC for initial access among incident HD patients after KAF is associated with highest risk of mortality. Future studies should elucidate barriers to timely arteriovenous access placement and PD initiation in patients with KAF.

**SA-PO804**

**Impact of Willingness to Accept a Hepatitis C Viremic Donor Kidney on Access to Transplant**

Warren T. Mckinney,<sup>1,2</sup> David P. Schladt,<sup>3</sup> Ajay K. Israni.<sup>1,2</sup> <sup>1</sup>*Hennepin Healthcare Research Institute, Minneapolis, MN;* <sup>2</sup>*Scientific Registry of Transplant Recipients, Minneapolis, MN;* <sup>3</sup>*Chronic Disease Research Group, Minneapolis, MN.*

**Background:** The approval of effective therapy for Hepatitis C (HCV) for use in transplant patients changed considerations for using organs recovered from HCV viremic donors. We evaluated the impact of kidney transplant candidates' willingness to accept a HCV donor on access to deceased donor kidney transplant (DDKT). We also sought to determine the effect of race when considering willingness to accept a HCV donor.

**Methods:** This study used Scientific Registry of Transplant Recipients data, and included all candidates for DDKT between Jan. 1, 2015 and Mar. 12, 2020 (n= 233,033). Candidates were classified as African American (AA) or non-African American (non-AA) and categorical differences in clinical factors were evaluated by X<sup>2</sup> tests. Cox models with time to transplant were constructed to assess the impact of willingness to accept a HCV donor and the effect combined with race. Sub-analyses evaluated the impact of geography and Latino ethnicity.

**Results:** 76,576 (32.9%) candidates during the study period were AA, and there was significant variation in clinical factors between AA and non-AA candidates. AA candidates were more likely to: be female, blood type B, have 3 or more years of waiting time, and be willing to accept a HCV donor (all p < 0.001). Willingness to accept a HCV donor was associated with increased access to transplant for all candidates, hazard ratios (HR) for non-AA access to transplant was 2.174 (95% CI, 2.097-2.254) and 2.196 (95% CI, 2.096 – 2.300) for AA (Figure 1). Similar results were seen in Latinos and across geographies.

**Conclusions:** Willingness to accept a HCV donor is associated with increased access to DDKT. There is an opportunity to expand access to DDKT by providing decision support for AA and non-AA candidates on accepting HCV donors. However, further analysis is necessary to disentangle the interaction between candidate selection and candidate-level risk tolerance.

**Funding:** Other NIH Support - This material is based in part upon work supported by the Agency for Healthcare Research and Quality (AHRQ) and the Patient-Centered Outcomes Research Institute (PCORI) grant K12HS026379 (W.T.M.).

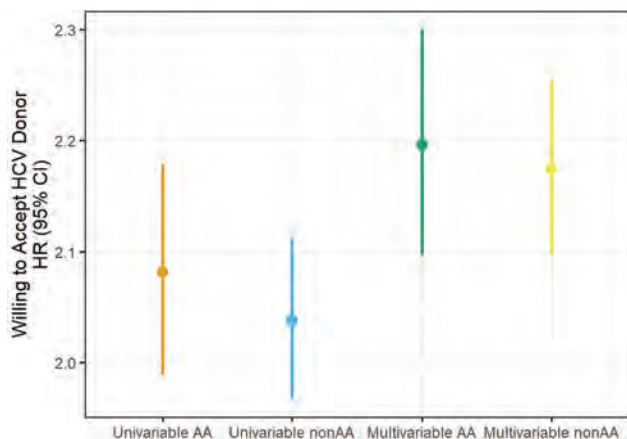

Impact of willingness to accept HCV donor kidney on access to DDKT

SA-PO805

**Racial Differences in Trends and Survival After Simultaneous Heart and Kidney Transplantation in the United States**

Alexis K. Okoh,<sup>1</sup> Joseph Ruberwa,<sup>2</sup> <sup>1</sup>Emory University School of Medicine, Atlanta, GA; <sup>2</sup>University of North Carolina System, Chapel Hill, NC.

**Background:** Among patients with chronic kidney disease listed for Heart Transplantation (HT), survival outcomes are better after simultaneous heart and kidney transplantation (sHKT) than isolated HT. However, racial differences in utilization of sHKT and post sHKT survival are unknown.

**Methods:** The United Network for Organ sharing database was queried for data on all adult patients who underwent sHKT between January 1990 and December 2019. Recipients were classified based on self-reported race and ethnicity, including non-Hispanic White, non-Hispanic Black, Hispanic, and Asian. Trends in sHKT over five eras (1990-1995, 1996-2001, 2002-2007, 2008-2013, 2014-2019) were examined. Kaplan-Meier analysis was used to examine one- and five-year post-transplant survival over the eras and by race-ethnic groups. Median survival rates were estimated from Cox proportional Hazard modelling.

**Results:** During the study period, a total of 1872 patients (non-Hispanic White (n=1082), non-Hispanic Black (n=556), Hispanic (n=157), and Asian (n=77) underwent sHKT in the United States. A significant increase in utilization of sHKT from 3.9% in 1990 to 51.9% in 2019 was seen overall and proportionally by race-ethnic group. Both one- and five-year survival post-sHKT were comparable by race. 1-year [Log rank test; p=0.623], 5-year [Log rank test; p=0.063] with no observed differences. Risk adjusted median survival rates by race were estimated as: [Race; Years] Non-Hispanic White: 11.9 non-Hispanic Black: 12.5, Hispanic: 16.8, Asian: 13.2.

**Conclusions:** There has been an increasing trend in the utilization of sHKT over the past 3 decades. There were no differences in post-transplant survival at both one- and five years by race-ethnic groups. Estimated median survival after sHKT is 12-years and remains comparable by race-ethnic groups.

SA-PO806

**Variations in Access to Repeat Transplantation by Transplant Center Continuity**

Davidson F. Emanuels,<sup>1</sup> Timothy P. Copeland,<sup>2</sup> Kirsten L. Johansen,<sup>3</sup> Charles E. McCulloch,<sup>2</sup> Elaine Ku,<sup>4</sup> <sup>1</sup>University of California San Francisco School of Medicine, San Francisco, CA; <sup>2</sup>University of California San Francisco, Department of Epidemiology and Biostatistics, San Francisco, CA; <sup>3</sup>Hennepin Healthcare, Minneapolis, MN; <sup>4</sup>University of California San Francisco Medical Center at Parnassus, San Francisco, CA.

**Background:** In the U.S., there is significant fragmentation in the care of patients with a failing kidney transplant. Our objective was to examine the association between transplant center continuity and access to repeat transplantation.

**Methods:** Using US Renal Data System data, we studied adults relisted for kidney transplantation between 2006-2016. We examined whether transplant center continuity (same versus different transplant center where relisting occurred) was associated with time to a second kidney transplant or odds of preemptive relisting using cause-specific and logistic regression models, respectively. We tested for effect modification by race/ethnicity.

**Results:** Among 21,154 patients, 29% switched transplant centers, 31% were preemptively relisted, and 48% received a second transplant during median follow-up of 2.9 years. Patients who switched centers had a 9% lower hazard of repeat transplantation, particularly from a deceased donor source (Figure 1). Patients who switched centers had 29% lower odds of preemptive relisting compared to those who remained at the same center (OR 0.71; 95% CI 0.66-0.77). This finding was modified by race/ethnicity (interaction p<0.001), with non-Hispanic Black (OR 0.52; 95% CI 0.45-0.61) and Hispanic (OR 0.59; 95% CI 0.47-0.73) patients who switched centers having disproportionately lower odds of preemptive relisting compared with non-Hispanic White patients (OR 0.81; 95% CI 0.74-0.89, Figure 2).

**Conclusions:** Individuals who remained at the same transplant center had better access to preemptive relisting and retransplantation. Black and Hispanic candidates who switched centers were especially disadvantaged. Additional studies on the role of continuity of care are needed to improve outcomes.

**Funding:** NIDDK Support

Figure 1: Adjusted Hazard of Repeat Transplantation by Transplant Center Continuity

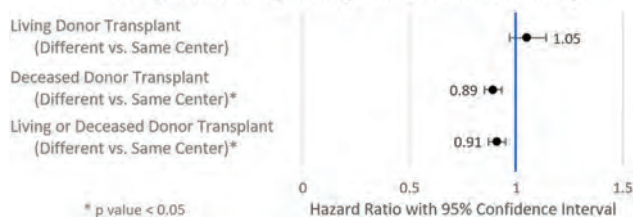
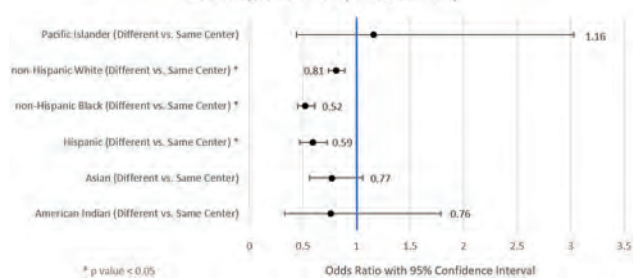

Figure 2: Adjusted Likelihood of Preemptive Relisting by Center Continuity, Stratified by Race/Ethnicity



SA-PO807

**Outcomes of Commercial Renal Transplantation: A Single Center Experience**

Amgad E. El Agroudy. Arabian Gulf University, Manama, Bahrain.

**Background:** While the ethical aspects of transplant tourism have received much attention recently, less has been written about the medical safety of this practice. We retrospectively evaluated the outcomes of patients who purchased organs internationally and presented to our center for follow-up care.

**Methods:** We report the outcome parameters of 270 local recipients of unrelated kidney (URT) vendor transplants presenting to our institute between 1986 and 2014. Their outcome was compared with 123 recipients of living-related donor transplants matched for age, gender and transplant duration done in our center as controls (RT).

**Results:** Age of unrelated recipients was 42.6 ± 13.4 years with Male % of 68. The country of transplant was mainly in Philippines (n = 85), Pakistan (n = 56), India (n = 57), Iran (n = 40) and Egypt (n = 25). Comparison of commercial recipients with controls showed high co morbidities (P = 0.01) with hepatitis-C (n=2 vs. 0) and hepatitis-B (n=2 vs. 0) and cytomegalovirus (n=4 vs. 1). Donor age was 25.9 ± 3.8 vs. 34.6 ± 8.6 years (P = 0.0001) and 90.4% were male. Biologic agents induction in 74 (27.4%) vs. 123 (100%) (P = 0.00001), acute rejections in 65 (24.1%) vs. 26 (21.1%) (P = 0.7), while recurrent rejection in 13 (4.8%) vs. 1 (0.8%) (P = 0.04), surgical complications including lymphocele 16 (5.9%) vs. 0 (0%) (P = 0.0001), ureteral obstruction 7 (2.6%) vs. 0 (0%) (P = 0.007), hematoma 4 (1.5%) vs. 1 (1.1%) (P = 0.06) and recurrent urinary tract infection 18 (9.9%) vs. 6 (6.8%) (P = 0.3). Overall 1- and 10-year for graft survival was 91% and 22% vs. 98% and 44% and for patient survival 96% and 70% vs. 98% and 78% in URT and RT, respectively (P = 0.001)

**Conclusions:** Although recent developments increased success in renal transplantation, receiving a kidney from a paid living donor at a commercial transplant center still carries great risks for the recipient.

SA-PO808

**Concordance of Social Deprivation Among Living Kidney Donor-Recipient Pairs**

Yara Bilen, Jesse D. Schold, Susana Arrigain, Robert B. Buchalter, Anne M. Huml. Cleveland Clinic, Cleveland, OH.

**Background:** Living kidney transplant is the most effective replacement therapy. Pervasive socioeconomic disparities in access to living kidney transplant exist and little is known about how closely socioeconomic indicators match within living donor-recipient pairs. We aimed to examine concordance of social deprivation indices (SDI) in living donor-recipient pairs.

**Methods:** We conducted a retrospective cohort study of living kidney donor-recipient pairs in the Scientific Registry of Transplant Recipients from 2010-2020. Living donors and kidney recipients were geocoded to link with a ZIP code tabulation area-level SDI and outcomes were stratified by donor type (altruistic, biological, non-biological and paired exchange). The association between donor-recipient SDIs were evaluated using Pearson's correlation.

**Results:** 59,575 living donor-recipient pairs (≥18 years old) with documented residential ZIP codes were identified. We characterized the donor type among 58,589 pairs: 2,343 altruistic, 26,363 biological, 22,698 non-biological, and 7,185 paired. The mean donor and recipient SDI were 45, with 26% of both donors and recipients coming from the lowest SDI quintile. The mean SDI for donor and recipient was 47.2 vs. 47.4 for biological, 42.5 vs. 42.7 for non-biological, 42.5 vs. 44.7 for paired, and 43.2 vs. 46.7 for altruistic. Among biological and non-biological donor-recipient pairs, SDI was highly correlated (Pearson Rho 0.51, and 0.56 respectively). In contrast, the SDI of altruistic donor-recipient pairs did not show a clear correlation (Rho = 0.15) except for two clusters in lowest and highest SDI. Paired exchanges were clustered at the lowest SDI (Rho=0.10 Fig.1).

**Conclusions:** Living kidney transplants occur across all SDIs, with different representation by donor types. By understanding these differences, we can leverage community resources to better support living donation in areas of neighborhood disadvantage.

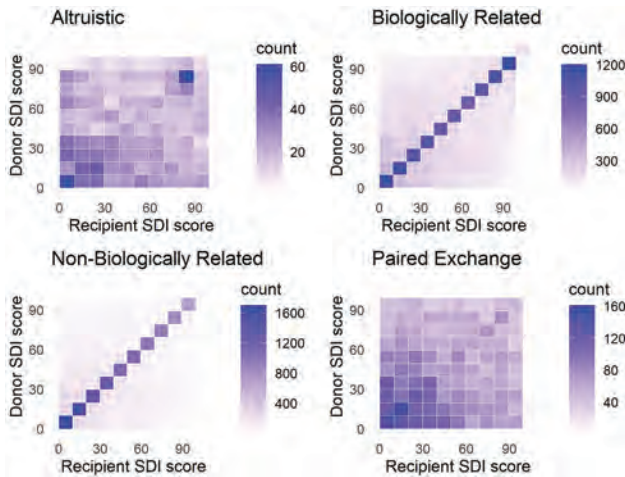

Fig.1 SDI comparison by donor type

SA-PO809

**Opportunities to Leverage Personal Networks to Increase Living Donor Kidney Transplant**

**Karen-Marie Eaton,<sup>1</sup> Michael H. O’Shea,<sup>2</sup> Steven M. Brunelli,<sup>1</sup> Francesca Tentori.<sup>1</sup>** <sup>1</sup>Davita Clinical Research, Minneapolis, MN; <sup>2</sup>DaVita Inc, Denver, CO.

**Background:** Living donor kidney transplant (LDKT) offers patients another treatment option for kidney failure. In this study, we sought to understand dialysis patients’ and care partners’ knowledge, beliefs, and attitudes toward transplant and living donation.

**Methods:** A total of 38 participants were interviewed by phone between May and August 2021. Interviews ranged in time from 10-45 minutes and included a spectrum of participants including dialysis patients and members of their care team. Interviews were recorded and transcribed verbatim (Figure 1); responses were analyzed separately using inductive thematic analysis.

**Results:** The study found that almost all patients and care partners had discussed transplant with their dialysis care team, and that patients perceived LDKT as superior to both deceased donation and dialysis - leading to longer life and better clinical outcomes. Although LDKT was discussed, the amount of retained/detailed knowledge was inconsistent among patients, often leading to misperceptions of the process. Of the few patients who had a negative perception of transplant, all cited knowing someone who had a poor outcome. When it came to having LDKT discussions with potential donors, 42% of participants had broached the subject; of those, most conversations were with a close relative. Patients and care partners tended to rely heavily on potential donors volunteering to be tested instead of proactively seeking a donor from personal networks.

**Conclusions:** Families are not always skilled in leveraging all resources to identify potential donors and patients/care givers could use assistance crafting their donor pitch as well as a viable strategy to leverage personal and extended networks.



SA-PO810

**Barriers to “The Big Ask” and Opportunities to Increase Living Donor Kidney Transplant Among Dialysis Patients and Care Givers**

**Karen-Marie Eaton,<sup>1</sup> Michael H. O’Shea,<sup>2</sup> Steven M. Brunelli,<sup>1</sup> Francesca Tentori.<sup>1</sup>** <sup>1</sup>Davita Clinical Research, Minneapolis, MN; <sup>2</sup>DaVita Inc, Denver, CO.

**Background:** Living donor kidney transplant (LDKT) offers patients another treatment option for kidney failure. Previous studies indicate that while many dialysis patients and care partners are aware of LDKT, they are unable to leverage their personal networks to obtain a living donation. In this study, we sought to understand current barriers to kidney transplant and living donation for dialysis patients and care partners.

**Methods:** A total of 38 participants were interviewed by phone between May and August 2021. Interviews ranged in time from 10-45 minutes and included a spectrum of participants including dialysis patients and their care partners. Interviews were recorded and transcribed verbatim (Figure 1); responses were analyzed separately using the inductive thematic analysis procedure.

**Results:** Results from the study indicated that many participants were reluctant to make the “big ask” for a kidney from people within their networks and instead relied on volunteers. Reasons for this were varied, but it was a key driver of LDKT hesitancy. Interestingly, male participants tend to report more “organic” donor conversations, while females report proactively bringing up the topic of living donation. Some participants stated that they have difficulty getting past the information-sharing stage of the LDKT conversation and the conversation stops before getting to the “big ask”. Many participants stated that they have “lived a good life,” and do not want to inconvenience anyone. More specifically, older patients felt “less worthy” of receiving a kidney over younger dialysis patients and/or receiving a kidney from a younger donor who has “more life” left to live and may need two functioning kidneys. Additionally, patients are especially averse to the idea of accepting a kidney from their own children - even when they have expressed initial interest in donating. Finally, almost all participants acknowledged future concerns for prospective donors.

**Conclusions:** Significant barriers to LDKT consideration were largely social and psychological, including unwillingness to make the “big ask” of their social network

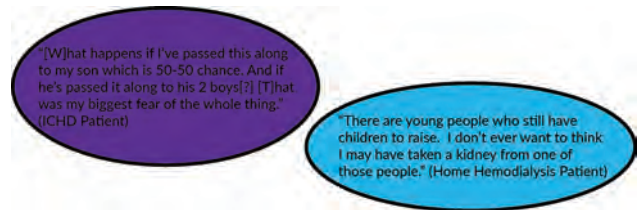

SA-PO811

**Structured Literature Review of the Economic and Humanistic Burden in Kidney Allograft Loss**

**Emily Moss,<sup>1</sup> Anita D. Burrell,<sup>2</sup> James C. Lee,<sup>3</sup> Dawn Reichenbach,<sup>3</sup> Sarah E. Mitchell,<sup>1</sup> Songkai Yan,<sup>3</sup> Kris Thiruvillakkat.<sup>3</sup>** <sup>1</sup>RTI Health Solutions, Manchester, United Kingdom; <sup>2</sup>Anita Burrell Consulting LLC, Flemington, NJ; <sup>3</sup>CSL Behring LLC, King of Prussia, PA.

**Background:** Kidney allograft loss (KAL) results in both an economic burden to the healthcare system, and an economic and humanistic burden to kidney transplant recipients, with ~30% of patients with antibody-mediated rejection (AMR) experiencing graft loss. The 2017 Banff Criteria includes diagnostic guidelines for AMR, however there are no ICD codes specifically for AMR as a cause of KAL, leading to difficulty in investigating clinical data to understand underlying etiology. The review objective was to systematically gather evidence on the economic burden (costs and healthcare resource use) and humanistic burden (health-related quality-of-life [HRQOL]) in patients with AMR KAL.

**Methods:** A comprehensive review of the literature was conducted from 2011-2021, with a focus on the United States, United Kingdom, France, Germany, Spain, and Italy.

**Results:** The review identified 21 studies reporting on the economic and/or humanistic burden of KAL; nine of these reported AMR-specific outcomes. As the studies were often small and lacking clear case definitions for AMR and the associated costs, comparisons between studies were difficult. However, the studies consistently demonstrated that there was a higher clinical and economic burden associated with AMR-related KAL than non-AMR KAL. A key result of the review was that the total annual cost of AMR-kidney graft loss ranged between \$USD \$116,988 and \$159,705 compared with \$75,909 and \$94,352 for non-AMR KAL, demonstrating a higher cost associated with AMR. One study assessed HRQOL using the Kidney Disease Quality of Life Instrument; HRQOL tended to be lower for AMR patients versus non-AMR patients when compared across different chronic kidney disease (CKD) stages for both the physical composite scores (PCS) and mental composite scores (MCS). The exception to this trend was the PCS in CKD stages 3b and 4 and the MCS in CKD stage 4, where AMR patients had a higher HRQOL than non-AMR; the finding was not discussed in the article.

**Conclusions:** There is a paucity of high-quality studies reporting the burden of AMR-related KAL. The establishment of etiology associated kidney transplant rejection ICD-10 codes including AMR-related KAL would greatly benefit future research activities by enabling the generation of real-world evidence in this population.

**Funding:** Commercial Support - CSL Behring

## SA-PO812

## Validation of Adjusted Donor Age: A Tool to Support Deceased-Donor Kidney Organ Acceptance at a Eurotransplant Centre

Christoph F. Mahler,<sup>1</sup> Damien Ashby,<sup>2</sup> Christian Nussbag,<sup>1</sup> Claudius Speer,<sup>1</sup> Louise Benning,<sup>1</sup> Daniel Göth,<sup>1</sup> Matthias Schaefer,<sup>1</sup> Ariane Mehrabi,<sup>3</sup> Martin G. Zeier,<sup>1</sup> Christian Morath,<sup>1</sup> Florian Kälble.<sup>1</sup> <sup>1</sup>Universitätsklinikum Heidelberg Nierenzentrum Heidelberg eV, Heidelberg, Germany; <sup>2</sup>Imperial College London, London, United Kingdom; <sup>3</sup>Universitätsklinikum Heidelberg Chirurgische Klinik, Heidelberg, Germany.

**Background:** In view of the organ donor shortage and growing waiting lists for kidney transplantation an optimal acceptance strategy for deceased-donor kidney offers is paramount. However, acceptance decisions are challenging not the least because current tools for assessment of kidney offers, e.g. KDRI/KDPI (Kidney Donor Risk Index/Kidney Donor Profile Index) are limited and most transplant centres lack clear criteria.

**Methods:** To meet the multi-morbid patient population at a London transplant centre Adjusted donor age (ADA) was developed as a tool to support organ acceptance decision making in deceased-donor kidney transplantation. Thereby offers are divided according to risk into quintiles (A - E). (A - C favourable, D moderate, E unfavourable). These quintiles are associated with the adjusted donor age. Underlying is the real donor age, adjusted for associated risk factors and the immunological constellation.

**Results:** Here, we evaluate whether ADA can be applied at a Eurotransplant Centre in Germany to assess organ quality and guide acceptance decisions. For this monocentre validation study we included 463 deceased-donor kidney organ offers of which 173 were accepted and transplanted. We followed organ recipients for three months after transplantation and measured eGFR as the primary outcome parameter. Statistical analysis revealed that indeed higher ADA quintile was associated with poorer transplant outcome. The three-month eGFR was strongly associated with ADA ( $r=0.56$ ) in patients with functioning graft and decreased with higher ADA quintiles (A: 64, B: 60, C: 49, D: 37 and E: 28 mL/min/1.73m<sup>2</sup>).

**Conclusions:** Taken together our study suggests that ADA can be applied at a Eurotransplant centre as a simple tool to characterise deceased-donor kidney organ offers. ADA may facilitate acceptance decision making and help to distinguish organs with favourable outcomes from ones with high probability of poor graft function.

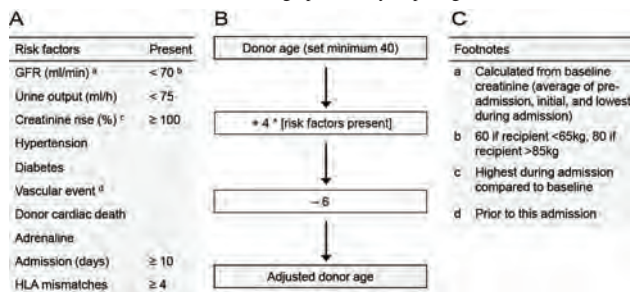

## SA-PO813

## Evaluation of Measured Glomerular Filtration Rate in Living Related Kidney Donors Before and After Donor Nephrectomy

Tushar A. Dighe, Abhijit S. Chavan, Charan B. Bale, Pavan Wakhare, Nilesh Shinde, Akshay R. Kulkarni, Atul Sajgure. *Dr.D.Y.Patil Medical College, Hospital and Research Centre, Pimpri, Pune, Dr DY Patil Vidyapeeth, Pune, India, Pune, India.*

**Background:** Understanding the pathophysiologic effects of kidney donation is important for judging donor safety and analysing compensatory changes occurring in remnant kidney after donation. If remnant kidney undergoes inadequate compensatory changes in Glomerular filtration rate (GFR), it can have undesirable effects on long term health of donors.

**Methods:** We performed a prospective observational study of 10 subjects who underwent Nephrectomy for living related kidney transplant over a period of 1 year in tertiary care hospital. It was approved by Institutional Ethics committee. Baseline evaluation of all subjects was done 10 to 14 weeks prior and at 11 to 13 weeks after nephrectomy, which included Tc-99m DTPA scintigraphy for measured GFR, Spot Urine Albumin Creatinine ratio and laboratory parameters (serum creatinine, urea and electrolytes). Lab parameters, spot urine albumin creatinine ratio and GFR by DTPA scan pre (10-14 weeks) and post (11-13 weeks) nephrectomy were compared and analysed. P values were calculated using paired t test.

**Results:** Mean age of donors was 49.1±15.38 (range 23-73) years. Pre-Nephrectomy, mean total GFR by DTPA scan was 101.7 ml/min (±9.28) which reduced to 61.13 ml/min (±5.87), a 40% decline in total GFR was noticed, 11-13 weeks after Nephrectomy. Mean serum creatinine pre and post donor Nephrectomy was 0.73 mg/dl (±0.94) and 0.96mg/dl(±0.54) respectively, with a significant mean rise of 0.23 mg/dl. Mean GFR of the remnant kidney increased by + 9.64 ml/min (± 6.36), 11-13 weeks post Donation. Urinary Albumin Creatinine ratio pre and post Nephrectomy was 15.25 (±17.08) and 22.19 (±20.45) ug/mg respectively.

**Conclusions:** The mean total GFR reduced significantly by 40.5%(P<0.0001), however a significant increase in mean GFR of remnant kidney by 9.64 ml/min(±6.36) (P<0.001) 11 to 13 weeks Post Nephrectomy was seen. This average increase in GFR

was not significantly higher in young donors as compared to older donors(P<0.9). There was no significant difference in Urinary Albumin creatinine ratio pre and post nephrectomy(P<0.06). A better understanding of trends and variations observed in post donation GFR over time can aid in analysing effect of compensatory changes in GFR, which can benefit Living related kidney donors, in monitoring and patient care.

## SA-PO814

## A Social Network Analysis of Barriers to Requesting or Accepting an Offer for a Living Donor Kidney Transplant for People With ESKD

Briana E. Lee,<sup>1</sup> Heather M. Gardiner,<sup>2</sup> Crystal A. Gadegebu,<sup>3</sup> Peter P. Reese,<sup>4</sup> Zoran Obradovic,<sup>5</sup> Edward L. Fink,<sup>6</sup> Avrum Gillespie.<sup>1</sup> <sup>1</sup>Lewis Katz School of Medicine at Temple University, Philadelphia, PA; <sup>2</sup>Temple University College of Public Health, Philadelphia, PA; <sup>3</sup>Cleveland Clinic, Cleveland, OH; <sup>4</sup>University of Pennsylvania Perelman School of Medicine, Philadelphia, PA; <sup>5</sup>Temple University, Philadelphia, PA; <sup>6</sup>Temple University, Philadelphia, PA.

**Background:** Living donor kidney transplant (LDKT) is the optimal but underutilized treatment for end-stage kidney disease (ESKD). Most living kidney donations come from a patient's social network through donation offers or requests. Our study aims to identify barriers to living kidney donations by analyzing a patient's social network.

**Methods:** Data were collected via cross-sectional survey of hemodialysis patients at two facilities. We used a multilevel binary logistic regression model to examine from which network member a participant would accept a living donation offer from or make a living donor request to. The independent variables included mean strength of relationships in the network, cohabitation, and emotional support. Confounding variables included patient demographic factors. We performed a qualitative analysis of open-ended responses to assess reasons for declining an offer or non-request.

**Results:** The mean age of 106 patients is 60; 55% are female, 75% self-identify as Black, 16% made a living donor request. The mean network size is 4.6, 70% of the network was eligible for donation, 8% of network members received a donation request, 21% of members offered with 41% of total offers accepted. 73% of members did not offer or receive a request. The odds of accepting an offer or receiving a request is higher for members who lived with the patient (OR: 3.58, 95% CI: 1.07-12.0) and with greater network strength (OR: 3.38, 95% CI: 1.47-7.79). In addition, the odds of accepting an offer or requesting was lower for members that provided the patient with emotional support (OR: 0.15, 95% CI: 0.05-0.44). Feeling guilty/concerned for the donor is the most common reason for declining an offer (48%) or not requesting (28%).

**Conclusions:** Patients with stronger relationships in their network were more likely to accept an offer or request. However, participants were less likely to accept an offer or request from network members that provided emotional support because of guilt/concern for the member. Further network interventions to strengthen relationships, assist in identifying potential donors within the network and alleviate concerns about donation for the patient and their networks may help overcome social barriers to LDKT.

**Funding:** NIDDK Support

## SA-PO815

## Efficacy of Remote Ischemic Preconditioning in Living Donor Renal Transplantation: A Randomized Controlled Trial

Anurag Gupta, Nikita Pawar, Vaibhav Tiwari, Vinant Bhargava, Manish Malik, Anil Bhalla, Ashwani Gupta, Devinder S. Rana. *Sir Ganga Ram Hospital, New Delhi, India.*

**Background:** In kidney transplantation, ischemia-reperfusion injury (IRI) is an inevitable complication. However, paradoxically, an additional injury occurs upon reperfusion which limits the amount of tissue that can be salvaged. This is termed 'ischemia-reperfusion injury' (IRI). Different strategies have been tried to reduce ischemic reperfusion injuries. Ischemic preconditioning is one of such strategies. Thus, we have conducted RIPC, a randomized controlled trial in patients undergoing renal transplantation.

**Methods:** A randomized controlled trial was done to assess the efficacy and safety of remote ischemic preconditioning in living donor renal transplantation from June 2020 to September 2021. This study was conducted on a total of 110 ABO compatible live donor kidney transplant recipients. Randomization was done, 58 patients in the RIPC group and 52 patients in the control group were studied. They were followed for 3 months of study. primary objective- the proportion of patients achieving a 50% decline in serum creatinine level at 72 hours after transplantation and oliguria on day 1, 2 and 3. secondary objective-eGFR at 3 months of transplantation, acute rejections, and delayed graft function.

**Results:** The mean age in both groups was comparable (37.09 vs 38.3 years) All patients showed a >50% decline in creatinine level at 72 hours of transplant. The mean serum creatinine on day 7 of transplant level in the RIPC group was 1 mg/dL and 1.1 mg/dL in the control group. There was no oliguria in 1st 3 days. There was no difference in urine output in both groups. The stable graft function was present in 83.6% of cases. It was higher in the RIPC group compared to the control group (p=0.08). Delayed graft function was present in 3.8% of cases in the control group and 1.7% in the RIPC group (p=0.9). Similarly, slow graft function was present in 17.3% in the control group while 10.3% in the RIPC group (p=0.8). The mean serum creatinine level in both groups was the same at 3 months, 1.2 mg/dL. Acute tubular necrosis was the most common finding on biopsy (63.6%). Acute rejections were similar in both the groups (2 vs 3; p=0.9)

**Conclusions:** There was no effect of RIPC on slow graft function, rate of fall of creatinine, graft function and rate of rejection at 3 months.

SA-PO816

**How Do Kidney Transplant Attitudes and Behaviors Affect Popularity and Influence Within the Hemodialysis Clinic Social Network?**

Hannah Calvelli,<sup>1</sup> Avrum Gillespie,<sup>1</sup> Heather M. Gardiner,<sup>2</sup> Crystal A. Gadegbeku,<sup>3</sup> Peter P. Reese,<sup>4</sup> Zoran Obradovic,<sup>5</sup> Edward L. Fink.<sup>5</sup>  
<sup>1</sup>Lewis Katz School of Medicine at Temple University, Philadelphia, PA; <sup>2</sup>Temple University College of Public Health, Philadelphia, PA; <sup>3</sup>Cleveland Clinic, Cleveland, OH; <sup>4</sup>University of Pennsylvania, Philadelphia, PA; <sup>5</sup>Temple University, Philadelphia, PA.

**Background:** Patient social networks in hemodialysis clinics may facilitate the spread of information, attitudes, and behaviors surrounding kidney transplantation. Identifying influential social network members is an important first step for future transplant interventions among hemodialysis patients. In this study, we mapped the social networks of two different hemodialysis facilities to identify which patients could be the most influential. We used in-degree centrality (identified most frequently by other network members) as a proxy for popularity and influence.

**Methods:** We conducted a cross-sectional social network survey of hemodialysis patients in two geographically and demographically different hemodialysis facilities. We evaluated the demographic and clinical differences between the two facilities using univariate statistics. We used regression models to determine the relationship between in-degree centrality and kidney transplant-related variables.

**Results:** A total of 111 patients were surveyed, with 71 at facility 1 and 40 at facility 2. The mean age was 60.1 ± 13.0 years old. Half (55.0%) identified as male. 73% of participants identified as Black. In-degree centrality was higher in facility 1 (1.1 ± 1.2) compared to facility 2 (0.6 ± 0.9). Facility 1 had a greater percentage of patients who reported being on the kidney transplant waitlist than facility 2 (51% vs. 20%, p = 0.02). Patients at facility 1 also knew more people who have had a successful kidney transplant and placed a higher importance on receiving a kidney transplant compared to patients at facility 2 (Median 1 [0-30] vs. 0 [0-4], p = 0.002). Participants who knew more successful kidney transplants had higher in-degree centrality (β 0.11, 95% CI [0.05-0.17], p = 0.003). Those who had completed more steps in the transplant process also had higher in-degree centrality (β 0.11, 95% CI [0.02-0.20], p = 0.02).

**Conclusions:** In-degree centrality is associated with positive attitudes and behaviors towards kidney transplantation and differs between facilities. Patients with high in-degree centrality within the hemodialysis social network have the potential to influence other patients' attitudes and behaviors towards kidney transplant via social network interventions.

**Funding:** NIDDK Support

SA-PO817

**Detection of Transmissible Severe Acute Respiratory Syndrome Coronavirus-2 (SARS-CoV-2) in Blood and Biopsies From Deceased Kidney Donors**

Ambreen Azhar,<sup>1</sup> Shiba Khorsandi,<sup>1</sup> Irfan A. Moinuddin,<sup>1</sup> Miklos Z. Molnar,<sup>2</sup> Marlon F. Levy,<sup>1</sup> Bekir Tanriover,<sup>3</sup> Gaurav Gupta.<sup>1</sup> <sup>1</sup>Virginia Commonwealth University, Richmond, VA; <sup>2</sup>University of Utah Health, Salt Lake City, UT; <sup>3</sup>Banner University Medical Center Tucson, Tucson, AZ.

**Background:** We recently reported that in United States, 388 organs from SARS-CoV-2 nucleic acid test (NAT) positive 150 donors were procured between Aug 2020 to Sep 2021. Nearly 1 million deaths have been attributed to SARS-CoV-2 pandemic however only selected group of donor organs were assessed for transplantation. Even after procurement, 28% (of 388) organs were discarded. For kidney transplants (KT), commonest reason for relatively high-quality organ discards (35%) was 'exhaustion of wait list', indicating reluctance to accept these organs.

**Methods:** We investigated potential risk of donor transmission of SARS-CoV-2 by a prospective study including 23 KT recipients with prior SARS-CoV-2 vaccination. Donor serum and pre-implantation kidney biopsy tissue were assessed for detection of SARS-CoV-2 via a validated commercially available real-time reverse transcription polymerase chain reaction (RT-PCR) (threshold 73 copies/mL). All recipients had SARS-CoV-2 RT-PCR on plasma and nasopharyngeal swab at Day-7 post-KT.

**Results:** A total of 23 KT were performed from 22 SARS-CoV-2 NAT positive donors between Nov 2021 and Feb 2022. All 22-donor serum samples and 23 procurement biopsies were negative for SARS-CoV-2, including those from 8 donors with symptomatic disease. Six (of 22 donors; 27%) had death attributable to SARS-CoV-2 complications. Three recipients with asymptomatic donors were diagnosed with clinical SARS-CoV-2 disease at 10, 14, and 23 days post-KT during 4<sup>th</sup> pandemic surge. Both graft and patient survival rate was 100% at a median 3 month followup. Collation with national 'Organ Procurement and Transplant Network' registry showed that majority of other organs from these donors were not procured [zero pancreata, zero lungs, 11 (50%) livers, 19 (86%) hearts]. Among 42 KT [55% (23/42) performed at our center], 10 transplanted livers, and 3 hearts; no graft loss or death was reported.

**Conclusions:** In this single-center study we report an absence of detectable SARS-CoV-2 virus in donor kidney tissue and plasma from SARS-CoV-2 positive donors and absence of recipient viremia and nasopharyngeal detectable virus immediately after KT indicating a lack of donor transmission. Our results of excellent graft and patient survival favor utilization of SARS-CoV-2 infected donors.

SA-PO818

**Transplant or Discard: Pathology From a Single Biopsy Should Not Influence Decision to Discard**

Stephen C. Muzyka,<sup>1</sup> Gavin T. Oxley,<sup>1</sup> Hannah Morrison,<sup>1</sup> Helen P. Cathro,<sup>2</sup> Kimberly Deronde,<sup>3</sup> Aleksandra Cwiek,<sup>1</sup> Kevin M. Bennett,<sup>4</sup> Jennifer R. Charlton.<sup>3</sup> <sup>1</sup>University of Virginia, Charlottesville, VA; <sup>2</sup>UVA Health, Charlottesville, VA; <sup>3</sup>University of Virginia Children's Hospital, Charlottesville, VA; <sup>4</sup>Washington University in St Louis, St Louis, MO.

**Background:** Thousands of patients die awaiting a transplant, while 20% of kidneys are discarded. Glomerulosclerosis (GS) and interstitial fibrosis with tubular atrophy (IFTA) are the main reasons to discard kidneys. Histologic risk scores have been developed, but assume a single biopsy represents the whole kidney. The variance of pathology from high risk kidneys, representing the reproducibility of a decision to transplant based on biopsy, has not been evaluated. Here, we measured the variance of pathology in KPDI≥85 kidneys to determine the effect on discard decisions.

**Methods:** Kidneys unsuitable for transplant (some non-renal reasons) were acquired (n=26, 18 donors). KDPI was calculated. Three needle biopsies were performed. A renal pathologist identified GS. IFTA was measured with Amira software.

**Results:** Table 1 has donor demographics. The intra- and inter-kidney variance of GS was large (Figure). There was no difference in the %GS or variance in those with KDPI<85 vs ≥85 (p=0.65). Four KDPI≥85 kidneys had GS scores of ≤20% in all biopsies. IFTA variance was greater in KDPI<85 vs. ≥ 85 (p=0.02).

**Conclusions:** A single biopsy does not represent whole kidney pathology. Pathologic findings from a single biopsy should not guide decisions to discard potentially suitable kidneys. These data, and observations that biopsy findings do not predict transplant outcomes, highlight the need for tools to measure whole kidney pathology to identify transplantable kidneys.

**Funding:** NIDDK Support

	KDPI<85% (n=9)	KDPI≥85% (n=17)
sex (male, %)	89	24
age (mean±SD)	49±7	67±9
ethnicity (white, %)	89	59
hypertension (yes, %)	22	73
diabetes (yes, %)	0	20
pair of kidneys (n)	2	6

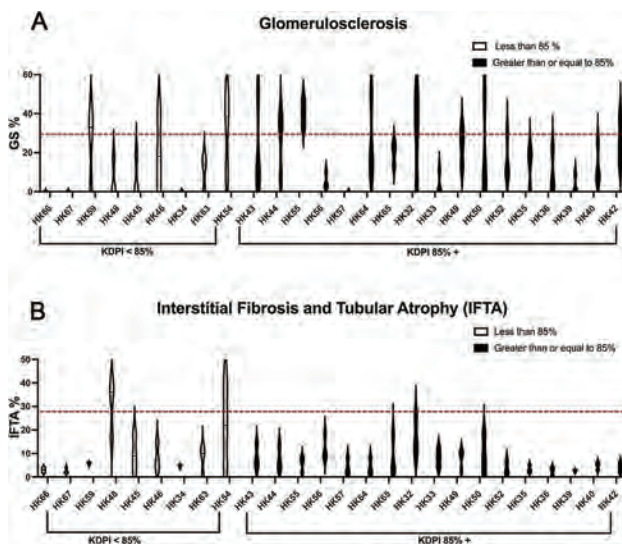

SA-PO819

**Addressing the Organ Shortage, Increasing Transplant Longevity, and Enabling Minimally Invasive Kidney Transplantation: Ex Vivo Validation of a Kidney Anastomosis Facilitation and Cooling Device**

Keith S. Hansen,<sup>1,2</sup> James M. Gardner.<sup>1</sup> <sup>1</sup>University of California San Francisco, San Francisco, CA; <sup>2</sup>Stanford University, Stanford, CA.

**Background:** Kidneys are particularly susceptible to anoxic damage and ischemia due to their aerobic metabolism. Hypothermia protects against anoxia by reducing the energy dependent metabolic activities. The warming of a donor kidney during the vascular anastomosis of a transplant i.e., second warm-ischemia time (SWIT), is independently associated with higher rates of delayed graft function, premature graft failure, and the discard of high-risk kidneys. SWIT is protracted in patients with complex anatomy, obesity, and in minimally invasive transplantation. Elimination of SWIT via intra-operative thermal regulation can increase the donor pool and proffer significant cost-savings.

**Methods:** ASTS surgeons (n=185) and transplant nephrologists were surveyed to determine the needs-criteria for a device. A prototype applied to the kidney immediately prior to anastomosis was built using stretchable hydrogel and phase-change gel. Adult porcine kidneys were used to test the device in a validated retroperitoneal-model placed

within a water bath at 37°C (98.6°F). Core temperatures were monitored using implanted probes at 30 second intervals. Time to reach the maximum ischemic threshold of necrosis (15°C, 59°F) was compared to an ice + gauze control.

**Results:** The needs-criteria for the device were addressed with a retraction handle, no tubing, a low profile, and a flexible material to accommodate variable kidney sizes. The device-covered kidneys (n=3) did not reach the ischemic threshold at the 60-minute cutoff and remained below 6°C compared with the ice + gauze covered control kidneys (17±1.8 minutes, n=3, p <0.001).

**Conclusions:** A breakthrough designated medical device to facilitate the vascular anastomosis and eliminate SWIT was successfully developed. Device-covered kidneys remained well below the ischemic threshold of necrosis for a duration exceeding 95% of vascular anastomoses. Use of this device will enhance the surgical workflow and enable minimally-invasive transplantation and has the potential to significantly impact rates of delayed graft function, organ longevity, and organ acceptance practices.

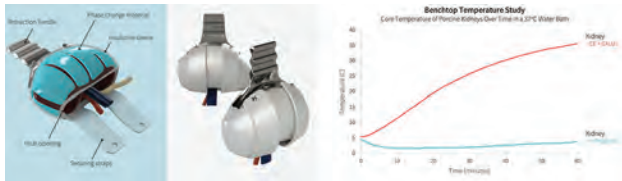

Cooling Device

SA-PO820

**Factors Enabling Transplant Program Participation in the Scientific Registry of Transplant Recipients (SRTR) Living Donor Collective: A National Survey**

Krista L. Lentine,<sup>1</sup> Mary amanda Dew,<sup>2</sup> Addie Wisniewski,<sup>1</sup> Macey L. Henderson,<sup>3</sup> Fawaz Al Ammary,<sup>4</sup> Asif A. Sharfuddin,<sup>5</sup> Bertram L. Kasiske.<sup>6</sup>  
<sup>1</sup>Saint Louis University School of Medicine, Saint Louis, MO; <sup>2</sup>University of Pittsburgh, Pittsburgh, PA; <sup>3</sup>New York University, New York, NY; <sup>4</sup>Johns Hopkins University, Baltimore, MD; <sup>5</sup>University of Indiana, Indianapolis, IN; <sup>6</sup>Hennepin Healthcare, Minneapolis, MN.

**Background:** The Scientific Registry of Transplant Recipients (SRTR) Living Donor Collective (LDC), the first effort to create a lifetime registry for living donor candidates in the United States, requires transplant centers to register candidates while the SRTR conducts follow-up

**Methods:** To better understand facilitators and barriers to program participation, we conducted a brief electronic survey of U.S. transplant program staff (10/26/2021–12/17/2021).

**Results:** We received 132 responses, with at least one response from 87 living donor programs (46 kidney programs, 33 kidney and liver programs, and 8 liver programs alone). We found 86% of program representatives strongly agreed or agreed that funding adequate to cover the cost of data collection would facilitate LDC participation, 92% agreed or strongly agreed with importance of electronic data submission options, and 74% reported that elimination of requirements to submit duplicative pre-operative information to the Organ Procurement and Transplantation Network (OPTN) would be helpful. Other potentially enabling factors include reduction in duration of OPTN follow-up requirements, ease-of-use, protection from data use for regulation, adequate data security, and equity in data access. Responses did not differ significantly when stratified by program type (Figure), role, volume and follow-up success.

**Conclusions:** Collaboration and investment to overcome barriers to program LDC participation are vital to generate long-term data on living donation for donor candidates, donors, and patients in need of transplant.

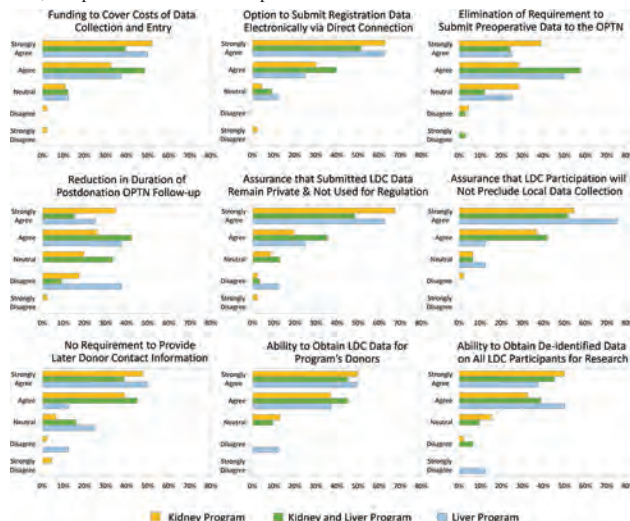

SA-PO821

**Long-Term Outcomes for Living Kidney Donors With Early Guideline-Concordant Follow-Up Care**

Anisha Dhalla,<sup>1</sup> Anita Lloyd,<sup>4</sup> Krista L. Lentine,<sup>2</sup> Amit X. Garg,<sup>3</sup> Robert R. Quinn,<sup>1</sup> Pietro Ravani,<sup>1</sup> Scott Klarenbach,<sup>4</sup> Brenda Hemmelgarn,<sup>4</sup> Ngan Lam.<sup>1</sup>  
<sup>1</sup>University of Calgary Cumming School of Medicine, Calgary, AB, Canada; <sup>2</sup>Saint Louis University School of Medicine, Saint Louis, MO; <sup>3</sup>Western University Schulich School of Medicine & Dentistry, London, ON, Canada; <sup>4</sup>University of Alberta Department of Medicine, Edmonton, AB, Canada.

**Background:** Current guidelines recommend that living kidney donors receive lifelong annual follow-up care. In the United States, the reporting of complete clinical and laboratory data for kidney donors has been mandated for the first two years post-donation to improve adherence with follow-up; however, the long-term impact of early guideline-concordant care remains unclear.

**Methods:** We conducted a retrospective, population-based cohort study using linked healthcare databases in Alberta, Canada to compare long-term post-donation follow-up care and clinical outcomes of living kidney donors with and without early guideline-concordant care. The primary outcome was receipt of continued follow-up at 5 and 10 years after donation as defined by annual physician visits, serum creatinine, and albuminuria measurements (adjusted odds ratio with lower and upper 95% confidence limits, <sub>LCL</sub> aOR <sub>UCL</sub>).

**Results:** Of the 460 donors included in the study, 187 (41%) had clinical and laboratory evidence of guideline-concordant follow-up care throughout the first two years post-donation. The odds of receiving annual follow-up for donors without early guideline-concordant care were 76% lower at 5 years (aOR <sub>0.18</sub> <sub>0.24</sub> <sub>0.32</sub>) and 68% lower at 10 years (aOR <sub>0.22</sub> <sub>0.32</sub> <sub>0.40</sub>) compared to donors with early care. The odds of continuing follow-up remained stable over time for both groups. Early guideline-concordant follow-up care did not substantially influence estimated glomerular filtration rate (eGFR) or hospitalization rates over the longer term.

**Conclusions:** Although policies directed towards improving early donor follow-up may encourage continued follow-up, additional strategies may be necessary to mitigate lifetime donor risks.

**Funding:** Government Support - Non-U.S.

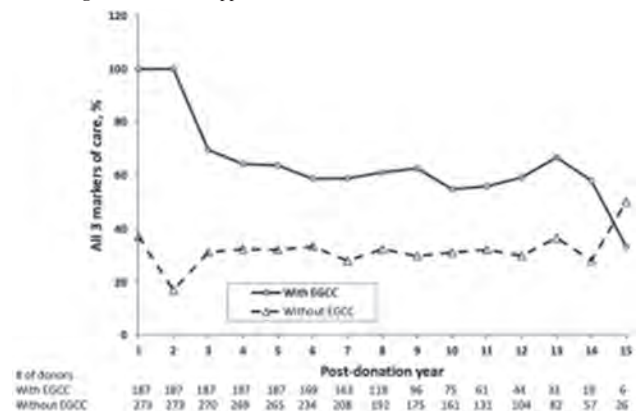

Proportion of living kidney donors with 3 markers of follow-up care (physician visit, serum creatinine and albuminuria measurement) during each post-donation year stratified by those with and without early guideline-concordant care (EGCC).

SA-PO822

**Risk Factors for Developing Low eGFR and Albuminuria in Living Kidney Donors**

Anisha Dhalla, Huda Al-Wahsh, Ngan Lam. University of Calgary Cumming School of Medicine, Calgary, AB, Canada.

**Background:** Chronic kidney disease is associated with significant morbidity and mortality in the general population, but little is known about the incidence and risk factors associated with developing kidney dysfunction in living donors following nephrectomy.

**Methods:** We conducted a retrospective, population-based control study using linked healthcare databases in Alberta, Canada to identify 590 donors who underwent nephrectomy between May 2001 and December 2017. The primary outcome was evidence of sustained kidney dysfunction following nephrectomy, defined as either 2 estimated glomerular filtration rate (eGFR) measurements <45 mL/min/1.73 m<sup>2</sup> or 2 measurements of moderate or severe albuminuria that were at least 90 days apart. We used Cox proportional hazard regression analyses to examine the association between potential risk factors and the outcome of post-donation kidney dysfunction.

**Results:** Over a median follow-up period of 8.6 years (interquartile range [IQR]: 4.7-16.9 years), 47 donors (8.0%) developed sustained kidney dysfunction, with an incidence rate of 9.2 per 1,000 person-years (95% confidence interval: 6.6-11.8). The median time for development of kidney dysfunction beyond the first year after nephrectomy was 2.9 years (IQR: 1.4-8.0 years). Donors who developed kidney dysfunction after donation were more likely to be older, male, have lower pre-donation eGFR, have evidence of pre- or post-donation hypertension, and post-donation diabetes.

**Conclusions:** A small proportion of kidney donors will develop post-donation kidney dysfunction. Donors with risk factors associated with sustained kidney dysfunction may benefit from more diligent follow-up care.

**Funding:** Government Support - Non-U.S.

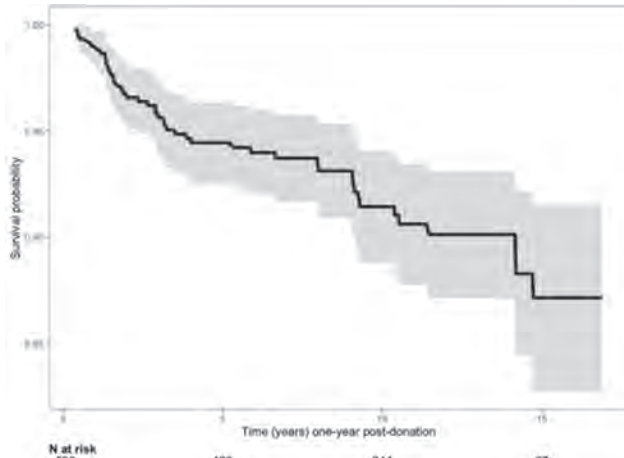

Kaplan-Meier curve with 95% confidence interval of estimated kidney dysfunction free survival in living kidney donors from one-year post-donation onwards.

**SA-PO823**

**Living Kidney Donor Candidates With Nephrolithiasis: Examination of Current Practices**

**Matthew Howard,<sup>1</sup> Andrew D. Rule,<sup>5</sup> Nan Zhang,<sup>2</sup> Matthew D'Costa,<sup>5</sup> Hasan Khamash,<sup>3</sup> Hani Wadei,<sup>4</sup> Ivan E. Porter,<sup>4</sup> Caroline Jadlowiec,<sup>6</sup> Mira T. Keddis,<sup>3</sup>** <sup>1</sup>Mayo Clinic School of Medicine - Scottsdale Campus, Scottsdale, AZ; <sup>2</sup>Mayo Clinic Department of Quantitative Health Sciences, Scottsdale, AZ; <sup>3</sup>Mayo Clinic Department of Nephrology and Hypertension, Scottsdale, AZ; <sup>4</sup>Mayo Clinic Department of Nephrology and Hypertension, Jacksonville, FL; <sup>5</sup>Mayo Clinic Department of Nephrology and Hypertension, Rochester, MN; <sup>6</sup>Mayo Clinic Department of Transplant Surgery, Phoenix, AZ.

**Background:** There are currently no universal standards regarding acceptance policies for potential kidney donors with nephrolithiasis. The objective of this study was to describe the acceptance practices at a large center and factors associated with being denied to donate.

**Methods:** 446 adult potential living kidney donors evaluated between 2000 and 2016 with either a personal history or radiological evidence of nephrolithiasis were included. We assessed whether various clinical characteristics and risk factors for stone recurrence including stone size, stone number, and history of symptomatic stone events affected the selection committee's final decision.

**Results:** Mean age was 46.0 years (SD 11.7), 247(55.4%) were female, 391(87.7%) were white. 297 (67%) were approved for donation. Of the 149 who were denied, 75 (50%) were denied specifically due to kidney stones and 74 (50%) were denied for other reasons. When comparing the group that was denied due to kidney stones with the approved group, the number of symptomatic stone events (p=0.01), number of stones present on CT (p<0.001), stone diameter (p<0.001), and bilaterality (p<0.001) were all significantly associated with denial. Donor age, sex, family history of stones, presence of medullary sponge kidney, and history of hematuria were not significant predictors of denial. On multivariate analysis, symptomatic stone event (OR 2.3 (95% CI 1.16, 4.56), p=0.017), bilateral kidney stones (OR 4.39 (95% CI 1.78, 11.7), p=0.002) and diameter of largest stone ≥3mm (OR 5.23 (95% CI 2.86, 9.68), p<0.001) were independent predictors of denial due to kidney stone risk.

**Conclusions:** Most patients seeking to donate a kidney with either a personal history or radiological evidence of nephrolithiasis were approved. Symptomatic stone events, bilateral stones, and stone size ≥3mm negatively influenced donor candidacy. Future studies to assess risk of stone recurrence and related morbidity among those who were approved and those who were denied will better inform selection committee.

**Table 1. Risk Factors comparison by Approved vs. Denial due to kidney stone group**

Variables of interest	Approved (N=297)	Denial due to kidney stone (N=75)	Total (N=372)	p value
Symptomatic stone events, n (%)	64 (21.5%)	26 (34.7%)	90 (24.2%)	0.018
Number of symptomatic stone events >= 2	16 (5.4%)	10 (13.3%)	26 (7.0%)	0.023
Medullary sponge kidney	16 (5.4%)	8 (10.7%)	24 (6.5%)	0.113
Number of stones present on CT, mean (SD)	1.3 (1.3)	3.3 (3.4)	1.7 (2.0)	< 0.001
Number of stones present on CT >= 2	73 (24.6%)	50 (66.7%)	123 (33.1%)	< 0.001
Bilateral kidney stones	35 (12.1%)	41 (54.7%)	77 (20.7%)	< 0.001
Diameter of largest stone on CT, mean (SD) mm	1.6 (1.2)	3.9 (3.6)	2.1 (2.1)	< 0.001

**SA-PO824**

**Distinct Phenotypes of Kidney Retransplantation by Machine Learning Consensus Clustering in the United States**

**Michael A. Mao,<sup>1</sup> Shennen Mao,<sup>1</sup> Charat Thongprayoon,<sup>2</sup> Pradeep Vaitla,<sup>3</sup> Caroline Jadlowiec,<sup>4</sup> Prakrati C. Acharya,<sup>5</sup> Napat Leeaphorn,<sup>6</sup> Wisit Kaewput,<sup>7</sup> Patharawin Pattharanitima,<sup>8</sup> Wisit Cheungpasitporn,<sup>2</sup>** <sup>1</sup>Mayo Clinic, Jacksonville, FL; <sup>2</sup>Mayo Clinic Minnesota, Rochester, MN; <sup>3</sup>University of Mississippi Medical Center, Jackson, MS; <sup>4</sup>Mayo Clinic Arizona, Scottsdale, AZ; <sup>5</sup>Texas Tech Health Sciences Center, El Paso, TX; <sup>6</sup>St. Luke's Health System, Kansas City, MO; <sup>7</sup>Phramongkutklao College of Medicine, Bangkok, Thailand; <sup>8</sup>Thammasat University, Pathum Thani, Thailand.

**Background:** The application of machine learning may provide a novel understanding of unique phenotypes of kidney retransplant recipients that will allow identification of new strategies to improve outcomes. Our study aimed to characterize kidney retransplant recipients using an unsupervised machine learning approach.

**Methods:** We performed consensus cluster analysis using recipient-, donor-, and transplant-related characteristics in 17,443 kidney retransplant recipients from the 2010-2019 OPTN/UNOS database. We identified each cluster's key characteristics using the standardized mean difference of >0.3. Posttransplant outcomes including acute allograft rejection, death-censored graft failure, and mortality were compared among the assigned clusters.

**Results:** Consensus cluster analysis identified three distinct clusters of kidney retransplant recipients. The key characteristics of cluster 1 were white patients who received pre-emptive kidney retransplant or had dialysis duration less than 1 year before receiving kidney retransplant from living, female, and older donors. Cluster 1 patients had lower PRA, cold ischemia time, use of kidney machine perfusion, and occurrence of delayed graft function, but had more private insurance. In contrast, cluster 2 patients had higher PRA and received kidney retransplant from non-ECD deceased donors with a lower number of HLA mismatches. Cluster 3 patients received kidney retransplant from non-ECD deceased donors with a higher number of HLA mismatches. Cluster 1 had the most favorable patient and graft survival while cluster 3 had the worst patient (HR 2.17) and graft survival (HR 2.64).

**Conclusions:** Unsupervised machine learning approach characterized kidney retransplant recipients based on their pattern of clinical characteristics into three clinically distinct clusters with differing posttransplant outcomes.

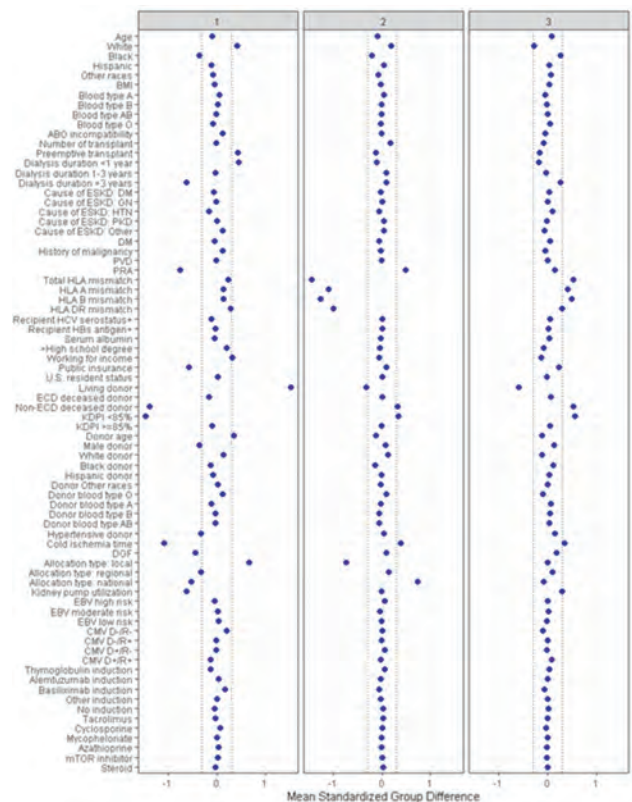

Standardized differences across the three clusters for each baseline parameter.



SA-PO825

Using Twitter for Kidney Transplant: A Tweet Analysis for Living Donation

Everly Ramos,<sup>1</sup> Dillon Corrigan,<sup>2</sup> Anne M. Huml,<sup>1</sup> Liza Cholin,<sup>1</sup> <sup>1</sup>Cleveland Clinic, Cleveland, OH; <sup>2</sup>Cleveland Clinic Department of Quantitative Health Sciences, Cleveland, OH.

**Background:** Social media is increasingly utilized by patients, health-care providers, and medical centers to disseminate information. This study aimed to describe Twitter conversations relating to kidney transplant and specifically, living kidney donation.

**Methods:** Using the open-source snscrape tool, we identified twitter posts between February 2021 and February 2022 that contained the hashtags “living donor,” “live donor,” “living kidney donor,” “live kidney donor,” “kidney donor,” or “kidney transplant.” A descriptive analysis was done on the tweets using the R statistical software.

**Results:** A total of 6,773 unique tweets were generated. 70.8% of tweets contained the hashtag “kidney transplant.” The most popular terms used were “kidney,” “transplant,” and “donor.” Peaks in tweet volumes were noted around World Kidney Day and on the event of a pig kidney xenotransplantation (Fig 1). The top Twitter users were private nephrology practices in the US. Sentiment analysis on the tweets in English language showed a general positive sentiment about living kidney organ donation (Fig 2).

**Conclusions:** There is a lot of positive discussion on Twitter relating to living kidney donation. Further research is needed to determine the impact these social media conversations have on actual donation.

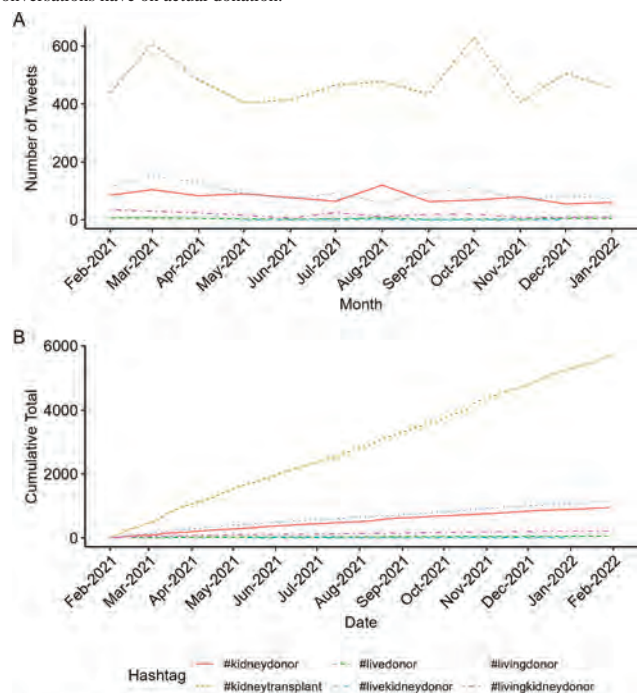

Figure 1. (A) Monthly tweet count; and (B) cumulative total tweet count by hashtag.

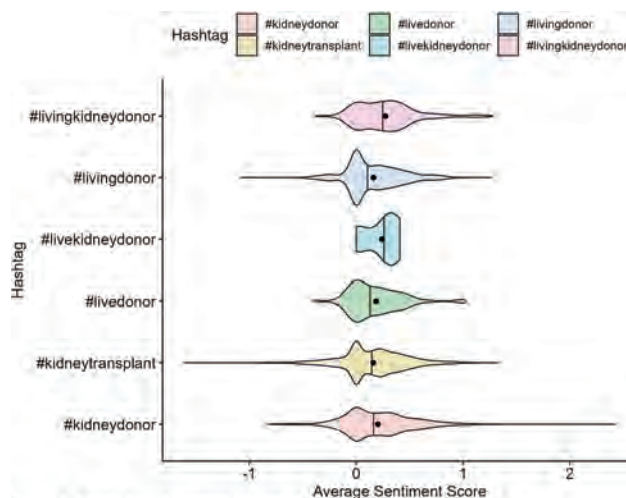

Figure 2. Distribution of Average Sentiment Score by Hashtag. Vertical line represents median; dot represents mean.

SA-PO826

BK Polyomavirus (BKPyV) and Cytomegalovirus (CMV) Infections in Kidney Transplantation (KT) From Hepatitis C Positive (HCV) Viremic Donors to Uninfected Recipients

Viralkumar Amrutiya, Idris Yakubu, Irfan A. Moinuddin, Marlon F. Levy, Gaurav Gupta, Ambreen Azhar. Virginia Commonwealth University, Richmond, VA.

**Background:** KT from HCV viremic donor to uninfected recipients (D+/R-) is becoming more common across United States. Recent ‘transmit-and-treat’ studies suggest that donor HCV might be associated with an increased risk of BKPyV and CMV infections due to the suppression of host immune response by HCV. We have previously reported HCV transmission rate of only 9% with ultra-short pangenotypic Direct Acting Antiviral prophylaxis (DAA) of 2-7days. Here we report the incidence of BKPyV and CMV infections in this cohort in comparison with a matched cohort (1:1) of HCV D-/R- KT recipients.

**Methods:** All patients received rabbit anti-thymocyte globulin followed by tacrolimus, mycophenolate and prednisone. D-/R- recipients (controls) were matched with cases (D+/R-) in a 1:1 distribution based on; waitlist time, ‘kidney-only’ transplant with ≤1 previous organ transplant, pre-transplant diabetes, Expected Post Transplant Survival category in four quantiles, calculated Panel Reactive Antibodies <50%; negative crossmatch, and Donor Specific Antibodies (DSA) at transplant ≤3000 MFI.

**Results:** A total of 102 D+/R- transplants were included as; Group 1 (2-4d prophylaxis (ppx); N=52) and Group 2 (7d ppx; N=50). All 9 patients that developed viremia achieved sustained virologic response post-full course DAA. Controls were more likely to be African American (73% vs 59%; p=0.04), with pre-formed DSAs (13% vs 3%, p=0.02) and higher Kidney Donor Profile Index (66 vs 56, p=0.001) compared to the cases. Recipients of HCV D+/R- had equivalent CMV infection (14% vs 14%, p=1.0) but less CMV disease vs controls (71% vs 29%, p=0.05) amongst those who developed viremia. There was a numerically higher incidence of any BKPyV infection (20% vs 12%, p=0.12), and high plasma titer BKPyV ≥10000 (12% vs 6%, p=0.21) in the D+/R- group compared with D-/R- group that did not reach statistical significance.

**Conclusions:** We did not find increased risk of CMV infections however numerical trend for increased BKPyV was seen predominantly in patients without HCV replication in (D+/R-) recipients suggesting either lack of HCV replication may be protective against CMV, or apparent increased risk of opportunistic viral infections due to unmeasured confounders in patient selection.

SA-PO827

Survival Differences in Elderly Patients on Renal Replacement Therapy

Erzsi Tegzess,<sup>1</sup> Hessel Peters-Sengers,<sup>2</sup> Robert Pol,<sup>1</sup> Jan-Stephan Sanders,<sup>1</sup> Stefan P. Berger.<sup>1</sup> <sup>1</sup>Universitair Medisch Centrum Groningen, Groningen, Netherlands; <sup>2</sup>Amsterdam UMC Locatie AMC, Amsterdam, Netherlands.

**Background:** Rising numbers of elderly patients (≥65 years) are in need of renal replacement therapy (RRT), with a growing proportion being waitlisted for kidney transplantation. To date little is known about the effect of living versus deceased donor kidney transplantation in these recipients. This study investigated the differences in patient survival between elderly kidney transplant recipients with a living donor (LDK), a young (<65, YDK) or an old (≥65, ODK) deceased donor kidney and compared it to waitlisted dialysis patients (≥63).

**Methods:** In this nation-wide retrospective cohort study survival was investigated using a multi-state model with Cox regression analysis in elderly patients waitlisted and transplanted between 2000 and 2019 in the Netherlands.

**Results:** 4138 patients were included in this study (65.5% male, age 68 [65-71]), with 1374 (33.2%) remaining waitlisted. Out of the 2762 (66.7%) patients who received a kidney transplant, 1095 (39.6%) had a LDK, 672 (24.3%) a YDK and 997 (36.1%) an ODK. Median patient survival from start of RRT in was significantly lower in patients remaining waitlisted (4.51 years) compared to those who received a transplant (9.54 years,  $p < 0.001$ ). Waiting time on dialysis was significantly longer for YDK [2.5 years (1.4-3.8)] and ODK [2.6 (1.7-3.7)] compared to LDK [0.0 (0.0-1.4)] recipients. 5 year survival from start of RRT did not differ significantly between donor types (82.4%), but median survival from start of RRT was significantly lower in ODK (8.88 years,  $p < 0.001$ ) patients compared to the LDK (10.06 years) and YDK (10.28 years) recipients. After correction for potential confounders, survival still did not differ significantly between LDK (Ref.) and YDK [HR 1.19 (0.99-1.44),  $p = 0.081$ ] recipients, but was lower in ODK [HR 1.67 (1.39-1.99)] recipients.

**Conclusions:** For elderly recipients starting RRT, there was a limited survival difference between donor categories, with slightly lower survival for ODK recipients. Additionally, deceased donor kidney recipients have a longer waiting time, which carries a significantly increased risk of mortality. However, ultimately, all donor types had satisfactory survival, with any type of transplantation having a clear survival benefit over dialysis.

**Funding:** Government Support - Non-U.S.

SA-PO828

**Effect of Pretransplant Dialysis Vintage on Clinical Outcomes in Deceased Donor Kidney Transplant**

Hee Won Noh, Soojee Jeon, Hee-Yeon Jung, Ji-Young Choi, Sun-Hee Park, Chan-Duck Kim, Yong-Lim Kim, Jeong-Hoon Lim, Jang-Hee Cho. *Kyungpook National University Hospital, Daegu, Republic of Korea.*

**Background:** The shortage of donor organs and the increase of waiting lists increase the waiting time for deceased donor kidney transplants (DDKT). We evaluated DDKT prognosis according to the pretransplant dialysis vintage.

**Methods:** A total of 4,117 first-time kidney transplant recipients were enrolled from a prospective nationwide cohort. DDKT recipients were divided into tertiles according to pretransplant dialysis duration. Graft failure, mortality, and composite were compared between DDKT and living donor kidney transplant (LDKT) recipients.

**Results:** Pretransplant dialysis vintage was longer annually in DDKT recipients. In the subdistribution of the hazard model for the competing risk (set as patient death), the first tertile did not show an increased risk of graft failure compared with LDKT recipients; however, the second and third tertile groups had an increased risk of graft failure compared to LDKT recipients (adjusted hazard ratio [aHR], 3.59; 95% confidence interval [CI], 1.69–7.63;  $P < 0.001$ ; aHR, 2.37; 95% CI, 1.06–5.33;  $P = 0.037$ ). All DDKT groups showed a significantly higher risk of patient death than LDKT, with the highest risk in the third tertile group (aHR, 11.12; 95% CI, 4.94–25.0;  $P < 0.001$ ). The risk of the composite of mortality and graft loss significantly increased in tertile order compared with LDKT recipients (all  $P < 0.05$ ).

**Conclusions:** A longer pretransplant dialysis period was associated with a higher risk of the composite of patient death and graft failure in DDKT recipients. DDKT after a short period of dialysis had non-inferior results on graft survival compared with LDKT.

**Funding:** Government Support - Non-U.S.

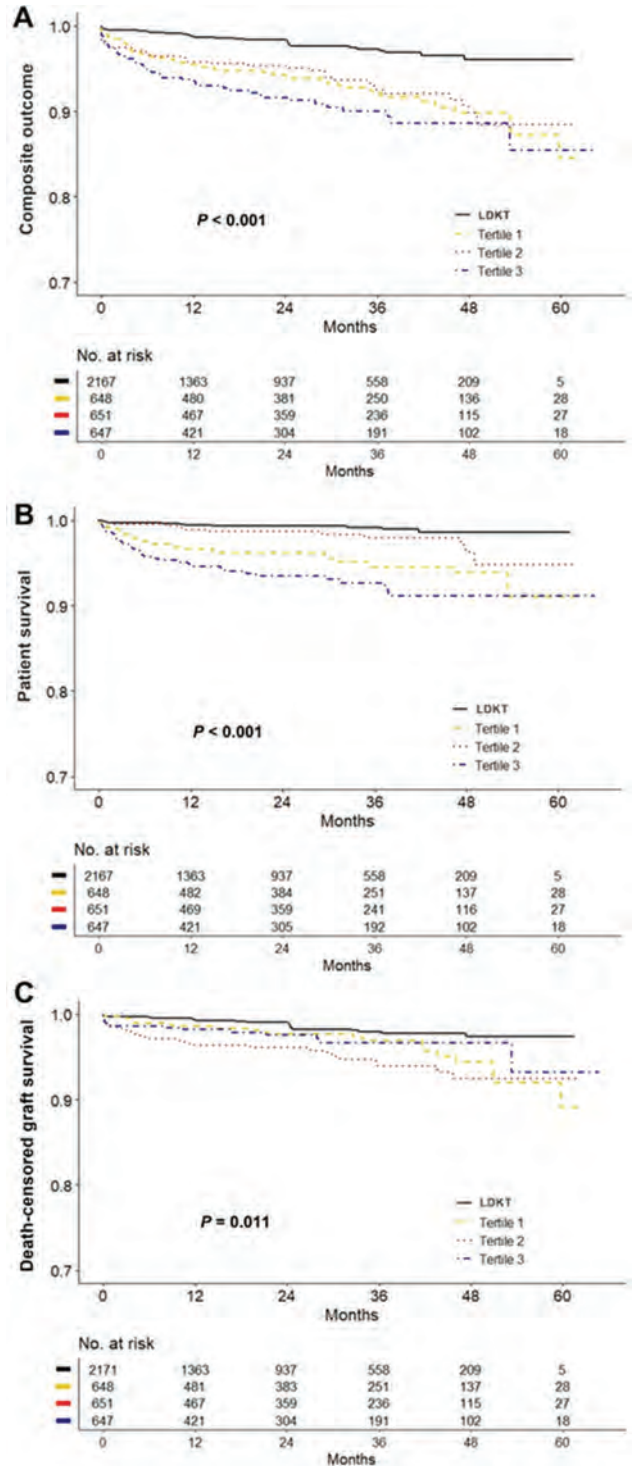

Kaplan–Meier curves for outcomes.

SA-PO829

**The Effect of Weight, Body Mass Index, and Body-Surface-Area on the Agreement Between Estimated and Measured GFR in Heart Transplant Recipients**

Morten B. Jørgensen,<sup>1</sup> Mads Hornum,<sup>1,2</sup> Lærke M. Nelson,<sup>3</sup> Bo Feldt-Rasmussen,<sup>1,2</sup> Kasper Rossing,<sup>3</sup> Esteban Porrini,<sup>4</sup> Finn Gustafsson.<sup>3</sup>  
<sup>1</sup>Department of Nephrology, Copenhagen University Hospital, Rigshospitalet, Copenhagen, Denmark; <sup>2</sup>Department of Clinical Medicine, University of Copenhagen, Copenhagen, Denmark; <sup>3</sup>Department of Cardiology, Copenhagen University Hospital, Rigshospitalet, Copenhagen, Denmark; <sup>4</sup>Faculty of Medicine, Instituto de Tecnologías Biomédicas (ITB), University of La Laguna, La Laguna, Spain.

**Background:** Assessing glomerular filtration rate (GFR) in heart transplant (HTx) recipients is paramount to adjust immunosuppressive, anti-bacterial, and anti-viral therapy. Estimated GFR (eGFR) has shown poor agreement with measured GFR (mGFR) in populations with changing body composition yielding HTx recipients at risk of suboptimal treatment as weight gain and weight loss are frequent complications to HTx. We investigated the effect of weight, BMI and body-surface-area (BSA) on the accuracy and precision of eGFR in HTx recipients.

**Methods:** In a longitudinal, observational, retrospective study-design, patients receiving first-time HTx with at least one registered mGFR within 15 months after HTx and a corresponding plasma creatinine were included. GFR was measured by <sup>51</sup>Cr-EDTA. eGFR adjusted for BSA was calculated by creatinine-based CKD-EPI formula and eGFR not adjusted for BSA was calculated using Dubois and DuBois. Longitudinal data were analyzed within a linear mixed model and cross-sectional data were analyzed using Bland Altman analysis and ANOVA.

**Results:** 150 patients with a total of 723 mGFR measurements were included. During the first year after HTx, mean weight increased by 4.2 kg (CI: 3.2 to 5.1) followed by an annual decrease of 0.35 kg/year (CI: -0.05 to 0.74). mGFR increased by 7.5 ml/min (CI: 3.2 to 11.8) the first year but was stable hereafter (0.0 ml/min/year, CI: -1.0 to 1.0). The initial weight gain and increase in mGFR were most pronounced in patients <45 years. Neither eGFR adjusted nor unadjusted for BSA detected the initial increase in mGFR. At one year after HTx, limits of agreement of the Bland Altman plot were -37.2 to 33.1 ml/min with a bias of -2.1 ml/min (CI: -5.0 to 0.9). In patients <45 years, eGFR significantly overestimated mGFR by 7.1 ml/min (CI: 1.0 to 13.2) and showed a significant lower precision than patients >45 years. The overestimation of mGFR was persistent after the first posttransplant year. There was no effect of weight, BMI, BSA or change in BMI class on the difference between eGFR and mGFR.

**Conclusions:** In heart transplant recipients, eGFR was, on average, very accurate and was not affected by body composition. The precision was, however, very low and eGFR performed poorly especially in younger patients.

SA-PO830

**Comparing Measures for Evaluating Dialysis Facilities by Their Kidney Transplant Referral Rates**

Adam S. Wilk,<sup>1</sup> Mengyu Di,<sup>2</sup> Laura Plantinga,<sup>2</sup> Sudeshna Paul,<sup>3</sup> Stephen O. Pastan,<sup>2</sup> Rachel E. Patzer.<sup>2</sup>  
<sup>1</sup>Emory University School of Public Health, Atlanta, GA; <sup>2</sup>Emory University School of Medicine, Atlanta, GA; <sup>3</sup>Emory University School of Nursing, Atlanta, GA.

**Background:** Among the >560,000 U.S. patients receiving dialysis, many would benefit from transplantation, yet many transplant-eligible dialysis patients are never referred to a transplant center for evaluation. Policymakers are considering including referral rate measures in dialysis facility performance measurement programs. It is unknown to what extent alternative referral rate measures, which are materially different in their sample exclusion criteria and risk adjustment approaches, may be differentially correlated with waitlisting rates downstream.

**Methods:** We compared three measures that can be used to assess dialysis facilities' referral rates: raw referral rate (percent of patients referred), Paul et al.'s (2018) Standardized Transplantation Referral Ratio (STRr), and the Kidney Care Quality Alliance's (KCQA) percent referred measure. Using 2014-2020 registry data for incident dialysis patients referred to all nine established transplant centers across Georgia, North Carolina, and South Carolina (referral dates) linked to United States Renal Data System data (denominators, waitlisting dates), we compared the referral measures' unadjusted distributions and used linear regression to test associations with facility waitlisting rates, overall and among referred patients.

**Results:** Distributions for the raw referral rate (35,627 patients, 815 facilities), STRr (24,241 patients, 718 facilities), and KCQA measure (8,687 patients, 746 facilities), were similarly right-skewed. Pairwise Pearson correlations among the measures were positive but varied (range 0.34-0.57). Each measure was positively associated with overall waitlisting (estimated change in waitlisting [percentage points] per 1 SD increase in measure: raw referral rate  $\beta=5.2$ ; STRr  $\beta=1.3$ ; KCQA  $\beta=2.7$ ; all  $p<0.001$ ). None of these measures was statistically associated with waitlisting among referred patients (all  $p>0.2$ ).

**Conclusions:** The impact of alternative dialysis facility referral rate measures on subsequent waitlisting may be inconsistent, in part because the measures have different facility exclusion criteria—and so represent different patient and facility populations—and risk adjustment approaches. Programs using these measures should be monitored to ensure they are effective in maximizing transplant access for U.S. patients receiving dialysis.

**Funding:** NIDDK Support, Other NIH Support - NIMHD

SA-PO831

**Indexing Glomerular Filtration Rate by Body Surface Area in Live Kidney Donors: Is It Really Necessary?**

Nisarg Gandhi,<sup>1</sup> Sean Hebert,<sup>1</sup> Duc T. Nguyen,<sup>1</sup> Edward A. Graviss,<sup>1</sup> Hassan N. Ibrahim.<sup>2</sup>  
<sup>1</sup>Houston Methodist, Houston, TX; <sup>2</sup>Memorial Hermann Health System, Houston, TX.

**Background:** Glomerular filtration rate (GFR) is proportional to both kidney and body size. It is commonly expressed as estimated (e)GFR as ml/min/1.73m<sup>2</sup>, which represents the adjustment to a standard body surface area (BSA). However, a compelling rationale for this recommendation is lacking. In the case of kidney donor candidates, eGFR adjustment by BSA may result in wider acceptance of those with BSA <1.73 m<sup>2</sup> and restrict access for those with a BSA >1.73 m<sup>2</sup> as adjusted eGFR will be higher in the former and lower in the latter. Long term outcomes of kidney donors who have adjusted eGFR are higher, lower, or equal to their raw eGFR has not been studied.

**Methods:** Using the publicly available data from The Renal and Lung Living Donor Evaluation Study (RELIVE), we compared the development of hypertension, proteinuria, reduced eGFR, and kidney failure in 8578 donors with: 1) raw and adjusted eGFR  $\geq 80$  ml/min/1.73m<sup>2</sup>; 2) only adjusted eGFR  $\geq 80$  ml/min/1.73m<sup>2</sup>; 3) only raw eGFR  $\geq 80$  ml/min; and 4) both raw and adjusted eGFR < 80 ml/min/1.73m<sup>2</sup>.

**Results:** 5504 donors had both adjusted and raw eGFR  $\geq 80$  ml/min, 258 donors had only adjusted eGFR  $\geq 80$  ml/min/1.73m<sup>2</sup>, 1086 donors had only raw eGFR  $\geq 80$  ml/min, and 1730 had both adjusted and raw eGFR < 80 ml/min. The median age of the entire cohort was 39 years, 43.7% were male, 85.1% were non-Hispanic white, median BMI was 25.8 kg/m<sup>2</sup>, and mean BSA at donation was 1.88  $\pm$  0.22 m<sup>2</sup>. Other than the development of eGFR < 45 ml/min/1.73m<sup>2</sup>, no statistical difference was noted in post-donation mortality, CVD, diabetes, hypertension, proteinuria, eGFR < 30 ml/min/1.73m<sup>2</sup>, and ESKD (Figure 1).

**Conclusions:** Raw and adjusted pre-donation eGFR were highly comparable in predicting long-term outcomes of kidney donors and perhaps the practice of adjusting for BSA should be reconsidered.

Post-donation outcomes	Multivariate		
	Adjusted eGFR C-statistic (95% CI)	Raw eGFR C-statistic (95% CI)	p-value
Mortality	0.77 (0.74, 0.81)	0.77 (0.74, 0.81)	0.75
Cardiovascular Disease	0.75 (0.73, 0.77)	0.74 (0.72, 0.77)	0.11
Diabetes	0.73 (0.68, 0.77)	0.73 (0.68, 0.77)	0.29
Hypertension	0.70 (0.68, 0.72)	0.70 (0.68, 0.72)	0.40
Proteinuria	0.81 (0.79, 0.84)	0.81 (0.79, 0.84)	0.61
eGFR<45 ml/min/1.73m <sup>2</sup>	0.76 (0.73, 0.79)	0.74 (0.71, 0.77)	<0.001
eGFR<30 ml/min/1.73m <sup>2</sup>	0.83 (0.77, 0.90)	0.84 (0.77, 0.90)	0.86
ESKD	0.75 (0.64, 0.86)	0.78 (0.68, 0.88)	0.14
ESKD or eGFR<30 ml/min/1.73m <sup>2</sup>	0.71 (0.64, 0.79)	0.71 (0.64, 0.79)	0.80

Figure 1: C-statistic comparisons between adjusted and raw eGFR, multivariate Cox regression

SA-PO832

**Impact of Kidney Volume on Proteinuria 3 Years Post-Transplantation in Living Kidney Donors**

Makoto Tsujita, Masuko Kinen Byoin, Nagoya, Japan.

**Background:** In living kidney transplantation, predicting the risk of end-stage kidney disease in the organ donors though crucial remains to be resolved. Thus, any useful biomarker to predict kidney outcome would be highly desirable to safeguard donors.

**Methods:** This retrospective study was conducted at Nagoya Daini Red Cross Hospital to confirm whether an increase in preserved kidney volume (PKV) was a predict marker of proteinuria. The ratio of body surface area (BSA) adjusted PKV before and 1 year after kidney donation was measured, and its association with proteinuria 3 years after the donation was analyzed.

**Results:** A total of 119 kidney donors who met the Japanese donor guideline were enrolled. The mean age of 57.4 years old, 46.2 % were male. The mean values of the variables before kidney donation (baseline) were: BMI levels: 23.4 kg/m<sup>2</sup>, BSA adjusted PKV: 132.9 cm<sup>3</sup>/1.73m<sup>2</sup>, and estimated glomerular filtration rate (eGFRave): 82.9 ml/min/1.73m<sup>2</sup>. A positive correlation was noted between BSA adjusted PKV and eGFRave ( $r = 0.61, p < 0.001$ ). The mean ratio increased by 19.5% (143.5 cm<sup>3</sup>/1.73m<sup>2</sup>) 1 year after donation, and the median urine protein was 0.04 g/gCre. Linear regression analyses showed that the ratio and BSA adjusted PKV before the donation were significantly associated with proteinuria 3 years after donation.(Figure 1)

**Conclusions:** The ratio and BSA adjusted PKV before donation is important factors for proteinuria after donation under the Japanese donor guidelines. Further studies would be needed to confirm whether these factors are associated with renal survival after donation.

**Figure 1. Associations of pre-donation risk factors and the ratio with proteinuria 3 years after donation**

	univariate			multivariate		
	$\beta$	t	p	$\beta$	t	p
Ratio	0.003	2.45	0.016	0.004	3.29	0.001
Age	-0.0001	-0.07	0.942	0.0004	0.41	0.684
Female	-0.038	-2.21	0.029	-0.05	-1.93	0.056
Body mass index	0.006	2.14	0.034	-0.001	-0.38	0.708
BSA adjusted PKV	0.001	2.72	0.008	0.002	2.68	0.009
eGFRave	-0.0003	-0.54	0.592	-0.002	-1.68	0.096
Hypertension	0.017	0.81	0.419	0.006	0.25	0.801
Hyperlipidemia	0.022	0.92	0.361	0.02	0.68	0.499
Diabetes mellitus	0.068	1.60	0.112	0.03	0.74	0.459
History of smoking	0.013	0.72	0.474	-0.03	-1.31	0.193

**SA-PO833**

**Understanding Public Perceptions of Deemed Consent Legislation for Organ Donation in Canada**

Danielle E. Fox, Maoliosa Donald, Christy Chong, Robert R. Quinn, Paul E. Ronksley, Meghan J. Elliott, Ngan Lam. *The University of Calgary, CALGARY, AB, Canada.*

**Background:** Deemed consent legislation was implemented in Nova Scotia in 2021 and is being considered in other jurisdictions in Canada to increase deceased organ donation and transplantation rates. We have previously described the public perceptions of deemed consent and concerns for lawmakers to consider; however, there are other personal factors that should be understood prior to addressing these public concerns. Our objective was thus to explore the factors underlying public perceptions of deemed consent legislation in Canada.

**Methods:** We searched four major Canadian news outlets for published articles about deemed consent between January 2019 and July 2020. Using a descriptive qualitative method, public comments from relevant articles were extracted and analyzed using an inductive conventional content analysis approach.

**Results:** We extracted and analyzed 4,357 comments from 35 eligible news articles. Four primary themes emerged that helped explain the public's perception of deemed consent. **Entwined beliefs:** Commenters' beliefs included how they defined consent, human rights, and end-of-life practices. **Connected experiences:** Commenters described the impact of life experiences that were connected to deemed consent. These included being an organ donor or recipient but also other experiences such as accessing healthcare and government services (e.g., unable to navigate existing opt-in processes). **Inescapable uncertainty:** Organ donation was a difficult and personal decision. Many commenters were undecided in their decision to be an organ donor yet were being asked to firmly decide. **Guarded trust:** Some commenters described having little trust in healthcare providers, government officials, their family and friends, and others responsible for carrying out their wishes.

**Conclusions:** Public perceptions of deemed consent appeared to be influenced by the collective value commenters ascribed to numerous related elements. Lawmakers should consider these determinants when addressing public concerns.

**SA-PO834**

**Findings From a Cardiovascular Screening Workup of Kidney Transplant Recipients**

Ziad Arabi,<sup>1,2</sup> Talha M. Youssouf,<sup>1,2</sup> Mohamad Y. Abdulgadir,<sup>1,2</sup> Nayef Alawadh,<sup>1,2</sup> Dr Junaid Iqbal,<sup>1,2</sup> Mubarak I. Abdalla,<sup>1,2</sup> Ahmad I. Alflawr,<sup>1,2</sup> <sup>1</sup>Division of Nephrology, Department of Medicine, King Abdulaziz Medical City, Riyadh, Saudi Arabia; <sup>2</sup>King Abdullah International Medical Research Center; College of Medicine, King Saud Bin Abdulaziz University for Health Sciences, Riyadh, Saudi Arabia.

**Background:** There is limited data about the findings of cardiovascular (CV) workup of kidney transplant recipients (KTR). Our center follows the AHA/ACC 2013 guidelines of the cardiovascular risk assessment of renal transplant candidates (KTC). Screening echo is performed in all KTC. PET stress nuclear test is done in those who have  $\geq 3$  CV risk factors, limited functional status or abnormal echo findings. Decision of cardiac catheterization is deferred to cardiologist's assessment. Abdominal/pelvis CT with IV contrast is done to evaluate the extent of pelvic vascular calcifications and atherosclerosis. It is performed in most the KTC unless if they are on PD, undergoing preemptive transplantation or at low surgical risk.

**Methods:** In this single center retrospective study, we reviewed the prevalence of CV risk factors and the results of the CV workup of KTR who underwent renal transplant from 2017 to 2020.

**Results:** A total of 287 KTR were included. 74% were  $\geq 30$  years, 58% were men and 80% were living-donor KTR. Preemptive transplantation was 10.1%. Pre-KT dialysis modality was PD in 11.5% and HD in 78.4% (AVF: 42% versus Permcath: 58%). Dialysis vintage was  $4.8 \pm 3.3$  years for DDKT versus  $2.4 \pm 2.6$  years for LKT. CV risk factors among KTR were: CAD: 13.2%, CVD: 5.2%, PVD: 2.8%, CVA: 2.4%, HTN: 76%, DM: 34.5%, [DM type I: 25 (25.3%) and DM type II: 74 (74.7%)], HLP (LDL > 100): 39.7% and smoking: 10.1%. The prevalence of obesity stage 2 (BMI 35-39.9): 4%, and obesity stage 1 (BMI: 30-34.9) was 20%. LVH was present in 38%. EF was abnormal (<55)

in 20.5% [45-55: 43 (15%), 35-45: 15 (5.2%), 25-35:1 (0.3%)]. Abnormal wall motion (mostly global dyskinesia) was present in 12%. Stress test was indicated in 152 (53.3%) and it showed abnormal perfusion in 26% of cases. Calcium scoring: >400: in 17%, zero in 43%, 1-100: in 42 (27%), and 100-400: in 13%. Cardiac catheterization was required in only 46 (16%) and findings were: CAD for intervention in 26%, CAD for med TX in 63% and no CAD in 11% CT abdomen and pelvis was performed in (138) 38.1% and findings were: moderate or severe calcifications/ atherosclerosis in only 6%, normal in 82% or only mild calcifications in 12%.

**Conclusions:** This study outlines the high prevalence of CV risk factors in KTR and the findings of pre-KT CV workup.

**SA-PO835**

**Distinct Characteristics of High Sensitized Kidney Transplant Recipients in the United States by Machine Learning Consensus Clustering**

Charat Thongprayoon,<sup>1</sup> Michael A. Mao,<sup>2</sup> Shennen Mao,<sup>2</sup> Caroline Jadowiec,<sup>3</sup> Prakrati C. Acharya,<sup>4</sup> Napat Leeaphorn,<sup>5</sup> Wisit Kaewput,<sup>6</sup> Patharawin Pattharanitima,<sup>7</sup> Wisit Cheungpasitporn.<sup>1</sup> <sup>1</sup>Mayo Clinic Minnesota, Rochester, MN; <sup>2</sup>Mayo Clinic in Florida, Jacksonville, FL; <sup>3</sup>Mayo Clinic Arizona, Scottsdale, AZ; <sup>4</sup>Texas Tech University Health Sciences Center El Paso, El Paso, TX; <sup>5</sup>Saint Luke's Health System, Kansas City, MO; <sup>6</sup>Pramongkutklao College of Medicine, Bangkok, Thailand; <sup>7</sup>Thammasat University Hospital, Khlong Nueng, Thailand.

**Background:** Our study aimed to characterize highly sensitized kidney transplant patients using unsupervised machine learning approach.

**Methods:** We used the OPTN/UNOS database from 2010 to 2019 to perform consensus cluster analysis based on recipient-, donor-, and transplant-related characteristics in 7,458 kidney transplant patients with pre-transplant panel reactive antibody (PRA)  $\geq 98\%$ . We identified each cluster's key characteristics using the standardized mean difference of >0.3. We compared the posttransplant outcomes among the assigned clusters

**Results:** Consensus cluster analysis identified two clinically distinct clusters of highly sensitized kidney transplant patients. Cluster 1 patients were older (mean age 45 vs 54 years), more male (59% vs. 9%), had more kidney retransplant (98 vs. 3%), but less diabetic kidney disease (3% vs 29%), compared to cluster 2. While patient survival was comparable between two clusters, cluster 1 had lower death-censored graft survival but higher acute rejection compared to cluster 2.

**Conclusions:** Unsupervised machine learning approach characterized highly sensitized kidney transplant patients into 2 clinically distinct clusters based on age, sex, kidney retransplant status, and diabetes, with differing posttransplant outcomes.

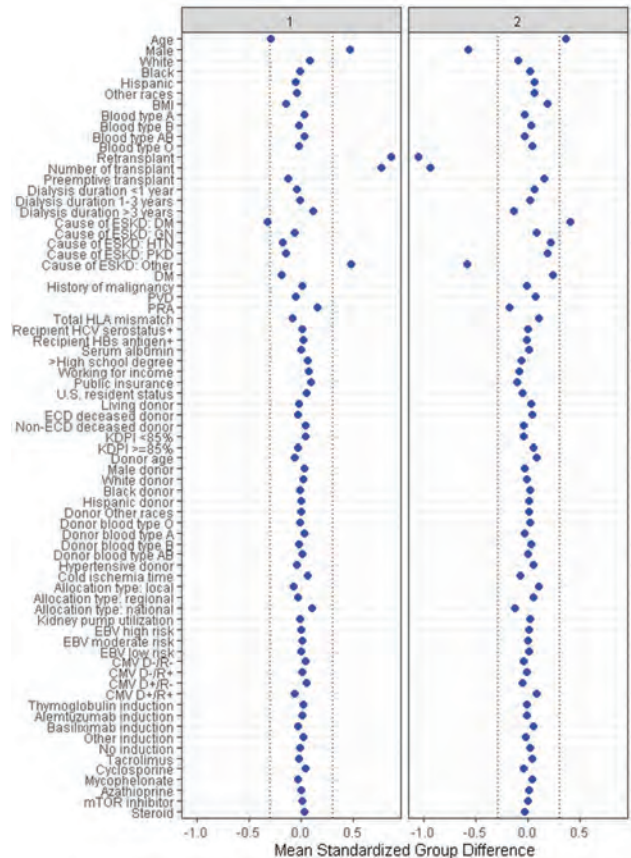

SA-PO836

**Should We Discontinue Angiotensin Converting Enzyme Inhibitor and Angiotensin Receptor Blocker Before Kidney Transplantation?**

Chung Hee Baek, Hyosang Kim, Su-Kil Park. *Asan Medical Center, Songpa-gu, Seoul, Republic of Korea.*

**Background:** Angiotensin converting enzyme inhibitors (ACEi) and Angiotensin receptor blockers (ARB) are usually recommended to stop before surgery to prevent post-operative acute kidney injury. However, it is uncertain that ACEi and ARB should be discontinued before kidney transplantation (KT). Therefore, we investigated the effect of pre-KT administration of ACEi and ARB on the outcomes of KT.

**Methods:** We reviewed patients who received living-donor KT in our tertiary center between 2018 and 2020. Among 923 patients, 291 patients continued ACEi/ARB within 3 days before KT (ACEi/ARB group), and 632 patients did not take ACEi/ARB within 3 days before KT (No ACEi/ARB group). Delayed graft function, hyperkalemia events, slope of creatinine after KT, rejection and graft survival were compared between two groups.

**Results:** Baseline characteristics were not significantly different between two groups except medical history of hypertension (96.2% in ACEi/ARB group vs. 90.2% in no ACEi/ARB group, P=0.001) and number of re-transplantation (4.1% in ACEi/ARB group vs. 7.8% in no ACEi/ARB group, P=0.039). The numbers of ABO incompatible KT or HLA-sensitized KT, the degree of HLA mismatches and immunosuppressant were not different significantly between two groups. Delayed graft function occurred in 2 patients (0.7%) in ACEi/ARB group and 13 patients (2.1%) in no ACEi/ARB group (P=0.165). The event of hyperkalemia (K $\geq$ 5.5 mEq/L) did not happen more frequently in ACEi/ARB group (21.3% vs. 22.9%, P=0.611, the day before KT; 11.3% vs. 10.1%, P=0.566, the day of surgery; 0.3% vs. 0.3%, P=1.000, the day after surgery). The slopes of creatinine from post-operative day 0 to day 7 were similar in two groups (-0.732 $\pm$ 0.349 vs. -0.751 $\pm$ 0.325, P=0.435). Rejection-free survival and graft survival were not significantly different between two groups (P=0.890 and 0.619 by Log-Rank test, respectively).

**Conclusions:** Use of ACEi/ARB before KT did not increase the incidence of delayed graft function, hyperkalemia and rejection. Also, renal function improvement after KT was not affected by the use of ACEi/ARB before KT. Therefore, ACEi/ARB might not give significant impact on the outcomes of KT. Further well-designed studies are necessary to confirm the effect of ACEi/ARB on KT.

SA-PO837

**Organ Discards Rates a Year After Change in Increased Risk Definition for Organ Allocation**

Jordan Morrison-Nozik,<sup>1</sup> Marios Prikis,<sup>1</sup> Maricar Malinis,<sup>2</sup> Abhishek Kumar.<sup>2</sup>  
<sup>1</sup>University of Vermont College of Medicine, Burlington, VT; <sup>2</sup>Yale School of Medicine, New Haven, CT.

**Background:** The public health service designation of increased high-risk donor (IRD) was first established in 1994 to identify donors with potential higher risk of transmission of HIV, hepatitis B and hepatitis C infections. The risk criteria were updated recently in 2020 to include only 10 risk categories instead of 14. It also reduced the risk behavior time frame from 12 months to 30 days prior to organ procurement. The new criteria also stipulated that donor specimen should be collected within 96 hours before the procurement.

**Methods:** We analyzed United Network of Organ Sharing data one year prior and one year after the current implementation of new guidelines to see if the new guidelines reduced organ discard rates based on the increased risk criteria. Chi square was used to compare the difference in organ utilization between these two time periods.

**Results:** There were 6111 kidney which were labelled as having increased risk for disease transmission prior to the change in definition and 5970 after the change. The discard rate remained stable at 17%. Discard rates for heart and lungs also did not change, however less pancreas and livers were discarded based on increased risk criteria.

**Conclusions:** Our one year analysis shows that there is increased organ utilization for pancreas and liver but not for heart, lungs and kidney. However we should point out that numbers are small and that this is a very preliminary data. Full impact of the change will likely be observed in few years' time.

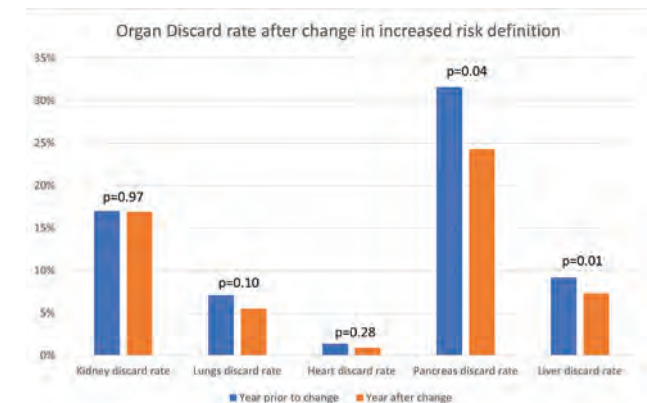

		Total organs procured	Organs transplanted	Organs discarded
Kidney	Prior to change	6111	5075	1036 (17%)
	After change	5970	4959	1011 (16.9%)
Lung	Prior to change	1418	1373	105 (7.1%)
	After change	1192	1126	66 (5.5%)
Heart	Prior to change	1150	1134	16 (1.4%)
	After change	1100	1090	10 (0.9%)
Pancreas	Prior to change	323	221	102 (31.6%)
	After change	317	240	77 (24.3%)
Liver	Prior to change	2579	2341	238 (9.2%)
	After change	2384	2209	175 (7.3%)

Total number of organs procured, transplanted and discarded based on increased risk status

SA-PO838

**Preemptive Kidney Transplants Lead to Cost Savings in Less Than a Year**

Rahul Dhawan, Ashley Crossman, Gregory Wysocky, Jiang Tao, Kevin Plosser. Optum KRS Nurses and Product Team and the OHS Medical Office Team Optum Inc, Eden Prairie, MN.

**Background:** For patients living with chronic kidney disease (CKD), it is theorized that receiving a kidney transplant before they need to start dialysis allows them to stay healthier and live longer than if they were to receive a transplant after initiating dialysis.<sup>1</sup> The current study assessed the cost savings associated with a preemptive kidney transplant, when available.

**Methods:** The study population consisted of patients drawn from a national health plan claims database who were identified as having stage 4–5 CKD and either received a kidney transplant prior to initiating dialysis (N = 249) or initiated dialysis (N = 1,657) between July 2017 and June 2020. To measure the total costs avoided by preemptively transplanting a kidney, the difference between an ESRD per member per month and a post-transplant per member per month was analyzed while adjusting for member retention.

**Results:** For members initiating dialysis, incident ESRD per diseased member per month (PDMPM) was calculated as the mean medical allowed amount for each of the first 6 months following the ESRD start date. The average PDMPM for the first 6 months was \$24,308, and \$18,465 each month after six months. Using the mean cost of a kidney transplant of \$109,513, the costs of the transplant are offset within the first 7 months. If the member is retained on the health plan for at least 1 year, the transplant results in \$211,000 in avoided medical expenditures and a net 1-year savings of \$101,800 after the cost of the transplant.

**Conclusions:** Preemptive kidney transplants for patients with CKD have numerous benefits, including higher patient survival, improved quality of life and significant cost savings. Transitioning a patient to dialysis costs as much as \$211,000 per year. While the cost of transplantation is around \$110,000, those costs are offset after less than seven months due to avoidance of dialysis and other health complications. Preemptive transplants therefore greatly benefit the patient and can also allow for cost savings.

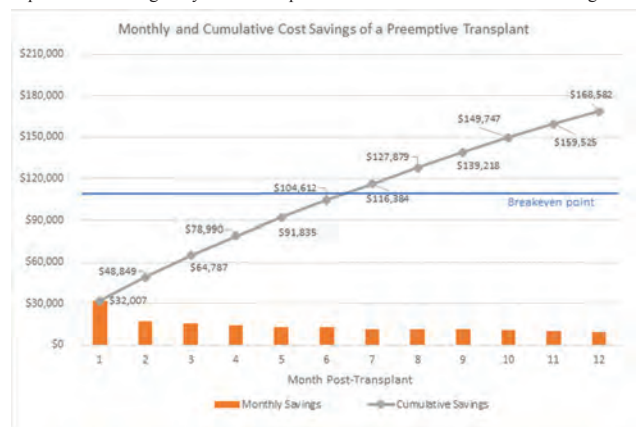

SA-PO839

**Prediction of Post-Donation Kidney Function for Persons Considering Living Kidney Donation**

Fawaz Al Ammary, Abimereki Muzaale, Allan Massie. *Johns Hopkins University, Baltimore, MD.*

**Background:** Healthy adults who donate a kidney lose 50% of their nephron mass following nephrectomy. However, kidney reserve may vary by donor health and demographic characteristics. We aimed to predict 6-month post-donation eGFR (6M-eGFR).

**Methods:** We used the US national registry of 60,584 living kidney donors from 2005-2019 to identify the clinical phenotypes associated with 6M-eGFR. We estimated eGFR for each participant using the CKD-EPI 2009 creatinine equation for eGFR. We built multivariable regression models of 6M-eGFR on baseline donor factors.

**Results:** The median (IQR) pre-donation and post-donation eGFR was 98 (86-110) and 64 (54-75). For 30-year-old female who were biologically related with the recipient and had no hypertension, no history of smoking, BMI=25, and predonation eGFR 100 ml/min/1.73m<sup>2</sup>, the predicted 6M-eGFR was 69 ml/min/1.73m<sup>2</sup> for white, 66 ml/min/1.73m<sup>2</sup> for black, 71 ml/min/1.73m<sup>2</sup> for Asian, and 73 ml/min/1.73m<sup>2</sup> for Hispanic donors.

**Conclusions:** Post-donation six-month compensatory kidney function varies by donor demographic and health characteristics. Our prediction of individualized 6M-eGFR helps inform donor selection and counseling of persons who consider donation.

**Funding:** NIDDK Support, Other NIH Support - NKF

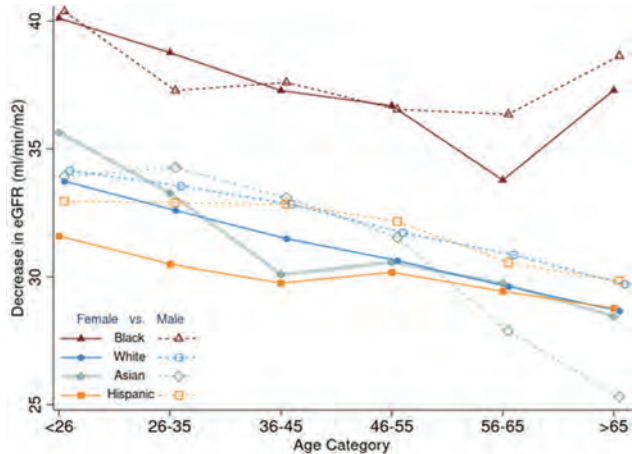

Figure. Individual Change of eGFR Comparing 6-Months Post-Donation to Pre-Donation

SA-PO840

**A Fatal Case of T-Cell Post-Transplant Lymphoproliferative Disorder After Kidney Transplant Deteriorating to Acute Liver Failure**

Jeongmin Cho, Yong Chul Kim, Yon Su Kim, Hajeong Lee. *Seoul National University Hospital, Jongno-gu, Seoul, Republic of Korea.*

**Introduction:** Post-transplant lymphoproliferative disorder (PTLD) is a rare and serious complication of kidney transplantation (KT). PTLD, mostly of B-cell lineage, progresses even after reduction of immunosuppression in half of patients. Herein, we report a deteriorating case of T-cell PTLD after KT, that rapidly progressed to liver failure, septic shock, and death despite various therapeutic attempts.

**Case Description:** A 50-year-old woman received HLA-incompatible, ABO-compatible pre-emptive KT for her diabetic end-stage kidney disease under basiliximab induction treatment. In the routine surveillance, Epstein-Barr (EB) viral copies elevated with 318,443 copies/mL at 2 months after KT. EB viremia continued to increase in spite of reducing maintenance immunosuppressive agents or preemptive rituximab treatment. At 8 months after KT, she was admitted due to fever and found multifocal splenic lesions and nonspecific lymph node enlargement in the abdomen-pelvis CT (Figure 1). After then, her liver function test started to elevate without any evidence of hepatitis-viral infection. Considering PTLD, we performed a percutaneous liver biopsy and confirmed EBV-associated T-cell PTLD with CD3 and CD56 expression (Figure 2). Because of the absence of proven treatment for the T-cell lineage PTLD, we just monitored her watchfully. Only 2-month after PTLD diagnosis, she was admitted for acute and severe liver failure. We tried rescue cytotoxic chemotherapy at hospital day 6, although she died at 12 days after hospitalization.

**Discussion:** This is a case of very rare and refractory EB virus-associated T-cell PTLD after KT does not have any specific treatment option until now. Further studies for a preventative and therapeutic method for T-cell lineage PTLD are warranted.

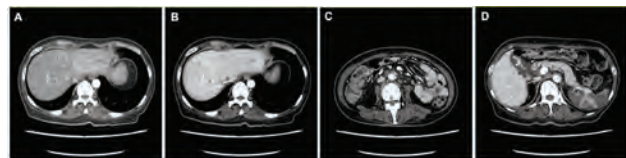

Figure 1. CT findings of hepatic nodules in (A) Arterial and (B) Venous phase indicating liver involvement of PTLD. (C) PTLD with lymph node and (D) splenic involvement.

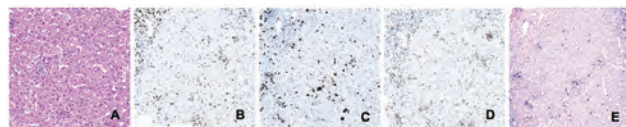

Figure 2. Pathologic findings of T-cell PTLD of liver. H&E stain (A), lymphoid cells Positive for CD3 (B), Ki67 (C), CD56 (D), and EBV (E).

SA-PO841

**Lenalidomide and Risk of Acute Rejection in the Kidney Allograft**

Radames A. Zuquello,<sup>1,2</sup> Shahrzad Zonoozi,<sup>1,2</sup> Suman Chauhan,<sup>2</sup> Ping Li,<sup>2,3</sup> Scott D. Cohen,<sup>2,3</sup> <sup>1</sup>George Washington University Medical Faculty Associates, Washington, DC; <sup>2</sup>Washington DC VA Medical Center, Washington, DC; <sup>3</sup>The George Washington University, Washington, DC.

**Introduction:** Solid Organ Transplant is associated with an increased incidence of malignancy. It is important to understand the complications of chemotherapy and potential interactions with maintenance immunosuppression.

**Case Description:** 72yo male with ESKD secondary to FSGS received a deceased donor kidney transplant in 2008, DM, HTN, prostate CA, and recently diagnosed multiple myeloma (M M) who presented with abdominal pain. He was found to have AKI, Screat 6.9mg/dl from 1.2, with hydronephrosis and partially obstructing ureteral stone. He underwent percutaneous nephrostomy, he did not recover kidney function and required hemodialysis. Patient underwent allograft biopsy which showed grade 2A acute T cell-mediated rejection (TCMR). There was severe tubulointerstitial inflammation, tubulitis, and a focus of endothelialitis. 16/35 sclerosed glomeruli, moderate interstitial fibrosis and tubular atrophy. He was treated with IV methylprednisolone followed by IV thymoglobulin. Patient remained on tacrolimus 5mg BID and mycophenolic acid 360mg BID. It is unusual to see severe TCMR 13 years after his kidney transplant. He had no previous episodes of rejection with stable kidney function. Two months prior to presentation, he was started on chemotherapy for MM with bortezomib, lenalidomide and dexamethasone. The third cycle of chemotherapy was held. The patient had tacrolimus trough levels ranging from < 0.75µ/L to 4.4µ/L during the months leading up to presentation. Despite treatment patient continued to have dialysis dependent AKI without signs of recovery.

**Discussion:** Lenalidomide is associated with acute rejection in solid organ transplantation. A possible mechanism is activation of T-cells with secretion of interferon gamma and interleukin-2 leading to stimulation of CD8 and CD4+ helper T-cells promoting activation of the immune system. It is important to be aware of the potential complications of immunomodulatory chemotherapy which can increase risk of TCMR. Management of post transplant malignancies is challenging and requires a multidisciplinary approach.

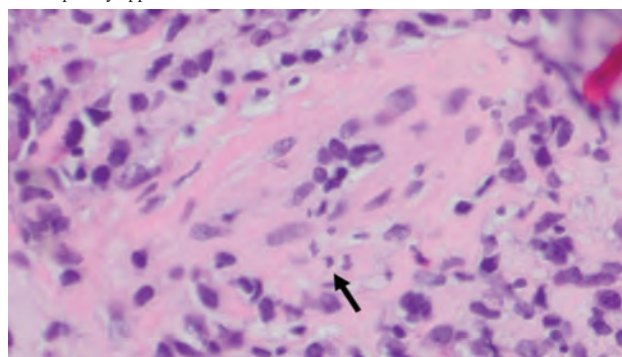

SA-PO842

**Refractory Diarrhea Following Kidney Transplantation: A Management Challenge**

Mario A. Leone, Reem Daloul, Michael Landau, Khaled Nashar, Kalathil K. Sureshkumar. *AHN Allegheny Health Network, Pittsburgh, PA.*

**Introduction:** Diarrhea in organ transplant recipients can be a management challenge with numerous causes including medications. We present a kidney transplant recipient (KTR) with refractory diarrhea in early post-transplant period. Colon mucosal biopsy showed changes consistent with tacrolimus related colonic injury with complete resolution of diarrhea after tacrolimus was switched to cyclosporine.

**Case Description:** A 65-year female KTR presented with profuse diarrhea in early post-transplant period. Donor and recipient were CMV and EBV IgG positive. Patient received Thymoglobulin induction followed by tacrolimus/mycophenolic acid (MPA) maintenance along with valgancyclovir for CMV and trimethoprim-sulfamethoxazole for Pneumocystis jirovecii prophylaxes. Patient was treated with IV hydration and MPA was held. Stool test returned positive for Clostridium difficile (C diff) toxin for which she received 2-week course of PO vancomycin. Diarrhea continued despite negative follow-up stool C diff toxin. Colonoscopy showed normal mucosa with random biopsies revealing patchy crypt apoptoses (figure) with negative CMV stain and no evidence for lymphocytic or collagenous colitis. Tacrolimus, because of its association with crypt apoptoses was changed to cyclosporine along with azathioprine and prednisone. Diarrhea started improving within a few days with complete resolution in 2 weeks. Currently the patient remains well with stable allograft function.

**Discussion:** There is emerging evidence for tacrolimus related colonic toxicity. Tacrolimus can interfere with mitochondrial oxidative phosphorylation thereby enhancing intestinal mucosa permeability resulting in exposure to luminal antigens that can trigger mucosal injury and diarrhea. In our patient, diarrhea continued despite stopping MPA and clearance of C diff infection. This, along with supporting colonic biopsy finding and resolution of diarrhea with tacrolimus discontinuation, strengthened the possible association of tacrolimus use with diarrhea in our patient. High index of suspicion is needed to make early diagnosis.

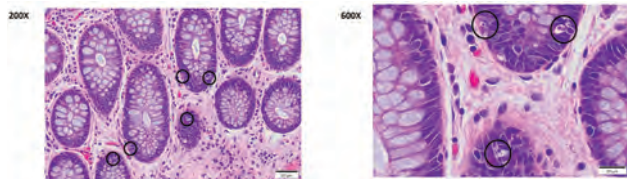

Colon mucosal biopsy showing crypt apoptoses marked with circles: low power left, high power right

SA-PO843

**Meningioma in a Kidney Transplant Recipient a Risk Factor for Primary Central Nervous System Lymphoma**

Sami M. Akram,<sup>1,2</sup> Sujay D. Paudel,<sup>1</sup> Rungwasee Rattanavich,<sup>1</sup> Surakshya Regmi,<sup>1</sup> Rafael Villicana,<sup>1</sup> Loma Linda Transplant Institute <sup>1</sup>Loma Linda University, Loma Linda, CA; <sup>2</sup>Masters of Medicine Health Care, Los Angeles, CA.

**Introduction:** Calcineurin inhibitor (CNI) neurotoxicity is common; has a wide array of presentation. Compromised blood brain barrier (BBB) is a risk factor. We studied a case of PCNSL in a kidney transplant recipient (KTR) with meningioma in order to bring to awareness of association between meningioma and PCNSL.

**Case Description:** A 56-year-old female is a deceased donor KTR from 11-years ago by thymoglobulin induction. She develops new left hemiparesis and confusion. She was maintained on Tacrolimus (FK), Mycophenolate (MMF) and Prednisone. FK levels were therapeutic and serum creatinine was 0.9 mg/dL. Epstein Barr Virus (EBV) and SARS-CoV-2 antigen tests were negative. Computed tomography (CT) of the brain showed a 4.2 x 4.5 x 3.9 cm mass centered in the left lentiform nucleus; midline shift of 1.1cm and a calcified meningioma. CT of the abdomen and pelvis was normal. Brain biopsy was consistent with PCNSL lymphoma. EBV encoded RNA staining was positive. Despite cytoreductive surgery and chemotherapy, PCNSL progressed. Her family elected hospice care.

**Discussion:** Meningioma is common primary brain tumor with latency period of up to 30 years. A meningioma makes BBB permeable due to neo-angiogenesis at its margins. PCNSL constitute only 1% of Non-Hodgkin Lymphoma (NHL). Yet, PCNSL is 65 times more common in solid organ transplant recipients (SOTR) than in general population and six times more common than Non-Hodgkin's lymphoma (NHL). Therefore, we posit that PCNSL is a form of neurotoxicity due to persistently high concentration CNI via a permeable BBB. EBV is present in 90% of cases which makes host cell genome vulnerable to neurostructural changes. In our case PCNSL occurred despite therapeutic levels of CNI and despite absence of EBV in the serum. **Conclusion:** Meningioma related BBB permeability, increases severity of neurotoxicity and therefore, risk of PCNSL in a SOTR. Due to long latency of meningioma, risk of PCNSL can be and should be assessed prior to transplantation.

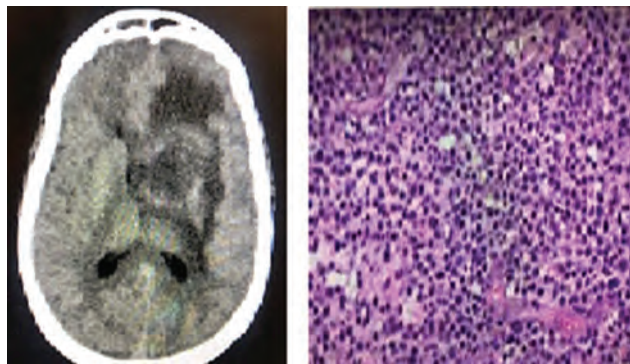

PCNSL

SA-PO844

**Kidney Transplant In Mentally Challenged Patients: A Single Centre Experience**

Jude A. Yagan,<sup>1,2</sup> Tarek S. Mahmoud,<sup>1</sup> Osama Gheith,<sup>1</sup> Mohamed M. Mostafa,<sup>1</sup> <sup>1</sup>Organ transplant centre, Kuwait, Kuwait; <sup>2</sup>Ibn Rushd hospital, Aleppo, Syrian Arab Republic.

**Background:** kidney transplant (KTx) is the best treatment for end-stage kidney disease (ESKD). Some medical conditions, like psychological and neurological status of the recipient, may pose ethical and legal questions on kidney allocation especially if medical improvement is not expected. Conversely, there is an obligation to provide the best care for this vulnerable group.

**Methods:** We retrospectively studied 10 children with a background of mental difficulties with variable severity, most had urological developmental abnormalities as the cause of ESKD. Children had KTx from all types of donors. 7 children were without

a labeled diagnosis (global developmental delay, cerebral palsy), one had Jeune syndrome (received combined deceased donor liver and KTx), 1 had Laurence-moon-Biedl syndrome, 1 with Down syndrome. We interviewed the families during outpatient visits asking questions about improved quality of life, social/emotional well-being, medication adherence.

**Results:** 10 children were followed for up to 23 years, the mean age at transplant time was 7.8 years. 4 had LRKTx, similar number had DDKTx, 2 had LUKTx. Mean serum creatinine of 135umol/l upon the last follow-up. The main benefit was relieving families from the burden of maintaining HD/PD and providing a better quality of life. The general misconception about inability to follow complex medication regimens or nonadherence in this group is highly contested in this cohort. Good caregiver support (family member/housemaid) ensured timely given medications on top of good support/medical education in our center. There were no rejection episodes or prolonged hospitalization except for mild infections (UTIs, chest infections).

**Conclusions:** Mentally challenged patients shouldn't be denied KTx based only on their mental condition. Issues of nonadherence can be overcome with stable family support even in patients with devastating neurological dysfunction. It will solve the ethical issues surrounding depriving this group of the best care while ensuring no waste of precious organs.

Cases	Age At Transplantation	Gender	Disability	Original Kidney Disease	Time on RRT [ys]	Donor Type	S. Creatinine (umol/l)
1	8	F	Jeune Syndrome	Solitary kidney	6.5	DDKTx	112
2	16	M	Reduced mental capacity	Solitary kidney, VUR	6	DDKTx	250
3	6	F	Developmental delay, Brain malformation	CNS (NPHS2) mutation	2.5	LRKTx	41
4	9	F	Laurence Moon Bardet Biedl Syndrome	Laurence Moon Bardet Biedl Syndrome	4	LRKTx	80
5	11	M	Bipolar/Schizophrenic	Unknown	1	LRKTx	130
6	4	M	Laurence Moon Bardet Biedl Syndrome	Bilateral renal dysplasia	2	LURKTx	140
7	14	M	Spina bifida, myelomeningocele	Reflux Nephropathy	6	DDKTx	50
8	32	M	Cerebral palsy	ADPKD	8	LURKTx	80
9	6	M	Unknown	Solitary kidney, Reflux nephropathy	Preemptive	LRKTx	70
10	45	M	Cerebral palsy	Unknown	5	DDKTx	60

SA-PO845

**BK Virus Nephropathy of Native Kidney After Hematopoietic Stem Cell Transplantation**

Ling Hong,<sup>1</sup> Xiaodong Wang,<sup>2</sup> Lin Wang,<sup>3</sup> Ying Wang,<sup>1</sup> Zhihua Zheng,<sup>1</sup> Wenfang Chen,<sup>4</sup> <sup>1</sup>The Seventh Affiliated Hospital Sun Yat-sen University, Shenzhen, China; <sup>2</sup>Shenzhen Children's Hospital, Shenzhen, China; <sup>3</sup>Guangzhou Kingmed Diagnostic Laboratory Ltd, Guangzhou, China; <sup>4</sup>Sun Yat-sen University First Affiliated Hospital, Guangzhou, China.

**Background:** BK virus nephropathy (BKVN) is characterized by a tubulointerstitial injury caused by BK virus infection, which is more common after kidney transplantation. Few cases have been described outside the context of renal allograft. This study aims to elucidate the clinicopathologic features and prognosis of BKVN after hematopoietic stem cell transplantation (HSCT).

**Methods:** A total of 667 patients who received HSCT treatment at 2 centers from January 2020 to April 2022 were reviewed. The clinical characteristics, renal biopsy results, and prognosis of 7 BKVN patients were analyzed.

**Results:** The incidence of BKVN after HSCT was 1.0%, with a median age of 17 years and a median onset time of 12 months post-HSCT. The primary diseases were thalassemia major (5 cases) and acute lymphoblastic leukemia (2 cases). Haploidentical transplantation was performed in 6 patients (85.71%), and cord blood in 1 patient. Hemorrhagic cystitis occurred in 5 patients (71.43%) after HSCT. Proteinuria was absent or slight and a BK viral load >4 log copies/ml in blood in 7 cases, the median serum creatinine levels were 2.19mg/dl at the time of biopsy. Histologically, all cases showed tubulointerstitial inflammation while glomeruli were spared. Nuclear inclusion was detected in 5 cases (71.43%). There were 4 (57.14%) with severe tubular atrophy and interstitial fibrosis (IFTA), 2 (28.57%) were moderate and 1 (14.29%) mild; with AST stage B1(28.57%), B3(28.57%), C (42.86%). The SV40 T antigen was detected in tubular epithelial cells in 7 cases (100%). 5 (71.43%) were treated with cidofovir against BK infection, while 2 were given intensive immunosuppressive therapy for GVHD. 3 (42.9%) progressed to end-stage renal disease (ESRD) within 6 months after renal biopsy, among which 2 was AST stage C and 1 was stage B1.

**Conclusions:** Patients who undergo HSCT, especially haploidentical transplantation, may develop BK virus infection, initially presenting as high levels of BK viruria or BK viremia and then progressing to BKVN, which will result in ESRD.

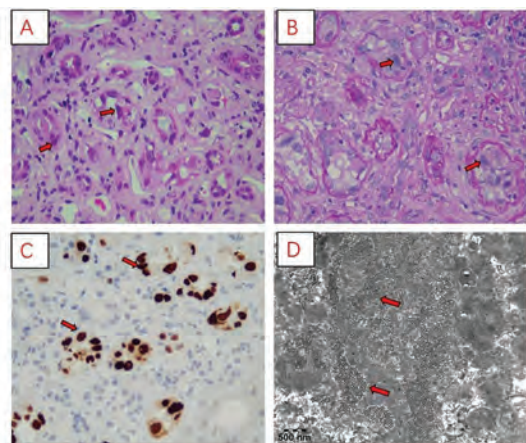

Figure 1. Pathologic Changes of BKVN after HSCT

SA-PO846

**Primary Hyperoxaluria Diagnosed After Second Kidney Transplantation and Treated With Lumasiran: Never Say Never!**

Mrinalini Sarkar, Elizabeth A. Kendrick, Erik L. Lum. Connie Frank Kidney Transplant Centre University of California Los Angeles David Geffen School of Medicine, Los Angeles, CA.

**Introduction:** Primary hyperoxalurias (PHs) are rare autosomal recessive caused by the functional defect of alanine-glyoxylate aminotransferase that causes overproduction of oxalate, increased urinary excretion and end-stage kidney failure via crystal aggregation, and nephrocalcinosis. PH1 is the most common and severe form with rapid progression to kidney dysfunction by young adulthood. We describe a case of a patient who received her second kidney transplant 32 years after her first and developed primary allograft dysfunction from PH1 related oxalate nephropathy.

**Case Description:** 56 y.o. female with end stage kidney disease secondary to unclear etiology underwent deceased donor kidney transplant (DDKT) 32 years after her first transplant for allograft dysfunction. She reported recurrent kidney stones until age 16 but no further renal issues. She developed renal failure a year later and started dialysis. She denied h/o Bowel dysfunction, IBD or bowel surgeries Post transplant she continued to have AKI prompting a renal biopsy that demonstrated extensive calcium oxalate crystal deposition. Her serum oxalate was 24.7 umol/L and urine oxalate was 60mg/d on a 24 hour collection. A genetic test (renasight) confirmed a homozygous pathogenic variant in the AGXT gene. She continued to be dialysis dependent post transplant for 4 months prior to starting lumasiran(RNA-I). She has been weaned off hemodialysis after 2 months of RNA-I use and is being closely monitored for recovery of graft function

**Discussion:** PH1 is a devastating disease especially for kidneys, leading to end-stage renal disease (ESRD) during the first 2 to 3 decades of life. Combined liver and kidney transplantation has become the treatment has been the mainstay of treatment, however newer drugs are on the horizon including lumasiran which has been tested in PH1 patients with severe kidney dysfunction, including chronic dialysis The goal before kidney transplantation is to limit as much as possible the systemic storage of oxalate to prevent oxalate precipitation in the allograft. Early initiation of a treatment (e.g. RNAi drugs) that corrects the metabolic defect should be considered. In PH1 patients not on dialysis and with limited systemic oxalate storage, preemptive kidney transplantation should be proposed as soon as possible after the correction of the metabolic defect

SA-PO847

**An Unusual Presentation of Hypercalcemia in a Patient With Kidney Transplant**

Thejeswi Pujar, Yasar Caliskan, Fadee Abu Al Rub, Bahar Bastani. Saint Louis University, Saint Louis, MO.

**Introduction:** Hypercalcemia in kidney transplant patients is not uncommon. Persistent hyperparathyroidism is reported to occur in approximately 15 to 50% of patients following transplantation causing hypercalcemia. A rise in calcium level on the background of previously stable calcium levels with stable elevated parathyroid hormone (PTH) should prompt investigating malignant etiology. We present the case of a 67-year-old man who was hospitalized with an unusual case of hypercalcemia.

**Case Description:** A 67-year-old male with history of kidney transplant [YC1] 3.5 years prior presented with progressive weakness and fatigue. On admission he had acute kidney injury (AKI) and hypercalcemia with a corrected calcium of 14.5 mg/dl. He had history of tertiary hyperparathyroidism controlled on cinacalcet, with calcium level in range of (9-10 mg/dl) in the previous year. Workup revealed a mildly elevated PTH 130 pg/ml, normal 25 hydroxy Vit D and normal PTH related protein levels. Serum and urine electrophoresis with immunofixation revealed IgG monoclonal gamma restriction. A bone marrow biopsy ruled out plasma cell dyscrasia. A whole-body PET CT revealed marked splenomegaly with intense Fluorodeoxyglucose (FDG) uptake. Epstein Barr Virus (EBV) PCR was 407,000 IU/ml raising the suspicion for post transplant lymphoproliferative disorder (PTLD). A subsequent splenic biopsy revealed: Diffuse Large B Cell Lymphoma

and EBER ISH (Epstein-Barr Encoding Region in Situ Hybridization) test was positive. Hypercalcemia was treated successfully with intravenous fluids and pamidronate, then the patient was initiated on rituximab. However, due to lack of response, this was changed to rituximab, cyclophosphamide, doxorubicin and prednisone (R-CHOP) therapy. The patient maintained normal calcium level in the range pf (8-9 mg/dl).

**Discussion:** This is a unique presentation of an EBV induced PTLD involving the spleen in a renal transplant patient. Hypercalcemia by extrarenal overproduction of 1,25-dihydroxyvitamin D3 (1,25(OH)2D3) is seen in < 1% of hypercalcemia of malignancy and is usually found in lymphomas. It is more common in granulomatous disease like Tuberculosis and Sarcoidosis. The extra renal production of calcitriol by these cells results in substantial increase in the absorption of calcium. In this case hyperparathyroidism probably aggravated the condition.

SA-PO848

**A Case of Isolated Banff 2b Arteriopathy**

Nathan Dang,<sup>1</sup> Alexander Pennekamp,<sup>1</sup> Jonathan Tobias,<sup>2,3</sup> Joseph Kremer,<sup>4,3</sup>  
<sup>1</sup>The Christ Hospital Internal Medicine Residency, Cincinnati, OH; <sup>2</sup>Greater Cincinnati Pathologists, Cincinnati, OH; <sup>3</sup>The Christ Hospital Health Network, Cincinnati, OH; <sup>4</sup>The Kidney and Hypertension Center, Cincinnati, OH.

**Introduction:** Carefully balancing the risk of malignancy with the risk of allograft rejection underscores the importance of treating immunosuppression (IS) as both a science and an art. This case highlight a rare finding of isolated Banff2b TCMR that developed 28 years after initial transplantation.

**Case Description:** This is a 65 y/o male with a past medical history of LDRK transplant 28 yrs ago (ESRD 2/2 IgAN), lymphoma s/p ABVD and invasive skin cancer who presented to the office with progressively worsening creatinine over the past month. The patient has been managed with cyclosporine and low dose prednisone since his initial transplant. He was diagnosed with an invasive microcystic adnexal carcinoma of the skin about 25 years after kidney transplant. He underwent resection of the carcinoma soon after diagnosis. About one year after resection, the invasive carcinoma recurred. He became blind in one eye as a consequence of his worsening malignancy. Ultimately, the decision was made to wean off of cyclosporine and start on sirolimus while low dose prednisone was continued. He was started on carboplatin and paclitaxel shortly after switching his IS medications. One month afterwards, he presented to his Nephrologist's office with a progressive increase in his creatinine and concern for rejection. A kidney biopsy was performed. The biopsy showed minimal interstitial inflammation with one artery showing marked intimal expansion with both fibrosis and an active appearing lymphocytic infiltrate. The chronic inflammatory infiltrate also involved the media and adjacent cortex.

**Discussion:** Isolated Banff 2b arteritis is a rare phenomenon. In this case, acute rejection developed rapidly after years of stable IS therapy once cyclosporine was changed to sirolimus. The findings were favored to represent active endarteritis superimposed on chronic transplant arteriopathy. He was then restarted on sirolimus and higher dose of steroids and completed four treatments of local graft radiation with interval improvement of his creatinine.

Mechanism of Allograft Dysfunction	Test	Value	Units	Interpretation
	creatinine, serum	2.72 (eGFR 42 by CKD-EPI 2009)	g/dL	Acute Allograft Dysfunction
	creatinine, serum, baseline	1.53		
deNovo GN / GN recurrence	Urine protein to creatinine ratio	0.23	g/g	GN Unlikely
	Urinalysis	bland; reflex culture not indicated		
Pre-renal causes	Allograft ultrasound and PVR, doppler	normal, without evidence of allograft renal artery stenosis		Pre-renal contribution unlikely
BK allograft Nephropathy	BK quant	0	copies/mL	BK Ruled Out
TCMR	C4d staining	negative		TCMR ruled out

SA-PO849

**Clinical Course of a Kidney Transplant Recipient With BK Polyomavirus Treated With Posoleuceel (PSL) Multivirus-Specific T-Cells**

Adetokunbo A. Taiwo,<sup>1</sup> Stephan Busque,<sup>1</sup> Francesca Cardarelli,<sup>2</sup> Patrick Ahearn,<sup>1</sup> <sup>1</sup>Stanford University, Stanford, CA; <sup>2</sup>AlloVir, Waltham, MA.

**Introduction:** Treatment of BK viremia and nephropathy primarily involves reducing maintenance immunosuppression. Adjunct therapies such as cidofovir, IVIG, and leflunomide produce mixed results. We present the clinical course of a kidney transplant (KT) recipient with BK polyomavirus treated with posoleuceel, a novel therapy using multivirus specific T-cells.

**Case Description:** A 67-year-old man with a history of AL amyloidosis post orthotopic heart transplant developed end stage kidney disease and underwent a living related KT. He received thymoglobulin induction and maintenance immunosuppression with tacrolimus, mycophenolate, and prednisone. His baseline creatinine settled around 1.4 mg/dL. Six months later, he was diagnosed with EBV+ post-transplant lymphoproliferative disease

Key: TH - Thursday; FR - Friday; SA - Saturday; OR - Oral; PO - Poster; PUB - Publication Only

Underline represents presenting author.



and was treated with rituximab. PET scan showed resolution. Soon after, his creatinine rose to 1.8-2 mg/dL and a kidney biopsy showed BK polyoma virus nephropathy. Serum BK PCR at diagnosis was 3.5 million copies/mL. Mycophenolate was discontinued, tacrolimus was switched to sirolimus, and he was started on cidofovir q 2 weeks with rise in serum BK to >10 million copies/mL. Cidofovir was discontinued when his kidney function worsened. IVIG was started but was complicated by hemolytic anemia. FDA approved posoleculel for compassionate use. He received 4x10<sup>7</sup> PSL cells weekly for 3 doses then every other week for 3 doses. Table 1 summarizes his BK viral load and creatinine.

**Discussion:** PSL treatment was well tolerated with no adverse events. PSL is the only intervention associated with a significant decline of BK viremia in this patient with BK nephritis, with a ½ log decline in BK viral loads during the treatment period and further ½ log decline over follow-up. A phase 2 trial has completed enrollment.

**BK viral load and creatinine**

Treatment/Follow Up	BK Viral Load (IU/mL)	Creatinine (mg/dL)
Treatment 1	2,530,654	3.35
Treatment 2	2,607,078	3.0
Treatment 3	1,583,579	3.45
Treatment 4	1,920,140	4.06
Treatment 5	1,164,649	3.39
Treatment 6	1,157,669	3.32
Follow-up 1	351,000	3.60
Follow-up 2	346,000	3.63
Follow-up 3	235,000	3.86

**SA-PO850**

**Immune Tolerance in a Kidney Transplant Recipient With Two Related Donors**

Aliza Anwar Memon, Krista L. Lentine, Thanh-Mai N. Vo, Fadee Abu Al Rub, Bahar Bastani, John C. Edwards, Yasar Caliskan. *Saint Louis University, Saint Louis, MO.*

**Introduction:** Immune tolerance is multifaceted and involves the interaction of different cells. Despite major advances, widespread tolerance in solid organ transplantation has not yet been achieved without dependence on immunosuppressive treatment. Compulsory exposure to genetically foreign maternal tissue imprints in offspring sustained tolerance to noninherited maternal antigens (NIMA). Here, we describe a case of successful second transplant with persistence immune tolerance more than 20 years.

**Case Description:** A 53-year-old man with second living donor kidney transplant from his sister was consulted with Transplant Nephrology Unit. Patient had a past medical history of end stage kidney disease due to bilateral vesicoureteral reflux nephropathy, status post failed living donor kidney transplant from his mother in 1981 until 1984, first allograft nephrectomy, status post hemodialysis between 1984-1988 and status post second living donor kidney transplant from his sister in 1988. Patient's first kidney transplant failed due to rejection after 3 years. The patient received second transplant from his sister in June 1988. Patient discontinued his immunosuppressive treatment in 1999. Since then his serum creatinine level ranged between 1-1.2 mg/dL without any immunosuppressive treatment. Laboratory tests revealed: serum BUN 14 mg/dL, creatinine 1.13 mg/dL, total protein 7 g/dL, albumin 4.2 g/dL. Urine sediment showed 0-2 red blood and 0-5 white blood cells per high power field. Urine analysis showed no proteinuria. The Luminex single antigen bead HLA antibody screening test showed panel reactive antibody level of 0% and 8% for class I and II antibodies. The weak class II antibodies were against HLA-DQ:06:01, DQ:05:01, DQ:05:03, DQ:06:03, DQ:06:04 and DQ:06:02. Previous donors' HLA DQ typing were not available. Patient continued his posttransplant follow up without any immunosuppressive treatment.

**Discussion:** Although the exact mechanism of tolerance to second kidney transplant in this case is not known, transplantation of a kidney from his mother exposes the patient to the other haplotype carrying the NIMAs and this exposure of the fetus to NIMAs can lead to tolerance because of immaturity of the fetal immune system. This case highlights an important model to study further the NIMA-specific tolerance and the underlying mechanisms.

**SA-PO851**

**Passenger Lymphocyte Syndrome in Post-Transplant Patients**

Aliza Anwar Memon, Vidya Fleetwood, Daniela Hermelin, Natalie Malvik, Yasar Caliskan, Bahar Bastani, Fadee Abu Al Rub, Thanh-Mai N. Vo, John C. Edwards, Krista L. Lentine. *Saint Louis University, Saint Louis, MO.*

**Introduction:** Passenger Lymphocyte Syndrome (PLS) is an immune mediated hemolysis directed against recipient red blood cells as the result of the concurrent transplantation of allograft derived "passenger" lymphocytes. It is an uncommon phenomenon that occurs in the setting of minor ABO mismatched solid organ transplant. We present a unique case of PLS due to Rh-incompatibility.

**Case Description:** A Rh positive 61-year-old man with end stage kidney disease underwent a deceased donor kidney transplant from a Rh-negative donor. Allograft started to function and patient was discharged at postop day 7. He was re admitted after two weeks with a low hemoglobin level. Work up for anemia was significant for elevated lactate dehydrogenase, unconjugated bilirubin, undetectable haptoglobin, and schistocytes on the peripheral smear. Flow cytometry for paroxysmal nocturnal hemoglobinuria and G6PD level were within normal limits. The antibody screen and direct antiglobulin test (DAT) became positive which were previously negative. The DAT showed strong reactivity with

the anti-IgG reagent which was associated with anti-D antibodies in patient's plasma. Results of *RHD* genotyping testing showed no associated variants in this patient. However, a pre-mortem donor blood specimen was recovered, which revealed the presence of anti-D and anti-C antibodies in the donor's plasma. The diagnosis of PLS due to anti-D antibody was made. Patient received supportive treatment with Rh D and C antigen negative blood, steroids and rituximab infusions. Three months from transplant, the patient is stable with a down trending anti-D titer.

**Discussion:** PLS should be suspected in cases of sudden anemia following solid organ transplant. The timing of this occurrence is consistent with an anamnestic immune response. Having an awareness of this potential phenomenon can aid in prompt diagnosis and treatment which can range from transfusion support to immunosuppressive therapy.

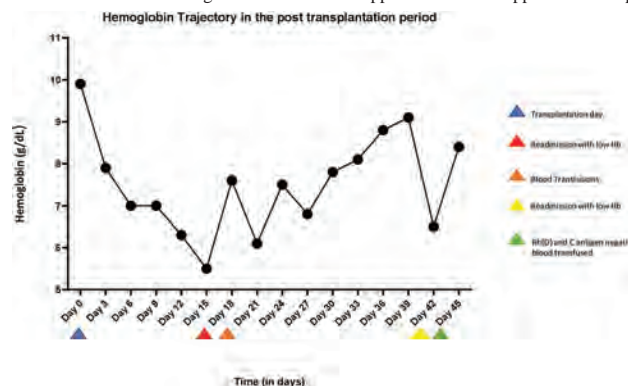

Hemoglobin trend in Passenger Lymphocyte Syndrome

**SA-PO852**

**Post-COVID-19 Syndrome Neuropsychiatric Complications Leading to Medication Non-Compliance and Acute Rejection in a Kidney Transplant Patient**

Taha M. Shaikh,<sup>1</sup> Thelmo Fidel Ernesto Barrantes Ramirez,<sup>2</sup> Michael B. Kuperman,<sup>3</sup> <sup>1</sup>Burrell College of Osteopathic Medicine, Las Cruces, NM; <sup>2</sup>Renal Medical Associates, Albuquerque, NM; <sup>3</sup>Arkana Labs, Little Rock, AR.

**Introduction:** Depression, anxiety, and fatigue, which can all contribute to medication non-adherence, have been described with different frequencies in post-COVID syndrome patients.

**Case Description:** The patient is a 41-year-old male with a past medical history of hypertension, type 2 diabetes mellitus, and hypothyroidism. He also has a history of end stage renal disease (ESRD) requiring kidney transplantation on 12/24/2017. He initially developed ESRD due to congenital unilateral renal agenesis and hypertension. He presented to the ED on 02/18/22 complaining of fatigue, dizziness, nausea and at least one prior syncopal episode. On 02/22/22, a kidney biopsy was taken showing evidence of acute vascular rejection, acute t-cell mediated rejection and acute antibody mediated rejection. The patient described increased fatigue and depressive symptoms following COVID hospitalization in November 2021, which he had not experienced before. After recovering from COVID in the hospital, he reported sleeping excessively, feeling exhausted throughout the day, decreased interest in activities, difficulty concentrating, and an overall decreased mood without suicidality. This combination of fatigue and depressive symptoms led to his medical non-compliance. He had no prior psychiatric history or issues with non-compliance.

**Discussion:** It is very likely that this patient is one of the first reported cases of post-COVID syndrome phenomena leading to serious downstream consequences such as kidney allograft failure. The goal of this case report is to increase awareness of post-COVID syndrome particularly in patients with chronic conditions that require strict medication regimens. By having adequate surveillance of these patients by both their primary care physicians as well as any specialists involved it is certainly possible to reduce the occurrence of serious downstream consequences. An example of this increased surveillance is prompt follow-up after COVID hospitalization for any patient with chronic health conditions. Another possible intervention is the use of questionnaires or surveys for post-COVID patients that can measure the effects of post-COVID syndrome, similar to how the PHQ-9 is utilized for MDD. Most importantly, it is crucial to provide knowledge of this phenomenon to patients and physicians alike.

**SA-PO853**

**Aliskiren as an Adjunct Treatment for Recurrent C3 Glomerulonephritis (C3GN) in a Transplant Patient**

Nouman Akbar, Selvaraj Muthusamy, Layla Kamal, Irfan A. Moinuddin. *Virginia Commonwealth University Health System, Richmond, VA.*

**Introduction:** C3GN is an immune complex disease mediated by activation of alternative complement pathway. This pathway can be activated by renin resulting in cleavage of C3, thus producing C3 convertase and subsequent membrane attack complex formation. Aliskiren, a direct renin inhibitor, can inhibit the complement and in a recent case report was successfully used for a case of native kidney C3GN.

**Case Description:** 25 years old African-American female with end-stage renal disease due to biopsy proven C3GN had a living unrelated kidney transplant at our center. Her pre-transplant testing showed elevated levels of complement fragments Ba/Bb and soluble C5b-9 but no pathogenic genetic mutations. C3 nephric factor and Factor H autoantibody were negative. She received induction with anti-thymocyte globulin, and maintenance immunosuppression was tacrolimus, mycophenolate mofetil (MMF) and prednisone. A surveillance biopsy at 3 months post-transplant did not show rejection or recurrence of primary disease. She developed 1.5 g/d proteinuria 3 years post-transplant while on losartan. A kidney biopsy showed recurrent C3GN, with immune complex deposits on electron microscopy. Her repeat testing was negative for C3 nephric factor and Factor H autoantibody. The complement fragments Ba/Bb and soluble C5b-9 levels were normal possibly due to her baseline immunosuppression. She was switched from losartan to Aliskiren and her MMF dose was increased by 500mg/d. Her proteinuria improved to 0.2 g/d over the next 8 months. A post-treatment biopsy was performed. Comparison of pre- and post-biopsy data showed a statistical reduction ( $p < 0.01$ ) in the mean (SD, standard deviation) size of deposits [2201 nanometer (SD 1102) vs 884 nm (SD 255)] as well as the density of deposits [3.8 per capillary loop (SD 2.5) vs 2.5 per capillary loop (SD 2.8)]

**Discussion:** Traditionally management of C3GN has included immunosuppressive agents including steroids, MMF and a possible role of complement pathway blocker, eculizumab. There have been case reports of successful treatment of native kidney C3GN in children with Aliskiren and MMF. In this first report we describe achievement of complete remission in a patient with recurrent C3GN after kidney transplant with Aliskiren and MMF intensification. These data support further trials for this relatively cheap therapy in this rare disease space.

#### SA-PO854

##### Malakoplakia of the Kidney Allograft

Jefferson L. Triozzi, Ramya Krishna Velagapudi, Mohammad Kazem Fallahzadeh Abarghouei, Agnes B. Fogo, Beatrice P. Concepcion. *Vanderbilt University Medical Center, Nashville, TN.*

**Introduction:** Malakoplakia is a rare granulomatous disease associated with infection, usually of the genitourinary tract. Solid organ transplant recipients and other immunocompromised individuals are at increased risk of malakoplakia. This case raises important considerations for the diagnosis and management of malakoplakia in kidney transplant recipients.

**Case Description:** A 40-year-old woman with end-stage kidney disease secondary to atypical hemolytic uremic syndrome, with a first kidney transplant nine years prior, a second kidney transplant four months prior, and a hospitalization for sepsis due to E Coli urinary tract infection one month prior, was hospitalized with worsening acute kidney injury despite resolution of sepsis. On presentation, she had normal vital signs and physical exam findings, and a serologic work-up and hemolysis studies were negative. A kidney biopsy demonstrated diffuse interstitial infiltrate with tubulitis and rare yeast-like forms for which she was empirically treated with fluconazole. Her kidney function continued to worsen, however, requiring hemodialysis. A second kidney biopsy demonstrated findings diagnostic of malakoplakia with foci of Michaelis-Gutmann bodies with targetoid appearance. Her kidney function improved with reduction of immunosuppression and a thirty-day course of ciprofloxacin.

**Discussion:** Malakoplakia is an inflammatory response to infection, often secondary to E coli or gram-negative bacteria in the genitourinary tract. Malakoplakia results from impaired phagolysosomal killing and elimination of bacteria by macrophages, resulting in Michaelis-Gutmann bodies (intracytoplasmic basophilic targetoid lesions of enlarged macrophages). Malakoplakia of the kidney allograft raises considerations for kidney transplant recipients. Firstly, urinary tract infections may herald the development of malakoplakia in predisposed individuals. Secondly, reduction of immunosuppression may improve antimicrobial treatment response. Thirdly, the diagnosis of malakoplakia requires collaboration with renal pathology to evaluate for other fungal or bacterial infectious etiologies that could present similarly. In sum, malakoplakia is a rare finding in the kidney transplant that can be treated with reduction of immunosuppression and appropriate antimicrobial therapy.

#### SA-PO855

##### Pharmacokinetic-Guided Dosing to Maintain Therapeutic Tacrolimus Levels During Post-Kidney Transplant Erythrocytapheresis in a Patient With Sickle Cell Anemia

John Caldwell, Danielle Lazear, Bradley Miyagawa, Tomoyuki Mizuno, Charles T. Quinn, Hillarey Stone, David K. Hooper, Charles D. Varnell. *Cincinnati Children's Hospital Medical Center, Cincinnati, OH.*

**Introduction:** To maximize renal recovery following kidney transplant (KT) in patients with sickle cell nephropathy (SCN) it is important to maintain a lower fraction of sickle hemoglobin (HbS). This can be done with erythrocytapheresis (RBCx). Tacrolimus (TAC), the primary immunosuppressive medication used after KT, is highly localized to red blood cells (RBCs) and is cleared by RBCx. This may result in subtherapeutic TAC levels and increased rejection risk. The impact of RBCx on post-KT TAC levels has not been described.

**Case Description:** A 16-y.o. male with ESKD secondary to SCN received a deceased donor KT. Pre-KT preparation included optimized hydroxyurea therapy and erythropoietin. He received one RBCx to target a HbS of  $< 10\%$  immediately prior to KT and subsequent scheduled RBCx to maintain HbS  $< 20\%$  for the first 3 months post-KT and  $< 30\%$  thereafter. Pre- and post-RBCx TAC levels were measured for pharmacokinetic modeling (PK). The patient received a post-RBCx dose of TAC after each treatment; the

dose was calculated based on estimated fraction of cells remaining (FCR), estimated RBC binding of TAC (85%), and the morning dose (Equation 1). Using PK, the estimated area under the curve (AUC) after RBCx with the extra TAC dose was 289 ng<sup>2</sup>h/mL which was comparable to his steady-state AUC (283 ng<sup>2</sup>h/mL) (Figure 1).

**Discussion:** Minimizing the risk of injury to a new allograft by minimizing HbS levels is an important aspect of post-KT care in patients with SCN. We show that a PK-guided dose of TAC after RBCx can allow highly effective treatment of SCN post-KT without compromising TAC exposure. This strategy protects the allograft by decreasing both SCN-related damage rejection risk.

$$\text{PostDose} = \text{MorningDose} * 0.85 * (1 - \text{FCR})$$

Equation 1. Tacrolimus post-dose calculation

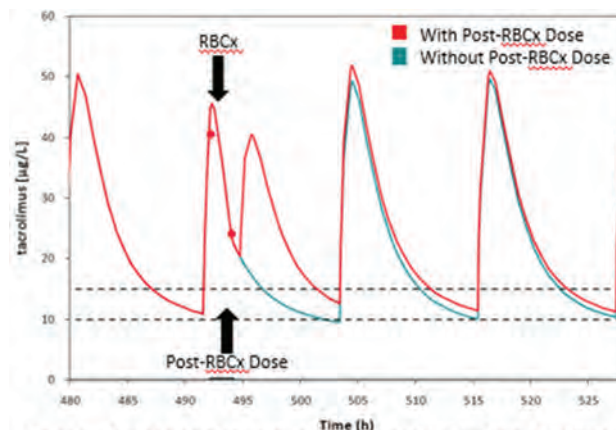

Figure 1. PK modeling of tacrolimus level with and without post-RBCx dose. Red dots indicate measured levels.

#### SA-PO856

##### Kidney Only Transplantation in Primary Hyperoxaluria Type 1: A Novel Approach in the siRNA Therapy Era

Matthew C. Breeggemann, Stephen L. Gluck, Marshall L. Stoller, Marsha May Lee. *University of California San Francisco, San Francisco, CA.*

**Introduction:** Primary hyperoxaluria type 1 (PH1) is a disease of impaired hepatic glyoxylate metabolism due to a deficiency in alanine glyoxylate aminotransferase (AGT) activity. PH1 is a major risk factor for calcium oxalate kidney stones, nephrocalcinosis, and end stage renal disease (ESRD). Following the onset of chronic kidney disease (CKD), plasma oxalate levels rise and oxalate deposition may occur in a variety of tissues. Oxalosis causes significant morbidity and mortality in this patient population and oxalate levels can continue to accumulate even with aggressive dialysis. The current surgical management of PH1 is combined liver-kidney transplantation. With the advent of silent RNA (siRNA) therapies targeting the hepatic overproduction of oxalate, kidney only transplantation is a practical novel approach for managing PH1 patients with severe renal impairment. We present the first known case of kidney only transplantation in a PH1 patient receiving siRNA therapy.

**Case Description:** A 17 year old patient with PH1 developed ESRD and was started on hemodialysis (HD). Three months after HD initiation, they started nedosiran on a compassionate use basis and declined an offer for a combined liver-kidney transplant in favor of waiting for a kidney only transplant. At age 19 years, they received a deceased donor kidney transplant and maintained on hemodialysis post-operatively to decrease oxalate burden (goal pre-HD plasma oxalate  $< 3$  umol/L) while continuing nedosiran. Subsequently, HD frequency decreased significantly and will likely be discontinued altogether at approximately six weeks post-transplantation.

**Discussion:** PH1 is a devastating kidney stone disease. Prior to 2020, there were no FDA approved drugs to treat PH1 and limited medical therapies aimed at delaying the onset of CKD and oxalosis were available. Definitive treatment in those with CKD has been combined liver-kidney transplantation to simultaneously replace the hepatic AGT deficiency and treat the renal impairment. Available novel siRNA therapies not only offer hope to the community of this ultra-rare disease but potentially eliminate the need for liver transplantation. This case is the first known kidney only transplant in a PH1 patient on siRNA therapy and may represent a major shift in the management of this vulnerable patient population.

## SA-PO857

**Relapsing Proliferative Glomerulonephritis With Monoclonal Immunoglobulin Deposits After Renal Transplantation Presenting With AKI and Gross Hematuria**

Sana J. Shaikh, Zoltan G. Laszik, Sandy W. Wong, Allison B. Webber. *University of California San Francisco, San Francisco, CA.*

**Introduction:** Proliferative Glomerulonephritis with Monoclonal Immunoglobulin Deposits (PGNMID) is a subtype of monoclonal gammopathy of renal significance (MGRS), resulting from deposition of intact monoclonal IgG in glomeruli.

**Case Description:** This is a 62-year-old woman with ESRD attributed to HTN who underwent a living-related renal transplant in 2009. She developed MGRS involving her allograft, diagnosed 7 years post-transplant during workup of AKI and nephrotic range proteinuria. Transplant biopsy showed membranoproliferative glomerulonephritis (MPGN) with gamma-3 heavy chain and kappa light chain restriction. Paraproteinemia workup was normal (SPEP, UPEP, serum and urine IFE, bone marrow aspirate and biopsy, PET-CT), aside from a marginal free light chain ratio (2.5). C3, C4, cryoglobulin, HIV, HBV, HCV were normal/negative. She received induction therapy with cyclophosphamide, bortezomib, dexamethasone (CyBorD), then carfilzomib, lenalidomide, dexamethasone. She transitioned to maintenance therapy with daratumumab and remained on tacrolimus monotherapy. Her renal function was stable on this regimen (Cr 1.7 mg/dL, UPCR 0.2) for the next 6 years. She then developed AKI and gross hematuria. Imaging and urologic workup were negative. Transplant biopsy was performed and revealed active MPGN. This was further classified as IgG3-kappa PGNMID, a more recently described entity. For her declining renal function, she required hemodialysis. As prior, there was no detectable paraprotein. She was treated with CyBorD. 3 months later dialysis was discontinued. The inciting event leading to her relapse was not clear.

**Discussion:** PGNMID is a plasma cell disorder associated with a paraprotein causing kidney injury that does not meet criteria for multiple myeloma or lymphoma. The rate of detection of the nephrotoxic monoclonal immunoglobulin in the serum or urine, or of an abnormal bone marrow B cell clone is only 30%. After transplantation, PGNMID has a high recurrence rate and is complicated by frequent relapses and decreased graft survival. Management of this disease requires close collaboration with Hematology and involves targeting the presumed plasma or B cell clone.

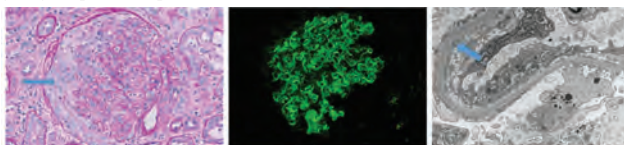

Light microscopy (left) - the glomerulus shows prominent endo and extracapillary (arrow) hypercellularity with reduplication of the basement membranes. Immunofluorescence microscopy (middle) - IgG3 is strongly positive in the mesangial area and also along the periphery of the capillary walls. Electron microscopy (right) disclosed subendothelial electron dense immunotype deposits.

## SA-PO858

**Normotensive Scleroderma Renal Crisis 8 Years After Living Donor Renal Transplantation: A Case Report**

Hajime Sanada, Satoshi Hara, Shunsuke Tsuge, Ryo Nishioka, Kiyooki Ito, Ichiro Mizushima, Mitsuhiro Kawano. *Kanazawa University Hospital Department of Rheumatology, Kanazawa, Japan.*

**Introduction:** Scleroderma renal crisis rarely occurs in transplanted kidneys, and it remains unknown whether prednisolone for transplantation could be the risk factor.

**Case Description:** A 36-year-old man was diagnosed with systemic sclerosis 19 years ago based on skin involvement and positive anti-topoisomerase I antibody. He often had to be hospitalized due to intractable digital ulcers and interstitial lung disease. He developed class 5 lupus nephritis and systemic lupus erythematosus 11 years ago. It was refractory and hemodialysis was started 9 years ago, and he underwent ABO-compatible living donor renal transplantation with his father as the donor 8 years ago. His renal function remained at serum creatinine (sCr) 1.0 mg/dL, but he had suffered from cytomegalovirus (CMV) infections such as esophagitis and enteritis after transplantation. Thus, we switched mycophenolate mofetil to everolimus 2 months ago. One month before, renal function had gradually declined to sCr 1.65 mg/dL, and a renal biopsy was performed. Pathological findings indicated granulomatous interstitial nephritis (GIN), which was diagnosed as idiopathic without any obvious secondary cause. The dose of prednisolone (PSL) was increased from 5 to 30 mg/day after steroid pulse therapy, but his renal function continued to deteriorate to sCr 2.9 mg/dL, and urine protein increased to 4.5 g/day. The second kidney biopsy next month showed the GIN improvement, and microarterial thrombus and glomerular endothelial cell damage were observed, leading to a diagnosis of acute thrombotic microangiopathy (TMA). The patient was considered to have normotensive scleroderma renal crisis (SRC), and an angiotensin-converting enzyme inhibitor was initiated. His renal function stopped falling at the sCr 3 mg/dL.

**Discussion:** SRC rarely develops in transplanted kidneys, and it has been suggested that PSL administration for transplantation may not be a risk factor for the development of SRC. However, we could not identify other causes of TMA except for PSL dose increase which may cause SRC in our case. In conclusion, SRC could emerge in the transplanted kidney and might be induced by PSL dose increase. PSL dose for patients with scleroderma should be taken carefully even after kidney transplantation.

## SA-PO859

**Loin Pain and a New Mechanism: Altruistic Kidney Donation Is a Win-Win!**

Sriram Sriperumbuduri, Pradeep Vaitla, Christopher Anderson, Tariq Shafi. *The University of Mississippi Medical Center, Jackson, MS.*

**Introduction:** Loin pain due to complex reno-vascular anatomy can be debilitating. Refractory cases need auto transplantation and rarely nephrectomy to control the symptoms. Utilizing the nephrectomized kidney for donation is an option that is not commonly explored.

**Case Description:** A 40-year-old-female, non-hypertensive and non-diabetic, with persistent left flank pain for 4 years, sought help at our center for further management. Prior contrast computerized scan of the abdomen showed compression of left renal vein between aorta and vertebra concerning for nutcracker phenomenon. However direct measurement of venous pressures showed no significant pressure gradient across the renal vein, raising concern for loin pain hematuria syndrome. Evaluation showed serum creatinine of 0.6 mg/dl and estimated glomerular filtration rate (eGFR) of 119 ml/min/1.73m<sup>2</sup>. Urine microscopy results over the past 4 years revealed no microscopic hematuria or significant proteinuria. Due to unrelenting and episodic pain despite multiple medications, treatment options were offered including auto transplantation and nephrectomy. She was presented with the option of kidney donation if she chooses to proceed with nephrectomy. She agreed with directed kidney donation to an acquaintance and after appropriate work up, she underwent laparoscopic left kidney nephrectomy. Intraoperatively note made of 2 left renal veins terminating at angles into lumbar veins. The consensus was that it was the lumbar collateral that is retro-aortic and she had venous outflow obstruction from the kidney due to lack of collaterals formed from the lumbar veins. Her most recent serum creatinine was 0.98 mg/dl (eGFR 75 ml/min/1.73m<sup>2</sup>) about 4 months after the surgery and she remains flank-pain free. Recipient of the kidney transplant is a 69-year-old caucasian male. He recovered well from the surgery with no symptoms of pain and hematuria. His nadir post-transplant creatinine was 1.2 mg/dL and eGFR of 55 ml/min/1.73m<sup>2</sup> at 4 months.

**Discussion:** This case demonstrates the treatment options in cases with complex reno-vascular anatomy causing debilitating pain, including the unique possibility of donation of the kidney. Donation of healthy nephrectomized kidney is a unique display of altruism.

## SA-PO860

**Green Donor Kidneys: Transplantable or Not**

Hay Me Me, Pooja Budhiraja, Sumi Sukumaran Nair, Lavanya Kodali. *Mayo Clinic Arizona, Scottsdale, AZ.*

**Introduction:** Hyperbilirubin cause detrimental effects on kidney tubule function. In ongoing organ shortage, utilization of high-risk donor kidneys is needed. The outcomes of transplanting donor kidneys with bile cast nephropathy is uncertain.

**Case Description:** A pair of deceased kidneys were offered from a 34-year-old male with history of cirrhosis of liver with portal hypertension secondary to alcohol dependent disorder. He had acute kidney injury (AKI) requiring continuous renal replacement therapy. His liver function tests were elevated including total bilirubin of 40.5 mg/dl and direct bilirubin of 20 mg/dl. Both kidneys had greenish discoloration in appearance (Fig 2). Renal biopsy on frozen section showed minimal interstitial fibrosis, moderate arterial sclerosis, moderate tubular injury. The right kidney was transplanted into a 67-year-old female with end stage renal disease (ESRD) from renal cell carcinoma and the left kidney was transplanted to a 64-year-old female with ESRD from hypertension. Cold ischemic time were 22 hours 40 minutes and 30 hours and 9 minutes, respectively. Post reperfusion renal pathology was consistent with bile cast nephropathy and acute tubular injury (Fig 1). Both kidneys had delayed graft function and required hemodialysis for 29 days and 22 days respectively. By second month, both creatinine improved to 1.6-1.8 mg/dl.

**Discussion:** Our case report indicates that kidneys from donors with cholemic nephropathy, even with severe AKI can be safely utilized. Although it is associated with delayed graft function in immediate post-transplant period, there is significant improvement by the second month.

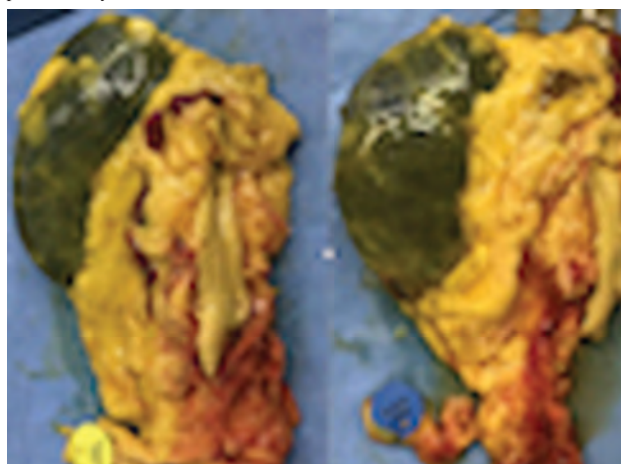

Donor Kidneys

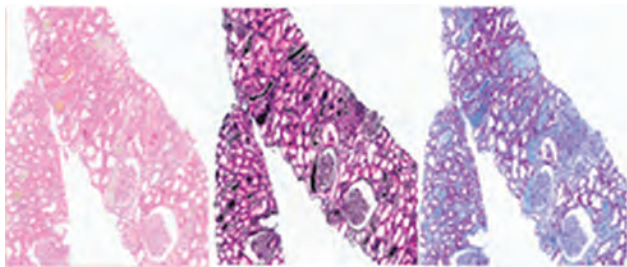

Bile Cast Nephropathy

## SA-PO861

### Effectiveness of Lymphatic Lipiodol Embolization for Post Renal Transplant Lymphoceles

Kasumi Konishi, Yugo Ito, Kotaro Shimoyama, Nozomi Kadota, Takuya Fujimaru, Fumika Taki, Masahiko Nagahama, Masaki Shimbo, Masaaki Nakayama. *St. Luke's International Hospital, Tokyo, Japan.*

**Introduction:** Lymphocele is a relatively common complications after kidney transplantation. Although the majority of cases are asymptomatic and self-limiting, interventional treatment is required for cases with worsening kidney function, deep vein thrombosis, lower leg edema or urinary tract obstruction. A wide range of treatment strategies are available, but there is no consensus on the optimal management as far as high recurrence and complication rate is concerned.

**Case Description:** A 75 year-old man with end-stage kidney disease due to diabetic nephropathy underwent ABO-incompatible living kidney transplantation from his wife. His perioperatively course was uneventful. He developed right lower leg edema 1 month after the surgery. Abdominal CT scan revealed the lymphoceles around the transplanted kidney with external iliac vein compression. Percutaneous catheter drainage reduced the size of lymphocele transiently only for 1 day. Since, right intranodal lymphography demonstrated active lymph leakage (Figure), we performed lymphatic embolization with Lipiodol. The lymphocele was diminished and his lower leg edema was improved successfully.

**Discussion:** Regarding treatment of lymphocele after kidney transplantation, high recurrence rate after aspiration and drainage have been important issue. Furthermore, sclerotherapy can cause allergy for sclerosant and spillage of it induces inflammation around the graft. Recently some case reports have indicated that lymphatic lipiodol embolization is effective for lymphoceles. Our case suggested that it is minimally invasive and safe for treatment as well as diagnosis of lymphoceles after kidney transplantation.

## SA-PO862

### A Rare Presentation of Recurrent c-ANCA Glomerulonephritis 10 Years Post-Kidney Transplant

Ahmad A. Masry,<sup>1</sup> Prerna Rastogi,<sup>2</sup> M. Lee Sanders.<sup>1</sup> <sup>1</sup>University of Iowa Hospitals and Clinics, Department of Internal Medicine, Division of Nephrology, Iowa, IA; <sup>2</sup>University of Iowa Hospitals and Clinics, Department of Pathology, Iowa, IA.

**Introduction:** Pauci-immune glomerulonephritis (GN) is the most common type of crescentic rapidly progressive GN. While kidney transplantation remains the optimal treatment for those patients who progress to end stage kidney disease (ESKD), patients remain at risk for disease recurrence even in the modern era of immunosuppression. Most anti-neutrophil cytoplasmic antibody (ANCA) associated vasculitis cases reoccur with a median time of 30 months post-transplant. We report a rare case presentation of a first recurrence of crescentic pauci-immune GN ten years following kidney transplantation.

**Case Description:** A 74-year-old female with a history of living related kidney transplant ten years ago was found to have blood and protein on her yearly urinalysis specimen. Her post-transplant course up to that point had been unremarkable with no rejection episodes and a baseline serum creatinine (sCr) range maintained between 0.9-1.1 mg/dL. Her chronic immunosuppression regimen consisted of tacrolimus and mycophenolate. While her sCr was within her baseline range, her urine protein to creatine ratio was 3.0 compared to 0.2 the year prior. No history of diabetes, no rashes were present, and she had no complaints. Additional work-up showed no monoclonal spike on serum protein electrophoresis, no donor specific antibodies, and a donor derived cell free DNA value of 0.16%. Of note, the original cause of her kidney failure was officially listed as lupus nephritis; therefore, an immunologic work-up was performed which revealed a positive ANCA with MPO titer of 1:320. A subsequent renal biopsy revealed pauci-immune necrotizing and crescentic GN. Treatment with rituximab 1000 mg for two doses 14 days apart and high dose oral prednisone was initiated. We were able to obtain the native kidney biopsy for review which showed a crescentic GN with negative immunofluorescence making pauci-immune GN the more likely cause of her original ESKD.

**Discussion:** New onset hematuria and proteinuria in a kidney transplant recipient warrants additional work-up. In this case, we surprisingly discovered a crescentic GN in the setting of stable renal function. This likely recurrence of primary disease ten years post-transplant is also well beyond the typical median time for recurrence. Our next clinical step will be to perform a repeat biopsy after treatment completion to ensure disease resolution.

## SA-PO863

### Kidney Biopsy Proven Thrombotic Microangiopathy in a Heart Transplant Recipient

Syed U. Haider, Kenar D. Jhaveri, Vanesa Bijol, Nupur N. Uppal. *Donald and Barbara Zucker School of Medicine at Hofstra/Northwell, Hempstead, NY.*

**Introduction:** Thrombotic Microangiopathy (TMA) after non renal solid organ transplantation is very rare. While few cases of TMA following liver and lung transplants have been published, it has been very rarely reported following orthotopic heart transplant (OHT). We report the first case of kidney biopsy proven De Novo TMA after OHT.

**Case Description:** 58-year-old male with non ischemic cardiomyopathy undergoes OHT in Jan 2021. He had normal renal function pre transplantation. Post-operatively he had pericardial effusion and in that setting developed oliguric AKI from ATN requiring dialysis. His renal function recovered and was discharged without dialysis. He was on tacrolimus, MMF and steroid regimen. Frequent heart biopsies were negative for rejection. In March 2021 the patient was admitted for GI bleed and again noted to have AKI. However, during this episode he developed proteinuria of over 2gm, new compared to previous urine studies. He was discharged with a serum creatinine of 2.6mg/dL. By July 2021 renal function worsened and he underwent a renal biopsy on 7/30/21 which showed acute and chronic TMA, related to calcineurin inhibitor use. Viral causes and other medications were ruled out (CMV, BK, adenovirus, SARS-COV2). Tacrolimus was held and he was initiated on Everolimus. Genetic and complement testing revealed normal complement levels, an elevated SC5b-9 complex, heterozygous for the APOL1 gene mutation (c.[1024A>G;1152T>G] p.[Ser342Gly;Ile384Met] (G1 allele)), and heterozygous for the CFHR5 gene mutation, suggestive for complement mediated TMA. He was initiated on Eculizumab. After two doses of Eculizumab he was again admitted with acute respiratory failure requiring intubation secondary to mTOR induced pneumonitis. His renal function worsened and he was reintitiated on dialysis. After a multidisciplinary discussion, he was transitioned to cyclosporine for immunosuppression. He continues to be on dialysis and cyclosporine with eculizumab without other non-renal findings of TMA. He is currently being evaluated for kidney transplantation. He has no signs of OHT rejection on heart biopsies.

**Discussion:** The early identification and treatment of TMA in OHT is important in preventing further complications associated with it. Although rare as compared to other solid organ transplants, it is essential to maintain TMA as a differential diagnosis for AKI following OHT.

## SA-PO864

### Severe Hydronephrosis in Kidney Transplant due to Ureteral Malakoplakia and Resolution With Immunosuppression Reduction and Antibiotics

David S. Rustom,<sup>1</sup> Sahar Amin,<sup>1</sup> Barry M. Wall,<sup>1,2</sup> Manish Talwar,<sup>1</sup> Vasanthi Balaraman,<sup>1</sup> Anshul Bhalla.<sup>1</sup> <sup>1</sup>The University of Tennessee Health Science Center, Memphis, TN; <sup>2</sup>VA Memphis Medical Center, Memphis, TN.

**Introduction:** Malakoplakia is chronic granulomatous inflammation that can demonstrate pseudotumor characteristics. It most often affects the genitourinary tract, but ureteral involvement resulting in urinary tract obstruction is rare. In this report, we present a case of extensive malakoplakia surrounding a renal transplant and ureter causing severe hydronephrosis and AKI.

**Case Description:** 55-year-old male with ESRD due to hypertension received a cadaveric kidney transplant in Nov 2020 with postoperative course complicated by recurrent urinary tract infections with *Escherichia coli*. He responded well to courses of antibiotics. However, he developed AKI (creatinine 3.3 mg/dL from baseline 2.0 mg/dL), in Feb 2021 and CT abdomen/pelvis revealed severe hydronephrosis of the transplant kidney and a multifocal hyperdense collection involving the renal transplant and ureter extending into surrounding structures and subcutaneous tissue of the abdominal wall to the skin surface. Due to concern for possible renal abscess, he was treated with IV antibiotics, and nephrostomy tube was placed with subsequent stent. Repeat CT in Mar 2021 showed progression of disease extent. To avoid seeding a potential abscess with invasive biopsy, he underwent superficial left abdominal wall biopsy, which showed foamy epithelioid histiocytes (CD68 positive) with granular eosinophilic cytoplasm and intracytoplasmic Michaelis-Gutmann bodies (Von Kossa positive), consistent with malakoplakia. Long-term antibiotics were continued with ceftriaxone that was transitioned to cefdinir, trimethoprim/sulfamethoxazole, and levofloxacin. Immunosuppression was reduced by discontinuing mycophenolic acid, lowering goal tacrolimus trough level, and maintaining low dose prednisone. Serial CT imaging over several months showed marked improvement in malakoplakia and complete resolution of hydronephrosis and AKI (creatinine 1.4 mg/dL). Ureteral stent was removed with no further hydronephrosis on imaging. Transplant kidney biopsy in June 2021 was negative for acute rejection.

**Discussion:** Malakoplakia can rarely involve a transplant kidney and ureter leading to severe urinary tract obstruction. In this report, we describe a case with gradual but dramatic response to management by treating with long-term antibiotics and reducing immunosuppression.

Key: TH - Thursday; FR - Friday; SA - Saturday; OR - Oral; PO - Poster; PUB - Publication Only

Underline represents presenting author.

## SA-PO865

**Recurrence of C3 Deficiency Related Membranoproliferative Glomerulonephritis After Kidney Transplantation**

João F. Bernardo, Sara Gonçalves, Iolanda Godinho, Fernando Abreu, Marta A. Neves, Maria Joao Melo, Joao A. Goncalves, Alice Santana, Jose A. Lopes. *Centro Hospitalar Universitario Lisboa Norte EPE, Lisboa, Portugal.*

**Introduction:** C3 deficiency is hereditary disease leading to ineffective opsonization and defective complement lytic activity, increasing infection susceptibility. Affected patients may develop an immune-complex mediated membranoproliferative glomerulonephritis (MPGN) due to inadequate immune complexes clearance. Theoretically possible, the MPGN disease recurrence in the kidney graft of C3 deficient patients has never been described and its impact on graft survival is unknown.

**Case Description:** 29-year-old caucasian male with complete absence of C3 factor due to a homozygous loss function mutation. He had a history of frequent respiratory infections and one episode of meningitis in childhood. At the age of 20 he presented hematuria, proteinuria (1,3g/24h) and elevated serum creatinine (pCr 2,3mg/dL). Kidney biopsy were compatible with MPGN secondary to IC deposition. He rapidly progressed to end stage kidney disease, starting haemodialysis at the age of 22, and was submitted to a kidney transplant five years later: Maastricht II cardiac death donor with 6 HLA mismatches, no donor specific antibodies (DSA) and induction therapy was thymoglobulin. Despite delayed graft function, one month after discharge the patient had a serum creatinine of 2,1mg/dL. There were no infectious complications but 18 months after transplantation he developed microscopic hematuria, proteinuria (4,1g/24h) and progressive kidney allograft dysfunction without DSA, without cytomegalovirus or polyoma virus infection. Kidney allograft biopsy revealed lobulated glomeruli, thickening of the capillary wall, endocapillary cellularity, mesangial expansion, "full house" pattern (deposition of IgG, IgA, IgM, C1q and C4 in the mesangium and capillary wall) and no C3. Based on this, we assumed a recurrence of IC mediated MPGN secondary to C3 deficiency. Despite initiation of antiproteinuric therapy, graft function deteriorated and nine months after he was started on hemodialysis.

**Discussion:** MPGN recurrence after kidney transplantation of C3 deficient patients seems to occur early and graft survival is considerably shorter. As C3 is mainly synthesized in liver, combined liver-kidney transplantation maybe a better option, in order to restore C3 plasma circulating pool and prevent MPGN recurrence.

## SA-PO866

**A Case of Mutation Negative Transplant Associated Thrombotic Microangiopathy Successfully Treated With Eculizumab**

Ujjwala Murari,<sup>1</sup> Divya Mounisha R. Thimmareddygar, <sup>1</sup> Purna Bindu Nandigam,<sup>2</sup> Umair Khan.<sup>1</sup> *<sup>1</sup>Newark Beth Israel Medical Center, Newark, NJ; <sup>2</sup>Cooperman Barnabas Medical Center, Livingston, NJ.*

**Introduction:** Transplant associated Thrombotic Microangiopathy (TA-TMA) is rare and causes graft failure. TMA may occur de-novo, triggered by immunosuppressive medication and antibody mediated rejection (AMR). We present a rare case of TA-TMA due to Atypical HUS (aHUS) successfully treated with Eculizumab.

**Case Description:** A 45-year-old female with history of end-stage renal disease of unclear etiology underwent a renal transplant with Thymoglobulin induction. A pre-transplant work up showed negative CDC cross match, zero percent PRA, and 2A-2B-0DR HLA mismatch. Post-operative course was complicated by persistently high creatinine, hemolytic anemia, thrombocytopenia, elevated LDH, and low haptoglobin by day 3. Given the possibility of Calcineurin inhibitor induced TMA. Tacrolimus was changed to Everolimus and the patient received plasmapheresis/hemodialysis. Allograft biopsy confirmed TMA without concurrent rejection. Disseminated intravascular coagulation was ruled out with a normal prothrombin and partial thromboplastin time. With poor response to Everolimus, a repeat allograft biopsy was done which showed prior findings. A negative workup for infection, ADAMTS13, complement genetic mutation panel, complement levels with above findings pointed towards atypical HUS induced by renal transplant and Tacrolimus. Everolimus was switched to Belatacept and Eculizumab. A significant improvement in her renal function following Eculizumab therapy was noted in the subsequent weeks.

**Discussion:** Incidence of renal transplant associated TMA is around 0.8-1.4%. It's often seen in the first week of post-transplant course when patients receive high doses of immunosuppressive medications. Often mutations in complement regulating or alternate pathway enhancing proteins or the presence of anti-factor H antibodies can predispose a patient to aHUS(1). Complement mutations are not seen in 30% cases. Upon literature review, a few cases with Plasma exchange resistant aHUS were successfully treated with Eculizumab, but had complement mutations, unlike our patient. MAC complex or C5b-9can be used as a marker to monitor complement inhibition. Given the rarity, there are no guidelines regarding the dose and duration of therapy with Eculizumab; relapses and renal complications often direct the duration (2) and is an area of ongoing research.

## SA-PO867

**Hemophagocytic Lymphohistiocytosis Following Simultaneous Liver and Kidney Transplant**

Zeeshan Azeem, Zahir Ali Shaikh, Gitana Bradauskaite, Radi Zaki, Hitesh Kaul, Kamran Khanmoradi, John P. Knorr. *Albert Einstein Medical Center, Philadelphia, PA.*

**Introduction:** Hemophagocytic lymphohistiocytosis (HLH) is a rare disease entity characterized by an inappropriate immune activation syndrome characterized by fever, hepatosplenomegaly, cytopenia and progressive multiple-organ failure. It is broadly classified as either primary or secondary form. Primary HLH is an autosomal recessive usually diagnosed in children less than 2 years of age. Secondary HLH is triggered by immune insults such as vaccinations, viral infections, autoimmune disorders or malignancies. HLH has also been reported after kidney, liver and hematopoietic stem cell transplants. We present a case of HLH secondary to graft vs host disease (GVHD) in a patient who underwent simultaneous liver-kidney transplant (SLKT).

**Case Description:** A 74 year old male received SLKT due to NASH cirrhosis, from a 29 year old female deceased donor. He was re-admitted 4 weeks post-transplant with altered mental status, diarrhea, fever, rash and signs of sepsis. Following initial resuscitation, intubation and mechanical ventilation, the patient was started on broad spectrum antibiotics and anti-fungal medications. His cell counts, kidney function and liver tests were within normal range at admission but he later developed severe pancytopenia and a very high ferritin (15,910 ng/mL). Blood cultures showed Paeruginosa and E. faecium. Abdominal imaging revealed splenomegaly. Patient's white cell count did not improve despite maximum dose of G-CSF. A bone marrow biopsy revealed hemophagocytes (Fig. 1). A diagnosis of HLH was made and the patient was started on etoposide and dexamethasone. A skin biopsy was suggestive of GVHD. Hemodynamic status continued to deteriorate during hospital course leading to death on 10th day of re-admission.

**Discussion:** HLH is a rare disease and should be suspected in patients with fever, cytopenias and ferritin >500 µg/L. Etoposide and dexamethasone are most commonly used therapies. Secondary HLH has a dismal prognosis and a very high fatality rate. Early diagnosis and treatment can lead to improved outcomes. Keywords: Hemophagocytic lymphohistiocytosis (HLH), graft versus host disease (GVHD).

## SA-PO868

**Granulomatous Interstitial Nephritis due to Histoplasma spp. in a Kidney Transplant**

Alyssa L. Davis,<sup>1</sup> Meghan Kapp,<sup>2</sup> Beatrice P. Concepcion.<sup>1</sup> *<sup>1</sup>Vanderbilt University Medical Center, Nashville, TN; <sup>2</sup>University Hospitals, Cleveland, OH.*

**Introduction:** There are numerous causes of acute kidney injury (AKI) in an acutely infected kidney transplant recipient. Here we present an unusual cause of AKI secondary to granulomatous interstitial nephritis.

**Case Description:** A 51/M with a kidney transplant in 2010 (maintained on FK/MMF/Pred), afib and HTN presented in early fall with fever and AKI. He described 1 month of fevers, myalgias, night sweats, shortness of breath and abdominal pain. On presentation, temp was 101.9°F, BP 111/76, HR 130, RR 24, O2 sat 97% RA. Physical exam revealed an ill-appearing man in no acute distress, clear lungs bilaterally and mild epigastric tenderness to palpation. Initial laboratory exam was notable for Na129 mmol/L, K 6.9 mmol/L, bicarbonate 12 mmol/L, BUN 48 mg/dL and Scr 3.7 mg/dL (baseline 1.6 mg/dL). Urinalysis had no protein, 24 WBC and 19 RBC. Transplant ultrasound was normal. CXR revealed a new 1cm dense nodule in the right lower lobe. CMV, EBV, and BK virus were not detected. Urine bacterial culture had no growth. Urine histoplasma antigen returned strongly positive. His epigastric pain was evaluated with endoscopy and colonoscopy, and he was found to have erosions and friable tissue in the duodenum, colon, and cecum. Due to persistent kidney dysfunction, a kidney biopsy was performed. This revealed two foci of granulomatous inflammation comprised of histiocytes and small lymphocytes. A GMS stain highlighted fungal organisms in these areas consistent with Histoplasma spp. There was global granular mesangial staining for C3 (1+) and segmental granular mesangial staining for IgM (trace) suggestive of sequelae of infection. He was treated for disseminated histoplasmosis with liposomal amphotericin B (8 days) with good clinical improvement and was transitioned to maintenance isavuconazole (due to drug interaction of itraconazole with patient's amiodarone). On follow-up eight months later, Scr improved to 2 mg/dL, and the patient remains on isavuconazole.

**Discussion:** Granulomatous interstitial nephritis may occur in the setting of direct infection of the kidney by Histoplasma spp. as demonstrated in this patient's kidney biopsy. In this case, prompt and appropriate treatment of the infection led to clinical improvement. Providers should be aware of unusual causes of AKI in an acutely infected kidney transplant recipient which may require a biopsy for diagnosis.

## SA-PO869

**Collapsing Focal Segmental Glomerulosclerosis Complicating BK Allograft Nephropathy in a Heart-Kidney Transplant Recipient**

Zamir A. Zamir,<sup>1</sup> Michelle A. Josephson,<sup>2</sup> Yousuf Kyeso,<sup>2</sup> Sambhavi Krishnamoorthy,<sup>2</sup> Patrick Cunningham.<sup>1</sup> *<sup>1</sup>Chicago State University, Chicago, IL; <sup>2</sup>The University of Chicago Medicine, Chicago, IL.*

**Introduction:** Collapsing focal segmental glomerulosclerosis (FSGS) is a variant of FSGS and is associated with severe nephrotic syndrome and acute kidney injury and can occur after kidney transplantation. The exact mechanism of collapsing FSGS after kidney transplantation is unclear, but potential causes include autoimmune diseases, cancers,

medications side effects, and viral infections. We describe a unique presentation of this detrimental diagnosis in kidney transplantation.

**Case Description:** 47-year old South East Asian male with ESRD secondary to DM and ischemic cardiomyopathy underwent HLA compatible simultaneous heart and kidney transplant. Nadir serum Cr was 1.5 mg/dl. Induction with Basiliximab and immunosuppression included Tacrolimus, Prednisone and Mycophenolate Mofetil (MMF). Four months after transplant, serum Cr peaked at 3 mg/dl and BK plasma viral load (VL) found to be 2 million copies per ml. Kidney biopsy confirmed BK nephropathy. MMF replaced with leflunomide, and IVIG 2g/kg were given. Three months later, serum Cr stabilized at 2 mg/dl and BK VL improved to 30,000 copies. Six months later, patient presented with acute onset hypervolemia, proteinuria of 18 grams, and oliguric AKI with Cr of 5.5 mg/dl. Repeat kidney biopsy revealed collapsing FSGS on pathology with diffuse podocytes effacement on electron microscopy. BK VL increased to 900,000 copies, and infectious workup was negative. Patient required hemodialysis for hypervolemia, IVIG 2g/kg, FK goal was lowered to 3-5 ng/ml, and empiric 3 sessions of plasmapheresis were instituted for a concern of de novo FSGS. Six weeks later, patient was able to be weaned off HD, serum Cr stabilized at 3.5 mg/dl, and urine protein improved to 1 mg/dl. Repeat BK VL came down to 35000 copies/ml.

**Discussion:** Here, we present a case of acute nephrotic syndrome secondary to collapsing FSGS 12 months post kidney transplantation. Patient has no known history of FSGS nor any evidence of autoimmune diseases or malignancy. He had no exposure to any new medication and his infectious workup was negative except for BK viremia. We believe that collapsing FSGS was triggered by the significant BK viremia and nephropathy in this case. Early detection of proteinuria and prompt treatment of BK viremia can potentially reverse this catastrophic sequel.

#### SA-PO870

##### BK Nephropathy in Hematopoietic Stem Cell Transplant Patients: An Upcoming Challenge

Shoab B. Fareedy,<sup>1</sup> Rana Raheel H. Khan,<sup>1</sup> Amanda Tchakarov,<sup>1</sup> Omar Mamlouk,<sup>2</sup> <sup>1</sup>The University of Texas Health Science Center at Houston John P and Katherine G McGovern Medical School, Houston, TX; <sup>2</sup>The University of Texas MD Anderson Cancer Center, Houston, TX.

**Introduction:** Nephropathy from BK virus (BKV) infection is a known challenge in the context of kidney transplant patients. Usually, a consequence of potent IS aimed at reducing acute rejection and improving allograft survival. Moreover, it can also be encountered in recipients of HSCT on IS to prevent or treat GVHD and can lead to progressive CKD and poor overall survival. As the number of HSCT patients is increasing worldwide, evidence-based guidelines are required, to combat potential loss of kidney function in these patients. Decreasing IS remains the principal treatment of BKV nephropathy in kidney transplant patients but predisposes to allograft rejection. Antiviral medications including leflunomide, cidofovir, quinolones, and intravenous Ig have been used with variable outcome and with risk for nephrotoxicity. In recipients of SCT there are no established guidelines to help with the diagnosis and treatment of BK nephropathy

**Case Description:** We present a case of a 39-year-old male with a history of AML who underwent cord blood allogeneic stem cell transplant in March 2021. He developed gastrointestinal GVHD and was treated for fungal pneumonia. 8 weeks post-transplant he started to have gradual decline in kidney function with rise in serum creatinine from 3.38 mg/dl to 5.65 mg/dl over 12 weeks. Urine was bland with no microscopic hematuria, pyuria, or proteinuria. US guided biopsy revealed tubulointerstitial injury attributed to BK tubulopathy. BK level in the blood was of 184,000 copies/ml and in the urine of 4.70E+09 copies/ml. Tacrolimus was tapered down and switched to sirolimus. Unfortunately, patient continued to have a steady decline in renal function and is now being prepared to initiate RRT.

**Discussion:** BK virus in HSCT recipient is usually asymptomatic infection, when it manifests clinically, the most common presentation is dysuria and hematuria (hemorrhagic cystitis). BK related nephropathy is a rare complication. Treatment of BK nephropathy in HSCT recipients is challenging and beside decreasing IS, there is still no consensus about effective therapy, and this can lead to progressive CKD. BKV-specific Cytotoxic T cell infusion is currently under investigation for treatment of BK related cystitis. Future studies are needed to evaluate its efficacy and other potential targeted therapies in treating BK nephropathy.

#### SA-PO871

##### Obinutuzumab Induction in a Kidney Transplant Recipient With Atypical Hemolytic Uremic Syndrome due to CFHR1/CFHR3 Gene Mutation and Anti-Complement Factor H Antibody

Evaldo Favi,<sup>1,2</sup> Paolo Molinari,<sup>2,1</sup> Samuele Iesari,<sup>2</sup> Carlo Alfieri,<sup>2,1</sup> Giuseppe Castellano,<sup>2,1</sup> Mariano Ferrareso,<sup>2,1</sup> Donata C. Cresseri,<sup>2</sup> <sup>1</sup>Università degli Studi di Milano, Milano, Italy; <sup>2</sup>Fondazione IRCCS Ca'Granda Ospedale Maggiore Policlinico, Milan, Italy.

**Introduction:** For many years, atypical hemolytic uremic syndrome (aHUS) has represented a relative contraindication to kidney transplantation (KT). The wide spread use of the anti-complement component 5 monoclonal antibody eculizumab has reduced post-transplant aHUS relapse and allograft loss rates. However, the optimal management of patients with DEficiency of CFHR plasma proteins and Autoantibody Positive form of Hemolytic Uremic Syndrome (DEAP-HUS) remains debated. In this particular subset of recipients, the benefits of repeated apheresis and/or chronic eculizumab administration should be weighed against the risk of fatal infections, severe adverse events, and exorbitant costs.

**Case Description:** We report the case of a 45-year-old woman with end-stage renal disease due to CFHR1/CFHR3 gene homozygous deletion-associated aHUS who underwent deceased-donor KT despite persistently elevated anti-CFH antibody titers. While on the transplant waiting list, she was not given any aHUS-targeted therapy. At transplant, she received an induction scheme including eculizumab (900 mg before surgery), basiliximab (20 mg on day 0 and day 4), methylprednisolone, and obinutuzumab (1000 mg on day 6). As a maintenance, we used LCP-tacrolimus, mycophenolate mofetil, and prednisone. The post-operative course was uneventful. After 1-year follow-up, she is doing well with excellent allograft function, undetectable anti-CFH antibody, full CD19+ cells depletion, and no signs of aHUS activity. Remarkably, no obinutuzumab infusion-related adverse reactions, severe infectious complications, or hematologic disorders were recorded.

**Discussion:** Although anecdotal, our experience suggests that peri-transplant administration of eculizumab and obinutuzumab safely and effectively inhibits complement activation and block anti-CFH antibody production, thus ensuring long-lasting protection from DEAP-HUS relapse, at a reasonable cost. For the first time, we have also provided evidence in vivo that obinutuzumab-induced B-cell depletion does not necessarily require complement activation. Such preliminary finding could provide the rationale for further studies investigating combined eculizumab and obinutuzumab use for antibody-mediated rejection prophylaxis or treatment.

#### SA-PO872

##### Parvovirus Red Blood Cell Aplastic Anemia in a Kidney Transplant Patient

Taqi Khaja, Shayan Amini, Angelina Edwards. *Houston Methodist Hospital, Houston, TX.*

**Introduction:** Anemia is common in kidney transplant patients and is linked with increased risk of patient mortality, reduced graft survival, and a decline in allograft function. There are multiples etiologies, and iron deficiency is the main contributor. However, viral infections are often overlooked and can lead to significant anemia post-transplantation. We report a unique case of parvovirus B19 infection leading to pure red blood cell aplasia in a kidney transplant patient.

**Case Description:** This is a 62-year-old Hispanic man with end stage kidney disease and dialysis dependence presumed secondary to diabetes and hypertension. He received a living related kidney transplant in December 2021. He was deemed low-immunologic risk and underwent induction with basiliximab. He was maintained on tacrolimus, mycophenolate, and prednisone. He attained excellent allograft function with nadir creatinine of 1.1 mg/dL. On February 2022, he was admitted to the hospital for symptomatic anemia with hemoglobin of 6.5 g/dL with low reticulocyte index of 0%. Evaluation was negative for GI blood loss, hemolysis, or iron/vitamin B12/folate deficiencies. Supportive blood transfusion was given and he was discharged with outpatient follow-up but remained transfusion dependent. Parvovirus B19 quantitative serum PCR was obtained and his viral load was greater than 5,000,000 copies. Patient was promptly treated 5 doses of IV IgG and his mycophenolate dosage was reduced. Since then, his hemoglobin as continued to improve without blood transfusions and his parvovirus B19 viral load has reduced substantially to 7,249 copies as of April 2022. He is followed closely by his nephrologist and hematologist.

**Discussion:** Parvovirus infection can cause refractory anemia in kidney transplant patients and this problem can progress to transfusion dependence. Incidence rate of anemia from parvovirus can occur up to 23% of renal transplant patients. Diagnosis is confirmed with PCR assay. Treatment consists of IV IgG and reduction in immunosuppression, specifically antiproliferative agents like mycophenolate. Relapse of anemia is common. Effectiveness of therapy is based on improvement in anemia. This disease should be considered when encountering refractory anemia during the post-transplantation period.

#### SA-PO873

##### A Case of False Elevation in Tacrolimus Levels due to Tacrolimus Line Adsorption

Rutu Shah,<sup>1</sup> Alexander Pennekamp,<sup>1</sup> Joseph Kremer,<sup>2</sup> <sup>1</sup>The Christ Hospital Internal Medicine Residency, Cincinnati, OH; <sup>2</sup>The Christ Hospital Health Network, Cincinnati, OH.

**Introduction:** Tacrolimus is a cornerstone of immunosuppressive therapy after solid organ transplantation, but post-transplant therapeutic drug level monitoring is crucial. Inappropriately high tacrolimus levels can result in calcineurin inhibitor (CNI) toxicity (and malignancy) while inappropriately low levels will result in acute graft rejection. Central venous catheters (CVC) are routinely used for infusions as well as lab draws, but rarely the CVC can pose challenges by obscuring true drug levels.

**Case Description:** A 60-year-old female with a past medical history of diabetes mellitus, hypertension, COPD, SLE, ESRD on hemodialysis (secondary to lupus nephritis) gastric sleeve procedure underwent deceased donor unrelated kidney transplantation. She was started on high risk immunosuppression with five doses of thymoglobulin, steroid taper and maintained on mycophenolate mofetil (MMF) and tacrolimus. Several days thereafter, she was admitted to the hospital for complications following transplant including development of new Class II antibody mediated rejection (ABMR) with donor specific antibodies (DSA) positive. Due to evidence of kidney biopsy showing antibody mediated rejection, she was treated with PLEX, IV velcade and rituximab. She presented again 1 month later for intractable nausea and vomiting. She underwent GI evaluation which showed gastric ulcerations, negative for CMV and HSV. Unfortunately, her condition progressed to florid septic shock which required ICU admission. CVC was placed through which she received IV tacrolimus. The same port was used to draw tacrolimus levels and surprisingly, levels obtained from that port were extremely elevated on multiple days, which

Key: TH - Thursday; FR - Friday; SA - Saturday; OR - Oral; PO - Poster; PUB - Publication Only

Underline represents presenting author.

resulted in dose reduction and multiple instances of held doses. Due to consistently elevated levels, a peripheral draw was obtained which showed a level of <2 ng/mL. The patient's creatinine worsened and eventually she ended up back on renal replacement therapy.

**Discussion:** Blood sampling for tacrolimus should never be performed from lumina previously used for infusing the drug even after prolonged periods of time and extensive rinsing. Physicians should be aware of the phenomenon of drug adsorption as it can lead to dangerous dose reductions putting the patient at risk of life threatening underdosage. Any suspicious tacrolimus lab value should be confirmed by a peripheral draw.

#### SA-PO874

##### Transplant Renal Artery Stenosis: An Overlooked Cause of Acute Kidney Allograft Injury

Rohit Aloor, Ekamol Tantisattamo. *University of California Irvine School of Medicine, Irvine, CA.*

**Introduction:** While recognized as an etiology of kidney dysfunction, transplant renal artery stenosis (TRAS) remains underdiagnosed and can exist with other causes of acute kidney injury (AKI), leading to a delay in diagnosis and treatment. We report a case of kidney transplant recipient that presented with biopsy-proven acute kidney allograft rejection that did not improve despite adequate therapy. Pathology revealed areas of allograft ischemia, leading to treatment for TRAS with balloon angioplasty and subsequent kidney recovery.

**Case Description:** A 74 year old woman with end stage kidney disease secondary to diabetes mellitus status post deceased donor kidney transplant five months prior to admission presented with sepsis from urinary tract infection and pneumonia complicated by oliguric AKI. Serum creatinine (SCr) was 3.7 mg/dL from the baseline creatinine of 2.7-3.1 mg/dL, peaking at 8.8 mg/dL on hospital day 15. Given persistently elevated SCr despite resolved sepsis, transplant allograft biopsy was performed with concerns for acute rejection. Pathology revealed severe tubulitis and acute T-cell mediated rejection (TCMR). Kidney function did not improve with pulse steroids and anti-thymocyte globulin. Further review of the pathology showed multiple areas of ischemia, suspected from compromised renal artery. Blood pressure (BP) was persistently elevated and no bruit noted at the allograft site. Cytomegalovirus PCR was not detected. Transplant ultrasound revealed peak systolic velocity of 310 cm/second at the anastomosis. Carbon dioxide angiography was consistent with severe transplant renal artery stenosis. Balloon angioplasty resulted in allograft recovery and SCr improved to a nadir of 1.0 mg/dL along with blood pressure normalization.

**Discussion:** Although AKI in our patient could be possibly explained by TCMR, persistent allograft dysfunction despite therapy for rejection raised suspicion for other causes. Scattered renal ischemic changes in the setting of ongoing AKI and hypertension within the first 6 months posttransplant led to TRAS evaluation. TRAS is a common complication but rarely occurs concomitantly with acute allograft rejection. Clinical presentation that includes allograft dysfunction and uncontrolled BP, particularly with evidence of allograft ischemia during early post-transplant period, should raise suspicion for this treatable cause of kidney allograft injury.

#### SA-PO875

##### Disseminated Histoplasmosis (DH) Involving the Central Nervous System in a Kidney Transplant Recipient

Antonette Veronica B. Hernandez, Beatrice P. Concepcion. *Vanderbilt University Medical Center, Nashville, TN.*

**Introduction:** Endemic fungal infection is rare but well documented in immunocompromised (IC) hosts where the most common presentation is DH. Of the endemic fungi, infection with *Histoplasma capsulatum* is the most common. Even so, the incidence of disseminated histoplasmosis in IC patients in endemic areas is low at <1%. Here we present a case of DH with CNS involvement in a kidney transplant recipient.

**Case Description:** A 40-year-old man with ESRD from HTN and T2DM received a DDKT in 2018 and was maintained on tacrolimus, mycophenolic acid, and prednisone. He presented with dyspnea and malaise over 3 weeks. Scr on admission was 5.45 mg/dl (baseline of 1.3 mg/dL). On hospital day 2, he became altered. MRI brain revealed 2 left-sided ring-enhancing lesions in the frontal/parietal region, concerning for "septic emboli." A TTE was negative for vegetations. Chest CT showed mild tree-in-bud nodularity and GGO, but no granulomas. Initial blood and urine cultures were negative. Urine and serum histoplasmosis Ag were above the limit of quantification. He was diagnosed with DH with CNS abscesses and started on Liposomal Amphotericin B 5mg/kg daily every 24 hours. CSF analysis showed pleocytosis, elevated protein, and low glucose. CSF histoplasma Ag was positive at 1.93ng/mL and CSF culture was negative. The initial fungal blood culture returned positive for *H. capsulatum* 4 weeks later.

**Discussion:** Only 5 to 10% of DH infections involve the CNS. Routes of infection include donor-derived, reactivation, and de-novo infection, the latter of which is suspected in this patient with no prior evidence of latent disease on chest imaging. Additionally, most cases of donor-derived infection occur within the first few months of transplant. Without obvious neurological symptoms, CNS involvement may be missed. Thus, a high clinical suspicion is necessary for prompt diagnosis and treatment.



MRI T2w-FLAIR ring-enhancing lesions

#### SA-PO876

##### Successful Use of Euro Lupus Regimen in PLA2R-Negative Recurrent Membranous Nephropathy After Kidney Transplant

Sahar Amin,<sup>1</sup> Vasanthi Balaraman,<sup>1</sup> Anshul Bhalla,<sup>1</sup> Manish Talwar,<sup>1</sup> David S. Rustom,<sup>1</sup> Barry M. Wall.<sup>1,2</sup> *<sup>1</sup>The University of Tennessee Health Science Center College of Medicine, Memphis, TN; <sup>2</sup>VA Memphis Medical Center, Memphis, TN.*

**Introduction:** Membranous nephropathy (MN) may recur after transplant. Recurrent post-transplant MN can occur in approximately 40% of patients, usually within the first year. The antibody most often implicated is M-type phospholipase A2 receptor (PLA2R) found in >70% of primary MN cases.

**Case Description:** 30 year-old male with ESRD secondary to PLA2R negative MN underwent a deceased-donor kidney transplant using induction with ATG. He was discharged with a creatinine of 1.9 mg/dL with UPCR 0.4 and maintained on tacrolimus (goal level 8-10 ng/ml), MMF 750mg twice a day and prednisone 5 mg/day. At two months post-transplant, he developed proteinuria (UPCR of 2.2) and started losartan at 100 mg/day. A graft biopsy revealed recurrent post-transplant MN. Immunohistochemical staining was negative for PLA2R, THSD7A, NELL1, EXT1, EXT2. Despite optimal RAAS blockade proteinuria worsened, Rituximab was given 4 times as 500-mg doses two weeks apart after which proteinuria came down to UPCR of 0.4. He then developed nephrotic range proteinuria UPCR of 4.2 again at 9 months post transplant. He was given another course of Rituximab 500mg weekly x 4 and ACTH gel 40 units SC twice a week after which proteinuria came down to UPCR of 1.8. 15 months post transplant, he presented with AKI (creatinine of 9 mg/dl), UPCR of 9, requiring hemodialysis. Repeat allograft biopsy showed persistent active MN along with Banff borderline TCMR and AMR with positive DSA against DQB1 MFI 4700. He was given pulse dose methylprednisone 500 mg daily x 3 days for ongoing active MN. Since patient had MN refractory to Rituximab, treatment with Cyclophosphamide (CP) was initiated, 500mg every two weeks, total of six doses along with prednisone 70 mg once daily which was slowly tapered. We chose the Euro Lupus regimen to minimize cumulative toxicity of oral CP regimen. For treatment of AMR, he received five sessions of plasmapheresis. His allograft function slowly improved and his creatinine came down to baseline of 1.9 mg/dl and proteinuria stabilized at around 1.2 g/g.

**Discussion:** This is the first report on use of IV low dose CP for treatment of post transplant recurrent MN. Our case describes the management strategy of a very difficult recurrent post-transplant PLA2R negative MN that was highly resistant to standard first line treatment.

#### SA-PO877

##### A Case of BK Virus-Associated Nephropathy in a Heart Transplant Patient

Paul T. Merchant, Kristen Tomaszewski, Saul Nurko. *Cleveland Clinic, Cleveland, OH.*

**Introduction:** BK virus associated nephropathy (BKVAN) causes allograft dysfunction in kidney transplant patients but is rarely reported as a cause of native kidney dysfunction in non-kidney solid organ transplant (NKSOT) patients. Treatment for BKVAN is limited, and reducing immunosuppression is the most common strategy. In NKSOT patients, the prevalence of BKVAN is not known but appears to be rare. We report a case of BKVAN in a heart transplant patient.

**Case Description:** A 26-year-old male with hypoplastic left heart, who underwent orthotopic heart transplant 9 years prior, presented with anemia and AKI. Post-transplant history showed no episodes of rejection requiring treatment and no kidney disease. Immunosuppression was tacrolimus 2mg BID and mycophenolic acid 360mg BID without recent changes. At presentation, patient had a hemoglobin of 7.2g/dL, and an evaluation for gastrointestinal bleeding was negative. The patient also had AKI with

serum creatinine of 4.32mg/dL from 0.88mg/dL five months prior. Workup showed bland urinalysis, unremarkable urine sediment examination, and negative hemolysis studies. The AKI failed to improve with conservative management, so kidney biopsy was performed which showed chronic tubulointerstitial nephritis, severe interstitial fibrosis and tubular atrophy, and negative immunofluorescence. Testing for serum BK virus was positive with 1.21 million copies/mL. The biopsy underwent immunostaining for polyomavirus marker SV40, which was positive in 15% of tubules. A diagnosis of BKVAN was made. The patient's mycophenolate was reduced by half, but serum BK viral load and creatinine remain elevated.

**Discussion:** BKVAN is an important cause of allograft dysfunction in kidney transplant patients, but prevalence in NKSOT patients is less understood and likely underestimated. As this case demonstrates, BKVAN should be part of the differential diagnosis in NKSOT patients with CKD/AKI.

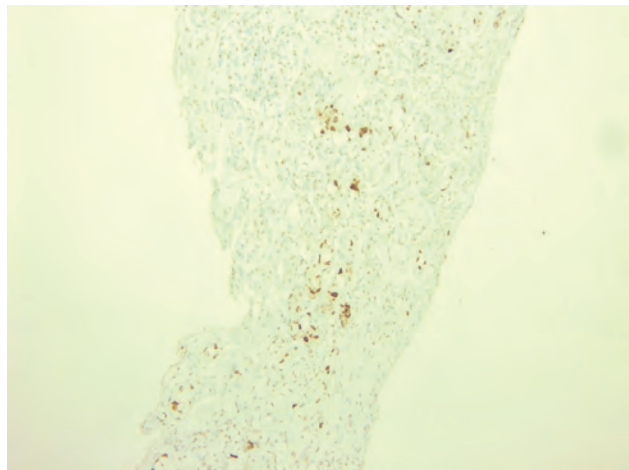

Positive immunostain for polyomavirus marker SV40.

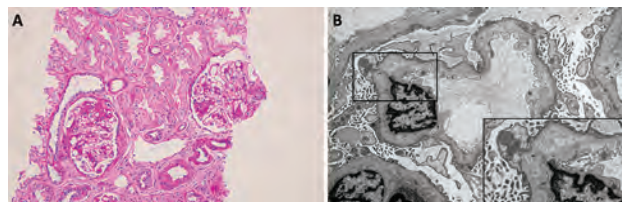

SA-PO879

**Treatment Dilemma: De Novo Focal Segmental Glomerulosclerosis (FSGS) in the Setting of Kaposi Sarcoma in a Heart-Kidney Transplant Recipient**

Joseph Ruberwa, Elizabeth Kotzen, Mark A. Kleman. *The University of North Carolina at Chapel Hill, Chapel Hill, NC.*

**Introduction:** We present a case of de novo FSGS in the setting of cutaneous kaposi sarcoma in a combined heart-kidney transplant recipient six months after transplant.

**Case Description:** A 48-year-old male status post combined heart and kidney transplant for non-ischemic cardiomyopathy and cardiorenal syndrome respectively; he also has well controlled HIV. Induction immunosuppression was basiliximab and methylprednisolone, and maintenance immunosuppression was tacrolimus, mycophenolate mofetil and prednisone. Post-transplant creatinine was 2.1-2.5. Six months post transplantation, he reported left leg hyper-pigmented macules and nodules that appeared gradually over the prior two months. Skin biopsy showed kaposi sarcoma with immunostain positive for human herpesvirus-8. At the same period, the patient developed nephrotic range proteinuria with urine protein to creatinine ratio (UPCR) of 4.7 g/g. Kidney biopsy demonstrated mild FSGS, and electron microscopy (EM) demonstrated 20% foot process effacement. Multiple UPCR prior to and in the first four months post-transplantation showed no proteinuria. Additionally, kidney biopsy done five weeks prior to this presentation for elevated creatinine had showed only focal interstitial fibrosis with normal glomerular basement membranes on EM. For de novo FSGS, the patient received six sessions of plasmapheresis and valsartan started. The UPCR improved to 1.5 g/g. Management of kaposi sarcoma was mainly modification of immunosuppression due to absence of visceral involvement. Mycophenolate mofetil was stopped, and later after proteinuria improved, sirolimus was initiated. At the last follow-up, the patient had an increase in both creatinine and UPCR. We anticipate reporting longer-term follow-up at the time of the meeting.

**Discussion:** We are not aware of case reports of de novo FSGS in kidney transplant recipients being associated with Kaposi sarcoma. In this case it is difficult to know whether the Kaposi served as an inciting event but the timeline raises this possibility. Sirolimus has become a cornerstone of management of Kaposi sarcoma in solid organ transplant recipients because of its antitumor effects (1,2). However, sirolimus is associated with proteinuria and FSGS (3,4,5). We therefore experienced a treatment dilemma between the potential benefit and risk of sirolimus.

SA-PO880

**Under the Hood: Nephrosis in Autosomal Polycystic Kidney Disease**

Bobak Sharifi, Helen P. Cathro, Angie G. Nishio Lucar, Joseph T. Leeds. *UVA Health, Charlottesville, VA.*

**Introduction:** About 50% of patients with autosomal dominant polycystic kidney disease (APKD) will develop end-stage kidney disease (ESKD). The presence of multiple bilateral cysts is a relative contraindication to percutaneous kidney biopsy. Thus, APKD patients with chronic kidney disease (CKD) rarely undergo a native kidney biopsy. Concomitant proteinuria may appear in advanced CKD but nephrotic syndrome is rare. We report the case of an APKD patient presenting with proteinuria and progressive allograft dysfunction after kidney transplantation (KT) suggesting recurrence of native glomerular disease.

**Case Description:** A 62-year-old female with ESKD secondary to ADPKD underwent an uncomplicated deceased-donor KT in 2020. During her third month post-transplant, her serum creatinine increased to 1.9mg/dL (post-transplant nadir of 1.2 mg/dL) and developed progressive proteinuria (urine protein quantification 2.5g/g). Serologic tests (ANA, ANCA, C3/C4, anti-GBM, SPEP/UPEP/SFLC) were unremarkable. An allograft biopsy revealed no rejection or glomerular abnormalities on light microscopy. No C4d staining seen on immunofluorescence (IF). Capillary loops stained for IgG (3+), kappa (2+), and lambda (3+). Electron microscopy noted moderately effaced foot processes with sub-epithelial immune complex deposits. Serum phospholipase A2 receptor antibody (PLA2Rab) was high at 544 RU/ml. IF was positive (1+) for PLA2Rab granular capillary staining confirming the diagnosis of recurrent membranous nephropathy (MN). She received Rituximab therapy with improvement in her creatinine and proteinuria. Creatinine returned to nadir. Repeat PLA2Rab reduced to 11 RU/ml and proteinuria to 0.06 g/g. interestingly, the patient's pre transplant serum revealed a PLA2Rab of 1247 RU/ml.

**Discussion:** There are few reports of MN associated with APKD and none in the context of KT. MN can present as de novo or recurrent disease after KT in 10-45% of cases. Although rare, limited literature suggest that 15-20% of APKD patients may have concomitant glomerular disease. This case emphasizes the importance of avoiding anchoring cognitive bias and remembering that primary causes of CKD may not be mutually exclusive.

SA-PO878

**Case Series of Donor-Recipient Renal Transplant Mismatches: Looking Beyond the Size?**

Cullen M. Lilley,<sup>1</sup> Maria M. Picken,<sup>2</sup> <sup>1</sup>Loyola University Chicago Stritch School of Medicine, Maywood, IL; <sup>2</sup>Loyola University Health System, Maywood, IL.

**Introduction:** While reports on the long-term pathology in mismatched allografts have been focused on the donor and recipient body surface area, evidence is emerging to support donor-recipient age difference as an additional prognostic factor. Most reports are based on pediatric recipients receiving older/bigger allografts. Here, we describe three cases with age mismatch including two cases of adult patients receiving pediatric allografts and a third case of a younger patient receiving an allograft from an older donor exhibiting findings not described in extant literature (Table 1).

**Case Description:** **Case 1:** a 60-year-old (y) female with history of hypertensive nephrosclerosis (HNS) received bilateral kidneys en block from a 5-day-old donor. Subsequently, stent-related hydronephrosis and hematuria developed. Biopsy showed persistent immature glomeruli. **Case 2:** a 33y male with history of HNS received one kidney from a 14y female donor. He developed perinephric seroma, oliguria and hematuria; biopsy revealed thin glomerular basement membrane disease. **Case 3:** a 21y female with ESRD of an unknown etiology received en block bilateral kidneys from a 74y female donor. Post-surgery one allograft required nephrectomy owing to necrosis. Subsequently, non-nephrotic proteinuria developed and allograft biopsy showed focal & segmental glomerulosclerosis (Fig. 1A) with podocyte effacement and GBM multilayering with Alport-like changes (Fig. 1B). None of these patients exhibited T-cell or antibody-mediated rejection (Table 1).

**Discussion:** Each of these cases exhibit unique changes seen in mismatched donor-recipient size/age post-transplant pathology. These non-rejection changes should be suspected in cases of donor-recipient size/age mismatch. In cases of allograft function decline, a full biopsy workup, including electron microscopy, should be considered.

Summary of Cases

Case	Donor Age	Recipient Age	Gender Mismatch	Time to Bx	UA at time of Bx.	Diagnosis	T-cell Infiltrate
1	5d	60y	?	96d	Hematuria	Immature Glomeruli	15%
2	14y	33y	Yes	65d	Oliguria with seroma hematuria	Thin GBM Disease	410%
3	74y	21y	No	1057d	Proteinuria	FSGS-Alport-like	<5%



## SA-PO881

**Case Reports of Trimethoprim/Sulfamethoxazole-Induced Pancreatitis Confirmed With a Lymphocyte Transformation Test**

Jin Chul Kim, Hanbi Lee, Byung ha Chung. *Seoul Saint Mary's Hospital, Seocho-gu, Seoul, Republic of Korea.*

**Introduction:** Kidney transplant recipients (KTRs) received trimethoprim/sulfamethoxazole (TMP/SMX) in early days of transplantation and during and after anti-rejection treatment for *Pneumocystis jiroveci* pneumonia (PJP) prophylaxis. TMP/SMX is one of the possible drugs that induce acute pancreatitis. The lymphocyte transformation test (LTT) is a safe diagnostic procedure for drug allergy but is reported to be rarely performed to find association between TMP/SMX and drug-induced acute pancreatitis (DIAP). Here we report two cases of TMP/SMX induced pancreatitis confirmed by rechallenging and LTT in KTRs.

**Case Description:** A 64-year-old man complained with epigastric pain during desensitization for ABO and human leukocyte antigen incompatible living donor kidney transplantation (KT). DIAP was suspected, based on his medical history including 8 days exposure of TMP/SMX without obvious cause. The LTT for TMP/SMX was performed and the result was positive. After quitting TMP/SMX, pancreatitis was resolved. Then he underwent KT without prevention of PJP. Since he developed PJP 2 months post-transplant, TMP/SMX was started. Three days after exposure acute pancreatitis was developed. A 58-year-old man developed acute pancreatitis 6 days after exposure of TMP/SMX, during anti-thymocyte globulin (ATG) infusion for treatment of acute T-cell mediated rejection (TCMR). After discontinuing suspected drugs including TMP/SMX, acute pancreatitis improved. Three months later, he readmitted with acute TCMR and infused ATG with TMP/SMX for prevention of PJP. 1 day after exposure, amylase level elevated. At that time, LTT for TMP/SMX was performed and the result was positive.

**Discussion:** Acute pancreatitis is a rare but life-threatening complication in patients with transplanted kidney if not properly managed. DIAP accounts for 0.1~2% of acute pancreatitis and more than 120 drugs are known to cause DIAP. Although previously TMP/SMX reported as a causative drug of DIAP, it was just suspected with cause-and-effect relationship and repeated episodes of adverse events. Above 2 patients were diagnosed with TMP/SMX induced pancreatitis by rechallenging and the results of LTT, which is known as an adjunctive diagnostic tool for hypersensitivity reactions, confirmed the diagnosis. These cases suggest TMP/SMX should be considered as a causative drug in case of acute pancreatitis in KTRs.

## SA-PO882

**Heartland Virus-Induced Hemophagocytic Lymphohistiocytosis in a Kidney Transplant Recipient**

Zoey Levine, Gaurav Rajashekar. *Washington University in St Louis, St Louis, MO.*

**Introduction:** Heartland virus (HRTV) is a tick-borne phlebovirus first discovered in 2009 in Missouri. Field studies identified *Amblyomma americanum* or the Lone Star tick as the most likely vector for HRTV. Since then, more than 50 cases of Heartland disease have been reported from 11 states in Central and Southeastern United States during the months of April to September, corresponding strongly with the geographical and seasonal distribution of *A. americanum*. Kidney transplant recipients are particularly susceptible to opportunistic infection due their degree of immunosuppression.

**Case Description:** Here we present a case of a 58-year-old male with a past medical history of end stage renal disease secondary to IgA nephropathy, post kidney transplant in 2006 from a living unrelated donor, on a prednisone and tacrolimus, deep vein thrombosis on warfarin, parotidectomy due to squamous cell carcinoma of the parotid gland presented to the hospital with fever, fatigue, and diarrhea for six days. Labs showed acute kidney injury with a serum creatinine 2.7 mg/dL (baseline of 1.2-1.3 mg/dL), thrombocytopenia (platelet 88 k/mm<sup>3</sup>), and anemia (hemoglobin 7.4 g/dl). Additional labs showed elevated ferritin > 190 000 ng/ml, Lactate dehydrogenase > 2000 units/L, triglycerides > 240 mg/dl, and low fibrinogen < 120 mg/dl. On further inquiry, he reported recent turkey hunting, handling dead mice and exposure to ticks. Based on lab analysis, a bone marrow biopsy was performed which showed normocellular marrow with hemophagocytic macrophages and no evidence of lymphoproliferative process confirming our initial suspicion of Hemophagocytic Lymphohistiocytosis (HLH). Given his recent social history and exposures, an extensive infectious workup was performed and was positive for Heartland Virus infection, a known tick-borne cause of HLH, prevalent in the state of Missouri. Treatment was initiated with high-dose dexamethasone and decreased level of chronic immunosuppression. Kidney function improved and laboratory parameters normalized.

**Discussion:** The case emphasizes the importance of prompt evaluation for HLH in severe heartland virus infection. However, there are many diagnostic challenges that can delay management and worsen survival outcomes. Social history is crucial in establishing a framework to diagnose a case. HLH presents with non-specific and variable findings that can be caused by Heartland virus disease.

## SA-PO883

**Genetically Identical Kidneys With Different Rates of Cyst Formation**

Roma N. Ahuja, Harshit Garg, Deepak K. Pruthi, Ronald Rodriguez. *The University of Texas Health Science Center at San Antonio, San Antonio, TX.*

**Introduction:** Renal damage due to end stage renal disease (ESRD) and chronic hypertension may result in the development of acquired cystic kidney disease (ACKD). Additionally, renal transplantation may cause ACKD, however it occurs at a less frequent rate than ESRD patients on dialysis.

**Case Description:** A 54-year-old male underwent voluntary left nephrectomy 18 years ago. Over the 18 year follow up period, he developed minimal cyst progression and retained optimal renal function. His serum creatinine (Cr) was 1.3mg/dL with estimated glomerular filtration rate (eGFR) of 56 mL/min/1.73m<sup>2</sup>. Magnetic resonance imaging (MRI) of the abdomen revealed right solitary kidney with 3 cysts, the largest being 1.1x1.0 cm in the interpolar region. The total cyst volume was 4.2cc and the total kidney volume was 252cc. His wife, a 52-year-old female with diabetes, hypertension, and ESRD underwent renal transplant 18 years ago with donor nephrectomy from her husband. Over the 18 years follow up period, the patient retained optimal renal function but had significant cyst progression. Her renal function was stable with a serum Cr of 1.2mg/dL and eGFR of 47 mL/min/1.73m<sup>2</sup>. MRI of the abdomen and pelvis revealed bilateral atrophic native kidneys with simple cyst of 1.5cm in left atrophic kidney. The right lower quadrant transplant kidney measured 12 cm in maximum dimension with numerous cysts of varying sizes with largest cyst measuring 7.7cm. The total kidney volume was 350cc and the total cyst volume was 185cc.

**Discussion:** Rarely has there been a situation in which the health of both the retained and transplanted kidney were able to be concurrently studied at regular intervals. This case provides a unique opportunity to study the impact of transplantation on the kidney as well as long-standing hypertension and immunomodulation on renal cyst development. A previous study demonstrated that environmental factors such as ischemic reperfusion injury causes acute kidney injury and promotes cystogenesis. In addition, immunomodulation has been reported to impact cyst development through activation of the mTOR pathway. Our findings support current literature and offer insight on the capacity environmental factors have on cyst development and progression in an otherwise healthy kidney.

## SA-PO884

**Citrate Therapy Outcomes in Patients With Renal Allograft Stones**

Holly Thomson, Nan Zhang, Mira T. Keddis. *Mayo Foundation for Medical Education and Research, Phoenix, AZ.*

**Background:** Renal allograft stones occur in 1% of patients, often causing morbidity. Hypocitraturia is the most significant urinary metabolic risk factor. We previously found that only 34 of 56 patients (61%) with allograft stones at our institution had urine supersaturation analysis. Here, we aim to describe treatment effectiveness of patients with stones in their allograft kidney.

**Methods:** Patients with kidney transplant and stones were identified by ICD-10 codes. Those with imaging-confirmed allograft stones and 2 urine supersaturation studies collected after diagnosis at least 3 months apart were included. Chart review yielded demographics, renal disease course, urine supersaturation results, stone therapies, and patient outcomes. Descriptive statistics were used to evaluate response to therapy.

**Results:** Urine supersaturation data were available at multiple time points in 11 patients (55% men; mean transplant age 58 years). In this group, 4 patients had ESRD due to stone related complications and 7 had a history of native stones. All developed de novo allograft stones at mean 4.9 years after transplant. Stones tended to be in the lower pole and nonocclusive at diagnosis. In all cases of known composition, stones were calcium. Mean urine citrate at first supersaturation analysis was 104 mg/24 hr (reference range >500 mg/24 hr). Potassium or sodium citrate was prescribed in 5 of 11 patients; the remaining 6 patients increased dietary citrate. Post-treatment supersaturation analysis occurred at a mean interval of 250 days. Urine citrate increased by mean 80 mg/24 hr and urine volume increased by mean 500 mL/24 hr. Despite improvement in these risk factors, 7 patients required surgical intervention. Radiologic clearance was achieved in 5 patients, in 2 of these without surgery. In both of those cases, urine citrate increased substantially over time. Graft failure occurred in 1 patient due to stone complications.

**Conclusions:** Clinicians should anticipate the possibility of allograft stone formation even years after kidney transplant, in patients with or without prior history of nephrolithiasis. Urine citrate is likely a key modifiable risk factor. In some cases, increasing urine citrate eliminates stone burden independently of surgical intervention.

## SA-PO885

**Effects of Dapagliflozin in Patients Without Diabetes and Microalbuminuria: An Exploratory Analysis From the DAPA-CKD Trial**

Hiddo J.L Heerspink,<sup>1,2</sup> Glenn Chertow,<sup>3</sup> Niels Jongs,<sup>1</sup> Ricardo Correa-Rotter,<sup>4</sup> Peter Rossing,<sup>5,6</sup> David Sjoström,<sup>7</sup> Anna Maria Langkilde,<sup>7</sup> David C. Wheeler,<sup>8</sup> DAPA-CKD Trial Committee and Investigators <sup>1</sup>Universitair Medisch Centrum Groningen, Groningen, Netherlands; <sup>2</sup>The George Institute for Global Health, Newtown, NSW, Australia; <sup>3</sup>Stanford University School of Medicine, Stanford, CA; <sup>4</sup>The National Medical Science and Nutrition Institute Salvador Zubiran, Mexico City, Mexico; <sup>5</sup>Steno Diabetes Center Copenhagen, Herlev, Denmark; <sup>6</sup>Kobenhavns Universitet, Kobenhavn, Denmark; <sup>7</sup>AstraZeneca, Gothenburg, Sweden; <sup>8</sup>University College London, London, United Kingdom.

**Background:** The DAPA-CKD trial demonstrated that the sodium glucose co-transporter 2 inhibitor dapagliflozin slows progressive kidney function loss in patients with CKD without type 2 diabetes. The majority of these participants had macroalbuminuria. Whether this effect persists in participants without type 2 diabetes and with microalbuminuria is unknown. We therefore assessed the effects of dapagliflozin on the rate of kidney function decline, albuminuria, and blood pressure in this subgroup.

**Methods:** DAPA-CKD randomized participants with or with type 2 diabetes and an urinary albumin-to-creatinine ratio (UACR) 200–5000 mg/g and eGFR 25–75 mL/min/1.73m<sup>2</sup> to dapagliflozin 10 mg or placebo once daily, added to standard care. The

kidney endpoint was a composite of sustained  $\geq 50\%$  eGFR decline, end-stage kidney disease or renal death. We analyzed, in participants without type 2 diabetes and with microalbuminuria (UACR  $< 300$  mg/g), eGFR slope using mixed effect models with slopes from baseline to Week 2 (acute change) and Week 2 to end-of-treatment (chronic eGFR slope). UACR change was an additional pre-specified exploratory outcome.

**Results:** Of 4304 randomized participants, 136 (72 randomized to dapagliflozin and 64 to placebo) did not have type 2 diabetes and had a UACR  $< 300$  mg/g. Their mean age was 61 years, 49 (36%) were female, mean eGFR was 42 mL/min/1.73m<sup>2</sup> and median UACR was 245 mg/g. In the dapagliflozin group UACR changed from baseline by -24.2% (95%CI -41.2, -2.3) versus -9.8% (-30.8, 17.7) in the placebo group (between group difference -16.0% [95%CI, -41.8, 21.3]). Compared to placebo, dapagliflozin caused an acute eGFR reduction of 2.4 mL/min/1.73m<sup>2</sup> (95%CI 0.4, 4.5). Thereafter, dapagliflozin reduced the mean rate of eGFR decline by 1.8 mL/min/1.73m<sup>2</sup> (95%CI 0.4, 3.1) compared to placebo. Few kidney endpoints occurred during follow-up (1 in the dapagliflozin group and 3 in the placebo group).

**Conclusions:** In patients without type 2 diabetes and with microalbuminuria, dapagliflozin slowed eGFR decline during chronic treatment suggesting that its kidney protective effects may extend to this subgroup of patients.

**Funding:** NIDDK Support, Commercial Support - AstraZeneca

**SA-PO886**

**Consistent Benefits of Dapagliflozin on Kidney End Points Defined by Different eGFR Thresholds: A Prespecified Analysis From DAPA-CKD**

Niels Jongs,<sup>1</sup> Glenn Chertow,<sup>3</sup> John McMurray,<sup>4</sup> Ricardo Correa-Rotter,<sup>5</sup> Peter Rossing,<sup>6</sup> Anna Maria Langkilde,<sup>7</sup> David Sjoström,<sup>7</sup> Robert D. Toto,<sup>8</sup> David C. Wheeler,<sup>9</sup> Hiddo J. L. Heerspink.<sup>1,2</sup> *Universiteit Groningen Faculteit Medische Wetenschappen, Groningen, Netherlands; <sup>2</sup>The George Institute for Global Health, Newtown, NSW, Australia; <sup>3</sup>Stanford University School of Medicine, Stanford, CA; <sup>4</sup>University of Glasgow, Glasgow, United Kingdom; <sup>5</sup>National Medical Science and Nutrition Institute Salvador Zubiran, Mexico City, Mexico; <sup>6</sup>Steno Diabetes Center Copenhagen, Herlev, Denmark; <sup>7</sup>AstraZeneca, BioPharmaceuticals R&D, Gothenburg, Sweden; <sup>8</sup>UT Southwestern Medical Center, Department of Internal Medicine, Dallas, TX; <sup>9</sup>University College London Faculty of Medical Sciences, London, United Kingdom.*

**Background:** Doubling of serum creatinine (equivalent to 57% eGFR decline) is an accepted component of composite kidney endpoints. Recently, lesser eGFR declines (40%, 50%) have been used as alternative endpoint components. We assessed the effect of dapagliflozin on kidney endpoints using different eGFR decline to explore whether alternative eGFR thresholds are useful.

**Methods:** This post hoc analysis of DAPA-CKD (N=4304) compared the effect of dapagliflozin vs placebo on kidney outcomes, including different eGFR thresholds ( $\geq 57\%$ ,  $\geq 50\%$ ,  $\geq 40\%$  eGFR decline from baseline), and a composite with end-stage kidney disease (ESKD) and kidney death. We used Cox-proportional hazards model adjusted for baseline eGFR and stratified according to randomization factors (type 2 diabetes; UACR  $\leq 1000$ / $>1000$  mg/g).

**Results:** Over 2.4 years' median follow-up, there were 201 (4.7%), 313 (7.3%) and 538 (12.5%) events of eGFR decline based on  $\geq 57\%$ ,  $\geq 50\%$ , or  $\geq 40\%$  eGFR decline, respectively. Compared to the effect of dapagliflozin in reducing risk of ESKD and kidney death, effect sizes for dapagliflozin on eGFR endpoints, defined by  $\geq 57\%$ ,  $\geq 50\%$ , or  $\geq 40\%$  decline, were comparable (Figure). Results were also similar when using eGFR endpoints or a composite with ESKD and kidney death (Figure) and in patients with or without type 2 diabetes.

**Conclusions:** Smaller declines in eGFR ( $\geq 40\%$  and  $\geq 50\%$ ) occurred more frequently than 57% decline and provided similar estimates of the efficacy of dapagliflozin on kidney outcomes. Use of smaller eGFR declines as endpoints may facilitate trials assessing CKD progression when sample size is limited.

**Funding:** Commercial Support - AstraZeneca

Figure: Effect sizes for the different eGFR thresholds

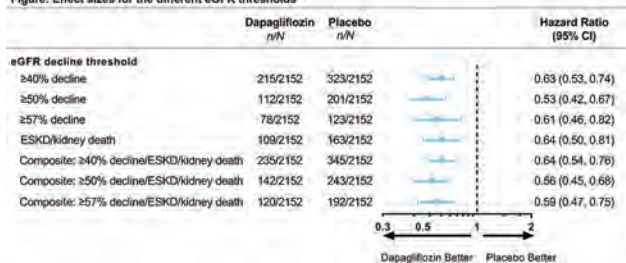

**SA-PO887**

**Translating the Findings of DAPA-CKD to Reductions in Healthcare Resource Utilization and Costs**

Philip McEwan,<sup>1</sup> Ryan Miller,<sup>1</sup> Juan Jose Garcia Sanchez,<sup>2</sup> Salvatore Barone,<sup>3</sup> Stephen Nolan,<sup>2</sup> Vivekanand Jha,<sup>4</sup> Ricardo Correa-Rotter,<sup>5</sup> Gil Chermín,<sup>6</sup> Luca De Nicola.<sup>7</sup> *Health Economics and Outcomes Research Ltd, Cardiff, United Kingdom; <sup>2</sup>AstraZeneca PLC, Cambridge, United Kingdom; <sup>3</sup>AstraZeneca R&D, Gaithersburg, MD; <sup>4</sup>The George Institute for Global Health, Newtown, NSW, Australia; <sup>5</sup>Instituto Nacional de Ciencias Medicas y Nutricion Salvador Zubiran, Ciudad de Mexico, Mexico; <sup>6</sup>Kaplan Medical Center, Rehovot, Israel; <sup>7</sup>Universita degli Studi della Campania Luigi Vanvitelli Scuola di Medicina e Chirurgia, Napoli, Italy.*

**Background:** Dapagliflozin reduced the risk of kidney failure and all cause, including cardiovascular, mortality in CKD patients with and without type 2 diabetes in the Study to Evaluate the Effect of Dapagliflozin and Prevention of Adverse Outcomes in Chronic Kidney Disease (DAPA-CKD). The trial was stopped early due to overwhelming efficacy, with a 39% reduction in the incidence of the primary composite endpoint ( $\geq 50\%$  eGFR decline, end-stage kidney disease (ESKD) and renal/cardiovascular death). This project aimed to estimate the impact on healthcare resource use and costs.

**Methods:** Event rates in dapagliflozin and placebo arms of the DAPA-CKD trial were used to predict the incidence of components of trial endpoints over a three-year period. Cost-offsets versus standard of care without dapagliflozin (SOC) were estimated by applying published US costs to the incidence of events. Those attributed to a  $\geq 50\%$  decline in eGFR were based on the resulting CKD stage compared with baseline CKD stage. Dapagliflozin costs were excluded. Results were estimated in a treated population of 10,000 people. Analysis of 10,000 people aged  $< 65$  years and 10,000 people  $\geq 65$  years was also conducted. Results for the USA will be supplemented with further analysis for a total of 32 countries.

**Results:** Over a three-year period, the estimation predicted 750 cases of  $\geq 50\%$  decline in eGFR with dapagliflozin versus 1,340 with SOC (590 fewer events, number needed to treat [NNT]: 17). 355 ESKD events would be avoided with dapagliflozin (722 vs 1,077, NNT: 28) as would 231 hospitalisations for heart failure (HHF) compared with SOC (237 vs 468, NNT: 43) and 249 deaths (638 vs 887, NNT: 40). Reduced incidences of adverse clinical outcomes were estimated to give cumulative medical care cost-offsets of \$126.9M per 10,000 treated patients, \$223.0M per 10,000 treated patients aged  $< 65$  years and \$61.9M per 10,000 treated patients aged  $\geq 65$  years, or 34%, 38%, and 25% reductions compared with SOC, respectively.

**Conclusions:** Dapagliflozin treatment in CKD has the potential to significantly reduce healthcare resource use through delayed CKD progression and reduced incidence of cardio-renal events and mortality.

**Funding:** Commercial Support - AstraZeneca

**SA-PO888**

**Extrapolation of DAPA-CKD Trial End Points in a Broad Urine Albumin Creatinine Ratio Population**

Jason Davis,<sup>1</sup> Peter D. Gabb,<sup>1</sup> Juan Jose Garcia Sanchez,<sup>2</sup> Salvatore Barone,<sup>3</sup> Johannes Nicolaas Martinus Ouwens,<sup>4</sup> David C. Wheeler,<sup>5</sup> Hiddo J. L. Heerspink.<sup>6</sup> *Health Economics and Outcomes Research Ltd, Cardiff, United Kingdom; <sup>2</sup>AstraZeneca PLC, Cambridge, United Kingdom; <sup>3</sup>AstraZeneca R&D, Gaithersburg, MD; <sup>4</sup>AstraZeneca, Goteborg, Sweden; <sup>5</sup>University College London School of Life and Medical Sciences, London, United Kingdom; <sup>6</sup>The George Institute for Global Health, Newtown, NSW, Australia.*

**Background:** The prevalence of chronic kidney disease (CKD) is estimated to be 8-16% worldwide. Patients with CKD have an increased risk of morbidity and mortality. The DAPA-CKD trial (NCT03036150) demonstrated that dapagliflozin, a sodium-glucose co-transporter-2 inhibitor, reduces kidney and cardiovascular (CV) events and mortality in CKD patients with levels of albuminuria in the range 200 to 5000 mg/g. This study aims to extrapolate the dapagliflozin treatment effect in a CKD population with a UACR  $< 200$  mg/g.

**Methods:** The analysis utilised data from the intention-to-treat DAPA-CKD trial population. The primary endpoint and the composite components, sustained estimate glomerular filtration rate (eGFR) decline and end-stage kidney disease (ESKD), were extrapolated as a function of UACR (continuous variable). Annualised estimated event rates spanning a UACR range (0-2,500 mg/g) were generated using poisson models fitted to each endpoint. Event counts were modelled as a function of baseline UACR using the DAPA-CKD data and extended to lower UACR levels. The results were expressed as the ratio of the event rate with dapagliflozin to that with placebo.

**Results:** The event rate ratios for dapagliflozin versus placebo for the primary composite endpoint (0.67 [95% confidence interval (CI): 0.56-0.80]) and sustained eGFR decline (0.59 [95%CI: 0.48-0.73]) indicated a preserved treatment effect when modelling was applied to those with low UACR ( $< 200$  mg/g). There was no evidence to suggest that efficacy would be different in patients with type 2 diabetes mellitus (T2DM) or without T2DM for the primary composite [95% CI: 0.56-0.86 (T2DM) versus 0.39-0.79 (no T2DM)], sustained eGFR decline [95% CI: 0.45-0.73 versus 0.36-0.86] or ESKD [95% CI: 0.55-1.11 versus 0.39-1.26] endpoints.

**Conclusions:** The analysis suggests that the treatment effect of dapagliflozin might be maintained in relation to the primary endpoint in DAPA-CKD and sustained eGFR decline in patients with low UACR ( $< 200$  mg/g). Furthermore, treatment efficacy could be similar between patients with or without T2DM. Validation in a prospective trial is required.

**Funding:** Commercial Support - AstraZeneca

SA-PO889

Efficacy and Safety of Dapagliflozin in Black vs. White Patients With CKD

Priya Vart,<sup>1</sup> Glenn Chertow,<sup>2</sup> Niels Jongs,<sup>1</sup> Ricardo Correa-Rotter,<sup>3</sup> Peter Rossing,<sup>4,5</sup> Robert D. Toto,<sup>6</sup> David C. Wheeler,<sup>7</sup> John McMurray,<sup>8</sup> Anna Maria Langkilde,<sup>9</sup> Hiddo J. L. Heerspink.<sup>1</sup> <sup>1</sup>Universiteit Groningen Faculteit Medische Wetenschappen, Groningen, Netherlands; <sup>2</sup>Stanford University School of Medicine, Stanford, CA; <sup>3</sup>National Medical Science and Nutrition Institute Salvador Zubiran, Mexico City, Mexico; <sup>4</sup>Steno Diabetes Center Copenhagen, Herlev, Denmark; <sup>5</sup>Kobenhavns Universitet Sundhedsvidenskabelige Fakultet, Kobenhavn, Denmark; <sup>6</sup>UT Southwestern Medical Center, Department of Internal Medicine, Dallas, TX; <sup>7</sup>University College London Faculty of Medical Sciences, London, United Kingdom; <sup>8</sup>University of Glasgow, Glasgow, United Kingdom; <sup>9</sup>AstraZeneca, BioPharmaceuticals R&D, Gothenburg, Sweden.

**Background:** Previous reports suggest that Black and White patients may respond differently to certain treatments for chronic kidney disease (CKD). We investigated the efficacy and safety of dapagliflozin in Black and White patients in the DAPA-CKD trial.

**Methods:** Adults with CKD, with or without type 2 diabetes, with eGFR 25-75 mL/min/1.73m<sup>2</sup> and UACR 200-5000 mg/g were randomized to dapagliflozin (10mg/day) or placebo. The majority of Black patients (>96%) were randomized in North and South America, so this post-hoc analysis only included patients enrolled in the Americas. Patients self-identified as Black or White. The primary outcome was a composite of ≥50% sustained eGFR decline, end-stage kidney disease, or death from kidney or cardiovascular causes.

**Results:** Overall, 1271 (29.5%) were enrolled in the Americas. Of these, 185 (14.6%) were Black and 1086 (85.4%) White. Over 2.2-years' median follow-up, 20 (10.8%) Black and 139 (12.8%) White patients developed the primary composite outcome (event rate, 5.3 and 6.2/100 patient years, respectively). Compared with placebo, dapagliflozin reduced the risk of the primary outcome in Black (HR: 0.35; 95%CI: 0.14-0.88) and White patients (HR: 0.64; 95%CI: 0.45-0.89; p-interaction=0.31). Consistent benefits were observed for other prespecified outcomes (Table). Occurrence of serious adverse events was similar with dapagliflozin vs placebo in Black (30.4% vs 39.8%) and White patients (34.9% vs 39.0%).

**Conclusions:** Black and White patients experienced similar clinical benefits with dapagliflozin including fewer kidney and cardiovascular events and prolonged survival, with a similar safety profile.

**Funding:** Commercial Support - AstraZeneca

Table: Efficacy of dapagliflozin regarding primary and secondary outcomes in Black and White patients.

	Dapagliflozin (N=622)		Placebo (N=649)		Absolute Risk Difference (95% CI)	Hazard Ratio (95% CI)	P-interaction
	No. (%)	Event/100 Patient-Yr	No. (%)	Event/100 Patient-Yr			
<b>Primary composite outcome: eGFR decline ≥50%, end-stage kidney disease, or kidney or cardiovascular death</b>							
Overall population	60 (9.3)	4.3	99 (15.3)	7.6	6.0% (2.4, 9.6)	0.59 (0.43, 0.81)	
Black (n=285)	7 (6.9)	3.2	13 (15.7)	8.0	8.8% (-0.4, 12.0)	0.35 (0.14, 0.88)	0.31
White (n=1,086)	53 (10.0)	4.8	86 (15.3)	7.6	5.3% (3.5, 8.4)	0.64 (0.45, 0.89)	
<b>Kidney composite outcome: eGFR decline ≥50%, end-stage kidney disease or kidney death</b>							
Overall population	38 (6.0)	2.9	74 (11.6)	5.7	5.8% (2.5, 8.7)	0.51 (0.34, 0.73)	
Black (n=185)	6 (5.9)	2.8	8 (9.6)	4.0	3.8% (-0.2, 8.0)	0.48 (0.17, 1.40)	0.87
White (n=1,086)	32 (6.0)	2.9	66 (11.9)	5.8	5.8% (2.5, 9.2)	0.50 (0.33, 0.77)	
<b>Cardiovascular death or hospitalization for heart failure</b>							
Overall population	42 (6.6)	2.9	50 (7.8)	3.5	1.2% (-1.7, 0.0)	0.81 (0.54, 1.22)	
Black (n=185)	4 (3.9)	1.7	9 (10.8)	5.1	6.9% (-0.8, 14.6)	0.30 (0.05, 0.98)	0.08
White (n=1,086)	38 (7.2)	3.1	41 (7.4)	3.3	0.2% (-2.8, 3.3)	0.95 (0.61, 1.47)	
<b>All-cause mortality</b>							
Overall population	41 (6.5)	2.8	58 (9.1)	4.1	2.7% (-0.3, 5.7)	0.68 (0.46, 1.01)	
Black (n=185)	4 (3.8)	1.7	8 (9.6)	4.3	5.7% (-1.3, 13.3)	0.33 (0.10, 1.12)	0.25
White (n=1,086)	37 (7.0)	3.0	51 (9.2)	4.0	2.2% (-1.0, 5.4)	0.75 (0.48, 1.18)	

SA-PO890

Renal Outcome With Empagliflozin in Non-Diabetic CKD Patients: A Randomized Control Trial

Zara Nisar,<sup>1</sup> Hassan Sajjad,<sup>2</sup> Akash Kumar,<sup>2</sup> Saima Afaq,<sup>1</sup> Nisar Anwar.<sup>2,3</sup> <sup>1</sup>Khyber Medical University, Peshawar, Pakistan; <sup>2</sup>Rehman Medical Institute, Peshawar, Pakistan; <sup>3</sup>Khyber Teaching Hospital, Peshawar, Pakistan.

**Background:** As CKD is a rapidly growing disease, it needs rigorous treatment to control its progression. New treatment options for diabetic and non-diabetic CKD are needed

**Methods:** This was a single centre trial (Trial registration: ACTRN12622000265774p). Study schema is in the figure. STUDY SETTING: Khyber Teaching Hospital. SAMPLE SIZE AND POWER: 70 per arm in 1:1 ratio. Statistical Analysis: Microsoft Excel was used to collect the raw data. SAS was used to manage the data and conduct the statistical analyses. This data was summarized to calculate the mean, median, interquartile range (IQR) and standard deviation for continuous variables. Categorical variables were summarized by means of counts and percentages per category. Pairwise correlation coefficient was calculated among the variables to explore between-participant variation. We used multivariate analysis of covariance (MANCOVA) main effect model which is the most efficient approach with smallest variance estimator.

**Results:** The mean age of the participants was 57.9 ±4.51, with 51% being male. The treatment's impact on the five variables of TotalCholesterol60, TotalCholesterol90, LDL60, LDL90, and Proteinuria60; were found to be statistically significant. On average, the treatment decreased a patient's total cholesterol by 20 units after 60 days. It decreased a patient's total cholesterol by 70 units after 90 days. LDL is decreased by 30 units after 60 days, and by 37 units after 90 days. As for proteinuria, the treatment decreased it by 350 units after 60 days. Up to the 60 days, UTI events for the treatment group were more than those for the control group. At the 90-day stage, males had more UTI events in the treatment group than their control counterparts whereas females in the treatment group had fewer events than their control counterparts

**Conclusions:** We conclude that Empagliflozin along with standard therapy has beneficial effect for the symptoms of the patients. Follow-up duration should be increased to see its effect on e-GFR.

**Funding:** Private Foundation Support

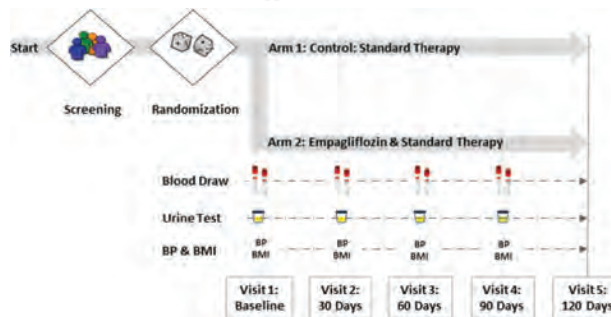

SA-PO891

Relationship Between Initial eGFR Dip and Changes in Laboratory Parameters With Dapagliflozin Treatment in Non-Diabetic CKD Patients

Maiko Kokubu, Masatomo Yamane, Shunsuke Kitamura, Kosuke Tansho, Masaru Matsui. Department of Nephrology, Nara prefecture General Medical Center, NARA, Japan.

**Background:** Treatment with sodium-glucose co-transporter-2 inhibitors (SGLT2i) induces an initial decline in estimated glomerular filtration rate, also termed the 'eGFR dip' and remains beneficial effects for cardiovascular and kidney outcomes, even after modified by eGFR dip in diabetic CKD. However, the difference of eGFR dip after SGLT2i between diabetic and non-diabetic CKD patients and the effects of eGFR dip on changes of laboratory parameters is not fully understood. In this study, we aimed to investigate the eGFR dip after Dapagliflozin and its relationship with clinical and laboratory data in non-diabetic CKD patients.

**Methods:** We conducted a cohort study on 127 non-diabetic CKD patients receiving Dapagliflozin in whom at least two measurements of eGFR levels at three months were confirmed. eGFR dip was defined by percent eGFR change from baseline. eGFR was calculated using Japanese equation. Correlation analyses between initial eGFR dip and clinical value were conducted using the Pearson correlation coefficient.

**Results:** The mean age of study participants was 60±13 years and 69 (54%) were male. The underlying kidney diseases included glomerulonephritis in 59 (46%) patients and hypertensive nephrosclerosis in 57 (45%). The mean levels of baseline eGFR were 43±13 mL/min/1.73m<sup>2</sup> and the mean proteinuria was 0.58±0.83 g/gCre. The mean eGFR change from baseline was -0.33±4.3 mL/min/1.73m<sup>2</sup> with eGFR dip of 0.8±9.4%. Factors including age, sex, body mass index, baseline eGFR and urinary protein were not significantly associated with the eGFR dip. Dapagliflozin increased hemoglobin levels by 0.5g/dL and decreased uric acid levels by 0.9 mg/dL. We found indirect and direct correlation of the eGFR dip with changes in proteinuria (r=0.30, p=0.001) and uric acid levels (r=0.21, p=0.015) after Dapagliflozin, respectively.

**Conclusions:** Our results suggest that the eGFR dip following SGLT2i initiation may be associated with the changes of proteinuria and uric acid levels in non-diabetic CKD patients.

SA-PO892

Semaglutide as an Aid to Weight Reduction in Adults With Obesity and Advanced CKD

Sarah Bukhari,<sup>1</sup> Sarah Cooney,<sup>1</sup> John Holland,<sup>1</sup> Husam Alzayer,<sup>2</sup> Michael Clarkson,<sup>2</sup> Peter J. Conlon.<sup>1</sup> <sup>1</sup>Beaumont Hospital, Dublin, Ireland; <sup>2</sup>Cork University Hospital, Cork, Ireland.

**Background:** Obesity is becoming more challenging in patients with chronic kidney disease. The efficacy and safety of the GLP-1 analogue semaglutide for weight loss in patients with and without diabetes has been demonstrated. However, there had been limited studies on the use of semaglutide in patients with advanced CKD.

**Methods:** In this retrospective study using electronic healthcare records, we evaluated the efficacy and safety of semaglutide for weight reduction in addition to lifestyle intervention in patients with eGFR of <30 ml/min/1.73 m<sup>2</sup> and a body mass index of >32 kg/m<sup>2</sup>. Paired t-test was performed and a p-value of <0.05 was considered statistically significant.

**Results:** Among the 14 patients included in this study, the mean percentage change in weight loss after three, six and nine months were 5.5%, 8.5% and 9.7%, respectively. After nine months, 7 patients (50%) achieved ≥5% weight loss. The most common

reported adverse events were gastrointestinal, including nausea, vomiting and diarrhoea. Two patients discontinued semaglutide because of intolerable gastrointestinal effects. No serious adverse events were noted.

**Conclusions:** In this set of patients with obesity and advanced CKD, semaglutide was safe, effective and led to significant reduction in weight.

Comparison of weight at baseline and post-treatment at three, six and nine months

Time point (months)	Sample size (N)	Mean weight loss	Mean percentage change in body weight (%)	p-value	95% confidence interval
3	13	6.1 kg	5.5%	< 0.001	3.68–8.61
6	10	9.3 kg	8.2%	< 0.001	5.04–13.58
9	7	10.4 kg	9.7%	< 0.001	7.34–13.50

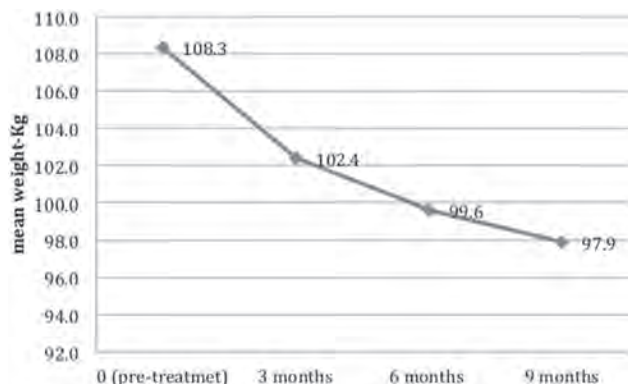

SA-PO893

**The Effect of Semaglutide on Kidney Function: Post Hoc Analysis of Three Randomized Controlled Trials in Non-Alcoholic Fatty Liver Disease**  
 Katherine R. Tuttle,<sup>1</sup> Thomas Idorn,<sup>2</sup> Maximilian K. Jara,<sup>2</sup> Mads S. Palle,<sup>2</sup> Anne-Sophie Sejling,<sup>2</sup> Henning Groenbaek,<sup>3</sup> <sup>1</sup>Providence Medical Research Center, Spokane, WA; <sup>2</sup>Novo Nordisk A/S, Søborg, Denmark; <sup>3</sup>Aarhus Universitetshospital Lever- Mave- og Tarmsygdomme, Aarhus, Denmark.

**Background:** Chronic kidney disease is a common comorbidity in non-alcoholic fatty liver disease (NAFLD). Semaglutide is being investigated in non-alcoholic steatohepatitis (NASH), a severe form of NAFLD. This post-hoc analysis pooled data from three randomized, placebo-controlled, phase 1 or 2 NAFLD trials to investigate the effects of semaglutide on kidney function.

**Methods:** Data from NCT03357380 (semaglutide 0.4 mg once daily [OD] for 72 weeks in NAFLD), NCT02970942 (semaglutide 0.1, 0.2, or 0.4 mg OD for 72 weeks in NASH with fibrosis stage 1–3), and NCT03987451 (semaglutide 2.4 mg once weekly [OW] for 48 weeks in compensated NASH cirrhosis) were included. Placebo arms were pooled, as were the semaglutide 0.4 mg OD arms in NCT03357380 and NCT02970942, and the semaglutide 2.4 mg OW arm in NCT03987451 (NCT02970942 semaglutide 0.1 and 0.2 mg OD arms were excluded). Annual slope of change in estimated glomerular filtration rate (eGFR) was analyzed for semaglutide vs placebo. Results were analyzed by baseline eGFR: <75 and ≥75 mL/min/1.73 m<sup>2</sup>.

**Results:** Baseline characteristics were comparable for semaglutide (n=163) and placebo (n=137). In eGFR <75 mL/min/1.73 m<sup>2</sup>, semaglutide appeared to have a beneficial effect on eGFR (annual slope semaglutide 5.91 mL/min/1.73 m<sup>2</sup> [n=19], placebo -1.53 mL/min/1.73 m<sup>2</sup> [n=19]; difference 7.45 mL/min/1.73 m<sup>2</sup> 95% confidence interval [CI] 3.12, 11.74). In eGFR ≥75 mL/min/1.73 m<sup>2</sup> there was no treatment difference (semaglutide n=144, placebo n=118; difference 0.40 mL/min/1.73 m<sup>2</sup> 95% CI -1.12, 1.92). The test for interaction between the <75 and ≥75 mL/min/1.73 m<sup>2</sup> groups was significant (p=0.0026). Semaglutide did not affect annual change in eGFR vs placebo in the overall population (difference 1.19 mL/min/1.73 m<sup>2</sup> 95% CI -0.24, 2.62). The difference in slopes was primarily driven by the positive slope in the eGFR <75 mL/min/1.73m<sup>2</sup> group.

**Conclusions:** A potential protective effect of semaglutide on eGFR was seen in patients with NAFLD and eGFR <75 mL/min/1.73 m<sup>2</sup>. Although this post-hoc analysis had a small sample size, the results support further studies of semaglutide in NAFLD with low eGFR, irrespective of diabetes status.

**Funding:** Commercial Support - Novo Nordisk A/S

SA-PO894

**Effects of Colchicine on Renal Fibrosis Marker in Patients With CKD**  
 Thunyatorn Wuttiputhanon, Jeerath Phannajit, Paweena Susantitaphong, Somchai Eiam-Ong, Pisut Katavetin. Chulalongkorn University Faculty of Medicine, Bangkok, Thailand.

**Background:** Renal fibrosis and chronic inflammation are key contributors to CKD. Colchicine which has both anti-fibrotic and anti-inflammatory properties might be an attractive drug to retard CKD progression.

**Methods:** In this randomized, double-blind, placebo-controlled trial, we randomly assigned patients with CKD stage 3 and 4 to receive either colchicine 0.6 mg on alternate day or placebo in 1:1 ratio. The primary outcome was the change in urine transforming

growth factor beta-1 (TGF-β1) from baseline to 12 weeks. Secondary outcomes were changes in urine monocyte chemoattractant protein-1 (MCP-1), kidney function, chronic inflammatory indicators and safety outcomes.

**Results:** A total of 40 patients underwent randomization. The change in urine TGF-β1 from baseline to 12 weeks did not differ among the two groups. The colchicine group showed significantly lower values of WBC counts, neutrophil counts, neutrophil-to-lymphocyte ratio and platelet count compared with the placebo group. On the contrary, the change in urine MCP-1 in colchicine group was significantly higher than placebo group. No significant differences of the change of kidney function and C-reactive protein were found. Adverse events between groups were comparable.

**Conclusions:** Colchicine failed to show improvement of renal function indicators and renal fibrosis marker. Effects on inflammation was inconclusive. Colchicine decreased systemic neutrophil-related inflammation in patients with CKD stage 3 and 4 but increased urine MCP-1. Further investigation of the role of colchicine in slowing CKD progression is required.

	Colchicine (n=20)	Placebo (n=20)	P-value
<b>Primary outcome (change in)</b>			
- Urine TGF-β1 (pg/gCr)	-1.238 (-3.382 to -0.065)	-0.463 (-1.803 to 0.624)	.414
<b>Secondary outcomes (change in)</b>			
- Urine MCP-1 (pg/gCr)	20.044 (4.628 to 77.618)	-5.273 (-25.068 to 14.551)	.038
- Urine albumin-to-creatinine ratio (mg/gCr)	-24.71 (-117.72 to 16.53)	-11.57 (-71.52 to 77.95)	.547
- eGFR (mL/min/1.73m <sup>2</sup> )	-1.59 ± 4.25	-1.33 ± 4.02	.841
- C-reactive protein (mg/L)	-0.25 (-0.70 to 0.08)	-0.02 (-0.76 to 0.675)	.565
- WBC count (x10 <sup>9</sup> /L)	-598.5 ± 731.4	122.1 ± 640.1	.002
- Absolute neutrophil count (x10 <sup>9</sup> /L)	-626.3 ± 644.7	240.5 ± 541.9	0.001
- Neutrophil-to-lymphocyte ratio	-0.380 ± 0.692	0.215 ± 0.582	.006
- Hemoglobin level (g/dL)	0.09 ± 0.63	-0.14 ± 0.68	.284
- Platelet count (x10 <sup>9</sup> /L)	-5,600 ± 28,577	13,000 ± 26,608	.04
- Platelet-to-lymphocyte ratio	-1,092 ± 2,054	1,203 ± 2,301	.002

Primary and secondary efficacy outcome

SA-PO895

**Efficacy and Safety of Urate Lowering Therapy (ULT) in CKD Patients With Gout**

Lindsay N. Helget,<sup>1,2</sup> Anne Davis-Karim,<sup>3</sup> James R. O’Dell,<sup>1,2</sup> Ted R. Mikuls,<sup>1,2</sup> Jeff A. Newcomb,<sup>1</sup> Maria Androsenko,<sup>4</sup> Mary T. Brophy,<sup>4</sup> Bryant England,<sup>1,2</sup> Ryan Ferguson,<sup>4</sup> Michael Pillinger,<sup>5,6</sup> Tuhina Neogi,<sup>7</sup> Hongsheng Wu,<sup>4</sup> Paul M. Palevsky.<sup>8,9</sup> <sup>1</sup>VA Nebraska-Western Iowa Health Care System, Omaha, NE; <sup>2</sup>University of Nebraska Medical Center, Omaha, NE; <sup>3</sup>VA Cooperative Studies Program Clinical Research Pharmacy Coordinating Center, Albuquerque, NM; <sup>4</sup>VA Boston Cooperative Studies Program Coordinating Center, Boston, MA; <sup>5</sup>VA New York Harbor Health Care System, New York, NY; <sup>6</sup>NYU Langone Health, New York, NY; <sup>7</sup>Boston University School of Medicine, Boston, MA; <sup>8</sup>VA Pittsburgh Healthcare System, Pittsburgh, PA; <sup>9</sup>University of Pittsburgh School of Medicine, Pittsburgh, PA.

**Background:** Limited data exist on the comparative effectiveness of allopurinol (ALL) and febuxostat (FEB) for the management of gout in patients with CKD. Using data from STOP-Gout, a recently completed multicenter RCT, we examined the efficacy and safety of ALL and FEB in the subgroup of patients with CKD.

**Methods:** Patients with gout and serum urate (SU) concentration ≥6.8 mg/dL were randomized 1:1 to receive ALL or FEB. ULT was titrated during weeks 0-24 (Phase 1) and maintained during weeks 25-48 (Phase 2), with escalation, to reach goal SU of <6.0 mg/dL. Participants were observed on stable ULT dose during weeks 49-72 (Phase 3). CKD was defined as an eGFR 30-59 mL/min/1.73 m<sup>2</sup> at baseline. Primary outcome was presence of ≥ 1 gout flare during Phase 3. Secondary outcomes were achievement of SU <6mg/dL at end of Phase 2, gout flare rates, and serious adverse events (SAEs).

**Results:** 351 of 940 trial participants had CKD;277 were assessed for the primary outcome. Fewer patients randomized to ALL had ≥1 gout flare during phase 3 (32% v 45%; p=0.02) despite similar attainment of SU <6.0 mg/dL by the end of Phase 2 (Table). CKD participants did not require higher doses of either ULT to reach goal SU as compared to non-CKD but had more SAEs. There were no differences in overall SAEs between ALL and FEB.

**Conclusions:** This prespecified sub-analysis from a large, RCT demonstrates that ALL and FEB are equally efficacious and well-tolerated in the treatment of gout in CKD when used in a treat-to-target regimen.

**Funding:** Veterans Affairs Support

Primary and secondary end points

	Allopurinol (n=181)	Febuxostat (n=170)	Total	P Value
<b>Primary Endpoint</b>				
≥1 Gout flare in Phase 3, %	31.9 (44/138)	45.3 (63/139)	38.6 (107/277)	0.02
<b>Secondary Endpoints</b>				
Serum Urate <6.0 mg/dl in Phase 2, %	78.8 (119/151)	81.3 (117/144)	80.0 (236/295)	0.59
Rate of gout flares (events/patient years)				
during Phase 3	1.54	2.36	1.85	<0.001
during Phase 1 and 2	1.47	2.04	1.75	<0.001
Serious Adverse Event, %	38.1 (69/181)	35.9 (60/170)	37.0 (130/351)	0.66
Cardiovascular event, %	13.8 (25/181)	10.6 (18/170)	12.3 (43/351)	0.35

SA-PO896

Urate Lowering Drugs for CKD Patients With Asymptomatic Hyperuricemia and Hypertension: A Randomized Trial

Kentaro Kohagura,<sup>1</sup> Atsushi Satoh,<sup>2</sup> Masako Kochi,<sup>3</sup> Kazushi Kinjo,<sup>5</sup> Masanobu Yamazato,<sup>4</sup> Akio Ishida,<sup>4</sup> Atsushi Sakima,<sup>4</sup> Kunitoshi Iseki,<sup>6</sup> Hisatomu Arima,<sup>2</sup> Yusuke Ohya,<sup>4</sup> URIC CKD study group <sup>1</sup>Ryukyuu Daigaku Igakubu Fuzoku Byoin, Nakagami-gun, Japan; <sup>2</sup>Fukuoka Daigaku Igakubu Daigakuin Igaku Kenkyuka, Fukuoka, Japan; <sup>3</sup>Tomishiro Chuo Byoin, Tomishiro, Japan; <sup>4</sup>Ryukyuu Daigaku Igakubu Daigakuin Igaku Kenkyuka, Nakagami-gun, Japan; <sup>5</sup>Nakagami Byoin, Okinawa, Japan; <sup>6</sup>Nakamura clinic, Urasoe, Japan.

**Background:** Xanthine oxidase (XO) inhibitors may retard the progression of chronic kidney disease (CKD). It is unknown whether a different type of urate-lowering therapy is comparably effective for it. To determine urate-lowering therapy with XO inhibitor and urate transporter 1 inhibitor are comparable for slowing the decline in renal function among CKD patients with hypertension and hyperuricemia.

**Methods:** Open-label, randomized, parallel-group clinical trial in 96 patients with stage 3 CKD from 9 facilities in Okinawa, Japan. Eligible patients had hyperuricemia without a history of gout, and hypertension. Patients were randomized to receive either febuxostat (n = 47) or benzbromarone (n = 48) and titrated to achieve serum urate levels less than 6.0mg/dL. The primary endpoint was change in the estimated glomerular filtration rate (eGFR) from baseline to 52 weeks. Secondary endpoints included percent change in uric acid, blood pressure, urinary albumin to creatinine ratio, and XO activity from the baseline to 8 and 52 weeks.

**Results:** Among 95 randomized patients, 88 (92.6%) completed the trial. There was no significant difference in change in eGFR (mL/min/1.73 m<sup>2</sup>) between the febuxostat (-0.23, 95% CI, -2.00 to 1.55) and benzbromarone (-2.18, 95% CI, -3.84 to -0.52) groups (difference, 1.95; 95% CI, -0.48 to 4.38; P = 0.1), and in secondary endpoints except for XO activity. Febuxostat significantly reduced XO activity. There were no significant differences in the effects of febuxostat compared with benzbromarone on primary outcomes in the whole analysis, although subgroup analysis demonstrated a significant benefit from febuxostat in patients with stage 3a CKD. There were no adverse effects specific to either drug.

**Conclusions:** There was no clear difference between febuxostat and benzbromarone in inhibiting the decline in renal function among stage 3 CKD patients with hyperuricemia and hypertension.

**Funding:** Commercial Support - Teijin Pharma

SA-PO897

eGFR Changes in Uncontrolled Gout Patients Undergoing Pegloticase Plus Methotrexate Co-Therapy

Brad A. Marder,<sup>1</sup> John A. Albert,<sup>2</sup> Aaron Broadwell,<sup>3</sup> Lissa Padnick-Silver,<sup>1</sup> Brian LaMoreaux,<sup>1</sup> <sup>1</sup>Horizon Therapeutics plc, Deerfield, IL; <sup>2</sup>Rheumatic Disease Center, Milwaukee, WI; <sup>3</sup>Rheumatology and Osteoporosis Specialists, Shreveport, LA.

**Background:** Renal function decline is associated with hyperuricemia and gout. Pegloticase can lower serum uric acid (sUA) in uncontrolled gout (UG) patients (pts), independent of CKD status. Recent trial/case data support immunomodulator (IMM) use with pegloticase to limit anti-drug antibody formation, increasing urate-lowering response rate and decreasing infusion reaction (IR) risk. CKD can limit IMM use, particularly methotrexate (MTX), and pegloticase+IMM clinical trials excluded pts with eGFR <40. However, CKD is common in gout pts and pegloticase+IMM use in CKD pts has been reported. Here we analyse case data to examine eGFR changes during pegloticase+MTX co-therapy in CKD and non-CKD pts.

**Methods:** Deidentified case data of pegloticase+MTX co-therapy were pooled and retrospectively analyzed. Pts were labeled as CKD (baseline [BL] eGFR <60 ml/min/1.73m<sup>2</sup>) or non-CKD (BL eGFR ≥60 ml/min/1.73m<sup>2</sup>). sUA, eGFR, blood cell counts, and liver function tests were monitored. Pt characteristics, treatment parameters, response rate (≥12 infusions [inf], pre-inf 12 sUA <6 mg/dL), eGFR, and AEs were examined. Pts on therapy at data collection with <12 inf were excluded from response analyses.

**Results:** 42 UG pts were included; 15 CKD (13 stage3, 2 stage4; eGFR=43±11 ml/min/1.73m<sup>2</sup>; sUA=9±2 mg/dL), 27 non-CKD (eGFR=83±19 ml/min/1.73m<sup>2</sup>; sUA=10±2 mg/dL). Comorbidity profiles were similar, but more CKD pts were female (33% vs 7%) and ≥65 yrs (60% vs 19%). MTX was started ~4 wks before pegloticase in both groups,

but CKD pts had lower dose (15±6 vs 19±5 mg/wk). Pegloticase response rate (CKD: 92% vs non-CKD: 86%) and treatment (14.7±8.1 vs 14.1±7.1 inf) were similar. In non-CKD pts, 44% had an eGFR increase (mean[±SD]: +4.2±15.0 ml/min/1.73m<sup>2</sup>). In CKD pts, 60% had an eGFR increase (+11.5±20.9 ml/min/1.73m<sup>2</sup>), with CKD stage stability/improvement in 13 (87%, both stage4→3a; 2 stage3a→3b). No new safety signals were identified. 7 (47%) CKD and 13 (48%) non-CKD pts had ≥1 AE; most-commonly gout flare (47%, 41%). Pancytopenia (n=1) and mild IR (n=1) were reported (both non-CKD pts).

**Conclusions:** These limited data show similar pegloticase+MTX urate-lowering efficacy in CKD and non-CKD pts. Most CKD pts had renal stability/improvement during therapy, but further study is needed.

**Funding:** Commercial Support - Horizon Therapeutics plc

SA-PO898

eGFR Changes in Uncontrolled Gout Patients Randomized to Receive Methotrexate or Placebo as Co-Therapy to Pegloticase: MIRROR RCT Findings

Abdul A. Abdellatif,<sup>1</sup> John K. Botson,<sup>2</sup> Katie L. Obermeyer,<sup>3</sup> Brian LaMoreaux,<sup>3</sup> Brad A. Marder,<sup>3</sup> <sup>1</sup>Baylor College of Medicine, Houston, TX; <sup>2</sup>Orthopedic Physicians Alaska, Anchorage, AK; <sup>3</sup>Horizon Therapeutics plc, Deerfield, IL.

**Background:** The MIRROR RCT trial (methotrexate [MTX] or placebo [PBO] co-therapy to pegloticase) showed increased urate-lowering response rate (71.0% vs 38.5% during Month 6) and lower infusion reaction rate (4% vs 31%) in patients (pts) co-administered MTX. Because CKD is prevalent in gout pts and MTX is used cautiously in CKD pts, pegloticase+MTX co-therapy impact on renal function is of interest. Here we report eGFR changes in MIRROR RCT pts.

**Methods:** Uncontrolled gout pts (serum uric acid [sUA]≥7mg/dL, ULT failure/intolerance, ≥1 gout symptom) received pegloticase (biweekly 8mg infusion) and blinded oral MTX (15mg/wk) or PBO (2:1 randomization) following a 2-wk MTX tolerance test and 4-wk blinded MTX/PBO Run-in (eGFR<40ml/min/1.73m<sup>2</sup> excluded). Baseline eGFR was measured before MTX exposure (Wk -6). Mean (SE) change from baseline (CFB) in eGFR was examined by treatment and baseline eGFR status (<60 and ≥60ml/min/1.73m<sup>2</sup>). Analyses were performed on all randomized pts (ITT).

**Results:** 100pts were randomized to pegloticase+MTX (56±13 yrs, 91% men, eGFR=68.9±18.0ml/min/1.73m<sup>2</sup>) and 52pts to pegloticase+PBO (53±12yrs, 85% men, eGFR=71.1±17.6ml/min/1.73m<sup>2</sup>). eGFR was stable during MTX/PBO Run-in and after pegloticase initiation (Day1) in both treatment groups (Figure). At Wk24, eGFR CFB was +5.3±1.3 and +4.3±2.3ml/min/1.73m<sup>2</sup> in the MTX (N=70; 69responders) and PBO (N=19, 19responders) groups, respectively. eGFR CFB at Wk24 did not differ between eGFR<60 and ≥60 groups in MTX (+4.1±2.4 [N=27], +6.3±1.7 [N=43] ml/min/1.73m<sup>2</sup> respectively) or PBO (+2.5±5.6 [N=7], +7.8±4.1 [N=12] ml/min/1.73m<sup>2</sup> respectively) pts (both p≥0.48).

**Conclusions:** eGFR did not appear to decrease after oral MTX initiation when administered as co-therapy with pegloticase. This was true for pts with and without pre-therapy eGFR <60ml/min/1.73m<sup>2</sup>. These findings suggest MTX co-therapy did not negatively impact renal function in MIRROR RCT trial participants.

**Funding:** Commercial Support - Horizon Therapeutics plc

Figure. eGFR change from baseline during MIRROR RCT study treatment

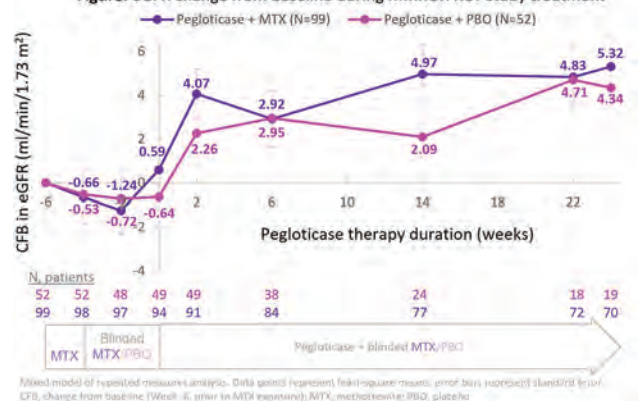

SA-PO899

Abstract Withdrawn

SA-PO900

Abstract Withdrawn

SA-PO901

**Amelioration of Uremic Toxin Indoxyl Sulfate by Oral Chito-Oligosaccharide in Predialysis Patients: A Randomized Controlled Trial**  
 Chumphon Sirisuksakun, Paramat Thimachai, Pamila Tasanavipas, Narongrit Siriwattanasit, Pitchamon Inkong, Narittaya Varothai, Amnart Chairprasert, Naowanit Nata, Theerasak Tangwongler, Wisit Kaewput, Bancha Satirapoj, Ouppatham Supasyndh. *Phramongkutkloa College of Medicine, Bangkok, Thailand.*

**Background:** Chito-oligosaccharide (COS) can bind indoxyl sulfate (IS) from protein-based foods. However, sparse data of COS on serum IS was studied. The study aimed to determine the efficacy of COS on serum IS reduction and delay of chronic kidney disease (CKD) progression.

**Methods:** A randomized, double-blind, placebo-controlled trial was conducted in CKD patients with eGFR < 20 ml/min/1.73 m<sup>2</sup> during September 2021 to February 2022. Treatment group received oral COS 500 mg once daily for 12-week. The other group received a placebo, which was identical to COS capsule. Patient's baseline characteristics and serum IS were collected at baseline, week-4 and week-12.

**Results:** Forty-seven out of fifty participants were enrolled and completed the study. The mean (SD) of IS level at baseline in the treatment (N=26) and placebo (N=21) group were 585.1 (402.2) and 466.8 (421.5) ng/ml (p=0.4). There was significant decrease in IS level at week-4 and week-12 in the treatment group (p=0.006 and p=0.007) but not in the placebo group, in which the IS level was increased significantly at week-12 (p=0.002). The mean of IS level at the end of the trial was significantly lower in the treatment group with the mean difference (95% CI) -960.1 (-1384.6 to -535.5) ng/ml (p<0.001). The eGFR declined significantly in the placebo at week-4 and week-12 (p =0.022 and p=0.004) but not in the treatment group (p=0.497 and p=0.113). No serious adverse event was found.

**Conclusions:** Oral 12-weeks of COS demonstrates the reduction of serum IS level and stabilizes eGFR without significant adverse event.

SA-PO902

**Incident Thiazide Use and Renal and Non-Renal Outcomes in Mild-to-Moderate CKD: A Large Nationwide Observational Study of US Veterans**

Csaba P. Kovcsdy,<sup>1,2</sup> Prabin Shrestha,<sup>1</sup> Yamini Mallisetty,<sup>1</sup> Abu Mohd Naser,<sup>4</sup> Satya Surbhi,<sup>1</sup> Fridtjof Thomas,<sup>1</sup> Elani Streja,<sup>3</sup> Connie Rhee,<sup>3</sup> Kamyar Kalantar-Zadeh,<sup>3</sup> Keiichi Sumida,<sup>1</sup> *The University of Tennessee Health Science Center, Memphis, TN;* <sup>2</sup>*VA Memphis Medical Center, Memphis, TN;* <sup>3</sup>*University of California Irvine, Irvine, CA;* <sup>4</sup>*The University of Memphis, Memphis, TN.*

**Background:** Thiazide diuretics are widely used for the treatment of hypertension and to improve outcomes in hypertensive patients without kidney disease. It is unclear whether the use of thiazides improves outcomes in patients with mild-to-moderate CKD.

**Methods:** In a nationwide cohort of >3.5 million US veterans, we identified 2,494 patients with an eGFR ≥45 mL/min/1.73m<sup>2</sup> who were incident new users of thiazides. Within the same 180-day calendar period, we identified 104,277 comparators who never used thiazides during the entire follow-up. After 1:1 propensity-score (PS) matching for socio-demographics, comorbidities, vital signs, eGFR, UACR, serum sodium and calcium, and relevant medications, the associations of thiazide use with incident ESKD and all-cause mortality were examined using competing risk regression and Cox regression models, respectively, overall and by subgroups of loop diuretic use status.

**Results:** Baseline characteristics were similar in patients with and without thiazide use (n=1,593 each) after PS matching. There were 53 and 823 cases of incident ESKD and all-cause death (event rates [95%CI], 3.1 [2.4-4.1] and 41.2 [38.5-44.2]/1000 PY) over a median follow-up of 5.4 and 6.1 years, respectively. Thiazide use was significantly associated with lower risk of all-cause mortality (HR [95%CI], 0.83 [0.73-0.93]) but not with incident ESKD (sub-HR [95%CI], 1.40 [0.81-2.40]). There was a significant interaction between loop and thiazide diuretic use, with the significantly lower thiazide-associated mortality risk only seen in patients without loop diuretic use (Table).

**Conclusions:** In patients with CKD stages G1-G3a, thiazide use was associated with significantly lower all-cause mortality but not with higher or lower incident ESKD. The lack of significant thiazide-mortality association among loop diuretic users may suggest the need for prudent use of combination diuretic therapy in patients with mild-to-moderate CKD.

**Funding:** Veterans Affairs Support

Associations of incident thiazide use (vs. no use) with outcomes in PS-matched cohort

	Incident ESKD				All-cause mortality				
	SHR	95% CI	P	P for interaction	HR	95% CI	P	P for interaction	
Overall	1.40	0.81	2.40	0.23	N/A	0.83	0.73	0.96	0.009
Subgroup									
No loop diuretic use	1.49	0.84	2.69	0.17		0.80	0.69	0.93	0.004
Loop diuretic use	0.93	0.21	4.13	0.92	0.55	1.22	0.85	1.76	0.27

SA-PO903

**Incident Thiazide Use and Outcomes in Advanced CKD: A Large Nationwide Observational Study of US Veterans**

Keiichi Sumida,<sup>1</sup> Prabin Shrestha,<sup>1</sup> Yamini Mallisetty,<sup>1</sup> Abu Mohd Naser,<sup>2</sup> Satya Surbhi,<sup>1</sup> Fridtjof Thomas,<sup>1</sup> Elani Streja,<sup>3</sup> Connie Rhee,<sup>3</sup> Kamyar Kalantar-Zadeh,<sup>3</sup> Csaba P. Kovcsdy,<sup>1,4</sup> *The University of Tennessee Health Science Center, Memphis, TN;* <sup>2</sup>*The University of Memphis, Memphis, TN;* <sup>3</sup>*University of California Irvine, Irvine, CA;* <sup>4</sup>*VA Memphis Medical Center, Memphis, TN.*

**Background:** A recent randomized controlled trial showed that chlorthalidone therapy improved blood-pressure control in patients with advanced CKD and poorly controlled hypertension. It remains unclear if the use of thiazide diuretics improves clinical outcomes in patients with advanced CKD.

**Methods:** In a nationwide cohort of >3.5 million US veterans, we identified 266 patients with an eGFR <45 mL/min/1.73m<sup>2</sup> who were incident new users of thiazides. Within the same 180-day calendar period, we identified 14,077 comparators who never used thiazides during the entire follow-up. After 1:1 propensity-score (PS) matching for socio-demographics, comorbidities, vital signs, eGFR, serum sodium and calcium, and relevant medications, the associations of thiazide use with incident ESKD and all-cause mortality were examined using competing risk regression and Cox regression models, respectively, overall and by subgroups of loop diuretic use status.

**Results:** Baseline characteristics were similar in patients with and without thiazide use (n=212 each) after PS matching. There were 54 and 184 cases of incident ESKD and all-cause death (event rates [95%CI], 35.3 [27.0-46.1] and 93.0 [80.5-107.5]/1000 PY) over a median follow-up of 3.0 and 4.2 years, respectively. Thiazide use was not associated with incident ESKD (sub-HR [95%CI], 0.94 [0.55-1.60]) nor with all-cause mortality (HR [95%CI], 0.99 [0.74-1.32]). There was a significant interaction between loop and thiazide diuretic use, with significantly higher thiazide-associated mortality risk observed in patients with loop diuretic use (1.67 [1.02-2.76]) (Table).

**Conclusions:** In patients with CKD stages G3b-G5, thiazide use was not significantly associated with incident ESKD or with all-cause mortality. The higher mortality risk associated with thiazide use in loop diuretic users may reflect an elevated risk of drug adverse effects and suggests the need for careful risk-benefit assessment for combination diuretic therapy in advanced CKD.

**Funding:** Veterans Affairs Support

Associations of incident thiazide use (vs. no use) with outcomes in PS-matched cohort

	Incident ESKD				All-cause mortality				
	SHR	95% CI	P	P for interaction	HR	95% CI	P	P for interaction	
Overall	0.94	0.55	1.60	0.82	N/A	0.99	0.74	1.32	0.93
Subgroup									
No loop diuretic use	1.19	0.61	2.35	0.17		0.78	0.54	1.11	0.17
Loop diuretic use	0.95	0.23	4.00	0.95	0.84	1.67	1.02	2.76	0.043

SA-PO904

**Angiotensin Receptor-Neprilysin Inhibitor vs. Renin-Angiotensin-Aldosterone System Inhibitors in Patients With Advanced CKD**

Jin hyuk Paek, Yaerim Kim, Woo Yeong Park, Seungyeup Han, Kyubok Jin. *Keimyung University School of Medicine, Daegu, Republic of Korea.*

**Background:** Patients with chronic kidney disease are at increased risk of cardiovascular events. Recently, angiotensin receptor-neprilysin inhibitor (ARNi) led to a reduced risk of heart failure hospitalization and cardiovascular mortality among patients with heart failure with reduced ejection fraction. However, there are few studies regarding ARNi in patients with advanced chronic kidney disease.

**Methods:** Among patients with estimated glomerular filtration rate (eGFR) < 30 ml/min/1.73m<sup>2</sup> and left ventricular ejection fraction (LVEF) < 40%, 31 patients who received ARNi were enrolled from August 2018 to April 2020. As a control group, 31 age- and sex-matched cohort who received renin-angiotensin-aldosterone system inhibitor (RAASi) with eGFR < 30 ml/min/1.73m<sup>2</sup> and LVEF < 40% were selected. We compared efficacy and safety of ARNi at 12 months. The primary outcome was four-point major adverse cardiovascular events (MACE), composite of death from cardiovascular disease, hospitalization for heart failure, nonfatal myocardial infarction, and nonfatal stroke.

**Results:** In total of 62 patients, the mean eGFR was 15.8 ± 9.7 ml/min/1.73m<sup>2</sup> and the mean LVEF was 29.8 ± 7.5%. There were 26 dialysis patients (41.9%) in the study cohort. At 12 months, there was no significant difference in LVEF between two groups, but MACE was significantly lower in ARNi group than RAASi group (12.9% vs. 35.5%, respectively, p = 0.038). The Kaplan-Meier curves showed that cumulative incidence of MACE was lower in the ARNi group than in the RAASi group (p = 0.043). The incidence of hyperkalemia was comparable between two groups. In non-dialysis cohort, there were no significant differences in the decrease of eGFR and development of hyperkalemia between two groups.

**Conclusions:** This study showed that ARNi might improve cardiovascular outcomes in patients with advanced chronic kidney disease. Further clinical trials are warranted.

Key: TH - Thursday; FR - Friday; SA - Saturday; OR - Oral; PO - Poster; PUB - Publication Only

Underline represents presenting author.

Figure 1, Kaplan-Meier Curves of MACE according to the type of medication

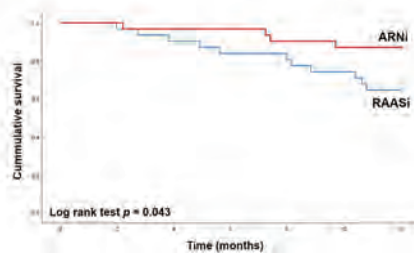

SA-PO905

Outcomes Differences in User vs. Non-User of Renin-Angiotensin Blockers in Early CKD

Narayan Prasad,<sup>1</sup> Monica Kundu,<sup>2</sup> Ashok K. Yadav,<sup>3</sup> Vivek Kumar,<sup>3</sup> Vivekanand Jha.<sup>2</sup> Indian Chronic Kidney Disease Study Group <sup>1</sup>Sanjay Gandhi Post Graduate Institute of Medical Sciences, Lucknow, India; <sup>2</sup>The George Institute for Global Health India, New Delhi, India; <sup>3</sup>Post Graduate Institute of Medical Education and Research, Chandigarh, India.

**Background:** Renin-angiotensin-aldosterone-system blockers (RASB) are the antihypertensive drug class of choice in patients with CKD. There are few head-to-head comparisons of the renal or nonrenal outcomes between RASB users and non-users. We aimed to compare the renal and cardiovascular outcomes between the two in patients enrolled in the Indian Chronic Kidney Disease (ICKD) Study.

**Methods:** A total of 4050 patients with mild-moderate CKD recruited in the ICKD cohort were studied. Patients were categorized as ARB users or nonusers. The renal outcomes [50% decline in eGFR and end stage kidney disease (ESKD)], all-cause mortality, and cardiovascular mortality was analysed over a median follow up period of 2.65 (1.40, 3.89) years between RASB users and nonusers.

**Results:** Out of a total of 4056 patients, 3487 (86%) were hypertensive. A total of 82 (89%) out of 92 in stage 1, 192 (70%) out of 275 in stage 2, 1677 (61%) out of 2742 in stage 3 and 154 (41%) out of 378 in stage 4 hypertensive patients received RASBs. The rate of decline of eGFR in RASB user was numerically low as compared to non-users (Figure 1). The adjusted hazard ratio (HR) for RASB user for a 50% decline in eGFR, ESKD, all-cause mortality and cardiovascular mortality was 0.72, 0.72, 0.59, and 0.48 respectively (Figure 2).

**Conclusions:** The use of RASBs decreased with advancing CKD stages from stage 1 to 4. RASB use is associated with slower rate of decline in eGFR in those with CKD stage 1-3. RASB users had a significantly lower risk of all-cause mortality and cardiovascular mortality

**Funding:** Government Support - Non-U.S.

Mean eGFR decline in ACEI/ARB users and non-users in stage 1-4 CKD patients at last follow up

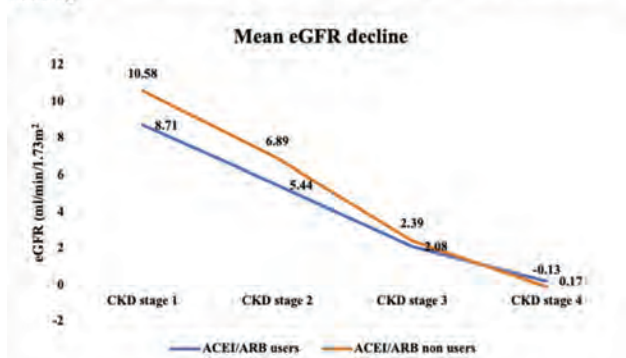

Use of Renin-angiotensin-aldosterone-system blockers (RASBs) and diuretics and outcome of Chronic kidney disease

	Unadjusted hazards ratio (95% CI)	P value	Adjusted hazards ratio (95% CI)	P value
50% eGFR decline	0.74 (0.62, 0.88)	<0.01	0.72 (0.59, 0.88)	<0.01
End stage kidney disease	0.67 (0.56, 0.81)	<0.01	0.72 (0.58, 0.90)	<0.01
All-cause mortality	0.76 (0.60, 0.96)	0.02	0.59 (0.45, 0.76)	<0.01
Cardiovascular mortality	0.87 (0.59, 1.27)	0.47	0.48 (0.30, 0.76)	<0.01

\*Adjusted for baseline age, residence, sex, income, any sign of heart failure, eGFR, baseline proteinuria, diabetes mellitus, obesity, systolic BP, aspirin use, statin use, family history of stroke.

SA-PO906

The Association of Statins on Mortality of Patients With CKD Based on Two Large-Scale Databases

Gang Jee Ko. Korea University College of Medicine and School of Medicine, Seoul, Republic of Korea.

**Background:** The role of statins in CKD has been extensively evaluated, but it remains controversial in specific population such as dialysis-dependent CKD. This study examined the effect of statins on mortality in CKD patients using two large-scaled databases.

**Methods:** Database for the Observational Medical Outcomes Partnership Common Data Model (OMOP-CDM) were formed from two hospitals. Medical records of patients admitted from 2002-2020 were extracted, which scored more than 2,000,000 cases from each hospital. As a sensitivity analysis, the results were validated with another large-scaled database, the Korea-National-Health-Insurance (KNHI) claims database constructed between 2003-2015. Multivariable Cox regression analyses were performed using adjustment with age, sex, and comorbidities.

**Results:** Among 44,431 and 64,165 CKD patients of two hospitals, the numbers of statin users were 7,467 (16.80%) and 13,212 (20.59%). During the follow-up period for 8.9±5.8 and 9.5±5.6 years of each hospitals, statin users were associated with 67% and 61% lower all-cause mortality (Hazard ratios [95% confident interval], 0.33[0.30-0.36] and 0.39[0.33-0.42] respectively). Risk for Cardiovascular mortality were 78% lower in both hospital. In both centers, the risk of all-cause mortality was consistently reduced in statin users regardless of age, sex, renal function, and the presence of diabetes or hypertension (Fig 1). Risk difference was also analyzed in low-risk young patients (currently statins are not recommended), and the risks for all-cause and cardiovascular mortality were significantly lower among statin users even in low-risk patients aged under 50. When confirmatory analysis were performed in 4,114 CKD patients of KNHI data, statin in non-dialysis patients were associated with 59% lower risk of all-cause mortality. Dialysis patients showed similar results as 36% lower risks.

**Conclusions:** Statins were associated with lower mortality in CKD patients, regardless of dialysis status or other risk factors.

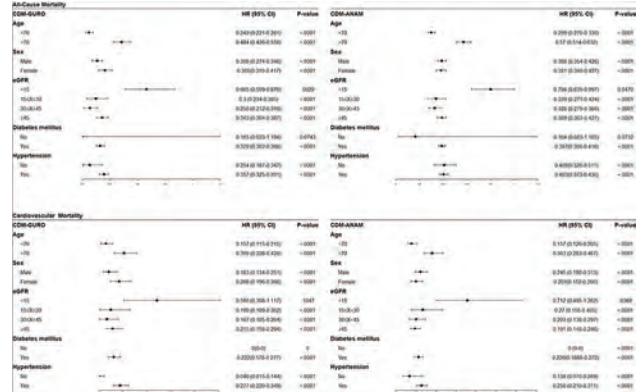

SA-PO907

Sevelamer vs. Cardiopulmonary Bypass on Renal Replacement Treatments, Cardiovascular Events, and Mortality in Non-Dialysis Dependent (NDD)-CKD Patients

Ping Li, Xuefeng Sun, Xiangmei Chen, Guangyan Cai. Chinese PLA General Hospital, State Key Laboratory of Kidney Disease, Beijing, China.

**Background:** Hyperphosphatemia is a key uremic toxin associated with adverse outcomes in patients with CKD. Sevelamer, a widely used non-calcium-based phosphate binder, has been proven to provide extra benefits. However, there is limited evidence on the long-term benefit of Sevelamer on renal and cardiovascular outcomes in NDD-CKD patients.

**Methods:** We used Optum Clinformatics® administrative claims database (May 1, 2000-November 30, 2021) as the data source in this study. We used 1:1 Propensity score matching (PSM) techniques to improve the comparability between Sevelamer group and CPB group. The primary endpoint is renal replacement therapy (RRT). The secondary endpoints include major adverse cardiovascular events (MACE, defined as a composite of non-fatal MI, non-fatal stroke, or all-cause mortality), MACE plus (defined as a composite of MACE, unstable angina pectoris, and congenital heart failure), and all-cause mortality. We also examined the incidence of hemorrhage stroke and fracture as safety endpoints.

**Results:** In total, 9,047 patients were included (Sevelamer group: n=6,644; CPB group: n=2,403). After PSM, 2399 patients remained in each group. During 3 years follow-up, patients in Sevelamer group experienced significantly lower incidence of RRT compared with patients in CPB group [1,560 (65.0%) in Sevelamer group vs. 1,687 (70.3%) in CPB group, HR, 0.84 (95%CI: 0.79-0.91), P<0.0001], MACE [1,077(44.9%) in Sevelamer group vs. 1,217 (50.7%) in CPB group, HR: 0.91 (95%CI: 0.84-0.99), P=0.0249] and MACE plus [1,244 (51.9%) in Sevelamer group vs. 1,419 (59.1%) in CPB group, HR: 0.88 (95%CI: 0.81-0.95), P=0.0009]. Patients in both groups experienced similar incidence of all-cause death, hemorrhage stroke and bone fracture.

**Conclusions:** In this PSM cohort study, Sevelamer showed a lower incidence of RRT, MACE, and MACE plus compared with CPB in NDD-CKD patients with

hyperphosphatemia. **Acknowledgement:** The access to Optum Clinformatics® administrative claims database and data analysis were supported by Sanofi Pharmaceuticals. In according to Good Publication Practice guidelines. The sponsor was involved in the study design and analysis of data and data checking of information provided in the abstract. The authors were responsible for all content and editorial decisions and received no honoraria related to the development of this publication.

**Funding:** Commercial Support - Sanofi Pharmaceuticals

## SA-PO908

### Association of Pharmacotherapy for Nausea and Vomiting Symptoms With Incident CKD and the Role of Confounding by Indication

Diana S. Kalantar,<sup>1</sup> Csaba P. Kovcsdy,<sup>2</sup> Fridtjof Thomas,<sup>2</sup> Keiichi Sumida,<sup>2</sup> Jun Ling Lu,<sup>2</sup> Kamyar Kalantar-Zadeh,<sup>1</sup> Elani Streja.<sup>1</sup> <sup>1</sup>University of California Irvine Medical Center, Orange, CA; <sup>2</sup>The University of Tennessee Health Science Center, Memphis, TN.

**Background:** Nausea and vomiting are effectively treated with pharmacotherapy. Potential associations of anti-emetic therapy with adverse kidney outcomes may reflect confounding by indication (CBI). We aimed to examine the association of anti-emetic therapies with the incidence of new onset CKD across Propensity Score (PS) methods that account for CBI.

**Methods:** In a historical cohort of 323,970 US Veterans with normal baseline eGFR ( $\geq 60$  ml/min/1.73m<sup>2</sup>) during 2004-2006, we identified 13,154 Veterans who were incident new anti-emetic therapy users. We used clinical trial emulation methods to model the associations of anti-emetic use with incident CKD (defined as eGFR  $< 60$  ml/min/1.73m<sup>2</sup> on two separate occasions with at least 90 days in-between) including PS matching and PS weighing.

**Results:** Non-users and users of anti-emetics were 64.1±14.2 and 62.1±12.9 (mean±SD) years old, respectively and anti-emetic users were more likely to be female, smokers, and had higher frequencies of comorbidities. Anti-emetic use (vs. non-use) was associated with a higher risk of incident CKD in unadjusted analyses (hazard ratio and 95%CI: 1.26, 1.22-1.31), and in PS matched (1.22, 1.17-1.28) and PS weighed analyses (1.28, 1.18-1.46) respectively [figure].

**Conclusions:** Anti-emetic medication use was associated with 22% to 28% higher risk of incident CKD in patients with no preexisting kidney disease. This association appears robust across different PS implementation models suggesting less likely involvement of confounding by indication as the explanation. The potential causality of this association still needs to be tested in additional studies, including clinical trials.

**Funding:** NIDDK Support, Veterans Affairs Support

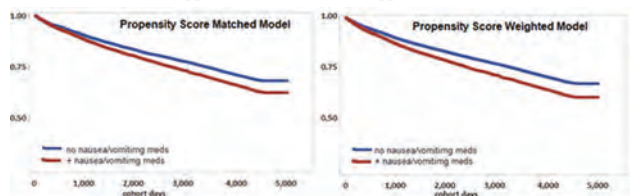

Kaplan-Meier Curves of Propensity Score Matched and Weighted Models

## SA-PO909

### Association of Long-Term Aspirin Use With Kidney Disease Progression

Jun Ling Lu,<sup>1</sup> Prabin Shrestha,<sup>1</sup> Elani Streja,<sup>2</sup> Kamyar Kalantar-Zadeh,<sup>2</sup> Csaba P. Kovcsdy.<sup>1,3</sup> <sup>1</sup>The University of Tennessee Health Science Center, Memphis, TN; <sup>2</sup>University of California Irvine, Irvine, CA; <sup>3</sup>VA Memphis Medical Center, Memphis, TN.

**Background:** Chronic microinflammation contributes to the progression of CKD. Aspirin (ASA) has been used to treat inflammation for centuries. Currently ASA is used for anti-platelet and analgesic functions, but the effects of ASA on CKD progression is unclear.

**Methods:** We examined the association of chronic use of newly initiated low-dose ASA (50-200mg) with ESKD and with eGFR decrease of  $\geq 40\%$  (eGFR40) in a nationwide cohort of US Veterans with incident CKD. Among 806,058 patients, we identified 21,161 who initiated ASA within one year of CKD diagnosis. We used propensity score matching to account for differences in key characteristics between ASA users and non-users, yielding 32,528 patients (16,264 in each group). We examined the association between ASA use and outcomes in competing risk regressions.

**Results:** In the matched cohort, the mean age (SD) was 67.1(11.0), 95.8% were male, baseline eGFR was 61.0 (20.7) and 38.1% had albuminuria. The characteristics were balanced between the two groups. Over a 4.8-year median follow-up, 857 (2.6%) patients reached ESKD (event rate: 5.2/1000 patient-years (95%CI: 4.9-5.6)) and 5,187 (16.5%) developed eGFR40 (34.9/1000PY (34.0-35.9)). ASA use was associated with a trend toward lower risk of ESKD (Subhazard ratio and 95%CI: 0.88 [0.77, 1.01], p=0.07), and with a higher risk of eGFR40 (1.24 [1.17, 1.31], p<0.001).

**Conclusions:** Long term use of ASA was associated with a trend towards lower ESKD risk, but higher risk of eGFR40 in patients with CKD. The higher risk of eGFR40 may be due to an acute glomerular hemodynamic effect of ASA. The long-term renoprotective benefits of ASA therapy will need to be examined in clinical trials.

**Funding:** Veterans Affairs Support

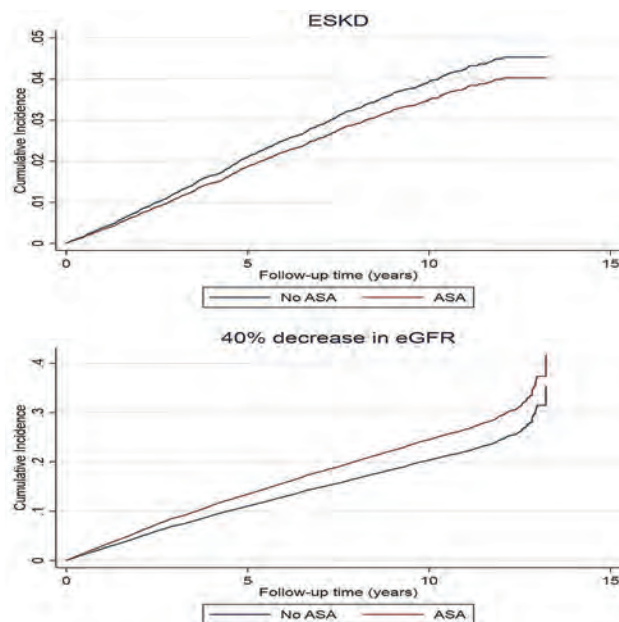

Cumulative incidence rate of ESKD (A) and 40% decline of eGFR (B) in patients receiving and not receiving chronic ASA treatment.

## SA-PO910

### The Effect of Randomized Beta-Carotene Supplementation on CKD in Men

Api Chewcharat,<sup>1</sup> Julie E. Buring,<sup>2</sup> Howard D. Sesso,<sup>2</sup> Kathryn Rexrode,<sup>2</sup> J. Michael Gaziano,<sup>2</sup> Robert J. Glynn,<sup>2</sup> Pol Chewcharat.<sup>3</sup> <sup>1</sup>Mount Auburn Hospital, Cambridge, MA; <sup>2</sup>Brigham and Women's Hospital, Boston, MA; <sup>3</sup>Harvard University T H Chan School of Public Health, Boston, MA.

**Background:** Beta-carotene may protect the body against free radicals that may damage the kidney and lead to the development of acute kidney injury and chronic kidney disease (CKD). Previous studies in animal models have demonstrated a potential protective effect of 30 mg/kg beta-carotene supplementation on renal ischemia/reperfusion injury and subsequently improved kidney function. The extension of these findings to humans, however, remains unclear.

**Methods:** Our study leverages previously collected data from the Physicians' Health Study I (PHS I), a large-scale, long-term, randomized trial of middle-aged and older U.S. male physicians testing 50 mg beta-carotene (BC) every other day for the primary prevention of cardiovascular disease and cancer. We examined the impact of BC supplementation on incident CKD identified by self-reports stating "yes" to kidney disease from annual follow-up questionnaires and ICD-9 codes, including 585.3-585.6 from randomization in 1982 through the end of the randomized BC intervention at the end of 1995. Analyses compared incident CKD between BC supplementation and placebo using Cox proportional hazards regression models. We also examined whether smoking status (current vs former/never smoker) modified the effect of randomized beta-carotene supplementation on CKD.

**Results:** A total of 10,947 participants were randomized to BC, and 10,965 participants were randomized to a placebo group. Baseline characteristics between randomized BC groups were similar. There was no significant association between BC supplementation and self-reported incident CKD after adjusting for age and randomized aspirin assignment (HR = 1.11, 95% CI [0.70, 1.76], p-value = 0.66). Stratified by smoking status, there was no significant association between BC supplementation and self-reported incident CKD either among former/never smoker (HR = 0.88, 95%CI [0.53, 1.47], p-value = 0.62) or current smoker (HR = 1.81, 95% CI [0.44, 7.71], p-value = 0.41). Smoking status did not modify the association between BC supplementation and incident CKD (p-interaction = 0.37).

**Conclusions:** Long-term randomized BC supplementation did not affect the risk of incident CKD in middle-aged and older male physicians.



SA-PO911

Associations Between Risperidone Use and Kidney Function Decline in Patients With Schizophrenia

Megumi Oshima, Tadashi Toyama, Hisayuki Ogura, Shiori Nakagawa, Taro Miyagawa, Shinji Kitajima, Akinori Hara, Yasunori Iwata, Norihiko Sakai, Miho Shimizu, Takashi Wada. *Kanazawa Daigaku Daigakuin Iyaku Hokengaku Sogo Kenkyuka Iyaku Hoken Gakuiki Igakurui, Kanazawa, Japan.*

**Background:** We have previously reported that the gut microbiota produces D-amino acids, and some acids have protective effects against acute kidney injury in mice. Risperidone is used as an atypical antipsychotic agent for schizophrenia and also known to inhibit the activity of D-amino acid oxidase. We thus hypothesized that risperidone may prevent kidney disease progression by enhancing the effects of D-amino acids and assessed the associations of risperidone use with kidney function decline in patients with schizophrenia.

**Methods:** This is a retrospective case-control study which included patients who were diagnosed with schizophrenia and had more than two measurements of serum creatinine at Kanazawa University Hospital between April 2010 and March 2020. Among them, 212 patients used risperidone for 30 days or more (risperidone group), while 1479 patients had no record of risperidone use (control group). The study outcome was a 40% decline in eGFR. Cox regression model was used to estimate the risk of kidney function decline.

**Results:** The mean(±SD) age was 55±19 years, 759 (45%) were men, and mean eGFR was 88±35 ml/min/1.73 m<sup>2</sup> at baseline. Both groups had similar baseline characteristics except for age: the risperidone group was younger than the control group (52 vs 56 years, p=0.006). During a mean follow-up of 1.6 years, 267 patients (16%) had a 40% eGFR decline. The incidence rate of a 40% eGFR decline was lower in the risperidone group than the control group (60 vs 104 per 1000 person-years). Compared with control, risperidone use was associated with a reduced risk of a 40% eGFR decline (HR 0.54, 95% CI 0.34 to 0.85, p=0.008). Similar association was observed after adjustment for baseline age, sex, and eGFR (0.54, 0.33 to 0.87, p=0.01).

**Conclusions:** Risperidone use was associated with a reduced risk of kidney function decline in patients with schizophrenia.

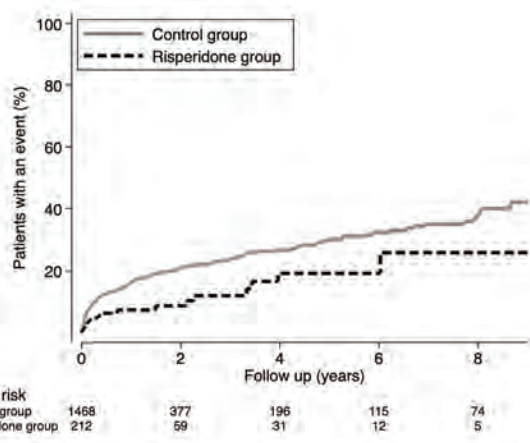

SA-PO912

High-Density Lipoprotein Lipidomics Across the Spectrum of Kidney Dysfunction

Benjamin Lidgard,<sup>1</sup> Andrew N. Hoofnagle,<sup>1</sup> Leila R. Zelnick,<sup>1</sup> Bryan R. Kestenbaum,<sup>1</sup> Ian H. de Boer,<sup>1</sup> Cassianne Robinson-Cohen,<sup>2</sup> Amanda M. Fretts,<sup>1</sup> Rozenn Lemaitre,<sup>1</sup> Nisha Bansal.<sup>1</sup> <sup>1</sup>University of Washington, Seattle, WA; <sup>2</sup>Vanderbilt University, Nashville, TN.

**Background:** Patients with CKD are known to have dysfunctional high-density lipoprotein (HDL), with impaired cholesterol efflux and anti-inflammatory properties. Differences in the lipid composition of HDL particles in these patients may in part be responsible for these impaired functions.

**Methods:** We studied 499 CKD participants from the Seattle Kidney Study. In each participant, HDL was isolated from serum, and targeted lipidomics were used to quantify amounts of ceramides, sphingomyelins, and phosphatidylcholines composing HDL. We evaluated the cross-sectional associations of estimated GFR (modeled continuously, per 15-point decrement) and natural log-adjusted albuminuria with individual lipids and lipid classes using multiple linear regression, adjusting for confounding characteristics and accounting for multiple comparisons at a false discovery rate of 5%.

**Results:** After adjustment, eGFR was not significantly associated with classes of lipids or individual lipids present in HDL. In contrast, natural log-transformed albuminuria was significantly associated with higher HDL levels of ceramides, short-chain sphingomyelins, glucosylceramide 16:0, and sphingomyelin 16:0, and phosphatidylcholine 30:1 (Figures).

**Conclusions:** Albuminuria, but not eGFR, was significantly associated with specific alterations in the lipid composition of HDL in participants with HDL. Further studies investigating the functional consequences of these differences are warranted.

**Funding:** NIDDK Support

Table: Association between eGFR, albuminuria and levels of various classes of lipids

	eGFR (per 15-point decrement)		Natural log-adjusted albuminuria (per SD-increase)	
	Beta (95% CI)	p-value	Beta (95% CI)	p-value
Ceramides	0.05 (-0.10, 0.21)	0.50	<b>0.32 (0.07, 0.56)</b>	<b>0.01</b>
Sphingomyelins	0.03 (-0.10, 0.16)	0.66	0.15 (-0.06, 0.35)	0.16
Short-chain sphingomyelins	0.04 (-0.03, 0.10)	0.26	<b>0.11 (0.00, 0.21)</b>	<b>0.046</b>
Long-chain sphingomyelins	-0.01 (-0.08, 0.06)	0.81	0.04 (-0.07, 0.15)	0.44
Phosphatidylcholines	0.14 (-0.34, 0.63)	0.57	0.18 (-0.59, 0.96)	0.64
0-1 double bonds	0.11 (-0.05, 0.28)	0.18	0.10 (-0.15, 0.36)	0.43
≥2 double bonds	-0.03 (-0.36, 0.30)	0.86	0.13 (-0.42, 0.67)	0.65
Total lipids	0.22 (-0.52, 0.97)	0.55	0.65 (-0.52, 1.81)	0.28

Beta represents fold change in lipid level per 15-point decrement in eGFR or per SD-increase in natural log-adjusted albuminuria.

Adjusted for age, gender, diabetes, hypertension, prior stroke or MI, eGFR, HDL, LDL, and use of statins and other cholesterol-lowering medications

**BOLD FONT** indicates significant findings

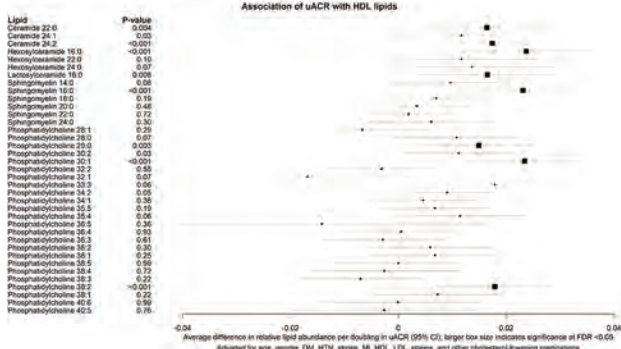
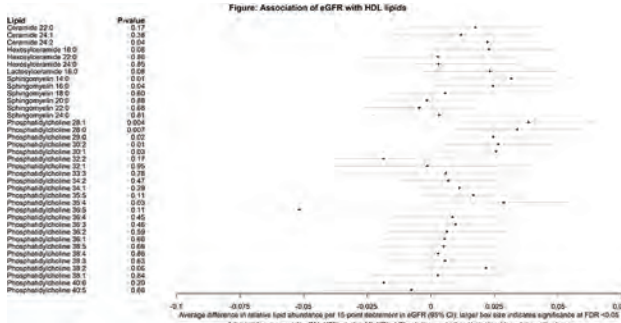

SA-PO913

Impact of Using the 2021 CKD-EPI Creatinine Equation on Clinical and Surrogate End Points in Trials

Juhi Chaudhari,<sup>1</sup> Shiyuan Miao,<sup>1</sup> Hocine Tighiouart,<sup>2</sup> Lesley A. Inker.<sup>1</sup> <sup>1</sup>Chronic Kidney Disease-Epidemiology Collaboration: Clinical Trials <sup>1</sup>Tufts Medical Center, Boston, MA; <sup>2</sup>Tufts Clinical and Translational Science Institute, Boston, MA.

**Background:** The new 2021 CKD-EPI creatinine GFR estimating equation that does not include a term for Black race is now recommended to replace the 2009 CKD-EPI creatinine equation in the US. We evaluated the impact of using the 2021 vs 2009 equation on treatment effects of GFR slope and on time-to-confirmed 40% decline in GFR in three past randomized trials.

**Methods:** In the SPRINT (low vs usual blood pressure control), IDNT (RAS blocker vs calcium channel blocker), and EMPA-REG Outcomes (SGLT2 inhibitor vs placebo) trials, we estimated GFR using the CKD-EPI 2009 and 2021 creatinine equations and computed total GFR slope (randomization to 3 years) as well as chronic slope (excluding the initial 3 months post-randomization) in the whole study as well as in Black and non-Black race groups. We estimated treatment effects on GFR slope as the mean difference in GFR slope between the randomized groups and treatment effects on a composite of time-to-confirmed 40% decline in GFR, GFR<15 mL/min per 1.73 m<sup>2</sup> and end-stage kidney disease using Cox proportional hazard regressions.

**Results:** The mean baseline GFR using the 2009 and 2021 equations are shown in Figure 1, along with the treatment effects on GFR slopes and on the time-to-event outcome. As expected, GFRs were lower for Black individuals using the 2021 equation compared to 2009. The treatment effects on the three outcomes did not meaningfully differ when using the two equations for each study and for Black and non-Black race groups.

**Conclusions:** Substituting the 2021 CKD-EPI equation for the 2009 equation had minimal numerical impact on the estimated treatment effects on GFR slope and on time-to-confirmed 40% decline in GFR in three past studies as a whole or in the Black race subgroup. It is reasonable to apply the new GFR equation in the design of future trials.

**Funding:** Private Foundation Support

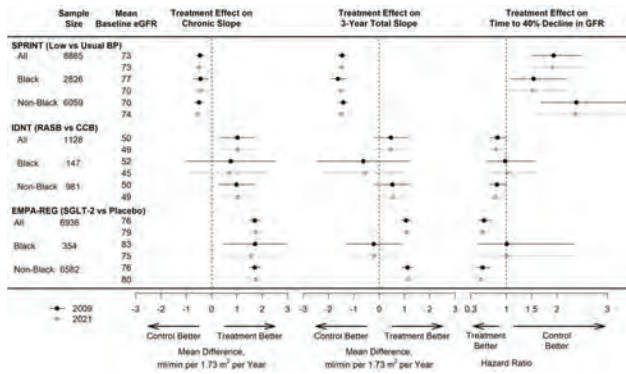

Treatment effects on GFR slope and on time-to-event outcome (composite of confirmed 40% decline in GFR, GFR<15 mL/min per 1.73 m<sup>2</sup> and end-stage kidney disease)

SA-PO914

**Cannabis Use and CKD: Epidemiological Associations and Mendelian Randomization**

Sergio Dellepiane, Faris F. Gulamali, Lili Chan, Joshua L. Rein, Ron Do, Steven G. Coca, Benjamin S. Glicksberg, Girish N. Nadkarni. *Icahn School of Medicine at Mount Sinai, New York, NY.*

**Background:** The association between cannabis use and chronic kidney disease (CKD) is controversial. We aimed to assess association of kidney traits with cannabis use in one of the largest cohort studies in the United States and then assess causality using Mendelian Randomization (MR) with genome wide association study (GWAS) summary statistics

**Methods:** In the retrospective study (n=315,297) we conducted an association analysis to test for frequency of cannabis use and CKD. To evaluate causal associations, we performed a two sample MR from a GWAS of cannabis use disorder (n=384,032 – exposure GWAS) and an outcome GWAS of CKD (n=1.2 million).

**Results:** In the observational study, compared to never users, less than monthly (OR 1.01, 95% CI 0.87 - 1.18 p = 0.867) and monthly cannabis users (OR 1.15, 95% CI 0.86 - 1.15, p = 0.327) did not have higher CKD odds. Conversely, weekly (OR 1.28, 95% CI 1.01 - 1.60, p = 0.0355) and daily use (OR 1.25, 95% CI 1.04 - 1.50, p = 0.018) were significantly associated to CKD, adjusted for multiple confounders. In MR, genetic liability to cannabis use disorder was not associated with increased odds for CKD (OR=1.00, 95% CI: 0.99 - 1.01, P=0.96). These results were robust across different MR techniques and considering multiple kidney related traits (cystatin-C and creatinine-based kidney function, proteinuria, and blood urea nitrogen).

**Conclusions:** We conducted the largest observational study to date and the first MR about the association between cannabis and CKD. Although there was an epidemiological association between frequent cannabis use and CKD, there was no evidence of a causal association indicating confounding in observational studies.

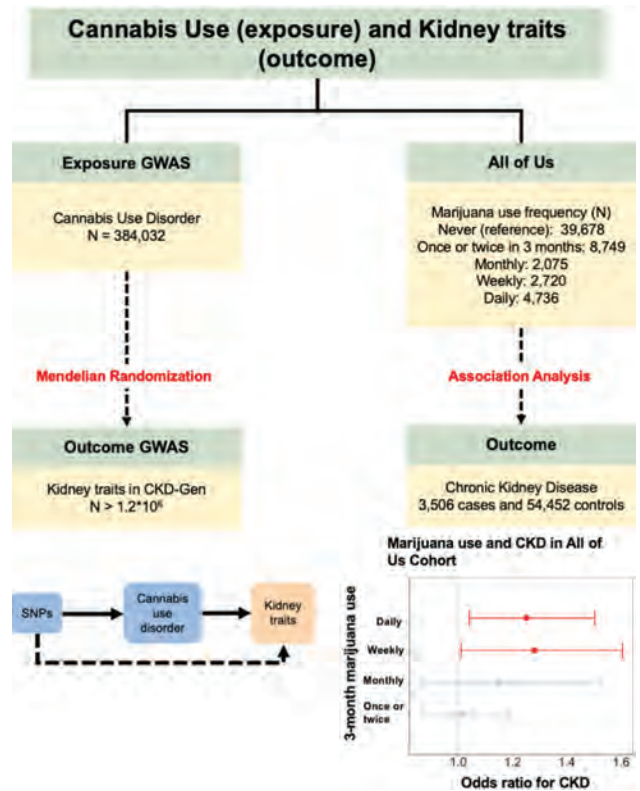

SA-PO915

**CT-Based Radiomic Feature Analysis for Identifying Baseline Kidney Function in Patients With Underlying CKD**

Seongho Jo,<sup>1</sup> Kipyoo Kim.<sup>2,1</sup> <sup>1</sup>Department of Internal Medicine, Inha University Hospital, Incheon, Republic of Korea; <sup>2</sup>Department of Internal Medicine, Inha University College of Medicine, Incheon, Republic of Korea.

**Background:** Decreased kidney size and cortical thickness were known as indicators for chronic changes in kidney, but the diagnostic accuracy was relatively low. Radiomics is a promising approach for quantitative analysis of various medical images. In this study, we investigated CT-based radiomic feature analysis for identifying baseline kidney function in patients with underlying chronic kidney disease (CKD).

**Methods:** A total of 487 patients who underwent a non-enhanced CT scan of the abdomen were included in the main analysis. Three-dimensional kidney segmentation was performed using semi-automated tools. A total of 1218 radiomic features were extracted using the PyRadiomics package, including shape features (n=14), original first order features (n=108), texture features (n=408), and wavelet features (n=688). We perform feature selection (n=20) using maximum-relevance minimum-redundancy methods. A prediction model for baseline kidney function was developed and validated using the XGBoost algorithm. For kidney biopsy findings within 3 months before and after CT scan, the association between selected radiomic features and chronic pathological findings was also examined.

**Results:** Conventional markers of CKD showed relatively low diagnostic accuracy (major axis length, AUC 0.75; kidney volume, AUC 0.82). The wavelet-HHH glcm dependence variance was the most predictive radiomic feature for eGFR <45ml/min/1.73m<sup>2</sup> (AUC 0.85). A multivariable predictive model only with radiomic features revealed an improved performance (AUC 0.86). Finally, a model combined with clinical and radiomic features showed the best performance (AUC 0.87). Most selected radiomic features were highly correlated with baseline kidney function, and several wavelet transform features for texture showed a high AUC value for the presence of severe interstitial fibrosis and tubular atrophy.

**Conclusions:** Our findings indicate that CT-based radiomics feature analysis can provide a more accurate predictive model for CKD than traditional morphological markers.

**Figure 1.** The performance of predictive model for eGFR <45 ml/min/1.73m<sup>2</sup> and the characteristics of the selected radiomic features. (A) The receiver operating characteristic curves of predictive models with different types of features. (B) The heatmap of selected radiomic features ordered vertically according to the baseline kidney function.

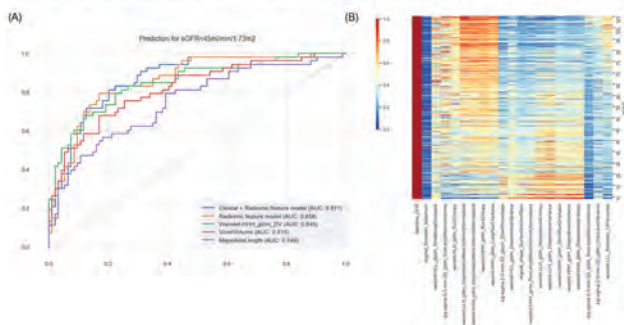

**SA-PO916**

**Sixteen Weeks of High Amylose-Resistant Starch Supplementation Leads to a Reduction in p-Cresyl-Sulphate in Predialysis Patients**

Sam A. Headley,<sup>1</sup> Donna J. Chapman,<sup>1</sup> Karen Madsen,<sup>4</sup> Elizabeth E. Evans,<sup>1</sup> Allen Cornelius,<sup>5</sup> Emily Miele,<sup>1</sup> Kristyn Kirton,<sup>1</sup> Joshua D. Loseke,<sup>1</sup> Brian J. Martin,<sup>6</sup> Talat Alp Ikizler,<sup>3</sup> Michael J. Germain.<sup>2</sup> <sup>1</sup>Springfield College, Springfield, MA; <sup>2</sup>Baystate Medical Center, Springfield, MA; <sup>3</sup>Vanderbilt University Medical Center, Nashville, TN; <sup>4</sup>University of Alberta, Edmonton, AB, Canada; <sup>5</sup>Fielding Graduate University, Santa Barbara, CA; <sup>6</sup>University of Pittsburgh, Pittsburgh, PA.

**Background:** Patients with chronic kidney disease (CKD) have high levels of systemic inflammation and oxidative stress. The current study was designed to determine the effect of 16 weeks of supplementation with high amylose resistant starch (HAM-RS2) on the microbiota and biomarkers indicative of inflammation, oxidative stress, and uremic toxins in stage 3-4 patients with CKD.

**Methods:** This was a double-blind, placebo controlled, parallel arm, randomized controlled trial. Sixty-eight participants were randomized to one of two groups: HAM-RS2 & usual care (RS2) or placebo (cornstarch) & usual care (Con). RS2 was provided as Hi-Maize® 260 RS. For week 1, the dose of supplements was 15 grams/day. The dose was then increased to 33 grams/day for weeks 2-16. Participants attended two baseline (BL) sessions with follow up visits 8 (wk8) and 16 weeks (wk16) later. Fasting blood samples were collected at BL, wk8 and wk16. A stool sample was collected for analysis of microbial composition using 16s RNA sequencing at BL and wk16. The blood samples were analysed for interleukin 6, interleukin 10, tumor necrosis factor alpha, c reactive protein, monocyte chemoattractant protein-1, malondialdehyde, 8-isoprostanes F2a, indoxyl sulphate (IS), and p-cresyl sulphate (PCS).

**Results:** Sixty-five patients completed the study (RS2 = 33, Con =32). RS2 led to a significant increase in the levels of butyrate producing bacteria. RS2 also led to a significant reduction in PCS (mg/dl): (BL, 3.75 ± 2.88, wk8 3.34 ± 2.65, wk16 2.88 ± 1.78)  $\chi^2(2) = 8.74, p = .02$ , while the control group did not change (BL 3.01 ± 2.18, wk8 2.62 ± 1.71, wk16 3.13 ± 2.52)  $\chi^2(2) = 1.13, p = .57$ . Post hoc analysis indicated that the change from baseline to 16 weeks for PCS in the RS2 group was significant ( $p = .02$ ). IS followed a similar pattern but did not reach statistical significance. In addition, RS2 did not lead to any significant changes in inflammatory or oxidative stress markers.

**Conclusions:** Supplementation with RS2 led to a reduction in PCS in our sample of patients with CKD. Since high levels of PCS are associated with increased mortality and progression of CKD, our finding has important clinical implications.

**Funding:** Commercial Support - Ingredient donated the resistant starch and the placebo that was used in this study

**SA-PO917**

**Ticagrelor Is Superior to Clopidogrel in Inhibiting Platelet Aggregation in Patients With Stages 4-5 CKD**

Otis Davis,<sup>1</sup> Junqiang Dai,<sup>2</sup> Nishank Jain.<sup>1</sup> <sup>1</sup>University of Arkansas for Medical Sciences, Little Rock, AR; <sup>2</sup>University of Kansas School of Medicine, Kansas City, KS.

**Background:** Although the more potent ticagrelor was shown to be superior to clopidogrel in reducing thrombotic events and mortality in a subgroup of PLATO trial non-dialysis participants with stage 4-5 CKD, post-marketing studies failed to demonstrate similar benefits among CKD population. Studies exploring the antiplatelet effects of ticagrelor in CKD have been limited by the lack of a control arm, high drop-out rates and lack of randomization. There are no RCT to dissect antiplatelet effects of ticagrelor vs. clopidogrel in CKD.

**Methods:** We conducted a mechanistic, double-blind, RCT to compare ADP-induced platelet aggregation on treatment with ticagrelor vs. clopidogrel in 48 people with CKD. In a parallel arm, we investigated the pharmacokinetics and the antiplatelet effects of ticagrelor among CKD and non-CKD controls (n=26).

**Results:** The population of our study was diverse- mean age 53.7 years, 62% women, 54% African American, mean GFR 16 ml/min/1.73m<sup>2</sup>. Ticagrelor was found to be

statistically superior to clopidogrel at inhibiting ADP-induced WBPA ( $87 \pm 22\%$  vs.  $63 \pm 50\%$  inhibition of platelet aggregation;  $P=0.04$ ), while the difference in post-treatment values remained significant when adjusting for diabetes (ANCOVA  $P=0.002$ ). There were no differences in the percent inhibition of ADP-induced platelet aggregation between CKD ( $87 \pm 22\%$ ) and controls ( $77 \pm 29\%$ ),  $P=0.14$ . This coincided with no difference in the pharmacokinetics of ticagrelor and its metabolite between CKD and controls.

**Conclusions:** Our findings provide mechanistic evidence for the greater efficacy of ticagrelor over clopidogrel in patients with stage 4-5 CKD.

**Funding:** Private Foundation Support

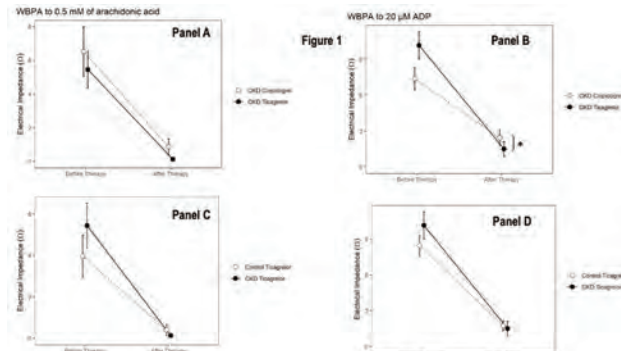

Graphs showing aspirin effect and P2Y12 inhibitor effect

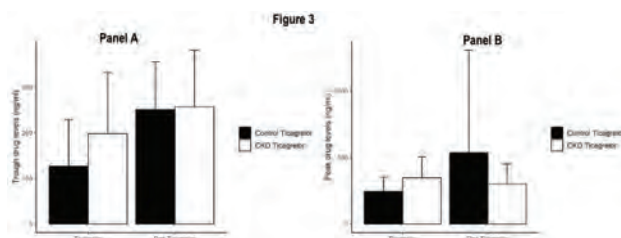

Peak and trough plasma levels of ticagrelor and its active metabolite

**SA-PO918**

**Treatment With Nicotinamide Riboside Alters Systemic Mitochondrial Metabolism Without Impacting Exercise Capacity in Patients With CKD**

Armin Ahmadi,<sup>1</sup> Gwenaëlle Begue,<sup>2</sup> Ana P. Valencia,<sup>3</sup> Jennifer E. Norman,<sup>1</sup> David J. Marcinek,<sup>3</sup> Matthew P. Van Doren,<sup>4</sup> David K. Prince,<sup>3</sup> Bryan R. Kestenbaum,<sup>3</sup> Baback Roshanravan.<sup>1</sup> <sup>1</sup>University of California Davis, Davis, CA; <sup>2</sup>California State University Sacramento, Sacramento, CA; <sup>3</sup>University of Washington, Seattle, WA; <sup>4</sup>Fred Hutchinson Cancer Research Center, Seattle, WA.

**Background:** The impact of therapies that target mitochondrial function in CKD is still unknown. We conducted a clinical trial of coenzyme Q10 (CoQ10) and nicotinamide riboside (NR) to determine their impact on endurance exercise capacity and metabolic profile in CKD patients.

**Methods:** We conducted a placebo-controlled, double blind, cross-over trial with 3 arms: placebo, CoQ10, and NR. Adults aged between 30-79 with moderate-severe CKD (N=25), eGFR of <60ml/min/1.73m<sup>2</sup>, were recruited. Subjects received NR (1000 mg/day) or CoQ10 (1200 mg/day) for 6 weeks. Maximal aerobic capacity (VO<sub>2</sub> peak) was assessed using a graded cycle exercise test. Plasma samples underwent semi-targeted metabolomics profiling using gas chromatography. Impact of treatment on VO<sub>2</sub> peak was assessed statistically using ANOVA. Linear mixed effects modeling was used to estimate differences in plasma metabolites

**Results:** Participants mean age was 61.0±11.6 with a mean eGFR of 36.9±9.2. Females comprised 40% of the cohort with a 16% prevalence of diabetes. CoQ10 and NR treatment had no impact on VO<sub>2</sub> peak ( $p=0.37, p=0.38$  respectively) (Figure 1A). A total of 13 out of the 98 detected metabolites were significantly altered in response to NR treatment. These metabolites were predominantly involved in TCA cycle and amino acid metabolism (Figure 1B). All noted metabolites significantly increased compared to placebo except for two TCA cycle intermediates ( $\alpha$ -KG and malate). Only 2 metabolites were significantly altered post CoQ10 treatment compared to placebo.

**Conclusions:** NR treatment alters systemic mitochondrial metabolism but had no meaningful impact on aerobic capacity in CKD. Future studies will focus on treatment associated changes in the mitochondrial transcriptome and other performance-based outcomes.

**Funding:** NIDDK Support

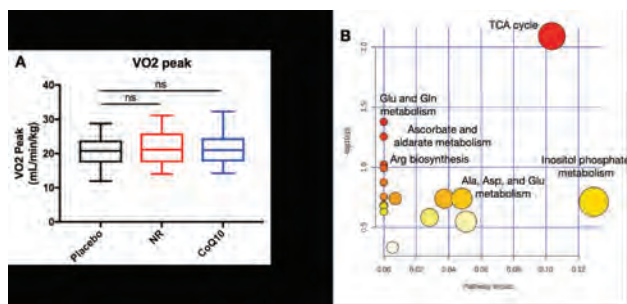

Figure 1. Impact of CoQ10 and NR on VO<sub>2</sub> peak compared to placebo (A). Pathway analysis of changes with NR treatment compared to placebo (B).

**SA-PO919**

**Results of Phase 2 MERLIN: An Evaluation of Safety, Tolerability, and Efficacy of Bardoxolone Methyl in Patients With Rapidly Progressing CKD**

Pablo E. Pergola,<sup>1</sup> Laura Kooienga,<sup>2</sup> Angie Goldsberry,<sup>3</sup> Colin J. Meyer,<sup>3</sup> Arnold L. Silva,<sup>4</sup> Samina Khan.<sup>3</sup> <sup>1</sup>Renal Associates PA, San Antonio, TX; <sup>2</sup>Colorado Kidney Care, Denver, CO; <sup>3</sup>Reata Pharmaceuticals Inc, Irving, TX; <sup>4</sup>Boise Kidney and Hypertension Institute, Meridian, ID.

**Background:** Bardoxolone methyl (Bard) is an investigational drug that activates Nrf2. Improvements in eGFR, creatinine clearance, and inulin clearance have been observed with Bard treatment in multiple clinical trials in patients with CKD of various etiologies like Alport syndrome, ADPKD, IgA nephropathy and DKD.

**Methods:** MERLIN (NCT04702997) was a multi-center, randomized, double-blind, placebo-controlled, phase 2 trial that enrolled patients with CKD of multiple etiologies at risk of rapid kidney disease progression (rate of eGFR decline  $\geq 4$  mL/min/1.73 m<sup>2</sup> in prior year or urine albumin-to-creatinine ratio  $\geq 300$  mg/g or persistent hematuria). Patients 18-75 years of age with eGFR  $\geq 20$  to  $<60$  mL/min/1.73m<sup>2</sup> were randomized 1:1 to receive Bard or placebo. Patients with BNP  $>200$  pg/mL at screening visit were excluded. The primary efficacy endpoint was the change from baseline (CFB) in eGFR at Week 12. To assess the exploratory objective of characterizing change in eGFR during the off-treatment (OT) period, serial eGFR was assessed at 3, 7, 14, 21, 28, and 35 days after last dose of Bard. Safety endpoints included lab results, vital signs, ECG, weight, and AEs.

**Results:** Eighty-one patients were treated with Bard (n=39) or placebo (n=42). Baseline eGFR was 35.7±9.9 mL/min/1.73m<sup>2</sup> (mean±SD), with 68 patients (84%) having eGFR  $<45$  mL/min/1.73 m<sup>2</sup>. The CFB in eGFR after 12 weeks of treatment was 6.79±0.93 (mean±SE) in patients treated with Bard as compared to -0.92±0.87 (mean±SE) mL/min/1.73m<sup>2</sup> in patients treated with placebo (p<0.0001). Mean eGFR CFB for patients on Bard declined once it was discontinued and stabilized at 1.58±0.83 (mean±SE) mL/min/1.73m<sup>2</sup> by Day 21 OT, with no further decline after that. Most TEAEs were mild to moderate in severity. Those reported in >5% of patients in either treatment group were muscle spasms, nausea and decrease in weight.

**Conclusions:** Consistent with previous studies of patients treated with Bard, the 12-week treatment in the MERLIN study resulted in significant increases in eGFR in patients taking Bard when compared with placebo. The acute eGFR increase associated with Bard was resolved by Day 21 OT. Bard was found to be safe and well tolerated. Overall, no new safety signals emerged during the study.

**Funding:** Commercial Support - Reata Pharmaceuticals, Inc

**SA-PO920**

**Evaluating GFR Slope as a Surrogate End Point Across Diseases**

Willem H. Collier,<sup>1</sup> Benjamin Haaland,<sup>1</sup> Lesley A. Inker,<sup>2</sup> Hiddo J. L. Heerspink,<sup>3</sup> Tom Greene.<sup>1</sup> Chronic Kidney Disease Epidemiology Collaboration <sup>1</sup>University of Utah Health, Salt Lake City, UT; <sup>2</sup>Tufts Medical Center, Boston, MA; <sup>3</sup>Universitair Medisch Centrum Groningen Afdeling Cardiologie, Groningen, Netherlands.

**Background:** We have previously demonstrated that treatment effects on GFR slope can be used to accurately predict treatment effects on time-to-kidney failure (KFRT) in randomized CKD trials. It has been hypothesized that accuracy can vary by sub-categories of disease. Yet, low statistical power in subgroups can challenge the interpretation of subgroup-to-subgroup variability in GFR slope as a surrogate.

**Methods:** We performed analyses on N=47 previously conducted CKD trials. For each trial, we estimated treatment effects on time-to-KFRT using proportional hazards models and treatment effects on GFR chronic slope using mixed-effects models. Meta-regression methods were used to assess the strength of the association between treatment effects on the separate endpoints within three disease-defined subgroups: Diabetes (DN), glomerular diseases (GN), and CKD without diabetes (CKD). We used a novel Bayesian modeling approach (partial-pooling) to facilitate improved precision in our estimation of model parameters. The results were contrasted with those obtained using an earlier no-pooling approach.

**Results:** Relative to no-pooling, the partial-pooling model improved precision in parameter estimates key to the interpretation of the surrogate (see the 95% credible intervals in Figure 1 legends). The partial-pooling model also improved prediction of treatment effects on time-to-KFRT (see narrower confidence bands on the left of Figure 1).

**Conclusions:** On a collection of CKD trials, use of a novel meta-regression approach for surrogate evaluation indicated homogeneity in the quality of GFR chronic slope across subgroups of trials defined by disease.

**Funding:** Private Foundation Support

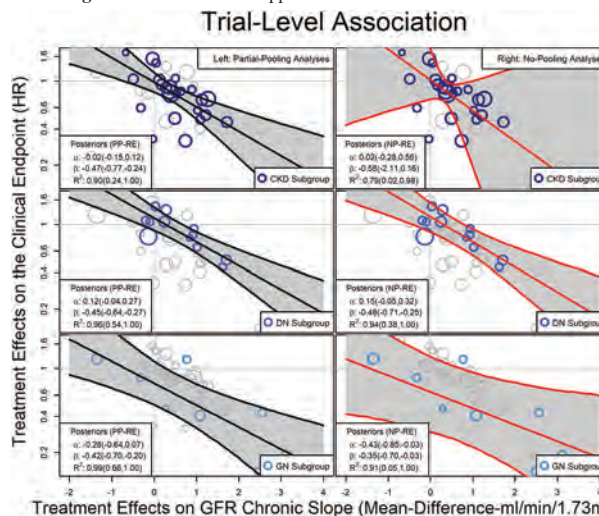

$\alpha$ : Meta-regression intercept  $\beta$ : Meta-regression slope. We display meta-regression lines as well as the upper and lower confidence bands in grey (partial-pooling) and red (no-pooling). Grey circles are trials not in the featured disease-defined subgroup.

**SA-PO921**

**Accuracy of CKD-EPI GFR Estimating Equations According to the Difference in eGFR Using Cystatin C vs. Creatinine**

Yeli Wang, Chronic Kidney Disease-Epidemiology Collaboration Harvard University TH Chan School of Public Health, Boston, MA.

**Background:** Estimated glomerular filtration rate (eGFR) using cystatin C is recommended as a confirmatory test, with eGFRcr-cys more accurate than eGFRcys. A large difference between eGFRcys and eGFRdiff (eGFRdiff) likely indicates a substantial divergence from usual in the non-GFR determinants of cystatin C, creatinine or both and a potential large error in either eGFR compared to measured GFR (mGFR). However, it is not known whether eGFRcys or eGFRcr-cys is more correct. We aimed to evaluate the performance of eGFRcr, eGFRcys, and eGFRcr-cys compared to mGFR according to the magnitude of eGFRdiff.

**Methods:** We assessed the CKD-EPI 2021 eGFRcr and eGFRcr-cys, and 2012 eGFRcys among 4,050 participants from 12 studies included in the CKD-EPI 2021 external validation dataset. eGFRdiff was defined as eGFRcys minus eGFRcr. The negative, reference, and positive eGFRdiff categories were defined as  $<-15$ ,  $-15$  to  $<15$ , and  $\geq 15$  mL/min per 1.73 m<sup>2</sup>, respectively. We compared bias (median difference in mGFR minus eGFR), P<sub>30</sub> (percentage of eGFR within 30% of mGFR), and concordance between eGFR and mGFR categories ( $<30$ ,  $30$ - $59$ ,  $60$ - $89$ ,  $\geq 90$  mL/min/1.73m<sup>2</sup>) according to eGFRdiff categories.

**Results:** In the overall cohort, mean (SD) GFR, age and BMI were 76.4 (29.6) mL/min/1.73m<sup>2</sup>, 57.0 (17.4) years and 26.9 (5.00) kg/m<sup>2</sup>, respectively. As reported before, eGFRcr-cys in the overall dataset had greater accuracy (higher P<sub>30</sub> and greater concordance) than eGFRcr or eGFRcys. In the reference eGFRdiff category, all equations displayed similar performance (small differences in bias, similar P<sub>30</sub> and concordance). In both negative and positive eGFRdiff categories, eGFRcr-cys generally had better performance (lesser bias, higher P<sub>30</sub> and higher concordance) than eGFRcr and eGFRcys (Table). These results were consistent across subgroups of age, sex, and BMI.

**Conclusions:** In ambulatory clinical settings eGFRcr-cys is more likely to be correct than either eGFRcr or eGFRcys across sex, age, and BMI groups. Future work should evaluate whether clinician knowledge of non-GFR determinants provides more informative decision making.

**Funding:** NIDDK Support

	Total population	eGFRdiff group (eGFRcys-eGFRcr) category		
		Negative (<-15) (eGFRcys higher)	Reference (-15 to <15)	Positive ( $\geq 15$ ) (eGFRcys higher)
Sample size	4,050 (100%)	851 (21.9%)	2,811 (69.2%)	388 (8.9%)
Age, y	57.0 ± 17.4	60.4 ± 17.3	57.1 ± 17.5	48.7 ± 13.8
Female, %	1,557 (38.4%)	314 (36.8%)	1,111 (39.7%)	132 (33.6%)
Body mass index, kg/m <sup>2</sup>	26.9 ± 5.00	27.6 ± 5.64	26.8 ± 4.74	26.6 ± 4.80
<b>eGFRcr</b>				
Bias, median difference (ml/min/1.73 m <sup>2</sup> )	-3.05 (-3.46, -2.63)	-13.3 (-14.5, -12.2)	-1.96 (-2.45, -1.49)	8.60 (7.20, 10.7)
Accuracy, P <sub>30</sub> <sup>a</sup>	87 (86.83)	70 (67.73)	83 (86.33)	91 (90.92)
Agreement with mGFR <sup>b</sup>	70 (69.72)	58 (54.61)	76 (74.77)	58 (55.43)
<b>eGFRcys</b>				
Bias, median difference (ml/min/1.73 m <sup>2</sup> )	0.60 (0.09, 1.03)	9.91 (9.138, 11.15)	-0.54 (0.98, -0.11)	-13.4 (-13.5, -11.8)
Accuracy, P <sub>30</sub> <sup>a</sup>	88 (87.89)	83 (86.33)	91 (90.92)	77 (73.13)
Agreement with mGFR <sup>b</sup>	71 (70.72)	58 (55.62)	76 (74.77)	64 (59.98)
<b>eGFRcr-cys</b>				
Bias, median difference (ml/min/1.73 m <sup>2</sup> )	-2.53 (-2.89, -2.14)	-0.77 (-1.74, 0.126)	-2.67 (-3.09, -2.24)	-5.07 (-6.84, -3.70)
Accuracy, P <sub>30</sub> <sup>a</sup>	91 (90.92)	78 (68.73)	91 (90.92)	82 (89.94)
Agreement with mGFR <sup>b</sup>	74 (73.76)	71 (68.74)	76 (74.77)	69 (64.74)

<sup>a</sup>Bias was expressed as the median difference in measured GFR minus estimated GFR (95% confidence interval). A negative bias indicates overestimation of the measured GFR, and a positive bias indicates underestimation of the measured GFR.  
<sup>b</sup>Accuracy (P<sub>30</sub>) was defined as the percentage of individuals within 30% of measured GFR (95% confidence interval).  
 Abbreviations: eGFRcr, creatinine-based estimated GFR; eGFRcys, cystatin C-based estimated GFR; eGFRcr-cys, estimated GFR based on creatinine and cystatin C; GFR, glomerular filtration rate.

Key: TH - Thursday; FR - Friday; SA - Saturday; OR - Oral; PO - Poster; PUB - Publication Only

Underline represents presenting author.

SA-PO922

Using the Difference in Estimated Glomerular Filtration Rate by Cystatin C vs. Creatinine to Improve the Ability to Predict the Competing Risk of Death or ESKD

O. Alison Potok,<sup>1,4</sup> Stein I. Hallan,<sup>2</sup> Joachim H. Ix,<sup>1,4</sup> Ronit Katz,<sup>3</sup> Nisha Bansal,<sup>3</sup> Dena E. Rifkin,<sup>1,4</sup> <sup>1</sup>University of California San Diego, La Jolla, CA; <sup>2</sup>Norges teknisk-naturvitenskapelige universitet, Trondheim, Norway; <sup>3</sup>University of Washington, Seattle, WA; <sup>4</sup>VA San Diego Healthcare System, San Diego, CA.

**Background:** Glomerular filtration rate (GFR) can be estimated using serum creatinine or cystatin C. Prior research shows that a greater negative difference in estimated GFR by cystatin C vs. creatinine (eGFRDiff = eGFRcys - eGFRcr) associates with frailty, hospitalizations, and mortality. We aimed to determine whether including eGFRDiff into existing predicting tools for kidney failure (KFRE) and mortality risk (MREK) would increase their accuracy in older persons with chronic kidney disease (CKD). We hypothesized that the MREK with eGFRDiff would perform better than the current equation, while the KFRE with eGFRDiff would perform as well as the current equation.

**Methods:** 1146 community-living participants of the Norwegian HUNT study (age >65, eGFRcr < 45 mL/min/1.73m<sup>2</sup>) were evaluated. eGFRDiff was calculated as eGFRcys - eGFRcr using the CKD-EPI 2012 and 2009 equations respectively. Standard KFRE and MREK scores were computed for each participant. Outcomes were end stage kidney disease (ESKD) and death at 5 years. C-statistics were computed for each predictor (KFRE and MREK) with and without the addition of eGFRDiff.

**Results:** Mean  $\pm$ SD age was  $80 \pm 7$  years, eGFRcr was  $36 \pm 8$ , eGFRcys was  $37 \pm 15$ , and eGFRDiff was  $1.04 \pm 12$  mL/min/1.73m<sup>2</sup>. Over the 5 year observation period, 60 participants (5%) reached ESKD and 444 died (39%), corresponding to KFRE and MREK predictions of 5 (10) % and 30 (19) %, respectively. Diagnostic accuracy measured as C-statistics [95% confidence interval] were 92.7% [88.9; 96.5] for KFRE alone, 93.5% [90.4; 96.6] for KFRE and eGFRDiff (Figure 1a,  $p=0.31$ ), 70.6% [67.2; 74.0] for MREK alone, 73.4% [70.1; 76.5] for MREK and eGFRDiff (Figure 1b,  $p<0.01$ )

**Conclusions:** The eGFRdiff improves the accuracy of the mortality risk but not the kidney failure risk equation in older patients with advanced CKD. Thus, incorporation of eGFRDiff may improve estimation of the competing risk of death vs. ESKD in older adults.

**Funding:** NIDDK Support

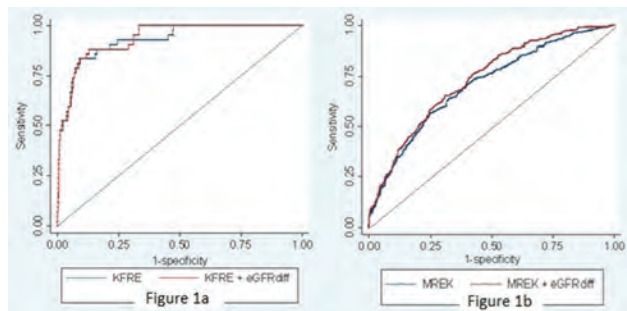

SA-PO923

Clinical Significance of Serum Creatinine-to-Cystatin C Ratio on Renal Outcomes in Non-Dialysis-Dependent CKD Patients: Results From the KNOW CKD Study

Donghyuk Kang,<sup>1,2</sup> Yaeni Kim,<sup>3,4</sup> <sup>1</sup>Korea University College of Medicine and School of Medicine, Seoul, Republic of Korea; <sup>2</sup>Korea University Guro Hospital, Seoul, Republic of Korea; <sup>3</sup>Catholic University of Korea School of Medicine, Seoul, Republic of Korea; <sup>4</sup>Seoul Saint Mary's Hospital, Seochogu, Seoul, Republic of Korea.

**Background:** Sarcopenia is prevalent in CKD patients and is associated with poor clinical outcomes. The assessment of skeletal muscle mass and strength may help in decision-making in patient care, but it is difficult to perform. Recently, the serum creatinine-to-cystatin C ratio has been proposed as a surrogate marker for detecting muscle wasting. We aimed to evaluate the impact of the creatinine-to-cystatin C ratio on renal outcomes in non-dialysis-dependent CKD patients.

**Methods:** In this observational Korean Cohort Study for Outcome in Patients with CKD (KNOW-CKD), 1,452 patients with CKD stages 1-3 were analyzed. Men and women were separately categorized into quartile groups according to their creatinine-to-cystatin C ratio. The primary outcome was a composite of renal outcome consisting of a 50% reduction in estimated glomerular filtration rate (eGFR) or initiation of renal replacement therapy, whichever occurred first. Using Cox regression analysis, the association between the creatinine-to-cystatin C ratio and the primary outcome was analyzed.

**Results:** During a median follow-up of 6.0 (4.3-7.8) years, the primary composite renal outcome occurred in 325 (22%) patients within a median of 4.0 (2.8-5.8) years. After sequential adjustment with 15 variables in the fully adjusted Cox regression model, lower creatinine-to-cystatin C ratio groups (quartiles 1 and 2) had a poor primary outcome compared to the highest group (quartile 4); the hazard ratios for quartiles 1, 2, and 3 compared with quartile 4 were 2.41 (95% confidence interval [CI], 1.61-3.60), 1.93 (95% CI, 1.37-2.72), and 1.40 (95% CI, 0.98-2.01), respectively.

Key: TH - Thursday; FR - Friday; SA - Saturday; OR - Oral; PO - Poster; PUB - Publication Only  
Underline represents presenting author.

**Conclusions:** Serum creatinine-to-cystatin C ratio is an independent predictor of renal outcomes. A low creatinine-to-cystatin C ratio is associated with poor renal outcome.

SA-PO924

Age-Specific Racial Differences in Kidney Failure and Death Following Incident CKD Using the 2021 CKD-EPI Creatinine Equation

Guofen Yan,<sup>1</sup> Robert Nee,<sup>2</sup> Julia J. Scialla,<sup>1</sup> Wei Yu,<sup>1</sup> Tom Greene,<sup>3</sup> Alfred K. Cheung,<sup>3,4</sup> Keith C. Norris,<sup>5</sup> <sup>1</sup>University of Virginia, Charlottesville, VA; <sup>2</sup>Walter Reed National Military Medical Center, Bethesda, MD; <sup>3</sup>University of Utah Health, Salt Lake City, UT; <sup>4</sup>VA Salt Lake City Health Care System, Salt Lake City, UT; <sup>5</sup>University of California Los Angeles, Los Angeles, CA.

**Background:** Recent research suggests that the 2021 CKD-EPI creatinine equation led to smaller estimated disparities in CKD outcomes (kidney failure [KF] and death) between Black and White veterans, but a greater disparity in age of CKD onset. Because the new equation changes estimated GFR (eGFR) for all adult individuals, we examined whether the recently reported racial differences in CKD outcomes based on the new equation also persisted across age groups.

**Methods:** The cohort included 180,881 non-Hispanic White and 32,187 non-Hispanic Black veterans, aged 18-90 years, with incident CKD from 2003-2008 in the US Veterans Health Administration, followed through 2018. Incident CKD was defined by the first time when two eGFR values at >3 months apart were both <60 mL/min/1.73 m<sup>2</sup> using the 2021 CKD-EPI equation. For each age group, we calculated cause-specific hazard ratios (HR) of KF, censoring on death, as well as HRs of death (including death after KF) over 10 years of follow-up for Blacks versus Whites, adjusting for covariates.

**Results:** Upon study entry, Black and White veterans had similar mean eGFRs (50-51 mL/min/1.73 m<sup>2</sup>). However, age distribution at incident CKD differed, with 4% of White veterans being aged 18-55 years, 17% aged 56-65, 29% aged 66-75, and 50% aged 76-90, in contrast to 20%, 32%, 24% and 24% respectively in Black veterans. In the overall cohort, the adjusted risk of KF was 30% greater in Black than White veterans (Table), consistent with a recent report. This greater risk of KF was consistently seen in the younger age groups  $\leq 75$  years (31%, 36% and 26% greater risk, respectively). In the overall cohort, after adjusting for major confounding of age, along with sex, clinical factors, and comorbidities, Blacks had similar risk of death as White peers; however, this depended on age (Table).

**Conclusions:** The relative risk of KF and death comparing Black and White patients depends on age, which warrants greater understanding of the underlying mechanisms.

**Funding:** NIDDK Support

Adjusted hazard ratios (95% CIs) of CKD outcomes for Black versus White veterans by age group

	Adjusted hazard ratio (95% CI and p value) of kidney failure		Adjusted hazard ratio (95% CI and p value) of death	
-Whole cohort	1.30 (1.24-1.37)	<0.0001	1.01 (0.99-1.03)	0.28
Age 18-55	1.34 (1.20-1.44)	<0.0001	0.82 (0.77-0.87)	<0.0001
Age 56-65	1.36 (1.27-1.46)	<0.0001	0.90 (0.87-0.94)	<0.0001
Age 66-75	1.26 (1.13-1.40)	<0.0001	1.01 (0.97-1.04)	0.74
Age 76-90	0.97 (0.81-1.15)	0.71	1.04 (1.01-1.07)	0.008

SA-PO925

Gender-Specific Risk of Atherosclerotic and Non-Atherosclerotic Cardiovascular Events in CKD

Anne-Laure Faucon,<sup>1,2</sup> Oriane Lambert,<sup>1</sup> Natalia Alencar de Pinho,<sup>1</sup> Carole Ayav,<sup>10</sup> Christian Combe,<sup>8</sup> Denis Fouque,<sup>4,5</sup> Christian Jacquelinet,<sup>9,1</sup> Maurice Laville,<sup>4,5</sup> Sophie Liabeuf,<sup>6</sup> Roberto Pecoits-Filho,<sup>7</sup> Ziad Massy,<sup>11,1</sup> Nicolas Mansencal,<sup>3,1</sup> Benedicte Stengel.<sup>1,2</sup> <sup>1</sup>CKD-REIN study group <sup>1</sup>Centre de Recherche en Epidemiologie et Sante des Populations, Villejuif, France; <sup>2</sup>Universite Paris-Saclay, Villejuif, France; <sup>3</sup>Department of Cardiology, Hopital Ambroise Pare, Boulogne Billancourt, France; <sup>4</sup>Department of Nephrology, CHU Lyon Sud, Lyon, France; <sup>5</sup>Universite Claude Bernard Lyon 1, Lyon, France; <sup>6</sup>Centre Hospitalier Universitaire Amiens-Picardie, Amiens, France; <sup>7</sup>Arbor Research Collaborative for Health, Ann Arbor, MI; <sup>8</sup>Centre Hospitalier Universitaire de Bordeaux Groupe hospitalier Pellegrin, Bordeaux, France; <sup>9</sup>Agence de la biomedecine, La Plaine Saint-Denis, France; <sup>10</sup>Centre hospitalier regional universitaire de Nancy, Nancy, France; <sup>11</sup>Department of Nephrology, Hopital Ambroise Pare, Boulogne-Billancourt, France.

**Background:** The excess risk of atherosclerotic cardiovascular disease (CVD) in men vs women is well-known in the general population. CKD increases the risks of both atherosclerotic and non-atherosclerotic CVD (ACVD, N-ACVD), but gender-related differences in risk by CVD type are poorly documented.

**Methods:** Among 3033 non-dialysis CKD patients included in the CKD-REIN Cohort (65% men; 67 years; eGFR 33 mL/min/1.73m<sup>2</sup>), we reviewed all hospitalization and death reports for CV events. Using criteria from the Cardiovascular and Stroke Endpoint Definitions for Clinical Trials, these were classified into fatal and non-fatal ACVD (coronary, cerebral, lower limb artery diseases) and N-ACVD (heart failure, atrial fibrillation). Cause-specific Cox models were used to estimate adjusted hazard ratios for CV death, ACVD and N-ACVD according to gender.

**Results:** At baseline, the prevalence of ACVD was higher in men (46%) than in women (28%), and slightly higher for N-ACVD (33% vs 27%). During a median follow-up of 4.6[IQR 2.8;5.0] years, 98 (5.0%) men and 43 (4.1%) women died from CVD. The crude risk for ACVD was significantly higher in men than in women, but not that for N-ACVD events and CV death (Figure). Kidney function was more strongly associated with N-ACVD than with ACVD, similarly in both genders. After adjusting for age, CV risk factors, and kidney function, the excess risk of ACVD associated with men was on the borderline of significance, HR: 1.33[1.00;1.77]; there was none for CV death, 0.93[0.58;1.50] and N-ACVD, 0.92[0.71;1.20].

**Conclusions:** In CKD patients, the burden of ACVD is higher in men than in women, and largely explained by their higher prevalence of CV risk factors. In contrast, the risk of N-ACVD appears to be similar in both genders and closely associated with kidney function, suggesting a more prominent role of CKD specific risk factors including volume disorders and uremic toxins.

Cumulative incidence of cardiovascular events, according to gender

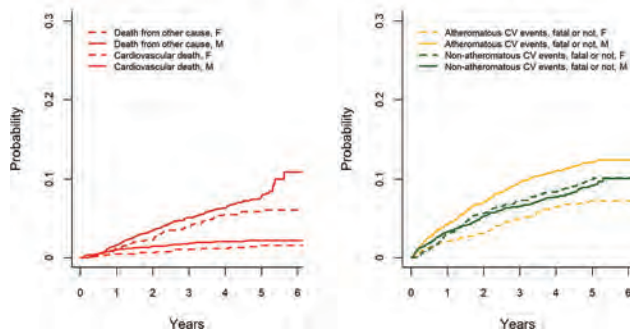

SA-PO926

Association of suPAR, Galectin-3, and ST2 With CKD Progression in Heart Failure With Reduced Ejection Fraction

Bethany A. Roehm, Jonathan Gordon, Meredith C. McAdams, Pin Xu, Justin Grodin, Susan Hedayati. *The University of Texas Southwestern Medical Center, Dallas, TX.*

**Background:** Patients with heart failure with reduced ejection fraction (HFrEF) are at risk for CKD. Elevated levels of the circulating biomarkers soluble urokinase plasminogen activator receptor (suPAR), Galectin-3, and soluble suppression of tumorigenicity 2 (ST2) have been associated with a greater risk of CKD progression and mortality. However, little is known about the predictive value of these biomarkers in a population with HFrEF and kidney disease.

**Methods:** We aimed to determine whether these biomarkers could be used to predict decline in eGFR in HFrEF and whether they are associated with mortality using a joint longitudinal and cox regression model to account for competing risks of ventricular assist device (VAD) implantation and heart transplantation (OHT). We included 310 participants from the Registry Evaluation of Vital Information for Ventricular Assist Devices in Ambulatory Life with baseline biomarkers and repeated eGFR measures, followed for 2 years. The primary outcome was change in creatinine-based eGFR, adjusted for age, sex, race, diabetes mellitus, and NYHA class. Secondary outcome was mortality, adjusted for the same covariates and change in eGFR.

**Results:** Mean age was 59 years. Median eGFR was 60 ml/min/1.73m<sup>2</sup>. Forty-five participants died, 33 received VAD, and 25 received OHT. Higher baseline plasma suPAR ( $\beta$  coefficient, -0.22  $\sqrt{(\text{ml}/\text{min}/1.73\text{m}^2)$ ;  $P < 0.001$ ), Galectin-3 (-0.02  $\sqrt{(\text{ml}/\text{min}/1.73\text{m}^2)$ ;  $P = 0.012$ ), and ST2 (-0.01  $\sqrt{(\text{ml}/\text{min}/1.73\text{m}^2)$ ;  $P < 0.001$ ) were associated with a decline in eGFR. Only ST2 (HR 1.02 per ng/mL increase;  $P < 0.001$ ) was associated with mortality (Figure).

**Conclusions:** Higher baseline suPAR, Galectin-3, and ST2 were associated with a decrease in eGFR in patients with HFrEF. Only ST2 was associated with increased mortality. These biomarkers may provide prognostic value with regards to kidney disease in HFrEF and may help guide candidacy for potential advanced heart failure therapies.

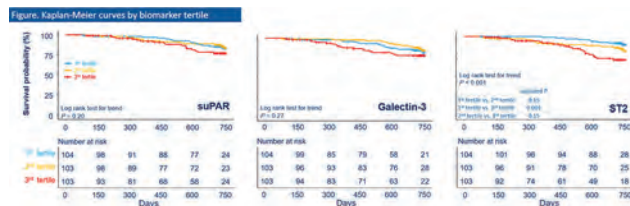

SA-PO927

Influence of Urine Creatinine Concentration on the Prognostic Value of Proteinuria for Major Adverse Cardiovascular Events in Patients With CKD: Findings From the KNOW-CKD Study

Yun Jung Oh,<sup>1</sup> Kook-Hwan Oh,<sup>2</sup> Ji Yong Jung,<sup>3</sup> *H Plus Yangji Hospital, Seoul, Republic of Korea;* <sup>2</sup>*Seoul National University College of Medicine, Seoul, Republic of Korea;* <sup>3</sup>*Gachon University Gil Medical Center, Incheon, Incheon, Republic of Korea.*

**Background:** Proteinuria is typically quantified according to the spot urine protein-creatinine ratio (UPCR) and an association with cardiovascular events has not been thoroughly investigated in chronic kidney disease (CKD) patients. We investigated whether the severity of proteinuria assessed by spot UPCR is associated with an increased risk for cardiovascular outcomes in the CKD population, and whether the relationship is influenced by urine creatinine concentration.

**Methods:** We analyzed 1,746 patients enrolled as part of The KoreaN cohort study for Outcome in patients With Chronic Kidney Disease (KNOW-CKD). Multivariable Cox proportional hazard analysis was performed to evaluate models with proteinuria as a predictor of renal events and extended major adverse cardiovascular events (eMACes).

**Results:** Risk for renal events was significantly associated with proteinuria across all eGFR and UPCR categories. By contrast, risk for eMACes increased significantly with UPCR in patients with eGFR  $\geq 60$  mL/min/1.73 m<sup>2</sup> (hazard ratio [HR] = 2.051; 95% confidence interval [CI] = 1.359–3.096;  $P = 0.001$ ), but not in patients with eGFR  $< 60$  mL/min/1.73 m<sup>2</sup> (HR = 1.083; 95% CI = 0.914–1.283;  $P = 0.358$ ). However, in those with the lower eGFR, risk for eMACes increased significantly with UPCR in participants with urine creatinine concentration  $\geq 95$  mg/dL (HR = 1.480; 95% CI = 1.045-2.097;  $P = 0.027$ ).

**Conclusions:** In non-dialysis CKD patients, the prognostic value of UPCR for eMACes is weakened in patients with reduced eGFR levels, for whom it has prognostic significance only in patients with high urine creatinine concentration.

SA-PO928

Non-Alcoholic Fatty Liver Disease (NAFLD) Diagnosed by Bioimpedance (BIA) and Heart Failure With Preserved Ejection Fraction (HFpEF) in CKD Stages 1-5 ND

Secundino Cigarrán Guldri,<sup>1</sup> Jose Lomban,<sup>2</sup> Luis E. Pérez Casares,<sup>2</sup> Ana maria Sanjurjo amado,<sup>1</sup> Eva P. Varela,<sup>1</sup> Lucía Grela,<sup>3</sup> Juan Latorre,<sup>3</sup> Jesus Calvino,<sup>4</sup> <sup>1</sup>*Nephrology Hospital Publico Da Mariña, Burela, Spain;* <sup>2</sup>*Cardiology Hospital Publico Da Mariña, Burela, Spain;* <sup>3</sup>*Renal Research Unit. Hospital Publico Da Mariña, Burela, Spain;* <sup>4</sup>*Nephrology Hospital Lucus Augusti, Lugo, Spain.*

**Background:** NAFLD, the hepatic outcome of metabolic abnormalities such as obesity, insulin resistance or T2DM and dyslipidemia, affects about 25% of the general population worldwide and is associated with an increased incidence of CVD, including impaired cardiac structure and function, endothelial dysfunction and early carotid atherosclerosis. A new tool derived from bioimpedance has emerged to identify NAFLD in the four stages based on the ratio of fat/muscle. The aim of this cross-sectional study is to assess the influence of NAFLD diagnosed by BIA compared to ultrasound in CKD pts with HFpEF.

**Methods:** 219 pts were included with GFR 44.22  $\pm$  12.9 60 ml/min, UACR 4419.19  $\pm$  941.25 mg/gr crea.26% women, Age mean 73.14  $\pm$  12.2 yo, 90.4% obese and 50.2% diabetic. BIA (Maltron, London) was performed using the manufacturer software based on the fat/muscle ratio, and echocardiographic HF was performed to determine subclinical left ventricular (LV) systolic dysfunction was defined using values of absolute peak global longitudinal strain (GLS). Analytical tests performed to assess liver function, GFR-EPI and UACR. AGEs by autofluorescence were read by (DiagnOtics, Groningen, Netherlands), and vascular Age was obtained from the Koetsier equation. The concordance between BIA & Liver echography was established in 195 pts with correlation of 96% for healthy and 98% for NAFLD. Data were processed with SPSS 27. A "p value  $< 0.05$  was considered statistically significant.

**Results:** Prevalence of NAFLD was: healthy 9.6%, Grade 1 10.5%, Grade 2 11%, Grade 3 18.7%, Grade 4 50.2%. NAFLD had higher LV filling pressure (E/e' ratio: 11.37  $\pm$  7.01 vs 10.8  $\pm$  3.9,  $p < 0.001$ ) and worse absolute GLS (-13.69  $\pm$  4.0% vs -14.85  $\pm$  5.44%,  $p < 0.001$ ) than non-NAFLD. When adjusted for HF risk factors, diabetes, carotid atheromatous or body mass index, NAFLD remained associated with subclinical myocardial remodelling and dysfunction ( $P < 0.01$ ).

**Conclusions:** NAFLD prevalence in CKD pts is 50% and is independently associated with subclinical myocardial remodelling and dysfunction. It provides further insight into a link between NAFLD and HF in CKD pts. BIA is a noninvasive, economic, non-observer tool and of easy use.

**Funding:** Government Support - Non-U.S.

SA-PO929

High-Density Lipoprotein Lipidomics and Risk of Mortality in CKD

Benjamin Lidgard,<sup>1</sup> Andrew N. Hoofnagle,<sup>1</sup> Leila R. Zelnick,<sup>1</sup> Bryan R. Kestenbaum,<sup>1</sup> Ian H. de Boer,<sup>1</sup> Cassianne Robinson-Cohen,<sup>2</sup> Amanda M. Fretts,<sup>1</sup> Rozenn Lemaitre,<sup>1</sup> Nisha Bansal.<sup>1</sup> <sup>1</sup>University of Washington, Seattle, WA; <sup>2</sup>Vanderbilt University Medical Center, Nashville, TN.

**Background:** Patients with CKD are at higher risk for mortality compared to the general population. Abnormalities in the structure and function of high-density lipoprotein (HDL) may contribute to this increased risk. We isolated HDL and utilized targeted lipidomics to identify its ceramide, sphingomyelin, and phosphatidylcholine components in participants with CKD and examined adjusted associations between these lipids and mortality.

**Methods:** We studied 498 participants with CKD from the Seattle Kidney Study. In each participant, HDL was isolated from serum, and targeted lipidomics were used to identify levels of various ceramides, sphingomyelins, and phosphatidylcholines composing HDL. We evaluated the associations between each lipid and mortality using Cox regression adjusted for potential confounders, accounting for multiple comparisons at a false discovery rate of 5%.

**Results:** Over a median (IQR) follow-up time of 5.9 (3.4, 8.9) years, there were 168 deaths. After adjustment, higher HDL composition of ceramide 24:2, glucosylceramide 16:0, and sphingomyelin 16:0 were significantly associated with death (HR per standard deviation greater lipid concentration, 95% CI; 1.31, 1.14-1.51; 1.25, 1.08-1.46; and 1.22, 1.07-1.40; respectively) (Figure).

**Conclusions:** After adjustment, higher HDL concentrations of ceramide 24:2, glucosylceramide 16:0, and sphingomyelin 16:0 were significantly associated with risk of death in patients with CKD. Further studies investigating functional significance for these findings may direct development of future therapies.

**Funding:** NIDDK Support

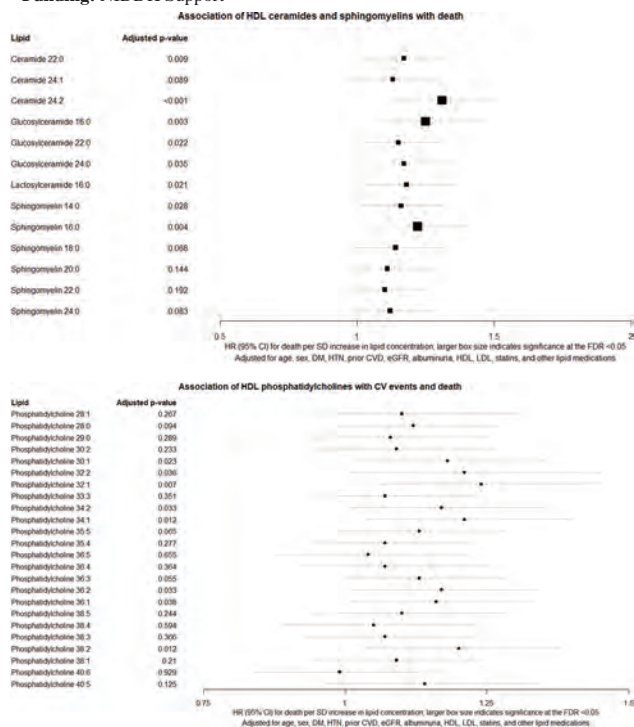

SA-PO930

Metabolomics Identifies New Markers of Tubular Secretory Clearance

Michael L. Granda,<sup>1,2</sup> David K. Prince,<sup>1,2</sup> Oliver Fiehn,<sup>4</sup> Yan Chen,<sup>3</sup> Andrew N. Hoofnagle,<sup>1</sup> Bryan R. Kestenbaum.<sup>1,2</sup> <sup>1</sup>University of Washington, Seattle, WA; <sup>2</sup>Kidney Research Institute, Seattle, WA; <sup>3</sup>Analysis Group Inc, Los Angeles, CA; <sup>4</sup>University of California Davis, Davis, CA.

**Background:** The proximal tubules eliminate protein-bound solutes and drugs via secretion, an energy dependent process that differs from glomerular filtration. Estimation of secretory clearance remains limited to research settings. We used metabolomic profiling to identify potential solutes that could serve as reliable markers of secretory clearance.

**Methods:** We quantified 528 small molecular solutes in plasma and timed urine from 50 people in a kidney pharmacokinetic study. We compared the kidney clearance of candidate solutes with the clearance of administered IV furosemide, an avidly secreted minimally filtered drug. We identified solutes favoring secretory clearance over GFR based on regressions of  $-\log_{10}(p\text{-values})$  for joint associations with furosemide and iohexol clearance. We further explored the prediction of secretory clearance by transformed plasma measurements alone.

**Results:** Mean age was 56 ±13 years; 32% were women. A total of 63 solutes met Bonferroni corrected significance for the association with furosemide clearance (Fig.1). Several solutes demonstrated preferential associations (>90<sup>th</sup> percentile) with furosemide clearance over GFR. Transformed plasma measurements of 4 solutes were also associated with kidney furosemide clearance in the absence of concomitant urine measurements: 2-[(4-aminobenzoyl) amino]acetic acid, 3'-sialyllactose, galactonic acid, 1,4-cyclohexanedicarboxylic acid.

**Conclusions:** We identified endogenous solutes that demonstrate properties for potential use as markers of tubular secretory clearance.

**Funding:** NIDDK Support

Figure 1: Association of solute kidney clearances with furosemide clearance and GFR

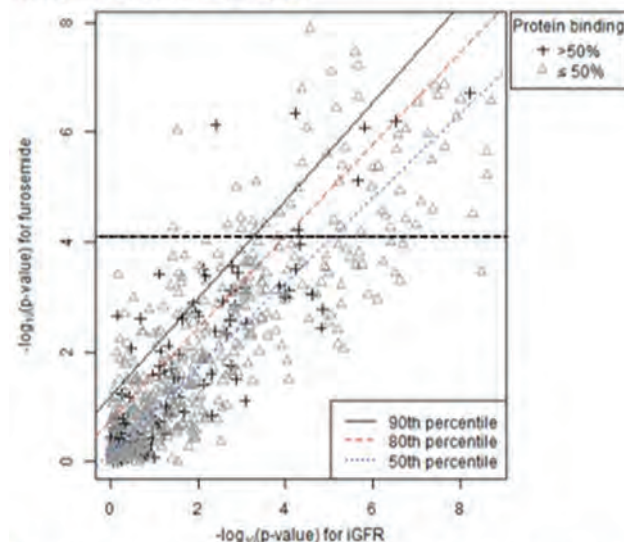

Each point represents an individual solute. Association with furosemide clearance plotted against GFR (by iohexol disappearance). Solute above Bonferroni threshold (horizontal dashed line) were significant. Diagonal lines represent quantile regression between iGFR and furosemide clearance.

Table 1: Solute significantly associated with furosemide clearance and iGFR, favoring furosemide clearance at 90<sup>th</sup> percentile

Compound	$-\log(p)$ : Furosemide	$-\log(p)$ : iGFR	Protein Binding (%)	CL <sub>r</sub> -to-CrCl Ratio
L-Homocitrulline	7.9	4.6	11	3.0
<b>2-[(4-Aminobenzoyl)amino]acetic acid</b>	<b>7.5</b>	<b>5.6</b>	<b>19</b>	<b>10.9</b>
(2R)-3-Hydroxyisoalloxarolcarbitine	7.2	5.7	21	3.0
<b>3'-Sialyllactose</b>	<b>7.1</b>	<b>5.0</b>	<b>21</b>	<b>5.7</b>
Galactonic acid	6.6	5.7	16	0.8
<b>1,4-Cyclohexanedicarboxylic acid</b>	<b>6.4</b>	<b>5.2</b>	<b>15</b>	<b>2.4</b>
Gentisic acid	6.3	4.2	64	2.3
Inosine	6.1	4.5	18	1.0
Ribose-5-phosphate	5.5	4.4	7	1.9

Solute exceeding 90<sup>th</sup> percentile in Figure 1, favoring furosemide clearance over iGFR. Bolded = Plasma levels alone without urine measurement were additionally significantly associated with furosemide clearance

SA-PO931

Metabolomics of Uremic Symptoms in CKD

Kendra E. Wulczyn,<sup>1</sup> Anand Srivastava,<sup>2</sup> Jiang He,<sup>3</sup> Tanika Kelly,<sup>4</sup> Ana C. Ricardo,<sup>5</sup> Vallabh O. Shah,<sup>6</sup> Robert G. Nelson,<sup>7</sup> Chi-yuan Hsu,<sup>8</sup> Amanda H. Anderson,<sup>4</sup> Michelle Denburg,<sup>9</sup> Vasani S. Ramachandran,<sup>10</sup> Harold I. Feldman,<sup>11</sup> Clary B. Clish,<sup>12</sup> Tianqi Ouyang,<sup>1</sup> Paul L. Kimmel,<sup>14</sup> Hernan Rincon-Choles,<sup>15</sup> Rupal Mehta,<sup>2</sup> Tariq Shafi,<sup>13</sup> Eugene P. Rhee,<sup>1</sup> Sahir Kalim.<sup>1</sup> CKD Biomarkers Consortium <sup>1</sup>Massachusetts General Hospital, Boston, MA; <sup>2</sup>Northwestern University Feinberg School of Medicine, Chicago, IL; <sup>3</sup>Tulane University School of Public Health and Tropical Medicine, New Orleans, LA; <sup>4</sup>Tulane University, New Orleans, LA; <sup>5</sup>University of Illinois Chicago, Chicago, IL; <sup>6</sup>University of New Mexico Health Sciences Center, Albuquerque, NM; <sup>7</sup>National Institutes of Health, Bethesda, MD; <sup>8</sup>University of California San Francisco, San Francisco, CA; <sup>9</sup>The Children's Hospital of Philadelphia, Philadelphia, PA; <sup>10</sup>Boston University School of Medicine, Boston, MA; <sup>11</sup>University of Pennsylvania, Philadelphia, PA; <sup>12</sup>Broad Institute, Cambridge, MA; <sup>13</sup>The University of Mississippi Medical Center, Jackson, MS; <sup>14</sup>National Institute of Diabetes and Digestive and Kidney Diseases, Bethesda, MD; <sup>15</sup>Cleveland Clinic, Cleveland, OH.

**Background:** The disrupted metabolic pathways causing uremic symptoms are not known. We utilized untargeted metabolomics to identify potential metabolite markers of uremic symptoms in patients with CKD.

**Methods:** We measured 540 plasma metabolites in 1,766 randomly selected CRIC Study participants at the Year-1 visit and examined their association with uremic symptoms, assessed concurrently using the KDQOL-36 instrument. Metabolites significantly associated with symptoms were identified in cross-sectional analyses using multivariable adjusted linear regression with Bonferroni correction. Then, a parsimonious metabolite profile for each symptom was investigated using LASSO regression.

**Results:** The mean eGFR of participants was 42 mL/min/1.73 m<sup>2</sup>. The most prevalent symptoms were pain (56%), fatigue (54%), paresthesia (46%), and pruritus (45%); nausea (29%) and anorexia (22%) were less common. Regression models identified several metabolites significantly associated with uremic symptoms (Table). Only xenobiotic metabolites were significantly associated with fatigue and paresthesia in both regression models. Notably, higher levels of dimethylguanidino valerate, a metabolite associated with cardiovascular risk, was associated with increased pruritus and nausea severity, and higher levels of N4-acetylcysteine, a potential uremic toxin, was associated with increased anorexia and pain.

**Conclusions:** Metabolomics may advance our understanding of the biologic pathways contributing to uremic symptoms. Results from this hypothesis-generating study identify metabolites that may contribute to symptoms and warrant further investigation.

**Funding:** NIDDK Support

Symptom	Linear regression*		Linear regression and LASSO		Least absolute shrinkage and selection operator (LASSO) <sup>†</sup>	
	Metabolite	β (+/-)	Metabolite	β (+/-)	Metabolite	β (+/-)
Fatigue	Acetaminophen	+	Acetaminophen glucuronide	*	Biliverdin	-
					Dimethylguanidino valerate	+
					Sucrose/lactose/trehalose	*
					Threitol	+
					C36:3 PE plasmalogen	-
Anorexia	C5:1 carnitine	-	Pseudouridine	+	Valine	-
	Creatine	-	Uridine	-		
	C38:7 PE plasmalogen	-	N-acetylaspartic acid	+		
	Uracil	-	N4-acetyltyrosine	*		
	C-glycosyltryptophan	+	Diacylglycerol	*		
Pruritus	Salicylate	-	Dimethylguanidino valerate	-	C-glycosyltryptophan	+
	C-glycosyltryptophan	+	Piperine	-	C34:2 PE plasmalogen	-
			C50:4 triacylglycerols	+	Tryptophan	+
			Dimethylguanidino valerate	+	Sucrose/lactose/trehalose	+
			N-acetylaspartic acid	+		
Paresthesia			Gabapentin	*	Hydroxyproline	+
					Biliverdin	-
					Dimethylguanidino valerate	+
					Glucuronate	+
					Sucrose/lactose/trehalose	+
Pain	C16:0 LPE	+	C34:2 phosphatidylcholines	-	C18:1 sphingomyelin	+
	Acetaminophen	+	3-(N-acetyl-L-cysteinyl-S-yl) acetaminophen	+	Asparagine	-
	Pseudouridine	+	Acetaminophen glucuronide	+		
			Gabapentin	*		
			N4-acetyltyrosine	+		
		Indole-3-propionamide	-			

Direction of the association between metabolite levels and symptom severity scores from regression models are shown for each metabolite. The middle column identifies metabolites that were selected by both multivariable adjusted linear regression models and LASSO regression. Higher scores on the KDQOL-36 indicate worse symptom severity. A positive coefficient indicates that higher metabolite levels are associated with worse symptom severity.  
\*Multivariable models were adjusted for age, sex, race, eGFR, urine protein-to-creatinine ratio (<0.2 g/gCr, 0.2-1 g/gCr, >1 g/gCr), body mass index, hypertension, current smoking, and study site.  
<sup>†</sup>A single penalty (lambda) for LASSO regression was computed based on an iterative formula. Coefficients, including eGFR, were not forced into the models.  
Abbreviations: PE, phosphatidylethanolamine; LPE, lysophosphatidylethanolamine

SA-PO932

The Association Between TMAO, CMPF, and Clinical Outcomes in Advanced CKD: Results From the EQUAL Study

Lu Dai,<sup>1</sup> Ziad Massy,<sup>2</sup> Peter Stenvinkel,<sup>1</sup> Nicholas C. Chesnaye,<sup>3</sup> Islam A. Larabi,<sup>4</sup> Jean-claude Alvarez,<sup>4</sup> Fergus Caskey,<sup>5</sup> Claudia Torino,<sup>6</sup> Gaetana Porto,<sup>7</sup> Maciej Szymczak,<sup>8</sup> Magdalena Krajewska,<sup>8</sup> Christiane Drechsler,<sup>9</sup> Christoph Wanner,<sup>9</sup> Kitty J. Jager,<sup>3</sup> Friedo W. Dekker,<sup>3</sup> Pieter Evenepoel,<sup>10</sup> Marie Evans.<sup>1</sup> <sup>1</sup>Karolinska Institutet, Stockholm, Sweden; <sup>2</sup>Centre Hospitalier Universitaire Ambroise Pare, Boulogne-Billancourt, France; <sup>3</sup>Universiteit van Amsterdam, Amsterdam, Netherlands; <sup>4</sup>Universite de Versailles Saint-Quentin-en-Yvelines, Versailles, France; <sup>5</sup>University of Bristol, Bristol, United Kingdom; <sup>6</sup>Universita degli Studi Mediterranea di Reggio Calabria, Reggio Calabria, Italy; <sup>7</sup>Azienda Ospedaliera Bianchi-Melacrino-Morelli, Reggio Calabria, Italy; <sup>8</sup>Uniwersytet Medyczny im Piastow Slaskich we Wroclawiu, Wroclaw, Poland; <sup>9</sup>Universitätsklinikum Würzburg Medizinische Klinik und Poliklinik II Abteilung für Molekulare Innere Medizin, Würzburg, Germany; <sup>10</sup>Katholieke Universiteit Leuven, Leuven, Belgium.

**Background:** Trimethylamine N-oxide (TMAO), a metabolite from red meat and fish consumption, plays a role in promoting cardiovascular events. However, data regarding TMAO and its impact on clinical outcomes are inconclusive, possibly due to its undetermined dietary source. We hypothesized circulating TMAO derived from fish intake might cause less harm compared to red meat by examining the concomitant level of 3-carboxy-4-methyl-5-propyl-2-furanpropionate (CMPF), a known biomarker of fish intake, and investigated the association between TMAO, CMPF and outcomes in CKD.

**Methods:** Patients were recruited from the European QUALITY study on treatment in CKD (EQUAL) among patients (≥65 years) whose eGFR had dropped for the first time to ≤20mL/min/1.73m<sup>2</sup> during last 6 months. The association between TMAO, CMPF and outcomes including all-cause mortality and kidney replacement therapy (KRT) was assessed among 824 patients. Patients were further stratified by median cut-offs of TMAO and CMPF, suggesting high/low red meat and fish intake.

**Results:** Higher TMAO was independently associated with an increased risk of all-cause mortality (multivariable-hazard ratio (HR) 1.41, 95% CI) 1.15-1.74). Higher CMPF was associated with a reduced risk of both all-cause mortality (HR 0.80, 95%CI 0.71-0.89) and KRT (HR 0.83, 95%CI 0.74-0.93), independent of TMAO and other confounders. In comparison to patients with low TMAO and CMPF, patients with low TMAO and high CMPF had reduced risk of all-cause mortality (adjusted HR 0.50, 95% CI 0.33-0.75), and those with high TMAO and high CMPF had a non-significant association with mortality risk (Figure1).

**Conclusions:** High CMPF conferred an independent role in health benefits and might even counteract the unfavorable effect of TMAO on outcomes. Whether higher circulating CMPF are due to fish consumption, and/or CMPF is a protective marker remain to be demonstrated by further studies.

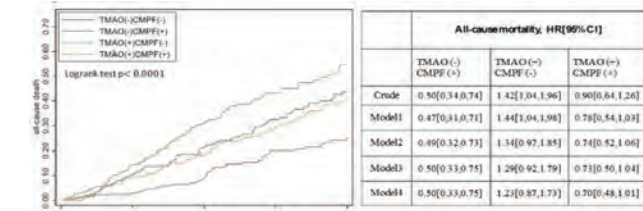

**Figure 1.** Kaplan-Meier estimates for all-cause mortality and cause-specific cox regression models according to TMAO and CMPF median groups. Model1, adjusted for age, sex, country; Model2, model1 + diabetes, pre-existing CVD, Charlson comorbidity index, diastolic blood pressure, systolic blood pressure, malnutrition (SGA<5); Model3, model2 + albumin, phosphate, hemoglobin; Model4, model3 + eGFR

SA-PO933

Indoxyl Sulfate Levels Are a Predictor for Sarcopenia but Myostatin Levels Are an Indicator for Muscle Mass in Patients With CKD

Su mi Lee, Won Suk An. Dong-A University, Busan, Republic of Korea.

**Background:** Serum myostatin and indoxyl sulfate (IS) levels are increased according to renal function decline and are the main mediators of chronic kidney disease (CKD)-related sarcopenia. However, a recent report showed that myostatin levels were increased in balance-trained CKD patients associated with increased lean mass. The aim of this study was to assess the association between serum myostatin and IS levels and sarcopenia in CKD patients. We performed a post-hoc analysis of data extracted from a RECOVERY study (clinicaltrials.gov: NCT03788252).

**Methods:** Baseline data from the RECOVERY study were analyzed in 150 CKD patients (mean CKD-EPI eGFR: 33.8±12.5). A Six-meter gait speed test and handgrip strength (HGS) were assessed. Skeletal muscle index (SMI) was measured by an InBody S10 based on bioelectrical impedance analysis. Low muscle mass was defined as an SMI <7.0 kg/m<sup>2</sup> in men and <5.7 kg/m<sup>2</sup> in women. Sarcopenia was assessed using the Asian Working Group for Sarcopenia 2019. Serum myostatin and IS levels were measured. We classified patients into two groups according to the median value of myostatin: patients with high myostatin levels (≥4.5 ng/mL) and those with low myostatin levels (<4.5 ng/mL). In addition, IS levels were divided into high (≥0.365 pg/mL) and low (<0.365 pg/mL) groups.



**Results:** The proportion of patients with sarcopenia was higher in patients with high IS levels but was lower in patients with high myostatin levels. SMI and HGS were significantly lower in patients with high IS levels but were significantly higher in patients with high myostatin levels. IS levels showed a negative correlation with eGFR, SMI, and HGS but myostatin levels showed a positive correlation with SMI, and HGS. Myostatin/SMI ratio reflected muscle mass was negatively associated with eGFR and was not associated with SMI and HGS. The ROC curve of IS levels for presarcopenia was 0.67 (95% CI, 0.51–0.84;  $P=0.022$ ). The sensitivity and specificity for predicting presarcopenia were 64.7% and 64.4%. Sarcopenia and presarcopenia were independently associated with age and IS levels after adjustment for gender, diabetes mellitus, creatinine, and myostatin/SMI.

**Conclusions:** Serum IS levels are an important predictor for sarcopenia but serum myostatin levels are indicator muscle mass in CKD patients with lower eGFR.

## SA-PO934

### Predicting Renal Function Decline From Readily Available Clinical Variables in Electronic Health Records Using Machine Learning

Roy O. Mathew,<sup>1,2</sup> Brendan E. Odigwe,<sup>4</sup> Sujay D. Paudel,<sup>2</sup> Celestine I. Odigwe,<sup>5</sup> Enrica Fung,<sup>1,2</sup> Sayna Norouzi,<sup>2,6</sup> Sergio Infante,<sup>2,6</sup> Amir Abdi Pour,<sup>2,6</sup> Janani Rangaswami,<sup>3</sup> Homayoun Valafar,<sup>4</sup> <sup>1</sup>Loma Linda VA Health Care System, Loma Linda, CA; <sup>2</sup>Loma Linda University School of Medicine, Loma Linda, CA; <sup>3</sup>The George Washington University School of Medicine and Health Sciences, Washington, DC; <sup>4</sup>University of South Carolina School of Engineering, Columbia, SC; <sup>5</sup>Thomas Hospital, Fairhope, AL; <sup>6</sup>Loma Linda University Health, Loma Linda, CA.

**Background:** This analysis sought to implement machine learning (ML) algorithms to incorporate readily available clinical variables from a nationally representative administrative dataset to predict future renal function decline.

**Methods:** All data retrieved from the Veterans Affairs (VA) corporate data warehouse. The outcome was the rate of estimated glomerular filtration rate (eGFR) decline over 3 years. An Artificial Neural Network (ANN) was developed as our machine learning technique of choice and was implemented utilizing the *neuralnet* package in R. A total of 183,054 unique veterans with baseline eGFR between 15 and 60 ml/min/1.73m<sup>2</sup> with follow up serum creatinine annually for 3 years following the index creatinine value were included. Training cohort consisted of 75% of the total population, leaving 25% for ML model testing. A total of 101 variables were initially available. For the final training cohort, 74 variables were included (after excluding outcomes, dates, and identifiers). Loma Linda VA IRB provided expedited review approval. For experimentation, we created a feed-forward Neural network with 2 hidden layers, having 32 and 16 neurons in the first and second hidden layers, respectively.

**Results:** Of the included patients, 81% had CKD G3a, 15% G3b, and 4% with G4. The optimal neural network architecture produced the prediction of the 3-year decline in eGFR in the testing cohort with mean square error of 0.04, and correlation coefficient of 0.998 (Figure).

**Conclusions:** ANNs accurately predicted the rate of progression. Such ML techniques can accurately identify high-risk patients for intensive risk reduction and/or targeted research efforts for novel interventions.

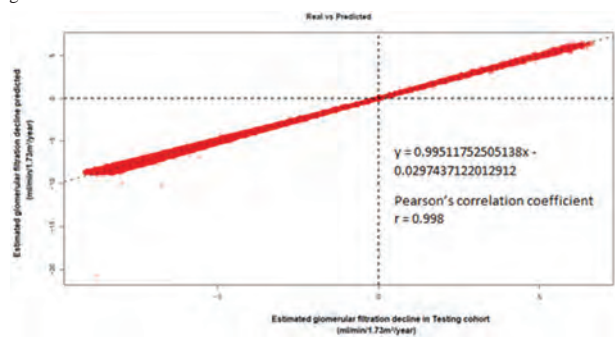

Predicted vs actual rate of eGFR decline using feed forward neural network from administrative health data.

## SA-PO935

### Development and Validation of Deep Learning Algorithm for Evaluating Kidney Function Based on Electrocardiogram

Dong Hee Lee, Jung Nam An, Sungmin Kim, Jwa-kyung Kim, Sung Gyun Kim. *Hallym University Sacred Heart Hospital, Anyang, Gyeonggi-do, Republic of Korea.*

**Background:** Chronic kidney disease (CKD) is a chronic progressive disease; however, there are no symptoms accompanying deterioration of kidney function, so evaluation of kidney function is possible only through periodic blood tests. Therefore, we aimed to detect kidney function through a deep learning-based model using an electrocardiogram (ECG) that is non-invasive and can be quickly measured.

**Methods:** Among patients who underwent an ECG at least once from 2006 to 2020, patients with blood test results within 24 hours were included. All ECGs were acquired using a GE ECG machine and the raw data (XML datatype) were stored using the MUSE data management system. For model training and evaluation, the ECG-CKD-EPI eGFR pair was separated into train, validation, and test set. We trained two binary classification model using a Convolutional Neural Network. The model input was a standard 10-second, 12-lead ECG and the output being the likelihood of the ECG being from a patient with CKD.

**Results:** In a total of 299,431 patients, 324,875 ECG-eGFR pairs were analyzed, of which 285,031 cases were in the train set, 13,805 cases in the validation set, and 26,039 cases in the test set. For the detection of eGFR below the 60 mL/min, the sensitivity and specificity of deep learning model were 85.2% and 72.9%; and for eGFR below the 30 mL/min, they were 87.6% and 75.8% in test set. These performances were calculated by using the operating point at Youden J statistics of validation set.

**Conclusions:** The deep learning model using the 12-lead ECG waveform detected CKD based on CKD-EPI eGFR with high accuracy. In the case of advanced CKD, the diagnostic predictive power is more increased. These results suggest the clinical applicability of AI software for diagnosing kidney function using ECG.

## SA-PO936

### Charlson Comorbidity Index as a Predictor of Mortality in ESRD Inpatients in Rural America: Evidence From a Nationally Representative Sample

Emmanuel O. Adeyemi. *Saint Peter's University Hospital, New Brunswick, NJ.*

**Background:** End Stage Renal Disease (ESRD) has been associated with an increase in all-cause mortality among patients. The accumulation of comorbidities appears to be a contributing factor. This study set out to identify the effect of comorbidity severity among ESRD inpatients in rural America.

**Methods:** This is a cross-sectional study that used the 2016-2018 Nationwide Inpatient Survey (NIS) from the Healthcare Cost and Utilization Project (HCUP). The study included patients aged 18yrs or more with ESRD hospitalized in rural hospitals in America. Independent variables used from the survey include age, gender, race, type of admission (elective vs non-elective), type of hospital control, expected primary payer, and severity of comorbidities. The dependent variable was death during hospitalization. All analyses were weighted. Univariate (frequencies), bivariate (Chi-square) and logistic regression (stepwise selection with P-value for entry of a variable and stay of a variable put at  $\leq 0.05$ ) analyses were done using SAS studio.

**Results:** There were 144,575 weighted ESRD hospitalizations. 5.0% of hospitalizations died. Gender was the only non-significant variable on bivariate analysis ( $P=0.6577$ ), hence, gender was not considered in our regression model. On multivariable logistic regression analysis that adjusted for age, race, type of admission, type of hospital control, and expected primary payer; ESRD patients with severe comorbidities had 40% (AOR: 1.40, 95% CI: 1.26-1.54) more odds of mortality compared to those with mild comorbidities and those with moderate comorbidities had 22% (AOR: 1.22 95% CI: 1.10-1.36) more odds of mortality compared to those with mild comorbidities. The area under the curve (AUC) for the model was 62%.

**Conclusions:** Severity of comorbidities is a modifiable predictor of ESRD inpatient mortality from this study. This suggests that strategies aimed at preventing accumulation of comorbidities might help reduce ESRD inpatient mortality in rural America.

## SA-PO937

### Higher Number of Kidney Cysts Predicts Progressive CKD After Radical Nephrectomy Independent of Kidney Function

Moldovan Sabov, Aleksandar Denic, Aidan F. Mullan, Timothy L. Kline, Andrew D. Rule. *Mayo Clinic Minnesota, Rochester, MN.*

**Background:** Simple kidney cysts are common and usually considered of limited clinical relevance. They are associated with older age and lower glomerular filtration rate (GFR), but little is known of their prognostic utility for progressive chronic kidney disease (CKD) or end-stage kidney disease (ESKD).

**Methods:** We studied patients with a pre-surgical CT or MRI imaging who underwent a radical nephrectomy for a tumor between 2000 and 2019 and who had no cancer recurrence at least 4 months after nephrectomy. We reviewed the retained kidney images to characterize the number, size, and location of any parenchymal cysts. Cox models to assess the risk of ESKD defined as dialysis, kidney transplantation, or eGFR <10 ml/min/1.73 m<sup>2</sup> or CKD progression (ESKD or a 40% decline from postnephrectomy baseline eGFR). Models were adjusted for baseline age, sex, body mass index, hypertension, diabetes, eGFR, proteinuria, and tumor volume.

**Results:** There were 1237 patients (mean age 64 years; postnephrectomy baseline eGFR 48.4 ml/min/1.73 m<sup>2</sup> with 128 progressive CKD events and 26 ESKD events over a median 4.3 years of follow-up. In the cohort, 42% had any kidney cyst and the mean  $\pm$  SD number of cysts was 0.9  $\pm$  1.7 and diameter of largest cyst was 1.9  $\pm$  1.8cm. Higher number of cysts (but not diameter of largest cyst) predicted both CKD progression and ESKD. The risk of both progressive CKD and ESKD was strongest with presence and number of medullary cysts.

**Conclusions:** Detection and number of cysts in the kidney, and in particular the medulla, may be useful imaging biomarker beyond current clinical evaluations for predicting risk of progressive CKD and ESKD.

**Table.** Kidney cysts measures as predictor of CKD progression or ESKD.

	CKD Progression		ESKD	
	HR (95% CI)	P value	HR (95% CI)	P value
Number of any cysts	1.09 (1.00-1.19)	0.04	1.22 (1.06-1.42)	0.007
Number of cortical cysts	1.10 (0.98-1.23)	0.11	1.33 (1.11-1.60)	0.002
Number of medullary cysts	1.44 (1.13-1.83)	0.003	1.82 (1.23-2.70)	0.003
Number of indeterminate cysts	0.99 (0.75-1.32)	0.96	0.20 (0.03-1.40)	0.11
Presence of any cyst	1.04 (0.72-1.50)	0.83	0.84 (0.36-1.93)	0.67
Presence of any cortical cysts	1.11 (0.76-1.63)	0.59	1.25 (0.53-2.93)	0.61
Presence of any medullary cysts	2.03 (1.29-3.20)	0.002	2.76 (1.08-7.06)	0.03
Presence of any indeterminate cysts	0.80 (0.49-1.29)	0.35	0.17 (0.02-1.30)	0.09
Largest cyst diameter	1.02 (0.90-1.15)	0.78	1.00 (0.74-1.31)	0.97

**SA-PO938**

**Outcomes for Patients With Renal AA Amyloidosis Associated With Injection Heroin Use**

Rachel R. Johnson,<sup>1</sup> Anatoly Urisman,<sup>4</sup> Kerry C. Cho,<sup>6</sup> Ramin Sam,<sup>2,5</sup> Sandy W. Wong,<sup>3</sup> *American University of the Caribbean School of Medicine BV, Cupecoy, Sint Maarten (Dutch part); <sup>2</sup>Zuckerberg San Francisco General Hospital and Trauma Center Department of Medicine, San Francisco, CA; <sup>3</sup>University of California San Francisco Department of Medicine, Division of Hematology and Oncology, San Francisco, CA; <sup>4</sup>University of California San Francisco Department of Pathology, San Francisco, CA; <sup>5</sup>University of California San Francisco School of Medicine, San Francisco, CA; <sup>6</sup>University of California San Francisco Department of Medicine, San Francisco, CA.*

**Background:** AA amyloidosis is a rare but serious complication of chronic inflammation. Skin popping is a common practice among heroin users in the western United States and an under-studied cause of renal AA amyloidosis (R-AA). We performed a multicenter retrospective analysis of R-AA due to injection heroin use (IHU) in San Francisco (SF).

**Methods:** Patients with biopsy-proven R-AA were identified at UCSF and SF General Hospital between 1/1/2000 and 6/30/2021 under an IRB-approved study. Only patients with R-AA from IHU were included. Data for these patients including baseline characteristics, renal survival, and overall survival were abstracted from the medical records. Overall survival (OS), renal survival (RS) and time-to-dialysis (TTD) were summarized using Kaplan-Meier methods via GraphPad Prism 9.3.1.

**Results:** Sixty-seven subjects with biopsy-proven R-AA were identified, of which 55 had adequate medical records available to determine the underlying etiology. All R-AA biopsies must have had Congo Red positivity and amyloid typing by SAA positivity or mass spectrometry to be included. Of these 55 cases, 45 (82%) were attributable to IHU. For patients with R-AA due to IHU, the median age was 50 (range 24-70), 9 (20%) were female, 31 (69%) were Caucasian, 40 (89%) were non-Hispanic. At diagnosis, 82% had a history of skin abscess or skin ulceration related to IHU. Eighty-nine percent also had hepatitis C, 24% hepatitis B and 20% HIV. Twelve (27%) patients with R-AA from IHU were dialysis-dependent at the time of diagnosis. Thirty-three patients (73%) were dialysis-independent at diagnosis with a median eGFR of 13 ml/min/1.73m<sup>2</sup> (range 3 - >60) and a median protein/creatinine ratio of 8440 mg/g creat (range 380-48,280). Of these patients, 17 eventually required dialysis. Median RS and TTD for this cohort was 1.9 years and 6.7 weeks respectively. None of the patients who required dialysis came off dialysis. After cessation of IHU, 1 patient received a renal allograft with a renal allograft survival of 6 years. The median OS for patients with R-AA was 2.8 years. Median follow-up was 5.0 years.

**Conclusions:** The leading cause of R-AA in SF is IHS. R-AA patients often have concomitant infections such as hepatitis and HIV. R-AA is associated with high rates of dialysis-dependence and mortality.

**SA-PO939**

**Kappa-Restricted Light Chain Proximal Tubulopathy (LCPT) in Waldenström Macroglobulinemia (WM)**

Yani Zhang,<sup>1</sup> Donghyang Kwon,<sup>2</sup> Michael J. Choi,<sup>2</sup> *MedStar Union Memorial Hospital, Baltimore, MD; <sup>2</sup>MedStar Georgetown University Hospital, Washington, DC.*

**Introduction:** WM is a lymphoproliferative disorder with possible renal involvement from high tumor burden of IgM monoclonal protein or monoclonal gammopathy of renal significance (low tumor burden). LCPT is a rare cause for progressive kidney dysfunction in WM.

**Case Description:** A 62-yo man with CKD 3a from unknown cause and WM diagnosed 2 years ago presented with a serum creatinine of 1.71 mg/dL (1.38 mg/dL 15 months prior). Work up revealed serum albumin 4.8 g/dL, IgM 4,596 mg/dl, free K:L ratio 31, M-spike: 2.5 mg/dL, uric acid 1.7 mg/dL, phosphorus 3.3 mg/dL, LDH 153 u/L, viscosity 2.8, C3 81 mg/dL, UA: 1+ protein, trace glucose (serum glucose 87 mg/dl), pH 7, 0 RBCs or WBCs/HPF. 24-hr urine protein 2,139 mg, urine protein electrophoresis showed albumin 22.6%, and M spike 26.6%. Renal ultrasound unremarkable. Kidney biopsy revealed k-LCPT [Figure]. Serum parameters improved with stable proteinuria after therapy for WM with bortezomib, rituximab and dexamethasone.

**Discussion:** Crystalline k-LCPT is a rare renal presentation of WM in which monoclonal light chain can accumulate in proximal tubular cells when light chain production exceeds proximal tubule reabsorption capacity and lysosomal degradation. Clinicians should consider this disease in WM patients with CKD, sub-nephrotic proteinuria, and evidence of proximal tubulopathy with or without complete Fanconi syndrome.

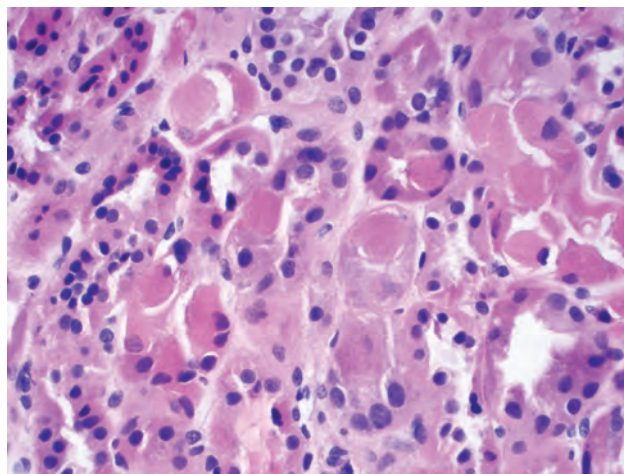

Proximal tubules show eosinophilic amorphous granular material in the cytoplasm and lumen.

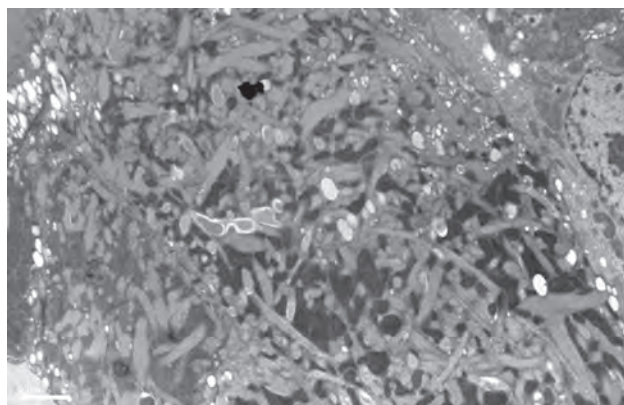

PTC shows intracytoplasmic and membrane-bound crystalline structures with rhomboid shapes.

**SA-PO940**

**Not So Familiar: A Case on Familial Mediterranean Fever**

Ram Sinha, Neha Siddiqui, Robert J. Mathews, Magdalena Szulc. *AtlantiCare Regional Medical Center, Atlantic City, NJ.*

**Introduction:** Familial Mediterranean Fever (FMF) is an autoinflammatory disorder that was thought to be autosomal recessive, however, there is increasing evidence of possible dominant penetrance. FMF is caused by mutations of the MEFV gene and the expression of pyrin. Pyrin is an intracellular pattern recognition receptor that leads to the formation of inflammasome complexes. Pyrin is expressed in several cells including granulocytes, monocytes, and fibroblasts of the synovium and peritoneum. The threshold to activate pyrin inflammasomes is reduced in patients with FMF. Up to ninety percent of patients have their first febrile attack with symptoms including pleural or abdominal pain, arthritis, and skin lesions by the age of 20. Systemic amyloidosis, caused by the deposition of serum amyloid A, was a common complication that affected the kidneys prior to the use of colchicine prophylaxis. This report presents a case of amyloidosis in the setting of FMF.

**Case Description:** We report a case of a 57-year-old white male with known PMHx of hypertension, arthritis on NSAIDs, and medication non-compliance who presented with hypertensive emergency. Patient endorsed no known family history. Patient was deemed to have acute kidney injury versus progression of chronic kidney disease. Urinalysis noted macroscopic hematuria and proteinuria. Renal ultrasound was read as unremarkable. Urine indices were consistent with an intrinsic etiology. The patient continued to have reduced kidney function, hematuria, and proteinuria. The patient was found to be positive for p-ANCA. A renal biopsy was performed and noted A.A. type amyloidosis and significant interstitial fibrosis. The patient denied fevers, abdominal and pleural pain. Upon learning his diagnosis, the patient endorsed a family history of arthritis and what was likely FMF. Patient was subsequently started on colchicine for suppressive therapy.

**Discussion:** Familial Mediterranean Fever is an autoinflammatory disorder that presents in ninety percent of patient by the age of 20. Recognition of the constellation of non-specific symptoms is crucial to the initiation of suppressive therapy to prevent systemic amyloidosis. In our case, the patient presented with renal amyloidosis at a later age and likely lacked febrile attacks due to his chronic NSAID use. The biopsy proved to be instrumental in the diagnosis and initiation of suppressive management.

**SA-PO941**

**Major Adverse Kidney Events in Multidisciplinary CKD Care Compared With Usual Outpatient Care: A Propensity Score Matched Analysis**

**Palita Chittinandana,** Pongsathorn Gojaseni, Anan Chuasuwan, Worawon Chailimpamontree, Anutra Chittinandana. *Bhumibol Adulyadej Hospital, Bangkok, Thailand.*

**Background:** Chronic kidney disease (CKD) causes a public health problem worldwide. Multidisciplinary CKD care (MDC) has been recommended in clinical practice guideline to delay disease progression and minimize complications. However, effectiveness of MDC on major adverse kidney events (MAKE) in CKD patients is still inconclusive.

**Methods:** We conducted a cohort study in patients with CKD stage G3b and 4 who were followed up at Bhumibol Adulyadej Hospital since 2014 to 2020. Propensity score matching by age, sex, CKD staging, diabetes, blood pressure and rate of estimated glomerular filtration rate (eGFR) decline before inclusion between patients in MDC and usual outpatient care (UOC) was done. The primary outcome was MAKE, a composite of cardiovascular or renal mortality, 40% eGFR decline and initiation of long-term kidney replacement therapy.

**Results:** After 1:1 propensity score matching, 822 patients were included. The mean age was 70.9 years, 64% have diabetes. During the mean follow up of 3.3 years, rate of the primary endpoint was lower in MDC group than UOC group (24.1% vs. 38.9%; hazard ratio [HR], 0.66; 95% confidence interval [CI], 0.52 to 0.86;  $P=0.002$ ). The results showed benefit of MDC over UOC in 40% eGFR declined (21.7% vs. 35.0%; HR, 0.67; 95%CI 0.52 to 0.88;  $P=0.004$ ), all-cause mortality (8.5% vs. 19.5%; HR, 0.60; 95%CI 0.40 to 0.90;  $P=0.014$ ), non-cardiovascular death (6.1% vs. 15.1%; HR, 0.56; 95%CI 0.35 to 0.90;  $P=0.015$ ) and hospitalization per year ( $1.0 \pm 1.5$  vs.  $1.6 \pm 2.0$ ;  $P<0.005$ ). According to subgroup analysis, diabetic patients benefit the most from MDC.

**Conclusions:** In a tertiary care hospital, MDC showed benefits over UOC on kidney outcomes in patients with CKD stage G3b and 4. The benefit will be enhanced in diabetes group.

**Funding:** Government Support - Non-U.S.

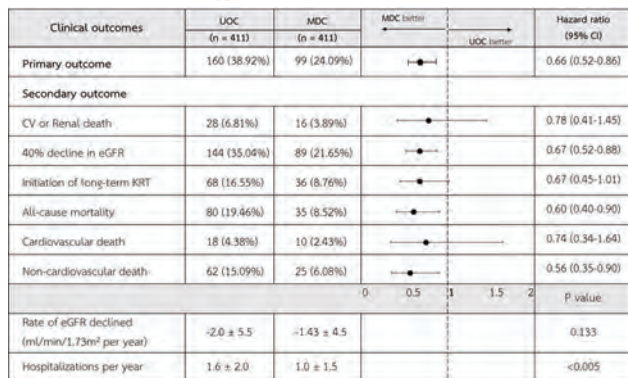

**Figure 1.** Forest plot comparing primary and secondary outcome between MDC and UOC

**SA-PO942**

**Acceptance of Recommendations for SGLT2 Inhibitors and GLP1 Receptor Agonists in a High-Risk CKD Population**

**Melanie R. Weltman,**<sup>1</sup> Manisha Jhamb,<sup>1,2</sup> Jonathan Yabes,<sup>3</sup> Manqi Cai,<sup>4</sup> Thomas D. Nolin,<sup>2,5</sup> Khaled Abdel-Kader.<sup>5,1</sup> *UPMC, Pittsburgh, PA; <sup>2</sup>University of Pittsburgh Renal-Electrolyte Division, Pittsburgh, PA; <sup>3</sup>University of Pittsburgh Department of Medicine, Pittsburgh, PA; <sup>4</sup>University of Pittsburgh Graduate School of Public Health, Pittsburgh, PA; <sup>5</sup>University of Pittsburgh School of Pharmacy, Pittsburgh, PA; <sup>6</sup>Vanderbilt University Medical Center, Nashville, TN.*

**Background:** Delaying or preventing CKD progression and reducing risk of cardiovascular events are priorities in the treatment of patients with CKD. SGLT2 inhibitors and GLP1 receptor agonists have shown kidney and cardiovascular benefit in those with CKD but prescribing of these medications remains low. We evaluated acceptance of recommendations for SGLT2 inhibitors and GLP1 receptor agonists and barriers to prescribing in a group of patients with high-risk CKD from the Kidney CHAMP trial.

**Methods:** The Kidney CHAMP trial is testing whether an electronic health record-based population health management approach improves CKD care. Eligible patients are 18-85 years with CKD, high risk of progression to ESKD, and are not followed

by a nephrologist. Enrolled patients receive nephrologist-led electronic consults and pharmacist-led medication therapy management encounters with recommendations (including use of SGLT2 inhibitors and GLP1 receptor agonists) provided to the primary care provider (PCP) for review at the upcoming office visit, with follow-up encounters every 6 months.

**Results:** Between October 1, 2019 and March 31, 2022, 697 baseline encounters and 709 follow-up encounters were completed. At baseline, 4% and 6% of patients were prescribed an SGLT2 inhibitor or a GLP1 receptor agonist, respectively. 284 recommendations were made for initiation or dose adjustment of an SGLT2 inhibitor in 206 unique patients, and 206 recommendations were made for initiation or dose adjustment of a GLP1 receptor agonist in 141 unique patients. PCPs accepted 26% of recommendations for SGLT2 inhibitors and 30% of recommendations for GLP1 receptor agonists. Commonly documented reasons for not accepting the recommendations were patient refusal, deferring to endocrinology, and cost/insurance coverage limitations.

**Conclusions:** Baseline use and acceptance of recommendations for SGLT2 inhibitors and GLP1 receptor agonists remains poor in our patient population. Reasons for nonacceptance suggest a need for patient and provider-level education related to their benefits, as well as system-level efforts to address medication cost and siloed care.

**Funding:** NIDDK Support

**SA-PO943**

**Patient Perceptions of a CKD Population Health Management Program to Improve Kidney Care**

**Susan M. Devaraj,**<sup>1</sup> Megan E. Hamm,<sup>1</sup> Balchandre N. Kenkre,<sup>1</sup> Flor Cameron,<sup>1</sup> Khaled Abdel-Kader,<sup>2</sup> Manisha Jhamb.<sup>1</sup> *<sup>1</sup>University of Pittsburgh Department of Medicine, Pittsburgh, PA; <sup>2</sup>Vanderbilt University Medical Center, Nashville, TN.*

**Background:** The majority of chronic kidney disease (CKD) patients are managed by primary care providers (PCPs), and novel approaches are needed to improve care and outcomes in these patients. We sought to ascertain patient perceptions of a population health management (PHM) approach to improving CKD care in high-risk patients managed by their PCP.

**Methods:** Patients with high-risk CKD who were receiving PHM intervention in an ongoing randomized control trial involving remote co-management of CKD by a nephrologist, pharmacist led medication reconciliation, and CKD education who had at least one CKD education session were recruited from May 2021-Feb 2022 for this study. Using purposive sampling, patients from three pre-defined strata (racial/ethnic minorities, low socio-economic status, multi-morbidities) were enrolled until thematic saturation was reached. A one-time 30-min phone interview was conducted, and data was analyzed using MAXQDA software.

**Results:** In this preliminary analysis of 30 of 45 patient interviews (mean age 74 years, 47% females, 17% racial/ethnic minorities, 47% low SES, 43% high comorbidity burden), several themes have emerged. First, patients expressed support for a collaborative relationship between their PCP and the nephrologist for co-management of CKD. Secondly, patients expressed poor understanding of the cause or health risks associated with CKD. In fact, some did not even recall receiving education although they had all met with the nurse educator. Thirdly, patients reported receiving diet/fluid education tips and had interest in implementing them, with many reporting a greater understanding of how diet/fluid recommendations related to their kidney health and could be implemented in the context of their personal habits. Finally, most patients affirmed they would recommend the education sessions to other CKD patients.

**Conclusions:** CKD patients who are managed by their PCP have high acceptance of remote co-management by a nephrologist. Patients perceive some aspects of CKD health education to be beneficial, however more effective approaches to communicating risk for CKD development and progression may be needed.

**Funding:** NIDDK Support

**SA-PO944**

**Patient Navigators for CKD and Kidney Failure: A Systematic Review**

**David T. Collister,**<sup>1</sup> Yasmin A. Iman,<sup>2</sup> Clara Bohm,<sup>2</sup> Paul Komenda,<sup>2</sup> Navdeep Tangri.<sup>2</sup> *<sup>1</sup>University of Alberta Faculty of Medicine & Dentistry, Edmonton, AB, Canada; <sup>2</sup>University of Manitoba Max Rady College of Medicine, Winnipeg, MB, Canada.*

**Background:** To what degree and how patient navigators improve clinical outcomes for patients with chronic kidney disease (CKD) and kidney failure is uncertain. We performed a systematic to summarize patient navigator program design, evidence, and implementation in kidney disease.

**Methods:** A search strategy was developed for randomized controlled trials and observational studies that evaluated the impact of navigators on outcomes in the setting of CKD and kidney failure. Articles were identified from various databases. Two reviewers independently screened the articles and identified those which met the inclusion criteria. Data was abstracted from full texts and risk of bias was assessed.

**Results:** After screening a total of 3371 citations, 17 articles met the inclusion criteria including 14 original studies. Navigators came from various healthcare backgrounds including nursing (n=6), social worker (n=2), medical interpreter (n=1), research (n=1) and also included kidney transplant recipients (n=2) and non-medical individuals (n=2). Navigators focused mostly on education (n=9) and support (n=6). Navigators were used for patients with CKD (n=5), peritoneal dialysis (n=2), in-center hemodialysis (n=4), kidney transplantation (n=2) but not home hemodialysis. Navigators improved transplant workup and listing, adherence, peritoneal dialysis utilization and patient knowledge.

**Key: TH - Thursday; FR - Friday; SA - Saturday; OR - Oral; PO - Poster; PUB - Publication Only**

**Underline represents presenting author.**

However, many studies did not show benefits across other outcomes, were at a high risk of bias, and none reported cost effectiveness or patient reported experience measures.

**Conclusions:** Navigators improve some health outcomes for CKD but there is heterogeneity in their structure and function. High-quality randomized controlled trials are needed to evaluate patient navigator program efficacy and cost effectiveness.

#### SA-PO945

##### Where Do Primary Care Physicians Fit in CKD Patient Care?

Meghan Staudt, Denise Foy. *Spherix Global Insights, Exton, PA.*

**Background:** This research examines the management of patients with chronic kidney disease (CKD) who are not on dialysis by primary care physicians (PCPs) and evolving best care practices given the emergence of new treatment options to delay CKD progression.

**Methods:** Patient level data was collected via an online, HIPAA-compliant form during June 2020 as part of an independent, retrospective chart audit. A total of 1,009 CKD non-dialysis patient records were submitted by 207 PCPs.

**Results:** While 87% of PCPs express that they are comfortable treating patients with mild kidney disease (CKD Stages 1-2), the majority are not comfortable managing patients who have progressed to more severe kidney disease (CKD Stages 4-5). Comorbidities and complications that patients have as CKD progresses contribute to this sentiment. Nearly two-thirds of PCPs agree early referral to nephrology results in better outcomes for patients with progressive renal disease; however, the referral often does not occur until patients reach CKD Stage 3, highlighting contradiction in PCP perceptions versus their actions. 75% of PCPs report they are comfortable initiating patients on an SGLT2 inhibitor, a therapy among several others proven to slow the progression of CKD, indicating there is potential to delay referral to nephrology even further. Several factors contribute to the delayed referrals, including 28% of PCPs who believe nephrologists cannot do more than a PCP to manage a patient until their CKD is severe enough to require dialysis, and 32% who believe many patients consider nephrologists as "dialysis doctors" and are reluctant to be referred. Additionally, one-quarter of PCPs say nephrologists have a financial incentive to place patients on dialysis, which further delays referrals. Conversely, 69% of PCPs report they have an excellent relationship with nephrologists when co-managing CKD patients. However, 24% report the wait time for a newly referred patient to see a nephrologist (when not an emergency) is very long. This compares well against rheumatology and dermatology where more than one-half of PCPs report the wait time is very long.

**Conclusions:** Although PCPs recognize the benefit of co-managing CKD patients with nephrologists, barriers to optimal care between physicians do exist. As PCPs adopt new therapies that delay CKD progression, there is potential for their CKD patient pool to expand and further delay referrals to nephrology.

#### SA-PO946

##### Feasibility of a Remotely Delivered Trial Testing an Online Self-Management Programme for People Living With CKD

Courtney J. Lightfoot,<sup>1,2</sup> Thomas J. Wilkinson,<sup>1,3</sup> Noemi Vadasz,<sup>1,2</sup> Alice C. Smith,<sup>1,2</sup> <sup>1</sup>University of Leicester, Leicester, United Kingdom; <sup>2</sup>Leicester NIHR Biomedical Research Centre, Leicester Diabetes Centre, Leicester, United Kingdom; <sup>3</sup>NIHR Applied Research Collaboration East Midlands, Leicester Diabetes Centre, Leicester, United Kingdom.

**Background:** Self-management of a long-term health condition, like CKD, requires appropriate knowledge, skills, and confidence (termed patient activation). However, resources to support and improve self-management behaviours in CKD are lacking. We developed a 10-week online self-management programme for people with non-dialysis CKD, called My Kidneys & Me (MK&M). This programme is being evaluated in an ongoing multi-centre randomised control trial (called SMILE-K). To ensure that the full-scale trial protocol is feasible, we conducted a mixed-methods nested feasibility pilot involving the first 60 participants.

**Methods:** The SMILE-K trial is conducted entirely using remote recruitment and outcome assessment methods. It has a 2:1 (intervention:control) randomisation. Assessment surveys, including the Patient Activation Measure, are collected at baseline and at 10 weeks. Based on recruitment rates, acceptability of recruitment and randomisation methods, feasibility and acceptability of outcome assessments, and engagement with and usage of MK&M, *a-priori* progression criteria were set using a 'red' (stop), 'amber' (make changes) and 'green' (go) system. Semi-structured interviews explored participant views of the trial design.

**Results:** 128 people expressed initial interest in the study, of which 77 (60%) consented to participate. 60/77 (78%) completed the baseline survey and were randomised and included in the pilot. Mean age was 63 (range: 20-88) years and 63% were male. All the pre-specified 'stop' progression criteria thresholds were exceeded, suggesting the full trial is feasible. Access to and engagement with MK&M were high with 36/41 (88%) participants in the intervention group activating their account. On average participants logged in 35 times during the 10 weeks spending a mean of 18 minutes per login. Participants described their views and experiences of taking part in this remote trial, including email communication, engaging in online assessments, online education and suggestions for improvements to full study protocol.

**Conclusions:** This nested pilot study provides evidence for the feasibility of the full-scale trial. Consequent refinements to the protocol have been made through the identified areas for improvement. These results are relevant to inform the design of other remotely delivered trials in CKD.

#### SA-PO947

##### Participant Experience in the Kidney Precision Medicine Project

Angela M. Victoria Castro,<sup>1</sup> Celia P. Corona Villalobos,<sup>2</sup> Natalya Sarkisova,<sup>4</sup> Kristina N. Blank,<sup>4</sup> Ashveena Dighe,<sup>4</sup> Glenda V. Roberts,<sup>4,3</sup> Alan Y. Xu,<sup>2</sup> Victoria Blanc,<sup>3</sup> Michael P. Rose,<sup>5</sup> Ian H. de Boer,<sup>4</sup> Jonathan Himmelfarb,<sup>4</sup> Katherine R. Tuttle,<sup>4</sup> KPMP <sup>1</sup>Yale University School of Medicine, Department of Internal Medicine, New Haven, CT; <sup>2</sup>Johns Hopkins University, School of Medicine, Division of Nephrology, Baltimore, MD; <sup>3</sup>Kidney Precision Medicine Project Patient Partner, Seattle, WA; <sup>4</sup>Kidney Research Institute and Division of Nephrology, University of Washington, Seattle, WA; <sup>5</sup>University of Michigan, Ann Arbor, MI.

**Background:** Optimal participant experience is a foundation of the Kidney Precision Medicine Project (KPMP). This study aimed to identify participants' motivation to participate in research, comprehension of informed consent, satisfaction with processes, and perception of personal impact.

**Methods:** Participants with acute kidney injury (AKI) or chronic kidney disease (CKD) enrolled at nine recruitment sites in the United States during 2019-2022 attended a visit 28 days after their KPMP protocol kidney biopsy. At that time, participants were asked to complete a survey about their experience with 48 questions developed in collaboration with an evaluation expert from the Institute of Translational Health Sciences at University of Washington.

**Results:** A 28-day survey was completed by 70% of 129 participants, 17 enrolled for AKI and 73 for CKD. Median age was 60 (IQR 46-66) years, 46% were women, and 27% identified as Black race. Individuals most commonly joined the KPMP to help future patients (56%), and 97-99% understood the informed consent process and their role in the study. They were asked to rate their anxiety during the biopsy on a graded scale; 4% of participants reported a scale of 10 (maximum) anxiety compared to 29% who reported no anxiety. They also rated the pain of the biopsy on a graded scale with 2% reporting 10 (maximum) while 46% chose a rating of 0 (none). Difficult aspects of their KPMP experience were reported by 8%, mostly related to biosample collection. They also commonly reported positive changes in taking medication, diet, physical activity, and views of kidney disease after receiving their biopsy results.

**Conclusions:** KPMP participants are motivated to participate primarily by altruism and report positive experiences with informed consent and the impact of the study on their daily lives, despite some anxiety and pain related to the biopsy. The KPMP will improve methodology based on participant feedback and will provide guidance for better clinical research processes more broadly.

**Funding:** NIDDK Support

#### SA-PO948

##### Assessing Cognition and Sex Differences in CKD Using the NIH Toolbox

Luis M. Perez, Seth B. Furgeson, Zhiying You, Jessica B. Kendrick. *University of Colorado Denver School of Medicine, Aurora, CO.*

**Background:** Chronic kidney disease (CKD) is largely an age-related clinical disorder with accelerated cognitive and cardiovascular aging. Cognitive impairment is a well-documented occurrence in midlife and older adults with CKD and affects multiple domains. In the general population, there is a higher prevalence of cognitive impairment in women. We examined whether cognition differed by sex in adults with CKD.

**Methods:** We included 109 individuals (51% women) with CKD stage 3b-4 (eGFR 15-44 ml/min) from the Bicarbonate Administration in CKD Trial. We measured cognitive function using the National Institute of Health (NIH) Toolbox® (TB) cognitive battery, which assesses cognitive and motor measures such as executive function, attention, memory, and dexterity. All study measures were collected and analyzed at the study baseline.

**Results:** The mean age and eGFR were 61 ± 12 years and 34.9 ± 9.8 ml/min/1.73m<sup>2</sup>. Overall, both men and women scored below the 50<sup>th</sup> percentile on all fluid cognition measures, dexterity and total fluid and total cognition scores (Table). Notably, men scored higher than women on the flanker test (11±21 pts, p<0.01). However, women scored higher on both the dominant/non-dominant pegboard test (12±16 pts, p<0.01, 10±15, p=0.01 respectively). There were no other sex differences among other cognitive measures (all p>0.05). EGFR was associated only with crystallized cognition (r=-0.26, p<0.01).

**Conclusions:** Individuals with CKD had cognitive function below the median NIH-TB reference population values. These results establish baseline cognitive impairment levels in individuals with CKD as well as sex differences in cognitive measures.

**Funding:** NIDDK Support

NIH-TB Cognitive Battery Scores

Measure	Uncorrected score (mean ± SD)	Corrected score (mean ± SD)	Percentile (mean ± SD)
<b>Fluid Cognition Measures</b>			
Flanker Test	92.9 ± 10.1	42.5 ± 7.7	28.4 ± 21.2
List Sort	95.5 ± 12.7	48.8 ± 10.2	46.1 ± 29.9
Pattern Comparison	87.7 ± 14.8	44.4 ± 11.9	35.9 ± 30.9
Picture Sequence	94.5 ± 13.0	48.4 ± 9.4	43.3 ± 26.5
Card Sort Test	97.1 ± 12.2	50.5 ± 10.9	48.4 ± 31.8
Dexterity			
Peg board (dominant)	80.5 ± 17.3	42.2 ± 10.1	27.6 ± 24.0
Peg board (non-dominant)	93.1 ± 16.6	43.7 ± 8.7	31.8 ± 24.2
<b>Total Cognition Measures</b>			
Fluid cognition	89.7 ± 13.1	45.2 ± 10.4	38.1 ± 30.4
Crystallized cognition	107.4 ± 10.0	51.7 ± 8.7	54.1 ± 27.6
Total cognition	97.3 ± 11.7	48.2 ± 9.0	44.7 ± 29.1

SA-PO949

Preliminary Self-Report Findings From the NIH Emotional Toolbox Among Youth With CKD

Rebecca J. Johnson,<sup>1</sup> Lyndsay Harshman,<sup>2</sup> Marc Lande,<sup>3</sup> Joann M. Carlson,<sup>4</sup> Camille Wilson,<sup>5</sup> Anne E. Dawson,<sup>5</sup> Matthew Matheson,<sup>6</sup> Susan L. Furth,<sup>7</sup> Bradley A. Warady,<sup>1</sup> Stephen R. Hooper.<sup>8</sup> <sup>1</sup>Children's Mercy Kansas City, Kansas City, MO; <sup>2</sup>The University of Iowa Stead Family Children's Hospital, Iowa City, IA; <sup>3</sup>University of Rochester Medical Center, Rochester, NY; <sup>4</sup>Robert Wood Johnson University Hospital, New Brunswick, NJ; <sup>5</sup>Nationwide Children's Hospital, Columbus, OH; <sup>6</sup>Johns Hopkins University Bloomberg School of Public Health, Baltimore, MD; <sup>7</sup>The Children's Hospital of Philadelphia, Philadelphia, PA; <sup>8</sup>University of North Carolina School of Medicine, Chapel Hill, NC.

**Background:** On measures of psychopathology, children with chronic kidney disease (CKD) are known to be at risk for inattention and internalizing symptoms such as sadness and anxiety. Less is known about their self-report of overall emotional health. The NIH Emotional Toolbox assesses negative emotions as well as psychological well-being, social relationships, stress, and self-efficacy.

**Methods:** The Chronic Kidney Disease in Children (CKiD) study is a multi-site, prospective cohort of children with eGFR 30-90ml/min/1.73m<sup>2</sup> at entry. In the past 3 years, 57 participants aged 8-17 have completed the NIH Emotional Toolbox. Linear regression models examined associations between emotional constructs and disease-related variables known to be associated with emotional health (glomerular diagnosis, urine Pr/Cr, blood pressure). These variables were hypothesized to be associated with poorer emotional and social health. Models were adjusted for U25eGFR, age, sex, and maternal education. Significance was set as p <= .01.

**Results:** 16 participants aged 8-12 and 41 aged 13-17 completed assessment of 11 NIH Emotional Toolbox constructs in 4 domains (Psychological Well-Being, Social Relationships, Stress and Self-Efficacy, and Negative Emotions). Median age was 14.7 [IQR=12.8,16.4], 58% were male, 16% had glomerular diagnosis, 78% of mothers had completed education beyond high school, median urine Pr/Cr was 0.23 [IQR=0.12,0.76], 75% were normotensive, and median eGFR was 52 [IQR 40, 70]. Emotional Toolbox T scores placed in the average range across constructs (median scores 43-55). Glomerular diagnosis was significantly associated with the construct positive affect in that participants with glomerular disease reported less positive affect (β=-13.54, 99% CI=-23.58, -3.50; p=.0007); this finding reflected a large effect size.

**Conclusions:** Preliminary findings suggest average self-reported emotional health for a subset of children enrolled in the CKiD study who completed the NIH Emotional Toolbox. Glomerular diagnosis was associated with less positive affect. A larger, more diverse sample of children with CKD is needed to determine if other disease-related variables are associated with emotional health. Future analyses will examine parent proxy report of emotional health for this cohort.

**Funding:** NIDDK Support, Other NIH Support - Eunice Kennedy Shriver National Institute of Child Health and Human Development, and the National Heart, Lung, and Blood Institute

SA-PO950

Cystatin C-Based Equations Underestimate Glomerular Filtration Rate in Men With or at Risk for Mesoamerican Nephropathy

Nathan H. Raines,<sup>1,2</sup> Lesley A. Inker,<sup>3</sup> Jesse C. Seegmiller,<sup>4</sup> Daniel R. Brooks,<sup>6</sup> Marvin A. Gonzalez,<sup>5</sup> David Friedman.<sup>1,2</sup> <sup>1</sup>Beth Israel Deaconess Medical Center, Boston, MA; <sup>2</sup>Harvard Medical School, Boston, MA; <sup>3</sup>Tufts Medical Center, Boston, MA; <sup>4</sup>University of Minnesota Academic Health Center, Minneapolis, MN; <sup>5</sup>Research Center on Health, Work, and Environment, National Autonomous University of Nicaragua, León, Leon, Nicaragua; <sup>6</sup>Boston University School of Public Health, Boston, MA.

**Background:** Estimated glomerular filtration rate (eGFR) equations using serum creatinine or cystatin C may introduce bias when applied to populations other than those in which the equation was derived. The accuracy of eGFR equations has not been evaluated in populations with high rates of Mesoamerican nephropathy (MeN), a syndrome of chronic kidney disease of unknown cause (CKDu) usually affecting young men from agricultural areas who are of mixed ancestry, perform strenuous labor, and live in poverty.

**Methods:** We compared eGFR from three modern and three historically-used equations against measured GFR (mGFR) by serum iohexol disappearance in 50 men aged 19-45 from a population with high risk for MeN in Nicaragua.

**Results:** mGFR ranged from 24 to 137ml/min/1.73m<sup>2</sup>. Among modern equations, the CKD Epidemiology Collaboration (CKD-EPI) creatinine equation (2021) had minimal bias and good accuracy, while equations that incorporated cystatin C led to a systematic underestimation of GFR and poorer overall performance (Fig. 1), potentially resulting in misdiagnosis (Fig. 2).

**Conclusions:** CKD-EPI creatinine (2021) accurately estimates GFR in men with or at risk for MeN, whereas Cystatin C-based equations do not. More studies are needed to extend these results to other populations affected by CKDu.

**Funding:** Private Foundation Support

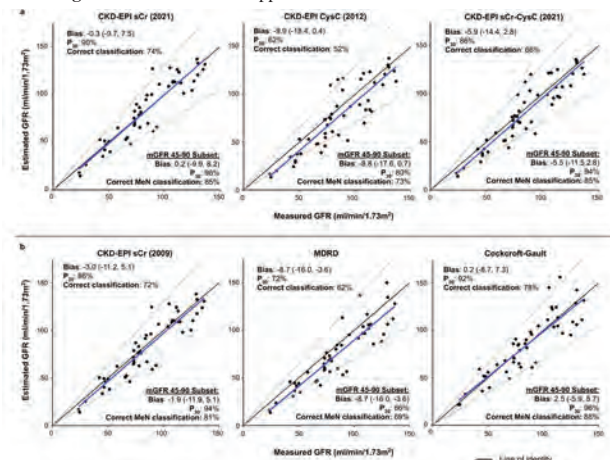

Figure 1. Performance of estimating equations against measured glomerular filtration rate (GFR) by iohexol disappearance in a Nicaraguan Mesoamerican Nephropathy (MeN) Population. (a) Equations currently recommended by the National Kidney Foundation - American Society of Nephrology Task Force on Reassessing the Inclusion of Race in Diagnosing Kidney Disease. (b) GFR estimating equations historically used in MeN populations. Bias is defined as the median difference between measured GFR (mGFR) and estimated GFR (eGFR), with interquartile range in parentheses. P<sub>95%</sub> is defined as the percentage of eGFR values with 30% of the mGFR or greater (ml/min/1.73m<sup>2</sup>). Correct MeN classification is defined as the percent agreement between mGFR and eGFR when classifying individuals as having a GFR above or below 60 ml/min/1.73m<sup>2</sup>, its threshold frequently used for diagnosing MeN. CKD-EPI, Chronic Kidney Disease Epidemiology Collaboration; sCr, serum creatinine; CysC, serum cystatin C; MDRD, Modification of Diet in Renal Disease.

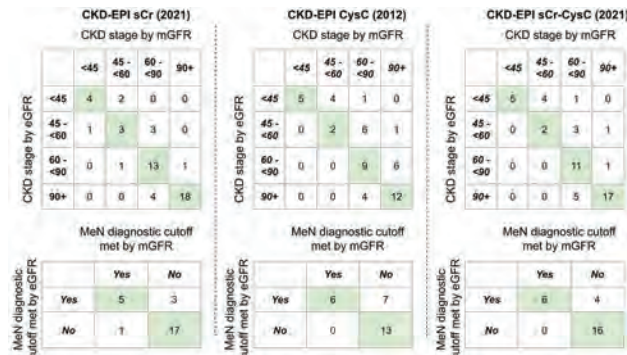

Figure 2. Agreement in staging of chronic kidney disease (CKD) and Mesoamerican Nephropathy (MeN) diagnostic criteria by estimated glomerular filtration rate (eGFR) compared with measured GFR (mGFR). Data presented as counts of participants meeting criteria by mGFR versus eGFR. MeN diagnostic criteria are defined by a GFR cutoff of 60ml/min/1.73m<sup>2</sup> and are evaluated only in the subset of individuals with measured GFR falling between 45 and 90 ml/min/1.73m<sup>2</sup>. Green shading indicates staging agreement between mGFR and eGFR. CKD-EPI, Chronic Kidney Disease Epidemiology Collaboration; sCr, serum creatinine; CysC, cystatin C.

SA-PO951

Enhanced Telemedicine With Trained Medical Assistants Using Augmented Reality Glasses for Inpatient Nephrology Visits

Thelmo Fidel Ernesto Barrantes Ramirez,<sup>1,2</sup> Chudi Adi,<sup>3,1</sup> Jayant Kumar.<sup>1</sup> <sup>1</sup>Renal Medicine Associates, Albuquerque, NM; <sup>2</sup>Burrell College of Osteopathic Medicine, Albuquerque, NM; <sup>3</sup>CADIS Healthcare Inc, Albuquerque, NM.

**Background:** Tele-nephrology utilizes communication technologies to provide care to patients with kidney diseases. Inpatient non-nephrology telemedicine services have shown positive outcomes such as decreased mortality and length of hospital stay. Despite its advantages, "conventional" telemedicine is limited by inadequate clinical examination, and reduced provider/patient emotional connection. Here, we report the use of a novel inpatient telemedicine delivery model with trained medical assistants (MAs) wearing augmented reality (AR) glasses and using a digital stethoscope (DS) capable of maintaining real-time audio-visual telecommunication with the nephrologist.

**Methods:** Six MAs underwent a customized 6-week long training on history taking, physical examination (PE), and use of the AR telehealth platform with two nephrologists. Training involved hands-on interaction with patients. Inpatient telemedicine privileges

were provided by the hospital. Inpatient visits were performed by the MA equipped with AR glasses capable of hands-free operation, and a live-transmitting DS. The consulting nephrologist was located remotely, and could synchronously see and hear what the MA was experiencing in patients' rooms. Direct communication with the patient if needed, and real-time guidance to the MA including AR telestration capabilities, were provided by nephrologist. Auscultation sounds were live streamed to the nephrologist located remotely within or outside the hospital facility.

**Results:** Between January and April 2022, 89 patients consented to participate. The average patient age was 62.3 years, and 65.5% were male. From the total, 14.6% were new consults and 85.3% were follow-ups. Average encounter time was 21.2 minutes. PE was completed in all patients, 17.9% were seen on dialysis. After, each encounter, the MA surveyed the patient on usefulness, technology interface quality and interaction quality. Of the total, 16.8% requested a post encounter doctor visit (in person/video), 55% declined the additional encounter and 28.1% did not respond. Written feedback from patients was positive. Hearing impaired patients showed some difficulty with this technology.

**Conclusions:** Inpatient telemedicine nephrology evaluation using MAs, AR glasses and a DS platform was found to be effective, with excellent clinical utility, patient satisfaction and acceptance.

**Funding:** Private Foundation Support

**SA-PO952**

**Mayo Clinic Experience With Endovascular Renal Denervation for Kidney Pain**

Vartika Singh, Seif Bugazia, Rajiv Gulati, Abhishek Deshmukh, Stephen B. Erickson, Marie C. Hogan. *Mayo Clinic Minnesota, Rochester, MN.*

**Background:** The objective of this study was to evaluate outcomes following endovascular renal denervation (ERD) for intractable kidney pain performed in patients from 1/2017-5/2022. ERD has been used in few medical centers to manage kidney pain and only reported in small case series.

**Methods:** Retrospective & prospective analysis of 18 patients (with 23 ERDs). Data included patient demographics, etiology, response to ERD, time to recurrence of pain (visual analog scale) following first&/or second ERD. After renal artery angiogram in the electrophysiology lab under general anesthesia, 8 Fr sheath was placed in the femoral artery & renal artery cannulated using a destination sheath. Using Smarttouch DF(TM) catheters, serial, sequential ablation lesions were delivered in a spiral manner from distal to the ostium of renal arteries (power15-20W seeking impedance drop). Repeat renal angiogram was performed to ensure patency of the renal artery.

**Results:** Eighteen (13 F; 5M; median 42yo, range 23-71) had 23 RDNs (2 bilateral; 5 ipsilateral redos; median follow-up 33mo). Etiologies were loin pain hematuria (LPHS) (n=5; 28%), nephrolithiasis (n=5;28%), PKD (n=5; 28%), reflux (n=1; 5%), NOS (n=2; 11%). Five cases (28%) had recurrent ipsilateral pain at a median 21 mo(range 6-28 mo) after ERD. Six cases (33%; 2M; 4F) had abrogation of their pain (median follow-up 33 mo). Using the 'Was it Worth It' questionnaire, 9 pts reported ERD was worthwhile. A total of 13 (72%) reported improvement or resolution (n=7) of pain. One who underwent bilateral ERD had abrogation of right kidney pain while pain continued on the left kidney. Procedural complications included post-operative pain (n=8), dissection (n=2), retroperitoneal bleed (n=2), stenosis (n=1), where 1 patient experienced renal artery dissection after a repeat procedure. Five (all females) had no benefit from ERD.

**Conclusions:** ERD reduced or abrogated pain in 13 (72%) cases but had no impact on pain in 5 cases. LPHS cases had the highest likelihood of success. ERD may be used for palliation of pain within an interdisciplinary chronic pain management & rehabilitation program at specialty centers & only when patients have exhausted other conservative measures.

**Funding:** Private Foundation Support

**SA-PO953**

**Biomarker-Enriched Risk Scores and Prognostication of Kidney Outcomes Among African Americans With High-Risk APOLI Variants**

Kinsuk Chauhan,<sup>1</sup> George Vasquez-Rios,<sup>1</sup> Nidhi Naik,<sup>1</sup> Pattharawin Pattharanitima,<sup>2</sup> Lili Chan,<sup>1</sup> Girish N. Nadkarni,<sup>1</sup> Steven G. Coca.<sup>1</sup> *<sup>1</sup>Icahn School of Medicine at Mount Sinai Department of Medicine, New York, NY; <sup>2</sup>Thammasat University Faculty of Medicine, Khlong Nueng, Thailand.*

**Background:** Apolipoprotein L1 (APOLI) variants confer a high-risk for chronic kidney disease (CKD) among African American (AA) individuals. Adequate measures to understand abnormal pathophysiologic domains associated with this condition and risk-stratify those with high-risk APOLI variants are lacking.

**Methods:** Participants with APOLI high-risk (G1/G2 variants) genotype were selected from the Mount Sinai BioMe Biobank. Plasma TNFR1, TNFR2, KIM-1, MCP-1, YKL-40, IL-18, and suPAR were measured on banked specimens. The association between biomarkers and the composite kidney outcome (sustained ≥40% eGFR decline or ESKD during follow-up) was determined. A biomarker risk score was derived for each patient by summing the integer assigned to each biomarker tertile based on the coefficient in the hazard ratio (HR) model. The total score was divided into 8 categories and then further into low, moderate, and high-risk groups.

**Results:** Among 498 participants, the median age was 56 years, 67.6% were females, median eGFR was 83.3 ml/min/1.73m<sup>2</sup>, and 16.1% reached the outcome. Biomarkers were independently associated with a higher risk of the composite kidney outcome: adjusted HR per doubling for suPAR 1.7 (95% CI: 1.1-2.7), TNFR1: 2.2 (1.5-3.3), TNFR2: 1.6 (1.3-2.1), KIM-1: 1.5 (1.2-1.8), and IL-18: 1.4 (1.1-1.8). The incidence of the composite kidney outcome significantly increased with escalating risk scores. Overall, only 7% of participants in the low-risk group experienced the outcome compared with 15% in the moderate-risk group, and 33% in the high-risk group (Figure).

**Conclusions:** Inflammation and injury pathways may be differentially and independently associated with kidney events among patients with APOLI high-risk variants. Measuring biomarkers may assist in risk stratification to inform during patient care and potentially serve to enrich clinical trials.

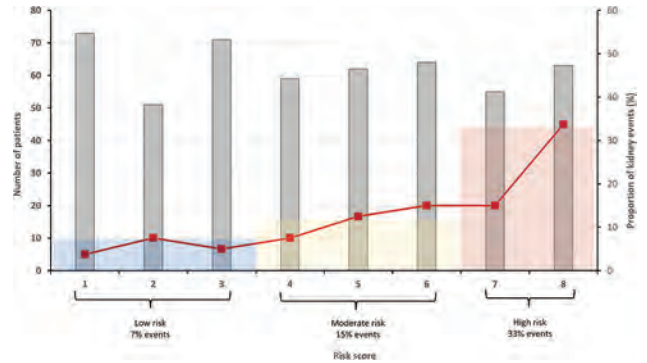

Higher biomarker risk scores show the increased risk of the composite kidney outcome

**SA-PO954**

**Radiomic Features of Kidney Magnetic Resonance Imaging (MRI) to Characterize CKD and Progressive CKD**

Alexander S. Leidner,<sup>1</sup> Luping Li,<sup>2</sup> Emily Wilt,<sup>2</sup> Stuart M. Sprague,<sup>2</sup> Henry Rusinek,<sup>3</sup> Anand Srivastava,<sup>1</sup> Pottumarthi V. Prasad.<sup>2</sup> *<sup>1</sup>Northwestern University Feinberg School of Medicine, Chicago, IL; <sup>2</sup>NorthShore University HealthSystem, Evanston, IL; <sup>3</sup>NYU Langone Health, New York, NY.*

**Background:** CKD represents a wide-spectrum of conditions with varying etiologies, manifestations and rates of progression. Application of radiomics, objective numerical representations of image texture, on MRI has potential to non-invasively identify disease features through evaluation of spatial heterogeneity. However, there is limited data on the application of kidney MRI-based radiomics in individuals with CKD.

**Methods:** We generated radiomic features from arterial spin labeling (ASL)-derived cortical blood flow (BF), blood oxygenation level dependent (BOLD)-derived relaxation rate (R2\*), and diffusion-weighted (DW)-derived apparent diffusion coefficient (ADC) maps on 9 healthy and 24 individuals with diabetic CKD (eGFR <60 ml/min/1.73m<sup>2</sup>). FireVoxel was used to calculate 54 radiomic features of the kidney cortex. Spearman correlations were calculated between features. Logistic regression models of radiomics and clinical variables were used to classify (1) CKD and (2) rapidly progressive CKD (eGFR decline >3 ml/min/1.73m<sup>2</sup>/year). Forward stepwise regression was based on area under the receiver operating characteristic curve (AUC) changes.

**Results:** The best model in predicting CKD used the ASL-derived mean BF value had an AUC of 1.0. The best model to predict rapidly progressive CKD included ASL-derived BF and BOLD-derived R2\* parameters with an AUC of 1.0 (Figure 1a). Model parameters were significantly correlated with the presence of CKD, eGFR, eGFR slope, and urine protein excretion (Figure 1b).

**Conclusions:** These preliminary results show the potential of MRI radiomics as a non-invasive diagnostic tool in phenotyping CKD. These results require validation in future larger studies with heterogeneous CKD etiologies.

**Funding:** NIDDK Support, Other NIH Support - National Institute of Biomedical Imaging and Bioengineering

Figure 1a. Correlations Between Model 2.d Radiomic Variables and Clinical Variables

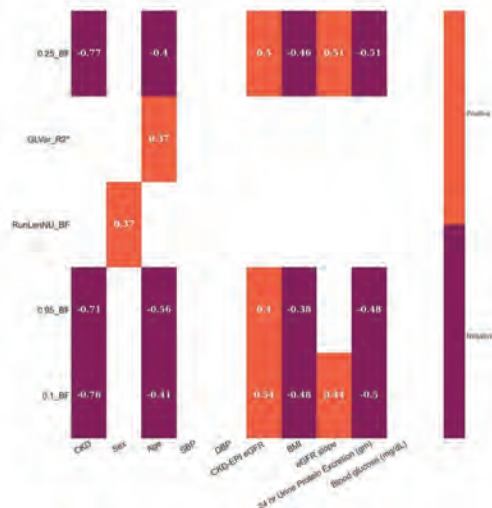

Key: TH - Thursday; FR - Friday; SA - Saturday; OR - Oral; PO - Poster; PUB - Publication Only

Underline represents presenting author.

**Figure 1b. CKD and Progressive CKD Logistic Regression Model Performance**

Model	Feature Sources	Features chosen for Model	AUC	Sensitivity	Specificity
<b>Model 1: CKD (n=24) Vs. Healthy (n=9)</b>					
Model 1.a*	BF	Mean	1.00	1.00	1.00
Model 1.b	R2*	invVar, RunLenNorm, 0.99	0.94	0.92	0.89
Model 1.c	ADC	GLNU, JointAvg, DiffAvg, Kurtosis, LongRunHighGLEmph	0.96	0.93	1.00
<b>Model 2: Rapid CKD Progressor (n=8) Vs. Non-Rapid CKD Progressor (n=18)</b>					
Model 2.a	BF	0.25, RunLenNU, 0.95	0.94	1.00	0.89
Model 2.b	R2*	ClstTend, 0.05, 0.9, GLNU, 0.1, DiffVar, Kurtosis	0.96	0.96	0.94
Model 2.c	ADC	Kurtosis, RunLenNU, Skewness, JointAvg, GLNU, JointEmp	0.86	0.93	0.78
Model 2.d	BF, R2*, ADC	0.25, BF, GLNU, R2*, RunLenNU, BF, 0.95, BF, 0.1, BF	1.00	1.00	1.00
Model 2.e	BF, R2*, ADC, Clinical†	24 hr Urine Protein, DiffVar, ADC, GLNU, Cor, BF	0.95	1.00	0.94

Spearman correlation coefficients are reported for statistically significant correlations (p<0.05). Test statistics are reported as fractions of 1. Rapidly progressive chronic kidney disease (CKD) is defined as an estimated glomerular filtration rate (eGFR) loss of >3 mL/min/1.73m<sup>2</sup>/year. \*Model 1.a performance with one variable would make identical combination models. †Clinical Variables include CKD, Sex, Age, Systolic Blood Pressure (BP), Diastolic BP, eGFR, Body Mass Index (BMI), 24 hr Urine Protein-excretion in grams, Blood glucose, BF, blood flow, ADC, apparent diffusion coefficient.

SA-PO955

**Differential Expression of Renal and Hepatic PCSK9 During Development of Hypercholesterolemia in the Puromycin Aminonucleoside Nephrosis Rat Model of Nephrotic Syndrome**

Eduardo Molina-Jijon,<sup>1</sup> Camille E. Mace,<sup>1</sup> Carmen Avila-Casado,<sup>2</sup> Lionel C. Clement.<sup>1</sup> <sup>1</sup>Rush University Medical Center, Chicago, IL; <sup>2</sup>University Health Network, Toronto, ON, Canada.

**Background:** In the US, 85% of patients with nephrotic syndrome (NS) have hypercholesterolemia, compared to 31.5% of the general population. Proprotein convertase subtilisin/kexin type 9 (PCSK9) plays a main role in the regulation of LDL-cholesterol in the liver. In the kidney, PCSK9 is expressed in the cortical collecting duct (CCD) where acts as a chaperone for the epithelial sodium channel. We showed that PCSK9 is increased in kidney biopsies of patients with NS and that it is implicated in the initiation of hypercholesterolemia in two animal models, Buffalo-Mna rats (model of focal and segmental glomerulosclerosis) and Rm2b<sup>-/-</sup> mice (model of collapsing glomerulopathy) (Molina-Jijon et al, 2020). In this study, we investigate the expression of PCSK9 in puromycin aminonucleoside (PAN) nephrosis in rats, a model of human Minimal Change Disease (MCD).

**Methods:** Sprague-Dawley rats were injected with saline 0.9% (control) or PAN (15 mg/100 g). Rats were euthanized daily from day 1 to 7 after PAN injection. Proteinuria, PCSK9 and serum cholesterol were assessed. PCSK9 gene and protein expression in liver and kidney were studied by RealTime PCR and Western blot

**Results:** Control rats did not develop proteinuria, hypercholesterolemia or high serum PCSK9. PAN rats developed proteinuria (mg/18h) from day 4 after injection (0.82±0.1 day 0; 4.4±1 day 4; 63±17 day 5; 145±7 day 6 and 128±13 day 7). Serum PCSK9 (ng/mL) significantly increased from day 5 (144±26 day 0; 404±81 day 5; 1635±263 day 6; 1816 ± 191 day 7), and hypercholesterolemia (mg/dL) significantly developed from day 6 to 7 (93±6 day 0; 326.80±37 day 6; 352±10 day 7). In the kidney, PCSK9 expression increased from day 3 after injection, and was not modified in the liver. Similarly, PCSK9 mRNA increased in the kidney from day 5 with no significant modification in the liver (fold change mRNA expression=18.9 for renal cortex vs 2.4 for liver day 5; 11.4 vs 2.6 day 6; 20.5 vs 1.6 day 7)

**Conclusions:** As rats develop NS, PCSK9 protein level increase in the kidney and serum and did not change in the liver. PCSK9 from CCD may play a role in the initiation of hypercholesterolemia in MCD-related nephrotic syndrome and could become a new therapeutic target to prevent development of hypercholesterolemia in nephrotic syndrome patients

Funding: NIDDK Support

SA-PO956

**The Cell-Type and Region-Specific Chromatin Landscape of the Kidney**

Debora L. Gisch,<sup>1</sup> Blue Lake,<sup>3</sup> Jeannine M. Basta,<sup>4</sup> Lynn Robbins,<sup>4</sup> Michelle Pherson,<sup>5</sup> Daria Barwinska,<sup>1</sup> Samir V. Parikh,<sup>2</sup> Brad H. Rovin,<sup>3</sup> Ying-Hua Cheng,<sup>1</sup> Kun Zhang,<sup>3</sup> Tarek M. El-Achkar,<sup>1</sup> Shamim Mollah,<sup>4</sup> Pierre C. Dagher,<sup>1</sup> Sanjay Jain,<sup>4</sup> Michael I. Rauchman,<sup>4</sup> Michael T. Eadon.<sup>1</sup> KPMP <sup>1</sup>Indiana University School of Medicine, Indianapolis, IN; <sup>2</sup>The Ohio State University Wexner Medical Center, Columbus, OH; <sup>3</sup>University of California San Diego, La Jolla, CA; <sup>4</sup>Washington University in St Louis, St Louis, MO; <sup>5</sup>Saint Louis University, Saint Louis, MO.

**Background:** Activation or repression of gene transcription is regulated by changes in the chromatin landscape, including post-translational modifications of histones and DNA methylation. In an integrated multi-omic approach, we characterized the regulation of reference transcript expression for the podocyte, proximal tubule (PT), and thick ascending loop of Henle (TAL) cells.

**Methods:** Using human nephrectomy and biopsy tissue, we developed quality (QC) standards for whole genome bisulfite sequencing (WGBS, N=30) of dissected glomeruli (GLOM) and tubulointerstitium (TI). Cleavage Under Targets & Release Using Nuclease (CUT&RUN) in bulk (N=12) with H3K27ac and H3K27me3 antibodies and single cell Multiome (combined snRNAseq and scATACseq, N=12) to comprehensively define epigenomic features of accessible chromatin regions in the kidney. Peak alignment in genomic regions (promoter, exon, CpG island, etc) was determined by Fisher's exact test. In identical specimens, proteomic, transcriptomic, and KPMP/HubMAP snRNAseq atlas (>200,000 nuclei) phenotypes were compared.

**Results:** QC measures for batch correction, controls, and reproducibility are optimized for human kidney. We describe the methylome for 22,156,845 CpGs. After genomic feature modeling (promoter, etc), WGBS inversely correlated with mRNA

(R=0.61) and protein (R=0.55). Peaks of WGBS, CUT&RUN, and the Multiome were aligned for cell-specific expressed genes, comparing podocytes to GLOM, and TAL/PT to TI or Bulk. Glom/TI WGBS valleys aligned with scATACseq peaks (p<9x10<sup>-11</sup>). CUT&RUN H3K27ac peaks aligned with TI WGBS valleys (p<0.03). CUT&RUN H3K27ac and scATAC-seq peaks coincided in TAL and PT (both p<0.001). A tensor factorization network analysis identified consistent regulation of ESRRG, a gene associated with TAL injury in a snRNAseq atlas, showing consistent WGBS, H3K27ac, H3Kme3, and scATACseq regulation in its promoter and introns 1 and 3.

**Conclusions:** These studies integrate histone modification and DNA methylation, which contribute to chromatin accessibility in the kidney. This epigenomic reference atlas is a first step to assess downstream expression changes in multiple kidney cell types and will be valuable to characterize CKD GWAS variants that map to distal enhancers.

Funding: NIDDK Support

SA-PO957

**Gene Ontology Reveals Potentially Unique Mechanism of Action Underlying Selected Renal Cells Bioactivity**

Prakash Narayan, Joseph Stavas, Tim A. Bertram, Deepak Jain. ProKidney, Winston-Salem, NC.

**Background:** Selected renal cells (SRC), a renal epithelial cell-enriched platform, is being advanced as autologous cell-based therapy for treatment of chronic kidney disease (CKD). In this study, we coupled empirical data with gene ontology to test the hypothesis that SRC stabilizes or improves renal function at least in part by co-expressing proteins involved in early kidney development.

**Methods:** Genes coding for 8 proteins viz. Rack1 (Gnb2l1), Six2, Osr1, Lhx1, Ret, Fgf8, nephrin (nphs1) and podocin (nphs2) expressed by human SRC (doi.org/10.1016/j.ekir.2022.04.014) were seeded into STRING and Genemania. The knowledge bases were queried for co-expression of these empirically identified nodes in human tissue, and other nodes comprising this interactome.

**Results:** Use of either database suggested that these 8 nodes are not known to be co-expressed in human tissue (Figures 1a and b). Indeed, both search engines returned co-expression interactomes less Rack1 and Ret. The resulting network nevertheless included additional nodes (Figure 1b) involved in urogenital development, metanephric nephron development, renal polarity, glomerular development, and other aspects of neo-nephrogenesis.

**Conclusions:** To the best of our knowledge, human SRC is unique, co-expressing Rack1, Six2, Osr1, Lhx1, Ret, Fgf8, nephrin and podocin. These data also suggest that SRC bioactivity is driven by co-expression of proteins critical to several elements of neo-nephrogenesis and their spatiotemporal coordination, and support the mechanism of action of its clinical effects. SRC-based Renal Autologous Cell Therapy (REACT™) is in clinical trials for CKD caused by type 2 diabetes and congenital anomalies of kidney and urinary tract and has been granted Regenerative Medicine Advanced Therapy designation by Food and Drug Administration.

Funding: Commercial Support - ProKidney

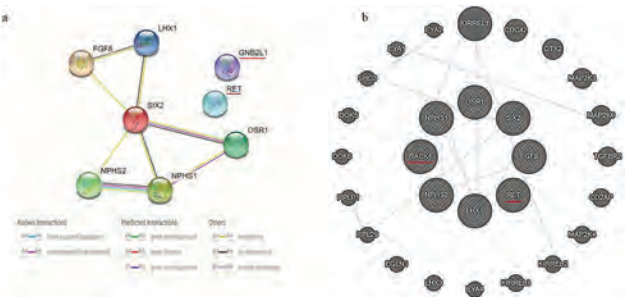

Figure 1. STRING (a) and Genemania (b) queries in human tissue for co-expression networks of 8 nodes expressed on SRC returned interactomes less rack1 and ret (red underbars); additional nodes were identified as part of this interactome.

SA-PO958

**Characterization of the Effects of HIV Vpr on Renal Distal Tubules by Single-Nucleus RNA-Sequencing**

Khun Zaw Latt,<sup>1</sup> Teruhiko Yoshida,<sup>1</sup> Shashi Shrivastav,<sup>1</sup> Amin Abedini,<sup>2</sup> Hwang Lee,<sup>6</sup> Yongmei Zhao,<sup>3</sup> Joon-Yong Chung,<sup>4</sup> Avi Z. Rosenberg,<sup>5</sup> Pedro A. Jose,<sup>6</sup> Cheryl A. Winkler,<sup>4</sup> Mark A. Knepper,<sup>7</sup> Tomoshige Kino,<sup>8</sup> Katalin Susztak,<sup>2</sup> Jeffrey B. Kopp.<sup>1</sup> <sup>1</sup>National Institute of Diabetes and Digestive and Kidney Diseases, Bethesda, MD; <sup>2</sup>University of Pennsylvania, Philadelphia, PA; <sup>3</sup>Frederick National Laboratory for Cancer Research, Frederick, MD; <sup>4</sup>National Cancer Institute, Bethesda, MD; <sup>5</sup>Johns Hopkins University, Baltimore, MD; <sup>6</sup>The George Washington University School of Medicine and Health Sciences, Washington, DC; <sup>7</sup>National Heart, Lung and Blood Institute, Bethesda, MD; <sup>8</sup>Sidra Medicine, Doha, Qatar.

**Background:** HIV retroviral protein R (Vpr) contributes to the pathogenesis of HIV-associated nephropathy (HIVAN). Vpr induces cell cycle arrest and apoptosis, and regulates expression of glucocorticoid- and mineralocorticoid-responsive genes.

**Methods:** To investigate the effects of Vpr on aldosterone-mediated regulation of *Slc12a3* expression and sodium reabsorption in distal nephron segments, we performed single-nucleus RNA sequencing of wild-type and Vpr transgenic mouse kidney cortex after 4 days of low (0.045%) sodium diet.

**Results:** In Vpr transgenic mouse, *Slc12a3* downregulation was observed in late distal convoluted tubule and connecting tubule cluster (DCT2/CNT) but not in early distal convoluted tubules (DCT1). Expression levels of the mineralocorticoid receptor (*Nr3c2*) and the enzyme 11- $\beta$ -hydroxysteroid dehydrogenase 2 (*Hsd11b2*) genes were higher in the DCT2/CNT compared to the DCT1 cluster. The percentage of DCT cells in Vpr mouse was lower (1.8% of total cells) compared to that observed in salt-depleted WT (3.7%) and salt-replete WT (3.6%). Sub-clustering of distal tubular cell clusters identified *Pvalb*<sup>+</sup> DCT1 and *Sle8a1*<sup>+</sup> DCT2 subclusters. The DCT1 cluster showed fewer cells in Vpr mouse (0.95%) compared to salt-depleted WT (2.9%) and salt-replete WT (3.1%). Pathway analysis of differentially expressed genes in DCT1 cluster showed that genes involved in autophagy and protein ubiquitination were upregulated in Vpr mouse compared to WT. There is an open chromatin mark over a 50 kb region spanning the *Slc12a3* gene exclusively in DCT cells, suggesting a DCT-specific super-enhancer state. RNAScope imaging revealed fewer *Slc12a3*<sup>+</sup> DCT segments in Vpr mouse cortex compared to WT.

**Conclusions:** The downregulation of *Slc12a3* and the higher expression levels of *Nr3c2* and *Hsd11b2* in the DCT2/CNT cluster suggest that the aldosterone-mediated upregulation of *Slc12a3* in the context of salt depletion was inhibited by Vpr mostly in late distal convoluted tubules. The major effect of Vpr on the DCT was the loss of DCT1 cells, likely due to autophagy. These observations suggest the salt-wasting effect of Vpr in transgenic mice was associated with loss of *Slc12a3*<sup>+</sup> DCT1 segments and not with the lower abundance in individual DCT1 cells.

**Funding:** NIDDK Support

### SA-PO959

#### SHROOM3 Expression and CKD: A Mendelian Randomization Analysis

Pukhraj S. Gaheer,<sup>1</sup> Nikhil Uppal,<sup>2</sup> Darren Bridgewater,<sup>2</sup> Matthew B. Lanktree,<sup>2,3</sup> <sup>1</sup>McMaster University Faculty of Arts and Science, Hamilton, ON, Canada; <sup>2</sup>McMaster University Faculty of Health Sciences, Hamilton, ON, Canada; <sup>3</sup>St. Joseph's Healthcare Hamilton, Hamilton, ON, Canada.

**Background:** Genome-wide association studies (GWAS) identified common genetic variants within 100 kilobases of the transcription start site of *SHROOM3* individually associated with chronic kidney disease (CKD), estimated glomerular filtration rate (eGFR), and urinary albumin-to-creatinine ratio (uACR). This upstream region contains regulatory elements, and the location of these variants suggests that altered *SHROOM3* expression could be the mechanism underlying the observed associations. We sought to evaluate if a genetically predicted decrease in *SHROOM3* expression was associated with an increased risk of CKD.

**Methods:** First, we found genetic variants associated with *SHROOM3* expression, known as expression quantitative trait loci (eQTL), by conducting a meta-analysis of 7408 genetic variants from 51 tissue datasets from the public Human Kidney eQTL Atlas, GTEx, and NephQTL resources. Independent eQTL variants were then selected to be used in a two-sample Mendelian randomization analysis. Using European ancestry summary-level GWAS results from the CKDGen Consortium, UK Biobank, and the Finnish Genetics Consortium, we compared the effect of each variant on *SHROOM3* expression to its effect on risk of CKD (n = 480,698), baseline cross-sectional eGFR (n = 1,201,929), previously defined decline in eGFR phenotypes "Rapid3" or "CKDi25" (n = 141,964), and uACR (n = 547,361).

**Results:** We identified 50 independent genetic variants associated with *SHROOM3* expression ( $P < 0.05$ ,  $r^2 < 0.01$ ). These variants cumulatively explained 2% of the variability in *SHROOM3* expression. A 34% reduction in genetically predicted *SHROOM3* expression was associated with a 0.3% (95% CI: 0.1% - 0.5%) reduction in cross-sectional eGFR ( $P = 0.002$ ). There was no association between genetically predicted *SHROOM3* expression and CKD, longitudinal rapid decline in eGFR, or uACR ( $P > 0.05$ ).

**Conclusions:** Mendelian randomization analysis suggests a small reduction in genetically predicted *SHROOM3* expression throughout life is associated with a slightly lower baseline eGFR. In a seeming contradiction, we did not find that lower genetically predicted *SHROOM3* expression was associated with the presence of CKD, rapid decline in eGFR, nor uACR. These results are consistent with recent reports that genetic association with cross-sectional eGFR, maximum attained eGFR, longitudinal decline in eGFR, and risk of CKD may differ.

**Funding:** Private Foundation Support

### SA-PO960

#### Single Nucleus Multiomic Sequencing of Human Kidney Identifies Potential Regulators of Fibrosis and Injury in CKD

Nicolas Ledru,<sup>1</sup> Yoshiharu Muto,<sup>1</sup> Parker C. Wilson,<sup>1</sup> Haojia Wu,<sup>1</sup> Giuseppe Orlando,<sup>2</sup> Sushrut S. Waikar,<sup>3</sup> Benjamin D. Humphreys,<sup>1,4</sup> <sup>1</sup>Washington University in St Louis School of Medicine, St Louis, MO; <sup>2</sup>Wake Forest Baptist Medical Center, Winston-Salem, NC; <sup>3</sup>Boston Medical Center, Boston, MA.

**Background:** Chronic kidney disease (CKD) is a progressive and prevalent disease with disproportionate impact on BIPOC patients, representing a large source of both disease burden and disparities in health outcomes in the US. CKD is characterized by declining renal function and fibrosis. We have identified a proximal tubule subpopulation that fails to repair following acute kidney injury (AKI) and takes on pro-inflammatory and pro-fibrotic characteristics, implicating its potential role in transition to CKD. This failed repair state also increases in prevalence with both aging and disease, indicating that accumulation of this cell population may contribute to fibrosis and declining kidney

repair capacity in CKD as well. Identification of regulatory elements associated with this proximal tubule state may lead to putative therapeutic targets in the treatment of CKD.

**Methods:** We performed single nucleus multiomic (simultaneous snRNA-seq and snATAC-seq) sequencing of eight healthy adult human kidneys in order to characterize the proximal tubule gene regulatory networks and the *cis*- and *trans*-regulatory elements underpinning the transition to the failed repair cell state. After quality control, we had 50,768 single cell transcriptomes and epigenomes. The latter identified 193,787 peaks.

**Results:** We applied a regularized regression analysis to generate a list of prioritized transcription factors and enhancer regions that regulate genes that change in expression along the healthy to failed repair trajectory. The findings were also integrated with CKD risk variants to provide putative mechanistic annotations. We used Cut&Run and siRNA knockdown in primary proximal tubule cell culture to validate our model's predicted *cis*- and *trans*-regulatory elements of interest.

**Conclusions:** Our integrated single nucleus multiomic sequencing atlas allowed us to construct predictive parametric gene regulatory networks for genes that changed in expression along the healthy-to-failed repair proximal tubule trajectory. This identified several regulatory elements that, when therapeutically targeted, may allow for targeting of the failed repair population to reduce fibrotic and inflammatory signaling, while promoting repair mechanisms and return to a healthy proximal tubule state.

**Funding:** NIDDK Support, Private Foundation Support

### SA-PO961

#### Early Signaling Events in Renal Compensatory Hypertrophy Revealed via Multi-Omics

Hiroaki Kikuchi,<sup>1</sup> Chin-Rang Yang,<sup>1</sup> Lihe Chen,<sup>1</sup> Hyun Jun Jung,<sup>2</sup> Euijung Park,<sup>1</sup> Mark A. Knepper,<sup>1</sup> Epithelial Systems Biology Laboratory, Systems Biology Center <sup>1</sup>National Institutes of Health, Bethesda, MD; <sup>2</sup>Johns Hopkins University, Baltimore, MD.

**Background:** Mechanisms involved in compensatory hypertrophy of the kidney remain incompletely understood. New "-omic" methodologies have been recently introduced that have the potential of identifying complex mechanisms. Here we seek to identify the earliest signaling changes in the contralateral kidney after unilateral nephrectomy (UNx) in mice using next-generation sequencing and proteomics techniques."

**Methods:** Experiments were done in mice undergoing UNx and sham nephrectomy. At specific time points (24 hours and 72 hours) after surgery, the earliest first portion of the kidney proximal tubule (PT-S1) was manually micro-dissected and utilized for transcriptomic analysis by single-tubule small sample RNA-Seq and single-tubule ATAC seq. Furthermore, quantitative proteomic analysis was carried out using protein mass spectrometry.

**Results:** Kidney volume was already increased 24 hours after UNx, reaching a plateau at 72 hours. Quantitative morphometry in microdissected proximal tubules showed that significant increases in outer diameter and mean cell volume in proximal tubules, but no clear increase in the cell count per unit length. RNA-Seq in microdissected PT-S1 at 24 hours showed that peroxisome proliferator-activated receptor alpha (PPARA) target genes such as *Angptl4*, *Acot1*, *Cyp4a14*, *Fabp1*, *Hmgcs2* and *Mgll* were strongly upregulated in PT (confirmed statistically). Motif analysis (HOMER) of sequences corresponding to significantly upregulated single tubule ATAC-seq peaks revealed upregulation of binding site motifs corresponding to PPARA and HNF4A, both lipid-regulated transcription factors. Quantitative protein mass spectrometry revealed increased abundances of PPAR regulated proteins such as HMGCS2, CYP4A14 and ANGPTL4 at 24 hours, consistent with RNA-Seq results.

**Conclusions:** Compensatory growth of the kidney is associated with increased proximal tubule cell size, but not cell number. Early stages of compensatory hypertrophy are associated with altered fatty acid and cholesterol metabolism including anabolic pathways required for synthesis of new membranes needed for cell growth.

### SA-PO962

#### Pathophysiology and Molecular Characterization of a Novel Model of CKD and Left Ventricular Diastolic Dysfunction (CKD-LVDD Model)

Alejandro R. Chade,<sup>1</sup> Alfonso Eirin,<sup>2</sup> <sup>1</sup>The University of Mississippi Medical Center, Jackson, MS; <sup>2</sup>Mayo Clinic Minnesota, Rochester, MN.

**Background:** Chronic kidney disease (CKD) is an independent risk factor for the development of heart failure, but the underlying mechanisms remain unknown. We developed a translational swine model of CKD and left ventricular diastolic dysfunction (CKD-LVDD) that replicates human disease and showed that cardiac abnormalities associate with a marked renal release of inflammatory cytokines to the systemic circulation, suggesting a potential pathophysiological connection. We examined whether the cardiac transcriptomic landscape is altered in CKD-LVDD pigs compared to normal controls.

**Methods:** CKD-LVDD and normal pigs (n=6 each) were studied for 14 weeks. Cardiac morphology and function (echocardiography) and renal hemodynamics (multi-detector CT) were quantified *in vivo*. mRNA-sequencing studies were performed (n=3 each) and expression profiles for dysregulated (fold change >1.4 or <0.7 and p<0.05) mRNAs in CKD-LVDD pigs were functionally interpreted by gene ontology analysis. Cardiac remodeling, inflammation, calcium cycling, and mitochondrial morphology.

**Results:** Cardiac abnormalities in CKD-LVDD were associated to differentially expressed calcium signaling, mitochondrial, and inflammatory genes, accompanied by cardiac fibrosis, mitochondrial damage, M1 macrophage infiltration, and altered calcium cycling vs. normal controls.

**Conclusions:** Our integrated pathophysiology and molecular data from a translational model of disease may set the stage for future specific interventions to ameliorate the development of LVDD in CKD.

**Funding:** NIDDK Support, Other NIH Support - HL095638

Key: TH - Thursday; FR - Friday; SA - Saturday; OR - Oral; PO - Poster; PUB - Publication Only

Underline represents presenting author.



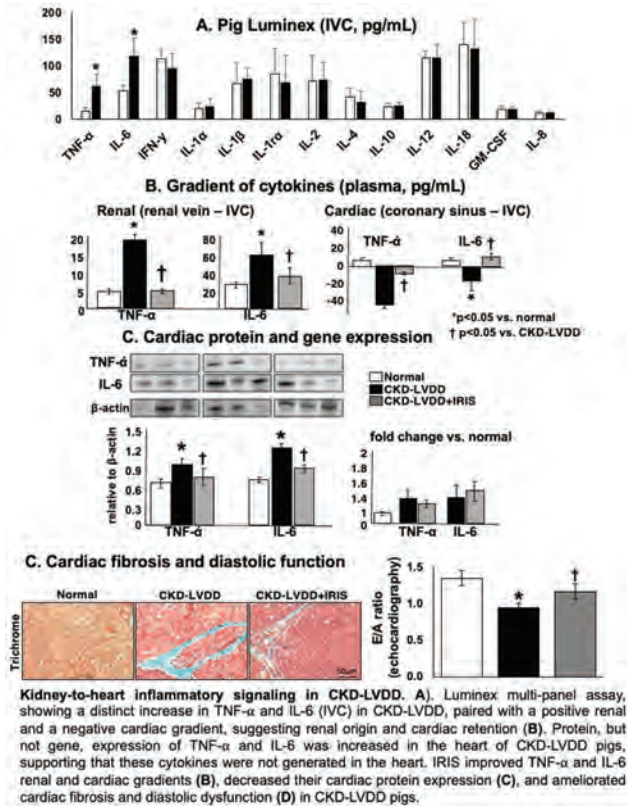
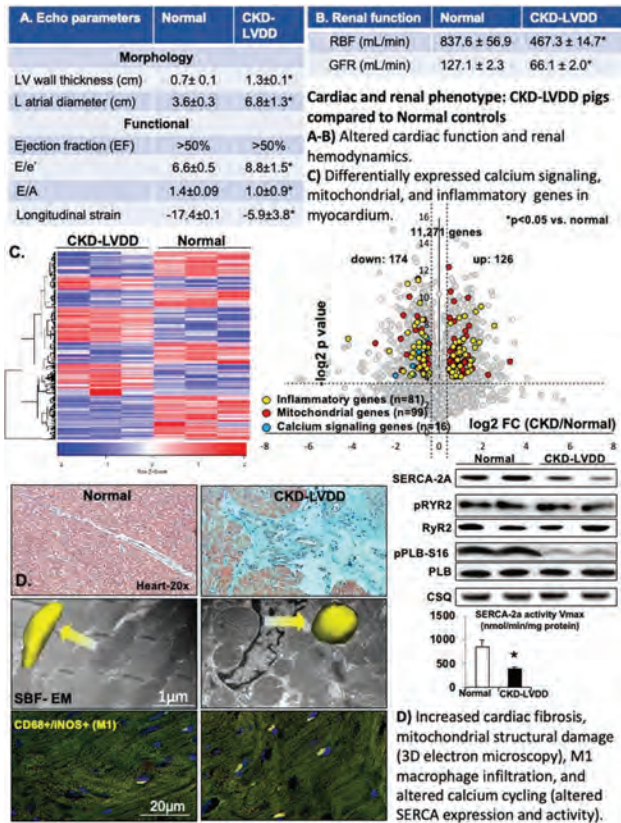

SA-PO963

**Pathophysiology of CKD-Left Ventricular Diastolic Dysfunction: Role of Renal TNF-α and IL-6 Inflammatory Signaling**  
 Alejandro R. Chade,<sup>1</sup> Alfonso Eirin,<sup>2</sup> <sup>1</sup>The University of Mississippi Medical Center, Jackson, MS; <sup>2</sup>Mayo Clinic Minnesota, Rochester, MN.

**Background:** Chronic kidney disease (CKD) is an independent risk factor for the development of heart failure, but their actual pathophysiological connection remains to be fully elucidated. We developed a translational swine model that recapitulates human CKD and left ventricular diastolic dysfunction (CKD-LVDD). We hypothesized that increased pro-inflammatory cytokine signaling of renal origin imposes cardiac structural and functional abnormalities in swine CKD-LVDD

**Methods:** CKD-LVDD pigs (n=6 each) were studied for 14 weeks, after inhibition of renal inflammatory signaling (IRIS) achieved by a single intra-renal administration of a biopolymer fused peptide inhibitor of NF-κB (SynB1-ELP-p50i) 8 weeks earlier. Untreated CKD-LVDD and Normal pigs served as controls (n=6 each). Using a specific pig Luminex, circulating levels (inferior vena cava blood, IVC) of inflammatory cytokines were measured. Tumor necrosis factor (TNF)-α and interleukin (IL)-6 levels were distinctly elevated, confirmed by (ELISA), also measured in renal vein (RV) and coronary sinus (CS) blood, and their renal (RV-IVC) and cardiac (CS-IVC) gradients quantified. Cardiac morphology, function (echocardiography), and fibrosis were also quantified.

**Results:** TNF-α and IL-6 levels were higher in CKD-LVDD (A), paired with a positive renal and a negative cardiac gradient (B), and increased cardiac protein, but not gene, expression levels (C). IRIS improved TNF-α and IL-6 renal and cardiac gradients (B), decreased their cardiac protein expression (C), and ameliorated cardiac fibrosis and diastolic dysfunction (D).

**Conclusions:** Our study supports a crosstalk between the kidney and the heart in CKD, suggesting that inflammatory signaling of renal origin (partly led by TNF-α and IL-6) may impose cardiac abnormalities towards development of LVDD in CKD.

**Funding:** NIDDK Support, Other NIH Support - HL095638

SA-PO964

**Circulating SIRPα Stimulates CKD-Induced Cardiomyopathy**  
 Jiao Wu, William E. Mitch, Sandhya S. Thomas. *Baylor College of Medicine, Houston, TX.*

**Background:** A major etiology of chronic kidney disease (CKD) is insulin resistance in CKD-induced cardiomyopathy. We have discovered a potential driver of insulin resistance, signal regulatory protein alpha (SIRPα) that circulates in response to CKD which adversely influences myocardial muscle.

**Methods:** Myotubes and cardiomyocytes, but not adipocytes treated with high glucose, or cardiomyocytes treated with uremic toxins stimulated secretion of SIRPα in culture media. Next, to determine myocardial-specific effects of suppressing SIRPα in CKD, csSIRPα<sup>-/-</sup> mice were created and subjected to subtotal nephrectomy and compared to flox mice with CKD. *In vivo* M-mode echocardiography imaging was utilized to determine myocardial function. csSIRPα<sup>-/-</sup> mice with CKD displayed improved ejection fraction %, fractional shortening %, and cardiac output when compared to flox littermate control mice with CKD.

**Results:** Myotubes and cardiomyocytes, but not adipocytes treated with high glucose, or cardiomyocytes treated with uremic toxins stimulated secretion of SIRPα in culture media. Next, to determine myocardial-specific effects of suppressing SIRPα in CKD, csSIRPα<sup>-/-</sup> mice were created and subjected to subtotal nephrectomy and compared to flox mice with CKD. *In vivo* M-mode echocardiography imaging was utilized to determine myocardial function. csSIRPα<sup>-/-</sup> mice with CKD displayed improved ejection fraction %, fractional shortening %, and cardiac output when compared to flox littermate control mice with CKD

**Conclusions:** These results suggest that skeletal or cardiac muscle are the origin of circulating SIRPα in response to uremia or hyperglycemia which stimulates its release. Importantly, cardioprotection from CKD was observed with myocardial suppression of SIRPα.

**Funding:** Private Foundation Support

SA-PO965

**The Gut Microbiome Regulates Glomerular Filtration Rate**  
 Jiaojiao Xu, Kunal Gupta, Jason Sanchez, Sepideh Gharraie, Hamid Rabb, Jennifer L. Pluznick. *Johns Hopkins University School of Medicine, Baltimore, MD.*

**Background:** Gut microbes influence physiology and pathophysiology. We hypothesized that gut microbes alter glomerular filtration rate (GFR).

**Methods:** Gut microbes were depleted using antibiotics in drinking water (ABX: 1g/L ampicillin, 1g/L neomycin, 0.5 g/L vancomycin). C57BL/6J male and female mice (6-weeks-old) were treated with ABX for 5 weeks, and GFR was measured by transcutaneous detection of FITC-sinistrin. Another cohort of mice were randomly assigned to four different groups (n=8 /sex/group): control diet (CD), high fat diet (HFD),

CD + ABX, HFD + ABX. After 9 weeks, we analyzed body weight (BW), non-fasting glucose, insulin, GFR, glucose tolerance test (GTT), and insulin tolerance test (ITT).

**Results:** Bacteria reduction with ABX treatment was confirmed by qPCR of fecal samples using pan-bacterial primers (Ct for Females, F: Ctrl 13±0.2 vs ABX 21±0.4; Males, M: 13±0.1 vs ABX 20±0.4, n=8). GFR increased with ABX (F: 172±11 vs ABX 229±8, p=0.03; M: 167±7 vs ABX 266±15 µl/min, p=0.02, n=8). Next, we measured GFR in germ-free (GF) mice (born and raised without gut microbes), conventional mice (Ctrl, born with gut microbes), and conventionalized GF mice (CGF, born without gut microbes but given oral gavage of a fecal slurry with gut microbes). GFR increased in GF mice (F: 286±23, p<0.001; M: 248±17, p=0.002) versus both conventional (F: 163±6; M: 186±5) and CGF (F: 185±21, p=0.003; M: 186±7, p=0.002, n=7-8). GFR also increases in high-fat diet (HFD) induced diabetic renal disease. To elucidate if mechanisms are similar, we measured GFR in mice on CD and HFD and/or with ABX. GFR was increased by HFD in both sexes. GFR in females was increased by ABX on CD (F: 182±13 vs. F+ ABX: 282±13; p=0.0005) and HFD (F: 290±20 vs. F+ ABX: 373±20; p=0.01). GFR in males increased with ABX on CD (M: 191±10 vs. M+ ABX: 263±10; p=0.04) but not HFD (M: 385±20 vs. M+ ABX: 390±33; NS). In both sexes, BW, GTT, and fasting glucose were affected by diet but not ABX. In females, ITT was affected by diet but not ABX. For males on a CD (but not HFD), ABX improved insulin responsiveness.

**Conclusions:** The absence (GF) and suppression (ABX) of gut microbes increase GFR. In females, the increased GFR from ABX and HFD are additive. The mechanisms of this microbe-GFR interaction merit further study.

**Funding:** NIDDK Support

## SA-PO966

### Gut Microbiota Modulates Gene Expression in the Kidney

Brittini Moore, Jiaojiao Xu, Jennifer L. Pluznick. Pluznick Lab Johns Hopkins University School of Medicine, Baltimore, MD.

**Background:** Gut microbes impact host gene expression in peripheral tissues; however, it is unknown whether gut microbes influence renal gene expression.

**Methods:** Germ-free (GF; lacking gut microbes) and conventionalized (Conv; GF mice given gut microbes by oral gavage at 4 wks of age) C57Bl/6J mice were compared by bulk RNA sequencing (RNA-Seq) of kidney, liver, and large intestine. At 8 wks of age, GF and Conv mice were sacrificed, tissues processed, and fecal pellets from Conv mice collected for 16S rRNA sequencing. Differentially expressed genes (DEGs) were defined as log<sub>2</sub> foldchange(log<sub>2</sub>fc) ≥ 0.5, p < 0.05, and baseline ≥ 15 TPM. For antibiotic-treated mice (ABX), conventional C57Bl/6 mice were given ampicillin (1g/L), neomycin (1g/L), and vancomycin (0.5g/L) in drinking water for 9 wks and kidneys were collected for real-time quantitative PCR (qPCR).

**Results:** Comparing Conv and GF mice (both sexes analyzed together, n=3-4/sex/condition) revealed 918 DEGs in kidney, 1701 in liver, and 1324 in large intestine. In males, 85% of kidney DEGs did not change in liver or large intestine. In females, 80% of DEGs were kidney-specific. 4 genes were changed in all 3 tissues in males (*Per1*, *Foxo3*, *Mt1*, *Mt2*), and 6 genes in females (*Per2*, *Mt1*, *Mt2*, *Jchain*, *Ext11*, *Lpl*). *Mt1* and *Mt2* were the only genes increased in GF mice in both sexes and in all 3 tissues. In kidney, *Mt1* expression was upregulated by log<sub>2</sub>fc = 1.10±0.22 (p<0.001) in GF vs Conv males (n=4,4), and by log<sub>2</sub>fc = 0.57±0.22 (p=0.01) in GF vs Conv females (n=4,4). *Mt2* was also increased in GF males (log<sub>2</sub>fc = 1.44±0.29, p < 0.001) and GF females (log<sub>2</sub>fc = 0.80±0.29, p = 0.006) vs Conv. To determine if changes in *Mt1* and *Mt2* are due to the absence of gut microbes, we performed qPCR using kidneys from ABX vs conventional mice (n=3 sex/condition). Although the trends in *Mt1* and *Mt2* were replicated in ABX samples, this only reached significance for *Mt2* in males (*Mt1* males: log<sub>2</sub>fc = 1.15±0.6, p=0.35; *Mt1* females: log<sub>2</sub>fc = 1.31±0.4, p=0.28; *Mt2* males: log<sub>2</sub>fc = 1.87±0.7, p=0.03; *Mt2* females: log<sub>2</sub>fc = 1.54±0.69, p=0.31). Finally, 16S rRNA sequencing showed *Verrucomicrobia* was more abundant in males (11.17% of gut microbes) compared to females (1.68%, p=0.005); no differences were observed in other phyla.

**Conclusions:** Renal gene expression is altered in GF mice. Genes regulated across tissues play roles in circadian entrainment (*Per1* and *Per2*) and zinc-binding (*Mt1* and *Mt2*).

**Funding:** NIDDK Support, Other U.S. Government Support

## SA-PO967

### Immune-Mediated Tubule Atrophy Promotes AKI to CKD Transition

Leyuan Xu, Jiankan Guo, Dennis G. Moledina, Lloyd G. Cantley. Yale School of Medicine, New Haven, CT.

**Background:** Incomplete repair after acute kidney injury (AKI) is associated with progressive loss of tubular cell function and development of chronic kidney disease (CKD).

**Methods:** We compared the kidney response to identical times of ischemic injury between mice subjected to unilateral ischemia-reperfusion kidney injury with contralateral nephrectomy (IRI/CL-NX, in which tubule repair predominates) or unilateral IRI with contralateral kidney intact (U-IRI, in which fibrosis and atrophy predominates). We performed single cell RNA-sequencing analysis on day 7, 14, and 30 after injury to identify major cell types in the kidney and the differential transcriptional response between the models in each cell type.

**Results:** The initial injury and early recruitment and activation of macrophages, dendritic cells (DCs), neutrophils, and T cells were similar through day 7 but markedly diverged afterwards between the two models. By day 14, kidneys subjected to U-IRI had greater numbers of macrophages with higher expression of *Ccl2*, *Ccl7*, *Ccl8*, *Ccl12*, and *Cxcl16*. These chemokines correlated with a second wave of *Ccr1*-positive neutrophils and *Cxcr6*-positive T cells, resulting in a proinflammatory milieu, accompanied by

increased expression of tubular cell injury, oxidative stress and major histocompatibility complex genes. This second wave of immune dysfunction led to a distinct profile of tubule injury with morphologic kidney atrophy and a decreased proportion of differentiated tubule cells. Combined depletion of neutrophils and T cells beginning on day 5 after U-IRI was found to reduce tubular cell loss and the associated kidney atrophy. In kidney biopsy samples from patients with AKI, the number of interstitial T cells and neutrophils negatively correlated with 6-month recovery of GFR.

**Conclusions:** Macrophage persistence after AKI promotes a T cell- and neutrophil-mediated proinflammatory milieu that leads to progressive tubule damage.

**Funding:** NIDDK Support

## SA-PO968

### Role of Proximal Tubule DPP4 in the Development and Progression of Obesity-Related Kidney Disease

Manoj K. Datta, Trupti Joshi, Sidharth Sen, Pallav Singh, Ricardo J. Restrepo, Jing Ren, Ravi Nistala. University of Missouri System, Columbia, MO.

**Background:** Western diet (WD) rich in refined sugars and fat, is associated with overnutrition and obesity that can lead to obesity related kidney disease (ORKD). We developed a mouse model of ORKD that mimics human ORKD in its pattern of initial glomerular hyperfiltration followed by decline in GFR, histopathological lesions in the form of proximal tubule brush border vacuolization and injury, basement membrane thickening, glomerular accumulation of fat globules and proteinuria. This model manifested increased proximal tubular (PT) expression and activity of Dipeptidyl Peptidase 4 (DPP4) causing activation of inflammatory pathways and fibrosis. The activation of pro-inflammatory cells and cytokines was suppressed by DPP4 inhibitors, global deletion of DPP4 & PT specific deletion of DPP4 which led to improvement in histopathological lesions and GFR. Therefore we hypothesized that PT DPP4 activation contributes to pathophysiological changes in ORKD.

**Methods:** PTWT and PTKO (Proximal Tubule specific DPP4 KO) mice were fed a WD and control chow (CD) till they were 6, 16 and 18-27 mths old. Unbiased gene expression analysis was performed on kidney tissue using Bulk RNAseq and mass spec.

**Results:** WD-feeding increased expression of DPP4 at all time-points and in comparison to CD-fed mice. WD-feeding increased gene expression of many pathways including pro-inflammatory cytokines/chemokines, growth pathways such as mTOR, MAPK, PI3K-Akt and NF-Kb and pathways such as Wnt, NAFLD and insulin resistance. Further analysis of differentially expressed genes revealed cell death/apoptosis gene (*trib3*, *fos*) expression was increased in the WD-fed WT animals. WD-fed PTKO showed reduction in expression of pro-survival genes and Wnt pathway genes. However, expression of other pro-inflammatory cytokines and growth pathway genes were largely unchanged or increased further suggesting modulation and/or compensatory increase in expression. This was confirmed with proteomic analysis on the same kidney tissue.

**Conclusions:** WD-feeding is associated with increased expression of DPP4 and genes in the pro-inflammatory, pro-survival and growth pathways. In PTKO mice, DPP4 expression is much reduced and those of select genes is modulated. Taken together, these results suggest that proximal tubular DPP4 activation contributes to pathophysiological changes in ORKD.

**Funding:** NIDDK Support

## SA-PO969

### Tubulovascular Protection of Protease-Activated Receptor-1 Deficiency During AKI-to-CKD Transition

Sarah W.Y. Lok, Wai Han Yiu, Yixin Zou, Jingyuan Ma, Loretta Y.Y. Chan, Sydney C. Tang. The University of Hong Kong, Hong Kong, Hong Kong.

**Background:** Thromboembolic event is evident in CKD patients with high risk of cardiovascular disease due to aberrant activation of the coagulation system. Endothelial cell injury leading to renal microvascular damage and rarefaction is a prominent feature in CKD. Our previous study demonstrates that protease-activated receptor-1 (PAR-1) inhibition by a clinically approved antagonist vorapaxar mitigates kidney fibrosis. However, its role in vascular damage following AKI contributing to CKD progression remains unexplored.

**Methods:** We employed the animal model of unilateral ischemia reperfusion (UIRI)-induced CKD to explore tubulovascular crosstalk of PAR-1 in AKI-to-CKD transition using transgenic PAR-1 deficient mice and vorapaxar treatment at different disease stages. Evans blue vascular permeability assay was performed to assess endothelial injury at both AKI and CKD stages.

**Results:** During AKI, mice with PAR-1 deficiency exhibited reduced renal inflammation, vascular injury and preserved capillary permeability. PAR-1 deficiency preserved kidney function and diminished tubulointerstitial fibrosis via TGF-β/Smad during transition phase to CKD. Maladaptive repair in the microvasculature after AKI exacerbated focal hypoxia with capillary rarefaction, which was rescued by Akt/GSK-3β-regulated stabilization of HIF and increase in VEGF in PAR-1 deficient mice. Chronic inflammation was prevented in PAR-1 deficient mice with reduced recruitment of infiltrating macrophages, and both M1- and M2- polarized macrophages. Finally, vorapaxar post-treatment after UIRI exerted greatest anti-fibrotic effect with alleviated ECM proteins and TGF-β1. Importantly, vascular regenerative capacity was higher in mice treated with vorapaxar during AKI, particularly showing significant increase of VEGF in full treatment and VEGFR2 in pre-treatment with vorapaxar.

**Conclusions:** Our findings elucidate a detrimental role of PAR-1 in vascular dysfunction and profibrotic responses upon tissue injury during AKI-to-CKD transition and provide an attractive therapeutic strategy for post-injury repair in AKI.

**Funding:** Health and Medical Research Fund (HMRF) of Hong Kong (grant no. 05163596), Research Grants Council of Hong Kong (General Research Fund, grant no. 17118720), the Mr & Mrs Tam Wing Fan Edmund Renal Research Fund and HKSN/HK Kidney Foundation Research Grant 2018.

#### SA-PO970

##### Glycolysis Regulates Kidney Repair After Ischemic Injury Through the Modulation of Intracellular pH and $\beta$ -Catenin Expression

Qingqing Wei,<sup>1</sup> Zheng Dong,<sup>1,2</sup> <sup>1</sup>Augusta University Medical College of Georgia, Augusta, GA; <sup>2</sup>Charlie Norwood Department of Veterans Affairs Medical Center, Augusta, GA.

**Background:** After acute injury, kidney will try to heal itself by preservation of functional renal cells and the failed renal repair may promote chronic kidney dysfunction. Meanwhile, the metabolism switch from oxidative phosphorylation to glycolysis has been noted in kidneys post-injury and experiencing chronic dysfunction. However, the role of glycolysis in kidney repair is unknown.

**Methods:** In this study, we tested a mouse model with inducible PKM2 (a key enzyme of glycolysis) knockout in renal tubular cells and found that these mice had similar level of renal fibrosis but better preserved renal proximal tubules and better renal function after 30 minutes of unilateral kidney ischemia and 2-week reperfusion (UI30/2wk) comparing to their wild-type litter mates, suggesting that glycolysis inhibition in renal tubules may enhance renal repair. Since glycolysis induction will lead to lactate accumulation and acidosis in kidney, we further explored whether the decreased intracellular pH can suppress wound healing and kidney repair.

**Results:** In vitro in cultured renal proximal tubule cells (RPTCs) with hypoxia treatment, when intracellular lactate accumulation was induced by  $\alpha$ -Cyano-4-hydroxycinnamic acid (CyA), there was significant intracellular pH decrease, which was partially reversed by glycolysis inhibition (shikonin to inhibit PKM2) or  $\text{NH}_4\text{Cl}$  to enhance intracellular pH. Concurrently, the scratched wound was healed much slower with CyA, accompanied with b-catenin increase. Either shikonin or  $\text{NH}_4\text{Cl}$  improved the wound healing speed with declined b-catenin. The delayed wound healing by CyA treatment was significantly enhanced if b-catenin was knockdown. In mice, the lactate was significantly accumulated after UI30/2wk in wild type kidney, which was relieved by PKM2 knockout. The accumulation of lactate in wild type kidneys after UI30/2wk was associated with b-catenin induction but less significant in PKM2 knockout kidneys. When renal acidosis was reduced by  $\text{NaHCO}_3$  treatment at 4 days after kidney ischemia, the mice showed better renal function and significantly more intact renal proximal tubules in kidney after 2-week reperfusion.

**Conclusions:** Altogether, the enhanced glycolysis after acute kidney injury may intracellular pH decrease with lactate accumulation, which will further suppress renal repair, potentially through the induction of b-catenin.

**Funding:** NIDDK Support, Veterans Affairs Support

#### SA-PO971

##### Hypermethylation of MicroRNA-219 Is an Anti-Fibrotic Mechanism in Maladaptive Kidney Repair by Preserving ALDH1L2

Qingqing Wei,<sup>1</sup> Zheng Dong,<sup>1,2</sup> <sup>1</sup>Augusta University Medical College of Georgia, Augusta, GA; <sup>2</sup>Charlie Norwood Department of Veterans Affairs Medical Center, Augusta, GA.

**Background:** Epigenetic mechanisms, such as DNA methylation and microRNAs, regulate maladaptive kidney repair including renal fibrosis. By global sequencing, we identified the hypermethylation of microRNA-219-2 (mir-219) gene in unilateral ureter obstruction (UO), 25 minutes of bilateral renal ischemia with 1 week reperfusion injury (I25/1wk), and 25 minutes of bilateral renal ischemia with 1 month reperfusion injury (I25/1M). mir-219 hypermethylation was further confirmed by pyro-sequencing. The hypermethylation was associated with downregulation of mir-219. Functionally, mir-219 overexpression enhanced fibronectin expression in cultured renal cells during hypoxia or TGF- $\beta$ 1 treatment. In mice, inhibition of mir-219 with anti-mir-219 LNA suppressed fibronectin accumulation in UO kidneys.

**Methods:** To understand how mir-219 regulates fibronectin expression, we performed RNA-induced silencing complex (RISC, the complex for microRNA to bind to its target) immunoprecipitation, followed by RNA-seq to identify the potential targets of mir-219.

**Results:** The potential candidate targets of mir-219 were further narrowed down to 5 (CANX, ALDH1L2, SMG1, NR2C2, CRTCI) after examination of the existence of predicted mir-219 binding sites in the seed sequence of the mRNAs accumulated in RISC, the conservation of the predicted mir-219 binding sites between species (in both human and mouse), and the reported expression level of the proteins in kidney. By screening the protein expression of these candidates, we found that mir-219 overexpression significantly suppressed ALDH1L2 in renal cells. In mice, mir-219 inhibition preserved ALDH1L2 expression in ureter obstructed kidneys. The functional binding site of mir-219 in the 3'-UTR of ALDH1L2 mRNA was further confirmed by luciferase assay. When ALDH1L2 was knockdown by siRNAs, obviously more fibronectin was induced in renal cells during TGF- $\beta$ 1 treatment.

**Conclusions:** In conclusion, mir-219-2 gene hypermethylation may suppress mir-219 expression. The downregulation of mir-219 may reduce renal fibrosis by repressing ALDH1L2.

**Funding:** NIDDK Support, Veterans Affairs Support

#### SA-PO972

##### BRCA1 Deletion Protects Mice From Kidney Fibrosis by Reducing G2/M Cell Cycle Arrest

Amrendra K. Ajay,<sup>1,2</sup> Akinwande A. Akinfolarin,<sup>1,2</sup> Venkata Sabbiseti,<sup>1,2</sup> Joseph V. Bonventre.<sup>1,2</sup> <sup>1</sup>Brigham and Women's Hospital, Boston, MA; <sup>2</sup>Harvard Medical School, Boston, MA.

**Background:** Injury to proximal tubular (PT) epithelial cells leads to fibrotic kidney disease. Toxic, ischemic, and obstructive kidney injuries lead to replication fork arrest and DNA double strand breaks, triggering the DNA damage repair mechanisms. Breast Cancer gene 1 (*Brcal*) is upregulated in response to DNA damage to help repair the damaged DNA. The function of *Brcal* is well investigated in cancer, recruiting RAD51 to the damaged DNA. We proposed that its effect to arrest the cell cycle might implicate it in fibrotic kidney disease.

**Methods:** *Slc34a1 Cre* mice were crossed with *Brcal* floxed mice yielding mouse models with PT *Brcal exon 11* gene deletion. After tamoxifen-induced Cre induction, mice were subjected to bilateral ischemia/reperfusion (BIRI), or aristolochic acid (AA)-induced fibrosis. The deletion of *Brcal exon 11* was confirmed by fluorescence in situ hybridization (FISH). Markers of DNA damage, cell cycle arrest, and senescence were evaluated by immunofluorescence staining. Kidney tissue lysates were evaluated using western blot, real-time PCR, and PicroSirius (PS) Red staining and markers of DNA damage, senescence, and interstitial fibrosis. HKC8 and HK-2 human PT epithelial cells (HPTECs) were transfected with either shRNA or siRNA and treated with either cisplatin or AA to investigate the injury associated with cell cycle stages, apoptosis, and senescence.

**Results:** BRCA1 protein expression was increased in human CKD kidneys. The expression of *Brcal exon 11* was increased following BIRI or AA. *Brcal* deletion protected mice from interstitial fibrosis when compared to control mice as shown by PS staining, fibronectin, collagen 1, and  $\alpha$ -smooth muscle actin ( $\alpha$ -SMA) following BIRI and AA. Western blot analysis of whole kidney cortex revealed reduction in CTGF, fibrogenic markers, collagen1, fibronectin and  $\alpha$ -SMA. PT *Brcal* depleted mouse had fewer pH3+ cells, a marker of G2/M cell cycle phase and reduced S- $\beta$ -Gal, a marker of senescence. shRNA or siRNA-induced reduction in BRCA1 in HPTECs reduced secretion of the proinflammatory cytokine IL-6 and sonic hedgehog following cisplatin or AA treatment.

**Conclusions:** BRCA1 induces interstitial fibrosis following tubular injury by inducing G2/M cell cycle arrest, cellular senescence, and secretion of profibrotic mediators.

**Funding:** NIDDK Support, Other NIH Support - American Heart Association

#### SA-PO973

##### CCL20 Blockade Mitigates the Progression of AKI to CKD

Kyung Don Yoo,<sup>1,2</sup> Mi-yeon Yu,<sup>3</sup> Kyu hong Kim,<sup>4</sup> Jehun Song,<sup>1,2</sup> Jinsuk Bae,<sup>1,2</sup> Sunhwa Lee,<sup>6</sup> Hyung Ah Jo,<sup>7</sup> Yong Chul Kim,<sup>4</sup> Dong Ki Kim,<sup>4,5</sup> Jong Soo Lee,<sup>1,2</sup> Yon Su Kim,<sup>4,5</sup> Seung Hee Yang.<sup>4,5</sup> <sup>1</sup>University of Ulsan College of Medicine, Songpa-gu, Seoul, Republic of Korea; <sup>2</sup>Ulsan University Hospital, Ulsan, Republic of Korea; <sup>3</sup>Hanyang University, Seongdong-gu, Seoul, Republic of Korea; <sup>4</sup>Seoul National University Hospital, Jongno-gu, Seoul, Republic of Korea; <sup>5</sup>Seoul National University College of Medicine, Seoul, Republic of Korea; <sup>6</sup>Kangwon National University Hospital, Chuncheon, Kangwon, Republic of Korea; <sup>7</sup>Inje University Ilsan Paik Hospital, Goyang, Republic of Korea.

**Background:** Chronic kidney injury promotes renal inflammation and oxidative stress, highlighting precondition for organ fibrosis. Here, we investigated how chemokine receptor CCR6 and its ligand can alter acute kidney injury (AKI) to chronic kidney disease (CKD).

**Methods:** Unilateral ischemia-reperfusion injury (uIRI) was induced for 30 minutes in 7- to 8-wk-old male C57BL/6 mice, and the animals were observed for 4 weeks. Meanwhile, rats with 5/6 nephrectomy were performed to evaluate transcriptome changes via RNA sequencing at 8 weeks. In vitro experiments, primary-cultured human tubular epithelial cells (hTECs) were cultured on hypoxia (5%  $\text{O}_2$ ,  $\text{CO}_2$ , and 90%  $\text{N}_2$ , 4days) and  $\text{H}_2\text{O}_2$ -induced oxidative stress (0.125mM, 3 days) conditions with/without CCL20 blocking antibody. In addition, CCR6/CCL20 expressions in kidney tissues of patients with CKD were assessed.

**Results:** In both animal models, the expression of CCL20 increased as inflammation and fibrosis increased. Therefore, a positive correlation was observed for CCL20 in fibrosis. Furthermore, CCL20 blockade in human tubular epithelial cells ameliorated apoptotic damage in a dose-dependent manner on hypoxia and ROS injury. Interestingly, the CCL20 blockade led to a more significant reduction of intracellular ROS, 8-OHdG, and ICAM-1 level. uIRI provoked CCR6 expression that showed a similar severity as patients with acute kidney disease (AKD) phenotype. We analyzed CCR6/CCL20 expression from 22/18/16 patients with CKD stages 1-2/3/4-5, respectively. Morphometry of CCR6/CCL20 co-expression revealed that CKD stage 3 patients were more likely to possess CCR6 expressions than CKD stage 1-2 patients (10.94% vs. 5.79%,  $p=0.001$ ). Together, kidney tissues of CKD patients frequently containing CCL20 cells showed a positive correlation with interstitial inflammation ( $p=0.001$ ). CCL20/CCR6 activation is associated with uIRI progression, and CCL20 may be an essential contributor.

**Conclusions:** CCR6/CCL20 inhibition could be a potential therapeutic target for managing AKD progression to CKD.

**Funding:** Other NIH Support - This work was supported by the Ulsan University Hospital Research Grant (UHH-2020-08).

## SA-PO974

**Human Immunodeficiency Virus Vpr Induces Severe Tubulointerstitial Damage With Progressive Fibrosis and Cystic Development**

Jia Fu,<sup>1</sup> Zeguo Sun,<sup>1</sup> Weijia Zhang,<sup>1</sup> Jeffrey B. Kopp,<sup>2</sup> Vivette D. D'Agati,<sup>3</sup> John C. He,<sup>1</sup> Kyung Lee.<sup>1</sup> *Icahn School of Medicine at Mount Sinai, New York, NY; <sup>2</sup>National Institute of Diabetes and Digestive and Kidney Diseases, Bethesda, MD; <sup>3</sup>Columbia University, New York, NY.*

**Background:** HIV-positive individuals are at increased risk for CKD and ESKD. HIV leads to a wide spectrum of glomerular and tubulointerstitial injuries, but molecular pathways by which HIV injures kidney cells are partly understood. Experimental mouse studies have implicated the key roles of Nef and Vpr in HIVAN pathogenesis. These studies also indicated that tubulointerstitial injury and inflammation occur secondary to glomerular injury, whereas human studies suggested a direct effect of HIV on tubular cells. In vitro studies demonstrated a salient role of Vpr on tubular injury, where Vpr induces DNA damage response, cell cycle arrest, and cytokinesis defects, resulting in apoptosis and polyploidy in a majority of cells and hyperproliferation in small subsets. To elucidate the pathogenic effects of Vpr in tubular injury in HIVAN, we examined the consequence of tubular Vpr expression in mice.

**Methods:** We generated mice expressing Pax8-rtTA and TetO-Vpr transgenes, which were induced with doxycycline (Pax8-Vpr). Histopathologic and marker analyses of tubular injury, fibrosis, cell cycle regulators, and apoptosis were performed in Pax8-Vpr kidneys over time. scRNAseq of Pax8-Vpr kidneys was performed to elucidate the pathways altered in Vpr-injured kidneys.

**Results:** Tubular Vpr expression led to progressive tubular atrophy, diffuse tubulointerstitial inflammation, and fibrosis, which were accompanied by prominent cortical cysts and kidney failure, but without proteinuria. Tubular cells of Pax8-Vpr kidneys displayed significant DNA damage and aberrant cell division, consistent with previous in vitro findings. scRNAseq analysis showed changes consistent with impairments in mitochondrial function and fatty acid oxidation and activation of various cell death pathways including ferroptosis in specific tubular cell subsets. Other subsets of tubular cells showed changes consistent with cell cycle deregulation and proliferation, suggestive of mechanisms involved in the expansion of cystic cells.

**Conclusions:** Our study demonstrates for the first time that the induction of an HIV gene specifically in tubular cells leads to severe tubulointerstitial injury and fibrosis, independent of HIV-mediated glomerulosclerosis and proteinuria. It also demonstrates tubular cell-specific gene expression changes induced by Vpr and its consequences in vivo.

**Funding:** NIDDK Support

## SA-PO975

**Loss of Soluble (Pro) Renin Receptor Attenuates Adenine Induced Kidney Disease**

Nirupama Ramkumar, Chunyan Hu, Deborah Stuart. *University of Utah Health, Salt Lake City, UT.*

**Background:** Cleavage of the extra-cellular domain of the (pro)renin receptor (PRR) yields a soluble fragment termed soluble PRR (sPRR). Elevated plasma sPRR levels have been described in patients with kidney disease and correlates with the stage of kidney disease. We previously demonstrated that loss of sPRR attenuated angiotensin-II induced hypertension and kidney injury. To further characterize the role of sPRR in chronic kidney disease and fibrosis, we used adenine diet to induce kidney disease in control and mutant mice with loss of sPRR.

**Methods:** Using CRISPR-Cas9, we developed a mouse model with site-directed mutagenesis of the PRR cleavage site. Male, 3-month old, mutant sPRR mice and littermate controls were treated with adenine diet (alternating between 0.25% and 0.15%) for 8 weeks. Only male mice were studied as the PRR gene is on the X-chromosome.

**Results:** Compared to controls, male mutant sPRR mice had markedly lower plasma sPRR levels (control:  $21.5 \pm 2.5$  vs mutant  $0.2 \pm 0.03$  ng/ml). Metabolic balance studies at the end of the study showed similar food intake and body weight between the two groups although water intake (control:  $6.9 \pm 0.4$  vs mutant:  $3.6 \pm 0.3$  ml/24 hrs,  $p < 0.001$ ) and urine volume (control:  $5.9 \pm 0.2$  vs mutant:  $2.9 \pm 0.5$  ml/24 hrs,  $p = 0.001$ ) was significantly lower in mutant sPRR mice. Mutant sPRR mice also had lower BUN (control:  $67.4 \pm 3.1$  vs mutant:  $42.9 \pm 2.2$  mg/dl  $p < 0.01$ ), serum creatinine (control:  $1.59 \pm 0.1$  vs mutant:  $1.21 \pm 0.04$  mg/dl,  $p < 0.01$ ) and urinary excretion of albumin (control:  $92.6 \pm 7.5$  vs mutant:  $47.1 \pm 5.7$  ug/day,  $p < 0.01$ ) and kidney injury molecule (KIM-1) (control:  $155 \pm 10$  vs  $75 \pm 5$  ng/day,  $p < 0.01$ ) compared to controls. Renal histology demonstrated significant tubular and interstitial injury with minimal glomerulosclerosis in control mice treated with adenine diet while injury was significantly reduced in mutant sPRR mice. Bulk RNA sequencing of whole kidney lysates showed 135 upregulated genes and 167 downregulated genes with pathway analyses suggesting downregulation of Jak/Stat, Mapk and TGF- $\beta$  signaling in the mutant sPRR mice.

**Conclusions:** Loss of sPRR attenuates adenine diet induced kidney disease likely via downregulation of inflammatory and fibrotic signaling pathways. Studies to delineate how sPRR mediates renal tubular injury and fibrosis are currently ongoing.

## SA-PO976

**Decreasing T-Cell Activation Inhibits Progressive Renal Injury in Obese Dahl Salt-Sensitive Rats Before Puberty**

Ubon S. Ekperikpe, Denise C. Cornelius, Jan M. Williams. *The University of Mississippi Medical Center, Jackson, MS.*

**Background:** Childhood obesity is growing at an alarming rate and is now considered a risk factor for renal injury and the development of chronic kidney disease later in life. Recently, we reported that the obese Dahl salt-sensitive leptin receptor mutant (SS<sup>lepr</sup> mutant) rat develops renal injury before puberty that was associated with increased T-cell infiltration and activation. The current study investigated the effect of abatacept on renal inflammation and the progression of renal injury in SS<sup>lepr</sup> mutant rats before puberty.

**Methods:** Four-week-old SS and SS<sup>lepr</sup> mutant rats were treated with either vehicle (PBS) or abatacept (1 mg/kg; ip, every other day) for 4 weeks. Proteinuria was measured every two weeks until the rats reached 8 weeks of age. At the end of the study, MAP (via chronic catheter) was measured, and the kidneys were collected to measure renal cytokine levels and the infiltration of immune cells (via ELISA and flow cytometry). Renal histopathology analysis was performed as well to determine glomerular/tubular injury and renal fibrosis.

**Results:** We did not observe any differences in MAP across the groups. While proteinuria rose from  $8 \pm 3$  to  $47 \pm 18$  mg/day in SS rats, proteinuria markedly increased from  $68 \pm 17$  to  $434 \pm 73$  mg/day in SS<sup>lepr</sup> mutant rats. Treatment with abatacept decreased proteinuria by almost 50% in SS<sup>lepr</sup> mutant rats ( $265 \pm 47$  mg/day;  $p < 0.05$ ) without affecting SS rats ( $26 \pm 7$  mg/day). We observed a significant increase in T-cell infiltration and activation in SS<sup>lepr</sup> mutant rats versus SS rats, and treatment with abatacept significantly reduced this response. Renal macrophage inflammatory protein-3 alpha (MIP-3 $\alpha$ ) was significantly increased, while interleukin-4 (IL-4) was markedly decreased in SS<sup>lepr</sup> mutant vs SS rats ( $20 \pm 2$  vs  $6 \pm 1$  pg/mg, and  $15 \pm 2$  vs  $42 \pm 6$  pg/mg, respectively;  $p < 0.05$ ), and treatment with abatacept significantly decreased renal MIP-3 $\alpha$ , while increasing IL-4 in SS<sup>lepr</sup> mutant rats, without affecting SS rats. We observed significant increases in glomerular and tubular injury and renal fibrosis in SS<sup>lepr</sup> mutant rats compared to SS rats, and treatment with abatacept decreased these renal parameters in SS<sup>lepr</sup> mutant rats.

**Conclusions:** These data suggest that anti-inflammatory strategies may be beneficial in managing renal injury associated with childhood obesity.

**Funding:** NIDDK Support, Other NIH Support - HL151407

## SA-PO977

**Increased Renal Elimination of Endogenous and Synthetic Pyrimidine Nucleosides in Concentrative Nucleoside Transporter 1 Deficient Mice**

Rajgopal Govindarajan,<sup>1</sup> Shipra Agrawal,<sup>2</sup> Tejinder Kaur,<sup>1</sup> Syed Saqib Ali,<sup>1</sup> Debasis Nayak.<sup>1</sup> *The Ohio State University, Columbus, OH; <sup>2</sup>Nationwide Children's Hospital, Columbus, OH.*

**Background:** Concentrative nucleoside transporters (CNTs) are active nucleoside influx systems, but their in vivo roles are poorly defined.

**Methods:** We generated and characterized global CNT1 knockout (KO) mice to study the role of CNT1 in the renal reabsorption of pyrimidine nucleosides. Mass Spectrometry based metabolomic analyses of mouse urine and plasma samples were conducted to identify changes in small molecules. Orthotopic implantation of pancreatic cancer cells in WT and KO mice was conducted to study the efficacy of chemotherapeutics in tumor-bearing mice. IVIS bioluminescence imaging was conducted to evaluate tumor burden. Kaplan-Meier analysis was conducted to changes in survival.

**Results:** CRISPR/Cas9 deletion of CNT1 in mice increased the urinary excretion of endogenous pyrimidine nucleosides with compensatory alterations in purine nucleoside metabolism but without impairment of fertility or survival. In addition, CNT1 KO mice exhibited high urinary excretion of the intravenously administered nucleoside analog drug gemcitabine (dFdC), which resulted in decreased systemic drug exposure. However, the increased urinary clearance of dFdC rendered this chemotherapeutic drug ineffective in controlling tumor burden and preventing mortality in CNT1 KO mice orthotopically implanted with syngeneic Kras/p53-mutated mouse pancreatic ductal adenocarcinoma cells. Interestingly, increasing the dFdC dose to attain an area under the concentration-time curve level equivalent to that achieved by wild-type (WT) mice rescued antitumor efficacy and survivability in CNT1 KO mice.

**Conclusions:** These findings provide new insights into how CNT1 regulates reabsorption of endogenous and synthetic nucleosides in murine kidneys and suggest that the functional status of CNTs should account for the optimal action of pyrimidine nucleoside analog therapeutics in humans. In addition, our studies propose that CNT1 KO mice are an excellent model to further study the role of CNT1 in nucleoside drug-drug interactions, CNT1 genetic polymorphisms, and SLC28A1-mutated human inborn errors of metabolism.

**Funding:** Other NIH Support - NIGMS

## SA-PO978

**Role of Apoptotic Cells in Mediating Progressive CKD**

Sylvia Cechova, Nabin Poudel, Mark D. Okusa, Peter I. Lobo. *Division of Nephrology and Center for Immunity, Inflammation and Regenerative Medicine University of Virginia, Charlottesville, VA.*

**Background:** Chronic kidney disease (CKD) is primarily caused by diabetes, hypertension, and acute kidney injury (AKI), but the pathophysiological mechanism leading to the progression of CKD is still not completely understood. Primarily, CKD

progression is attributed to intra-glomerular hypertension and renal tubular damage induced by hyperglycemia leading to proteinuria. Recently, several investigators have suggested that failed repair of renal tubules, damaged during AKI, contribute to pathogenesis of CKD progression. In this present study, we investigated the role of continued apoptotic cell death, post-AKI, in mediating CKD progression.

**Methods:** We performed unilateral ischemia reperfusion injury (u-IRI; 30 min) on C57BL/6 mice to induce CKD. Group 1 mice were subjected to nephrectomy on the non-ischemic contralateral kidney on day 4, and were euthanized on day 7. Group 2 mice underwent nephrectomy on day 27 and were euthanized on day 28. We collected plasma and kidney tissues. The relative mRNA expression of fibrotic, and pro-apoptotic genes were estimated by real-time PCR. To evaluate extent of kidney injury, we measured plasma creatinine and stained kidney section with Masson's Trichrome to quantitate the degree of fibrosis. Additionally, we performed Western blotting to quantify the level of cleaved Caspase 3 in the kidney tissue lysates and stained kidney section with cleaved Caspase 3 antibody.

**Results:** We observed significant upregulation of fibrotic and pro-apoptotic genes in Group 1 mice compared to Group 2 mice. IRI injured kidney progressed to CKD: day 7 plasma creatinine 0.72±0.13mg/dl for Group1 and day 28 plasma creatinine: 2.44±0.29 mg/dl; P=0.0006; n=5 for Group2. Masson's Trichrome staining revealed that Group 1 mice sustained significantly less injury when compared to Group 2. Additionally, there was no decrease in apoptosis with CKD progression; with Western blotting (Relative c-cleaved Caspase 3 protein level: Group 1: 1.01±0.13; Group 2: 1.43±0.18, P=NS; n=3), and with HRP-cleaved Caspase 3 staining, on day 28, there was more apoptosis and more CKD injury than on day 7 after IRI.

**Conclusions:** Our data suggest that apoptotic cells play a role in both phases i.e. during the acute phase of IRI and in the progressive CKD phase. However, further studies are necessary to elucidate the contribution of apoptotic signaling pathway to progression of CKD.

**Funding:** NIDDK Support

### SA-PO979

#### Chemerin/ChemR23 Axis: A New Therapeutic Target for Uraemic Sarcopenia

Luke A. Baker,<sup>1,2</sup> Thomas J. Wilkinson,<sup>1,2</sup> Milly Abbott,<sup>1</sup> Daniela F. Cardoso,<sup>3</sup> Nicola Parker,<sup>1</sup> Matthew Graham-Brown,<sup>1,4</sup> Joao L. Viana,<sup>3</sup> Emma L. Watson,<sup>1,2</sup> Alice C. Smith,<sup>1,2</sup> <sup>1</sup>University of Leicester College of Life Sciences, Leicester, United Kingdom; <sup>2</sup>NHRR Leicester Biomedical Research Centre, Leicester, United Kingdom; <sup>3</sup>Instituto Universitario da Maia, Castelo da Maia, Portugal; <sup>4</sup>University Hospitals of Leicester NHS Trust, Leicester, United Kingdom.

**Background:** People with chronic kidney disease (CKD) often experience muscle quality, wasting and dysfunction contributing to a reduced quality of life and increased risk of morbidity and mortality. The adipokine chemerin is associated with CKD progression and involved in inflammatory-related signalling processes. With chronic inflammation recognised as a key factor in uraemic sarcopenia, we aimed to investigate the potential role of chemerin as a uraemic toxin in CKD and identify the mechanisms of action to elucidate therapeutic opportunities in uraemic sarcopenia.

**Methods:** Chemerin levels from EDTA-plasma and urine samples were quantified via ELISA on basal samples from non-CKD controls (CON, n=32), CKD patients (CKD, n=100), and kidney transplant recipients (KTR, n=20). Chemerin levels were correlated with eGFR and measures of body composition, physical performance, muscle mass, and muscle quality. A sub-set of participants from each group underwent skeletal muscle biopsies and samples were processed for gene and protein analysis, or cells extracted for *in-vitro* experimentation.

**Results:** Higher chemerin concentrations were found in the urine of those with CKD compared to non-CKD controls (p<0.001). Higher circulating chemerin was associated with lower eGFR (p<0.001, r=-0.571). Positive correlations with body fat % and BMI were noted in CKD patients. Higher circulatory chemerin was associated with poorer muscle quality (r=-0.396, p=0.003). No associations were noted across other *in-vitro* muscle related assessments. Molecular analysis detected the presence of 2 out of 3 receptors of interest for chemerin in skeletal muscle, but no significant elevation in the expression in of chemerin itself in this tissue type in those with CKD. *In-vitro* analysis showed that the exposure of CKD derived muscle cells to chemerin induced a significant inflammatory response (IL-6 p<0.001; TNFa p=0.0215), which was halved using the ChemR23 receptor inhibitor aNETA (IL-6 p<0.001; TNFa p<0.001).

**Conclusions:** We report that chemerin is a uraemic toxin in those with CKD and that it may contribute to poorer muscle quality in these people. Chemerin can moderate indicators of inflammation within skeletal muscle via the activation of ChemR23 and as such proposes a new therapeutic target to alleviate the symptoms of uraemic sarcopenia.

### SA-PO980

#### Urine Ammonium Excretion Helps Identify High Dietary Acid Intake in Patients With Early-Stage CKD and Eubicarbonatemic Acidosis

Nimrit Goraya,<sup>1</sup> Nicolaos E. Madias,<sup>2</sup> Abdullah A. Mamun,<sup>4</sup> Jan Simoni,<sup>5</sup> Donald E. Wesson.<sup>3</sup> <sup>1</sup>Baylor Scott and White Central Texas, Temple, TX; <sup>2</sup>Tufts University School of Medicine, Boston, MA; <sup>3</sup>The University of Texas at Austin Dell Medical School, Austin, TX; <sup>4</sup>Baylor Scott & White Health, Dallas, TX; <sup>5</sup>Texas Tech University, Lubbock, TX.

**Background:** Better estimated glomerular filtration rate (eGFR) preservation in patients with Stage 2 chronic kidney disease (CKD) and normal plasma total CO<sub>2</sub> (PTCO<sub>2</sub>) despite acid (H<sup>+</sup>) retention (i.e., with eubicarbonatemic acidosis) was associated

with lower H<sup>+</sup> retention. Reduced dietary H<sup>+</sup> with ether oral NaHCO<sub>3</sub> or base-producing foods reduced H<sup>+</sup> retention and so dietary H<sup>+</sup> reduction might be kidney-protective in this setting. Even so, tabulating food intake then estimating potential renal acid load (PRAL) is challenging in clinical settings. We explored if urine excretion of citrate (UcitV), a metabolite that defends against H<sup>+</sup> accumulation, or ammonium (UNH<sub>4</sub>+V), a buffer whose urine excretion increases with an H<sup>+</sup> challenge, can evaluate dietary H<sup>+</sup> assessed by PRAL in patients with early-stage CKD (stage 2) and eubicarbonatemic acidosis for whom kidney protective interventions are most beneficial.

**Methods:** We measured 8-hour UcitV (8h UcitV) and 8-hour (8h UNH<sub>4</sub>+V) in participants with PTCO<sub>2</sub> ≥22 mM and CKD 2 (eGFR [mean (SD) ml/min/1.73 m<sup>2</sup>]=73.8 (6.3), n=167) or CKD 1 [eGFR=99.2 (7.3), n=62] due to macroalbuminuric, non-diabetic nephropathy. We compared these urine parameters across groups and performed linear regressions (LR) with PRAL within groups. We assessed H<sup>+</sup> retention by comparing observed to expected increase in PTCO<sub>2</sub> in response to retained HCO<sub>3</sub><sup>-</sup> (dose-urine excretion) 2 hours after an oral NaHCO<sub>3</sub> bolus (0.5 mEq/Kg bw), assuming 50% body weight HCO<sub>3</sub><sup>-</sup> space of distribution.

**Results:** H<sup>+</sup> retention [mean (SD), mmol] was higher in CKD 2 than CKD 1 [18.2 (12.4) vs. 3.8 (12.5), mmol, p<0.01]. CKD 2 vs. CKD 1 had lower 8h UcitV [1.00 (0.22) vs. 1.14 (0.03) mmol, p<0.01] but 8h UNH<sub>4</sub>+V (mEq/8h) was not different [14.1 (2.6) vs. 14.7 (2.5), p=0.24]. LR for 8h UcitV vs. PRAL was negative for CKD 1 (p<0.01, r<sup>2</sup>=0.15) and negative but not significant for CKD 2 (p=0.65, r<sup>2</sup>=0.01). LR for 8h UNH<sub>4</sub>+V was positive and significant for both CKD 1 (p<0.01, r<sup>2</sup>=0.14) and CKD 2 (p<0.01, r<sup>2</sup>=0.08). Adding UNH<sub>4</sub>+V to UcitV in the regression increased r<sup>2</sup> for CKD 1 (0.15 to 0.21) but not CKD 2 (0.08 to 0.06).

**Conclusions:** In patients with CKD and eubicarbonatemic acidosis, UNH<sub>4</sub>+V was positively associated with dietary H<sup>+</sup> intake as assessed by PRAL and should be further explored as an indicator of high dietary H<sup>+</sup>.

### SA-PO981

#### Urine Excretion of Citrate and Ammonium to Non-Invasively Identify Eubicarbonatemic Acidosis in Patients With CKD

Nimrit Goraya,<sup>1</sup> Nicolaos E. Madias,<sup>2</sup> Abdullah A. Mamun,<sup>4</sup> Jan Simoni,<sup>5</sup> Donald E. Wesson.<sup>3</sup> <sup>1</sup>Baylor Scott and White Central Texas, Temple, TX; <sup>2</sup>Tufts University School of Medicine, Boston, MA; <sup>3</sup>The University of Texas at Austin Dell Medical School, Austin, TX; <sup>4</sup>Baylor Scott and White North Texas, Dallas, TX; <sup>5</sup>Texas Tech University System, Lubbock, TX.

**Background:** Increasing acid (H<sup>+</sup>) retention while plasma total CO<sub>2</sub> (PTCO<sub>2</sub>) remained normal (eubicarbonatemic acidosis) during chronic kidney disease (CKD) progression was associated with decreasing urine citrate excretion (UcitV). Increasing positive H<sup>+</sup> balance while PTCO<sub>2</sub> remained normal in patients with CKD progression was associated with decreased urine ammonium excretion (UNH<sub>4</sub>+V). We explored if the combination of UcitV and UNH<sub>4</sub>+V, than either alone, better identified H<sup>+</sup> retention, in patients with CKD and eubicarbonatemic acidosis.

**Methods:** We recruited 313 macroalbuminuric, non-diabetic participants with eGFR [mean (SD), ml/min/1.73 m<sup>2</sup>] for CKD 1 [n=62, 99.2 (7.3)], CKD 2 (n=167, 73.8 (6.3)), and CKD 3 (n=84, 39.9 (6.7)) without metabolic acidosis (PTCO<sub>2</sub> ≥ 22 mM). We assessed H<sup>+</sup> retention by comparing observed to expected increase in PTCO<sub>2</sub> in response to retained HCO<sub>3</sub><sup>-</sup> (dose-urine excretion) 2 hours after an oral NaHCO<sub>3</sub> bolus (0.5 mEq/ Kg bw), assuming 50% body weight HCO<sub>3</sub><sup>-</sup> space of distribution. We compared 8-hour UcitV (8h UcitV) and UNH<sub>4</sub>+V (8h UNH<sub>4</sub>+V) across groups and performed linear regressions (LR) with H<sup>+</sup> retention within groups.

**Results:** With advancing CKD, H<sup>+</sup> retention [mean (SD), mmol] progressively increased [CKD 1= 3.8 (12.5), CKD 2=18.2 (12.4), CKD 3=25.6 (9.0), p<0.01]. With advancing CKD, 8h UcitV (mmol/8h) progressively decreased [CKD 1=1.14 (0.03), CKD 2=1.00 (0.22), CKD 3=0.87 (0.9), p<0.01]. By contrast, 8h UNH<sub>4</sub>+V (mEq/8h) was not different between CKD 2 vs. CKD 1 [14.1 (2.6) vs. 14.7 (2.5), respectively, p=0.24] but was lower in CKD 3 [13.0 (2.3)] than either CKD 2 or CKD 1 (p<0.01). LR for UcitV vs. H<sup>+</sup> retention was negative for both CKD 2 (p<0.01, r<sup>2</sup>=0.61) and CKD 3 (p<0.01, r<sup>2</sup>=0.75) but was not significant for CKD 1 (p=0.50, r<sup>2</sup>=0.04). LR for UNH<sub>4</sub>+V vs. H<sup>+</sup> retention was positive for CKD 2 (p<0.04, r<sup>2</sup>=0.05) and negative for CKD 3 (p<0.01, r<sup>2</sup>=0.80) but not significant for CKD 1 (p=0.14, r<sup>2</sup>=0.05). Adding UNH<sub>4</sub>+V to UcitV in the regression increased r<sup>2</sup> marginally for CKD 2 (0.61 to 0.63) and CKD 3 (0.75 to 0.79).

**Conclusions:** The data show that lower UcitV identified higher H<sup>+</sup> retention in eubicarbonatemic patients with CKD 2 or CKD 3 but the UNH<sub>4</sub>+V vs. H<sup>+</sup> retention relationship diverged between CKD 2 and CKD 3. Adding UNH<sub>4</sub>+V to UcitV marginally enhanced its predictive power.

### SA-PO982

#### Urine Citrate Excretion Better Identifies Eubicarbonatemic Acidosis Than Plasma Acid-Base Parameters in Patients With CKD

Nimrit Goraya,<sup>1</sup> Nicolaos E. Madias,<sup>2</sup> Abdullah A. Mamun,<sup>4</sup> Donald E. Wesson,<sup>3</sup> Jan Simoni.<sup>5</sup> <sup>1</sup>Baylor Scott & White Medical Center Temple, Temple, TX; <sup>2</sup>Tufts Medical Center, Boston, MA; <sup>3</sup>Dell Seton Medical Center at The University of Texas, Austin, TX; <sup>4</sup>Baylor Scott & White Health, Dallas, TX; <sup>5</sup>Texas Tech University Health Sciences Center, Lubbock, TX.

**Background:** Acid (H<sup>+</sup>) mitigating mechanisms help maintain normal plasma total CO<sub>2</sub> (PTCO<sub>2</sub>) in patients with chronic kidney disease (CKD) and reduced estimated glomerular filtration rate (eGFR) despite H<sup>+</sup> retention or positive H<sup>+</sup> balance (i.e., eubicarbonatemic acidosis). Current guidelines recommend oral alkali treatment of metabolic acidosis in CKD only for patients with PTCO<sub>2</sub> < 22 mM, thereby excluding

**Key: TH - Thursday; FR - Friday; SA - Saturday; OR - Oral; PO - Poster; PUB - Publication Only**

**Underline represents presenting author.**

those with eubicarbonatemic acidosis for whom oral alkali might slow CKD progression (AJP 317: F502, 2019). We tested if variances in urine excretion of citrate (UcitV), a metabolite that defends against H<sup>+</sup> retention, better identifies eubicarbonatemic acidosis in early-stage CKD (stage 2) than variances in plasma acid-base parameters.

**Methods:** We compared H<sup>+</sup> retention, plasma acid-base parameters, and UcitV between participants with PTCO<sub>2</sub> ≥22 mM and CKD 2 (eGFR [mean (SD) ml/min/1.73 m<sup>2</sup>] =73.8 (6.3), n=167) or CKD 1 [eGFR=99.2 (7.3), n=62] due to macroalbuminuric, non-diabetic nephropathy. We assessed H<sup>+</sup> retention by comparing observed to expected increase in PTCO<sub>2</sub> in response to retained HCO<sub>3</sub><sup>-</sup> (dose-urine excretion) 2 hours after an oral NaHCO<sub>3</sub> bolus (0.5 mEq/Kg bw), assuming 50% body weight HCO<sub>3</sub><sup>-</sup> space of distribution. We measured venous plasma bicarbonate (PHCO<sub>3</sub><sup>-</sup>), PCO<sub>2</sub>, pH (PpH), PTCO<sub>2</sub>, and 8-hour UcitV (8h UcitV).

**Results:** H<sup>+</sup> retention [mean (SD), mmol] was higher in CKD 2 than CKD 1 [18.2 (12.4) vs. 3.8 (12.5), mmol, p<0.01]. CKD 2 vs. CKD 1 participants had lower PTCO<sub>2</sub> [25.2 (1.2) vs. 25.9 (1.2) mM, p<0.01], PHCO<sub>3</sub><sup>-</sup> [24.0 (1.3) vs. 24.7 (1.2) mEq/L, p<0.01], PCO<sub>2</sub> [40.1 (1.2) vs. 41.0 (0.9) mm Hg, p<0.01] but no difference in PpH [7.397 (0.014) vs. 7.399 (0.016), p=0.31]. CKD 2 vs. CKD 1 8h UcitV was lower [1.00 (0.22) vs. 1.14 (0.03) mmol, p<0.01].

**Conclusions:** Substantially greater H<sup>+</sup> retention in CKD 2 than CKD 1 participants was associated with statistically but quantitatively minor decreases in plasma acid-base parameters, supporting the effectiveness of body mechanisms that mitigate against retained H<sup>+</sup> but challenging utility of plasma acid-base parameters to identify eubicarbonatemic acidosis. Conversely, UcitV was both statistically and substantially lower in CKD 2 than CKD 1, supporting this parameter as a better indicator of eubicarbonatemic acidosis in patients with early-stage CKD.

### SA-PO983

#### Increased Severity of CKD in Response to High Potassium Intake Depends on Mineralocorticoid Receptor Activation

Valerie Olivier, Eric Feraille. PHYME Université de Geneve, Geneve, Switzerland.

**Background:** Dietary treatment is seminal for the management of chronic kidney disease (CKD). The effects of potassium intake on CKD progression are controversial. The aim of the project was to assess the effects of potassium intake on CKD progression.

**Methods:** We used 2 mouse models of CKD to analyze the effects of potassium diet on kidney injury: the unilateral ureteral obstruction (UO) performed in wild type mouse, as an obstructive CKD model, and the POD-ATTAC mouse, as a glomerular CKD model. The POD-ATTAC mouse model displays a podocyte-specific apoptosis after the administration of a chemical inducer. We also studied the role of the mineralocorticoid receptor (MR) using the MR antagonist spironolactone in POD-ATTAC mice and UO in kidney tubule epithelial cell-specific MR KO mice.

**Results:** In UO and POD-ATTAC mice, high potassium diet increased interstitial fibrosis quantified by Sirius red staining of kidney slices (Fig.1). High potassium diet also increased the abundance of the extracellular matrix protein fibronectin and decreased the expression levels of the epithelial marker Na<sup>+</sup>-K<sup>+</sup> ATPase, assessed by Western blot. Consistently, POD-ATTAC mice fed with high potassium diet displayed lower glomerular filtration rate (Fig.1) and decreased peritubular capillary network assessed by CD34 staining. Spironolactone decreased fibrosis induced by high potassium diet in POD-ATTAC mice. However, tubular-specific MR knockdown did not improve the fibrotic lesions induced by UO under normal or high potassium diet. High potassium diet led to enhanced kidney inflammation and to a proinflammatory macrophage phenotype, which were reversed under spironolactone.

**Conclusions:** High potassium intake induces enhanced inflammation and accelerated fibrosis leading to decreased kidney function in 2 mouse models of CKD. Non-tubular MR plays a pivotal role in potassium-induced fibrosis. The effect of reducing potassium intake, as a way to slowdown CKD progression should be assessed in future clinical trials.

**Funding:** Private Foundation Support

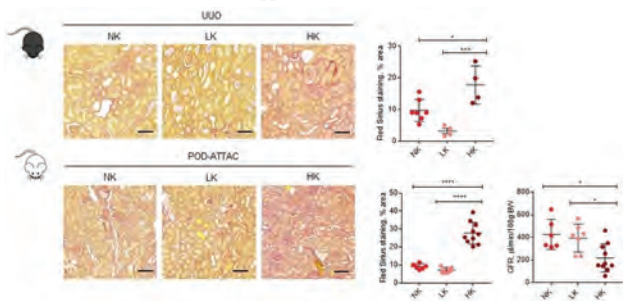

**Figure 1:** Mice were subjected to low (LK), normal (NK) or high potassium (HK) diet before urinary obstruction (UO) or induction of glomerular disease (POD-ATTAC) until the end of experiment. Kidney fibrosis was then assessed by Sirius red staining of collagen and the fibrotic area was quantified. GFR was measured in POD-ATTAC mice.

### SA-PO984

#### Suppressing Delayed Rectifier Potassium Channels (Kv1.3) in T Lymphocytes and Its Therapeutic Efficacy in Rats With CKD

Itsuro Kazama. Miyagi Daigaku, Kurokawa-gun, Japan.

**Background:** T lymphocytes predominantly express delayed rectifier K<sup>+</sup>-channels (Kv1.3) in their plasma membranes. In our previous study, we revealed that the overexpression of lymphocyte Kv1.3-channels contributed to the progression of chronic kidney disease (CKD) by promoting cellular proliferation and interstitial fibrosis. On the other hand, by suppressing the lymphocyte Kv1.3-channels, some drugs exert immunosuppressive properties.

**Methods:** Employing the standard patch-clamp whole-cell recording technique in murine thymocytes, we examined the effects of commonly used drugs, such as anti-hypertensive drugs, on Kv1.3-channel currents. Additionally, using male Sprague-Dawley rats that underwent 5/6 nephrectomy followed by a 14-week recovery period, we actually examined the therapeutic efficacy of these drugs in advanced CKD.

**Results:** In addition to some anti-hypertensive drugs, non-steroidal anti-inflammatory drugs, antibiotics and anti-cholesterol drugs, effectively suppressed the Kv1.3-channel currents in murine thymocytes. Among them, benidipine, a long-acting 1,4-dihydropyridine Ca<sup>2+</sup> channel blocker, most effectively and persistently inhibited the channel currents. Therefore, using the rat model with advanced CKD, we examined the effects of benidipine (5mg/kg) on the histopathological features of the kidneys, cellular proliferation of leukocytes and the cortical expression of pro-inflammatory cytokines. In the cortical interstitium of advanced CKD rat kidneys, benidipine significantly ameliorated the progression of renal fibrosis without affecting glomerular injury. This drug also reduced the number of proliferating leukocytes with a significant decrease in the pro-inflammatory cytokine expression.

**Conclusions:** Taken together, these *in vitro* and *in vivo* findings suggested the therapeutic potency of Kv1.3-channel inhibitors, such as benidipine, in the treatment or prevention of CKD.

### SA-PO985

#### Observation of Circadian Clock Genes Associated With Rhythmic Variation of the Aldosterone Signaling Pathway

Ryanne S. Thelwell, Michelle L. Gumz, G. R. Crislip, Lauren G. Douma. University of Florida, Gainesville, FL.

**Background:** Circadian rhythms regulate several physiological functions. In renal function, blood pressure is circadian regulated. The renin-angiotensin-aldosterone-system (RAAS) plays a major role in blood pressure homeostasis. Chronic kidney disease is primarily a disease of aging. The impact of circadian clock gene function with age requires further study. Variations in the rhythmically expressed genes (REGs) of this study play a role in the loss of the circadian nature of the aldosterone signaling pathway in older mice.

**Methods:** 6 month, 18 month, and 27 month old male mice from National Institute on Aging (NIA) were used to observe molecular clock transcriptional output after subsequent light/dark cycles. RNA sequencing performed on hypothalamus, kidney, lung, gastrocnemius, adrenal gland, and heart tissue. Data from RNA sequencing was processed using R software and circadian rhythmicity was analyzed using the cosinor model available in the diffCircadian software. REGs observed for their effect in aldosterone signaling pathway include Scnn1a, Scnn1b, Scnn1g, Nr3c1, Nr3c2, Hsp90, Atp1a1, Slc9a3, Slc12a1, Slc12a3, Prkca, Mapk1, Kras, Map2k1, Raf1, Pik3ca, Pdk1, Nedd4L, Sahn, Hsd11b1 and Hsd11b2.

**Results:** Kras expression rhythmically circadian in young and aged mice (p<0.05) but not at all in old mice (p=0.943). Pik3ca expression was rhythmically circadian in young, aged mice (p<0.05) but not at all in old mice (p=0.403). There was also a significant drop in basal expression levels (125 and 124 to 97 for young, aged, and old respectively). Most gene expression rhythmically circadian in young and aged mice (supported by lowest p values).

**Conclusions:** The decline in transcriptional output of rhythmically expressed genes throughout each tissue with age suggest a loss of circadian regulation. Variation in REGs' transcription observed in the aldosterone signaling pathway support loss of circadian patterns with increasing age in mice.

### SA-PO986

#### Effects of the Loop Diuretic Furosemide on Renal Hemodynamics and Synchronization Among Nearby Nephrons

Shayan Poursharif, Shereen M. Hamza, Branko Braam. University of Alberta Faculty of Medicine & Dentistry, Edmonton, AB, Canada.

**Background:** Autoregulation of renal blood flow (RBF) among nearby nephrons is presumably synchronized via tubuloglomerular feedback (TGF). TGF controls macula densa solute delivery by adjusting afferent arteriolar diameter and thereby single nephron GFR. As high doses of the diuretic furosemide impair TGF via inhibition of NKCC2 transporters and thus macula densa sodium sensing, we hypothesized that deactivating TGF with furosemide would impair nephron synchronization.

**Methods:** Mean arterial pressure, RBF, urine flow and GFR were measured in anesthetized rats (300-400 g). Left kidney cortical perfusion was recorded using laser speckle imaging, to assess surface perfusion and TGF-mediated nephron synchronization. After baseline, furosemide was infused (10, 20 or 30 mg/kg; n=8) to inhibit TGF. Mean phase coherence (PC), which assesses the degree of phase-locking (synchronization) among multiple oscillators (TGF-driven rhythmic changes of multiple afferent arterioles

resistance), the magnitude of decay of TGF PC and length constant associated with initial decay of TGF PC were used to assess strength of synchronization among nephrons.

**Results:** Furosemide did not change MAP ( $101 \pm 10$  to  $105 \pm 39$  mmHg, NS) or RBF ( $7.1 \pm 2.3$  to  $6.9 \pm 2.5$  ml/min, NS). Right kidney GFR increased after furosemide ( $1.10 \pm 0.22$  to  $1.27 \pm 0.27$  ml/min,  $p < 0.05$ ), while left kidney GFR was slightly reduced ( $1.06 \pm 0.22$  to  $0.92 \pm 0.16$  ml/min,  $p < 0.05$ ). Furosemide strongly increased right ( $8 \pm 5$  to  $134 \pm 18$  uL/min,  $p < 0.001$ ) and left ( $10 \pm 3$  to  $124 \pm 16$  uL/min,  $p < 0.001$ ) urine flow. Furosemide decreased the magnitude of the decay of TGF PC ( $0.46 \pm 0.06$  to  $0.42 \pm 0.06$ ,  $P < 0.05$ ) and length constant associated with initial decay of TGF PC ( $-0.28 \pm 0.11$  to  $-0.53 \pm 0.06$ ,  $P < 0.001$ ). Furosemide did not affect average PC. Correlation analysis of urine flow, RVR and GFR with parameters of synchronization did not reveal any further support for a decrease in synchronization after furosemide.

**Conclusions:** High dose furosemide decreased the magnitude of decay of TGF PC and length constant associated with initial decay of TGF PC. This indicates weaker synchronization among nephrons within lobules. However, the absence of a change in mean PC makes it likely that mechanisms other than the TGF sensing step in the macula densa differentially affect synchronization amongst nephrons.

**Funding:** Government Support - Non-U.S.

## SA-PO987

### High Phosphate Diet Induces the Development of Tertiary Lymphoid Structures and Fibrosis in Murine Kidneys

Bearrice Richter,<sup>1</sup> Nina Weingärtner,<sup>1</sup> Isabel Vogt,<sup>1</sup> Tamar G. Kapanadze,<sup>2</sup> Dieter Haffner,<sup>1</sup> Maren Leifheit-Nestler.<sup>1</sup> <sup>1</sup>Hannover Medical School, Department of Pediatric Kidney, Liver and Metabolic Diseases, Hannover, Germany; <sup>2</sup>Hannover Medical School, Department of Nephrology and Hypertension, Hannover, Germany.

**Background:** Tertiary lymphoid structures (TLS) are immune cell aggregates found in non-lymphoid organs, including the kidneys, and are associated with chronic inflammation. Similar to secondary lymphatic organs, TLS can initiate adaptive immune reactions. Among others, TLS are described in aging kidneys as well as in autoimmune diseases including IgA nephropathy, ANCA-associated glomerulonephritis and lupus nephritis. Recently, the role of vascular endothelial cells is discussed for the initiation of TLS. Here, we identify for the first time a chronically high phosphate load as a novel trigger for TLS formation in kidneys from mice.

**Methods:** C57BL/6N male mice received a 2% high phosphate diet (HPD) for 1-6 months and were compared to animals on a 0.8% normal phosphate diet (NPD). Renal tissue was collected for histology, flow cytometry, gene expression analyses and cytokine array.

**Results:** Starting after 2 months, in renal tissue from mice on HPD larger immune cell aggregates were found. In parallel, the renal mRNA levels for venous markers and cell adhesion molecules were significantly elevated. Distinctive TLS occurred in mice on HPD after 3 months. At the later time points, perivascular TLS formation in the corticomedullary junction and renal cortex was found for all mice on HPD. No TLS were detected in renal tissue derived from NPD controls. Flow cytometry analysis and histological staining showed a significant increase of CD3+ T cells and CD45R+ B cells starting after 3 months of HPD. Furthermore, an increased accumulation of collagen 3, podoplanin+ fibroblastic reticular cell networks, LYVE+ lymphatic vessel, and Cxcr4+ cells were found. F4/80+ macrophages accumulated in the periphery of TLS. Cluster of proliferating B cells, the presence of plasma cells and detection of IgG secretion in month 4 pointed to the existence of phosphate-induced mature TLS. The induction of Cxcl13, an important chemokine for recruitment and differentiation of B cells, was found in histology and confirmed by cytokine array.

**Conclusions:** Our results indicate that chronically increased phosphate intake leads to de novo formation of fully mature perivascular TLS in kidneys of mice, which was associated with significant interstitial fibrosis.

## SA-PO988

### Knockdown of TMEM30A Resulted in Reduced Uric Acid Absorption

Pei S. Chen, Guisen Li. Sichuan Academy of Medical Sciences and Sichuan People's Hospital, Chengdu, China.

**Background:** Uric acid is the end product of purine metabolism in human body, and the main organ of its excretion is the kidney, accounting for about 70% of the daily excretion of uric acid. The reabsorption and secretion of uric acid in renal tubules are mainly completed by different transporters, among which uric acid anion transporter 1 is considered to be an important uric acid reabsorption transporter, accounting for more than 90% of the reabsorption. URAT1 is mainly expressed at the brush border of renal tubular epithelial cells and transports uric acid from the lumen to the renal tubular epithelial cells. P4-ATPase works together with  $\beta$  subunit TMEM30A to mediate the asymmetric distribution of aminoacyl phospholipids such as phosphatidylserine (PS) and phosphatidylethanolamine (PE), promote the fusion of plasma membrane and internal vesicles, and facilitate vesicular protein transport. We observed decreased TMEM30A expression in the renal tubules of DKD and IgA patients, suggesting a potential role for TMEM30A in renal tubular cells.

**Methods:** To study the role of Tmem30a in renal tubules, we constructed a TMEM30A knockdown cell model by transfecting renal tubular epithelial cells with TMEM30A siRNA. Subsequently, the expressions of TMEM30A, URAT1 and related proteins were detected by immunohistochemical staining, qPCR and Western blotting. At the same time, uric acid with different concentrations of 0, 0.1, 0.5 and 1.0 mmol/L was added, and its absorption was detected after 24, 48 and 72 h of treatment, respectively.

**Results:** The mRNA and protein expressions of URAT1 and vesicle transporter Rab6 were significantly decreased after TMEM30A knockdown, and the absorption of uric acid was significantly reduced.

**Conclusions:** Knockdown of TMEM30A in TCMK-1 cells reduces the synthesis of vesicular transporters, resulting in decreased transport and expression of URAT1, which in turn reduces the absorption of uric acid. Our data suggest that TMEM30A plays a crucial role in renal tubules.

## SA-PO989

### SAMP1/YitFc as an Enteric Hyperoxaluria Mouse Model

Nadim Zaidan, Melody Ho, Lama Nazzal. NYU Langone Health, New York, NY.

**Background:** Enteric hyperoxaluria (EH) is a consequence of increased absorption of dietary oxalate secondary to fat malabsorption. Inflammatory bowel diseases, especially Crohn's disease, are one of the most prevalent conditions causing EH. This hyperoxaluric state accounts for the increased incidence of kidney stones in this population. Urinary oxalate was also linked with the progression of chronic kidney disease. SAMP1 is a mouse model that spontaneously develops ileitis and AKR is its closest genetic relative. We hypothesized that SAMP1 mice will develop an EH phenotype.

**Methods:** This study assessed the impact of fat and oxalate-enriched diets in mice with and without ileitis. Two outcomes were evaluated: urinary oxalate and kidney function by measuring plasma creatinine. We fed 7-10 weeks old male SAMP1 and AKR mice with increasing amounts of dietary fat every two weeks (10%, 45%, and 60%) without oxalate. This was followed by the addition of 1% oxalate (Ox) to the diet and a parallel decrease in dietary fat.

**Results:** At the start of the study, UOx levels were comparable in the AKR and SAMP1 mice ( $10.1 \pm 1.46$   $\mu\text{mol/L}$  for SAMP1 vs  $8.7 \pm 0.62$   $\mu\text{mol/L}$  for AKR,  $p = 0.09$ ). Increasing dietary fat did not affect UOx in either group, however, the addition of Ox in the diet led to a disproportional increase in UOx in SAMP1 mice as compared to AKR. On a 60% fat + 1% Ox, UOx levels were  $27.3 \pm 2.55$   $\mu\text{mol/L}$  in SAMP1 mice vs  $24.3 \pm 1.45$   $\mu\text{mol/L}$  in AKR ( $p = 0.05$ ). On 10% fat + 1% Ox at the end of the study, UOx from the SAMP1 mice was significantly higher than UOx from AKR mice ( $123 \pm 9.55$   $\mu\text{mol/L}$  vs  $48.9 \pm 7.48$   $\mu\text{mol/L}$  ( $p < 0.001$ )). Plasma creatinine (PCr) was 17.5% higher in SAMP1 mice compared with AKR mice at baseline ( $p < 0.01$ ) and at sacrifice, PCr concentration were 70% higher in the SAMP1/YitFc compared to its control population ( $p < 0.001$ ).

**Conclusions:** We were able to establish the presence of the EH phenotype in the SAMP1 mouse model. We also witnessed the development of kidney injury, highlighting the nephrotoxicity of high UOx levels. The next steps will involve the characterization of the factors causing the increased absorption of dietary oxalate and the enteric hyperoxaluria phenotype (intestinal inflammation, gut permeability, oxalate transporter epithelial expression, and gut microbiome differences).

**Funding:** NIDDK Support

## SA-PO990

### Drp1 Activates ROS/HIF-1 $\alpha$ /EZH2 and Triggers Mitochondrial Fragmentation to Deteriorate Hypercalcemia-Associated Neuronal Injury in a Mouse Model of CKD

Xitong Li,<sup>1</sup> Yaochen Cao.<sup>1,2</sup> <sup>1</sup>Charite Universitätsmedizin Berlin, Berlin, Germany; <sup>2</sup>Hainan Medical University, Haikou, China.

**Background:** Chronic kidney disease (CKD), characterized as renal dysfunction, is regarded as a major public health problem which carries a high risk of cardiovascular diseases. The purpose of this study is to evaluate the functional significance of Drp1 in hypercalcemia-associated neuronal damage following CKD and the associated mechanism.

**Methods:** Initially, the CKD mouse models were established. Next, RT-qPCR and Western blot analysis were performed to measure expression of Fis1 and Drp1 in CKD. Chromatin immunoprecipitation (ChIP) assay and dual-luciferase reporter gene assay were utilized to explore the relationship among Drp1, HIF-1 $\alpha$ , EZH2, and ROS with primary cortical neurons isolated from neonatal mice. Next, CKD mice were subjected to Calcitonin treatment or manipulation with adenovirus expressing sh-Drp1, so as to explore the effects of Drp1 on hypercalcemia-induced neuronal injury in CKD. TUNEL assay and immunofluorescence staining were performed to detect apoptosis and NeuN-positive cells (neurons) in brain tissues of CKD mice.

**Results:** It was found that hypercalcemia could induce neuronal injury in CKD mice. An increase of Fis1 and Drp1 expression in cerebral cortex of CKD mice correlated with mitochondrial fragmentation. Calcitonin suppressed Drp1/Fis1-mediated mitochondrial fragmentation to attenuate hypercalcemia-induced neuronal injury after CKD. Additionally, Drp1 could increase EZH2 expression through the binding of HIF-1 $\alpha$  to EZH2 promoter via elevating ROS generation. Furthermore, Drp1 knockdown inhibited hypercalcemia-induced neuronal injury in CKD while overexpression of EZH2 could reverse this effect in vivo.

**Conclusions:** Taken together, the key findings of the current study demonstrate the promotive role of Drp1 in mitochondrial fragmentation which contributes to hypercalcemia-induced neuronal injury in CKD.

**Funding:** Private Foundation Support

SA-PO991

**Quantitative In Situ Assessments of Mitochondrial Impairment Are Associated With Progressive Kidney Disease**

Huihui Huang,<sup>1</sup> Zsuzsanna K. Zsengeller,<sup>1</sup> Vasantha Jotwani,<sup>4</sup> Heather Thiessen Philbrook,<sup>2</sup> Ronit Katz,<sup>5</sup> Joachim H. Ix,<sup>6</sup> Chirag R. Parikh,<sup>2</sup> Dan Arking,<sup>2</sup> Mark J. Sarnak,<sup>7</sup> Michael Shlipak,<sup>4</sup> Sushrut S. Waikar,<sup>8</sup> Samir M. Parikh.<sup>3</sup> <sup>1</sup>Beth Israel Deaconess Medical Center, Boston, MA; <sup>2</sup>Johns Hopkins University, Baltimore, MD; <sup>3</sup>The University of Texas Southwestern Medical Center, Dallas, TX; <sup>4</sup>University of California San Francisco, San Francisco, CA; <sup>5</sup>University of Washington, Seattle, WA; <sup>6</sup>University of California San Diego, La Jolla, CA; <sup>7</sup>Tufts University, Medford, MA; <sup>8</sup>Boston University, Boston, MA.

**Background:** Mitochondrial impairment in the kidney tubule has been experimentally linked to the progression of chronic kidney disease (CKD). However, the relationships among in situ assessments of mitochondrial abundance, biogenesis capacity and oxidative phosphorylation and classical histopathological features remain under-explored in human CKD.

**Methods:** Among voluntary participants in a nephrectomy cohort for renal cell cancer who contributed non-tumor specimens to a CKD biorepository (n=42), we undertook blinded quantitative histochemical evaluation of several features related to mitochondria: immunostaining for mitochondrially encoded cytochrome C oxidase I (MTCO1) to assess mitochondrial abundance; PPAR-gamma-coactivator-1-alpha (PGC1a) to assess biogenesis capacity; and enzyme histochemistry for cytochrome C oxidase (COX-EHC) to assess mitochondrial oxidative phosphorylation. ImageJ was used to score staining intensity in ten randomly selected high-power fields per assessment, and the mean score was obtained from each specimen for the three mitochondrial assessments. These scores were compared to estimated glomerular filtration rate (eGFR) and to blinded semiquantitative assessments of glomerulosclerosis (GLOMSCL), arteriosclerosis (ARTSCL), and interstitial fibrosis/tubular atrophy (IFTA).

**Results:** The mean age was 61±11 years and the mean eGFR was 68±22 ml/min/1.73m<sup>2</sup>. The three mitochondrial parameters were significantly inter-correlated and were directly correlated with eGFR (Figure). COX-EHC was significantly and inversely correlated to GLOMSCL, ARTSCL, and IFTA. Conversely, IFTA was inversely correlated to all three mitochondrial assessments.

**Conclusions:** Quantitative in situ assessments of mitochondrial abundance, biogenesis, and oxidative phosphorylation are significantly correlated with functional and histopathological hallmarks of kidney disease. These results suggest that progressive mitochondrial impairments may be intimately linked to worsening kidney disease.

**Funding:** NIDDK Support, Other NIH Support - NIA 2R01AG027002

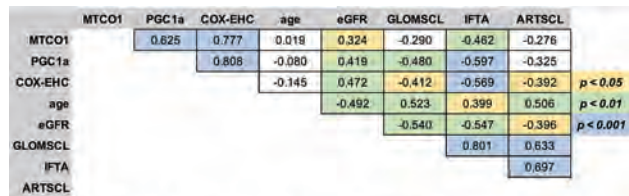

Figure: Correlogram of Spearman rank coefficients comparing mitochondrial parameters (MTCO1, PGC1a, and COX-EHC) to age and functional and histopathological hallmarks of kidney disease (eGFR, GLOMSCL, IFTA, ARTSCL). Abbreviations defined in text.

SA-PO992

**Inhibition of Hypoxia-Inducible Factor Hydroxylases in Proximal Tubules Alleviates CKD Progression After Ischemia-Reperfusion Injury**

Midori Sakashita,<sup>1</sup> Mai Sugahara,<sup>1</sup> Tetsuhiro Tanaka,<sup>2</sup> Motoko Yanagita,<sup>3</sup> Masaomi Nangaku.<sup>1</sup> <sup>1</sup>Tokyo Daigaku, Bunkyo-ku, Japan; <sup>2</sup>Tohoku Daigaku, Sendai, Japan; <sup>3</sup>Kyoto Daigaku, Kyoto, Japan.

**Background:** Hypoxia-inducible factor (HIF) is essential in many disease processes, including acute kidney injury (AKI) and the subsequent transition to chronic kidney disease (CKD). HIF-prolyl hydroxylase (HIF-PH) inhibitors stabilize HIF and promote erythropoietin (EPO) production; thereby currently utilized as a novel treatment for anemia in CKD patients. Systemic HIF activation alleviates acute ischemic kidney injury, but the role of HIF or HIF-PH inhibition in the proximal tubule during AKI-to-CKD transition remains unclear because of the difficulty in separating the possible beneficial effects of EPO on renal protection. Since the proximal tubules are strongly damaged in AKI and the degree of injury, dedifferentiation, and regeneration play a major role in the pathogenesis of AKI to CKD, we aimed to determine the role of HIF and HIF-PH in the proximal tubules in the recovery period after AKI.

**Methods:** *Ndrp1<sup>CreERT2/+</sup>; Phd1<sup>lox/lox</sup>/Phd2<sup>lox/lox</sup>/Phd3<sup>lox/lox</sup>* mice were subjected to bilateral renal ischemia-reperfusion injury (IRI). Tamoxifen was administered for 5 consecutive days starting 2 days after IRI to induce proximal tubule-specific HIF-PH deletion. Four weeks after IRI, the kidney function and pathology were evaluated to assess the severity of CKD after AKI.

**Results:** The expression of proximal tubule-specific HIF-1α in the knockout mice was confirmed by highly sensitive immunohistochemistry. HIF-PH deletion after IRI resulted in lower creatinine levels, decreased albuminuria, and improved fibrosis on picro-Sirius red staining after 4 weeks compared to the control group. Plasma EPO and hematocrit levels were comparable between the knockout and control mice.

**Conclusions:** HIF-PH inhibition in the proximal tubules alleviated renal damage during the transition to CKD independent of EPO production.

**Funding:** Government Support - Non-U.S.

SA-PO993

**Hypoxia-Inducible Long Non-Coding RNA, MIR210HG, Contributes to the Stability of HIF1α via miR-93-5p in Renal Tubular Epithelial Cells**

Hanako Saigusa, Imari Mimura, Masaomi Nangaku. *Tokyo Daigaku Daigakuin Igakukai Kenkyuka Igakubu, Bunkyo-ku, Japan.*

**Background:** Chronic hypoxia in the renal tubular interstitium is involved in the progression of chronic kidney disease. Hypoxia inducible factor (HIF1α), which is considered to be the master transcriptional regulator of response to hypoxia, is also subject to various regulation. Recently, there have been increasing reports that non-coding RNAs such as micro RNA (miRNA)s and long non-coding RNA (lnc RNA)s regulate the expression of HIF1α.

**Methods:** We exposed human renal proximal tubular cell lines (RPTEC) to 1% O<sub>2</sub> hypoxia for 1 to 48 hours, and examined the role of MIR210HG regulated by HIF1α.

**Results:** Micro RNA 210 host gene (MIR210HG) was up-regulated from 1 hour after the start of hypoxic stimulation, and maintained the rise until 48 hours. Knockdown of HIF1α decreased the expression of MIR210HG under hypoxia and the exposure of cobalt chloride promoted MIR210HG expression. Knockdown of MIR210HG significantly reduced both mRNA and protein levels of HIF1α, and promoted cell apoptosis. MiR-93-5p has the sequence predicted to bind to both MIR210HG and HIF1α and was previously reported to bind to HIF1α 3' untranslated region. Knockdown of MIR210HG increased the expression of miR-93-5p, and overexpression of miR-93 reduced the level of both HIF1α and MIR210HG. Luciferase assay confirmed that miR-93-5p binds to MIR210HG directly.

**Conclusions:** We revealed that MIR210HG was induced shortly after hypoxia under the regulation by HIF1α, and also modulated HIF1α by competing for miR-93-5p. Under the chronic hypoxia in the renal tubular cells, MIR210HG plays an important role in the biological response to hypoxia and cell survival.

**Funding:** Government Support - Non-U.S.

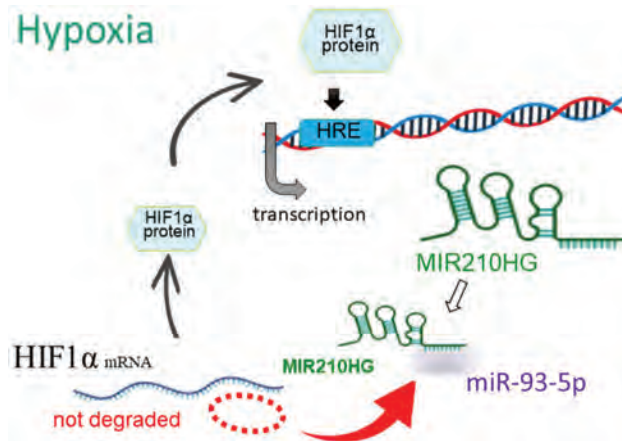

SA-PO994

**The Urothelium Deactivates Hematuria**

Tian Shen, Katherine Xu, Uddhav Neupane, Jonathan M. Barasch. *Columbia University, New York, NY.*

**Background:** American Urological Association reports that urine contains ~3 million RBC/day ("Addis Count"), containing 3x10<sup>15</sup> heme-bound iron atoms, sufficient to cause urothelial damage and promote growth of 3x10<sup>10</sup> bacteria. Hemolytic UTI increases uHeme by 5 fold, further promoting infection and cell damage. These data suggest that bladder expresses a heme detoxification system.

**Methods:** We used Hmox1 reporter mice and novel Nile Red-Palladium based probes to detect carbon monoxide (CO) with IVIS. *Slc48a1* knockouts and *Hmox1<sup>fl/fl</sup>* mice were kind gifts of Iqbal Hamza (UMaryland) and Anupam Agarwal (UAlabama), respectively. We also created nascent RNA capture from urothelia using uracil phosphoribosyl transferase expression (*Rosa-Upr<sup>fl/fl</sup>;Upk2Cre-ERT*) and 4-thiouracil pulse. RNAScope and immunostaining confirmed gene expression. Male and female mice were inoculated with 10<sup>7</sup> UPEC.

**Results:** Infected urothelium demonstrated the expression of heme metabolic genes (*Hp*, *Bach1*, *Hmox1*, *Slc48a1*, *Hebp*) and heme regulatory proteins Bmal and Npas2 within 4-6hrs of bacterial inoculation. To determine gene activity, we identified contemporaneous activation of *Hmox1* and release of CO (breakdown product of heme) 4-8hrs post infection (Heme or RBC lysis were positive controls). In addition, iron disposal



genes (*Lcn2*, *lactoferrin*, *ferritin*, *Slc11a1*, *Slc40a1*), downstream of heme metabolism were co-activated by UTI. The metabolism of heme contributed to the detachment and shedding of urothelial cells between 8-12hrs, since deletion of *Slc48a1*, the heme intake transporter (*L.Hamza*) and *Hmxo1*, mitigated the denudation of bladder mucosa from 70% to 40% of surface area (Padj=0.02).

**Conclusions:** We have identified an endogenous heme metabolic pathway in urothelia that is superactivated by excess heme or UTI likely mitigating bacterial growth. However the capture of excess heme in the setting of hematuria or UTI likely contributes to urothelial death and shedding.

**Funding:** NIDDK Support, Other NIH Support - Columbia Obrien Center for Benign Urology

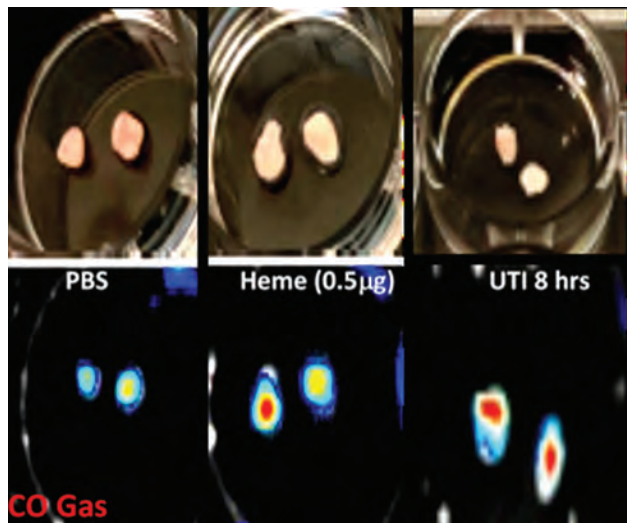

#### SA-PO995

##### A New Role of Acute Phase Proteins: Local Production Is an Ancient, General Stress-Response System of Mammalian Cells

Peter Hamar, Semmelweis Egyetem, Budapest, Hungary.

**Background:** The prevailing general view of acute-phase proteins (APPs) is that they are produced by the liver in response to the stress of the body as part of a systemic acute-phase response. We demonstrated a coordinated, local production of these proteins upon cell stress by the stressed cells.

**Methods:** Mouse left kidneys were subjected to 30 minutes ischemia. Contralateral right kidneys were removed on day 7. Furthermore, miR-193 transgenic renal fibrosis and bacterial endotoxin (LPS) induced acute renal injury and modulated electrohyperthermia treatment of breast cancer were investigated. Fibrosis progression (blood urea, renal fibronectin, collagen and TGF- $\beta$  expression) of the post-ischemic kidneys were assessed on day 8, 10, 14, 28 and 144. Next generation sequencing results were verified by nanostring and qPCR analysis. Protein level expression was profiled by mass spectrometry.

**Results:** Postischemic kidneys deteriorated resulting in a non-functional renal scar tissue within 28 days. This deterioration was delayed to 144 days by removal of the contralateral healthy kidney. The miR-193 transgene induced renal failure in 8 weeks and LPS induced AKI demonstrated by functional, morphologic and molecular data. Multiplex analysis of these models demonstrated a coordinated upregulation of several acute phase proteins on the mRNA and protein level in all 3 renal models. The similar APP response was demonstrated by us also in a breast cancer mouse model treated with hyperthermia.

**Conclusions:** The local, stress-induced APP production has been demonstrated in different tissues (kidney, breast cancer) and with different stressors (hypoxia, fibrosis and electromagnetic heat). Thus, this local acute-phase response (APR) seems to be a universal mechanism. Papers presented: 10.3390/ijms23062972, 10.3390/ijms21155316, 10.3390/ijms21113825, 10.3390/ijms21010200

**Funding:** Government Support - Non-U.S.

#### SA-PO996

##### Impact of Uremia on Regulatory T Lymphocytes Proliferation and Phenotype

Nicolas Valentini,<sup>1,2</sup> Maxime Raymond,<sup>1</sup> Caroline Lamarche,<sup>1,3</sup> <sup>1</sup>Hopital Maisonneuve-Rosemont Centre de Recherche, Montreal, QC, Canada; <sup>2</sup>Universite de Montreal Departement de Pharmacologie et Physiologie, Montreal, QC, Canada; <sup>3</sup>Universite de Montreal Faculte de Medecine, Montreal, QC, Canada.

**Background:** Chronic kidney disease (CKD) patients have a dysfunctional immune system that is chronically and non-specifically activated, leading to low grade inflammation. Inflammation is now considered both a risk factor and a consequence of reduced kidney function and is highly associated with cardiovascular disease, which is the

leading cause of mortality on dialysis. Regulatory T cells (Tregs) are important inhibitors of proinflammatory responses. While Tregs numbers are decreased in patients with CKD, their state and effectiveness remain poorly understood. We aim to investigate the impact of uremia on these cells.

**Methods:** Tregs and conventional CD4+ cells from hemodialysis (HD) patients and healthy donors were fluorescence-activated cell sorting (FACS)-sorted and serum was collected. We analyzed the Treg transcriptome using single cell RNA sequencing (scRNA-seq). Tregs and conventional CD4+ T cells from healthy donors were also expanded *in vitro* with media (IL-2 500U/mL) containing healthy donors' or HD patients' serum. After 7 and 12 days in culture, we used flow cytometry to compare changes in phenotype, viability, apoptosis and assess their function.

**Results:** We identified 11 Treg clusters from the scRNA seq data. From those, one is more present in HD patients, irrespective of donor's sex (FDR <0.05 & abs(Log2FD)>0.26) and 3 less present in HD patients. *In vitro* cultures show decreased Tregs number in uremic serum after 7 days compared to healthy donors (fold expansion 11.35 vs 19.27; p<0.001) and no significant impact on conventional CD4+ T cells (fold expansion 17.88 vs 19.52; p=0.34). They were no significant differences in Treg expansion or function, as assessed by a suppression assay, after 12 days (p>0.99). Staining for apoptosis with Annexin V/PI indicate no difference in viability or apoptosis between serums after 7 and 12 days. Markers associated with Tregs functions and activation such as CTLA4, GARP, LAP, CD69 and CD71 were expressed similarly in HD and healthy donors' serum after 7 days (p=0.82, 0.77, 0.73, 0.23 and 0.44 respectively).

**Conclusions:** Serum from HD patients selectively delays Tregs proliferation *in vitro* and not conventional CD4+ T cells, with no impact on cell death, activation and Tregs markers' expression. HD patients also have different Treg cluster composition. Further studies are needed to identify the causes and impacts of those changes.

#### SA-PO997

##### Angiotensin II Type 1 Receptor-Associated Protein Interacts With Transferrin Receptor 1 and Promotes Its Internalization

Eriko Abe,<sup>1</sup> Hiromichi Wakui,<sup>1</sup> Keigo Hirota,<sup>1</sup> Yamaji Takahiro,<sup>2</sup> Shingo Urate,<sup>1</sup> Toru Suzuki,<sup>1</sup> Shohei Tanaka,<sup>1</sup> Shinya Taguchi,<sup>1</sup> Shunichiro Tsukamoto,<sup>1</sup> Kengo Azushima,<sup>1</sup> Kouichi Tamura,<sup>1</sup> Department of Medical Science and Cardiorenal Medicine <sup>1</sup>Yokohama City University Graduate School of Medicine, Yokohama, Japan; <sup>2</sup>Duke-NUS Medical School, Singapore, Singapore.

**Background:** Angiotensin II type 1 receptor (AT1R)-associated protein (ATRAP) was originally identified as a binding protein of AT1R. ATRAP promotes constitutive internalization of AT1R so as to inhibit the pathological activation of its downstream signaling. Also, we reported that genetic knockdown of ATRAP exacerbates kidney fibrosis in mice along with functional mitochondrial abnormalities and subsequent increases in ROS production. These effects of ATRAP were suggested to be AT1R-independent actions. Thus, this study aimed to explore a novel interacting protein involved in the mechanism that ATRAP protects against kidney fibrosis independent of the interaction with AT1R.

**Methods:** We established Human Embryonic Kidney 293 cells which were able to induce the expression of Flag-ATRAP. In this cell line, after immunoprecipitation with anti-Flag antibodies, the Flag-ATRAP complex was analyzed with a mass spectrometer. Among identified proteins, we focused on transferrin receptor1 (TfR1). To confirm the molecular interaction, co-immunoprecipitation was performed. Additionally, to validate functional interactions, we analyzed intracellular iron concentrations using fluorescent probe of iron. Furthermore, to verify TfR1 expression and localization, immunofluorescence staining of TfR1 in the whole cell or on the cell surface only.

**Results:** Mass spectrometry analysis revealed various proteins associated with vesicular trafficking including TfR1. We confirmed the molecular interaction between ATRAP and TfR1 by co-immunoprecipitation. Enhanced ATRAP expression decreased the cellular iron levels and downregulate TfR1 expression on the cell surface despite no significant difference in whole cell.

**Conclusions:** We propose a molecular and functional link between ATRAP and TfR1. ATRAP would regulate TfR1 availability via downregulation of cell surface TfR1 via promotion of its internalization. TfR1 promotes intracellular localization of the iron-bound transferrin. Iron is a key factor in the process of kidney fibrosis via production of ROS in relation to deterioration of mitochondrial function. Taken together, this novel ATRAP-TfR1 axis might be the mechanism relevant to the ROS/mitochondrial dysfunction-mediated process of kidney fibrosis.

#### SA-PO998

##### Deficiency of Angiotensin II Type 1 Receptor Prevents Muscle Atrophy due to Denervation

Suguru Takayama,<sup>1</sup> Takeshi Sugaya,<sup>1</sup> Yugo Shibagaki,<sup>1</sup> Atsuko Ikemori,<sup>1,2</sup> <sup>1</sup>Division of Nephrology and Hypertension, Department of Internal Medicine, St. Marianna University School of Medicine, Kawasaki, Japan; <sup>2</sup>Department of Anatomy, St. Marianna University School of Medicine, Kawasaki, Japan.

**Background:** Because chronic kidney disease (CKD) is a high risk of muscle wasting, managing CKD is clinically important for promoting the health and well-being of patients with CKD in aging society. Although angiotensin II (Ang II) type 1 receptor blocker was reported to attenuate muscle atrophy after muscle injury model, its model does not reflect human pathophysiological conditions. The aim of this study is to reveal whether suppressed activation of angiotensin II type 1 receptor (AT1) prevents severe muscle atrophy after denervation which mimics disuse atrophy.

**Methods:** To induce severe muscle atrophy, the sciatic nerves in right and left inferior limbs were cut in AT1a knockout homo (AT1a<sup>-/-</sup>) male mice and wild type (AT1a<sup>+/+</sup>) male mice. Both leg muscle tissues were removed and were categorized as gastrocnemius muscle at 3-, 7- and 21-day post-denervation.

**Results:** Muscle weight and cross-sectional areas of type IIb muscle fibers in gastrocnemius muscle decreased at 7- and 21-day post-denervation in both AT1a<sup>-/-</sup> mice and AT1a<sup>+/+</sup> mice, and the degree was significantly milder in the denervated muscle of AT1a<sup>-/-</sup> mice than in the denervated muscle of AT1a<sup>+/+</sup> mice. Regarding activation of muscle protein degradation system, upregulated expressions of phosphorylated nuclear factor-κB at 3-day and two E3 ubiquitin ligases (muscle RING-finger protein-1 and atrogin-1) at 7- and 21-day were significantly downregulated in the denervated muscle of AT1a<sup>-/-</sup> mice compared to the AT1a<sup>+/+</sup> mice. In addition, while muscle apoptosis evaluated by gene expressions of Bcl-2-associated X protein and Tunel staining was induced in both AT1a<sup>-/-</sup> mice and AT1a<sup>+/+</sup> mice, the degree was significantly suppressed in the AT1a<sup>-/-</sup> mice. On the other hand, there were not significant differences in activations of protein synthesis and autophagy which were evaluated by protein expressions of phosphorylated ribosomal protein S6 kinase b-1 and LC3B-II/I, between the AT1a<sup>-/-</sup> mice and AT1a<sup>+/+</sup> mice.

**Conclusions:** Inactivation of the AT1 receptor prevented muscle atrophy due to denervation via suppressions of protein degradation system and apoptosis. Ang II type 1 receptor blocker may be useful for prevention of muscle atrophy in elder patients with CKD.

## SA-PO999

### Establishment of Quantitative Proteomics Platform for Urine Biomarker Discovery and Validation

Keiko Yamamoto,<sup>1</sup> Tadashi Yamamoto,<sup>1,2</sup> <sup>1</sup>Niigata Daigaku Igakubu Igakuka Daigakuin Ishigaku Sogo Kenkyuka, Niigata, Japan; <sup>2</sup>Shinrakuen Byoin, Niigata, Japan.

**Background:** Proteomics has been introduced for discovery of biomarkers in biological fluids such as plasma, urine and others. Recent advance of the data-independent acquisition (DIA) method of proteomics has improved the quantitative evaluation. We employed the method for urine biomarker discovery and adapted it for validation of the biomarkers.

**Methods:** Urine samples were collected in Biofluid Biomarker Center (BBC), Niigata University, Japan from patients with various diseases and healthy persons received medical examinations at several hospitals according to a guide proposed by Human Kidney & Urine Proteome Project of Human Proteome Organization and stored in -20°C freezers. Urine proteins were separated from 1ml of the frozen urine by a methanol/chloroform precipitation method and digested with trypsin to prepare peptides, purified through C-14 spin column. The urine peptide samples of 200 ng each were analyzed by liquid chromatography-mass spectrometry (LC-MS, tims-TOFpro, Bruker Daltonics) sequentially in data-dependent acquisition (DDA) and data-independent acquisition (DIA) manners. The platform was applied to urine samples from diabetic patients (n=200) and healthy volunteers (n=200).

**Results:** More than 100,000 urine samples have been collected from about 12,000 patients and healthy persons, indicating serial urine collections from the same patients. Approx. 2,000 proteins were identified by the DDA LC-MS and quantified by the DIA LC-MS using 200 ng peptides each. Qualities of the peptide samples and LC-MS analysis were certified by consistent identification and quantification of quality control proteins of high to low abundance, selected in BBC. The urine biomarker candidates were selected by comparing quantities of proteins, evaluated in about 50-100 sample analyses by the DIA-LC-MS between men and women and between DM patients and healthy people. The selected biomarker candidates were examined in another set of about 50-100 sample analysis data for validation of the urine biomarkers. Several urine biomarkers for gender identification and for DM-induced kidney injuries are demonstrated in the presentation.

**Conclusions:** The quantitative proteomics platform is powerful to find and validate new urine biomarkers since it is efficient to quantitate thousands of proteins in a single analysis and also consistent for quantitation by using several quality controls.

**Funding:** Commercial Support - Tosoh Corporation, Clinical Revenue Support, Government Support - Non-U.S.

## SA-PO1000

### SGLT2 Inhibitors Reduce Urinary Mitochondrial DNA Copy Number in Both Diabetic and Non-Diabetic CKD Patients

Haekyung Lee,<sup>1,2</sup> Junghyun Cho,<sup>1</sup> Eui Suk Chung,<sup>1</sup> Hyounghae Kim,<sup>1,2</sup> Jin seok Jeon,<sup>1,2</sup> Soon hyo Kwon,<sup>1,2</sup> <sup>1</sup>Soonchunhyang University Hospital, Yongsan-gu, Seoul, Republic of Korea; <sup>2</sup>Soonchunhyang University Hospital Kidney Center, Yongsan-gu, Seoul, Republic of Korea.

**Background:** Sodium-glucose co-transporter 2 (SGLT2) inhibitors improve renal and cardiovascular outcomes in patients with chronic kidney disease (CKD) regardless of the presence of type 2 diabetes mellitus (T2DM). In this work, we aimed to investigate whether SGLT2 inhibitors improve mitochondrial dysfunction in patients with T2DM or CKD.

**Methods:** We prospectively recruited SGLT2 inhibitor naïve patients with T2DM (n = 16), non-diabetic CKD (n = 16) and normal control (n = 22). Copy numbers of urinary mitochondrial DNA (mtDNA) in the form of mitochondrial nicotinamide dinucleotide dehydrogenase subunit-1 (mtND-1) and cytochrome-c oxidase 3 (mtCOX-3) were measured at baseline and after 3 months of treatment with SGLT2 inhibitors (empagliflozin in the T2DM group and dapagliflozin in the non-diabetic CKD group).

**Results:** Immunoglobulin A nephropathy was the most common underlying kidney disease (50%) in the non-diabetic CKD group. Estimated glomerular filtration rate was higher and albuminuria was lower in the T2DM group than in the non-diabetic CKD group (both p < 0.001). Baseline urinary mtDNA levels were significantly higher in either T2DM or non-diabetic CKD group than in healthy controls (p < 0.001 for mtND-1 and mtCOX-3, respectively), with mtDNA copy numbers comparable between the diabetic and non-diabetic CKD groups. SGLT2 inhibitors reduced urinary copy numbers of mtND-1 and mtCOX-3 in both the T2DM (p < 0.001 for mtND-1 and mtCOX-3, respectively) and non-diabetic CKD groups (p < 0.05 for mtND-1 and mtCOX-3, respectively) (Figure 1). The amount of reduction in urinary mtDNA copy number did not differ according to each SGLT2 inhibitor.

**Conclusions:** SGLT2 inhibitors reduce the elevated urinary mtND-1 and mtCOX-3 copy numbers in patients with T2DM or non-diabetic CKD, suggesting that SGLT2 inhibitors improve mitochondrial injury regardless of the presence of T2DM.

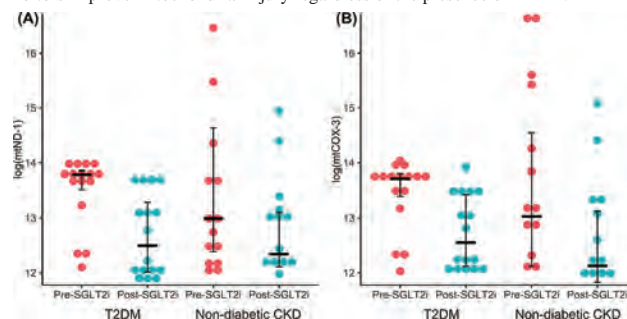

Figure 1. Change in urinary mitochondrial DNA copy numbers after sodium-glucose co-transporter 2 inhibitor treatment. (A) mtND-1, (B) mtCOX-3

## SA-PO1001

### Therapeutic Potential of Adipocyte Implantation in Experimental Uremic Cardiomyopathy by Antagonism of Na,K-ATPase Signaling

Sneha S. Pillai,<sup>1</sup> Duane G. Pereira,<sup>1</sup> Muhammad A. Chaudhry,<sup>1</sup> Joseph I. Shapiro,<sup>1</sup> Komal Sodhi,<sup>1</sup> Marshall University Joan C Edwards School of Medicine, Huntington, WV.

**Background:** The putative method of implantation of adipocytes has been shown to improve systemic inflammatory milieu and metabolic homeostasis in different disease models. We have recently demonstrated that administration of NaKtide, antagonist of Na/K-ATPase signaling, coupled to adipocyte-specific promoter can improve adipocyte phenotype and further attenuated experimental uremic cardiomyopathy. In the present study, we investigated the pathophysiological changes in recipient mice that underwent partial nephrectomy (PNx) surgery and implanted with NaKtide transfected human mesenchymal stem cell (MSC) derived adipocytes.

**Methods:** Human adipose-derived MSC were transfected with or without lentivirus with adipocyte-specific NaKtide/ scrambled NaKtide and cells were cultured for 15 days with adipocyte differentiation medium. For in vivo adipocyte implantation, Male Fox Chase severe combined immunodeficiency (SCID) (10-12 weeks old) mice were injected with 2x10<sup>6</sup> adipocytes/ml in the dorsal subcutaneous region of randomly divided groups of mice followed by PNx surgery on the same day. The tissues were harvested for morphological and molecular analyses after 4 weeks of transplantation. Statistical analysis was performed by one-way analysis of variance.

**Results:** The implantation of NaKtide transfected adipocytes improved adipocyte phenotype, systemic inflammation, and improved cardiac morphological and biochemical function in recipient PNx mice. The changes in plasma microRNA secretion, that act in a paracrine fashion to actively regulate cardiac inflammatory processes, were also ameliorated by NaKtide, implicating a possible mechanism of intra organ crosstalk. The results were compared with the implantation of control and Scrambled NaKtide transfected adipocytes. The study demonstrates that adipocyte-specific NaKtide reprograms the adipocyte phenotype and transplantation of these metabolically healthy adipocytes in PNx exhibits improved systemic and cardiovascular function, through intra-organ crosstalk between adipose and cardiac tissue.

**Conclusions:** The study establishes the clinical utility of targeting adipocyte Na/K-ATPase signaling as well as explores the therapeutic potential of transplanting healthy adipocytes in attenuating uremic cardiomyopathy.

**Funding:** Other NIH Support - National Institutes of Health Grants 1R15HL150721

## SA-PO1002

### GSTM1 Deficient Kidney Primary Tubular Epithelial Cells Have Augmented NF-κB p65 Signaling in Response to Angiotensin II

Luoqing Chen,<sup>1</sup> Timothy J. Beane,<sup>1</sup> Yves T. Wang,<sup>1</sup> Jason J. Cunningham,<sup>1</sup> University of Rochester, Rochester, NY.

**Background:** Glutathione-S-transferase Mu-1 (*Gstm1*) gene encodes an enzyme that functions in the detoxification of electrophilic compounds. The common *GSTM1* deletion variant in humans is associated with increased risks of chronic kidney disease (CKD) progression and incident end stage kidney failure. We previously reported that, in angiotensin II-induced hypertension (AngII-HTN), *Gstm1* knockout (KO) mice display increased kidney inflammation, characterized by increased inflammatory cell infiltration

(by flow cytometry), and increased kidney expression of CXCL1, MCP-1/CCL2, and IL-6, independent of blood pressure. Moreover, bone marrow cross-transplantation revealed GSTM1 deficiency in the parenchyma, not in bone marrow derived cells, determined kidney inflammation. Much of the proinflammatory effect of AngII is mediated via the canonical NF- $\kappa$ B pathway. We set to determine the influence of GSTM1 on NF- $\kappa$ B p65 signaling pathway in renal tubular cells.

**Methods:** Primary tubular epithelial cells (PTECs) were isolated from *Gstm1* KO and wild-type (WT) kidneys, and grown on pre-coated cover slips until ~70% confluent. Cells were then starved for 4 hours before treatment with AgII (100 nM) for 24 hours, fixed, and stained with anti-NF- $\kappa$ B p65 antibody. Images were taken with a fluorescence microscope (Olympus BX51).

**Results:** NF- $\kappa$ B p65 nuclear staining was quantified as percentage of p65 nuclei-positive stained cells to the total cells. Five random fields were counted for each group and similar results were obtained from two independent experiments. At baseline, there was no statistically significant difference. After 24 hrs of Ang II, there was a significant increase in intensity and localization of p65 in nuclei in KO compared to WT PTECs (% p65 positive cells: WT  $9.8 \pm 1.6$ , KO  $23.8 \pm 2.5$ ;  $p = 0.0014$ ).

**Conclusions:** Deletion of *Gstm1* augments AngII activation of NF- $\kappa$ B p65 signaling pathway in PTECs. This may explain the increased kidney inflammation in *Gstm1* KO mice in Ang II-HTN. Further studies are under way to determine the functional significance, including expression of CXCL1 and MCP-1 in PTECs, and whether this drives migration of inflammatory cells.

**Funding:** NIDDK Support

## SA-PO1003

### Tubule-Specific Overexpression of Krüppel-Like Factor 6 (KLF6) Is Detrimental After Nephrotoxic Kidney Injury

Sian Piret, Merin Davis, Samaneh Gholami, Nehaben A. Gujarati, Bismark Owusu Frimpong, Sandeep K. Mallipattu. *Stony Brook University, Stony Brook, NY.*

**Background:** Transcriptional control of transition to chronic kidney disease (CKD) after nephrotoxic injury is poorly understood. We previously showed that proximal tubule (PT)-specific knockdown of the transcription factor Krüppel-like factor 6 (KLF6) was protective after DNA damage using the PT-specific toxin aristolochic acid I (AAI). Our aim was to determine whether tubular overexpression (OE) of human (h)KLF6 (hKLF6<sup>OE</sup>) attenuates remodeling of the kidney post-AAI.

**Methods:** hKLF6<sup>OE</sup> mice were generated by breeding TRE-hKLF6 and Pax8-rtTA mice, with doxycycline (DOX) added to the diet. Controls were single transgenic TRE-hKLF6 mice. AAI was injected at 2mg/kg every 3 days for 2 weeks, followed by 2 weeks without AAI for development of CKD. Serum was collected for urea nitrogen and creatinine measurements, and kidneys for histology and gene expression analyses. Single nuclear RNA-sequencing (snRNA-seq) was undertaken on global hKLF6-OE mice 24 hours after one AAI injection. Locations of p53 and KLF6 binding sites (BS) from published ChIP-seq data were mapped against regions of open chromatin in published data from mouse nephron.

**Results:** To determine whether hKLF6 OE alone would induce injury, hKLF6<sup>OE</sup> and control mice were fed DOX for 18 weeks. There were no functional or histological differences between hKLF6<sup>OE</sup> and control mice at baseline. AAI-treated hKLF6<sup>OE</sup> mice had elevated serum creatinine and urea nitrogen, and more PT injury, inflammation, and fibrosis as compared to AAI-treated controls. To determine potential mechanisms, we utilized snRNA-seq in global hKLF6-OE mice. The most highly upregulated pathway both in PT from control mice with AAI versus no AAI, and in an injured-PT cluster, was p53 signaling, which was further elevated in hKLF6-OE mice. *In silico* ChIP-seq showed p53 and KLF6 occupy the promoters of key p53 downstream targets. In hKLF6<sup>OE</sup> mice cortex, expression of two p53 pathway members, *Cngl1* (which has KLF6 BS) and *Mdm2* (p53 and KLF6 BS), was significantly correlated with hKLF6 expression. Total KLF6 expression also correlated with serum creatinine and urea nitrogen levels in AAI-treated control and hKLF6<sup>OE</sup> mice.

**Conclusions:** Induction of tubule-specific KLF6 exacerbates the AKI to CKD transition post-nephrotoxic injury, which may be mediated through enhanced p53 signaling.

## SA-PO1004

### Altered Bone Marrow Myelopoiesis Contributes to Renal Injury

Ryan Spear,<sup>1</sup> Yan Xu,<sup>1</sup> Flavio Vincenti,<sup>2</sup> Yanxia Cao,<sup>1</sup> Steve Mangos,<sup>1</sup> Jochen Reiser,<sup>1</sup> Eunsil Hahm.<sup>1</sup> <sup>1</sup>Rush University Medical Center, Chicago, IL; <sup>2</sup>University of California San Francisco, San Francisco, CA.

**Background:** Altered hematopoiesis in bone marrow (BM) is commonly found in diverse disease conditions associated with CKD, including infection, chronic inflammation, diabetes, CVD, cancer and aging. However, the BM-kidney axis is poorly understood. Here, we tested if inflammatory signals alter BM myelopoiesis leading to renal injury.

**Methods:** We explored the phenotypic changes of BM components in renal disease by collecting BM aspirates and plasma from CKD patients and healthy donors. We used an *in vitro* differentiation system to examine how inflammatory signals affect myelopoiesis and cellular functions. Briefly, human CD34+ hematopoietic stem cells (HSC) were isolated from healthy donors and cultured in myeloid expansion media. TNF $\alpha$  was added to mimic inflammatory conditions. Cells and supernatants were subjected to Seahorse, flow cytometric and secretome analyses. The link between BM alteration and renal injury was tested *in vivo* using two animal models.

**Results:** CKD patients have high levels of TNF $\alpha$  and suPAR in both plasma and BM, indicative of chronic inflammation. These patients show myeloid-biased hematopoiesis and an increase in inflammatory CD14<sup>+</sup>CD16<sup>+</sup> BM monocytes expressing uPAR. Consistently, myeloid-lineage differentiation assays showed that TNF $\alpha$  skews HSC differentiation towards monocytic lineage at the expense of granulocytes. Along with altered myelopoiesis, TNF $\alpha$  markedly increases uPAR expression, suPAR secretion and promotes production of proinflammatory cytokines including TNF $\alpha$ , IL-8 and IL-6. Additionally, TNF $\alpha$  stimulates monocyte subsets to become metabolically active. Soluble factors from TNF $\alpha$ -driven myeloid cells cause filtration dysfunction in a transgenic zebrafish functional assay. Injecting mice with TNF $\alpha$  and IFN $\gamma$  (essential for myelopoiesis) leads to significantly elevated ACR, BUN and suPAR levels, along with an increase in uPAR expressing CD11b<sup>+</sup> BM myeloid cells, suggesting that TNF $\alpha$  contributes to renal injury by altering BM.

**Conclusions:** Our findings suggest that TNF $\alpha$  reprograms BM myelopoiesis. Renal injury results from the generation of metabolically active myeloid cells that secrete proinflammatory cytokines and soluble permeability factors. These observations provide important groundwork for the exploitation of the BM-kidney axis as a novel therapeutic target for immune-mediated nephrotic syndrome currently categorized as 'idiopathic'.

## SA-PO1005

### Myeloid-Specific Mitochondrial Fusion Proteins MFN1 and MFN2 Regulate Lung Injury Associated With CKD

Divya Bhatia, Maria Plataki, Mary E. Choi. *Weill Cornell Medicine, NY, NY.*

**Background:** Association of chronic kidney disease (CKD) and lung injury is under-recognized. Studies suggest increased prevalence of CKD in idiopathic pulmonary fibrosis (IPF) patients associates with worse survival than patients without CKD. We sought to understand mechanistic link between kidney and lung injury and role of macrophage mitochondrial fusion proteins, mitofusin (MFN)1 and MFN2.

**Methods:** Myeloid-specific *Mfn1* (*Mfn1*<sup>fl/fl</sup>, *LysM-Cre*<sup>+/+</sup>), *Mfn2* (*Mfn2*<sup>fl/fl</sup>, *LysM-Cre*<sup>+/+</sup>), or *Mfn1/Mfn2* double knockout (DKO) and corresponding *floxed/floxed LysM-Cre*<sup>+/+</sup> wild-type (WT) mice were subjected to unilateral ureteral obstruction (7-days) or sham surgery, or adenine (AD) or control (Ctl) diet (4 or 8-weeks). Lungs, bronchoalveolar lavage (BAL), and blood were collected and analyzed by flow cytometry and western blot.

**Results:** Pro-inflammatory monocytes (Ly6C+CD11b+), macrophages (infiltrated: CD11b+ CD64+SiglecF-; resident: SiglecF+CD11b-), and fibrotic response (arginase-I, galectin-3, YM-1, CD86, fibronectin, collagen-I) increased while anti-inflammatory monocytes (Ly6C-CD11b+) and MFN1 and MFN2 expression decreased in lungs from WT mice after UUO or AD than sham or Ctl respectively. Circulating pro-inflammatory (Ly6C+CCR2+) and profibrotic (galectin-3+, TGF- $\beta$ +) markers on monocytes but not on other (CD11b-) cells increased in WT mice after AD than Ctl. AD-fed WT but not *Mfn2*<sup>fl/fl</sup>, *LysM-Cre*<sup>+/+</sup> or DKO mice displayed an increase in infiltration of pro-inflammatory monocytes in lungs than Ctl. *Mfn2*<sup>fl/fl</sup>, *LysM-Cre*<sup>+/+</sup> mice displayed lower expression of fibrotic markers while higher total MFN2 expression in lungs during CKD than WT mice. Alveolar type II epithelial cells (AEC II, EpCAM+CD45-) from AD-fed *Mfn2*<sup>fl/fl</sup>, *LysM-Cre*<sup>+/+</sup> mice had a higher expression of MFN2 than AD-fed WT mice. *Mfn1*<sup>fl/fl</sup>, *LysM-Cre*<sup>+/+</sup> mice also displayed lower expression of galectin-3 and exhibited a compensatory increase in MFN1 expression in lungs than WT mice after AD. BAL from WT but not DKO mice displayed an increase in pro-inflammatory monocytes after AD than Ctl.

**Conclusions:** Pro-inflammatory monocytes/macrophages and fibrotic response in lungs were increased in experimental CKD in WT mice, with increases in circulating pro-inflammatory and profibrotic monocytes. Myeloid-specific *Mfn1* or *Mfn2*-deficiency resulted in attenuation, potentially mediated by compensatory induction of MFN1 and MFN2 expression in AEC II.

**Funding:** Other NIH Support - NHLBI

## SA-PO1006

### Renal Klotho Provides Inter-Organ Protection of Bone Marrow Hematopoiesis Against Phosphate Toxicity

Ke Yang,<sup>1</sup> Changhong Du.<sup>2</sup> <sup>1</sup>Xinqiao Hospital, Army Medical University (Third Military Medical University), Chongqing, China; <sup>2</sup>Institute of Combined Injury of PLA, Army Medical University (Third Military Medical University), Chongqing, China.

**Background:** Hematopoietic disorders including arterial thrombosis, innate immune inflammation and adaptive immunodeficiency are prevalent in patients with chronic kidney disease (CKD). However, the pathogenetic mechanism and the interactions between kidneys and bone marrow (BM) hematopoiesis remain poorly understood.

**Methods:** The role of kidney and renal Klotho in the regulation of BM hematopoiesis were evaluated *in vivo* and *ex vivo*, and confirming in targeted gene knockout and kidney-specific knockout mice.

**Results:** We found that CKD was characterized by myeloid-biased hematopoiesis and renal Klotho deficiency contributed to myeloid bias in CKD via impairing BM hematopoietic stem cell (HSC) maintenance. Using kidney-specific Klotho deletion mice and a CKD mouse model, we revealed that kidney-secreted soluble Klotho maintained pool size and differentiation propensity of human and mouse HSCs in an inter-organ manner through regulating inorganic phosphate (Pi) homeostasis of HSCs. Mechanistically, soluble carrier family 20 member 1 (SLC20A1) mediated Pi absorption and diphosphoinositol pentakisphosphate kinase 2 (PP1P5K2) mediated Pi sensing and signal transduction to Akt in HSCs; whereas renal Klotho restrained SLC20A1-mediated Pi absorption of HSCs. Klotho/Pi perturbation-induced Pi toxicity in CKD and high Pi diet (HPD) hyperactivated SLC20A1-PP1P5K2-Akt pathway to self-amplify Pi toxicity and boost GATA2 and mitochondrial activities in HSCs, which promoted expansion and

Key: TH - Thursday; FR - Friday; SA - Saturday; OR - Oral; PO - Poster; PUB - Publication Only

Underline represents presenting author.

megakaryocyte/myeloid-biased differentiation of HSCs and ultimately megakaryocyte/myeloid-biased hematopoiesis. Furthermore, single-cell RNA-sequencing revealed a heterogeneous Pi metabolic signature, which might underlie the distinct response of HSCs to Pi toxicity. Importantly, targeting Klotho/Pi-SLC20A1-PP1P5K2-Akt axis prevented Pi toxicity to BM hematopoiesis in CKD and HPD.

**Conclusions:** Our study uncovers a hitherto unrecognized role of kidneys in the regulation of BM HSC maintenance through secreting Klotho, and identifies that soluble Klotho and Pi are critical extrinsic factors that govern BM HSC maintenance. The findings not only provide deep insight into the function and composition of BM niches, but also extend our understanding of inter-organ regulation of BM hematopoiesis. Targeting Klotho/Pi-SLC20A1-PP1P5K2-Akt axis holds promise in protecting BM hematopoiesis against Pi toxicity such as in CKD and HPD.

**Funding:** Government Support - Non-U.S.

## SA-PO1007

### Changes in the Human Kidney Cellular Architecture During Fibrosis

Ghazal Z. Quinn,<sup>1</sup> Amin Abedini,<sup>1</sup> Xin Sheng,<sup>1</sup> Guannan Gao,<sup>3</sup> Lynda Vuong,<sup>2</sup> Matthew Palmer,<sup>1</sup> Jonathan Hill,<sup>3</sup> Steven S. Pullen,<sup>3</sup> A. A. Hakimi,<sup>2</sup> Katalin Susztak.<sup>1</sup> <sup>1</sup>University of Pennsylvania Perelman School of Medicine, Philadelphia, PA; <sup>2</sup>Memorial Sloan Kettering Cancer Center, New York, NY; <sup>3</sup>Boehringer Ingelheim International GmbH, Ridgefield, CT.

**Background:** Chronic diabetic and hypertensive kidney disease account for more than 75% of all end stage renal disease cases. The underlying mechanisms of disease progression are poorly understood. We hypothesized that changes in the cellular composition of kidney tissue might highlight disease-causal cell types or mechanisms.

**Methods:** We analyzed human kidney tissue samples (n=593) of patients with diabetic and hypertensive kidney disease or controls. We obtained associated clinical and histopathological information and generated corresponding bulk RNA sequencing information from kidney tissue. Histopathologic features such as interstitial fibrosis were scored by a renal pathologist. Human kidney single cell gene expression was generated to obtain cell type-specific gene expression changes. We used *in silico* deconvolution (CIBERSORTx) to estimate cell proportions in bulk tissue RNA sequencing data. We validated changes in immune cell fractions using flow cytometry analyses.

**Results:** We found strong correlations between kidney proximal tubule (PT) cells, regulatory T cells, Natural Killer cells, effector T cells and the degree of kidney dysfunction including interstitial fibrosis ( $r^2=0.51$ ,  $p < 0.001$ ) and estimated glomerular filtration rate (eGFR,  $r^2=0.39$ ,  $p < 0.001$ ). *In silico* deconvolution and flow cytometric analyses highlighted the association between T cells and eGFR. We found patients with low PT cell fractions (i.e., <45% PT cells) had significantly higher immune cell types such as Th17 cells, and more rapid eGFR decline over time ( $p < 0.05$ ).

**Conclusions:** In summary, kidney fibrosis is characterized by marked changes in kidney proximal tubules. Changes in immune and lymphocyte fractions are a key feature of diabetic and hypertensive CKD. Cell fraction changes predict the rate of kidney function decline.

**Funding:** NIDDK Support, Commercial Support - Boehringer Ingelheim, Private Foundation Support

## SA-PO1008

### ULK1-Regulated AMP Sensing Mechanism by AMPK Is Disrupted in CKD

Tomoki Yanagi,<sup>1</sup> Hiroaki Kikuchi,<sup>2,1</sup> Koh Takeuchi,<sup>3</sup> Koichiro Susa,<sup>1</sup> Naohiro Takahashi,<sup>1</sup> Yuta Nakano,<sup>1</sup> Fumiaki Ando,<sup>1</sup> Shintaro Mandai,<sup>1</sup> Takayasu Mori,<sup>1</sup> Shinya Honda,<sup>1</sup> Satoru Torii,<sup>1</sup> Shigeomi Shimizu,<sup>1</sup> Tatemitsu Rai,<sup>1</sup> Shinichi Uchida,<sup>1</sup> Eisei Sohara.<sup>1</sup> <sup>1</sup>Tokyo Ika Shika Daigaku, Bunkyo-ku, Japan; <sup>2</sup>National Heart Lung and Blood Institute, Bethesda, MD; <sup>3</sup>Tokyo Daigaku, Bunkyo-ku, Japan.

**Background:** AMP-activated protein kinase (AMPK) is a kinase that plays a major role in energy homeostasis. Increase in intracellular AMP causes AMPK activation through binding of AMP to AMPK  $\gamma$ -subunit, however, this phenomenon is impaired in chronic kidney disease (CKD). To date, the molecular mechanism of regulation of AMP sensing ability of AMPK, and the mechanism by which this AMP sensitivity is disrupted in CKD are totally unclear. We show a possible role for Unc-51-like kinase 1 (ULK1), whose expression is markedly decreased in CKD, in the regulation of this AMP sensing of AMPK.

**Methods:** *Ulk1*<sup>-/-</sup> mice were used in this study. Sub-total nephrectomy was applied as CKD mouse model. Purified AMPK $\gamma$  protein and fluorescently labeled AMP were used to measure the amount of AMP that binds to the AMPK $\gamma$  subunit.

**Results:** The activation of AMPK by AMP was impaired in *Ulk1*<sup>-/-</sup> mice, in spite of increased AMP/ATP ratio. We identify that ULK1 directly phosphorylates AMPK $\gamma$ 1, which is required for the activation AMPK, and that this phosphorylation is decreased in *Ulk1*<sup>-/-</sup> and CKD mouse kidney. Fluorescence binding assay reveals that the amount of AMP bound to AMPK $\gamma$ 1 is regulated by phosphorylation of AMPK $\gamma$ 1. Structural information also indicated that this phosphorylation could affect the AMP binding loops' conformation, modifying the AMP binding affinity to AMPK $\gamma$ 1. Absence of ULK1 promote more severe kidney dysfunction and renal fibrosis, due to AMPK inactivation.

**Conclusions:** We discovered an entirely new mechanism of energy homeostasis, in which ULK1 increases AMPK activity promoting AMP binding to AMPK  $\gamma$ 1 subunit, providing potential insight into the role of this new mechanism for AMP sensing failure of AMPK in CKD.

## SA-PO1009

### Ablation of the Non-Receptor Tyrosine Kinase c-Abl in Renal Tubular Cells Alleviates Renal Fibrosis in Mice

Qianyi Bao,<sup>1,2</sup> Anyu Wang,<sup>2</sup> Xiao-Dong Yuan,<sup>3</sup> Lin He,<sup>2</sup> Gang Ma.<sup>2</sup> <sup>1</sup>Department of Gynecology & Obstetrics, Medical School, Southeast University, Nanjing, China; <sup>2</sup>Key Laboratory for the Genetics of Developmental and Neuropsychiatric Disorders (Ministry of Education), Bio-X Institutes, Shanghai Jiao Tong University, Shanghai, China; <sup>3</sup>Department of Urology, Renji Hospital, Shanghai Jiaotong University, School of Medicine, Shanghai, China.

**Background:** Renal fibrosis is the uppermost symptom of chronic kidney disease (CKD). The renal tubules, particularly the proximal tubule cells (PTCs), are easily damaged and the injured PTCs are associated with the occurrence of CKD. C-Abl (encoded by the *Abl1* gene) is a member of the Abelson family of non-receptor tyrosine kinases and plays a fundamental function in organ fibrosis. However, the role of c-Abl in the pathogenesis of PTCs and CKD remains elusive.

**Methods:** Western blotting and immunofluorescence (IF) were used to determine the expression pattern of c-Abl in clinical samples and fibrotic kidneys from CKD mice treated with unilateral ureteral obstruction (UUO) and unilateral ischemia-reperfusion injury (uIRI). Next, c-Abl was deleted specifically in PTCs by using *Ksp-Cre* mice to generate *Ksp-Cre; c-Abl*<sup>fl/fl</sup> knockout mice which subsequently were treated with UUO and uIRI to obtain fibrosis models to understand the function of c-Abl. The role of c-Abl was further confirmed in human proximal tubule epithelial cells (HK-2 cell line) stimulated with TGF- $\beta$ 1. C-Abl knockout was induced in myofibroblasts to generate *aSMA-CreERT; c-Abl*<sup>fl/fl</sup> mice which were treated with UUO and uIRI to determine if targeting c-Abl in myofibroblasts was beneficial in alleviating established renal fibrosis and kidney dysfunction.

**Results:** The expression and kinase activity of c-Abl were elevated in human and mouse fibrotic kidneys, and were positively correlated with fibrogenic genes. IF staining showed that c-Abl was localized in parenchymal fibroblasts and myofibroblasts, notably enriched in PTCs of fibrotic kidneys. The specific deletion of c-Abl in *Ksp-Cre; c-Abl*<sup>fl/fl</sup> mice attenuated renal fibrosis through inhibiting PTCs activation and parenchymal collagen production. In HK-2 cells, c-Abl was shown to be essential and sufficient to induce a-SMA expression and collagen deposition as downstream of TGF- $\beta$  signaling pathway. Finally, ablation of c-Abl in myofibroblasts in *aSMA-CreERT; c-Abl*<sup>fl/fl</sup> mice significantly mitigated the progression of kidney fibrosis in established CKD mouse models.

**Conclusions:** This study primarily found that c-Abl is involved in renal fibrosis by regulating the activity of PTCs and the production of renal interstitial collagen, implying that c-Abl might be a new target for the prevention and treatment of renal fibrosis in the progression of CKD.

**Funding:** Government Support - Non-U.S.

## SA-PO1010

### Intra-Organ Cross-Talk via YB1 in the Kidney

Berend H. Isermann,<sup>1</sup> Jayakumar Manoharan,<sup>1</sup> Ahmed Elwakiel,<sup>1</sup> Silke Zimmermann,<sup>1</sup> Jonathan A. Lindquist,<sup>2</sup> Dheerendra Gupta,<sup>1</sup> Shrey Kohli,<sup>1</sup> Khurram Shahzad,<sup>1</sup> Sabine Brandt,<sup>2</sup> Peter R. Mertens,<sup>2</sup> Rajiv Rana.<sup>1</sup> <sup>1</sup>Institut für Laboratoriumsmedizin, Klinische Chemie und Molekulare Diagnostik, Universitätsklinikum Leipzig AöR, Leipzig, Germany; <sup>2</sup>Clinic of Nephrology and Hypertension, diabetes and Endocrinology, Magdeburg, Germany.

**Background:** Renal intra-organ glomerular-tubular crosstalk has been proposed, but the paracrine signals remain largely unknown. The ubiquitously expressed cold-shock protein YB1 regulates inflammation and renal diseases. Importantly, besides its intracellular functions, YB1 can be secreted upon acetylation, conveying extracellular effects. The role of podocyte YB1 remains unknown.

**Methods:** We analysed morphological and molecular changes in mice with podocyte-specific deletion of YB1 (YB1<sup>APod</sup>) and in mice expressing a nonsecretable YB1 mutant specifically in podocytes (YB1<sup>K2A</sup>) to evaluate YB1's role for glomerular-tubular cross-talk.

**Results:** Albuminuria was increased in unchallenged YB1<sup>APod</sup> mice compared to YB1<sup>WT</sup> mice. Albuminuria in YB1<sup>APod</sup> mice was associated with increased tubular dilation and damage, but – surprisingly – reduced glomerular mesangial area expansion and podocyte foot process effacement. The increased tubular injury in YB1<sup>APod</sup> mice was associated with increased tubular TLR4 expression, NLRP3 inflammasome activation and increased renal inflammatory cell infiltrate. Mice expressing a nonsecretable YB1 mutant (YB1<sup>K2A</sup>) specifically in podocytes phenocopied the changes observed in YB1<sup>APod</sup> mice. In vitro, pre-treatment of TLR4 overexpressing tubular cells with recombinant YB1 inhibits NLRP3 inflammasome activation, suggesting that exogenous YB1 negatively modulates sterile inflammation in tubular cells via TLR4.

**Conclusions:** YB1 secreted from podocytes suppresses TLR4- and NLRP3-mediated sterile inflammation in the tubular compartment, thus maintaining tubular physiology and kidney function. This uncovers a molecular mechanism of glomerular-tubular cross-talk required for normal renal physiology.

**Funding:** Government Support - Non-U.S.

## SA-PO1011

### Unsupervised Characterization of the NURTuRE Cohort Reveals Gene Expression and Tissue Remodeling Dynamics Along a Synthetic CKD Progression Axis

Tobias Bohnenpoll,<sup>1</sup> Mykola Dergai,<sup>1</sup> N. E. Olson,<sup>2</sup> Jennifer H. Cox,<sup>3</sup> Johannes Pospiech,<sup>1</sup> Niklas Michel,<sup>1</sup> Simone Romoli,<sup>3</sup> Seamus Ragan,<sup>2</sup> Mark McConnell,<sup>2</sup> Olivier Radresa,<sup>1</sup> Uwe Andag,<sup>1</sup> Andrew J. King,<sup>4</sup> *Evotec International GmbH, Göttingen, Germany; <sup>2</sup>Chinook Therapeutics, Inc., Seattle, WA; <sup>3</sup>Chinook Therapeutics, Inc., Vancouver, BC, Canada; <sup>4</sup>Chinook Therapeutics, Inc., Oakland, CA.*

**Background:** We combined molecular groups identified by unsupervised characterization of the QUOD and NURTuRE patient cohorts into a synthetic disease progression axis (sDPA) ranging from healthy to severe CKD. We aim to explore gene expression and tissue remodeling dynamics along this pseudotime trajectory to drive the discovery of new precision treatments.

**Methods:** A data-driven selection of QUOD (healthy, n = 36) and NURTuRE (CKD, n = 139) kidney transcriptomes (FFPE, RNAseq) was combined into a sDPA via principal component analysis. Clusters of genes with similar expression dynamics were derived by local regression and hierarchical clustering. Cell specific signatures were employed to explore tissue remodeling dynamics.

**Results:** Molecular stratification aligned with clinical CKD progression, with eGFR and urea decreasing or increasing along the sDPA, respectively (Fig. A). Clustering genes by their expression dynamics revealed early, intermediate and late changes with stable or variable slopes, potentially reflecting disease initiating events and adaptive responses (Fig. B). Exploration of cell-type specific signature expression suggested that gene expression dynamics correspond to tissue remodeling, with the loss of proximal tubules preceding podocyte loss (Fig. C). Interestingly, increasing parietal epithelial cell signature dynamics resembled interstitial remodeling as reflected by increasing immune and fibroblast signatures.

**Conclusions:** Unsupervised cohort characterization of kidney transcriptomes and integration into a pseudotime disease progression axis has the potential to unravel cellular and molecular mechanisms of CKD.

**Funding:** Commercial Support - Evotec SE and Chinook Therapeutics, Inc.

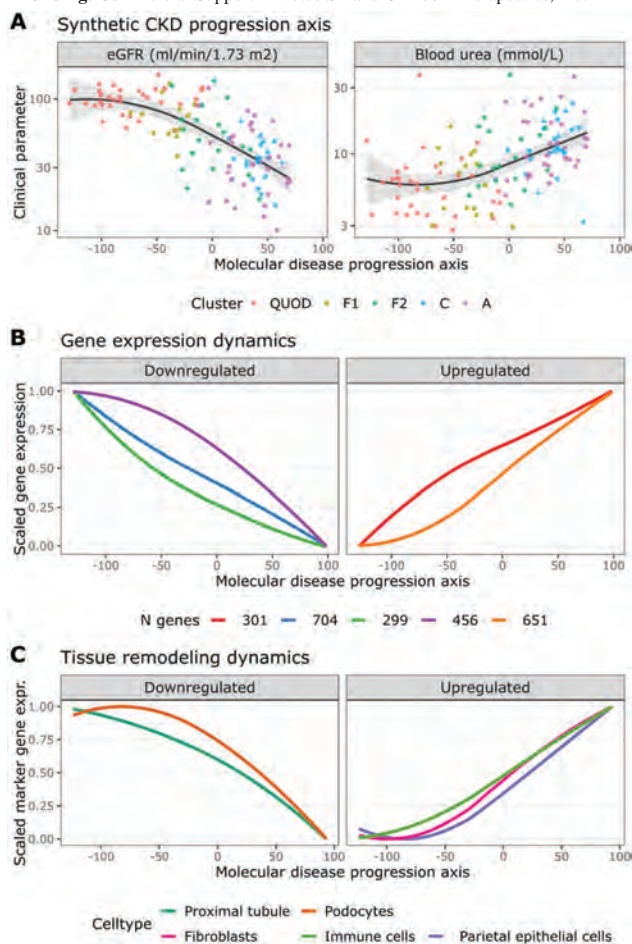

## SA-PO1012

### Gene Expression in Kidney Tissue From CKDu Patients in Central America and Sri Lanka

Julia Wijkstrom,<sup>1,2</sup> Angelina Schwarz,<sup>1</sup> Marvin A. Gonzalez,<sup>3,4</sup> Ricardo A. Leiva,<sup>5,6</sup> Zulma C. Cruz,<sup>6</sup> Channa Jayasumana,<sup>7</sup> Carl G. Elinder,<sup>1,2</sup> Annika Wernerson.<sup>1,2</sup> *<sup>1</sup>Karolinska Institutet, Stockholm, Sweden; <sup>2</sup>Karolinska Universitetssjukhuset, Stockholm, Sweden; <sup>3</sup>Universidad Nacional Autónoma de Nicaragua Leon, Leon, Nicaragua; <sup>4</sup>University College London, London, United Kingdom; <sup>5</sup>Universidad de El Salvador, San Salvador, El Salvador; <sup>6</sup>Hospital Nacional Rosales, San Salvador, El Salvador; <sup>7</sup>Ministry of Health Sri Lanka, Colombo, Sri Lanka.*

**Background:** Chronic kidney disease of unknown etiology (CKDu) or Mesoamerican Nephropathy was first reported from Central America and later from other countries such as Sri Lanka and India. CKDu in Central America and Sri Lanka have many clinical and morphological similarities, but if the disease has the same etiology or pathophysiological mechanisms has not been firmly established. We have previously conducted kidney biopsy studies in El Salvador, Nicaragua and Sri Lanka, where we have stored tissue for RNA-sequencing. In the current study we have analyzed the different gene expression in Central America and Sri Lanka and compared with healthy controls.

**Methods:** Kidney biopsy tissue stored in RNAlater<sup>TM</sup> from previous studies in El Salvador (n=7), Nicaragua (n=11), and Sri Lanka (n=10) and control tissue from Swedish living kidney donors (n=11) were microdissected into glomerular and tubulointerstitial fractions and RNA-sequencing was performed.

**Results:** Principal component analysis displayed a distinct separation of glomerular and tubulointerstitial fractions. RNA profiles of the tubulointerstitial fractions from Central America (El Salvador and Nicaragua) compared to Sri Lanka did not show any significant difference, i.e. genes in the tubules display similar expression. The glomerular fraction displayed some difference in the RNA profile between Central America and Sri Lanka but not as pronounced as between cases and controls. Preliminary results from differentially expressed gene analysis indicates significant differences in genes expression in both glomerular and tubulointerstitial fractions in cases compared to controls. Upregulated genes are involved in inflammation like the complement system and chemokine signaling. Further analysis of the results is ongoing.

**Conclusions:** Tubulointerstitial fractions in kidney biopsies from Central America and Sri Lanka show a strikingly similar gene expression. However, the glomerular fractions show some differences that will be further explored. The gene expression profile in this study suggests that the pathophysiological mechanisms behind CKDu in Central America and Sri Lanka are the same and a joint etiology is probable. Preliminary analysis of upregulated genes shows involvement in inflammatory pathways.

**Funding:** Private Foundation Support, Government Support - Non-U.S.

## SA-PO1013

### V-Set and Ig Domain Containing 4 Is Upregulated in Doxorubicin-Induced Kidney Injury Model

Sang Youb Han,<sup>1</sup> Jungyeon Ghee,<sup>2</sup> Jin Joo Cha,<sup>2</sup> Dae R. Cha,<sup>2</sup> *<sup>1</sup>Inje University Ilsan Paik Hospital, Goyang, Republic of Korea; <sup>2</sup>Korea University Ansan Hospital, Ansan, Gyeonggi-do, Republic of Korea.*

**Background:** V-set Ig domain containing 4 (VSIG4) is related to fibrosis in several diseases. However, the role of VSIG4 in the kidney diseases is still not clear. We investigated the expression of VSIG4 in doxorubicin-induced mice and doxorubicin-induced podocyte injury model.

**Methods:** Doxorubicin-induced animal model was observed for 4 weeks. In addition, cultured podocytes were treated by doxorubicin.

**Results:** In doxorubicin-induced model, the levels of urinary albumin and VSIG4 for 24 h were significantly higher in doxorubicin group than control mice: albumin, median, 12.7  $\mu$ g (IQR, 9.48-13.03) vs. 6.12, (IQR 2.56-9.26), P=0.006; VSIG4, median, 104.1 pg (IQR 66.3-135.1) vs. 46.3 (IQR 40.9-67.2), P=0.006. Interestingly, urinary VSIG4 levels were significantly correlated with urinary albumin levels (r = 0.912, P<0.001). The expression of intrarenal VSIG4 mRNA showed 2.69-fold higher in the doxorubicin mice than the control mice. To confirm expression of VSIG4 protein, the expression of VSIG4 protein was determined by Western blot. It was significantly higher in the doxorubicin mice than the control mice. In cultured podocytes, the expression of VSIG4 mRNA and protein was significantly higher in doxorubicin (1.0 and 3.0  $\mu$ g/mL) than the control at 12 and 24 hours. The mRNA expression showed 20.7-fold higher in doxorubicin (3.0  $\mu$ g/mL) group at 24 hours. The protein expression determined by western blot also showed a similar pattern to the mRNA expression.

**Conclusions:** In conclusion, the expression of VSIG4 was upregulated in the UUO and doxorubicin-induced models. VSIG4 would be involved in the pathogenesis of renal progression in chronic kidney diseases model.

## PUB001

**Hyperkalemia Is Associated With Increased Mortality Rates in COVID-19 Patients**

Lucas Wang, Victor A. Canela. Methodist Dallas Medical Center *Methodist Dallas Medical Center, Dallas, TX.*

**Background:** Abnormal potassium (K) levels are strongly associated with higher mortality rates among all hospitalized patients. In this study we aim to identify a correlation between abnormal K levels and mortality in coronavirus disease (COVID-19) patients may likely optimize inpatient management.

**Methods:** Using an observational database, we analyzed 3310 unvaccinated hospitalized COVID-19 PCR-positive patients at Methodist Health System from March 2020 to December 2020. We compared in-hospital death or hospice referral rates between patients with normal K levels (K = 3.5 to 5.0meQ/L), hypokalemia (K < 3.5meQ/L), or hyperkalemia (K > 5.0meQ/L) on first encounter. Chi-square ( $\chi^2$ ) and odds ratio tests were used to analyze observed variables.

**Results:** Of the 3310 COVID-19 patients, 463 (14.0%) died in the hospital or were discharged to hospice and 2747 (86.0%) were discharged home or to a post-acute care facility. In this study cohort, 285 (8.6%) patients had hyperkalemia, 453 (13.7%) had hypokalemia, and 2572 (77.7%) had normal K levels. Patients with abnormal K levels on initial encounter had a higher mortality rate than those who had normal K levels (OR 1.32, 95% CI 1.05 – 1.64,  $p = 0.02$ ). However, upon closer examination we found that hyperkalemia had a strong association with increased mortality in COVID-19 patients compared to normal K levels (OR 2.00, 95% CI 1.49 – 2.69,  $p < 0.001$ ); however, hypokalemia did not ( $p = 0.66$ ).

**Conclusions:** Hyperkalemia on presentation is associated with a significantly increased risk of in-hospital death or hospice discharge among hospitalized COVID-19 patients.

## PUB002

**COVID-19, ACE2, Plus Human Angiotensin II: The Perfect Storm**

Sean Barnett. *United States Air Force, Dayton, OH.*

**Background:** SARS-CoV-2 causes a disease unlike any we have seen before. The virus is similar to some, but the resultant disease is vastly different in the short and long term. This appears to be due to the Cytokine Storm (CS). The connection between COVID and the CS is likely related to Angiotensin II. Specifically, the Angiotensin II Type 1 Receptor (AT1R) which is regulated via the ACE2 Receptor (ACE2R). The AT1R pathway is the primary pro-inflammatory pathway that promotes endothelial activation, cellular recruitment and differentiation, T and B cell co-stimulation, and complement activation. This would explain the exact findings in the Cytokine Storm.

**Methods:** Extensive literature search including international publications and presentations as well as clinical experience. Direct clinical observation of the impact of RAAS on pathophysiology in COVID patients.

**Results:** The connection between COVID and the ACE2 Receptor (ACE2R) is the best explanation for the CS. COVID induced ACE2R endocytosis, decreased expression, and decreased transcription facilitates unchecked activation of AT1R. In addition to controlling AT1R mediated endothelial inflammation, the ACE2R is also the regulatory mechanism for the Bradykinin mediated coagulation pathway. This would enhance the explanation of not just the inflammation, but the clotting as well.

**Conclusions:** The ACE2R and AT1R connection is the best explanation for the tissue damage from COVID. AT1R mediated inflammation and vascular complications would explain the laboratory findings, histology findings, and clinical symptoms found in the Cytokine Storm. Furthermore, one of the key differences between SARS-CoV-2 and other recent virus outbreaks is the affinity with which SARS-CoV-2 binds to the ACE2R. It has the highest binding affinity of all current coronaviruses. This may explain the different outcomes in certain patients also. Any patients that would be at a higher RAAS baseline (Diabetes, Kidney Disease, Heart Disease) would be more likely to have complications. This is what we have seen clinically. Finally, this pathway gives us a mechanism for certain therapies that have shown promise such as Tocilizumab and Baricitinib. It also offers further treatment potentials for RAAS. In my experience, adequate blood pressures and ongoing diuresis are beneficial. Of particular benefit is diuresis with Hypertonic Saline, which has the best RAAS suppression and diuresis capabilities of any diuretic adjunct.

## PUB003

**Collapsing Glomerulopathy in a Patient With Recent COVID-19 and APOL-1 High-Risk Genotype**

Nang San Hti Lar Seng,<sup>1,2</sup> Michael J. Ross,<sup>3,2</sup> Daniel Schwartz,<sup>3,2</sup> Rimon Golovey,<sup>3,2</sup> *Jacobi Medical Center, Bronx, NY;* <sup>2</sup>*Albert Einstein College of Medicine, Bronx, NY;* <sup>3</sup>*Montefiore Medical Center, Bronx, NY.*

**Introduction:** Collapsing glomerulopathy (CG) is an aggressive subtype of focal segmental glomerulosclerosis, associated with poor renal outcomes. Risk factors for CG include HIV infection, APOL1 high-risk genotypes, and CG has also recently been reported in patients with COVID-19. We report a case of CG with acute kidney injury (AKI) in a patient with a high risk APOL1 genotype, who had renal recovery after prednisone treatment.

**Case Description:** A 43-year-old male with no past medical history presented with fever, myalgia, hemoptysis, vomiting, and diarrhea of 2 weeks duration. Initial exam was remarkable for temperature 103 degrees Fahrenheit, SpO2 95% on room air, and inspiratory crepitations without peripheral edema. Labs were notable for serum creatinine

2.6 mg/dL (unknown baseline), peak creatine kinase 4037 U/L, and urine protein creatinine ratio 19 g/g without RBCs. Chest CT was consistent with multilobar pneumonia. SARS-CoV2 PCR was repeatedly negative but COVID-19 spike and nucleocapsid IgG were positive. Extensive serologic workup for causes of glomerulonephritis and nephrotic syndrome was negative. He was empirically treated with antibiotics for pneumonia but cultures remained negative. Bronchoscopy revealed no evidence of alveolar hemorrhage. His renal function worsened, requiring hemodialysis. Kidney biopsy revealed collapsing glomerulopathy associated with thrombotic microangiopathy, few myoglobin casts suggestive of rhabdomyolysis, and acute tubular injury. Prednisone was initiated at 1mg/kg daily and tapered over 2 months. Lisinopril was initiated for proteinuria. After 5 months, serum creatinine was 1.3 mg/dL and urine protein creatinine ratio improved to 0.6g/g. Genetic testing revealed APOL1 G1/G1 genotype.

**Discussion:** In this patient, SARS-CoV2 PCR was likely negative because he presented weeks after symptom onset but the clinical course and serologic evidence of prior SARS-CoV-2 infection supports the diagnosis of COVID-19 associated CG in the setting of APOL1 high-risk G1/G1. Proposed mechanisms of COVID-19-related CG include increased cytokines, that upregulate podocyte expression of toxic APOL1 variants and AKI with tubular injury is often found. Our patient improved with steroid treatment but the treatment of COVID-19 associated CG requires further study.

## PUB004

**Pseudolung Cancer Lymphadenopathy, Development of Idiopathic Tubulointerstitial Nephritis, and Dense Deposit Disease Following Pfizer-BioNTech COVID-19 Vaccination**

Hironori Nakamura, Michiko Ueda, Anayama Mariko, Masaki Nagasawa, Yasushi Makino. *Department of Nephrology, Shinonoi General Hospital, Nagano, Japan.*

**Introduction:** Despite reports of glomerulonephritis associated with COVID-19 mRNA vaccines, no study has reported about the dense deposit disease (DDD). Here we present a case of pseudolung cancer lymphadenopathy following COVID-19 mRNA vaccine, following which the patient developed idiopathic tubulointerstitial nephritis (TIN) and DDD.

**Case Description:** A 74-year-old man received his second dose of the mRNA vaccine, and he developed fever, urticaria, and dyspnea. On further examination, he had pleural effusion and right hilar lymphadenopathies, which were improved with conservative therapy. On 48 days after the second vaccination, he developed renal dysfunction and new-onset hematuria. Light microscopy findings by a renal biopsy demonstrated apparent mesangial cell proliferation and diffuse inflammatory cell infiltration in the interstitium. Immunofluorescence analysis revealed 1+ positive results for IgG and IgM, negative results for IgA, and 2+ positive results for C3 with a garland pattern on the capillary walls. Electron microscopy detected that continuous and thickened highly dark-stained spotty dense deposits in the glomerular basement membrane. Based on the decrease in C3 and pathological findings, idiopathic TIN accompanied with DDD was diagnosed.

**Discussion:** After vaccination acute allergic reaction, pseudolung cancer lymphadenopathy, hematuria, and hypocomplementemia were observed. Thus, both coincidental onset with DDD and TIN following acute allergic response that occurred about 7 weeks before made us think that each event or disease might be associated with COVID-19 mRNA vaccination as part of immunological reactions. In complement activation related pseudoallergy syndrome, it is recently recognized that several modern-day therapeutic molecules may activate complements via the nonIgE mediated mechanism with the C3a and C5a anaphylatoxins binding to mast cells, triggering that the release of a number of several vasoactive mediators that cause the clinical features associated with hypersensitivity reactions. mRNA vaccine might have contributed to the development of lymphadenopathies, TIN and DDD in this case. Moreover, TIN and DDD might be associated with the activated alternative pathway induced by the mRNA vaccine.

## PUB005

**Predicting In-Hospital Mortality Among COVID-19 Pneumonia Patients With AKI**

David J. Wilhelm, T'shura Ali, Michael E. Brier, Dawn J. Caster, Forest W. Arnold, Jiapeng Huang. *University of Louisville, Louisville, KY.*

**Background:** COVID-19 has been identified as a disease causing respiratory failure but is now known to affect the kidneys among other organs. Several studies among COVID-19 patients have shown a significant association between acute kidney injury (AKI) and mortality. There is limited data examining if the effect of AKI on mortality is different across variants. The main objective of this study is to examine the association between AKI and in-hospital mortality among COVID-19 pneumonia (PNA) patients during the original strain and the delta variant.

**Methods:** Data was obtained from a retrospective analysis of patients hospitalized with COVID-19 PNA from March 2020 until March 2021. The database had two cohorts: the original strain and the delta variant. The presence of AKI was confirmed by an examination of medical records for 612 patients using the AKIN criteria (creatinine  $\geq 0.3$  mg/dL above baseline). Chronic kidney disease was defined by estimated Glomerular Filtration Rate (eGFR) calculated using the CKD-EPI 2021 equation. Logistic regression was used to estimate relative risk (RR) for mortality using factors in Table 1.

**Results:** AKI was present in 414 patients (67.6%). Of the 612 patients reviewed, there were 443 survivors and 169 non-survivors at discharge. Among the non-survivors, there were a higher proportion of AKI (84%) and males (64%) and a lower proportion of African Americans (30%). The non-survivors were younger (67 years) and had a lower eGFR (37 mL/min). Logistic regression results are shown in Table 1.

Key: TH - Thursday; FR - Friday; SA - Saturday; OR - Oral; PO - Poster; PUB - Publication Only

Underline represents presenting author.

**Conclusions:** Analyses showed that among patients hospitalized with COVID-19 PNA, the RR of in-hospital mortality was 3.28 times higher for those with AKI compared to those without AKI. We found no significant difference for in-hospital mortality between the two cohorts when adjusted for presence of AKI. Other findings showed that males may have a greater risk of mortality as compared to females and those of African American race may have a potential survival advantage.

Table 1

Factor	P value	Relative Risk
AKI vs non-AKI	<0.001	3.278
COVID-19 Cohort	0.486	0.868
Age (years)	0.085	1.013
Male vs Female	0.055	1.460
African American vs other races	0.108	0.713
eGFR (mL/min)	0.225	0.985

**PUB006**

**Lactic Dehydrogenase Is Associated With Renal Function Tests in Adults Hospitalized With SARS-CoV-2 Infection**

Karen Hopf, J. Perez, Edwing Campos, Damayanty Gomez, Damayanty Solis, Nuri P. Campos. *Hospital General Tacuba, Mexico City, Mexico.*

**Background:** Lactic dehydrogenase (LDH) is considered an inflammatory biomarker and its levels rise in many illnesses. Inflammation plays a critical role in the progression of kidney damage leading to lowering of glomerular filtration rate (GFR) and altering of kidney function tests including creatinine, blood urea nitrogen (BUN) and urea. The following trial has as its main goal to identify the degree of association between LDH levels and kidney function tests.

**Methods:** A retrospective, transversal study that took place in Tacuba General Hospital. Adults hospitalized with SARS CoV2 infection from May 2020 to December 2021 were included. Descriptive statistical analysis was made using Mann-Whitney U test. A boxplot graph was drawn comparing subjects that developed acute kidney injury (AKI) with those who did not (Figure 1A). Spearman's rank correlation coefficient was calculated. The risk of developing AKI with LDH above its cutoff value was calculated with logistic regression. The analysis was made using the STATA 14 program.

**Results:** 295 subjects, 64% men, mean age 61 ± 14 years. We obtained the following correlation using LDH as dependent variable: for GFR a r= -0.497; for creatinine a r= 0.539; urea r= 0.625; BUN r= 0.636 (Figure 1B). The risk of developing AKI with LDH above its cutoff value had an odds ratio of 3.64 [CI 95% (1.57-8.43)]. Statistical significance was considered with p<0.05.

**Conclusions:** Our results suggest that LDH serum levels are associated with every kidney function test.

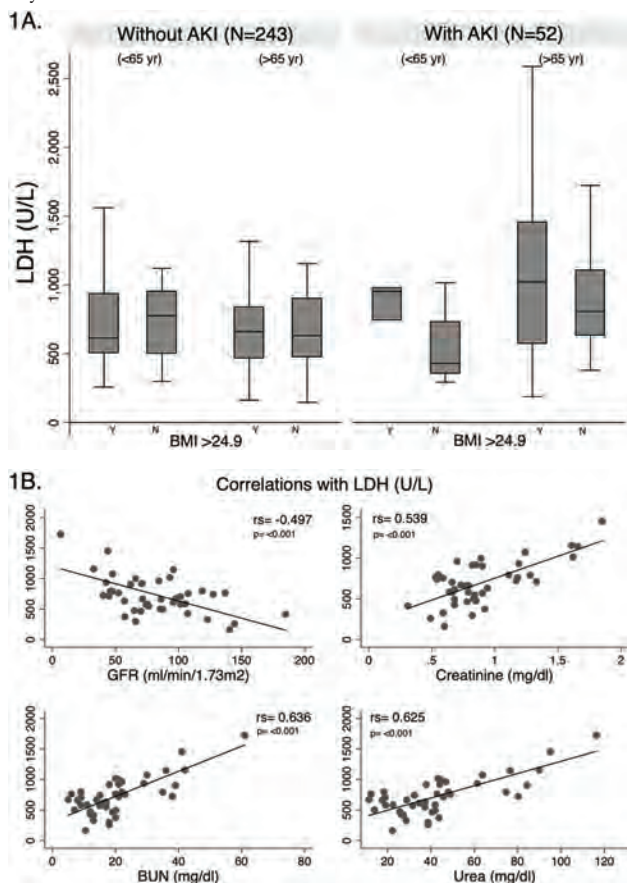

**PUB007**

**Podocytopathy After COVID-19 Vaccine Administration in a Patient With Autosomal Dominant Polycystic Kidney Disease**

Armando T. Cardenas, Ramesh Saxena. UT Southwestern *The University of Texas Southwestern Medical Center, Dallas, TX.*

**Introduction:** Development of vaccines against SARS-COV-2 has resulted in considerable reduction in severe complications and mortality. Several cases of glomerular disease have been recently reported such as Minimal Change disease and Focal Segmental Glomerulosclerosis. We describe a patient with autosomal dominant polycystic kidney disease (ADPKD) who developed nephrotic syndrome, soon after receiving COVID-19 vaccine.

**Case Description:** 40-year-old male with history of chronic kidney disease stage-3 due to ADPKD diagnosed 20 years ago. Baseline serum creatinine 2 - 2.5 mg/dl and minimal proteinuria. Other comorbidities include well-controlled type 2 diabetes mellitus and hypertension. Received two doses of Covid-19 vaccine on February 25 and March 24, 2021. He had malaise, myalgia, and fatigue after vaccination. On April 2021, was noted to have 3+ protein on dipstick, no quantification done. In May of 2021 patient presented to hospital with heart failure and ejection fraction of 39% in association with acute coronary syndrome due to ST elevation myocardial infarction, underwent placement of a drug-eluting stent and placement on dual antiplatelet therapy (DAPT). He had 3+ protein on dipstick. In June 2021 developed abdominal pain with hematuria which was attributed to cyst-hemorrhage, underwent decortication of left renal cyst. However, the patient continued having gross hematuria requiring multiple blood transfusions and cessation of DAPT. Patient was admitted to UTSW in September 2021 and was noted to have nephrotic syndrome with proteinuria of 3925 mg, low serum albumin of 2.0 g/dL and pedal edema concerning for podocytopathy associated with COVID-19 vaccine. Kidney biopsy was deferred due to active bleeding. Patient was empirically started on Prednisone 60mg with rapid taper. At discharge 12 days later, proteinuria was down to 0.6 g/g of creatinine, serum albumin 3.2 g/dL and hematuria resolved. On his last follow up, proteinuria was 0.3 g/g, serum albumin 3.6 g/dL and serum creatinine 2.67 mg/dl.

**Discussion:** Millions of mRNA vaccines have been administered since the development of the COVID-19 vaccine. Proposed mechanisms when mounting a response to the vaccine are toll-like receptors promoting podocyte damage in the glomeruli. These glomerulopathies once noted have been treated with immunosuppression and there has been remission reported.

**PUB008**

**An Unusual Case of ANCA Associated Vasculitis (AAV) After a COVID-19 Vaccine**

Maria Lanau,<sup>1</sup> Loreto Fernandez.<sup>1,2</sup> <sup>1</sup>Hospital Universitario de Navarra, Pamplona, Spain; <sup>2</sup>Instituto de Investigacion Sanitaria de Navarra, Pamplona, Spain.

**Introduction:** COVID-19 vaccines have been related to immune mediated adverse events and recently some case reports of AAV precipitated after either RNA or viral vector vaccines have been reported.

**Case Description:** A 83 year old woman with past records of polymyalgia rheumatica (2017) treated with low dose prednisone, was admitted to our hospital because of malaise, hypoxemia and weight loss in the context of urinary symptoms. These started since the second COVID-19 Pfizer- BioNTech vaccine dose administered 3 months ago. Initial blood test revealed anemia, acute kidney injury (serum creatinine 1.7mg/dl), leucocytosis and elevated CRP. Urinalysis showed microhematuria and mild proteinuria in the context of a positive urine culture. She had normal kidneys on ultrasonography. Diuretics and antibiotics were started, but few days after renal function continued worsening (sCr 4.3 mg/dl) with an active sediment. For this reason, immunology tests were ordered with positive high MPO-ANCA antibodies. Hence, a kidney biopsy was performed showing 11 normal glomeruli but severe arteritis in two small-middle sized arterioles with fibrinoid necrosis. Steroids and Rituximab were given as induction therapy with good renal response.

**Discussion:** AAV after COVID-19 vaccine administration has been reported previously, and it could be related to its molecular mimicry and immune crossreaction. Most of them were typical forms of pauci-immune crescentic glomerulonephritis, but none with isolated vascular damage. Although cases reported appeared shorter time after vaccine administration, our patient was on low dose prednisone which may explain a subacute onset of the disease. Moreover, she clearly presented constitutional symptoms ever since the second vaccine dose was administered. Finally, although the efficacy and safety of the COVID-19 vaccines have been demonstrated, particular attention should be paid to patients with known or suspected autoimmune diseases.

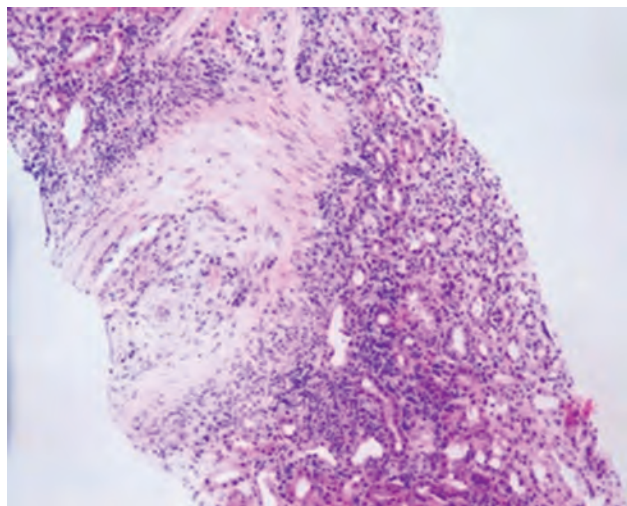

		Kevzara - 1	Kevzara-0	Marginal Row Totals
Alive		7 (4.33) [1.64]	6 (8.67) [0.82]	13
Dead		1 (3.67) [1.94]	10 (7.33) [0.97]	11
Marginal Totals	Column	8	16	24 (Grand Total)

Chi square value is 5.3706. The p-value is .020479. Significant at  $p < .05$

While Kevzara significantly prolonged life, the number of dialysis days per patient increased. The number of dialysis days per patient (DDPP) was 12 in the Kevzara group whereas DDPP was 4.258 in the non-Kevzara group. All patients who had RRT also received Mechanical ventilation except one patient in the non-Kevzara group.

		Alive	Dead	Marginal Row Totals
No support		2 (4.25) [1.19]	4 (1.75) [2.89]	6
Support		15 (12.75) [0.4]	3 (5.25) [0.96]	18
Marginal Totals	Column	17	7	24 (Grand Total)

The chi-square statistic is 5.4454. The p-value is .01962. Significant at  $p < .05$ .

This suggests that organ support in the form of mechanical ventilation, and renal replacement therapy was provided to most patients who were alive at four weeks.

		Alive	Dead	Marginal Row Totals
No support		2 (4.5) [1.39]	4 (1.5) [4.17]	6
Support		16 (13.5) [0.46]	2 (4.5) [1.39]	18
Marginal Totals	Column	18	6	24 (Grand Total)

The chi-square statistic is 7.4074. The p-value is .006496. Significant at  $p < .05$ .

The chi-square statistic with Yates correction is 4.7407. The p-value is .029456. Significant at  $p < .05$ .

**PUB009**

**Impact of Kevzara on the Survival and the Need for Renal Replacement Therapy (RRT) in the Alpha-Wave of COVID-19 Patients: Retrospective Cohort Study**

Nehemias Guevara,<sup>1</sup> Claudia G. Olano,<sup>3</sup> Andrea L. Urrutia,<sup>2</sup> Sami M. Akram,<sup>4</sup>  
<sup>1</sup>St Barnabas Hospital, Bronx, NY; <sup>2</sup>FOMAT Medical Research, Los Angeles, CA; <sup>3</sup>Harbor-UCLA Medical Center, Torrance, CA; <sup>4</sup>Loma Linda University, Loma Linda, CA.

**Background:** The alpha wave of COVID-19 brought death and dismay to patients and to providers respectively. Remdesivir nor plasma was available. We studied this cohort to evaluate the need for mechanical ventilation (MV) and Renal replacement therapy and the outcome of hospital discharge. It is well known that the covid-19 causes Cytokine Release Syndrome (CRS), therefore, producing dysregulation and an increase in the immune response, interleukin 6, plays a central role in triggering the (CRS) and stimulating other inflammatory markers.

**Methods:** A retrospective-observational study. We reviewed the patients admitted to the intensive care unit of a metropolitan hospital in the Los Angeles area from February 17th, 2020, till March 14th, 2020. There was 24 patient who was in the ICU. At the time, Remdesivir was not available at the hospital

**Results:** Eight of the 24 patients received Kevzara. Of the 8 patients, 2 required RRT while of the 16 patients who did not receive Kevzara, 6 required RRT. All 8 patients who received RRT also had MV for varying number of days and all were alive at 28 days. Among the 16 patients who did not receive Kevzara, 11 required mechanical ventilation, and 6 got RRT. 5 patients got both MV and RRT. The number of days of RRT was required was 12 in the Kevzara group and 4.25 in the none-Kevzara group. Chi Square value of 5.3706  $p$  value =  $<0.5$

**Conclusions:** Kevzara reduced 28-d mortality in the alpha wave of covid-19. There is incremental value in the use of Kevzara and Organ support technologies such as MV and RRT in the ICU. As the patient's life is prolonged in critical care units, there is increased demand for renal replacement therapy resources

**PUB010**

**Transient Elevation of Serum  $\beta_2$ -Microglobulin in Hemodialysis Patients After COVID-19 Vaccination: A Retrospective Case Series Study**

Hiroki Uchida, Takeshi Nakata, Jun Okita, Akiko Kudo, Akihiro Fukuda, Hirotaaka Shibata. Oita Daigaku Igakubu Daigakuin Igakukei Kenkyuka, Yufu, Japan.

**Background:** Serum  $\beta_2$ MG (beta2-microglobulin) is an indicator of dialysis efficiency; however, it is also elevated in immune diseases and infections. The mRNA vaccines for corona virus disease 2019 (COVID-19) have been reported to produce stronger immune responses than conventional vaccines. In this study, we examined whether mRNA vaccination increases serum  $\beta_2$ MG levels in hemodialysis patients.

**Methods:** This was a single-center, case series study. A total of 23 maintenance hemodialysis patients who received Pfizer's vaccine (brand name: BioNTech SE) were included and observed between January 1, 2021 and December 31, 2021. We analyzed changes in serum  $\beta_2$ MG levels before and after vaccination. The pre-vaccination  $\beta_2$ MG value (baseline) was measured within 3 months prior to the first vaccination, and the post-vaccination  $\beta_2$ MG values were evaluated at 2 weeks, 1 month, and 3 months.

**Results:** Twenty-one patients were finally enrolled in this study. Fifteen (71.4%) patients were male, mean age was  $70.7 \pm 12.8$  years, and dialysis period was 5.3 (2.0 - 12.7) years (median, interquartile range). Some side effects were observed, fever in six cases (28.6%) and diarrhea in one case (4.8%). Serum  $\beta_2$ MG levels transiently increased from  $27.6 \pm 5.7$   $\mu$ g/L to  $32.1 \pm 8.4$   $\mu$ g/L before and after vaccination ( $P < 0.001$ ), and C-reactive protein (CRP) levels also increased transiently from  $0.24 \pm 0.37$  mg/dL to  $0.59 \pm 0.66$  mg/dL before and after vaccination ( $P < 0.05$ ). These transient elevations were restored to baseline levels over time. Serum  $\beta_2$ MG and CRP levels showed no significant differences after 1 and 3 months compared with baseline. During this observational period, no patient had changes in dialysis condition, size or type of dialyzer, modality, and blood volume flow.

**Conclusions:** In hemodialysis patients, a transient increase in serum  $\beta_2$ MG levels after vaccination may be caused by an immune response to vaccination and should be differentiated from worsened dialysis efficiency.

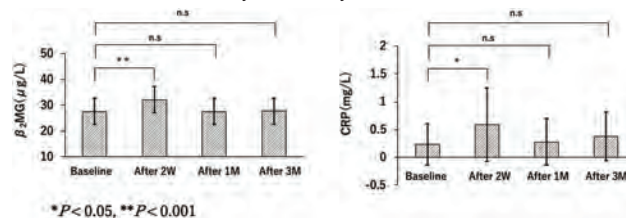

Fig.  $\beta_2$ MG and CRP levels before and after vaccination.



**PUB011**

**A Third Dose or Booster Dose of SARS-CoV-2 mRNA-1273 Vaccine Increases Antibody Levels Among Dialysis Patients**

Linda Ficociello,<sup>1</sup> Joanna Willetts,<sup>1</sup> Curtis D. Johnson,<sup>2</sup> Sandra E. Alexander,<sup>3</sup> Claudy Mullon,<sup>1</sup> Jeffrey L. Hymes.<sup>1</sup> <sup>1</sup>Fresenius Medical Care, Waltham, MA; <sup>2</sup>Spectra Laboratories, Milpitas, CA; <sup>3</sup>Fresenius Medical Care North America, Waltham, MA.

**Background:** To help protect dialysis patients from COVID-19, efforts have been made to ensure widespread vaccination, however, reports have shown waning antibody (AB) levels that may decline faster than the general population. The current analysis examines AB response to a 3<sup>rd</sup> or booster dose of mRNA-1273 vaccine among dialysis patients across 7 dialysis clinics in Massachusetts.

**Methods:** All patients received 2 mRNA-173 doses and had AB measured 250+ days after 2<sup>nd</sup> dose (when additional/booster doses were available). Covid-19 positive/suspected cases were not included in the analysis. As part of a quality improvement project, patients were classified into 3 groups based on further doses received: mRNA booster (Booster 50 mcg), mRNA additional dose (Additional; 100 mcg), and no second dose or booster (Primary). AB response was measured in remnant blood with semiquantitative chemiluminescent assay detecting IgG AB directed against receptor binding domain of S1 subunit of SARS-CoV-2 spike antigen (Siemens); AB index >1 was considered reactive, >7 as adequate, and > 750 was maximum detected. For time periods with multiple AB measurements, the latest AB value was utilized.

**Results:** Distribution of AB levels before and after booster/additional dose are presented in figure. Before booster/additional dose few patients had AB levels > 750 (2%). After booster or additional dose, 58% and 50% had AB levels > 750, respectively. AB response ≤ 7 was common (46%) before and rare after booster and additional dose (2% and 0%).

**Conclusions:** After the administration of booster/additional doses of mRNA COVID-19 vaccines, nearly all patients had at least adequate AB response and the majority had maximum response. This is contrasted with the patients not receiving booster/additional dose, where 72% had adequate AB response and 27% had maximum response.

**Funding:** Commercial Support - Fresenius Medical Care

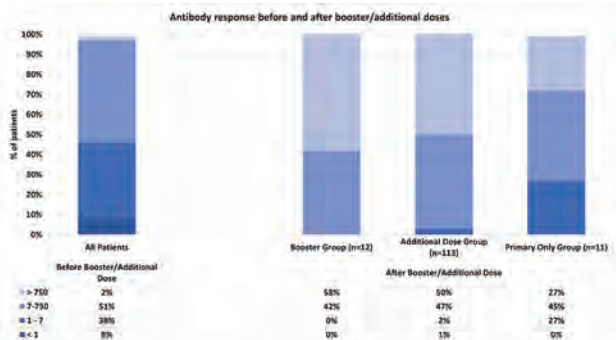

**PUB012**

**Outcomes of COVID-19 Hospitalization in Kidney Transplant Recipients: A Single Center Experience**

Michael Turk,<sup>1</sup> Ali W. Rizvi,<sup>1</sup> Laith Alhuneafat, Naman Gupta, Shane Mealy, Alisha Sharma, Omar Osman, Ramya Gutta, Aaisha Shah, Tabeer Rana, Katherine Barnett, Kalathil K. Sureshkumar. *Allegheny Health Network, Pittsburgh, PA.*

**Background:** COVID-19 infection is associated with worse outcomes in kidney transplant recipients (KTRs). Despite wide availability of safe and effective vaccines, transplant recipients are disproportionately affected. We aim to investigate our center's experience with COVID-19 hospitalization in KTRs and measure their clinical outcomes.

**Methods:** In this retrospective observational cohort study, we identified KTRs who developed COVID-19 infection between March 2020 and January 2022 within our integrated health network. Through chart review, patient characteristics and outcomes were collected.

**Results:** Among 186 patients who tested positive for COVID-19, 114 (61%) required hospitalization out of which 53 received at least one dose of vaccine and 61 were unvaccinated. Among the unvaccinated, 26 (43%) patients were admitted prior to January 2021 when vaccines were not yet widely available. Vaccination rate among patients admitted after January 2021 was 53/88 (60%). Baseline characteristics between vaccinated and unvaccinated patients were similar. There were 24 deaths during admission and another 7 deaths within 90 days, for a total of 31/114 (27%). There was a trend towards lower mortality in vaccinated patients (10/53 (19%) vs. 21/61 (34%), *p*=0.06). The need for dialysis was significantly lower in vaccinated patients (9/53 (17%) vs. 21/61 (34%), *p*=0.03) (Table).

**Conclusions:** COVID-19 infection is associated with higher mortality in KTRs with a mitigating effect from vaccination. Decreased dialysis requirement in vaccinated but hospitalized KTRs with COVID-19 infection likely reflects less severe infection, indicating that vaccination confers allograft protection. Every effort should be made to encourage and educate KTRs regarding COVID-19 vaccination including booster doses in order to reduce morbidity and mortality.

Outcomes by Vaccination Status

Variables	Vaccinated (n=53)	Unvaccinated (n=61)	p-value
Mortality during admission	8 (15%)	16 (26%)	0.15
Mortality within 90 days	10 (19%)	21 (34%)	0.06
DVT/PE during admission or within 30 days	2 (3.8%)	6 (9.8%)	0.21
Required supplemental oxygen during admission	28 (53%)	36 (59%)	0.51
AKI on or during admission	33 (62%)	44 (72%)	0.26
Need for new dialysis during admission or on discharge	9 (17%)	21 (34%)	<b>0.03</b>
Length of stay (days)	8.3 ± 9.1	8.1 ± 6.2	0.86

**PUB013**

**COVID-19-Associated Collapsing Glomerulopathy: A Report of Three Patients With African Ancestry**

Maryam Saleem, Bharat Neelam Raju, Scott C. Stockholm, Bjorn Anderson, Tingting Li. *Washington University in St Louis, St Louis, MO.*

**Introduction:** Collapsing glomerulopathy has become an important cause of acute kidney injury (AKI) in COVID-19 patients. Reports on presentation & outcomes of COVID-19-associated collapsing glomerulopathy (COVAN) have been published. We report 3 patients who presented with COVID-19, AKI & nephrotic range proteinuria.

**Case Description: Patient 1:** 58 year-old African American (AA) male with hypertension presented with dyspnea, was diagnosed with COVID-19 & found to have serum creatinine (SCr) of 21.5 mg/dL (baseline 0.8 mg/dL) & urine protein of 9.3 g/day. Renal biopsy showed collapsing glomerulopathy, acute tubular injury (ATI) & severe podocyte foot process effacement. APOL1 genotyping revealed high-risk genotype (G1/G1). Patient required 4 sessions of hemodialysis (HD) & recovered enough kidney function to discontinue HD. At 6 months follow-up, SCr was 1.6 mg/dL. **Patient 2:** 29 year-old AA female with sickle cell disease & previous history of collapsing glomerulopathy in remission presented with dyspnea & was diagnosed with COVID-19. SCr was 3.6 mg/dL (baseline 0.9 mg/dL) & urine protein of 28 g/day. Renal biopsy showed focal collapse of capillary loops, severe podocyte foot process effacement, & moderate interstitial fibrosis/tubular atrophy. APOL1 genotyping revealed high-risk genotype (G1/G1). Patient was started on prednisone. SCr stabilized between 2-2.5mg/dL on discharge. At 6-month follow-up, SCr was 2.6mg/dL. **Patient 3:** 53 year-old AA male with hypertension presented with cough and was diagnosed with COVID-19. SCr was 3.2 mg/dL (baseline 1.1 mg/dL), with nephrotic range proteinuria (5.6 g/day). Work up revealed new diagnosis of HIV & syphilis. Renal Biopsy showed collapsing glomerulopathy. APOL-1 genotyping showed high risk genotype (G1/G1). Patient was started on treatment for COVID-19 pneumonia & penicillin G for syphilis. Renal function & proteinuria improved within a few days, prior to initiation of HIV therapy. At 1 month follow-up, SCr was 3.0 mg/dL & at 2 years, SCr was 1.6 mg/dL.

**Discussion:** Our report supports the published findings that COVAN manifests as AKI, heavy proteinuria, can occur even in the absence of severe respiratory symptoms, & is strongly associated with high-risk APOL1 genotype. Although AKI & proteinuria improved all 3 patients, all are left with some degree of chronic kidney disease

**PUB014**

**Acute Pericarditis in ESRD due to COVID-19 Despite Vaccination**

Muhammad Khalid Tahir,<sup>1</sup> Usman Kazi,<sup>2</sup> Arun U. Mahtani,<sup>1</sup> Angela Grigos,<sup>1</sup> Farhang Ebrahimi,<sup>1</sup> Syed Rizwan A. Bokhari,<sup>3</sup> <sup>1</sup>Richmond University Medical Center, Staten Island, NY; <sup>2</sup>HCA Florida Citrus Hospital, Inverness, FL; <sup>3</sup>Bassett Healthcare, Cooperstown, NY.

**Introduction:** - Myocarditis, cardiomyopathy, and heart failure; common cardiac manifestations of Coronavirus infectious disease (COVID-19).<sup>1-3</sup> - Acute pericarditis is rare.<sup>4</sup> - We report a case of a new-onset pericardial rub diagnosed as acute pericarditis due to COVID-19 in a patient with end-stage renal disease (ESRD) despite vaccination.

**Case Description:** - A 61-year-old male with a history of chronic kidney disease stage 5 (CKD 5) approaching dialysis, status post renal transplant twice (first in 1997 and second in 2010) presented with dyspnea of a few days' duration. - Medications: amlodipine, atorvastatin, calcitriol, clonidine patch, hydralazine, sevelamer, tacrolimus, and tamsulosin. - Physical examination: 2+ pitting edema and rales over bilateral lung fields. - Laboratory tests: Blood urea nitrogen (BUN) and Creatinine (Cr) of 154/13.6, respectively. Initial COVID-19 serologies were negative. - Electrocardiogram (EKG) and echocardiogram (ECHO) at admission were unremarkable. - Received seven hemodialysis sessions that improved his symptoms. - Subsequently, he spiked a fever with a recurrence of dyspnea and pleuritic chest pain. - Auscultation: New onset pericardial rub. - Laboratory test: BUN/Cr of 54/5.3. Tested positive for COVID-19. - Repeat ECHO: Pericarditis and moderate-sized pericardial effusion with normal left ventricular systolic function and ejection fraction. - Treated with heparin-free intensive hemodialysis and colchicine.

**Discussion:** - Acute pericarditis presentation; Two or more of the following symptoms: chest pain, friction rub, diffuse ST-elevations, PR depressions on EKG, and new or worsening pericardial effusion.<sup>5</sup> - Can lead to cardiac tamponade if left untreated.<sup>6</sup> - In ESRD, important to consider differential diagnoses of pericarditis; uremia, and fluid overload causing effusion. Due to the recent pandemic, COVID-19 must be taken into consideration irrespective of vaccination status.

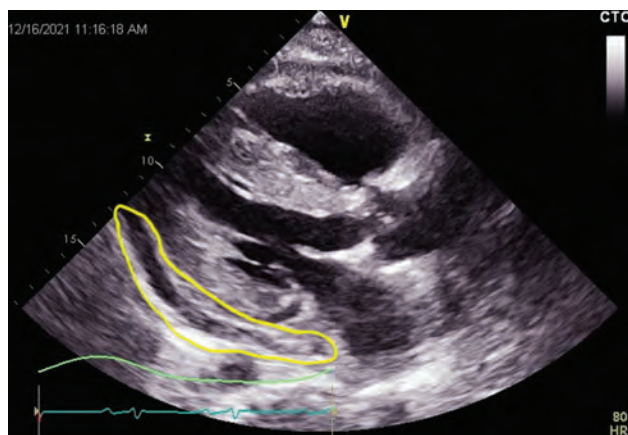

Parasternal Long Axis View Showing Pericardial Effusion

**PUB015**

**Impact of Hypertension on Long-Term Humoral and Cellular Response to SARS-CoV-2 Infection**

Chang Chu,<sup>1</sup> Anne Schönbrunn,<sup>3</sup> Volker von Baehr,<sup>3</sup> Bernhard K. Krämer,<sup>2</sup> Saban Elitok,<sup>4</sup> Berthold Hoher.<sup>2</sup> <sup>1</sup>Charite Universitätsmedizin Berlin, Berlin, Germany; <sup>2</sup>Ruprecht Karls Universität Heidelberg, Heidelberg, Germany; <sup>3</sup>Institute of Medical Diagnostics, Berlin, Germany; <sup>4</sup>Klinikum Ernst von Bergmann gGmbH, Potsdam, Germany.

**Background:** It was shown that hypertension delays SARS CoV-2 viral clearance and exacerbates airway hyper-inflammation in the respiratory tract. However, it is unknown whether hypertension determines the long-term cellular and humoral response to SARS CoV-2.

**Methods:** Health care workers (HCWs) after an outbreak of SARS CoV-2 infections were recruited. Two groups were analyzed, infected and fully vaccinated HCWs. Clinical data were recorded. Blood was drawn and the humoral and cellular immune responses were examined.

**Results:** 5-14 months (median 7 months) after detection of SARS CoV-2 infection, blood was taken to analyze humoral response (S1 IgG and SARS CoV-2 neutralizing antibodies) and cellular (T cell responses to SARS-CoV-2 with Lymphocyte Transformation Test). Infected hypertensive HCWs more often developed anosmia, myalgia and needed to be hospitalized as compared to non-hypertensive HCWs. The long-term humoral and cellular immune response was significantly strengthened in hypertensive versus normotensive infected HCWs. Multivariate regression analysis revealed that only hypertension but not age, BMI, sex, diabetes, smoking, COPD, asthma and time between PCR positivity and blood taking was independently associated with the humoral and cellular response to SARS CoV-2 infection.

**Conclusions:** In conclusion, SARS CoV-2 infection strengthened humoral and cellular immune response to SARS CoV-2 infection in hypertensive HCWs independent of other risk factors and also severity of symptoms.

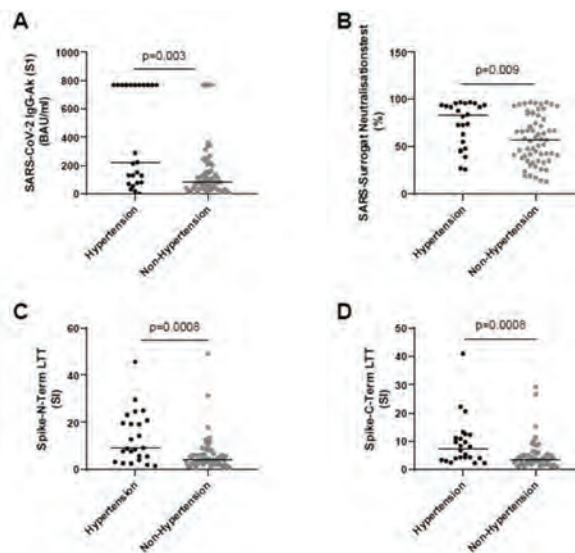

**Figure 1.** (A) SARS-CoV-2 IgG-Ab (S1) (BAU/ml) in SARS-CoV-2 infected health care workers (HCWs) with and without hypertension. (B) SARS surrogate neutralization test (%) in SARS-CoV-2 infected HCWs with and without hypertension. (C) Spike-N-Term LTT (SI) in SARS-CoV-2 infected HCWs with and without hypertension. (D) Spike-C-Term LTT (SI) in SARS-CoV-2 infected HCWs with and without hypertension. Lines show median. Comparison was made by Mann-Whitney U test

**PUB016**

**A Study of ESRD Patients on Maintenance Haemodialysis With COVID-19**

Lakshmi Aishwarya Pavuluri,<sup>1</sup> Venkata A. Yalamanchili,<sup>2</sup> Ram Rapur.<sup>1</sup> Nephrology, SVIMS, Tirupati <sup>1</sup>Sri Venkateswara Institute of Medical Sciences, Tirupati, India; <sup>2</sup>Dallas Nephrology Associates, Dallas, TX.

**Background:** This study presents the data of ESRD patients on maintenance haemodialysis (MHD) with COVID-19 disease from Sri Padmavathi Medical College (SPMC) Hospital, SVIMS University, Andhra Pradesh, India which had been ordained as the State COVID Hospital in March 2020.

**Methods:** We collected the data from March 2020 to December 2021 of ESRD patients on MHD in a retrospective observational study and identified the risk factors for mortality.

**Results:** At SPMC Hospital, the total number of COVID-19 disease patients managed was 15,719. The number of deaths reported was 2,878 (18.3%). We identified a total of 714 ESRD patients who required MHD during this period. We analyzed data for 595 patients (83.3%). The rest of patient files could not be traced owing to mismatch in the medical record numbers and patient names. The number of ESRD patients on MHD with COVID-19 disease who died were 203 out of 595 (34.1%). We identified age, SpO<sub>2</sub> at admission, number of dialysis sessions, total leucocyte count, neutrophils, lymphocytes, blood urea, serum glutamic-oxaloacetic transaminase (SGOT), serum glutamic-pyruvic transaminase (SGPT), C-reactive protein (CRP), serum ferritin, serum lactate dehydrogenase (LDH), male, diabetes mellitus, oxygen requirement at admission, non invasive ventilation (NIV) at admission and NIV in hospital as significant risk factors for mortality (P<0.001). On multivariate analysis age, NIV during hospital stay and serum LDH returned significant.

**Conclusions:** The mortality rate in ESRD patients on MHD with COVID-19 disease at our institution was not divergent from the published studies; however, we identified several different risk factors.

**PUB017**

**Pauci-Immune Crescentic Glomerulonephritis (PICGN) Following SARS-CoV-2 Vaccination**

Lakshmi Aishwarya Pavuluri,<sup>1</sup> Venkata A. Yalamanchili,<sup>2</sup> Ram Rapur.<sup>1</sup> Nephrology, SVIMS, Tirupati <sup>1</sup>Sri Venkateswara Institute of Medical Sciences, Tirupati, India; <sup>2</sup>Dallas Nephrology Associates, Dallas, TX.

**Introduction:** We report two patients (pt) of PICGN following administration of Indian vaccines (COVISHIELD and COVAXIN) against COVID-19.

**Case Description:** Pt 1: A 41-year old women with no hypertension or diabetes received COVAXIN in June 2021. Six days later she developed joint pain, fever, cough and hemoptysis along with fourth urine, pedal edema but no hematuria. Serological work up was negative for ANA, Anti GBM and pANCA. She had a positive cANCA (PR3) titer. Renal biopsy showed fibrocellular crescents with segmental sclerosis. Basement membrane showed no spikes or double contour. No endocapillary proliferation or necrotizing lesion seen. Immunofluorescence (IF) was negative. We initiated intravenous (IV) methylprednisolone 15 mg/kg/d for three days followed by PO prednisolone

0.5 mg/kg/d and IV cyclophosphamide 500 mg monthly for 3 months. Five daily sessions of plasmapheresis with 1.5 times volume exchange followed by alternate day exchanges for five more sessions was completed. Serum creatinine improved to 2.0 mg/dl from a peak creatinine of 7.6 with out requiring hemodialysis (HD). Pt 2: A 45-year old woman with history of hypertension treated with telmisartan and amlodipine received COVISHIELD vaccine against COVID-19 in June 2021. Next day she had vomiting and abdominal pain. No joint pains, fever, cough, hemoptysis, hematuria or frothy urine reported. Serum Creatinine was elevated at 2.85 mg/dl. ANA and Anti-GBM negative but ANCA (PR3, MPO) was positive. Renal biopsy showed a cellular crescent and a fibrocellular crescent in one glomerulus each. IF was negative. She was started on IV methylprednisolone 15 mg/kg/d for three days followed by prednisolone 0.5 mg/kg/d PO and IV cyclophosphamide 500 mg monthly for 4 months. Five daily sessions of plasmapheresis with 1.5 times volume exchange followed by alternate day exchanges for five more sessions was done. Serum creatinine improved to 2.7 mg/dl from a peak of 3 without requiring HD.

**Discussion:** Both COVAXIN and COVISHIELD are developed using Whole-Virion Inactivated Vero Cell derived platform technology. Inactivated vaccines do not replicate and are therefore unlikely to revert and cause pathological effects. In our pt, causality of PICGN with these two vaccines is based on temporal association. The appearance of ANCA and PICGN shortly after vaccination raises suspicion that the two events are more than coincidence.

## PUB018

### Outcomes of Patients in Advanced CKD Consultation With COVID-19 Infection

Juan Carlos Herrero, *University Hospital Severo Ochoa, Leganes, Spain.*

**Background:** The coronavirus disease 2019 (COVID-19) has affected to our patients in renal replacement therapy (RRT). But also, has affected to patients in Advanced Chronic Kidney Disease (ACKD) consultation. Our aims are to assess the impact of COVID-19 in a group of patients of our ACKD consultation.

**Methods:** Retrospective observational study in our center of patients from ACKD consultation with hospitalization due to COVID-19 infection in the period from March to December/2020. We have studied demographic parameters, characteristics during hospitalization, analytics values (3 months before and 1, 3, 6, and 12 months after infection), and final status at the end of follow up on December 31, 2021. Values comparison is made with the Wilcoxon test for paired data.

**Results:** In ACKD consultation with ninety patients, 12 (13%) required hospitalization due COVID-19. 75% was male, mean age 77.6 years (SD 7) (range 59-89), 25% due to Diabetic Kidney Disease. Mean time in consultation 28 months (SD 14) (range 12-58). Mean Comorbidity Charlson Index 8.2 (SD 1.2) (range 7-11), all hypertensive, 42% treatment with insulin, 25% ischemic heart disease and 42% chronic obstructive pulmonary disease. In COVID-19 hospitalization, 83% they had pneumonia, only two required tocilizumab, none required admission to intensive care unit. During hospitalization, 3 (25%) patients died, and one during follow-up, all males. Comparison before and during COVID, hemoglobin and albumin was lower, and white cell, ferritin, creatinine, and C-reactive protein increase with significant value. From 6 months after COVID, the analytics results are like 3 months after disease. The consequences after infection: 42% pneumology (cough, varying degrees of shortness of breath), 8% neurological (headaches, varying degrees of memory loss) and 8% loss of smell (from 1 to 6 months). At the follow up, only one patient needs RRT with hemodialysis (at 19 months after COVID-19).

**Conclusions:** With the important limitation of few patients and without control group, ACKD patients with hospitalization to COVID-19, show similar patterns to those with RRT: more frequent in males, advanced age, lung comorbidity and diabetic, elevation of inflammatory parameter, anemia and increase of creatinine during hospitalization. Recovery to values prior to admission occurs from the first month after infection.

## PUB019

### One Year Antibody Response to COVID-19 mRNA Vaccinations in Hemodialysis Patients

Mingyue He,<sup>1</sup> Zakir Shaik,<sup>1</sup> Crystal A. Gadegbeku,<sup>2</sup> Louise Enderle,<sup>3</sup> Christina Petyo,<sup>3</sup> Sally B. Quinn,<sup>1</sup> Zoe Pfeffer,<sup>1</sup> Kathleen Murphy,<sup>3</sup> Aaron D. Mishkin,<sup>1</sup> Jean Lee,<sup>1</sup> Avrum Gillespie.<sup>1</sup> <sup>1</sup>Lewis Katz School of Medicine at Temple University, Philadelphia, PA; <sup>2</sup>Cleveland Clinic Glickman Urological and Kidney Institute, Cleveland, OH; <sup>3</sup>DCI, Dialysis Clinic Inc, Philadelphia, PA.

**Background:** The hemodialysis patients have a high risk of contracting SARS-CoV2 and high COVID-19 related mortality. We examined the durability and persistence of antibody response to a series dose of COVID19 vaccination in a single-center cohort of hemodialysis patients.

**Methods:** We conducted a longitudinal SARS-CoV2 antibody surveillance study of a cohort of 30 hemodialysis patients between March 2021 to March 2022. Participants received a two-dose mRNA vaccine and a booster as clinically indicated independent of the study. Antibody levels were measured using the Beckman Coulter Access SARS-CoV-2 IgG Antibody Test<sup>®</sup> on the day of enrollment, and every month after enrollment.

**Results:** The mean age of participants was 61±14 years old, 97% self-identified as African America, and 53% identified as male. The mean dialysis vintage was 4.6±3.7 years. None received immunosuppressive therapy. Participants were divided into those who had COVID19 infection prior to enrollment (8/30) and those who did not (22/30). Those with a previous infection had a durable antibody response 10 to 12 months post the first dose of mRNA vaccine as well as a response to the booster. Of those without previous COVID19 infection, 91% (20/22) had positive antibodies after two doses of the vaccine. Two patients (9%) remained seronegative until receiving the third dose (booster), 5-9 months post the first vaccine series. Half of the previously uninfected patients (11/22) did not

have a durable antibody response at 6 ± 2 months but had a positive response to the booster. There were no demographic differences associated with antibody response. Two participants developed a COVID19 infection in March 2022.

**Conclusions:** mRNA vaccines induced antibody responses in all patients receiving dialysis in our cohort. However, we observed delayed and foreshortened antibody response to COVID19 vaccination in patients without previous COVID exposure. By contrast, patients who have recovered from COVID19 had lasting antibody titers. Booster immunization was efficacious in counteracting the waning of vaccine-induced antibody response over time and induced antibody response in patients who did not respond to a standard two-dose immunization. Post-vaccination measurement of antibody titers may help make personalized vaccination schedules.

## PUB020

### Titration of Trimeric Antibodies of SARS-CoV-2 in Hemodialysis Patients at the Hospital Metropolitano de Santiago (HOMS), Dominican Republic

Eliana Dina-Battle,<sup>1,2</sup> Nicole M. Suárez,<sup>1</sup> Anthony J. Gutierrez,<sup>2</sup> Carlos Jimenez,<sup>1</sup> Liz M. Portorreal Gómez,<sup>1</sup> Hector A. Pantaleon,<sup>1</sup> Eliana Bencosme.<sup>1</sup> <sup>1</sup>Hospital Metropolitano de Santiago, Santiago De Los Caballeros, Dominican Republic; <sup>2</sup>Pontificia Universidad Catolica Madre y Maestra, Santiago de los Caballeros, Dominican Republic.

**Background:** Knowing that the immune response can be limited in hemodialysis patients, and as a consequence of the that, the antibody production can be impaired, the evaluation of the titer of trimeric antibodies against SARS-CoV-2 after standard vaccination of patients in a regular hemodialysis program can be a useful tool in our regular practice.

**Methods:** A descriptive, observational, cross-sectional study conducted at the Hemodialysis Center of the Hospital Metropolitano de Santiago (HOMS), Dominican Republic from June to August 2021. All patients in the hemodialysis unit with a complete vaccination schedule against COVID-19 and with SARS-CoV-2 trimeric antibody test for at least 1 month after the last dose was placed were enrolled.

**Results:** A total of 23 patients were evaluated, 56.52% being male. The median (and IQR) age was 61 years (44-68). The time from administration of the first dose was 109 (72-120) days, and 81 (35-92) days for the second dose. A 17.39% of the patients had at some point a positive diagnosis of COVID-19; 8.69% were admitted for the same cause. Antibody titer yielded a median of 74.80 (31.63 - 829.50).

**Conclusions:** Infection and hospitalization rates were comparable to the 80/20/5 rule of asymptomatic, symptomatic, and hospitalized. 75% of the patients eventually infected by COVID-19 presented antibodies > 1,400Au/mL, considering a positivity range equal to 33.8Au/mL. A study showed a less effective response, both in magnitude and time, which can be seen by lower trimeric antibody levels compared to the general population, taking a positive titer of 13 Au/ml as a cut-off point. This explains why the response to a full schema is poor but satisfactory. Follow-up at 6-8 months is recommended to verify that this response is maintained.

## PUB021

### Systemic Lupus Erythematosus (SLE) Flare Following Second Dose of mRNA COVID-19 Vaccine

Miguel A. Cota, Martha D. Rodriguez. *Universidad de Monterrey, San Pedro Garza Garcia, Mexico.*

**Introduction:** Inclusion of patients with rheumatic diseases in COVID vaccine trials is limited. Here we present a 28-year-old male with no comorbidities nor family history who developed lupus nephritis, pneumonitis and heart failure.

**Case Description:** He presented with a four day history of non-bloody diarrhea three days after his second dose of the Moderna vaccine. He reported thoracic petechiae and arthralgia five years ago treated with steroids but without a definitive diagnosis. Initial Cr was 5.2 mg/dL with a BUN:Cr of 15.6, positive ANA 1:3200, Anti-La >200 and hypocomplementemia. HD was started due to a decline in kidney function and hyperkalemia. A TTE reported a LVEF of 25% and pericardial effusion. Treatment with 1g of MPRed every 24 hours, IgIV for 4 days and 5 sessions of plasmapheresis showed no response. Kidney biopsy was programmed twice but had to be postponed. Steroids, hydroxychloroquine and mycophenolic acid were given, but despite 35 days of in-patient care, the patient passed away

**Discussion:** Based on our research, there hasn't been a correlation between mRNA vaccine administration and the development of SLE, despite multiple cases reported. According to current guidelines, patients with autoimmune and inflammatory rheumatic diseases (AIIRD) should be prioritized for vaccination before the general population, even though there is a theoretical risk for a flare following COVID-19 vaccination; the benefit of it trumps the potential risk. The Moderna vaccine encodes the SARS-CoV-2 spike protein, responsible for host cell attachment and viral entry. The RNA enters the host cells and elicits high levels of antibodies and antigen-specific CD8+ and CD4 cytokine response involving Th1 cells. Phase III trials reported a low risk of serious adverse events, however patients treated with immunosuppressants and those with a history of autoimmune disease were excluded from phase I, which makes data limited. The mechanisms behind the flares are elusive, mRNA technology has been shown to induce a potent immune response, this is the reason why post vaccination surveillance of serologic markers, renal function and symptoms is essential in the population at risk or with previously known rheumatic pathologies. To our knowledge, our case report is the first to describe a case of a severe flare leading to a patient's death after vaccine administration, despite adequate inpatient management.

Key: TH - Thursday; FR - Friday; SA - Saturday; OR - Oral; PO - Poster; PUB - Publication Only

Underline represents presenting author.

## PUB022

**Pauci-Immune Crescentic Glomerulonephritis Post COVID-19 Vaccination**

Maria Izabel N. de Holanda,<sup>1,3</sup> Marcelo Dessen,<sup>1</sup> Janaina F. Ferreira,<sup>1</sup> Claudia D. Silva,<sup>1</sup> Lilian M. Palma,<sup>2</sup> Joao Luiz Ferreira Costa.<sup>1</sup> <sup>1</sup>Hospital Pro-Cardiaco, Rio de Janeiro, Brazil; <sup>2</sup>Universidade Estadual de Campinas, Campinas, Brazil; <sup>3</sup>Hospital Federal de Bonsucesso, Rio de Janeiro, Brazil.

**Introduction:** COVID-19 is a problem for the humanity. Since now, 526.534.751 of confirmed cases. The world campaign vaccination started in the end of 2020. Until now, we had almost 12 billions people vaccinated. We never had in the world a massive vaccination campaign like that. Considering that medications and vaccines can present adverse events, some cases of glomerulopathies were described.

**Case Description:** We describe 50 year-old white male patient who was obese and presented hypertension well controlled with Six months before admission, routine blood and urine tests were normal. He received two doses of Coronavac (Sinovac, China) inactivated virus vaccine for Covid-19 (28 day interval between doses). On December 2021, he received a third dose (booster) Covid-19 vaccine from Pfizer-BioNTech (RNA). One day later, he began to experience high fever lasting one day, severe and progressively chest pain. The patient was hospitalized with pericarditis and AKI KDIGO 1. Corticosteroids and support measures were taken leading to an improvement in the cardiac condition. Two weeks later, renal function progressively worsened, and hematuria and proteinuria ensued. Investigation was negative for autoimmune diseases, serum levels C3 and C4 were normal, and viral serologies were negative. The creatinine level rose to 5 mg/dL (440 mmol/L). A pulse of 1 g methylprednisone was initiated for 3 days. Renal biopsy showed necrotizing glomerulonephritis, with fibrocellular crescents and immune paucity. Two doses of Rituximab 1g was added and prednisone 1 mg/kg and azathioprine were used as maintenance regimen. After 4 months of treatment, the patient presented partial recovery of renal function with a creatinine of 1.7 mg/dL (150 mmol/L).

**Discussion:** Glomerulopathies related to Covid infection and vaccines are scarce. Rocatello et al reported 17 cases of post-vaccination glomerulopathies, most of which were of minimal change disease with no case of necrotizing pauci immune-negative being related. Few cases were reported with positive ANCA-related necrotizing GN, and in the present case the patient had all negative antibodies. A causal relationship cannot be stated, but with mass vaccination, cases of rare adverse effects must be monitored and reported to better clarify their mechanisms and evolution.

## PUB023

**Virtual Mindfulness-Based Intervention for Hemodialysis Patients During COVID-19 for Chronic Pain, Stress, Anxiety, and Depression**

Mona Ben m'rad,<sup>1</sup> Christina Rigas,<sup>2,3</sup> Katie Bodenstern,<sup>2,3</sup> Karin Cinalioglu,<sup>2,3</sup> Maryse Gautier,<sup>2,3</sup> Harmehr Sekhon,<sup>2,3</sup> Soham Rej.<sup>2,3</sup> <sup>1</sup>Hopital du Haut-Richelieu, Saint-Jean-sur-Richelieu, QC, Canada; <sup>2</sup>McGill University Faculty of Medicine and Health Sciences, Montreal, QC, Canada; <sup>3</sup>Sir Mortimer B Davis Jewish General Hospital, Montreal, QC, Canada.

**Introduction:** Up to 50% of hemodialysis (HD) patients experience stress, anxiety, depression and chronic pain. With COVID-19, these symptoms are often exacerbated, and healthcare services are harder to access due to distancing measures and staff shortages. Mindfulness-based interventions (MI) are effective in reducing these symptoms. As part of our institution's standard clinical practice, we offered a virtually-delivered adapted Mindfulness-Based Stress Reduction (MBSR) program to patients during their HD sessions given by an MBSR-certified psychologist.

**Case Description:** A 35-year-old female, on HD since age 6, received five 20-40 minutes individual sessions of the virtual adapted MBSR program over 3 weeks. Perceived stress (Perceived Stress Scale), anxiety (Generalized Anxiety Disorder-7), depression (Patient Health Questionnaire-9) and chronic pain (Questionnaire de Saint-Antoine which is a french adapted version of the McGill pain questionnaire) levels were measured prior to starting the program, and 2 weeks after the last session. Over 5 weeks, the patient's stress decreased by 1 point (PSS = 17; PSS = 16, both moderate), anxiety decreased by 50% (GAD-7 = 14, moderate; GAD-7 = 7, mild), depression decreased by 15 points (PHQ-9 = 15, moderately severe; PHQ-9 = 0, none/mild), and chronic pain decreased by 19 points (QDSA = 22, moderate; QDSA = 3, mild). The patient also reported successful withdrawal from her restless-legs syndrome and insomnia medications, due to the MBSR breathing techniques she learnt for pain-management and sleep. Using the same MBSR techniques, 18 months after the program, she reported continuing self-management of her insomnia, chronic pain, and restless-legs syndrome without medication and feeling capable of coping with new health challenges, managing difficult emotions, and being able to calm and detach herself from worries and negative self-talk.

**Discussion:** This case illustrates that an adapted MI delivered during HD sessions: 1) may help in managing symptoms of chronic pain, sleep disorders, anxiety and depression, 2) can be delivered virtually, 3) may be a viable short-term and long-term non-pharmacological alternative to managing symptoms in HD patients, for which polypharmacy is a high safety concern.

## PUB024

**Vocal Fold Paralysis Following COVID-19 Vaccination in a Patient on Hemodialysis**

Syed U. Haider, Nupur N. Uppal, Tanazul T. Pariswala. *Donald and Barbara Zucker School of Medicine at Hofstra/Northwell, Hempstead, NY.*

**Introduction:** With the increase in number of the people receiving COVID-19 vaccination, different adverse effects associated with vaccine are being described. While vocal fold paresis (VFP) after both COVID-19 disease and COVID-19 vaccination has been rarely reported, data on this entity in dialysis population is still lacking. We present a case of VFP in a hemodialysis patient following the administration of Pfizer-BioNTech COVID-19 vaccine.

**Case Description:** 45-year-old West Indian female with DM, HTN and End Stage Kidney Disease 2/2 Focal Segmental Glomerulosclerosis s/p kidney transplant that failed after 16 years (on low dose tacrolimus) requiring to start hemodialysis presented to the ED with complaints of voice hoarseness with dysarthria and throat itching that started ~30-45 minutes after having received the first dose of Pfizer-BioNTech COVID-19 vaccine. She underwent Fiberoptic Indirect Laryngoscopy that showed widely patent airway with mobile vocal cords bilaterally. Symptoms were thought to be secondary to a reaction to the vaccine vs mild GERD. She received steroids and was discharged home within 24 hours after symptomatic improvement on steroid therapy. Her voice normalized within a week. Six months later, she received the second dose of Pfizer-BioNTech vaccine, ~30 minutes after which again developed dysphonia and dysarthria. This time, she was found to have bilateral VFP with incomplete closure. Steroid therapy was reinitiated and is slowly being tapered. Her dysarthria has improved; however, she continues to have hoarseness of voice even after 9 months of having received 2nd dose of vaccine. She has not received the booster dose of vaccine.

**Discussion:** Current guidelines recommend booster doses of COVID-19 vaccine for immunocompromised individuals including those on dialysis. The benefits of vaccination markedly outweigh the risk of very rarely reported development of VFP after vaccination. Further research is needed to determine the prevalence of this complication in dialysis patients and to elucidate the underlying mechanisms leading to it.

## PUB025

**Glucocorticoid Therapy in the Prevention of COVID-19-Associated AKI**

Fehlin Stone, Robert Nee, Christina M. Yuan, Maura A. Watson. *Walter Reed National Military Medical Center, Bethesda, MD.*

**Background:** COVID-19 is a global pandemic, with acute kidney injury (AKI) as one of the major complications amongst hospitalized patients. We assessed if glucocorticoid therapy can reduce the incidence of acute kidney injury.

**Methods:** We compared the demographics, clinical characteristics, and COVID-19 disease severity in a large adult cohort of 140 patients, hospitalized from March to December 2020, comparing their glucocorticoid treatment status with their odds of developing AKI using data from the US Department of Defense health care network.

**Results:** Forty two patients received glucocorticoid therapy and 98 patients did not receive glucocorticoid therapy. Five patients in the treatment group and 10 patients in the non-treatment group developed AKI during admission. Per multivariate analysis, when adjusting for age, gender, and chronic kidney disease status, there appeared to be no difference in the odds of developing an AKI (odds ratio (OR) 1.08; 95% confidence interval (CI) 0.265 to 3.87; P=1.00). However, when also adjusting for COVID-19 disease severity, the treatment group had a statistically significant lower odds of developing an AKI compared to the non-treatment group (OR 0.180; 95% CI 0.0244 to 0.950; P=0.0415).

**Conclusions:** In hospitalized patients with COVID-19, glucocorticoid therapy decreased the odds of developing an AKI. COVID-19 disease severity was found to be a major confounder to the development of AKI. *The views expressed are those of the authors and do not reflect the official policy of the Department of the Army/Navy/Air Force, the Department of Defense, or the United States government.*

## PUB026

**Mental Health in Dialysis Nurses During COVID-19**

Soo min Jang,<sup>1,3</sup> Danquynh C. Bui,<sup>1</sup> Paul Gavaza,<sup>1</sup> Rita Hanna Al-Kass,<sup>1</sup> Reem H. Hanna Al-Kass,<sup>1</sup> Charilyn L. Fox,<sup>3</sup> Sergio Infante.<sup>2,3</sup> <sup>1</sup>Loma Linda University School of Pharmacy, Loma Linda, CA; <sup>2</sup>Loma Linda University School of Medicine, Loma Linda, CA; <sup>3</sup>Loma Linda University Kidney Center, Loma Linda, CA.

**Background:** Dialysis nurses have long working hours and provide high-quality care for immunocompromised patients. During COVID-19, dialysis nurses are confronted with life and death situations in fast-paced and demanding environments. Thus, they are vulnerable to mental health problems which may influence organizational productivity and pose serious health and safety hazards.

**Methods:** This was a quality improvement project to evaluate depression (Patient Health Questionnaire-9, PHQ9), anxiety (General Anxiety Disorder-7, GAD7) and stress (Perceived Stress Scale, PSS) in dialysis nurses between November 2021 and January 2022 at a large academic medical center. Descriptive statistics were computed for all variables.

**Results:** A total of 24 nurses [54% outpatient hemodialysis (HD), 17% outpatient peritoneal dialysis, 25% inpatient HD nurses] with a mean age of 49 (SD=10) years old participated in the survey. Most were female (71%), married or with a significant other (79%), and had children (75%). Majority was Asian (63%), followed by Caucasian (29%), Hispanic (4%) and African American (4%). Almost half of them had a bachelor's

degree (46%), were licensed vocational nurses (29%), had an associate degree (13%), and had a master's or doctoral degree (13%). The majority (75%) worked full-time, 13% worked overtime and 7% worked part-time. The mean PHQ9 score was 4±4 (minimal depression), GAD7 score was 4±4 (minimal anxiety) and PSS score was 21±3 (moderate stress). Eighteen (75%) dialysis nurses had prayed to control their mood and 85% of these said praying helped. Four nurses (16.7%) started or tried counseling to control their mood and three (75%) of them mentioned it helped. Two nurses (8.3%) started a new medication to control their mood and both nurses said it helped.

**Conclusions:** Dialysis nurses showed minimal depression and anxiety despite the moderate stress level associated with their work. Most dialysis nurses found praying to be helpful to control their moods.

**PUB027**

**Effect of Sodium-Glucose Cotransporter-2 Inhibitors on Cardiovascular Outcomes in COVID-19 Patients**

Lucas Wang, Victor A. Canela, Manavjot Sidhu. Methodist Dallas Medical Center, Dallas, TX.

**Background:** Recent data has shown that sodium-glucose cotransporter-2 (SGLT-2) inhibitors decrease cardiac related mortality in patients with and without diabetes. In this study we aim to explore the relationship between outcomes in patients hospitalized with coronavirus disease 19 (COVID-19) and whether they did or did not take SGLT-2 inhibitors.

**Methods:** Using an observational database, we analyzed 3293 unvaccinated hospitalized COVID-19 PCR-positive patients at Methodist Health System from March to December 2020. We compared incidence of in-hospital death or hospice referral rates, major acute cardiovascular event (MACE), and acute respiratory failure requiring mechanical ventilation between patients who did or did not take SGLT-2 inhibitors on first encounter. In this study, MACE was identified as congestive heart failure (CHF) exacerbation, pericarditis, pericardial effusion, myocardial infarction (MI), stroke, pulmonary embolism (PE), deep venous thrombosis (DVT), or shock. We used Chi-square and odds ratio tests to analyze observed variables.

**Results:** Of the 3293 COVID-19 patients, 149 (4.5%) took SGLT-2 inhibitors prior to admission while 3144 (95.5%) did not. A statistically significant difference was observed when comparing mortality as an outcome between patients who took SGLT-2 prior to admission and those who did not (OR 0.54, 95% CI 0.29-0.98, p = 0.04). Interestingly, an opposite trend was seen in these two groups when comparing whether they had an incidence of MACE during hospitalization (OR 2.36, 95% CI 1.69 – 3.29, p < 0.01). In specific, patients who took SGLT-2 prior to admission had higher incidences of MI (OR 2.02, 95% CI 1.43 – 2.85, p < 0.01) and stroke (OR 1.28, 95% CI 2.87 – 7.82, p < 0.01). Finally, we noted that there was no statistically significant difference in incidence of acute respiratory failure leading to intubation (p = 0.35), or mortality of intubated patients (p=0.18) when comparing these two groups.

**Conclusions:** SGLT-2 inhibitors use was associated with a decreased incidence of in-hospital mortality of patients admitted with COVID-19 infection even in a patient population that had a significantly higher number of MACE during hospitalization. We also show that SGLT-2 inhibitors had no association with change in incidence of acute respiratory failure requiring intubation in this patient population.

**PUB028**

**In ICU Patients With COVID-19, Estimating Glomerular Filtration Rate From Creatinine and Cystatin C**

Ayesha Khader, Leila R. Zelnick, Eric D. Morrell, Mark M. Wurfel, Bryan R. Kestenbaum, Pavan K. Bhatraju. University of Washington Department of Medicine, Seattle, WA.

**Background:** Accurate estimation of the glomerular filtration rate (eGFR) in critical illness is essential for judging the severity of kidney injury and informing medication dosing. Many drugs used to treat COVID-19 require dose adjustment (baricitinib) or are withheld (remdesivir) based on kidney function. Cystatin C provides more accurate and precise estimation of GFR than serum creatinine in outpatient settings, but the relationship of creatinine and cystatin C in critically ill patients with and without COVID-19 is less known.

**Methods:** We prospectively enrolled 253 ICU patients, including 176 (70%) patients with COVID-19 and 77 (30%) patients without COVID-19. We collected plasma on days 1, 3, 7, 10 and 14 leading to a total of 643 samples. Plasma creatinine was measured using the modified Jaffe method and plasma cystatin C was measured using an immunoturbidimetric assay (Gentian AS) on a Beckman DXC Unicell clinical analyzer.

**Results:** Among 486 plasma samples in 176 unique COVID-19 patients, plasma cystatin C and creatinine were correlated (r=0.79) but calculated eGFR differed. Values of eGFRcr were, on average, 16-41 mL/min/1.73m<sup>2</sup> higher than those of eGFRcys during hospitalization (p < 0.001) (Figure 1). Each 15 mL/min/1.73m<sup>2</sup> lower eGFRcys was associated with an estimated 11% greater risk of hospital mortality (RR =1.11, 95% CI, 1.03 to 1.21) compared to an estimated 6% greater risk of hospital mortality with eGFRcr (RR = 1.06; 95% CI: 0.97 to 1.16). Among non-COVID-19 patients there was a similar trend with higher eGFRcr than eGFRcys but the difference on ICU admission was non-significant.

**Conclusions:** In COVID-19 ICU patients eGFRcr was consistently higher than eGFRcys, and eGFRcys may more strongly associate with clinical outcomes. Our findings suggest that in COVID-19, calculating eGFR using creatinine or cystatin C could have implications on which treatments are available to patients.

**Funding:** Other NIH Support - NIH Grant

**Figure 1. Creatinine compared to cystatin C consistently estimated a higher eGFR until an eGFR of 120 mL/min/1.73 m<sup>2</sup>**

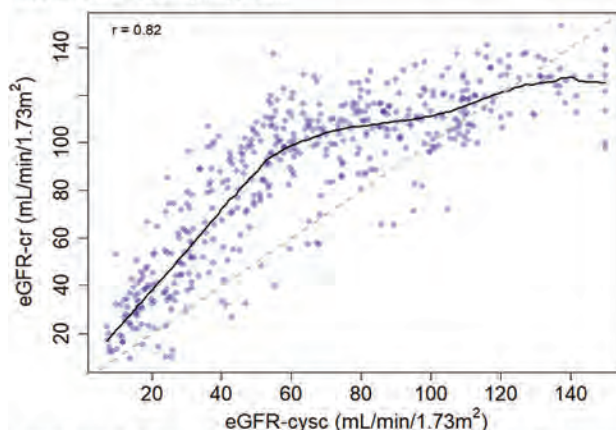

**Figure legend.** Plotted is the eGFR calculated using plasma creatinine and cystatin C in 176 COVID-19 patients with blood collected on days 1, 3, 7, 10 and 14 after ICU admission for a total of 643 samples. Each dot is an individual patient on a given day during hospitalization. eGFR was calculated using either creatinine or cystatin C and age and gender. eGFR was limited to 150 mL/min/1.73 m<sup>2</sup>. Differences in eGFR calculation can have implications of which patients would receive remdesivir, which is held in patients with an eGFR<60 mL/min/1.73 m<sup>2</sup>. For example, on ICU admission, eGFRcys identified 49 patients (41%) with an eGFR less than 60 mL/min/1.73 m<sup>2</sup> compared with only 37 (31%) using eGFRcr.

**PUB029**

**Effects of SARS-CoV-2 Vaccination on Outcomes of COVID-19 in ESKD Patients on Dialysis**

Jing Miao, Elsa Olson, John J. Dillon, Ziad Zoghby. Mayo Clinic Minnesota, Rochester, MN.

**Background:** COVID-19 is associated with increased morbidity and mortality in patients with ESKD on chronic dialysis. Vaccination against other viruses is known to be less effective in these patients compared to the general population. Data on the titers of antibody following SARS-CoV-2 vaccination in these patients is inconsistent. The efficacy of SARS-CoV-2 vaccination to prevent severe disease in ESKD patients with COVID-19 remain unknown. We compared the incidence of hospitalization and COVID-19 related death after COVID-19 disease in dialysis patients based on SARS-CoV-2 vaccine status.

**Methods:** Single-center, retrospective cohort study. We included all adults on dialysis (in-center and home) within the Mayo Clinic Health System in the Midwest (USA) with laboratory proven SARS-CoV-2 infection between 1/1/2020 and 3/30/2022 (n=225). Patients' demographics, clinical characteristics, laboratory data including SARS-CoV2 infection test results, and SARS-CoV-2 vaccination information were collected. The primary outcome was the incidence of hospitalization and COVID-19 related death after COVID-19 disease.

**Results:** 244 infections occurred in 225 patients, 119 (49%) were vaccinated and 8.4% (n=19) died. Among those who died, 73.7% (n=14) were not vaccinated compared to 49.3% of those who were alive (p=0.041). A total of 78 patients had 83 hospitalizations; 71.1% were not vaccinated compared to 41% not hospitalized (p<0.001) (Table).

**Conclusions:** The incidence of hospitalization and COVID-19 related death after COVID-19 disease was significantly higher in non-vaccinated compared to vaccinated dialysis patients. This data suggests that SARS-CoV-2 vaccination improves outcomes in dialysis patients who develop COVID-19 disease.

Table - Death and hospitalization in vaccinated and non-vaccinated dialysis patients

	Total (n=225) a	Vaccinated	Not vaccinated	P value
Death, n (%)	19 (8.4)	5 (26.3)	14 (73.7)	0.041
Alive, n (%)	206 (91.6) b	114 (50.7)	111 (49.3)	
Hospitalization, n (%)	83 (34.7) c	24 (28.9)	59 (71.1)	<0.001

a Total 244 infections. 18 patients had reinfection (1 with 2 reinfections and 17 with one reinfection). Among the 18 patients with reinfection, 2 died, 8 were not hospitalized, 4 were hospitalized after 1st COVID, and 5 were hospitalized after 2nd COVID. b Total 225 infections. c Among 78 patients.

**PUB030**

**Clinical Outcomes of COVID-19 in Critically Ill Patients Treated With Hemoperfusion in a Tertiary Hospital in Davao City, Philippines**

Joy Blossom Anne Y. Lacang, Mark Anthony A. Tom. Davao Doctors Hospital, Davao City, Philippines.

**Background:** The excessive immune response against COVID-19 results in a cytokine storm from overproduction of pro-inflammatory cytokines. Hemoperfusion has a potential role in improving clinical symptoms and reducing mortality in critically ill

patients by eliminating circulating inflammatory mediators. This study aims to look into the clinical outcomes of COVID-19 critically ill patients who underwent hemoperfusion.

**Methods:** This study utilized a descriptive research design conducted among critically ill COVID-19 patients who completed hemoperfusion treatment admitted from October 2020 to October 2021 in Davao Doctors Hospital.

**Results:** Most patients who received hemoperfusion treatment expired (n= 11, 57.89%), while 9 of the patients survived (42.11%). The oxygen saturation for both patients increased after hemoperfusion, but patients who did not survive had the lowest oxygen saturation before hemoperfusion treatment (0.78 vs. 0.89). Among those who died, all inflammatory markers were elevated post hemoperfusion except for C Reactive Protein (CRP) (-16.50%). Meanwhile, for patients who survived, all inflammatory markers: Lactate dehydrogenase (LDH) (-17.31%), CRP (-77.69%), ferritin (-30.95%), and procalcitonin (-34.74%) decreased after hemoperfusion (Table 1). The median time between symptoms onset to hospital admission and hemoperfusion treatment was longer in patients who did not survive (6.3, 10.2 vs. 3.3, 8.5).

**Conclusions:** The mean inflammatory markers decreased after hemoperfusion treatment among those who survived. Patients with lower baseline oxygen saturation and longer time of hemoperfusion initiation from symptoms onset were less likely to survive even with hemoperfusion. It is highly recommended that hemoperfusion be performed at the earliest possible time before severe clinical manifestations occur. Overall, our study shows a higher number of critically ill patients who died from COVID-19 disease.

	Expired			Survived		
	Pre	Post	%	Pre	Post	%
Oxygen Saturation	0.78	0.96	22.86	0.89	0.97	9.04
LDH	639.64	1459.36	128.16	484.50	400.63	-17.31
CRP	106.86	89.24	-16.50	67.06	14.98	-77.69
Ferritin	4417.97	5570.65	26.09	2771.45	1913.61	-30.95
Procalcitonin	0.50	1.28	154.18	0.19	0.12	-34.74

CRP: C Reactive Protein; LDH: Lactate dehydrogenase

Table 1. Oxygen saturation and inflammatory markers pre and post hemoperfusion

**PUB031**

**Impact of Development and Severity of AKI on In-Hospital Outcomes Among Patients With COVID-19**

Jin Huang, Te Du, Arrsh Bajaj, David J. Gemmel, Erdal Sarac. *Mercy Health St Elizabeth Youngstown Hospital, Youngstown, OH.*

**Background:** Acute kidney injury (AKI) is a common complication of COVID-19 and is associated with poor outcomes. The aim of this study was to describe the incidence of AKI and to compare its clinical impact with other risk factors on the severity and outcomes of hospitalized COVID-19 patients.

**Methods:** We conducted a retrospective study on patients ≥ 18 years old who were admitted to our institution with a laboratory-confirmed diagnosis of COVID-19 infection from March 2020 to December 2020. Data on demographics, kidney function prior to and during hospitalization, inflammatory biomarkers, comorbidities, medications, and outcomes including mortality, mechanical ventilation (MV) and renal replacement therapy (RRT) were collected from electronic medical record. Definition and staging of AKI were based on the KDIGO guidelines. Survival and use of MV by AKI and AKI stage was analyzed using Chi-square test; strength of association was measured using correlation coefficients; and significance was assessed at p < 0.05.

**Results:** Of 240 inpatients admitted for COVID-19, 153 (63.7%) survived to discharge. A total of 121 (50.4%) patients developed AKI during hospitalization: 43.7% stage 1, 34.5% stage 2, and 21.8% stage 3. Almost 1 in 4 patients with AKI (23.1%) required RRT. Fifty-eight (49.2% overall, 37.3%, 51.2%, and 70.8% for AKI stage 1, 2, and 3, respectively) patients with AKI required mechanical ventilation, compared to 15 (13.5%) with normal renal function (p < 0.001). Age, presence of AKI, AKI stage, history of coronary artery disease, and initial lactate dehydrogenase were significantly associated with in-hospital death. Development of AKI (r=0.33, p < 0.001) and AKI stage (r=0.38, p < 0.001) were more strongly associated with in-hospital mortality than the remaining bivariate associations. Survival at discharge was strongly associated with renal function, with survival declining from 79.5% among patients with normal renal function to 61.5%, 41.5%, and 30.7% among AKI stage 1, 2, and 3 patients (p < 0.001).

**Conclusions:** AKI is more strongly associated with increased mortality among patients with COVID-19 infection compared with demographics, comorbidities, and inflammatory biomarkers. Patients with Stage 2-3 AKI are more likely to have greater severity and worse outcomes.

**PUB032**

**Changes in Physical Activity, Physical Function, and Depressive Symptoms Associated With the Coronavirus Disease 2019 Pandemic in Japanese Patients Undergoing Hemodialysis**

Takuya Nakajima,<sup>1</sup> Keigo Imamura,<sup>1,2</sup> Yuta Suzuki,<sup>3</sup> Narumi Fukuzaki,<sup>1</sup> Juri Uchida,<sup>1</sup> Shohei Yamamoto,<sup>4</sup> Shun Yoshikoshi,<sup>1</sup> Manae Harada,<sup>5</sup> Atsuhiko Matsunaga.<sup>1</sup> <sup>1</sup>Department of Rehabilitation Sciences, Kitasato University Graduate School of Medical Sciences, Kanagawa, Japan; <sup>2</sup>Tokyo Metropolitan Institute of Gerontology, Tokyo, Japan; <sup>3</sup>Center for Outcomes Research and Economic Evaluation for Health, National Institute of Public Health, Saitama, Japan; <sup>4</sup>Department of Epidemiology and Prevention, Center for Clinical Sciences, National Center for Global Health and Medicine, Tokyo, Japan; <sup>5</sup>Department of Rehabilitation, Sagami Circulatory Organ Clinic, Kanagawa, Japan.

**Background:** There are concerns about the impact of the coronavirus disease 2019 (COVID-19) pandemic on physical and mental health. This study aimed to investigate changes in physical activity, physical function, and depressive symptoms during the COVID-19 pandemic in Japanese hemodialysis patients.

**Methods:** This retrospective longitudinal study included 159 clinically stable outpatients (mean age, 66.8±10.9 years; men, 62.2%; median hemodialysis vintage, 8 years) who underwent maintenance hemodialysis at two Japanese dialysis centers between April 2019 and March 2021. Participants' physical activity (steps taken per non-dialysis day), physical function (walking speed and leg strength), and depressive symptoms (Center for Epidemiologic Studies Depression [CES-D] score) before and during the COVID-19 pandemic were compared.

**Results:** The steps on non-dialysis day was significantly lower during than before the COVID-19 pandemic (P < 0.01). On the other hand, there were no significant differences in walking speed, leg strength, and CES-D score before and during the COVID-19 pandemic (Figure).

**Conclusions:** Although a decline in physical activity during the COVID-19 pandemic was not prevented, no negative impacts of declining physical activity on physical function and depressive symptoms were observed. This is likely because we have implemented a long-term disease management program, such as regularly assessing the physical function and mental status of the patients. Our findings may provide insight into disease management in hemodialysis patients after the COVID-19 pandemic.

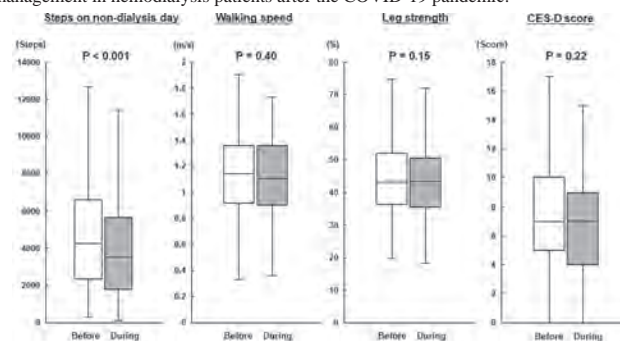

**PUB033**

**Effect of the COVID-19 Pandemic on Clinical Phenotype of Glomerular Disease: Single Centre Experience**

Katie Chu, Sharad C. Sinha, Philippa G. Boothroyd, Kazi M. Fardeen, Bhriagu Raj Sood, David Makaanjuola. *Epsom and Saint Helier University Hospitals NHS Trust, Carshalton, United Kingdom.*

**Background:** Presenting features for glomerular disease can be varied, including but not exclusively, acute kidney injury, nephrotic syndrome or haemo-proteinuria. At our regional tertiary centre we conducted a retrospective study to see whether clinical presentations of glomerular diseases had changed during the COVID-19 pandemic.

**Methods:** In this study, new and repeat native renal biopsies were included from January 2018 to October 2021. Glomerular pathologies of interest included minimal change disease, membranous nephropathy, IgA nephropathy, lupus nephritis and pauci-immune glomerulonephritis. We looked at three periods of time: prior to the start COVID-19 pandemic in 2018/19; during the COVID-19 pandemic in 2020; and after the introduction of COVID-19 vaccines in 2021.

**Results:** 263 biopsies were identified over the 4-year period. IgA nephropathy – n = 13. Lupus nephritis – n = 43. The different classes of lupus nephritis are shown in (see figure 1) Minimal change disease – n = 57. All presented with the nephrotic syndrome. Between 6-25% over the study period presented with AKI (mean 19%) Pauci-immune glomerulonephritis – n = 85. Between 81%-91% over the study period presented with AKI, or AKI on CKD (mean 84%) Membranous glomerulopathy – n = 66. 50%, presented with the nephrotic syndrome. 20% presented with AKI in addition to proteinuria.

**Conclusions:** Our analysis has not shown a significant change in clinical presentations of glomerular disease. There has not been an increased propensity in presenting with AKI in minimal change disease or membranous nephropathy. We saw the highest proportion of class IV lupus nephritis in 2021.

Figure 1: Class of lupus identified on biopsy from 2018-2021

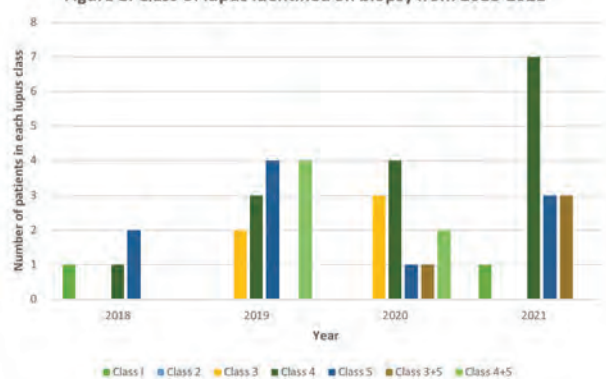

PUB034

COVID-19 Diagnosis by Computed Tomography in Renal Replacement Therapy Patients

Lilian Carmo,<sup>1</sup> Tiago L. Cerqueira,<sup>1</sup> Pedro Augusto B. Lemos,<sup>1</sup> Mariana O. Vieira,<sup>2</sup> Mariana D. Oliveira,<sup>3</sup> Bráulio R. Couto,<sup>1</sup> Camila A. Souza,<sup>2</sup> Yan L. Goll,<sup>2</sup> Vitor S. de Souza,<sup>2</sup> Pedro Alves Soares Vaz de Castro,<sup>2</sup> Ana cristina Simões e Silva,<sup>2</sup> Gabriel A. Carmo.<sup>1</sup> <sup>1</sup>Hospital Evangelico, Belo Horizonte, Brazil; <sup>2</sup>Universidade Federal de Minas Gerais, Belo Horizonte, Brazil; <sup>3</sup>Hospital Felício Rocho, Belo Horizonte, Brazil.

**Background:** Lung diseases are common in Patients with End Stage Kidney Disease (ESKD) making the differential diagnosis with COVID-19 a challenge. This study describes pulmonary chest tomography (CT) findings in hospitalized ESKD on renal replacement therapy (RRT) patients with clinical suspicion of COVID-19 and compare image characteristics of positive versus negative cases.

**Methods:** ESKD individuals referred to Emergency Department older than 18 with clinical suspicion of COVID-19 were recruited. Epidemiological, baseline clinical information was extracted from electronic health records. Pulmonary CT was classified as typical, indeterminate, atypical or negative. We then compare CT findings of positive and negative COVID-19 patients.

**Results:** We recruited 109 patients (62,3% COVID-19 positive) between March and December 2020. Mean age was 60 ± 12.5 years-old, 43% were female and the most common etiology of ESKD was diabetes. Median time on dialysis was 36 months, Interquartile range=12-84. The most common pulmonary lesion on CT was ground glass opacities. Typical CT pattern was more common in COVID-19 patients (40(61%) vs 0(0%), p<0.001). Sensitivity was 60.61% (40/66) and specificity was 100% (40/40). Positive predictive value and negative predictive value were 100% and 62.3%, respectively. Atypical CT pattern was more frequent in COVID-19 negative patients (9(14%) vs 24(56%), p<0.001), while the indeterminate pattern was similar in both groups (13(20%) vs 6(14%), p=0.606), and the negative pattern was more common in COVID-19 negative patients (4(6%) vs 12(28%), p=0.002).

**Conclusions:** In hospitalized patients with ESKD on RRT an atypical chest CT pattern cannot adequately rule out the diagnosis of COVID-19.

**Funding:** Private Foundation Support

PUB035

Membranous Nephropathy in the Era of COVID-19 and Vaccines: Is There a Story to Tell?

Sharad C. Sinha, Philippa G. Boothroyd, Katie Chu, Kazi M. Fardeen, Bhriagu Raj Sood, David Makanjuola. *Epsom and Saint Helier University Hospitals NHS Trust, Carshalton, United Kingdom.*

**Background:** Membranous nephropathy is a relatively common glomerular pathology that manifests with either nephrotic or sub-nephrotic range proteinuria. Evidence is emerging of COVID-19 and its vaccines having an influence on various glomerular diseases, including IgA nephropathy and minimal change disease, with limited information on membranous nephropathy. Data from our tertiary centre suggested a rise in cases of membranous nephropathy within a month after vaccination.

**Methods:** Patients who had renal biopsies in 2021 were identified from pathology results and online clinical records. Information on COVID-19 status, COVID vaccinations and biochemical results were compared. Patients were then split into 2 groups; those presenting within 1 month of vaccination or COVID infection and those who hadn't had vaccinations or a COVID infection within 4 weeks of presentation.

**Results:** Complete vaccination and COVID infection history was present in 17 of the 24 patients. Of the 17 patients, 6 were in group 1 and 11 in group 2. 16 out of the 17 patients had nephrotic range proteinuria, 6 also had an AKI at presentation. There was no significant difference in presentation between the groups (see table 1).

**Conclusions:** Our data has not conclusively shown a difference between the two groups probably because of the low numbers. But further studies are needed to see if there is a link between either COVID infections or COVID vaccinations and glomerular disease

	Group 1 (n=7)	Group 2 (n=10)
nephrotic range proteinuria	7	9
Age (mean)	59.4	68.7
avg uPCR g/mol (range)	1050 (497 - 1600)	1040 (126-2280)
avg serum albumin g/l (range)	18.8 (11-31)	24 (12-34)
avg serum creatinine micromol/l (range)	271 (63 - 1135)	94 (60-278)
gender (M:F)	M=4, F=2	M=5, F=5
Presented with: AKI	33%	30%
Presented with: Nephrotic Syndrome	100%	90%

PUB036

Clinical Characteristics of Hemodialysis Patients Hospitalized With COVID-19: A Case Series of 70 Cases From the Dominican Republic

Denazir Atizol Rodriguez,<sup>1</sup> Nicole M. Suárez,<sup>1</sup> Irvianny Madera,<sup>1</sup> Jordy Batista,<sup>1</sup> Eliana Dina-Battle,<sup>1</sup> Nicolle M. Battle.<sup>2</sup> <sup>1</sup>Hospital Metropolitano de Santiago, Santiago De Los Caballeros, Dominican Republic; <sup>2</sup>Pontificia Universidad Católica Madre y Maestra, Santiago de los Caballeros, Dominican Republic.

**Introduction:** The Coronavirus disease (COVID-19) is more severe in patients with pre-existing comorbidities; therefore, dialysis patients fall into this category. Not to mention the risk among patients receiving in-center dialysis, since they are known to be at higher risk of contracting this disease. Information about the clinical characteristics among hemodialysis patients with COVID-19 in Latin America and low-and middle-income countries are limited. Considering the importance of this topic, the aim of this study was to describe the clinical characteristics along with the outcome of 70 hemodialysis patients hospitalized for COVID-19.

**Case Description:** The mean age of the patients was 58 (range 19-87), where 65.7% were male. The most prevalent comorbidities were Hypertension (98.6%) and Type 2 Diabetes (54.3%). The most common presenting symptoms were dyspnea (71.4%), fever (68.6%) and cough (58.6%). In addition of abnormal pulmonary auscultation in most patients (78.6%). Lymphocytopenia and elevated inflammatory markers as Procalcitonin, ESR, D-dimer and CRP were the main prevalent lab findings. At admission 90.1% had ground-glass abnormalities in the CT findings, being CO-RADS 3 the most frequent category between these patients. The average hospital stay was 8.51± 6.39 days, 35.7% of these patients were admitted to ICU with a median of 5.00 (IQR: 2.5-11) days and only 4 (5.7%) required mechanical ventilation. Therapeutic management included statins and antithrombotic therapy for all the patients at prophylactic doses. Treatment options were Remdesivir, corticosteroids, hydroxychloroquine, antibiotics, and other immunosuppressant drugs. A total of 8 (11.4%) patients died during hospitalization and 62 (88.6%) were discharged.

**Discussion:** Even though dialysis patients are at higher risk of death, especially in developing countries, our findings suggest that the mortality rate were lower in comparison with other studies in Latin America and similar to some developed countries. The use of statins and antithrombotic prophylaxis in all hospitalized patients seems to be associated with a lower risk of death in conjunction with other therapeutic regimens according to the guidelines. No major adverse consequences were observed with Remdesivir in these patients.

PUB037

AKI From Cholesterol Embolization Syndrome Treated With Corticosteroids

Kelly V. Liang, Kamal Gupta. *University of Kansas School of Medicine, Kansas City, KS.*

**Introduction:** Cholesterol atheroembolism is a dreaded complication of interventional vascular procedures, causing renal atheroembolism, gastrointestinal ischemia, and peripheral limb gangrene. Although renal atheroembolic disease can be self-limited, it is often progressive. It is unclear whether corticosteroids are beneficial. We present a case of renal atheroembolism that was successfully treated with corticosteroids.

**Case Description:** A 69 year-old male with history of hypertension, hyperlipidemia, coronary artery disease s/p coronary artery bypass graft twice (1998 and 2008), multiple percutaneous coronary interventions (PCI), peripheral arterial disease, renal artery stenosis, diabetes mellitus type 2, heart failure with reduced ejection fraction (HFrEF) (EF 45%), and chronic kidney disease (CKD) stage 3, underwent PCI with stent placement on 12/20/21 and 1/24/22. After his Jan 2022 procedure, he noted onset of painful bluish bilateral toe discoloration, concerning for cholesterol embolization. His creatinine (Cr) progressively worsened from baseline of 1.3-1.7 mg/dL to 2.63 over a period of 6 weeks. Differential diagnosis included low cardiac output related AKI (cardiorenal syndrome), overdiuresis, contrast nephropathy, and cholesterol emboli. Right heart catheterization on 3/7/22 showed normal filling pressures and cardiac output, ruling out cardiorenal syndrome or overdiuresis. Presence of toe gangrene, increased urine eosinophils, and a diffuse maculopapular rash made cholesterol embolism the most likely diagnosis. There was no improvement in renal function with conservative treatment with lipid-lowering therapy for 6 weeks, so he was treated with steroids with rapid taper. His Cr started improving steadily from 2.63 to 1.96 within 5 days and declined to 1.1 over 3 weeks in April 2022, and his rash resolved.

**Discussion:** We present a rare case of cholesterol embolization in which rapidly tapering corticosteroids improved renal function. Supportive care is the mainstay of therapy for renal atheroembolism. However, renal dysfunction often is progressive despite conservative treatment. Corticosteroids may ameliorate the inflammatory reaction at the site of embolization in distal arteries, thereby preventing irreversible ischemia. Therefore, corticosteroids should be considered early in atheroembolic disease to prevent persistent inflammation, irreversible ischemia, and renal failure.

## PUB038

**Features and Long Term Follow Up of Collapsing Glomerulopathy in Three Patients of COVID-19 Infection Presenting With Severe AKI**

Reshub R. Pendyala,<sup>1</sup> Prashant Pendyala,<sup>2</sup> <sup>1</sup>Nichols School, Buffalo, NY; <sup>2</sup>Buffalo General Medical Center, Buffalo, NY.

**Introduction:** Collapsing Glomerulopathy has been well described in patients with COVID 19. However their long term outcomes are still not clear This is a case report of 3 patients who had relatively mild COVID 19 symptoms but were in severe acute kidney injury (AKI). They were followed for 18 months till date.

**Case Description:** The patients were 42, 50 and 55 yrs of age. All the three were Black Their COVID 19 symptoms were limited to fever, cough and myalgia. None of the three needed supplemental oxygen. Only the 50 yr old had hypertension and was on Amlodipine. The other two did not have any significant past history and were not on any regular medications. Their hospitalization was triggered by the blood work. They did note some decrease in their urine output and increased fatigue. None of them had hypotension, though all three were febrile and tachycardic. They did not have any edema. Their creatinine was 12.5, 14 and 9.6 at admission. WBC count was mildly elevated. Bicarbonate was low and potassium was normal in range. All the three had proteinuria of 5.6 gm, 4.8 gm and 6.2 gm All the three needed renal replacement therapy in the ensuing 1-3 days. All the three underwent kidney biopsy and it confirmed presence of Focal Segmental Glomerulosclerosis with features of the Collapsing variant. The three were on dialysis for 32, 58 and 46 days. All the three recovered enough kidney function to be able to discontinue dialysis. They were followed for the next several months. Currently the 42 yr old is on a single anti hypertensive and so is the 50 yr old that is continuing his need for medication. The current creatinine after 14, 16 and 20 month follow up are 3.5, 2.9 and 3.1. They still have 5gm, 4.8 gm and 3.8 gm of urine protein and have been tolerating angiotensin receptor blockers and spironolactone.

**Discussion:** Obviously this is a study of only 3 patients but the presentation and course and current residual disease are in line with prior literature of COVID 19 associated Collapsing Glomerulopathy. They presented with relatively mild COVID 19 symptoms and had severe AKI needing dialysis. All the three patients were black. They did not have hemodynamic instability. They did recover enough to be off dialysis but have significant residual disease with advanced Chronic Kidney Disease and severe proteinuria.

## PUB039

**Cefepime-Induced Neurotoxicity in the Setting of AKI Requiring Renal Replacement Therapy**

Natalia Plotskaya, Cristine K. Arcilla. <sup>1</sup>Capital Health System Inc, Trenton, NJ.

**Introduction:** Cefepime is a commonly used parenteral antibiotic for severe infections. 85% of the drug is excreted renally and crosses the blood-brain barrier. Cefepime-induced neurotoxicity (CIN) manifests as encephalopathy, myoclonus and seizures. It is reported in patients with renal impairment if administered in high dosage. CIN is reversible after drug discontinuation and faster clinical recovery is achieved by intermittent hemodialysis (IHD).

**Case Description:** A 53-year-old female with a history of sleep apnea, obesity, recent COVID pneumonia presented with worsening dyspnea on exertion for 5 days. Physical examination revealed tachycardia, tachypnea, diminished breath sounds at lung bases. Admission laboratory results were a creatinine (Cr), 0.96 mg/dl; BUN, 18 mg/dl. Chest x-ray showed bilateral ground glass pulmonary opacities. Patient was started on Vancomycin 2 g IV every 12 hours and Cefepime 2 g IV every 8 hours. On day 2 she was in septic shock due to E.Coli bacteremia, intubated and started on pressors. Vancomycin was discontinued. On day 8 Cr increased to 1.49 mg/dl. Patient remained on Cefepime without dosage change for six more days despite glomerular filtration rate decreased to 20 ml/min/1.73 m<sup>2</sup>. On day 18 patient was noted to have altered mental status and jerking movements of upper extremities and head. Cefepime was stopped, Cr peaked at 3.95 mg/dl, BUN was 130 mg/dl at that time. CT scan of head was negative for acute findings. EEG showed focal cortical hyperexcitability, no seizure activity. Cr increased to 4.41 mg/dl, IHD was started. After two IHD sessions jerking movements disappeared, and consciousness improved. Work up for acute kidney injury (AKI) revealed negative Hepatitis B,C, HIV serology. ANA, ANCA serology was negative. Patient regained renal function within 1 week after six IHD sessions.

**Discussion:** CIN is a known complication in patients with renal dysfunction but remains challenging to recognize in critically ill patients. Our patient had various causes of altered mental status: shock, hypoxemia, uremia. Despite decline in renal function cefepime dose was not adjusted and patient developed CIN which required emergent hemodialysis initiation. A high index of suspicion for CIN is critical when evaluating a patient with AKI. Discontinuation of cefepime and emergent IHD initiation leads to resolution of neurological symptoms within 48 hours.

## PUB040

**Acute Renal Failure With Severe Flank Pain Following Binge Drinking and Non-Steroidal Anti-Inflammatory Medication Intake**

Meloney Oliveira, Steven T. Heidt, Roger A. Rodby, Pravir V. Baxi. *Rush University Medical Center, Chicago, IL.*

**Introduction:** An acute kidney injury (AKI) syndrome with severe flank pain following the combination of binge alcohol drinking with NSAID intake was first described by Elsasser et al. in 1988. We present two such cases.

**Case Description:** Case 1 - A 24-year-old healthy man presented with severe bilateral flank pain after a night of binge alcohol drinking followed by ibuprofen the next day for a

hangover. His physical exam was unremarkable and without flank tenderness. His serum creatinine (SCr) was 2.8 mg/dL. He was non-oliguric. A urinalysis had no proteinuria, pyuria, hematuria or casts. The fractional excretion of sodium FeNa was 1.9%. The creatinine kinase (CK) and lactate dehydrogenase (LDH) were normal. A retroperitoneal ultrasound (RPUS) demonstrated no abnormality. He was initially treated with intravenous fluids without improvement in renal function. His SCr peaked at 4.8 mg/dL (Figure 1) but he did not require dialysis. His renal function spontaneously improved on day 3 and his flank pain resolved. Case 2 - A 34-year-old woman with hypothyroidism presented with severe bilateral flank pain. Prior to admission, she had been using ibuprofen for back pain. She admitted to drinking excessive amounts of alcohol on a daily basis. Her SCr was 5.0 mg/dL. She was non-oliguric. A urinalysis had no proteinuria, pyuria, hematuria or casts. The CK and LDH were normal. A RPUS was unremarkable. Her SCr peaked at 5.8 mg/dL (Figure 1) and did not require dialysis. Her renal function spontaneously improved on day 2 and her flank pain resolved.

**Discussion:** AKI with flank pain following excessive alcohol intake and NSAID usage is a rare idiosyncratic reaction to these not unusual behaviors. Both cases presented as complete mysteries until an internet search led us to this previously described syndrome. While the risk factors are known, the pathophysiology is not but would be especially interesting as both AKI diagnoses were recognized only as a result of an evaluation for acute flank pain. Both patients had an uneventful recovery.

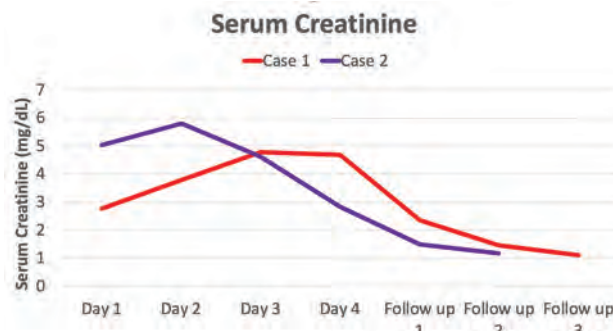

## PUB041

**The Sickest COVID-19 Patients During the First Wave of the Epidemic: Strong Clinical Evidence for Acute Tubular Injury**

Phoenix Xu,<sup>1</sup> Harshad Chaudhari,<sup>1</sup> Smita Mahendrakar,<sup>1</sup> Jennine Michaud,<sup>2</sup> Joshua Kaplan,<sup>1</sup> Alex Plamm,<sup>1</sup> Sacha Balmir,<sup>2</sup> Michael Yudd.<sup>2</sup> <sup>1</sup>Rutgers New Jersey Medical School, Newark, NJ; <sup>2</sup>VA New Jersey Health Care System, East Orange, NJ.

**Background:** From March through June 2020, SARS-CoV-2 virus surged through the New York Metropolitan area, killing 43,000 in NY and NJ. The sickest patients had both respiratory failure and severe acute kidney injury (AKI), were intubated and on dialysis.

**Methods:** Seventy intubated patients with severe covid and severe AKI requiring dialysis were treated in 2 north Jersey hospital ICU during this period. Their records were reviewed, focusing particularly during the period of AKI onset to identify potential renal insults – hypotension and shock, secondary infections, and inflammation markers.

**Results:** Following admission, respiratory failure quickly progressed, and intubation occurred 3.3 ± 3.7 days after admission. AKI became evident 1.5 days later (4.7 ± 4.8 days after admission), and dialysis was initiated 5.4 ± 6.6 days after AKI onset. Serum creatinine at the start of dialysis was 6.44 ± 3.40 mg/dl. Around the onset of AKI (start of dialysis ± 5 days), hemodynamic and clinical instability were rampant. Hypotension requiring vasopressors occurred in 83%; oliguria developed in 79% and worsened to anuria in 33%. Bacteremia and fungemia complicated this period in 28% and 10%. The inflammatory markers - CRP, d-dimer, ferritin, interleukin-6 and ESR, were extremely elevated. Fifty-two patients (74%) died during the hospitalization, 17.7 ± 11.8 days from admission. Renal function improved in only 1 of these patients. Eighteen patients (26%) survived, and were discharged 63 ± 15 days after admission. Fifteen (83%) of them regained renal function after requiring dialysis for 20 ± 15 days. Their serum creatinine decreased to 1.15 ± 0.63 mg/dl at discharge. Some went through a polyuric phase. Most of these survivors had severe medical problems. Over the next 3.5 months, 5 of them died.

**Conclusions:** The following clinical aspects were highly suggestive of acute tubular injury: - onset of AKI during severe hemodynamic instability, intubation, pressor use, secondary infections and intense inflammation; - the rapid progression to uremia; - oliguria early in AKI; some with polyuric phase that preceded improvement of renal function; - short period of dialysis and marked improvement of renal function 8 weeks after onset in 83% of the survivors.



## PUB042

**A Rare Case of Magic Mushroom (Psilocybin) Related AKI and Hypertensive Emergency**

Syed Rizwan A. Bokhari,<sup>1</sup> Ahmed Abdullah,<sup>2</sup> Zamir A. Zamir,<sup>3</sup> Raquel M. Rosen.<sup>1</sup> <sup>1</sup>Bassett Healthcare, Cooperstown, NY; <sup>2</sup>King Edward Medical University, Lahore, Pakistan; <sup>3</sup>University of Chicago Pritzker School of Medicine, Chicago, IL.

**Introduction:** Magic (Psilocybin) mushrooms are used as hallucinogens, renal dysfunction as a rare side effect has been reported in literature. We chronicle a rare case of acute kidney injury and hypertensive emergency precipitated by psilocybin ingestion in a young female.

**Case Description:** A 31-year-old female with good overall health and medical history of well controlled Hypertension (HTN) and metabolic syndrome presented with AKI in the setting of hypertensive emergency. Initial blood pressure (BP) on presentation was 210/140, with transient visual loss and elevated troponin >6000. Her other past medical history was significant for nephrolithiasis and COVID-19 few months ago. Physical examination was significant for HTN; no significant edema was present. Remaining physical examination was unremarkable. Laboratory evaluation demonstrated serum creatinine 4.6 mg/dL (baseline creatinine 0.9 mg/dL), 24-hr urine protein 920 mg/g, and serum albumin 3.0 g/dl. A blood film revealed occasional schistocytes. Urinalysis showed proteinuria and microscopic hematuria. Urine toxicology screen was negative. Routine blood and urine cultures showed no growth. Her serology, infectious disease workup and workup for paraproteinemia were inconclusive. Workup for secondary hypertension was negative. Computed tomography of the brain in the setting of transient visual loss, and ultrasound of the kidneys and bladder were unremarkable. Her transthoracic echo (TTE) showed severe concentric left ventricular hypertrophy, with grade II diastolic dysfunction. Renal biopsy showed features suggestive of vascular-predominant acute thrombotic microangiopathy. Patient was managed conservatively and did not require renal replacement therapy. Her serial follow up labs from last several months revealed the new baseline creatinine of 2.2-2.4 mg/dl, resulting in CKD as a sequel of partial recovery from AKI in the setting of psilocybin poisoning.

**Discussion:** Psilocybin use can be associated with AKI leading to CKD and secondary hypertension. Mechanisms of renal injury are thought to be secondary to vasoconstricting effects and endothelial reaction, which needs to be further investigated. Nephrologists and primary providers should be vigilant to identify this rare cause of AKI.

## PUB043

**Reducing the Incidence of Hospital Acquired AKI (HAAKI) by Careful Assessment and Intervention on the Trend of Abnormal Vital Signs**

Harshil Fichadiya, Raghu Tiperneni, Rana Prathap Padappayil, Ahmad S. Al-Alwan, Farah Heis, Charmee H. Vyas, Doantrang Du. *Monmouth Medical Center, Long Branch, NJ.*

**Background:** HAAKI is associated with increased mortality and prolonged duration of hospitalization. The incidence of HAAKI in the US is 2-5%. The most common identified etiologies of HAAKI are hemodynamic changes from volume depletion, sepsis and from use of nephrotoxic drugs. We attempted to reduce the incidence of HAAKI by assessing and intervening on the trend of abnormal vital signs to prevent further clinical deterioration from the hemodynamic perspective. Clinical deterioration was measured by the number of Rapid Response Team (RRT) and sepsis alert triggered on abnormal vital signs.

**Methods:** All patients admitted to medical service during the study period were included with the exclusion of those admitted with pre-existing AKI, AKI explained by etiologies except those related to abnormal vital signs. The primary team carefully evaluated the trend of abnormal vital signs and intervened on them based on a guideline sheet (approach to abnormal vital signs) provided to correct the abnormal trend. This allowed early detection and correction of clinical deterioration which was measured by a reduction in number of RRT and sepsis alert triggered by abnormal vital signs. Urine output and serum creatinine were measured on daily basis to assess for the evolution of an AKI using the KDIGO criteria (rise in creatinine >0.3mg/dl in 24 hr, >1.5X in 1week, urine output <0.5 mL/kg/h for 6 hours. The incidence of AKI was compared with the national incidence of HAAKI. Number of RRT and sepsis alert were compared between the one month study period and the month prior.

**Results:** National incidence of HAAKI: 2-5% Incidence of HAAKI in our study: 0.7% % of RRT triggered on abnormal vital sign during pre-study period: 53% VS study period: 42% Number of sepsis alert during pre-study period: 86 VS study period: 59

**Conclusions:** -Our intervention of assessing abnormal vital sign trend and correcting them using interventions suggested on the guideline sheet helped in early detection of clinical deterioration as evidenced by reducing in the % of RRT and sepsis alert triggered on abnormal vital signs -It helped in reduction of the incidence of HAAKI from hemodynamic and septic etiologies -It contributed to resident education by helping them in assessing and intervening on abnormal vital sign trends

## PUB044

**Inadequate Diuresis due to AKI in Cardiorenal Syndrome Patients**

Sushma Medikayala,<sup>1</sup> Kristi A. Njaravelil,<sup>2</sup> Surafel K. Gebreselassie.<sup>1</sup> <sup>1</sup>Cleveland Clinic Florida, Weston, FL; <sup>2</sup>Nova Southeastern University, Fort Lauderdale, FL.

**Background: Objective:** To find out if patients with CHF are underdiuresed due to AKI. **Background:** 20-40% of inpatients with acute CHF develop AKI. Providers in dilemma to continue diuretics to treat fluid overload or reduce diuretics to avoid dialysis. This is a grey zone with no clear answers, consensus or treatment protocols. Renal parameter used to define AKI is creatinine (Cr). In AKI, Cr relates to glomerular function and does not represent true tubular injury. Is the AKI present on admission (CRS) or developed with the use of diuretics? In patients that receive diuretics, elevation of Cr could be due to: i) Redistribution of fluid occurs within different body compartments. Increase in Cr is a reflection of changed hemodynamic and hormonal changes. ii) hypovolemia with prerenal state due to diuresis- as kidney sees less volume, it will increase reabsorption of Na, Urea, Uric acid, Creatinine, leading to elevated Cr and Bun. At this stage, there is no anatomic injury to the nephrons. iii) True AKI - either directly from long standing CRS or persistent hypovolemia from aggressive diuresis, ATN develops. Here, there is real damage to the tubules. It is a common myth that Lasix is nephrotoxic. In reality, Lasix is not Nephrotoxic. But why does the creatinine rise with diuretics? It is due to the hypovolemia, prerenal state caused by Lasix. Lasix does not cause direct toxic injury to the tubules. iv) Acute GN- Patient has concomitant Glomerulo nephritis unrelated to CRS. v) ineffective diuresis due to hypoalbuminemia as albumin is the carrier for Lasix to the site of action in renal tubules. vi) Nephrotic syndrome- albumin in the tubules binds Lasix and effective circulatory Lasix is reduced. i-iii - not associated with true renal tubule damage. There is a critical need for guidelines and best clinical practice models for management of diuresis in cardiorenal syndrome patients.

**Methods:** Retrospective Chart Review

**Results:** Pts with CHF and AKI-145. Pts with AKI as per RIFLE classification- 16, 3 with inadequate data. Pts with CRS 10, developed AKI due to diuresis 3. Of the 10 CRS patients, at the time of discharge, 5 gained wt, 5 lost wt, 4 readmissions. AKI due to diuretics-3, at the time of discharge, 2 gained wt, 1 lost wt and 1 readmission.

**Conclusions:** Though small sample size, study indicates that CRS patients are underdiuresed due to AKI leading to readmissions. Future prospective studies needed.

## PUB045

**AKI and Renal Recovery After Lung Transplantation: The Experience in México**

Lilia M. Rizo Topete,<sup>1,2</sup> Patricia Rodriguez,<sup>1</sup> Sergio Saul Sanchez-Salazar,<sup>1</sup> Uriel Chavarria-Martinez,<sup>1,2</sup> Manuel Wong-Jaen,<sup>1</sup> Alicia Estela López-Romo,<sup>1</sup> Mariana N. Zavala,<sup>1</sup> Adrian Camacho-Ortiz.<sup>2,1</sup> Lung Transplant Program in Christus Muguerza, Monterrey, México <sup>1</sup>Christus Muguerza Sistemas Hospitalarios SA de CV, Monterrey, Mexico; <sup>2</sup>Universidad Autonoma de Nuevo Leon, San Nicolas de los Garza, Mexico.

**Background:** Few centers around the globe have a lung transplant (LT) program in Mexico there is only one. The possible complications are associated pre transplant time, surgical and the post-surgical recovery, common one is AKI (20 to 90%), 15% need KRT. The AKI will complicate the in hospital evolution, time in ICU, risk of infections, also increase mortality and possibility of no renal recovery (RR).

**Methods:** Is a Retrospective and Descriptive study. patients 18y who performed LT in Christus Muguerza from January 2017 to May 2022. Data was collected in excel and the analysis was performed in SPSS V21. The confidentiality agreement is accordance with Helsinki declaration.

**Results:** 24 patients had LT, 62.5% men, average age is 54 y, average BMI 23kg/m2. Idiopathic pulmonary fibrosis the most common diagnosis (58.3%) follow by COVID-19 (16.6%), 15 receive bi-pulmonary transplant. Survival rate is 66%. 37.5% developed AKI with the need of KRT all CKRT as initial therapy. 7 patients were discharge with a complete renal recovery after KRT. 32% patients were in ECMO and 75% from these need CKRT.

**Conclusions:** The involvement of kidney function is essential for the decision to go forward to LT, some patients develop AKI before surgical time, these should be evaluated from the crosstalk organ view, remembering that a high possibility of RR exist if the lung recovery is successful. Our work demonstrate that nephrology intervention in a team work help patient to RR.



Rehabilitation before lung trasplant with ECMO and CKRT and after lung trasplant without KRT, two days before catheter withdrawal.

KRT Type	Initial Modality	Filter	Days In KRT	Initial Dose	KRT Indication	Initial Creatinine	Final outcome
CKRT	HDFVVC	Oxiris	41	25 ml/kg/hr	Anuria, Fluid Overload	1.5	Live
CKRT	HDFVVC SCUF	Oxiris	13	28 ml/kg/hr	Uremia, Fluid overload	3	Live
CKRT	HDFVVC	Oxiris	8	30 ml/kg/hr	Oliguria Fluid overload Hyperkalemia	3.74	Live
CKRT	HDFVVC	ST-150	2	30 ml/kg/hr	AKI KDIGO 3/ 3/MAT/Sepsis	1.6	Dead
CKRT	HDFVVC	Oxiris	18	30 ml/kg/hr	AKI KDIGO 3/ Sepsis	1.8	Dead
CKRT	HDFVVC HDVVC	Oxiris	56	26 ml/kg/hr	Fluid Overload Metabolic Acidosis	2.72	Live
CKRT	HDFVVC HVVC SCUF	Oxiris	85	25 ml/kg/hr	Fluid Overload Oliguria	3.6	Live
CKRT	HDFVVC	Oxiris	5	30 ml/kg/hr	Fluid Overload Metabolic Acidosis	2.6	Live
CKRT	HDFVVC	ST-150	5	31 ml/kg/hr	Anuria, Uremia, Hyperkalemia	3.3	Live

The modality, prescription and outcome of the patientes who need KRT.

**PUB046**

**Treatment of Cisplatin-Induced AKI With Renal Selective Nanotherapy**  
Chintan H. Kapadia,<sup>1</sup> Daniel A. Heller,<sup>2</sup> Magdalini Panagiotakopoulou,<sup>2</sup> Edgar A. Jaimes,<sup>2</sup> <sup>1</sup>Goldilocks Therapeutics Inc., Wilmington, DE; <sup>2</sup>Memorial Sloan Kettering Cancer Center, New York, NY.

**Background:** Acute kidney injury (AKI) occurs in up to 30% of cancer patients treated with cisplatin, and accounts for approximately 1% of total hospital admissions. Further, up to 25% of patients in intensive care develop AKI and up to 25% of these patients require renal replacement therapy with mortality rates up to 60%. Despite the prevalence and associated morbidities of AKI, there are no therapeutics that specifically treat this disease.

**Methods:** We synthesized proprietary nanoparticles from biodegradable materials which preferentially target renal proximal tubular epithelial cells. Nanoparticles were loaded with free radical scavenger molecule, Edaravone. In previously published studies, our nanoparticles exhibited significant therapeutic efficacy in cisplatin-induced kidney injury in mice. For the successful clinical translation of our lead therapeutics, we have developed cisplatin induced AKI model in pigs.

**Results:** After administration of 5 mg/kg cisplatin intravenously, blood urea nitrogen (BUN) and creatinine were significantly elevated from baseline post 72 hours. Currently, we are evaluating, biodistribution, pharmacokinetics and efficacy of our lead therapeutics, Edaravone nanoparticles, in our pig model of CI-AKI.

**Conclusions:** The results of this work will provide pharmacokinetic, safety, and efficacy data of a lead candidate in a large animal model of CI-AKI. Results from these studies will provide essential final validation before initiating the remaining CMC/IND-enabling studies.

**Funding:** NIDDK Support

**PUB047**

**Hemoperfusion in a COVID-19 Patient With Severe Burn Injuries**  
Lorraine S. Vergara-Rejante, Maria kristina Alolod. Saint Luke's Medical Center, Quezon City, Philippines.

**Introduction:** Severe burn injury can cause effects in cellular mechanisms known as systemic inflammatory response syndrome. Survival rate is decreased in patients with severe burns with the added insult of this inflammatory response. Optimizing management for these patients can include utilization of hemoperfusion to decrease inflammatory response and mortality rate. The use of hemoperfusion is not usually included in the initial treatment but few studies showed promising benefits.

**Case Description:** A 29-year old male who works in smelting industry, had a flame burn injury. Upon arrival in the ER, COVID-19 RT PCR oral and nasopharyngeal swab turned out to be positive, and he was transferred to a COVID critical care unit. Altogether there was ~67% TBSA affected. Fluid resuscitation was started with saline alternating with Lactated Ringer's solution. Surgeries were done sequentially. There was a high inflammatory state on the 2nd hospital day as shown by high-grade fever with a temperature of 38-39°C and elevated CRP of 48 and Procalcitonin at 22.51 ng/mL. Hemoperfusion was done for three consecutive days from 2nd to 4th hospital day using HA330 cartridge. Urine output and biochemical markers eventually improved (Fig. 1).

**Discussion:** Hemoperfusion is indicated to remove cytokines in patients with sepsis and systemic inflammatory response syndrome. There were several studies with conflicting evidence for the use of hemoperfusion and other forms of extracorporeal therapies in an inflammatory state. Hemoperfusion done in this case involves the use of a standard hemodialysis machine done for 3 consecutive days using the HA330 cartridge for 3 hours each session. The return of levels to baseline or normal procalcitonin plasma concentrations have a high negative predictive value to rule out severe systemic inflammation. The indication for hemoperfusion in severe burn injury patients with severe inflammatory response syndrome still remains experimental. There is no current recommendation for the use of hemoperfusion specifically on burn patients, and further clinical trials were recommended.

	1 <sup>st</sup> Day	2 <sup>nd</sup> Day	3 <sup>rd</sup> Day	4 <sup>th</sup> Day	5 <sup>th</sup> Day
Hemoglobin (g/dL)	25	17.1	13.7	11.7	10.5
Hematocrit (%)	69.2	47.5	39.8	33.8	31.6
White Blood Cell (per mm <sup>3</sup> )	32,750	6780	4040	4620	11930
Platelet (per mm <sup>3</sup> )	310,000	169,000	169,000	101,000	220,000
Procalcitonin (ng/mL)		22.51		5.15	
C-reactive protein (mg/dL)		48		48	
Ferritin (ng/mL)		745		694.1	
D-Dimer (ng/mL)		1559		934	
Erythrocyte Sedimentation rate (mm/hr)		2		19	
Lactate Dehydrogenase (U/L)		403		346	
Creatinine (mg/dL)	2.27	1.83		0.67	

Summary of Serum Biochemical Markers and Blood Counts

**PUB048**

**Late-Onset Scleroderma Renal Crisis: A Case-Control Study**  
Manal Alotaibi, Xuan Cai, Cybele Ghossein. Northwestern University Feinberg School of Medicine, Chicago, IL.

**Background:** Scleroderma renal crisis (SRC) is a life-threatening complication of Scleroderma (SSc) that occurs in the first 4 years of disease. Here we report a case series of late-onset SRC (SRC-l) (>5years from SSc onset) and compare clinical presentation and outcomes to our early-onset (<5years) SRC (SRC-e) cohort.

**Methods:** Retrospective chart review of SRC patients at Northwestern Memorial Hospital from 2000-2019. History, demographics, lab values, medication exposure, clinical presentation and outcomes were compared.

**Results:** 42 patients had SRC-e and 6 patients (12%) met the criteria for SRC-l. There was no difference in baseline demographics between SRC-e and SRC-l patients. 33% of SRC-l had positive anti-RNP antibodies as compared to 7% of SRC-e (p<0.05). Prior exposure to steroids and ACE inhibitors (ACEI) was significantly associated with SRC-e but not SRC-l. Microscopic hematuria was a presenting sign in 75% of SRC-e patients but in none of SRC-l patients (p<0.001) TABLE 1. There was no significant difference in risk of death or renal replacement between SRC-e and SRC-l during the acute SRC episode at years 1 and 3.

**Conclusions:** 12% of all SRC patients present more than five years after SSc diagnosis. RNP antibody positivity, lack of microscopic hematuria, and no increased risk of exposure from the use of steroids and ACEI differentiate SRC-l from SRC-e. Most of our current understanding of SRC is based on early-onset disease, more research is needed to better elucidate late-onset SRC.

	Total N = 48	Late-onset N = 6	Early-onset N = 42	p-value
<b>Demographics</b>				
Age, mean, years ± SD	50.5 ± 12.5	51.8 ± 15.2	50.3 ± 12.3	0.79
dcsSc (Diffuse), n (%)	39 (81.3%)	5 (83.3%)	34 (81.0%)	1.00
SSc duration (years), median (IQR)	1.1 (0.8 – 2.3)	8.5 (7.0 – 16.0)	1.0 (0.7 – 2.0)	<.0001
<b>Serologies</b>				
RNP, n (%)	3 (7.1%)	2 (33.3%)	1 (2.8%)	0.049
<b>Medication exposure, 1 month prior</b>				
Corticosteroid, n (%)	22 (50.0%)	0 (0.0%)	22 (57.9%)	0.02
Max steroid dose, median (IQR)	25.0 (10.0 – 96.7)	NA	25.0 (10.0 – 96.7)	
ACE inhibitor, n (%)	27 (57.5%)	0 (0.0%)	27 (65.9%)	0.004

Table1: Demographics of study population

**PUB049**

**A Strange Case of Prolonged Anuric AKI Following a Urethral Surgery: Reflex Anuria?**  
Alan Segal. Maine Medical Partners--Nephrology MaineHealth, Portland, ME.

**Introduction:** Anuria lasting more than a week is rare. An entity called “reflex anuria” has been associated with urological procedures performed on one kidney or ureter. Here, we present a case of prolonged anuria following manipulation of the urethra.

**Case Description:** A 41-year-old man with a chronic urethral stricture from remote trauma and baseline [creatinine] of 0.96 mg/dL underwent an attempted urethral repair under general anesthesia at an outside hospital. Approach from the distal urethra was complicated by creation of a false lumen so a proximal approach via the bladder was attempted but this also failed. A supra-pubic bladder catheter (SPBC) was placed and the procedure was aborted. Purportedly, the patient had MAPs in the 50s transiently in

the OR. The patient was sent home but returned 6 hours later because of complete anuria despite a patent catheter. He was given copious amounts of IV saline. Anuria persisted and hypervolemia supervened so he was placed on dialysis. Following 4 HD treatments over 5 days, he requested transfer to our hospital. On admission, serum [creatinine] was ~11 mg/dL with no urine output. CK and LDH were normal. Imaging showed normal appearing kidneys with no evidence of hydronephrosis. A cystogram performed via the SPBC did not show any leak. He remained normokalemic but anuria persisted so a tunneled dialysis catheter was placed. Urine output remained less than 50 mL/day for a total of 12 days and he required 10 HD treatments before oliguria resolved. He made 3-4 L of urine/day for 5 days and initial sediment showed granular casts, then urine output normalized. Serum [creatinine] recovered to 1.2 mg/dL 7 weeks after the surgery.

**Discussion:** Complete anuria is rare but can be caused by shock, bilateral urinary tract or renal artery obstruction, cortical necrosis, or RPGN. An entity called "reflex anuria" is a very rare (<100 cases since 1948) complication of trauma or manipulation of a kidney or ureter. The mechanism is thought to relate to reflex vasoconstriction of arterioles or reflex spasm of both ureters causing a functional obstruction. It is a diagnosis of exclusion and seems to respond to percutaneous nephrostomy. Unlike our patient—who had urethral surgery—the anuria typically lasts 5 days or less and few patients have required RRT. We conclude that our patient most likely had severe ATN seemingly well out of proportion to the purported inciting event.

## PUB050

### Outpatient Recovery From Acute Kidney Injury Requiring Dialysis (ORKID): A Pilot Trial

Ian McCoy, Yuenting D. Kwong, Kathleen D. Liu, Chi-yuan Hsu. *University of California San Francisco, San Francisco, CA.*

**Background:** After leaving the hospital, patients with dialysis-requiring AKI (AKI-D) are currently treated largely the same as patients with end-stage kidney disease. Routine outpatient dialysis may result in low blood pressure during the dialysis session, which may further damage the kidneys and inhibit recovery. There is currently limited infrastructure supporting AKI-D recovery at outpatient dialysis facilities.

**Methods:** The ORKID trial (NCT05158153) is a single-center, single-arm pilot trial with target recruitment of 20 subjects with a primary aim to test the feasibility of providing a bundle of five interventions: chilled dialysate (35-36°C), high sodium dialysate (145 mmol/L), high dose diuretics (160 mg oral furosemide twice daily), high ultrafiltration hold threshold (SBP > 110 mmHg), and active dialysis weaning to patients with AKI-D being treated with outpatient hemodialysis. The bundled intervention aims to prevent intradialytic hypotension, recognize renal recovery, and wean dialysis off safely as soon as recovery occurs. Recruitment occurs before discharge from the University of California San Francisco (UCSF) hospitals and study investigators implement the intervention for participants during the first 90 days of outpatient dialysis at dialysis facilities within 30 miles of UCSF. The primary outcome is feasibility; secondary outcomes include tolerability (dropout to day 90), safety (including electrolyte abnormalities and emergent dialysis treatments), rates of recruitment, intradialytic hypotension, renal recovery, and patient reported outcomes.

**Results:** We identified 15 patients discharged with AKI-D still requiring HD. 10 patients lived outside the 30-mile radius for study inclusion (mean > 100 miles from UCSF). Four patients were excluded for clinician refusal or other reasons. One patient was recruited and underwent intervention but subsequently transitioned to hospice care. The trial was terminated after six months due to inadequate recruitment.

**Conclusions:** Given that outpatient dialysis facilities are often located far from the hospitals where AKI-D occurred, dialysis-unit based recruitment rather than hospital-based recruitment may be superior for trials of outpatient AKI-D recovery. Whether this bundled intervention to decrease intradialytic hypotension and support AKI-D recovery is feasible in outpatient dialysis units remains unknown.

**Funding:** NIDDK Support, Commercial Support - Satellite Healthcare, a not-for-profit renal care provider

## PUB051

### Contrast-Induced Nephropathy Resulting in a Persistent Nephrogram

Tanner Bond, Jacob Delalla, Christian Dias. *Erlanger Baroness Campus, Chattanooga, TN.*

**Introduction:** Acute kidney injury (AKI) within 24 to 48 hours after iodine containing contrast historically has been the third most common cause of hospital-related AKI. Patients at highest risk typically have baseline CKD, but other important risk factors include older age and other coincident exposures such as hypovolemia, heart failure, or sepsis. The injury can be attributed to various mechanisms including vasoconstriction of the afferent arterioles, medullary ischemia, renal epithelial cell necrosis, and direct renal tubular toxicity due to oxidative stress.

**Case Description:** A 59-year-old female with a BMI of 14.5 kg/m<sup>2</sup> was admitted to the hospital with failure to thrive and a large palpable breast mass. During workup, the patient underwent various CT imaging with a total of 150 ml of iodinated contrast (Iohexol). Imaging and biopsy revealed extensive breast cancer with metastatic disease to the liver, spleen, orbits, & axial skeleton. In the subsequent days, she developed a sudden decline in mentation with respiratory distress and was taken for repeat CT scan without contrast (hospital day 6). CT scan report revealed that the kidneys demonstrated uniform enhancement suggesting contrast nephropathy with a persistent nephrogram (figure 1). Intermittent straight catheterization with 30cc of black colored urine with muddy brown casts seen under urine microscopy. Unfortunately, the patient decompensated followed by family electing to pursue comfort focused care.

**Discussion:** This clinical scenario highlights the risk a physician must discern when ordering imaging for each patient. The case details the clinical syndrome of a patient with metastatic disease and hypovolemia complicated by unusual abrupt anuric AKI shortly after undergoing CT imaging with contrast. Most patients with CI-AKI are nonoliguric, with only the most severe and rare cases presenting with anuria, such as in this case.



CT without contrast, axial view. Both kidneys demonstrate persistent uniform enhancement which suggests contrast nephropathy.

## PUB052

### Exploring a Unique Case of Renal Oxalosis Secondary to Diabetes Mellitus: A Case Report and Literature Review

Bair Cadet, Kettia N. Guillite, Oshin M. Bansode, Dimitri P. Archer German, Alejandro Alvarez Betancourt. *Nassau University Medical Center, East Meadow, NY.*

**Introduction:** Hyperoxaluria causes kidney disease via obstruction from calcium-oxalate crystal, tubular epithelial cell injuries, & inflammation. This is seldomly observed in CKD Pts w/ Diabetes Mellitus (DM). DM is one of the most common causes of CKD & ESRD, but is unclear if DM associates w/ renal oxalosis, or if hyperoxaluria increases CKD in DM.

**Case Description:** 74-yr-old asymptomatic Caucasian male with HTN, T2DM, sent to ER for AKI stage 3 with SCr 6.2. No h/o alcohol, drug use, and smoking. No family Hx of kidney problems. Unremarkable physical examination. CBC normal, HbA1c 6.9%; blood gas non-anion gap metabolic acidosis, BUN 73 mg/dl, normal LFT; urine protein 34 mg/dl, IF no mAb, UPEP glomerular proteinuria. Uniform and echogenic b/l kidneys on ultrasound. Normal C3 & C4; neg. ANA, anti-Smith, anti-dsDNA, MPO, proteinase 3. Bx ATN 70% interstitial fibrosis, tubular atrophy & calcium oxalate deposit. Serum oxalate 69 mcmol/L w/ normal urine oxalate. B1 & B6 normal level. SCr raised to 17 mg/dl, renal replacement therapy was initiated. Remained dialysis dependent

**Discussion:** This case highlights a diabetic Pt w/oxalate nephropathy w/o other risk factor. Pt had rapidly declining kidney function w/ calcium oxalate deposition, severe ATN & interstitial fibrosis. DM causes systemic organ dysfunction, & targets kidneys causing ESRD. In a study by Furuichi K, et al., 600 Bx specimens of diabetic nephropathy were analyzed, w/diffuse lesions in majority; some w/nodular lesions & mesangiolysis. Interstitial cell infiltration, tubular atrophy, arteriolar hyalinosis, vascular hyperplasia, & arteriosclerosis were found. DM is independent risk factor for urinary oxalate excretion/nephrolithiasis. Oxalate nephropathy of CKD results from deposits calcium oxalate crystals in tubular epithelial cells or kidney parenchyma w/inflammation & worsening kidney function. In a 2015 study by Muji, et al., 3 cases of AKI occurring in diabetic Pts, & renal Bx diagnosed acute oxalate nephropathy which can be primary hyperoxaluria or secondary enteric malabsorption. Similarly, cases of oxalate nephropathy have been reported in DM but highlighted other factors (gastric bypass/ increased dietary oxalate). Though it demonstrated that DM have higher urinary oxalate concentrations, it does not imply that DM causes oxalate nephropathy.

## PUB053

### Mortality Associated With Acquired AKI at General Regional Hospital No. 46 of the Mexican Institute of Social Security

Juan O. Romero Tafuya, Renato Parra Michel, Javier Soto-Vargas, Jorge fernando Topete reyes, Marcos A. Elias Lopez, Jesus A. Vega Lopez de Nava, Mónica L. Morales Guillén, Roxana Villanueva Macedo, Fabiola V. Rios Rios, Mario Valdez Avendaño. *Universidad de Guadalajara, Guadalajara, Mexico.*

**Background:** Acute kidney injury is a group of syndromes that leads to an abrupt decline in kidney function, occurring in 2-7% of hospitalized patients and up to 50% of patients in intensive care units, in which 5% of them will require renal replacement therapy. The aim of the study is to associated the mortality associated with hospital-acquired acute kidney injury.

**Methods:** Retrospective cohort study. We included hospitalized patients over 18 years of age who presented acute kidney injury assessed by the Nephrology service in the January-December 2019. Objective: assessing mortality in patients with in-hospital

Key: TH - Thursday; FR - Friday; SA - Saturday; OR - Oral; PO - Poster; PUB - Publication Only

Underline represents presenting author.

acute kidney injury. Variable of interest: mortality. Inclusion and exclusion: Hospitalized patients diagnosed with acute kidney injury by a nephrologist, excluding glomerular diseases and G4-G5 chronic kidney disease.

**Results:** A total of 165 patients were included, 78 (47.3%) hospitalized and 87 (52.7%) acquired in the community. With a history of (35.2%) hypertensive, (47.9%) diabetic, (29.7%) chronic kidney disease, (15.2%) congestive heart failure, (9.7%) diagnosis of solid tumor, (9.1%) liver disease and (6.1%) coronary artery disease. AS for the severity AKI (6.1%) KDIGO 1, (15.8%) KDIGO 2 and (78.2%) KDIGO 3. Mortality was found in 44.9% of in-hospital AKI, which increased to 50% at 90 days. The mean rate of survival was 73.6 days.

**Conclusions:** In this study, it is possible to show that acute kidney injury is an entity of great importance due to the increased in-hospital mortality in a second-level hospital unit, evidencing the associated risk factors. Is desirable to continue evaluating this entity with prospective studies, identifying other factors associated with mortality for early intervention.

90-day survival curve according to the type of acute kidney injury

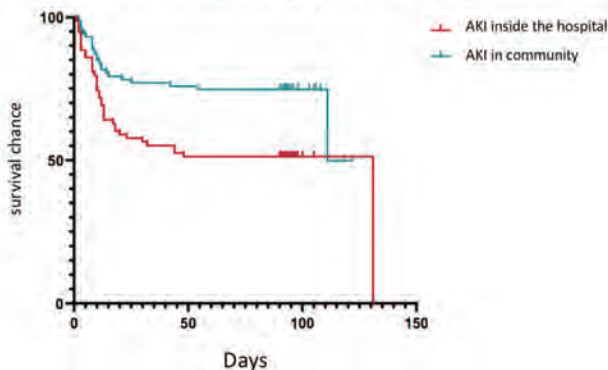

PUB054

Results of Patient Experience Surveys 30 Days After Kidney Biopsy

Hannah C. Melchinger, Jason N. Weinstein, Frida S. Calderon Gutierrez, Melissa M. Shaw, Candice Kent, Randy L. Luciano, Francis P. Wilson, Dennis G. Moledina. Yale School of Medicine, New Haven, CT.

**Background:** The kidney biopsy procedure is important for both clinical diagnosis and research. However, patient experiences during and after kidney biopsy are not sufficiently characterized.

**Methods:** We conducted a participant experience survey 30 days after kidney biopsy in participants enrolled in the Yale Kidney Biopsy Biobank to assess biopsy-related pain, anxiety, complications, and attitude toward future biopsies.

**Results:** Of the 42 participants contacted, 38 (90%) responded to the survey. Biopsy-related pain was common, occurring in 29 (76%) participants during the biopsy (median (IQR) severity, 1 (0, 5) on a scale of 1-10 with 10 being most severe) and 26 (68%) after the biopsy (severity, 1.5 (1, 4)). Pain lasted for over 1 week in 5 (14%) participants and 9 (24%) participants reported limitation in their day-to-day functioning after biopsy. Anxiety during biopsy was reported by 26 (68%) participants with a median severity of 3 (0, 5.5). Blood in urine was reported by 8 (21%) participants. When asked if they would be willing to undergo another biopsy for clinical reasons, 32 (87%) participants responded positively with 26 (81%) of these willing to donate kidney tissue for research during such a procedure. Only 8 (23%) were willing to undergo a biopsy solely for research purposes.

**Conclusions:** In this prospectively administered survey conducted 30 days after kidney biopsy, pain and anxiety were common during kidney biopsy but did not deter participants from willing to undergo another biopsy if indicated.

**Funding:** NIDDK Support

Table. Results of participant experience survey from Yale Kidney Biopsy Biobank

Experience category	N (%) or median (IQR)
<b>Was pain experienced?</b>	
During biopsy	29 (76%)
Severity (Scale 1-10)	1 (0, 5)
After biopsy	26 (68%)
Severity (Scale 1-10)	1.5 (1, 4)
1 week after biopsy	5 (13%)
1 month after biopsy	1 (3%)
Limited day-to-day functioning	9 (24%)
<b>Was there anxiety during biopsy</b>	26 (68%)
Severity (Scale 1-10)	3 (0, 5.5)
<b>Was there blood in urine?</b>	8 (21%)
Duration, days	2 (1.5, 4)
<b>Willingness to undergo repeat kidney biopsy</b>	
For clinical reasons	32 (87%)
Allow tissue taken for research during clinical biopsy	26 (81%)
Research purpose biopsy	8 (23%)

PUB055

Antineutrophil Cytoplasmic Antibody (ANCA) Positive Infective Endocarditis Complicated by AKI

Shilpa Sannapaneni, Louis Damian, Wesley Hiser, Akinwande A. Akinfolarin, Harold M. Szerlip. Baylor University Medical Center at Dallas, Dallas, TX.

**Introduction:** Kidney injury related to infectious etiologies have been well described in literature. Here we present an interesting case of a patient with infective endocarditis, antineutrophil cytoplasmic antibody (ANCA) positivity complicated by acute kidney injury without evidence of vasculitis.

**Case Description:** A 63-year-old male presented to the emergency department with elevated creatinine detected on outpatient testing. Past medical history was significant for intellectual disability, cardiac defibrillator placement in 2010 for ventricular tachycardia that was partially ex-planted in 2017 due to infectious complications, however, a residual ventricular lead was left in place. He had initially presented to an outpatient clinic with hematuria, a petechial rash, generalized weakness and was found to have elevated ANCA titers. He was started on steroids based on symptoms, elevated ANCA titer and rash improved but hematuria and fatigue persisted which prompted a visit to the emergency department. On presentation his vital signs were normal. Cardiovascular exam was remarkable for a new systolic murmur. Labs showed creatinine 4 mg/dl and a positive anti-proteinase 3 ANCA (PR3-ANCA) 26.1 U/mL. His urinalysis revealed microscopic hematuria with >100 red blood cells/ HPF, 2+ protein, no casts, while urine protein creatinine ratio was 3.2. Two sets of blood cultures were positive for staphylococcus epidermidis. He had a vegetation involving the aortic valve on trans-esophageal echocardiography. A kidney biopsy showed acute interstitial nephritis and acute tubular injury, immunofluorescence was negative, electron microscopy was significant for wide spread foot process effacement, negative immune complex deposits. There was no evidence of vasculitis. He was started on antibiotics and underwent replacement of his aortic valve. At the time of discharge his creatinine had decreased and follow-up testing revealed negative ANCA titers.

**Discussion:** ANCA is detected in 18% - 33% of patients with infective endocarditis. Anti-PR3 is the predominant antibody. Most patients test negative for ANCA once the infection resolves. PR-3 positivity does not appear to represent an active vasculitis. This unique case emphasizes the importance of distinguishing infectious etiologies from an auto-immune process to guide appropriate therapy.

PUB056

Use of Polymyxin (PMX) B Cartridge in a Patient With AKI and Septic Shock

Sobia N. Khan,<sup>1</sup> Sandeep K. Mallipattu,<sup>1,2</sup> <sup>1</sup>Stony Brook University, Stony Brook, NY; <sup>2</sup>Northport VA Medical Center, Northport, NY.

**Introduction:** Polymyxin (PMX) B cartridge has been reported to remove endotoxin from the bloodstream and decrease mortality in patients with AKI and septic shock.

**Case Description:** 36-year-old female with HTN and history of opioid use admitted with severe lethargy. Vitals: Tmax 39.6, HR 110, BP 85/58. wbc 12.91, H/H 14.7/49.4, platelets 182, BUN/Cr 45/5.56, Na 138, K 6.5, Hco 17, Ua bland. CXR: bilateral patchy opacities concerning for aspiration pneumonia. CT abdomen/pelvis negative for fracture or hardware complication. Blood cultures negative. She received intravenous fluid, antibiotics, norepinephrine for suspected septic shock in the setting of possible aspiration Pneumonia and was intubated. For acute kidney injury and shock liver required continuous renal replacement therapy and N-acetylcysteine. Screened for septic shock, multiple organ dysfunction score (MODS) above 9 and high endotoxin activity levels (>0.60). She qualified for randomized clinical study [NCT03901807] for comparison of hemoperfusion treatment of cartridge containing polymyxin-B affixed to polystyrene fibers versus standard medical management for sepsis and was randomized to the treatment arm. As per protocol, she received two sessions of 2-hour hemoperfusion treatment 24 hour apart. EAA and hemodynamics monitored. Post treatment, hemodynamics improved, weaned off norepinephrine and oxygen requirement, 100% to 40%. CRRT was discontinued after 2 days. Multiorgan failure improved but no improvement in mental status, attributed to anoxic brain injury secondary to aspiration pneumonia. EEG showed diffuse slowing. MRI brain revealed diffuse hypoxic ischemic encephalopathy. She was discharged from hospital after 3 weeks, to Rehab, was responding to verbal stimuli and would grunt, stayed at rehab for 4 months and with intense therapy, returned to baseline.

**Discussion:** Our patient was a candidate for the study using Polymyxin B hemoperfusion treatment based on MODS > 9 and high EAA (0.62). Her blood cultures were negative. Elevated endotoxin activity likely translocated from the GI tract. Following treatment with PMX, MODS improved from >9 to 5, hemodynamics improved, her FiO2 requirement decreased to 40%, she was weaned off norepinephrine, AKI resolved, and she was off CRRT. PMX cartridge has shown to remove endotoxin from the bloodstream.

PUB057

Impact of Intense Physical Activity in Renal Risk

Henrique S. Sousa, Ana Fernandes, Pedro A. Cruz. Hospital das Forças Armadas, Lisboa, Portugal.

**Background:** Intense physical activity is associated with dehydration and risk of AKI. Army citizens are subjected to intense exercise and it is not well known what happens to their renal function immediately after exercise.

**Methods:** The authors designed a trial to evaluate renal risk immediately after intense exercise, and features associated. Inclusion criteria: Army citizens; Used to do intense physical exercise; Healthy Exclusion criteria: Participants who did not finish the

exercise or who were identified at renal risk before the exercise. Renal risk was defined by a positive result in nephrocheck<sup>®</sup> test. Participants did forced marches (16Km) outside during three hours carrying weight. We evaluated their clinical condition before and after the activity. Moreover, renal function was evaluated by creatinine and nephrocheck previously and after the exercise.

**Results:** 44 subjects enrolled, 41 conclude the exercise and 6 excluded because at renal risk before the exercise. Mean age of the participants was 20±3.5 years, their body mass index was 22.51±1.75. The mean weight each participant had to carry was 37.35Kg. Participant's lost an average of 1.7±0.64 kg, corresponding to a loss of 2.35% of their weight. After the intense physical activity: 13 patients were in renal risk according to nephrocheck; 18 patients had AKI according to KDIGO definition, 8 patients had both AKI and positive nephrocheck. Neither the percentage of lost weight or the % of added weight were associated with increased renal risk.

**Conclusions:** On one hand the population of the study is healthy, fitted, homogeneous, which is unusual in these kind of studies. On the other hand, the sample is small and follow up of the participants was short. We were able to identify 18 subjects in AKI, 8 of whom were identified at renal risk by nephrocheck, which do not allow us to use it straightforward in this population. We think that nephrocheck maybe can be added to renal risk evaluation since a single measurement is worth valuable.

			P value
Weight (mean)	70.4± 7.66	69.05± 7.30	0.11
Hand Grip left	45.6± 10.28	42.25± 15.39	0.03
Hand Grip right	49.7± 10.59	46.25± 16.20	0.03
Hb	13.8± 0.62	14.0± 0.66	0.01
Ur	33.5± 9.24	40± 8.85	0.58
cr	0.81± 0.11	1.16± 0.19	0.29
Glucose	73± 8.31	81± 16.35	0.54
Na	140± 1.37	141± 2.46	0.87
K	4.2± 0.33	4.5± 0.37	0.97
Total Proteins	7.2± 0.33	7.9± 0.38	0.93
Uric acid	5.7± 0.93	6.6± 1.05	0.48
CK	469.5± 263.21	685± 379.65	0.01
Urine density	1025± 2.48	1030± 2.98	0.72
Protein/creatinine	73.15± 29.63	92.7± 40.96	0.17
Nephro check...	0.09± 0.53	0.18± 0.72	

Clinical evaluation of the participants before and after the intense physical activity

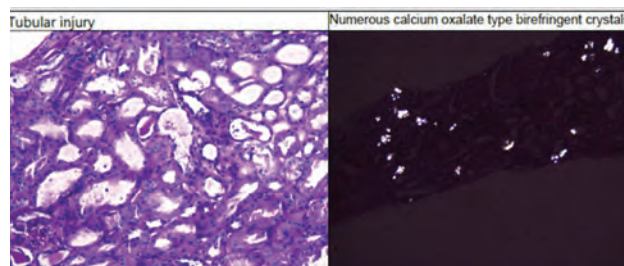
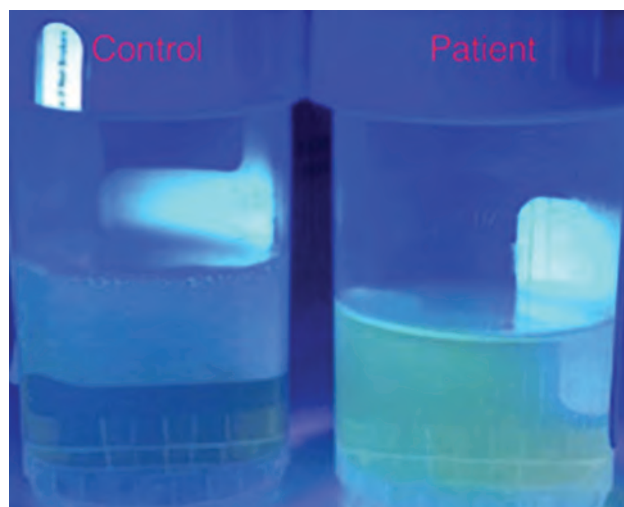

**PUB058**

**He Tried to Get Drunk but Got Dialyzed Instead: A Case of Ethylene Glycol Intoxication**

Safa Moursy, Priyanka Jagannath, Khaled Shawwa. *West Virginia University, Morgantown, WV.*

**Introduction:** Ethylene glycol (EG) is a toxic alcohol found in antifreeze solutions. It's ingested w/ the intent of suicide or inebriation. EG intoxication presents w/ neurologic, pulmonary, cardiac, & renal dysfunction.

**Case Description:** 31 y/o M brought to the ED after found unresponsive. Labs: Na 143, K 7.8, Cl 106, CO2 5, BUN 30 mg/dL, Cr 2.59, Ca 9.6, Phos 10.8, lactic acid 3.8, pH <6.81, pCO2 51, lactate >17.5, serum Osm 346 mOsm/kg. UDS (+): benzos, meth, cannabinoids, & fentanyl. Serum EG levels returned 4 days later at 505.7 mg/L. Urine examined under Wood's lamp was fluorescent. He was started on Fomepizole & HD. Renal biopsy showed diffuse ATN w/ associated calcium oxalate deposition w/in tubular lumens, consistent w/ h/o EG intoxication leading to hyperoxaluria. His renal function gradually improved & returned to normal w/in 2 weeks.

**Discussion:** The harmful effects of EG occur due to accumulation of its toxic byproducts, oxalic & glycolic acid. ADH plays a key role in this process by catalyzing oxidation. An increased osmolal gap is prominent early due to accumulation of unionized alcohols. As metabolism proceeds, osmolal gap decreases w/ formation of ionized metabolites. Conversely, anion gap is lowest before EG is metabolized & increases w/ formation of ionized metabolites. Early recognition of toxic alcohol ingestion is crucial as early treatment w/ antidotes serve as inhibitors of ADH which prevents their metabolism to their toxic end products. HD can be used to remove the parent alcohol & its toxic byproducts. EG has a low molecular weight, high water solubility, low protein binding, & small volumes of distribution, all of which favor rapid removal by ECTR.

**PUB059**

**Tubulointerstitial Nephritis (TIN) in a 36-Year-Old Woman With Crohn Disease and Iritis**

Trey Richardson,<sup>1</sup> Antonette Veronica B. Hernandez,<sup>1,2</sup> William H. Fissell,<sup>1,2</sup> Mark Lusco.<sup>1,3</sup> <sup>1</sup>Vanderbilt University Medical Center, Nashville, TN; <sup>2</sup>Vanderbilt University Division of Nephrology and Hypertension, Nashville, TN; <sup>3</sup>Vanderbilt University Medical Center Department of Pathology Microbiology and Immunology, Nashville, TN.

**Introduction:** TIN is due to infiltration of inflammatory cells into the renal interstitium. TIN is a frequent cause of acute kidney injury (AKI) and is typically due to drugs, infections, or systemic inflammatory conditions including inflammatory bowel disease and tubulointerstitial nephritis with uveitis (TINU). What follows is a patient with a classic presentation of ischemic ATN later found to have TIN on kidney biopsy.

**Case Description:** A 36-year-old woman with Crohn's disease (on ustekinumab & mesalamine), HLA-B27 positivity, RA, and remote history of iritis, presented with 2 months of hematochezia, anorexia, and weight loss. Her Scr was 6.24 mg/dL (baseline 0.7 mg/dL). A UA showed moderate protein, LE, 288 WBCs, 7 RBCs. UPCr was 0.2 mg/g. Serologic work up and SPEP/UPEP were negative. Infectious work up including *C.difficile* testing and urine culture was negative. Her omeprazole was changed to famotidine and her mesalamine was stopped. Her Scr improved to 3.55 mg/dL with volume expansion. Her Scr remained elevated at 2.7-2.9 mg/dL 2.5 months later. Kidney biopsy was pursued and showed TIN with moderate interstitial lymphocytic infiltrate, occasional tubulitis, ATI, interstitial edema, 60% fibrosis. She was started on prednisone 40mg daily which was tapered after 2.5 months due to side effects. Her most recent Scr was 2.1mg/dL.

**Discussion:** Here we present a case of AKI with persistent renal dysfunction initially felt to be the result of ATN. However, her history of iritis prompted a renal biopsy out of suspicion for TINU syndrome. Her biopsy did in fact reveal TIN and initiation of glucocorticoids led to some improvement in renal function. In systematic reviews, TINU syndrome is more common in the pediatric population. Adult presentation is a risk for AKI and progression to CKD. No randomized control trials exist to guide therapy for TIN, however, retrospective studies have suggested early initiation of glucocorticoids is associated with improvement in renal function.

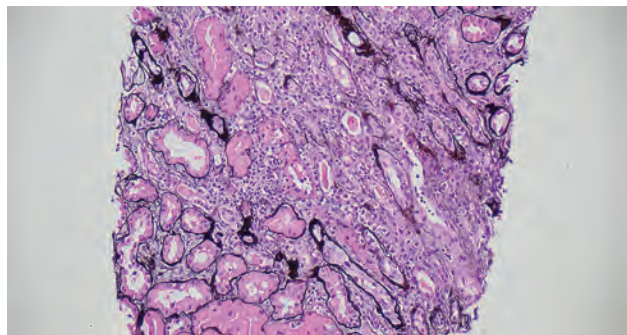

Interstitial infiltrate with tubulitis on silver stain

**PUB060**

**Two Cases of Postpartum Thrombotic Microangiopathy (TMA) Associated With Renal Cortical Necrosis (RCN) Treated With Eculizumab**

Nurit S. Katz, Karim Yatim, Yael Kushner Heher, Reza Zonozi, John Niles, Anushya Jeyabalan. *Massachusetts General Hospital, Boston, MA.*

**Introduction:** Postpartum TMA is a rare potential cause of RCN, often with hemorrhage preceding acute kidney injury (AKI). The utility of complement blockade in this setting is unknown. We describe 2 patients who achieved renal recovery post eculizumab therapy.

**Case Description:** **Case 1:** A 35 y.o woman with history of HTN was admitted for premature rupture of membranes and chorioamnionitis at 31 weeks gestation requiring Caesarean section, complicated by hemorrhagic shock and E. Coli bacteremia. She developed abrupt anuric AKI requiring HD, concurrent microangiopathic hemolytic anemia (MAHA) and low C3 levels. Kidney biopsy revealed severe TMA with RCN (Figure 1). Eculizumab therapy resulted in rapid hematological improvement. After 8 doses of eculizumab, 3 months postpartum, her kidney function improved and both HD and eculizumab therapy was stopped (Table 1). Complement panel was negative. **Case 2:** A 37 y.o woman presented after spontaneous septic abortion at 5 weeks gestation requiring dilation and curettage complicated by significant hemorrhage and abrupt anuric AKI requiring HD. Labs revealed concurrent MAHA and disseminated intravascular coagulopathy (DIC). Contrast CT revealed bilateral RCN (Figure 2). Given ongoing MAHA and AKI, renal TMA was clinically diagnosed. After 2 doses of eculizumab, she had rapid hematological improvement and 4 months postpartum, she had adequate renal recovery to stop HD (Table 1). Functional complement panel showed mild complement dysregulation.

**Discussion:** Postpartum TMA due to alternative complement pathway defects appears to be associated with RCN, a devastating renal complication of pregnancy. Eculizumab, an inhibitor of complement protein C5, may lead to favorable renal outcomes in this population.

Creatinine trends

	baseline Cr	Day of AKI (postpartum day)	Cr on day of dialysis initiation	Cr upon discharge <sup>a</sup> *On iHD	Cr Most recent <sup>b</sup> *Off iHD
Case 1	0.56	1.35 (d4)	9.84 (d8)	5.72	2.19
Case 2	0.65	1.65 (d2)	4.69 (d3)	9.75	2.99

Cr: Creatinine

d: Day post-partum

iHD: Intermittent hemodialysis

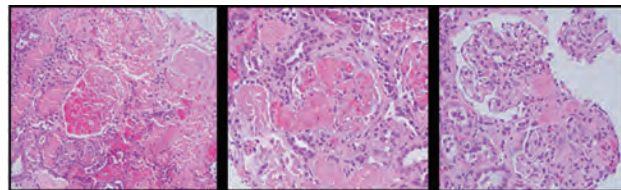

Figure 1: H&E stain (from left to right) show cortical necrosis with glomerular dropout, tubulointerstitial necrosis, glomerular intracapillary fibrin thrombi and fragmented red blood cells occluding capillary loops. Fibrin thrombi of afferent and efferent arterioles in more preserved, viable areas

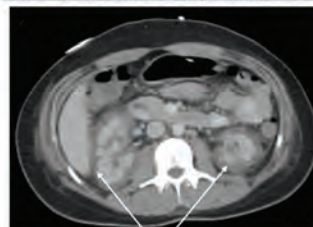

Figure 2: Post-op contrast CT abdomen & pelvis: Diffuse hypodensity of bilateral renal cortex in relation to the medullary pyramids. No hydronephrosis. No stones.

**PUB061**

**Experience of Continuous Renal Replacement Therapy in Critically Ill Patients With AKI: A Single-Center Retrospective Study**

Juan D. Diaz Garcia, Claudia B. López, Irving G. Ramirez, Julio C. Nieto, Pedro Morales Molina, Pamela Prado, Beatriz R. Cerezo Samperio, Abel Humberto V. Compean, Karina Chimbo Lituma, Mario Alamilla Sanchez. *Centro Medico Nacional 20 de Noviembre, Mexico City, Mexico.*

**Background:** Acute kidney injury is a complication of critical patients that has been associated with a high risk of hospital mortality, where identifying modifiable and non-modifiable clinical variables at the start of dialysis that are associated with hospital survival can help, not only in prognosis, but also in clinical classification. Whether this reflects the severity of the disease or is an independent risk factor is unknown.

**Methods:** A descriptive, observational and retrospective study was carried out in patients with acute kidney injury requiring continuous renal support therapy in the intensive care units of a tertiary reference medical center, from January 2013 to March 2022.

**Results:** Of the 136 critically ill patients with acute kidney injury admitted to intensive care units, the mean age was 56.45 ± 19.81 years, with a predominance of men (61%) and the mean SOFA score was 11.8 ± 4.3 (table 1). The indications for CRRT were mainly fluid overload (22%) and acute kidney injury with oliguria and fluid overload (60%). Mean overload-adjusted serum creatinine before the start of CRRT was 3.37 ± 1.18 mg/dl, fluid overload was 12.56 ± 4.45 liters, with a percentage of 13.2 ± 6.4%. The most frequent causes of AKI were shock of any cause (72%) (of these was mainly due to cardiogenic shock (51%)), of the total number of patients, 82% required vasopressor support and 86% invasive mechanical ventilation, the most common modality of CRRT being continuous venovenous hemodiafiltration (CVVHDF) (72%). The incidence of overall survival was 27%.

**Conclusions:** The results of our study suggest that acute kidney injury in patients undergoing continuous renal replacement therapy presents a high risk of in-hospital death. This increased risk cannot be explained solely by a more pronounced severity of the disease. Our results provide strong evidence that acute kidney injury presents a specific and independent risk factor for poor prognosis.

Variable	n=136 (total) mean ± SD	n=36 (survivor) mean ± SD	n=100 (non survivor) mean ± SD	p
Age (years)	56.45 ± 19.81	54.34 ± 17.15	58.12 ± 18.56	0.181
Male/female, n	83/53	22/14	61/39	0.094
Intubated, n(%)	117 (88)	17(47)	100 (100)	0.001
Vasopressor, n (%)	112 (82)	19 (52)	93 (93)	0.605
Fluid overload CRRT initiation, (%)	13.2 ± 6.4	5.2 ± 3.9	15.1 ± 7.2	0.004
SOFA	11.8 ± 4.3	6.7 ± 2.2	13.1 ± 5.1	0.04
Serum creatinine adjusted for overload (mg/dl)	3.37 ± 1.16	3.41 ± 1.21	2.86 ± 1.11	0.134
Effluent dose (ml/kg/hr)	26.94 ± 12.34	26.14 ± 10.21	30.87 ± 11.31	0.083

PUB062

**Mucormycosis of the Lung and Kidney Presenting as Drug Induced Vasculitis**

Mohamed Hassanein,<sup>1</sup> Tarek Ashour,<sup>2</sup> Jane K. Nguyen,<sup>2</sup> Sevag Demirjian,<sup>2</sup>  
<sup>1</sup>University of Mississippi Medical Center, Jackson, MS; <sup>2</sup>Cleveland Clinic, Cleveland, OH.

**Introduction:** Mucormycosis (MM) is a rare opportunistic, angio-invasive infection most commonly caused by *Rhizopus* species. Infection spreads through spore inhalation or wound inoculation to multiple organs including lungs, paranasal sinuses, brain, skin and rarely to the kidneys. We report a case of MM of the lung and kidney presenting as drug induced vasculitis.

**Case Description:** A 79-year-old gentleman with a history of coronary artery disease, hypertension (on hydralazine), heart failure and atrial fibrillation was transferred to our hospital for management of acute hypoxic respiratory failure and bronchoalveolar hemorrhage secondary to antineutrophil cytoplasmic antibody (ANCA) vasculitis. He received intravenous steroids for 10 days before being admitted to our hospital. Labs on admission showed creatinine 1.7 mg/dL (reference range 0.73 – 1.22 mg/dL), blood urea nitrogen 81 mg/dL (reference range 9 – 24 mg/dL), glucose 214 mg/dL (reference range 74 – 99 mg/dL), and white blood cell count 27 k/uL (reference range 3.7 – 11 k/uL). Urinalysis showed 3+ blood and 11-25 red blood cells per high power field. Computed tomography (CT) of the chest showed ground glass opacities suggestive for diffuse alveolar hemorrhage and two cavitary lesions in the right lung. Serological workup showed positive myeloperoxidase (MPO) ANCA, anti-nuclear antibodies (ANA) and anti-histone antibodies suggestive for drug induced vasculitis. Kidney biopsy showed tubulointerstitial and vessel wall invasion with fungal hyphae suggestive for *Mucorales* with negative immunofluorescence and no evidence of glomerulonephritis. He was started on amphotericin B but eventually transitioned to comfort care measures. Autopsy results showed disseminated MM involving the lungs, right kidney and right ureter.

**Discussion:** MM of the native kidneys is extremely rare. Risk factors include immunosuppression, diabetic ketoacidosis, disrupted skin barrier, and iron overload. Spore inhalation or direct skin inoculation leads to angioinvasion, dissemination, and multi-organ failure. We present a case of MM of the lung and kidney presenting as drug induced vasculitis. Albeit rare, MM should be considered in the differential diagnosis of hemoptysis and kidney failure. Biopsy is imperative to avoid unnecessary immunosuppression which could be fatal in such cases.

PUB063

**Safety and Diagnostic Yield of Protocolized Percutaneous Kidney Biopsies in Mechanically Ventilated Patients With AKI**

Christopher Estiverne, Gearoid M. McMahon, David B. Mount, Giada Bianchi, Helmut G. Rennke, Peter G. Czarnecki. *Brigham and Women's Hospital, Boston, MA.*

**Introduction:** Ultrasound-guided percutaneous kidney biopsy and renal histopathology remain the gold standard in the differential diagnosis of kidney disorders. However, kidney biopsies are rarely considered in patients in the ICU, and even less in intubated and mechanically ventilated patients. We sought to establish a protocol for kidney biopsies in mechanically ventilated patients, utilizing ICU resources to manage patient-related procedural risks.

**Case Description:** We designed a protocol, involving deep sedation, neuromuscular blockade and prone positioning of the patient. Percutaneous ultrasound-guided kidney biopsy is performed during an inspiratory pause maneuver on the ventilator, minimizing diaphragmatic motion. We approached the families of 11 mechanically ventilated patients with AKI, in whom biopsy was deemed necessary, with 7 families consenting to the procedure. 5/7 patients were already on renal replacement therapy (RRT) on day of biopsy. 6 biopsies revealed acute tubular necrosis (ATN) in different histopathological contexts: 3/6 patients had ATN with no other pathologic findings, one patient had coexisting interstitial nephritis, one had minimal change glomerulopathy resulting in ATN, and one had severe TMA leading to cortical necrosis. Another patient had no ATN, but severe arteriolar sclerosis and chronic thrombotic microangiopathy (TMA). Perinephric hematomata were detectable in 6/7 biopsied patients. Except in one patient, the extent of perinephric hematoma did not correlate with the need for additional postprocedural imaging studies or transfusion requirement. In all biopsied patients, the pathologic diagnosis led to a change in management, either through the initiation of new therapies, through discontinuation of existing therapies, or through readdressing the goals of care.

**Discussion:** Our experience demonstrates that kidney biopsies in carefully selected patients in the ICU with AKI yield highly informative histopathologic diagnoses resulting in important management decisions in all examined cases. Of the 7 patients biopsied, 6 patients eventually recovered and no longer required RRT. We conclude that in a high-risk population, a protocol like ours may optimize procedural conditions and complication management.

PUB064

**Riboflavin Excretion as a Functional Biomarker of Renal Tubular Secretion**

Valentina Sedlacek,<sup>1</sup> Martin Sedlacek,<sup>2</sup> <sup>1</sup>University of Rochester, Rochester, NY; <sup>2</sup>Icahn School of Medicine at Mount Sinai, New York, NY.

**Background:** Nutritional yeast is a health food widely used in vegetarian and vegan diets that contains exceptionally high amounts of Riboflavin (vitamin B1). Riboflavin is excreted by renal tubular secretion. Here we use nutritional yeast to investigate if riboflavin could be a practical functional marker of renal tubular secretion.

**Methods:** We collected and examined urine before and after a meal containing nutritional yeast.

**Results:** Figure 1: Urine before and after a meal containing nutritional yeast with riboflavin highlighted by yellow fluorescence. This simple experiment demonstrates that riboflavin is detectable by fluorescence.

**Conclusions:** In the kidney riboflavin is filtered and both reabsorbed and secreted in the proximal tubule with secretion predominant on a normal diet. Riboflavin transport has been demonstrated in MDCK cells and hence might occur also in the distal tubule. Secretion is subject to competitive inhibition by probenecid, suggesting that organic anion transporters are involved. The measured renal clearance of riboflavin in humans is 570-680ml/min/1.73m<sup>2</sup>, several fold higher than GFR, because of secretion. Because of protein binding, free riboflavin excretion rate exceeds RBR. Riboflavin and its metabolites can be detected by spectrophotometry around 450nm at concentrations as low as 0.3 ppm. A study of the natural fluorescence of human urine with normal renal function and with CKD showed that at the range of 450nm there are no other potentially interfering endogenous substances. Tubular secretion of riboflavin is an active tubular process, while accumulation of creatinine is a passive process with changes detectable only after a time delay. Thus, urine riboflavin excretion could serve as a functional biomarker of the state of the renal tubule in various conditions, such as ATN and other forms of AKI, quantifiable by simple spectrophotometry, thanks to the fluorescent properties of riboflavin.

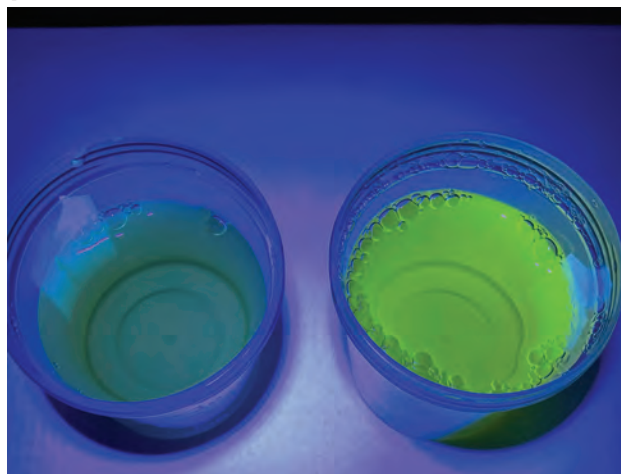

Riboflavine visualized by yellow fluorescence under Woods light.

PUB065

**A Study of Clinical Characteristics and Outcomes of Patients With AKI Hospitalized in a Tertiary Care Centre in South India**

Prafull B. Chege, Manjusha Yadla. *Gandhi Hospital Gandhi Hospital, Secunderabad, India.*

**Background:** Acute kidney injury (AKI) is a major public health concern, associated with high mortality. More than 85% of the global burden of AKI is from developing countries. AKI in developed countries tends to affect elderly patients with comorbidities, and result in higher mortality rates. The proportion of community acquired AKI is more and most often a single reversible factor such as infection, toxin, volume depletion, or drugs might be responsible. AKI is common in critical care units and is a major factor contributing to adverse outcomes. In this Study, KDIGO criteria is used for the diagnosis of AKI.

**Methods: Patients and Methods:** This retrospective study with 859 AKI patients, admitted at Gandhi Hospital, Secunderabad, from January 2020 to April 2022 at having a serum creatinine level greater than 1.4 mg/dl and blood urea greater than 40 mg/dl. The AKI patients aged less than 18 years at the time of enrollment and ultrasound evidence of bilaterally small kidneys suggestive of chronic renal failure were excluded from the study. **Study design:** This is Observational Retrospective study.

**Results:** A total of 859 Patients were included in this Study and Analysis includes clinical profile, epidemiological data, lab parameters and outcomes.

**Conclusions:** Sepsis was most common cause for Acute Kidney Injury. Decreased urine output was most common presenting symptom followed by fever breathlessness. Patients recovered completely were 30.15%, Partially recovered 27.7% and CKD in 9.20%. Out of 859 Patients 576 (67.05%) Survived and 139(16.18%) died. Factor affecting mortality were age, thrombocytopenia and Patients on vasopressors.

Table 7: Etiologies of acute kidney injury

Etiology	Frequency	Percentage
Cardiac	41	47.83
Drug/Medication	39	45.40
Celestis	91	10.59
Central nervous system	39	45.54
Polymia	113	13.15
ICU	91	10.59
Septic	229	26.78
Cardiogenic shock	31	36.21
Fracture femur	3	0.35
Glomerulonephritis	87	10.13
Glomerulonephritis	18	2.10
Metabolic	28	3.27
Obstructive uropathy	91	10.59

Table 8: Characteristics of survivor's versus nonsurvivors

Characteristic	Survivors (n=576)	Nonsurvivors (n=139)	P
Age	53.94(18.22)	53.94(18.22)	0.81
Creatinine	3.29(4.39)	3.29(4.39)	0.87
Urea/creatinine	33.04(42.27)	33.04(42.27)	0.24
Positive sepsis	1.56(6.95)	1.56(6.95)	0.82
Arterial thrombosis	32.22(55.7)	32.22(55.7)	0.94
Yeast/psoriasis	32.55(56.5)	32.55(56.5)	0.83

Conclusion:  
 Sepsis was most common cause for Acute Kidney Injury.  
 Decreased urine output was most common presenting symptom followed by fever breathlessness.  
 Patients recovered completely were 30.15%, Partially recovered 27.7% and CKD in 9.20%.  
 Patients recovered completely were 30.15%, Partially recovered 27.7% and CKD

Key: TH - Thursday; FR - Friday; SA - Saturday; OR - Oral; PO - Poster; PUB - Publication Only

Underline represents presenting author.

Lab Parameters	Reference Range
WBC	7.8
Hemoglobin	14.8
Hematocrit	43.2
Platelets	20900
Protein	7.8800

Treatment Modality	Start Date	End Date
Acute HD	1	10/18
Intermittent HD	12	18/18
Hemodialysis	19	22/18

Survival	Timepoint	Survival
Survival	7.5	8/10
Survival	7.5	11/11
Non Survival	14	15/15

**PUB066**

**Clinically Diagnosed Bile Cast Nephropathy in a Patient With Severe Alcoholic Hepatitis and COVID-19 Pneumonia**  
 Gaoyuan Huang, Winston Lee, Adel S. El-Hennawy, Elena Frolova. *New York City Health and Hospitals Coney Island, Brooklyn, NY.*

**Introduction:** Bile cast nephropathy (BCN) has been underreported and there are no established treatment guidelines. Renal biopsy is the gold standard for diagnosis but could be a challenge in some situations. BCN in patients with COVID-19 has not been reported. We present a case of clinically diagnosed BCN in an alcoholic patient with COVID-19 pneumonia.

**Case Description:** A 47-year-old Caucasian man with a history of fatty liver and alcohol abuse (last drink was 4 days before admission, baseline bilirubin was normal) presented with unsteady gait and tremors. He was fully oriented on admission. ALT/AST 123/352 U/L, Total bilirubin(TB)11.5mg/dl, direct bilirubin(DB) 8.5mg/dl, albumin 3.1g/dl, INR 1.4, normal WBC and PLT. Scr normal. Urine analysis(UA) showed large bilirubin but no cast. COVID-19 pneumonia existed. Hepatitis B and C negative. Abdominal ultrasound and CT ruled out liver cirrhosis, portal hypertension or ascites. MRCP excluded biliary duct obstruction. Dexamethasone was given for 10 days. However, TB and DB further trended up to 21.8/>10 mg/dl (figure 1) while ALT and AST went down to 7/106 U/L. Mental status altered with ammonemia and INR 1.9. UA showed large bilirubin, moderate bilirubin casts, no proteinuria or hematuria, no bacteria. Meanwhile, Scr rapidly increased to 6.73mg/dl. The patient started hemodialysis(HD) and was intubated. Renal biopsy was suspended due to his unstable condition. TB began trending down on day 34, accompanied by decreasing urine bilirubin casts. Renal function subsequently improved with increasing urine output and was finally normalized. The patient was extubated later.

**Discussion:** Albumin and fluid challenge failed; prerenal azotemia was excluded. The absence of portal hypertension or ascites made hepatorenal syndrome less likely. Despite the lack of renal biopsy, the temporal coherence between severe hyperbilirubinemia, urine bilirubin casts and acute renal injury(AKI) strongly favored the diagnosis of BCN. Additionally, concurrent COVID infection may exacerbate hyperbilirubinemia and AKI.

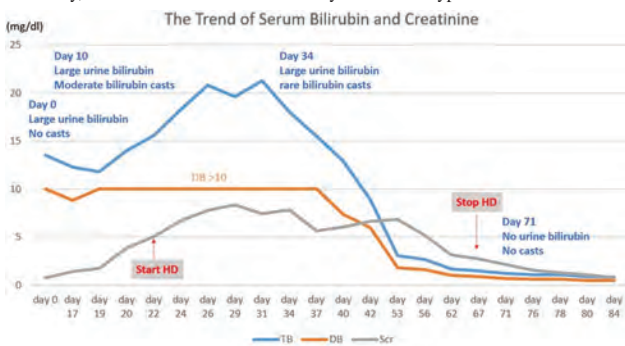

**PUB067**

**Massive Rhabdomyolysis in the Setting of Influenza A Infection Requiring Renal Replacement Therapy**  
 Aisha Batool,<sup>1,3</sup> Shahzad Chaudhry,<sup>3</sup> Muneeba Sarosh,<sup>2</sup> Muhammad A. Omar,<sup>4</sup> Sarah E. Simon.<sup>6</sup> <sup>1</sup>Medical College of Wisconsin, Milwaukee, WI; <sup>2</sup>Ascension Columbia St Mary's Hospital Milwaukee, Milwaukee, WI; <sup>3</sup>Aurora Health Care, Milwaukee, WI; <sup>4</sup>TidalHealth Nanticoke, Seaford, DE; <sup>5</sup>Ascension Columbia St Mary's Hospital Milwaukee, Milwaukee, WI; <sup>6</sup>Midwest Nephrology Group, Milwaukee, WI.

**Introduction:** Rhabdomyolysis can range from an asymptomatic illness to severe muscle breakdown leading to Acute Renal Failure which can be life threatening. Massive rhabdomyolysis is defined as Creatine Kinase Level greater than 50,000 u/L. Acute renal failure in these patients can sometimes require renal replacement therapy in spite of aggressive fluid resuscitation.

**Case Description:** Our patient is a 36-year-old black male who presented to the Emergency Room with flu-like symptoms and generalized body aches. He tested positive for influenza A and also had massive rhabdomyolysis with serum Creatine Kinase level 1,358,480 u/L. He had overt uremic symptoms with azotemia and serum creatinine level of 7.9 mg/dl. He was profoundly hypocalcemic with a serum calcium level of 4.2 g/dl.

He was transferred to the Intensive Care Unit and Continuous Venovenous Hemodialysis was initiated. He was eventually switched to intermittent hemodialysis and had full renal recovery in 6 weeks.

**Discussion:** Rhabdomyolysis is defined as breakdown of striated muscle fibers and release of large quantities of intracellular contents into plasma and extracellular compartment. Influenza virus being implicated in nearly 33% of known Viral-induced rhabdomyolysis. Acute Renal Failure is the most serious complication of rhabdomyolysis and develops in almost 33% of patients. Acute Renal Failure is the result of accumulation of nephrotoxic pigment myoglobin alongwith hypovolemia that leads to renal hypoperfusion. Mainstay of treatment remains early and aggressive fluid resuscitation alongwith correction of electrolytes. Early dialytic treatment in these patients allows not only to avoid life-threatening complications, moreover it's a pathogenetic treatment by removal of a great amount of myoglobin. This case is a reminder for clinicians to expect rhabdomyolysis in viral illnesses. Depending on the severity of disease, prognosis is overall good, mostly patients recover from it with less permanent damage.

**Graphical Description of Creatine Kinase and other Laboratory Parameters during hospital stay**

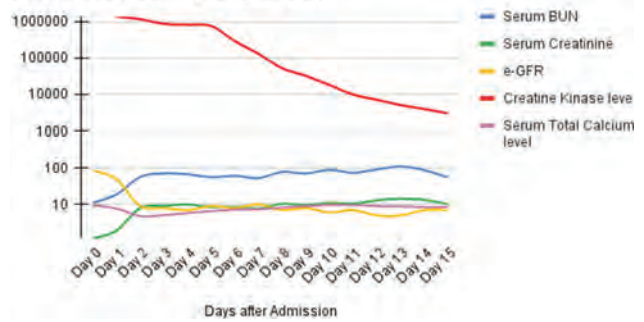

**PUB068**

**Microscopic Polyangiitis Presenting as Diffuse Alveolar Hemorrhage**  
 Stephanie Rothweiler,<sup>1</sup> Shiguang Liu,<sup>2</sup> Raafat F. Makary,<sup>2</sup> Alaa S. Awad.<sup>1</sup> <sup>1</sup>University of Florida, Jacksonville, FL, Jacksonville, FL; <sup>2</sup>University of Florida Jacksonville Department of Pathology and Laboratory Medicine, Jacksonville, FL.

**Introduction:** Microscopic Polyangiitis (MPA) is a rare vasculitis with devastating complications leading to multiorgan failure.

**Case Description:** We present a case of a 39-year-old male with history of hypertension, and tobacco use was admitted for acute renal failure and respiratory failure. Serology was significant for hemoglobin 3.1 gm/dl, creatinine of 12.70 mg/dl. Urine studies significant for hematuria and proteinuria. Chest imaging showed extensive bilateral infiltrates predominantly in the bases consistent with diffuse alveolar hemorrhage (DAH) associated with hemoptysis. He was intubated and started on continuous renal replacement therapy. Therapeutic plasma exchange (TPE) was initiated immediately for 6 sessions in addition to pulse steroids with improvement of respiratory function; but not renal function. Renal biopsy immunofluorescence revealed pauci-immune complex crescentic glomerulonephritis, acute tubular injury with marked acute interstitial nephritis, and mild arterial and arteriolar sclerosis. Anti-myeloperoxidase antibody level of >100 U/ml, positive P-ANCA titer (1:320) consistent with MPA. Induction immunosuppressive therapy was initiated. He was extubated and transitioned to intermittent hemodialysis. The patient demonstrates no long-term sequelae of DAH, however, remains on long-term intermittent hemodialysis, steroids and rituximab as he developed hemorrhagic cystitis from Cytosax.

**Discussion:** MPA is an acknowledged cause of diffuse alveolar hemorrhage, but is observed in less than a third of cases (1). We present a case with DAH as the presenting feature of vasculitis associated with renal failure which are more commonly observed. Vasculitis with DAH and renal failure often leads to a fulminant disease course (2). Other metrics have been validated as poor prognostic factors including a history of cardiovascular disease, tobacco use, mechanical ventilation, age >60 years, and shock (3). Our patient met all parameters aside from age. Despite presenting critically ill with multi-organ failure and poor prognosis, his clinical course was likely shifted due aggressive management with TPE and prompt immunosuppressive therapy; but remains on dialysis.

**PUB069**

**Severe AKI in a Patient With G6PD Deficiency and Acute Hepatitis A Infection**  
 Wid Yaseen,<sup>1</sup> Jonathan S. Zipsky,<sup>1,2</sup> Bourne L. Auguste.<sup>1,3</sup> <sup>1</sup>University of Toronto Temerty Faculty of Medicine, Toronto, ON, Canada; <sup>2</sup>Division of Clinical Pharmacology and Toxicology, Sunnybrook Health Sciences Centre, Toronto, ON, Canada; <sup>3</sup>Division of Nephrology, Sunnybrook Health Sciences Centre, Toronto, ON, Canada.

**Introduction:** Hepatitis A virus (HAV) is a vaccine-preventable infection that classically causes mild illness. Less than 1% of patients with acute HAV develop fulminant liver failure, and those with comorbidities are at increased risk.



**Case Description:** A 25-year-old male presented to a community hospital with a 1-week history of fevers, night sweats, 4kg weight loss, and dark urine. Past medical history included sickle cell trait and he was not taking any medications. He returned from a 1-month trip to India 5-days prior to symptom onset. On presentation, he was afebrile and skin was jaundiced with icteric sclera. Abdominal exam showed palpable hepatomegaly. Bloodwork revealed hemoglobin 70g/L, WBC 84x10<sup>9</sup>/L (5x10<sup>9</sup>/L blasts and significant neutrophilia), creatinine 267μmol/L, lactate 5.9mmol/L, ALT 3,538, ALP 99, total bilirubin 784, LDH 10,000U/L, and undetectable haptoglobin. Given the blasts noted on peripheral smear, the patient was suspected to have acute leukemia, and an infectious and autoimmune work up was also sent. He was transferred to our hospital for management. Repeat peripheral blood film revealed spherocytes without increased blasts, and flow cytometry was consistent with a leukemoid reaction. Coomb's test was negative. The patient had rapid clinical deterioration requiring hemodynamic support in the ICU. He developed oligoanuric acute kidney injury (AKI) and renal replacement therapy was initiated. Urinalysis at that time showed bile pigmented casts and no other microscopic signs of glomerular injury. A diagnostic work up revealed hepatitis A IgM antibodies and a positive glucose-6-phosphate dehydrogenase (G6PD) deficiency screen. The patient was treated supportively and had dramatic clinical improvement with complete recovery in hepatic and renal function over the next weeks.

**Discussion:** The presentation of severe AKI, hyperbilirubinemia, and bile casts was highly suggestive of bile cast nephropathy, an uncommon cause of acute tubular necrosis. The patient's enzymopathy and acute HAV resulted in fulminant liver failure and severe oxidative hemolysis, leading to direct nephrotoxicity and renal tubular ischemia from systemic hypoperfusion. Although rare, clinicians should recognize bile cast nephropathy as an important mechanism of AKI. Prompt recognition allows for early identification of the cause of liver dysfunction and prevention of further renal injury.

**PUB070**

**A Case of Hydralazine Induced c-ANCA Associated Vasculitis**

Nimit Dalal,<sup>1</sup> Ankur Shah,<sup>2</sup> Harshil Fichadiya,<sup>3</sup> <sup>1</sup>Western Reserve Health Education, Warren, OH; <sup>2</sup>Brown University, Providence, RI; <sup>3</sup>Monmouth Medical Center, Long Branch, NJ.

**Introduction:** The incidence of drug induced vasculitis in long term hydralazine users is estimated at 10 percent. The most frequent manifestation is kidney sparing drug induced lupus. A rarer, more severe manifestation is that of drug induced anti neutrophil cytoplasmic antibody (ANCA) associated vasculitis (AAV). We report a case of hydralazine induced AAV presenting with acute renal failure.

**Case Description:** A 75-year old male with PMH of stage 3b chronic kidney disease, diabetes mellitus and hypertension was admitted for evaluation of acute kidney injury. 14 months prior, hydralazine had been prescribed for HTN (200 mg daily). Admission serum creatinine(Cr) was 4.9 mg/dL. Urinalysis and sediment examination were notable for hematuria, proteinuria, dysmorphic red blood cells, and hyaline casts. Serology is summarized table 1. Renal biopsy showed pauci-immune necrotizing and crescentic glomerulonephritis, with 2 out of 38 glomeruli displaying active necrotizing cellular crescents. Dual positivity of ANCA and ANA along with microscopic findings of glomerulonephritis led to a diagnosis of drug induced AAV. Hydralazine was discontinued. Methylprednisone 1 g daily for 3 days was prescribed followed by taper. 4 doses of rituximab were given. 3 months later, creatinine stabilized to 2.8 mg/dL.

**Discussion:** Hydralazine induced vasculitis is an underappreciated cause of autoimmune disease; the commoner drug induced lupus in about 10% of patients, and the less common but more severe AAV seen here. The incidence, risk factors, optimal management and long term outcomes are yet to be determined. Management of drug induced lupus and drug induced AAV include different immunosuppression regimens, and knowledge of these complications is critical.

ANA Homogeneous pattern	≥1:280
ANA confirmation	Positive
c-ANCA antibody	1:180
p-ANCA antibody	Negative
Anti myeloperoxidase	91.8
Complement C3	60
Complement C4	14.1

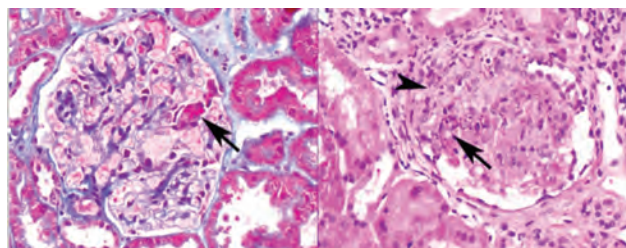

Focal and segmental necrosis (left), cellular crescents and karyorrhexis (right)

**PUB071**

**Vancomycin Induced Leukocytoclastic Vasculitis With AKI**

Sara Alattal, Si Yuan Khor, Amira S. Kamboj. Michigan State University, East Lansing, MI.

**Introduction:** Leukocytoclastic vasculitis (LCV) is a small vessel hypersensitivity vasculitis (SVHV). Vancomycin has the potential to cause different types of immune-mediated hypersensitivity reactions, however, vancomycin-associated LCV (VA-LCV) cases are rare. We present a case of VA-LCV with worsening acute kidney injury (AKI) that improved on discontinuation of vancomycin.

**Case Description:** 45-year-old male patient with diabetes, atrial fibrillation, and ischemic cardiomyopathy presented with left foot pain for 3 days. There were no fevers or chills. Vitals were stable. Physical exam revealed a 4\*4 cm ulcer of the 4th toe and erythema of left foot. Labs were Cr 1.05 (baseline Cr 0.7), BUN 20, WBC 10.9 and ESR 96. MRI of the left foot demonstrated osteomyelitis of the 4th distal and middle phalanges. He was started on cefepime, a day later vancomycin was introduced. Over 24 hours of starting vancomycin he developed a maculopapular rash over bilateral upper and lower extremities. AKI worsened with Cr of 1.26. Punch skin biopsy of the rash showed perivascular and interstitial neutrophilic infiltrate with numerous nuclear dusts, the papillary dermis showed extravasated erythrocytes/microhemorrhage, most consistent with LCV. ANA was negative. Vancomycin was discontinued with resolution of rash and improvement of AKI.

**Discussion:** LCV is a rare SVHV with incidence of 15 cases/million/year<sup>1</sup>. LCV is usually confined to the skin with rare extracutaneous manifestations in less than 30% of cases<sup>2</sup>. When present, extracutaneous manifestations usually involve kidneys, joints and gastrointestinal tract. Reported renal involvement includes an increase in creatinine, tubulointerstitial nephritis and acute renal failure<sup>1</sup>. Different etiologies include medications, infections and malignancies. Compared to other drug induced LCV incidence, VA-LCV cases with involvement of the kidneys are rare. Onset of VA-LCV ranges from within 24hrs to as late as 1 month after drug initiation. Diagnosis is made with punch skin biopsy. Most cases are self-limited and resolve with withdrawal of vancomycin and recovery time ranges from days to weeks<sup>3</sup>. In our patient, the temporal timing between initiating vancomycin and appearance of the rash and increase in creatinine level strongly suggests that the LCV was related to vancomycin. This is further supported by the resolution of rash and AKI following cessation of vancomycin.

**PUB072**

**Histopathology of Adult Minimal Change Disease Comparing Those With AKI of Differing Stages to Those Without**

Hillary Grainer,<sup>1</sup> Maria V. DeVita,<sup>1</sup> Vanesa Bijol,<sup>2</sup> Jordan L. Rosenstock,<sup>1</sup> <sup>1</sup>Lenox Hill Hospital, New York, NY; <sup>2</sup>Northwell Health, New Hyde Park, NY.

**Background:** Minimal change disease (MCD) in adults is associated with acute kidney injury in approximately 25% of cases. The pathophysiology of AKI associated with MCD is unclear but is associated with acute tubular injury (ATI) and interstitial edema in many cases. It is not clear if the severity of AKI in MCD correlates with pathologic findings.

**Methods:** We retrospectively reviewed biopsy proven MCD cases from our institution over the last 3 years. Patients less than 18 years of age, those who received kidney transplants, those whose baseline Cr could not be obtained and those with secondary causes of MCD were excluded. We stratified AKI cases based on KDIGO AKI staging and evaluated pathological characteristics including presence and extent of injury, as well as presence of interstitial inflammation.

**Results:** The total number of patients meeting criteria was 61. Those with AKI totaled 16(26%). Based on KDIGO staging 6 patients were stage 1, 7 stage 2 and 3 stage 3. Among patients with AKI, ATI was confirmed in 10/16(63%). Of these, mild ATI was seen in 8(50%) moderate in 2(12%) and no cases of severe ATI. Among those with stage 1 AKI, 3(50%) had mild ATI, 1(17%) had moderate ATI. Among those with stage 2 AKI, 4(57%) had mild ATI, 3 (43%) had no ATI. Among those with stage 3 AKI, 1(33%) had mild ATI and 2(67%) moderate. Those without AKI totaled 45(74%). Among these cases, ATI was present in 14/45 (31%). Mild ATI was seen in 13(29%) and moderate ATI in 1(2%). Interstitial nephritis and edema were noted in three cases overall.

**Conclusions:** The majority of MCD patients with AKI had ATI and this was significantly more common than those without AKI (p=0.027), supporting that ATI is a mechanism of AKI in MCD. The severity of AKI did not clearly correspond with the severity of ATI in this small population, though 2/3 cases with stage 3 AKI had moderate ATI and interstitial nephritis.

**Funding:** Private Foundation Support

		Pathology		
		Mild ATI	Moderate ATI	No ATI
Clinical	AKI KDIGO Stage			
	1 (n=6)	3(50)	1(16)	2(33)
	2 (n=7)	3(42)	0(0)	4(57)
	3 (n=3)	1(33)	2(66)	0(0)
	All AKI (n=16)	7(44)	3(19)	6(38)
	Non-AKI (n=45)	13(28)	1(2)	31(69)

n(%)

**PUB073**

**A Unique Case of Daptomycin Induced Myoglobinuria and AKI With Normal Creatinine Phosphokinase Level**

Brian Monk, Melinda M. Talley, Mohammad Atari. *University of Mississippi, Jackson, MS.*

**Introduction:** Myoglobinuria is the presence of excessive amount of myoglobin in the urine. Most cases are induced by a traumatic or non-traumatic muscle injury that releases myoglobin into the blood and then is filtered by the kidneys. Large amounts of myoglobin can cause acute kidney injury (AKI). Myoglobinuria is usually associated with elevated creatinine phosphokinase (CPK) serum levels. Daptomycin is associated with elevated CPK and an increased risk of rhabdomyolysis. We report on a unique case of daptomycin-induced myoglobinuria and AKI with normal CPK levels.

**Case Description:** A 73-year old man was admitted for the management of an infected diabetic foot ulcer. Initial evaluation was notable for fever and hypovolemic AKI which improved with intravenous fluids (IVF). Empiric treatment with vancomycin and cefepime was started. Antibiotics were deescalated to daptomycin after blood cultures grew *methicillin-resistant Staphylococcus aureus* (MRSA) and *Staphylococcus epidermidis*. An echocardiogram showed no vegetation. Initially, CPK was 302 U/L and creatinine was 0.88 mg/dL. Forty-eight hours after starting daptomycin, creatinine increased without major electrolyte abnormalities. Renal ultrasound was unremarkable. Urine analysis was positive for red blood cells (RBCs) and myoglobin. CPK level was normal at 106 U/L. Fractional excretion of sodium was <1%. The patient was euolemic. Urine microscopy showed numerous intact RBCs and fine granular casts, no white blood cells or RBCs casts, and no dysmorphic RBCs. The patient declined a kidney biopsy. Daptomycin was switched to vancomycin and IVF was initiated. Twenty-four hours after stopping daptomycin, creatinine stabilized and started to improve the following day.

**Discussion:** Daptomycin-induced rhabdomyolysis is one of the rarely encountered side effects of daptomycin administration and is reported in ~5% of patients. Severe myocyte injury resulting in rhabdomyolysis secondary to daptomycin is usually accompanied by muscle weakness and pain, elevated serum CPK, and myoglobinuria. Regular CPK checks and monitoring for myopathy are recommended. As emphasized in this case, myoglobinuria and renal failure can still happen with normal CPK levels. To the best of our knowledge, this is the first reported case describing daptomycin-induced myoglobinuria and AKI without an elevation in CPK serum levels.

**PUB074**

**Interlobar Pseudoaneurysm With Gross Hematuria 10 Days After Kidney Biopsy**

Victor A. Canela, Roberto L. Collazo-Maldonado. *Methodist Dallas Medical Center, Dallas, TX.*

**Introduction:** Kidney biopsy remains the gold standard for the diagnosis of kidney pathologies. The procedure is simple, well tolerated and relatively safe. In the last fifteen years and for a variety of reasons, nephrologists have been doing less biopsies in favor for interventional radiology. Bleeding is a rare but important complication of biopsies. Bleeding complications include need for blood transfusion, radiology procedures to control the bleeding and even nephrectomy. Pseudoaneurysm formation are relatively rare with an incidence of <0.01%. Nephrologists, clinicians and interventionists should be aware of these complications occurring after biopsies. This case highlights a patient with gross hematuria ten days after the initial kidney biopsy.

**Case Description:** A 58 y/o AA man with history of DM2, HTN and CKD IV presented with worsening left flank pain and gross hematuria. He had undergone a left kidney biopsy ten days prior due to worsening kidney function. Medication list included torsemide, bicarbonate and amlodipine. On physical exam he was afebrile with BP 197/91 and HR of 87 bpm. There is significant left flank pain and an intact PD catheter on the LLQ. Hb was 8.9 g/dl, platelets 287x10<sup>3</sup>/UI, K 4.8 mmol/L, BUN was 51 mg/dl, Cr 8.40 mg/dl. INR 1.1 IU and aPTT 25 sec. A CTA showed active extravasation/pseudoaneurysm in the mid pole of the left kidney, there was also edema and inflammatory changes around

the left kidney. He received 1 unit of blood transfused and underwent a successful embolization of the left interlobar artery branch that was feeding the pseudoaneurysm.

**Discussion:** Complications after kidney biopsy are rare and infrequently encountered. Factors such as advance kidney disease and uremic platelet dysfunction, increase the chances of parenchymal bleeding after the procedure. Pseudoaneurysm reports account for less than 0.01% of the total complications. We presented a case of gross hematuria and pseudoaneurysm ten days after a kidney biopsy. This case highlights the importance of Nephrologists and clinicians to recognize the possible complications occurring late after a biopsy. By early recognition, appropriate therapies can be implemented, and better outcomes can be achieved.

**PUB075**

**Drug Induced Obstruction? A Case of Ketamine Induced Uropathy**

Latoya N. Gayle, Sylvia Wu, Nathaniel Berman. *NewYork-Presbyterian Hospital/Weill Cornell Medical Center, New York, NY.*

**Introduction:** The habitual use of Ketamine as a recreational drug has been increasing due to its sought after dissociative effect. Numerous nephrological abnormalities including hemorrhagic cystitis, hydronephrosis and resultant chronic kidney disease-classified as Ketamine Induced Uropathy(KIU) have been found in individuals who are regular users. We present a case of KIU in a young male with Acute Kidney Injury(AKI) and Acute Liver injury(ALI)

**Case Description:** A 29-year-old male with history of Substance Misuse–Ketamine~8g/day, occasional cocaine and recurrent hemorrhagic cystitis was brought in by EMS after being found unresponsive. Given Naloxone 4mg with mild improvement. He was found with hyponatremia, AKI and ALI as in figure 1. CT Abdomen/pelvis showed bilateral hydroureteronephrosis extending to the ureterovesical junctions-collapsed bladder, no stones or mass. Foley passed with stat return of >1L urine, then having >6L of urine daily and marked progressive improvement in Cr and electrolytes. He was also given N-acetylcysteine and had progressive improvement in his ALI. At discharge, his Cr was down to 2.11

**Discussion:** The increased recreational use of Ketamine has given rise to nephrological abnormalities, concentrated in younger healthy patients. KIU is postulated to arise from urinary tract destruction;however the exact mechanism remains uncertain. It is thought that Ketamine and its metabolites in the urine act as a direct toxin to the urinary epithelium causing microvascular changes, inflammation and an immune response in the lower and upper urinary tracts. This results in a contracted bladder with vesicoureteral reflux epithelial thickening and hydronephrosis as in our patient. Treatment is immediate decompression with Foley catheter, as in our patient, which most often results in immediate improvement. Counseling on discontinuation of Ketamine is essential as recurrent use can lead to irreversible injury and even ESRD. Clinicians should be alerted to this presentation, which outside Ketamine misuse is rare in otherwise young, healthy patients. Further study is needed into the pathophysiology, treatment and longterm outcomes of patients with KIU

	Admission	Day 1 post Foley	Day 5	Day 10	Day 16
Sodium	122	130	131	136	135
Potassium	6.9	5	3.2	3.4	3.6
Chloride	89	89	91	104	107
Carbon dioxide	<5	16	22	23	20
Urea Nitrogen	>118	200	144	48	31
Creatinine	8.2	6.56	4.46	2.53	2.28
ALT	504	471		113	60
AST	417	340		40	42
Total bilirubin	6.6	6.5		13.7	7.3
Alkaline phosphatase	1409	1110		823	663

**PUB076**

**Mice, Men, and the Kidney: A Puzzling Case of AKI With Hypokalemia**

Temitayo M. Adebile, Trixie Cruz, Steven C. Borkan, Titilayo O. Ilori, Helena Kurniawan, Kwon Soo Kim. *Boston University School of Medicine, Boston, MA.*

**Introduction:** Leptospirosis is a disease that can be caused by bacteria in the urine of infected animals. Rodents are common asymptomatic carriers of *Leptospira* and maintain the spirochaetes in their proximal tubules (PT). Prevalence of AKI in leptospirosis ranges from 40-60%. Leptospirosis induced AKI is multifactorial and could result from PT or endothelial cell injury as well as interstitial inflammation.

**Case Description:** A 22-year-old male student living in Massachusetts presented with 5 days of non-bloody diarrhea, fever, chills, sweating, and dizziness upon standing. He was brought to the ER because he had fainted multiple times and reported headaches and muscle pains. In the ER he was febrile, tachycardic, and hypotensive with thrombocytopenia (platelets=57,000). His creatinine was elevated at 1.41 mg/dl. He was diagnosed with acute gastroenteritis, given IVF and sent home. Three days later, he presented to the ER again with fever and recurrent syncope. On exam, he had conjunctival injection, scleral icterus and splenomegaly. Lab findings at this time showed a creatinine of 1.45mg/dl, hypokalemia, thrombocytopenia, elevated CPK 4,257, hyperbilirubinemia 7.5 mg/dl, and transaminitis. His serum creatinine continued to trend up and peaked at 1.96mg/d. Peripheral blood smear didn't show schistocytes. The infectious disease and renal services were consulted. Further history revealed that he was from an African country, but he had no recent travel, no TB or other travel related infections. However,

his apartment had been infested with mice. Infectious work up revealed IgM antibodies to *Leptospira*. Patient had clinical improvement after 48 hours of starting empiric therapy with Ceftriaxone. He completed 7 days of doxycycline with resolution of AST, bilirubin and AKI. His creatinine reduced to 0.8mg/dL on discharge.

**Discussion:** AKI in leptospirosis can be caused by rhabdomyolysis or severe volume depletion leading to acute tubular necrosis. Spirochetes targets endothelial cells and proximal tubular cells causing inflammation and PT defects. Collecting tubules become resistant to vasopressin causing urinary concentrating defect. Hypokalemia occurs commonly due to reversible PT defect. Leptospirosis associated AKI represents a major risk factor for death hence, early diagnosis and management of leptospirosis is crucial to prevent renal involvement or progression.

**PUB077**

**Status Epilepticus With an AKI**

Ayesha M. Malik. *LSU Health Shreveport, Shreveport, LA.*

**Introduction:** Acute uric acid nephropathy is characterized by oliguric renal failure due to overproduction of uric acid and its deposition in renal tubules. This typically occurs in cases of leukemias and lymphomas or following chemotherapy due to tumor lysis. A few cases have reported uric acid crystals in the urine of patients with status epilepticus (1,2,5). Seizures can cause direct nucleotide breakdown, producing adenosine which is converted to uric acid in the liver. Serum nucleotidase activity can be elevated for several hours after seizures, increased systemic breakdown of adenosine triphosphate, generating urate (1). Seizures cause dehydration and hyperthermia resulting in increased water reabsorption. This increases concentration of uric acid in urine, precipitates in renal tubules. it can cause direct damage to kidneys by activating pro-inflammatory mediators inducing renal vasoconstriction (3).

**Case Description:** 64 year old woman with history of glioblastoma multiforme status post multiple craniotomies for resection, admitted with status epilepticus. She required a midazolam drip and was intubated for airway protection. She subsequently became bradycardic, hypothermic and anuric and remained so for the next 3 days despite 5L of crystalloids. Her creatinine increased from 0.5 to 1.8mg/dl and she developed anasarca. Laboratory studies were significant for BUN 28, C02 17mmol/L, CPK 18U/L and BNP 554 pg/ml. Her renal ultrasound was normal. Initial urine analysis showed a pH of 5 with bland sediment. A second bedside urine analysis performed a few days later revealed abundant uric acid crystals, but no muddy brown casts or RTECs. In the absence of any other etiology for the AKI, a diagnosis of acute uric acid nephropathy was made and she was started on a bicarbonate drip along with furosemide to keep urine pH 6.5-7. Her urine output consequently increased and creatinine normalized.

**Discussion:** Urinalysis with microscopic examination of urine sediment is an important clinical tool for diagnosing AKI. Varghese et al showed that 20-25% cases which yielded no diagnosis on first urine microscopy, showed casts representing acute tubular injury on a second or third urine microscopy done 2-3 or 4-6 days later.(4) In our case, uric acid crystals were identified on a second urine microscopy while the first one was clear. Serial exams may be helpful in uncovering the cause of AKI which a single inspection may miss.

**PUB078**

**Experiences of Intravenous Iron Therapy in Non-Anaemic Functional Iron Deficient Individuals With Non-Dialysis Kidney Disease: A Qualitative Study**

Courtney J. Lightfoot,<sup>1,2</sup> Sharlene A. Greenwood,<sup>3</sup> Kate Bramham,<sup>3,4</sup> Alice C. Smith.<sup>1,2</sup> <sup>1</sup>University of Leicester, Leicester, United Kingdom; <sup>2</sup>NIHR Leicester Biomedical Research Centre, Leicester, United Kingdom; <sup>3</sup>King's College Hospital NHS Foundation Trust, London, United Kingdom; <sup>4</sup>King's College London, London, United Kingdom.

**Background:** In non-dialysis CKD, functional iron deficiency (low iron stores in the absence of overt anaemia) is an under-recognised state which may be associated with substantial symptoms, but iron replacement is not routinely offered. The Iron and Muscle study is a multicentre randomised trial of the impact of intravenous iron therapy on physical function in people with non-anaemic functional iron deficiency and non-dialysis CKD. Understanding the patient perspective is an essential part of the evaluation of therapeutic strategies, and to this end the Iron and Muscle study included a qualitative sub-study with the aim of exploring the patient experience of the therapeutic intervention.

**Methods:** A sample of Iron and Muscle participants (stages 3-4 CKD, Hb 110-150 g/L, Ferritin < 100 µg/L and/or Transferrin Saturations (TSAT) <20%) were interviewed three months following receipt of the therapeutic intervention (intravenous infusion of iron or placebo) and completion of 8-weeks exercise training. Semi-structured interviews explored participants' views and experiences of receiving the therapeutic intervention. Data were audio-recorded and transcribed verbatim. Thematic analysis was used to identify and report themes.

**Results:** 17 participants (7 males, average age 58 years (range:39-72 years)) were interviewed, of which 5 received intravenous iron. Interviews lasted an average of 51 minutes (range:28-83 minutes). Five themes were identified: Perceptions of therapeutic intervention received Changes in energy levels/ alertness/ concentration Impact on daily life and activities Impact on psychosocial wellbeing Impact on sleep

**Conclusions:** There were no clear differences in themes reported between treatment groups, with mixed perceptions amongst participants about which therapeutic intervention they had received. Most participants, including some who received the placebo, described increased energy levels, increased ability to perform activities, improved concentration, and better sleep quality with decreased daytime sleepiness. Increased motivation and

wellbeing were frequently discussed, with participants having a more positive outlook on life with CKD. Therapeutic interventions, with exercise components, can improve the quality of life of people living with CKD and non-anaemic functional iron deficiency.

**PUB079**

**Association of Oral vs. Parenteral Iron Therapy With Risk of ESKD and Mortality**

Shejuti Paul,<sup>1</sup> Prabin Shrestha,<sup>1</sup> Keiichi Sumida,<sup>1</sup> Fridtjof Thomas,<sup>1</sup> Satya Surbhi,<sup>1</sup> Abu Mohd Naser,<sup>2</sup> Elani Streja,<sup>3</sup> Connie Rhee,<sup>3</sup> Kamyar Kalantar-Zadeh,<sup>3</sup> Csaba P. Kovcsdy.<sup>1,4</sup> <sup>1</sup>The University of Tennessee Health Science Center, Memphis, TN; <sup>2</sup>The University of Memphis, Memphis, TN; <sup>3</sup>University of California Irvine, Irvine, CA; <sup>4</sup>VA Memphis Medical Center, Memphis, TN.

**Background:** Iron deficiency can be effectively treated with oral or parenteral (IV) iron, but little is known about the comparative long-term safety of these different modalities. We aimed to investigate the association of oral vs IV iron therapy with the incidence of ESKD and all-cause mortality.

**Methods:** We identified 94,931 incident new users of iron replacement therapy (N=91,945 on oral and 2,986 on IV iron) from 2004-2018 in a large national cohort of US Veterans. We used clinical trial emulation methods including propensity score (PS) matching to account for differences in key baseline characteristics. We examined the association of oral vs IV iron with the incidence of ESKD and with all-cause mortality using competing risk regression and Cox models, respectively.

**Results:** In the PS matched cohort of 5,972 patients (2,986 on oral and 2,986 on parenteral iron), the overall mean (SD) age was 69±11 years, 95% were male, 72% were white, and the baseline eGFR, hemoglobin and ferritin levels were 68±30 ml/min/1.73m<sup>2</sup>, 9.4±1.7 gm/dL and 65 (25<sup>th</sup>-75<sup>th</sup> pctl: 17-231), respectively. There were 246 cases of ESKD (event rate 19/1000PY; 95% CI 16-21) and 3,962 deaths (290/1000PY; 95% CI 281-300) over a median follow up of 1.1 years. IV iron therapy (vs oral iron) was associated with a higher risk of ESKD (subhazard ratio, 1.58; 95% CI 1.22-2.04) and all-cause mortality (hazard ratio, 1.11; 95% CI, 1.04-1.18) (Table).

**Conclusions:** IV iron therapy was associated with a higher risk of ESKD and mortality when compared to oral iron therapy. The long-term safety of IV vs oral iron therapy needs to be examined in clinical trials.

**Funding:** Veterans Affairs Support

Association of Oral vs Parenteral Iron Therapy with Risk of ESKD and All-Cause Mortality

	ESKD			All-cause death		
	Event rate per 1000PY (95%CI)	Subhazard ratio (95%CI)	P value	Event rate per 1000PY (95%CI)	Hazard ratio (95%CI)	P value
Oral Iron (N=2,986)	14 (12, 17)	Reference		275 (263, 287)	Reference	
Parenteral iron (N=2,986)	24 (20, 28)	1.58 (1.22, 2.04)	<0.001	307 (294, 320)	1.11 (1.04, 1.18)	0.001

**PUB080**

**Therapy Software for Personalized Anemia Management in Hemodialysis Patients: Description of the Population in a Randomized Controlled Trial**

Lemuel Rivera Fuentes,<sup>1</sup> David J. Joerg,<sup>2</sup> Doris H. Fuertinger,<sup>2</sup> Lin-Chun Wang,<sup>1</sup> Amrisha U. Patel,<sup>1</sup> Xiaoling Ye,<sup>1</sup> Stephan Thijssen,<sup>1</sup> Peter Kotanko.<sup>1,3</sup> <sup>1</sup>Renal Research Institute, New York, NY; <sup>2</sup>Fresenius Medical Care Deutschland GmbH, Bad Homburg, Germany; <sup>3</sup>Icahn School of Medicine at Mount Sinai, New York, NY.

**Background:** Anemia is a common complication in patients on hemodialysis (HD). The use of erythropoiesis-stimulating agents (ESA) has become standard-of-care (SOC). The non-linear relationship between ESA administration and hemoglobin (Hgb) response is one of the biggest challenges in anemia management. Therefore, we devised a novel software that individualizes ESA-dose prescription based on mathematical modeling of anemia. We present the design of our randomized controlled trial (RCT) and a brief description of the population enrolled.

**Methods:** We conducted an RCT in subjects on HD who were randomized 1:1 to be managed by our personalized ESA-dose recommendation tool (*intervention*) or continue to be on SOC treatment (*control*). For 26 weeks the intervention group received biweekly individualized ESA-recommendations generated by our software to target an Hgb of 10-11 g/dL. These recommendations were provided to an anemia manager who evaluated the subject's clinical status before ESA administration. The software was updated biweekly with the subjects' most recent clinical parameters.

**Results:** Ninety-six subjects were enrolled, 82 were randomized and completed the study (61 [50.2-70.7] years, 58.1% male, 51.2% black, Hgb of 10.5 ± 0.4 g/dL, Ferritin 812 [489.3-1117.5] ng/mL) (Table 1). Forty subjects were randomized to the intervention arm and 42 to the control. When comparing general data (demographics, comorbidities, etc.) there was no statistical significance between the two arms (Table 1).

**Conclusions:** We successfully conducted a clinical RCT to test our therapy software for personalized anemia management in HD patients. The population enrolled and randomized was balanced between the 2 arms.

	All Subjects	Intervention	Control	p value
Number of patients (n)	82	40	42	
Age [years] [median (IQR)]	61 (20.5)	61.5 (14.2)	59.5 (21.2)	0.593
Gender: Male [n(%)]	50 (58.1%)	26 (65%)	24 (57.1%)	0.615
Race: Black [n(%)]	42 (51.2%)	22 (55%)	20 (47.6%)	0.054
Ethnicity: Hispanic [n(%)]	27 (32.9%)	14 (35%)	13 (30.7%)	0.752
Diabetes mellitus [n(%)]	3 (3.7%)	3 (7.5%)	0	0.063
Dialysis vintage [years] [median (IQR)]	3 (1)	3 (1)	3 (1)	0.994
Body Mass Index (at baseline) [kg/m <sup>2</sup> ] [mean ± SD]	27.3 ± 6.6	27.6 ± 6.6	27.0 ± 6.7	0.694
Interdialytic weight gain [kg] [mean ± SD]	2.2 ± 0.8	2.2 ± 0.8	2.3 ± 0.7	0.606
Treatment time [hr] [median (IQR)]	3.4 (0.7)	3.9 (0.7)	3.4 (0.7)	0.162
Diabetes mellitus [n(%)]	20 (24%)	7 (17.5%)	13 (30.9%)	0.245
Congestive heart failure [n(%)]	13 (15.8%)	7 (17.5%)	6 (14.2%)	0.923
Hemoglobin concentration [g/dL] [mean ± SD]	10.5 ± 0.4	10.4 ± 0.4	10.6 ± 0.4	0.313
Ferritin concentration [ng/mL] [median (IQR)]	812.5 (628.17)	777 (553.04)	865.7 (740.6)	0.268
Transferrin [mg/dL] [median (IQR)]	165 (42.09)	149.5 (53.7)	212.7 (40.2)	0.121
Serum albumin [g/dL] [mean ± SD]	3.9 ± 0.3	3.9 ± 0.2	3.8 ± 0.3	0.498
Predialysis SBP [mmHg] [mean ± SD]	151.9 ± 19.0	151.5 ± 19.7	152.3 ± 20.2	0.962
Kt/V [mean ± SD]	1.6 ± 0.2	1.6 ± 0.2	1.7 ± 0.3	0.473
PTH [pg/mL] [median (IQR)]	548.7 (396.5)	651.6 (410)	518.5 (386.8)	0.348
IFN dose [per 30 days] [mg] [median (IQR)]	85.5 (34.4)	85.4 (30.7)	85.8 (67.5)	0.841
Iron dose [per 30 days] [mg] [median (IQR)]	212.5 (181.19)	204.3 (195.8)	225 (173.9)	0.472
Ultrafiltration volume [L] [mean ± SD]	2.2 ± 0.8	2.2 ± 0.8	2.3 ± 0.7	0.641

PUB081

Report of the Compliance of Renal Anemia in Maintenance Hemodialysis Patients in Sichuan

Mingzhu Li, Daqing Hong. Sichuan Academy of Medical Sciences and Sichuan People's Hospital, Chengdu, China.

**Background:** To investigate the compliance of hemoglobin and iron metabolism in maintenance hemodialysis (MHD) patients in various areas of Sichuan.

**Methods:** A total of 7190 maintenance hemodialysis patients in 41 dialysis centers in Sichuan were enrolled in this study. Hemoglobin, ferritin, transferrin saturation, total iron binding capacity and other indicators were collected. The standard: 110 g/L ≤ hemoglobin < 130 g/L. To analyze the hemoglobin compliance rate and the distribution of iron metabolism parameters in MHD patients.

**Results:** A total of 7190 patients in 41 hemodialysis centers were included in the final analysis, including 58.9% males, 57 (49-69) years of age, 2451 patients were reaching the standard, with a compliance rate of 34.1% (95% confidence interval 33.0%-35.2%). The compliance rate was different in different regions ( $p < 0.0001$ ), 31.8% (29.5%-34.0%) in northern Sichuan, 36.8% (34.2%-39.5%) in southern Sichuan, 30.1% (27.6%-32.6%) in western Sichuan, 36.1% (33.4%-38.7%) in eastern Sichuan and 35.9% (33.6%-38.1%) in central Sichuan. The compliance rate was 32.0% (30.4%-33.7%) in female patients, 35.5% (34.1%-37.0%) in male patients. Women had a lower compliance rate than men, and the difference was statistically significant ( $p = 0.002$ ). There was a significant difference in gender ( $\chi^2 = 9.412$ ,  $p = 0.002$ ). The compliance rate of hemodialysis centers was 33.2% (31.5% - 34.9%) in tertiary hospitals and 34.7% (33.3% - 36.2%) in non-tertiary hospitals, the difference was not statistically significant ( $p = 0.121$ ). The risk of substandard hemoglobin was increased (OR = 1.167, 95% CI: 1.057 - 1.290). Serum iron 11.4 (8.4-15.4) IU/ml, ferritin 163.3 (60.4-321.9) µg/L, transferrin saturation 25.5% (18.8% -34.1%), total iron binding capacity 48.4 (39.5-56.8) µg/dl; patients with absolute iron deficiency accounted for 18.9% (16.9%-20.9%); patients with absolute iron deficiency with hemoglobin ≥ 110 g/L accounted for 48.0% (41.9%-54.0%), patients with non-absolute iron deficiency accounted for 49.7% (46.8%-52.5%), the difference was not statistically significant ( $p = 0.616$ ).

**Conclusions:** The compliance rate of hemoglobin in MHD patients in Sichuan is low, with regional differences. The compliance rate in females is lower than that in males, and about 1/4 of MHD patients have absolute iron deficiency.

PUB082

Collagen, Hemodynamics, and Wall Mechanics of Failed vs. Successful Arteriovenous Fistulas From a Single Patient

Hannah M. Northrup,<sup>1</sup> Yong He,<sup>2</sup> Brayden Fairbourn,<sup>1</sup> Timmy C. Lee,<sup>3,4</sup> Scott A. Berceci,<sup>5,6</sup> Alfred K. Cheung,<sup>1,7</sup> Yan-Ting E. Shiu.<sup>1,7</sup> <sup>1</sup>University of Utah, Salt Lake City, UT; <sup>2</sup>University of Florida, Gainesville, FL; <sup>3</sup>University of Alabama at Birmingham, Birmingham, AL; <sup>4</sup>Veterans Affairs Medical Center, Birmingham, AL; <sup>5</sup>University of Florida, Gainesville, FL; <sup>6</sup>VA Medical Center Malcom Randall, Gainesville, FL; <sup>7</sup>VA Salt Lake City Health Care System, Salt Lake City, UT.

**Background:** The low one-year patency rate of mature arteriovenous fistulas (AVFs) remains a significant clinical problem. Although vascular collagen and biomechanics have been suggested to affect AVF function, understanding their roles in AVF patency failure is challenging due to the heterogeneity within the patient population. Here we present a unique case of a patient with two upper-arm AVFs withof different 1-year patency outcomes, and investigated whether they had different histological and biomechanical features.

**Methods:** The patient underwent the first AVF (AVFA) creation surgery in the left upper arm, and a piece of the vein was excised at the time of surgery. AVFA was then subject to magnetic resonance imaging (MRI) at 1 day (1D) and 6 weeks (6W), used for hemodialysis, thenbut failed 1 year after creation. The second AVF (AVFB) was created in the right upper arm, and a piece of the vein was excised intraoperatively. AVFB was subject to MRI at 1D and 6W after creation and was used for 5 years until the patient's death. Vein samples were analyzed for collagen content. MR images were used for fluid-structure interaction simulations to analyze hemodynamics and wall mechanics.

**Results:** Both AVFs had similar medial collagen content, but AVFA had more intimal collagen than AVFB (72% vs. 55%). MRI-based cross-sectional lumen area (CSA) was 21.03 and 28.80 mm<sup>2</sup> at 1D for AVFA and B, respectively, and 29.96 and 45.95 mm<sup>2</sup> at 6W for AVFA and B, respectively. At 1D AVFA had smaller average velocity than AVFB (0.46 vs. 0.67 m/s), wall shear stress (WSS) (93 vs. 187 dyne/cm<sup>2</sup>), and vorticity (686 vs. 853 1/s). These values increased from 1D to 6W in AVFA but decreased in AVFB resulting in higher values for AVFA than B (velocity: 0.70 vs. 0.40 m/s, WSS: 213 vs. 128 dyne/cm<sup>2</sup>, vorticity: 1110 vs. 641 1/s). Wall von Mises stress was smaller for AVFA than AVFB at 1D (0.013 vs. 0.017 MPa) but 0.011 MPa for both at 6W.

**Conclusions:** Despite both AVFs being from the same patient and both upper arm, there were differences in intimal collagen content, hemodynamics, and wall mechanics. Low intimal collagen content before AVF surgery and higher velocity, WSS, vorticity, and von Mises stress immediately after AVF creation surgery may be important for long-term AVF patency.

**Funding:** NIDDK Support, Other NIH Support - NHLBI, Veterans Affairs Support

PUB083

Simple Breath Test for Ammonia (NH3) as a Potential At-Home Monitoring Method for CKD Patients

Robert A. Latour,<sup>1</sup> Sudha Garimella,<sup>2</sup> <sup>1</sup>Clemson University, Clemson, SC; <sup>2</sup>Prisma Health, Greenville, SC.

**Background:** Chronic kidney disease (CKD) patients do not have the ability to monitor azotemia via an at-home test. To address this, we have developed a simple method for measuring breath NH<sub>3</sub> and conducted a clinical trial with CKD patients (stages 1, 3, 5) with comparison to blood urea nitrogen (BUN) as a potential at-home method for monitoring kidney function.

**Methods:** The device includes a mouthpiece, pressure gauge to monitor flow rate, color-indicating disc, and breath collection bag (1-L Tedlar bag) to control exhaled breath volume (Fig. 1). The color response is read using a MatLab program to quantify the color using an RGB scale. Calibration was conducted in the lab using simulated exhaled breath (5% CO<sub>2</sub> in humidified air with NH<sub>3</sub> ranged from 0 - 10,000 ppb). The clinical trial was conducted with 10 CKD patients, including a patient immediately before and after hemodialysis. Patients exhaled through the device at a designated pressure gauge reading until the Tedlar bag was full (< 1 min), with the test done in triplicate. The color change was then read and the ppb of NH<sub>3</sub> determined using the calibration plot and plotted against the patient's BUN level.

**Results:** High correlation was found between breath NH<sub>3</sub> and BUN level (Fig. 2), with significantly different values in breath NH<sub>3</sub> between stages 1-5 and 3-5, but not between stages 1-3. Results for the patient undergoing hemodialysis showed 58 mg/dL (BUN) and 5,400 +/- 1,400 ppb (breath NH<sub>3</sub>) before hemodialysis and 11 mg/dL (BUN) and 300 +/- 100 ppb (breath NH<sub>3</sub>) after hemodialysis.

**Conclusions:** These results indicate that the developed test has potential as a simple at-home method for patients to monitor their CKD condition, especially in advanced CKD.

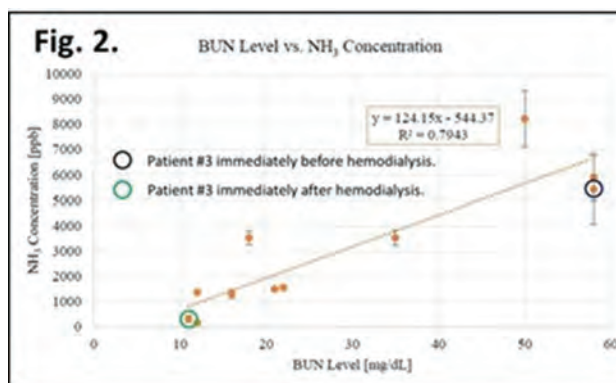

PUB084

**Mechanical Rotatory Method of Anticoagulation-Free Hemodialysis Using a Hemodialysis Filter Rotator With the NxStage Hemodialysis Machine: A UVM-MC-UVM Burlington VT Research Collaboration Effort**

Macaulay A. Onuigbo,<sup>1,2</sup> Nick Bowman,<sup>3</sup> Nik Cobb,<sup>3</sup> Aliza George,<sup>3</sup> Steve O'Driscoll,<sup>3</sup> Katie Thomas,<sup>3</sup> Adam Locke,<sup>2</sup> Pablo Vila-Beamonte,<sup>3</sup> Yves Dubief.<sup>3</sup> <sup>1</sup>University of Vermont College of Medicine, Burlington, VT; <sup>2</sup>University of Vermont Medical Center, Burlington, VT; <sup>3</sup>University of Vermont College of Engineering and Mathematical Sciences, Burlington, VT.

**Background:** The maintenance of blood fluidity in the extracorporeal circuit during hemodialysis (HD) often requires systemic anticoagulation. While effective, these anticoagulants cause bleeding, have other side effects, cannot be used in critically ill patients and in the peri-operative period, and add to costs. We recently described a novel mechanical rotational approach to anticoagulation-free HD using the "Locke-Onuigbo" maneuver (Figure 1).<sup>1</sup>

**Methods:** Prototype Completion: In collaboration with the University of Vermont Center for Biomedical Innovation (UVM CBI), five Senior Engineering students from the UVM, under the supervision of Yves Dubief PhD, Associate Professor of Mechanical Engineering, UVM, the first author and his Home Dialysis Program at the UVM Medical Center, have successfully prototyped an AI-modulated hemodialysis filter rotator that enables anticoagulation-free HD using the NxStage HD machine (Figure 2).

**Results:** The Hemodialysis Filter Rotator Prototype running test on the HD machine (Figure 2)

**Conclusions:** This Hemodialysis Filter Rotator enhances the capabilities of enabling sustainable Home HD for ESRD patients and represents a most welcome option in a "post-COVID" world and expands the offering of a convenient, safe and effective Home HD option to thousands of patients who prefer this choice of treatment. Moreover, we would argue that our novel prototype will deliver the unmet need for anticoagulation-free HD in critically ill patients, in the peri-operative period, and in hospitalized patients, in general. Investors and sponsors are welcome.

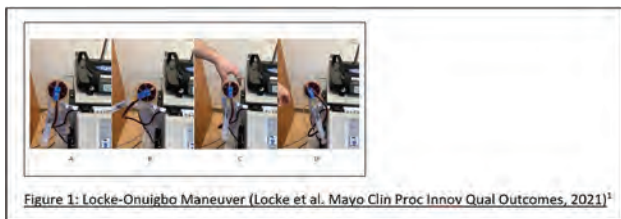

Figure 1: Locke-Onuigbo Maneuver (Locke et al. Mayo Clin Proc Innov Qual Outcomes, 2021)<sup>1</sup>

The Locke-Onuigbo Maneuver (Locke et al. Mayo Clin Proc Innov Qual Outcomes, 2021)<sup>1</sup>

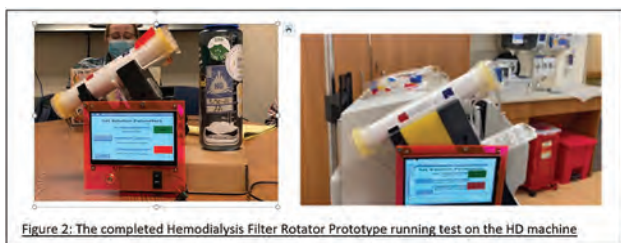

Figure 2: The completed Hemodialysis Filter Rotator Prototype running test on the HD machine

The Hemodialysis Filter Rotator Prototype running test on the HD machine

PUB085

**Safety Evaluation of Balloon Dilatation of Human Veins Using the Vessel Restoration System for Autologous Arteriovenous Fistula Creation**

Yong He,<sup>1</sup> Blake Anderson,<sup>2</sup> Qiongyao Hu,<sup>1</sup> Katalin Kauser,<sup>2</sup> Scott A. Berceli.<sup>1,3</sup> <sup>1</sup>University of Florida, Gainesville, FL; <sup>2</sup>Alucent Biomedical Inc, Salt Lake City, UT; <sup>3</sup>Malcom Randall VAMC, Gainesville, FL.

**Background:** Failure rates of arteriovenous fistula (AVF) maturation are high, especially when veins with suboptimal diameters are used to create vascular access. Natural Vascular Scaffolding (NVS) Therapy targets the natural extracellular matrix of a vein using a photoactivatable small molecule (4-amino-1,8-naphthalimide, 10-8-10 dimer) coated on an angioplasty balloon and activated by an intravascular light fiber (450nm wavelength) during inflation upon delivery to the vein wall before AVF creation. NVS Therapy may promote the successful maturation of small-diameter venous conduits via positive outward remodeling, but its safety needs to be evaluated.

**Methods:** We exposed n=22 freshly harvested human vein segments to intraluminal stretches between 20-106 % using the Vessel Restoration System (VRS)-AVF device. Evidence of histologic disruption (microtears in the intima/media) or loss of vein integrity (fluid leakage from the lumen when pressurized) was assessed.

**Results:** The existing hyperplasia distribution in the veins was similar to earlier reports. Intravascular balloon inflation up to 60% over-sizing from the unpressurized diameter showed no evidence of histologic disruption or loss of vein integrity. However,

dilation of the veins with greater than 60% oversizing increased the risk of histologic damage and/or loss of conduit integrity.

**Conclusions:** NVS Therapy delivered to explanted veins and dilated to 60% of their native diameters appears safe and assures that the in vivo application of NVS Therapy in small vein diameters in patients with end-stage renal disease is safe.

**Funding:** Commercial Support - Alucent Biomedical Inc

**Relationship between Percent Over-Dilation and Vein Injury**

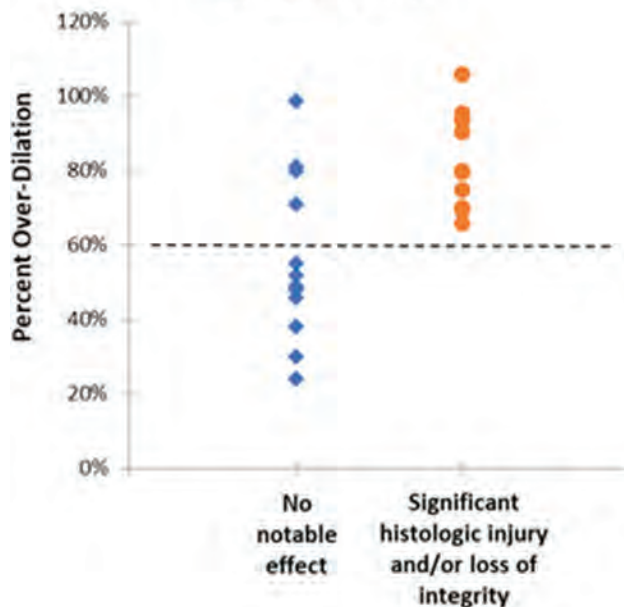

PUB086

**Effects of Paricalcitol on Klotho Protein, Oxidative Stress, and Micro Inflammation in Maintenance Hemodialysis Patients**

Lei Tao. The Third Affiliated Hospital of Shandong First Medical University, Jinan, China.

**Background:** To investigate the efficacy of paricalcitol in the treatment of MHD patients with secondary hyperparathyroidism (SHPT), and its effects on Klotho protein, oxidative stress, and micro inflammation.

**Methods:** 10 patients with MHD complicated with SHPT (Abbvie company, the single injection dose is 5ug. After HD, the drug is injected into the patient through the dialysis pathway immediately, 3 TIW) in the Third Affiliated Hospital of Shandong First Medical University were treated with paricalcitol. Serum samples were taken before treatment, 1 month, 2 months and 3 months. The levels of Klotho protein, MDA and hs CRP in serum were measured by ELISA, the iPTH, Ca and P were detected at the same time.

**Results:** The mean levels of serum MDA, hs-CRP and PTH in 10 patients at the end of 3 months of treatment were significantly lower than those at baseline (P = 0.0030, 0.0009 and 0.0048), with statistical significance; The mean levels of Klotho protein and Ca at the end of 3 months of treatment were significantly higher than those at baseline (P = 0.0067 and 0.0188), with statistical significance; There was no significant difference in P.

**Conclusions:** Paricalcitol can effectively control SHPT, significantly reduce the level of iPTH and increase Ca. But it has little effect on the change of P. It can increase the expression of Klotho protein and reduce the level of oxidative stress and micro inflammation in patients.

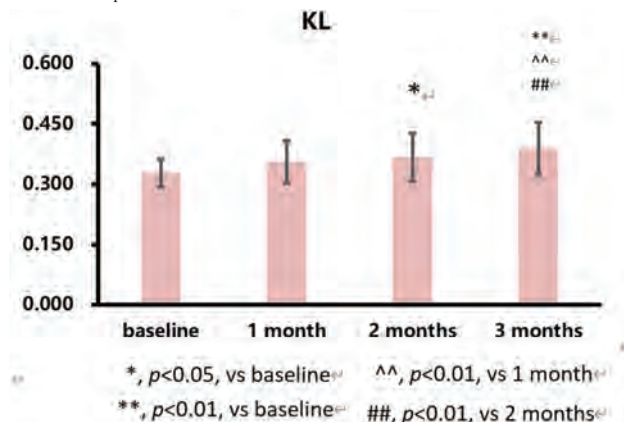

PUB087

**The Expression Characteristics and Correlation Analysis of Bone Mineral Density and Bone Turnover Biomarkers in CKD Patients**

Jiyi Si,<sup>1,2</sup> Xiaoliang Zhang,<sup>1</sup> <sup>1</sup>Southeast University Zhongda Hospital, Nanjing, China; <sup>2</sup>Southeast University, Nanjing, China.

**Background:** Chronic kidney disease–mineral and bone disorder(CKD-MBD) is a common complication of CKD. It will cause renal osteopathy and vascular calcification.

**Methods:** The patients were divided into four groups: CKD1-2 stage, CKD3-5ND stage, CKD5D stage and calciphylaxis. We analyzed the differences and variation tendency among groups. Logistic regression analysis showed the protect and risk factors for osteoporosis. Finally, we drew the ROC curves to explore if the BTMs can predict the osteoporosis.

**Results:** 326 CKD patients was included. With the progression of the CKD, bone mineral density (BMD) decreased and bone turnover biomarkers(BTMs) became disordered, calciphylaxis patients were more serious than general dialysis patients. Logistic regression analysis showed that male(OR=0.558;OR=0.554)and BMI(OR=0.890;OR=0.911) were the protect factors of both left total hip and lumbar bone loss. LogPTH(OR=5.140)was risk factor of left total hip bone loss. ALP(OR=1.008) was risk factor for lumbar bone loss. The AUC of PTH and ALP were the highest one in the ROC curve of left total hip and lumbar respectively.

**Conclusions:** When the GFR decreased, BMD and BTMs became abnormal gradually. The BMD of calciphylaxis patients were lower than other patients. PTH and ALP were risk factors and best predictors for osteoporosis in CKD patients.

**Figure 2 ROC curve**

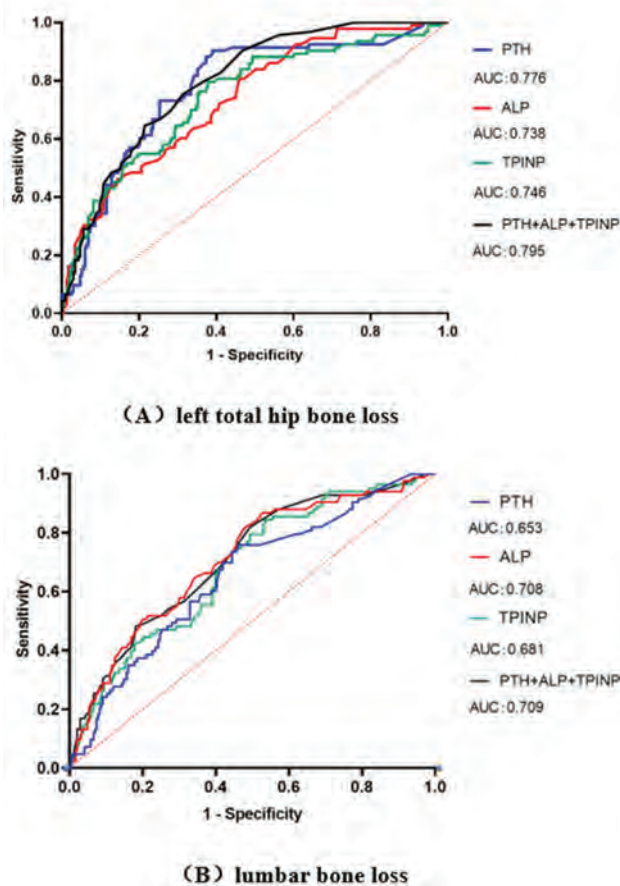

**Figure 1 The expression characteristics and variation tendency of patients**

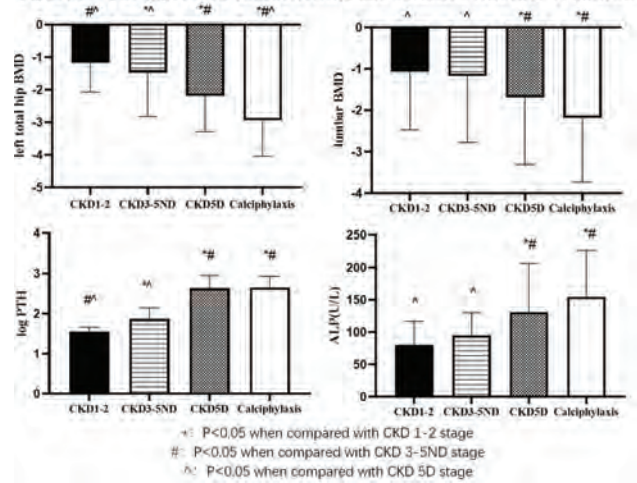

PUB088

**Prevalence of Secondary/Tertiary Hyperparathyroidism Among Patients With CKD Stage 5 on Hemodialysis at the Victoriano Luna Medical Center**

Grace Haziol C. Manarang, Rafael Montepio. *Armed Forces of the Philippines, Quezon City, Philippines.*

**Background:** A common complication of renal failure is Secondary Hyperparathyroidism (SHPT) which if left untreated, can lead to Tertiary Hyperparathyroidism (THPT). Baseline prevalence data is highly required to reduce the risk of complications since both of these can lead to significant morbidity, mortality and additional healthcare cost.

**Methods:** Medical Record of patients with CKD stage 5 on hemodialysis in Victoriano Luna Medical Center were reviewed. Excluded were those who underwent Hemodialysis due to Acute Kidney Injury, those with history of thyroid or parathyroid surgery, those with hypoparathyroidism or primary hyperparathyroidism, active pulmonary tuberculosis, active malignancy and vitamin D disorder. Data collected were age, sex, presence of comorbidities, etiology of CKD, duration and frequency of Hemodialysis, maintenance medication and Laboratory parameters such as intact PTH (iPTH), serum phosphorus, ionized calcium. All data were statistically analyzed.

**Results:** 101 patients were included in the study. 42.5% (43 out of 101) of them have SHPT, while 4.95% (5 out of 101) have THPT. Among those with SHPT, majority were female(74.4%), have single comorbidity (69.7%), and with Chronic Glomerulonephritis (34.5%) as the most common etiology of CKD. On the other hand, all patients with THPT were male, majority(80%) have single comorbidity, but with Hypertensive Nephrosclerosis (40%) as the most common etiology of CKD. In patients with elevated iPTH, majority (71.4%) have iPTH of <300pg/mL, while 16.6% have iPTH level between 300-500pg/mL, and 11.9% have iPTH level of >500pg/mL. Majority of patients with iPTH level of <300pg/mL and between 300-500pg/L were on 2x a week schedule of hemodialysis as compared 3x a week schedule of Hemodialysis in patients with iPTH level of >500pg/mL. Based on data collected, increasing level of iPTH is associated with increasing trend of serum phosphorus and ionized calcium.

**Conclusions:** Factors such as duration and frequency of hemodialysis and medications taken may influence level of iPTH. iPTH level is congruent with level of serum phosphorus and serum calcium, indicating possible progression of the disease which may be due to inadequacy of calcium, Vitamin D, Phosphate binder supplement and hemodialysis frequency schedule.

PUB089

**Severe Hyperparathyroidism Associated With Increased Functional and Mobility Impairment in Ecuadorian Hemodialysis Patients With Prolonged Time in Hemodialysis**

Juan C. Santacruz, Ana K. Vásquez Perez, Layla N. Baez, Paola K. Arévalo, Paulo Reinoso, Angel C. Santacruz. *Clínica de los Riñones Menydia, Quito, Ecuador.*

**Background:** Secondary hyperparathyroidism (SH) is associated with increased morbidity and mortality in hemodialysis (HD) patients which worsens with long HD stay. Vitamin D, phosphate-binders and calcimimetics are used, however their high cost make them unavailable for some Latin-American patients. Few is known about SH behavior in Ecuadorian patients with prolonged HD stay and lack of IV vitamin D agonists/calcimimetics. The aim of the study was to describe SH behavior in one Ecuadorian cohort of HD patients and the effect mobility and functional status as the relation with time in HD.

**Methods:** Observational-retrospective study in Ecuadorian HD cohort in “Clinica de los Ríones Menydia”. Inclusion criteria: Age  $\geq$ 18 years, time in HD  $\geq$ 3 meses. Patients younger 18 years, less of 3 months in HD, prior parathyroidectomy were excluded. Karnofsky state, mobility status, PTH values, time in HD, age and sex were collected for analysis.

**Results:** A total of 152 patients were included, 57% were male with mean age 57 ( $\pm$ 15.2 years), time in HD 6 ( $\pm$ 4.3 years), median PTH 321.6 (126.1-700.6 pg/L), 21% had mobility restriction and 27% of patients had Karnofsky score  $<$ 70%. PTH values above 1000 pg/l had a prevalence of 15%, significantly related with prolonged HD stay (7.1 $\pm$ 3.1 vs 5.4 $\pm$ 4.7 years), impaired mobility ( $p=0.014$ ) and pathological Karnofsky scale (below 70) ( $p=0.03$ ) It was observed that extreme pathological PTH values (above 1000 pg/l) was more frequent in patients with HD stay above 80 months (6.6 years).

**Conclusions:** HD time over 6 years contributes to severe secondary hyperparathyroidism which is associated with impaired mobility and functional status. Lack of IV vitamin D agonists/calcimimetics complicates SH treatment and should call for other treatment options to avoid deleterious effects on functional status, impaired mobility and quality of life of severe secondary hyperparathyroidism. Kidney transplant programs must be more active to avoid prolonged HD time.

## PUB090

### Outcomes of Symptomatic Kidney Stone Formers

Young Eun Choi, Sungyeon Kim, Suk Min Chung, Yina Fang, Myung-Gyu Kim, Sewon Oh, Sang-Kyung Jo. Korea University Anam Hospital Korea University Anam Hospital, Seoul, Republic of Korea.

**Background:** Recent epidemiologic studies have shown that incidence of urolithiasis is increasing and these stone formers are at increased risk for end stage kidney disease (ESKD). However, most of the studies are population-based historical cohort studies with the use of diagnostic codes including both symptomatic and asymptomatic stone formers.

**Methods:** Given that urolithiasis is a highly heterogenous conditions potentially linked to different clinical outcomes according to stone compositions, we performed a single center retrospective study of symptomatic stone formers with known compositions.

**Results:** Baseline characteristics and prevalence of diverse comorbid conditions and long-term mortality were compared according to different subtypes of stones. As expected, calcium-oxalate stone (45.0%) was the most common type followed by struvite stone (32.9%) and urate stone (15.7%). Uric acid stone formers were significantly older and more likely to have various comorbidities including diabetes, hypertension, ischemic heart disease, heart failure, dementia and chronic kidney disease and acute kidney injury. Long-term mortality rate was also significantly higher in carbonate stone (3.4%) and urate stone (6.1%) formers.

**Conclusions:** These data suggest that clinical characteristics and short and long-term kidney outcomes might be significantly different according to subtypes of stones. Larger studies to identify different risk factors and outcome according to different types of stones are needed.

## PUB091

### The Impact of Calcimimetics in the CMS Perspective Payment System

Skylar Malone,<sup>1</sup> Stuart M. Sprague,<sup>2</sup> Jennifer Robinson.<sup>1</sup> <sup>1</sup>Spherix Global Insights, Exton, PA; <sup>2</sup>NorthShore University HealthSystem, Evanston, IL.

**Background:** Etelcalcetide, an IV calcimimetic, was approved by the FDA in February 2017, and fully launched in Q1 2018. In 2018, etelcalcetide was reimbursed at ASP+6%, as of January 2020 etelcalcetide was reimbursed at ASP+0%, then was added to the bundle payment rate in 2021. During this period, cinacalcet became generic in March 2019. In 2021, etelcalcetide and oral cinacalcet transitioned into the bundled payment system. CMS increased the bundle reimbursement rate by \$10.09 per treatment to account for utilization of calcimimetics during its TDAPA period, Q1 2018 to Q4 2019. Initial clinical experience and reimbursement clarity led dialysis organizations to update their protocols.

**Methods:** Using a HIPAA-compliant, online chart review tool, 158 nephrologists submitted de-identified clinical and non-clinical information for 1,003 dialysis patients in Fall 2021. Data were then merged with physician demographic profiles and attitudinal responses; the data set was analyzed in SPSS.

**Results:** Nephrologists believe treating SHPT early will improve outcomes and yet mean iPTH initiation levels in the dialysis community continue to increase. Physicians prefer etelcalcetide over oral cinacalcet because they believe it offers better compliance and improves SHPT control in HD patients. While physicians prefer to use etelcalcetide, most dialysis organizations require a patient to fail oral cinacalcet first. To address compliance issues, many dialysis organizations have shifted from once daily dosing to three-times-weekly dosing with dialysis. The FDA has not evaluated the use of cinacalcet in this manner. Over two-thirds of nephrologists would like to use etelcalcetide with more of their dialysis patients but are prevented from doing so due to the reimbursement rate and strict protocols. Physicians prefer to use etelcalcetide in 44% of their patients, and yet in a this study of in-center HD patients revealed etelcalcetide is currently prescribe to 4.4% of patients.

**Conclusions:** This study suggests the perspective payment system does not provide ample time for dialysis organizations and physicians to determine where and how to use new agents. Dialysis organizations have implemented protocols that may be inconsistent with FDA labeling. The cost, reimbursement, and limited clinical experience has led dialysis organizations to favor oral cinacalcet over etelcalcetide regardless of physician preference.

## PUB092

### FABP4 Is Involved in High Glucose-Induced Ferroptosis in HK2 Cells

Jiasi Chen, Keping Wu, Hui Guan, Yan Lei, Xiaohua Wang, Zhihua Zheng. The Seventh Affiliated Hospital Sun Yat-sen University, Shenzhen, China.

**Background:** Ferroptosis is involved in the progression of diabetic kidney disease, and is regulated by lipid metabolism. Previous studies showed that inhibition of fatty acid  $\beta$ -oxidation (FAO) increases the sensitivity of cells to ferroptosis. Upregulation of fatty acid binding protein 4 (FABP4) can inhibit FAO. Thus, we hypothesized that FABP4 may be involved in renal injury mediated by ferroptosis in DKD.

**Methods:** HK2 cells were cultured with high glucose (HG) and treated with FABP4 inhibitor BMS to analyze ferroptosis-related indexes.

**Results:** FABP4 was upregulated in HK2 cells under HG, accompanied by elevated lipid deposition and ROS, which can be reversed by BMS. Iron ( $Fe^{2+}$ ) and malondialdehyde (MDA) were increased in HG group, while glutathione (GSH) and glutathione peroxidase 4 (GPX4) were decreased. Cells in HG group presented mitochondrial cristae reduction and outer membrane rupture. The ferroptosis-related changes described above can be reversed with the treatment of BMS.

**Conclusions:** FABP4 is involved in HG-induced ferroptosis in HK2 cells.

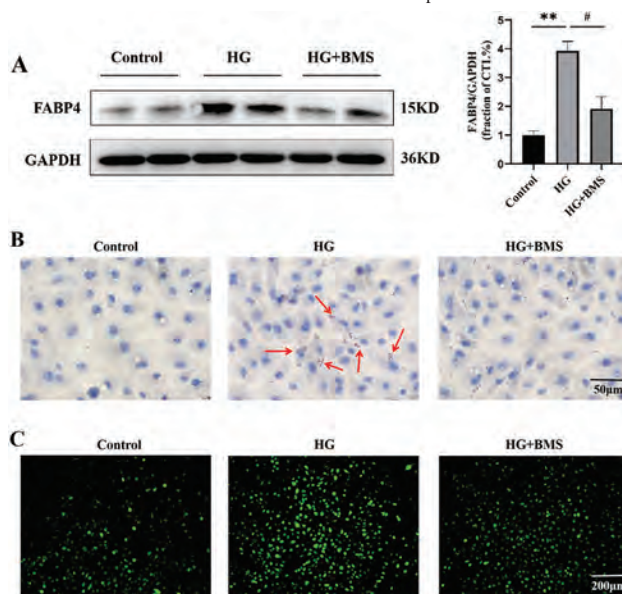

BMS reduces lipid deposition and ROS in HK2 cells. (A)FABP4 levels. (B)Oil Red O staining. (C)ROS levels.

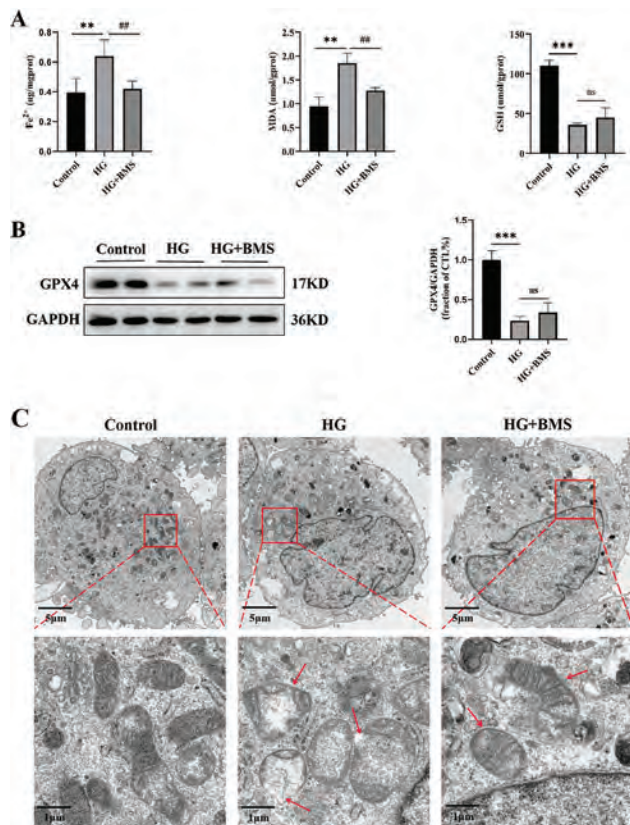

Effect of BMS in HG-induced ferroptosis in HK2 cells. (A)Iron, MDA and GSH content. (B)GPX4 levels. (C)Mitochondrial morphology.

**PUB093**

**Tetracyclines Abrogate the Development of Proteinuria by Reducing Kidney Protein Synthesis in a Diabetic Mouse Model**

Anne Long,<sup>1,2</sup> Amy Zollman,<sup>1</sup> Jessica Overstreet,<sup>2</sup> Takashi Hato,<sup>1</sup> Pierre C. Dagher,<sup>1</sup> Timothy A. Sutton.<sup>1</sup> <sup>1</sup>Indiana University School of Medicine, Indianapolis, IN; <sup>2</sup>Eli Lilly and Company, Indianapolis, IN.

**Background:** Diabetes remains a major cause of chronic kidney disease and end stage kidney disease. The pathophysiologic processes leading to the development of kidney disease in diabetes are poorly understood because it is not common practice to obtain kidney biopsies in diabetic patients without diabetic kidney disease (DKD). We have previously demonstrated that translation, the fundamental process in protein synthesis, is increased in the kidney in a mouse model of diabetes. This increase in translation was observed prior to the onset of DKD. Here we investigate whether direct inhibitors of protein translation, such as tetracyclines, can mitigate the development of proteinuria.

**Methods:** We used Db/Db mice on a Kaliss strain background which are prone to developing manifestations of DKD over time. These mice demonstrate an increase in translation starting as early as eight weeks. Treatment with minocycline (50mg/kg daily x 3 days by gavage) was started at 8 weeks and the kidneys were harvested for polyribosomal profiling. In a parallel set of experiments, 6-week old Db/Db mice (n=10) were treated for up to 10 weeks with minocycline (50mg/kg daily in drinking water) and urine was collected weekly for measurement of albuminuria.

**Results:** Treatment with minocycline resulted in a 30% reduction in protein translation as measured by polyribosomal profiling. Fifty percent of the vehicle control-treated mice developed significant albuminuria (albumin/creatinine ratio between 0.6-6 µg/µg). All mice treated with minocycline had albumin/creatinine ratios < 0.5 µg/µg.

**Conclusions:** Increased protein synthesis in the kidney is a feature of diabetes before the onset of DKD. Pharmacologic strategies to reduce protein synthesis may serve as a new therapeutic avenue to prevent the development of DKD.

**Funding:** NIDDK Support

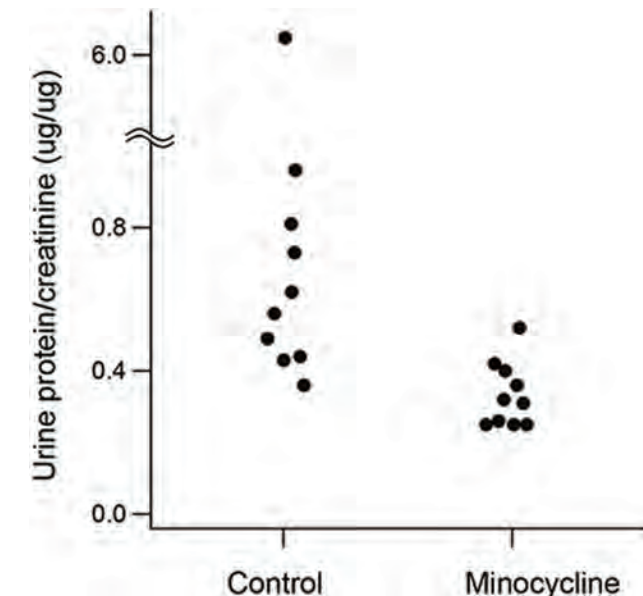

**PUB094**

**Urinary Angiotensinogen in Patients With Type 1 Diabetes With Microalbuminuria: Effect of Gender and Insulin Modality**

Jessica Z. Navarro Motta, Alejandro Sanchez, Sheeba H. Ba aqeel, Minghao Ye, Mohammed Z. Rehman, Jan Wysocki, Alfred Rademaker, Mark E. Molitch, Daniel Batlle. Northwestern University Feinberg School of Medicine, Chicago, IL.

**Background:** Angiotensinogen (AOG) is the precursor of peptides of the renin angiotensin system (RAS). Since insulin up-regulates transcriptional factors that normally repress kidney AOG synthesis, we evaluated urinary AOG in patients with type 1 diabetes (T1D) and microalbuminuria to examine the effect of intensive versus conventional insulin therapy as well as possible gender differences.

**Methods:** Urine samples from participants of the Diabetes Control and Complications Trial (DCCT) who had albumin excretion rate (AER) in the microalbuminuric range at the entry of the study were used for: a) Measurements of AOG/creatinine (ng/mg) in 103 patients with T1D and microalbuminuria (AER 30-300 mg/24hrs) as compared to controls with normalalbuminuria (AER < 30 mg/24hrs), matched for age, gender, disease duration and allocation to insulin therapy and b) Measurements of AOG/creatinine from patients with microalbuminuria allocated to intensive or conventional insulin therapy using samples after 3 years on either modality.

**Results:** The uAOG/creatinine was higher in patients who started with microalbuminuria than in those with normoalbuminuria (6.65 vs. 4.0 ng/mg, p <0.01). uAOG was higher in females than males with microalbuminuria (11.7 vs. 5.4 ng/mg, p=0.015). The uAOG was lower in patients with microalbuminuria allocated to intensive than in conventional insulin therapy (3.98 vs. 7.42 ng/mg, p<0.01), while AER was not (20 vs 21 mg/24hrs p=0.68).

**Conclusions:** In patients with T1D and microalbuminuria, uAOG is increased and the excretion varies with gender and the type of insulin modality, independently of AER. This suggests that AOG production in females is increased and that intensive insulin therapy decreases it. The reduction in uAOG production with intensive insulin therapy, can lead to kidney RAS down-regulation, and therefore may contribute to the known renoprotective action associated with improved glycemic control.

**Funding:** NIDDK Support, Private Foundation Support

**PUB095**

**Presence of Retinopathy and Kidney and Cardiovascular Events in Type 2 Diabetes and Normoalbuminuria: A Post Hoc Analysis of the PRIORITY Study**

Viktor Rotbain Curovic,<sup>1</sup> Nete Tofte,<sup>1</sup> Christian Delles,<sup>3</sup> Marie Frimodt-Moller,<sup>1</sup> Harald Mischak,<sup>2</sup> Frederik Persson,<sup>1</sup> Heiko von der Leyen,<sup>4</sup> Tine Hansen,<sup>1</sup> Peter Rossing,<sup>1</sup> the PRIORITY Study Group <sup>1</sup>Steno Diabetes Center Copenhagen, Herlev, Denmark; <sup>2</sup>Mosaiques Diagnostics, Hannover, Germany; <sup>3</sup>University of Glasgow Institute of Cardiovascular and Medical Sciences, Glasgow, United Kingdom; <sup>4</sup>Hannover Clinical Trial Center, Hannover Medical School, Hannover, Germany.

**Background:** To evaluate the association between diabetic retinopathy and development of albuminuria, impaired kidney function and cardiovascular events in persons with type 2 diabetes and normoalbuminuria.

**Methods:** Post-hoc analysis of the prospective observational PRIORITY study including 1756 persons with type 2 diabetes and normoalbuminuria followed for three



years. The study was originally designed to investigate the prediction of a urinary proteomic risk classifier (CKD273) for development of albuminuria. Diabetic retinopathy included information from medical records on non-proliferative and proliferative changes, presence of macular oedema and history of laser treatment. Cox proportional hazard models were fitted to investigate baseline retinopathy status to development of 1) microalbuminuria (urinary albumin-creatinine ratio >30mg/g on ≥ 2 out of 3 urine samples); 2) chronic kidney disease (eGFR <60 ml/min/1.73m<sup>2</sup>); and 3) cardiovascular events (myocardial infarction, stroke, coronary intervention, and hospitalization for heart failure). Adjustment included sex, baseline age, diabetes duration, HbA<sub>1c</sub>, systolic blood pressure, eGFR, urinary albumin-creatinine rate and urinary proteomic risk classifier status. Baseline LDL cholesterol, body mass index and history of cardiovascular disease were also included in the adjustment for cardiovascular events.

**Results:** At baseline, 287 (16.3%) had retinopathy. Compared to persons without retinopathy, they were older (mean ±SD: 62.7±7.7 vs 61.4±8.3 years, p=0.019), had longer diabetes duration (17.9±8.4 vs. 10.6±7.0 years, p<0.001) and higher HbA<sub>1c</sub> (62±13 vs. 56±12 mmol/mol, p<0.001). The adjusted hazard ratios of retinopathy at baseline for development of albuminuria (n=197), chronic kidney disease (n=166) and cardiovascular events (n=64) were: 1.54 (95%CI: 1.06, 1.73), 0.89 (95%CI: 0.57, 1.38), and 2.56 (95%CI: 1.40, 4.66), compared to persons without retinopathy.

**Conclusions:** Individuals with normoalbuminuric type 2 diabetes and retinopathy had higher risk of developing albuminuria, but not impaired kidney function, and had a markedly higher risk of cardiovascular disease during the 3-year follow-up, compared to individuals without retinopathy.

**Funding:** Government Support - Non-U.S.

**PUB096**

**Design and Methodology of the PRIMETIME1 Cohort Study: Precision Medicine Based on Renal Tissue Molecular Interrogation in Diabetic Nephropathy**

Karina Haar,<sup>1,2</sup> Hanan Amadid,<sup>2</sup> Frederik Persson,<sup>2</sup> Ditte Hansen,<sup>3,4</sup> Iain O. Bressendorff,<sup>3</sup> Marie Møller,<sup>3</sup> Peter Rossing,<sup>2,4</sup> Rikke Borg,<sup>1,4</sup> PRIMETIME <sup>1</sup>Clinical Research Unit, Zealand University Hospital, Roskilde, Denmark; <sup>2</sup>Steno Diabetes Center Copenhagen, Herlev, Denmark; <sup>3</sup>Department of Nephrology, Herlev and Gentofte Hospital, Herlev, Denmark; <sup>4</sup>Department of Clinical Medicine University of Copenhagen, Copenhagen, Denmark.

**Background:** The diagnosis of diabetic kidney disease (DKD) is practically based on clinical characteristics. However, clinical features of DKD alone cannot reliably differentiate between DKD and non-DKD in diabetes. A kidney biopsy is necessary to make the definitive diagnosis of diabetic nephropathy (DN). However, there is no clear clinical guideline on when to perform a biopsy in individuals with diabetes and kidney disease. Furthermore, the implication of non-DN versus DN in diabetes on management, morbidity, and kidney prognosis is unclear. The long-standing tradition of national population registration in Scandinavia offers a unique possibility of working with high-quality registry data and a long period of follow-up. With the potential to perform comprehensive studies, we aimed to create a national cohort of individuals with diabetes who had a kidney biopsy performed – the PRIMETIME1 cohort.

**Methods:** We performed a retrospective cohort study, intending to include all Danish adults diagnosed with diabetes between 1997 and 2020 and who had a kidney biopsy performed - excluding tumor, donor and transplant biopsies. We established the cohort by linking a nationwide diabetes register, The Steno Diabetes Center Copenhagen Diabetes Registry, and The Danish Pathology Registry. Data from eleven nationwide registries and databases are comprised and stored at Statistics Denmark. Epidemiologic studies and stratified analyses will be founded on the classification of kidney disease in subgroups based on the histopathological diagnosis of DN, non-DN, and mixed disease. Classification of kidney disease is defined by doing a three-step analysis of SNOMED (Systematized Nomenclature of Medicine) IDs.

**Results:** The PRIMETIME1 cohort contains information on 3592 individuals. A variety of demographic, socioeconomic, clinical, and prognostic variables have been gathered and data analysis is ongoing.

**Conclusions:** A large cohort with comprehensive data has been created. The PRIMETIME1 cohort has the ability to perform epidemiologic studies on comorbidity and kidney disease, to study the predictive value of clinical variables on disease course, the prognostic value of findings in kidney biopsies, and how to guide risk stratification of individuals with diabetes and kidney disease.

**Funding:** Commercial Support - Novo Nordisk Foundation, Government Support - Non-U.S.

**PUB097**

**Empagliflozin Associated Severe Hyponatremia in the Setting of Subclinical Diabetes Insipidus: A Case Report**

Maha Ahmed,<sup>1</sup> Tai Truong,<sup>2</sup> Clay A. Block,<sup>2,1</sup> Dartmouth Geisel School of Medicine <sup>1</sup>Dartmouth College Geisel School of Medicine, Hanover, NH; <sup>2</sup>Dartmouth-Hitchcock Medical Center, Lebanon, NH.

**Introduction:** SGLT2i are an important class of drug in the management of diabetes, diabetic nephropathy, chronic kidney disease and heart failure. We describe a case in which the introduction of empagliflozin resulted in severe hyponatremia by unmasking previously unrecognized chronic lithium induced nephrogenic diabetes insipidus (NDI).

**Case Description:** A 67-year-old veteran with longstanding hypertension, obesity, chronic kidney disease stage 3A, and bipolar disorder on lithium was admitted for

management of a hyperosmolar hyperglycemic state with glucose levels exceeding 900 mg/dL. The corrected sodium concentration was 153 mEq/L. After treatment with insulin and IV fluid, the patient was discharged on metformin and 10mg of empagliflozin. Lithium was discontinued and sodium valproate was initiated. On discharge glucose concentration was 267 mg/dL, serum sodium 148 mEq/L, and creatinine 1.41 mg/dL. Four days after discharge, the patient returned with worsening fatigue, confusion, polyuria, and polydipsia. Serum chemistries revealed glucose level at 267 mg/dL, serum sodium at 156 mEq/L, serum osmolality 338 Osm/L, creatinine 2.08 mg/dL, urine sodium 38 mEq/L, urine osmolality was 500 Osm/L, and urine glucose concentration greater than 500 mg/dL (beyond detected range). Hydration was provided along with insulin; empagliflozin was discontinued. Serum sodium continued to climb to a peak of 161 mEq/L on hospital day 4 and subsequently improved. Glycemic control was achieved with glipizide. Despite resolution of his hyperglycemia, polyuria persisted. Daily urine specific gravity measurements were below 1.005 and urine osmolality was less than 200 mosmol/kg. NDI was inferred related to his history of long standing lithium use. Hydrochlorothiazide and a low salt diet were initiated. On hospital day 10, his serum sodium level remained stable at 144 mEq/L without need of intravenous fluid. Follow up sodium level 1 month later was 142 mEq/L.

**Discussion:** In this clinical vignette, we described a patient who developed severe hyponatremia in the setting of diabetes mellitus and concurrent diabetes insipidus. To our knowledge, our case report is the first to describe severe hyponatremia with empagliflozin in a patient with diabetes insipidus and uncontrolled diabetes mellitus.

**PUB098**

**Conserving Renal Function With a Novel Care Model: A 3-Year Retrospective EHR-Based Analysis of eGFR in 1,871 Elderly Patients With CKD 3/Diabetes After Switching to Cano Health**

R. B. Aguilar,<sup>1,2</sup> Re Kenney,<sup>1,2</sup> E. Antunez,<sup>1,2</sup> R. S. Busch,<sup>4</sup> M. E. Herman,<sup>5</sup> M. Aguilar,<sup>3</sup> M. Conger.<sup>6</sup> Cano Health <sup>1</sup>Nova Southeastern University, Fort Lauderdale, FL; <sup>2</sup>Florida International University, Miami, FL; <sup>3</sup>Gonzaga University, Spokane, WA; <sup>4</sup>Albany Medical Center, Albany, NY; <sup>5</sup>University of Illinois System, Urbana, IL; <sup>6</sup>Oregon State University, Corvallis, OR.

**Background:** The Cano Health (CANO) Model of Care (CMC; launched in 2014), has demonstrated improvements in chronic disease management for Medicare Advantage patients (1-6). The current 3Y retrospective study was designed to evaluate the potential of the CMC to slow the decline of renal function and positively impact clinical outcomes in an at-risk population.

**Methods:** Between 1/1 and 12/31/2018, 1,871 patients newly enrolled in CANO (≤3 mos) with CKD 3/diabetes were identified. Clinical care was guided by the CMC including adherence to structured data protocols and input from a proprietary care management tool, CanoPanorama™(2). eGFR, A1C, albuminuria, BMI, SBP/DBP were collected at baseline and to 36 mos. CHF, MI, Stroke/TIA, dialysis, all-cause mortality, medication use, hospitalizations, and ER visits, were tracked using claims data.

**Results:** Mean age 76.5-Y with mean f/u of 2.4 Y. Mean eGFR significantly improved for 15 mos and was preserved over 36 mos (Table 1). Death from any cause, dialysis, MI, CHF, stroke/TIA events, ER visits, and hospitalization per 1000 patient-yr were 33.0, 3.2, 4.5, 8.1, 15.4, 96.4 and 55.0 respectively. Mean A1C decreased from 7.1% to 6.9% at 24 mos while BMI decreased from 30.7 to 29.9 over the same period.

**Conclusions:** Outpatient management of CKD with diabetes has been suboptimal and will be of greater consequence as our population ages (7). The CMC model reduced the need for dialysis and durably slowed decline of renal function while positively impacting clinical outcomes when compared to reference clinical studies on similar populations (8). This scalable model of care offers an opportunity to improve the short- and long-term health of these patients in the primary care setting.

Table 1

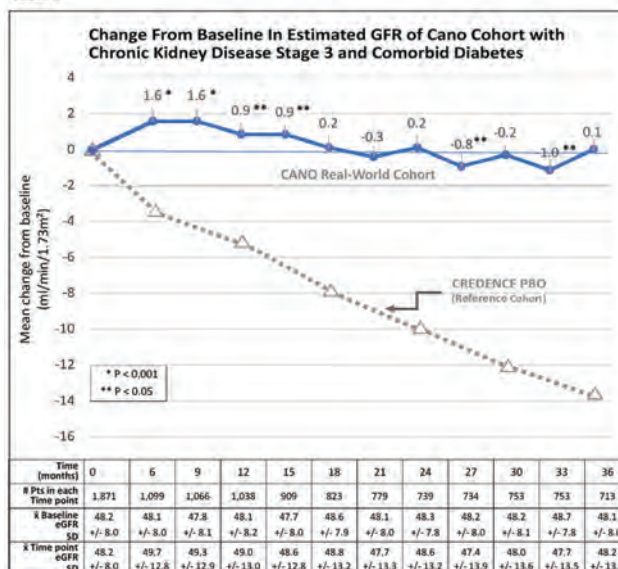

Table 1

## PUB099

## Predictors and Facility-Level Variation in SGLT2i Prescription Among US Veterans

L Parker Gregg,<sup>1,2</sup> David J. Ramsey,<sup>1,2</sup> Liang Chen,<sup>1,2</sup> Julia Akeroyd,<sup>1,2</sup> Salim S. Virani,<sup>1,2</sup> Sankar D. Navaneethan.<sup>1,2</sup> <sup>1</sup>Baylor College of Medicine, Houston, TX; <sup>2</sup>Michael E DeBakey VA Medical Center, Houston, TX.

**Background:** Sodium-glucose cotransporter-2 inhibitors (SGLT2i) are recommended for patients with type 2 diabetes mellitus (T2DM), and chronic kidney disease (CKD). We studied the facility level variation in prescription patterns and factors associated with SGLT2i prescription among patients with atherosclerotic cardiovascular disease (ASCVD), CKD, and T2DM.

**Methods:** Using a nationally representative data from the Veterans Affairs (VA) Corporate Data Warehouse from January 1, 2020 to December 31, 2020, we identified individuals with ASCVD, T2DM, and CKD stage 3 (defined as eGFR 30-59 mL/min/1.73 m<sup>2</sup>). Associations between patient and treatment characteristics with SGLT2i prescription were studied using logistic regression. Facility-level variation in SGLT2i prescription was described using median rate ratio, which is the likelihood that two randomly selected facilities differ in use of SGLT2i among similar patients.

**Results:** Of 378,469 patients with ASCVD, T2DM and CKD, 59,755 (15.8%) were prescribed a SGLT2i. Those on SGLT2i were younger (69±8 vs. 72±9 years), had higher hemoglobin A1c levels (8.0±1.4 vs. 7.5±1.5), and more likely to have heart failure (25.8% vs. 20.8%), P<0.001 for each. In the multivariable model, younger age, male sex, non-Hispanic White race, hypertension, higher HbA1c, ischemic heart disease, and heart failure were associated with higher odds of SGLT2i prescription (Figure). The mean (SD) proportion prescribed a SGLT2i per individual VA facility was 15.3% (5.2). The adjusted median rate ratio for facility level variation was 1.56 (95% CI 1.47-1.64) indicating an unexplained 56% difference in the probability of two similar patients with T2DM, and CKD receiving SGLT2i at two random facilities.

**Conclusions:** Prescription rate of SGLT2i for eligible patients was low, with significant variation between individual facilities. Further health services research should target improving guideline-based prescribing of these agents to improve cardiovascular and kidney outcomes.

**Funding:** NIDDK Support, Veterans Affairs Support

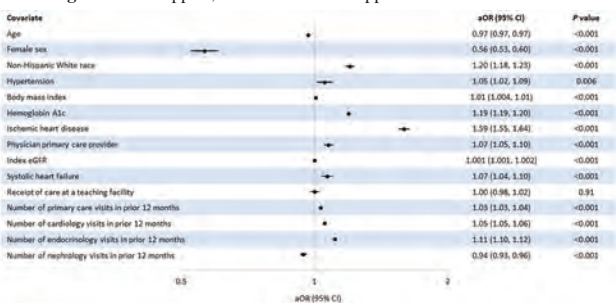

Factors associated with SGLT2i prescription

## PUB100

## Unhealthy Body Composition Phenotype Correlates With Intraglomerular Hemodynamic Dysfunction in Adolescents With Type 1 Diabetes

Kalie L. Tommerdahl,<sup>1,2</sup> Jessica B. Kendrick,<sup>1</sup> Carissa Vinovskis,<sup>1</sup> Laura Pyle,<sup>1,3</sup> Daniël H. van Raalte,<sup>4</sup> Ian H. de Boer,<sup>5</sup> Robert G. Nelson,<sup>6</sup> Petter Bjornstad.<sup>1</sup> <sup>1</sup>University of Colorado Denver School of Medicine, Aurora, CO; <sup>2</sup>University of Colorado Denver Barbara Davis Center for Childhood Diabetes, Denver, CO; <sup>3</sup>University of Colorado School of Public Health Department of Biostatistics & Informatics, Aurora, CO; <sup>4</sup>Amsterdam UMC Locatie VUmc, Amsterdam, Netherlands; <sup>5</sup>University of Washington Department of Medicine, Seattle, WA; <sup>6</sup>National Institute of Diabetes and Digestive and Kidney Diseases, Phoenix, AZ.

**Background:** High fat mass and central adiposity are associated with cardiovascular and kidney dysfunction in youth and adults with type 1 diabetes (T1D), yet little is known regarding the association between body composition and direct measures of intraglomerular hemodynamic function in youth with T1D of short duration. We evaluated the relationships between body composition (i.e., lean mass, fat mass, and trunk mass) and estimated insulin sensitivity and markers of intraglomerular hemodynamic function in adolescents with T1D of less than 10 years duration.

**Methods:** Baseline evaluation of glomerular filtration rate (GFR) and renal plasma flow (RPF) by iohexol and p-aminohippurate clearance during a hyperglycemic clamp, and body composition assessments by dual-energy x-ray absorptiometry for lean, fat, and trunk mass, were completed. Intraglomerular pressure (P<sub>GLO</sub>) was estimated using Gomez equations. Insulin sensitivity was estimated (eIS) using the SEARCH equation. Urine albumin to creatinine ratio (ACR) was assessed using the average of two collections during a single study visit. Pearson correlations and multivariable linear regression analyses were performed on all reported outcomes.

**Results:** Fifty adolescents with T1D (aged 16±3 years, 50% female, HbA1c 8.6±1.2%, BMI 23.4±5.1 kg/m<sup>2</sup>, T1D duration 5.7±2.6 years) were included. Trunk mass and fat mass were strongly positively correlated with GFR, RPF, P<sub>GLO</sub>, and ACR (Table).

Lean mass was inversely correlated with ACR and eIS with GFR, RPF, P<sub>GLO</sub>, and ACR. Most relationships remained statistically significant after multivariable adjustment for age, sex, and hemoglobin A1c.

**Conclusions:** Central adiposity is strongly associated with early intraglomerular hemodynamic dysfunction in youth with T1D of short duration. The effects of central adiposity on the onset and progression of diabetic kidney disease remains to be determined.

**Funding:** NIDDK Support, Private Foundation Support

**Table.** Relationships between markers of intraglomerular hemodynamic function and assessments of body composition and estimated insulin sensitivity.

	Fat mass (kg)	Lean mass (kg)	Trunk mass (kg)	eIS
GFR (mL/min)	r: 0.54* p<0.0001	r: -0.16* p=0.26	r: 0.60* p<0.0001	r: -0.54* p<0.0001
RPF (mL/min)	r: 0.48* p=0.003	r: -0.27 p=0.11	r: 0.44 p=0.006	r: -0.41* p=0.01
P <sub>GLO</sub> (mmHg)	r: 0.55* p=0.0004	r: -0.21 p=0.21	r: 0.65* p<0.0001	r: -0.52* p=0.0009
ACR (mg/g)	r: 0.37 p=0.009	r: -0.39 p=0.006	r: 0.38* p=0.006	r: -0.35* p=0.01

\*Denotes additional statistical significance after multivariable linear regression analyses adjusted for age, sex, and hemoglobin A1c.

Key: ACR = urine albumin to creatinine ratio; eIS = estimated insulin sensitivity; GFR = glomerular filtration rate; P<sub>GLO</sub> = intraglomerular pressure; RPF = renal plasma flow.

## PUB101

## Risk of ESKD and Incidence of New-Onset Major Adverse Cardiovascular Events in a Large, Deprived Population With Type 2 Diabetes Mellitus

Saif Al-Chalabi,<sup>1,2</sup> Schanave Santhirasekaran,<sup>1</sup> Smeeta Sinha,<sup>1</sup> Philip A. Kalra,<sup>1</sup> James Ritchie.<sup>1</sup> <sup>1</sup>Northern Care Alliance NHS Foundation Trust, Salford, United Kingdom; <sup>2</sup>The University of Manchester Faculty of Biology Medicine and Health, Manchester, United Kingdom.

**Background:** Chronic kidney disease (CKD) is a major public health condition. It is estimated that 2.6 million people in England are living with CKD. In this study of adults with type 2 diabetes mellitus (T2DM) living in the Salford area (amongst the top 10% deprived local authorities in England), we describe the baseline predicted population incidence of end-stage kidney disease (ESKD), and the observed incidence of major adverse cardiovascular events (MACE) over a 61-month period, medication uptake is also described.

**Methods:** A retrospective analysis using data from the Salford Integrated Record. The study population included all adult patients with T2DM who were actively registered with a general practitioner and had either a coded CKD diagnosis, a measured eGFR<60 mL/min/1.73 m<sup>2</sup> or a measured albumin-creatinine ratio >3 mg/mmol.

**Results:** The current estimated total adult population living within Salford city is 260,000. Based on the study inclusion criteria, we identified 11546 adult patients (4.4% of the total adult population in Salford). The median age was 65.5 years with a predominance of males (57.5%). For the estimated incidence of ESKD, data were available for 9841 (85.2%) and 9734 (84.3%) patients for KIDIGO CKD prognosis and kidney failure risk equation (KFRE) respectively. The KIDIGO CKD prognosis estimation showed that 603 (6.1%) patients had a very high risk for ESKD determined by eGFR and albuminuria, whereas the KFRE indicated that only 94 (0.97%) patients had a >5% risk of ESKD within 5 years. Over the 61 months follow-up period (01/01/2016 to 28/02/2021), 2742 patients (23.7%) developed new-onset hypertension, 1127 (9.8%) had an acute coronary syndrome and 410 (3.5%) had new-onset heart failure. Use of key medications at end of follow-up period was renin-angiotensin-aldosterone blockade (63.6%), sodium-glucose cotransporter 2 (SGLT2) inhibitors (19.8%) with 34.8% receiving antiplatelet therapy, and 81.4% statins.

**Conclusions:** Our analysis shows a low utilisation of cardio-renal-metabolic preventive medications such as SGLT2 inhibitors. We suggest opportunities to optimize their use to reduce incidence of ESKD and new-onset MACE.

**Funding:** Commercial Support - AstraZeneca

## PUB102

## Molecular Signatures of Glomerular Neovascularization in a Patient With Diabetic Kidney Disease

Daria Barwinska,<sup>1</sup> Ashish Verma,<sup>2</sup> Michael J. Ferkowicz,<sup>1</sup> Ricardo Melo ferreira,<sup>1</sup> Joel M. Henderson,<sup>2</sup> Devin Steenkamp,<sup>2</sup> Carrie L. Phillips,<sup>1</sup> Mary P. Kirkpatrick,<sup>2</sup> Sushrut S. Waikar,<sup>2</sup> Timothy A. Sutton.<sup>1</sup> KPMP <sup>1</sup>Indiana University School of Medicine, Indianapolis, IN; <sup>2</sup>Boston University School of Medicine, Boston, MA.

**Introduction:** A 67-year old woman with CKD stage G3aA3, latent autoimmune diabetes (LADA), diabetic retinopathy, and hypertension underwent a kidney biopsy as a participant in the Kidney Precision Medicine Project (KPMP).

**Case Description:** Prior to biopsy the patient received 11 intravitreal VEGF inhibitor injections and had proteinuria of 1.4 grams/g, serum creatinine of 1.05 mg/dL, and eGFR of 58 mL/min per 1.73 m<sup>2</sup> at the time of kidney biopsy. Kidney biopsy tissue cores were allocated to the pathology and tissue interrogation sites according to KPMP tissue analysis protocols. Core 1 underwent standard pathology processing and examination. Core 2 was immediately frozen in OCT. Sections from Core 2 were stained with eight fluorescent probes and imaged by confocal microscopy to obtain large volume 3-dimensional (3D)-immunofluorescence (IF) images. In addition, spatial transcriptomic analysis was performed on a sequential tissue section from Core-2. Nephrectomy tissue sections underwent identical interrogation protocols and served as control.

Key: TH - Thursday; FR - Friday; SA - Saturday; OR - Oral; PO - Poster; PUB - Publication Only

Underline represents presenting author.

**Discussion:** Histopathologic examination revealed diabetic nephropathy, RPS class III, with diffuse, focally nodular mesangial expansion, focal global glomerulosclerosis, and mild tubulointerstitial chronic damage. Notably, the cortical arteries and arterioles showed severe sclerosis. Large volume 3D-IF images demonstrated prominent neovascularization (PECAM1/CD31+) in the surrounding connective tissue of all glomeruli. Similar peri-glomerular neovascularization was also identified in PAS stained sections. Spatial transcriptomic deconvolution revealed increased signature of endothelial/vascular cell types in diabetic glomeruli and higher expression of associated genes when compared to the control tissue, demonstrating alignment with gene expression reported in animal models of retinal neovascularization. Although there are prior reports of glomerular neovascularization in patients with DKD, it is challenging to detect in standard thin histopathology sections and molecular information about it is sparse. Utilizing large volume 3D-IF imaging combined with spatial transcriptomics we demonstrated prominent glomerular neovascularization in a patient with DKD and its corresponding molecular signature.

## PUB103

### Association Between Carotid Artery Plaque and Albuminuria in Individuals With Type 2 Diabetes and No Clinical Cardiovascular Disease

Luis Felipe Ferreira-Divino,<sup>1</sup> Viktor Rotbain Curovic,<sup>1</sup> Christina G. Poulsen,<sup>1</sup> Lærke Urbak,<sup>3</sup> Nete Tofte,<sup>1</sup> Marie Frimodt-Møller,<sup>1</sup> Nikolaj Eldrup,<sup>3</sup> Tine Hansen,<sup>1</sup> Henrik H. Sillesen,<sup>3</sup> Peter Rossing.<sup>1,2</sup> <sup>1</sup>Steno Diabetes Center Copenhagen, Herlev, Denmark; <sup>2</sup>København's Universitet, København, Denmark; <sup>3</sup>Department of Vascular Surgery, Rigshospitalet, Copenhagen, Denmark.

**Background:** The association between albuminuria and subclinical atherosclerosis in type 2 diabetes (T2D) remains unclear. We investigated the association between carotid artery plaque thickness and albuminuria in individuals with T2D and no clinical cardiovascular disease (CVD) to better understand the pathophysiology of renal and vascular disease in T2D.

**Methods:** In total, 500 individuals with T2D and no clinical CVD underwent 2-dimensional ultrasound scans of the carotid arteries. The side with the highest plaque thickness (mm) was included in the analyses. Albuminuria measurements were available for 466 individuals, who were stratified based on history of two out of three consecutively recorded measurements of UAER or UACR; normal albuminuria (<30mg/24h or mg/g), moderately increased albuminuria (30-299 mg/24h or mg/g) and severely increased albuminuria (≥300mg/24h or mg/g). Association between highest plaque thickness and albuminuria was analyzed with linear regression. Adjustments included sex, age, diabetes duration, systolic blood pressure, eGFR, LDL-cholesterol, body mass index, smoking, and statin treatment.

**Results:** The study population had a mean (±SD) age of 65 ± 9 years, a mean diabetes duration of 14 ± 8 years, and two thirds (67%) were males. A total of 357 (71%) individuals had carotid plaque (>1.5mm), and 351 (75%) had normal albuminuria, 87 (19%) moderately increased albuminuria, and 28 (6%) severely increased albuminuria. In the unadjusted analysis, moderately increased albuminuria was associated with thicker carotid plaque compared to normal albuminuria (0.27 mm, 95%CI: (0.02 - 0.51); p=0.03), however, the significance was lost after adjustment (0.13 mm, (-0.13 - 0.38); p=0.34). Severely increased albuminuria was not associated with carotid plaque thickness in neither unadjusted (0.35 mm, (-0.04 - 0.75); p=0.08) nor adjusted (0.01mm, (-0.35 - 0.50); p=0.74) models compared to normal albuminuria.

**Conclusions:** In individuals with T2D but no clinical CVD, presence of albuminuria was not associated with carotid plaque thickness, a measure of subclinical CVD.

## PUB104

### Validating a Novel Prediction Model in Diabetic Nephropathy in Type 2 Diabetes Mellitus

Niveda Shekar, Dimeji O. Williams, Pius E. Ojemolon. *John H Stroger Jr Hospital of Cook County, Chicago, IL.*

**Background:** The prevalence of diabetic nephropathy (DN) among patients with type 2 diabetes mellitus (T2DM) is approximately 30-50% in the adult U.S. population. We looked at an original study done at the China-Japan Friendship Hospital which aimed to create a novel prediction model that could be utilized by clinicians to determine the probability of DN in patients with T2DM in an effort to forgo the renal biopsy. In our study, we aimed to derive the net benefit of utilizing the prediction model in an American population.

**Methods:** This is a retrospective data analysis of patients >18 years of age with T2DM who underwent a kidney biopsy at John H. Stroger, Jr. Hospital of Cook County between January 2014 and December 2019. Chart review was done to collect multiple variables including gender, diabetes duration, diabetic retinopathy, hematuria, hemoglobin A1C, anemia, blood pressure, urinary protein excretion, and glomerular filtration rate. Individual records were analyzed and assigned points as suggested in the original study. Point values correlated to probabilities, if the probability is near 0, the patient should undergo a biopsy while a probability of 1 suggests a patient should forego biopsy. A net benefit was calculated and compared to the validation dataset.

**Results:** A total of 89 records were analyzed 44% were female and 56% were male. Each of the variables listed above was collected and assigned points per the nomogram. The highest scoring variables were noted to be the duration of diabetes and the presence of diabetic retinopathy. The cumulative points correlated to the probability of DN. Thirty-three points were assigned as a 50% probability of finding DN if the patient were to

undergo a biopsy per the validation data set. This cut-off was later used to determine the number of true positives, true negatives, false positives, and false negatives. The net benefit found in our study was calculated to be 0.258. The net benefit in the validation dataset of the original study was 0.375.

**Conclusions:** This study, when compared to the validation dataset of the original study, showed an overall lower net benefit in the use of the novel model to predict diabetic nephropathy among the American population. This suggests that the training dataset of the original study would need to include a larger population from different locations for the model to be generalized.

## PUB105

### Association Between Platelet Aggregation and Albuminuria in Individuals With Type 2 Diabetes and No Clinical Cardiovascular Disease

Luis Felipe Ferreira-Divino,<sup>1</sup> Viktor Rotbain Curovic,<sup>1</sup> Christina G. Poulsen,<sup>1</sup> Nete Tofte,<sup>1</sup> Marie Frimodt-Møller,<sup>1</sup> Tine Hansen,<sup>1</sup> Anne-Mette Hvas,<sup>2</sup> Peter Rossing.<sup>1,3</sup> <sup>1</sup>Steno Diabetes Center Copenhagen, Herlev, Denmark; <sup>2</sup>Department of Clinical Biochemistry, Aarhus University Hospital, Aarhus, Denmark; <sup>3</sup>University of Copenhagen, Copenhagen, Denmark.

**Background:** To better understand the pathophysiology of renal and vascular disease in type 2 diabetes (T2D), we investigated the association between platelet aggregation and albuminuria in individuals with T2D and no clinical cardiovascular disease (CVD).

**Methods:** Cross-sectional study including 466 individuals stratified by history of normal albuminuria (<30 mg/24h or mg/g); moderately increased albuminuria (30-299 mg/24h or mg/g); and severely increased albuminuria (>300 mg/24h or mg/g) in two out of three consecutive measurements. Platelet aggregation was measured by whole blood impedance aggregometry (Multiplate® Analyzer). Three agonists were used, arachidonic acid (ASPItest), adenosine diphosphate (ADPtest), and thrombin receptor activating peptide-6 (TRAPtest). Higher test levels (area under the curve (AUC<sub>0-10min</sub>)) indicate higher platelet aggregation. Association between platelet aggregation and albuminuria was analyzed with linear regression. Adjustments included sex, age, diabetes duration, systolic blood pressure, eGFR, LDL-cholesterol, body-mass index, smoking and statin treatment. Analyses of ASPItest were stratified by treatment with acetylsalicylic acid (ASA) and further adjusted for non-steroidal anti-inflammatory treatment.

**Results:** The study population had a mean (±SD) age of 65±9 years, a diabetes duration of 14±8 years and most (66%) were men. 351 (75%) had normal, 87 (19%) moderately increased, and 28 (6%) severely increased albuminuria. In individuals treated with ASA (n=183), the moderately increased albuminuria group had a significantly higher platelet aggregation (ASPItest: unadjusted p=0.013; adjusted p=0.004) compared to those with normal albuminuria. This was not observed in individuals without ASA. In the total population, individuals with moderately increased albuminuria had higher platelet aggregation (ADPtest and TRAPtest: unadjusted p<0.047; adjusted p<0.038) compared to the normal albuminuria group. No differences were observed for any of the tests between severely increased albuminuria and normal albuminuria.

**Conclusions:** Individuals with T2D, but no clinical CVD, and moderately increased albuminuria had significantly higher platelet aggregation levels compared to those with normal albuminuria.

## PUB106

### Rationale and Design of a Prospective, Clinical Study of Biopsy-Proven Diabetic Nephropathy in People With Type 2 Diabetes: Prevalence and Predictive Factors (The PRIMETIME 2 Study)

Marie Møller,<sup>1</sup> Iain O. Bressendorff,<sup>1</sup> Rikke Borg,<sup>2,3</sup> Karina Haar,<sup>2,4</sup> Eva Gravesen,<sup>5</sup> Dorrit Krstrup,<sup>5</sup> Peter Rossing,<sup>4,3</sup> Frederik Persson,<sup>4</sup> Ditte Hansen.<sup>1,3</sup> PRIMETIME <sup>1</sup>Department of Nephrology, Herlev and Gentofte Hospital, University of Copenhagen, Copenhagen, Denmark; <sup>2</sup>Department of Nephrology, Zealand University Hospital Roskilde, Roskilde, Denmark; <sup>3</sup>Department of Clinical Medicine University of Copenhagen, Copenhagen, Denmark; <sup>4</sup>Steno Diabetes Center Copenhagen, Herlev, Denmark; <sup>5</sup>Herlev Hospital Afdeling for Patologi, Herlev, Denmark.

**Background:** Diabetic kidney disease (DKD) is a severe complication of diabetes. The diagnosis is based on the clinical characteristics of persistent macroalbuminuria, hypertension, and decline in kidney function, although this definition is subject to significant uncertainty. The only way to secure an accurate diagnosis of diabetic nephropathy (DN) is by performing a kidney biopsy. The clinical presentation of DN can be associated with a heterogeneous range of histological features with many pathophysiological factors involved demonstrating the complexity of the condition. Current treatment plans aim to slow disease progression with little focus on underlying and individual pathological processes.

**Methods:** In the PRIMETIME 2 (PREcision MEDicine based on renal Tissue Molecular interrogation in diabetic nephropathy) study, we will prospectively collect research kidney biopsies from an unselected cohort of 300 participants with type 2 diabetes (T2DM), severe albuminuria (urine albumin/creatinine-ratio ≥ 700 mg/g), and an eGFR > 30 mL/min/1.73 m<sup>2</sup>. The kidney tissue, blood, urine, feces, and saliva samples will be thoroughly investigated with cutting-edge molecular technologies for comprehensive profiling and associated with disease course and clinical outcome with annual follow-up for 20 years. We will use the tissue for a precise histological diagnosis and RNA sequencing to provide a new understanding of the molecular features of DN. Proteomic and metabolomic profiles will be made from urine and plasma. Lastly, we plan to profile the whole genome and microbiome.

Key: TH - Thursday; FR - Friday; SA - Saturday; OR - Oral; PO - Poster; PUB - Publication Only

Underline represents presenting author.

**Results:** We started inclusion on Dec. 2021 from one site. In the nearest future, five other sites will startup. End of Study is scheduled for Dec. 2023, but the inclusion period will probably be extended. We had included ten participants before the abstract submission deadline and performed three biopsies.

**Conclusions:** This study will investigate the prevalence of DN in individuals with T2DM and albuminuria. The deep characterization of the biopsy material and biological specimens may lead to a better understanding of the pathological processes involved and reveal new targets for individualized treatment and improve diagnostic accuracy.

**Funding:** Commercial Support - The Novo Nordisk Foundation, Copenhagen, Denmark, Private Foundation Support

## PUB107

### External Validation of a Predictive Model of Non-Diabetic Renal Disease in Patients With Type 2 Diabetes Mellitus

Bogdan Obrisca,<sup>1</sup> Roxana A. Jurubita,<sup>1</sup> Alexandra Vornicu,<sup>1</sup> Alexandru F. Procop,<sup>1</sup> George Terinte-Balcan,<sup>2</sup> Mihaela Gherghiceanu,<sup>2</sup> Gener Ismail,<sup>1</sup> <sup>1</sup>Fundeni Clinical Institute, Bucharest, Romania; <sup>2</sup>Victor Babes National Institute of Pathology, Bucharest, Romania.

**Background:** We aimed to evaluate predictive factors for non-diabetic renal disease (NDRD) in patients with type 2 diabetes mellitus (T2DM) and to validate a previously proposed predictive model of NDRD (Nefrologia. 2020;40:180-189).

**Methods:** 122 patients with T2DM that underwent a kidney biopsy were included in this study. The predictive model of NDRD scored the presence or absence of the following variables: diabetic retinopathy, chronic ischemia of lower limbs, insulin therapy, nephrotic-range proteinuria, evolution of diabetes  $\geq 10$  years, overweight and hematuria.

**Results:** In the study cohort, 46 patients had diabetic nephropathy (DN) alone, 37 had DN+NDRD and 39 had NDRD alone. All the variables included in the predictive model were significantly associated with the presence of NDRD. After multivariate adjustment, the independent predictors of NDRD were duration of diabetes (OR, 0.85 per 1 y; 95%CI, 0.77-0.94,  $p=0.002$ ), 24-h proteinuria (OR, 0.866 per 1 g/24h; 95%CI, 0.75-0.99,  $p=0.04$ ) and hematuria (OR, 1.016 per 1 cell/mmc; 95%CI, 1.00-1.03,  $p=0.05$ ). The predictive score was significantly lower in patients with NDRD alone ( $-0.06 \pm 2.9$ ), compared to patients with DN+NDRD ( $2.1 \pm 2.9$ ,  $p=0.003$ ) and DN alone ( $3.5 \pm 2.7$ ,  $p<0.001$ ) (Figure 1). A score  $\geq 3$  was encountered in 60.9% of patients with DN alone, 40.5% of those with DN+NDRD and 12.8% of those with NDRD alone ( $p<0.001$ ). The model had a predictive capacity for NDRD with an area under the ROC curve of 0.75 (95%CI, 0.67-0.83;  $p<0.001$ ) and an Youden Index of 0.42 (Figure 1). A score  $< 3$  had a sensitivity of 74% (95%CI, 62-83%) and a specificity of 61% (95%CI, 45-75%) to identify NDRD, with a model accuracy of 69% (95%CI, 60-77%).

**Conclusions:** This predictive model had the capacity to discriminate the presence of NDRD in patients with T2DM, albeit with a predictive capacity inferior to what was previously reported.

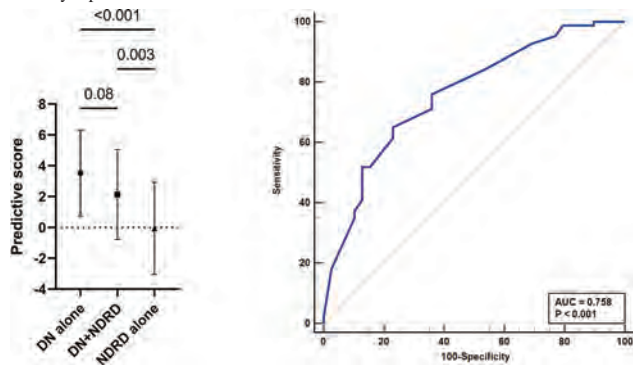

Figure 1

## PUB108

### A Proof-of-Concept Study of CD34+ Cell Therapy for Diabetic Kidney Disease

Pablo E. Pergola,<sup>1</sup> Swetha Mandava,<sup>2</sup> William K. Sietsema,<sup>2</sup> Ronnda L. Bartel,<sup>2</sup> Ann M. Schumacher,<sup>2</sup> Surabhi Sharma,<sup>2</sup> Sapna K. Ghuman,<sup>2</sup> Kristen K. Buck,<sup>2</sup> <sup>1</sup>Renal Associates PA, San Antonio, TX; <sup>2</sup>Caladrius Biosciences Inc, Basking Ridge, NJ.

**Background:** Diabetic kidney disease (DKD) is associated with renal vascular rarefaction. Bone marrow derived hematopoietic CD34+ stem cells are known from preclinical investigations to home to ischemic tissue and promote revascularization. Further, in clinical trials, treatment with CD34+ cells have been shown to improve ischemic diseases including refractory angina, coronary microvascular dysfunction, and critical limb ischemia. CLBS201 consists of autologous, mobilized peripheral blood-derived CD34+ cells. In the current investigation, the safety and potential efficacy of CLBS201 is being evaluated in the treatment of DKD

**Methods:** In this proof-of-concept, open-label study conducted at 1 center in the US, 6 subjects with chronic kidney disease and type 2 diabetes mellitus are treated with

CLBS201 and followed for 26 weeks. At the baseline, subjects are required to have an eGFR of  $\geq 20$  to  $< 45$  mL/min/1.73m<sup>2</sup> and either UACR  $> 300$  to  $\leq 5000$  mg/g OR documented eGFR decline of at least 3 mL/min/year. Subjects are excluded for certain laboratory abnormalities or unstable disease states, or if there is an anticipated need for near term dialysis or kidney transplant. The primary endpoint for the study is change in eGFR at 6 months compared to baseline. Secondary endpoints include slope of eGFR change and change in UACR and UPCR. For preparation of CLBS201, subjects are treated with GCSF 5  $\mu$ g/day for 5 days, then undergo apheresis to collect a mononuclear cell fraction. CD34+ cells are isolated using a magnetic separation method. CLBS201 is formulated as a cell suspension in proprietary media in a 10 mL volume for administration into the renal arteries. The first subject will receive CLBS201 to a single kidney. Subsequent subjects will receive CLBS201 in both kidneys. There will be pauses after the first and second subjects' Day 15 visit to review data for safety before proceeding with further exposures

**Results:** The study was initiated in December 2021 and is expected to complete enrollment mid-2022. Information on study status, baseline demographics, and up-to-date observations will be presented

**Conclusions:** CLBS201 cell therapy may be a promising treatment strategy for diabetic kidney disease

**Funding:** Commercial Support - Caladrius Biosciences

## PUB109

### Relationship Between Plasma Fibrinogen and Prognosis of Type 2 Diabetes With CKD

Huan Li, Lu H. Ding. Sichuan Academy of Medical Sciences and Sichuan People's Hospital, Chengdu, China.

**Background:** Several studies have found that plasma fibrinogen (Fib) is often elevated in type 2 diabetes mellitus (T2DM), but its correlation with the clinicopathological manifestations, prognosis, and pathogenic mechanisms of chronic kidney disease (CKD) in type 2 diabetes are not fully understood. Our study aims to investigate the relationship between plasma Fib levels and clinicopathological profile, renal prognosis in T2DM patients with CKD, to early identify high-risk patients with high likelihood of progression to end-stage renal disease (ESRD).

**Methods:** We conducted a retrospective cohort study, including a total of 277 T2DM patients with CKD (defined as biopsy proven glomerular disease). The patients were classified into diabetic nephropathy (DN) (145 cases) and non-diabetic renal disease (NDRD) (132 cases), according to the pathological findings. T2DM patients with CKD were divided into 4 groups (Q1, Q2, Q3, and Q4), based on quartiles of plasma Fib levels. The renal outcomes were defined by reaching ESRD. The influence of plasma fibrinogen levels on renal outcomes was evaluated using Cox regression analysis.

**Results:** The analysis after grouping T2DM patients with CKD based on plasma Fib level in quartiles, demonstrated that, the groups with higher plasma Fib levels tend to be associated with higher 24-hour urinary protein levels. Importantly, in adjusted analysis, higher plasma fibrinogen level is independently associated with a higher risk of progression to ESRD in T2DM patients with CKD (HR, natural log-transformed plasma Fib per 1 SD is 2.91; 95% CI, 1.43 to 5.93,  $P=0.003$ ). Compared with Q1, the HR values for Q2, Q3 and Q4 were 2.68 (95% CI 1.23-5.84,  $P=0.013$ ), 3.08 (95% CI 1.42-6.68,  $P=0.004$ ), and 2.51 (95% CI 1.15-5.50,  $P=0.021$ ), respectively. For prediction of ESRD, the addition of plasma fibrinogen to gender, age, duration of diabetes, hypertension, 24-hour urinary protein, serum creatinine level, and pathological factors etc increased the area under the receiver operating curve from 0.85 to 0.86. The same analysis was also conducted in DN patients, the area under the receiver operating curve from 0.71 to 0.74.

**Conclusions:** Plasma Fib is an independent risk factor for progression to end-stage renal disease in T2DM patients with CKD, and the addition of Plasma Fib to the traditional prediction models improves the predictive power.

## PUB110

### Impact of Implementation of a Renal Diabetes Multidisciplinary Team Clinic in District General Hospital

Senthilkumar Krishnasamy, Riaz V. Bavakunji, Mohamed Thahir Kolpurka Abdul Samad, Murad Al-Dujaili. Walsall Manor Hospital, Walsall, United Kingdom.

**Background:** Diabetic Kidney Disease (DKD) is the leading global cause of end stage kidney disease (ESKD). So far, there is no meaningful collaboration between specialists who were managing vascular complications in these patients. In recent years there have been multiple advances in the glucose-lowering agents available for the treatment of diabetes, which also have very important benefits of diminishing cardiovascular complications and ameliorating renal disease.

**Methods:** A joint MDT clinic was set up in January 2021 to bring the expertise of Diabetes and Nephrology to maximise benefit for DKD patients. We triaged GP referrals, moved patients from separate diabetes and CKD clinics with DKD. There are 112 patients in clinic out of which 92 analysed due to completeness of data and have had follow up between 6-15 months.

**Results:** The mean age for the cohort was 60 years  $\pm$  14 years; 69% were caucasians, 46% were female. The median HbA1c decreased from 71 (IQR 57-91) mmol/mol at baseline to 62.5. (IQR 48 - 74.2) mmol/mol after 6-15 months. Average body weight decreased by 4.1 kg. At baseline, median eGFR was 50.0 mL/min/1.73m<sup>2</sup> and no significant changes noted over the study period. Median UACR showed significant improvement from baseline to 6-15 months period (64.3 mg/mmol to 34.3 mg/mmol). Modest improvement in total cholesterol (0.2mmol/l) & BNP (41.5pg/ml) were noted. In

all eligible patients, RAAS inhibition was prescribed in 86.6% and 91% received sick day rule card. Most patients had more than 2 treatment changes during the initial review. We introduced GLP1RA for 34% and SGLT2i for 71% at first visit. Kidney Failure Risk Equation (KFRE) improved in 70% patients. No one approached ESRD or developed DKA/Fracture /amputations over the intervention period.

**Conclusions:** The interventions demonstrate early benefits not observed in separate specialist clinics. Patients experience with this new initiative was really positive especially with reduced clinic visit with improvement in clinical parameters. We are hopeful with this MDT Clinic, will prevent future adverse CV and renal events

Table 1. Prospective Data over 6-15 months (Change in relevant parameters)

Outcome	First visit	Follow Up	Change
Weight (Kg) (Mean +/- SD)	97.6 +/- 22.0	93.6 +/- 20.4	-4.1 +/- 5.8
HbA1c (mmol/mol) (Median/IQR)	71 (57, 91)	62.5 (48, 74.2)	-7 (-20.3, 2.3)
eGFR EPI (mls/min) n=90 (Median/IQR)	50 (33, 61)	47 (35, 61)	0 (-3, 2)
Urine ACR (mg/mmol) n=75 (Median/IQR)	64.3 (15.45, 178.85)	34.35 (4.3, 117.9)	31.0 +/- 94.7 (Mean +/- SD)
Brain Natriuretic Peptide (pg/ml) (Median/IQR)	316 (108.5, 1718.25)	207 (73.25, 632.25)	-115 (-60.5, 437)
Total Cholesterol (mmol/l) (Mean +/- SD)	-4.5 +/- 1.3	-4.2 +/- 1.3	-0.2 +/- 1.1

**PUB111**

**Urine Fatty Acids as a Biomarker for Diabetic Kidney Disease Progression**

Hima Sapa,<sup>1</sup> Ali Murra,<sup>4</sup> Stephen J. Ganocy,<sup>1</sup> Kinsuk Chauhan,<sup>2</sup> Steven G. Coca,<sup>2</sup> Jeffrey R. Schelling,<sup>1,3</sup> <sup>1</sup>Case Western Reserve University, Cleveland, OH; <sup>2</sup>Icahn School of Medicine at Mount Sinai, New York, NY; <sup>3</sup>Icahn School of Medicine at Mount Sinai, New York, NY; <sup>4</sup>Northeast Ohio Medical University, Rootstown, OH.

**Background:** Accurate biomarkers to identify risk for diabetic kidney disease (DKD) are not clinically available. In mice apical proximal tubule fatty acid transporter-2 (FATP2) mediates fatty acid uptake, tubular atrophy and DKD progression. Because FATP2 is a high affinity, low capacity transporter, we hypothesized that urine palmitate is a DKD biomarker in humans.

**Methods:** We employed a case-cohort design in a discovery set with family history of DKD and a validation set from the ACCORD trial. Study participants with diabetes and baseline eGFR >60 ml/min/1.73m<sup>2</sup> were evaluated for the primary outcome, incident CKD (eGFR decline by >40% and to <60 ml/min/1.73m<sup>2</sup>). We measured urine palmitate by GC-MS, which was indexed to urine creatinine. Cox regression models were used to determine the association of Upalm:creat with the primary outcome, after adjustment for co-variables (age, sex, race, smoking, baseline eGFR and UACR, diabetes duration, HbA1c, sBP, dBP).

**Results:** The discovery set (34 cases, 148 cohort) had longer follow-up, diabetes duration (18.9 ± 11.8 [SD] yrs), younger age (59.4 ± 8.3 yrs), Blacks (53.5%) and women (66.9%). Higher Upalm:creat was associated with incident CKD (adjusted HR [95% CI] 1.5 [1.3-1.8] per log<sub>e</sub> increase; 15.9 [3.3-76.7] for 4<sup>th</sup> vs. 1<sup>st</sup> quartile). For the validation set (187 cases, 463 cohort; 10.8 ± 7.2 yrs diabetes, 62.2 ± 6.8 yrs, 36.6% Black, 38.6% women), Upalm:creat was not associated with incident CKD (adjusted HR [95% CI] 1.0 [0.9-1.2] per log<sub>e</sub> increase; 0.9 [0.5-1.6] for 4<sup>th</sup> vs. 1<sup>st</sup> quartile).

**Conclusions:** In persons with diabetes and eGFR >60, higher Upalm:creat was associated with increased risk of incident CKD in the discovery set, which was not confirmed in the validation set. Discrepant findings could be due to differences in study populations, including DKD family history and less power in the discovery set. Resolution might be achieved with additional studies, such as inclusion of a well-matched third cohort.

**Funding:** Other NIH Support - Rosenberg grant (CDC grant), Other U.S. Government Support

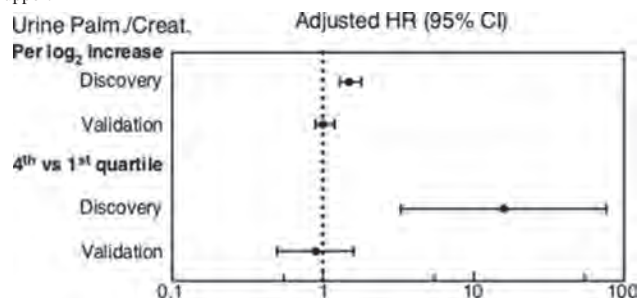

**PUB112**

**Plasma and Urine Biomarkers for CKD Outcomes: A Systematic Review and Meta-Analysis**

Caroline Liu,<sup>1</sup> Neha Debnath,<sup>1</sup> Gohar Mosoyan,<sup>1</sup> Kinsuk Chauhan,<sup>1</sup> George Vasquez-Rios,<sup>1</sup> Celine Soudant,<sup>2</sup> Steven Menez,<sup>3</sup> Chirag R. Parikh,<sup>3</sup> Steven G. Coca,<sup>1</sup> <sup>1</sup>Icahn School of Medicine at Mount Sinai, New York, NY; <sup>2</sup>Memorial Sloan Kettering Cancer Center, New York, NY; <sup>3</sup>Johns Hopkins University, Baltimore, MD.

**Background:** Sensitive and specific biomarkers are needed to provide better biological insight into the risk of incident and progressive chronic kidney disease (CKD). However, studies have been limited by sample size and design heterogeneity. We conducted a comprehensive assessment of the prognostic value of preclinical plasma and urine biomarkers for CKD outcomes.

**Methods:** We searched Embase (Ovid), MEDLINE ALL (Ovid), and Scopus up to November 30, 2020 for studies exploring the association between baseline kidney biomarkers and CKD outcomes (incident CKD, CKD progression, or incident end-stage kidney disease). We used random-effects meta-analysis.

**Results:** We screened 26,456 abstracts, 352 full-text articles and included 129 studies in the meta-analysis for the most frequently studied plasma (TNFR1, FGF23, TNFR2, KIM-1, suPAR, IL-6, GDF-15, UMOD, Endostatin, MCP-1, Galectin-3, and YKL-40) and urine (KIM-1, NGAL, L-FABP, A1M, UMOD, EGF, IL-18, B2M, NAG, MCP-1, YKL-40, and CKD273) biomarkers (Figure). Pooled risk ratios [RRs (95% CI)] for CKD outcomes of the most frequently studied plasma biomarkers were: 2.17 (1.91, 2.47) for TNFR1 (n=31); 1.22 (1.15, 1.28) for FGF-23 (n=30); 2.07 (1.82, 2.34) for TNFR2 (n=23); 1.51 (1.38, 1.66) for KIM-1 (n=18); and 1.42 (1.30, 1.55) for suPAR (n=12). Pooled RRs (95% CI) of the most frequently studied urine biomarkers were: 1.10 (1.05, 1.16) for KIM-1 (n=19) and 1.12 (1.06, 1.19) for NGAL (n=19).

**Conclusions:** Biomarker studies of CKD outcomes are considerably heterogeneous, limiting comparisons of prognostic performance across studies. Plasma TNFR1, FGF23, TNFR2, KIM-1, and suPAR were among the most frequently studied for CKD outcomes.

Figure. Number of Studies and Pooled Relative Risks for Twelve Most Frequently Studied Plasma (A) and Urine (B) Biomarkers for Chronic Kidney Disease Outcomes

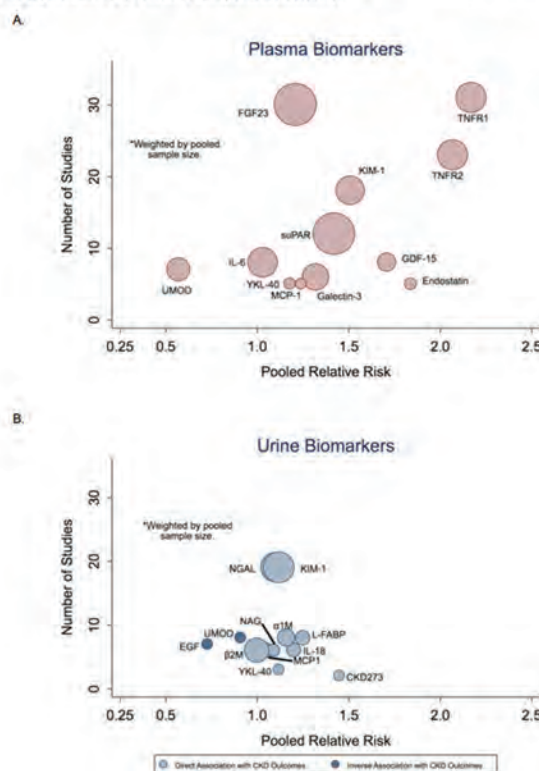

**PUB113**

**Improvement of Blood Glucose Control Using Continuous Glucose Monitoring in Dialysis Patients With Diabetes**

Sua Lee, Eulji University College of Medicine, Daejeon, Republic of Korea.

**Background:** Diabetes is the most common cause of end stage renal disease and as a risk factor of cardiovascular morbidity and mortality in many countries worldwide. Recently, in the management of diabetes, not only reaching the target blood glucose level but also blood glucose stability is considered important. Moreover, glycated hemoglobin A1c (HbA1c) is less accurate in dialysis patients. This study aimed improvement of blood glucose control using continuous glucose monitoring (CGM) in dialysis patients with diabetes.

**Methods:** All patients aged above 18 years, with diabetes mellitus and more than 3 months on hemodialysis or peritoneal dialysis were included from November 2021 to January 2022 in Eulji Medical Center. Patients underwent 2 times CGM during study period. Patients were monitored with self-monitoring blood glucose at least 3 times per day during CGM period. Based on results of baseline study, a dialysis physician modified treatment strategy such as insulin or medication dose and taking time. After 12 weeks, follow-up study was conducted with same protocol of baseline study.

**Results:** Twenty patients who entered the study had a male/female ratio 15/5 and mean age 61.7 ± 10.5 years. Only one patient had type 1 diabetes. Mean diabetes duration was 22.3 ± 7.4 years, and eleven patients (55%) were on insulin therapy such as multiple daily injection or premix insulin or basal insulin plus oral hypoglycemic agents. Patients had a hemodialysis/peritoneal dialysis ratio 18/2 and mean dialysis duration 4.9 ± 3.5 years. Mean blood glucose level were 164.5 ± 36.4 mg/dL at baseline and 150.3 ± 31.9 mg/dL at follow-up study (*p* = 0.026). Mean HbA1c were 7.4 ± 1.3 % at baseline and 6.9 ± 1.1 % at follow-up study (*p* = 0.023). In CGM profile, mean time of target in range (TIR) were 10 hour 57 min ± 6 hour 38 min and 29.2 ± 8.3 (%) at baseline and 14 hour 34 min ± 4 hour 31 min (*p* = 0.009). Glucose area under curve (AUC) over 180 mg/dL were 29.9 ± 25.9 mg/dL/day at baseline and 12.7 ± 10.1 mg/dL/day at follow-up study (*p* = 0.001) without change glucose AUC under 60 mg/dL.

**Conclusions:** In dialysis patients with diabetes, CGM can be useful assessment tool for better glucose control and helpful for improvement of blood glucose level and achievement of blood glucose stability.

**PUB114**

**Gender Type and Age Are Associated With Urinary Neutrophil Gelatinase-Associated Lipocalin (NGAL) in CKD Naïve Individuals**

*Swasti Tiwari, Sukhanshi Khandpur, Mansi Bhardwaj, Shafaque Asif. Sanjay Gandhi Post Graduate Institute of Medical Sciences, Lucknow, India.*

**Background:** Urinary tubular injury markers, kidney injury molecule-1 (KIM-1), and neutrophil gelatinase-associated lipocalin (NGAL), may help in predicting a decline in renal function in individuals with diabetes. However, the role of gender and age in defining urinary KIM-1 and NGAL in individuals with diabetes is not well established

**Methods:** A total of 545 individuals between 18-60 years were enrolled in the study. Urine KIM-1, NGAL, and albumin concentrations were estimated using sandwich ELISA. Urine creatinine was estimated by autoanalyzer (XL-640, Erba Mannheim, Germany), and blood glucose was measured using a handheld glucometer (Blood Glucose and Blood b- Ketone Testing Kit, Abbott Health Pvt. Ltd., India). Diabetes was defined using the International Diabetes Federation guideline. Urinary albumin, KIM-1, and NGAL were normalized with urine creatinine. Albuminuria was defined as urine albumin to creatinine ratio (ACR) ≥30 mg/g.

**Results:** The total cohort included 272(49.9%) males and 273(50.1%) females. Albuminuria was absent in the enrolled subjects. However, 66% of the individuals were found to have diabetes. Although within normal range, ACR was significantly higher in females (Median (IQR):2.04mg/g (1.11-3.97)) when compared to males (Median (IQR): 1.66mg/g (0.62-3.49)) in normoglycemic individuals. Further, urine NGAL (ng/mg creatinine) was also significantly higher in females compared to males. The Median (IQR) of urinary NGAL for individuals with diabetes were: 17.55 ng/mg (8.57) vs 11.37 ng/mg (4.78-26.15), *p*=0.04], and for those without diabetes: 11.93 ng/mg(6.06-29.90) vs 8.47 ng/mg (4.26-18.32), *p*<0.01. Significantly higher levels of NGAL were observed in individuals of age≥45 years (median (IQR): 11.35 ng/mg (5.74-28.77)) when compared to those below 45 years (median (IQR): 9.68 ng/mg (4.26-21.90)) (*p*=0.02). We observed no difference in KIM-1 levels by gender or age in individuals with or without diabetes.

**Conclusions:** Females and individuals older than 45 years had higher urine NGAL levels. Age and gender type need to be considered while establishing the clinical utility of urine NGAL. Funded by Indian Council of Medical Research (ICMR).

**Funding:** Government Support - Non-U.S.

**PUB115**

**Silent Kidney Disease in a Young Diabetic Woman**

*Julio C. Nieto, Pamela Prado, Karina Chimbo Lituma, Pedro Morales Molina, Juan D. Diaz Garcia, Ydris Z. Rosillo-Salgado, Francisco Velasco Garcia Lascrain, Mario Alamilla Sanchez, Julio Manuel Flores Garnica. Instituto de Seguridad y Servicios Sociales de los Trabajadores del Estado, Mexico City, Mexico.*

**Introduction:** Chronic Kidney Disease (CKD) and Diabetes Mellitus (DM) are two non-communicable diseases of global significance. Although, DM is the main cause of CKD worldwide, not all cases of CKD are a direct consequence of DM. Other glomerular diseases such as IgA Nephropathy, Focal Segmental Glomerulosclerosis, Minimal Change Disease and Infection-Related Glomerulonephritis are important causes of nondiabetic renal disease (NDRD) in diabetic patients. Highlighting the importance of kidney biopsy in these patients.

**Case Description:** A 29 year-old woman with a history significant for DM2 of 5 years, in treatment with insulin; Hypertension of 1 year, in treatment with Losartan BID and Nifedipine TID, and Obesity class II; was sent to Nephrology consultation after presenting symmetric pitting edema of the lower limbs and uncontrolled hypertension. Laboratory findings: Hemoglobin: 12.2 gr/dL, Leukocytes: 10.72 x 10<sup>9</sup>/L, Creatinine: 1.26 mg/dL, Blood Urea Nitrogen: 25 mg/dL, Triglycerides: 185 mg/dL, Cholesterol: 150 mg/dL, Albumin: 3.9 gr/dL, HbA1C: 6%. A 24 hour urine sample with 3.6 grams of proteins, normal complement levels, positive antinuclear antibodies (ANA) with a fine speckled pattern 3+ and negative extractable nuclear antigens were obtained. Kidney

biopsy was performed with histological finding of focal and segmental glomerulosclerosis tip lesion variant plus acute interstitial nephritis with eosinophil infiltrate and grade 2 interstitial fibrosis.

**Discussion:** NDRD ranges from 33% to 72.5% among patients with DM and It should be suspected in a diabetic patient with persistent decrease in glomerular filtration rate (GFR), markers of kidney injury such as proteinuria and a relatively recent diagnosis of DM without evidence of microvascular damage. The presence of Nephrotic Syndrome, glomerular hematuria and a decrease in GFR > 5 ml / min / 1.73 m2 per year, are among the indications to perform a kidney biopsy in diabetic patients. Allowing us to unmask a silent kidney disease.

**PUB116**

**Diabetic Kidney Disease Progression Risks in US Veterans**

*Kibum Kim,<sup>1,2</sup> Heather A. Nyman,<sup>3,4</sup> Jacob L. Crook,<sup>2,5</sup> Chao-Chin Lu,<sup>2,5</sup> Richard E. Nelson,<sup>2,5</sup> Joanne LaFleur,<sup>6,7</sup> DeCIPHER<sup>1</sup> University of Illinois at Chicago College of Pharmacy, Department of Pharmacy Systems, Outcomes and Policy, Chicago, IL; <sup>2</sup>VA Salt Lake City Health Care System, Salt Lake City, UT; <sup>3</sup>University of Utah College of Pharmacy, Department of Pharmacotherapy, Salt Lake City, UT; <sup>4</sup>University of Utah Hospitals and Clinics, Department of Pharmacy, Salt Lake City, UT; <sup>5</sup>University of Utah School of Medicine, Division of Epidemiology, Salt Lake City, UT; <sup>6</sup>University of Utah Department of Pharmacotherapy, Salt Lake City, UT; <sup>7</sup>COIN Informatics Decision-Enhancement and Analytic Sciences Center, Salt Lake City, UT.*

**Background:** In the Veteran’s Health Administration (VHA), patients at high risk of diabetic kidney disease (DKD) require interventions to delay progression to end-stage disease. We examined progression rates for DKD stages 3-5 in US veterans.

**Methods:** We identified veterans with type 2 diabetes (T2D) and DKD using diagnosis codes, prescription records, problem lists, and lab test results from October 2015 through 2021. Prevalent and incident DKD stages were characterized using KDIGO definitions. We used descriptive statistics to characterize the cohort and DKD stage prevalence and incidence rates.

**Results:** Out of 2.1 million US veterans with T2D, most (1.5 million [75.1%]) had reduced renal function (<90 mL/min/1.73m<sup>2</sup>). The mean age was 67.9, and most were male (95.3%) and White (72.4%), Black (19.0%) or Asian American (2.2%). Prevalent and incident DKD stage findings are in the Table. At baseline, 37.6% of T2D veterans with below-normal renal function had DKD. Over a mean follow-up time of 3.3 years, their annual risk of progressing to stages 3-5 was 10.8%. For veterans with prevalent DKD stages 3-4, annual risks of progressing were 26.5%, 16.1%, and 24.5% for stages 3a, 3b, and 4, respectively.

**Conclusions:** Only 4.6% of the VHA’s large T2D population had DKD stages 4-5. Another 58% had filtration rates <90, with about 47.9% of these progressing to higher stages annually (121,000 veterans). These findings suggest that interventions are needed to slow DKD progression at early stages, minimizing the burden of DKD in this population.

**Funding:** Commercial Support - Renalyticx

*Table. Prevalent DKD stage (according to eGFR and UACR/PCR laboratory results) and incidence rates for first stage progression in US veterans with DKD*

<b>Prevalent stage</b>	<b>Prevalence Frequency (%)</b>	<b>Incidence per 1000 PY (95% CI)</b>
<b>Any</b>	<b>753,933 (100.0)</b>	<b>116.8 (116.4, 117.2)</b>
<b>Stage 1</b>	<b>58,107 (7.7)</b>	<b>888.4 (885.7, 891.1)</b>
<b>Stage 2</b>	<b>59,192 (7.9)</b>	<b>174.6 (172.7, 176.6)</b>
<b>Stage 3a</b>	<b>517,001 (68.6)</b>	<b>129.2 (128.3, 129.4)</b>
<b>Stage 3b</b>	<b>84,606 (11.2)</b>	<b>153.6 (152.1, 155.2)</b>
<b>Stage 4</b>	<b>23,725 (3.1)</b>	<b>251.2 (247.3, 255.2)</b>
<b>Stage 5</b>	<b>11,302 (1.5)</b>	<b>-</b>

*Abbreviations: DKD, diabetic kidney disease; eGFR, estimated glomerular filtration rate; UACR, urinary albumin-creatinine ratio; PCR, protein-creatinine ratio; PY, person years; eGFR, estimated glomerular filtration rate; CI, confidence interval*

PUB117

**Improving Care in Diabetic Kidney Disease: Identifying the Implementation Gap**

Prakash S. Gudsoorkar,<sup>1</sup> Nicole Piero,<sup>1</sup> Karthikeyan Meganathan,<sup>1</sup> Begonia Campos,<sup>1</sup> Charuhus V. Thakar.<sup>1,2</sup> *University of Cincinnati, Cincinnati, OH; <sup>2</sup>Cincinnati VA Medical Center, Cincinnati, OH.*

**Background:** Diabetic kidney disease (DKD), the leading cause of end-stage kidney disease (ESKD), is associated with excess mortality in patients with diabetes mellitus (DM). Narrowing the implementation gap by embracing emerging therapies is quintessential for improving patient outcomes in DKD. In our study we evaluated the gaps in care of assessment of proteinuria in DKD as well as usage of disease modifying therapies.

**Methods:** This observational cohort study included adult patients attending renal clinic (Jan 2019 – Dec 2019) at a tertiary academic health center with a diagnosis of DKD (Stage 1 – 5). Exclusions included Type 1 DM, solid organ transplants and ESKD. The first available nephrology clinic visit was considered as an index visit. Eligible patients were assessed for DKD severity based on the estimated glomerular filtration rate and presence of proteinuria. Conformity to treatment was assessed based on use of renin angiotensin system inhibitors (RASi), mineralocorticoid antagonists (MRA) and SGLT2 inhibitors (SGLT2i). Informatics approaches extracted all clinical and laboratory information. Chi-square tests were used for comparison across groups.

**Results:** 1,330 patients whose serum creatinine measurements were available were included in the study of which 70% had CKD Stage 3 or better and 30% had CKD Stage 4/5. Cohort was 52% male, 54% white, 50% of them between ages of 60-75, and Medicare as a primary payor in 60%. 711/1,330 (54%) had presence of proteinuria; it was 61% in CKD 4/5. 917/1,330 (69%) had verifiable prescription information. Of those patients, 72.5% were on insulin. Usage of DKD modifying therapy was 8% for SGLT2i, 76% for RASi and 22% for MRA agents. Usage of these agents was higher in presence of proteinuria [SGLT2i 10% vs 6% (p=0.018); RASi 81% vs 69% (p<0.0001); MRA 25% vs 19% (p=0.0515)]. Medication usage was lower in CKD 4/5 compared to other stages [SGLT2i 2% vs 11% (p<0.0001); RASi 70% vs 78% (p=0.0212); MRA 18% vs 24% (p=0.065)].

**Conclusions:** By informatics based approach we demonstrate gaps in care of evaluation and treatment of DKD in a tertiary referral center. Both proteinuria and CKD stage influence usage of necessary therapies. Adoption of clinical pathways may narrow implementation gap in DKD management, and allow in improving patient outcomes.

PUB118

**Blood Pressure Patterns and Associated Factors in Chronic Haemodialysis Patients at Korle Bu Teaching Hospital**

Edward P. Kwakye, Dwomoa Adu, Vincent W. Boima. *University of Ghana School of Medicine and Dentistry, Accra, Ghana.*

**Background:** Patients on chronic haemodialysis are predisposed to a number of abnormal blood pressure (BP) patterns either as a result of their underlying kidney dysfunction or the haemodialysis process. These abnormal BP patterns are associated with morbidity and mortality. BP patterns in chronic haemodialysis patients are yet to be studied in a Ghanaian population.

**Methods:** This was a cross-sectional, hospital-based study in which 135 patients aged 18 years and above on chronic haemodialysis at the Korle Bu Teaching Hospital (KBTH) were recruited. Patients had their history and demographic data recorded using a questionnaire. Their haemodialysis parameters were also documented. BP readings were recorded at home and during haemodialysis for all patients. Multivariate logistic regression analysis was used to determine associated factors with the BP patterns identified.

**Results:** A total of 130 patients were analysed. The mean age was 44.58±13.98 years with 61% of the patients aged between of 30 – 60 years. The BP patterns identified were: hypertension, intradialytic hypertension and normotension. The prevalence of hypertension by BP measurement method used was: home interdialytic BP: 74.62% (95% CI = 65.51-80.86), peridialytic BP: 86.15% (95% CI = 78.98-91.12) and peridialytic plus intradialytic BP: 86.92% (95% CI = 79.86-91.76). The prevalence of intradialytic hypertension and normotension were 26.9% and 10% -21% (depending on the BP measurement method) respectively. No patients met the criteria used for intradialytic hypotension. Using home interdialytic BP measurements as the standard for hypertension, peridialytic BP measurements had a sensitivity of 82% and a specificity of 78%. Peridialytic plus intradialytic BP measurements had a sensitivity of 82.3% and a specificity of 82.4%. Factors associated with a higher risk of hypertension were high (>2 kg) interdialytic weight gain, haemoglobin (Hb) <10 g/ dL and self-sponsored haemodialysis. Hb <10 g/dl was associated with a higher risk of intradialytic hypertension.

**Conclusions:** The BP patterns prevalent in patients on chronic haemodialysis at KBTH were hypertension, intradialytic hypertension and normotension. Peridialytic or peridialytic plus intradialytic BP measurements may be used instead of home interdialytic BP measurements to screen patients on chronic haemodialysis for hypertension.

PUB119

**A Case of Idiopathic Hypereosinophilic Syndrome in a Hemodialysis Patient**

Jeongmyung Ahn, Joon Seok Oh, Joong Kyung Kim. *BongSeng Memorial Hospital, Busan, Republic of Korea.*

**Introduction:** Idiopathic hypereosinophilic syndrome is a rare disorder characterized by hypereosinophilia and damage to multi-organ, which include lungs, heart, skin, nervous system, and gastrointestinal(GI) tract. In the event of organ damage that requires immediate treatment, diagnosis is possible regardless of the duration.

**Case Description:** A 69-year-old male patient was admitted for intradialytic hypotension, fever, abdominal pain and diarrhea. He had been undergoing hemodialysis for 30 months. Previously he had hypertension, gout, BPH, psoriasis, severe gastric and duodenal ulcers. At the time of hospitalization, antibiotics were administered because he had fever and an increased CRP. Despite antibiotic treatment, his symptoms did not improve at all. Due to intradialytic shock, we changed his dialysis method from conventional HD to CRRT. During CRRT, his symptoms such as GI symptoms, intradialytic hypotension and post-dialytic fever, improved. After switching to conventional hemodialysis, similar symptoms occurred again, and consistent eosinophilia was observed. We recognized that the patient's symptoms were correlated with conventional hemodialysis. Although we changed dialysis membranes, blood flow rates, and dialysate flow rates, his symptoms and eosinophilia did not improve. We diagnosed him with Idiopathic hypereosinophilic syndrome and administered steroid 0.5mg/kg/day. Within one day, his symptoms improved, and dialysis became possible. Currently, his symptoms have completely improved, and low dose steroid has been maintained.

**Discussion:** We report a case, which was a hemodialysis patient with idiopathic hypereosinophilic syndrome, treated by using steroids. Steroids may be an effective treatment for idiopathic hypereosinophilic syndrome in HD patients.

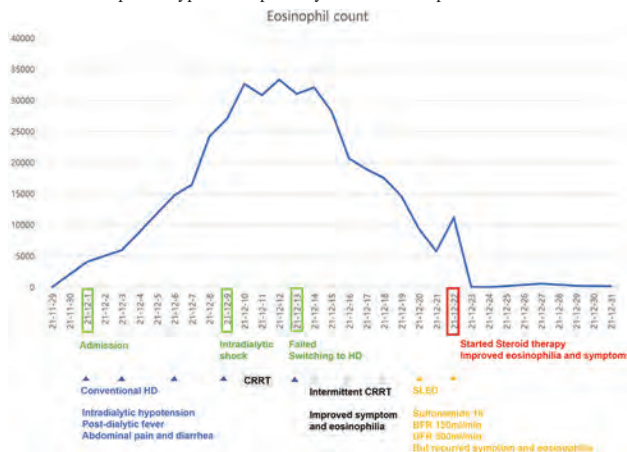

PUB120

**Conserving Water and Dialysate During Inpatient Dialysis Sessions**

Belal I. Hakim, Mario R. Funes Hernandez, Fahmeedah Kamal, Pedram Fatehi, Tammy L. Sirich. *Stanford Medicine, Stanford, CA.*

**Background:** Assessing hemodialysis adequacy for inpatients remains poorly understood. The applicability of outpatient targets such as the urea reduction ratio (URR) to inpatients has not been systematically studied, yet is a marker measured in our hospital. Furthermore, the average baseline dialysate flow rate employed in our institution exceeds the rate that is sufficient to achieve adequate dialysis per guidelines. Patients receiving hemodialysis have their URR measured when our nurses anticipate they will remain longer than 3 sessions. Our current practice is to prescribe a standard dialysate flow rate of 700ml/min for all established patients. We aimed to improve the quality of our inpatient dialysis unit by educating providers about the conservation benefits of dialysate flow rates that can be employed without any decrement to the adequacy of dialysis treatments.

**Methods:** We educated prescribing providers of the minimal impact of a Qd exceeding 1.5 times the Qb on measured URR, and proposed that a new universal standard of 600ml/min be implemented. Providers maintained the ability to prescribe any dialysate flow rate they felt appropriate for the patient. Measurements of URR continued as per standard dialysis practice. Data from one month prior to and after the education intervention were reviewed.

**Results:** In the one month preceding the intervention, 49 dialysis sessions had a measured URR, and there were 44 sessions in the month immediately after. The average pre-BUN, post-BUN, blood flow rate and treatment time were not statistically different.

The prescribed average dialysate flow rate was 686ml/min pre-intervention and 620ml/min post-intervention (p = 0.000002). Despite this, there was no statistically significant difference in measured URR (p = 0.19). The average used dialysate volume per session decreased from 138L to 130L (p = 0.04).

**Conclusions:** Decreasing the standard dialysate flow rate for acute inpatients had no impact on measured URR. While this confers modest dialysate concentrate and water savings per patient, the net effect of multiple daily sessions over a prolonged period of time offers important conservation benefits to any dialysis unit.

	# of Encounters	Pre BUN (mg/dl)	Post BUN (mg/dl)	Wt (kg)	Qb (ml/min)	Qd (ml/min)	Qd/Qb	Treatment Time (hrs)	URR	Total Dialysate Volume (L)
Average Pre-Intervention	49	63	19	76	360	686	1.91	3.37	0.69	138
Average Post-Intervention	44	56	19	78	365	620	1.71	3.47	0.67	130
Unpaired two-tailed p value		0.14	0.93	0.71	0.44	0.000002	0.0000001	0.18	0.19	0.04

**PUB121**

**Hyperkalemia Prevalence, Practice Pattern, and Mortality in Chinese Hemodialysis Patients: Visualize-HD Study**

Xinju Zhao,<sup>1</sup> Jianwei Ren,<sup>2</sup> Yan Xu,<sup>3</sup> Yingchun Ma,<sup>4</sup> Haidan Zhao,<sup>5</sup> Jinghong Lei,<sup>6</sup> Li Zuo.<sup>1</sup> <sup>1</sup>Department of Nephrology, Peking University People's Hospital, Beijing, China; <sup>2</sup>Department of Nephrology, Aviation General Hospital, Beijing, China; <sup>3</sup>Department of Nephrology, Emergency General Hospital, Beijing, China; <sup>4</sup>Department of Nephrology, Beijing Boai Hospital, China Rehabilitation Research Center, Captain Medical University, Rehabilitation Medical College, Beijing, China; <sup>5</sup>Department of Nephrology, Peking University Shougang Hospital, Beijing, China; <sup>6</sup>Department of Nephrology, Beijing Aerospace General Hospital, Beijing, China.

**Background:** Hyperkalemia (HK) is a potentially life-threatening disorder in maintenance hemodialysis (MHD) patients associated with ventricular arrhythmias and sudden cardiac arrest. However, studies on the descriptive epidemiology of HK in China and management of potassium and crude mortality are scarce. The aim of this study was to examine HK prevalence, associated practice patterns and mortality in HD patients in China.

**Methods:** This is a multicenter, observational study. Data about serum potassium (sK), patient characteristics, practice patterns, and death records were collected. Continuous and categorical variables were summarized by descriptive statistics and frequency (percentages) respectively.

**Results:** In total, 1096 patients (61% Male) from 6HD centers having age distribution as 18-44(yrs) 11.8%, 45-64(yrs) 43.3%, 65-74(yrs) 27.6%, ≥75(yrs) 17.3% were enrolled. The dialysis vintage distribution of <5yrs; 5-10yrs; ≥10yrs was 56%, 32% and 12%, respectively. Nearly 30% patients were using renin angiotensin aldosterone system inhibitors. Nearly 20% patients were using K<sup>+</sup>-lowering drugs. 2.0mmol/L was the most common dialysate K<sup>+</sup> concentration (utilization rate 70%). There were 91% of patients on regular dialysis thrice a week. Most patients (94%) tested sK once every month. The prevalence of HK (sK>5.0mmol/L) in Beijing HD patients was 44%. The proportion of sK>5.5 mmol/L,>6.0 mmol/L,>6.5 mmol/L was 20%, 7%, and 3%, respectively. The 3-year cumulative mortality of HD patients was 25% and 37% patients had HK on the last sK test before death. HK or acute cardiovascular events accounted for 22% of death causes.

**Conclusions:** High HK prevalence is evident in Chinese HD patients and HK management is paramount as it is an important component for the death in HD patients.

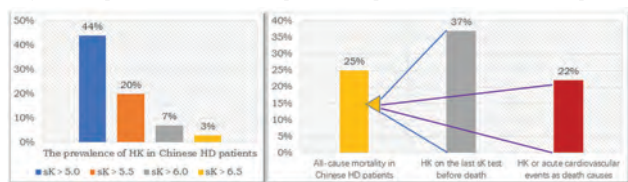

Clinical outcome of HK in Chinese HD patients

**PUB122**

**Giant Mesenteric Cyst in a Patient Who Had Peritoneal Dialysis for 10 Years**

Clementina Elizabeth Calderon Garcia,<sup>1,2</sup> Guillermo Navarro Blackaller,<sup>1,2</sup> Jonathan Chavez,<sup>1,2</sup> Ana E. Oliva,<sup>1,2</sup> Frida Margarita de la Vega Méndez,<sup>1,2</sup> Alexia Romero,<sup>1,2</sup> <sup>1</sup>Hospital Civil de Guadalajara Unidad Hospitalaria Fray Antonio Alcalde, Guadalajara, Mexico; <sup>2</sup>Universidad de Guadalajara Centro Universitario de Ciencias de la Salud, Guadalajara, Mexico.

**Introduction:** We present the case of a 30-year-old man with a history of chronic kidney disease of 11 years of diagnosis, a based on peritoneal dialysis for 10 years, during this period he presented peritonitis refractory, and suspected sclerosing peritonitis was made, and he was transferred a hemodialysis.

**Case Description:** The patient presented with a progressive and painful increase in the abdominal perimeter that did not decrease with ultrafiltrate in hemodialysis sessions. An abdominal CT scan showed a giant mesenteric cyst measuring approximately 22 x 17 x

22 cm with a volume of 4,344 cubic centimeters, that was drained percutaneously through a multipurpose catheter without microbiological isolation and negative for malignancy.

**Discussion:** Mesenteric cysts are uncommon abdominal tumors, with an incidence ranging from 1 per 100,000 in adults, with varied symptomatology from asymptomatic to acute or chronic vague abdominal pain, increased abdominal perimeter. In 2010 a similar case was reported in the journal Nephrology Dialysis Transplantation of the University of Oxford, where a 55 years old woman on hemodialysis but previously on peritoneal dialysis and with a history of recurrent peritonitis and suspected sclerosing peritonitis with a giant mesenteric cyst. Giant mesenteric cysts are rare abdominal tumors. In the literature there are few cases where this tumor is related to peritonitis secondary to peritoneal dialysis catheter. The treatment of choice is complete excision of the cyst, in our case, it was treated with prolonged percutaneous drainage, so far without recurrence.

**PUB123**

**Dialysis Patients' Preferences for Pain Management at End of Life: A Discrete Choice Experiment**

Ania Filus,<sup>1</sup> David A. Roer,<sup>2</sup> Steven M. Brunelli,<sup>1</sup> Francesca Tentori,<sup>1</sup> <sup>1</sup>Davita Clinical Research, Minneapolis, MN; <sup>2</sup>DaVita Inc, Denver, CO.

**Background:** Quality of care at the end of life (EoL) is an important topic for ESKD patients. Previous results indicate that the level of pain management is the most important attribute of care among dialysis patients at the end of life. We conducted a discrete choice experiment to evaluate patients' preferences for aspects of pain management.

**Methods:** An online survey conducted in February-March 2022 collected data from 233 in-center and 98 home dialysis patients and tested the relative importance of two aspects related to daily pain management: (i) the intensity of pain (mild, moderate, severe) and (ii) the duration of pain (1 hour, 5 hours, 24 hours). We utilized a block fraction factorial design with 3 blocks and 3 questions within each block.

**Results:** Results of this study indicate that pain intensity and duration were important attributes of pain management at the end of life. Patients ranked pain intensity from most preferred to least preferred as mild, moderate, severe. Results were similar with regards to pain duration; patients preferred 1 hour over 5 hours or 24 hours. Additionally, results indicate that patient preference for pain management at the end of life is an interaction of both pain intensity and duration, and depends on the initial level of pain intensity and duration a patient is experiencing. For example, a patient who is in severe 24 hour pain daily will find it more attractive to reduce their pain intensity from severe to mild than to reduce daily pain duration from 24 hours to 5 hours (Figure 1).

**Conclusions:** Pain management with respect to intensity and duration are both significant aspects of quality of care at the end of life among ESKD patients. Results from this study can help inform dialysis clinics' approach towards discussing pain management at EoL and palliative care.

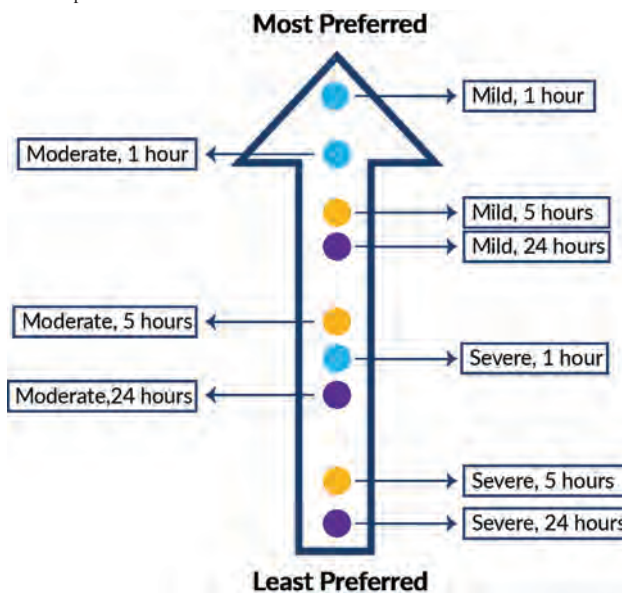

**PUB124**

**Halving Sodium Heparin While Maintaining Dialytic Clearances During Hemodiafiltration With an Asymmetric Cellulose Triacetate Membrane**

Antonino Sidoti,<sup>1,2</sup> Beatrice Braccagni,<sup>1,2</sup> Marina Biagioli,<sup>1,2</sup> Nephrology unit Poggibonsi-Siena Italy <sup>1</sup>Nefrologia Valdelsa, Poggibonsi, Italy; <sup>2</sup>USLSUDEST, Poggibonsi, Italy.

**Background:** Computed tomography studies showed no significant filter coagulation while reducing by 50-75% heparin sodium (Hep) in extracorporeal circuit during in vitro hemodiafiltration (HDF) with an asymmetric cellulose triacetate filter. We checked if a 50% Hep reduction affects dialytic clearance (KD) during high volumes HDF.



**Methods:** Six patients (Pts) more than a year on hemodialysis with no residual kidney function participated. They had a two weeks HDF course, on a count of 3 sessions every week, using a Solacea 21H Nipro filter. 1st week (1stW) had same Hep dose of previous dialysis treatments, second week (2ndW) had an average of 54.7% Hep reduction. Treatments lasted 240', 2 Pts out of six at 210'. Hep was given as a bolus at start and as continuous infusion afterward, stopping Hep pump 15' before HDF end. aPTT was performed at 0', 30', 60', 120', 180', HDF end, at 1stW and 2ndW start. KD was acquired from the dialysis machine at 30', 120' and HDF end, Pts used always same machine (Baxter, Nipro, Medtronic) during 1stW and 2ndW. Ultrafiltration (UF), liters of blood treated (LTr), infused (Linf) were recorded for each HDF. Comparison of 1stW and 2ndW averages were made by paired t Student test, statistical significance set at p<0.05

**Results:** KD 1stW and 2ndW (table 1) pNS, average 239 1stW vs 236 ml/min' 2ndW; being UF 1stW 3.088, 2ndW 2.88 pNS, LTr 1stW 75.5 2ndW 77 pNS; Linf 1stW 20.54, 2ndW 21.63 pNS (Table 2); pNS for aPTT comparing 120' 180' and HDF end to aPTT basal level. Tiny signs of coagulation at venous drip chamber in two dialysis session 2ndW for pts 4 and 6.

**Conclusions:** KD doesn't change during high volume HDF even with an aPTT near to basal level, as seen in the second half of dialysis. Solacea filters can be used with minimal Hep doses without affecting dialysis adequacy.

**Funding:** Government Support - Non-U.S.

	Timing	KD Average 1stW ml/min'	KD Average 2ndW ml/min'
HDF 1	30'	249	255
	120'	238	232
	end	238	231
HDF 2	30'	254	246
	120'	238	233
	end	223	223
HDF 3	30'	265	247
	120'	237	237
	end	219	226

Pts	Hep		aPTT 0'	aPTT 30'	aPTT 60'	aPTT 120'	aPTT 180'	HDF end
	U/kg/1stW	Pts weight kgs						
1	79	67.5	28	92	82	73	59	39
2	66	60.4	25	102	81	64	36	33
3	54	98	23	72	57	42	34	36
4	82	59	27	104	91	78	75	47
5	93.5	46	30	178	168	165	83	67
6	81	83	32	90	83	66	68	50

Pts	Hep		aPTT 0'	aPTT 30'	aPTT 60'	aPTT 120'	aPTT 180'	HDF end
	U/kg/2ndW	Δ%1stW-2ndW						
1	37.5	-52.53	33	42	44	36	36	32
2	52	-21.21	29	45	42	32	31	30
3	27.5	-49	29	42	34	33	35	30
4	30.5	-62.8	23	48	42	38	36	33
5	35	-62.56	34	39	33	34	32	32
6	27	-66.6	31	45	43	38	33	33

**PUB125**

**Two Cases of Tandem Therapy With New Sell Adsorption Type Blood Purification Device Rheocarna™ and Online Hemodiafiltration for Hemodialysis Patients With Arteriosclerosis Obliterans**  
 Toshihide Naganuma, Kentaro Shin, Yoshiaki Takemoto, Junji Uchida. *Osaka Koritsu Daigaku, Osaka, Japan.*

**Introduction:** In Japan, new sell Adsorption Type Blood Purification Device Rheocarna™ (KANEKA CORPORATION) has been available for patients with the most severe form of arteriosclerosis obliterans (ASO). However, there is a disadvantage in performing the treatment on non-dialysis days or after the completion of dialysis, as the patient is restrained for long periods of time. Therefore, we report on an opportunity to use Rheocarna™ in tandem with online hemodiafiltration (OHDF) to reduce patient restraint time.

**Case Description:** Two hemodialysis patients with diabetic nephropathy as etiology and with Fontain classification IV ASO were included in the study. The patients were placed on Rheocarna™ due to worsening leg ulcers. Rheocarna™ was connected in parallel series to OHDF, and each monitoring value and blood pressure were measured every 30 minutes. The tandem therapy was performed in two ways: arterial (A-side) and venous (V-side) connection. Case 1 was connected 9 times on the A side and 13 times on the V side. Case 2 had 3 A-side connections and 6 V-side connections. The pressure in the circuit was significantly higher for the A-side connection. Systolic blood pressure remained stable during treatment (Figure 1).

**Discussion:** Although the tandem therapy is a complicated procedure and requires higher alarm settings than usual because the pressure is higher than when performed alone, the combination therapy of Rheocarna™ and OHDF was considered to reduce the patient's restraint time. In addition, both the A-side and V-side connections were considered to provide functionally stable treatment. In particular, the V-side connection is considered to provide more functionally stable treatment because the intra-circuit pressure remains low and the hypotension remains high, reducing the effect of pressure. In conclusion, we experienced two cases in which combination therapy of Rheocarna™ and OHDF was safely administered without trouble.

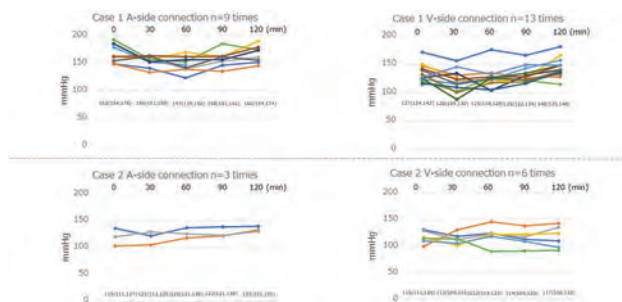

**PUB126**

**Frequent Circuit Clotting in a COVID-19 Patient on ECMO and CRRT**  
 Bijin Thajudeen. *Banner University Medical Center Tucson, Tucson, AZ.*

**Introduction:** A striking feature of COVID-19 is the high frequency of thrombosis, particularly in patients who require admission to the intensive care unit because of respiratory complications (pneumonia/adult respiratory distress syndrome). The spectrum of thrombotic events is broad, including in situ pulmonary thrombosis, deep-vein thrombosis, associated pulmonary embolism, and arterial thrombotic events. We report a case of frequent filter clotting secondary to heparin.

**Case Description:** A 37-year-old Hispanic male patient was admitted to the hospital with complaints of fatigue, cough, and shortness of breath. After his positive PCR result, he was diagnosed with SARS-CoV2 infection. He was transferred to the intensive care unit due to worsening hypoxia with subsequent intubation and mechanical ventilation. Due to persistent hypoxia, extracorporeal membrane oxygenation was started along with heparin anticoagulation. Around this time, he also had a drop in urine output due to acute kidney injury. With the initiation of ECMO, CRRT was started for volume and electrolyte management. Two days after the start of ECMO and CRRT, frequent clotting of the CRRT filter and the ECMO circuit was noticed. There was a simultaneous drop in platelet count as well. The reduction in platelet count and regular filter clotting was initially attributed to covid 19. But with increasing frequency of clotting episodes, we performed anti-PF4/Heparin antibody test, which was positive, confirming heparin-induced thrombocytopenia. Given HIT, anticoagulation was transitioned to argatroban, which resulted in the resolution of frequent clotting of both CRRT and ECMO circuits. Thrombocytopenia also resolved.

**Discussion:** This case highlights the importance of considering HIT as one of the reasons for hypercoagulability in patients with covid 19. There is an increased risk of HIT in patients with covid 19.

**PUB127**

**Risk Factors for Admission Among Dialysis Patients in Southeast North Carolina**  
 Andrew Lee, Hsiao L. Lai. *East Carolina University, Greenville, NC.*

**Background:** Hospitalizations account for nearly a third of cost of care for hemodialysis patients. There are many reasons for admission in this population. The purpose of this quality improvement project is to determine the common admission diagnoses for hemodialysis patients in southeast North Carolina and identify modifiable risk factors.

**Methods:** The hospital medical record for Vidant Medical Center, the largest hospital serving southeast North Carolina was reviewed from 1/1/2021 to 1/1/2022 for admissions from the local outpatient dialysis unit. Admission diagnoses included access related admissions, infection, anemia, acute coronary syndrome, cerebral vascular accident, and missed dialysis.

**Results:** Out of 135 patients, there were 250 admissions over a period of 1 year among 91 patients. 44 patients (~33%) had no admissions over this time. Admissions related to access issues or dialysis-treatment issues accounted for the top 2 reasons for admission at 26% each. Most access related issues were for creation or revision with 7 admissions for infected vascular access. Half of all dialysis-related admissions were due to shortness of breath. Non-access related infections accounted for a total of 59 admissions. Anemia and gastrointestinal bleeding accounted for 16 admissions.

**Conclusions:** Dialysis access management which vascular access centers help control admission rates with only two admissions for permcath placement. Missed dialysis resulting in volume overload, hyperkalemia and hypertensive emergency occurs frequently. Much attention is paid in the outpatient setting to volume management, but patient compliance can be difficult to manage. Infections accounted for almost a quarter of admissions. A high prevalence of risk factors such as: diabetes, hypertension, cardiovascular disease and a high prevalence of protein malnutrition in this population are likely contributors. Anemia admissions accounting for 5% of the total, were mostly secondary to gastrointestinal bleeding rather than due to anemia of chronic disease. The average number of admissions per patient was 1.85 per year. If we exclude the 44 patients who did not get admitted the average number of admissions was 2.7 per year. Of the remaining 91 patient's requiring hospitalization, 21 of these patient's had more than 3 admissions.

**PUB128**

**Anti-Depressing Intradialytic Blood Pressure**

Antonio Corona, Northwell Health, New Hyde Park, NY.

**Introduction:** Intradialytic hypotension (IDH) is a frequently encountered complication of hemodialysis, with a prevalence of more than 10% of treatments. It causes debilitating symptoms, access thrombosis and under-dialysis. Furthermore, it is associated with poor outcomes, correlating negatively with cardiovascular and all-cause mortality. Interventions such as sodium modeling, cooled dialysate and vasopressors have been used to mitigate IDH, but despite these, refractory IDH cases remain difficult to manage. The following case describes a lesser known therapeutic option: Sertraline.

**Case Description:** A 66 y.o. M was referred to our Palliative Nephrology service for symptom management. His medical history included for end stage kidney disease on hemodialysis, coronary artery disease, heart failure, and peripheral vascular disease (PVD). His primary complaint was uncontrolled pain in his legs consistent with neuropathy due to PVD. His hemodialysis was complicated by IDH, with systolic blood pressures (SBP) of 80-90 mm Hg, despite midodrine. His low SBP limited the patient's ultrafiltration (1.2L on average that month), and furthermore, precluded his use of opioid analgesics, often leading to acute pain crises. Sertraline was started for his neuropathic pain and for his IDH. The initial dose was 50mg and then uptitrated to 100mg after two weeks. After an 8 week follow-up, his SBP improved to a range of 84 to 96 mm Hg with an increase in average volume removal of 1.5L. He reported improved subjective pain scores as well.

**Discussion:** Sertraline is a selective serotonin reuptake inhibitor anti-depressant medication. Although there are studies of its use in the hemodialysis population, the sample sizes are usually small and not placebo-controlled. Regardless, it has been described as having a positive effect on IDH by an average of 8.7mmHg in some case series. The mechanism is not well understood but the theory is that it can have vasodilatory and vasoconstrictive effects in different vascular beds in the circulatory system, mediated by pre-junctional S1 receptors and S2 receptors on smooth muscle. It has also been used as first-line for neuropathic pain, by acting on serotonin-mediated analgesic pathways. It is a well-tolerated drug for patients with kidney insufficiency with no dose adjustments necessary based on clearance. Sertraline can serve as an available, safe, therapeutic option for dialysis patients with IDH.

**PUB129**

**Efficacy of Paricalcitol in the Treatment of Secondary Hyperparathyroidism in Maintenance Hemodialysis Patients**

Santao Ou, The Affiliated Hospital of Southwest Medical University, Luzhou, China.

**Background:** To investigate the efficacy of paricalcitol on maintenance hemodialysis (MHD) patients with secondary hyperparathyroidism (SHPT).

**Methods:** Using the self-control method, 101 patients undergoing MHD with SHPT in the Affiliated Hospital of Southwest Medical University from September 2019 to December 2021 were retrospectively collected. The patients were treated with paricalcitol, and the serum parathyroid hormone(PTH), calcium, phosphorus, and alkaline phosphatase(ALP) were measured before and after treatment, respectively, and the dosage was adjusted according to the changes of the indexes in the monthly review. Statistical analysis was performed using SPSS 26.0 software.

**Results:** The PTH of all patients after treatment was lower than that before treatment (P<0.001), the overall compliance rate was 66.3%, and the average compliance time was 4.6 months; the average PTH change was (-414.3±465.9) pg/ml. (1) According to the follow-up time, the patients were divided into 5 groups (1-3 months, 3-6 months, 6-12 months, 12-24 months, >24 months) (n=15; n=31; n=31; n=10), each The end point of the follow-up time in the two groups was lower than the baseline PTH level. Except for the 3-6 month group, there was no significant difference before and after PTH (P=0.074), and the differences between the other groups were statistically significant (P=0.001, <0.001, <0.001, 0.01). (2) The blood calcium level was higher than that before treatment (P<0.001), and the differences in the baseline and end-point calcium levels in each group were statistically significant (P=<0.01, 0.02, <0.01, <0.01, 0.03). There was no significant difference in serum phosphorus levels in each group before and after treatment (P>0.05). ALP levels in each group had no significant differences (P>0.05), while 6-12 months, 12-24 months and overall differences were statistically significant (P<0.05).

**Conclusions:** Paricalcitol can effectively reduce the levels of PTH and ALP in MHD patients with SHPT, and has little effect on calcium and phosphorus levels.

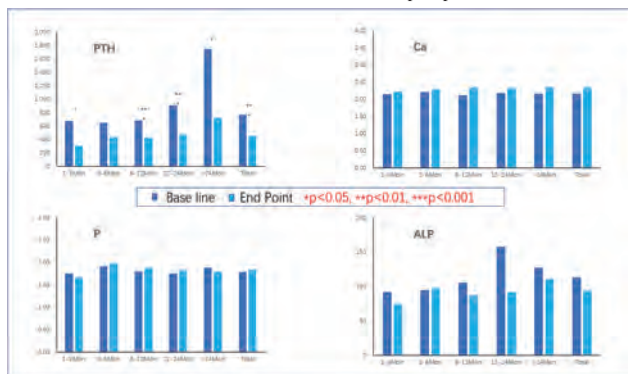

Key: TH - Thursday; FR - Friday; SA - Saturday; OR - Oral; PO - Poster; PUB - Publication Only

Underline represents presenting author.

**PUB130**

**Ocular Disequilibrium Syndrome as a Cause of Dialysis Noncompliance**

Martin Sedlacek, Icahn School of Medicine at Mount Sinai, New York, NY.

**Introduction:** Non-compliance with dialysis treatments is a frequent problem in the ESRD population that is associated with increased morbidity, mortality and health care cost. Clinical assessment can often reveal an underlying cause to non-compliance with treatment. Here we present the case of a patient who experienced severe headaches that developed within the first hour of dialysis treatment.

**Case Description:** A 64 y/o man with ESRD, type 1 diabetes mellitus, HFpEF, PVD and proliferative retinopathy was seen during his third hospitalization for volume overload in three months since he started hemodialysis treatment. The patient had missed multiple treatments and shorted dialysis treatments, often to one hour or less. He was aware of the risks of missing dialysis but could not bear the intense frontal retroocular headaches that appeared during the first hour of dialysis and usually were accompanied by very high BP over 200mmHg. He previously was followed by ophthalmology for severe diabetic retinopathy with neovascularization glaucoma and open angle glaucoma but did not have follow up since two years with the pandemic and had run out of eye drops. Ophthalmology was consulted and restarted his treatment for glaucoma. His intraocular pressure (IOP) was 19/25 mmHg (normal <21mmHg), measurements during the dialysis procedure could not be obtained. The patient's headaches improved and he was able to tolerate full treatments. The patient was seen again 6 months later when he came to the ED for a vasovagal syncope. He had been hospitalized for uncontrolled HTN once in the interim but did not miss dialysis treatments. He did not have the recommended ophthalmology follow up but was taking his eye drops religiously and experienced headaches only on rare occasions.

**Discussion:** The rapid decrease of plasma osmolality at the beginning of hemodialysis can acutely increase IOP which may be symptomatic in the susceptible patient. This syndrome has been called ocular dialysis disequilibrium syndrome and occurs mainly in patients with glaucoma or a predisposition to glaucoma. Ocular dialysis disequilibrium is described only rarely which may be related to a lack of familiarity of nephrologists with ophthalmology and vice versa. This case illustrates how ocular dialysis disequilibrium syndrome can impact dialysis treatment and the importance of communication and clinical assessment in patients with non-compliance to dialysis.

**PUB131**

**Home Hemodialysis (HHD) in a Critically Ill Patient With Sepsis**

Artur Q. Silva,<sup>1</sup> Joao Braz Bezerra,<sup>2</sup> Nefron Group <sup>1</sup>Universidade Federal do Rio Grande do Norte, Natal, Brazil; <sup>2</sup>Americas Servicos Medicos, Rio de Janeiro, Brazil.

**Introduction:** HHD has been available as a modality of renal replacement therapy (RRT) since the 1960s for stable patients but not for critically ill patients. This study aims to present an experience in performing HHD in an elderly patient with multiple comorbidities and AKI due to sepsis.

**Case Description:** A 93-year-old man with several chronic diseases (CPOD, atrial fibrillation, dementia, stroke), had sepsis due to cholecystitis, which required percutaneous drainage and broad-spectrum antibiotic therapy (BSAT) for 10 days. After hospital discharge, the patient developed new sepsis due to pneumonia with MODS, and a new BSAT was initiated. The patient presented with gastrointestinal tract symptoms. Oral anticoagulant was discontinued, and total parenteral nutrition was started. All complementary examinations were performed at the patient's home (laboratory tests, ultrasonography, and transthoracic echocardiography). The patient's family refused a hospital regimen. A room in the patient's apartment was structured as an intensive care environment He developed AKI with AKIN 3, RRT was indicated, an HD catheter was implanted, and HHD was initiated. The patient underwent nine sessions of HHD in 2 weeks, with hypervolemia reduction, interruption of the infusion of norepinephrine, improved level of consciousness, conclusion of the antibiotic therapy regimen, and replacement of continuous positive airway pressure with low-flow nasal cannulas. After >3 days, the patient died. Cardiopulmonary resuscitation maneuvers were not performed, as agreed with the family. No conflicts occurred with the patient's family at any time.

**Discussion:** HHD is indicated for stable patients and is possible in palliative care scenario. In our case, HHD was needed for end-of-life symptom management, and the physician board reflected that maintenance dialysis was palliative. All HD sessions (sustained low efficiency dialysis) were maintained full time by a nephrologist and nephrologist nurse in an apartment room structured as an intensive care unit, ensuring patient safety. HHD in critically ill patients is possible in selected cases, especially in a favorable risk-benefit ratio, and attempts to provide a last chance for patient recovery and time for the family to prepare for potential death. To the best of our knowledge, this is the first case of HHD in a critically ill patient in Brazil. HHD should not be used as a dysthanasia therapy.

**PUB132**

**Unilateral Transudative Pleural Effusion in a Peritoneal Dialysis (PD) Patient**

Violeta Alvarez Retamales, Hafiz Sarfraz A. Khan, Ronald L. Mars. *University of Florida College of Medicine, Jacksonville, FL.*

**Introduction:** A massive pleural effusion is a rare complication seen in patients on PD. Determining the etiology can be challenging. A pleuroperitoneal leak should be considered in order to prevent recurrent hospitalizations and/or inappropriate changes in therapy with no improvement in symptoms.

**Case Description:** 65 Y/O female with ESRD began PD one year prior to admission (PTA). One week PTA her PD effluent volume dropped significantly & she developed dyspnea. An abdominal KUB showed stool burden and a CXR showed a large sized(R) pleural effusion. Four days later, laxatives had improved her retained stool burden, her PD effluent returned to her normal baseline state, and her respiratory distress improved. Yet a repeat CXR confirmed a larger(R) pleural effusion. A thoracentesis produced 1200 mL of clear yellow transudate (pH 8.0, LD 20 IU/L, protein < 0.2g/L, glucose 387 mg/dl). Simultaneous serum studies showed LD 230 IU/L, total protein 6.2 g/L & glucose 238 mg/dl. PD was stopped and she was transitioned to hemodialysis with subsequent resolution of pleural effusion.

**Discussion:** A pleuroperitoneal leak is an unusual complication of PD, but the common denominator reflects a communication between these two cavities. A high glucose concentration in the pleural fluid is pathognomonic for this condition, as no other cause of pleural effusion has a marked elevation of glucose compared with serum levels. Etiologies may include trauma, sudden increasing intra-abdominal pressure or peritoneopleural fistula. Diagnosis may require scintigraphy, CT peritoneography or MRI to localize the leak. Therapeutic approaches with resolution may include discontinuing PD for 3-6 months, surgical patch grafting of the diaphragmatic leak, tetracycline instillation in the pleural space, or video-assisted talc pleurodesis.

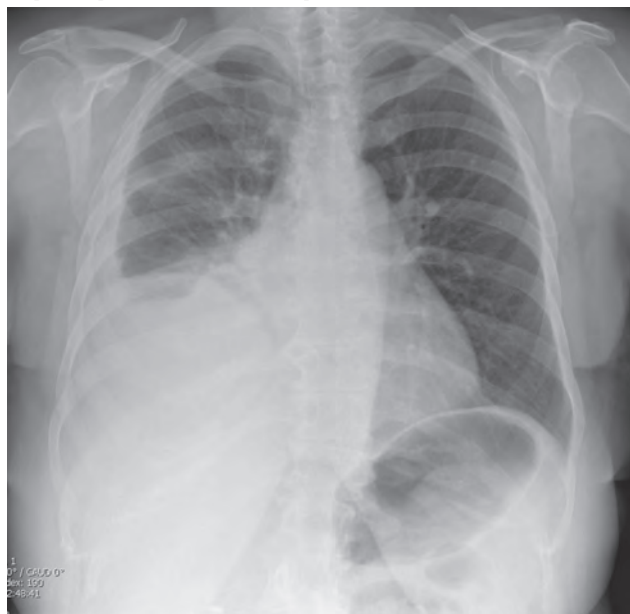

CXR revealing a large sized (R) pleural effusion

**PUB133**

**Patients' Preferences of Dialysis Modalities: Experiences From a Tertiary Level Military Hospital in the Philippines**

Cernan C. Oliveros, Rafael Montepio. *Armed Forces of the Philippines Medical Center, Quezon City, Philippines.*

**Background:** There are two modalities of renal replacement therapy available in our country ; Hemodialysis and Continuous Ambulatory Peritoneal Dialysis. Usually renal replacement therapy is initiated when patients present with emergency indications. There are institutions that are only capable of emergency hemodialysis and many patients with emergency indications are put on it as default. The goal of this study is to educate chronic kidney disease patients about the attributes of the two modalities and find out their preference ahead of initiation of dialysis.

**Methods:** The study is prospective and observational, using a survey tool with to quantify preferences between two dialysis treatment attributes (Hemodialysis And Continuous Ambulatory Peritoneal Dialysis). The attributes include (1) Access site (2) Dialysis Frequency (3) Dialysis Participation (4) Dialysis Place (5) Travel Considerations (6) Fluid Intake (7) Diet Considerations (8) Activity Planning (9) Symptom Fluctuation (10) Activity Restrictions (11) Troubleshooting. After choosing their favored attributes between the two, patients will be asked the final choice of their preferred dialysis modality.

**Results:** The study has 95 respondents. Attributes of Continuous Ambulatory Peritoneal Dialysis that are favored over Hemodialysis are Fluid Intake, Symptom Fluctuation, Diet Considerations, Activity Planning, Activity Restrictions, Travel, Dialysis Place, and Dialysis Access, Hemodialysis attributes favored over Continuous Ambulatory Peritoneal Dialysis are Troubleshooting, Dialysis Participation and Dialysis Schedule. Majority of the patients prefers Continuous Ambulatory Peritoneal Dialysis (N=64, 67.37%) over Hemodialysis (N=31, 32.63%).

**Conclusions:** After giving predialysis education, majority of the patients chose Continuous Ambulatory Peritoneal Dialysis because it has many favored attributes than Hemodialysis.

Dialysis Characteristics	Hemodialysis	%	Continuous Ambulatory Peritoneal Dialysis	%
1. Dialysis Access Site	44	46.32%	51	53.68%
2. Dialysis Schedule	56	58.95%	39	41.05%
3. Dialysis Participation	61	64.21%	34	35.79%
4. Dialysis Place	36	37.89%	59	62.11%
5. Travel	34	35.79%	61	64.21%
6. Fluid Intake	0	0%	95	100%
7. Diet Considerations	7	7.37%	88	92.63%
8. Activity Planning	14	14.74%	81	85.26%
9. Symptom Fluctuation	0	0%	95	100%
10. Activity Restrictions	33	34.74%	62	65.26%
11. Troubleshooting	76	80%	19	20%

Preferred Dialysis Attributes

**PUB134**

**Relationship Between Dialysate Conductivity and Intraperitoneal Volume During Peritoneal Dialysis Treatment**

Fansan Zhu,<sup>1</sup> Laura Rosales,<sup>1</sup> Lela Tisdale,<sup>1</sup> Maricar Villarama,<sup>3</sup> Peter Kotanko.<sup>1,2</sup> <sup>1</sup>Renal Research Institute, New York, NY; <sup>2</sup>Icahn School of Medicine at Mount Sinai, New York, NY; <sup>3</sup>Mount Sinai Hospital Mount Sinai Heart, New York, NY.

**Background:** Dialysate ionic conductivity (Cd) has been considered as a useful method to provide information about the peritoneal membrane transport (La Milia *et al.*, NDT, 2015). However, it is not clear whether the Cd is correlated with a change in intraperitoneal volume (IPV). The aim of the study was to evaluate the relationship between IPV on Cd during PD dwell.

**Methods:** Seven peritoneal dialysis (PD) patients (2 females; age 58.7±10.2 years, weight 87.9±23.2 kg) underwent a standard 4-hours peritoneal equilibration test (PET) using 2 L of 2.5% glucose dialysate. Dialysate Cd was measured hourly during dwell (conductivity meter CDH-280, Omega, CT). Segmental bioimpedance analysis (SBIA) using the Hydra 4200 device was performed during PD treatment (Zhu *et al.*; ASN, 2019). Ratio of IPV to 5 kHz resistance (R5) was calibrated by the known volume of fresh dialysate (2 L). IPV was calculated from continuous SBIA measurement of R5 during dwell. Ultrafiltration volume (UFV) was defined as the weight difference drained minus filled dialysate.

**Results:** One SBIA measurement was unavailable for technical reasons. Mean UFV was 0.40±0.35 L. Cd increased from pre to post PET from 11.25±0.18 to 12.61±0.46 mS/cm (p<0.0001). UFV was not associated with the change in Cd during the dwell (R<sup>2</sup>=0.34; p=0.17). Cd did not correlate with IPV. R5 correlated with IPV in all patients (Fig.1). Cd in individual patients was unrelated to membrane transport characteristics as measured by PET.

**Conclusions:** While IPV was correlated significantly with the resistance at 5 kHz (R5), Cd did not correlate with IPV (Fig.1). Our preliminary results show that R5 is mainly influenced by IPV changes rather than by changes in dialysate conductivity. This insight is relevant for the interpretation of R5 measurements.

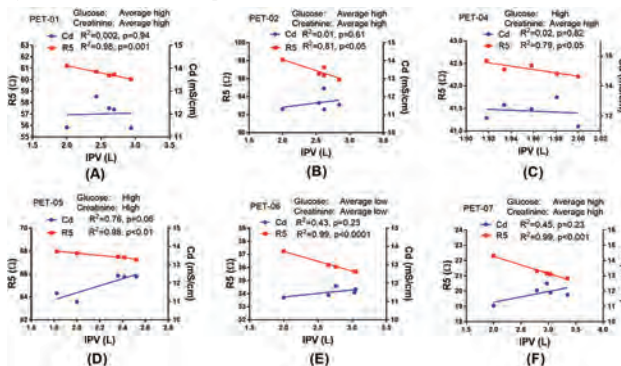

Fig.1

**PUB135**

**Association of Primary Care Provider (PCP) Use With Mortality and Hospitalization Among Older Home Dialysis Patients**

Rohanit Singh,<sup>1</sup> Raquel C. Greer,<sup>1</sup> Laura Plantinga,<sup>2</sup> Sandeep S. Soman,<sup>3</sup> Michael J. Choi,<sup>4</sup> Mara McAdams-DeMarco,<sup>1</sup> Bernard G. Jaar.<sup>1</sup> National Kidney Foundation Education Committee <sup>1</sup>Johns Hopkins University, Baltimore, MD; <sup>2</sup>Emory University, Atlanta, GA; <sup>3</sup>Henry Ford Hospital, Detroit, MI; <sup>4</sup>MedStar Georgetown University Hospital, Washington, DC.

**Background:** The impact of PCP services on outcomes for home dialysis patients is not well established. This study assesses the association of PCP services before and after dialysis start with mortality and hospitalization.

**Methods:** Using data from the USRDS, we assembled a cohort of 9854 incident (2008-2014) older (age ≥67 years) U.S. home dialysis patients. PCP use was measured for 2 years (1 year before and 1 year after dialysis start). PCP use was defined as “never used” if there was no PCP use during study period, “discontinued” for PCP use before but not after dialysis start, “initiated” for no PCP use before but PCP use after dialysis start, and “continued” for PCP use before and after dialysis start. We used Cox proportional hazards models to assess all-cause mortality and first all-cause hospitalization within the first year after starting dialysis. Inverse probability weighting was used to adjust for confounding.

**Results:** Overall, 21% never used PCP, 11% discontinued PCP use, 9% initiated PCP use, and 59% continued PCP use after starting dialysis. Compared to never using PCP services, discontinuing or continuing PCP services were associated with 11% and 9% adjusted lower risk of mortality, respectively. Initiating PCP use after home dialysis start was associated with 13% greater risk of first all-cause hospitalization (Table).

**Conclusions:** PCP use prior to starting home dialysis has a beneficial impact on mortality, even a legacy effect on patients who discontinued PCP use. Higher risk of hospitalization for initiating PCP use may reflect confounding by indication. Further research assessing the beneficial components of primary care use in the context of home dialysis is needed.

**Funding:** Private Foundation Support

Adjusted Hazard Ratios (95% CIs) for All-Cause Mortality and First All-Cause Hospitalization

	Never Used (n=2122)	Discontinued (n=1047)	Initiated (n=869)	Continued (n=5816)
	HR (95% CI)*	HR (95% CI)*	HR (95% CI)*	HR (95% CI)*
Mortality	Reference	0.89 (0.81-0.97)	0.99 (0.90-1.08)	0.91 (0.86-0.97)
First all-cause Hospitalization	Reference	0.96 (0.90-1.06)	1.13 (1.04-1.23)	1.05 (0.99-1.11)

\*Adjusted for age, sex, race/ethnicity, employment, Medicaid coverage, geographic area, % neighborhood level poverty and urban, Liu’s comorbidity index, Kim’s frailty index, and pre-ESKD nephrology care

**PUB136**

**Severe Metabolic Acidosis due to Sodium Thiosulfate in Peritoneal Dialysis**

Mal P. Homan, Mykel G. Tadros, Joseph C. Guzzo. *Lehigh Valley Health Network, Allentown, PA.*

**Introduction:** Calcific Uremic Arteriopathy (CUA), known as calciphylaxis, is a disease process resulting in painful lesions due to necrosis and skin ischemia. It is usually seen in patients with End-Stage Kidney Disease (ESKD) with risk factors including secondary hyperparathyroidism, warfarin use, and longstanding renal replacement therapy. Sodium thiosulfate (STS) is used in treatment, which has demonstrated clinical improvement of calciphylaxis.<sup>5</sup> Typical dosing is thrice weekly on hemodialysis, though there are reports of intra-peritoneal administration.<sup>3</sup> One complication potentially limiting the use of STS is severe metabolic acidosis.<sup>1</sup>

**Case Description:** A 49-year-old female with ESKD on PD, Protein C deficiency, and DVT on warfarin presented to the hospital with multiple painful lesions; CUA was diagnosed. Warfarin and calcitriol were discontinued, and she was transitioned to apixaban. The patient remained on peritoneal dialysis as vascular access was complicated given history of recurrent DVT surrounding dialysis catheter placement. She was started on STS 25g thrice weekly through Hickman catheter. She presented two months later with worsening, severe pain. Her labs revealed elevated anion gap of 47 with a serum bicarbonate of 14 mmol/L. Venous blood gas revealed pH 7.21. Urinalysis negative for ketones, blood glucose was 94, mg/dL, and lactate was 1.2 mmol/L. She was started on bicarbonate therapy, PD was restarted, and further STS was held. Bicarbonate improved to 17-19 mmol/L the following day, and her anion gap improved down to 11 nine days later. Ultimately, STS was discontinued. Unfortunately, the patient’s severe pain persisted despite escalation of analgesic therapy prompting consideration of hospice.

**Discussion:** This case highlights the potential effect of high anion gap metabolic acidosis attributed to STS therapy in a PD patient. Severity ranges from mild and asymptomatic to severe life-threatening metabolic acidosis.<sup>4</sup> The mechanism is unknown although several theories have been postulated, including hydrogen sulfide as a metabolite of STS inhibiting mitochondrial electron transport chain shunting ATP production towards lactate production, as well as formation of thiosulphuric acid in vivo and oxidative stress from sulfide-containing compounds. Better understanding of the use of STS, including its metabolism and side effects is needed, especially in PD patients.<sup>2</sup>

**PUB137**

**Evolution of Peritoneal Functions in Patients Receiving Long Term Peritoneal Dialysis**

Cheng-Hsu Chen,<sup>1,2</sup> Jie-Wei Chiu,<sup>3</sup> Shangfeng Tsai,<sup>2</sup> Yu-Chen Tsai,<sup>3</sup> Ren-Shiang Chen.<sup>3</sup> <sup>1</sup>National Chung Hsing University, Taichung, Taiwan; <sup>2</sup>Division of Nephrology, Department of Internal Medicine, Taichung Veterans General Hospital, Taichung, Taiwan; <sup>3</sup>Tungshai University, Taichung, Taiwan.

**Background:** Long-term peritoneal dialysis (PD) results in structural and functional changes in peritoneum. The peritoneal equilibration test (PET) is a semi-quantitative measurement that characterizes the rate of transfer of solutes and the water transfer rate across the peritoneum in patients treated with PD. This study was to prospectively evaluate patients’ survival in different peritoneal transport status as well as the potential correlations with disease categories.

**Methods:** The data were retrieved from the the Taiwan Society of Nephrology Data Platform (TSN-KiDiT) with 268 patients in Taichung Veterans General Hospital (VGHTC) started chronic PD between 2014 to 2019. The longitudinal evolution of peritoneal function was analyzed by their alternative change of PET by the time. Patients were categorized into four groups based on their first PET D/P ratio at month 3 for each PD patients, and their trajectories were analyzed until the end of the study or time before drop-out PD. The data was analyzed their risk of their original disease entities, at the meanwhile, technique survival and patient survival were analyzed by their PET.

**Results:** Trajectories over time for high and low PET groups were evolved toward the high average (HA) or low average (LA) PET within four years. Patients with different PET groups in the first year of PD had significant difference in the technique survival (P = 0.006), but not in patient survival (P = 0.151). According to the risk factors of technique survival within 6 years of PD, we found patients with chronic glomerulonephritis (CGN) with different PET groups had significantly different in the technique survival (P = 0.012), however, we could not demonstrate PET affected their survival in hypertension and diabetes patients.

**Conclusions:** We concluded that trajectories of four PET groups were evolved toward the average peritoneal function over the time. Though, solution type, using biocompatible solutions and duration of vintage of PD might affect peritoneal function, their entities of underlying disease might also play important role for their technique survival.

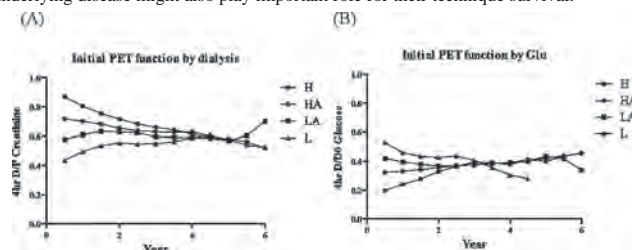

**PUB138**

**Global Clinician Perceptions on the Priorities for Exercise Programming in People Receiving Peritoneal Dialysis**

Oksana Harasemiw,<sup>1,2</sup> Emilie Ford,<sup>1,2</sup> Iwona Gabrys,<sup>5</sup> Ruth Getachew,<sup>1</sup> Paul N. Bennett,<sup>3,4</sup> Clara Bohm.<sup>1,2</sup> Global Renal Exercise Network (GREX) <sup>1</sup>Seven Oaks Chronic Disease Innovation Centre, Winnipeg, MB, Canada; <sup>2</sup>University of Manitoba Max Rady College of Medicine, Winnipeg, MB, Canada; <sup>3</sup>University of South Australia, Adelaide, SA, Australia; <sup>4</sup>Satellite Healthcare, San Jose, CA; <sup>5</sup>Alberta Health Services, Edmonton, AB, Canada.

**Background:** Although exercise and physical activity have been shown to improve physical function among people receiving Peritoneal Dialysis (PD), little is known about PD clinicians’ perceptions and practices regarding exercise prescription and promotion.

**Methods:** A cross-sectional online questionnaire was developed through expert and patient consensus, and distributed to PD clinicians from 100 PD prevalent countries between July and December 2021 through social media and professional nephrology societies. As part of this survey, participants were asked the question “What are the most important aspects you would like to see incorporated in an exercise program for PD patients?” Responses were coded using Summative Content Analysis and grouped into themes by two analysts.

**Results:** 610 respondents (74% females; 37% nephrologists, 49% nurses, and 14% allied health professionals; 0.7% were from Africa, 25% Asia, 16.6% Australia/New Zealand, 22.1% Europe, 10% South America, 1.8% Middle East, 24% North America) provided 1076 unique perspectives that were included in the analysis. The overarching theme identified was the need for individualized and accessible programming. Under this umbrella, the four main themes identified were: promotion of specific exercise activities, overcoming common barriers to exercise for patients and PD programs, perceived cornerstones of exercise prescribing, and program design to address important outcomes for patients.

**Conclusions:** Overall, PD clinicians believe that PD does not preclude exercise participation and recognize the benefits for improving physical, mental, and social well-being. The involvement of exercise professionals is valued in clinical programs, however additional education for practitioners and patients regarding safety and the benefits of exercise is required.

## PUB139

**A Case of Calciphylaxis in a Patient on Apixaban**

Louis Damian, Asha J. Chemmalakuzhy. *Baylor Scott & White Health, Dallas, TX.*

**Introduction:** Calciphylaxis is a rare but serious condition that is mainly seen in chronic kidney failure patients treated with dialysis. While Warfarin has been demonstrated in many studies to be associated with increased vascular calcification due to inhibition of vitamin-K-dependent carboxylation of Matrix gla protein (MGP). Direct Oral Anticoagulants (DOACs) can prevent the progression of vascular calcification. Nevertheless, Calciphylaxis is reported among people who take apixaban

**Case Description:** 69 years-old female with a past medical history of end-stage renal disease on CCPD, atrial fibrillation, hypertension, moderate aortic stenosis, and type 2 diabetes mellitus, presented to the hospital with several weeks of bilateral lower extremities pain. There are no specific aggravating or alleviating factors. She reported skin nodules in her bilateral lower extremities which she noticed around the same time. The patient was on Apixaban for atrial fibrillation for more than 12 months. She was on calcitriol for secondary hyperparathyroidism and Sevelamer for hyperphosphatemia. On physical exam, multiple tender subcutaneous nodules were noted on bilateral lower extremities without ulcerations or signs of infection. Laboratory findings were significant for Corrected calcium 8.0 mg/dL, Phosphorus 11.7 mg/dL, Intact PTH 286 pg/mL. A Punch biopsy was performed on the skin of the left thigh, it showed morphologic features consistent with calciphylaxis. Calcitriol was discontinued, patient switched to hemodialysis and was treated with sodium thiosulfate

**Discussion:** Calciphylaxis is a result of progressive arteriolar thrombosis. While Direct Oral Anticoagulants (DOACs) can prevent the progression of vascular calcification by direct inhibition of factor X which can create vascular smooth muscle migration and proliferation, which is a key step in atherosclerosis, In phase IV clinical study of FDA data, 18,315 people reported side effects when taking Eliquis. Among them, 6 people (0.01%) have Calciphylaxis. Further trails needed to investigate this association

## PUB140

**Challenges of Treating Stenotrophomonas maltophilia Peritonitis in a Peritoneal Dialysis Patient With Suprapubic Catheter**

Krishnakumar D. Hongalgi, Sidrah Abid, Kelly H. Beers, Swati Mehta. *Albany Medical Center, Albany, NY.*

**Introduction:** Peritoneal dialysis (PD) is a preferred home modality of treatment for end stage kidney disease (ESKD). Peritonitis is the most feared complication associated with long term PD and is associated with increased morbidity and mortality. We report a rare case of stenotrophomonas maltophilia peritonitis in a patient with chronic suprapubic catheter.

**Case Description:** 59-year-old male with ESKD with history of suprapubic catheter had beta hemolytic strep peritonitis followed by another episode of coagulase negative staph peritonitis which were treated outpatient with intraperitoneal (IP) antibiotics. He was admitted to the hospital later with another episode of abdominal pain and cloudy peritoneal effluent. He was hemodynamically stable, afebrile and had mild leukocytosis without left shift. Empiric treatment with IP vancomycin and ceftazidime was started. Peritoneal culture grew >100,000 colonies of stenotrophomonas maltophilia resistant to ceftazidime, sensitive to levofloxacin and trimethoprim/sulfamethoxazole. Ceftazidime was discontinued and patient was started on oral levofloxacin and trimethoprim/sulfamethoxazole with plan for 21 days of treatment. PD catheter was left in-situ and PD was continued without interruption. Patient improved clinically and was discharged with outpatient follow up. Levofloxacin was eventually discontinued after 2 weeks due to prolonged QT interval.

**Discussion:** PD has been established as a safe modality of kidney replacement therapy empowering patients in selfcare. PD catheter associated peritonitis is common cause of treatment failure as it can result in loss of PD catheter. Stenotrophomonas maltophilia is a rare cause of peritonitis with reported loss of PD catheter in over half of cases. Treating peritonitis in a patient with suprapubic catheters is challenging. Our patient was successfully treated with levofloxacin and trimethoprim/sulfamethoxazole without necessitating the removal of his PD catheter.

## PUB141

**Patients With Refractory Heart Failure and Diuretic Resistance: Is Peritoneal Dialysis a Good Therapeutic Option?**

Gonçalo Ávila, Patrícia Matias, Rita Calça, Patrícia Q. Branco. *Centro Hospitalar de Lisboa Ocidental EPE Hospital de Santa Cruz, Carnaxide, Portugal.*

**Background:** Patients with refractory heart failure (HF) and resistance to diuretics despite optimal medical treatment require frequent hospitalization and/or outpatient intravenous diuretic therapy. Peritoneal dialysis (PD) can be used as an alternative treatment to promote ultrafiltration and control fluid overload in these patients. The aim of this study was to assess PD efficacy in reducing hospitalization rate and congestion markers, technique complications, and survival in a group of patients with HF.

**Methods:** We performed a single-center, retrospective study, from 2014 to 2022, which included patients with New York Heart Association (NYHA) class IV HF despite optimal medical treatment, with resistance to diuretics, and estimated glomerular filtration rate (eGFR) > 15 mL/min/1.73m<sup>2</sup> according to the 2021 CKD-EPI equation. Clinical and laboratorial parameters were collected before and after PD initiation.

**Results:** Eleven patients were included, with mean age of 63.7 ± 14.4 years, and 72.7% males. Seven patients (63.3%) were diabetic. Most patients had reduced left-ventricular ejection fraction (81.8%) and two patients had congestive right-side HF. The most common HF etiology was ischemic (72.7%). Median follow-up was 18 months (IQR 12 - 33). Median eGFR at the time of PD start was 19 mL/min/1.73m<sup>2</sup> (IQR 16 - 21). The median hospitalization days due to fluid overload in the 12 months before starting PD was 18 days (IQR 1 - 37), and significantly decreased to 0 days (IQR 0 - 4) in the 12 months after (p=0.012). The median value of N-terminal prohormone of brain natriuretic peptide (NT-pro-BNP) in the 12 months prior to the beginning of PD was 8014 pg/mL (IQR 4038 - 30523), which declined to 5156 pg/mL (IQR 2885 - 8618) in the 12 months after (p=0.022). Complications included 8 episodes of peritonitis. Four patients dropped out of the technique after a median of 38.5 months, due to ultrafiltration failure (n=3) and refractory tunnel infection (n=1). Survival rate was 90.9% at 12 months and 63.6% at 24 months. Eighty percent of deaths were due to cardiovascular events.

**Conclusions:** In this group of patients, PD was a safe and effective therapeutic option for the treatment of refractory HF, leading to improved management of congestion and decreasing hospitalization days.

## PUB142

**Percutaneous Peritoneal Dialysis Catheter Insertion in an Office-Based Lab: A Retrospective Study**

Mohamed A. Sheta. *Global Vascular Access Center, Houston, TX.*

**Background:** Peritoneal Dialysis Catheter (PDC) can be inserted by one of three methods: Surgical, Laparoscopic and Percutaneous. The first two typically require inpatient settings. In this unique study we explore multiple aspects of percutaneous peritoneal dialysis catheter (pPDC) insertion in our office based lab (OBL).

**Methods:** This is retrospective study in our OBL reviewing the patient data in one year. This include patients demographics, number of previous abdominal surgeries, complications, sedation, one month patency, and causes of failure. We inserted all our pPDC under ultrasound and fluoroscopic guidance using Seldinger technique.

**Results:** From May 2021 to April 2022, we inserted 36 pPDCs in 36 patients. Average BMI was 32 (22.9-53.5). Two of our patients have colostomies and another two with moderate ascites. Only one patient was done under local anesthesia and rest were done under moderate sedation. Patients were not required to stop antiplatelet therapy or anticoagulation. No cardiac clearance was required. Success rate was 94% (34/36). Operating room time ranged from 15 minutes to 35 minutes. There was no reported intraoperative complications including bowel injury or major bleeding. No peri-catheter leak. Three patients prescribed narcotics for post-operative pain. Out of the 34 patients that got their pPDC successfully inserted, 31 had functional catheter at one month (91%).

**Conclusions:** Percutaneous peritoneal dialysis catheter insertion in OBL is a cost effective, safe procedure with very high patency rate.

## PUB143

**Mortality and Demographics Associated With Fungal Peritonitis in Patients on Peritoneal Dialysis in a Regional Hospital in Mexico**

Manuel A. Marquez, Jorge A. Gómez, Oscar Ollarvide. *Instituto Mexicano del Seguro Social, Jalisco, Mexico.*

**Background:** Peritonitis is one of the most frequent complications of peritoneal dialysis, and between 1% - 15% of these episodes are caused by fungal infections. The mortality rate of fungal peritonitis varies in different studies, with percentages from 5% to 53%. Despite the availability of newer antifungal drugs, catheter removal remains the cornerstone of managing fungal peritonitis. Some studies report mortality from 50% to 91% among patients without catheter removal. Courses of antibiotics precede most fungal peritonitis episodes. Other risk factors that may account for the risk of development of fungal peritonitis are low educational status and unhygienic conditions. Candida species cause most of these infections. Candida albicans and Candida parapsilosis are the most common pathogens, although the frequency of the latter is reported to exceed that of C. albicans species. One of the difficulties of fungal peritonitis is the failure to resume PD after a temporal transfer to hemodialysis, which occurs in up to 40% of patients.

**Methods:** We conducted a retrospective cohort study including all confirmed or suspected fungal peritonitis episodes among peritoneal dialysis patients followed in our institution between January 2020 and February 2022. We collected demographic characteristics, laboratory and clinical findings, management, and outcome from medical records.

**Results:** 13 cases were obtained from the database, 3 men and 10 women, with a mean age of 45 years, 38% with a history of diabetes mellitus, 61.5% of the patients had a history of peritonitis in the previous 6 months, and 46% with a history of peritonitis in the last month, the most frequently isolated microorganism was Candida in 76.9%, Candida parapsilosis complex was isolated in 61% (8 cases), Candida tropicalis in one case, Candida guilliermondii in one case and 23% (three patients) there was no absolute isolation. Of the 13 cases, 38.4% (5 cases) died during hospitalization, and one died after 6 months of follow-up.

**Conclusions:** Fungal peritonitis is a complication with a high mortality rate, with a mortality of 38% in our center, unlike what was reported by other centers. Candida parapsilosis complex was the fungus that was isolated most frequently; the history of peritonitis in the previous months forces us to focus on prevention.

**PUB144**

**In-Center Hemodialysis vs. Home Dialysis: Comparison of Choice of Dialysis Modality**

Isabella L. Melena, Frank J. O'Brien, Lisa A. Koester. *Washington University in St Louis School of Medicine, St Louis, MO.*

**Background:** Both in-center hemodialysis (IHD) and home methods, peritoneal dialysis (PD) and home hemodialysis (HHD), have their advantages and disadvantages, but IHD continues to be the most common form of dialysis therapy even with similar mortality rates between the modalities and several studies showing a patient preference for home dialysis. Reasons for choosing a certain dialysis modality and continuing with the modality are varied and include factors of the patients, their caregivers, the healthcare monitoring system, and dialysis approach. Identifying factors a patient uses to choose a modality is important to increase the availability and utilization of the increasingly preferred and beneficial home modalities.

**Methods:** Participants on IHD and home methods, PD and HHD, were surveyed at the Washington University in St Louis School of Medicine dialysis clinics. Survey questions included questions on deciding factors for the chosen dialysis modality and education on other modalities.

**Results:** We enrolled 120 participants (n=90 on in-center hemodialysis and n=30 on home dialysis, 43% female, age [mean±SD] 59±14 years). Top factors for choosing in-center hemodialysis included perceived safety, convenience, or doctor choice. For home dialysis, the factors mentioned most included convenience, independence, and doctor recommendation. 69% of participants on in-center dialysis received education of other modalities, compared to 100% of participants on home dialysis.

**Conclusions:** Our data reaffirm that modality selection is a complex process and highlight potential areas for intervention and education to increase the utilization of home dialysis.

**PUB145**

**Acute PD in ESKD Jehovah's Witness Patient With Severe Anemia and Uremic Bleeding**

Lakshmi Ganesan, Amir Abdi Pour, Sergio Infante. *Loma Linda University School of Medicine, Loma Linda, CA.*

**Introduction:** Due to high mortality associated with severe anemia and hemodialysis, anemia is aggressively managed with iron and ESA therapy in chronic HD patients. Severe anemia is generally managed first with transfusion. In patients who refuse transfusion, anemia management can pose a challenge. We present a case of changing modality to PD in Jehovah's Witness patient to allow for improvement of uremic bleeding, and stabilization of hemoglobin without transfusion.

**Case Description:** 39 yo M Jehovah's Witness with ESRD 2/2 DM2 on HD, PAD on DAPT (and h/o BLE angioplasty) admitted with LLE necrotizing fasciitis. Admission hemoglobin was 9.2g/dL. He received 5 HD treatments before his BKA on day 9. Due to symptomatic post-op anemia (5g/dL, nadir 4.2g/dL), he was too unstable for HD. Pt had ongoing bleeding attributed to blood thinners, surgery and uremic platelet dysfunction. Patient's volume status and mentation worsened. On day 17, Quinton catheter was placed and CCPD started. BUN was at 167mg/dL at start of PD. Due to bleeding from prior Veress access site, patient had two revisions before PD was successful. On day 21, pt completed full PD. He tolerated 6 days of 24hr/day of PD, 11 cycles, fill volume 500mL, increased to 1000mL. Repeat labs showed BUN 110mg/dL and Hgb 9.6g/dL. Anemia was managed with aggressive ESA dosing - Epogen 40K units qHS, started day 16. Respiratory status and mentation improved. He was transitioned back to HD on day 27 at patient's behest due to ongoing scrotal edema and hydrocele. He tolerated resuming HD, though Hgb was 7-8g/dL on HD even with higher dose ESA. He was discharged from hospital to resume outpatient HD.

**Discussion:** To date, there is no reported case of converting dialysis modality for anemia in Jehovah's Witness patients who are too unstable for HD. There is a reported case of using acute PD post-laparotomy. They do not cite anemia or ongoing bleeding as an indication in this case, but rather related to patient's advanced directive against autologous procedures. They acknowledge peritoneal dialysis superiority where cardiovascular instability and bleeding risk are concerned. While our patient experienced further bleeding after catheter placement, he still had improvement in his hemoglobin over one week of PD. This supports using acute PD when ESRD patients may be too unstable for HD due to severe anemia.

**PUB146**

**Percutaneous Single Stitch Peritoneal Dialysis Catheter Insertion Using the Seldinger Technique: Boost for Interventions by Nephrologist**

Jitendra Goswami, *Soni Manipal Hospital, Jaipur, India.*

**Background:** Peritoneal dialysis (PD) catheter implantation is one of the effective treatments for patients with end-stage renal disease (ESRD). This study aimed to evaluate the safety and efficacy of percutaneous single stitch PD catheter insertion technique and its associated short-term postoperative outcomes.

**Methods:** In this study, ESRD patients who underwent peritoneal catheter insertion were enrolled retrospectively during September 2017- April 2019. All patients were evaluated for demographic and clinical characteristics, operative parameters and postoperative complications.

**Results:** A total of 43 patients were enrolled. The mean age of the patients was 61.90 years. Type 2 diabetes was the most common cause of ESRD. The median operative time was 12.00 min and the incision length were <1cm. the operative cost was 12000 per

patients and the median length of the hospital stay was 4 days. Three (6.97%) patients showed bloody dialysis. The number of patients using analgesic within 24 hrs and 48 hrs was 2.00 (4.65%) and 1.00 (2.32%), respectively.

**Conclusions:** This technique has the benefits of reduced surgical trauma, a shorter operative time, faster postsurgical recovery, less postoperative complications and may improve the patient's survival and decrease the morbidity.

**PUB147**

**Lost Dwell Time and Cyclor Alarms in Inpatient Automated Peritoneal Dialysis**

Nasha Elavia, Adrienne E. Flowers, Ami M. Patel. *University of Maryland School of Medicine, Baltimore, MD.*

**Background:** Automated peritoneal dialysis (APD) has multiple advantages over continuous ambulatory peritoneal dialysis in the hospital setting including lower risk of peritonitis from fewer connections, increased treatment options, reduced nursing time, and preferred modality for patients with higher membrane transport characteristics. To date, there are no previous studies investigating the loss of dwell time and cyclor alarms using APD in the hospital setting.

**Methods:** We conducted a retrospective study of all inpatient APD treatments using the Amia Automated Peritoneal Dialysis System in a tertiary-care hospital from December 1, 2021 to May 30, 2022. The differences between prescribed and actual dwell times and the frequency of different cyclor alarms were recorded.

**Results:** In the past 6 months, 13 patients underwent APD treatments at our hospital. Three patients were excluded due to incorrect orders or missing flowsheets. The remaining 10 patients completed 62 treatments. Approximately 31% of treatments had lost dwell time exceeding 30 minutes per treatment. Table 1 shows the frequency of the most common alarms.

**Conclusions:** There was significant lost dwell time and inadequate drain volume with inpatient APD. This can impact solute clearance and ultrafiltration. Future studies are required to investigate measures to minimize lost dwell time, reduce slow drain and improve drain volume in the hospital setting.

Table 1. Frequency of common alarms

Alarm	Frequency (%)
All slow drain	60
Slow drain requiring intervention	40
Inadequate drain volume	23
Patient line occlusion	10

**PUB148**

**Tenckhoff Catheter Placement in Heart Failure With Refractory Ascites**

María Guadalupe C. Núñez,<sup>1</sup> Lillana Pacchiano,<sup>2</sup> Gabriela Leal,<sup>3</sup> Bernardo Moguel,<sup>3</sup> Karla B. Cano Escobar.<sup>3</sup> <sup>1</sup>Hospital General de Zona #32, Instituto Mexicano del Seguro Social, Mexico City, Mexico city, Mexico; <sup>2</sup>Instituto Nacional de Enfermedades Respiratorias, Mexico city, Mexico; <sup>3</sup>Instituto Nacional de Cardiología Ignacio Chavez, Mexico city, Mexico.

**Background:** Bening refractory ascites due to heart failure (HF) represents 5%, with a poor life expectancy. For treatment, instead of paracentesis, peritoneal dialysis catheter placement has been utilized. We describe our experience using Tenckhoff catheter in this patients.

**Methods:** Retrospective cohort study in a single third level center, from January 2015 to August 2021. Patients with benign refractory ascites due to HF with or without hepatic insufficiency were included. A Tenckhoff (TNK) catheter was placed. Follow-up was made a month after insertion and until outcomes (end stage renal disease (ESRD) or death) occurred.

**Results:** 16 patients were included. Patient characteristics are shown in Table 1. Weight fell from 69 to 62.2 Kg after TNK placement (p 0.017). Improvement of HF functional class was noticed, NYHA I/II changed from 12.5 to 66.7% and NYHA III/IV from 87.5% to 33.3% (p 0.034). Tricuspid insufficiency was improvement from 68.7% to 47.3% (p 0.041). There were no significant change in LVEF, sPAP or pericardial effusion. Emergency visits and hospitalizations were not changed significantly. eGFR and urinary volume improved from 28 to 35 ml/min/1.73 m<sup>2</sup> (p 0.025) and 1200 to 1483 cc (0.052), respectively (Figure 1). 81.25% developed AKI, requiring RRT in 38.4%. Complications: hematic fluid (25%), leakage (12.5%), accidental catheter displacement (6.2%). Peritonitis rate was 1 episode per-19 patient-months and 0.62 episodes per patient year. TNK was removed in 37.5% of cases. Death occurred in 25% and ESRD in 25%.

**Conclusions:** TKN placement is viable and safe in the management of refractory ascites in HF. However, it is important to select properly the patient in order to reduce the peritonitis events.

Table 1. Basal Patient Characteristics	Total (n=16)
Age (years)	59.63±14.06
Men (%)	11 (68.7)
Cardiac insufficiency etiology	
Ischemic cardiopathy (%)	8 (50)
Valvulopathy (%)	7 (43.75)
Congenital cardiopathy (%)	1 (6.2)
Comorbidity	
Diabetes (%)	6 (37.5)
Hypertension (%)	6 (37.5)
Arrhythmias (%)	9 (56.25)
Charlson comorbidity index (score)	6.5 (6-9)
Chronic hepatic insufficiency (%)	9 (56.2)
Child Pugh Classification (%)	
B (%)	4 (44.4)
C (%)	5 (55.5)
NYHA functional class	
II (%)	2 (12.5)
III (%)	10 (62.5)
IV (%)	4 (25)
Diuretic treatment	
Furosemide (mg)	100 (80-120)
Spironolactone (mg)	50 (18.75-50)
Previous paracentesis (n)	10
1 (n, %)	4 (40)
2 (n, %)	6 (60)
Average paracentesis volumen (cc)	3800 (1800-4700)
Body weight (Kg)	69 (65.6-80)
SBP (mmHg)	109.5 (97.3-119.5)
DBP (mmHg)	67 (59.3-73.7)
Laboratory findings	
Basal SCr (md/dl)	1.45 (0.99-2.00)
Basal eGFR (ml/min/1.73m2)	54.5 (30.5-70.7)
Tenckhoff placement SCr (md/dl)	2.02 (1.39-2.98)
Tenckhoff placement eGFR (ml/min/1.73m2)	26.3 (18.8-48)
BUN (mg/dl)	49.7 (40.6-80.5)
Albumin (g/dl)	3.48 (3.21-4)
Hemoglobin (g/dl)	11.45 (9.82-13.1)
Leucocytes (cells/mm3)	6.5±2.6
Platelets (cells/mm3)	155 (127.5-232)
Na (mEq/l)	132.7 (125.3-135.3)
K (mEq/l)	4.1 (3.8-4.8)
Cl (mEq/l)	98.5 (90.04-102.2)
NT ProBNP (pg/ml)	12081.5 (4477-43622.5)
BT (mg/dl)	1.66 (1.07-2.11)
BD (mg/dl)	0.74 (0.37-1.22)
ALT (IU/L)	14.8 (10.72-21.5)
AST (IU/L)	24.8 (15.5-31.57)
DHL (IU/L)	313±184
INR	2.09 (1.26-3.58)

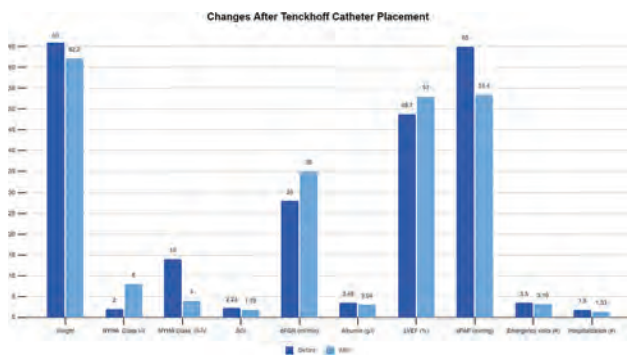

PUB149

**Clinical Observation of Safflower Wine Wet Dressing to Improve the Function of Autogenous Arteriovenous Fistula in Hemodialysis Patients**  
 Renhong Kang, Weijian Xiong. ChongqingTraditional Chinese Medicine Hospita, Chongqing, China.

**Background:** Autogenous arteriovenous fistula (AVF), as the first choice of long-term vascular access, is an important lifeline for maintenance hemodialysis (MHD) patients, most patients will have AVF dysfunction in the course of MHD treatment, which will eventually lead to the loss of AVF function. This clinical observation found that safflower wine wet dressing can effectively increase the blood flow of AVF and enlarge the diameter of AVF. Therefore, the function of AVF can be improved and the service life of AVF can be prolonged.

**Methods:** Patients undergoing maintenance hemodialysis using AVF were selected from the blood purification center of Chongqing Traditional Chinese hospital from November to December 2021, the patients were divided into control group (34 cases) and treatment group (34 cases). The treatment group was treated with self-made safflower wine and the control group was treated with Mucopolysaccharide polysulfate (MPS). After 2 months of treatment, the Pump-controlled Blood Flow in Dialysis(PBFID), the diameter of AVF and Blood Flow under Color Doppler (BFUCD) were observed and recorded.

**Results:** There was no significant difference in PBFID, the diameter of AVF and BFUCD between the control and treatment groups before treatment. After 2 months treatment, both the control group and the treatment group were able to increase PBFID,BFUCD and expand AVF tube diameter,the effect of the treatment group Significantly better than the control group.

**Conclusions:** Using the safflower wine wet dressing can effectively enhance the blood flow of AVF and enlarge the vascular diameter of AVF.

**Funding:** Government Support - Non-U.S.

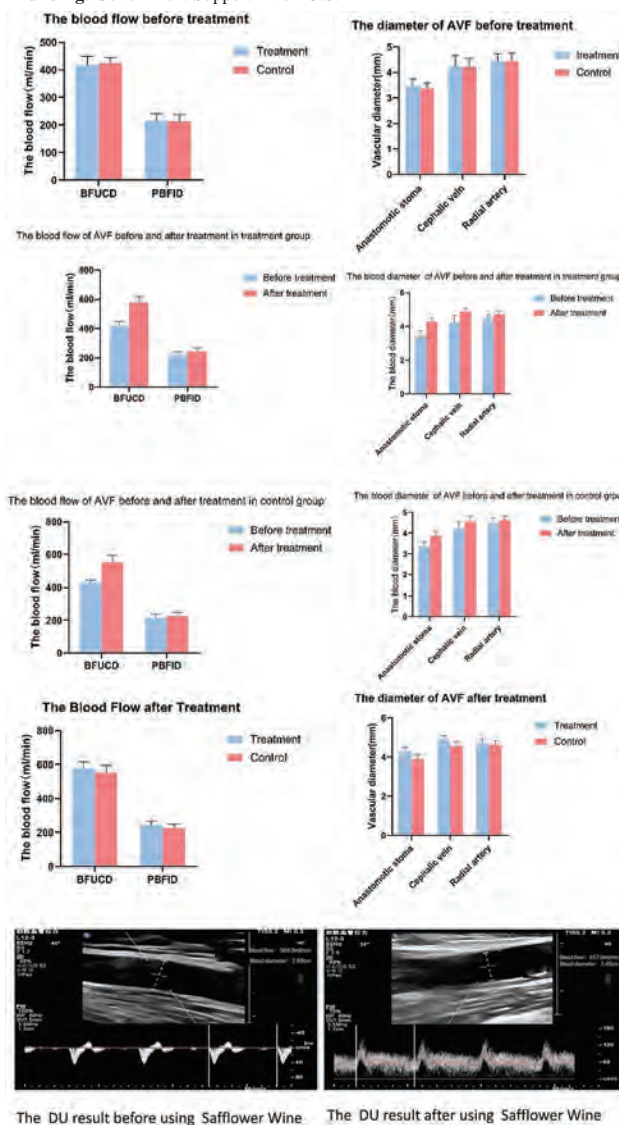

## PUB150

**Effects of Monitoring and Surveillance in Assessing Vascular Access Complications in Patients on Hemodialysis**

Vinant Bhargava, Aditi Pandey, Anil Bhalla, Ashwani Gupta, Manish Malik, Anurag Gupta, Vaibhav Tiwari, Shiv Chadha, Devinder S. Rana. *Sir Gangaram Hospital, New Delhi, India.*

**Background:** Vascular Access forms the backbone and ensuring longevity of access directly correlates with longevity of hemodialysis.

**Methods:** Study Center: Sir Ganga Ram Hospital, New Delhi. Duration: 13th September 2020 to 13th March 2021. Population: chronic kidney disease patients undergoing hemodialysis through upper extremity vascular access. Design: Randomised controlled study. Inclusion Criteria: 1) Adult population between 18-65 years with end stage renal disease undergoing hemodialysis. 2) Patient undergoing at least 2 sessions per week with an upper extremity VA (AV fistula/AVG) created at least one month before inclusion in the study. 3) Patients with radiocephalic, brachiocephalic AV fistula and with basilic vein transposition.

**Results:** There were 32 males and 18 females and 28 males and 22 females among cases and controls. The mean age of the study population and controls were 51.61 years with a standard deviation of 9.9 years and 50.06 years with a standard deviation of 10.26 yrs respectively. Vascular access monitoring by physical examination was done in all patients in both groups. Vascular access surveillance by ultrasound doppler was done in all cases and 29 controls. On the basis of outcome, thrombosis (26%) and infection (22%) of the vascular access were the most common complications in the study population overall followed by stenosis (19%), aneurysm (8%) and ischemia of limb bearing the AV access (3%). Among the cases, the complications of vascular access reported were thrombosis in 19 (38%), infection in 12 (24%), stenosis in 11 (22%), aneurysm in 5 (10%) and ischemia of limb in 2 (4%) cases. Among the controls, the outcomes reported were infection in 10 (20%), thrombosis in 7 (14%), stenosis in 8 (16%), aneurysm in 3 (6%) and ischemia of the limb bearing the AV access in 1 (2%). Considering the cases and controls individually, overall complications were reported in 35 cases (70%) and 29 controls (56%) on vascular access monitoring and surveillance.

**Conclusions:** The association between vascular access surveillance and detection of vascular access complications was not significant as compared to vascular access monitoring alone. Outcomes were statistically comparable in both groups. Hence hemodialysis vascular access surveillance despite being widely used is still an area of ongoing controversy.

## PUB151

**Tunneled Dialysis Catheter Exchange in the Hands of the Interventional Nephrologist: The Fulquet Technique**

Irati Tapia, Diana Oleas. *Consorci Sanitari de Terrassa, Terrassa, Spain.*

**Background:** The high rate of complications related tunneled dialysis catheters (TDC) is widely known. Often, the malfunction of the TDC requires its exchange or replacement, generally performed by interventional radiologists. In our unit, the exchange procedure is performed by the interventional nephrology team. We use a guide wire through the old catheter lumen using the same venotomy site to place the new TDC, avoiding a new puncture. Objective: To describe our novel TDC exchange technique over guide wire ("Fulquet technique") as well as to analyze the main characteristics and complications derived from its implementation in our unit over the past 9 years.

**Methods:** A retrospective review from January 2012 to December 2021 of TDC exchange using the "Fulquet technique" performed by interventional nephrologists. The main demographic data, comorbidities, causes for TDC exchange, and major complications related to the procedure were analyzed.

**Results:** In terms of demographic data 58% of the patients were women. As cardiovascular risk factors 93% percent had a history of hypertension and 51.6% of diabetes. Nephroangiosclerosis was the predominant etiology of chronic kidney disease in the studied patients. Two hundred and sixty TDC were inserted during the reviewed period. Thirty-one TDC exchanges were performed representing an 11.9%. Ninety six percent of TDC exchanged were SPLIT CATH@III type. The average time of TDC use was 307.7±401.9 days. The jugular vein was the most used with a 93.5% and 100% were located on the right site. Catheter malfunction was observed in 55.2% and cuff extrusion in 44.8%. These were the main indications for exchange. No exchange was performed due to TDC infection. We only observed one major complication (1/260, 0.003%) due to loss of the distal end of the TDC that required a surgical rescue.

**Conclusions:** In our experience, TDC exchange over guide wire ("Fulquet technique") can be performed by interventional nephrologist safely and effectively. Additionally, the development of novel techniques in vascular access provides nephrologists greater autonomy and a wider range of capabilities in terms of training. Based on these results we will continue using this technique in our unit.

## PUB152

**Removal of "Stuck Tunneled Hemodialysis Catheter" by Hong's Technique**

Ajay Jaryal,<sup>1</sup> Kunal Mahajan,<sup>2</sup> Sanjay Vikrant,<sup>1</sup> Dheeraj Sharma,<sup>2</sup> Praveen Dhaulta,<sup>2</sup> Ram Singh.<sup>2</sup> *<sup>1</sup>All India Institute of Medical Sciences - Bilaspur, Bilaspur, India; <sup>2</sup>Indira Gandhi Medical College, Shimla, India.*

**Introduction:** Sometimes tunneled catheters (TC) are the only means of long-term vascular access for hemodialysis (HD). They can be safely removed, but very rarely they may get stuck. Herein we report such a scenario where stuck TC was successfully removed by endoluminal dilation or "Hong's technique".

**Case Description:** A 21-year-old male, on maintenance HD, arrived in our hospital with a thrombosed brachiocephalic arteriovenous fistula (AVF). With no suitable veins for AVF, and refusal of the patient for peritoneal dialysis or AV graft, a TC was inserted, through which he received HD uneventfully for the next one and a half years until the TC, developed a crack and there was no way to salvage it. So, we went ahead to remove it but failed, as it was stuck. We asked for cardiology and vascular surgery consultation, who were equally unfamiliar. We discussed Hong's technique with them, and a team led by an interventional cardiologist decided to attempt it. In the cardiac catheterization laboratory, a guidewire was passed inside the lumen of TC over which endoluminal dilation of the TC was done with a 6.0 x 40 mm balloon (Figure 1) following which the TC was successfully removed (Video <https://www.kapwing.com/videos/628e597d96c0a100a2191963>).

**Discussion:** A stuck TC is one, which cannot be removed from its location i.e., central vein or right atrium by conventional technique. It usually happens due to the formation of fibrin sheath. Forceful removal can lead to life-threatening complications like catheter fragmentation or injury to large blood vessels. Then surgery is the only option. However, a novel procedure of endoluminal dilation pioneered by Hong can be lifesaving. As in the words of the pioneer, "the endoluminal balloon dilation of the HD catheter not only separates the stuck catheter from the adherent vein but also expands the vein simultaneously, thus enabling easy removal of the stuck catheter".

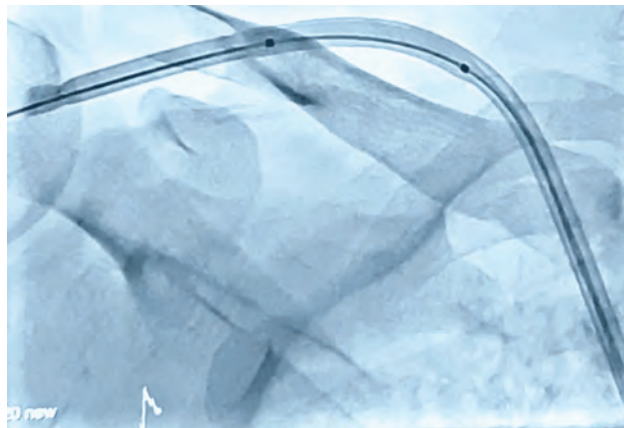

Balloon dilatation in the lumen of tunneled catheter.

## PUB153

**Nursing Care of Allergic Dermatitis for a Maintenance Hemodialysis Patient with a Tunneled Cuffed Catheter**

Liang Chen, Wu L. Li. *Chongqing City Hospital of Traditional Chinese Medicine, Chongqing, China.*

**Introduction:** Allergic dermatitis caused by disinfectant iodophor is known by nurse staffs. What make us confused in this case was regularly used iodophor to disinfect the catheter inlet before, but the patient suddenly allergic to it. It tricked us for a long time. It is not easy to disclose the real reasons at the first time.

**Case Description:** An 81-year-old male patient, dialysis for 1 year, underwent tunneled cuffed catheter (TCC) vascular access, no history of food and drug allergies, and self-care ability score: 70 points. Diagnosis: Chronic kidney disease stage 5, renal anemia, hyperphosphatemia. On May 19, 2021, TCC was intubated. On January 3, 2022, the skin around the catheter inlet appears red and desquamated, accompanied by an itching symptom.

**Discussion:** The key point for this case is that the patient has TCC implanted since May 2021, but the patient suffered redness, scaling, and itching after 8 months. No systemic symptoms, no allergic history. Even consulted by a dermatologist, the patient's skin symptom did not relief. We need to distinguish the possibility of catheter inlet infection. Raising the level of nursing is essential, we set up a treatment special group to deal with this problem. At the same time of confirming the diagnosis, we should deal with the local symptoms, or there would raise the risk of catheter infection for repeated scratching caused by itching. All the special group staffs agree that the symptoms were caused by local irritating. we changed all the nurse procedure but disinfectant iodophor, and the region of skin lesions is consistent with the region of iodophor disinfection. We used hydrogen peroxide instead of iodophor to disinfect the catheter inlet. The local skin symptoms gradually relieved, and get healed finally. From this case, we know that beside the conventional procedure to deal with the problems, we should change our mind because change will occur to some constant matters.



The process of the skin symptoms nursing care



A: Jan. 3 2022  
The early stage of skin symptoms redness, itching



B: Jan. 10 2022  
Get worse redness, scaling, itching



C: Jan. 26 2022  
Hydrogen peroxide instead of iodophor skin symptoms gradually relieved



D: Jan. 31 2022  
Get healed finally

The process of the skin symptoms nursing care.

PUB154

Outcomes of Tunneled Venous Catheters for Chronic Hemodialysis in a Tertiary Care Centre

Kudithi Soundarya, Manjusha Yadla. Gandhi Hospital, Secunderabad, India.

**Background:** Vascular access is an important aspect of hemodialysis treatments and determinant of patient outcomes. AV fistula is preferred mode of vascular access but has many limitations including challenges in fistula creation, shortage of vascular surgeons, failure rates. Tunneled catheters are progressively more commonly used vascular access now a days.

**Methods:** Aim of the study is to determine the Outcomes of Tunneled venous catheters for chronic hemodialysis in tertiary care hospital. Study design is prospective observational study patients who underwent tunneled catheterization in Gandhi hospital during from January 2021 to March 2022 were analyzed. Outcomes assessed were demographics, etiology of ESRD, catheter outcomes, complications and patient outcomes.

**Results:** Total no of patients were 148, out of which 3 patients were HBV positive, 3 patients were HCV positive, one patient was HIV positive. Right IJV tunneled catheterization done in 144 patients, Left IJV tunneled catheterization done in 2 patients, femoral catheterisation done in 2 patients. Mean age of patients was 52+/-12 years. Male to female ratio was 2:1. Out of 148 patients, 132 were hypertensive and 34 were Diabetic. Average duration of catheter survival in patients were 98+/-22 days. Average time to complications were 56 +/- 16 days. Immediate complications (9 patients) include exit site ooze in 5 patients, flow related problems in 2 patients, arrhythmias in 1 patient, seizures in 1 patient. Late Complications were seen in 23 patients (12 patients has CRBSI, 6 patients - blockage of catheter, 4 patients - catheter dislodgement, 1 patient had haemothorax during left IJV catheterization). On follow up, 28 patients expired, 40 patients alive with functional catheters, 66 patients converted to AV fistula, 1 patient converted to CAPD, and in 96 patients catheter removed, 14 patients lost to followup.

**Conclusions:** Percentage of tunneled catheter usage was 6% in our center. Average survival of catheter in patients was 98 +/- 22 days Percentage of complications was seen in 21 % of patients. Most common complication in our study was CRBSI (8%). Assisted survival of catheter was 62 %. Mortality of patients of chronic haemodialysis in our study was 20 %. Rate of conversion to AV fistula was around 49 %. Most common cause of catheter removal was conversion to permanent access (68%) followed by death (29%)

PUB155

Long-Term Conditions and Health Inequalities: Kidney Care for All, in Support of World Kidney Day (2022)

Shahid N. Muhammad. Coventry University, Coventry, United Kingdom.

**Background:** In the UK, unfortunately, one of the main issues surrounding healthcare is that patients with chronic illnesses like Chronic Kidney Disease (CKD) are restricted to NHS healthcare services and approaching healthcare provider. Further complications can arise especially for those who have healthcare challenges and where misinformation can lead to fragility and health inequalities. Patient and Public Involvement (PPI) can help bridge issues surrounding health inequalities. **Aims:** To identify 1) whether patients with CKD would like to approach health professionals and patients through online consultations and educational support, thus prompting collaborative efforts and 2) understand if/ whether CKD patients would welcome more integrative support from healthcare professionals through social media, wherein patients and professionals can bridge gaps across health inequalities.

**Methods:** In support of World Kidney Day (2022), this article seeks to highlight how health inequality can be bridged through online spaces and integrative practices between patients and health professionals.

**Results:** Patients are the intermediaries between primary and secondary healthcare services. CKD patients now have more opportunities to share lived experiences owing to the nature and implementation of social media platforms, like the Renal Patient Support Group (RPSG) and the Kidney Disease and Renal Support Group (KDARs) for Kids.

**Conclusions:** In addition to sharing experiences, this prompts patients to be more than mere recipients of healthcare; CKD patients become more empowered so that more informed decisions can be made. Educational intercessions are required generally to offset issues where there are inequalities but also to ensure excellence in health practice.

PUB156

Patient Perspective on Home Dialysis Access for Latinx Patients With Kidney Failure

Katherine M. Rizzolo, Rebeca Gonzalez Jauregui, Lilia Cervantes. University of Colorado, Denver, CO.

**Background:** Latinx people experience a 1.3 times greater incidence rate of kidney failure compared to non-Latinx White individuals, but are less likely to utilize home dialysis therapies. The motivation and mitigating factors allowing for Latinx individuals with kidney failure to pursue home therapies has not been elicited. In this study, we aim to better understand the patient experience as a Latinx-identifying patient with kidney failure treated with home dialysis.

**Methods:** Participants include patients over 18 years old identifying as Latinx receiving home dialysis in two home dialysis clinics in the Denver Metro area. 30-60 minute semi-structured phone interviews were conducted, transcribed and de-identified for thematic analysis.

**Results:** At the time of this abstract submission, 9 patients had been enrolled, though it is expected a maximum of 20 participants may be enrolled or until thematic saturation is reached. Full enrollment is expected by August 2022. The main reported reasons for pursuing home dialysis included independence, quality of life, and flexibility. A major driver towards success with home was self-advocacy, many participants reported they educated themselves on home dialysis modalities. Favorable characteristics of the home dialysis clinic included approachable staff and individualized education and training. Participants noted the need for widespread language and culture concordant home dialysis modality education. Major themes with illustrative quotes are noted in Table 1.

**Conclusions:** In our study, self-advocacy and individualized education was noted by almost all participants. Future directions with these findings may be interventions focusing on culture and language concordant modality education for the Latinx community with kidney failure.

**Funding:** NIDDK Support

Theme	Subtheme	Illustrative quote
<b>Theme 1</b> Reasons for pursuing home dialysis	Independence	I have to do eight hours of treatment. And so within that time period, most of the time I'm sleeping, but it doesn't impede me from doing what I need to do in my house.
	Quality of Life	Just being able to be myself and be able to continue my lifestyle as I currently live it. I didn't want any restrictions to inhibit my ability to, you know, really work on my health really work on my being available to my husband and my two children. You know, just not losing myself if that makes sense.
	Flexibility	They told me home dialysis or I go to a place. but for me, it was better to be at home it'd be more comfortable for me. Because you know, I can do it on my time. And that was very important to me.
<b>Theme 2</b> Reasons for success with home dialysis	Self-advocacy	The education at all was so minimal. The only option there was the blood one. And I said, "Hold it on, I'm going to do my research. And you guys can just say that I can do it."
	Individualized training	I really want to stress for families, it's, you know, the hands-on training is really, really important... I think that all people have, you know, different ways of learning. And so the more multifaceted the way that the teaching is, the better it is for everyone. Whoever really goes into this type of, you know, clinical treatment.
	Approachable clinic staff	The first few days was a lot of learning, but I always had access to a technician or a nurse to help me answer my questions.
<b>Theme 3</b> Ways to improve home dialysis access for the Latinx community	Improved dialysis education for the Latinx community	I think that there's a lot of unknowns for our community. I think people who do get on dialysis really don't know a lot about it. I know for a fact that I didn't know anything about it prior to getting on.
	Improved kidney education for families of patients	About a month ago I went to Mexico for two days to visit my relatives, and automatically, as soon as you arrive, it's nice, but it's sad. The first thing they say to you: Oh, how are you, keep fighting and so on... I mean, they think that because I'm on dialysis, I'm already ah, I'm already sad, I'm dying, this and that. There's not a lot of information in Spanish. So, that's why a lot of people, I think they're not choosing the PD catheter.
	Language concordance	

Table 1. Major themes and illustrative quotes

## PUB157

**Examining Renal Concerns in Ethics Consults**

Julie Steinberg,<sup>1</sup> Lauren Sparber,<sup>2</sup> <sup>1</sup>*Cohen Children's Medical Center, Queens, NY;* <sup>2</sup>*Northwell Health, New Hyde Park, NY.*

**Background:** Few published studies focus on the effects of collaboration between nephrology and ethics. It is widely accepted by nephrologists that there are ethical concerns which arise in daily practice. In addition to the impact on the individual, societal concerns include equitable access to care for kidney disease. The American Society of Nephrology, with the European Renal Association-European Dialysis and Transplant Association and International Society of Nephrology Joint Working Group released ten topics, which should serve as an ethical priority (2020). These include: Equity in access to integrated kidney failure care; Setting priorities in kidney disease prevention and care; Supporting shared decision making about kidney failure care; Avoiding futile or overly burdensome dialysis treatment; Reducing the cost of dialysis care without compromising quality; Preventing organ trafficking and transplant tourism; Evaluating the risks and outcomes of living kidney donation; Addressing the ethical implications of genetic kidney disease; Managing conflicts of interest in nephrology; Advocating responsibly for kidney health. Yet, there is no clear guidance on how to manage these concerns. Additionally, training does not focus on this in a standardized manner. This pilot study sought to describe the ethical framework necessary towards improving overall outcomes.

**Methods:** IRB approval was obtained to perform a retrospective chart review of bioethics consults for renal patients treated in a tertiary medical system in New York State. This included pediatric and adult patients. The authors reviewed the consults. Reasons for consult were extracted and categorized based on the priorities set forth in 2020. This included: organ transplantation; genetic kidney disease; avoidance of futile/overly burdensome dialysis; shared decision-making.

**Results:** Population-level concerns did not emerge in consults. More than one reason for consult could be identified, as well as a "none of the above" category. Continued analysis is on-going.

**Conclusions:** It is likely that the concurrent COVID-19 global pandemic and its effect on renal health and resource allotment heavily impacted these results. However, it is apparent that there is a large focus on the burden of dialysis, suggesting that these should be more clear approaches to these concerns, used by practicing nephrologists. Additional studies are required to further evaluate this initiative.

## PUB158

**Improving Transition of Care From Hospital to Clinic**

Vishnupriyadevi Parvathareddy, *Baylor College of Medicine, Houston, TX.*

**Introduction:** Patients evaluated by inpatient nephrology consult service often require outpatient follow up. Our SMART aim was to ensure follow up after hospitalization in clinic upon discharge in a previously fragmented system for requesting and scheduling appointments with a significant obstacle of having two separate EMR systems for inpatient and outpatient care.

**Case Description:** A hospital discharge follow up order was created in inpatient EMR which would be received by referral team and clinic requests were scheduled directly by contacting patients. In order to implement this change, educational handout was created for fellow/faculty and dot phrases were created to standardize information input. Both outcome measures (percentage of requested appointments completed) and process measures, (percentage of requested appointments scheduled and percentage of requests that prompted a scheduling attempt) were measured and followed on for a year. Baseline data and data after intervention were compared and early results showed a trend towards improvement in capture rate of patients scheduled and scheduling attempts.

**Discussion:** Pre- intervention scheduling process was quite fragmented and varied and there was no way to determine the outcome of the scheduling attempt. The new process of having a referral team which uses EMR to make and track appointments helped immensely with data gathering and detect any failures in the process. The newly designed process allows for collection of detailed data on the outcomes of scheduling requests which can help identify additional targets for improvement. Future PDSA cycles will focus on ways to target patients not captured in order to improve follow up rates. few things we will be adding would be screening for insurance compatibility prior to discharge, adding hospital follow up schedule slots each week to accommodate requests, monitoring data for no-shows to identify areas of improvement and sending a confirmation of scheduled appointment to requesting provider via EMR.

## PUB159

**Failure of Social Work, Education, and Environmental Improvements in the Evolution of Cardiovascular and Renal Risk Factors in an Ethnic Minority**

Maria Eugenia V. Bianchi,<sup>1</sup> Velasco Gustavo,<sup>2</sup> Daniel Forlino,<sup>1</sup> Ana M. Cusumano,<sup>3</sup> National Northeast University <sup>1</sup>*National Northeast University, Corrientes, Argentina;* <sup>2</sup>*Universidad Tecnologica Nacional, Buenos Aires, Argentina;* <sup>3</sup>*Centro de Educacion Medica e Investigaciones Clinicas Norberto Quirno, Buenos Aires, Argentina.*

**Background:** For 15 years (from 2003 to 2018), diverse Organizations including the Governments advocated to give consciousness and work together to stop or unless slow down the evolution of cardiovascular and renal risk factors in a minority ethnic group in Resistencia, Chaco Argentina. the poorest region. No improvements were seen during 15 years in their contribution to the nationwide IBP (almost 1,3%). This work aims to

show the results of the evolution of cardiovascular and renal risk factors(CVRRF) in two measurements (2003-2018) in the same cohort of Qom borignes.

**Methods:** Since 2003 a program has been designed and evaluated by the National Northeast University for early Detection of Cardiovascular and renal risk factors, (CVRRF). There were actions with population meetings. Governments during this year constructed houses, install water in each house and made sewers. Schools and Health Care centers were inaugurated for every 4000 persons approximately. A survey for those inhabitants was made to ask about Health accessibility.

**Results:** Obesity was the CVRF that has impressively grown over 15 years, with an increase in DM and GFR. GFR showed a RR factor for Mortality. Causes for Mortality changed from 2007 to 2018 with a 50% of TBC caused to be Cancer especially in females of gynecologic origin. Cardiovascular causes of dead increased too. The survey showed that they had no problems with the Health system, especially at the community level, but was afraid to go to the Hospital.

**Conclusions:** At a rhetorical level the population has recognized these actions studied. Although this Community received particular attention, other strategies should be thought. Or perhaps if the IBP does not grow in the province of Chaco, these actions are not sufficient.

**Funding:** Government Support - Non-U.S.



## PUB160

**Educational Support Surrounding CKD: A Qualitative Enquiry**

Shahid N. Muhammad,<sup>1,2</sup> <sup>1</sup>*The University of the West of England, Bristol, United Kingdom;* <sup>2</sup>*Coventry University, Coventry, United Kingdom.*

**Background:** An estimated 15 million patients in England have at least one Long-Term Conditions with the prevalence of Chronic Kidney Disease (CKD) rising. Understanding educational support can help navigate between health sectors. **Research Question:** This UK study seeks to understand Educational Support surrounding CKD. **Ethics:** This research was approved by Greater Manchester South Research Ethics Committee (Project ID: 19/NW/0282).

**Methods:** This research used Qualitative Methodology, and an Inductive Content Analysis (ICA) approach which is particularly effective in linking theory, or framework. **Patient and Public Involvement (PPI):** Two workshops took place in May and June (2019) wherein topic tagging activities were co-developed between the Renal Patient Support Group (RPSG) and the Kidney Disease and Renal Support Groups (KDARs) for Kids platforms. **Sampling and Recruitment:** 19 participants between 4 cohorts, that included 6 General Practitioner (GPs), 4 Healthcare Scientists (HS), 3 Nephrologists/Clinicians (N/Cs), and 6 CKD Patients (CKDPs) were recruited and participated in telephone interviews.

**Results: Data Collection:** Topic guides were developed for participant cohorts with several themes to collect data through one-to-one telephone interviews **Analysis:** NViVo-12 software provided opportunity to code and glean insight to develop overall conclusions. **Results:** Nine (9) main themes and several sub-themes were identified when coding for Health Professionals (HPs), and Nine (9) main themes and several sub-themes identified when coding qualitative data for Chronic Kidney Disease Patients (CKDPs).

**Conclusions:** There needs to be a coordinated effort between patients and professionals, to understand how CKD education should be more integrated at point of care, and in line with public health. Keywords: Nephrology, Education, Qualitative Research, PPI.

## PUB161

**Validating a Novel Framework to Classify Inpatient Nephrology Consultation Requests**

Larissa Kruger Gomes, Rushad Patell, Jeffrey H. William. *Beth Israel Deaconess Medical Center, Boston, MA.*

**Background:** Consistent classification of consult requests may lead to more productive, efficient, and collegial conversations about patient care which can facilitate improved work satisfaction and an enhanced learning environment. We propose a framework of 7 consultation types: ideal (I), obligatory(O), procedural, S.O.S., confirmatory(C), inappropriate, and curbside. We aimed to obtain validity evidence for this rubric to consistently classify consultation requests in an academic setting.

**Methods:** A random sample of 100 de-identified nephrology consultation requests from a single academic center were selected and independently coded as 1 of the 7

Key: TH - Thursday; FR - Friday; SA - Saturday; OR - Oral; PO - Poster; PUB - Publication Only

Underline represents presenting author.

consultation types by 3 nephrologists and 3 hospitalists. Total (same consult assignment by 6/6 coders) and partial (same consult assignment by >4/6 coders) concordance was calculated. Total and partial (>2/3 coders) inter-rater concordance based on consult and provider types was calculated.

**Results:** Of the 100 consults, perfect concordance was 55%, and partial was 36%. Amongst nephrologists total concordance (agreement in 3/3) was 61% and 78% for hospitalists. In cases where there was not perfect concordance (n=45), nephrologists completely agreed with each other 13.3% of the time, and partially agreed 68% of the time, while hospitalists completely agreed with each other 51% of the time and partially agreed 37.8%. Of the consults that at least 4 coders classified in the same way, nephrologists were less likely to have perfect concordance for I (68% vs 83%, respectively; P=0.028), similarly for SOS (32% vs 72% P<0.001), hospitalists had a lower concordance rate for O (82% vs 94% P = 0.27). Nephrologists and hospitalists were similarly likely to consider a consult to be I (53 vs 54% p=0.4), SOS (28% VS 24% p=0.12) or C (1.7% vs 3% p=0.15). There was no significant difference in word count of the requests that were concordant (65±44), partially concordant (59±40) and discordant (77±31p=0.51).

**Conclusions:** Nephrology consult requests can be classified into a rubric of 7 subtypes. Perfect concordance between hospitalists and specialists was 55% and reached 91% if partial and complete concordance are combined. Nephrologists and hospitalists were as likely to classify consults as SOS or I consults. Opportunities exist to utilize the rubric to improve communication between providers and to improve the medical education of trainees.

**PUB162**

**The Path to a Nephrology-Critical Care Medicine Career and Outcomes**  
 Isaac Pak, Michelle Kirk, George N. Coritsidis. *Westchester Medical Center, Valhalla, NY.*

**Background:** The interest in this dual specialty eligibility has recently been on the rise since our program at Mount Sinai - Elmhurst Hospital was initiated over 15 years ago. Understandably so, since hemodynamic knowledge, electrolyte understanding, and volume status are key pathophysiological concepts necessary in both nephrology and critical care. It is an exciting and quickly evolving field that is drawing the attention of physicians-in-training. However, there is little data on the path and aftermath of those interested in Nephrology/Critical Care (NCC). This makes it difficult for those interested to accurately gauge the compatibility between their personal goals and outcomes pursuing this field. Our goal was to create a current and updated snapshot of this cohort and to explore existing opportunities and challenges as well as future prospects of this unique field.

**Methods:** In 2 different surveys, 1) we contacted applicants for the NCC program at Elmhurst Hospital Center-Mount Sinai in New York between 2014-2019, and 2) surveyed physicians identified as NCC from present CMS lists regarding: programs trained, practice status and satisfaction with NCC decision.

**Results:** Of the 25 applicants, 20 were contacted. 4 were initially interested in pulmonary critical care before applying to NCC, 10 did not pursue NCC after doing nephrology due to family/personal reasons, 2 did neither, and 8 (40%) completed NCC. Of the 50 currently practicing NCC physicians, 40 were successfully contacted, with 11 responses. Of the respondents, 8 were foreign medical school graduates. None of the respondents completed a combined 3-year fellowship, but stated that they would have preferred a combined fellowship. 3 were practicing both equally, 5 primarily nephrology, and 3 primarily critical care. 3 of the 8 who were primarily practicing one specialty were moonlighting in the opposite specialty, 8 were affiliated with an academic institution. When asked about the benefits of their training, all were satisfied and believed their training in both specialties positively affected their ability to practice the other.

**Conclusions:** Over half of applicants do not complete the dual training, often due to personal reasons, remained in nephrology. Of the responding NCC physicians, 6 of 11 were practicing both specialties. 9 of 11 were satisfied with their choice and would choose the same dual-specialty training.

**PUB163**

**Comparison of Self-Reported Medical History and ICD Codes for Diagnosis of CKD, Hypertension, and Diabetes Mellitus**  
 Aparna Saha,<sup>1,2</sup> Cristina M. Liriano Cepin,<sup>2</sup> Ron Do,<sup>3,2</sup> Girish N. Nadkarni,<sup>1,2</sup> Lili Chan,<sup>1,2</sup> BPC <sup>1</sup>Icahn School of Medicine at Mount Sinai Department of Medicine, New York, NY; <sup>2</sup>The Charles Bronfman Institute for Personalized Medicine, New York, NY; <sup>3</sup>Icahn School of Medicine at Mount Sinai Department of Genetics and Genomic Sciences, New York, NY.

**Background:** Patient medical history obtained from electronic health records (EHR) or patient self-report are important features used in clinical research. However, EHR data may be incomplete and patients may not be aware of their medical diagnoses. We aimed to evaluate the concordance between EHR and self-report to assess their reliability and validity for chronic kidney disease(CKD), hypertension(HTN) and diabetes mellitus(DM).

**Methods:** We utilized data collected as part of the BioMe Phenomics Center (BPC) from 2018-2021. Medical surveys were administered at enrollment and yearly thereafter. Patient diagnosis of CKD, HTN, and DM were extracted from the problem list using ICD codes from EHR and surveys. We compared EHR and survey diagnosis with our ground truth diagnosis as: 1. CKD if the patient had 2 values of eGFR<60 mL/min/1.73m<sup>2</sup>, 2. DM if they had a HbA1c >6.5% or DM medication and 3. HTN if patients had 2 values of either a systolic blood pressure >130 mmHg or diastolic blood pressure >80 mmHg or HTN medication. Comparison testing used chi-square test and agreement assessed using Cohen's κ.

**Results:** 154 subjects participated in our research study. The mean age was 56 years with 70% female, 32% black, 54% white and 7% hispanic. 22% of subjects had CKD by eGFR criteria and 13% had ICD code for CKD and reported CKD on the survey(Fig

1a). However, there was moderate agreement between eGFR and ICD codes (κ=0.4) and surveys (κ=0.6). For DM, while there were significant differences between HgbA1c/medication diagnosis and survey and ICD codes, there was substantial agreement between the HgbA1c/medication diagnosis and ICD codes (κ=0.7) and perfect agreement with surveys (κ=0.9). ICD codes and surveys found significantly less HTN compared to blood pressure/medication diagnosis. However, there was fair agreement between the blood pressure/medication diagnosis and ICD (κ=0.3) and surveys (κ=0.2). Discrepancies were noted in the use of medications on survey at baseline and follow-up compared to EHR (Fig 1b).

**Conclusions:** Survey data was better at identifying patients with DM and HTN and was similar to ICD codes for CKD. A combination of ICD and survey data should be used when available.

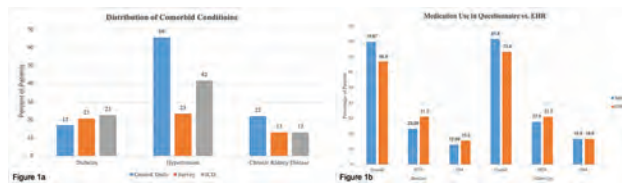

**PUB164**

**Nephrologists Frustrated With FDA Decisions on Roxadustat, Vadadustat, and Tenapanor**  
 Jennifer Robinson, Chris Dudzenski, Denise Foy. *Spherix Global Insights, Exton, PA.*

**Background:** The FDA has had recent controversial decisions, notably, the approval of Aduhelm (aducanumab) in Alzheimer's Disease in 2021 despite the Advisory Committee's vote against recommendation. Over the past year, the renal community has seen multiple Complete Response Letters (CRL) for drugs in development including vadadustat, roxadustat, and tenapanor. We sought to understand how these regulatory decisions were being perceived by clinicians.

**Methods:** 252 specialty physicians participated in an online survey in July 2021. Follow-up studies were conducted in August 2021 and March 2022 with nephrologists (n=105 each).

**Results:** Nearly half of physicians surveyed in July 2021 indicated their confidence in the FDA eroded in some degree in recent years, most notably a staggering 84% of neurologists (Figure 1). Among leading health organizations, 48% indicated high confidence in the Centers for Disease Control, compared to only 37% in the Food and Drug Administration and 26% in the American Medical Association. Comparatively, confidence in professional organizations such as American Society of Nephrology, American College of Gastroenterology, American College of Rheumatology, American Academy of Dermatology, and American Academy of Neurology were significantly higher. Among nephrologists surveyed in August 2021, 71% disagreed with the FDA's decision not to approve roxadustat, which was approved for use in the EU shortly after. March 2022 feedback after the vadadustat CRL was similar. Nephrologists were even more frustrated by the lack of approval for tenapanor with only 20% of nephrologists supporting the FDA's decision not to approve.

**Conclusions:** The majority of nephrologists, 74%, agree there is a high unmet need for an alternative to phosphate binders while 58% agree there is a similar unmet need for an alternative to ESAs. Despite this, half of the surveyed nephrologists from March 2022 feel the recent FDA decisions are stifling innovation within the renal field.



**PUB165**

**Pilot Study of Leadership Lecture Series in Nephrology Fellow Education**  
 Lakshmi Ganesan. *Loma Linda University School of Medicine, Loma Linda, CA.*

**Background:** ACGME identifies six core competencies required in trainees - patient care, medical knowledge, practice-based learning and improvement, interpersonal and communication skills, professionalism, and systems-based practice. Notably, three of the six directly correlate to leadership skills such as emotional intelligence, communication, conflict management, advocacy and advancement. While some argue these skills are partly inherent, there is still a teachable component. Here we have taken the approach of introducing these skills during fellowship.

**Methods:** We introduced a lecture series, integrated into fellows' education, over the course of two year fellowship. Topics varied from communication, financial literacy to conflict management, diversity and inclusion, mindfulness/self-care, and business of medicine, advancement and early career transitions. Though these may be part of many curricula in other programs, we formalized the curriculum to include guest speakers as well to enhance networking opportunities.

**Results:** Based on internal survey data, recent and past Nephrology graduates and current faculty, these topics were selected as vital to education. After one year of insinuating this curriculum, our trainees report feeling more prepared for the transition to attendinghood. All four fellows report they were very likely to use these skills in the future. They also report being able to use the skills learned in leadership series during their time as a trainee as well.

**Conclusions:** Physicians are often thrust into leadership roles. Whether that is managing a multi-disciplinary team of nurses, social workers, dietitians or more, or in more traditional administrative roles. We are also gaining recognition of leadership skills in patient-centered care with conflict resolution, communication skills and emotional intelligence. These skills emphasize and enrich the clinical education we receive by allowing us to implement our medical knowledge as effective healthcare leaders.

**PUB166**

**Denosumab in Immobilization-Induced Hypercalcemia**

Jugal Thaker, Abdallah Sassine Geara. *University of Pennsylvania, Philadelphia, PA.*

**Introduction:** Critically-ill patients with prolonged immobility are at risk of hypercalcemia. In ESRD patients with hypercalcemia therapeutic options are limited: Hydration may cause volume overload, loop diuretics are not effective and bisphosphonates may cause over suppression of bone turnover. This case series presents two patients with immobilization-induced hypercalcemia successfully treated with denosumab

**Case Description:** Case 1: a 51 y/o male s/p bilateral lung transplant who developed chronic respiratory failure due to COVID-19. Case 2: a 54 y/o male initially admitted with COVID-19 requiring b/l lung transplant. Both patients developed AKI that progressed to ESRD and were bed bound. Evaluation for the hypercalcemia was compatible with immobilization-induced hypercalcemia: low iPTH, normal 1,25-VitD levels, negative multiple myeloma workup and mildly elevated PTH-rp (due to accumulation of the carboxy-terminal fragments). We eliminated calcium in the enteral feeds, used low calcium dialysis bath without success. Both patients received denosumab 60mg S/c once with improvement of the hypercalcemia. They developed asymptomatic hypocalcemia treated with resumption of calcium in the diet and using a 2.5Ca dialysis bath.

**Discussion:** Denosumab is monoclonal antibody to the RANKL that inhibits osteoclast formation. It is currently used in osteoporosis therapy and cancer-induced hypercalcemia. In ESRD patients with immobilization-related hypercalcemia, denosumab offers the advantage of no renal dose adjustment necessary, rapid onset of action and longer therapeutic duration. Patient should be monitored for hypocalcemia, rebound hypercalcemia and risk of over suppression of bone remodeling.

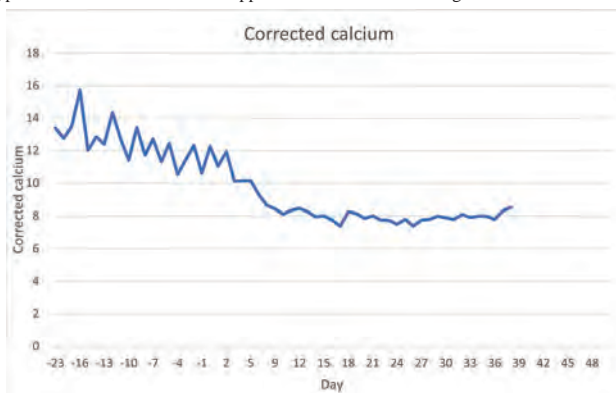

Case 1

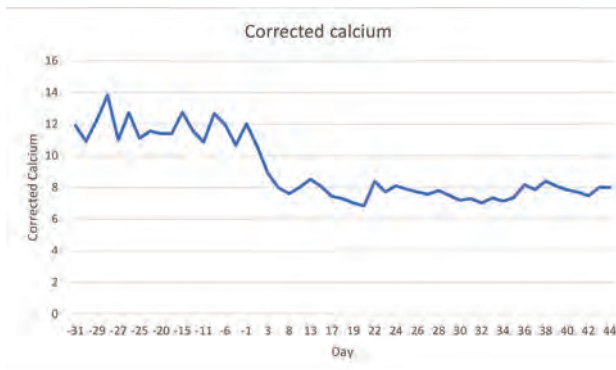

Case 2

**PUB167**

**Not Your Typical Heart Failure: A Rare Case of Adult-Onset Bartter Syndrome**

Hanah L. Williams,<sup>1,2</sup> Andrew T. Ho,<sup>2</sup> Joseph Ahoulim,<sup>3,2</sup> Andrew Y. Kim,<sup>3,2</sup> Ellika Salari,<sup>3,2</sup> Sheldon J. Myers.<sup>1,2</sup> *<sup>1</sup>Western University of Health Sciences, Pomona, CA; <sup>2</sup>Temecula Valley Hospital, Temecula, CA; <sup>3</sup>UHS Southern California Medical Education Consortium, Temecula, CA, USA, Temecula, CA.*

**Introduction:** Bartter Syndrome (BS) is a renal tubulopathy characterized by hypokalemia, hypochloremia, metabolic alkalosis, hyperreninemia, and hyperaldosteronism. It causes a mutation in the loop of Henle’s thick ascending limb’s Na-K-Cl (NKCC) cotransporter. This gives BS a characteristic mechanism mimicking the loop diuretic, furosemide. Understandably, this complicates the treatment of comorbid conditions, specifically heart failure (HF). In HF, if potassium (K+) falls below 3.5 mmol/L (4-5 mmol/L) in the setting of aggressive replenishment, an alternative diagnosis should be considered. Furthermore, if an electrolyte imbalance cannot be explained, tubulopathies should be on the differential. The complexity of HF and renal response can be exacerbated by BS, thus playing a role in overall management.

**Case Description:** We report an unusual case of a 55-year-old female with a history of HF with reduced ejection fraction (HFrEF) and chronic hypotension, who presented with HFrEF (EF 10%) exacerbation. Her course was complicated by metabolic alkalosis and severe hypokalemia (as low as 1.8 mmol/L) refractory to aggressive potassium repletion protocols. Serum renin, serum chloride (Cl-), urine Cl-, and urine K+ levels were 32,092 ng/ml/hr (<5.82 ng/ml/hr), 81 mmol/L (96-106 mmol/L), 87 mmol/L (<40 mmol/L), and 108 mmol/L (<62 mmol/L), respectively. These findings are consistent with BS. Ultimately, she required ICU monitoring and emergent airway protection. The patient developed recurrent ventricular arrhythmias and passed from cardiac arrest.

**Discussion:** In the setting of BS, a HFrEF patient’s survival is futile if not caught early. Both HF and hypokalemia carry a risk of sudden cardiac death as a single entity, so when seen concurrently, treatment becomes complicated. While BS is underrepresented in adults, early recognition and understanding of this tubulopathies’ effects on heart failure management could reduce mortality and morbidity in this complicated patient population.

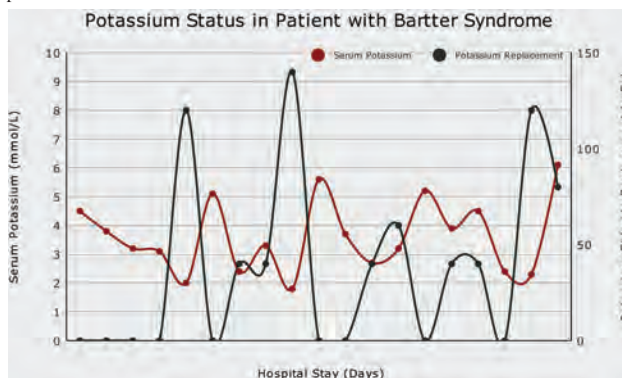

KCl Response in Patient with BS

**PUB168**

**A Case of Hyperkalemia and Hypocalcemia With IV Magnesium Administration in Preeclampsia**

Anne Brooker, Ira S. Meisels, Martine Pollack-Zollman. *Mount Sinai Morningside Hospital, New York, NY.*

**Introduction:** Magnesium (Mg) is used to decrease neuromuscular excitability in cases of preeclampsia/eclampsia. High serum levels are needed to achieve this. Although usually safe, there are reports of maternal hyperkalemia (hyperK) and hypocalcemia (hypoCa). We describe one such case.

**Case Description:** A 44 year old woman was admitted for preeclampsia due to intrauterine growth restriction and HTN. IV Mg was started. Mild hyperK developed, which resolved once IV Mg was stopped. When IV Mg was restarted, she developed severe hyperK and hypoCa that correlated with hyperMg (Graph 1). HyperK was medically treated and AKI was not present. Work up for hyperK included PAC (2.5 ng/dL, range 0.0-30.0 ng/dL) and PRA (0.925 ng/mL/hr, range 0.167-5.380 ng/mL/hr). HyperK and HypoCa improved with resolution of hyperMg.

**Discussion:** HypoK is resistant to correction if hypoMg is present. Rodan et al presents evidence of Mg inhibition of ROMK channels (via effects on membrane potential) and suggests that hypoMg fails to inhibit ROMK causing increased urinary K excretion. It is possible that the opposite is true: hyperMg may inhibit ROMK to the point of hyperK. A review of the literature revealed 3 cases of hyperK with the use of IV Mg in preeclampsia; we present the 4th case. Our literature search did not reveal cases of hyperMg causing hyperK in non-pregnant women. Possibly, the combination of hyperMg with the relatively low renin/aldo state of preeclampsia is needed to provoke hyperK. The patient did receive labetalol, ketorolac and heparin, which may cause hyperK. While calcium (Ca) is the main mediator of PTH secretion, hyperMg can directly suppress the release of PTH from the parathyroid gland, blunt PTH’s actions peripherally and compete with Ca for reabsorption leading to increased urinary Ca losses. This case highlights

the importance of careful electrolyte monitoring in pregnant patients with preeclampsia on IV Mg. Further studies are needed to elucidate the physiologic mechanism of these electrolyte derangements.

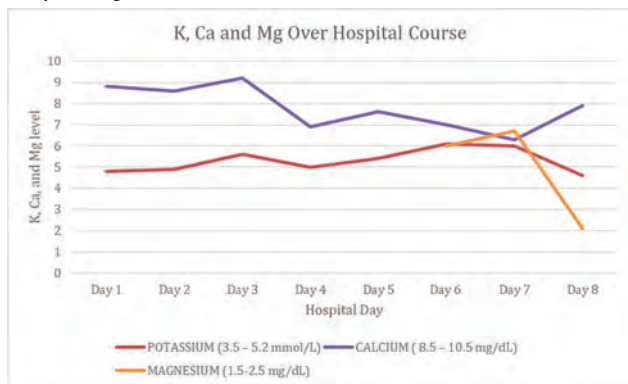

**PUB169**

**Laboratory Findings in Fatal Ingestion of Hand Sanitizer**

Kaitlyn E. Spinella,<sup>1</sup> Jared Yeggy,<sup>1</sup> Judy Sakya,<sup>1</sup> Kirtan Patel,<sup>1</sup> Nathan Dang,<sup>1</sup> Shahzad Safdar,<sup>1,2</sup> <sup>1</sup>The Christ Hospital Health Network, Cincinnati, OH; <sup>2</sup>Mt Auburn Nephrology, Cincinnati, OH.

**Introduction:** Alcohol-based hand sanitizer is typically composed of ethanol or 2-propanol, as recommended by the Center for Disease Control and Prevention. However, since the start of the SARS-CoV-2 pandemic, the demand has increased exponentially, leading to the increased circulation of products that do not meet regulatory standards. This case describes a patient who ingested hand sanitizer; however, based on the laboratory findings, it likely contained more toxic alcohols than ethanol.

**Case Description:** A 53-year-old male presented to the emergency department (ED) via emergency medical services (EMS). Patient reportedly had ingested hand sanitizer and become unresponsive. EMS found him pulseless upon arrival, and advanced cardiac life support (ACLS) was initiated, resulting in return of spontaneous circulation (ROSC). He arrested again in the ED and ACLS was initiated, resulting in ROSC again. No family was present, but per chart review, patient had a history of a seizure disorder, polysubstance abuse, and cirrhosis. Patient was admitted to the intensive care unit for further management. Labs indicated an anion gap metabolic acidosis, significant for anion gap of 48 mmol/L, sodium 151 mmol/L, potassium 5.7 mmol/L, bicarbonate 8 mmol/L, creatinine 4.96 mg/dL, blood urea nitrogen (BUN) 74 mg/dL, glucose 196 mg/dL, and lactate 30.48 mmol/L. Serum osmolality was measured at 407 mOsm/kg with a calculated osmolality of 389 mOsm/L (including ethanol level of 216 mg/dL). Venous blood gas showed a pH of 6.86 on admission. Upon discussion with Poison Control, fomepizole or ethanol treatment was not recommended, as hand sanitizers are typically made from ethanol and his level was not severely elevated, so only supportive care was necessary. Continuous renal replacement therapy (CRRT) was initiated. However, he began to demonstrate decorticate posturing. Following discussion of prognosis with family, they decided to pursue comfort care.

**Discussion:** Since the beginning of the SARS-CoV-2 pandemic, hand sanitizer production has increased, with some being manufactured outside of typical regulatory standards. As indicated by the osmolar gap and severe anion gap metabolic acidosis, the hand sanitizer ingested in this case may have contained methanol or ethylene glycol. Consequently, it is essential to have a high index of suspicion for alcohols other than ethanol in hand sanitizer ingestion.

**PUB170**

**Transtubular Potassium Gradient in Hypertensive Emergency**

Jia Wei Tan, Kwabena S. Nketiah Sarpong, Sun-Joo Jang, Samdish Sethi, Lakshmi D. Polisetty, Arjun Gogna. *Bridgeport Hospital, Bridgeport, CT.*

**Background:** Transtubular potassium gradient (TTKG) indirectly evaluates the potassium secretion at the site of cortical collecting duct and serves as a surrogate marker for mineralocorticoid activity. In hypokalemic hypertensive emergency (HE) patients, TTKG is a useful test in the workup for secondary cause of hypertension.

**Methods:** We conducted a retrospective study on HE patients admitted under the Yale New Haven Health (YNHH) system from 2016 to 2021. We selected patients with International Classification of Diseases, Tenth Edition (ICD-10) diagnosis of HE (I16.1) and at least 1 additional diagnosis for concurrent end organ damage. We excluded patient with urine sodium less than 25 mEq/L and patients who have a urine osmolality that is less than plasma osmolality.

**Results:** Among the hypokalemic patients, the median TTKG is 10.21 (IQR: 8.88-12.45). Among the normokalemic patients, the median TTKG is 4.35 (IQR: 3.33-6.49). Among the hyperkalemic patients, the median TTKG is 2.29 (IQR: 1.80-2.77). The TTKG is significantly different among the 3 groups (p<0.01). There is no significant difference of serum creatinine, systolic blood pressure (SBP) and urine potassium/urine creatinine ratio (uK/uCr) across the three potassium groups.

**Conclusions:** The high TTKG in hypokalemic HE patients reflects an underlying renal potassium wasting disorder. We suggest to trend the values of TTKG during treatment course of HE. If the abnormal TTKG returned to normal with reduction in blood pressure, the potassium wasting state is likely secondary to pressure natriuresis from accelerated hypertension, and further diagnostic tests should be ordered with discretion. If the TTKG is persistently high, evaluation of a mineralocorticoid excess state should be pursued in the inpatient setting.

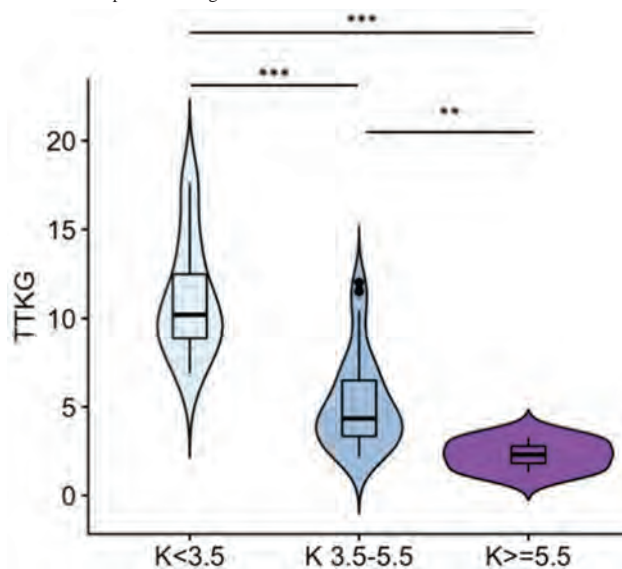

Post-hoc analyses were performed with pairwise Wilcoxon ranksum test (\*\*\*) P<0.01, \*\* P<0.05).

**PUB171**

**Nephrogenic Diabetes Insipidus Secondary to Foscarnet**

Wadhah M. Bin Homam, Joseph H. Holthoff, Umair Ali, Yazan A. Bashtawi. UAMS Internal Medicine/Nephrology *University of Arkansas for Medical Sciences, Little Rock, AR.*

**Introduction:** Foscarnet is a pyrophosphate analog. It binds reversibly near the pyrophosphate-binding site of DNA polymerase and selectively inhibits viral polymerase. Foscarnet is used in the treatment of CMV infection in immunocompromised patients. We are presenting a case report of a patient with lambda light chain myeloma post SCT who developed nephrogenic diabetes insipidus secondary to foscarnet for the treatment of CMV viremia.

**Case Description:** A 71-year-old lady was diagnosed with lambda light chain myeloma in 9/2021 when she presented with nose bleeds, headaches, loss of appetite, and was found to have pancytopenia. The patient underwent autologous SCT. The patient was readmitted due to worsening nausea and vomiting, underwent upper GI endoscopy with a biopsy suggestive of chemical gastritis. The patient was found to have CMV/HH6 viremia for which ganciclovir was started. Due to worsening pancytopenia, ganciclovir was shifted to foscarnet (80 mg/kg, 6 g iv daily). 3 days after initiation of foscarnet, the patient developed hypernatremia with serum sodium increased to 147 mmol/L. Other investigations showed a serum creatinine of 1 mg/dL, BUN of 5 mg/dL, serum albumin of 2.2 mg/dL, serum calcium of 7.5 mg/dL, corrected serum calcium of 8.9 mg/dL and a serum potassium of 3.3 mmol/L. Initially, hypernatremia was believed to be secondary to volume depletion in the setting of vomiting and poor oral intake. Despite isotonic fluid replacement, serum sodium continued to increase, reaching 164 mmol/L and the patient became confused. The patient was polyuric with a maximum urine output of 9L/d. The plasma osmolality was 311 mmol/kg, and the urine osmolality was 191 mmol/kg. Having the patient's general condition, the water deprivation test wasn't done. Nephrogenic diabetes insipidus secondary to foscarnet was highly suspected. IV chlorthalidone 500 mg/day was started and foscarnet was discontinued, 10 days after its initiation. Upon foscarnet's withdrawal and along with hypotonic fluids infusions, hypernatremia started to gradually improve, and serum Na+ reached the normal levels 5 days after.

**Discussion:** Nephrogenic diabetes insipidus is a rare side effect of foscarnet use. A search of the World Health Organization's adverse effect database revealed 359 reports of drug-induced diabetes insipidus. Lithium was the most common cause (159 reports) followed by foscarnet (15) and clozapine (10).

**PUB172**

**A Prospective, Real-World Evidence Study of Hyperkalemia Management Decision Making: Design of the TRACK Study**

**Judith Hsia,<sup>1</sup> Nitin Shivappa,<sup>2</sup> Ameet Bakhai,<sup>3</sup> Jordi Bover,<sup>4</sup> Javed Butler,<sup>5,6</sup> Pietro Manuel Ferraro,<sup>7,8</sup> Linda F. Fried,<sup>9</sup> Markus P. Schneider,<sup>10</sup> Navdeep Tangri,<sup>11</sup> Wolfgang C. Winkelmayer,<sup>12</sup> Meredith S. Bishop,<sup>3</sup> Hungta (tony) Chen,<sup>2</sup> Krister Järbrink,<sup>13</sup> Ewelina Rzepa,<sup>14</sup> Marc P. Bonaca.<sup>1</sup>** <sup>1</sup>University of Colorado, Aurora, CO; <sup>2</sup>AstraZeneca, Gaithersburg, MD; <sup>3</sup>Royal Free NHS Hospital, London, United Kingdom; <sup>4</sup>Hospital Germans Trias i Pujol, Badalona, Spain; <sup>5</sup>Baylor Scott & White Research Institute, Dalla, TX; <sup>6</sup>University of Mississippi, Jackson, MS; <sup>7</sup>Fondazione Policlinico Universitario A. Gemelli IRCCS, Rome, Italy; <sup>8</sup>Università Cattolica del Sacro Cuore, Rome, Italy; <sup>9</sup>University of Pittsburgh, Pittsburgh, PA; <sup>10</sup>University of Erlangen-Nürnberg, Erlangen, Germany; <sup>11</sup>University of Manitoba, Winnipeg, MB, Canada; <sup>12</sup>Baylor College of Medicine, Houston, TX; <sup>13</sup>AstraZeneca, Gothenburg, Sweden; <sup>14</sup>AstraZeneca, Cambridge, United Kingdom.

**Background:** Prospective data on healthcare professionals' (HCP) decision making and patient management related to hyperkalemia (HK) are scarce. The TRACK study will collect data on HCP objectives and decision-making behaviors when encountering patients with HK in real-world practice, as well as patient perceptions of HK and its treatment.

**Methods:** TRACK is a multinational, prospective, observational, longitudinal cohort study within the US and Europe. We plan to enroll approximately 1250 patients with established HK. During the 12-month follow-up, data will be collected from health records and HCPs using an electronic case report form at 3-month intervals. Patient-reported outcomes will also be collected. The primary objective is to describe HK management decisions, their rationale, and expectations at baseline, and their association with treatment response indicators (correction of HK; target doses of renin-angiotensin-aldosterone system inhibitors [RAASi]; healthcare resource utilization) (Figure). The secondary objective is to describe patients' clinical parameters during follow-up. Exploratory objectives include patient awareness and satisfaction with HK management.

**Results:** Anticipated study completion is 2024.

**Conclusions:** This non-interventional, real-world study will gather insights into HCP approaches to implementing HK management. TRACK will characterize the impact of HCP decision making on HK recurrence, inform the use of guideline-directed therapies related to RAASi use, and address knowledge gaps regarding HCP and patient perspectives on HK management.

**Funding:** Commercial Support - AstraZeneca

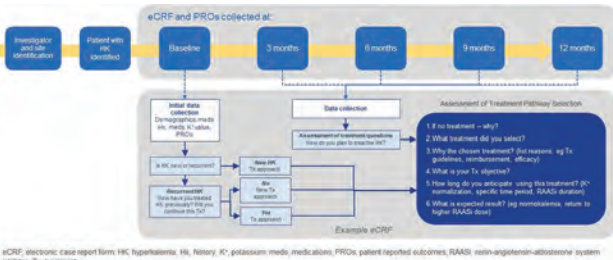

TRACK Study Design Concept

**PUB173**

**Management of Severe Hyponatremia With Modified Continuous Venovenous Hemodiafiltration (CVVHDF) Solutions**

**Stephanie M. Sanders, Matthew Kaptein. Loma Linda University, Loma Linda, CA.**

**Introduction:** Hyponatremia is common in patients with cirrhosis. Guidelines suggest limiting the rate of serum sodium concentration (S[Na]) correction of chronic hyponatremia to reduce complications, including osmotic demyelination syndrome (ODS). Standard solutions used in continuous venovenous hemodiafiltration (CVVHDF) have [Na] 140mEq/L. In patients with severe hyponatremia requiring CVVHDF, it is difficult to prevent rapid correction of S[Na].

**Case Description:** We present a 40 yo woman in ICU with decompensated cirrhosis. On admission, she had serum Cr 1.0mg/dL and S[Na] 134mEq/L. S[Na] decreased by 18mEq/L roughly linearly over 16 days to a nadir of 116mEq/L despite free H2O restriction <1L/day. CVVHDF was started overnight 2h later with standard [Na] 140mEq/L solutions. 12h later, S[Na] increased to 125mEq/L. The CVVHDF order was modified to target [Na] 125mEq/L in pre-filter fluid, dialysate, and post-filter fluid. H2O was added to each dialysate bag using the principle Concentration1(140mEq/L)\*Volum e1(5L)=Concentration2(125mEq/L)\*Volume2(5.6L), yielding 600mL sterile H2O added to each 5L bag. S[Na] was 124mEq/L by CVVHDF day 2. That day [Na] in dialysate was kept constant because of a transient S[Na] increase the day prior. CVVHDF day 3, H2O added to dialysate was reduced to target dialysate [Na] 130mEq/L, and on CVVHDF day 4 was reduced again to target [Na] 135mEq/L. CVVHDF days 5+, standard dialysate with [Na] 140mEq/L was used. S[Na] increased to 128mEq/L 24h after S[Na] 116mEq/L, likely due to administration of hypertonic saline. 18h later, after about 30h CVVHDF, 12h with [Na] 140mEq/L bath, 18h with [Na] 125mEq/L bath, S[Na] was 124mEq/L.

**Key: TH - Thursday; FR - Friday; SA - Saturday; OR - Oral; PO - Poster; PUB - Publication Only**

**Underline represents presenting author.**

S[Na] increased roughly linearly to 136mEq/L 5 days after measurement of S[Na] 116mEq/L. After correction of 12mEq/L in the first 24h with concurrent hypertonic saline administration, rate of correction never exceeded 7mEq/L/day. The patient was discharged without liver transplant, on HD, and showed no signs of ODS.

**Discussion:** Changing the target [Na] in CVVHDF solutions is a more precise method for gradually increasing S[Na] than administering D5W intravenously at high rate during CVVHDF, and adjusting D5W rate according to frequent S[Na] measurements. Adding more than 600mL sterile H2O to each 5L bag was not attempted. The maximum amount of H2O that can be added is unknown.

**PUB174**

**Immobilization Related Hypercalcemia in ESRD: Is Denosumab a Viable Treatment Option?**

**Abhinava Sridhar,<sup>1</sup> Sanjeev Gupta,<sup>1,2</sup> Savneek S. Chugh,<sup>1,2</sup> Amol Mittal,<sup>1,2</sup> Uzma Malik.<sup>1,2</sup>** <sup>1</sup>Westchester Medical Center, Valhalla, NY; <sup>2</sup>New York Medical College, Valhalla, NY.

**Introduction:** The most common abnormality of mineral bone disease seen in ESRD is renal osteodystrophy. However, persistent parathyroid hormone (PTH) independent hypercalcemia raises the possibility of immobilization or malignancy. Denosumab is a potential treatment option but its efficacy and safety in ESRD remains poorly studied. We describe 2 ESRD patients with immobilization related hypercalcemia that was successfully treated with denosumab.

**Case Description:** Case 1: 54 year old man with well controlled diabetes and Chronic Kidney Disease (CKD), started on hemodialysis (HD) after cardiac arrest with poor neurological recovery. Case 2: 57 year old man with laparoscopic gastric sleeve complicated by hemorrhagic shock and Acute Kidney Injury (AKI) needing HD. Course of hypercalcemia described in table. Neither patients experienced hypocalcemia as a side effect.

**Discussion:** Immobilization related hypercalcemia occurs when osteoclastic bone resorption exceeds osteoblastic bone formation causing an imbalance in the bone remodeling process. Denosumab is a monoclonal antibody that binds and inhibits RANKL reducing osteoclast maturation and bone resorption. Both our patients were not on any drugs that could cause hypercalcemia and had no evidence of underlying granulomatous disease. Although PTHrP was mildly elevated in both patients, it was attributed to ESRD itself and we hypothesize that hypercalcemia was due to prolonged immobilization. Intravenous hydration is an unsafe option in ESRD. HD using low Ca dialysate is an option, but both patients were resistant to this. Both patients had improvement in Ca levels with denosumab and neither experienced hypocalcemia as a side effect probably due to ongoing hemodialysis. Case reports describe patients with ESRD and hypercalcemia who were successfully treated with denosumab. It offers advantages compared to bisphosphonates with its rapid onset, longer action and no dose adjustment for kidney function. **Learning objectives:** Denosumab is a potential treatment option for immobilization or malignancy related hypercalcemia in ESRD. Hypocalcemia which is a common side effect of denosumab could be averted in ESRD patients due to ongoing HD.

Course of Hypercalcemia during hospital stay

Weeks 6-14	Calcium (Ca) levels between 11.1-11.3 mg/dL. Initial testing revealed PTH 92 pg/mL, and Vitamin D 19 ng/mL. Patient was started on Vitamin D supplementation and low Ca dialysate bath was used.
Week 15	Worsening Hypercalcemia peaking at 12mg/dL. Repeat testing revealed Vitamin D 34 ng/mL, PTH 19 pg/mL, and PTHrP 34 pg/mL. Vitamin D was discontinued in setting of suppressed PTH. Given ESRD, pamidronate was contraindicated and patient received one dose of subcutaneous (SQ) Denosumab 60mg.
Weeks 16-19	Ca levels between 9.6-10.6 mg/dL.
Week 20	Worsening Hypercalcemia peaking at 12.3 mg/dL. Patient received another dose of Denosumab 60mg SQ.
Weeks 21-22	Ca levels between 9.6-10 mg/dL. Patient ultimately underwent palliative extubation given poor neurological status and worsening sepsis.
Week 1	Initiated Vitamin D supplementation for Vitamin D level 15.7 ng/mL.
Week 10	Initial work up notable for PTH 16 pg/mL, Vitamin D 20 ng/mL, and PTHrP 39 pg/mL. Vitamin D supplementation was decreased and low Ca dialysate bath was used.
Week 12	Persistent hypercalcemia peaking at 11.8 mg/dL. 1 dose of calcitonin 544 units SQ given.
Week 13	Continued on Calcitonin 400 units Intramuscular q12. Ca levels 12.3-12.9 mg/dL.
Weeks 14-18	Worsening Hypercalcemia peaking at 13 mg/dL. Received Denosumab 120mg SQ. Ca levels 8.8-9.5 mg/dL. Discharged with outpatient follow up.

PTHrP-PTH related peptide

**PUB175**

**β-Blockers (BB) and Serum Potassium (K) Levels in Hemodialysis (HD) Patients**

**Sally Chau,<sup>1</sup> Vinod K. Valluri,<sup>1</sup> Garrett Yu,<sup>1</sup> Masoud Haghi,<sup>1</sup> Kulwant S. Bath,<sup>1</sup> Golriz Jafari,<sup>1</sup> Anita Kamarzarian,<sup>1</sup> Susana M. Mendoza,<sup>1</sup> Phuong-Thu T. Pham,<sup>2</sup> Phuong-Chi T. Pham.<sup>1</sup>** <sup>1</sup>UCLA Medical Center Olive View, Sylmar, CA; <sup>2</sup>University of California Los Angeles David Geffen School of Medicine, Los Angeles, CA.

**Background:** Chronic hemodialysis patients commonly require the use of multiple antihypertensive or cardiovascular protective agents including BB. As BB may cause hyperkalemia via blocking renin secretion (β1) and Na-K-ATPase (β2), we aimed to investigate whether the use of BB, in particular, nonselective vs. selective BB, is associated with increased serum K levels and hyperkalemia in patients receiving chronic HD therapy.

**Methods:** Inclusion: Chronic HD patients admitted to Olive View-UCLA Medical Center Exclusion: Patients admitted for missed dialysis treatments, vascular access repair, rhabdomyolysis or cell death (e.g., hemolysis, elevated lactate dehydrogenase levels) Data collected: Age, gender, comorbidities (diabetes mellitus, hypertension, heart disease); Factors that could contribute to hyperkalemia (glycemia control, use of

inhibitors of the renin angiotensin aldosterone system, acidemia (serum bicarbonate), bowel regimen); The use of nonselective versus selective BB Analysis: Average values of all lab values collected will be compared among the 3 groups: 1. No beta-blockers, 2. Any form of BB, 3. Nonselective BB (carvedilol, labetalol), and 3. Cardioselective beta-blockers (metoprolol). Stepwise regression was also performed for factors that could affect potassium levels.

**Results:** Results are summarized in Figure.

**Conclusions:** To date, our data suggest: 1. BB users do not have higher serum K level compared with non-BB users 2. Non-selective BB (carvedilol and labetalol) is not associated with greater K levels compared to selective BB. 3. Blood urea significantly correlates with serum K. The use of angiotensin converting enzyme inhibitors or angiotensin receptor blockers does not correlate with serum K. Limitations: Ongoing study, small dataset

**Effect of  $\beta$ -blockers on serum potassium levels in patients receiving chronic hemodialysis support**

	No $\beta$ -blockers	$\beta$ -blockers	p-value
Number of patients	31	39	
Age (years)	62.1 $\pm$ 13.9	57.5 $\pm$ 12.6	NS
Gender (% female)	21.4	44	NS
Body mass index (Kg/m <sup>2</sup> )	26.37 $\pm$ 5.39	26.30 $\pm$ 6.30	NS
Serum K (mmol/L)	4.70 $\pm$ 0.86	4.82 $\pm$ 0.96	NS
Percentage of patients with serum K > 5.0 mmol/L	35.3	25.6	NS

	Selective $\beta$ -blocker		Non-selective $\beta$ -blockers	
	No $\beta$ -blockers	Metoprolol	Carvedilol	Labetalol
Number of patients	31	11	23	5
Serum K (mmol/L)	4.70 $\pm$ 0.86	5.05 $\pm$ 1.15	4.96 $\pm$ 0.88	4.16 $\pm$ 0.63

The difference in the mean serum K levels between selective and non-selective  $\beta$ -blockers is nonsignificant.

Stepwise regression analysis revealed that only blood urea nitrogen positively correlated with serum potassium level (correlation coefficient 0.012, p-value 0.04). There was no statistically significant correlations between serum potassium and the use of  $\beta$ -blockers, angiotensin receptor blockers, angiotensin converting enzyme, or daily bowel regimen, or glucose or serum bicarbonate levels. None of our patient cohort used aldosterone antagonists.

Study limitation: small number of patients; study ongoing

**PUB176**

**A Case of Medullary Sponge Kidney Presented With Persistent Hypokalemia**

Rui Song,<sup>1</sup> Sunita Lakhani,<sup>1</sup> Syeda Hassan,<sup>1</sup> Raja N. Kyriakos,<sup>1</sup> Lawrence Freitas,<sup>1,2</sup> Abington Memorial Hospital, Abington, PA; <sup>2</sup>Hypertension Nephrology Associates, Willow Grove, PA.

**Introduction:** Medullary sponge kidney (MSK) is a rare and benign congenital abnormality of renal tubules characterized by cystic dilation of the renal medullary collecting ducts. We present a case who was found to have MSK during hypokalemia workup.

**Case Description:** A 33-year-old female with well-controlled HIV on Biktarvy (HIV-1 RNA < 20 copies/ml) presented with palpitations and tingling in the arms and legs for one day. She was found to have a serum potassium of 2.8mmol/L, magnesium of 1.6mEq/L, normal anion gap metabolic acidosis (NAGMA), creatinine of 0.8mg/dL, calcium of 9mg/dL and phosphorus of 3mg/dL. She is normotensive. She denies diuretic/laxative use, eating disorder, hypothyroidism, polyuria or diarrhea. She had chronic persistent hypokalemia (2.7-3.3mmol/L) and one episode of pyelonephritis 7 years ago. Family history includes ESRD of her grandmother. Her urine tests showed a urine potassium of 22 mmol/L, urine sodium of 64 mmol/L, urine anion gap of 13, urine PH of 7.5 with no proteinuria or hematuria. The urine drug screen was negative. Nephrology was consulted and further workup showed normal serum cortisol level, TSH and aldosterone/renin ratio, vitamin D deficiency (25-OH vitamin D 16.4ng/mL) with secondary hyperparathyroidism (PTH 252 pg/mL). A urine diuretic screening test was sent. Renal ultrasound (US) showed bilateral diffuse echogenic renal medullary pyramids, no hydronephrosis, mass or stone. The cause of the hypokalemia was thought to be MSK complicated by incomplete distal renal tubular acidosis (RTA). Potassium citrate was started but she was lost to follow-up.

**Discussion:** Incomplete distal RTA is common in MSK and is often asymptomatic. The patient was detected with mild hypokalemia, NAGMA and a urine pH of 7 since 7 years ago when having pyelonephritis, indicating distal RTA. Her distal RTA could be multifactorial. Vitamin D deficiency might be a factor but her normal serum calcium level does not support it. Her HIV and Biktarvy (has Tenofovir) usage are unlikely the main contributors as her hypokalemia happened much earlier than the HIV history. Her kidneys from the CT scan 7 years ago did not show calcification or increased density of the pyramids but now she has a typical US finding of MSK. This case highlights that hypokalemia and distal RTA might be the first sign of MSK while structural changes were not prominent in the imaging.

**PUB177**

**Lithium Induced Partial Nephrogenic Diabetes Insipidus: An Unusual Presentation**

Jesus D. Vega-Colon, Maria E. Rivera, Alexis Rivera Gonzalez, Hillarie A. Rios Torres, Cristina M. Casas Loyola, Carlos G. Rivera-Bermudez, Krystahl Z. Andujar-Rivera, Ileana E. Ocasio Melendez. University of Puerto Rico Medical Sciences Campus, San Juan, Puerto Rico.

**Introduction:** Nephrogenic Diabetes Insipidus (NDI) is described as a reduction in urinary concentrating ability caused by a resistance of vasopressin. It is characterized by hypotonic polyuria, polydipsia, and hypernatremia. Hereditary causes or acquisition from drugs like lithium and amphotericin B most be considered as potential triggers.

Fluid deprivation with subsequent urine osmolality (Uosm) measurement can help us classify this disorder into partial (Uosm: 250-750 mOsm/Kg) or complete NDI (Uosm <250 mOsm/Kg). Few cases describe the occurrence of partial NDI in a Hispanic male with history of lithium use.

**Case Description:** We report a 47-year-old Puerto Rican male with Bipolar disorder and Epilepsy brought to our institution due to general weakness, lethargy and decrease appetite in the past 7 days. Caretaker reported use of lithium carbonate 300 mg twice a day for the past 12 years. During hospital stay nephrology service was consulted due to hypernatremia of 155 meq/L and lithium toxicity (1.97 mg/dl). Urine output showed evidence of persistent polyuria of 4.5 liters in 24 hours. Upon further evaluation urine osmolality was obtained showing results of 358 mOsm/Kg. Decision was made to stop lithium and perform fluid deprivation achieving minimal increase in urine osmolality to 391 mOsm/kg. As part of treatment, low dose thiazide diuretic was started with goal of impairing free water excretion. Resolution of hypernatremia to 143 meq/L and adequate uresis of 1.4 liters in 24 hrs was acquired following 72 hours. Based on the association of hypernatremia, polyuria with initial Uosm greater than 250 mOsm/Kg, history of Lithium use and minimal increase in Uosm following fluid deprivation, the diagnosis of partial NDI was recognized.

**Discussion:** This case exemplifies an uncommon type of NDI that should be involved on the differential diagnosis. A thorough history is essential as it can help unravel the offending agent. Increased awareness of lithium toxicity side effects will help clinicians prevent life-threatening electrolyte disorders. The uniqueness of our case lies on the rarity of this type of NDI reported on literature. Our patient successfully responded to low dose thiazide diuretic correcting dysnatremia and archiving satisfactory uresis.

**PUB178**

**Persistent Normo-Osmolar Hyponatremia in an Ex-Alcoholic**

Tushar Bajaj, L. Tammy Ho. University of Chicago Pritzker School of Medicine, Chicago, IL.

**Introduction:** Dysnatremia is common in patients with chronic-alcohol use disorder. Differential includes beer portomania which is a vasopressin-independent mechanism in which patients drink large quantities of beer and have inadequate food intake. This leads to low excretion of urinary solute and limited excretion of renal water. We present an interesting case of a previous alcoholic with normo-osmolar hyponatremia; however, despite abstaining from drinking. She continued to have normoosmolar hyponatremia which questions true abstinence versus resetting of the osmostat.

**Case Description:** Patient is a 66 YO Female with goblet cell carcinoid s/p right hemicolectomy, left ovarian mucinous cystadenoma s/p TAH/BSO, HTN, GERD, HLD, Knee OA, PTSD, normocytic anemia who has had persistent hyponatremia. This was noted 2 years prior to initial evaluation with a hospital admission for generalized weakness, nausea, slurred speech, alcohol abuse. She was found to have hypovolemic hyponatremia and starvation ketoacidosis. She had multiple ED visits for generalized weakness and fatigue. There were multiple reports of alcohol abuse in the past but she reported quitting 1 year prior to evaluation. Patient was started initially on salt tablets but this was later discontinued. Whole blood sodium confirmed true disorder with value of 125mmol/L. Refer to Table 1 for timeline of events.

**Discussion:** Etiology of normo-osmolar hyponatremia in patient remains uncertain. The patient has had persistent polyclonal gammopathy with elevated kappa free light chains but this predates the hyponatremia onset. Patient had normal triglyceride levels and slightly elevated total cholesterol. There was no evidence of a serum osmolar gap, measured at 288, calculated at 286-294. Measurements of ETOH level could not explain normal osm in setting of low sodium. On several non-related lab draws, ETOH levels were consistent with her history of abstinence and documented to be zero. We recommended the patient to stop salt tablets and continue to monitor off medications. Persistent normoosmolar hyponatremia suggests possibility of reset osmostat.

**Timeline**

	Month 1	Month 2	Month 12	Month 22	Month 22
Serum Sodium	121	134	130	123	124
Serum Osmolality	259	348	293	293	288
Urine Sodium	31		20		
Urine Osmolality	223		127	160	202
Serum Ethanol	20			140	

**PUB179**

**A Rare Case of Aspirin-Induced Symptomatic Hyponatremia**

Madeline S. Chung, Amy Yau. The Ohio State University Wexner Medical Center, Columbus, OH.

**Introduction:** Prostaglandins in the kidney act to attenuate the actions of antidiuretic hormone (ADH). Non-steroidal anti-inflammatory drugs (NSAIDs) inhibit the synthesis of prostaglandins resulting in an increased response to ADH in the kidney leading to free water retention and hyponatremia, especially under conditions which also promote hyponatremia.

**Case Description:** We present a 61-year-old man with past medical history significant for hypertension and basal and squamous cell skin carcinomas who presented complaining of excessive urination and generalized weakness for 3 days and altered mentation. Blood pressure was 153/76 mmHg and other vitals unremarkable. He was lethargic with delayed response to questions and euvolesmic on exam. Medications included losartan 50mg daily with no diuretics. Admission labs were significant for a serum sodium of 111 mEq/dL, urine sodium of 135 mmol/L, urine osmolality of 542 mOsm/L, TSH 1.633  $\mu$ U/mL and cortisol 53.52  $\mu$ g/mL. Two weeks prior, his serum sodium level was 138 mEq/dL. CT

**Key: TH - Thursday; FR - Friday; SA - Saturday; OR - Oral; PO - Poster; PUB - Publication Only**

**Underline represents presenting author.**

head and chest X-ray were negative for any acute pathologies. He was started on 3% saline with improvement in symptoms but 24 hours later developed a brisk water diuresis. Labs were significant for a serum sodium of 122 mEq/dL, urine sodium of 12 mmol/L, and urine osmolality of 98 mOsm/L. Further history revealed a high water intake based on advice from his physician and new intake of aspirin 325mg three times a day due to shoulder pain. His hyponatremia was managed with DDAVP, free water, and saline. It remained normal prior to discharge without any additional intervention. Pan-CT and MRI brain were obtained and negative.

**Discussion:** SIADH attributable to NSAIDs is a rare occurrence, especially since prostaglandins present in the kidneys inhibit the actions of ADH while prostaglandins present in the central nervous system stimulate the secretion of ADH. But NSAID use can lead to an effect similar to SIADH in the setting of other situations which also promote ADH secretion such as pain and/or nausea. In our case, there were multiple factors that likely contributed to hyponatremia including pain, increased free water intake, and new NSAID use. The half-life of aspirin increases with higher plasma concentrations and is anywhere from 3-10 hours. Clinicians should be careful about encouraging excessive water intake especially in the setting of other risk factors for hyponatremia to include NSAID use.

**PUB180**

**Executive Summary of the Korean Society of Nephrology 2022 Recommendations on Controversial Issues in the Diagnosis and Management of Hyponatremia**

Yeonhee Lee,<sup>1</sup> Kyung Don Yoo,<sup>2</sup> Seon Ha Baek,<sup>3</sup> Yang gyun Kim,<sup>4</sup> Hyo Jin Kim,<sup>5</sup> Ji Young Ryu,<sup>3</sup> Jin hyuk Paek,<sup>14</sup> Sang Heon Suh,<sup>8</sup> Sewon Oh,<sup>6</sup> Jeonghwan Lee,<sup>7</sup> Jong Hyun Jhee,<sup>13</sup> Jin-Soon Suh,<sup>12</sup> Eun mi Yang,<sup>8</sup> Miyoung Choi,<sup>11</sup> Kook-Hwan Oh,<sup>10</sup> Sejoong Kim.<sup>9</sup> The Hyponatremia Guideline Development Group <sup>1</sup>*UiJeongbu Eulji Medical Center, Eulji University, Gyeonggi-do, Republic of Korea;* <sup>2</sup>*Ulsan University Hospital, Ulsan, Republic of Korea;* <sup>3</sup>*Hallym University Dongtan Sacred Heart Hospital, Hwaseong, Gyeonggi, Republic of Korea;* <sup>4</sup>*Kyung Hee University Hospital at Gangdong, Gangdong-gu, Seoul, Republic of Korea;* <sup>5</sup>*Pusan National University Hospital, Busan, Republic of Korea;* <sup>6</sup>*Korea University Anam Hospital, Seoul, Republic of Korea;* <sup>7</sup>*Seoul National University Seoul Metropolitan Government Boramae Medical Center, Dongjak-gu, Seoul, Republic of Korea;* <sup>8</sup>*Chonnam National University Hospital, Gwangju, Republic of Korea;* <sup>9</sup>*Seoul National University Bundang Hospital, Seongnam, Republic of Korea;* <sup>10</sup>*Seoul National University Hospital, Jongno-gu, Seoul, Republic of Korea;* <sup>11</sup>*National Evidence-Based Healthcare Collaborating Agency, Jung-gu, Seoul, Republic of Korea;* <sup>12</sup>*Bucheon St. Mary's Hospital, College of Medicine, The Catholic University of Korea, Seoul, Republic of Korea;* <sup>13</sup>*Gangnam Severance Hospital, Seoul, Republic of Korea;* <sup>14</sup>*Keimyung University School of Medicine, Daegu, Republic of Korea.*

**Background:** Hyponatremia, defined as serum sodium concentration <135 mmol/L, is the most frequent body fluid and electrolyte balance disturbance encountered in clinical practice. Although several international guidelines for hyponatremia have been available, the differential diagnosis of hyponatremia is frequently challenging in patients with complex clinical settings and varying treatment.

**Methods:** A multidisciplinary guideline development committee representing specialists with a genuine interest in hyponatremia was convened by the Korean Society for Electrolyte and Blood Pressure Research in collaboration with the Korean Society of Nephrology (KSN), clinical practice guideline (CPG) committee. The committee has developed the CPG and applied strict management strategies to minimize potential bias. The committee prioritized clinical questions and outcomes according to their importance for clinicians and patients. The committee used the Grading of Recommendations Assessment, Development and Evaluation (GRADE) approach, including GRADE Evidence-to-Decision frameworks, to assess evidence and make recommendations.

**Results:** This CPG consists of 12 recommendations (2 in diagnosis, 8 in treatment, and 2 in special situations of hyponatremia). Each begins with statements graded by the strength of recommendations and the quality of the evidence. Each statement is followed by rationales supporting the recommendations.

**Conclusions:** We were keen to ensure that the document represents recommended approaches for multiple etiologies of hyponatremia based on both consensus of experts in hyponatremia and the most recent published data in this field. We hope this CPG will be meaningful as a recommendation in practice, providing clinical decision support to improve patient outcomes.

Table 1. Recommendations

Topic	Recommendation	Recommendation Strength	Quality of Evidence
Differential diagnosis of hyponatremia	1. For patients with hyponatremia, we consider it reasonable that additional measurement of fractional urea acid excretion (FEUA) may be recommended to differentiate likely causes of hyponatremia, such as syndrome of inappropriate antidiuresis (SIAD) or diuretic-induced hyponatremia.	Expert consensus	
	2. There are insufficient data to make a recommendation for using the copegita to urine sodium (CUN) ratio to differentiate patient's volume status.	Inconclusive (I)	Very low
Treatment of severe hyponatremia	3. We suggest rapid intravenous bolus administration of hypertonic saline in patients with symptomatic severe (Na <125 mmol/L) hyponatremia.	Conditional recommendation (B)	Low
Management for mild hyponatremia	4-1. We consider it reasonable to rigorously evaluate the causes of mild hyponatremia and to manage causative diseases to improve the clinical outcomes. 4-2. There are insufficient data to make a recommendation for treating mild hyponatremia with hypertonic saline or oral sodium chloride solely to increase the serum sodium (SNa) concentration.	Expert consensus	
Treatment of hypervolemic hyponatremia	5-1. We suggest vasopressin receptor antagonists (vaptans) use in heart failure with hypervolemic hyponatremia in terms of rapid sodium correction. 5-2. We do not recommend vaptans in liver cirrhosis with hypervolemic hyponatremia.	Conditional recommendation (B)	Moderate
SIAD	6. We suggest the treatment of vaptans in SIAD patients with moderate to severe hyponatremia.	Conditional recommendation (B)	Low
Prevention of overcorrection in hyponatremia	7. We suggest that desmopressin should be applied individually according to risk factors affecting overcorrection, therapeutic regimen of hypertonic saline, and whether or not glucose solution is administered during overcorrection in patients with hyponatremia.	Conditional recommendation (B)	Very low
Special issues (1) Hyponatremia in patients with cerebral diseases	8. We consider it reasonable that the treatment with hypertonic or isotonic saline infusion, oral sodium chloride, or fluid restriction for the correction of hypo-osmolar hyponatremia should be individualized among patients with cerebral diseases.	Expert consensus	
Special issues (2) Prevention of hyponatremia in pediatric patients under the age of 18 years	9-1. We recommend the administration of isotonic fluids as maintenance fluid therapy in hospitalized pediatric patients over 1 month and under the age of 18 years. 9-2. There are insufficient data to make a recommendation for administering isotonic fluids as maintenance fluid therapy in neonates, because of risk of the development of hyponatremia.	Strong recommendation (A)	High
		Inconclusive (I)	Moderate

**PUB181**

**Ethylene Glycol Toxicity: Usual Presentation With Uncommon Clinical Course**

Asma Rashid,<sup>1</sup> Sangeetha Murugapandian,<sup>2</sup> <sup>1</sup>*Banner University Medical Center Tucson, Tucson, AZ;* <sup>2</sup>*Banner University Medical Center Tucson, Tucson, AZ.*

**Introduction:** Ethylene Glycol a toxic alcohol found in many household and industrial products, is an odorless, colorless, and sweet tasting liquid. It can be taken as a substitute for alcohol, swallowed accidentally or deliberately in a suicidal attempt. Fomepizole, which inhibits the formation of toxic metabolites, has become the mainstay in the treatment preventing the need for hemodialysis. We describe a case of ethylene glycol poisoning, treated early with fomepizole, with improvement in acidosis but subsequently developed worsening kidney function and required dialysis.

**Case Description:** 63-year-old male with history of hypertension, diabetes mellitus type II, hyperlipidemia, peripheral vascular disease, and depression, presented to hospital following ingestion of 24 Oz of antifreeze in a suicidal attempt. He was hemodynamically stable. Ethanol level was negative. He had anion gap of 21, osmolar gap of 88, pH of 7.29 and lactate of 10 mMol/L. Given clear history of ethylene glycol ingestion patient was started on fomepizole along with thiamine, folic acid and pyridoxine. His anion gap and osmolar gap started to improve however after 48 hours they started to increase again along with new onset AKI and development of calcium oxalate crystals requiring hemodialysis. Following two hemodialysis sessions, his ethylene glycol level was less than 10. He did not require any more hemodialysis sessions.

**Discussion:** Ethylene glycol, after ingestion is quickly absorbed from gastrointestinal tract and rapidly redistributed throughout the body. Oxidative reactions convert ethylene glycol to glycolaldehyde and glycolic acid responsible for metabolic acidosis and lactic acidosis. The glycolic acid is then converted to glyoxylic acid, oxalic acid and glycine. Oxalic acid is deposited as calcium oxalate crystals and contributes to renal failure and hypocalcemia. Fomepizole prevents formation of ethylene glycol toxic metabolites thus preclude hemodialysis need. In our case, patient presented with normal kidney function, but with elevated anion gap and osmolar gap which resolved with fomepizole. Although fomepizole prevents further formation of toxic metabolites, the already formed toxic metabolites along with high osmolality and direct effects of ethylene glycol on renal tubules, induced acute kidney injury, with subsequent development of oxalate crystals, necessitating hemodialysis.

**PUB182**

**Hiding in Plain Sight: Licorice, the Culprit of Severe Hypokalemia**

Srikanth Thiruvurudsothy,<sup>1</sup> Theesitha Srikanth,<sup>2</sup> Arsitha Jeyarajasingam,<sup>3</sup> <sup>1</sup>*Virtua Health, Marlton, NJ;* <sup>2</sup>*Sichuan University West China Hospital, Chengdu, China;* <sup>3</sup>*University of Sri Jayawardanapura Department of Medical Education and Health Sciences, Nugegoda, Sri Lanka.*

**Introduction:** Chronic ingestion of licorice is well known to cause findings similar to those with the syndrome of apparent mineral corticoid excess (AME), which can result in hypertension, hypokalemia, and metabolic alkalosis. Here we present an interesting case of a woman with persistent hypokalemia.

**Case Description:** Patient is a 70-year-old Caucasian woman referred to nephrology for persistent hypokalemia. She has a history of hospitalizations in the past for hypokalemia and hypomagnesemia. The patient has had a history of hypertension for approximately 10 years and had been on Losartan and Verapamil. She also has a history of Gastroesophageal reflux disease and was on Pantoprazole. During a recent hospitalization for hypokalemia and hypomagnesemia, pantoprazole was switched to famotidine and was started on magnesium and potassium supplementation. She has no history of diuretic use or alcohol abuse. No diarrhea. She was eating a balanced diet. At a follow-up visit, the patient revealed that she consumed licorice, at least once daily. She was asked to stay away from licorice. We subsequently held potassium and magnesium supplementation,



and followed up with repeat labs in a few weeks. Testing including renin, aldosterone, and urine electrolytes were unremarkable. Renal ultrasound with doppler showed normal-sized kidneys and no evidence of renal artery stenosis. Subsequent blood work showed stable potassium levels without supplementation. She has had elevated serum bicarbonate levels which also seem to have improved since then. Interestingly, her blood pressure readings are also improved.

**Discussion:** Persistent hypokalemia, metabolic alkalosis and HTN should trigger a variety of differential diagnoses. In our patient's case, chronic proton pump inhibitor use was a confounding factor for low magnesium and potassium. A thorough history is essential to differentiate diagnoses such as AME and chronic licorice ingestion. Licorice ingestion is well known to cause hypertension and hypokalemia. Our case demonstrates, how the cessation of licorice consumption has improved the patient's quality of life, decreased pill-burden, and prevented recurrent hospitalizations, for severe hypokalemia.

**PUB183**

**Severe Hyponatremia due to Dehydration Causing AKI Requiring Dialysis: A Case Report**

Sini Bijoy,<sup>1</sup> Muhammad Khalid Tahir,<sup>1</sup> Angela Grigos,<sup>1</sup> Farhang Ebrahimi,<sup>1</sup> Muhammad Durrani,<sup>2</sup> Nusayba Ahmed.<sup>2</sup> <sup>1</sup>Richmond University Medical Center, Staten Island, NY; <sup>2</sup>American University of Antigua College of Medicine, Saint Johns, Antigua and Barbuda.

**Background:** Hyponatremia is an electrolyte derangement defined as a serum sodium value exceeding 145 mmol/L. It is primarily caused by unreplaced water loss due to impaired thirst or inaccessibility to water. The latter explains why hyponatremia is often seen in the elderly population who are mentally and/or physically impaired and often present with a concomitant infection. Hyponatremia can also be caused by the excess consumption of salt without the addition of water or iatrogenically caused by the administration of hypertonic solutions.

**Methods:** We report a case of an 81 year old male from a nursing home, who, at baseline, is alert and communicative, but presented with markedly diminished mental status and lethargy. Routine admission labs showed a critical serum sodium level of 187 mmol/L and a marked leukocytosis which was later explained by a left sided pneumonia and a urinary tract infection. The patient was admitted to the intensive care unit for closer monitoring and management.

**Results:** On admission, physical examination revealed severe dehydration with dry mucous membranes, severely contracted upper and lower extremities, marked lethargy and an almost negligible response to noxious stimulation. A 24 hour T-max of 100.6F, blood pressure of 156/90, and saturating adequately on nasal cannula. Further lab-work showed serum osmolality of 386 mosm/kg, a creatinine of 2.6 mg/dl, and glucose level of 166. Hypotonic saline was started with supplemental free water administration and frequent assessment of volume status and a sodium correction goal between 6-8 mmol per 24 hours. After 36 days of hospitalization, intensive care unit monitoring, intermittent dialysis, and treatment of urinary tract infection and left sided pneumonia, the patient was discharged to back to home facility with a serum sodium of 131 mmol/L and a creatinine of 0.3 mg/dl, at baseline mental status.

**Conclusions:** Careful administration of hypotonic fluids over multiple days to avoid over correction and intermittent hemodialysis, resulted in normalization of sodium levels, improved urine out, stabilizing of renal function, and improvement in overall hemodynamics.

Parameters	D1	D3	D5	D6	D8	D9	D16	Day of DC
Natremia (mmol/l)	167	172	162	158	144	141	144	134
Creatinine umol/l	2.6	3.5	4.0	4.1	3.9	3.4	1.9	0.3
Hemoglobin (g/dl)	19.2	12.5	10.7	9.9	8.9	9.7	9.3	8.1

**PUB184**

**Diagnosing Cerebral Salt Wasting: Are We Swimming Against the Current?**

Cyndia Rodriguez Negron, Carlos Cortes, Herminio Garcia-Estrada, Luis A. Diaz Cruz. VA Caribbean Healthcare System VA Caribbean Healthcare System, San Juan, Puerto Rico.

**Introduction:** Syndrome of Inappropriate Antidiuretic Hormone (SIADH) after brain injury is characterized by euolemic hyponatremia, concentrated urine & increased natriuresis. Cerebral Salt Wasting (CSW) also presents with concentrated urine & increased natriuresis, but patients are hypovolemic. Some authorities argue that CSW does not exist & it is simply SIADH with increased natriuresis due to iatrogenic volume expansion or reduced venous capacitance caused by catecholamine-induced vasoconstriction. We herein present a case of moderate hypovolemic hyponatremia after cerebral manipulation.

**Case Description:** 47 y/o man admitted to ICU due to moderate hyponatremia & altered mental status with sepsis due to meningitis. Had a recent left frontotemporal craniotomy & lobectomy for glioblastoma multiforme. Slow mentation, dry oral mucosa & decreased skin turgor present upon examination. Urine output >4 L in <24 hours. Serum: Na: 123mEq/L Cr: 0.5mg/dL BUN: 7.3mg/dL K:4.0mEq/L HCO<sub>3</sub>: 18mEq/L Cl: 97mEq/L Glu: 158mg/dL Urine Na: 223mEq/L K: 37mEq/L Cr: 42.7 Spec. Gravity: 1.014. Cortisol: 13.36ug/dL TSH: 1.690. Was not taking diuretics, SSRIs nor other medications associated with SIADH. 3% Saline had to be provided x2 & mostly had to be kept on 0.9%NSS & fludrocortisone up to 0.3mg BID to maintain normal Na levels. Urine became dilute after 0.9%NSS. He was later transferred to another institution for neurosurgical care.

**Discussion:** CSW is extremely rare & not universally contemplated in differential diagnoses. SIADH is more common, but polyuria & hypovolemia are not present. While 0.9%NSS would worsen serum Na in SIADH, in CSW it should remove the ADH stimulus, cause dilute urine & thus correction of Na, as was in our case. Some authors believe that SIADH & CSW are one entity, but this case clearly presents marked differences in diagnosis & treatment as previously described. Recognition is of importance as some therapies used in SIADH like fluid restriction, vaptans & oral urea powder would be harmful in CSW. It is imperative for physicians to detect CSW early, this will allow for proper management & thus avoiding consequences of worsening hyponatremia & hypovolemia.

**PUB185**

**Partial Nephrogenic Diabetes Insipidus Secondary to Lithium Use**

Sameh Nassar,<sup>1</sup> Simon A. Kashfi,<sup>2</sup> Maria C. Sanchez,<sup>1</sup> Bessy Suyin Flores Chang,<sup>1</sup> Jamil Ibrahim.<sup>1</sup> <sup>1</sup>St. Barnabas Hospital, Bronx, NY; <sup>2</sup>The City College of New York CUNY School of Medicine, New York, NY.

**Introduction:** Nephrogenic diabetes insipidus (NDI) is caused by reduced renal response to vasopressin. NDI affects up to 40% of patients on lithium. We present a case of partial NDI secondary to lithium use.

**Case Description:** A 66 year old male with bipolar disorder on lithium presented with shortness of breath, chest tightness and cough. On exam he was cachectic, lethargic, tremulous with decreased skin turgor and dry mucous membranes found to have COVID-19 with initial unremarkable blood work. Received treatment for COVID and subsequently developed worsening encephalopathy, follow up blood work revealed elevated serum sodium of 168 mg/dl, with urine osmolality of 382 and lithium level was elevated at 1.6 mEq/L. He received adequate IV fluid hydration with hypotonic fluids and free water. Serum sodium remained elevated with polyuria. Follow up labs showed urine osmolality decrease to 94 mosm/L therefore nephrogenic diabetes insipidus was suspected. A desmopressin stimulation test was performed and hourly urine osmolality was obtained [Table 1] confirming the diagnosis of nephrogenic diabetes insipidus with a partial response to desmopressin compatible with lithium-induced partial diabetes insipidus. Treatment was started initially with chlorthalidone with inappropriate response, then dose increased to 100mg daily with further addition of amiloride 10mg twice daily with subsequent response and decrease of sodium level from 167 to 147 mEq/L.

**Discussion:** Lithium-induced NDI is explained by downregulation of aquaporin 2 channel expression in the principal cells due to accumulation of toxic concentrations of lithium and reduction of the kidneys' ability to preserve water in response to vasopressin. NDI usually presents with polyuria, polydipsia, severe dehydration, and electrolyte imbalance. A less than 50% increase in urine osmolality following desmopressin administration proves NDI. Treatment options include high doses of desmopressin, low sodium diet, thiazide diuretics, amiloride, and NSAIDs.

Urine osmolalities during the desmopressin stimulation test

Hour	Urine Osmolality (mosm/kg)
Before desmopressin	90
1	113
2	113
3	113
4	118

**PUB186**

**Clinical and Laboratory Profile of Patients With Autosomal Dominant Polycystic Kidney Disease (ADPKD)**

Vasiliki Gkika, Michaela Louka, Eirini Tigka, Myrto Kostopoulou, George I. Tspirpanlis. General hospital of Athens "G. Gennimatas", Athens, Greece.

**Background:** Recent advances in the treatment of ADPKD highlight the interplay between the clinical and laboratory profile of the disease. This study aims to present the baseline characteristics of patients followed in a large ADPKD cohort from a single center and explore possible associations between demographic, clinical, and laboratory parameters.

**Methods:** This study enrolled patients who were being followed in a specialized outpatient ADPKD clinic from December 2018 to December 2021. At enrollment, demographics, medical and family history, and laboratory data were recorded using a standardized form. Estimated glomerular filtration rate (eGFR) was calculated and Magnetic Resonance Imaging for total kidney volume (TKV) measurement was performed.

**Results:** Three hundred (162 females and 138 males) ADPKD patients at a mean age±SD of 40.87±12.9 years were enrolled in the study. Overall, 67.3% of them were classified as Chronic Kidney Disease, (CKD) stage 1 and 2. The ADPKD was diagnosed at a mean age±SD of 27.2± 11.65 years. Twenty-six percent of 300 patients were diagnosed before the age of 20. A positive family history was present in 89.75% of patients. In this subgroup, the mean age of the affected parent who reached end stage renal disease (ESRD) was 55 (range 28-87) years. Hypertension was diagnosed in 88% of the patients at a mean± SD age of 35.89 ± 11 years. Hepatic cysts were present in 78% of them, urinary tract infections, nephrolithiasis, macroscopic hematuria, and pain in 44.87%, 43%, 24.71% and 54.23% respectively. In 31% of the cases, there was a family history of intracranial bleeding. In multivariable analysis, lower eGFR was associated with older age (p< 0.001), younger age at the time of ADPKD diagnosis (p < 0.012) and greater values of the height-adjusted TKV (p < 0.001) and Body Mass Index (BMI) (p = 0.11).

**Conclusions:** In this study, patients with ADPKD were diagnosed at a young age and hypertension developed in the majority of them early in the course of the disease. Renal function was influenced by age, height-adjusted cyst-renal volume, early diagnosis of ADPKD, and BMI.

## PUB187

### Machine Learning Techniques for Automated Segmentation of Kidneys and Cysts in Autosomal Dominant Polycystic Kidney Disease: A Systematic Review

Hyun Bae Jang,<sup>1</sup> Ahsan Alam,<sup>2</sup> *McGill University Faculty of Medicine and Health Sciences, Montreal, QC, Canada; <sup>2</sup>McGill University Health Centre, Montreal, QC, Canada.*

**Background:** Autosomal Dominant Polycystic Kidney Disease (ADPKD) is the most common hereditary kidney disease. Total kidney volume (TKV) is used clinically as a prognostic biomarker, so its accurate determination is critical to determine treatment eligibility or inclusion into clinical studies. Recently, machine learning techniques have been applied to ADPKD to better segment kidneys or cysts. We performed a systematic review of machine learning models applied to ADPKD kidney and cyst segmentation.

**Methods:** We conducted a literature search using relevant search terms including ADPKD, imaging, kidney or cyst segmentation, and machine learning techniques. The last search date was May 12, 2022. Studies were screened for relevance prior to inclusion in the systematic review. We identified seventeen studies. Two were excluded as they involved mouse models. We examined the patient and disease characteristics included in these studies, as well as the machine learning technique employed, and whether any external validation was performed.

**Results:** Of the fifteen human studies eligible for inclusion (n=5243 kidney images[SJ1]), one used 3D ultrasound (n=66), three used CT images (n=502), and the remaining 11 used MR images (n=4675). The study sizes ranged from 11 up to 1445 patients, with 13 to 2400 scans. Four studies used axial cuts and 11 studies used coronal cuts to develop their model. The majority of models employed an artificial neural network approach; however, some studies utilized and compared the performance of different machine learning techniques. Only one study developed a model to segment kidney cysts. All models achieved high dice coefficient, sensitivity, specificity or recall when comparing with manual segmentation. Only one study performed external validation using a different cohort.

**Conclusions:** Various machine learning techniques can accurately automate kidney segmentation in patients with ADPKD. Most studies relied on a small sample size and only one performed external validation. Whether these automated segmentation models can be deployed in a clinical environment or can outperform estimated TKV remains to be determined.

## PUB188

### A Mutation in the GANAB Gene as a Cause of Bilateral Renal Cysts

Jean H. Ancion, Dina R. Al-Tuhafy, Katerina Hysi, Saira Sajid, James Drakakis. *NYU Langone Hospital - Long Island, Mineola, NY.*

**Introduction:** Polycystic kidney disease can cause of chronic renal failure in children and adults. The disease is inherited by an autosomal dominant trait (ADPKD) or an autosomal recessive trait (ARPKD). ADPKD commonly results from a mutation in the PKD1 (80-85%) and PKD2 (15-20%) genes, which code for polycystin-1 (PC1) and polycystin-2 (PC2), respectively. These are a significant cause of end stage renal disease due to renal cell dysplasia. There is another, lesser known form of ADPKD known as polycystic kidney disease-3 (PKD3). This results from mutations in glucosidase II alpha subunit (GANAB) gene and present in mid- and late adulthood. As such, there is a third source of genetic renal cyst formation, albeit not as commonly encountered or described.

**Case Description:** 61 year old male with past medical history of hypertension was referred after an in office urologic ultrasound noted bilateral cysts (quite large on the left). Complete abdominal sonogram showed R kidney 13.5 cm + L kidney 17.1 cm with L sided cysts including --5 x 4.5 cm cyst upper pole, 13.4 x 10.8 cm cyst lower pole, 3.7 x 1.7 cm hypochoic nodule adj to upper pole cyst. CT scan followed for better characterization and revealed several L kidney cysts; Bosniak class I cysts upper/lower pole and also Bosniak class II cyst in upper pole on L (3.3 x 2.4 cm). Plus several subcentimeter cortical R kidney cysts. The patient's father was noted to have been on dialysis (cause unknown). Due to the extensive nature of the cysts and family history, genetic testing was undertaken. This revealed heterozygous likely pathogenic variant in the GANAB gene.

**Discussion:** Until recently, mutations in the genes coding for PC1 and PC2 were believed to be the only ones implicated in genetic cystic kidney disease. In 2016, mutations in GANAB, encoding the glucosidase IIa subunit were reported to cause ADPKD (0.3%) and this was called PKD3. The phenotype is one of mild to very mild cystogenic effects in the kidneys. This case illustrates the importance of genetic testing in the workup of otherwise incidentally noted large bilateral renal cysts. The identification of GANAB mutation offers possible further gene targeted therapeutics and potentially better insight into the management of ADPKD. Furthermore, it helps us better understand the spectrum of such disorders.

## PUB189

### Complicated Retroperitoneal Hemorrhage in Autosomal Dominant Polycystic Kidney Disease: A Case Report

Yeshwanter Radhakrishnan,<sup>1</sup> Parikshit Duriseti,<sup>1</sup> Maroun Chedid,<sup>1</sup> Fouad T. Chebib,<sup>2</sup> *Mayo Clinic Minnesota, Rochester, MN; <sup>2</sup>Mayo Clinic in Florida, Jacksonville, FL.*

**Introduction:** Autosomal dominant polycystic kidney disease (ADPKD) is the leading genetic cause and the 4th most common cause of end-stage kidney disease worldwide. Cyst bleeding is not uncommon, however rarely, ruptured cysts may present with life-threatening retroperitoneal hemorrhage requiring prompt management. We report a case of a patient with ADPKD who presented with hemorrhagic shock in setting of cyst rupture and severe retroperitoneal hemorrhage.

**Case Description:** A 60-year-old male with chronic kidney disease of unknown stage secondary to ADPKD presented to the hospital with chief complaints of lethargy, chest pain, and altered mental status. His initial labs were significant for hemoglobin (Hb) 4.7 g/dL, high anion gap metabolic acidosis with serum bicarbonate 5 mmol/L, serum lactate 3.3 mmol/L, blood urea nitrogen 217 mg/dL, and serum creatinine 17.1 mg/dL with an unclear baseline. Abdominal imaging revealed enlarged polycystic kidneys bilaterally with soft tissue masses concerning for retroperitoneal hematoma (RPH) from a ruptured renal cyst. He was noted to have bleeding from left L3 lumbar artery that was embolized by Interventional Radiology (IR). He was admitted to the ICU for hemorrhagic shock and was initiated on Hemodialysis (HD) and massive transfusion protocol. The Hb continued to trend down despite transfusions and repeat imaging demonstrated expanding RPH. He underwent repeat IR guided embolization of the left L1, L3, L4 lumbar arteries and left renal capsular artery. The Hb transiently stabilized for next 3 days, however it continued to trend down. Oral tranexamic acid (TA) 1300mg once daily for 9 days was trialed due to continued bleeding. The patient's Hb stabilized around 8.5 g/dL after TA and he did not require any further transfusions. He remained HD dependent at the time of discharge.

**Discussion:** Life-threatening spontaneous RPH following cyst rupture in the absence of major trauma or use of anti-coagulants, is a rare complication in ADPKD. Treatment involves blood transfusions, management of shock, IR guided embolization. TA can be considered when the above measures fail for cyst bleeding. Urgent nephrectomy might be considered for refractory bleeding.

## PUB190

### ARPKD Diagnosed in an Adult Without Kidney Manifestations

Benjamin R. Wagner. *Dignity Health Medical Group Dominican, Santa Cruz, CA.*

**Introduction:** Autosomal recessive polycystic kidney disease (ARPKD) is largely a condition of infancy or childhood. Its prevalence among adults is low and incident diagnosis during adulthood is exceedingly rare. Here, a case is presented of compound heterozygosity with two different mutant alleles in PKHD1 in a young adult with advanced cirrhosis, though no kidney disease.

**Case Description:** A 30-year-old woman presented with jaundice, easy bruising, and hemolytic anemia. Abdominal imaging revealed stigmata of cirrhosis with massive hepatosplenomegaly. Liver biopsy was performed and a diagnosis of cirrhosis was confirmed. This was initially attributed to alcohol use, as she had consumed 2-5 drinks daily between March and November 2020 – early in the COVID-19 pandemic. Testing for autoimmune etiologies, alpha-1 antitrypsin deficiency, hemochromatosis, and Wilson's disease was negative. Genetic testing was ultimately obtained and revealed two variants in the PKHD1 gene (c.1018 G>A p.[G340R], c.983 G>A p.[R328Q]), raising the possibility of ARPKD. Kidneys were unremarkable on imaging, being normal in size and without cysts. Creatinine remained stable at ~0.8-0.9 mg/dL. Urinalysis was bland. Family history is notable for cirrhosis in her father and possible cholangiocarcinoma in a maternal aunt. The patient's mother has tested positive for one mutant allele.

**Discussion:** Our knowledge of the manifestations of ARPKD in adulthood is scarce, based largely on small case series and case reports. Its phenotypic presentation in adults has proven to be highly variable, though most often with strong hepatobiliary sequelae. A presentation with a complete lack of kidney manifestations – as seen in this case – should now be recognized.

## PUB191

### Macronutrient Composition and Protein Intake of a Plant-Focused, Kidney-Safe Ketogenic Approach for Individuals With Autosomal Dominant Polycystic Kidney Disease

Jessianna Saville,<sup>1,4</sup> Clarissa S. Paimanta,<sup>1,4</sup> Diana Bruen,<sup>1,4</sup> Jacob A. Torres,<sup>2,3</sup> Thomas Weimbs,<sup>2,3</sup> *<sup>1</sup>RenAlign, Titusville, FL; <sup>2</sup>Santa Barbara Nutrients, Santa Barbara, CA; <sup>3</sup>Department of Molecular, Cellular, and Developmental Biology and Neuroscience Research Institute, University of California Santa Barbara, Santa Barbara, CA; <sup>4</sup>Kidney Nutrition Institute, Titusville, FL.*

**Background:** Autosomal dominant polycystic kidney disease (ADPKD) is the most common inherited cause of renal failure and has limited pharmacological treatment options. Recent research has uncovered that cyst cells in ADPKD depend on glucose for energy and are unable to metabolize fatty acids and ketones. As such, the ketogenic diet may be a viable nutrition intervention to slow or prevent ADPKD progression and improve health outcomes. However, most clinically used ketogenic or low-carbohydrate diets are either normoproteic or hyperproteic, while for ADPKD, lowering protein intake and promoting intake of plant protein are recommended to prevent further renal injury and

Key: TH - Thursday; FR - Friday; SA - Saturday; OR - Oral; PO - Poster; PUB - Publication Only

Underline represents presenting author.

slow disease progression. This study assesses the macronutrient composition of the plant-focused ketogenic diet (PFKD) as implemented in the Ren.Nu program, a breakthrough dietitian-led program to teach individuals with ADPKD the implementation of the kidney-safe PFKD.

**Methods:** Nutrient intake of 7 participants enrolled in the Ren.Nu program who had consistent daily food logs were analyzed for macronutrient composition. Nutrient analysis was based on approximately 1-week of food logs marked as complete days, extracted from week 10 out of 12 weeks of the Ren.Nu program.

**Results:** The daily intake in a PFKD averages to 82.6 g of total carbohydrates, 30.7 g of fiber, 131.1 g of total fat, and 46.7 g of protein intake, which ranges between 0.63 to 0.83 g of protein/kg of body weight/day. The macronutrient breakdown in percentage of daily energy intake was 20.2% for total carbohydrates, 72.1% for total fat, and 11.4% for protein. The Atwater general factors were used for energy calculations based on grams of each macronutrient consumed.

**Conclusions:** This study indicates that the PFKD approach for ADPKD as taught in the Ren.Nu program successfully sustained a macronutrient composition to achieve ketosis, while keeping protein levels within the appropriate recommendations to avoid renal stressors and slow or prevent disease progression. The Ren.Nu program is now publicly available for individuals with ADPKD.

**Funding:** Commercial Support - Kidney Nutrition Institute

**PUB192**

**SGLT-2 Inhibitors Are Well Tolerated in Patients With Autosomal Dominant Tubulointerstitial Kidney Disease (ADTKD)**

Anthony J. Bleyer,<sup>1,2</sup> Kendrah O. Kidd,<sup>1</sup> Victoria C. Robins,<sup>1</sup> Alice Kim,<sup>1</sup> Martina Zivna,<sup>2</sup> Stanislav Kmoch.<sup>2,1</sup> <sup>1</sup>Wake Forest University School of Medicine, Winston-Salem, NC; <sup>2</sup>Univerzita Karlova, Praha, Czechia.

**Background:** SGLT-2 inhibitors (SGLT2i) are effective in chronic kidney disease but have not been studied in ADTKD. There are currently no treatments available for ADTKD. We performed a prospective observational study to determine if SGLT2i are safe in ADTKD patients.

**Methods:** Patients in the Wake Forest ADTKD prospective cohort study were asked to alert us if started on SGLT2i (either empagliflozin or dapagliflozin). Baseline laboratory studies were obtained with sample storage for biomarker measurement at baseline and 1 month. Patients were followed with serum creatinine measurements at least quarterly.

**Results:** The baseline characteristics of participants included: mean age 44±16 y, 53% ADTKD-*MUC1*, 47% ADTKD-*UMOD*, 53% male, mean baseline eGFR 37±11 ml/min/1.73m<sup>2</sup>, with 5 with eGFR <30 ml/min/1.73m<sup>2</sup> (21,21,25,26, and 26 ml/min/1.73m<sup>2</sup>) and the remaining participants with eGFR between 30 and 57 ml/min/1.73m<sup>2</sup>. Eight participants stopped SGLT2i: 1 due to pregnancy, 1 due to anxiety, and 6 due to early eGFR decline that concerned the patient or doctor. For the 6 who stopped due to eGFR concerns, the mean time of discontinuation was 2 months, with a mean decline in eGFR of 6 ml/min/1.73m<sup>2</sup> (2-11 ml/min/1.73m<sup>2</sup>). The eGFR returned to prior values after stopping medication. For patients who did not stop, the mean decline in eGFR at two months was 3.5 ml/min/1.73m<sup>2</sup>. Urinary KIM-1 levels were measured in 10 individuals and increased from a mean baseline of 644±671 pg/mg creatinine to 5152±9062 and at 6 month follow up decreased to 1671±2390 in 6 patients. Change in KIM1 did not correlate with eGFR change. The mean change in eGFR over the course of the study is shown in the figure with comparison to DAPA CKD results. One patient started SGLT2i with an eGFR of 21 ml/min/1.73m<sup>2</sup>, which has remained stable for 16 months.

**Conclusions:** SGLT2i were well tolerated and patient outcomes were similar to DAPA-CKD.

**Funding:** Private Foundation Support

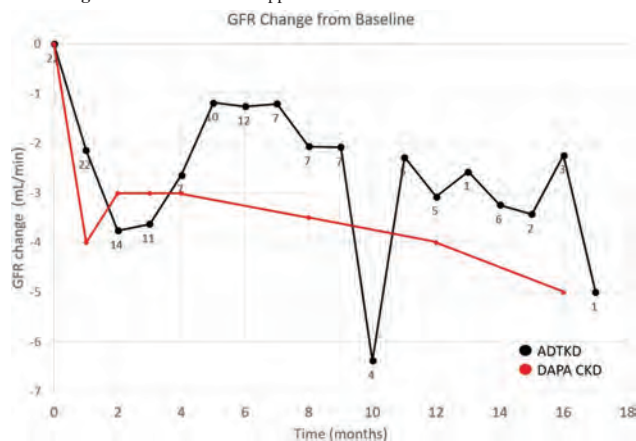

**PUB193**

**An Unusual Presentation of Fabry Disease in an Elderly Female**

Justin Ilagan,<sup>1</sup> Yihan Wang,<sup>2</sup> Christin M. Giordano McAuliffe,<sup>3</sup> Jersey Shore University Medical Center, Neptune City, NJ; <sup>2</sup>Vanderbilt University Medical Center, Nashville, TN; <sup>3</sup>Nephrology Associates, Murfreesboro, TN.

**Introduction:** Fabry disease is an X-linked lysosomal storage disease that causes an accumulation of globotriaosylceramide within lysosomes due to a lack of alpha-galactosidase. While a typical patient is a white male in their second decade of life, atypical presentations can be seen in up to 1 in 40,000 females [1,2]. We present an unusual clinical presentation of an elderly female patient found to have a positive alpha-galactosidase (GLA), Glu398Lys subtype, mutation identified following presentation with uremic symptoms.

**Case Description:** A 71 year old female with a past medical history significant for chronic kidney disease (CKD) stage 3, atrial fibrillation, and hypertension who presented in the hospital for altered mental status. Physical examination was unremarkable. Initial labs were notable for a bicarbonate of 11 mmol/L (normal 24-31 mmol/L), blood urea nitrogen of 113 mg/dL (normal 5-25 mg/dL), creatinine of 3.4 mg/dL (normal 0.61-1.24 mg/dL), and an albumin of 2.4 g/dL (normal 3.5-5 g/dL). Initially, the C3 and C4 complement levels were undetectable, but later improved. Renal ultrasound was notable for a 10.1 cm left kidney and 4.5 cm right kidney with normal dopplers. Due to concern for uremia, she underwent hemodialysis (HD) after which her altered mental status resolved. A renal biopsy was performed with findings notable for myelin bodies on electron microscopy. Prior to discharge, renal function improved and HD was stopped. Due to her age, the possibility of drug-induced Fabry disease was explored and genetic testing was performed.

**Discussion:** FD is considered the second most common lysosomal storage disease, leading to acroparesthesias, angiokeratomas, proteinuria, and cardiac manifestations. In our case, we suspect that she had underlying CKD due to FD leading to her presentation. Her atrial fibrillation may also be a manifestation of FD. Due to the infrequency of reported cases, there should be increased awareness of manifestations of the disease to identify appropriate patients for genetic testing, so treatment is prompt. Family members should also be genetically tested to treat and avoid complications later in life. Additionally, drugs, most notably hydroxychloroquine, are also known to cause FD and should be considered when there is an unusual presentation.

**PUB194**

**The Novel MYH9 Variant, c.1270C>G, p.Arg424Gly, May Primarily Cause Hepato-Renal Disease**

Tilman Jobst-Schwan,<sup>1,2</sup> Antje Wiesener,<sup>3</sup> Florian J. Wopperer,<sup>1,2</sup> Mario Schiffer,<sup>1</sup> Michael S. Wiesener.<sup>1</sup> <sup>1</sup>Universitätsklinikum Erlangen Medizinische Klinik 4 Nephrologie und Hypertensiologie, Erlangen, Germany; <sup>2</sup>RECORD – Research Center On Rare Kidney Diseases, Erlangen, Germany; <sup>3</sup>Universitätsklinikum Erlangen Institut für Humangenetik, Erlangen, Germany.

**Background:** The gene *MYH9* encodes for the heavy chain of non-muscular myosin IIA. Mutations in *MYH9* cause a very rare autosomal-dominant monogenic disorder that may include macrothrombocytopenia, proteinuric kidney disease, cataract, sensorineural deafness and elevated liver enzymes. The full set of symptoms is defined as Epstein-Fechtner syndrome.

**Methods:** Whole exome sequencing was performed in a patient with ESRD and unclear elevated liver enzymes. Segregation analysis in affected and unaffected family members was performed by Sanger sequencing. Biopsies of kidney and liver as well as skin fibroblasts were investigated. Blood smears were inspected by light microscopy for Döhle like bodies in granulocytes, and stained for Myosin IIA.

**Results:** We identified the putative deleterious *MYH9* variant c.1270C>G, p.Arg424Gly (ACMG class 4, CADD score 22, evolutionary highly conserved), heterozygously in 4 affected members of a non-consanguineous family of Albanian descent (Fig. 1A). The variant affects the α-helix of the motor domain according to *in silico* analysis (Fig.1B). Granulocytes in the blood smears presented neither Döhle like bodies nor Myosin IIA positive conglomerates, the typical findings of *MYH9* related disease. However, all 4 patients presented with proteinuria, elevated liver enzymes and intermittent thrombocytopenia. The 3 adult patients developed sensorineural hearing impairments, both patients of the parental generation cataracts in addition.

**Conclusions:** We identified a novel variant in the gene *MYH9* in a family with a hepato-renal disease as the major phenotype of the intrafamilial syndrome. Despite the segregation and the matching clinical pattern in all 4 affected family members, the typical microscopic phenotypes of granulocytes (Döhle like bodies, Myosin IIA conglomerates) were not detected. However, *MYH9* variants affecting the motor domain have a high risk for manifestations in adulthood as shown before by Pecci et al. (*Hum Mutat* 29:409, 2008), supporting the pathogenicity of the *MYH9* variant c.1270C>G, p.Arg424Gly.

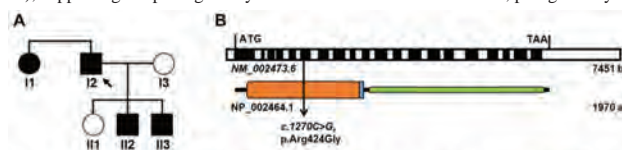

**Fig. 1: MYH9 variant c.1270C>G, p.Arg424Gly affects the motor domain. (A)** All 4 affected family members carry the variant in a heterozygous state. **(B)** The variant is located in the exon sequence coding the motor domain (orange bar) of Myosin IIA (NP\_002464.1).

## PUB195

## Family Cluster of IgA Nephropathy Combined With Fabry Disease and Alport Syndrome

Chia-Yu Shih,<sup>1</sup> Cheng-Hsu Chen,<sup>1,2</sup> Shangfeng Tsai,<sup>1</sup> Taichung Veterans General Hospital, Taichung, Taiwan; <sup>2</sup>Department of Post-Baccalaureate Medicine, College of Medicine, National Chung Hsing University, Taichung, Taiwan.

**Introduction:** IgA nephropathy (IgAN) was the leading cause of chronic nephritic syndrome, acute nephritic syndrome, and persistent hematuria, accounting for 55.2%, 36.7%, and 76.7% in Taiwan, respectively. Fabry disease and Alport syndrome are inherited as an X-linked disorder caused by mutation of GLA gene and COL4A5 gene, and these diseases are rare in Taiwan. Thus, most clinical practice might neglect the combination of rare disease. Here, we reported a family cluster of IgA nephropathy by clinical manifestations, laboratory and pathology examinations, and simultaneous diagnosis of Alport syndrome and Fabry disease through our precision medicine screening.

**Case Description:** The indicated brothers were diagnosed as IgAN by renal biopsy at their age 8 and 10 with hematuria and proteinuria. Light microscopy and immunofluorescence showed that IgA was deposited in the mesangium. They received kidney transplantation with triple therapy for more than 15 years. The precision medicine project screening the Fabry disease found they are GLA gene mutant c.639+919 G>A (IVS4+919G>A), the whole exome sequencing (WES) demonstrated COL4A5 c.2917+1 del confirmed with Alport syndrome. Their mother was also KTx recipients concomitantly diagnosed Fabry disease IVS4 and carrier of COL4A5 c.2917+1 del. The findings in our case emphasize the importance of renal biopsy and gene detection in hereditary kidney disease, especially for Fabry disease and its rare coexistence with Alport syndrome.

**Discussion:** In general, the biopsy-proven IgAN is major cause of GN in the world, however, we should still keep in mind that persistent nephritis or nephrotic syndrome without complement consumption might also include with variants in Alport syndrome. Thanks to Fabry disease screening, we found this family cluster of concomitant of IgAN, Alport syndrome and Fabry disease IVS4, through the enzyme supplement therapy to preserve their heart function.

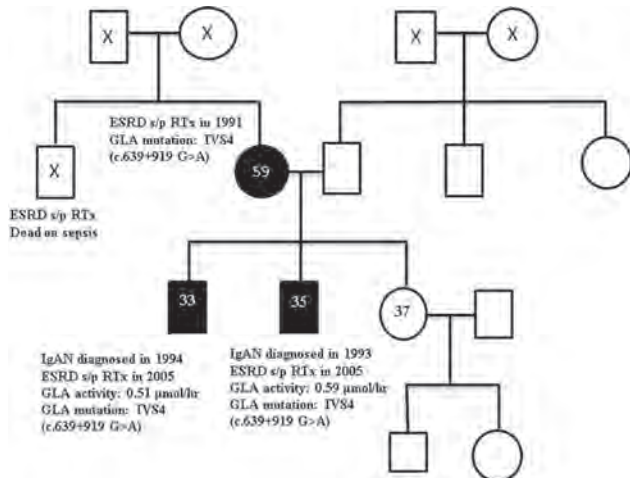

## PUB196

## Partial Results of a Brazilian Study Evaluating an Alternative Method for Fabry Disease Screening in Women

Cassiano Augusto Silva,<sup>1</sup> Fellype Barreto,<sup>2</sup> Osvaldo M. Vieira Neto,<sup>3</sup> Leandro J. Lucca,<sup>3</sup> Carolina Barretto,<sup>4</sup> Valeria Veloso,<sup>5</sup> Gabriela Sevigiani,<sup>6</sup> Luiz Roberto Carvalho,<sup>7</sup> Marta V. Boger,<sup>8</sup> Roberta C. Pascoito,<sup>9</sup> Karla Cristina P. Israel,<sup>10</sup> Ana Paula Gueiros,<sup>11</sup> Artur Q. Silva,<sup>12</sup> Felipe Leite Guedes,<sup>12</sup> Gelzie S. Ennes,<sup>13</sup> Eduarda M. Souza,<sup>14</sup> Gina Moreno Gordon,<sup>15</sup> Fernando A. Vieira,<sup>16</sup> Márcia G. Ribeiro,<sup>17</sup> Luis Gustavo Modelli de Andrade.<sup>1</sup>  
<sup>1</sup>Universidade Estadual Paulista Julio de Mesquita Filho, Botucatu, Brazil; <sup>2</sup>Universidade Federal do Paraná, Curitiba, Brazil; <sup>3</sup>Universidade de São Paulo Faculdade de Medicina de Ribeirão Preto, Ribeirão Preto, Brazil; <sup>4</sup>Santa Casa de Misericórdia de Itabuna, Itabuna, Brazil; <sup>5</sup>Universidade Federal de Goiás, Goiania, Brazil; <sup>6</sup>Fundacao Pro-Rim, Joinville, Brazil; <sup>7</sup>Serviço de Terapia Renal de Orlinhos, Orlinhos, Brazil; <sup>8</sup>Metta Saúde Clínica do Rim, Foz do Iguaçu, Brazil; <sup>9</sup>Santa Casa de Maringá, Maringá, Brazil; <sup>10</sup>Universidade Federal do Amazonas, Manaus, Brazil; <sup>11</sup>Instituto de Medicina Integral Professor Fernando Figueira, Recife, Brazil; <sup>12</sup>Universidade Federal do Rio Grande do Norte, Natal, Brazil; <sup>13</sup>Centro de Nefrologia de Nova Friburgo, Nova Friburgo, Brazil; <sup>14</sup>Sanofi, Sao Paulo, Brazil; <sup>15</sup>Grupo Instituto do Rim do Paraná, Curitiba, Brazil; <sup>16</sup>Clirenal, Caratinga, Brazil; <sup>17</sup>DLE, Rio de Janeiro, Brazil.

**Background:** Fabry disease (FD) is a rare X-linked lysosomal storage disorder that may affect multiple organs, including the kidneys. The main objective of this study was to evaluate the effectiveness of combining  $\alpha$ -GAL enzyme activity and plasma levels of lyso-GL3 for screening FD in females with chronic kidney disease (CKD).

**Methods:** Female with CKD, stages 3 to 5, under regular nephrology follow up were selected from renal centers of all regions of Brazil. Exclusion criteria: under 18 years old and a known diagnosis of FD. Patients underwent biochemical analysis of  $\alpha$ -GAL enzyme activity and plasma levels of lyso-GL3. GLA gene sequencing was performed if  $\alpha$ -GAL enzyme activity was below and/or the lyso-GL3 levels were above the reference range. Sensitivity and specificity analyses were performed to assess the performance of the combined biochemical approach for the diagnosis of FD.

**Results:** From October 2020 to December 2021, 1163 patients were included. Low  $\alpha$ -GAL activity was found in 36 (3.1%) patients and increased lyso-GL3 levels were found in 95 (8.2%) patients. The median age was 52 [42–63] years. Genetic analysis of the patients who presented low  $\alpha$ -GAL and/or increased lyso-GL3 detected the same genetic variant of unknown significance in the GLA gene, R118C, in 3 unrelated patients. The sensitivity and specificity of  $\alpha$ -GAL reduction for the detection of FD was 97% and 66%, respectively. Whereas for high plasma levels of lyso-GL3, they were 91% and 33%, respectively. No cases presented concomitantly increased lyso-GL3 and reduced enzyme activity.

**Conclusions:** Preliminary results suggest that combining  $\alpha$ -GAL enzymatic activity with lyso-GL3 dosage may be a good alternative for screening FD in females with CKD. A thorough medical evaluation is required to determine the pathogenicity of R118C in our patients.

## PUB197

## Are Kidney Cysts More Frequent in Individuals With COL4A3-COL4A4 Pathogenic Variants?

Melissa Pilco Teran,<sup>1,2</sup> Monica Furlano,<sup>1,2</sup> Víctor Martínez Jimenez,<sup>4</sup> Marc Pybus,<sup>1,2</sup> María vanessa Pérez gómez,<sup>3</sup> Asunción Rius Peris,<sup>5</sup> Leonor Fayos de Arizón,<sup>1,2</sup> Gerson Berná,<sup>1,2</sup> Jonathan Hernandez Mancera,<sup>1,2</sup> Hugo Vergara Pérez,<sup>5</sup> Elisabet Ars,<sup>1,2</sup> Roser Torra,<sup>1,2</sup> Fundacio Puigvert, Barcelona, Spain; <sup>2</sup>Hospital de la Santa Creu i Sant Pau Institut de Recerca, Barcelona, Spain; <sup>3</sup>Hospital Universitario Fundacion Jimenez Diaz, Madrid, Spain; <sup>4</sup>Hospital Clínico Universitario Virgen de la Arrixaca, El Palmar, Spain; <sup>5</sup>Hospital General Universitari de Castello, Castellon de la Plana, Spain.

**Background:** Individuals carrying heterozygous DNA pathogenic variants in COL4A3 and COL4A4 have a wide spectrum of disease and constitute the most underdiagnosed genetic kidney condition. Recent data suggested that up to 1/106 individuals may harbor a pathogenic variant in COL4A3 or COL4A4 although all published series are biased towards more affected individuals. Some reports suggest a high prevalence of kidney cysts in these persons. We analyzed the possibility of cystic phenotype related to this condition.

**Methods:** Clinical, radiological (ultrasound) and laboratory data from patients with heterozygous pathogenic variants in COL4A3 and COL4A4 were retrospectively analyzed.

**Results:** Our cohort include 178 patients (mean age 43 years (SD 14.6)) with a pathogenic variant in COL4A3 or COL4A4. Age and eGFR were related to the presence of kidney cysts ( $p < 0.001$ ). Kidney cysts were more frequent in patients older than 50 years (59%), but in patients from 30-50 years the incidence was 41%. Patients with kidney cysts had a mean age of 53 years and a mean eGFR (CKD-EPI) of 58ml/min/1.73m<sup>2</sup> (SD 32). We found a positive correlation between presence of proteinuria and kidney cysts: 59% of patients with proteinuria developed cysts compared to 28% in patients without albuminuria or proteinuria. As proteinuria increased, the presence of cysts did so, however, only 40% (2/5) with nephrotic range proteinuria showed cysts. Prevalence of cysts was not affected by the mutated gene (47.7% in COL4A3 patients vs 43.1% in COL4A4) neither severity of mutation. Seven patients from this cohort showed nephromegaly.

**Conclusions:** The presence of kidney cysts in individuals with a pathogenic variant in COL4A3 or COL4A4 is mostly associated with age, eGFR and proteinuria but not with genotype and has no clinical consequences. Due to the high prevalence of both ADPKD and pathogenic variants in COL4A3 or COL4A4 it is expected that both conditions coexist in a number of patients.

**Funding:** Private Foundation Support, Government Support - Non-U.S.

## PUB198

## Crescentic Alport Syndrome: A Rare Clinical Entity

Chintav Shah, Casey N. Gashti. Rush University Medical Center, Chicago, IL.

**Introduction:** Alport's syndrome is an X-linked disorder caused by mutations in alpha 3, 4 or 5 collagen IV chains resulting in defective assembly of glomerular basement membrane (GBM) heterotrimer. It typically presents in 2<sup>nd</sup> to 4<sup>th</sup> decade with the triad of CKD with hematuria and proteinuria, sensorineural deafness and anterior lenticonus. It is histologically characterised by thinning of GBM early followed by thin and thick basket weave appearance on EM, lack of immune complex on IF and abnormal collagen type IV staining with eventual glomerular sclerosis and ESKD. Rare cases of crescentic glomerular lesions have been reported.

**Case Description:** A 23-y/o woman with a history of microscopic hematuria since age 2 presented with fatigue and a serum creatinine (SCr) of 2.5 mg/dl from a normal baseline a few months prior. Father has hx of gross hematuria and one atrophic kidney, sister with visual problems, but no Hx of ESKD or deafness. Urinalysis was significant for 2+ protein, 2+ blood, 3-10 RBC/HPF and Urine protein/Cr ratio of 1.9 g/g. An autoimmune, serologic and infectious workup was negative. A renal ultrasound was normal. A renal biopsy demonstrated focally active pauci-immune crescentic glomerulonephritis with thin GBM (213 nm). Genetic testing demonstrated a heterozygous mutation in COL4A5 gene, confirming the diagnosis of X-linked Alport's. Due to the clinical presentation of rapidly progressive glomerulonephritis, we opted to treat her with prednisone and Rituximab in addition to RAAS blockade. Her serum Cr improved to 1.7 mg/dl and has remained stable in 1 year of follow up.

Key: TH - Thursday; FR - Friday; SA - Saturday; OR - Oral; PO - Poster; PUB - Publication Only

Underline represents presenting author.

**Discussion:** Alport's syndrome, while typically X-linked, has a variable phenotype in women although crescents are rare in any gender. The presence of crescents suggests a faster progression and poorer prognosis. It is hypothesized that high intraglomerular capillary pressure and defective synthesis of collagen IV leads to loss of structural integrity of the GBM, leading to rupture of capillary loops and formation of crescents. Although no definitive treatment is presently available for this disease, our case demonstrates that immunosuppressive therapy can be used to treat the inflammatory component of crescentic Alport's and preserve renal function.

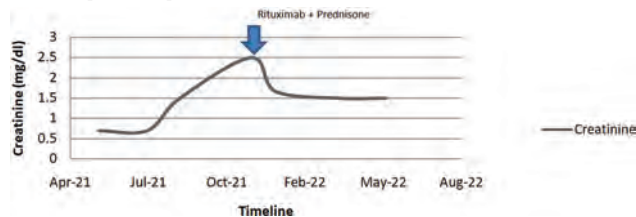

## PUB199

### Mysteries of Alport Syndrome

Muhammad F. Habib, Sharmil Suma Kumaran, Michael Lioudis. *SUNY Upstate Medical University, Syracuse, NY.*

**Introduction:** Thin basement membrane nephropathy (TBMN) occurs in approx. 5-9% of the population, but <1% get diagnosed. TBMN when associated with COL4A3/COL4A4 variants is often referred to as autosomal dominant Alport syndrome.

**Case Description:** A 56-year-old female with a 30-pack year smoking history presented with microscopic hematuria and proteinuria for the last 20 and 14 years respectively. She was normotensive and work up in the past was unrevealing. Initial labs showed a creatinine of 0.69 mg/dl with urinalysis showing 100 mg/dl proteins as well as 19/HPF RBCs. Her urine protein/creatinine ratio was 1.13 mg/mg. CTA/P was benign and nephritic/nephrotic syndrome testing were negative. Family history revealed microscopic hematuria in her siblings, mother, and maternal grandmother. There was no family history of deafness, ocular abnormalities, or renal failure. She underwent a renal biopsy showing segmental thinning of glomerular basement membrane (GBM), hypertensive nephrosclerosis, 30% global glomerulosclerosis, and 20% interstitial fibrosis and tubular atrophy (IFTA). Her genetic testing was positive for heterozygous variant of COL4A4. Patient was treated with angiotensin II receptor blockers.

**Discussion:** Alport syndrome can be inherited in an autosomal dominant/recessive and X-linked pattern. Autosomal dominant disease is also called TBMN (20-30% of Alport syndrome). It differs from X-linked form in the manner of inheritance, lack of COL4A5 variant, severity of disease and histological features. Microscopic hematuria is the main feature of TBMN with no family history of renal failure, ocular or hearing abnormalities. COL4A3/COL4A4 variants along with an autosomal dominant inheritance pattern is required for diagnosis. Patients with proteinuria who undergo a renal biopsy show diffuse thinning of the GBM (<250 - <265 nm-WHO criteria) on electron microscopy. However, as seen in our patient's biopsy, a mix of thin and lamellated GBM can also be seen. Our patient had all the clinical features, as well as the inheritance pattern to suggest an autosomal dominant Alport syndrome. However, the diagnosis was missed for decades. We believe at the onset of hematuria/proteinuria, a thorough history followed by a renal biopsy could have led to an early diagnosis and initiation of therapy leading to a reduction in morbidity. Therefore, providing appropriate genetic counseling/family screening for the patient and her family.

## PUB200

### Sarcopenia, Nutritional Status, and Mortality Risk Assessed Using Bioimpedance Spectroscopy in the Elderly Living in a Long-Term Care Facility

Hyokyong Yu, Young Eun Kwon, Song in Baeg, Hye Min Choi, Dong-jin Oh. *Myongji Hospital, Hanyang University College of Medicine, Goyang-si, Gyeonggi-do, Republic of Korea.*

**Background:** This study was aimed to clarify the impact of sarcopenia and on mortality risks.

**Methods:** This prospective cohort study enrolled the elderly residents who were living in nine long-term care facilities. We collected participants' data such as body mass index (BMI), comorbidities, and laboratory data from September to October in 2017 and mortality data until October 2019. Nutritional status was evaluated using mini nutritional assessment (MNA) score and multi-frequency bioimpedance spectroscopy was used to check body composition. Appendicular skeletal muscle mass was calculated using the equation according to the article of Lin T-Y et al (Clinical Nutrition, 40(5), 3288-3295, 2021). Sarcopenia was diagnosed by European Working Group on Sarcopenia in Older People (EWGSOP2) definition (sarcopenia vs. normal group). In addition to the comparison between the two groups, and multivariate regression analyses were performed to verify the association with mortality risks according to sarcopenia group.

**Results:** A total number of 279 elderly participants were enrolled, and 238 seniors were diagnosed with sarcopenia according to the EWGSOP2 guideline. Median age was 83 years old and median BMI was 20.4 kg/m<sup>2</sup>. Sarcopenia group was older than normal group, showed lower BMI and had lower MNA score. Muscle mass was positively correlated with BMI, MNA score, hand grip strength and albumin level. In univariate Cox regression analysis, hazard ratio (HR) of sarcopenia was 4.541 (95% confidence interval

(CI) 1.429–14.429, P=0.010). Sarcopenia was associated with higher mortality risk after adjusting age, gender and diabetes mellitus (HR 3.744, 95% CI 1.155–12.134, P=0.028).

**Conclusions:** Sarcopenia was very prevalent in the elderly of long-term facility care. Sarcopenia group were significantly associated with higher mortality risks.

**Funding:** Government Support - Non-U.S.

## PUB201

### Palliative Goals of Care With Conservative Treatment of CKD 5 Prolonged Life Up to 24 Months in an Elderly Patient

Jasjot K. Bhullar. *Spartanburg Regional Healthcare System, Spartanburg, SC.*

**Introduction:** One-fifth of patients on dialysis in the USA and Australia are ≥75years old, and this segment of the population constitutes the fastest growing dialysis age-group. While there is a paucity of data surrounding mortality in elderly patients treated with conservative measures, it is understood that elderly patients are more likely to have greater morbidity, increased frailty, and decreased functional status. For these patients and others, a conservative approach may be optimal.

**Case Description:** 82-year-old female presented to the emergency room in September 2019 with the chief complaint of chest pain. She was found to have CKD stage IV with a serum creatinine of 3.7 at that time. Due to changes on chest Xray and presumed Acute Kidney Injury she underwent aggressive diuresis. Unfortunately, her creatinine worsened. A renal ultrasound at that time showed bilateral atrophy. She was discharged home once stable with outpatient nephrology follow up. Due to weakness and hypertensive urgency, she was rehospitalized in December 2019. By that time, she had progressed to ESRD. The patient and family were hesitant to pursue dialysis and her creatinine and symptoms stabilized, so the decision was made to pursue conservative management of CKD 5. Assessment and plan as follows: 1. Hyperkalemia—Lokelma 2. Constipation- Milk of magnesium 3. Pain- low dose gabapentin + opioids per pain management 4. Fatigue- 5. Swelling- Torsemide increased to 40mg daily (Oct 2021), then to 40mg bid (Nov 2021) 6. Hyperphosphatemia- Phoslo 667mg tid 7. HTN- Torsemide, Norvasc 8. Vit D deficiency- vit D supplement Despite multiple kidney-related symptoms for which she is being treated, she has been able to maintain autonomy, quality of life and increased independence due to successful conservative medical management of her ESRD for over 2 years.

**Discussion:** Symptoms and medical management of CKD 5 is a two pronged approach which can help ease the burden of the nephrology team and the palliative care team while achieving patient oriented outcomes of prolonged and improved quality of life. Palliative Management Plan: 1. Pain 2. Fatigue 3. Anorexia 4. Nausea and vomiting 5. Pruritus and Restless Leg Syndrome 6. Advanced Care Planning CKD Medical Management Plan: 1. Volume status 2. Hyperkalemia 3. Metabolic acidosis 4. Anemia of CKD 5. weight loss 6. Hyperphosphatemia and secondary hyperparathyroidism 7. Hypertension

## PUB202

### Lupus-Like Glomerulonephritis as the First Presentation of AIDS

Stefan C. Hemmings, Maxine C. Seales Kasangana. *Baptist Health, North Little Rock, AR.*

**Introduction:** Crescentic Glomerulonephritis (GN) with Full House Immune Complex staining is typical of lupus nephritis and is an uncommon presentation of AIDS in the HAART era.

**Case Description:** A 21 yo Black man presented to hospital with chest pain and feeling generally unwell. One month earlier he presented to another hospital with abdominal pain and PR bleed. A CT abdomen was unremarkable and his creatinine was 1.0mg/dL then. On exam he had normal blood pressure and a mild fever (Temp 100.1F). He was slim built with shotty cervical and axillary lymph nodes, without edema. Labs showed mild anemia, Hb 10.9g/dL and creatinine 1.9mg/dL. On day 2 his creatinine was 1.96mg/dL. On urinalysis: 3+ blood and 3+ protein, UPCR 1.6g/g and albumin of 2.8. His CRP 3.4 and ESR >140mm/hr were elevated. With a presumed GN diagnosis and suspicion for lupus, pulse methylprednisolone 1g daily x 3 doses was started. A renal biopsy performed on Day 4 revealed: "Focal Necrotizing and Crescentic GN with Full House Immune Complex staining". Serology was negative for ANA, dsDNA and ANCA. Complements were normal. At follow up, review of his sexual history was significant for unprotected MSM starting only the year prior. Additional serology was significant for positive HIV antibodies and syphilis (1:64 titer). A CD4 count of 158 met AIDS criteria, with a viral load of 59,000 copies. Oral steroids were continued with a 4 month taper along with MMF. Biktarvy was initiated within 2 weeks of his HIV diagnosis. His creatinine normalized within 1 month (1.19mg/dL) and within 2 months his UA and UPCR (0.1g/g) were unremarkable. He had a normal CD4 count >400 and an undetectable viral load within 6 months.

**Discussion:** HIV-associated lupus-like GN is rare but well described in HIV positive individuals. HAART with steroids +/- MMF therapy early in disease can stabilize renal function. HIV testing should be performed more frequently in patients presenting with acute GNs.

Key: TH - Thursday; FR - Friday; SA - Saturday; OR - Oral; PO - Poster; PUB - Publication Only

Underline represents presenting author.

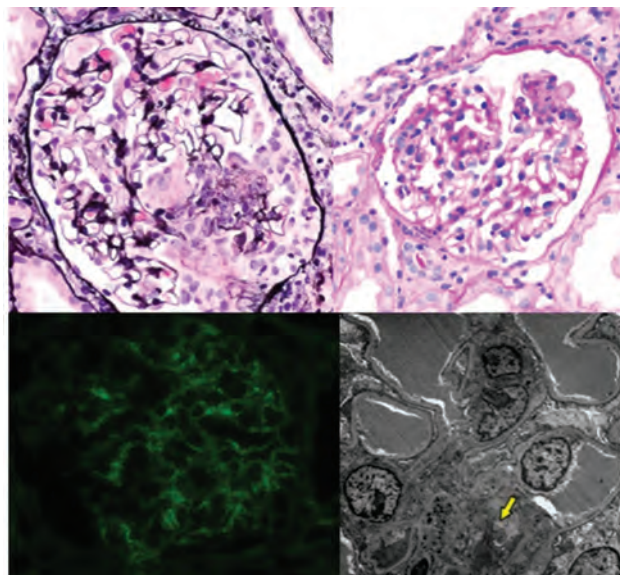

**PUB203**

**Profound Proteinuria and Pathology Pearls: A Case of Secondary Focal Segmental Glomerulosclerosis**

Sruthi Sundaram,<sup>1</sup> Joseph Doan,<sup>2,1</sup> <sup>1</sup>University of Nevada Reno School of Medicine, Reno, NV; <sup>2</sup>Sierra Nevada Nephrology, Reno, NV.

**Introduction:** A 68-year-old male presented with several months of worsening lower extremity edema. Pertinent history included type 2 diabetes, obesity, and hypertension.

**Case Description:** The patient’s initial labs demonstrated albumin 3.5 with 24-hour urine showing isolated nephrotic-range proteinuria at 5.4g/24hr without hematuria. Chemistries were normal without evidence of declining renal function. Workup for autoimmune diseases and light chain gammopathy was negative as were imaging studies for malignancy. Kidney biopsy showed severe arterial intimal fibrosis without arteriolar hyalinosis, two globally sclerosed glomeruli, and one segmental sclerosed glomerulus. Clinicopathologic findings were most consistent with secondary focal segmental glomerulosclerosis (FSGS). There was no evidence of immune-complex or paraprotein-related disease. Patient was initiated on ACE-inhibitor therapy and started a weight-loss program, with subsequent improvement in quantitative proteinuria. The patient’s mildly low serum albumin also normalized, and his lower extremity edema improved.

**Discussion:** Secondary FSGS is diagnosed with kidney biopsy. Light microscopy, immunofluorescence, and electron microscopy assess for structural capillary, tubular, and glomerular abnormalities, and investigate immune-complex or paraprotein-related disease. In this case, identification of nephrotic-range proteinuria led to early diagnosis and intervention to slow progression prior to development of advanced kidney disease. Additional pathology findings of severe arterial intimal fibrosis without diffuse foot process effacement to suggest a primary process, confirmed secondary FSGS attributed to obesity and hypertension. This case is unique due to the patient presenting with symptoms of proteinuria despite the absence of significant hypoalbuminemia, that led to diagnosis of secondary FSGS prior to progression of their kidney disease. In most cases, proteinuria in the absence of nephrotic syndrome is asymptomatic, and early diagnosis requires screening with urine studies. Nephrotic-range proteinuria is a risk factor for progression of obesity-related glomerulopathy to advanced kidney disease. An increase in incidence of obesity-related FSGS has been shown in studies over the past few decades, highlighting the importance of appropriate screening and monitoring in patients with obesity.

**PUB204**

**Glomerulonephritis in Sickle Cell Disease**

Hanna T. Webb, Katherine J. Kelly, Carrie L. Phillips. *Indiana University School of Medicine, Indianapolis, IN.*

**Introduction:** Sickle cell nephropathy is varied, related to chronic ischemic changes, TMA, papillary necrosis, glomerulonephritis. Nephrotic syndrome in sickle cell anemia: - FSGS - MPGN - TMA - Hyperfiltration

**Case Description:** 43 yr old PMH sickle cell anemia with dyspnea. Edema for one year but recently worse. One week of pleuritic chest pain. Anasarca, crackles at right lung base. Urinalysis: 2 RBCs, neg WBC 24-hr urine protein 6.2 g CT chest: right lower lobe consolidation, loculated pleural effusion Renal ultrasound: echogenic parenchyma, right 12 cm and left 11 cm Kidney biopsy: Immune complex GN (diffuse proliferative glomerulonephritis with focal crescents and segmental membranous glomerulopathy) Completed 14 days prednisone for pneumonia, persistent proteinuria and edema. Initiated mycophenolate 1000mg BID and prednisone 60mg for lupus nephritis class IV/V. Urine protein-creat ratio 10->6 after one month of MME. In interim with acute heart failure and an ejection fraction of 30%. Planning endomyocardial biopsy for lupus myocarditis and added hydroxychloroquine.

**Discussion:** We decided to pursue biopsy for broad differential of nephrotic syndrome in sickle cell disease and pneumonia. This case highlights unrelated conditions that occurred concurrently, with variable presentations.

**Serologic Workup**

Study	Result
Creatinine	1.13 mg/dL
Albumin	1.2 g/dL
Cryoglobulin	neg
Lupus anticoagulant	pos
ANA	1:640, homogeneous
Anti-dsDNA	290
C3/C4	71/19 mg/dL
Hep B/Hep C/HIV	neg
ANCA	neg
Anti-streptolysin ab	neg
Anti-PLA2R	neg

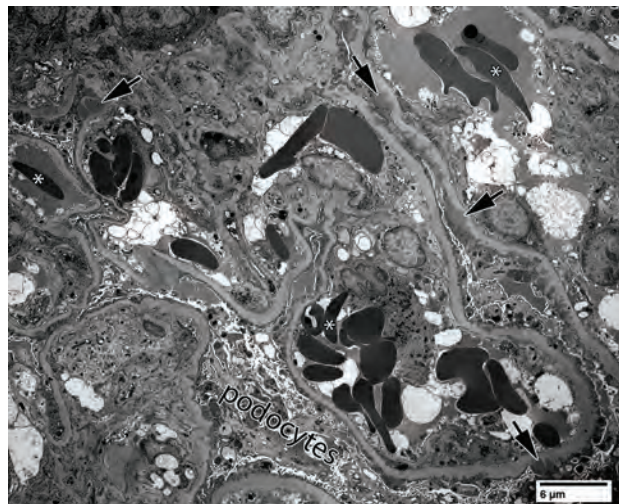

Subepithelial dense deposits (arrows), intracapillary RBCs with elongated sickles (asterisk)

**PUB205**

**IgM Nephropathy, a Rare Variant of Minimal Change Disease: A Case Report**

Dominic D. Archer,<sup>1</sup> Frederick Smith,<sup>2</sup> Monique N. Pratt,<sup>1</sup> <sup>1</sup>Rand Memorial Hospital, Freeport, Bahamas; <sup>2</sup>Princess Margaret Hospital, Nassau, Bahamas.

**Introduction:** Immunoglobulin M (IgM) Nephropathy is a rare presentation of nephrotic syndrome. IgM Nephropathy is an autoimmune disease and is immune complex mediated with deposition in the mesangium of the kidneys. The presentation is similar to minimal-change disease, and can present as acute renal failure in both children and adults. The objective of this clinical case is to highlight a successful treatment response of a patient with IgM Nephropathy with rituximab.

**Case Description:** A 28-year-old female diagnosed with minimal change disease in childhood who was maintained on steroids since childhood, had worsening proteinuria on 24-hour urine collection despite receiving higher doses of oral steroids in May 2019. A kidney biopsy was performed on July 2019, which revealed IgM 1+ segmental granular staining on immunofluorescent histology, and diffuse visceral epithelial cell foot processes effacement on electron microscopy. The patient was diagnosed with IgM nephropathy, a variant of minimal change disease. The patient was managed on prednisone 40mg po od and mycophenolate mofetil 1g po bd. On 24<sup>th</sup> February 2020 the patient had 7906.8mg/24-hr of proteinuria. In July 2020 the patient had 2362mg/24-hr urine collection. The patient had some reduction in proteinuria, but the response was inadequate and remained steroid dependent. The patient was given one dose of rituximab 1-gram intravenous infusion, and a repeat 24-hour urine collection showed 803mg/24-hr in August 2020. Prednisone and mycophenolate mofetil were discontinued. The patient then received a second dose of rituximab 1-gram intravenous infusion in November 2020, and a repeat 24-hr urine collection showed 450mg. On subsequent visit the patient was noted to have normal levels of proteinuria of 140mg/24-hr in February 2021. The patient is no longer steroid dependent and is maintaining normal levels of proteinuria.

**Discussion:** The use of rituximab in patients with inadequate response to steroids, cyclophosphamide and mycophenolate mofetil may be beneficial.

## PUB206

**Systemic Lupus Erythematosus and Anti-Neutrophil Cytoplasmic Antibody-Associated Vasculitis Overlap Syndrome vs. Drug-Induced Autoimmune Disease: A Diagnostic Challenge**

Lindsay Richels, Dorothy Thomas. *University of Saskatchewan, Regina, SK, Canada.*

**Introduction:** Autoimmune conditions with renal involvement often have a wide range of clinical symptoms and laboratory findings suggestive of more than one autoimmune disease. Therefore, antibodies and clinical features play a significant role in guiding the initial treatment choices of clinicians, especially when patients present acutely.

**Case Description:** A 79-year-old female presented to the emergency department with worsening shortness of breath and fatigue. Laboratory results showed a serum creatinine of 213  $\mu\text{mol/L}$  (baseline 90  $\mu\text{mol/L}$ ). Urine analysis showed 3+ blood and +2 protein. ANA was positive with a titre of 1:2560, C3 was low at 0.52, C4 was low at 0.13, anti-double-stranded DNA (dsDNA) was positive 48.2. Further autoimmune workup revealed positive anti-SSA and anti-SSB, positive ANCA with a perinuclear pattern and elevated anti-MPO antibody (>200); Histone Ab was elevated with a ratio of 1.2. Bronchoscopy showed diffuse alveolar hemorrhage. Past medical history included resistant hypertension, and, two years prior, the patient had been started on hydralazine with increasing doses. The patient denied any history of rashes, arthritis, myalgias or family history of autoimmune disease. Hydralazine was discontinued and the patient was pulsed with corticosteroids. She was then transitioned to oral prednisone and mycophenolate mofetil with improvements in renal function. Hydroxychloroquine was later added and the patient's urine analysis normalized.

**Discussion:** Hydralazine-induced ANCA vasculitis is reported in the literature and can be associated with elevated ANCA MPO-antibodies and positive dsDNA, ANA and anti-histone antibodies. We present a patient of advanced age who was thought to have lupus nephritis as an initial presentation of systemic lupus erythematosus or SLE/AAV overlap syndrome. Still, given her advanced age, clinical presentation, positive antibodies, and recent hydralazine use, the diagnosis of hydralazine-induced ANCA vasculitis was also considered a likely diagnosis. Without renal biopsy it is difficult to say with complete certainty the exact renal pathology however, treatment response with immunosuppression was achieved and despite using less aggressive treatments the patient expired secondary to infectious complications.

## PUB207

**It's Probably the Lupus: A Case of Secondary Thrombotic Microangiopathy**

Victor D. Hoang, David N. Dado. *Keesler Air Force Base, Keesler AFB, MS.*

**Introduction:** Thrombotic microangiopathy (TMA) is a group of rare disorders characterized by thrombocytopenia, hemolytic anemia, and microvascular thrombi leading to end-organ damage. Secondary TMA occurs in response to an underlying trigger such as infection, connective tissue disease, or medications. Most secondary cases occur via unclear mechanisms, however kidney biopsy can assist in diagnosis.

**Case Description:** A 28-year-old female with history of systemic lupus erythematosus with class V lupus nephritis presented with a 2 month history of worsening bilateral lower extremity weakness. She had unremarkable brain and whole spine imaging. The patient was hemodynamically stable, with no focal neurologic deficits on exam. Her labs were notable for Cr 1.8, Hgb/Hct 7.1/22.8, and Plt 9. Her peripheral blood smear was notable for a significant number of schistocytes per high-power field. An apheresis catheter was urgently placed for plasma exchange, and the patient was scheduled to receive methylprednisolone daily. Additional labs were ordered to include ADAMTS13 level, HIV, hepatitis panel, coagulation factors, and urine pregnancy test. Initial labs resulted: C3 50, C4 3, ESR 13, CRP 0.2, haptoglobin <10, LDH 2286, dsDNA 1, INR 0.8, fibrinogen 212, and reticulocyte index 11.9%. This prompted additional workup with atypical hemolytic uremic syndrome genetic panel and renal biopsy. Preliminary renal biopsy demonstrated class V lupus nephritis with mild class III features, and evidence of thrombotic microangiopathy. After discussion with Rheumatology, Hematology, and Nephrology, the patient was diagnosed with secondary TMA from lupus flare. She was discharged to complete rituximab infusions weekly for 4 weeks.

**Discussion:** This case demonstrates the difficulty in distinguishing between primary and secondary TMA syndromes, and the urgency required to manage these patients. In this case, kidney biopsy was critical in determining the management plan for this patient, confirming secondary TMA.

## PUB208

**A Case of Crescentic C3 Glomerulonephritis in a 24-Year-Old Male: A Rare Entity**

Venkata Kishore R. Mukku, Tina Kochar, Shancy Jacob, Syed A. Hussain. *The University of Texas Medical Branch at Galveston, Galveston, TX.*

**Introduction:** C3 glomerulopathy (C3G) is a clinicopathologic entity secondary to dysregulation of alternative complement pathway in plasma and glomerular microenvironment. C3 glomerulopathies are uncommon forms of glomerulonephritis (GN) characterized by substantial risk of progression to end stage renal disease.

**Case Description:** 24-year-old male with history of hypothyroidism presented to clinic with throat infection and was treated with amoxicillin. Lab work showed worsening renal function and admitted for further work-up which showed negative serologies for Hepatitis B, C, HIV, ANA, ANCA, Anti-ds DNA, cryoglobulin, anti-GBM antibody and complements. Urinalysis revealed microscopic hematuria and random urine protein was 1.3g/g. Patient was initiated on dialysis for worsening renal function and oliguria. He was started on solumedrol and underwent renal biopsy which showed diffuse crescentic glomerulonephritis (GN) on light microscopy. There were 28 glomeruli, 7 of which were globally sclerotic. 15 glomeruli show cellular crescents, 3 of which showed fibrinoid necrosis. There was mild interstitial fibrosis and tubular atrophy. Mesangial and rare subepithelial electron dense deposits were seen on electron microscopy. Immunofluorescence revealed, 1-2 + granular mesangial end glomerular capillary wall positivity for C3 with trace IgM and C4d. These findings are consistent with crescentic C3 GN in the absence of bacterial infection. Patient was started on mycophenolate, steroids and was referred for out-patient genetic testing.

**Discussion:** The spectrum of clinical manifestations in C3G is wide, from incidental asymptomatic microscopic hematuria to rapidly progressive forms leading to kidney failure. However, most common presentation in clinical setting is proteinuria with preserved kidney function. When the disease is diagnosed in adults, presence of monoclonal gammopathy must be ruled out. Serum C3 hypocomplementemia is a characteristic feature of C3G, although not strictly necessary for the diagnosis. The clinical manifestations of C3G may be preceded by an infection. Hence, a differential diagnosis considering postinfectious GN is mandatory. The therapeutic alternatives available at present can be classified as supportive therapy with angiotensin converting enzyme inhibitors, immunosuppression with steroids, mycophenolate, and anticomplement therapy with eculizumab.

## PUB209

**Lupus Nephritis With Thrombotic Microangiopathy Resistant to Immunosuppression**

Frida Margarita de la Vega Méndez,<sup>1,2</sup> Ana E. Oliva,<sup>1,2</sup> Clementina Elizabeth Calderon Garcia,<sup>1,2</sup> Alexa N. Oseguera Gonzalez,<sup>1,2</sup> Miguel Ángel P. Venegas,<sup>1,2</sup> Jonathan Chavez,<sup>1,2</sup> Maria de la luz Alcantar Vallin,<sup>1,2</sup> Ramon Medina.<sup>1,2</sup> <sup>1</sup>*Universidad de Guadalajara, Guadalajara, Mexico;* <sup>2</sup>*Hospital Civil de Guadalajara Unidad Hospitalaria Fray Antonio Alcalde, Guadalajara, Mexico.*

**Introduction:** LN can be complicated by vascular conditions and hematological disorders patients with thrombotic microangiopathy show a greater severity and worse prognosis

**Case Description:** A 16-year-old woman with SLE treated with a 6 monthly cycles of cyclophosphamide prednisone and chloroquine At the onset of SLE she presented serum creatinine levels of 0.8 She was admitted into our emergency unit due to nausea In her clinical examination she was found 152/98 mmHg, HR of 90 RR of 18 generalized pallor facial and limb edema hemoglobin 4.9 g/dl leukocytes 9.24 thrombocytopenia of 73.25 urea 205.8 mg/dl creatinine 12.39 phosphate 11.4 mg/dl calcium 8 mg/dl potassium 6.4 mmol/l sodium 134 mmol/l LDH 826 U/L 24-hour urine protein 1.87 grams complement test for HBsAg positive serum smear with schistocytes 3 per field haptoglobin 10.1 and a negative ADAMTS13 and shiga toxin test Hemodialysis was started as well as bolus of methylprednisolone for 3 days renal biopsy was performed which showed diffuse LN IV and the presence of thrombi The patient presented a partial clinical improvement however bicytopenia worsens and mycophenolic acid was started with any hematological improvement and persistent schistocytes so we decided to restart methylprednisolone Due to the presence of hepatitis B and TMA not responding to the initial immunotherapy it was decided to start prophylaxis with tenofovir/emtricitabine and an initial dose of rituximab This revealed clinical and hematological improvement

**Discussion:** This case represented a clinical challenge because the patient presented resistance to the initial treatment A treatment with rituximab was considered however the patient became diagnosed with chronic hepatitis B which made it even more difficult to decide the treatment since the risk of reactivation is high using monoclonal antibodies It was also difficult to determine if the affection to the kidney was due mainly to LN or to the presence of TMA or to know whether renal functions could be recovered with immunosuppressive treatment In those patients with LN and TMA the treatment is not clearly defined patients with TMA and LN have a worse renal prognosis than those with only LN Thus determining which would be the best treatment for them is highly relevant

## PUB210

**High Chronicity Index of the Modified National Institutes of Health Scoring System of Lupus Nephritis Is Associated With Increased Risk of ESKD: A Retrospective Single-Center Study**

Shiori Nakagawa, Yasunori Iwata, Tadashi Toyama, Megumi Oshima, Hisayuki Ogura, Taro Miyagawa, Shinji Kitajima, Akinori Hara, Norihiko Sakai, Miho Shimizu, Takashi Wada. *Kanazawa University Hospital, Department of nephrology Kanazawa Daigaku, Kanazawa, Japan.*

**Background:** Lupus nephritis (LN) is a major manifestation which develops in more than 50% of patients with systemic lupus erythematosus, and is also a risk factor for morbidity and mortality in these patients. The revision of International Society of Nephrology/Renal Pathology Society (ISN/RPS) classification for LN was suggested by a working group, who recommended a modified National Institute of Health (NIH) activity and chronicity scoring system to evaluate active and chronic LN lesions. However, whether this approach was useful for estimating prognosis for LN patients is unclear.

Key: TH - Thursday; FR - Friday; SA - Saturday; OR - Oral; PO - Poster; PUB - Publication Only

Underline represents presenting author.

**Methods:** We conducted a retrospective cohort study in Japanese subjects with biopsy-proven LN, between 1977 and 2022. Pathologic lesions were evaluated based on ISN/RPS 2003 classification and the modified NIH scoring system. Patients were grouped by activity index (low, 0–5; moderate, 6–11; high, 12–24), and chronicity index (low, 0–2; moderate, 3–5; high, 6–12). The primary outcome was a composite of end-stage kidney disease (ESKD) or all-cause death, and the secondary outcome was ESKD.

**Results:** Seventy subjects with a median age of 31 years were included. Median follow-up period was 11.3 years. For the activity index, Kaplan–Meier analysis showed that the survival rate of the primary outcome decreased with a higher activity index (log-rank trend  $p = 0.026$ ). Multivariable analysis, adjusted by age and serum creatinine, did not show any significant relationship to the activity index. For the chronicity index, Kaplan–Meier analysis showed that the survival rate of the primary outcome decreased with a higher chronicity index (log-rank trend  $p < 0.001$ ). Multivariable analysis revealed that moderate (HR 6.18, 95% CI 1.15 to 33.3;  $p = 0.034$ ) and high chronicity indices (HR 20.33, 95% CI 1.14 to 360.50;  $p = 0.04$ ) were significant risk factors for the primary outcome. Consistent results with the primary outcome were determined by Kaplan–Meier and univariable analysis for the secondary outcome.

**Conclusions:** Moderate and high chronicity indices were associated with an increased ESKD risk for LN. This modified NIH scoring system may help physicians predict long-term prognosis for patients with LN.

## PUB211

### Concurrent Anti-Neutrophil Cytoplasmic Antibody Associated Vasculitis and Anti-Glomerular Basement Membrane Disease

Emma Greear,<sup>1,2</sup> Jahanzeb Saeed,<sup>1,2</sup> Justin A. Amato,<sup>1,2</sup> Jeff S. Croteau,<sup>1,2</sup> Carl S. Henderson,<sup>1,2</sup> Adegbenga Bankole,<sup>1,2</sup> <sup>1</sup>Carilion Clinic, Roanoke, VA; <sup>2</sup>Virginia Tech Carilion School of Medicine, Roanoke, VA.

**Introduction:** Many diseases, infections and medications plague the kidneys. However, the likelihood of having two uncommon disease processes simultaneously affecting the kidneys is quite rare.

**Case Description:** A 79-year-old woman with upper airway limited anti-neutrophil cytoplasmic antibody (ANCA) associated vasculitis (AAV) noted worsening fatigue. Laboratory testing revealed a new increase in serum creatinine, elevated inflammatory markers, and proteinuria. The patient had historically been on Rituximab for maintenance AAV therapy but developed an allergy. The patient was then placed on methotrexate, but this was stopped due to postoperative wound healing complications following an abdominal surgery. She had been off all AAV therapies for 1 year when her renal function began to decline. She was admitted to the hospital due to acute renal failure and concern for relapse of AAV. While hospitalized the patient was treated with intra-venous pulse dose methylprednisolone, Plasma Exchange (PE), and cyclophosphamide. Serum anti-glomerular basement membrane (anti-GBM) antibody and proteinase 3 (PR3) antibody testing was positive. A renal biopsy confirmed anti-GBM and PR3 ANCA associated crescentic glomerulonephritis. Despite aggressive treatment the patient's renal function did not recover and hemodialysis was initiated.

**Discussion:** Guidelines created by the American College of Rheumatology (ACR) and Kidney Disease Improving Global Outcomes (KDIGO) discuss treatment of AAV and anti-GBM disease. The AAV guideline created by ACR recommends against the use of PE in patients with AAV with one caveat. The role of PE is still recognized by the ACR in those patients with both diseases. KDIGO also recommends PE in this patient population. No direct statements are made to guide the initial therapy beyond PE in this group of patients. Therefore, the treatment of this patient subgroup must be individualized and based upon evidence used to guide the treatment of the two distinct diseases. Here in this case, we will explore the management of this unique subgroup of patients.

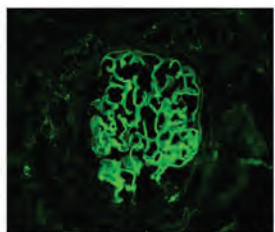

Linear glomerular basement membrane IgG

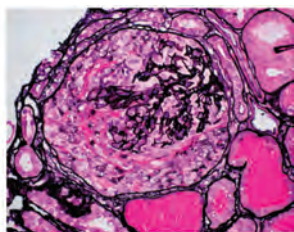

Cellular crescent

Renal Biopsy

## PUB212

### Cannabinoids May Be a Trigger or a Stop of Glomerular and Podocyte Injury From Parvovirus B-19 Infection

Hussein A. Hussein, CLS Nephrology CLS Health, Webster, TX.

**Introduction:** Cannabinoids are widely distributed recreational substances and young patients with chronic epilepsy tend to use the substance even though harmful side effects such as acute tubular necrosis (ATN) and acute interstitial nephritis (AIN) have been reported. This is a rare case of glomerulopodocytopathy that might be triggered by Cannabinoids to raise awareness among clinicians and to emphasize on the need for patient education concerning the deleterious side effect of these substances.

**Case Description:** A 21 years-old African American male was brought to the emergency room with seizure disorder and hypertension. Initial lab results showed a creatinine kinase of 233, serum creatinine of 1.13 mg/dL, it peaked at 7.6 in 72 hours.

Upon nephrology consultation, obstructive nephropathy was ruled out. His renal ultrasound showed severe echogenicity. Urine microscopy showed granular cast with no WBC or RBC casts. His urine protein creatinine ratio was 1.3 gm. A physical examination showed mild lower extremity edema, he denies NSAIDs use. Serology for ANA, Anti dsDNA, Anti Smith Ab, ANCA, COVID-19, HIV, HCV. Serology for Parvovirus B-19 (IgG) was positive while IgM was negative, APOL1 gene wasn't done due to lost follow up. 3 months earlier creatinine was 0.9 mg/dL, at time he was admitted for respiratory illness treated with steroid and antibiotics. Pathology revealed collapsing glomerulopathy in 4/22 glomeruli, no interstitial fibrosis and tubular atrophy and mild arterio- and arteriolosclerosis. His renal function responded well to pulsed steroids. He was maintained on 1 mg/kg daily prednisone taper, and his creatinine started trending down, while the edema resolved and the blood pressure normalized. The patient was discharged with nearly normal creatinine and a urine protein to creatinine ratio of 0.3.

**Discussion:** Cannabinoids induced AKI with ATN or AIN are common. The renal injury related to delta-9-tetrahydrocannabinol (active ingredient in marijuana). The cannabinoid might trigger glomerulopathy and podocytopathy due to underlying viral illness could need further investigations, or it can be a protective substance for the glomerulus. Being vigilant with a high index of suspicions to any rapid progression of GN with a decline of renal functions, in order to take immediate actions with a diagnostic biopsy; prompting treatment to reverse salvaged renal functions.

## PUB213

### IgA Nephropathy as a Potential Complication of SARS-CoV-2 Vaccination

Olusola Sogbein, Tina Kocher. *The University of Texas Medical Branch at Galveston, Galveston, TX.*

**Introduction:** Vaccination against COVID-19 is essential, however an immunological flare is a potential rare complication resulting in glomerulonephritis with IgA deposits in the mesangium. We present a case of a patient who developed IgA nephropathy post-vaccination.

**Case Description:** 48-year-old woman with a past medical history of Leukocytoclastic vasculitis and hypertension presented to the Emergency Department with fatigue, nausea, epigastric pain, foamy urine and a diffuse erythematous purpuric rash within days of receiving the SARS CoV-2 vaccination. Her creatinine was 1.92 mg/dL and urinalysis showed 3+ blood and 30 mg/dL of protein. COVID-19 testing was negative. Protein/creatinine ratio was 2.1 g/g and urine microscopy showed dysmorphic red blood cells. Serologies for HIV, Hepatitis B and C were negative. Further testing revealed negative ANA, normal ASO titer, absent cryoglobulins, rheumatoid factor < 20, C3 158 (nl) and C4 35 (nl). However, IgA level was elevated at 462 mg/dL (reference 70-312 mg/dL). Patient was started on prednisone at a dose of 1mg/kg with a presumptive diagnosis of IgA vasculitis/HSP. Subsequent skin biopsy was consistent with leukocytoclastic vasculitis while kidney biopsy showed glomerular deposition of IgA and endocapillary hypercellularity. At one month follow-up with nephrology, prednisone taper was started because of good clinical response and partial remission with UPCR reduction to 1 g/g. Prednisone was gradually tapered over the next 2 months. At her 3 month follow-up she was found to be in complete remission with a UPCR 0.2 g/g and her creatinine was 0.83 mg/dL.

**Discussion:** We present a case of IgA nephropathy post-SARS CoV-2 mRNA vaccination. It has been speculated that the mRNA lipid nanoparticle-encapsulated platform contained within the mRNA vaccine produces such a robust CD4 and CD8 T-cell response that pro-inflammatory cytokines activate this immune complex associated glomerular disease. In conclusion, SARS CoV-2 vaccination may potentially trigger IgA nephropathy in predisposed patients. Steroid therapy may be efficacious in managing this rare complication.

## PUB214

### Progression of Proteinuria and Renal Insufficiency in Two Patients With Inflammatory Bowel Disease: Does Fecal Microbiota Transplantation Matter?

Ping Wen, Jie Zhang, Jining Wu, Yi Fang, Weichun He, Junwei Yang. *Second Affiliated Hospital of Nanjing Medical University, Nanjing, China.*

**Introduction:** Inflammatory bowel disease (IBD), including Crohn's disease (CD) and ulcerative colitis (UC), is a chronic, immune-related, progressive disease. Numerous extraintestinal manifestations occur in IBD, including lesions of the skin, hepatobiliary and renal complications. Proteinuria and/or hematuria is the main manifestation of kidney injury.

**Case Description:** Patient A: A 46-year-old Asia male with history of CD (6 years) presented with proteinuria, hematuria, and elevated serum creatinine. After several flares of CD, the patient received fecal microbiota transplantation (FMT). The patient developed proteinuria (2.3g/d), hematuria and renal insufficiency (eGFR 56.4ml/min/1.73m<sup>2</sup>) 5 years after the CD. The pathological diagnosis is IgA nephropathy (IgAN), mild to moderate mesangial proliferation with global abandon (9/27), segmental abandon (4/27) and crescent formation (3/27). Patient B: A 46-year-old Asia male with history of CD (7 years) presented with proteinuria and hematuria. Different from patient A, patient B manifested proteinuria and hematuria at the onset of CD but the kidney function was normal. The patient also received FMT for several times. In emergency department, he was dyspnea and chest tightness. Lab was notable for anemia, renal insufficiency, heart failure, and hyperkalemia. Hemodialysis was performed to improve heart failure, acidosis, and hyperkalemia. Because of the poor heart function, kidney biopsy was not performed.

Key: TH - Thursday; FR - Friday; SA - Saturday; OR - Oral; PO - Poster; PUB - Publication Only

Underline represents presenting author.



**Discussion:** The common features of two patients were proteinuria, hematuria, and renal insufficiency. However, the appearances of kidney injury were at different stages of CD. The pathological feature of kidney was IgAN, indicating IgA may play a crucial role. Increased small intestinal mucosal permeability during disease progression has been demonstrated in IgAN, and the intestinal mucosa is one possible source of IgA in IgAN. Another common point of two patients was fecal bacteria transplantation. Whether fecal microbiota can act as an antigen to trigger immune response is unknown. Previous studies have demonstrated peptides from bacteria can activate CD4+ T cells or B cells to produce autoantibodies. Different flora may play opposite effects in gut immune, therefore induce kidney injury.

## PUB215

### A Case of Renal Amyloidosis (AD) Presented as Orthostatic Hypotension

Rula A. Abdulrahman, Stony Brook University, Stony Brook, NY.

**Introduction:** Neurogenic hypotension can happen in the context of immunoglobulin light chain AD. The most serious feature is autonomic nervous system impairment, mainly characterized by severe refractory orthostatic hypotension. Amyloid deposition may be found in many organs and the patient can present with cardiac, gastrointestinal, renal, and neurological symptoms, but rarely hypotension only. Here we describing a patient who presented with severe orthostatic hypotension, found to have renal AD.

**Case Description:** 67 year old male with past medical history of type 2 diabetes, chronic kidney disease, coronary artery disease, colon cancer, and history of COVID-19 infection who presents to nephrology clinic after being referred by primary care provider for elevated Creatinine to 2.5 mg/dl (baseline around 1.2 mg/dl), on clinic visit found to have severe orthostatic hypotension. blood pressure (BP) supine 121/80 mmHg, heart rate (HR) 87 beat per minute (BPM) ; sitting 106/70 mmHg, HR-92 BPM; standing: 92/59 mmHg, HR-100 BPM, no other abnormalities on physical examination. and was admitted to the hospital for evaluation. upon admission to the hospital, patient received IV fluid, found to have 11 gram protein on 24 hour urine collection laboratory work up showed positive ANA, immunofixation was positive for lambda chain. Fat pad biopsy without signs of AD. Bone marrow biopsy results were inconclusive. Renal biopsy was performed, findings consistent with AL AD. patient to start treatment with hematology

**Discussion:** The amyloidoses are a group of disorders in which soluble proteins deposit extracellularly in tissues as insoluble fibrils, causing organ dysfunction that is usually progressive. Renal amyloid is a major source of morbidity in affected individuals. When the kidney is involved, renal insufficiency is common, accounting for 47% of cases in a study. Proteinuria has been reported with full nephrotic syndrome in 25–68%. it usually progress to end stage renal disease if left untreated. in our case we are describing an unusual presentation of renal AD, in which the symptoms were orthostatic hypotension. renal function was below baseline but was improving with volume replacement, patient was felt to have prerenal acute kidney injury. the significant amount of proteinuria prompted further testing. We feel that nephrotic syndrome from amyloid should be considered when patient presented with orthostatic hypotension.

## PUB216

### A Rare Case of Class 4 Lupus Nephritis Presenting With Type 4 RTA

Tram Dao, Shubha Ananthakrishnan, Niti Madan. *University of California Davis Department of Internal Medicine, Sacramento, CA.*

**Introduction:** Renal tubular acidosis is sometimes seen in patients with lupus nephritis. A recent study of a large systemic lupus erythematosus patient population demonstrates that about 16% of the group had RTA. The most common type seen is type 1 RTA. However, there have been less than 10 cases reported of type 4 RTA associated with lupus nephritis. It is thought that type 4 RTA is an indication for a more aggressive form of SLE, with wider tubular damage caused by severe lupus nephritis.

**Case Description:** We present a 30 year old female with history of cutaneous systemic lupus erythematosus who presented to the emergency department for abnormal lab values. She was found have nephrotic range proteinuria and acute kidney injury. Patient only reports acute periorbital swelling and ongoing hair thinning. Admission labs were notable for potassium 6.8 mmol/L, carbon dioxide 21 mmol/L, anion gap of 5 mEq/L, urea nitrogen 17 mg/dL, and creatinine 1.55 mg/dL. Urine studies shows a spot protein to creatinine ratio of 4,444 mg/g. Urine microscopy showed numerous white blood cells, white blood cell clumps, and scattered renal tubular epithelial cells; no red blood cells were noted. Urine anion gap was positive at 47 mEq/L. Renal biopsy showed diffuse class 4 lupus nephritis with moderate activity and no significant chronicity, membranous class 5 lupus nephritis, and moderate interstitial inflammation. Type 4 RTA was also diagnosed and confirmed with renin level < 0.1 ng/mL/hr, and aldosterone level < 3 ng/dL. Patient was started on steroids and mycophenolate for her lupus nephritis. The patient's renal function then improved with improvement of hyperkalemia, she was then transitioned off of sodium zirconium cyclosilicate.

**Discussion:** It's important for providers to keep type 4 RTA in mind when hyperkalemia is detected in their SLE patients. Often times, the use of ACE inhibitors can mask the RTA association and delay diagnosis. Treatment includes addressing the underlying autoimmune disease with steroids, immunosuppressive therapy, as well as loop diuretics and fludrocortisone to address the RTA.

## PUB217

### Myeloperoxidase-ANCA-Positive Granulomatosis with Polyangiitis with Severe Renal Dysfunction: A Case Report

Brian Bustos, Soo H. Kae, Pooja Shekar, Eduardo M. Padrao. *University of Connecticut School of Medicine, Farmington, CT.*

**Introduction:** Granulomatosis with polyangiitis (GPA) is associated with antineutrophil cytoplasmic antibody (ANCA) and rarely, myeloperoxidase (MPO). In previous studies, MPO-ANCA-positive GPA frequently has had limited disease without severe organ involvement and less of a need for aggressive immunosuppressive therapy.

**Case Description:** 59-year-old male with a history of hypertension presented to the hospital due to 10 days of nausea and vomiting. Two months prior, he developed fatigue, malaise, and ear pain. Outpatient lab work at the time was unremarkable. In the emergency department, lab work was significant for creatinine of 20.0 mg/dL (baseline 0.86 mg/dL one month prior), BUN 224 mg/dL, erythrocyte sedimentation rate of greater than 129 mm/h, c-reactive protein of 15.86 mg/L, and ferritin of 3,388 ng/mL. A Foley catheter was placed and the patient produced only about 40 cc of urine. Urinalysis demonstrated moderate protein and 3 red blood cells per high-power field. Ultrasound and computed tomography of the abdomen showed no obstructive renal pathology, however noted increased parenchymal echogenicity. A dialysis catheter was placed and he underwent hemodialysis. Further lab work was notable for positive double-stranded DNA, p-ANCA, and MPO, however a negative PR3 antibody. Renal biopsy revealed focal necrotizing and crescentic glomerulonephritis, granulomatous interstitial inflammation, and multifocal necrotizing arteritis and arteriolitis. He was diagnosed with acute oliguric renal failure secondary to MPO-ANCA-positive GPA. He underwent five sessions of plasmapheresis, managed with steroids, and was subsequently started on Cyclophosphamide following improvement in renal function.

**Discussion:** GPA may have renal involvement, and glomerulonephritis has been seen to develop in 77-85 percent of patients. MPO-ANCA-positive GPA is rare, and MPO positivity is usually associated with microscopic polyangiitis (MPA). Additionally, in previous studies, it was seen that MPO-ANCA-positive GPA frequently had limited disease without severe organ involvement and also a lesser need for aggressive immunosuppressive therapy. This particular case is unique such that our patient was MPO-ANCA positive, while developing severe renal involvement. Moreover, he eventually required immunosuppressive therapy with steroids and cyclophosphamide.

## PUB218

### Focal Proliferative Glomerulonephritis, IgA and C3 Predominant

Marwa Alithawi,<sup>1</sup> Tina Sharma,<sup>1,3</sup> Bassam Alkamachi,<sup>2</sup> <sup>1</sup>Pontiac General Hospital, Pontiac, MI; <sup>2</sup>Henry Ford Hospital, Detroit, MI; <sup>3</sup>St. Martinus University Faculty of Medicine, Willemstad, Curaçao.

**Introduction:** Glomerulonephritis (GN) is classified into five groups: immune complex-mediated GN, antineutrophil cytoplasmic antibody-associated GN, anti-glomerular basement membrane GN, monoclonal immunoglobulin-mediated GN and C3 glomerulopathy[1,2]. Distinguishing between the subtypes is based on factors such as the clinical presentation, comorbidities, labs and the histopathology of the renal biopsy.

**Case Description:** A 66-year-old male with a past medical history of Chronic Obstructive Pulmonary Disease, hyperlipidemia, Diabetes mellitus type II and schizoaffective disorder was found to have abnormal kidney function, hematuria and proteinuria. He presented with a new onset cough, shortness of breath, diarrhea and vomiting. For the past 25 years, he smoked 10 cigarettes a day and denied recreational drug use. Physical examination revealed reduced air entry and coarse crackles in the right middle and lower lobes of the lung. Labs showed a serum Creatinine of 8.1 mg/dL and an estimated glomerular filtration rate (eGFR) of 7 mL/min. Chest X-Ray showed streaky densities in the right middle and lower lobes of the lung. Retroperitoneal ultrasound of the kidneys showed normal kidney size bilaterally and the CT scan of the abdomen and pelvis was within normal limits. Further workup ruled out paraproteinemias, systemic lupus erythematosus, vasculitis, pauci-immune disorders and Goodpasture syndrome. The kidney biopsy revealed focal proliferative glomerulonephritis with IgA, C3 and lambda chain deposition within the glomerulus. If IgA nephropathy, then it would correspond to Oxford classification of M1 E1 S1 T1 C1 – one small cellular crescent.

**Discussion:** Extensive workup failed to identify the cause of the acute deterioration in kidney function. The clinical course did not align with histopathology leading to the management and prognosis to be challenging. Though no official diagnosis was made, a thorough review was done of the differentials: Rapidly Progressive GN, Primary versus Secondary IgA Nephropathy, and Postinfectious GN. The most plausible diagnosis is IgA-Dominant or codominant postinfectious GN. It is important to know the details and the difference between the subtypes of glomerulonephritis to manage the various aspects of the patient's health such as assessing risk factors, associated comorbidities, clinical management, medication adjustments, follow up work up, complications and prognosis.

## PUB219

### Floats Like a Butterfly, Stings Like a Bee: Lupus Nephritis

Krvstahl Z. Andujar-Rivera,<sup>1,2</sup> Ileana E. Ocasio Melendez,<sup>1</sup> Jesus D. Vega-Colon,<sup>1</sup> Maria E. Rivera,<sup>1</sup> Alexis Rivera Gonzalez,<sup>1</sup> Jose D. Ortiz Rosario.<sup>2</sup> <sup>1</sup>Universidad de Puerto Rico Recinto de Ciencias Medicas, San Juan, Puerto Rico; <sup>2</sup>Doctors' Hospital of San Fernando de la Carolina, Carolina, Puerto Rico.

**Introduction:** Lupus nephritis (LN) is a severe complication of Systemic Lupus Erythematosus (SLE) that has a broad spectrum of clinical and pathologic features with various prognoses according to its stage. A kidney biopsy contributes in terms of diagnosis, prognosis and management.

Key: TH - Thursday; FR - Friday; SA - Saturday; OR - Oral; PO - Poster; PUB - Publication Only

Underline represents presenting author.

**Case Description:** A 28-year-old woman with SLE presents to the emergency department due to progressive swelling of lower extremities associated with facial swelling and periorbital edema. She was on therapy with mycophenolate mofetil, hydroxychloroquine and prednisone 60 mg/day. Physical examination was notable for lower extremity pitting edema up to thighs and decreased breath sounds. Found to have oliguric AKI with SCr of 3.0 mg/dL (baseline Cr 0.6 mg/dL), low C3/C4 levels, elevated anti-dsDNA antibodies. Hepatitis B, Hepatitis C and HIV serologies were negative. UPCr revealed 13,000 mg/g of proteinuria (1,400 mg/g 2 months prior). Urine sediment was active with evidence of acanthocytes. A kidney biopsy was performed which revealed lupus nephritis class IV and V. Intravenous pulse methylprednisolone was initiated 1,000 mg for 3 days and IV cyclophosphamide as recommended by rheumatology specialist. Mycophenolate mofetil was continued. Despite aggressive immunosuppressive treatment, kidney function continued to deteriorate, and she was started on kidney replacement therapy.

**Discussion:** Treatment of lupus nephritis is as multisystemic and complex as the disease itself. Class V lupus can occur in combination with class III or IV, as in our patient. In some studies, patients with combined diffuse LN and lupus membranous nephropathy have worse outcomes than those with diffuse disease only. In a review, it was documented that the risk of ESKD in lupus nephritis increased in the late 2000s after a decrease in the 1970s and mid-1990s. Recently, new research has demonstrated improved outcomes in lupus nephritis with novel therapy like Belimumab and Voclosporin. Development of novel therapies is exciting however given the risk for kidney loss and increased risk for ESKD, it is imperative that treatments for lupus nephritis be both accessible and effective for our patients.

## PUB220

### Simultaneous Presentation of ANCA-Associated Pauci-Immune Crescentic Glomerulonephritis and Systemic Lupus Erythematosus

Manuel Arizaga Napoles, Guadalupe Montserrat Ochoa De Leon, Maria de la Luz Alcantar Vallin, Ramon Medina, José David G. Barajas, Juan Gómez Fregoso, Jonathan Chavez. *Hospital Civil de Guadalajara, Guadalajara, Mexico.*

**Introduction:** The presence of vasculitis may be found in the course of Systemic lupus erythematosus (SLE) but rarely corresponds to an ANCA-associated vasculitis (AAV) furthermore antineutrophil cytoplasmic antibodies (ANCA) positivity can be present in patients with SLE and may be related with a poor prognosis however the clinical expression of an AAV is extremely uncommon. We report a case of a young man fulfilling the criteria for SLE who develop a Rapidly progressive glomerulonephritis (RPGN) and the findings on the kidney biopsy corresponds to a Pauci-immune crescentic glomerulonephritis (PICGN)

**Case Description:** Patient with history of hypertension diagnosed 1 year earlier and previous hospitalization six months ago for an episode of venous thrombosis. Begin oral anticoagulation and was discharged with an estimated glomerular filtration rate (eGFR) of 76ml/min/1.73m<sup>2</sup>. It was referred to our unit for a decline of 50% in eGFR and glomerular hematuria. In physical exam we found arthritis and peripheral edema. We approach this case by performing levels of complements both were found low. In the setting of RPGN and low complements. We order antinuclear antibodies that resulted positive 1:1,280 with a fine speckled pattern. By this point the patient fulfilled the ACR/EULAR 2019 criteria for SLE. We carry out a kidney biopsy that concluded necrotizing proliferative extracapillary pauciimmune glomerulonephritis, with granulomas without eosinophilic infiltration. Tubulointerstitial nephritis and arteriolar fibrosis were also found. Due to this findings ANCA were perform anti-myeloperoxidase antibody was found positive 1:10 2+ on immunofluorescence and 1.35 in enzyme-linked immunoassay. The patient receive an induction therapy with methylprednisolone and cyclophosphamide. We achieve no progression in the necessity of renal replacement therapy but the eGFR remains on 35ml/min/1.73m<sup>2</sup> after induction therapy

**Discussion:** This case demonstrates that the presence of overlap between SLE and AAV is a rare but feasible entity. Although ANCA may be present in SLE they are typically not related with a clinical expression of the disease. As the seen in this case where the kidney biopsy findings are strongly associated with AAV

## PUB221

### A Case of ANCA Vasculitis and IgA Nephropathy in a Patient With Hematuria

Leanne Brown, Aditi Singh, Nickolas Coombs. *UConn Health, Farmington, CT.*

**Introduction:** Anti-neutrophil cytoplasmic antibody (ANCA)-associated vasculitis (AAV) represents a group of autoimmune small vessel diseases with a broad array of clinical manifestations. The pathologic hallmark of AAV glomerulonephritis (GN) is necrotizing and/or crescentic lesions without significant immune complex deposition. Co-existent IgA nephropathy and ANCA-associated crescentic glomerulonephritis represents the rare concurrence of two common forms of glomerulonephritis. We present a case of renal-limited antibody positive ANCA vasculitis with a background of IgA nephropathy.

**Case Description:** A 69 year-old-male with a history of chronic kidney disease, presented to the hospital for evaluation of painless hematuria and an acute kidney injury. Urinalysis was positive for proteinuria and hematuria with dysmorphic red cells seen on microscopy. He was subsequently found to have high titers of myeloperoxidase (MPO) positive ANCA antibodies and therefore started on empiric immunosuppressive therapy with high dose steroids. Renal biopsy demonstrated no crescentic lesions or fibrinoid changes to the glomeruli. Interestingly, IgA stain was positive with mesangial expansion without subendothelial or subepithelial deposits on electron microscopy. Due to worsening kidney function, and no response to steroid therapy, the patient was initiated

on vasculitis treatment protocol, with prednisone followed by cyclophosphamide. The result was improvement in serum creatinine and MPO-ANCA titers. He was continued on maintenance therapy with rituximab with clinical and biochemical remission achieved.

**Discussion:** Co-existent IgA nephropathy and ANCA-associated crescentic GN represents the rare concurrence of two common forms of GN with very few cases documented in literature. The pathogenesis, treatment and prognosis of this dual glomerulopathy is not well defined. However, as highlighted by this case, there is a favorable response to immunosuppressive therapy. Given the high mortality rate associated with AAV, prompt and adequate treatment is paramount. Adequate therapy requires an early diagnosis, but diagnosing AAV can be challenging, and is often made based on clinical features in combination with positive ANCA serology. Renal biopsy remains gold standard for diagnosis but should not delay initiating immunosuppressive therapy.

## PUB222

### Sudden Onset Hyperglycemic Hyperosmolar Syndrome due to Tacrolimus in a Patient With FSGS

Daniel J. Castro-Pereira. *Southwest Kidney Institute PLC, Tucson, AZ.*

**Introduction:** The initial treatment for primary focal segmental glomerulosclerosis (FSGS) includes glucocorticoids. Those with no reduction in proteinuria are considered glucocorticoid resistant and subsequent administration of another agent such as Tacrolimus is recommended. This is a case of sudden onset of hyperglycemic hyperosmolar syndrome (HHS) due to tacrolimus shortly after having started therapy.

**Case Description:** A 21-year-old Hispanic female was found to have hypertension and proteinuria. Work up revealed: total cholesterol 250 mg/dL, albumin 3.5 g/dL, creatinine (SCr) 0.9 mg/dL, hemoglobin A1c (HbA1c) 5.4% and urine protein/creatinine ratio 8,794 mg/g. Renal biopsy found FSGS, therefore the patient was initiated on prednisone. After 12 weeks of therapy and no reduction in proteinuria, the prednisone was tapered, and tacrolimus initiated. Within a few days the patient reported blurry vision and feeling dizzy. Blood tests revealed tacrolimus level of 2.3 ng/mL, glucose 493 mg/dL, SCr 1.99 mg/dL, carbon dioxide 20 mmol/L, triglycerides 2,866 mg/dL and HbA1c of 10.9%. She was admitted for treatment of HHS and Tacrolimus was stopped. Three months later her HbA1c was 5.4%.

**Discussion:** The risk of DM is well established with CNIs. Tacrolimus can reduce insulin secretion and contribute to insulin resistance. In the post-transplant population, Tacrolimus has been associated with a higher incidence of DM (16.6%) vs CSA (9.8%). In an analysis of the United States Renal Data System, data from primary renal transplant recipients who developed new onset DM following transplantation, found that over a 3-year posttransplant period, 58.3% developed at least one diabetic complication which included DKA in 8.1%, and HHS in 3.2%. There are multiple reports of patients who have developed DM due to the use of tacrolimus, when used as an immunosuppressant and preventative agent against organ rejection in patients that have presented with DKA or HHS. Although most of these cases have presented in patients with a kidney transplant, cases of liver, heart, lung, and bone marrow transplant have also been reported. There are also a small number of cases of sudden onset DKA in patients that have not received a solid organ nor a bone marrow transplant which is quite unusual. These cases include patients with polymyositis, interstitial pneumonia, aplastic anemia, lupus nephritis, FSGS and minimal change disease.

## PUB223

### Membranous Nephropathy Associated With Mantle Cell Lymphoma: A Case Report

Lauren Bernard,<sup>1,2</sup> Mohamed G. Atta,<sup>1</sup> John Sperati,<sup>1</sup> Celia P. Corona Villalobos,<sup>1</sup> Alan Y. Xu,<sup>1</sup> Avi Z. Rosenberg,<sup>1</sup> Steven Menez.<sup>1</sup> <sup>1</sup>*Johns Hopkins Medicine, Baltimore, MD;* <sup>2</sup>*Johns Hopkins University Bloomberg School of Public Health, Baltimore, MD.*

**Introduction:** The KDIGO 2021 Clinical Practice Guideline for the Management of Glomerular Diseases recommends age-appropriate cancer screening in patients with membranous nephropathy (MN). Computed tomography (CT) scanning of the chest, abdomen, and pelvis is typically not recommended in that screening paradigm. Here, we report a case of MN associated with mantle cell lymphoma diagnosed by pan-CT.

**Case Description:** A 63-year-old man with chronic untreated hepatitis B virus (HBV) developed fatigue, bilateral leg edema, nephrotic range proteinuria (15.8 g/24 hr), and microscopic hematuria (11-30 RBCs/hpf) over several weeks. Serological workup included normal or negative serum free light chain ratio, serum protein electrophoresis/immunofixation, C3/C4, ANA, ANCA, HIV, and HCV. Double-stranded DNA titer was borderline positive at 10 IU/mL (<10). HBV viral load was 37,000 copies/mL, and he was initiated on entecavir. Kidney biopsy was performed, with light microscopy showing mild focal mesangial hypercellularity. Immunofluorescence showed granular capillary wall and mesangial staining for IgG, IgA, IgM, C3, and C1q with ultrastructural confirmation of subepithelial electron dense deposits, consistent with MN. Staining was negative for PLA2R, NELL-1, and THSD7A. Age-appropriate screening for colon and prostate cancer was normal. A CT scan was then performed, revealing mediastinal, retroperitoneal, and superficial axillary lymphadenopathy. Lymph node biopsy established a diagnosis of mantle cell lymphoma. He was started on rituximab and bendamustine, achieving full remission. Proteinuria subsequently declined, with UPCr decreasing to 10.4, 4.6, and <1 g/g at 1, 3, and 6 months, respectively. While the patient received simultaneous treatment for his cancer and HBV, given his low-level viremia and PLA2R negativity, it was favored that his MN presentation was secondary to his lymphoma.

Key: TH - Thursday; FR - Friday; SA - Saturday; OR - Oral; PO - Poster; PUB - Publication Only

Underline represents presenting author.

**Discussion:** The association of malignancy with MN is well-established. The optimal approach, however, to excluding malignancy in patients with MN remains incomplete. Mantle cell lymphoma is associated with a spectrum of immune complex mediated kidney disease, including MN. This case supports more aggressive cancer screening in the evaluation of patients with glomerular disease of unknown origin.

**PUB224**

**Full-Blown Nephrotic Syndrome in a Fully Vaccinated Woman Following COVID-19 Infection**

*Alan Segal, Maine Medical Partners--Nephrology MaineHealth, Portland, ME.*

**Introduction:** There have been a few cases of nephrotic syndrome reported after vaccination for COVID-19. When GFR is well-preserved, the majority of these patients have Minimal Change Disease (MCD). Here, we present a case of full-blown nephrotic syndrome in a fully vaccinated woman developing 6 weeks after she had a COVID-19 infection

**Case Description:** A 66-year-old woman with a 6 year history of well-controlled type 2 DM but no history of retinopathy, proteinuria, or kidney disease received the Pfizer-BioNTech vaccine x 2 in April 2021 and Pfizer booster in October 2021. She had an exuberant local reaction each time she had a vaccine. In January 2022, she suffered a COVID-19 infection and about 6 weeks later, she noted the onset of peri-orbital edema followed by progressive leg edema. At the time of evaluation 5 weeks later, she had pitting edema to the abdomen and sacral edema. Overall, she gained 30 pounds of edema. She had not used any new medications including NSAIDs. Labs showed serum [albumin] of 2.2 g/dL and serum [creatinine] of 0.92 mg/dL. A full serological work-up including serum free light chains and anti-PLA2R antibody was negative. Urine [albumin]:[creatinine] ratio increased from <30 mg/g in May 2021 to >22,000 mg/g in April 2022. A kidney biopsy was scheduled and the results are pending at the time of this writing.

**Discussion:** A number of glomerulopathies have been reported in vaccinated patients and those with COVID-19 infection. The majority of post-vaccination cases have been due to MCD, almost always developing within 10 days of receiving the vaccine. Although our patient had a severe local reaction to the 2 vaccines she received in April 2021, she did not have proteinuria in May 2021 and did not present with nephrotic syndrome until 6 weeks after a COVID-19 infection in January 2022. The kidney biopsy results are pending, but given her presentation and the few similar cases reported, it seems most likely she will have MCD triggered by immune dysfunction, dysregulation, or a circulating permeability factor affecting the podocytes. Of course, it is also possible that the development of her nephrotic syndrome was not related to her COVID vaccinations or infection.

**PUB225**

**ANCA+ Glomerulonephritis: A Comparison of Epidemiology and Phenotype Before and After the COVID-19 Pandemic**

*Ian D. Brodka, Andrew Lee, Fatima Bawany, Ryan O'Connor, Tanzy Love, Hae Yoon Grace Choung, Catherine A. Moore. University of Rochester, Rochester, NY.*

**Background:** ANCA-associated glomerulonephritis (ANCA-GN) is a complex disease with high risk of mortality and morbidity. Although the cause of disease is commonly not identified, infections and environmental exposures have been observed. The COVID-19 pandemic has increased concerns about immunologic risk, with post-vaccination diagnosis highlighted in several case reports. We aimed to evaluate the changes in incidence and clinical/histopathological profile of ANCA-GN over time, comparing a historical cohort to recent cases in the COVID era.

**Methods:** We conducted a retrospective review of patients with a pathologic diagnosis of ANCA-GN at the University of Rochester from 1/1/15 to 11/1/21. Data obtained included biopsy reports, laboratory findings, comorbidities, COVID vaccination status, and demographics. The 2015-2020 cohort was compared to the 2021 cohort.

**Results:** 65 subjects were included, including 54 from 2015-2020 and 11 from 2021, with a consistent incidence of 10-11 diagnoses per year. There was no significant difference in age, sex, race, or geographic region between cohorts, and no difference in histopathological findings. Clinical variables were similar between groups. Among the 11 subjects diagnosed in 2021, 6 received COVID vaccination before diagnosis, 2 were unvaccinated at diagnosis, and 3 were unknown. Two subjects received vaccination within 60 days of diagnosis and the remainder were >90 days from vaccination.

**Conclusions:** There was no significant difference in the incidence of ANCA-GN between the historical cohort of patients and those diagnosed in 2021. The histopathologic and biochemical profile did not differ significantly. There was no temporal relationship noted between vaccine timing and disease onset in the post-COVID cohort.

**Table 1. Comparison of Demographic, Clinical, and Histopathological Findings between the Historical and Recent Cohorts.**

	2015-2020 (n=54)	2021 (n=11)	p-value
<b>Age at Disease Onset (years)</b>			
Median (IQR)	69 (62-75)	68 (60-69)	0.73
<b>Sex, N (%)</b>			
F	25 (46.30)	6 (54.55)	0.86
M	29 (53.70)	5 (45.45)	
<b>Race, N (%)</b>			
White	22 (40.74)	8 (72.73)	0.61
All other	32 (59.26)	3 (27.27)	
<b>Region, N (%)</b>			
Finger Lakes	16 (29.63)	9 (81.82)	0.078
Western NY	16 (29.63)	1 (9.09)	
Southern Tier	7 (12.96)	1 (9.09)	
Central NY	4 (7.41)	0 (0.00)	
All other	3 (5.56)	0 (0.00)	
<b>Lung involvement at Diagnosis, N (%)</b>			
Y	12 (22.22)	7 (63.64)	0.38
N	14 (25.93)	3 (27.27)	
<b>ANCA type, N (%)</b>			
p-ANCA	13 (24.07)	3 (27.27)	0.71
c-ANCA	6 (11.11)	3 (27.27)	
Indeterminate	7 (12.96)	2 (18.18)	
ANCA neg	1 (1.85)	1 (9.09)	
<b>PR3/MPO, N (%)</b>			
PR3	8 (14.81)	2 (18.18)	0.23
MPO	13 (24.07)	3 (27.27)	
PR3/MPO neg	1 (1.85)	1 (9.09)	
PR3/MPO+	0 (0.00)	1 (9.09)	
<b>Clinical Diagnosis, N (%)</b>			
GPA	7 (12.96)	4 (36.36)	0.52
MPA	2 (3.70)	0 (0.00)	
EGPA	1 (1.85)	1 (9.09)	
<b>Crescents, N (%)</b>			
None	2 (3.70)	0 (0.00)	0.78
Focal	34 (62.96)	7 (63.64)	
Diffuse	18 (33.33)	3 (27.27)	
<b>Fibrinoid Necrosis, N (%)</b>			
None	10 (18.52)	1 (9.09)	0.55
Focal	35 (64.81)	6 (54.55)	
Diffuse	9 (16.67)	3 (27.27)	
<b>Cellular or Fibrocellular % of total glomeruli, median (IQR)</b>	0.25 (0.09-0.45)	0.28 (0.15-0.66)	0.28
<b>Fibrosis % of total glomeruli, median (IQR)</b>	0.05 (0.00-0.11)	0.00 (0.00-0.02)	0.12
<b>IFTA, N (%)</b>			
None	0 (0.00)	1 (9.09)	0.063
Mild	16 (29.63)	3 (27.27)	
Moderate	15 (27.78)	5 (45.45)	
Severe	23 (42.59)	2 (18.18)	

Breakdown of demographic data not listed by year of clinical diagnosis. P-values represent significance of changes over time. IQR = interquartile range. IFTA = Interstitial Fibrosis and Tubular Atrophy.

**PUB226**

**An Overlapping Case of Predominant Tubulointerstitial Lupus Nephritis and IgG4-Related Kidney Disease**

*Benjamin S. Horowitz, Lilian Saro-Nunez, Billie S. Fyfe-Kirschner, Jonathan Lebowitz. Rutgers Robert Wood Johnson Medical School, Piscataway, NJ.*

**Introduction:** Lupus nephritis (LN) occurs in up to 50% of patients with systemic lupus erythematosus (SLE) and leads to significant morbidity and mortality, with up to 25% of proliferative LN patients having CKD-related mortality within 5 years. Occurring in two thirds of LN cases, Tubulointerstitial nephritis (TIN) is a key prognostic factor in LN and is associated with progression to ESRD, lower response to therapy, and development of hypertension. In LN, TIN rarely occurs in isolation, as it usually occurs with concurrent glomerulonephritis (GN). IgG4-Related Kidney Disease (IgG4-RKD) can also cause TIN and shares certain pathologic features with Lupus TIN. However, fewer than 5 cases of true overlap between these disorders have previously been reported.

**Case Description:** A 27-year-old man, without known medical history, presented with 3 months of fevers and arthralgias. Laboratory testing revealed a Creatinine (Cr) 7.2 mg/dl (unknown baseline), a positive ANA 1:1280, low C3 and C4, IgG4 215 mg/dl, and platelets 27. Urinalysis was significant for 55 RBCs/hpf and the urine protein to creatinine ratio was 1.396 mg/mg. Imaging revealed diffuse mediastinal and cervical lymphadenopathy. Renal biopsy showed TIN with dense lymphoplasmacytic infiltrate, storiform fibrosis, 14.3 IgG4-positive cells per high powered field, and “full house” immunoglobulin staining, with minimal mesangial hypercellularity and immune complex deposition. Kidney function improved with pulse dose methylprednisolone followed by a prednisone taper and mycophenolate mofetil, both of which were slowly tapered off by 18 months. However, the patient suffered a suspected relapse six months later, for which he received pulse dose methylprednisolone and was then restarted on prednisone and mycophenolate mofetil. Currently, the patient has stage 4 CKD, but is not on dialysis.

**Discussion:** The patient met both EULAR/ACR 2019 and SLICC 2012 criteria for SLE, as well as pathology consensus criteria and organ-specific criteria for IgG4-RKD. This case highlights that IgG4-RKD and LN can occur concurrently. Further research is needed to understand the pathogenesis and elucidate optimal treatment for such patients. This case highlights the need for research into the optimal treatment of LN patients with isolated or predominant TIN.

**PUB227**

**Rituximab Dosing in Glomerular Diseases: A Narrative Review**

*Husam Alzayer,<sup>1,2</sup> Kuruvilla K. Sebastian,<sup>1</sup> Michelle M. O’Shaughnessy,<sup>1</sup> <sup>1</sup>Cork University Hospital, Cork, Ireland; <sup>2</sup>Saudi Arabia Ministry of Health, Arar, Saudi Arabia.*

**Background:** Rituximab is increasingly prescribed for glomerular diseases. However, the recently published Kidney Disease Improving Global Outcomes (KDIGO) 2021 Clinical Practice Guideline for the Management of Glomerular Diseases lack details on recommended dosing regimens for most individual glomerular diseases. We performed this structured narrative review summarizing the evidence for rituximab dosing in glomerular disease to guide safe and effective prescribing in this setting.

**Methods:** The Pubmed search methodology was developed with a medical librarian and performed by the first, with review by a second, author. Randomized controlled trials (RCTs) and prospective cohort studies (PCSs) examining rituximab efficacy and/or safety

in ANCA associated vasculitis (AAV), membranous nephropathy (MN), lupus nephritis (LN), or podocytopathies (minimal change disease or FSGS) were included.

**Results:** Fifty-three studies (14 RCTs and 39 PCSSs) were included. We identified no fewer than 16 different rituximab dosing regimens studied as induction therapy for one or more of these five glomerular diseases (**Figure**). The most frequently studied rituximab induction regimens were 1,000mg as two doses two weeks apart (17 studies, 32%) and four doses of 375 mg/m<sup>2</sup>/week (18 studies, 33.9%). Twenty-six studies (49%) examined rituximab as monotherapy or in conjunction with steroids alone, while the remaining studies examined rituximab as part of combination immunosuppression.

**Conclusions:** Rituximab is a valuable treatment for glomerular disease. Adapting treatment to achieve B-cell depletion, with frequent evaluation of disease-specific biomarkers, might prove the optimal approach to achieving and maintaining remission.

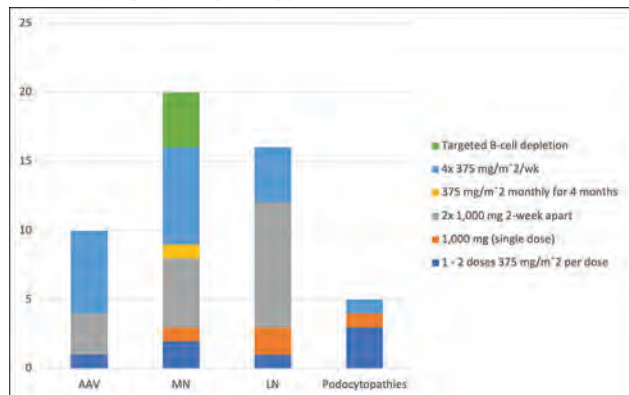

Most frequently studied rituximab induction regimens, by number of studies

**PUB228**

**Proteinuria Reduction in FSGS and IgAN: Are Nephrologists and Other Specialists Ready for a Change in Standard of Care?**

Carole Drexel,<sup>1</sup> Emily Bixler,<sup>1</sup> Edgar V. Lerma,<sup>2</sup> Jai Radhakrishnan,<sup>3</sup> Rosanna Coppo,<sup>4</sup> Michael Cheung,<sup>5</sup> <sup>1</sup>PlatformQ Health, Needham, MA; <sup>2</sup>Associates in Nephrology, SC, Evergreen Park, IL; <sup>3</sup>Columbia University Medical Center, New York, NY; <sup>4</sup>Fondazione Ricerca Molinette, Torino, Italy; <sup>5</sup>KDIGO, Rego Park, NY.

**Background:** With the release of the 2021 KDIGO Practice Guidelines and a growing pipeline based on an improved understanding of disease progression and proteinuria regulation, the management of glomerular diseases (GD), such as focal segmental glomerulosclerosis (FSGS) and immunoglobulin A nephropathy (IgAN), is rapidly changing. Nephrologists (neph) and other providers (HCPs) have evolving roles, with an urgent need to recognize and treat patients early to reduce risk of transplantation.

**Methods:** Three 60-minute CME activities were held live from Feb to Dec 2021 and will remain on-demand for 1 year. Test questions were administered before and immediately after each activity. A follow-up survey on HCP behavior was sent to post-test respondents 2 months after completion. Responses were analyzed for engagement, lessons learned, and continuing gaps. Cohort analysis compared the performance of neph with the overall HCP population. Chi-square tests compared paired responses ( $P < 0.0001$ ; pre/post and pre/2 months).

**Results:** As of 5/3/2022, 4,835 HCPs (20% neph) had engaged. About 48% of neph said that 1%-15% of their patients had been newly diagnosed with GD. After participating in at least 1 activity, neph enhanced their knowledge and competence (pre- vs post-activity) regarding diagnosis (59% vs 91%), proteinuria regulation (47% vs 66%), KDIGO guidelines (43% vs 84%), and trial data on sparsentan (39% vs 82%). The performance of neph was higher than HCPs across all domains tested. On follow up, >90% of respondents said the education had a positive impact on their clinical practice and on patient experiences and outcomes.

**Conclusions:** Data support the positive impact of live and on-demand CME on ability of HCPs to adapt to the changing paradigm for proteinuria reduction in FSGS and IgAN management. Additional education is needed for neph on the dual roles of endothelin I and angiotensin II in kidney-function decline, and to reinforce KDIGO guidelines on goals of GD management and place of steroids in IgAN. Education for the larger group of HCPs can also enhance GD diagnoses, early recognition, and referrals.

**Funding:** Commercial Support - The CME was supported by Traverre Therapeutics.

**PUB229**

**IgA Nephropathy With c-ANCA Positivity in a Patient With Crohn Disease**

Kelly V. Liang, Kimberly P. Liang, Timothy A. Fields. University of Kansas School of Medicine, Kansas City, KS.

**Introduction:** IgA nephropathy (IgAN) is an immune complex glomerulonephritis (GN) characterized by glomerular deposition of IgA-dominant immune complexes, often accompanied by mesangial hypercellularity. Antineutrophil cytoplasmic antibodies (ANCAs) cause small-vessel vasculitis and pauci-immune crescentic GN. The coexistence

of ANCAs and IgAN is quite rare. ANCAs have been associated with inflammatory bowel disease (IBD) but are more prevalent in ulcerative colitis (~75%) than Crohn's disease (~17%). IBD-associated ANCAs are usually p-ANCA or atypical ANCA rather than c-ANCA. ANCA-associated vasculitis (AAV) can be associated with tumor necrosis factor-alpha inhibitors such as infliximab. We report a rare case of c-ANCA PR3-positive IgAN in a patient with IBD treated with infliximab who presented with proteinuria.

**Case Description:** A 27-year-old female with history of Crohn's disease since 2010 treated with infliximab, allergic rhinoconjunctivitis, mild asthma, erythema nodosum in June 2021 (resolved with prednisone), Charcot-Marie-Tooth disease, psoriasis, and COVID-19 disease in Oct 2021, was found to have positive c-ANCA (1:160) and PR3 (5.0 AI, reference <1.0) in Dec 2021, raising question of vasculitis. Her rhinosinusitis was well controlled with allergy medications without oral steroids. She was referred to Nephrology for proteinuria with urinalysis (UA) in April 2022 showing 2+ protein, 3+ blood, 2-10 WBC, 20-50 RBC. Urine protein/creatinine ratio was 1.9. She had foamy urine but no gross hematuria. She previously had UA with packed RBC in June 2021. Urogram showed non-specific bladder wall thickening. Cystourethroscopy was negative. In April 2022, her BP was 97/66 and she had no edema. A renal biopsy in May 2022 revealed IgAN (M0 E1 S1 T0 C0). She was started on lisinopril and fish oil.

**Discussion:** This is a very rare case of c-ANCA PR3-positive IgAN in IBD treated with infliximab. The patient's history of sinusitis along with c-ANCA PR3 antibody positivity suggested possibly an AAV associated with infliximab, which has been reported rarely in IBD. Her proteinuria of 1.9 g/day raised concern for GN due to pauci-immune AAV. However, renal biopsy showed IgAN rather than AAV. This case highlights the importance of renal biopsy in establishing a definitive diagnosis of glomerular disorders in patients with ANCA positivity, as serum ANCAs do not necessarily represent pauci-immune GN.

**PUB230**

**Recovery of Infective Endocarditis-Associated Glomerulonephritis in a Pediatric Patient After Orthotopic Pulmonary Valve Replacement**

Dalia Zubidat, Efrén Bernal, Lihong Bu, Cheryl L. Tran, Christian Hanna. Mayo Clinic Minnesota, Rochester, MN.

**Introduction:** Infective endocarditis (IE) associated glomerulonephritis (GN) is caused by immune-mediated glomerular injury, and treatment is mainly focused on eliminating the source of infection. Here, we describe a case of *Aggregatibacter actinomycetemcomitans* IE associated GN in a pediatric patient with congenital heart disease.

**Case Description:** An 8-year-old boy with Tetralogy of Fallot underwent a right ventricular outflow tract augmentation and new pulmonary artery valve creation. Six months after, he presented with *Aggregatibacter actinomycetemcomitans* endocarditis affecting mainly the pulmonary valve, non-oliguric acute kidney injury, hypertension, hematuria, and nephrotic range proteinuria. Immunological workup showed low complement proteins C3 and C4, elevated ANCA titers (1:320), negative MPO, PR3, anti-GBM antibody, ANA, anti-DNase B, and ASO. A percutaneous native kidney biopsy was performed and showed proliferative GN suggestive of IE-induced GN (Figure 1). Due to failure of medical therapy, including a prolonged IV antibiotic course, and ongoing active glomerular disease, he underwent an orthotopic pulmonary valve replacement 4 months after his IE presentation resulting in a rapid improvement in his glomerular disease and near-complete recovery on follow up 4 months after valve replacement, except mild microscopic hematuria and proteinuria (Table 1).

**Discussion:** Surgical intervention can be considered an effective treatment in patients with IE-associated GN in cases refractory to medical therapy.

**Figure 1.**

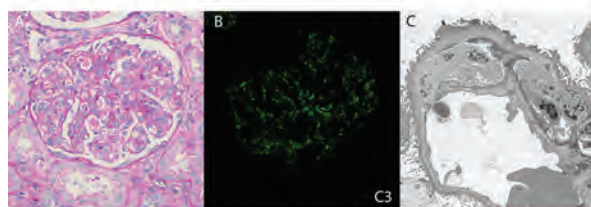

**Kidney biopsy findings.** Light microscopy shows a glomerulus with global endocapillary hypercellularity and influx of lymphocytes and neutrophils, and glomerular basement membrane duplication (A, PAS, original magnification x400). By immunofluorescence, there is diffuse global granular mesangial and capillary wall staining for C3 (B, original magnification x400). Ultrastructurally, there are segmental cellular interposition with glomerular basement membrane duplication and patchy foot process effacement, without evident mesangial, subepithelial or subendothelial deposits (C, original magnification x8000).

**Figure 1.**

**Table 1.**

Laboratory studies	At kidney biopsy	Prior to valve replacement	2 weeks post-replacement	4 months post replacement	Reference Range
Hemoglobin	8.1	7.1	10.0	12.7	10.5-14.0 g/dL
Serum Creatinine	0.53	1.2	0.35	0.30	0.15-0.53 mg/dL
protein/creatinine	0.50	10.66	0.26	0.23	<0.2 mg/mg
Serum albumin	1.7	2.2	4.1	4.3	3.4-5.0 g/dL
C3 complement	58	39	129	-	80-172 mg/dL
C4 complement	6	8	14	-	14-45 mg/dL
C-reactive protein	5.95	140.0	6.4	<3	<3 mg/L
Serumination rate	>100	61	70	16	2-17 mm/h
RBC in urine	49	>100	10-20	3-10	<3 RBCs/hpf

**Key: TH - Thursday; FR - Friday; SA - Saturday; OR - Oral; PO - Poster; PUB - Publication Only**

**Underline represents presenting author.**

## PUB231

**Renal IgA Deposits in Cirrhosis, Innocent Bystander to Rapidly Progressive GN: A Case Report**

Nitpriya Paliwal, Christopher Canfield, Sandeep Aggarwal. *University of Pennsylvania, Philadelphia, PA.*

**Introduction:** Cirrhosis is associated with renal mesangial IgA deposits thought to be due to reduced immune complex hepatic clearance but associated rapidly proliferative Glomerulonephritis (RPGN) is uncommon. We present a case of IgA predominant RPGN in a cirrhotic patient.

**Case Description:** 36 y/o M with PMHx of psoriasis, ETOH cirrhosis, strong family h/o FSGS presented with AKI along with nephrotic syndrome & microscopic hematuria. Labs: Serum cr: 4.3 mg/dl, UPCr -13 gm/gm, Una <10, Ucr: 153, CK - 409, INR - 1.2, WBC - 6200/ cum, hb - 6.8 gm/dl, Sr albumin -1.7 gm/dl Urine microscopy: Multiple dysmorphic rbc's & RBC casts Imaging : Renal US without hydronephrosis, TTE revealed no obvious valvular abnormalities or no intra-cardiac vegetations or thrombus. Significant serologies : negative for HIV, viral hepatitis panel, SPEP with immunofixation, Anti-gbm ANA, Anti-ds dna, anca, ASLO and RF, quantiferon gold, covid-19, INR -1.2 cryocrit negative. Low complement c4 (17mg/dl) with c3 (94mg/dl). Clinical course : Given Cirrhosis & low urine Na; albumin based volume resuscitation & HRS protocol was attempted with no improvement. Urine microscopy findings prompted us to do renal biopsy. Biopsy : LM, 12 glomeruli, 3 globally sclerosed: Diffuse, global endocapillary and mesangial hypercellularity. No crescents or microthrombi Glomerular capillary walls with double contours and fuchsinophilic material within mesangial, subendothelial and epimembranous areas. IF: capillary wall and mesangial immunostaining: Ig-A 3+, IgG: 1+, IgM: 1+, C3: 3+,C1q: trace, kappa: 2+, lambda: 3 + EM: 1 glomerulus : Extensive subendothelial expansion + subendothelial/mesangial immune-type deposits & associated cellular interposition. Intramembranous/subepithelial hump-like deposits. No tubuloreticular inclusions.70% podocyte foot process effacement. Patient diagnosed with Ig A predominant MPGN & was treated with solumedrol x 3 and started on steroid taper along with cellcept and discharged home with improvement in creatinine and proteinuria.

**Discussion:** Immune complex glomerular disease in cirrhotic patients can be of varied etiology. Although common, renal IgA deposition in cirrhotic patients are of unclear clinical significance. Larger scale clinicopathological studies are needed to understand the risk factors for development of clinically significant glomerulonephritis in cirrhosis.

## PUB232

**IgA-Dominant Postinfectious Glomerulonephritis, the Other Side of the Coin: Case Report**

Rodolfo A. Moreno,<sup>1,2</sup> Guillermo Navarro Blackaller,<sup>5,3</sup> Kevin A. Solis,<sup>4</sup> Werner De León,<sup>4</sup> Jorge A. Hernández,<sup>1,2</sup> Jonathan Chavez,<sup>5,3</sup> <sup>1</sup>Centro Medico Militar, Guatemala, Guatemala; <sup>2</sup>Universidad Mariano Galvez de Guatemala Facultad de Ciencias Medicas y de la Salud, Guatemala, Guatemala; <sup>3</sup>Universidad de Guadalajara, Guadalajara, Mexico; <sup>4</sup>Universidad de San Carlos de Guatemala Facultad de Ciencias Medicas, Guatemala, Guatemala; <sup>5</sup>Hospital Civil de Guadalajara Unidad Hospitalaria Fray Antonio Alcalde, Guadalajara, Mexico.

**Introduction:** Postinfectious glomerulonephritis (PIGN) is a disease presented as nephritic syndrome with hypocomplementemia usually secondary to a skin or throat infection by B-hemolytic Streptococcus and with biopsy findings of endocapillary proliferation, C3 deposits along the capillary wall and mesangium, subepithelial immune complex deposits and IF positive for IgG. There are other unusual presentations of PIGN with IgA dominance or C3-IgA codominance.

**Case Description:** A 58-year-old Guatemalan male with history of consumption of 10 beers/month for 40 years. No other medical history. During hospitalization for diagnosis of cholangitis presented a lower-limb cellulitis, for which clindamycin was started. Blood cultures were taken and were positive for *S. epidermidis* and AKI (Cr 2.84mg/dl) was observed, associated with de novo appearance of hematuria (80% acanthocytes), proteinuria (580mg/day) and hypertension. Diagnostic approach for nephritic syndrome was performed obtaining: low C3 0.592, ANA, ANCA, HIV-HCV-HBV negative, total cholesterol 184mg/dl, albumin 2.78g/dl. Renal biopsy was performed and reported: PIGN with IgA dominance with extra capillary proliferation. Reason why pulses of methylprednisolone were given for 3 days and then oral prednisone (1mg/kg/day), tapered until suspended. The soft tissue infection resolved and was discharged. At 1-month follow-up evaluation was evidence of a 50% decrease in proteinuria compared to baseline, disappearance of hematuria but with persistence of high SCr (2.09mg/dl).

**Discussion:** IgA-dominant PIGN is characterized by usually presenting in patients >60 years with DM, alcohol consumption and staphylococcal skin infections. It can present low complement and biopsy findings are characterized by IgA dominance over C3 and no IgG in IF. Elevated serum IgA levels may be involved in the pathogenesis. Treatment is based on eradication of the infection with antibiotics and in some cases the use of steroids is suggested depending on the aggressiveness of the lesion and the presence of crescents in the renal biopsy. It has worse prognosis than the traditional PIGN.

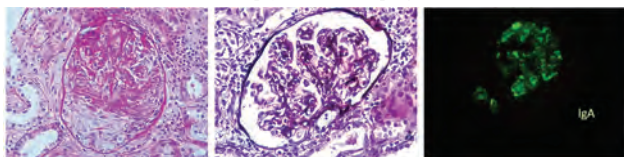

## PUB233

**Kidney Biopsies During the COVID-19 Outbreak: A Series of Cases**

Eliana Dina-Battle,<sup>1,2</sup> Hector A. Pantaleon,<sup>1</sup> Nicole M. Suárez,<sup>1</sup> Cindy S. Valera Saleta,<sup>1</sup> Eliana Bencosme,<sup>1</sup> <sup>1</sup>Hospital Metropolitano de Santiago, Santiago De Los Caballeros, Dominican Republic; <sup>2</sup>Pontificia Universidad Catolica Madre y Maestra, Santiago de los Caballeros, Dominican Republic.

**Background:** Kidney disease due to COVID-19 has been described with several presentations, both in acute phase and in posterior timing of the infection, and kidney biopsy is important for an ideal management. But the process of adequately perform a biopsy during the pandemic entails risks, as being the exposed and infected by the SARS-CoV-2. Besides of the usual potential complications, such as post-biopsy hemorrhage, that may require admission in an already crowded medical structure. For these reasons, attainment of kidney biopsies was limited to those who without an adequate histopathological diagnosis, were at higher risk of inappropriate management, as well as a pathology secondary to the SARS-CoV-2 could be ignored. The aim of this study is to perform a description of the cases biopsied during the SARS-CoV-2 pandemic, being emphasized those whose indication emerged because of the viral infection.

**Methods:** Descriptive study of the clinical presentation in addition to histopathological findings of cases requiring kidney biopsy during the period of March 2020 - July 2021.

**Results:** A total of 37 cases were collected, with a median age of 40 years (range: 60), 51% males and 73% with known history of hypertension. A 35% of the cases presented nephrotic syndrome; with average proteinuria of 4189.5mg/24h. The most frequent histopathological diagnosis was focal segmental glomerulosclerosis (FSGS), accounting for 40% of the cases. 4 patients required biopsy after COVID-19. One of them presented with Acute Kidney Injury (AKI) during the acute phase of the SARS-COV-2 infection with prolonged hemodialysis requirement; presenting histopathological diagnosis of global and segmental glomerulosclerosis. Another case of AKI during the acute phase of infection and subsequent proteinuria presented global and segmental glomerulosclerosis with collapsing characteristics; while 2 cases due to nephrotic syndrome post-infection, presented histological data of minimal change disease and FSGS with acute tubular injury.

**Conclusions:** Regardless of the appearance of a new pathology that affects the kidneys, the incidence of entities such as FSGS persists with greater frequency. However, that does not diminish the importance of performing renal biopsies, since this is an essential tool for management in cases where there is overlap of specific glomerular diseases with COVID-19.

## PUB234

**FSGS Recurrence: Status Report on a New International Collaborative**

Eloise Salmon,<sup>1</sup> Abhijit S. Naik,<sup>1</sup> Alessia Fornoni,<sup>2</sup> Hailey Desmond,<sup>1</sup> Rasheed A. Gbadegesin,<sup>3</sup> Matthias Kretzler,<sup>1</sup> Leonardo V. Riella,<sup>4</sup> Howard Trachtman,<sup>1</sup> Debbie Gipson,<sup>1</sup> <sup>1</sup>University of Michigan Michigan Medicine, Ann Arbor, MI; <sup>2</sup>University of Miami, Coral Gables, FL; <sup>3</sup>Duke University School of Medicine, Durham, NC; <sup>4</sup>Massachusetts General Hospital, Boston, MA.

**Background:** Recurrent FSGS post-kidney transplantation occurs in nearly 20-60% of patients with devastating effects on graft and patient survival. The risk of recurrence increases with each subsequent transplant procedure. This phenomenon represents a scientific and therapeutic challenge because it is an unexpected complication and occurs in a setting in which clinical research is difficult to implement. In order to improve our understanding of FSGS recurrence, a multidisciplinary conference was organized to explore the pathogenesis, current treatment, and potential therapeutic options for this serious condition.

**Methods:** A two-day virtual meeting was convened in December 2021. The participants included clinicians, basic scientists, epidemiologists, bioinformaticians, patients, and patient advocacy group representatives. The conference was divided into the following thematic areas: (1) the state of the problem; (2) use of genetics as a research accelerator; (3) identifying disease pathways: podocyte and beyond; (4) identifying disease pathways and modifiers; (5) exploring disease mechanisms: methodology; and (6) therapy development & rare disease trial design.

**Results:** The session format was split to allow presentation followed by moderated discussion. Each session in the symposium included 3-4 presentations by experts in the field that highlighted the scope of the problem existing knowledge, key gaps, and future opportunities.

**Conclusions:** The FSGS Recurrence Collaborative represents an important effort to gather the intellectual and practical knowledge and experience that will be needed to improve our understanding of this severe complication of kidney transplantation. It is hoped that bringing this interdisciplinary expertise in glomerular disease together will stimulate innovative ideas and original approaches to treatment of FSGS recurrence.

## PUB235

**Clinical-Pathological Features of Repeat Renal Biopsies in Patients With Refractory Nephrotic Syndrome**

Xinyuan Cui,<sup>1,2</sup> Shuguang Yuan,<sup>1</sup> Xuejing Zhu,<sup>1</sup> Yifu Li,<sup>1,2</sup> <sup>1</sup>The Second Xiangya Hospital of Central South University Department of Nephrology, Changsha, China; <sup>2</sup>Renal Research Institute of Central South University, Changsha, China.

**Background:** Refractory nephrotic syndrome is a subset of nephrotic syndrome with pathological conditions resistant to the treatment using corticosteroids and other immunosuppressives for six months or more. Patients who had these underlying

Key: TH - Thursday; FR - Friday; SA - Saturday; OR - Oral; PO - Poster; PUB - Publication Only

Underline represents presenting author.

conditions had poor clinical outcomes in general. In addition, the pathological changes associated with the progress of the disease were not fully understood.

**Methods:** This retrospective study was on patients with refractory nephrotic syndrome undergoing repeat renal biopsies between August 2011 and June 2021 from a single center in Changsha, China. Relevant clinical and histological records of patients with repeat renal biopsies were documented. In addition, a comparison of data from the first and second renal biopsies was performed.

**Results:** This study included ten cases with complete clinical and histological records. Each case had a poor response to corticosteroids and other immunosuppressive agents and poor clinical outcomes for at least six months. The ages of the first and second renal biopsies were  $28.9 \pm 13.1$  and  $31.5 \pm 13.6$  years, and the mean biopsy interval was  $2.6 \pm 2.4$  years. The first pathological diagnosis included: three cases of membranoproliferative glomerulonephritis, two cases of crescentic glomerulonephritis and minimal change glomerulonephritis, and one case of IgA nephropathy, Henoch-Schönlein purpura nephritis, and Idiopathic nodular glomerulosclerosis. After comparing the data at the first and second renal biopsies, the results showed that: (1) The renal function had worsened compared with the baseline at the first renal biopsy; serum creatinine increased significantly ( $234.5 \pm 183.3$  vs.  $411.9 \pm 364.3$  mmol/L,  $p < 0.05$ ). (2) Major pathological features had not changed significantly, and only one case had changed the diagnosis from minimal change glomerulonephritis to focal segmental glomerulosclerosis. (3) An increasing percentage of global glomerulosclerosis and segmental sclerosis had been found compared to the first renal biopsy ( $19.0 \pm 24.3$  vs.  $42.2 \pm 28.9\%$ ,  $p < 0.05$ ). (4) Other immunofluorescences staining for IgG, IgA, IgM, Fibrin, C1q, and C3 had no significant changes.

**Conclusions:** The disease progresses of refractory nephrotic syndrome is associated with the severity of glomerular sclerosis. Therefore, the value of repeat renal biopsies for refractory nephrotic syndrome may be limited.

## PUB236

### Desires and Needs of Dutch Atypical Hemolytic Uremic Syndrome Patients and Relatives

Romy N. Bouwmeester, Nicole Van De Kar. In collaboration with the Dutch Kidney Patient Association *Radboud UMC, Nijmegen, Netherlands*.

**Background:** Atypical hemolytic uremic syndrome (aHUS) is a rare and severe form of a thrombotic microangiopathy (TMA). Our knowledge in the biochemical and genetic mechanisms of aHUS is continuously increasing, resulting in the development of targeted treatments such as eculizumab. The improved outcome perspectives and switch to a restrictive eculizumab treatment strategy could be considered life changing for aHUS patients. However, little is known on individual experiences, needs and desires of atypical HUS patients and their relatives.

**Methods:** This is a nationwide, exploratory, qualitative interview study with a direct content analysis approach. In-depth interviews and a six-week evaluation were audio-recorded and semi-structured. A topic guide included the Institute for Positive Health (IPH) model, which contains six domains of health on a subjective scale.

**Results:** Thirteen interviews with five aHUS patients and fourteen relatives were conducted after which data saturation was obtained. Long-term disease symptoms (e.g. fatigue) are present in the majority of patients and negatively influence bodily and daily functioning. The resilience of both patients and relatives is remarkable. However, despite a high rate of acceptance, among others the (potentially traumatic) acute phase of aHUS and the unpredictable possibility of disease recurrence have a lasting impact on mental well-being. Support is essential yet to be improved by increasing the accessibility of psychological support in aHUS healthcare and the availability of more comprehensible information.

**Conclusions:** A new era should begin, as we strive to further optimize health care for aHUS patients while focusing on the person and not only the disease. These insights in the actual needs and desires of Dutch aHUS patients and their relatives will help optimize and personalize aHUS health care. In addition, this study can be an example of a more personalized approach in both research and health care of other rare kidney diseases.

## PUB237

### Adult Primary Podocytopathy in Southeast Asia: Clinicopathological Characteristics, Treatment-Associated Toxicities, and Outcomes

Ru Sin Lim<sup>1</sup>, Chye Chung Gan,<sup>2</sup> Geraldine Boh,<sup>1</sup> Soo Ying Yew,<sup>2</sup> Shok H. Ooi,<sup>2</sup> Soo Kun Lim,<sup>2</sup> See Cheng Yeo.<sup>1</sup> <sup>1</sup>Tan Tock Seng Hospital, Singapore, Singapore; <sup>2</sup>University of Malaya Medical Centre, Kuala Lumpur, Malaysia.

**Background:** Glucocorticoid remains the treatment of choice in adult primary podocytopathy (Minimal Change Disease, MCD and Focal Segmental Glomerulosclerosis, FSGS). The use of steroid-minimization strategy to minimize toxicity has not been well studied. We aim to study the efficacy and safety of glucocorticoid minimization (IV Methylprednisolone 500mg daily for 3 days followed by Prednisolone 0.5-0.7mg/kg/day) versus high dose glucocorticoid (Prednisolone 1mg/kg/day) regimen for the treatment of newly diagnosed adult primary podocytopathy in Singapore (Tan Tock Seng Hospital, TTSH) and Malaysia (University Malaya Medical Center, UMMC).

**Methods:** Patients with newly-diagnosed renal biopsy proven MCD and FSGS at TTSH and UMMC from 01/01/2011 till 31/12/2021 were included in this study. Exclusion criteria include that of age <18 years old, follow up duration of < 3 months, or development of End Stage Kidney Disease (ESKD) which precludes the use of immunosuppressants. The remission rate and treatment-related toxicities between the 2 cohorts will be compared and analyzed.

**Results:** A total of 58 (36 MCD, 22 FSGS) and 34 (30 MCD, 4 FSGS) patients were included from TTSH and UMMC respectively. Compared to UMMC cohort, TTSH cohort is older (mean age in years  $\pm$  standard deviation, SD is  $51.5 \pm 21.5$  vs  $32.5 \pm 16.6$ ,

$p < 0.001$ ), more patients present with edema 54 (93.1%) vs 26 (76.5%),  $p = 0.029$ , with heavier proteinuria (mean proteinuria  $11.2 \pm 5.8$  g/day vs  $5.9 \pm 3.9$ g/day,  $p < 0.001$ ), and better baseline renal function mean eGFR ( $81.5 \pm 36.8$  ml/min per  $1.73 \text{ m}^2$  vs  $97.7 \pm 35.0$  ml/min per  $1.73 \text{ m}^2$ ,  $p = 0.041$ ). The starting prednisolone dose is higher for TTSH in relation to UMMC cohort (mean dose  $\pm$  SD is  $62.0 \pm 11.0$  mg/day vs  $39.1 \pm 9.8$  mg/day,  $p < 0.001$ ). There is no difference in terms of complete remission (60.4% vs 70.6%), partial remission (24.1% vs 14.7%) and steroid resistance (15.5% vs 14.7%),  $p = 0.602$  in TTSH and UMMC cohorts respectively. No difference was observed with regards to median days (interquartile range, IQR) to achieve remission, 41 (25.5-94.5) days in TTSH vs 56 (27-84) days in UMMC,  $p = 0.452$ . There is no significant treatment-related toxicity difference observed in the 2 cohorts.

**Conclusions:** Glucocorticoid minimization strategy appear to be efficacious and safe in adult primary podocytopathy.

## PUB238

### CT-Guided Kidney Biopsy by Interventional Nephrologists

Mohamed A. Rahil, Jean Michel Marc, Carole Deprele, Ophélie Baudoin, Agnes Delay, Eric Legrand. *Centre hospitalier d Ardeche Nord, Annonay, France*.

**Background:** Histopathology of renal parenchyma is the key diagnostic for kidney disease treatment. Generally, the act is simple under US guidance, but when the kidney size is small or for obese patients, this act could be a real challenge with more risk of complications. In Annonay Hospital (France) all renal biopsies are done by a CT guidance. We report a retrospective study of 123 patients who have had a CT guided kidney biopsies by interventional nephrologists.

**Methods:** Between January 2016 and June 2020, 123 CT guided kidney biopsies were performed at Annonay hospital in France. 77 man, and 46 women. The mean age was 64 years, the mean BMI was 26.54. The patient was installed in prone position. Preliminary CT images at 5-mm axial slices covering the entire length of the kidney are obtained. A metallic mark is placed at the right side of the back to localize the entrance skin site. A local anesthetic agent is then injected. A 16-gauge core biopsy is introduced following exactly the calculating depth. Once two samples are acquired, postprocedure images are obtained to assess major complications.

**Results:** Renal parenchyma is obtained in all patients (100%), over 123 biopsies, 121 presented between 1 to 48 glomerulus (98.37%), 2 biopsies presented a medulla tissue (1.62%), 97 patients (78%) presented a perinephric hemorrhage more than 1 cm in postprocedure images. 15 patients presented a macroscopic hematuria (12.19%). One patient required renal embolization for an expansive perinephric hemorrhage.

**Conclusions:** The CT guided renal biopsy is a precise and rapid technic to have a renal parenchyma with a failure rate bordering 0%, but the cost and the radiations rate should be compared with the other methods.

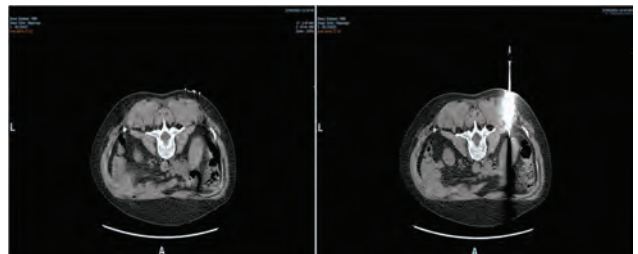

## PUB239

### Clinical Study on the Therapeutic Effect of Englitazone on Urinary Protein in Patients With IgA Nephropathy

Qin Y. Du, Sheng Xiao, Fei F. Jiang, Fei Deng. *Sichuan Academy of Medical Sciences and Sichuan People's Hospital, Chengdu, China*.

**Background:** In this study, irbesartan and englitazone were used in IgA nephropathy patients with urinary protein, and comparing the therapeutic effect of englitazone with irbesartan, on IgA nephropathy urinary protein. The adverse reactions of IgA nephropathy patients were recorded during the treatment, so as to bring new therapeutic strategies for IgA nephropathy.

**Methods:** 1. From January 2020 to January 2022, 40 patients with proteinuria more than 300mg/24h were confirmed as primary IgA nephropathy according to Oxford classification have been done the underwent renal biopsy in Sichuan Provincial People's Hospital or Jinniu District People's Hospital. They were the research subjects, and 20 patients were in each group. Group A (control group) : SGLT2 inhibitor (Englitazone, 10 mg/ tablet), one tablet daily after breakfast for 24 weeks; Group B (control group) : RAAS blocker (irbesartan), 150 mg/ tablet, one tablet daily after breakfast for 24 weeks. 2. Body temperature, pulse, respiration, systolic blood pressure, diastolic blood pressure, blood routine, urine routine, liver function, serum creatinine, urea nitrogen, urinary microalbumin to creatinine ratio,  $\beta_2$ -microglobulin, cystatin C, and hypoglycemic events were observed before treatment and at the week 8<sup>th</sup>, 12<sup>th</sup>, 24<sup>th</sup> after treatment.

**Results:** 1. There were no significant differences in general clinical data and observation indicators between the two groups at baseline ( $P < 0.05$ ). 2. There was statistically significant difference in proteinuria between 2 groups before and after treatment ( $P < 0.05$ ). 3. After treatment, there was statistically significant difference in urinary protein between group A and group B within 8<sup>th</sup> after the treatment ( $P < 0.05$ ),

Key: TH - Thursday; FR - Friday; SA - Saturday; OR - Oral; PO - Poster; PUB - Publication Only

Underline represents presenting author.

but there was no difference within 12<sup>th</sup>, 24<sup>th</sup> after the treatment ( $P > 0.05$ ). There were no statistically significant differences in blood routine, liver function, serum creatinine, urea nitrogen and  $\beta_2$ -microglobulin between group A and group B after treatment ( $P > 0.05$ ); there were statistically significant differences in blood pressure between group A and group B after treatment ( $P < 0.05$ ); there were no statistically significant differences in blood glucose between group A and group B after treatment ( $P < 0.05$ ).

**Conclusions:** Application of SGLT2 inhibitor in early IgA nephropathy can reduce urinary protein and stabilize renal function, and the safety is quite well.

## PUB240

### Complement Mediated Hemolytic Uremic Syndrome After an Egyptian Vacation

Evgueni M. Minev,<sup>1</sup> Jamey E. Eklund,<sup>2</sup> *<sup>1</sup>Nephrology Associates Of Northern Illinois and Indiana, Mount Prospect, IL; <sup>2</sup>Medical College of Wisconsin, Milwaukee, WI.*

**Introduction:** Thrombotic microangiopathy (TMA) is characterized by intravascular hemolysis, low platelets, CNS & renal pathology. TTP is caused by congenital or acquired ADAMTS-13 deficiency, resulting in large vWF multimers and creation of platelet-rich thrombi. Enterohemorrhagic colitis causes HUS via shiga toxin, while complement dysregulation is an increasingly recognized cause of hemolytic-uremic syndrome (cHUS).

**Case Description:** A 24 year-old previously-healthy man presented with 3 days' of bloody diarrhea, fever and abdominal cramps after returning from a 7-day trip to Egypt. He stayed in a hotel and ate meat in restaurants. He received ciprofloxacin but developed a rash, so he was then given IV Bactrim, Flagyl, and saline. Colonoscopy revealed presumed infectious pseudomembranous hemorrhagic colitis. On day 6 of symptoms, he developed AKI, thrombocytopenia, and anemia so nephrologist was consulted and TMA diagnosed. Labs listed below. Daily plasmapheresis with FFP replacement was started. Once ADAMTS13 resulted, PLEX was stopped. The patient suffered seizures and transient cortical blindness. Treatment with eculizumab was initiated with immediate symptom improvement, and complete recovery in 3 months. Genetic complement testing revealed one abnormal allele in exons 4 & 5 of CFHR5 gene. Eculizumab was successfully weaned after 6 months (monitoring by daily UA, weekly labs, CH50 monthly), and the patient remains in remission 3 years later.

**Discussion:** The majority of cHUS is mediated by abnormal regulatory factors (CFH, CFI, MCP); activation factors (C3 & CFB); and coagulation related factors (DGKE, THBD, PLG). Our patient had 2 abnormal alleles in the CFHR5, gene c622T>C, p.Cys208Arg in exon 5 and c480\_481insA located in exon 4. While these mutations are described as variants with unknown significance (VUS), carriers of the double-mutated CFHR5 alleles have lower CFHR-5 levels. It is likely that the initial hemorrhagic colitis inflammatory milieu overwhelmed and shifted the alternative complement pathway into activated mode, leading to severe HUS, which improved only after eculizumab therapy.

Labs

Serum	Stool	Complement
Platelets 19	(-) Shiga toxin PCR	C3 70
Creatinine 3	(-) Shigella	C4 8
(++) Schistocytes	(-) E Coli O157:H7	CH50 79
Haptoglobin <7.8		C5-9 524
LDH 796		CFH 19.6
ADAMTS13 activity 63%		

## PUB241

### The Gut: A Giant Nephron!

Jennifer Bergeron, Agnes B. Fogo, Julia Lewis, *Vanderbilt University Medical Center, Nashville, TN.*

**Introduction:** Anti-glomerular basement membrane (anti-GBM) disease is a rare pulmonary-renal syndrome in which  $\alpha 3(\text{IV})\text{NC1}$  autoantibodies bind to the GBM in the lung and kidneys to cause severe deterioration in renal function and life-threatening lung hemorrhage. Here we report an indolent form of anti-GBM disease causing a severely elevated creatinine.

**Case Description:** A 27-year-old Caucasian man with class II obesity and average muscle mass presented with 3 weeks of upper respiratory infection symptoms, 3 days of dyspnea, scant hemoptysis, peripheral edema, and progressive oliguria after having worked as a mechanic that day. Surprisingly, serum creatinine (SCr) was 36.3mg/dL with BUN 160mg/dL, potassium 6.8mg/dL, bicarbonate 11mg/dL, phosphorus 9.1mg/dL, albumin 2.6mg/dL, and hemoglobin 4.4mg/dL. Chest CT revealed diffuse ground glass opacities in both lungs with subpleural sparing consistent with pulmonary hemorrhage. Serologic work up included normal CPK, negative ANCA, and anti-GBM titer of 225. Kidney biopsy showed 3 of 26 glomeruli globally sclerosed and 16 with early fibrocellular crescents, 10-20% diffuse early interstitial fibrosis, and 3+ diffuse global linear staining along capillary loops for IgG by IF, diagnostic of anti-GBM mediated glomerulonephritis. He was treated with 3 days of IV steroids then a prednisone taper, plasmapheresis (14 days), and cyclophosphamide 0.8mg/kg/day. He required CRRT then HD before switching to PD, on which he remains. He has had no signs of renal recovery and his titers have been normal for 3 months.

**Discussion:** Patients with anti-GBM disease can present late in their disease course as they can be asymptomatic, or with symptoms related to anemia or a mild upper respiratory illness. SCr is a function of the generation of creatinine by muscle and its renal and extrarenal excretion. With an average creatinine generation of 20mg/kg/day, without renal excretion SCr will rise about 1mg/dL per day, suggesting that this patient had a prolonged time with a marked reduction in GFR before presentation. With severely

reduced GFR, nonrenal creatinine clearance by gut flora creatinases can account for 2-4ml/min, resulting in a maximum SCr of 35-40mg/dL in the average muscle massed human, as we saw in this patient's steady state SCr of 36 before dialysis. This patient has the highest creatinine reported in anti-GBM disease (previously SCr 21). As expected, such a high SCR predicted a poor renal prognosis.

## PUB242

### Outcome of Conservative Management Strategy for Fibrillary Glomerulonephritis

Saira Sajid, Katerina Hysi, Jean H. Ancion, Dina R. Al-Tuhafy, James Drakakis, *NYU Langone Hospital - Long Island, Mineola, NY.*

**Introduction:** Fibrillary glomerulonephritis (GN) is an immune complex GN with amyloid like fibrils (larger than those in amyloid) which are IgG positive and Congo red negative. It is a rare entity, diagnosed in 0.5-1.0% of native kidney biopsies. The usual presentation is proteinuria, hematuria and hypertension in middle aged to older adults. Frequently, there is an association with hepatitis C infection. DNAJB9 detection in biopsies has been reliable for the diagnosis. The outcome is poor with progression to ESRD occurring in 50% of patients within a few years of diagnosis. There are no well established treatment options, though there have been reports of Rituximab stabilizing disease progression.

**Case Description:** 88 year old female with hypertension who upon returning to the US after residing in Italy, was found to have 3+ protein on urinalysis (UA). Subsequent UA was consistent, despite being on Valsartan. Initial urine protein quantification 4.6 g/g. Serum albumin was relatively preserved and creatinine 1.4 - 1.5 mg/dL. Imaging revealed kidney size to be normal, with bilateral parapelvic cysts. Basic serologies were negative. Kidney biopsy was done revealing fibrillary glomerulonephritis, with mesangial proliferative features. Strongly positive glomerular staining for DNAJB9. There were no signs of endocapillary proliferation or cellular crescents. 50% tubular atrophy and interstitial fibrosis. Offered trial of immunosuppression (with Rituximab), which was declined. Over the next nearly 2 years, proteinuria remained nephrotic spectrum, but renal function held steady and without change.

**Discussion:** Most studies of fibrillary GN cite poor renal outcomes. Age, degree of proteinuria at the time of biopsy and amount of fibrosis have all been listed as negative predictors of renal outcomes. In some reports, Rituximab has been associated with non progressive chronic kidney disease, although literature overall suggests there is no clear benefit of immunosuppression. Our case is illustrative in that it outlines the course of an 88 year old female with fibrillary GN (not related to hepatitis C or monoclonal protein) treated conservatively. Over the span of 2 years from diagnosis, her proteinuria remains 4-5 g/g while Cr is unchanged at 1.4 - 1.6 mg/dL. More data need to be gathered on which factors render the patient most likely benefit from immunosuppression.

## PUB243

### Anti-PLA2R Autoantibodies and Clinical Activity in Patients With Primary Membranous Nephropathy

Vinod Kumar,<sup>1</sup> Deeksha Pal,<sup>1</sup> Krishan Lal L. Gupta,<sup>1</sup> Vivekanand Jha,<sup>2</sup> Raja Ramachandran,<sup>1</sup> *<sup>1</sup>Post Graduate Institute of Medical Education and Research, Chandigarh, India; <sup>2</sup>The George Institute for Global Health India, New Delhi, India.*

**Background:** Two-thirds primary membranous nephropathy (PMN) patients have M-type Phospholipase A2 receptor autoantibodies (anti-PLA2R Abs). Change in circulating anti-PLA2R Abs can serve as a predictor of treatment response. We examined the temporal association of anti-PLA2R Abs with a clinical response among a cohort of patients with PMN

**Methods:** We enrolled consecutive treatment naïve or relapsing PMN patients who were treated with immunosuppressive therapy. Serum anti-PLA2R Abs were evaluated at baseline, 3, 6 & 12 months using a Euroimmune ELISA kit (Lübeck, Germany). Clinical response was defined as per the KDIGO2021 guidelines; complete remission(CR): proteinuria reduction to <0.3g/d, stable serum albumin and creatinine >3.5g/dl; Partial remission(PR): proteinuria reduction to 0.3-3.5g/d and a decrease of >50% from baseline. Patients were followed up for 18 months

**Results:** A total of 64 patients (44 males & 20 females) were enrolled in the study. The mean age, baseline proteinuria, serum albumin, creatinine, and anti-PLA2R Abs was 40±13.8 yrs, 8.63±5.17 g/day, 2.3±0.69 g/dl, 0.90±0.43 mg/dl, and 250.29±243.09 RU/ml, respectively. At the end of follow-up, 49 patients (76.5%) had achieved clinical remission (CR; n=14). Baseline anti-PLA2R Abs titers were 168.8(127.3,197.6), 204.7(64.8,332.2) and 370(129.2,481.1) RU/ml respectively in complete, partial or no response patients. There was 98% and 69% reduction in anti-PLA2R at 12 months as compared to baseline in CR/PR and resistant group, respectively (**Figure**). Patients with the resistant disease had a resurgence of antibodies at 12 months. Serological remission preceded clinical remission, and persistence or resurgence of antibodies at 12 months was associated with resistant disease.

**Conclusions:** Patients with PLA2R-associated PMN had a significant reduction in anti-PLA2R Abs with treatment which preceded clinical response. Persistence of anti-PLA2R Abs at 12 months is strongly associated with clinical activity.

**Funding:** Government Support - Non-U.S.

Key: TH - Thursday; FR - Friday; SA - Saturday; OR - Oral; PO - Poster; PUB - Publication Only

Underline represents presenting author.

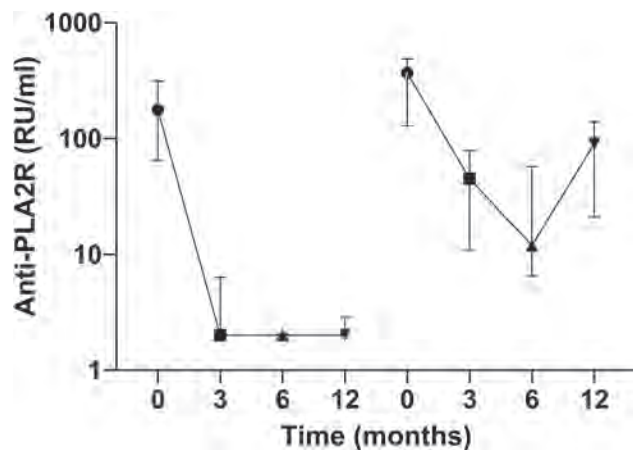

**PUB244**

**Atypical Presentation of Kidney Involvement in Sjögren Syndrome**

Karina Chimbo Lituma, Julio C. Nieto, Claudia B. López, Carolina Gonzalez-Fuentes, Guillermo E. Ramírez García, Mario Alamilla Sanchez, Julio Manuel Flores Garnica, Faustino J. Silva Centeno, Regina C. Hernandez, Victor M. Ulloa Galvan. *Instituto de Seguridad y Servicios Sociales de los Trabajadores del Estado, Mexico City, Mexico.*

**Introduction:** Primary Sjögren’s syndrome (pSS) is an autoimmune disorder that mainly affects the exocrine glands. Kidney involvement is manifest by proteinuria and defects in tubular function. Renal biopsy confirms the presence of tubulointerstitial nephritis, this is the most common presentation of kidney disease, glomerulonephritis is an infrequent presentation.

**Case Description:** 51-year-old female with pSS diagnosed 10 years ago by biopsy, with glandular manifestations. 1 month before admission, she presented a tumor at the level of the right submandibular region. She received treatment with clindamycin and NSAIDs, alongside drainage of the collection. She developed purpuric lesions in the pelvic limbs and presented intermittent fever accompanied by impaired renal function, glomerular hematuria, and decreased urine volumes. Hemoglobin 8.7 gr/dl, Hematocrit 27.7%, Creatinine 2.0 mg/dl, Albumin 2.1 gr/dl, viral panel no reactive, C3: 55.4 mg/dl, C4: 1.7 mg/dl, rheumatoid factor: 94.2 IU/ml, urine test: DU 1.018 Ph 5.0 Leuko 4 Proteins 500 Erythrocytes 250 Bacteria Moderate Proteinuria 1.7 g/24h, Albuminuria 1.1 g/24 h. Renal biopsy reporting a membranoproliferative, extracapillary glomerulonephritis, due to immune complex deposition. Tubulointerstitial nephritis rich in plasma cells, and intracapillary hyaline thrombi indicative cryoglobulins. Treatment with intravenous steroids was implemented with a satisfactory clinical response.

**Discussion:** PSS is an entity with infrequent kidney involvement. Renal tubular acidosis is described as the foremost clinical manifestation in pSS renal involvement and is associated with tubulointerstitial nephritis by histopathological findings, followed by membranous-like glomerular involvement reported in reviews. Treatment with glucocorticoids and other immunosuppressive agents appear to slow the progression of kidney disease.

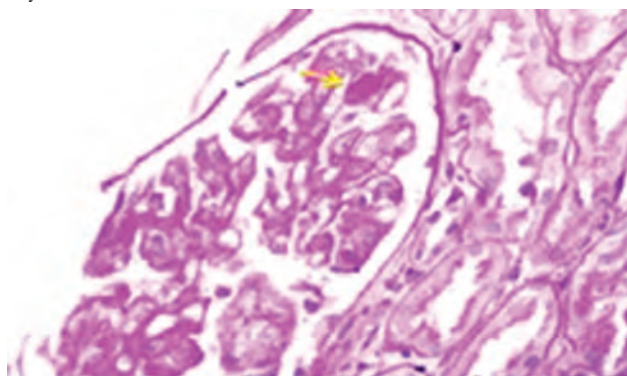

**PUB245**

**Adalimumab: A Case of Secondary Membranous Nephropathy**

Gina G. Suarez, Angel R. Castro, Pedro A. Canuelas. *Hospital de la Concepcion, San German, PR.*

**Introduction:** Membranous nephropathy (MN) is a cause of nephrotic syndrome characterized by a pattern of histologic change noted on light microscopy: glomerular basement membrane thickening with little or no cellular proliferation or infiltration. Around 75% of cases of MN in adults are primary or idiopathic, and the rest are attributed to an assortment of agents or conditions, mostly due to observational data that removing the inciting agent or treating the underlying condition resulted in improvement or overall termination of the nephrotic syndrome. Anti-TNF agents have been shown to be a secondary cause of MN, but there is limited documentation about this. We give you a case of secondary MN manifesting in a patient after starting treatment for inflammatory bowel disease with adalimumab. This adverse effect is a rare complication of treatment making this case relevant for clinicians to monitor and maintain a high level of suspicion.

**Case Description:** A 51-year-old female with severe Crohn’s Disease, but controlled Type II Diabetes Mellitus, and Essential Hypertension presents with isolated, nephrotic-range proteinuria in routine lab work sent by her primary care physician after two months of initiating adalimumab for her Crohn’s Disease (24-hour urine collection yielded 7.1 g of protein and urine spot yielded 6.9 g of protein). Age- and sex-based cancer screening, anti-double stranded DNA, antinuclear antibodies, and complement levels, Hepatitis Panel, HIV, and RPR were all negative. Renal biopsy demonstrated MN Stage I with deposits negative for phospholipase A2 receptor (PLA2R; a major antigen in human primary MN) antibodies plus mild acute tubular injury and arterio- and arteriolonephrosclerosis. Adalimumab was discontinued; the patient was started on infliximab and in follow-up the patient’s proteinuria decreased significantly, supporting the theory of adalimumab having caused MN.

**Discussion:** In light of aforementioned workup being found negative, including imaging for hidden malignancy, tumor markers, SPEP/UPEP, adequate blood pressure and glycemic control, timeframe of proteinuria coinciding with the commencement of adalimumab and improvement of proteinuria after it was discontinued, the most likely explanation for this patient’s nephrotic range proteinuria remains the usage of adalimumab. Biopsy confirms our hypothesis with presence of secondary MN supported by negative PLA2R antibodies.

**PUB246**

**Predicting ESRD in Pauci-Immune Glomerulonephritis**

Saliha Yildirim, Emre Yasar, Betül Oğut, Ipek Isik gonul, Galip Guz. *Gazi Universitesi Tıp Fakültesi, Ankara, Turkey.*

**Background:** Pauci-immune GN is a vasculitis presented with absence of immune deposits on kidney biopsy. Three different scoring systems have been proposed to predict renal disease prognosis; Berden classification (BC), Mayo Clinic/Renal Pathology Society Chronicity Score (MCS) and ANCA Renal Risk Score (ARRS). In this article we aimed to compare the predictiveness of scoring systems in terms of end-stage renal disease in pauci-immune GN.

**Methods:** Patients diagnosed with pauci-immune GN in our center were included. BC classes, MCS and ARRS of the patients were calculated. The patients were divided into two groups according to ANCA positivity and the relationship of the scoring groups with the development of end-stage renal disease (ESRD) was evaluated using appropriate statistical methods.

**Results:** A total of 42 patients were included in this study (Table 1). %25 of the ANCA positive group (ANCAP) and %16.7 of the ANCA negative pauci immune group (ANCAN) patients developed ESRD. When the ANCAP classified according to BC all of the sclerotic patients (p=0.011), according to MCS %50 of the patients with severe disease (p=0.652), according to ARRS %75 of the patients with high risk disease developed ESRD (p=0.017). When the ANCAN classified according to BC %20 of the sclerotic patients (p=0.026), according to MCS %33.3 of the patients with severe disease (p=0.770), according to ARRS %27.3 of the patients with medium risk disease developed ESRD (p=0.308).

**Conclusions:** In our study we found that regardless of ANCA, BC was a valuable method to predict ESRD. In ANCAP ARRS was also valuable for ESRD prediction. Our study is unique for including both ANCAN and ANCAP patients. Major limitations of our study were low number of patients and retrospective nature of the study. Further studies with more patients are needed for the evaluation of ESRD in this patient group.

**Funding:** Private Foundation Support



	ANCA positive peuci-immun glomerulonephritis (n=24)	ANCA negativ peuci-immun glomerulonephriti grupu (n=18)	Total Peuci-immune glomerulonep itria group (n=42)
Gender (F/M) (n)	9/15	6/12	15/27
Age (mean±SD)	60,04±11,36	49,38±19,25	55,47±15,95
Blood urea nitrogen (mg/dL) (Mean±SD)	45,84±23,26	31,54±12,56	40,77±21,06
Creatinine (mg/dL) (mean±SD)	3,02±1,76	2,56±0,99	2,85±1,53
Albumin (g/dL) (mean±SD)	3,06±0,70	3,27±0,62	3,13±0,67
Proteinuria (g/24 hour) (mean±SD)	2,48±2,42	6,03±7,38	3,74±4,98
Renal replacement therapy at the admission (n (%))	7(29,2)	1(5,6)	8(19,0)
Lung involvement at the admission (n (%))	11(45,8)	6(33,3)	17(40,5)
Other organ involvement at the admission (n(%))	10(41,7)	4(22,2)	14(33,3)

PUB247

Autosomal Recessive Alport Syndrome With Pathogenic Variants

Lakshmi Kannan, Rahul Mishra, UmmeRubab Syeda, Rishi Raj. Pikeville Medical Center, Pikeville, KY.

**Introduction:** Approximately 0.2% of adults and 3% of children in the United States with end-stage renal disease have Alport Syndrome (AS). The hallmark of AS is microscopic hematuria; cochlear and ocular manifestations can also occur. It is caused by genetic mutations affecting type IV collagen which consists of a heterotrimeric complex of α3, α4, and α5 chains encoded by COL4A3, COL4A4 (situated on chromosome 2), and COL4A5 (situated on X-chromosome).

**Case Description:** A 56-year-old female with a medical history significant for hypertension, hypothyroidism, and high-tone sensorineural hearing loss presented with hematuria, hypertension, and abnormal renal function. Family history revealed a sister with hearing loss and microscopic hematuria and a maternal grandmother with a progressive renal disease requiring dialysis at the age of 32 years. A recent eye exam revealed an immature cataract in the left eye. Renal biopsy revealed only revealed thin basement membrane but no specific diagnostic features. The biopsy was insufficient and given the finding of high-frequency hearing loss and hematuria suspicion of hereditary nephritis was high. DNA analysis was done which showed a novel pathogenic mutation of the COL4A3 gene (c.4981C>T (p.Arg1661Cys) and c.2048G>A (p.Gly683Glu) indicating a diagnosis of autosomal-recessive AS. The patient is on lisinopril for hypertension and has only microscopic hematuria and stable kidney function at present.

**Discussion:** When a diagnosis of AS from histological analysis of renal biopsy specimens becomes difficult, comprehensive genetic testing can provide a definitive means of making a diagnosis. Once a genetic diagnosis is established, screening of symptomatic, at-risk family members or prenatal testing for pregnancy and preimplantation genetic testing can obviate the need for a kidney biopsy. The rate of progression of kidney disease in patients with AS is highly variable; genetic analysis would provide additional prognostic information and it has been found that early stop codons, frameshift mutations, large deletions, and rearrangements are associated with early-onset renal failure and hearing loss than missense mutations. In individuals requiring a kidney transplant, there is a 3% chance of developing anti-glomerular basement membrane disease, possibly from more destructive genetic alterations.

PUB248

Elderly Age, Female Gender, and Prolonged Hemodialysis Stay Related With Pathological Body Composition Bioimpedance in Ecuadorian Hemodialysis Patients

Juan C. Santacruz, Kevin G. Armijo, Nicole D. Noguera Barrera, Layla N. Baez, Veronica Gavilanes, Angel C. Santacruz. Clínica de los Riñones Menydia, Quito, Ecuador.

**Background:** Hemodialysis (HD) patients are exposed to nutritional and volume disturbances. Bioimpedance Spectroscopy (BIS) performs nutritional and hydration status analysis allowing nutritional diagnosis and dry-weight adjustment. Few is known in Ecuadorian HD population about BIS disturbances. The aim of this study was to evaluate nutritional and volume status by BIS in Ecuadorian chronic HD patients.

**Methods:** Observational, cross-sectional study, in Ecuadorian HD patients in “Clínica de los Riñones MENYDIAL”. Inclusion criteria: Age ≥ 18 years, HD for ≥ 3 months, non-prior hospitalization in last 3-month. Amputees and younger 18 years were excluded. BIS was performed prior HD session using Body Composition Monitor. Blood analysis of ferritin, transferrin, and cholesterol, were obtained.

**Results:** Totally 283 patients, 55% were male, age 56,5(±15,years), HD time 4.5(±3,6,years). BIS findings: decreased fat tissue mass 64% and sarcopenia 32%. Pathological phase angle (<4.6°): 57%, patients were older (p<0.001), mainly female (p=0.003) and longer HD stay (p=0.02). Women were related with decreased lean tissue (p<0.001) and transferrin (p=0.005) higher adipose tissue (p=0.001) ferritin (p<0.001), and cholesterol (p=0.03). BIS in water distribution revealed 73% overhydration (±2,2L), altered EC/IC water ratio (>1.1) in 73% where patients were significantly older (p<0.001). See image 1.

**Conclusions:** BIS offered accurate water distribution and body composition information which could help to identify earlier disturbances in elderly Ecuadorian HD patients with prolonged HD stays and women which were linked with protein-energy wasting syndrome findings and increased risk of mortality.

Population studied (N=283)	Results
Age (years)	56,5 (±15,0)
* Time in hemodialysis (months)	57,5 (23 – 84)
Sex	
-Male (%)	55
Body Mass Index	
Malnutrition (%)	14
Normal (%)	47
Overweight (%)	30
Obesity (%)	9
Water distribution:	
Total body water (L)	30,5 (±6,7)
Extracellular water (L)	15,3 (±3,5)
Intracellular water (L)	16,0 (±10,6)
Extracellular/intracellular water ratio	1,01 (±0,2)
Body composition:	
Lean Tissue Mass (%)	51,0 (±31,2)
Adipose Tissue Mass (%)	34,0 (±10,9)
Phase Angle 50 kHz (°)	4,4 (±1,2)
<b>Variables with statistical significance</b>	
<b>Female gender</b>	
Decreased Phase Angle (< 4,6)	*p-value 0,003
Decreased Lean Tissue Mass	< 0,001
Increased Adipose Tissue Mass	0,001
Increased Ferritin Levels (ng/mL)	< 0,001
Decreased Transferrin Levels (mg/dl)	0,005
Elevated Total Cholesterol (mg/dl)	0,03
<b>OLDER AGE</b>	
Decreased Phase Angle (< 5,0)	*p-value < 0,001
Elevated Ratio E/I (> 1,1)	< 0,001
* Values expressed in percentage or mean +/- standard deviation. * Values expressed in median and interquartile range (25 – 75). *P-values obtained chi-square test between male VS female gender. *AP-values obtained through t student test of age between non-pathological and pathological groups.	

**PUB249**

**Associations Between Albuminuria and Mortality Among US Adults With and Without Comorbidities, 1999-2019**

Yelena Drexler,<sup>1</sup> Julien Tremblay,<sup>1</sup> Robert Mesa,<sup>1</sup> Bailey Parsons,<sup>2</sup> Efrén Chavez,<sup>1</sup> Gabriel Contreras,<sup>1</sup> Alessia Fornoni,<sup>1</sup> Leopoldo Raij,<sup>1</sup> Samuel L. Swift,<sup>3</sup> Tali Elfassy,<sup>1</sup> <sup>1</sup>University of Miami School of Medicine, Miami, FL; <sup>2</sup>University of Central Florida College of Medicine, Orlando, FL; <sup>3</sup>University of New Mexico Health Sciences Center, Albuquerque, NM.

**Background:** Albuminuria is a risk factor for all-cause mortality. It remains unclear whether the association between albuminuria and mortality differs based on demographic and comorbidity factors and which populations benefit most from identifying elevations in the urine albumin-to-creatinine ratio (ACR). We assessed whether albuminuria is differentially associated with mortality by demographic characteristics and co-morbid conditions.

**Methods:** This study included 49,955 adult participants from the nationally representative National Health and Nutrition Examination Survey (1999-2018) with mortality data through 2019 linked from the National Death Index. ACR was calculated using albumin (mg)/creatinine (g) from spot urine samples and classified as: ACR <10, ≥10 to <30, ≥30 to <300, or ≥300 mg/g. We used multivariable adjusted Poisson regression models to determine the incidence density ratio (IDR) for the association between ACR category with all-cause mortality. We tested for effect modification between ACR category with demographic characteristics and comorbidities.

**Results:** Over 9.86 years of follow-up, compared with ACR <10, greater ACR was associated with increased mortality risk of 39% at ACR 10–30 (IDR: 1.39, 95% CI: 1.29–1.50), 85% at ACR 30–300 (IDR: 1.85, 95% CI: 1.70–2.02), and 125% at ACR ≥300 (IDR: 2.25, 95% CI: 1.91–2.64) after adjusting for demographic, socioeconomic, behavioral, and clinical factors. Results differed by sex and presence of comorbidities (p for interactions <0.05). For example, compared with ACR <10, ACR ≥300 was associated with increased mortality risk of 148% among women (IDR 2.48, 95% CI: 2.01–3.07), 124% among men (IDR: 2.24, 95% CI: 1.84–2.72), 125% among individuals without hypertension or hypercholesterolemia (IDR: 2.25, 95% CI: 1.60–3.16), 128% among individuals with hypertension only (IDR: 2.28, 95% CI: 1.88–2.76), and 169% among individuals with both comorbidities (IDR: 2.69, 95% CI: 2.09–3.45).

**Conclusions:** Albuminuria ≥10 mg/g is associated with increased risk of all-cause mortality. The relative mortality risk is more pronounced among women than men, and among hypertensives with hypercholesterolemia. These findings highlight the importance of albuminuria for risk stratification among US adults.

**Funding:** Other NIH Support - Dr. Elfassy is currently supported by the National Institute on Minority Health and Health Disparities (K01MD014158).

**PUB250**

**Heart Failure With Preserved Ejection Fraction (HFpEF): A Cardiologist Disorder or a Nephrologist Problem? Analysis From a Largely Hispanic Population**

Rahul Patel,<sup>1</sup> Akash Sharma,<sup>2</sup> Roma N. Ahuja,<sup>2</sup> Nghia D. Tran,<sup>2</sup> Aliseiya J. Garza,<sup>1</sup> Shweta Bansal.<sup>1</sup> <sup>1</sup>The University of Texas Health Science Center at San Antonio, San Antonio, TX; <sup>2</sup>The University of Texas Health Science Center at San Antonio Joe R and Teresa Lozano Long School of Medicine, San Antonio, TX.

**Background:** Heart failure with preserved ejection fraction (HFpEF) has been recognized as a multisystem process and chronic kidney disease (CKD) plays a central role in this paradigm. However, racial/ethnic variability and prevalence of CKD are not well described.

**Methods:** Consecutive HFpEF patients (total n=204) were identified from a HF population screened for a clinical trial from 2019-2020 (n=188) and inpatients with HF exacerbation during 2021 (n=16) at University Hospital. HFpEF was defined as symptomatic HF with left ventricular ejection fraction (LVEF) >40% on Echo. Clinical and lab variables were collected ±1 year from Echo date. Race/ethnicity was self-reported. CKD was identified from the problem list. Rates were compared with EMEROR-preserved trial's HFpEF population which was largely White.

**Results:** Of 204 HFpEF patients, 9 were Black, 14 were from other races, and due to small size were excluded from the analysis. Majority of the study population were Hispanics (130 of 181, 72%). LVEF was 40-50% in 31% of the study population. Table 1 demonstrates characteristics by EMEROR population, and Hispanics and non-Hispanic Whites (NHW) in our analysis. Of significance, our population was younger, had DM2, CAD, CKD and obesity at higher rates, and AFib and BNP at lower rates as compared to EMEROR population. The differences in Hispanics and NHW were unremarkable except more HTN and lower eGFR in Hispanics.

**Conclusions:** CKD and diabetes are highly prevalent in HFpEF patients in South Texas. In context of this observation and recent success of newer agents as empagliflozin, a multispecialty integrative approach is strongly warranted for management of HFpEF patient population.

Table 1: Baseline Characteristics of EMEROR-Preserved and South Texas HFpEF Study Populations

Variables	EMEROR-Preserved (n=5,988)	South Texas Study Population (n=181)	Hispanics (n=130)	Non-Hispanic Whites (n=51)	p-Value (EMEROR vs. Study Population)	p-Value (Hispanics vs. NHW)
<b>Demographics</b>						
Age (yr)	71.8 ± 9.5	59.8 ± 12.5	59.8 ± 12.1	59.8 ± 13.6	<0.0001	ns
Male sex, n (%)	3,353 (56)	99 (55)	72 (55)	27 (53)	ns	ns
Body mass index (kg/m <sup>2</sup> )	29.8 ± 5.8	31.9 ± 7.8	32.0 ± 7.6	31.8 ± 8.5	<0.0001	ns
<b>Comorbidities, n (%)</b>						
Type 2 diabetes mellitus (DM2)	2,938 (49)	141 (78)	105 (81)	36 (71)	<0.00001	ns
Hypertension (HTN)	5,424 (91)	171 (94)	127 (98)	44 (86)	ns	0.002
Coronary artery disease (CAD)	2,117 (35)	129 (71)	91 (70)	38 (75)	<0.00001	ns
Atrial fibrillation (AFib)	3,057 (51)	15 (8)	10 (8)	5 (10)	<0.00001	ns
CKD	2,988 (50)	127 (70)	92 (71)	35 (69)	<0.00001	ns
CKD stage 3	***	48 (27)	31 (24)	17 (33)	***	ns
CKD stage 4	***	23 (13)	17 (13)	6 (12)	***	ns
CKD stage 5	***	56 (31)	44 (34)	12 (24)	***	ns
Anemia	***	132 (73)	99 (76)	33 (65)	***	ns
<b>Laboratory</b>						
eGFR (mL/min/1.73m <sup>2</sup> ) Calculated using CKD-Epi 2021	60.6 ± 19.9	37.8 ± 29.7	34.8 ± 28.5	45.6 ± 32.4	<0.0001	0.03
Median B-type natriuretic peptide (ng/mL)	995 (500-1733)	357 (108-1487)	491 (167-1570)	220 (69-1195)	<0.05	ns

**PUB251**

**Why Can Physical Activity Reduce ESRD or CKD? Exploring the Role of the “Heart Rate Paradox”**

Chi pang Wen, Min Kuang Tsai. National Health Research Institutes, Zhunan, Taiwan.

**Background:** Physical activity has been shown to reduce chronic kidney disease/end-stage renal disease. Much of its mechanism was attributed to the reduction of risk factors associated with CKD. The role of “resting heart rate (RHR)” in its association with CKD/ESRD with physical activity involved has never been explored.

**Methods:** MJ cohort, N=543,667 adults, was recruited from participants from a private medical screening program across Taiwan (1996-2017). Each participant had data on physical activity (5 categories of MET-h/w), CKD (5 stages by eGFR and proteinuria) and RHR (10 beats/min increment from 40 based on EKD reading). Heart rate paradox connotes “rapid heart rate by vigorous exercise is required to achieve a healthier state of slower heart rate at rest”. Hazard ratios were calculated by Cox model. Some participants, active or inactive, made second visits offering data on changing RHR after engaging in physical activity.

**Results:** A 3-way associated risks were established among physical activity, RHR and CKD/ESRD on this cohort, indicating: (1) Active individuals had less CKD: 11%, 7% and 12% less for CKD, proteinuria and ESRD, respectively. (2) Faster RHR had more CKD/ESRD: Risk increased by 14% /10 beat/min increase and by 24% increase comparing ≥80/min with 60-69/min.(3) Active individuals had slower RHR: 6 beats/min difference with active and 14% less all-cause mortality. Becoming active at second visit 1-2 years later from initially inactive participants with RHR at 80-89/min (N=6269), 2/3 of them slowed RHR down to <80/min, lowered mortality, fewer CKD and gained 4 years in life expectancy.

**Conclusions:** We found slowing down RHR as an important mechanism for our observation of the ability of physical activity to reduce CKD/ESRD. CKD had faster RHR and, with vigorous exercise, “heart rate paradox” reduced CKD when RHR was reduced.

**PUB252**

**Echocardiographic Findings in ESRD Patients in Hemodialytic Treatment**

Ana E. Oliva, Frida Margarita de la Vega Méndez, Clementina Elizabeth Calderon Garcia. Hospital Civil de Guadalajara Unidad Hospitalaria Fray Antonio Alcalde, Guadalajara, Mexico.

**Background:** Chronic kidney disease is a worldwide health problem, representing approximately 15% of the population in the United States. Up to 60% of patients are in hemodialytic therapy and suffer hemodynamic, inflammatory and neurohumoral changes, associated with traditional factors such as diabetes mellitus, arterial hypertension, obesity and metabolic syndrome; which predispose more than 40% to cardiovascular diseases, leading to cardiac complications occupying the first cause of mortality worldwide in 2017. Screening and echocardiographic follow-up are of great importance to determine cardiovascular compromise and identify possible structural alterations that may develop cardiovascular diseases.

**Methods:** The present study was of an analytical retrospective, carried out in 55 chronic kidney patients undergoing hemodialysis treatment.

**Results:** The predominant gender was male 36% and the mean age was 65.5 years. The risk factors are arterial hypertension (94%) and type 2 diabetes mellitus (76.4%), which were statistically significantly related to the etiology of aortic stenosis (p = 0.005, OR: 0.52, CI: 0.130 to 2.080) and (p = 0.01, OR: 0.00, CI: 0.00 to 1.03) respectively. The prevalent echocardiographic findings were left ventricular hypertrophy (65.5%), mitral regurgitation (54.5%), aortic regurgitation (38.2%), left ventricular diastolic dysfunction (34.5%), and 80% had left ventricular ejection fraction normal.

**Conclusions:** The prevalent echocardiographic findings were left ventricular hypertrophy (65.5%), left ventricular systolic dysfunction (12.7%) and aortic insufficiency (38.2%). There was a statistically significant relationship in risk factors such as arterial hypertension and type 2 diabetes mellitus with the appearance of aortic stenosis.

Echocardiographic findings in End-stage Renal Disease Patients in Hemodialysis Treatment

Echocardiographic findings	%
Left ventricular hypertrophy	65.5
Left atrial enlargement	34.3
Left ventricular diastolic dysfunction	34.5
Left ventricular systolic dysfunction	12.7
Mitral stenosis	1.8
Mitral regurgitation	54.5
Aortic stenosis	3.6
Aortic insufficiency	38.2
Right ventricular systolic dysfunction	0

## PUB253

### Cardiorenal Units as a Strategy to Improve Outcomes in Cardiorenal Syndrome

Maria Marques Vidas, Marta Maria Cobo Marcos, Belen Garcia Magallon, Jorge Vázquez, Maria Luisa Serrano Salazar, Darío Janeiro, Jose M. Portoles. *Hopital Universitario Puerta de Hierro, Majadahonda, Spain.*

**Background:** Cardiorenal Syndrome (CRS), is often a challenging condition with paucity of evidence-based therapy. The increasing burden of this entity has prompted the creation of cardiorenal units (CRU) as integrating programs intended to provide a combined multidisciplinary approach to maximize all chances for organ and patient recovery. Here we describe the early results of the creation of one CRU

**Methods:** Observational study; all patients diagnosed with CRS, who have been seen in the cardiorenal day care unit, formed by specific trained nephrologist, cardiologist and nurses. Assessment of cardio-renal function and volume status was performed by conventional cardiac ultrasound plus V-Scan, GFR estimation by CKD EPI, NT-proBNP determination and bioelectrical impedance when indicated.

**Results:** Cardiorenal Unit of Puerta de Hierro University Hospital was created in Jan 2021. 68 patients have been evaluated with a mean follow up of 4 months (SD 3.2). Most frequent cardiologic diagnoses were 63.9% heart failure with reduced function (HFrEF) and 37.1% Heart failure with preserved ejection fraction (HFpEF) and the presence on Pulmonary Hypertension or Tricuspid regurgitation was 29.4% and 50.9%. 51.6% patients showed diuretic resistance. Most frequent renal diagnosis were pure CRS 36.9%, and 27.7% and 24.6% CRS associated to diabetic kidney disease or nephroangiosclerosis, respectively. Mean FGe rate when patients were initially evaluated was 31.5 ml/min/1.73m<sup>2</sup> (SD 11.0) with demonstration of albuminuria in 48.5% of patients. The integrated cardiorenal management of these patients included initiation or adjustment of specific cardio-nephro protective drugs (SGLT2 inhibitors (46.8%), ARNi (25.8%), aldosterone receptor antagonists (4.8%)) or diuretic regime adjustment including iv administration (54.8%). Peritoneal dialysis was indicated in 3 patients and hemodialysis in none. 13.2% patients suffer new episodes of heart failure that needed hospitalization or unexpected medical attention at the day-care clinic. One patient died during follow-up (1.5%).

**Conclusions:** We conclude that this coordinated cardio-nephro approach of CRS was useful to optimize drug therapy aimed to mid-long term goals of cardio-nephro protection and to implement advanced therapies for fluid management in patients with diuretic resistance.

## PUB254

### Effects of Uremic Toxins TMAO and PAGIn on In Vivo and Ex Vivo Vascular Function in Patients With ESRD

Samsul Arifin, Sam Hobson, Leah N. Hernandez, Peter Stenvinkel, Karolina Kublickiene. *Karolinska Institutet Institutionen för klinisk vetenskap intervention och teknik, Huddinge, Sweden.*

**Background:** Patients with end stage kidney disease (ESKD) are characterized by the aggregation of uremic toxins that have an extensive range of pathophysiological actions on organ systems. We focused on trimethylamine N-oxide (TMAO) and phenylacetyl glutamine (PAGIn) due to their proposed effects on vascular dysfunction, calcification with following increased risk for cardiovascular disease. We aimed to investigate if TMAO and PAGIn have any detrimental effects on peripheral microcirculation in ESKD patients.

**Methods:** Living-donor kidney transplantation patients were included, in which *in-vivo* endothelial function and soluble TMAO and PAGIn were assessed together with other functional and biochemical parameters. Reactive hyperemia index (RHI) and soluble TMAO and PAGIn were measured using EndoPAT and ELISA technique, respectively. For *ex-vivo* effects of TMAO and PAGIn we used organ bioassays with isolated small vessels from subcutaneous fat biopsies donated from non-CKD participants. Briefly, isolated arteries were cultured under controlled conditions with and without addition of 10µM TMAO or 100µM PAGIn. After 24 hours arteries were mounted on Myography system to assess of vascular function and structure.

**Results:** Circulating TMAO correlated with RHI in patients with ESKD ( $\rho=0.255$ ,  $p<0.05$ ,  $n=64$ ). This correlation existed in males ( $\rho=0.286$ ,  $p<0.05$ ,  $n=49$ ) but not in females ( $\rho=0.157$ ,  $p>0.05$ ,  $n=15$ ). The arteries from ESKD patients with higher circulating PAGIn ( $>49.38\mu\text{g/mL}$ ) showed increased adrenergic tone ( $p<0.05$ ,  $n=17$ ) and reduced endothelium independent dilatation ( $p<0.05$ ,  $n=20$ ). Isolated artery bioassay with

TMAO showed preserved overall endothelial function, but contribution of endothelium-derived hyperpolarizing factor (EDHF) vs. nitric oxide (NO) was reduced ( $p<0.05$ ,  $n=8$ ). After PAGIn, the overall endothelium dependent dilatation was reduced and both EDHF & NO contribution impaired ( $p<0.05$ ,  $n=8$ ). No effects of TMAO and PAGIn were observed on contractile function or structure.

**Conclusions:** Uremic toxins such as TMAO and PAGIn are associated with adverse effects on peripheral microcirculation in patients with ESKD. Further studies are ongoing to assess how TMAO and PAGIn affects NO vs EDHF pathways.

**Funding:** Private Foundation Support, Government Support - Non-U.S.

## PUB255

### Does Gender Affect Electrophysiological Properties of Neurons With Axons From the Kidney?

Kristina Rodionova,<sup>1</sup> Tilmann Ditting,<sup>1,2</sup> Johannes Döllner,<sup>1</sup> Nada Cordasic,<sup>1</sup> Karl F. Hilgers,<sup>1</sup> Peter Linz,<sup>1</sup> Christian Ott,<sup>1,2</sup> Roland E. Schmieder,<sup>1</sup> Mario Schiffer,<sup>1</sup> Kerstin U. Amann,<sup>1</sup> Roland Veelken,<sup>1,2</sup> *Friedrich-Alexander-Universität Erlangen-Nuremberg Medizinische Fakultät, Erlangen, Germany;* <sup>2</sup>*Paracelsus Private Medical University Nuremberg, Nuremberg, Germany.*

**Background:** Previously we reported on a complex composition of afferent nerves from the kidney comprising highly active tonic and less active phasic neurons. The portion of the latter is significantly increased in renal inflammation and hypertension likely impairing the sympathetic control by afferent renal nerves. Androgens were reported to act on sensitive afferent nerve structures. Hence we wanted to test the hypothesis that the function of neurons with renal afferents is subject to sexual dimorphism.

**Methods:** Three groups of SD rats (male, female and ovariectomized female) were investigated. Renal neurons were retrogradely labeled with DiI. In culture, labeled dorsal root ganglion neurons (DRG Th11-L2) with renal afferents were investigated electrophysiologically using current clamp mode to assess action potential generation during current injection (neurons were characterized as tonic highly active ( $>5$  action potentials, AP) and phasic less active neurons ( $\leq 5$  AP upon stimulation). Rats were matched for body weight and age.

**Results:** In neurons from male and female rats, the relation of tonic highly active neurons to less active phasic neurons did not differ significantly (82% tonic neurons in male vs. 79% in female, z-test). No significant differences in the firing pattern of renal neurons were also observed in ovariectomized females as compared to males and females that were not ovariectomized. Threshold of action potential generation and duration of action potentials did likewise not differ between the various groups investigated.

**Conclusions:** Although sexual dimorphism may occur in the nervous control of visceral organs like the kidney it proved to be not obvious with respect to the renal afferent innervation. In how far afferent renal nerve fibers from male and females may have a different influence on central sympathetic outflow remains to be determined.

## PUB256

### An Eye to the Future: Development of a Metabolic-Renal-Cardiac (MRC) Service

Saif Al-Chalabi,<sup>1,2</sup> Saira Nawaz,<sup>2</sup> Helen Alderson,<sup>1</sup> Philip A. Kalra,<sup>1</sup> Dimitrios J. Poulidakos,<sup>1</sup> James Ritchie,<sup>1</sup> Smeeta Sinha,<sup>1</sup> *Northern Care Alliance NHS Foundation Trust, Salford, United Kingdom;* <sup>2</sup>*The University of Manchester Faculty of Biology Medicine and Health, Manchester, United Kingdom.*

**Background:** Diabetes mellitus (DM), chronic kidney disease (CKD), and cardiovascular diseases (CVD) share common risk factors, often co-exist together, and are associated with poor outcomes. With the emergence of cardio-renal-metabolic protective medications, it is time to manage these conditions as one entity: cardiorenal metabolic syndrome (CRS). Here we report on the development of our own MRC clinic and describe the MRC clinic cohort.

**Methods:** The clinic was designed to provide diabetology and cardiology input in addition to nephrology care for patients with CRS. The majority of referrals were patients with cardio-renal syndrome or advanced diabetic nephropathy. A retrospective analysis was done for all patients that attended the MRC clinic in the first 8 months since establishment (1/3/2021-1/11/2021). Demographic data as well as data on chronic kidney disease stage, metabolic and cardiovascular morbidity and medication uptake was collected.

**Results:** The MRC clinic was founded by a dedicated team of nephrologists with a special interest in CVD and DM. A total cohort of 209 patients were seen in the MRC clinic during the first 8 months with more than 450 patient visits. The median age was 71 years (IQR 59-78) with a predominance of males (56%). Patients with CKD stage 3 or 4 accounted for 85% of patients and 73.2% had DM. Patients had a significant burden of CVD: 47.8% heart failure 50.2% hypertension, 34% ischemic heart disease. Use of key medications at MRC entry was sub-optimal with 59.8% receiving renin-angiotensin-aldosterone (RAAS) inhibitors, 22% sodium-glucose cotransporter 2 inhibitors, 23.9% mineralocorticoid antagonist (MRA), and 63.6% receiving beta-blockers. Potassium binders were prescribed for 24 patients (11.5%) to facilitate optimisation of RAAS inhibition and MRA use.

**Conclusions:** Optimisation of disease modifying medications was sub-optimal in the patients at referral into the MRC service. The MRC clinic provides an opportunity to improve medicines optimisation as well addressing risk factors for disease progression e.g. blood pressure and glycaemic control. An effective multi-morbidity service should also incorporate patient and clinician education with integrated care pathways and multi-disciplinary review, and these facets are being developed within our local service.

**Funding:** Commercial Support - AstraZeneca

Key: TH - Thursday; FR - Friday; SA - Saturday; OR - Oral; PO - Poster; PUB - Publication Only

Underline represents presenting author.

## PUB257

**Metabolic Cage Housing Alters Heart Rate Variability in Male Adrenal-Specific BMAL1 KO Mice**

Victor M. Mendez, Cheoting C. Maugans, Hannah M. Costello, G. R. Crislip, I. Jeanette Lynch, Kityan Cheng, Lauren G. Douma, Michelle L. Gumz. *University of Florida, Gainesville, FL.*

**Background:** The clock protein BMAL1 is a transcription factor that regulates many genes that set the physiological clock in motion, generating circadian rhythms in regulated variables including heart rate (HR). BMAL1 action is also important for the regulation of physiological functions independent of timing to maintain homeostasis. Previous work in the lab has shown altered HR rhythm in male adrenal-specific BMAL1 knockout (AS-BMAL1 KO) mice. Changes in HR may be associated with adverse cardiorenal outcomes. The time intervals between adjacent heart beats (RR intervals) can be studied to determine HR variability (HRV), which can provide insight into changes in HR and autonomic system balance. The goal of this study was to determine the role of adrenal BMAL1 in the regulation of HRV.

**Methods:** AS-BMAL1 KO and control male mice ( $n=5-6$ ) were implanted with telemeters. Mice then recovered for 10 days before 4 days of HR baseline measurements were made in home cages. Mice were then placed in metabolic cages and HR was collected over 5 days. HR was collected at 1000Hz for 2 mins every 3 hrs on the last day of home and metabolic cage recordings. Time- and frequency-domain analyses were performed using Kubios software with pre-determined high frequency (HF) and low frequency (LF). An index of parasympathetic and sympathetic nervous system (PNS and SNS) activity was also calculated.

**Results:** For AS-BMAL1 KO male mice and controls housed in home cages, changes in RR intervals, LF and HF variability, and LF/HF ratio were not apparent. Kubios-generated indexes of PNS and SNS activity showed no difference between KO mice and controls. When mice were placed in metabolic cages, HR increased and there was a significant genotype effect in LF/HF ratio (ANOVA genotype  $p=0.0232$ ). Additionally, time-dependent effects in LF and HF variability were also present (ANOVA time  $p=0.0356$  and  $p=0.0258$ , respectively). Differences in indexes of PNS and SNS activity were not apparent.

**Conclusions:** Adrenal BMAL1 influences LF/HF ratio only when mice were in metabolic cages, which acted as a stressor, but does not impact indexes of PNS and SNS activity. Future work will focus on understanding the mechanisms behind changes in HR in AS-BMAL1 KO mice and the role of adrenal BMAL1 on HR/HRV in females.

**Funding:** Private Foundation Support

## PUB258

**Nephrology Chronicles: Stone Baby**

Muhammad F. Habib, Haris Mobeen. *SUNY Upstate Medical University, Syracuse, NY.*

**Introduction:** Lithopedion is an extrauterine pregnancy resulting from fetus death and calcification. It is extremely rare with an increased incidence in geographical areas with poor socio-economic conditions and lack of adequate medical care.

**Case Description:** A 50-year-old Congolese female refugee presented for hypertension (HTN) evaluation with an initial BP of 160/90 and labs showing CKD G2/A1. In 2012, she had a 3<sup>rd</sup> trimester missed miscarriage secondary to an abdominal ectopic pregnancy. At the time, due to inadequate medical resources in Congo, she was unable to have products of conception removed and this was left unattended for 9 years. Upon her arrival to the U.S. in 2021, an US A/P with her PCP showed a calcified pregnancy. CT A/P revealed a 92 x 176 x 155 mm extrauterine lithopedion causing bowel obstruction, IVC compression with collaterals and significant compression of pelvic structures. Patient was worked up for secondary causes of HTN, which were normal. Renal doppler ultrasound was ordered, but patient missed her appointments. She was treated with ACE-inhibitors with relative normalization of blood pressures.

**Discussion:** Lithopedion is an extremely rare event with approximately 300 reported cases over 400 years of medical literature. It was 1<sup>st</sup> described by Albucasis in the 10<sup>th</sup> century and has been associated with hypertensive cerebrovascular events and bowel obstruction. In our patient, inadequate medical care led to lithopedion being unattended for over 9 years. The mechanism of HTN is unclear in these patients and the exact physiology can only be postulated. A myriad of physiological changes could have caused her HTN; sustained sympathetic activity with increased peripheral vascular resistance as well as persistence of gestational alterations of renin-angiotensin-aldosterone system with lithopedion can be one explanation. However, other mechanisms like compressive effect of lithopedion on the abdominal vasculature like aorta and renal arteries might have also led to our patient's HTN. A much simpler explanation such as essential HTN is always a possibility. The paucity of medical literature on the subject makes it difficult to understand the exact physiology of development of HTN in lithopedion patients. Hence, we present this case to the nephrology community to discuss and better understand the complex physiological interplay that could have happened in our patient with a lithopedion leading to HTN.

## PUB259

**Uremic Toxins Promote Early Vascular Ageing in CKD**

Sam Hobson, Samsul Arefin, Leah N. Hernandez, Chiara Leotta, Peter Stenvinkel, Karolina Kublickiene. *Karolinska Institutet, Stockholm, Sweden.*

**Background:** Chronic kidney disease (CKD) is a clinical model of premature ageing, a phenomenon described as a discrepancy between chronological and biological age. One system affected is the vasculature, termed early vascular ageing (EVA), characterized by endothelial dysfunction, arteriosclerosis, and vascular calcification. Multiple uremic toxins that accumulate as renal function declines have been independently associated with EVA, cardiovascular disease, and mortality in CKD patients. These compounds include indoxyl sulphate (IS), trimethylamine N-oxide (TMAO), and phenyl acetyl glutamine (PAG). In recent years, the pathogenic roles of distinct uremic toxins and how they contribute to progress CKD have been elucidated, however an exhaustive list of mechanisms that promote EVA are far from complete.

**Methods:** We aimed to better understand how the aforementioned toxins drive specific components of EVA using a combination of experimental techniques.

**Results:** Firstly, implementing an *in vitro* calcification assay using uremic serum from CKD G5 patients, we demonstrated uremic serum-induced calcification in aortic vascular smooth muscle cells (aVSMCs) was associated with reduced NRF2 expression, the master regulator of antioxidant genes, as well as downstream targets of NRF2. Next, to investigate the role of individual toxins, we found that TMAO, but not PAG, associated with coronary artery calcification (CAC) score in a binational CKD G4-5 cohort ( $n=388$ ), which further associated with oxidative stress/advanced glycated end-product generation. To adopt a translational approach, we found TMAO, but not PAG, promoted calcification in aVSMCs and vessel rings isolated from CKD G5 patients undergoing living donor-kidney transplantation (LD-KTx). Finally, in a separate study, we showed that IS, a protein-bound uremic toxin, negatively correlated with reactive hyperaemia index, an *in vivo* marker of endothelial dysfunction, at baseline and 2-years after LD-KTx. Preliminary wire myography experiments in resistance vessels suggest IS may affect endothelial function.

**Conclusions:** In summary, we have used a plethora of experimental techniques to give new insights into how uremic toxins detrimentally effect the vessel wall in uremic conditions. Further experiments are required determine whether use of therapeutics to target these pathways can delay the onset of EVA.

**Funding:** Private Foundation Support, Government Support - Non-U.S.

## PUB260

**Multiple Renal Cysts**

Roy Rajan,<sup>1,2</sup> Clay A. Block,<sup>1,2</sup> Thomas M. Kaneko,<sup>1,2</sup> Charles W. Hopley,<sup>1,2</sup> <sup>1</sup>Dartmouth-Hitchcock Health GraniteOne, Lebanon, NH; <sup>2</sup>Dartmouth College Geisel School of Medicine, Hanover, NH.

**Introduction:** Hyperaldosteronism can cause hypertension and hypokalemia. Chronic hypokalemia in turn can lead to renal scarring and cystogenesis in the kidneys.

**Case Description:** A 77-year-old man was referred for numerous bilateral kidney cysts up to 8.9 cm, identified on CT obtained to investigate for renal artery stenosis. He had been on antihypertensive medications for more than 25 years. Hypokalemia had been present for at least 10 years and had persisted even when diuretic therapy was discontinued. His medical history includes CKD stage 2-3a, prostate cancer in remission, GERD, and hypothyroidism. His medications were atenolol, amlodipine, losartan, potassium chloride 10mEq daily, and levothyroxine. There was no family history of kidney disease. The BP was 138/78 and the physical examination unremarkable. Morning plasma aldosterone-to-renin ratio was followed by salt-loading and measurement of 24-hr urine aldosterone were diagnostic of primary aldosteronism. Patient elected for medical therapy with a mineralocorticoid receptor blocker. His BP control improved and his potassium normalized.

**Discussion:** The differential diagnosis of bilateral kidney cysts includes genetic conditions (ADPKD) and acquired conditions like advanced CKD or ESKD and medications such as lithium. Less appreciated is the role of chronic hypokalemia in the induction of cyst formation. Hypokalemia induces intra-cellular acidosis by promoting K<sup>+</sup> efflux, which in turn promotes H<sup>+</sup> influx into cells causing intracellular acidosis. This has been proposed to increase ammonia genesis, which activates complements and causes tubular damage, causing cell growth and proliferation and alteration in cytokines leading to cyst formation. Cyst formation might be reversible if hypokalemia is corrected early in the course. Primary hyperaldosteronism may increase activity of Na<sup>+</sup> + K<sup>+</sup> ATPase causing increased intra cellular K<sup>+</sup> contributing to its efflux. Our patient did not have a family history of renal disease and due to his advanced age with relatively normal kidney function, it is unlikely due to a genetic renal disease.



**PUB261**

**Type B Lactic Acidosis in a Patient With Metastatic Rectal Cancer**

Supriya Gerardin,<sup>1</sup> Latoya N. Gayle,<sup>2</sup> Aisha Shaikh,<sup>1,2</sup> <sup>1</sup>Memorial Sloan Kettering Cancer Center, New York, NY; <sup>2</sup>Weill Cornell Medicine, New York, NY.

**Introduction:** Lactic acidosis in the absence of systemic hypoperfusion is due to type B lactic acidosis. Type B lactic acidosis has been observed in malignancies, but the underlying pathogenesis is poorly understood. Type B lactic acidosis is rare in cancer patients, but when it occurs, it is commonly observed in hematological malignancies and rarely with solid organ tumors. Here we describe a case of type B lactic acidosis in a patient with acute liver failure due to metastatic rectal cancer.

**Case Description:** A 50-year-old man with metastatic rectal cancer presented to the hospital with severe lower back pain due to a pathologic fracture of L3. He was normotensive, and his heart rate, temperature, and oxygen saturation were normal. Laboratory tests revealed high anion gap metabolic acidosis (31.5) due to severe lactic acidosis (> 11.9 mmol/L) (Table). Kidney function was normal; blood and urine cultures were negative, and there was no evidence of an underlying infection. CT scan showed complete replacement of the liver parenchyma due to numerous metastases. Over the next 48-hours, the patient developed acute liver failure and became encephalopathic. Due to extensive metastatic disease, the patient transitioned to palliative care and passed away.

**Discussion:** Type B lactic acidosis in malignancy can be caused by increased lactate production and decreased lactate clearance. The increase in lactate production can be due to hepatic glycolysis, anaerobic glycolysis in tumor cells (Warburg effect), paracrine actions of tumor necrosis factor- $\alpha$ , and vitamin deficiency. The decrease in lactate clearance occurs in severe liver disease. Treatment of type B lactic acidosis is directed toward treating the underlying malignancy. In this case, increased lactate production by tumor cells and decreased hepatic lactate clearance caused type B lactic acidosis. The decreased hepatic lactate clearance was due to metastatic liver disease. Type B lactic acidosis is rare and awareness of this entity can lead to prompt diagnosis and management of malignancy.

Laboratory test (reference range)	Day of admission	2-days after admission
Sodium (133-143 mEq/L)	132	134
Potassium (3.3-4.9 mEq/L)	4.9	4.4
Chloride (98-109 mEq/L)	94	95
Bicarbonate (18-29 mEq/L)	9	15
Blood urea nitrogen (6-20 mg/dL)	10	9
Creatinine (0.6-1.3 mg/dL)	0.5	0.5
Lactic acid (0.5-2.0 mmol/L)	> 11.9	>11.9
Albumin ((3.8-5.0 g/dL)	3.0	3.1
Anion gap (8-16 mEq/L)	31.5	26
Glucose (70-140 mg/dL)	65	62
Bilirubin, direct ( $\leq$ 0.5 mg/dL)	4.5	-
Alkaline phosphatase ( $\leq$ 130 U/L)	1101	806
Alanine aminotransferase ( $\leq$ 55 U/L)	42	309
Aspartate aminotransferase ( $\leq$ 37 U/L)	102	411
Ammonia (0-50 mcM/L)	-	141
pH, venous	7.32	7.29
pCO <sub>2</sub> , venous	34	33

**PUB262**

**AKI due to Waldenström Macroglobulinaemia Manifesting as Acute Tubular Necrosis**

Michelle Madden,<sup>1</sup> Mairead Hamill,<sup>1</sup> Brendan Doyle,<sup>2</sup> Catherine M. Brown,<sup>1</sup> Sean F. Leavey,<sup>1</sup> <sup>1</sup>University Hospital Waterford, Waterford, Ireland; <sup>2</sup>Beaumont Hospital, Dublin, Ireland.

**Introduction:** A sixty-one year old man was referred with an elevated creatinine of 2.6mg/dL (eGFR 25ml/min) detected on a routine screening blood test. Creatinine had been 0.85mg/dL eight months previously.

**Case Description:** There was no relevant medical history and no regular medications. He described no systemic symptoms, no recent illness and no ingestion of new medications or toxins. Physical examination was unremarkable. Urinalysis showed trace blood, negative for protein, glucose and leukocyte esterase. The urine albumin/creatinine and protein/creatinine ratios were normal, but lambda light chains were detected in trace quantities on immunofixation. Blood tests showed a 12.5g/L IgM lambda monoclonal paraprotein. Bone marrow biopsy detected no excess plasma cells and only a mild increase in B cell lymphoid population to 10%. Ultrasound demonstrated normal size kidneys with no evidence of obstruction. A skeletal survey was negative for bony lesions. In the absence of a clear haematologic indication to commence treatment for monoclonal gammopathy, a kidney biopsy was performed. This showed acute tubular necrosis but there was no demonstrable evidence of cast nephropathy, lymphomatous infiltration, abnormal light chain or immunoglobulin accumulation/ deposition on immunofluorescence or on electron microscopy; thus not pathognomonic for paraprotein-mediated kidney injury. Plasma viscosity measured within the normal range. Kidney function was monitored closely for a few more weeks before a decision to proceed with clonally directed therapy. The patient's eGFR was in the 20-25 ml/min range for 8 weeks from initial diagnosis to initiation of therapy. He received six cycles of cyclophosphamide, rituximab and dexamethasone. Paraprotein reduced from 12.5g/L to 1.1g/L and creatinine reduced in tandem to 0.93mg/dL after three months of chemotherapy, remaining stable twelve months later.

**Discussion:** Paraproteins cause both glomerular and tubular patterns of injury, but acute tubular necrosis without demonstrable paraprotein or a cast nephropathy has been rarely described as a presentation in Waldenström macroglobulinemia. The acute kidney injury resolved with clonally directed therapy. This case highlights the importance of considering a monoclonal paraprotein as potentially pathogenic in otherwise unexplained presentations of acute tubular necrosis.

**PUB263**

**Carfilzomib-Associated Accelerated Hypertension**

Niloufarsadat Yarandi,<sup>1</sup> Nelson Leung,<sup>1,2</sup> <sup>1</sup>Mayo Clinic Division of Nephrology and Hypertension, Rochester, MN; <sup>2</sup>Mayo Clinic Division of Hematology, Rochester, MN.

**Introduction:** Carfilzomib is a highly selective irreversible second-generation proteasome inhibitor, currently used for relapsed refractory multiple myeloma (MM). Hypertension (HTN) is one of the most common cardiovascular adverse events (CVAEs) of carfilzomib which may lead to treatment interruption.

**Case Description:** 77-year-old female with history of marginal zone lymphoma and well-controlled HTN on hydrochlorothiazide 25 mg daily and spironolactone 25mg daily, was diagnosed with IgG lambda MM. Creatinine 0.8 mg/dL, Kappa free light chain (FLC) 0.26 mg/dL, Lambda FLC 25.2 mg/dL, kappa/lambda FLC 0.010, IgG 6060 mg/dL. The patient had multiple lines of therapy but due to either disease progression or drug intolerance was eventually transitioned to carfilzomib/dexamethasone(Kd) when her BP noted to increase. She did not tolerate amlodipine and nifedipine due to lower extremity edema and ultimately was maintained on benazepril 40 mg daily, carvedilol 12.5 mg twice daily and chlorthalidone 25 mg daily. The patient developed accelerated HTN after cycle 6 of carfilzomib with BP of 205/165 mmHg. There was no neurologic deficit or signs of volume overload. CT scan did not show any acute intracranial pathology. She was stabilized in the ICU and later downgraded to the floor. Isosorbide mononitrate 10 mg daily to antihypertensive regimen. Her creatinine increased to 1.13 mg/dL by day 2 of hospital stay. Upon discharge, her BP was 134/56 and was restarted on full-dose carfilzomib 2 days after. BP remained well-controlled.

**Discussion:** ENDEAVOR and ASPIRE showed improvements in progression-free survival (PFS) and overall survival with twice-weekly carfilzomib-based therapy. In ARROW, once-weekly Kd improved PFS and overall response rate compared to twice-weekly Kd. Older patients with lower kidney function experienced more adverse events. HTN is one of the most common CVAEs reported. Oxidative stress on cardiac myocytes, increase in vascular tone and reactivity, vascular dysfunction caused by endothelial effects of proteasome inhibition are proposed mechanisms for CVAE and HTN associated with Carfilzomib. Nifedipine and nitroglycerin can reduce spasmodic effect of carfilzomib. Therefore, long-acting nitrates and dihydropyridine calcium channel blocker are preferred in treatment of carfilzomib-associated hypertension. Effective management of the adverse event allows patients to continue with their life-saving therapy.

PUB264

**Incubation in Michel Transport Medium as a Diagnostic Tool to Differentiate Between Calcium Oxalate and 2,8-Dihydroxyadenine Tubular Crystals in a Kidney Biopsy**

Dalia Y. Ibrahim, Laura Biederman, Tibor Nadasdy, Anjali A. Satoskar, Sergey V. Brodsky. *The Ohio State University, Columbus, OH.*

**Background:** Differential diagnosis of crystal deposition in the kidney is one of the challenging areas of renal pathology. Some crystals (such as calcium oxalate and 2,8-dihydroxyadenine (DHA)) show bright birefringence under the polarized light. We had earlier reported that calcium oxalate crystals dissolve in Michel transport medium (MTM).

**Methods:** To analyze the utility of MTM as a differential diagnostic tool between calcium oxalate and DHA crystals, we incubated kidney biopsy cores (3 patients with calcium oxalate nephropathy), not previously exposed to MTM, in MTM for 24h.

**Results:** A patient with end stage kidney disease secondary to DHA crystal deposition had early recurrence of the disease in a kidney allograft 4 weeks post-transplant. In a kidney allograft biopsy, brown, calcium oxalate-like, brightly birefringent crystals were noted in the tubules both in formalin fixed paraffin sections and in frozen sections cut from the snap frozen tissue (Figure 1 A, B). This tissue was exposed to MTM prior to freezing. To compare, 3 kidney biopsies with calcium oxalate tubular deposits where tissue was not exposed to MTM, were used. In fresh frozen tissue sections, numerous birefringent calcium oxalate crystals were seen (Figure 1, E). After 24-hour incubation of the biopsy cores in MTM, the birefringent calcium oxalate crystals disappeared in all 3 cases. Next, we incubated unstained sections of frozen tissue that was not exposed to MTM prior to freezing from cases with calcium oxalate crystals; as well as sections of frozen tissue from the case with DHA crystals for 2h, 8h and 24 hours. Incubation for 2 h, 8h and 24h resulted in dissolving of calcium oxalate crystals in all 3 biopsies (Figure 1, F) but not DHA crystals (Figure 1, C).

**Conclusions:** We suggest that exposure to MTM may be helpful in patients with birefringent crystal deposition in frozen tissue.

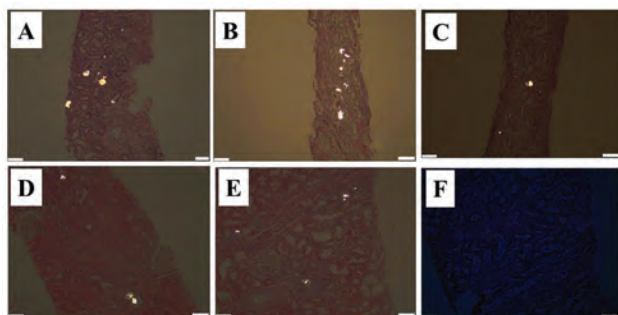

**Figure 1. Polarization of sections with tubular crystal deposits.** Sections of kidney biopsy with 2,8-dihydroxyadenine (A-C) or calcium oxalate (D-F) tubular deposits were analyzed under the polarized light. A, D – sections of paraffin-embedded tissue. B – sections of frozen tissue that was exposed to Michel transport medium (MTM) for 24 h as a biopsy core. C – slide with sections was exposed to MTM for 24 h. E – section of fresh frozen tissue prior to incubation in MTM. F – slide with sections was exposed to MTM for 24 h. Magnification 100x.

PUB265

**How Can Hemolysis Affect a Urine Protein Electrophoresis Test? A Case of Proteinuria due to Postartemisinin Delayed Hemolysis**

Christina L. Tamargo, Sandra I. Vazquez Salas, Jose M. Monroy-Trujillo. *Johns Hopkins Medicine, Baltimore, MD.*

**Introduction:** Proteinuria on urine dipstick typically reflects albumin, but it can reflect other proteins. Furthermore, hemolysis can affect proteinuria and urine protein analyses. Here we report a case of proteinuria due to hemolysis after malaria treatment with artemether/lumefantrine.

**Case Description:** A 22-year-old woman with no past medical history was referred to the emergency department because of lightheadedness and dyspnea in clinic. She had been discharged three days prior after a hospitalization for *Plasmodium falciparum* malaria; she completed a course of artemether/lumefantrine during that stay. On admission she was tachycardic and febrile, with labs notable for hemoglobin 6.5, platelets 339, Cr 0.7 mg/dL, AST 88, ALT 39, total bilirubin 3.5 mg/dL (direct 3.4), LDH 1680, haptoglobin <3 mg/dL, fibrinogen 214 mg/dL, and negative direct antiglobulin test. Urinalysis showed 2+ protein, large hemoglobin, and 2 RBC/hpf, with urine pH of 7.0. 24-hour urine protein electrophoresis (UPEP) later revealed 1440 mg protein/day (165 mg albumin, 108 mg alpha-1 globulin, 876 mg alpha-2 globulin, 108 mg beta globulin, 183 mg gamma globulin). Urine microalbumin-to-creatinine ratio was 124 mg albumin/g creatinine. Her proteinuria was deemed to be secondary to postartemisinin delayed hemolysis.

**Discussion:** The protein detected on urine dipstick is typically only albumin, though false positives can occur with hematuria and alkaline urine. In this case, while the patient had microalbuminuria, alpha-2-globulin was the most elevated component on her UPEP (Figure 1). Alpha-2-globulin is usually increased as an acute-phase reactant; however, it also contains haptoglobin. During hemolysis, hemoglobin-haptoglobin complexes can form and create a large band in the alpha-2-globulin region. Given the hemolysis confirmed on her other laboratory workup, this patient's proteinuria was likely due to formation of such complexes, with possible contribution from microalbuminuria and/or false positive urine dipstick. This case highlights the importance of 24-hour UPEP in the evaluation of proteinuria.

Key: TH - Thursday; FR - Friday; SA - Saturday; OR - Oral; PO - Poster; PUB - Publication Only  
Underline represents presenting author.

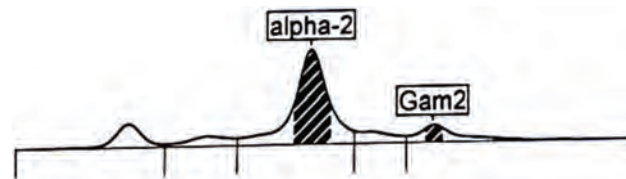

Figure 1. UPEP

PUB266

**A Retrospective Review of Kidney Biopsy: What's Time and Needle Got to Do With It?**

Larab L. Giniyani,<sup>1,2</sup> Andrew A. Moses,<sup>1,2</sup> Maria V. DeVita,<sup>1,2</sup> Jordan L. Rosenstock.<sup>1,2</sup> <sup>1</sup>Lenox Hill Hospital, New York, NY; <sup>2</sup>Northwell Health, New Hyde Park, NY.

**Background:** The in-center observation time (OT) needed post-kidney biopsy is controversial. A recent review suggested 6-8 hours after biopsy because most complications have been detected by this time. At our institution we aimed to lower the OT after outpatient kidney biopsies. Initially, since 2015 we were monitoring for less than 6 hours and gradually began to decrease the OT over time. From 2020 we have adopted an OT of less than 4 hours. From 2018 onwards, we also began using a smaller gauge needle (18 gauge).

**Methods:** We reviewed all outpatient kidney biopsies performed by the nephrology division at our institution from 2015 until 2022.

**Results:** All patients had a hemoglobin checked after the biopsy and prior to discharge. There were 107 biopsies reviewed. 69 had OT of 4-6 hours and 38 had OT < 4 hours. There was a total of 4 complications (3.74%). Two complications, symptomatic retroperitoneal bleeds, were detected in less than 3 hours. The other 2 complications were seen at 9 hours (clot retention) and 72 hours (retroperitoneal bleed after anticoagulation restarted). Forty nine percent of the biopsies were done using 18-gauge needles with 1 complication in this group versus 3 in the 16 gauge group. All cases had adequate tissue for interpretation.

**Conclusions:** In summary, in an outpatient population, it does not appear that post biopsy OT between 3 and 8 hours is necessary to identify complications as complications developing during this time period are uncommon. Furthermore, an 18-gauge needle may lower the risk of complications and obtains adequate tissue.

**Major Complications of Kidney Biopsy from 2015 -2022**

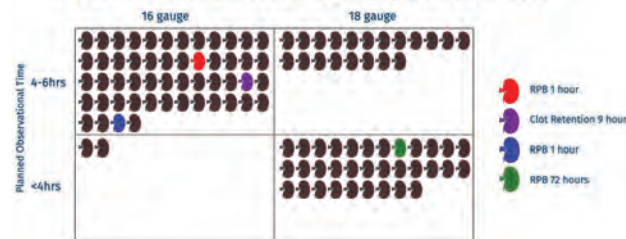

Each kidney represents a kidney biopsy. The complications are in different colors as explained in the legend. Retroperitoneal bleed within 48hrs.

PUB267

**Light-Chain Amyloidosis With Concurrent Apolipoprotein A4 Amyloidosis in a Case of Autosomal Dominant Polycystic Kidney Disease**

Atsuko Uehara,<sup>1</sup> Daisuke Ichikawa,<sup>1</sup> Tsutomu Sakurada,<sup>1</sup> Akira Shimizu,<sup>3</sup> Yugo Shibagaki,<sup>1</sup> Tomo Suzuki.<sup>1,2</sup> <sup>1</sup>Sei Marianna Ika Daigaku, Kawasaki, Japan; <sup>2</sup>Kameda Medical Center, Kamogawa, Japan; <sup>3</sup>Nihon Ika Daigaku Fuzoku Byoin, Bunkyo-ku, Japan.

**Introduction:** Most cases of amyloidosis are caused by the deposition of a single amyloid protein, and the deposition of two or more proteins is rare. We describe a case of autosomal dominant polycystic kidney disease (ADPKD) who developed progressing kidney disease due to concurrent immunoglobulin light chain (AL) and apolipoprotein A4 (ApoA4) amyloidosis.

**Case Description:** The patient was a 54-year-old man who was referred to our hospital because of chronic kidney disease (CKD) with serum creatinine (sCr) of 1.3 mg/dL. Based on the presence of multiple kidney cysts and family history with PKD2 mutation, he was diagnosed as CKD due to ADPKD. Since his sCr doubled within a year, he underwent kidney biopsy, which showed amorphous deposits localized in the interstitium stained positive with Congo red. The deposits were strongly positive for PAS staining, which was atypical of amyloidosis. Immunofluorescence revealed kappa restricted staining. Electron microscopy revealed the deposition of amyloid fibrils. With amyloid detected within his bone marrow, he was diagnosed as AL amyloidosis and underwent autologous hematopoietic stem cell transplantation. Later, laser microdissection-liquid chromatography-tandem mass spectrometry (LC-MS/MS) detected ApoA4 and kappa

in the kidney tissue. Immunohistochemistry stainings also revealed co-deposition of kappa and ApoA4. Therefore, we concluded that our case was concurrent AL and ApoA4 amyloidosis.

**Discussion:** This is the first case of concurrent AL and ApoA4 amyloidosis developed in a case with ADPKD. Concurrent AL amyloidosis might be different from single AL amyloidosis regarding symptoms and treatment responsiveness. Therefore, it is important to accurately diagnose amyloidosis using LC-MS/MS when kidney biopsy findings are atypical of AL amyloidosis.

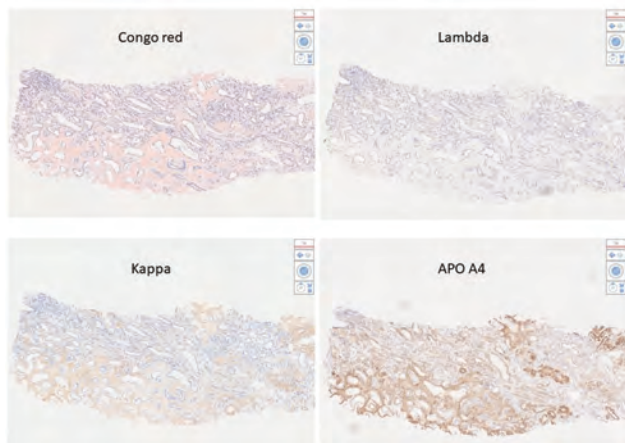

Immunohistochemistry stainings of kidney tissue revealed similar distribution of kappa and ApoA4.

## PUB268

### Using miR21 as a Marker of AKI in Nephrolithiasis

Roma N. Ahuja, Sitai Liang, Ronald Rodriguez, Dean Bacich. *The University of Texas Health Science Center at San Antonio, San Antonio, TX.*

**Background:** Perturbation of miRNA expression regulates inflammation and fibrosis. In animal studies, sustained high grade renal obstruction results in miR-21 induction which then targets a series of genes resulting in increased collagen deposition and interstitial fibrosis. miR-21 is therefore predictive of later stage renal fibrosis, and its profile could be a promising biomarker for the acute renal injury. We sought to explore this relationship in human populations.

**Methods:** Blood samples from patients presenting to the emergency department for acute renal colic due to kidney stones were collected at the time of presentation and again one month after definitive treatment to serve as a baseline for miR-21 expression. They were compared against a control group with no history of nephrolithiasis. RT-PCR was used to quantify miR-21 expression.

**Results:** The relative fold change was calculated using the miR-21 expression levels at time of presentation and one month after completion of stone treatment and then compared against controls. The experimental group had a higher average upregulation than the non-stone patients, however this difference was not statistically significant (Figure 1).

**Conclusions:** Kidney damage is measured through serum BUN and Cr, however both markers are indicative of irreversible damage. miR-21 is unique as its elevation occurs during the reversible phase of injury, and therefore has the propensity to serve as a definitive marker of acute kidney injury. Animal studies found that expression levels rose in obstructive cases. We hypothesized expression levels of miR21 would be elevated at least two-fold in nephrolithiasis patients relative to normal controls. We performed a prospective non-randomized pilot study measuring miR-21 expression in urolithiasis patients presenting to the emergency department compared against non-stone controls. In this cohort, we were unable to demonstrate that miR-21 can be used as a marker of acute kidney injury.

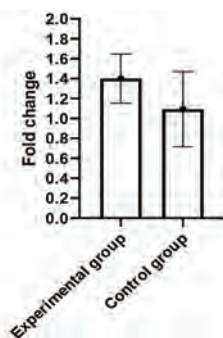

Figure 1. Relative fold change of miR-21 from time of presentation to ED compared to baseline levels one month after resolution of stones.

## PUB269

### A Simple Method for the Bioinformatical Identification of ARMH4 and WIPF3 as Previously Uncharacterized Human Podocyte Proteins With Structural and Immunomodulatory Functions

Francesco De Luca,<sup>1</sup> Michelle Kha,<sup>1</sup> Karl Swärd,<sup>2</sup> Martin E. Johansson.<sup>1</sup>  
<sup>1</sup>Goteborgs universitet Sahlgrenska Akademin, Goteborg, Sweden; <sup>2</sup>Lunds universitet Medicinska fakulteten, Lund, Sweden.

**Background:** The podocytes are critically involved in maintaining the selective filtration barrier of the kidneys. They are target for a multitude of kidney diseases such as the glomerulonephritides and diseases causing nephrotic syndrome. Despite being in the focus of intense investigation, the transcriptome and proteome of human podocytes remain incompletely characterized.

**Methods:** We have analyzed publically available data sets of bulk RNA-Seq data from human kidneys (n=85, <https://gtexportal.org>) to computationally define potential novel podocyte markers. For confirmation we used an online histology resource ([www.proteinatlas.org](http://www.proteinatlas.org)) followed by in-house staining of human kidneys and glomerular isolation. We also cross referenced to GWAS findings with bearing on proteinuria. Putative functions of the novel factors were examined using viral overexpression in tubular epithelial cells and by changes in gene expression in differentiating podocytes.

**Results:** Several previously unrecognized gene products were identified that correlated to established podocyte markers on RNA level and could be histologically confirmed to localize to podocytes. *ARMH4* (a.k.a. UT2 or C14orf37) and *WIPF3* (a.k.a CR16) were among the hits. These were selected due to their connection to findings in GWAS studies. We show that these transcripts increase in response to overexpression of the podocyte transcription factor *LMX1B*. Moreover, overexpression of *ARMH4* from low endogenous levels in primary kidney epithelial cells reduced release of the inflammatory mediators IL-1B and IL-8 (CXCL8), whereas *WIPF3* stabilized N-WASP, which is known to be required for maintenance of podocyte foot processes.

**Conclusions:** *ARMH4* and *WIPF3* are proteins expressed by human podocytes. We suggest that they may modulate inflammatory insults by controlling release of cytokines and contribute to cytoskeletal structure, respectively.

**Funding:** Government Support - Non-U.S.

## PUB270

### An Unusual Complication of a Kidney Biopsy

Abdullah Shahid, Joseph C. Parker. *East Carolina University, Greenville, NC.*

**Introduction:** Kidney biopsy is the gold standard procedure for the diagnosis of multiple kidney disorders. Various complications can occur during the procedure including bleeding due to puncture of an intra-renal vessel. Injury to the extra-renal vessels is rare. We present a case of a bleeding complication due to injury to the lumbar artery after a kidney biopsy.

**Case Description:** A 54-year-old female presented to the nephrology clinic for evaluation of proteinuria. She has had hypertension for about 8 years. Diabetes mellitus was recently diagnosed. Our workup showed proteinuria of 3 gm. Serum albumin level was 3.9 gm/dL and urinalysis was unremarkable. Serological workup for evaluation of proteinuria was negative. A decision was made to pursue a kidney biopsy. With the patient in the prone position, the left kidney was identified with an ultrasound. An 18-gauge spring loaded needle was used to obtain 2 cores of kidney tissue under ultrasound guidance. After the second pass the patient developed sudden pain at the biopsy site. A quick look with the ultrasound did not show any obvious hematoma but because of patient's discomfort, the procedure was abandoned. A CT scan of the abdomen showed a 14 cm perinephric hematoma. An immediate arteriogram showed bleeding from a pseudoaneurysm of a branch of the L1 lumbar artery which was stopped with micro-coil embolization. There was no evidence of bleeding from the intra-renal arteriogram.

**Discussion:** Bleeding is one of the common complications of a kidney biopsy. Most of the bleeding episodes occur due to an injury of an intra-renal vessel. Injury of a lumbar artery is rare, with only a few cases reported so far. Small branches of lumbar arteries may not be detectable on doppler ultrasound and are vulnerable to injury during a kidney biopsy. Injury of a lumbar artery should be considered in case of a negative renal arteriogram. Hence a kidney biopsy should only be performed at or near a center with angiographic and surgical support.

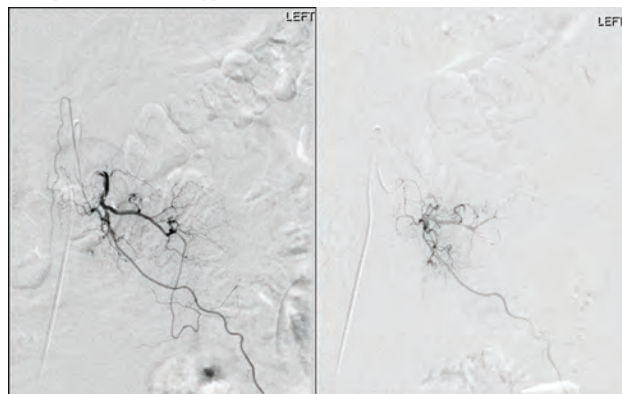

Lumbar artery angiogram, pre and post coil embolization

PUB271

**Indications and Complications Associated With Centrifuge-Based Therapeutic Plasma Exchange**

David M. Warner, Prakash S. Gudsoorkar, Manish Anand. *University of Cincinnati, Cincinnati, OH.*

**Background:** Therapeutic Plasma Exchange (TPE) is an extracorporeal treatment modality for management of certain diseases. To investigate the indications and safety of TPE, a retrospective review was conducted to identify the indications for TPE and the associated complications.

**Methods:** This is a single center retrospective review of centrifuge based TPE performed by the nephrology department at a tertiary care academic center between June 2018 to July 2019. Overall, 320 TPE treatments were performed on 44 patients.

**Results:** In total, there were fourteen diagnostic indications for TPE (Fig 1) along with their category of indication based on the American Society for Apheresis (ASFA) guidelines. The most common indication was myasthenia gravis, followed by autoimmune encephalitis and Antibody-Mediated Rejection (AMR) in kidney transplant recipients. Complications are documented in Fig 2. The most common complications were coagulopathy (43%), hypokalemia (41%), hyperglycemia (41% each), and hypotension (27%).

**Conclusions:** Overall, 14 diseases were noted as indications for TPE with myasthenia gravis being the most common. In terms of complications, depletion coagulopathy, hyperglycemia, and hypokalemia were the most common. This study exemplifies the utility of having a systematic audit to review the practice patterns and complications of TPE.

Diagnosis	ASFA category	No: of patients
Myasthenia Gravis	I	9
Autoimmune Encephalitis	I	6
AMR, kidney transplant	I	5
Guillain-Barré Syndrome	I	4
ANCA Vasculitis	I	1
CIDP <sup>2</sup>	I	1
Renal Transplant, DSA <sup>1</sup> Pre-treatment	I	1
Neuromyelitis Optica	II	5
Multiple Sclerosis	II	5
Paraneoplastic neurological syndromes	III	3
Stiff Person Syndrome	III	2
Myelitis	Unknown	1
AMR, cardiac transplant	III	1
Central Pontine Myelinolysis	Unknown	1

<sup>1</sup>Donor-specific alloantibody

<sup>2</sup>Chronic Inflammatory demyelinating polyneuropathy

Indications for TPE

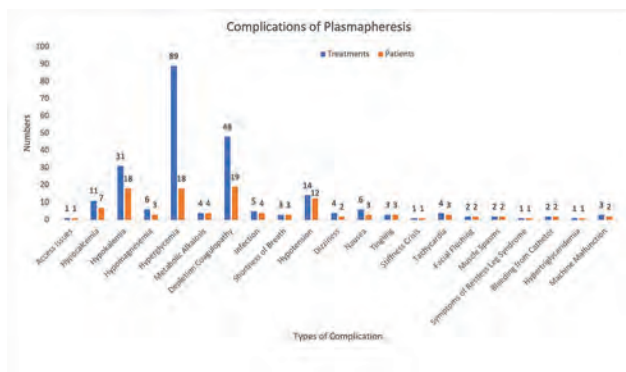

Complications of TPE

PUB272

**Lupus Nephritis: A Case Series on Hispanic Patients**

Jordy Batista,<sup>1</sup> Denazir Atizol Rodriguez,<sup>1</sup> Irvianny Madera,<sup>1</sup> Eliana Bencosme,<sup>2</sup> Eliana Dina-Battle,<sup>1</sup> *Hospital Metropolitano de Santiago, Santiago De Los Caballeros, Dominican Republic;* <sup>2</sup>*Centros de Diagnostico y Medicina Avanzada y de Conferencias Medicas y Telemedicina, Santo Domingo, Dominican Republic.*

**Introduction:** Lupus Nephritis (LN) is considered to be one of the main causes of death in patients with lupus systemic erythematosus (LSE). The evolution of this disease in the kidney may be insidious, showing no clinical signs of damage while creating irreversible changes to the kidney architecture. While clinical and laboratory assessment is used to gauge the progress of the disease, the kidney biopsy (KB) is paramount.

**Case Description:** KB results were taken from 26 patients of a large hospital in Santiago, Dominican Republic. 92.31% of the patients were female, all of them were hispanic, the mean age of biopsy was 29.5 ± 10.4 years and the mean serum creatinine was 1.098 ± 0.246 mg/dL. 96.29% of the biopsies reported with LN, while only 3.71% reported with focal segmental glomerulosclerosis (FSGS). Out of the biopsy reports of LN, the most frequent classes reported were IV and V, each having 23.08% of the total biopsies, followed by class III (19.23%). Among the coexisting findings, 2 arteriosclerosis, 3 FSGS, and 3 acute tubule injuries were reported. Incidentally, four out of the six patients who had a class V LN, also suffered from hypertension. There was no significant difference in the mean ages between the proliferative classes (I-IV) (27.53±4.77) and the non-proliferative class (31.17±8.5). The mean activity and chronicity indexes were 4.31±3.43 out of 24, and 1.92 ± 1.51 respectively. In the immunostaining reports, 30.77% of the biopsies reported a full house staining (IgM, IgA, IgG, C3 and C1q positive).

**Discussion:** Serum creatinine values may not relate to the anatomopathological (AP) diagnosis of LN. Additionally, the same is to say when referring to the pathology report and the clinical manifestation of the patients at the time of the biopsy. Out of the patients with low C4 at the moment of biopsy, no specific class of LN was predominant. On the other hand, C4 values could be related to the presence of hypercellularity in the kidney interstice. Moreover, C3 levels were not related to the AP findings. Given the subtle nature of LN, patients and healthcare providers should be attentive of their condition to avoid further complications.

PUB273

**Outpatient Safety on CT-Guided Percutaneous Kidney Biopsy: A Retrospective Cohort of 254 Patients in Two Private Hospitals of the Dominican Republic**

Irvianny Madera,<sup>1</sup> Jordy Batista,<sup>1</sup> Denazir Atizol Rodriguez,<sup>1</sup> Eliana Bencosme,<sup>2</sup> Eliana Dina-Battle,<sup>1</sup> Hector A. Pantaleon,<sup>1</sup> Julia A. Gómez Jackson,<sup>3</sup> *Hospital Metropolitano de Santiago, Santiago De Los Caballeros, Dominican Republic;* <sup>2</sup>*Centros de Diagnostico y Medicina Avanzada y de Conferencias Medicas y Telemedicina, Santo Domingo, Dominican Republic;* <sup>3</sup>*Pontificia Universidad Catolica Madre y Maestra, Santiago de los Caballeros, Dominican Republic.*

**Background:** The kidney biopsy (KB) is a vital tool for diagnosis and further management of kidney disease, with the drawback of possible complications particular to the procedure. In the past, to avoid these, KB were made as inpatient. Given the higher cost of the inpatient process and the safety of the procedure, KB started to be performed as outpatient, this sought to reduce the costs and, at the same time, did not alter the complication rate.

**Methods:** A retrospective analysis of Computerized Tomography (CT) guided percutaneous renal biopsies done at two private hospitals in Dominican Republic from January 2002 to May 2022 was performed. Clinical and laboratory data were collected for a total of 254 patients. Statistical analysis was performed using the Student's t-test for continuous variable and chi-square test for categorical variables.

**Results:** A total of 254 CT-guided percutaneous KB were performed between 2002 and 2022 of which 66.5% were made as an outpatient procedure. The prevalent gender was female (50.8%), the average age at the time of the biopsy was 35.7±17.5 years, and the most common comorbidities were hypertension (47.2%) and diabetes mellitus (14.6%). Only 15.4% of the population presented complications such as: hematoma (61.5%), pain (46.2%), hematuria (28.2%), and hypotension (15.4%). There was an association between increased number of platelets and hematoma development (p<0.001). Only nine patients (5.0%) that were biopsied as an outpatient had to be hospitalized due to arising complications, mostly hematoma (77.8%). All complications emerged between the 8 hour observation period. There were no associated biopsy major complications or mortality related to the procedures.

**Conclusions:** While the complication percentage of the ultrasound guided biopsy appears to be comparable to the CT guided, the latter boasts lower major complication rate, and while it is a higher cost than the go-to option, there could be a reduction in hospital costs. Additionally, this alternative should be considered in patients in more delicate states. Compared to the US, CT-guided biopsies generally are a better diagnostic tool, reducing the need to repeat procedures, therefore reducing further risks.



**PUB274**

**Use of Narsoplimab in a Paediatric Patient With IgA Nephropathy**

Louise Oni,<sup>1,2</sup> Vincent McCormack,<sup>1</sup> Caroline A. Jones,<sup>1</sup> Jonathan Barratt.<sup>3</sup>  
<sup>1</sup>Alder Hey Children's NHS Foundation Trust, Liverpool, United Kingdom;  
<sup>2</sup>University of Liverpool Faculty of Health and Life Sciences, Liverpool, United Kingdom;  
<sup>3</sup>Leicester General Hospital, Leicester, United Kingdom.

**Introduction:** Narsoplimab is an investigational fully human mAb targeting MASP-2, the effector enzyme of the lectin pathway of the complement system. We report the first example of narsoplimab in a paediatric patient with IgA nephropathy (IgAN).

**Case Description:** An 8-year-old girl presented in 2013 with history of macroscopic haematuria, proteinuria (urine albumin:creatinine ratio [UACR] 81 mg/mmol Cr) and a transient decline in estimated glomerular filtration rate (eGFR). IgAN was diagnosed with histological features of focal proliferative glomerulonephritis and IgA deposition. She received corticosteroids, mycophenolate mofetil, an ACE inhibitor and ran a relapsing, remitting course (Fig). In 2021 at age 16, there was an irreversible decline in renal function and rise in proteinuria. Renal biopsy demonstrated 70% global sclerosis (M1, E0, S1, T1, C1). Due to declining renal function, persisting active inflammation and promising adult studies, compassionate use narsoplimab was provided and administered by IV infusion over 30 min once a week. The patient was observed for 30 min after each infusion with weekly surveillance tests to detect adverse events. She received 9 of 12 planned doses between Dec 2021 and Feb 2022. Dose 7 was omitted due to intercurrent febrile illness and the final 2 doses were omitted to focus on preparation for renal replacement therapy. All 9 doses were well tolerated with no adverse events. Narsoplimab did not appear to influence renal function (eGFR dropped from 36 to 24 ml/min/1.73m<sup>2</sup>) but demonstrated a dramatic reduction in proteinuria (425 to 157 mm/mmol Cr) similar to adult trials (Lafayette et al. *KI Rep.* 2020;5:11).

**Discussion:** This is the first report of complement inhibition for paediatric IgAN. Narsoplimab was well tolerated and dramatically improved proteinuria. Irreversible histological features of resistant IgAN may have impacted narsoplimab use in this patient warranting earlier intervention. Studies into efficacy of narsoplimab in children with IgAN are required.

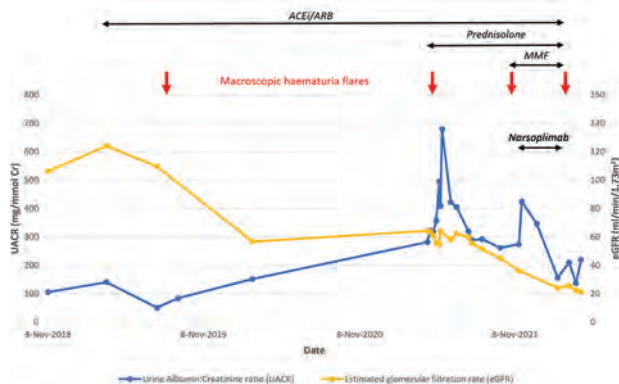

**PUB275**

**Severe Pediatric Methanol Intoxication Treated With Novel Tablo System**

Hanan K. Tawadrous, Alyssa E. Ruddy, Cynthia J. D'Alessandri-Silva.  
 Connecticut Children's Medical Center, Hartford, CT.

**Introduction:** Morbidity and mortality from toxic alcohols like methanol is largely increasing across age and ethnic groups in America. Hemodialysis (HD) can efficiently remove methanol and improve patient outcomes. Current guidelines recommend HD when the methanol concentration is >50 mg/dL until concentrations are <20 mg/dL and acid-base disturbances have been corrected. We describe a case of methanol intoxication successfully treated with the novel Tablo® Hemodialysis System ("Tablo System"; Outset Medical, San Jose, CA, USA).

**Case Description:** A 15-year-old, 55 kg male with a history of depression and prior suicidal ideas was admitted for blurred vision after ingestion of antifreeze. Labs revealed Hemoglobin 14.5 g/L, Na 143 mmol/L, K 3.9 mmol/L, Chloride 108 mmol/L, Total CO<sub>2</sub> 22 mmol/L, BUN 9 mmol/L, Cr. 0.9 mg/dL, Alb 4.3 g/L, Amylase 67, Lipase 32 unit/L, pH of 7.32 and negative urine drug screen. Initial methanol level was 124 mg/dL with serum osmolality of 340 mOsm/kg. Mental status was normal. Vital signs stable with adequate urine output. The patient was started on fomepizole, folic acid, thiamine and received 2 HD treatments, first using the Tablo System with a Revaclear™ 400 dialyzer, at blood flow rate (Qb) of 350 mL/min and dialysate flow rate (Qd) of 300 mL/min for 240 minutes. Post treatment, methanol was 28 mg/dL, serum Osm 307 mOsm/kg, with serum pH 7.4. Second treatment was performed using a conventional HD device with a Revaclear 400, Qb 350, and Qd 700 for 240 minutes. Post treatment methanol level was 9 mg/dL. Calculated time to methanol clearance via logarithmic regression yielded 7.07 hours and was achieved in 8 hours.

**Discussion:** Methanol toxicity can be successfully treated within the standard of care using the Tablo System in the pediatric population. Lessons: Qd of 300 and 700 can equivalently remove toxic Methanol levels via HD in a pediatric patient. Pediatric patients are experiencing an increasing rate of intoxications and HD geared towards these needs must be expanded.

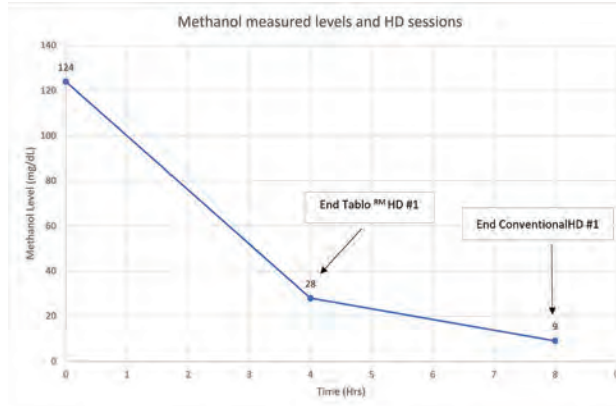

**PUB276**

**Associations of Clinical Characteristics With Metabolic Acidosis in Pediatric Kidney Transplant Recipients**

Stella R. Kilduff,<sup>1,2</sup> Matthew K. Abramowitz,<sup>2,3</sup> Nicole A. Hayde.<sup>1,2</sup>  
<sup>1</sup>The Children's Hospital at Montefiore General Pediatrics, Bronx, NY; <sup>2</sup>Albert Einstein College of Medicine, Bronx, NY; <sup>3</sup>Montefiore Medical Center, Bronx, NY.

**Background:** Adult transplant studies have associated metabolic acidosis with graft failure and mortality. No study has systematically examined metabolic acidosis in pediatric kidney transplant recipients.

**Methods:** Children <18 years of age who received a kidney transplant at Montefiore Medical Center from 1/1/10-12/31/18 and had 3-month post-transplant lab data were included unless they underwent multi-organ transplant or experienced graft loss or had eGFR <30 ml/min/1.73m<sup>2</sup> at 3 months. Cross-sectional associations with serum bicarbonate and with metabolic acidosis (serum bicarbonate <22 meq/L or requiring alkali therapy) were examined at 3 months post-transplant using multivariable linear and logistic regression, respectively.

**Results:** 63 patients were identified. Mean age at transplant was 9.9±5.4 years. Baseline serum bicarbonate was 21.7±2.4 meq/L, 45% had serum bicarbonate <22meq/L and 48% were receiving alkali therapy; prevalence of metabolic acidosis was 68%. Each 1-year higher age and 10 ml/min/1.73m<sup>2</sup> higher eGFR were associated with 0.2 meq/L (95% CI 0.02-0.31) and 0.3 meq/L (95% CI: 0.03-.55) higher serum bicarbonate, respectively (Table 1). Older age at transplant was associated with 21% lower odds of metabolic acidosis (95% CI: 0.66-0.94) (Table 2). Patients with a living donor transplant had 84% lower odds of metabolic acidosis (95% CI: 0.03-0.89).

**Conclusions:** Lower age and eGFR were associated with lower serum bicarbonate in children 3 months after kidney transplantation. In addition to older age, living donor status was associated with lower odds of metabolic acidosis. Future studies should examine determinants of serum bicarbonate over time and the impact of metabolic acidosis on pediatric transplant outcomes.

**Funding:** Other NIH Support - T32DK007110, Clinical Revenue Support

Table 1: Associations with serum bicarbonate at 3-months post-transplantation

	β coefficient	95% CI	p
Age at transplant (per year)	0.16	0.02-0.31	<b>0.03</b>
Female (vs. male)	0.3	-1.1-1.7	0.66
Race/ethnicity			
Hispanic/Latino	ref	ref	ref
Non-Hispanic Black	0.69	-0.83-2.2	0.37
Non-Hispanic White	-0.27	-2.1-1.5	0.76
Multi-racial & Asian	-0.28	-3.3-2.7	0.85
Cause of ESRD			
CAKUT	ref	ref	ref
Glomerular Disease	0.75	-0.99-2.5	0.39
Other*	-0.02	-2.3-2.2	0.99
Preemptive transplant (vs. dialysis pre-transplant)	-0.06	-1.6-1.5	0.94
Living donor (vs. deceased)	0.44	-1.3-2.1	0.61
eGFR (per 10ml/min/1.73m <sup>2</sup> )	0.29	0.03-0.55	<b>0.03</b>
Alkali therapy (vs. none)	0.28	-1.1-1.7	0.69

Multivariable linear regression model including all variables listed above.

\*Other category: unknown etiology (n=2), ARPKD (n=2), Cystinosis (n=1), and neoplasm (n=1).

Table 2: Associations with metabolic acidosis at 3-months post-transplantation

	Odds Ratio	95% CI	p
Age at transplant (per years)	0.79	0.66-0.94	<b>0.01</b>
Female (vs. male)	0.33	0.09-1.2	0.1
Race/ethnicity			
Hispanic/Latino	ref	ref	ref
Non-Hispanic Black	0.66	0.12-3.6	0.63
Non-Hispanic White	0.73	0.12-4.3	0.73
Multi-racial & Asian	0.46	0.02-9.7	0.62
Living donor (vs. deceased)	0.16	0.03-0.89	<b>0.04</b>
eGFR at 3 months (per 10ml/min/1.73m <sup>2</sup> )	0.8	0.6-1.1	0.12

Multivariable logistic regression model including all variables listed above.

PUB277

**Aberrant JAK/STAT Signaling in Nephrotic Syndrome**

Carol L. Shen, Louise Malle, Ashley Richardson, Sofija Buta, Jeffrey Saland, Dusan Bogunovic. *Icahn School of Medicine at Mount Sinai, New York, NY.*

**Background:** Nephrotic syndrome (NS) is one of the most common childhood kidney diseases worldwide. Despite evidence suggesting immunologic derangements as contributors to disease, detailed understanding of the pathogenesis remains elusive. Current non-specific immunosuppressive therapy carries significant morbidity and mortality. We recently identified *JAK1* gain-of-function mutation in a patient with NS and multisystem immune dysregulation who was successfully treated with a JAK inhibitor. We hypothesized that dysregulation of JAK/STAT pathway is also present in different NS disease entities.

**Methods:** We recruited 10 subjects age 8-18yr with various etiologies of NS and 7 age and sex-matched healthy controls. We stained heparinized whole blood with immune surface markers including JAK/STAT members and performed mass cytometry to characterize immune system breadth and steady state activity.

**Results:** Despite canonical immune cell distribution of patients (Fig 1), JAK/STAT pathway overactivity is present in various NS etiologies compared to controls (Fig 2A). While all patients had dysregulated pSTAT1, pSTAT3 and pSTAT5, in patients with FSGS and IgA nephropathy, pSTAT3 pathway overactivity dominated T and NK cell subsets, whereas in individuals with Henoch Schonlein Purpura, pSTAT1 and pSTAT6 in B cells. Treatment-refractory patients had augmented levels of JAK/STAT pathway overactivity (Fig 2B).

**Conclusions:** JAK/STAT pathway overactivity may be present in some individuals with NS. Better characterization of JAK/STAT activity could inform targeted therapy.

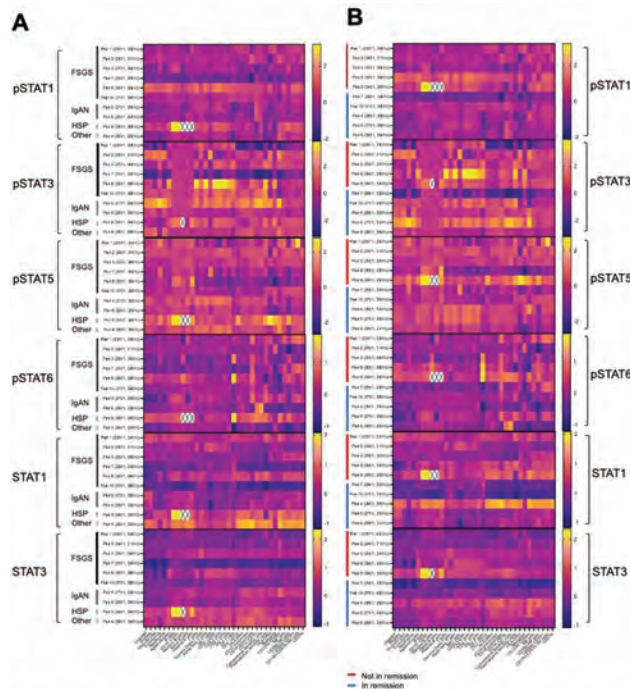
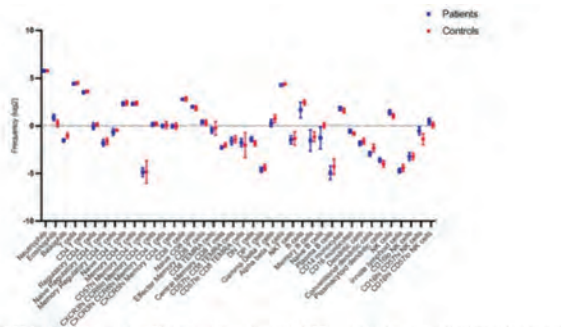

Figure 2. Phosphorylated (p)STAT and unphosphorylated STAT Member activity (A) disease and (B) remission status. pSTAT and STAT activity analyzed by CyTOF was quantified and expressed as relative intensity (log2) of each patient to their age- and sex-matched control. FSGS = Focal segmental glomerulosclerosis; IgAN = IgA nephropathy; HSP = Henoch Schonlein Purpura

PUB278

**New-Onset Dyslipidemia After Pediatric Kidney Transplantation: Long-Term Outcomes**

Emily E. Zangla,<sup>1</sup> Scott Jackson,<sup>2</sup> Dao Huynh,<sup>1</sup> Sarah J. Kizilbash,<sup>1</sup> <sup>1</sup>University of Minnesota Twin Cities, Minneapolis, MN; <sup>2</sup>Fairview Health Services, Minneapolis, MN.

**Background:** The incidence of dyslipidemia after pediatric kidney transplant in the United States is unknown, as are its long-term consequences. We sought to identify the incidence of dyslipidemia and its effects on cardiovascular events (CVEs), allograft rejection and graft failure in pediatric renal transplant recipients.

**Methods:** We performed a single-center retrospective study of patients ages 0-21 who underwent kidney transplantation from 2011-2021. Dyslipidemia was determined by the terms: hypercholesterolemia, hypertriglyceridemia, hyperlipidemia and dyslipidemia. The composite outcome was time to a CVE (myocardial infarction, stroke, angina, arrhythmia, or cardiomyopathy), allograft rejection or failure. Dyslipidemia-free survival was analyzed using Kaplan-Meier curves, and the effect of dyslipidemia on the composite outcome was evaluated using Cox proportional model, treating dyslipidemia as a time-dependent covariate.

**Results:** 139 patients were included. Dyslipidemia-free survival after ten years was 67% (95% CI 55-81%). We found no effect of age, gender, race, BMI or steroid-based immunosuppression on dyslipidemia-free survival. Post-transplant dyslipidemia did not affect the likelihood of the composite outcome (HR 1.46; 95% CI 0.41-5.16). 6 patients (4.3%) received statin therapy for dyslipidemia without any adverse effects.

**Conclusions:** Dyslipidemia is common after pediatric kidney transplantation. We found no effect of dyslipidemia on cardiovascular events, allograft rejection and graft failure.

**Table 1. Patient characteristics at the time of kidney transplantation**

<b>n</b>	139
<b>Age, mean (SD)</b>	10.61 (6.18)
<b>Male gender</b>	n (%) 84 (60.4)
<b>Race</b>	
Caucasian	91 (66.4)
American Indian	11 (8)
African American	19 (13.9)
<b>Primary disease</b>	
CAKUT	69 (49.6)
Glomerulonephritis	8 (5.8)
Nephrotic	19 (13.7)
Other	43 (30.9)
<b>Living donor</b>	71 (51.1)
<b>Dialysis before transplant</b>	94 (67.6)
<b>BMI class</b>	
Obese	23 (16.5)
Overweight	12 (8.6)
<b>Maintenance immunosuppression</b>	
Tacrolimus	116 (84.1)
Mycophenolate	102 (73.9)
<b>Steroid-inclusive</b>	29 (20.9)

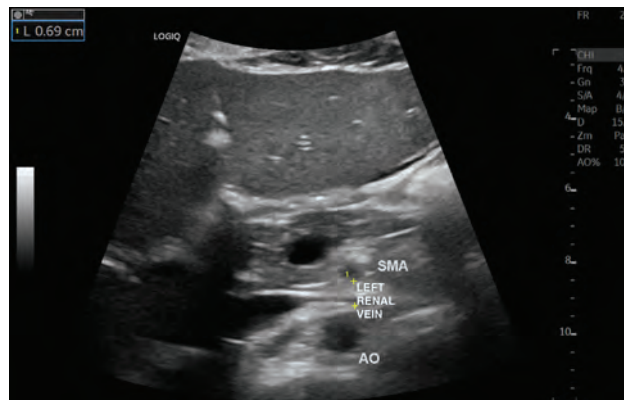

LRV compressed between aorta and SMA

**Figure 1. Dyslipidemia-free survival after pediatric kidney transplantation**

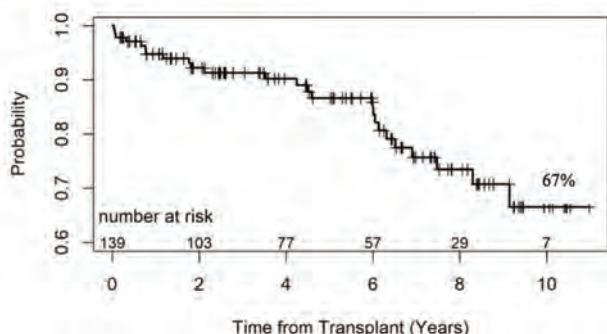

**PUB279**

**Nutcracker Syndrome: A Rare Cause of Gross Hematuria**

Vimal Master sankar raj, Division of Pediatric Nephrology University of Illinois Chicago College of Medicine at Peoria, Peoria, IL.

**Introduction:** Nutcracker syndrome (NCS) is a unique vascular compression disorder, where the left renal vein (LRV) is trapped between the aorta and superior mesenteric artery (SMA). We present here a pediatric patient with solitary kidney and this rare presentation.

**Case Description:** 12-year-old boy with prior H/o R multicystic dysplastic kidney, surgically removed, presented with bright red hematuria and abdominal pain for a day. His evaluation showed normal vitals and renal function. U/A with 2+ protein and 3+ blood. Further workup for GN was normal. A renal visceral duplex exam was done which showed an adequately enlarged solitary L kidney at 14.5 cm with duplex studies showing, a narrowed LRV as it crosses between SMA and aorta. The renal vein ratio was elevated at 5.8 confirming the diagnosis. He was conservatively treated with fluids and resolution of hematuria in 24 hrs.

**Discussion:** The term Nutcracker syndrome (NCS) refers to LRV compression between SMA and aorta. Prevalence remains unknown due to the variability of symptomatology. Clinical features are non-specific presenting as varying degrees of abdominal pain, flank pain, hematuria, proteinuria, varicocele, chronic pelvic pain, dyspareunia and dysmenorrhea. Affected individuals tend to be tall and thin contributing to an acute angle between aorta and SMA. Though gold standard for diagnosis is venography, CT scan and renal duplex are also useful tools to establish diagnosis. Ultrasound being noninvasive and radiation-free should be the preferred initial modality of imaging in pediatrics. Diagnosis can be made successfully when the rate of systolic peak velocity between the site of compression and vein at renal hilum is > 4.7. Treatment varies based on the severity of presentation and age at presentation. Conservative management is the norm in children as they may outgrow the condition. In patients with recurrent severe presentations and those who have failed conservative management, IR techniques such as stent placement or conventional surgical procedures may be indicated.

**PUB280**

**Stability of Novel Urinary Biomarkers Used for Lupus Nephritis**

Ellen Cody,<sup>1</sup> James Rose,<sup>1</sup> Rebecca Hopkins,<sup>1</sup> Megan Quinlan-Waters,<sup>1</sup> Catherine E. Robben,<sup>1</sup> Tingting Qiu,<sup>1</sup> Bin Huang,<sup>1</sup> Prasad Devarajan,<sup>1,2</sup> Hermine Brunner.<sup>1,2</sup> <sup>1</sup>Cincinnati Children's Hospital Medical Center, Cincinnati, OH; <sup>2</sup>University of Cincinnati, Cincinnati, OH.

**Background:** We have developed and validated the Renal Activity Index for Lupus (RAIL), a composite score of six urinary biomarkers including neutrophil gelatinase – associated lipocalin (NGAL), monocyte chemoattractant protein-1 (MCP-1/CCL2), kidney injury molecule-1 (KIM-1), ceruloplasmin, adiponectin, and hemopexin) to monitor disease activity. It is critical to establish optimal sample handling conditions and storage prior to widespread clinical deployment and meaningful use in clinical trials. We have previously demonstrated the excellent short-term storage stability of NGAL and KIM-1; here we expand testing to include the other 4 RAIL biomarkers.

**Methods:** Urine was collected from 10 patients enrolled in the SLE Clinical and Research Database (IRB 2008-0635). The urine was then aliquoted and tested under shipping conditions, including freeze/thaw, ambient and longer-term storage (Figure 1). MCP-1, Ceruloplasmin, Adiponectin and Hemopexin were assayed by single-plex ELISA assay via commercially available kits. We performed Pearson Correlation Coefficient, Deming regression and Bland-Altman analysis.

**Results:** There was no statistical difference in biomarker concentrations in any of the four biomarkers in any of the experimental conditions. Urinary MCP-1, Adiponectin, Hemopexin and Ceruloplasmin are stable following storage at -80°C for up to 3 months, and at 4° or 25°C up to 48 hours followed by -80° C. In addition, shipping on dry ice or with refrigeration leads to no significant loss of signal. The addition of 1 or 2 additional freeze thaw cycles also did not change mean biomarker levels.

**Conclusions:** RAIL biomarkers are stable following short-term storage at clinically relevant conditions, including shipping on ice.

**Funding:** NIDDK Support, Private Foundation Support

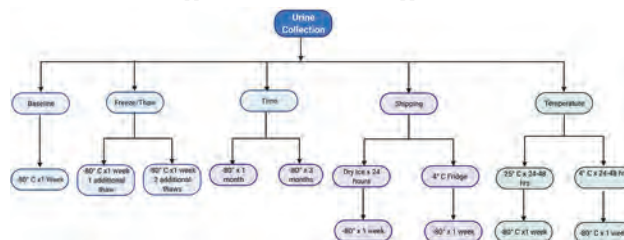

	Condition	Mean	St Dev	Min	Max	Spearman Correlation Coefficient	P-value
Aripiprazole	Baseline	1.935	1.521	-0.486	3.441	0.973	<0.01
	Dry Ice	1.901	1.466	-0.486	3.438	0.979	<0.01
	Wet Ice	2.045	1.530	-0.486	3.681	0.961	<0.01
	Fridge	2.132	1.476	-0.486	3.626	1.00	<0.01
	RT	2.025	1.530	-0.018	3.615	0.888	<0.01
	FT1	1.862	1.627	-0.486	3.469	0.998	<0.01
	FT2	1.976	1.596	-0.486	3.483	0.988	<0.01
	1MO	1.950	1.532	-0.486	3.478	0.982	<0.01
3MO	1.626	1.482	-0.486	3.220	0.910	<0.01	
Ceruloplasmin	Baseline	3.618	2.248	0.754	6.669	0.991	<0.01
	Dry Ice	3.552	2.180	0.754	6.669	1.00	<0.01
	Wet Ice	3.553	2.305	0.754	6.669	1.00	<0.01
	Fridge	3.483	2.250	0.754	6.669	0.984	<0.01
	RT	3.614	2.175	0.754	6.669	1.00	<0.01
	FT1	3.692	2.310	0.754	6.669	0.869	<0.01
	FT2	3.491	2.326	0.754	6.669	1.00	<0.01
	1MO	3.803	2.071	0.754	6.669	1.00	<0.01
3MO	4.245	1.538	2.259	6.669	0.962	<0.01	
Hemopexin	Baseline	5.522	0.835	3.738	6.575	0.915	<0.01
	Dry Ice	5.524	0.887	3.738	6.643	0.989	<0.01
	Wet Ice	5.530	0.847	3.738	6.663	0.976	<0.01
	Fridge	5.510	0.862	3.738	6.741	0.964	<0.01
	RT	5.413	1.004	3.738	6.663	0.963	<0.01
	FT1	5.488	0.935	3.738	6.602	0.961	<0.01
	FT2	5.470	0.898	3.738	6.533	0.967	<0.01
	1MO	5.536	0.905	3.738	6.712	0.973	<0.01
3MO	5.817	0.897	4.187	6.897	0.952	<0.01	
MCP-1	Baseline	4.558	1.600	1.760	6.448	1.00	<0.01
	Dry Ice	4.596	1.562	2.255	6.379	1.00	<0.01
	Wet Ice	4.556	1.633	1.888	6.468	1.00	<0.01
	Fridge	4.503	1.710	1.386	6.397	1.00	<0.01
	RT	4.426	1.813	0.987	6.423	0.999	<0.01
	FT1	4.553	1.582	2.135	6.376	0.993	<0.01
	FT2	4.471	1.751	1.456	6.408	1.00	<0.01
	1MO	4.673	1.504	2.309	6.402	0.992	<0.01
3MO	4.607	1.601	2.156	6.467	1.00	<0.01	

Abbreviations: RT=Room Temperature, FT=Freeze Thaw, MO=Month

PUB281

**Pediatric Kidney Transplant Recipients' Emergency Room Visit Alert**

Amal G. Ezzaiyani, Arwa Nada, Rima S. Zahr. *The University of Tennessee Health Science Center, Memphis, TN.*

**Background:** Pediatric kidney transplant recipients are a unique patient population who have a complicated medical history requiring multidisciplinary care. Improve care between different teams involved in kidney transplant (KTx) patients, including emergency room (ER) physicians, is imperative. Aim: Quality Improvement project to improve timely communication between ED staff and KTx team from 74.4% (1/2017-12-2018) to 100% by June 30th 2021.

**Methods:** Key Drivers: using electron medical record (EMR) to alert ER team of patients' transplant status. (Figure 1)

**Results:** As shown in Figure 2, over time the EMR alert improved communication between the ED team and the KTx team to 100%.

**Conclusions:** EMR alert significantly improved communication to 100% between ED staff and the KTx team. The alert allowed for improved communication between the ER team members and the nephrology service, further allowing for a timely managed visit for this vulnerable population.

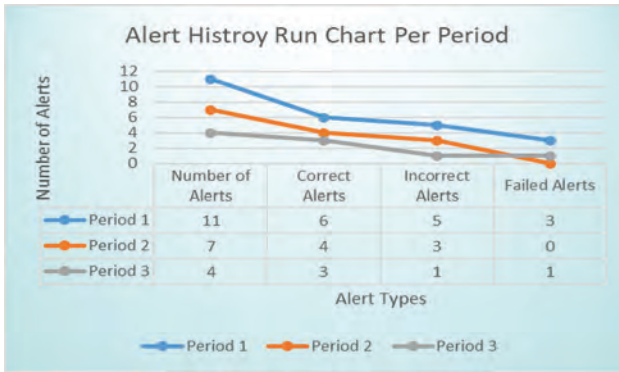

PUB282

**Content Analysis of Online Birth Club Forums in Relation to Antenatal Kidney Defects**

Katie Sullivan, Davy Weissenbacher. *University of Pennsylvania, Philadelphia, PA.*

**Background:** Despite being one of the most common congenital abnormalities, we know little about woman's experiences and what kinds of information they may seek when receiving diagnoses of Antenatal kidney defects. Objective: With the large adoption of Social Media by pregnant women as sources of information during their pregnancy, we propose to apply machine learning methods to analyze online pregnancy forums to better understand how women seek information from a community of online peers regarding renal defects. This will help us to address gaps in knowledge and ultimately provide more personalized, effective prenatal care.

**Methods:** We collected posts from seven "birth club" forums (March-November 2021) from WhatToExpect.com and analyzed the initial posts from each thread (n = 15,000). We computed the topics discussed with the Latent Dirichlet Allocation statistical model, and, after manual review of the topics, we grouped them categorically.

**Results:** Largest topic categories included worry about the abnormality detected on anatomy scan (33 percent) followed by posts offering reassurance of a normal life with the kidney anomaly (31 percent).

**Conclusions:** Women do use online forums to discuss antenatal kidney defects, but these posts are relatively rare compared with the frequency of kidney defects (6.8 percent). This suggests potentially that women diagnosed with antenatal kidney anomalies talk about these less commonly online than women diagnosed with other antenatal defects. Amongst the relevant posts, the most common anomalies mentioned are also the most common antenatal renal anomalies, hydronephrosis and unilateral renal agenesis.

**Funding:** Other NIH Support - Pediatric Scientist Development Program

PUB283

**Transition Readiness in Kidney Disease**

Isabelle Lopez, Sarah K. Coufal, Taryn Shappell, Elaine Ku. *University of California San Francisco, San Francisco, CA.*

**Background:** To mitigate the challenges faced by patients transferring into adult care, we established a Transition Clinic to support adolescents with kidney disease during the transition to adult care. The clinic focused on improving self-efficacy including educating patients about their baseline kidney function, laboratory values, and concrete health care management skills necessary for post-kidney transplant care. The clinic also performed assessments of mental health.

**Methods:** 40 participants >18 years of age were asked to complete a survey on their transition experience, quality of health (using the PROMIS survey), and transition readiness. Subjects were asked to self-report hospitalizations and emergency room visits over the prior 12 months. Chi square tests were used to relate knowledge about kidney disease and quality of mental health with use of emergency room or hospitalizations.

**Results:** The mean age of participants was 23 and 52% had a functional kidney transplant. Overall, knowledge regarding kidney disease (Figure 1) and participants' self-reported mental health varied (Figure 2). We found that 60% of patients who did not know their baseline serum creatinine had at least 1 emergency room visit in the past year.

Additionally, 66% of patients who rated their mental health "very good" had no hospital overnight stays in the past year, versus 65% of patients who rated their mental health poor had at least 1 overnight stay.

**Conclusions:** We found that individuals who did not know their baseline serum creatinine were more likely to have emergency room visits and subjects who reported poor mental health tended to be admitted to the hospital. Addressing specific knowledge gaps and recognizing individuals with poor mental health may improve outcomes in this vulnerable population.

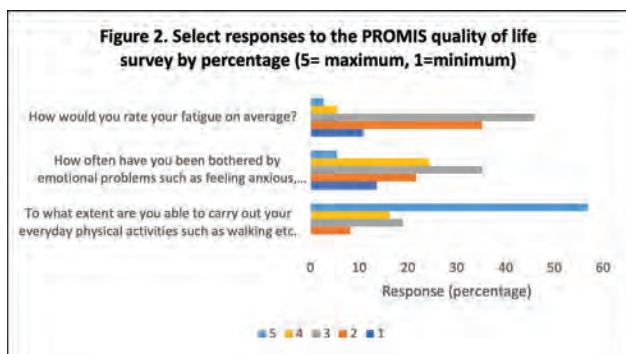
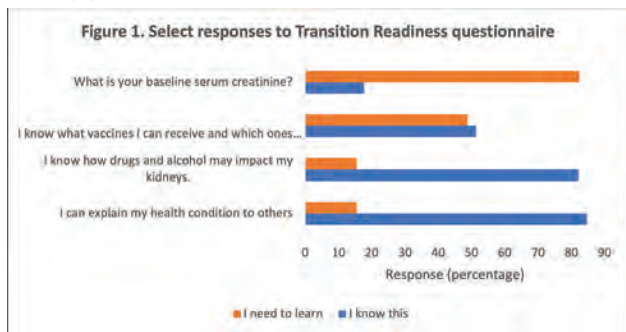

PUB284

**Diuretic Exposure in Critically Ill Pediatric Patients Who Progress to Continuous Renal Replacement Therapy**

Rosanna Fulchiero,<sup>1</sup> Benjamin L. Laskin,<sup>1</sup> Sarah J. Schrauben.<sup>2</sup> <sup>1</sup>The Children's Hospital of Philadelphia, Philadelphia, PA; <sup>2</sup>Hospital of the University of Pennsylvania, Philadelphia, PA.

**Background:** Fluid overload (FO) is common in critically ill children and is associated with substantial morbidity, including prolonged mechanical ventilation (MV), need for continuous renal replacement therapy (CRRT), and mortality. The optimal management of FO remains unclear and diuretic use among critically ill children with FO is not well described. In this study, we aim to characterize diuretic exposure in children with FO who progressed to CRRT.

**Methods:** This is a single center retrospective cohort study of pediatric patients admitted to a general pediatric intensive care unit (ICU) in a large academic children's hospital from 2018-2020, who progressed to CRRT for a primary indication of FO as determined by: comparison to admission weight, MV dependence, oliguria and/or clinical exam. Charts were manually reviewed for all study variables. Diuretic exposure was calculated as mg/kg/day for each respective medication class in the 72 hours prior to initiation of CRRT. Outcomes included % FO at CRRT initiation, CRRT duration, hospital length of stay and mortality. Clinical outcomes were compared between groups using Kruskal-Wallis or Pearson's chi-squared tests as appropriate.

**Results:** Fifty patients (age 0-20 years) met the inclusion criteria within the study period. All patients (100%) were on MV prior to CRRT. Forty (80%) received a diuretic in the 72 hours prior to CRRT; of which, all received a loop diuretic, and 38% also received chlorothiazide or metolazone. Loop diuretic dosing differed among groups (Table 1). Total hospital stay was longest among those in the loop/chlorothiazide group (p=0.049). There was no difference between groups for % FO at CRRT initiation, CRRT duration, or mortality (Table 1).

**Conclusions:** To our knowledge, this is the first study to report diuretic exposure in critically ill pediatric patients with FO that progressed to CRRT. Future research is necessary to determine optimal timing and dosing of diuretic therapy to mitigate adverse outcomes associated with fluid overload.

**Funding:** Other NIH Support - T32 GM 075766-15

	No Diuretics N=30	Loop only N=25	Loop + Metolazone N=5	Loop + Chlorothiazide N=10	P-value
Diuretic Dosing (mg/kg/day), median (IQR)					
Loop dosing*	—	3.3 (1.7, 3.7)	3.5 (2.0, 9.4)	5.2 (3.4, 9.7)	0.042
Metolazone dosing	—	—	0.2 (0.1, 0.3)	—	—
Thiazide dosing	—	—	—	7.5 (2.7, 15.7)	—
Clinical Outcome					
% Fluid Overload at CRRT onset†, median (IQR)	20.7 (14.1, 27.3)	11.4 (4.6, 30.7)	20.3 (18.9, 28.8)	27.1 (20.0, 38.0)	0.23
Duration of CRRT (days), median (IQR)	7.9 (4.6, 22.0)	6.8 (2.8, 14.4)	5.8 (3.6, 12.0)	7.4 (3.0, 13.2)	0.94
Hospital Length of Stay, median (IQR)	23.0 (12.0, 41.0)	30.0 (21.0, 45.0)	47.0 (46.0, 48.0)	50.0 (37.0, 102.0)	0.049
Mortality	8 (80%)	15 (60%)	2 (40%)	6 (60%)	0.48

\*: Dosing is in furosemide equivalents (includes cumulative intermittent and continuous IV dosing of furosemide and bumetanide)  
†: Calculated as [(Weight on CRRT start - weight on ICU admission)/weight on ICU admission]\*100

Comparison of clinical outcomes by diuretic exposure groups in the 72 hours prior to CRRT.

PUB285

**Renin Mediated Hypertension in Pediatrics**

Miranda J. Floen,<sup>1,2</sup> Arwa Nada,<sup>1,2</sup> <sup>1</sup>UTHSC, University of Tennessee Health Science Center, Memphis, TN; <sup>2</sup>LeBonheur Children's Hospital, Memphis, TN.

**Introduction:** Hypertensive crisis is uncommon in children, however when children present with severely elevated blood pressure or acute change in blood pressure further evaluation is needed for secondary causes. Presented are 3 separate cases of renin mediated hypertension due to 3 different pathologies.

**Case Description:** Twenty one month old boy presented with severe hypertension, imaging and lab work up showed elevated renin (32 ng/ml/hr) & aldosterone (68ng/dL). CT angiography (CTA) showed findings consistent with mid-aortic syndrome (figure 1A). The second was 6 years old girl presented with salt craving, emesis and seizure; hypokalemia (1.8 mmol/L), high renin (42 ng/ml/hr) and aldosterone (60ng/dL). CTA was showed poorly enhancing 0.2mm x 0.3mm cortical lesion (figure 1B) that was surgically resected. Pathology confirmed a juxtaglomerular cell tumor. The third patient was a 13-year-old female with known hypertension admitted with a hypertensive crisis, hypokalemia (2.7 mg/dL), high renin (38 ng/ml/hr) and aldosterone (16ng/dL). Renal ultrasound and Doppler noted interval growth of a right renal complex renal cyst (Figure 1C), noted on previous imaging. Pathology completed following partial right nephrectomy identified renal cell carcinoma.

**Discussion:** The stepwise diagnosis of high renin HTN in pediatric population is shown in figure 2.



A: Patient 1 with mid-aortic syndrome; B: Patient 2 with juxtaglomerular cell tumor; C: Patient 3 with complex renal cyst/renal cell carcinoma

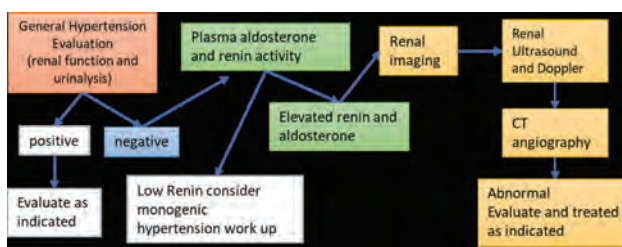

PUB286

**Daily Medication Volume of Phosphate Binder Therapies**

Nupur S. Mistry,<sup>1</sup> Nadia Khambati,<sup>3</sup> Pramod Gupta,<sup>2</sup> Suresh Vayalakkada,<sup>2</sup> Stuart M. Sprague.<sup>1,3</sup> <sup>1</sup>The University of Chicago Medicine, Chicago, IL; <sup>2</sup>Unicyclic Therapeutics, Inc., Los Altos, CA; <sup>3</sup>NorthShore University Health System, Evanston, IL.

**Background:** Elevated phosphate concentrations are associated with a significantly increased risk of cardiovascular events and mortality in patients with chronic kidney disease. The current KDIGO guideline recommends lowering elevated serum phosphorus concentrations toward normal range in patients with ESKD on dialysis through restriction of dietary phosphorus intake, increase in clearance by dialysis, and the use of phosphate binders. There is evidence that 78% of patients are not adherent to phosphate binders. This is thought to be the result of phosphate binders' large sizes and high pill burden. A high daily medication volume creates a barrier to adherence and can negatively impact the quality of life. Thus, a phosphate binder that maintains efficacy with a lower daily medication volume could improve adherence, quality of life, and potentially clinical outcomes. This study evaluated the daily medication volume of various phosphate binders to determine the option with the lowest required daily volume.

**Methods:** The daily dose volumes for lanthanum dioxycarbonate (RENAZORB™), sucroferic oxyhydroxide, calcium acetate, lanthanum carbonate, ferric citrate, and sevelamer carbonate were calculated. The volume for each binder was determined by fluid displacement method, which measures the increase of volume after placing the binder into a graduated measuring cylinder with a fixed volume of liquid. Each measurement was performed in duplicate. The mean daily dose volume was calculated by multiplying the volume per tablet by the mean number of tablets taken per day, based on literature.

**Results:** Lanthanum dioxycarbonate and sevelamer carbonate had the lowest and highest daily dose volume, respectively. (Fig 1) The daily dose volume for lanthanum dioxycarbonate was 3-to-4-fold lower than other phosphate binders, with a total daily volume similar to ~3.5 M&M's.

**Conclusions:** Lanthanum dioxycarbonate, a novel investigational nanotechnology product, may be a welcome choice for patients to manage their hyperphosphatemia. Improved size (easily swallowed) and tolerability have the potential to increase medication adherence and phosphate control.

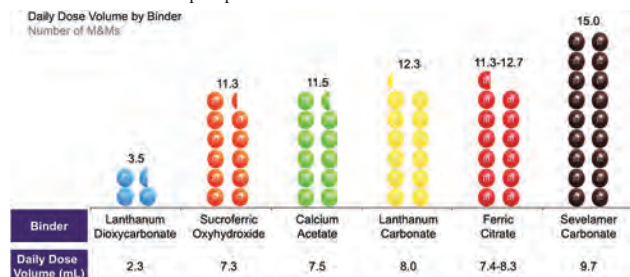

PUB287

**Comparison of Hydroxychloroquine Concentration Among Whole Blood, Serum, and Plasma Samples in Indian Patients With Lupus Nephritis**

Arunkumar Subbiah, Ujjalkumar S. Das, Thirumurthy Velpandian, Sanjay K. Agarwal. *All India Institute of Medical Sciences, New Delhi, India.*

**Background:** Lupus nephritis (LN) is an important risk factor for morbidity and mortality in systemic lupus erythematosus (SLE). Hydroxychloroquine (HCQ) is an integral part of the therapeutic armamentarium for SLE, both in prophylaxis and treatment. Data regarding HCQ levels in whole blood, serum and plasma and recommended therapeutic cut-offs have not been reliably determined. The present study aims to estimate and correlate HCQ concentrations in whole blood and its components (serum and plasma) in LN patients in Indian subpopulation.

**Methods:** Lupus nephritis patients on HCQ therapy for a minimum of 3 months were included in this study. HCQ blood levels (ng/mL) in same patient from EDTA whole blood, plasma and serum were measured by liquid chromatography-tandem mass spectrometry and correlation among different bio sample was done.

**Results:** In this cohort study, 51 patients were included with mean age of 29.5±8.98 years, of which 88.2% were women. The mean HCQ dose was 4.9±1.7 mg/kg/day. The mean HCQ levels in whole blood, plasma and serum were 934.3±707.7 ng/mL, 357.2±259.4 ng/mL and 354.93±276.44 ng/mL, respectively. The mean levels in whole blood were approximately 2.5-fold the levels in serum and plasma. Whole blood concentrations of HCQ had positive linear correlations with both plasma and serum concentrations, with a correlation coefficient of 0.549 and 0.778 (p<0.001), respectively (Figure 1). Whole blood levels with dose of 200 mg/day were lower than 400 mg/day (736±666.40 ng/mL vs 1117.45±814.66 ng/mL).

**Conclusions:** This is the first Indian study to look at HCQ concentrations in patients with lupus nephritis in whole blood, serum and plasma. All three samples' sources have good correlation and any sample can be used from clinical point of view.

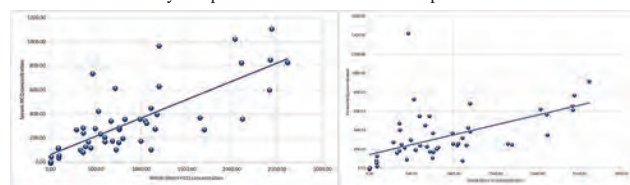

PUB288

**Improving Opioid Utilization for Pain Management in Patients Suffering From CKD5 and ESRD**

Marcus Castillo,<sup>1</sup> Charles Bonanno,<sup>2,3</sup> Michael M. Samiratedu,<sup>2,3</sup> Aliericy Nunez Sanchez,<sup>2</sup> Marie A. Sosa.<sup>2,1</sup> <sup>1</sup>University of Miami School of Medicine, Miami, FL; <sup>2</sup>University of Miami Health System, Miami, FL; <sup>3</sup>Jackson Memorial Hospital, Miami, FL.

**Background:** The use of morphine and codeine to treat pain in patients with CKD5 or ESRD has been associated with neurotoxic side effects due to the accumulation of drug metabolites secondary to impaired renal clearance and altered pharmacokinetics. Guidelines that offer physicians alternative treatment options with a safer side effect

profile are essential. The goal of this project is to reduce the unnecessary use of these drugs in these patients at the University of Miami Hospital (UMH).

**Methods:** A retrospective study was performed to determine the baseline metrics for how often morphine and codeine were prescribed to CKD5 and ESRD patients at UMH. From August 1st 2021 - January 31st 2022, data obtained from the Epic Electronic Medical Records showed that these opioids had been prescribed to this patient population a total of 532 times. Additionally, of 32 opioid related ADRs in 2021, 12 (38%) were seen in patients with renal dysfunction. Following a root cause analysis, the team detailed interventions to optimize treatment for these patients including: 1) offering brief educational materials 2) providing an evidence-based adapted WHO analgesic ladder with alternative treatment options, 3) creating physician and pharmacist electronic safety and best practice alerts (BPA) 4) initiating a daily report by the Opioid Stewardship for the prescription of these drugs in ESRD whereby pharmacists contact providers with recommendations.

**Results:** This quality improvement project is currently being implemented.

**Conclusions:** Following these interventions, we will analyze patient data to see if there has been a reduction in the overuse of these medications with the goal of reducing the number of opioid related ADRs from 38% to less than 10% in the 6 months following the PDSA cycle.

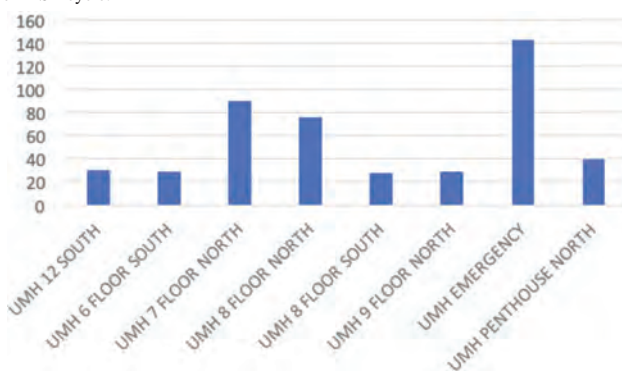

Figure 1. Codeine and Morphine Prescribed in CKD5 and ESRD at UMH 8/1/21 - 1/31/22.

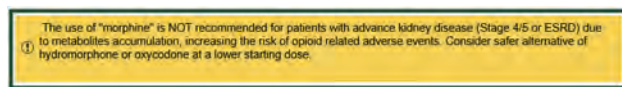

Figure 2. BPA Safety Alert for the Prescription of Morphine in ESRD

PUB289

**Role of Cell-Free DNA in the Follow-Up of CKD Patients After Kidney Transplantation**

Chiara Leotta,<sup>1,2</sup> Leah N. Hernandez,<sup>1</sup> Lubomira Tothova,<sup>3</sup> Milan Chromek,<sup>1</sup> Paola Ciceri,<sup>2</sup> Mario Cozzolino,<sup>2</sup> Peter Stenvinkel,<sup>1</sup> Karolina Kublickiene,<sup>1</sup> Renal division of Karolinska Institute and University of Milan ASST Santi Paolo e Carlo <sup>1</sup>Karolinska Institutet, Stockholm, Sweden; <sup>2</sup>Universita degli Studi di Milano, Milano, Italy; <sup>3</sup>Univerzita Komenskeho v Bratislava, Bratislava, Slovakia.

**Background:** Circulating cell-free DNA (cfDNA) has emerged as a novel biomarker in patients who have undergone an organ transplant but also in pregnant women and cancer patients. Studies have shown that cf-DNA strongly correlates with cell damage and rejection after transplantation. In particular mitochondrial-DNA is known to be related to the inflammatory state. Cf-DNA is a potential non-invasive marker that could be used for diagnosis and monitoring of possible graft rejection and organ damage.

**Methods:** Plasma samples were collected from 44 chronic kidney disease patients before and two years after kidney transplantation. The group of patients consisted in 33 males and 11 females with age ranging between 25-80 years old, undergoing conservative therapy and haemodialysis. Clinical inclusion criteria were at least one of the following: diabetes, hypertension or cardiovascular disease. Cf-DNA were isolated from plasma and then quantified with fluorometric method. A qPCR procedure was used to quantify and distinguish between the mitochondrial and the nuclear cf-DNA amount.

**Results:** Total cf-DNA from kidney transplant patients showed decreased trend from baseline to two years post-transplantation. The same decreased pattern of total cf-DNA were also observed among males and females, however it was not statistically significant. Further evaluation of the two cf-DNA fractions, mitochondrial cf-DNA was significantly higher than nuclear cf-DNA both for the baseline and two years after transplant (p<0.05). Sex disaggregated analysis showed also a trend in males having a higher mitochondrial and nuclear cf-DNA than females at the baseline and at two years follow-up, although not statistically significant.

**Conclusions:** Our preliminary results suggest that transplant may reduce the inflammatory state of patients and this is supported by the lower levels of mitochondrial-cfDNA 2 years after transplant compared to baseline. The lack of differences between males and females may suggest that kidney transplantation has the same effects in both sexes, although extended studies are required, including separation between mitochondrial and nuclear cf-DNA. Further studies are ongoing to assess if cf-DNA could serve as an accurate non-invasive method for monitoring the response to organ transplant in the future.

**Funding:** Government Support - Non-U.S.

**PUB290**

**Anemia in the First Year Post Kidney Transplantation**

Ziad Arabi,<sup>1,2</sup> Talha M. Youssouf,<sup>1,2</sup> Dr Junaid Iqbal,<sup>1,2</sup> <sup>1</sup>Division of Nephrology, Department of Medicine, King Abdulaziz Medical City, Riyadh, Saudi Arabia; <sup>2</sup>King Abdullah International Medical Research Center, College of Medicine, King Saud Bin Abdulaziz University for Health Sciences, Riyadh, Saudi Arabia.

**Background:** Anemia, defined as hemoglobin (Hb) <120 g/L in women and <130 g/L in men, is a common finding before and after kidney transplantation (KT). Late post transplantation anemia is defined as anemia which develops after 6 months. There is no previous data about anemia post KT and the associated factors of late anemia at our center.

**Methods:** A single center retrospective study of kidney transplant recipients (KTR) from 2017 to 2020. We collected data about patients' demographics, cardiovascular risk factors, and the values of hemoglobin at baseline (before KT), and up to 24 months post KT. We defined anemia as above.

**Results:** We included 287 KTR. 74% were ≥ 30 years, 58% were men and 80% were living-donor KTR. Pre-emptive KT was performed in 10.1%. Pre- KT dialysis modality was PD in 11.5% and HD in 78.4% (AVF: 42%). Dialysis vintage was 4.8±3.3 years for deceased donor KT versus 2.4±2.6 years for living donor KT. Mean Hb (g/L) at baseline (before KT): 114.3±17.3; at 1- 6 months: 101.5±15.3; at 6-12 months: 138.6±19.4; and after 12 months: 141.2±20.1. Average hemoglobin change from baseline to 12 months was 26.6 (23.8 to 29.5). P value: <0.001. Figure 1 illustrates average Hb at the time of KT, 1-6, 6-12 and after 12 months post KT. Anemia was identified in 197 (68.6%) at baseline (before KT) but it decreased to only 31 (10.8%) by 12 months and only 21 (7.3%) KTR had severe anemia at 12 months. There were no association between anemia at 12 months and patients' demographics including age, gender, blood group, type of dialysis, and type of access; nor baseline cardiovascular risk factors.

**Conclusions:** Anemia is common among renal transplant candidates. Hemoglobin levels drop further, early, after transplantation but progressively improve by 12 months. There was no association between the incidence of late anemia post KT and baseline patients' demographics or pre-transplant cardiovascular risk factors.



Changes of hemoglobin (HG) post kidney transplantation

**PUB291**

**The Management of Dyslipidemia in Kidney Transplant Recipients According to Kidney Disease: Improving Global Outcomes vs. the Guidelines of the American Heart Association**

Ziad Arabi,<sup>1,2</sup> Ahmed S. Alnasrullah,<sup>1,2</sup> Abdullah A. A. AlGhamdi,<sup>1,2</sup> Mohammed H. Tawhari,<sup>1,2</sup> <sup>1</sup>Division of Nephrology, Department of Medicine, King Abdulaziz Medical City, Riyadh, Saudi Arabia; <sup>2</sup>King Abdullah International Medical Research Center; College of Medicine, King Saud Bin Abdulaziz University for Health Sciences, Riyadh, Saudi Arabia.

**Background:** The management of dyslipidemia, according to the guidelines of the KDIGO organization of kidney transplant recipients (KTR), has not been reviewed in terms of the more recent guidelines of the American Heart Association (AHA).

**Methods:** We conducted a single-center, retrospective study with KTR, from 2017 to 2020. The data included the demographic characteristics, cardiovascular risk factors, and the lipid profile (pre-transplant and at 12 months post-transplantation). The study aimed to compare the rate of achieving the target goals of dyslipidemia management, as defined by the two guidelines.

**Results:** In total, 287 KTR were included, 214 (74.6%) were ≥ 30 years old (yo), 58.2% male, and 80.5% a living-donor KTR. Of the 214 patients 30 years and older, 80% received a statin. Statins were prescribed in 93% and 96% of the patients with Diabetes (DM) or coronary artery disease (CAD) respectively. The LDL targets were achieved in 62% of the group ≥30 yo (LDL target of 2.6), or in 19% (LDL target of 1.8).

**Conclusions:** Despite a high compliance rate with statin prescriptions, based on the protocolized approach of the KDIGO guidelines, a significant proportion of the KTR with risk factors did not achieve the LDL targets proposed by AHA guidelines for dyslipidemia management.

**PUB292**

**Differential Control of Systolic and Diastolic Blood Pressure in Kidney Transplant Recipients**

Ziad Arabi,<sup>1,2</sup> Nayef Alawadh,<sup>1,2</sup> Abdullah S. Bawazir,<sup>1,2</sup> Nasser M. Alnazari,<sup>1,2</sup> Mubarak I. Abdalla,<sup>1,2</sup> Fayeze F. Alhejaili,<sup>1,2</sup> Dr Junaid Iqbal,<sup>1,2</sup> <sup>1</sup>Division of Nephrology, Department of Medicine, King Abdulaziz Medical City, Riyadh, Saudi Arabia; <sup>2</sup>King Abdullah International Medical Research Center; College of Medicine, King Saud Bin Abdulaziz University for Health Sciences, Riyadh, Saudi Arabia.

**Background:** Differential control of systolic and diastolic blood pressure (BP) is well documented in the treatment of hypertension in the general population but there is limited data in kidney transplant recipients (KTR).

**Methods:** A single center retrospective study of KTR who received kidney transplantation (KT) between January 2017 and May 2020. We reviewed BP readings before transplant and at one month, 6 months, and 12 months after kidney transplantation. We also reviewed the number of BP medications at the same intervals post transplantation. Blood pressure goal was <140/90 mmHg during the time of this retrospective study as per published guidelines. BP measurement in clinic was standardised.

**Results:** The number of anti-hypertensive medications post KT decreased with time (Table 1). There was positive correlation between SBP and number of BP medications, however DBP fell as number of anti-hypertensive medications increased (Table 2 and Figure 1).

**Conclusions:** Diastolic BP appeared much amenable to control than systolic BP in the first year and it required significantly a fewer BP medications to control to target. Further research is warranted to confirm this interesting observation.

Table 2 The correlation between BP meds and SBP and DBP in the first year after kidney transplant

	Coefficient	P value
Systolic BP & number of meds at 12 months	0.379	<0.001
Diastolic BP & number of meds at 12 months	-0.154	0.016

Number of medications	1 month	6 months	12 months	P (For 1month vs. 12 months)
0	67 (23.3%)	82 (28.6%)	84 (29.3%)	0.001
1	91 (31.7%)	93 (32.4%)	89 (31%)	
2	85 (29.6%)	83 (28.9%)	81 (28.2%)	
3	27 (9.4%)	18 (6.3%)	18 (6.3%)	
4	6 (2.1%)	2 (0.7%)	6 (2.1%)	
5	2 (0.7%)			

Table 1: Number of BP medications in the first year post KT

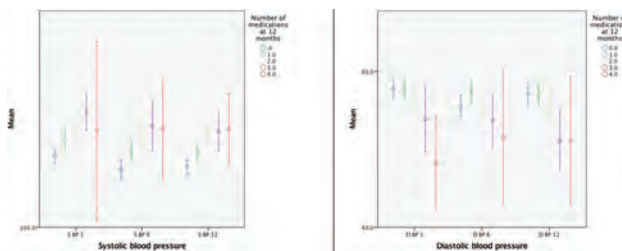

Figure.1 Number of BP medications and mean SBP and DBP in the first year post KT

**PUB293**

**The Impact of Dialysis Vintage on Cardiovascular Risk Factors and the Findings of Cardiovascular Screening Workup of Renal Transplant Candidates**

Ziad Arabi,<sup>1,2</sup> Talha M. Youssouf,<sup>1,2</sup> Mohamad Y. Abdulgadir,<sup>1,2</sup> Hazim S. Alghamdi,<sup>1,2</sup> Abdullah S. Bawazir,<sup>1,2</sup> Nayef Alawadh,<sup>1,2</sup> Mohammed H. Tawhari,<sup>1,2</sup> Mubarak I. Abdalla,<sup>1,2</sup> Fayeze F. Alhejaili,<sup>1,2</sup> <sup>1</sup>Division of Nephrology, Department of Medicine, King Abdulaziz Medical City, Riyadh, Saudi Arabia; <sup>2</sup>King Abdullah International Medical Research Center; College of Medicine, King Saud Bin Abdulaziz University for Health Sciences, Riyadh, Saudi Arabia.

**Background:** Although dialysis vintage is associated with increased mortality risk in patients receiving dialysis, the association of dialysis vintage with cause-specific mortality is unclear.

**Methods:** In a single center retrospective study, we reviewed the renal transplant recipients who underwent renal transplant from 2017 to 2020. We divided the group based on their dialysis vintage, < 3 years versus > 3 years. We collected the data about the patients' demographics, cardiovascular risk factor, dialysis modality, and pre-transplant work-up images.

**Results:** We included 278 patients, 109 patients in the longer vintage group and 169 patients in the shorter vintage group. The mean age 43.8±16.1 and 164 patients (59%) were male. The mean dialysis vintage in the shorter group was 1± 0.1 year, and 5.7± 2.7 years in the longer vintage group, p <0.001. The most common comorbidities were hypertension (76%), followed by diabetes mellitus (41.7%), and were present in similar proportions of both groups. Compared to the shorter dialysis vintage group, those who had longer dialysis vintage were more likely to have a deceased kidney donor (36.7% vs 8.9%, p <0.001), receive hemodialysis (88.1% vs 76%; p=0.006), predominantly through an arteriovenous fistula (55% vs 20.7%; p <0.001). The results of pretransplant work up including cardiac stress test, calcium scoring, coronary angiogram, cardiac ejection fraction, left ventricular hypertrophy, wall motion abnormalities and the degree of calcifications of pelvic arteries on pelvic Ct scan did not differ between the two groups.

**Conclusions:** Dialysis vintage up to 3 years was not associated with increased incidence of the traditional cardiovascular risk factors, nor changes of cardiovascular imaging. This suggests that the increase of mortality related to dialysis vintage might be related to other factors such as uremia, electrolytes shifts and / or infections. Further studies with longer follow up are needed.

**PUB294**

**Hyperglycemia (Hemoglobin A1c) in the First Year Post Kidney Transplantation**

Ziad Arabi,<sup>1,2</sup> Aya K. Alkhudhairy,<sup>1,2</sup> Nayef Alawadh,<sup>1,2</sup> Reem A. Baduwaylan,<sup>1,2</sup> <sup>1</sup>Division of Nephrology, Department of Medicine, King Abdulaziz Medical City, Riyadh, Saudi Arabia; <sup>2</sup>King Abdullah International Medical Research Center; College of Medicine, King Saud Bin Abdulaziz University for Health Sciences, Riyadh, Saudi Arabia.

**Background:** There is limited data about hyperglycemia and its risk factors in the first year post kidney transplantation (KT).

**Methods:** A single center retrospective study of kidney transplant recipients (KTR) who underwent KT between 2017 to 2020. We reviewed the patients' demographics, weight changes and A1C values (at baseline and every 3 months) for 12 months post KT.

**Results:** A total of 287 KTR were included. 74% were ≥ 30 years, 58% were men and 80% were living-donor KTR. Preemptive KT was 10.1%, PD: 11.5% and HD: 78.4%. At baseline, obesity stage 1 (BMI: 30-34.9) was present in 20.2% of patients and obesity stage 2 (BMI 35-39.9) in 4.2%. Diabetes (DM) was present in 99 (34.5%), [DM type I: 25 (25.3%) and DM type II: 74 (74.7%)]. By 12 months, both females and males significantly gained weight [6.33 Kg versus 5.79 Kg respectively]. The percentage of (weight gain / baseline weight) was numerically higher in females than males (10.6% versus 7.8%; p: 0.588). In females, A1C was 5.3±1.1 at baseline, and increased by 1.44 (0.82 to 2.06) at 12 months; p <0.001. Whereas in males, A1C was 6.5±5.8 at baseline, and increased by 0.8 (0.14 to 1.47) at 12 months; p=0.02. The increase of A1C was statically significant higher in females (p: 0.04). See Fig. 1. By one year, (n:22, 7.7%) developed post KT diabetes mellitus. Predictors of A1C increase of > 0.5% were: age (OR: 1.05, CI: 1.02 to 1.08, P< 0.01), weight change (OR: 1.05, CI: 1.01 to 1.10, P= 0.01) and hypertension (OR:3.01, CI: 1.25 to 7.23, P: 0.01). Baseline A1C was a negative predictor (OR: 0.45, CI: 0.32 to 0.62, P:<0.01) but gender and dialysis vintage were not associated.

**Conclusions:** A1C increased significantly in the first-year post KT especially in females. Age, weight gain, lower A1C at baseline were positively correlated with increment in A1C.

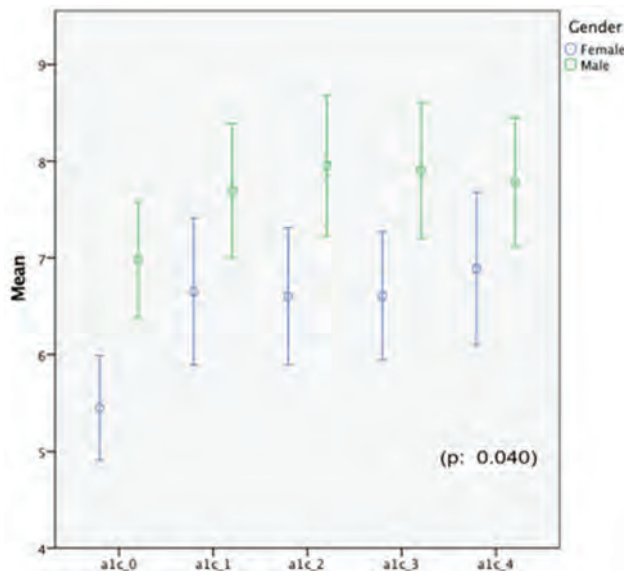

HbA1C increase in the first year post KT

**PUB295**

**Factors Associated With a Higher Need for Antihypertensive Medications at 12 Months Post Kidney Transplantation**

Ziad Arabi,<sup>1,2</sup> Talha M. Youssouf,<sup>1,2</sup> Elwaleed A. Elhassan.<sup>1,2</sup> <sup>1</sup>Division of Nephrology, Department of Medicine, King Abdulaziz Medical City, Riyadh, Saudi Arabia; <sup>2</sup>King Abdullah International Medical Research Center; College of Medicine, King Saud Bin Abdulaziz University for Health Sciences, Riyadh, Saudi Arabia.

**Background:** In this study we examined risk factors of “difficult to treat hypertension” at one year post kidney transplantation (KT).

**Methods:** A retrospective study of kidney transplant recipients (KTR) who underwent KT between 2017 and 2020. We reviewed results of pretransplant cardiovascular (CV) imaging, and the changes of CV risk factors during the first-year post KT. We divided patients according to the number of their BP medications at one year into two groups; those who required ≤ 1, and those who required ≥ 2 medications “difficult to treat hypertension”. The target BP during the time of this retrospective study was <140/90 mm Hg as per the published guidelines.

**Results:** A total of 278 KTR were included. Of them 74% were ≥ 30 years, 58% were men and 80% were living-donor KTR. Preemptive KT was 10.1%. PD and HD were 11.5% and 78.4%, respectively. At one year, 70.1% of the patients attained the target BP goal. Thirty eight percents of the patients had “difficult to treat HTN”. Risk factors were: age (50 vs. 39 years, P<0.01), prior history of HTN (P<0.01), prior AV fistula (P=0.04) and diabetes mellitus (P<0.01). Whereas, dialysis vintage (including preemptive transplantation), type of dialysis, type of KT, and smoking were not different among the two groups. Patients with “difficult to treat HTN” at one year were more likely to have abnormal pre-transplant CV baseline imaging including abnormal ejection fraction <55% (P=0.04), abnormal wall motion on echocardiography (P<0.01), abnormal perfusion stress test (P<0.01), higher calcium scoring (P<0.01), abnormal cardiac catheterization (P<0.01), and a higher degree of calcifications on CT of pelvic arteries (P< 0.01). Patients with “difficult to treat HTN” were likely to have a higher BMI at 12 months (P=0.02), whereas rejection, change of creatinine, persistent hyperparathyroidism and anemia at 12 months were not different among the two groups. Multivariate analysis indicated a relation with age (aOR: 1.025); male gender (aOR: 2.41); DM (aOR: 2.07); baseline HTN (aOR 2.58). However, the odds ratio for BMI at 12 months was insignificant (P=0.98).

**Conclusions:** At one year post transplantation, about a third of KTR required two or more BP medications. These patients were more likely to be older, males, diabetic, previously hypertensive and to have abnormal baseline pre-transplant CV imaging.

**PUB296**

**Kidney Transplantation and Statins' Effects on Dyslipidemia in Kidney Transplant Recipients**

Ziad Arabi,<sup>1,2</sup> Abdullah A. A. AlGhamdi,<sup>2,1</sup> Ahmed S. Alnasrullah,<sup>2,1</sup> <sup>1</sup>King Abdullah International Medical Research Center; College of Medicine, King Saud Bin Abdulaziz University for Health Sciences, Riyadh, Saudi Arabia; <sup>2</sup>Division of Nephrology, Department of Medicine, King Abdulaziz Medical City, Riyadh, Saudi Arabia.

**Background:** To review the effect of kidney transplantation (KT) and adding of statins on dyslipidemia in kidney transplant recipients (KTR)

**Methods:** A single center retrospective study of KTR, from 2017 to 2020. Lipid's profile and Hgb A1C were reviewed at baseline (before KT) and at average 12 months of KTR who received statins or not

**Results:** We included 287 KTR, 74% were ≥ 30 years. Statins were prescribed to 80% of KTR who were ≥30 years old. The most common statin used was Atorvastatin at 10 mg in 60% or 20 mg in 23% of the cases. In KTR who did not receive statins: KT was associated with an increase of total cholesterol (TC) by 0.31 mmol /L (P: 0.02) and an increase of LDL by 0.40 mmol /L (P<0.01). On the other hand, and despite weight gain of average 6.9 kg (P <0.01), and increase of A1C by 0.71(P<0.01); KT was associated with an increase of HDL by 0.17 mmol /L (P:<0.01) and down trending but not statically significant decrease of triglyceride (TG) by -0.09 mmol /L (P= 0.28). In KTR who received statins: despite weight gain of 5.6 kg (P <0.01) and increased of A1C by 0.93 (P <0.01), HDL improved by 0.17 mmol /L (P<0.01) and TG decreased by -0.34 (P<0.01). Statins were associated with a numerical decrease of TC by -0.06 (P=0.51) and nonsignificant increase of LDL by only 0.04 (P= 0.60). Statins were associated with improvement of TC and LDL compared to no statins. The mean changes of TC (from baseline to 12 months) while on statins versus none were (-0.06 versus 0.31, P<0.02) and the mean changes of LDL (from baseline to 12 months) while on statins versus none were (0.04 versus 0.40, P=<0.01).

**Conclusions:** Despite weight gain and the increased level of A1C seen after KT, KT was associated with improved TG and HDL. Adding statins in patients at higher risk of dyslipidemia not only maintained the beneficial effects of KT on HDL and TG but also had significant “buffering” effect against the rising of TC and LDL



Lipids profile changes in the first year after renal transplant

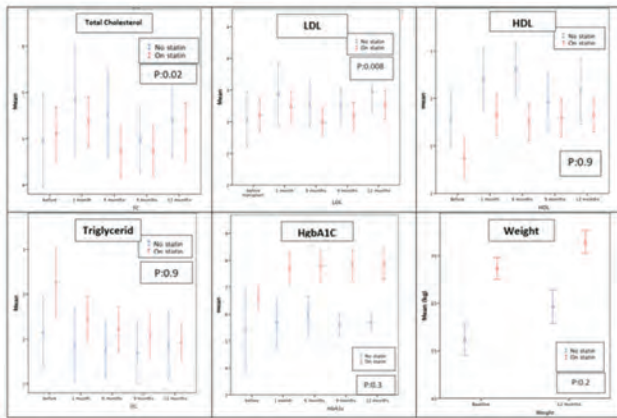

P values were calculated for the difference of changes from baseline to 12 months for those who were on statins versus no statins.

PUB297

The Trend of Blood Pressure in the First Year Post Kidney Transplantation in Kidney Recipients With Uncontrolled Hypertension

Ziad Arabi,<sup>1,2</sup> Talha M. Youssouf,<sup>1,2</sup> Mohamad Y. Abdulgadir,<sup>1,2</sup> Hazim S. Alghamdi,<sup>1,2</sup> Abdullah S. Bawazir,<sup>1,2</sup> Fayez F. Alhejailli,<sup>1,2</sup> Reem A. Baduwaylan,<sup>1,2</sup> Dr Junaid Iqbal.<sup>1,2</sup> <sup>1</sup>Division of Nephrology, Department of Medicine, King Abdulaziz Medical City, Riyadh, Saudi Arabia; <sup>2</sup>King Abdullah International Medical Research Center; College of Medicine, King Saud Bin Abdulaziz University for Health Sciences, Riyadh, Saudi Arabia.

**Background:** It has been shown that both systolic and diastolic BP significantly trend down in the first-year post kidney transplantation (KT). We investigated if BP follows the same pattern in kidney transplant recipients (KTR) with uncontrolled hypertension (HTN).

**Methods:** A single center retrospective study of KTR who underwent KT between 2017 and 2020. We recorded and compared trends of systolic and diastolic BP readings at baseline (before transplant), and at 1-, 6- and 12-months post-transplant in addition to the number of BP medications post- KT at the same intervals. The target BP was <140/90 mmHg as per published guidelines at the time of this study. We divided patients according to their BP control at one-year post-transplant into two groups, controlled (≤140/90) and uncontrolled (>140/90). We compared BP trends and the number of medications in the first year in those with controlled versus uncontrolled HTN at 12 months.

**Results:** A total of 254 KTR were included. Of those, 74% were ≥ 30 years, 58% were men and 80% were living-donor kidney recipients. Preemptive transplantation was 10.1%, PD 11.5% and HD 78.4%, respectively. At one year, 76 (29.9%) did not attain target BP goal. Systolic BP decreased by 7.2±18.6 mmHg from baseline in the group with controlled BP and whereas it increased by 3.5±16.9 mmHg in the group of uncontrolled BP (P<0.001). Diastolic BP decreased by 4.1±12 mmHg in the group with controlled BP whereas it increased by 2±13.7 mmHg in the group of uncontrolled BP (P<0.001). The number of BP medications in KTR with uncontrolled HTN was higher than those with controlled HTN as shown in Table.1.

**Conclusions:** Systolic and diastolic BP trended down from baseline after transplantation in KTR with controlled hypertension whereas both systolic and diastolic BP increased despite a higher number of BP medications in those with uncontrolled hypertension. This interesting finding requires further evaluation by a controlled prospective study.

Number of antihypertensive medications	Total 254	BP ≤ 140/90 178	BP > 140/90 76 (29.9%)	P value
0	71 (28%)	40 (42.1%)	31 (20.7%)	0.006
1	80 (32.7%)	29 (30.5%)	51 (34%)	
2	72 (29.4%)	20 (21.1%)	52 (34.7%)	
3	17 (6.9%)	5 (5.3%)	12 (8%)	
4	5 (2%)	1 (1.1%)	4 (2.7%)	

Table.1 Number of BP medications at 12 months post KT in KTR with controlled versus uncontrolled HTN

PUB298

The Impact of Dialysis Vintage on the Metabolic and Cardiovascular Risk Factors in the First Year Post Renal Transplantation

Ziad Arabi,<sup>1,2</sup> Mohamad Y. Abdulgadir,<sup>1,2</sup> Talha M. Youssouf,<sup>1,2</sup> Reem A. Baduwaylan,<sup>1,2</sup> Dr Junaid Iqbal,<sup>1,2</sup> Abdullah S. Althani,<sup>1,2</sup> Hamzah A. Alhamzah,<sup>1,2</sup> Aya K. Alkudhairy.<sup>1,2</sup> <sup>1</sup>Division of Nephrology, Department of Medicine, King Abdulaziz Medical City, Riyadh, Saudi Arabia; <sup>2</sup>King Abdullah International Medical Research Center; College of Medicine, King Saud Bin Abdulaziz University for Health Sciences, Riyadh, Saudi Arabia.

**Background:** Although dialysis vintage is associated with increased mortality risk in patients receiving dialysis, the association of dialysis vintage with cause-specific mortality is unclear.

**Methods:** In a single center retrospective study, we reviewed the renal transplant recipients who underwent renal transplant from 2017 to 2020. We divided the group based on their dialysis vintage, < 3 years versus > 3 years. We collected the data about the patients' demographics, cardiovascular risk factor, dialysis modality, and the changes in metabolic and cardiovascular risk factors in the first post-transplantation year.

**Results:** We included 278 patients, 109 patients in the longer vintage group and 169 patients in the shorter vintage group. The mean age 43.8±16.1 and 164 patients (59%) were male. The mean dialysis vintage in the shorter group was 1±0.1 year, and 5.7±2.7 years in the longer vintage group, p <0.001. The most common comorbidities were hypertension (76%), followed by diabetes mellitus (41.7%), and were present in similar proportions of both groups. Compared to the shorter dialysis vintage group, those who had longer dialysis vintage were more likely to have a deceased kidney donor (36.7% vs 8.9%, p<0.001), receive hemodialysis (88.1% vs 76%; p=0.006), predominantly through an arteriovenous fistula (55% vs 20.7%; p<0.001). In the first post-transplantation year, patients in the longer vintage group were more likely to have reduction in their systolic blood pressure (-7.1±20.7 mmHg vs -1.6±17.5; p=0.027) and were at a higher risk of developing persistent hyperparathyroidism (27% vs 18%, p=0.003). However, patients in the shorter vintage group were more likely to have post-transplant weight gain (6.8±8.8 kg vs 4.7±; p=0.039). Post transplantation diabetes at one-year post-transplantation was similar between the two groups.

**Conclusions:** Patients with dialysis vintage up to 3 years were not different in their baseline traditional risk factors. However they were at a higher risk of having persistent hyperparathyroidism at 12 months post renal transplant (27% vs 18%, p=0.003). On the other hand, patients with shorter dialysis vintage were more likely to have post-transplant weight gain (6.8±8.8 kg vs 4.7±; p=0.039).

PUB299

A Phase 1b, Multicenter, Open-Label Study to Evaluate the Safety, Pharmacokinetics, and Efficacy of Tegoprobart (AT-1501) in Patients Undergoing Kidney Transplant

Jean Tchervenkov,<sup>1</sup> Patrick T. Coates,<sup>2</sup> Matthew J. Kadatz,<sup>3</sup> Jeffrey D. Bornstein,<sup>4</sup> John S. Gill.<sup>5</sup> <sup>1</sup>McGill University Faculty of Medicine and Health Sciences, Montreal, QC, Canada; <sup>2</sup>Royal Adelaide Hospital, Adelaide, SA, Australia; <sup>3</sup>Vancouver General Hospital, Vancouver, BC, Canada; <sup>4</sup>Eledon Pharmaceuticals, Irvine, CA; <sup>5</sup>St Paul's Hospital, UBC, Vancouver, BC, Canada.

**Background:** Calcineurin inhibitors (CNIs) are the backbone of kidney transplant anti-rejection therapy, and they substantially reduce the risk of acute rejection, providing excellent one-year patient and graft survival. However, only ~50% of the grafts survive 10 years, with these graft failures often being due to either late onset antibody mediated rejection or the direct nephrotoxicity of the CNIs themselves. CNIs are also associated with an increased risk of new onset diabetes after transplant, tremor, cognitive impairment, and other adverse events. As such, an agent that could produce comparable one-year results while improving long term outcomes and reducing CNI toxicities would address a significant unmet medical need. Tegoprobart (AT-1501) is a monoclonal antibody directed against the CD40 ligand (CD40L), a key mediator of co-stimulation. Inhibition of CD40L should result in a decrease in both cell and antibody mediated immunity and create a more tolerogenic immune environment. Tegoprobart has been shown to be effective in animal models and is currently being studied in kidney transplant recipients.

**Methods:** This pilot study will investigate the use of tegoprobart to prevent rejection in human kidney transplant recipients. Up to 12 participants will be enrolled in this open label study, and enrollment will be staggered such that the second subject cannot be screened until the first subject completes 28-days post-transplant and the DMC completes a review of the data. Adult recipients of their first allograft are eligible if they meet inclusion / exclusion criteria and if the donor kidney does not meet extended criteria, have a prolonged cold ischemia time, or come from a donor with cardiac death. All study participants will receive rATG induction therapy and a maintenance regimen of tegoprobart dosed at 20mg/kg IV every 3 weeks after a loading dose, MMF and corticosteroids. The safety of the regimen, PK of tegoprobart, and the ability of this regimen to prevent rejection will be assessed.

**Results:** The results will be presented when available.

**Conclusions:** Tegoprobart is a potential alternative to CNI in maintenance therapy for the prevention of allograft rejection in kidney transplant recipients. A Phase 1b trial to assess its safety, PK and efficacy is ongoing.

**Funding:** Commercial Support - Eledon Pharmaceuticals

## PUB300

**High HLA Class II Epitope-Mismatch Load and Low Tacrolimus Level Are Associated With the Development of Donor-Specific Antibodies and Poor Graft Outcome**

**Dong Ryeol Lee, Byung chang Kim.** *Maryknoll Medical Center, Busan, Republic of Korea.*

**Background:** HLA matching has been an essential role in the risk assessment for long-term graft outcomes in kidney transplantation recipients. Recent HLA epitope matching at HLA-DR and HLA-DQ loci between donor and recipient are better predictors for the development of de novo DSAs (donor-specific antibodies) and graft outcome. Limited data are available on the association between HLA class II epitope-mismatch load and the development of de novo DSA. The purpose of our study is to evaluate the clinical significance of HLA class II epitope mismatch for the development of de novo DSA and graft outcome.

**Methods:** We examined 178 kidney transplant recipients for the development of DSAs from June 2015 to June 2018. We excluded patients whose data on HLA-DQ matching were missing and HLA class II epitope matching was not available. A nadir FK trough level was collected over 6 months prior to the development of de novo DSA. We compared HLA-DR/DQ matching / HLA class II epitope matching and a nadir FK level over 6month prior to DSA occurrence for the development of de novo DSA and graft outcome

**Results:** 25 of 178 stable KTRs (14.0%) had HLA class II DSAs (10DR-DSA/14DQ-DSA, 1 combined DR-and DQ-DSA) on SAB. The median follow-up was a 90.0±5.9 month (range 0-215). Mean HLA mismatch numbers were 3.5±0.2. Six (3.4%) of 25 de novo HLA class II DSA had biopsy-proven CABMR (chronic antibody-mediated rejection). Three of 5 DQ-DSA positive patients and one of 1 DR-DSA positive patient were lost graft function to CABMR. Not High DR epitope mismatch load(DR epitope mm≥10) but High DQ epitope mismatch loads(DQ epitope mm ≥17) and the lowest FK trough level (<6ng/ml) during the past 6month prior to de novo DSA occurrence were significantly associated with the development of de novo DQ-DSA. Independent predictors of graft failure on multivariate analysis were CABMR and the development of de novo DQ DSA.

**Conclusions:** Our study showed that combined high DR /DQ epitope mismatch loads and less than 6ng/ml of FK trough levels over 6month prior to the development of de novo DSAs are associated with the development of de novo DSAs which subsequently lead to CABMR and graft failure. Our study needs to verify whether intensifying immunosuppression can prevent the development of de novo DSA among patients who have high DQ-epitope mismatch loads

## PUB301

**Outcome of Renal Transplant Recipients Admitted to the Intensive Care Unit: Long Term Follow-Up**

**Amgad E. El Agroudy.** *Arabian Gulf University, Manama, Bahrain.*

**Background:** The goal of this study was to evaluate the course and outcome of kidney transplant (KT) recipients admitted to intensive care unit

**Methods:** We reviewed the data of all adult renal transplant recipients who are admitted to the ICU at our center, between 1997 and 2021 that included the demographic features, causes of end-stage renal disease (ESRD), causes of admission, time between transplantation and admission and ICU courses and outcome. Among 400 KT followed up in our center, 70 patients were admitted to ICU and were categorized to early (during first 3 months; n=32); intermediate (3–12 months; n=10); and late (12 months and afterwards, n=28).

**Results:** The rate of ICU admission was 17.5% and the mean age was 49.3 ± 10.6 years. The main cause of admissions was surgical complication (71%) in early group and infection (57% and 80%) in later groups, respectively. In early group, the major reason admission was postoperative surgical complications and care, like lymphocele (5 patients), wound dehiscence (3 patients), urinoma (2 patients) urinary leakage (3 patients). Four of the patients in this group were admitted after surgery unrelated to kidney transplantation (two after an operation for peripheral vascular disease and two after a laparotomy for intestinal obstruction). In late group, the most common cause of admission was infections. Mortality on discharge was significantly higher in late admission (56%) (p=0.0001) and the leading cause of death in all groups was sepsis (91%). Twenty-four patients required ventilator that was an independent risk factor for mortality (P < 0.05). There was statistically significant decrease in the overall 5-year and 10-year patient survival (P = 0.031) in KT patients admitted to the ICU.

**Conclusions:** Our study shows that the main reason for ICU admissions was infections especially in late admission. Mortality rate were relatively high and was linked to need for ventilators. Admission to the ICU is usually associated with decrease in the graft and patient survival.

## PUB302

**Diagnostic Components of Sarcopenia in Kidney Transplant Recipients: Prevalence and Associated Factors Study in a Single Center**

**Shok H. Ooi, Kok Peng Ng, Soo Kun Lim.** *University Malaya medical center, Kuala Lumpur, Malaysia.*

**Background:** Chronic kidney disease (CKD) contributes to secondary sarcopenia which may be associated with adverse outcomes. The impact of kidney transplantation on sarcopenia remains uncertain. As sarcopenia is a potentially reversible condition, understanding contributing factors for the development of sarcopenia is important to

allow proper intervention. This study aimed to assess the prevalence and the predictors/ associated factors of sarcopenia in kidney transplant recipients (KTRs)

**Methods:** This is a cross-sectional study of stable KTRs at transplant clinic of University of Malaya. Consented patients will be subjected to the laboratory, questionnaire, and bio-impedance analysis evaluation. Sarcopenia was assessed based on the European Working Group on Sarcopenia in Older people (EWGSOP2) which include evaluation for presence of low appendicular skeletal muscle mass, low muscle strength, and/or low muscle performance

**Results:** 113patients were recruited with male to female ratio of 62.8%(n=71) and 37.2%(n=42).17 participants(15%) had probable sarcopenia but none had confirmed/ severe sarcopenia.15 of KTRs were found to have low muscle strength and 13%(n=15) deemed to have low physical performance. KTRs with probable sarcopenia had longer kidney transplantation vintage, and significantly lower serum albumin, body mass index (BMI), skeletal muscle mass (SMM), phase angle compared to no sarcopenia. Univariate analysis adjusted for age revealed factors like kidney transplant vintage, serum albumin, skeletal muscle mass (SMM), arm circumferences and phase angle are predictors of probable sarcopenic state. In our study serum albumin level negatively correlate with sarcopenia and is found to be an independent predictor after adjusting to age. This indicates that nutrition markers eg, albumin may be useful in predicting outcome

**Conclusions:** Sarcopenia is an established pathological entity in KTRs and its etiology may be multifactorial. Serum albumin level can be useful as a predictor for this aforementioned condition and potentially amenable for intervention

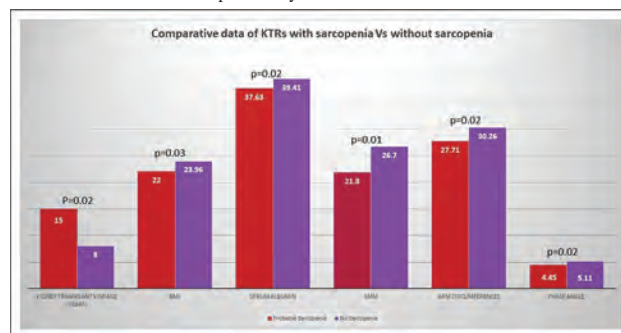

## PUB303

**Discordance in Cytomegalovirus Viremia in Kidney Recipients From the Same Donor Is Associated With Worst Outcomes**

**Emily E. Zona, Sonam Dolma, Margaret R. Jorgenson, Angelie Santos, Neetika Garg, Fahad Aziz, Maha A. Mohamed, Didier A. Mandelbrot, Sandesh Parajuli.** *University of Wisconsin School of Medicine and Public Health, Madison, WI.*

**Background:** Cytomegalovirus (CMV) is a common viral infection in kidney transplant recipients (KTR) associated with adverse outcomes. The effect of concordance versus discordance in CMV viremia between two different recipients of kidneys from the same donor remains unknown.

**Methods:** In a retrospective study on adult deceased donor KTRs (DDKTR) at our center from 2014 to 2019, recipient pairs from the same donor were divided into groups based on the development of CMV viremia between the pair. Concordance no CMV (cc-no-CMV) if neither KTR developed CMV, concordant CMV (cc-CMV) if both KTRs developed CMV, Dc-CMV and dc-no-CMV referred to the discordant groups pertaining to individual CMV development or lack of, respectively. Outcomes included death censored graft failure (DCGF) and patient mortality.

**Results:** Of 578 KTRs, 67% were cc-no-CMV, 5% were cc-CMV and 28% were discordant; 14% dc-no-CMV and 14% dc-CMV. In the cc-CMV group, significant donor features include higher serum Cr (~1.27 mg/dl), mean kidney donor profile index (KDPI) and donation after circulatory death (DCD) donor (50%), while recipients have lower BMI (mean 26.8 ± 5.2) and received Basiliximab induction (50%). The prevalence of high-risk serostatus (D+/R-) was higher in cc-CMV (32%) and dc-CMV (32%) (vs 14% cc-no-CMV and 20% dc-no-CMV, p < 0.001). As compared to cc-no-CMV, dc-CMV was associated with increased risk for DCGF (HR 3.90, 95%CI 2.01-7.57), so was advanced donor age, higher KDPI, diabetes mellitus and delayed graft function (DGF). Interestingly, high-risk serostatus and cc-CMV were not associated with DCGF. Development of CMV in cc-CMV or dc-CMV were not associated with mortality. The only factors associated with increased risk of mortality were advanced recipient age and DGF.

**Conclusions:** In this study of DDKTRs, discordant development of CMV viremia after transplant was associated with graft failure, but not mortality. High-risk serostatus, while a risk factor for subsequent viremia, was not a risk factor for graft failure or death, nor was concordant development of CMV. These findings reflect clinical anticipation of this event and suggest prompt management to prevent negative outcomes.

**PUB304**

**Subclinical Kidney Allograft Rejection Without Maintenance Immunosuppressive Therapy (mIST)**

**Kulwant S. Bath,<sup>1</sup> Phuong-Thu T. Pham,<sup>2</sup> Sally Chau,<sup>1</sup> Jean Hou,<sup>3</sup> Svetlana O. Villano,<sup>1</sup> Vinod K. Valluri,<sup>1</sup> Golriz Jafari,<sup>1</sup> Anita Kamarzarian,<sup>1</sup> Susana M. Mendoza,<sup>1</sup> Phuong-Chi T. Pham.<sup>1</sup>** <sup>1</sup>*UCLA Medical Center Olive View, Sylmar, CA;* <sup>2</sup>*University of California Los Angeles David Geffen School of Medicine, Los Angeles, CA;* <sup>3</sup>*Cedars-Sinai Medical Center, Los Angeles, CA.*

**Introduction:** Kidney transplant (KTx) generally requires mIST to prevent rejection and graft loss. A mother-to-son kidney recipient presents with preserved kidney function despite being off mIST for 26 years.

**Case Description:** A 44-year-old man with diabetes mellitus, unknown congenital kidney disease requiring peritoneal dialysis for 3y and KTx from his mother at age 13, and status post COVID-19 infection 2m prior, presents with diabetic ketoacidosis due to insulin nonadherence. Patient received unknown mIST until age 18 when he self-discontinued therapy. Initial studies: Serum: glucose 1064 mg/dL, pH 7.28, +ketones, creatinine (Cr) 2.4 mg/dL (baseline Cr 1.1); Urinalysis 4-10 white blood cells/high power field, few bacteria; Urine protein/Cr 0.4 g/g, albumin/Cr 0.1 g/g Patient received insulin and fluid with Cr improved to 1.1 mg/dL. Fig 1 shows Cr timeline. Kidney biopsy was performed prior to discharge to determine the need for mIST reinitiation. While awaiting for pathology report as outpatient, Cr increased to 1.82 mg/dL. Pathology Fig 2: Chronic active T-cell-mediated tubulointerstitial rejection, active vascular rejection, and chronic active antibody-mediated rejection. Patient was readmitted for intravenous immunoglobulin & antithymocyte globulin with appropriate Cr improvement and discharged on prednisone, mycophenolate, & tacrolimus. Donor HLA-typing was not available for donor specific antibody testing.

**Discussion:** The case demonstrates 1) Subclinical rejection may occur in the setting of prolonged IST discontinuation and 2) Cr is insensitive in detecting rejection and raises the possibility of COVID-19-induced exacerbation of ongoing low-level rejection.

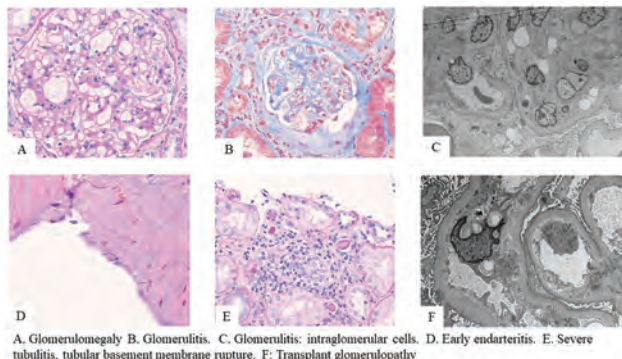

A. Glomerulomegaly B. Glomerulitis. C. Glomerulitis: intraglomerular cells. D. Early endarteritis. E. Severe tubulitis, tubular basement membrane rupture. F. Transplant glomerulopathy

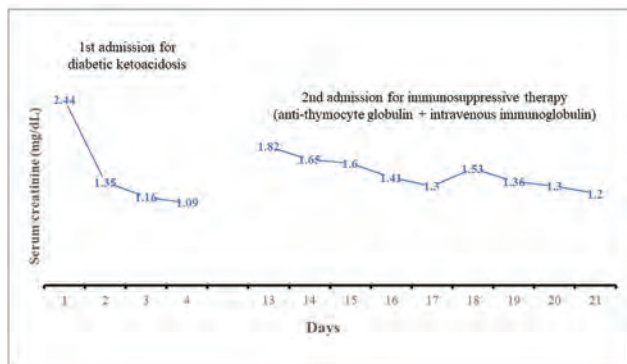

**PUB305**

**Seroprevalence and Management of Strongyloides stercoralis at a Large Tertiary Kidney Transplant Centre in London, United Kingdom**

**Mukunthan Srikantharajah, Mohd Radzi Rodzlan Akib, Eleanor C. Sandhu, Paul Arkell.** *Imperial College Healthcare NHS Trust, London, United Kingdom.*

**Background:** The soil transmitted helminth *Strongyloides stercoralis* is endemic across the tropics and causes pauci/asymptomatic infection which persists for decades when no longer living in an endemic area. In individuals who receive corticosteroids and/or organ transplantation, rapid replication and dissemination of larvae can result in Strongyloides hyperinfection syndrome (SHS), a severe multi-system illness with high mortality. This study aimed to determine the seroprevalence of *S. stercoralis* at our centre and assess whether screening and pre-emptive treatment may be beneficial.

**Methods:** Kidney transplant candidates registered at our institution in West London between July-November 2021 were tested for *S. stercoralis* IgG/IgM (NovaLisa® ELISA, Eurofins Biomnis Laboratory). Results were obtained from 5 different haemodialysis units. Those with positive results were reviewed by the Infectious Diseases and/or Nephrology team.

**Results:** 133 individuals were included. The mean age of the cohort was 52 years (range 19-79). 64% were male. 32% were Asian, 29% White, 24% Black, 13% Other, 2% Mixed. The most common underlying renal pathologies were Diabetes (30%), Unknown (21%), Glomerulonephritis (18%) and Hypertension (7%). 8/133 (6%) were found to be *S. stercoralis* seropositive. 7/8 of these individuals were born or had significant travel in the tropics but 1/8 had no identifiable epidemiological risk factors. Upon clinical review, 1/8 individuals had symptoms which were potentially attributable to strongyloidiasis, and 3/8 had eosinophilia. 7/8 were treated with ivermectin. 1/8 was concluded to be a false positive, most likely due to previous Taenia solium infection, and therefore was not treated. 5/8 individuals had previously undergone kidney transplantation and were at risk of SHS.

**Conclusions:** This study found a high *S. stercoralis* seroprevalence among renal transplant candidates. These individuals may be at risk of SHS upon receiving immunosuppression. Targeted screening and pre-emptive treatment is likely to be beneficial.

**PUB306**

**Avascular Osteonecrosis in Kidney Transplant Recipients Is Associated With Increased Risk of Patient Death**

**Sonam Dolma, Emily E. Zona, Fauzia Osman, Angelie Santos, Fahad Aziz, Neetika Garg, Maha A. Mohamed, Didier A. Mandelbrot, Sandesh Parajuli.** *University of Wisconsin-Madison, Madison, WI.*

**Background:** Avascular Osteonecrosis (AVN) is a debilitating osseous complication associated with kidney transplantation. However, risk factors, and adverse outcomes of AVN in kidney transplant recipients (KTR) remains largely unknown.

**Methods:** This is a retrospective study involving all KTR and recipients of simultaneous pancreas and kidney (SPK) between 2001 and 2018 at our center. Recipients with AVN were compared to those who did not have AVN. Controls were selected based on the incidence density sampling at a 1:3 ratio based on the post-transplant interval if they do not have AVN. Outcomes of interest included acute rejection, death-censored graft failure (DCGF) and patient mortality.

**Results:** A total of 88 KTR or SPK (n=8) had AVN and were compared with 257 controls. Although we attempted to select controls at a 1:3 ratio, it was not possible in all cases. Most of the recipients and donors baseline characteristics were similar between the groups, except calcineurin inhibitor (CNI) based immunosuppression was more prevalent and non-white donors were less prevalent in the control group compared to the AVN group. Looking for risk factors for AVN, CNI based immunosuppression was associated with lower risk for AVN (HR: 0.46; 95% CI: 0.22-0.92) in the univariate analysis, but this was not true after adjustment of multiple variables in the multivariate analysis. In multivariate analysis, AVN was associated with increased risk for patient death (HR: 1.67; 95% CI: 1.14-2.45; p=0.008) but not for acute rejection (HR: 0.7; 95% CI: 0.02-1.27; p=0.08) or DCGF (HR: 1.53; 95% CI: 0.94-2.47; p=0.09).

**Conclusions:** Although limited by small sample size, we found AVN to be associated with increased risk for patient death among kidney transplant recipients. More studies are needed.

**Funding:** Private Foundation Support

	Univariable			Multivariable		
	HR	95% CI	P	HR	95% CI	P
AVN	1.35	0.93 - 1.97	0.11	1.67	1.14 - 2.45	<b>0.008*</b>
Recipient Age ( per year)	1.05	1.03 - 1.06	<b>&lt;0.001*</b>	1.04	1.02 - 1.06	<b>&lt;0.001*</b>
Male recipient	1.19	0.83 - 1.70	0.35			
Non-Caucasian recipient	0.92	0.57 - 1.50	0.75			
Body Mass Index- recipient	1.04	1.00 - 1.07	<b>0.03*</b>	1.00	0.97 - 1.04	0.83
Cause of ESRD						
Diabetes	Ref	Ref	Ref	Ref	Ref	Ref
Hypertension	0.58	0.32 - 1.06	0.08	0.46	0.25 - 0.86	<b>0.01*</b>
Glomerulonephritis	0.24	0.09 - 0.66	<b>0.006*</b>	0.27	0.10 - 0.76	<b>0.01*</b>
Other	0.38	0.26 - 0.55	<b>&lt;0.001*</b>	0.35	0.24 - 0.52	<b>&lt;0.001*</b>
Previous transplant	1.34	0.89 - 2.00	0.16			
Simultaneous pancreas and kidney	1.01	0.51 - 2.00	0.97			
Deceased donor	1.45	0.99 - 2.11	0.06	1.19	0.80 - 1.78	0.38
Pre-transplant dialysis	1.61	1.05 - 2.46	<b>0.03*</b>	1.16	0.65 - 2.05	0.62
Time on dialysis pre-transplant	1.00	0.99 - 1.01	0.26			
HLA mismatch ( per 1)	0.98	0.89 - 1.09	0.71			
PRA >10%	1.08	0.50 - 2.31	0.84			
Depleting induction agent	0.87	0.60 - 1.27	0.47			
Age - Donor	1.03	1.02 - 1.05	<b>&lt;0.001*</b>	1.03	1.02 - 1.04	<b>&lt;0.001*</b>
Male - Donor	0.88	0.62 - 1.24	0.46			
Non-Caucasian - Donor	0.96	0.52 - 1.78	0.90			
Body mass index - Donor	1.02	0.99 - 1.04	0.16			
Kidney donor profile index (KDPI)+	1.02	1.01 - 1.02	<b>&lt;0.001*</b>			

\*Statistically significant at p≤ 0.05  
+Removed due to multicollinearity with deceased donor

Table 1: Risk factors for patient death

## PUB307

**Pseudoaneurysm in Pancreas Transplantation: A Rare and Life-Threatening Vascular Complication**

Naseer Khan,<sup>1,2</sup> Renat Kudyakov,<sup>1</sup> Phillip Wortley,<sup>1</sup> <sup>1</sup>Medical City Dallas Hospital, Dallas, TX; <sup>2</sup>Dallas Renal Group, Dallas, TX.

**Introduction:** Pseudoaneurysm is a very rare vascular complication in pancreas transplantation. Here we report a case of a kidney-pancreas transplant who presented 20 days post transplant with abdominal pain. She was diagnosed with Pseudoaneurysm of the donor splenic artery. Early suspicion & serial imaging led to proper diagnosis and non-invasive treatment without any complications.

**Case Description:** 28 year old female 20 days post deceased donor Pancreas-Kidney transplantation presented with abdominal pain. She underwent serial CT scans which detected expanding pseudoaneurysm at the anastomosis of the donor splenic artery. She was treated with endovascular stent placement by Interventional Radiology (IR). Patient remained stable without any complications of graft loss, morbidity or mortality.

**Discussion:** Surgical complications after Pancreas transplantations are mostly related to thrombosis often times needing heparin post-op. There are only a few case reports of life threatening Pseudoaneurysms in pancreas transplants recipients. In our case the pseudoaneurysm was diagnosed without being ruptured. Early diagnosis by serial exams and imaging was the key to prevention of rupture, graft loss and mortality.

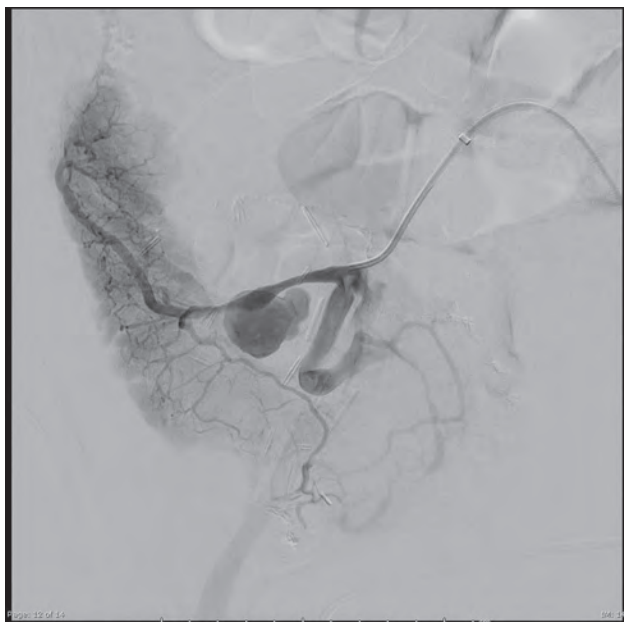

Pancreatic pseudoaneurysm at donor splenic artery

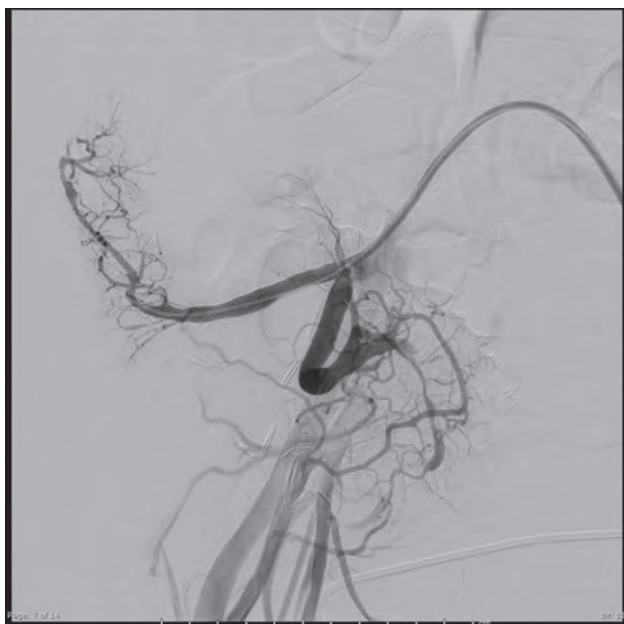

Covered Stent (IR)

## PUB308

**Application of Metagenomic Next-Generation Sequencing in the Treatment Guidance of Infection in Kidney Transplantation**

Ahebaota Baibutihian, Yue Qu, Jing Zhuang, Yan Li, Qingqing Zhang, Hongjuan Zhao, Hong Jiang. *People's Hospital of Xinjiang Uygur Autonomous Region, Urumqi, China.*

**Background:** Kidney transplantation (KT) exhibits many advantages compared to dialysis. Donation after citizen death (DCD) in China is playing a critical role in the KT. However, a relatively higher risk of infection in DCD organ recipients has been observed. Metagenomic next-generation sequencing (mNGS) can identify the microorganism pathogens. This study aims to detect the pathogenic microorganisms in the KT recipients using the mNGS, following guiding antiinfection therapy.

**Methods:** The 14 KT recipients and 7 DCD donors from October 2021 to April 2022 in our hospital were enrolled. The serum samples of recipients and renal vascular lavage fluid samples from donors were detected using mNGS and analyzed. In addition, clinical data, mNGS results and outcomes of the 14KT recipients were collected and analyzed.

**Results:** The mNGS results of 7 DCD donors showed, 1) bacteria detected: Enterococcus (4/7), Klebsiella (3/7), Acinetobacter (3/7), Monomonas (1/7); 2) fungi detected: Candida albicans (1/7); 3) DNA viruses detected: human polyomavirus type 2 (2/7), human polyomavirus type 4 (1/7), human alphaherpesvirus type 1 (1/7), human gammaherpesvirus type 4 (1/7), beta papillomavirus type 1, 2 (1/7). The mNGS results of 14 KT recipients revealed, 1) bacteria detected: Bacteroides (5/14), Enterococcus (2/14), Acinetobacter (2/14), Klebsiella (2/14); 2) fungi detected: Candida parapsilosis (1/14); 3) DNA viruses: human beta herpesvirus type 7 (2/14), human beta herpes simplex virus type 5 (1/14), human alphaherpesvirus type 1 (1/14), human gammaherpesvirus type 4 (1/14). The median time of obtaining the mNGS results was 1 day. The 14 KT recipients were routinely given piperacillin/sulbactam combined with caspofungin, imipenem/cilastatin and vancomycin were administered appropriately according to clinical data related to infection and mNGS results. All the infections were controlled very well and no serious complications occurred.

**Conclusions:** These findings suggest that Bacteria are possibly the main pathogenic microorganisms for KT recipients. The mNGS could timely and efficiently increase the positive detection rate of pathogenic microorganisms. Adjusting antimicrobial treatment approach according to the mNGS result could more precisely and efficiently decrease the serious complications and improve patient outcomes.

**Funding:** Government Support - Non-U.S.

## PUB309

**Preemptive Living Kidney Transplantation in Asymptomatic CKD Stage 4 With Autosomal Dominant Polycystic Kidney Disease: To Transplant or Not to Transplant? That Is the Question**

Macauley A. Onuigbo,<sup>1,2</sup> Silviana Marineci,<sup>1,2</sup> Marios Prikis,<sup>1,2</sup> <sup>1</sup>University of Vermont College of Medicine, Burlington, VT; <sup>2</sup>University of Vermont Medical Center, Burlington, VT.

**Introduction:** Kidney transplantation (KT) is the sine qua non consummate form of renal replacement therapy for ESRD with higher patient survival, improved quality of life, and lower healthcare costs. In the US, pre-emptive kidney transplantation (PEKT), defined as KT prior to progression to ESRD and maintenance dialysis, occurred in 17% of recipients overall, and in 31% of living donor kidney transplantation recipients. Advantages of PEKT over KT after starting maintenance dialysis are fewer pretransplant blood transfusions, increased rate of patients continuing employment, improved long-term graft survival, lower rates of delayed graft function, fewer episodes of acute rejection and decreased healthcare expenditures. Annual dialysis payer expenses in the US range from \$60,000 - \$125,000 excluding dialysis access-related costs which range from \$7,000 - \$19,000. Although KT has relatively high initial costs associated with induction immunosuppression and the initial hospitalization, maintenance immunosuppression costs range between \$18,000 - \$23,000, annually. Conversely, PEKT may arguably be unnecessary for some patients with eGFR in the 15-25 range who are otherwise asymptomatic, and where eGFR decline is slow. We have such a dilemma.

**Case Description:** 71-yo male patient with CKD stage 4, controlled hypertension and ADPKD, current eGFR of 17 ml/min/1.73 m<sup>2</sup> BSA, as at January 2022. He is presently otherwise asymptomatic, is normally active, working from home since the COVID-19 pandemic, appetite is good, and exercise tolerance is good and unchanged over the past year. Electrolytes are normal or controlled, and hemoglobin was 14.0 g/dL. Serum creatinine was 1.1 mg/dL in September 2003. However, serum creatinine increase in the past 42 months has only been very slow (Figure).

**Discussion:** The QUESTION: To Transplant or Not to Transplant? (See Survey Link)

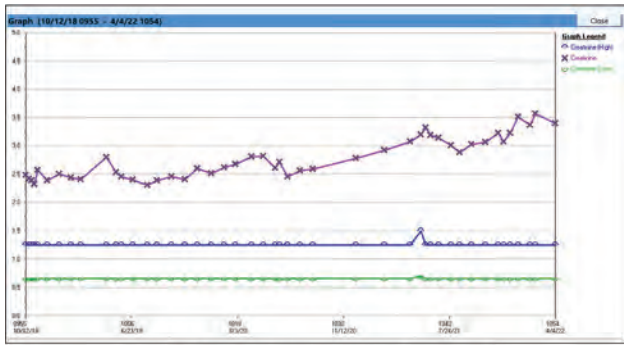

Serum creatinine trajectory from October 2018 - April 2022

**PUB310**

**Anti HLA Antibodies and Their Association With Chronic Allograft Dysfunction and Kidney Allograft Loss in Western Mexico**

Jesus A. Vega Lopez de Nava, Renato Parra Michel, Javier Soto-Vargas, Jorge fernando Topete reyes, Leonardo Pazarin-Villaseñor, Carlos A. Lepe, Luz Yareli Villegas Gutierrez, Juan O. Romero Tafoya, Rubén Lara Monterrubio, Alejandro Garcia Rivera. *Instituto Mexicano del Seguro Social, Guadalajara, Mexico.*

**Background:** Jalisco holds the first place worldwide in end stage kidney disease incidence and it is the state that performs more kidney transplants in Mexico per year. There is still a lack of information between the association of anti HLA antibodies and chronic allograft dysfunction (CAD) and allograft loss (AL) in Mexico. Few studies suggest a higher risk.

**Methods:** Retrospective cohort study that included patients 18 years or older, with studies that included serum creatinine and urine protein determination in a second level of attention hospital in Jalisco. These patients were followed until CAD or AL developed. We excluded patients with more than one kidney transplant.

**Results:** 292 patients with a median age of 30 years old were included, 65% were men. They were followed for a median time of 123.2 months. 49.3% had anti HLA antibodies. The median serum creatinine among those with anti HLA antibodies was 1.35 mg/dl with a median eGFR of 64.6 ml/min, 1.28 mg/dL with an eGFR of 66.5 ml/min for those without them. 60.4% developed CAD and 12.2% developed AL. The median proteinuria was 150 mg/g, with no significant statistic differences among groups. HLA class I antibodies were found in 39.5%, whilst for class II 41.4% patients and 22.3% had both class antibodies. Median time until the outcomes developed was 123 months.

**Conclusions:** We could not find a clear association between the presence of anti HLA antibodies and CAD and AL, which was attributed to survival bias, since the multivariate logistic regression analysis detected that time from detection of these antibodies since kidney transplant had a significant statistic correlation between both outcomes (p=.001, HR .893).

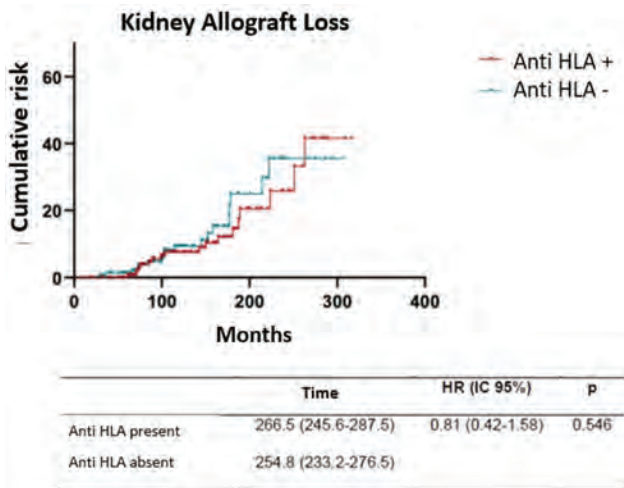

Log rank test for allograft loss

**PUB311**

**POWERED Study Protocol: Prophylaxis With Metformin to Prevent Post-Transplantation Diabetes Mellitus**

Michelle E. Allan,<sup>1,2</sup> Tahseen A. Chowdhury,<sup>1,2</sup> Stanley Fan,<sup>1,2</sup> Muhammad Magdi Yaqoob,<sup>1,2</sup> Kieran Mccafferty.<sup>1,2</sup> <sup>1</sup>Barts Health NHS Trust, London, United Kingdom; <sup>2</sup>Queen Mary University of London, London, United Kingdom.

**Background:** Up to 30% of renal transplant recipients develop post-transplant diabetes mellitus (PTDM). PTDM is associated with adverse graft and patient outcomes and increased financial burden to healthcare services. There is an urgent clinical need to discover therapies to decrease the risk of developing PTDM. Metformin offers a safe and cheap therapeutic option which can reduce the incidence of type 2 diabetes in a high-risk non-transplant patient group. We propose to study its safety and efficacy in preventing the development of PTDM. Ethical approval has been obtained from the relevant regulatory bodies.

**Methods:** POWERED is a single site, placebo-controlled, double-blind randomised clinical trial of metformin in patients without pre-existing diabetes mellitus who have received a new renal transplant. Eligible, consented patients at a tertiary renal centre are screened within 10 days post-transplant with an oral glucose tolerance test (OGTT). Patients with a negative OGTT and with eGFR>30ml/min are then randomised to a 3-month course of either metformin or placebo. All patients will receive the usual standard of care for transplant patients. Clinical and laboratory data will be collected and assessed at baseline and throughout their participation in the study. The primary endpoint is the development of PTDM at 1 year post-transplant as defined by a positive OGTT. Secondary endpoints include graft outcomes, pancreatic b-cell function and safety endpoints. Patients have fasting bloods including OGTT at 3, 6 and 12 months post-transplant.

**Results:** The study population is 60 patients. There are no interim analyses planned.

**Conclusions:** This is the first randomised controlled trial to use metformin in the immediate post-transplant period as prophylaxis against the development of PTDM. Our hypothesis is that early intervention will ameliorate the maximal pro-diabetogenic stimuli in the acute transplant phase, and will shield the pancreas from the directly injurious effects of tacrolimus. We postulate that waiting for overt hyperglycaemia to develop before intervening risks irreversible pancreatic toxicity and hence loss of benefit from any drug intervention. We look forward to publishing our results with ASN in the near future.

**Funding:** Clinical Revenue Support

**PUB312**

**Baseline Characteristics and Representativeness of the BEST-Fluids Trial Participants: A Randomized Trial of Balanced Crystalloid Solution vs. Saline in Deceased Donor Kidney Transplantation**

Michael G. Collins,<sup>1,2</sup> Magid Fahim,<sup>3,4</sup> Elaine Pascoe,<sup>3</sup> Philip A. Clayton,<sup>5,2</sup> Carmel Hawley,<sup>3,4</sup> David W. Johnson,<sup>3,4</sup> Kathryn Dansie,<sup>5</sup> Julie A. Varghese,<sup>3</sup> Rachael C. McConnochie,<sup>1</sup> Laura Robison,<sup>3</sup> Donna Reidlinger,<sup>3</sup> Charani Kiriwandeniya,<sup>3</sup> Steven J. Chadban.<sup>6,7</sup> The BEST Fluids Trial Investigators <sup>1</sup>Auckland City Hospital, Auckland, New Zealand; <sup>2</sup>Royal Adelaide Hospital, Adelaide, SA, Australia; <sup>3</sup>University of Queensland, Australasian Kidney Trials Network, Brisbane, QLD, Australia; <sup>4</sup>Princess Alexandra Hospital, Woolloongabba, QLD, Australia; <sup>5</sup>Australia and New Zealand Dialysis and Transplant Registry, Adelaide, SA, Australia; <sup>6</sup>Royal Prince Alfred Hospital, Camperdown, NSW, Australia; <sup>7</sup>The University of Sydney, Sydney, NSW, Australia.

**Background:** Delayed graft function (DGF), the need for post-transplant dialysis due to poor graft function, is a major complication of deceased donor kidney transplantation. Isotonic 0.9% sodium chloride (saline) is a widely used intravenous fluid in transplantation but may increase the risk of DGF due to its high chloride content. BEST-Fluids is a pragmatic, registry-based, double-blind randomized controlled trial to determine if using a balanced low-chloride crystalloid solution (Plasma-Lyte 148) instead of saline will reduce the incidence of DGF and improve other transplant outcomes. The aim of this presentation is to describe the baseline characteristics and representativeness of trial participants.

**Methods:** Comparison of demographic and clinical characteristics between the BEST-Fluids participants and all other recipients of a deceased donor kidney transplant during the same period in Australia and New Zealand. Data were obtained from the Australia & New Zealand Dialysis & Transplant (ANZDATA) Registry.

**Results:** From January 2018 to August 2020, 2178 deceased donor kidney transplants were performed; 808 of these (37%) enrolled in BEST-Fluids. The groups were similar in age, gender, BMI, smoking, kidney failure cause, graft number, dialysis modality, comorbidities (diabetes, cerebrovascular and peripheral vascular disease), HLA mismatches, peak panel reactive antibody, donor age, cause of death, terminal creatinine, expanded criteria donor status and total ischemic time (p>0.05 for all comparisons). However, trial participants had more coronary artery disease (24% vs 20%, p=0.03), longer mean dialysis duration (41 vs 35 months, p<0.0001), and their donors were less likely to be hypertensive (22% vs 27%, p=0.01), be a circulatory death donor (25% vs 31%, p=0.002), or be in the highest Kidney Donor Risk Index tertile (30% vs 35%, p=0.02).

**Conclusions:** BEST-Fluids trial participants had a slightly higher co-morbidity burden and received slightly fewer high risk deceased donor kidneys, but were otherwise representative of the wider transplant population. The trial results are likely to be applicable in a broad range of settings.

**Funding:** Commercial Support - Baxter Healthcare Corporation, Government Support - Non-U.S.

**PUB313**

**Early Post-Transplant Vitamin D Improvement Is Associated With Better Long-Term Kidney Graft Survival**

Jung-hwa Ryu,<sup>1</sup> Tai yeon Koo,<sup>2</sup> Hyo Jeong Kim,<sup>3</sup> Ga Young Heo,<sup>3</sup> Jaeseok Yang,<sup>3</sup> KNOW-KT Study group <sup>1</sup>*Ewha Womans University Seoul Hospital, Seoul, Republic of Korea;* <sup>2</sup>*Korea University, Seoul, Republic of Korea;* <sup>3</sup>*Yonsei University College of Medicine, Seoul, Republic of Korea.*

**Background:** Vitamin D [25(OH)D] deficiency in chronic kidney disease (CKD) is usually ameliorated after kidney transplantation (KT). However, it is not conclusive if the post-transplant vitamin D deficiency is associated with poor graft outcome. This study aimed to investigate the effect of early post-transplant vitamin D status on clinical outcomes.

**Methods:** The KoreaN cohort study for Outcome in patients With Kidney Transplantation (KNOW-KT) is a multicenter, observational cohort study. Total 1,034 hundred subjects were included in this study. Annual serum 25(OH)D<sub>3</sub>, 1,25(OH)<sub>2</sub>D<sub>3</sub> and clinical outcomes; all-cause mortality, cardiovascular event, graft survival, and fracture were assessed according to vitamin D improvement.

**Results:** The Median follow-up duration was 7.4 years. Serum 25(OH)D<sub>3</sub> levels were increased after KT (before KT, 12.6±7.4; 1 year after KT, 22.6±6.4; 3 years after KT, 24.3±5.8 ng/mL). Vitamin D deficiency was present in 79.1% just before KT. The prevalence of vitamin D deficiency was decreased after transplantation; however, it was still 38.2% at 7 years after KT. The patients with 25(OH)D<sub>3</sub> improvement 1 year after transplantation showed higher 25(OH)D<sub>3</sub> level than the patients without improvement at any point during follow-up. At 7 year-follow-up, higher vitamin D level was associated with vitamin D improvement after KT and vitamin D analog supplementation during 1 year after KT. The 25(OH)D<sub>3</sub> non-improvement at 1 year after KT was a risk factor for poor graft survival (HR 2.408, 95% C.I.; 1.187-4.886, P=0.015).

**Conclusions:** The early vitamin D improvement after kidney transplantation was associated with better long-term graft outcome.

**PUB314**

**Perioperative Anaphylaxis to Cefazolin During Renal Transplant: A Preventable Phenomenon?**

Salman Salehin, Anand Kumar, Hania Kassem, Nantian Harsell, Syed A. Hussain, Muhammad A. Mujtaba. *The University of Texas Medical Branch at Galveston, Galveston, TX.*

**Introduction:** Intraoperative anaphylaxis is a life threatening and multiorgan system hypersensitivity reaction that leads to cessation of operations. Anaphylaxis to Cephazolin is on the rise due to its growing popularity as a choice of intraoperative antibiotic. We describe a case of perioperative anaphylaxis to Cefazolin leading to the cessation of the deceased donor kidney transplant (TX) in a patient with no known beta-lactam allergy.

**Case Description:** A 56 y/o female with end stage kidney disease was admitted for planned cadaveric kidney TX. Anesthetic induction and intubation were uneventful. She was given 2 grams of Cefazolin at 21:26. Meanwhile, the patient had been draped appropriately in the operating table and the donor kidney prepared on the back table. At 21:29, patient's blood pressure plummeted from 116/60 to 40/18 and she had simultaneous desaturation to mid 80s with elevated peak airway pressures. Fortunately, the surgeon was able to abort the procedure just seconds before the skin incision was made. To combat anaphylaxis, patient was given 3 doses of intramuscular epinephrine and started on norepinephrine infusion prior to being transferred to the ICU. She was eventually stabilized and discharged 36 hours later. Luckily the 'uncontaminated' kidney was reallocated to another local recipient. Of note, patient had a positive outpatient skin prick test to Cefazolin in allergy clinic, thus confirming Cefazolin allergy. The patient did end up receiving a new kidney 6 months after this incident.

**Discussion:** Peri- or intraoperative anaphylaxis to Cefazolin is on the rise and its consequences in TX candidates are even more dire given the pre-existing end organ failure, financial burden for health care system, potential loss of donor organs, and emotional burden for recipients and their families. Pre-operative skin prick testing to Cefazolin, which is the most frequently used antibiotic in kidney TX surgery, could have prevented this case scenario. Furthermore, a sensitive assay should be established for pre-op allergy evaluation. Considering the fear of skin prick tests triggering systemic or anaphylactic reactions in some patients, there is a need for development of in vitro allergy testing to evaluate hypersensitivity to commonly used intraoperative agents, especially cefazolin to minimize risks of intraoperative anaphylaxis.

**PUB315**

**ADOPTION Study Protocol: AZD1656 in Transplantation With Diabetes to Promote Immune Tolerance**

Michelle E. Allan,<sup>1,2</sup> Stanley Fan,<sup>1,2</sup> Federica M. Marelli-Berg,<sup>2</sup> Muhammad Magdi Yaqoob,<sup>1,2</sup> Kieran McCafferty,<sup>1,2</sup> <sup>1</sup>*Barts Health NHS Trust, London, United Kingdom;* <sup>2</sup>*Queen Mary University of London, London, United Kingdom.*

**Background:** Transplant recipients with pre-existing T2DM commonly experience a deterioration in glycaemic control in the early post-transplant period, due to the effects of prednisolone on gluconeogenesis, CNI-related pancreatic beta cell toxicity and enhanced renal clearance of insulin. Elevated glucose profiles have been associated with poorer graft outcomes. The glucokinase activator AZD1656 has been shown to be a potent anti-diabetic medication and safe in patients with T2DM, including those with

chronic kidney disease. Recent data has shown that glucokinase activation increases regulatory T cell(Treg) migration and trafficking. We propose to study the safety and efficacy of AZD1656 in optimising glycaemic control and stimulating Treg migration to the transplant in a population of renal transplant patients with pre-existing T2DM. Ethical approval has been obtained from the relevant regulatory bodies.

**Methods:** ADOPTION is a single site, placebo-controlled, double-blind randomised clinical trial of AZD1656 in patients with T2DM and a new renal transplant. Eligible, consented patients at a tertiary centre are randomised to a 3-month course of either AZD1656 or placebo within 24 hours of transplantation. Clinical and laboratory data is collected and assessed at baseline and throughout their participation in the study. The primary endpoint is the mean change in peripheral Tregs between baseline and 3 months as analysed by flow cytometry. Secondary endpoints include graft outcomes, histological staining for Tregs, glycaemic control and safety endpoints. Patients are closely monitored for the first 14 weeks post-transplant. Their records are reviewed at 1 year.

**Results:** We plan to recruit 50 patients. There are no interim analyses planned. **Conclusions:** AZD1656 offers the chance to achieve better glycaemic control in the early post transplant period, but of greater potential benefit is the immunomodulatory effect which could lead to improved renal outcomes. We hope to demonstrate that AZD1656 increases Treg localisation to the renal transplant and provides an effective and safe adjunct for the management of diabetes in the early post-transplant period. A positive signal generated by this pilot study would provide future opportunities for further study and we look forward to sharing our results with the ASN in the near future.

**Funding:** Commercial Support - AstraZeneca, Clinical Revenue Support

**PUB316**

**Thrombotic Thrombocytopenia With Acute Graft Thrombosis (AGT) After Kidney Transplantation**

Julie Steinberg, *Cohen Children's Medical Center, Queens, NY.*

**Introduction:** Our case is a patient with AGT of multiple failed kidney transplants.

**Case Description:** A 15 year old F with Nephronphthisis and ESKD had a living unrelated kidney transplant (LUKT), when poor graft perfusion prompted arterial reanastomosis with improvement. After closure intrarenal doppler waveforms were poorly visualized. Given decreasing serum creatinine (SCr) and good urine output, she was observed. Hours later SCr rose with intrarenal blood flow (BF) on doppler. The graft was found mottled with AGT and thrombi in the right (Rt) external iliac artery, renal artery (RA) and vein (RV). Graft was removed, flushed with heparin/alteplase and reimplanted with doppler-confirmed BF. After closure BF was not detected with diminished Rt lower extremity pulses. The graft was necrotic and removed. Thrombi were removed from the Rt common/ iliac, femoral and popliteal arteries. HD was restarted with heparin. Within hours, thrombocytopenia worsened. Elevated D-dimer and positive platelet factor-4 antibodies (PF-4Ab) suggested heparin-induced thrombocytopenia (HIT) despite negative serotonin release assay (SRA). Heparin was changed to argatroban then apixiban. Following resolved thrombocytopenia and negative PF-4 Ab, she had a second LUKT on therapeutic argatroban. She again had AGT with intrarenal, RV and RA thrombi requiring graft removal. Workup showed positive Coombs and negative heparin Ab, suggestive of Ab-mediated consumptive coagulopathy consistent with vaccine induced thrombotic thrombocytopenia (VITT).

**Discussion:** Initially HIT was presumed, and heparin discontinued, yet AGT occurred despite heparin avoidance. Thus, symptoms were more consistent with VITT, a syndrome that can occur after COVID-19 vaccines with adenovirus vector. Yet, she was not vaccinated. Like HIT, VITT is thought to be from IgG binding to the PF-4-heparin complex, activating platelets and initiating a hypercoagulable cascade with platelet consumption. Although clinically similar, HIT and VITT are treated differently, thus it is vital to differentiate the two.

	HIT	VITT
Timeline	-PF-4 ab detectable 4 days after heparin exposure -Thrombocytopenia/thrombosis 5-14 days after heparin exposure	-5-24 days after COVID-19 vaccine
Laboratory Features	-Thrombocytopenia -PF-4 antibodies -SRA	-Thrombocytopenia -PF-4 antibodies -SRA
Clinical Features	-Venous Thrombosis -Arterial Thrombosis	-Venous thrombosis -Cerebral venous -Splanchnic Vein -Pulmonary Emboli -Arterial thrombosis -Ischemic stroke -Acute limb ischemia -Myocardial Infarction
Treatment	-Removal/Avoidance of heparin/heparin products -Anticoagulation with alternative agent	-Anticoagulation (unclear if heparin should be avoided) -IVIg -PLEX

## PUB317

**A Rock and a Hard Place: Simultaneous Adenovirus Nephritis and Acute Rejection in a Kidney Transplant Patient**

Kathleen Borghoff, Audai Ma'ayah, Scott G. Westphal. *University of Nebraska Medical Center, Omaha, NE.*

**Introduction:** Adenovirus causes significant morbidity and mortality in transplant recipients, and may cause direct injury to the allograft. While antiviral therapy is frequently utilized, reduction of immunosuppression is often required, increasing the risk for simultaneous rejection.

**Case Description:** A 63 year-old man presented with fever and body aches 2 weeks after kidney transplantation. Immunosuppression included anti-thymocyte globulin induction followed by belatacept, mycophenolate, and prednisone, and he had immediate graft function. On presentation, he was febrile and tachypneic. Labs revealed leukopenia, mild transaminitis, but stable initial allograft function (serum creatinine 1.0 mg/dl). Infectious workup detected adenovirus in the urine, serum, and via nasal swab. Mycophenolate dose was reduced, cidofovir was initiated, and subsequently switched to brincidofovir to minimize potential nephrotoxicity. Despite therapy, fevers persisted, and serum viral load rose to 16 million copies/ml. His course was subsequently complicated by allograft dysfunction, with serum creatinine acutely increasing to 2.1 mg/dl. Biopsy revealed marked interstitial inflammation, tubulitis, and endotheliitis with areas of cortical necrosis, as well as positive adenovirus staining, suggesting the presence of both acute cellular rejection (Banff 2a) and adenovirus nephritis. Pulse corticosteroids were initiated, and antiviral therapy continued. In the subsequent days, fevers improved, clinical symptoms resolved and he had progressive decline in adenovirus viral load with eventual complete viral clearance. Allograft function improved as well, and current serum creatinine is 1.1 mg/dl.

**Discussion:** Antiviral therapies utilized for adenovirus infection demonstrate inconsistent efficacy and are limited by potential toxicity. As shown here, reduction of immunosuppression, which is often necessary, may increase risk of acute rejection. We discuss successful management of a rare and challenging case of simultaneous adenovirus nephritis and acute rejection using corticosteroids and antiviral therapy.

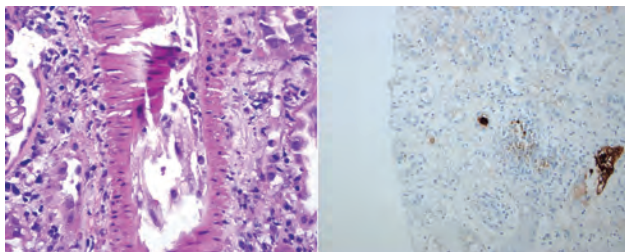

Endotheliitis and adenovirus stain.

## PUB318

**Bartonella Induced Hemophagocytic Lymphohistiocytosis (HLH) in a Kidney Transplant Recipient**

Sarah Mouawad, Costi D. Sifri, Kelly Davidson, Alden M. Doyle. *University of Virginia, Charlottesville, VA.*

**Introduction:** HLH is a rare, severe hyperinflammatory syndrome that can cause significant morbidity and mortality, especially if not recognized early. Transplant recipients are at elevated risk of HLH and infections that can drive this disease because of their immunosuppressive regimens.

**Case Description:** Herein we present a 63-year-old male with a history of end stage kidney disease secondary to diabetes mellitus who received a deceased donor kidney transplant in April 2019. Three years after transplant, he presented with fatigue and fever. He was found to have acute kidney injury and was urgently started on renal replacement therapy. He had anemia, thrombocytopenia, hyperferritinemia, abnormal liver function tests and splenomegaly. Hemolysis workup was negative. Presence of elevated ferritin led to investigation for HLH. The patient met 5 criteria for diagnosis of HLH: cytopenias, elevated ferritin, elevated CXCL9, splenomegaly and hemophagocytosis on bone marrow biopsy. HLH genetic panel was without abnormalities. Computed tomography scan of chest abdomen and pelvis were unremarkable for malignancy. Since the patient had a new 6-month-old cat, serologies for *Bartonella henselae* as a potential secondary cause of HLH were obtained and returned positive. The urine *Histoplasma* and *Blastomyces* antigens were also positive, both below the limit of quantification; serum *Histoplasma* and *Blastomyces* antigens and serologies were negative. Pathology stainings of bone marrow biopsy were negative for fungal or bacterial elements. *B. henselae* was suspected to be the causative pathogen, but given unable to definitively rule out fungal infection, the patient was treated with azithromycin, doxycycline, and posaconazole. Brain MRI and lumbar puncture failed to demonstrate CNS involvement, so intrathecal therapy was not indicated. Dexamethasone was initiated to treat HLH; with persistent cytopenias and elevated ferritin, etoposide was added. The patient improving with repeat bone marrow biopsy revealed absence of overt hemophagocytosis, down trending ferritin, and improving blood counts on a slow steroid taper and continued antimicrobials. The patient remains dialysis-dependent.

**Discussion:** HLH is a rare but severe disease that must be suspected early in kidney transplant recipients, without prompt recognition and treatment, prognosis remains poor.

## PUB319

**Impact of the COVID-19 Pandemic on Molecular Surveillance in the KOAR Registry**

Tarek Alhamad,<sup>1</sup> Andrew F. Malone,<sup>1</sup> Didier A. Mandelbrot,<sup>2</sup> Prince M. Anand,<sup>3</sup> Hani Wadei,<sup>4</sup> Nikhil Agrawal,<sup>5</sup> Kevin Pinney,<sup>5</sup> Amishi S. Desai,<sup>6</sup> <sup>1</sup>Washington University in St Louis, St Louis, MO; <sup>2</sup>University of Wisconsin-Madison, Madison, WI; <sup>3</sup>Medical University of South Carolina, Charleston, SC; <sup>4</sup>Mayo Clinic in Florida, Jacksonville, FL; <sup>5</sup>CareDx Inc, Brisbane, CA; <sup>6</sup>Loyola University Medical Center, Maywood, IL.

**Background:** The SARS-CoV2 pandemic increased the complexity of delivering clinical care and laboratory services for immunosuppressed kidney transplant (KTx) recipients. We evaluated how the pandemic impacted adherence with laboratory draws among patients in the Kidney allograft Outcomes AlloSure Registry (KOAR, NCT03326076).

**Methods:** 1663 KTx recipients undergoing post-transplant surveillance using donor-derived cell-free DNA (dd-cfDNA) were enrolled in KOAR between 2017 and 2021. Participating centers were free to individualize their surveillance strategies. We estimated adherence by using the pre-pandemic distribution of surveillance dd-cfDNA draws across participating sites to establish a baseline regimen, and then compared adherence before the pandemic (P1; through 1/2020) with two subsequent periods in 2020: P2 (2/2020 - 6/2020), coinciding with the first wave of infections, and P3 (7/2020 - 12/2020), which captures the bulk of the second and third waves in the US.

**Results:** The distribution of surveillance dd-cfDNA draws at participating sites before COVID (P1) identified 7 peaks corresponding to draw points at months 1, 2, 3, 4, 6, 9, and 12 [Figure 1a]. Estimated adherence during P1 based on this regimen was 60.5%. Over the subsequent 5 months (P2), reflecting the early months of the pandemic, adherence declined to 50.5% ( $p < 0.01$ ). After the expanded availability of mobile phlebotomy services in 7/2020 and despite rising SARS-CoV2 case counts and hospitalizations, adherence during P3 improved to 57.6% ( $p < 0.01$  compared to P2,  $p = 0.1$  compared to P1) [Figure 1b].

**Conclusions:** Our findings demonstrate that adherence to laboratory surveillance among transplant recipients enrolled in the KOAR registry declined in the early period of the SARS-CoV2 pandemic, however, a variety of adaptations in the latter half of 2020, including the widespread availability of remote phlebotomy for these patients, appears to have led to substantial improvements, with adherence approaching pre-pandemic levels.

**Funding:** Commercial Support - CareDx

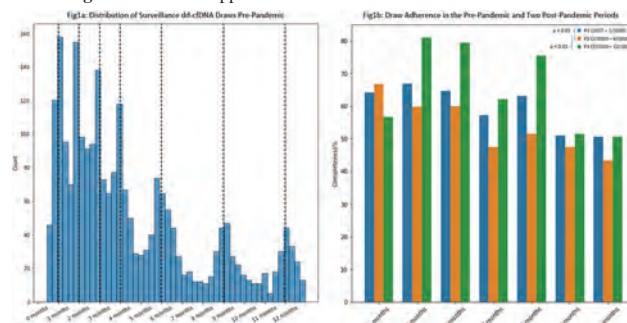

## PUB320

**Anemia Is the Main Factor Related to Allograft Dysfunction in Kidney Transplantation**

Beatriz M. Silva, Thiago Terzian Ganadjian, Vinicius Pereira Leite Nakamura, Bárbara F. Domingues, Otavio H. Clemente, Jessica L. Andrade, Adelson Rodrigues, Miguel Angelo Goes. *Universidade Federal de Sao Paulo, Sao Paulo, Brazil.*

**Background:** Anemia is quite common in end-stage kidney disease patients. Anemia is associated with outcomes in kidney transplant patients. To evaluate the correlation between kidney pre-transplantation anemia and delayed allograft function (DGF), chronic kidney allograft dysfunction (CKAD), and the deceased donor kidney transplantation mortality.

**Methods:** An observational retrospective study with 206 kidney transplant patients from deceased donors in 2008 at Hospital do Rim, Brazil. We analyzed deceased donors and kidney transplant patients demographic data. Moreover, biochemical parameters, anemia status, and treatment were compared between DGF and non-DGF groups. Thus, a multivariate analysis was performed. Outcome comparisons were calculated at 1 year for CKAD and at 10 years for mortality.

**Results:** Within 1 week after the transplantation requirement, there was higher donor serum creatinine, and red blood transfusion frequency, but lower pre-transplant hemoglobin concentration (Hgb) in the DGF group. In addition, there was a pre-transplant Hgb with DGF independent association [OR 0.252, 95%CI: 0.159-0.401;  $p < 0.001$ ]. After 6 months of kidney transplantation, there was a Hgb concentration with both CKAD association [OR 0.798, 95% CI: 0.687-0.926;  $p = 0.003$ ] and mortality.

**Conclusions:** This study documented pre-transplantation anemia in relation to DGF. Besides, it was related 6 months post-transplantation anemia to both CKAD and mortality.

Delayed allograft function (DGF) vs. non-DGF	Odds Ratio (OR)	95% confidence interval for OR Lower Upper	p value
Hemoglobin (g/dl)-pre-transplant	0.252	0.159/0.401	<0.001
Donor serum creatinine (mg/dl) #	2.038	0.919/4.518	0.08
Donor age (years)	1.002	0.950/ 1.057	0.37
Red blood cell transfusion within first-week post-transplantation (%)	1.609	0.541/4.771	0.39
Dose of rHuEPO (U)/week #	1.001	0.998/1.002	0.68
Kidney donor profile index (%)	0.999	0.974/ 1.024	0.91

R2= 0.709; Model (p=0.02); #, after logarithmic transformation for statistical analysis;

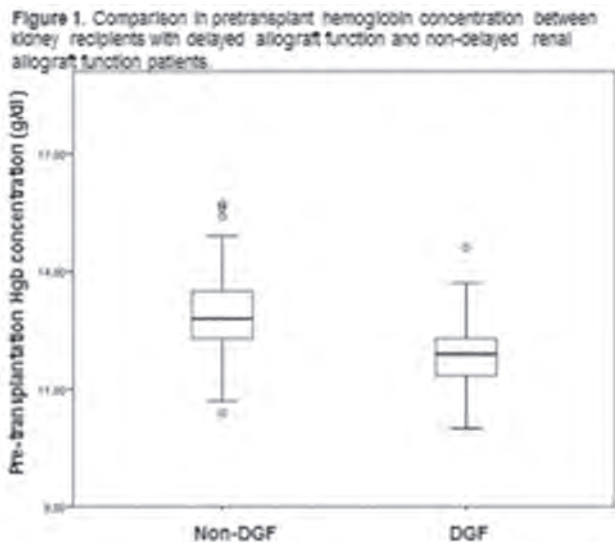
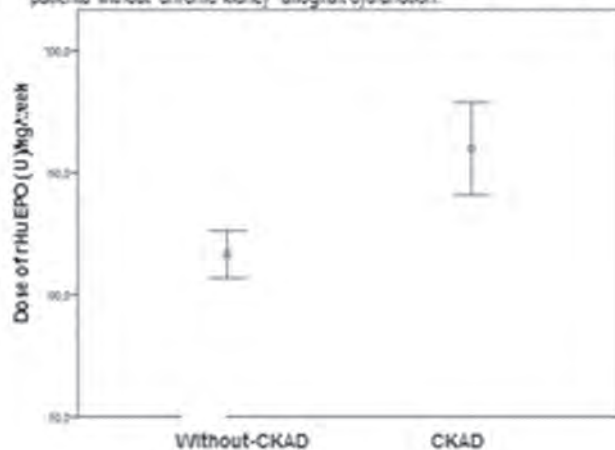

Figure 2. Human recombinant erythropoietin dose pre-transplantation comparison between patients with chronic kidney allograft dysfunction and patients without chronic kidney allograft dysfunction.



PUB321

**Kidney Transplant Patient Immunological Hyporesponsiveness to SARS-CoV-2 Vaccination**

Olusola Sogbein, Asim Rizvi, Muhammad A. Mujtaba, Michael Kueht, Ann Kathleen N. Gamilla-Crudo, Syed A. Hussain. *The University of Texas Medical Branch at Galveston, Galveston, TX.*

**Background:** Multiple studies have shown an association between immune status and SARS CoV-2 disease severity, however data on specific immunosuppressive medications is not fully described. Immunocompromised individuals are at increased risk of mortality and morbidity therefore, vaccination against COVID-19 is essential. Research also suggests that elevated IgG levels post-vaccination correlate with host viral neutralization. We present data indicating that induction and maintenance immunosuppression therapy affects responsiveness to SARS CoV-2 vaccination among kidney transplant recipients.

**Methods:** 48 kidney transplant patients at our institution were retrospectively analyzed after receiving two doses of the SARS CoV-2 mRNA type vaccine between January and March 2021. Kidney transplantation occurred between 1983 and 2020. SARS-CoV-2 spike antigen-specific IgG levels were measured after 30-days to evaluate immunological responsiveness to the vaccine.

**Results:** 35% of study subjects showed detectable peak COVID IgG serum levels 30 days after the second vaccine dose while 65% showed no response. Of the non-responders, (62%) were predominantly heavily immunocompromised; on either high dose Mycophenolate (at least 720 mg twice daily) in addition to standard Calcineurin inhibitor/Sirolimus +/- Prednisone), or had received high dose Thymoglobulin (6 mg/kg or more) within a year of vaccination. This contrasts to published reports of over 95% immunological responsiveness or viral neutralization after the second vaccination dose among immunocompetent patients.

**Conclusions:** Induction therapy with Anti-Thymocyte globulin and maintenance immunosuppression with Mycophenolate serve as the cornerstone of transplantation management. However, their utilization impacts B cell proliferation which is hypothesized to reduce antibody production and the effectiveness of the SARS-CoV-2 vaccine in transplant patients. This finding supports the need for a third or possibly fourth booster dose to achieve a sustained and effective response in combination with ongoing immunological surveillance post-vaccination among transplant patients.

PUB322

**Operations Research to Solve Kidney Allocation Problems: A Scoping Review**

Nigar Sekercioglu.<sup>1,2</sup> <sup>1</sup>Saglik Bilimleri Universitesi, Istanbul, Turkey; <sup>2</sup>University of Ottawa, Ottawa, ON, Canada.

**Background:** In the context of kidney transplantation, health, compatibility, and availability of organs need to be considered to allocate kidneys. Operations research enables health care administrators to optimize resource allocation problems (e.g., kidney allocation for kidney transplant) as well as scheduling problems (staff scheduling and patient scheduling). Operations research employs various techniques incorporating both soft and hard constraints in the equations. The goal is to reduce the gap between demand and supply using advance organ allocation systems and enable adequate access. This paper aims to synthesis the evidence on the use of operations research for allocating deceased donor organs. We also assessed the quality of published studies.

**Methods:** We searched MEDLINE and EMBASE databases from 1946 up to May 2022 without any restrictions. We included studies that explore the methods about the distribution of kidneys from a deceased donor using operations research methods for the conflict resolution if they explore the optimal threshold level to accept/reject a transplant and optimal kidney acceptance strategies for stochastically arriving organs. One investigator (NS) screened each title and abstract and reviewed full text articles and abstracted the data from eligible studies.

**Results:** This scoping review included three published studies that employed operations research techniques. Ahn and Hornberger et al. developed a semi Markov model with five states while examining minimal threshold level of accepting and rejecting the kidney based on QALY index based patient specific ratings. Later on, the sequential stochastic assignment model was developed by Su and Zenios in 2005 and included multiple patients and panelized those who rejected the offer. Stanford et al. suggested a blood type compatible queuing model for stochastically arriving kidneys from deceased donors.

**Conclusions:** The present study is the first to systematically review the operations research methods to manage time and limit wait times with establishing the optimal threshold level to accept/reject a transplant and optimal kidney acceptance strategies for stochastically arriving organs.

PUB323

**Risk Factors Associated With Acute Respiratory Failure in Renal Transplant Patients**

Phoenix Xu.<sup>1</sup> Aditi Saha,<sup>2</sup> Sasa Ivanovic,<sup>2</sup> Ehsen Z. Rao,<sup>2</sup> Anvitha R. Ankireddy,<sup>2</sup> Kushal Shukla,<sup>2</sup> Vagram Ovnianian,<sup>2</sup> Fariborz Rezai,<sup>2</sup> Patrick Hilden,<sup>2</sup> Nirav Mistry,<sup>2</sup> Paul C. Yodice.<sup>2</sup> <sup>1</sup>Rutgers New Jersey Medical School, Newark, NJ; <sup>2</sup>Cooperman Barnabas Medical Center, Livingston, NJ.

**Background:** Renal transplant is the most common solid organ transplant. It improves quality of life and mortality for patients with end stage kidney disease and progressive chronic kidney disease. Despite the improvement in the 10-year graft survival rate over the past decades, acute respiratory failure (ARF) remains one of the most common causes of death and graft failure. Few studies have been done to study the risk factors associated with ARF in this specific population. The objective of this retrospective study is to assess the incidence and identify the risk factors associated with ARF within one-year post renal transplant.

**Methods:** All patients older than 18 years of age who received a renal transplant between January 1, 2015 and December 31, 2017 were included. Patients with ARF were evaluated against patients without ARF. ARF was defined as respiratory distress requiring non-invasive (bilevel positive airway pressure or high flow nasal cannula) or invasive mechanical ventilatory support in the ICU. Patients who were pregnant or had terminal diseases prioritizing comfort measures were excluded. Patients' demographics, substance use history, and past medical history were recorded.

**Results:** This study included 879 patients. Sixty-three (7.2%) met criteria to be included in the ARF group. Majority of ARF (6.9% accumulative incidence rate) occurred in the first 180 days post-transplant. Based on univariate analysis, increased age (P<0.001, hazard ratio [HR] 1.55), history of cardiomyopathy both ischemic (P<0.001, HR 2.78) and nonischemic (P=0.001, HR 2.83), smoking (P=0.011, HR 1.91), diabetes mellitus (P=0.024, HR 1.77), and hypotension intraoperatively and postoperatively (P=0.009, HR 3.09) were significant risk factors for ARF. Based on multivariate analysis, hypotension intraoperatively and postoperatively (P=0.035, HR 2.89), and history of cardiomyopathy both ischemic (P=0.039, HR 1.89) and nonischemic (P=0.008, HR 2.59) were significant risk factors.



**Conclusions:** Since ARF is a common cause of renal transplant failure and death, identifying risk factors can facilitate early recognition and treatment. Risk factors identified in this study were increased age, smoking, diabetes mellitus, history of cardiomyopathy, and hypotension in intraoperative and/or postoperative periods.

**PUB324**

**Nocardiosis in Renal Transplantation: A Single Center Study From India**

Anurag Gupta, Vaibhav Tiwari, Gaurav M. Bhandari, Vinant Bhargava, Manish Malik, Anil Bhalla, Ashwani Gupta, Devinder S. Rana. *Sir Ganga Ram Hospital, New Delhi, India.*

**Background:** Nocardiosis is a rare opportunistic infection seen in kidney transplant patients which is caused by an aerobic actinomycete. Disease manifestations can vary from a localized infection to multisystem organ failure. Despite the high mortality, there are limited data on nocardiosis in kidney transplant patients because of low incidence, non-specific clinical presentation, presence of coinfections that preclude further workup for nocardiosis.

**Methods:** Kidney transplant patients with age more than 18 years diagnosed with Nocardiosis on gram-stain, modified acid-fast stain, and culture between 2010 to 2019 were included. Clinical and microbiological data of these patients were retrospectively analyzed.

**Results:** A total of 1801 kidney transplants were done from 2010 to 2019. Sixteen cases of nocardiosis were identified. The median time from transplant to Nocardiosis was 21 months (IQR 9.75-45). Acute rejection episodes and CMV infection within 6 months of nocardiosis were found in 12.5% and 25% respectively. In the form of immunosuppressants, 15 out of 16 patients (93.75%) received Anti thymocyte globulin (ATG) while 1 patient received Grafalon (ATG-Fresenius). The most common organ involvement was the lungs (75%) followed by the brain (12.5%). Only 1 patient showed cutaneous involvement (6.25%). The severe form of the disease in the form of disseminated infection was seen in one patient. Sub-species identification was possible in the last 3 years of study after the introduction of MALDI TOF. Six patients were diagnosed with nocardiosis from 2017 to 2019, of which *Nocardia farcinica* was the most common type (4 out of 6 patients) and was resistant to cotrimoxazole. The mortality rate was 31.25%. Patients with brain involvement and disseminated infection had 100% mortality.

**Conclusions:** Though nocardiosis in kidney transplant patients has a very low incidence but is an important cause of mortality. *Nocardia farcinica* is the predominant species which is mostly resistant to cotrimoxazole. Cerebral and disseminated nocardiosis have a poor prognosis. Drug sensitivity, if available, is an important tool to guide treatment.

**PUB325**

**Analysis of Graft Survival: 14 Years of Experience in a Dominican Transplant Program**

Anthony J. Gutierrez,<sup>1</sup> Nicolle M. Batlle,<sup>1</sup> Lorgis I. Jiménez,<sup>1</sup> Nicole M. Suárez,<sup>2</sup> Denazir Atizol Rodriguez,<sup>2</sup> Eliana Dina-Batlle.<sup>2</sup> <sup>1</sup>*Pontificia Universidad Católica Madre y Maestra Facultad de Ciencias de la Salud, Santiago De Los Caballeros, Dominican Republic;* <sup>2</sup>*Hospital Metropolitano de Santiago, Santiago De Los Caballeros, Dominican Republic.*

**Background:** Renal transplant is a life-changing intervention with many landmark changes in the past years. Latin America and the Caribbean have low-income health systems and limited access to proper interventions. Even where there is access to transplantation, the maintenance of the graft is an issue. Due to the lack of data to create personalized programs to enhance the renal transplantation experience in the Caribbean region, we aimed to describe the graft survival characteristics of a single-center experience

**Methods:** This is a retrospective cohort observation in a renal transplant unit at Hospital Metropolitano De Santiago, Dominican Republic from 2008 to 2021. All patients consenting patients from the program were included. The statistics relied on descriptive statistics, survival analysis for the primary outcome and Cox regressions to adjust the shown effects.

**Results:** Analyzing 71 cases, we found that 75% of the population maintained their graft by the 8th year of observation and a propensity of 3.6x for graft loss by females. Only 5% of the grafts came from cadaveric donors, as for the graft survival analysis. The hazard ratio for patients with infection post-transplant is 3.58 (CI95%1.29-9.94), and for females, the HR is 3.66 (CI95%1.44-9.28). The Cox regression model shows that controlled by sex, the HR of post-transplant infection on graft survival is 2.55 (CI95%0.894-7.284), offering a confounding role of sex over post-transplant infection.

**Conclusions:** These results support that the standard treatment of the Dominican Republic is up to global standards concerning the survival of the graft. However, a clear predominance of graft loss by females was shown, contrary to the well-described pattern. Further observation to obtain a median value of survival and the addition of more patients would complement this analysis and increase its external validity.

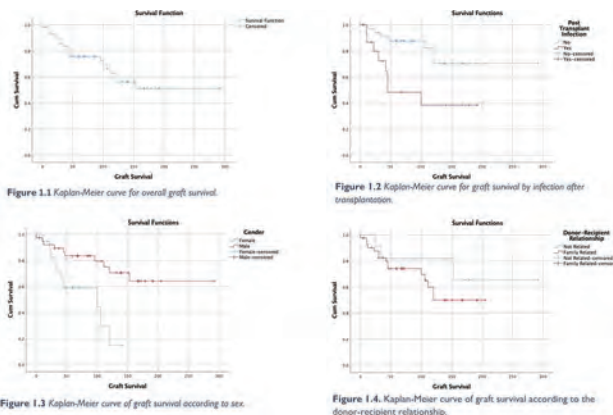

Figure 1. Kaplan Meier curves of graft survival.

**PUB326**

**Glycemic Control With Continuous Glucose Monitoring in Kidney Transplant Patients**

Welly Agate,<sup>1</sup> Ngoc-Yen Pham,<sup>2</sup> Maria-Eleni Roumelioti,<sup>2</sup> Christos Argyropoulos.<sup>2</sup> <sup>1</sup>*University of New Mexico School of Medicine, Albuquerque, NM;* <sup>2</sup>*University of New Mexico Health Sciences Center, Albuquerque, NM.*

**Background:** Kidney transplant immunosuppressants result in challenging glycemic control. Continuous Glucose Monitoring (CGM) is associated with an improvement in hemoglobin A1c (HbA1C) in non-transplant patients with type 2 DM (T2DM). We investigated whether the implementation of CGMs in kidney transplants patients with T2DM would decrease the HbA1C and the average blood glucose (Glc) levels.

**Methods:** We reviewed retrospectively medical charts (3/2019-3/2022) in Cerner UNM. We included 23 adults with a kidney transplant and T2DM, on daily insulin therapy, and eligible for a CGM device. We collected demographics, antidiabetics, comorbidities, pre- and post-CGM markers of glycemic control (HbA1C, average serum Glc, Glc Management Indicator [GMI], Time In Range [TIR]). These markers were recorded from the Index visit (Day1 of CGM) to subsequent and previous visits (1 year before & after the Index visit). Repeated observations were analyzed with linear mixed models to account for correlations in the same individual.

**Results:** Patients were on average 59.5 (±15.1) years old; 83% were white and 52% were males, while 65% were on Freestyle Libre. Most common comorbidities were: Hypertension (96%), Hyperlipidemia (57%), and Coronary Artery Disease (13%). Most patients (39%) were on 3 antidiabetic agents, and only 39% were on prednisone. We analyzed 128 repeated HbA1C measurements (65 obtained before CGM initiation). The use of CGM was associated with a reduction in the HbA1C (Figure 1) by -0.73+/- 0.20 (p=0.0003). Each 10% in TIR was associated with a reduction in the GMI by -0.23 +/- 0.03 (p < 0.0001).

**Conclusions:** Kidney transplant patients with T2DM may benefit from the use of CGM. Further studies should evaluate if the improved HbA1C and Glc control with CGM translates into a significant morbidity/mortality benefit.

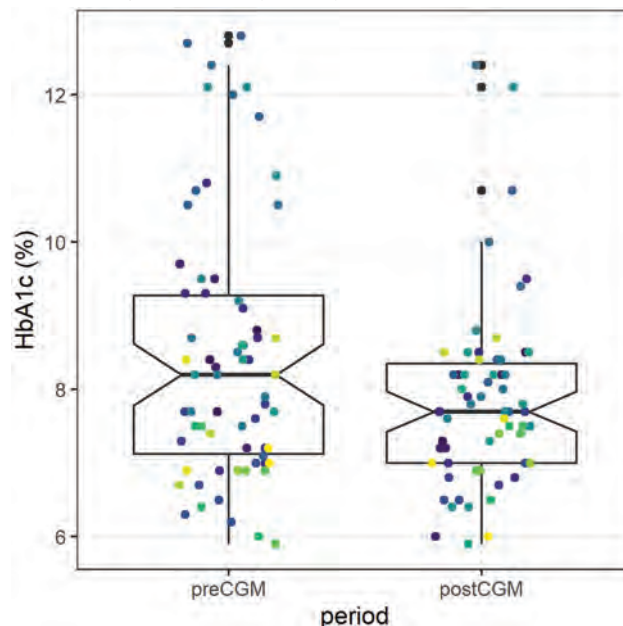

PUB327

**Efficacy and Safety of Cessation and/or Reduction of Mycophenolic Acid (MPA) in BK Viremia Post-Renal Transplant**

Ramyangshu Chakraborty, Michelle E. Allan, Tasnuva S. Kashem, Kieran McCafferty, Stanley Fan, Teresa M. Cutino Moguel, Muhammad Magdi Yaqoob. *The Royal London Hospital, London, United Kingdom.*

**Background:** Stopping antiproliferative agents is a common first-line response to patients with BK viremia with or without biopsy-proven nephropathy. However, the efficacy and safety of this strategy (resolution of viremia, breakthrough rejection/de novo DSA formation) remains unknown in a multi-ethnic cohort of renal transplant patients.

**Methods:** Retrospective study of incident kidney transplants at The Royal London Hospital, UK between 2017-2020 who developed detectable serum BK DNA. Patients received standard maintenance IS: tacrolimus, mycophenolate mofetil (MPA) and prednisolone (weaned to 5 mg/d) after induction with basiliximab or ATG. All patients had at least 1 biopsy. Data were analysed using R statistical software.

**Results:** 143 patients (62% male) were included. The mean (SD) age of the cohort was 51 (13.7) years. 32% were South Asian, 27% Caucasian, 21% Afro-Caribbean and 20% were mixed. 24.5% received a kidney from LD, 52.5% DBD, and 23.1% DCD respectively. The mean follow-up was 3.2 yrs. 113 (79%) patients had their antiproliferative reduced or stopped for BK viremia; the rest had no change in antiproliferative dose. Those who had no changes to antiproliferative dose were younger (p 0.04), had longer follow up (p 0.04), had lower peak BK titres (p<0.001), had less biopsy-proven BKVaN (p 0.04), recovered from viremia more frequently (p< 0.001) and had less eGFR loss (p 0.005). There were no differences in donor or recipient types, induction agent, tacrolimus levels during viremia, and rates of rejection or development of de novo DSA between the groups. 70 patients from the cohort had resolution of viremia. The persistently viremic group had a higher cessation rate of MPA (78.1% to 48.6%, p < 0.01) and was associated with biopsy-proven BK nephropathy (p < 0.01).

**Conclusions:** Our study suggests that stopping/reducing antiproliferative medications as first line for BK viremia is safe but maybe an ineffective strategy for lessening the severity of the disease. A randomized controlled trial is warranted to compare stopping antiproliferative medications with targeting lower tacrolimus concentrations with and without mTOR inhibitors as the first option for BK viremia.

PUB328

**Recurrence of Glomerular Disease in Kidney Transplant Recipients in a National Cohort**

Ana Dovc,<sup>1,2</sup> Andreja Ales Rigler,<sup>1</sup> Miha Arnot.<sup>1</sup> *<sup>1</sup>University Medical Centre Ljubljana, Division of Internal Medicine, Department of Nephrology, Ljubljana, Slovenia; <sup>2</sup>Medical Faculty, University of Ljubljana, Ljubljana, Slovenia.*

**Background:** Recurrence of glomerular disease after kidney transplantation is common and presents a management challenge. Knowledge of the incidence of glomerular disease recurrence in specific cohorts may facilitate shared decision-making.

**Methods:** We performed a retrospective analysis of all kidney transplant recipients at our national transplant center, who received a kidney transplant between January 1st, 2000, and May 1st, 2021, with a minimal follow-up of 1 year. We collected data on the cause of kidney failure of native kidneys from electronic medical records. We considered a recurrence of glomerular disease confirmed if glomerular changes were detected at any (indication or surveillance) kidney biopsy, and the findings matched the primary diagnosis.

**Results:** We included 1,033 kidney transplant recipients, of whom 856 (83%) had a known cause of kidney failure. The commonest diagnosis was glomerulonephritis (300 cases, 29%), followed by diabetic or hypertensive kidney disease (162 cases, 16%) and polycystic kidney disease (151 cases, 15%). IgA nephropathy was the predominant glomerular disease with 190 cases (27 recurrences, 14% incidence of recurrence), followed by focal and segmental glomerulosclerosis in 29 cases (10 recurrences, 34%) and membranoproliferative glomerulonephritis 22 cases (6 recurrences, 27%). Other glomerular diseases rarely recurred, including systemic vasculitides (21 patients, 1 recurrence), membranous nephropathy (12 patients, 1 recurrence), and systemic lupus erythematosus (11 patients, 2 recurrences). Patient survival was similar to the whole cohort (85.9% vs. 81.3%, p=0.358), however, recurrent glomerular disease reduced graft survival, censored for death with function (60.9% vs. 81.1%, p<0.001).

**Conclusions:** Recurrence of glomerular disease after transplantation was less frequent in our cohort than in the literature, possibly due to the preferred immunosuppressive regimen, biopsy practice, or some other factor. Recurrence of glomerular disease portends worse graft survival.

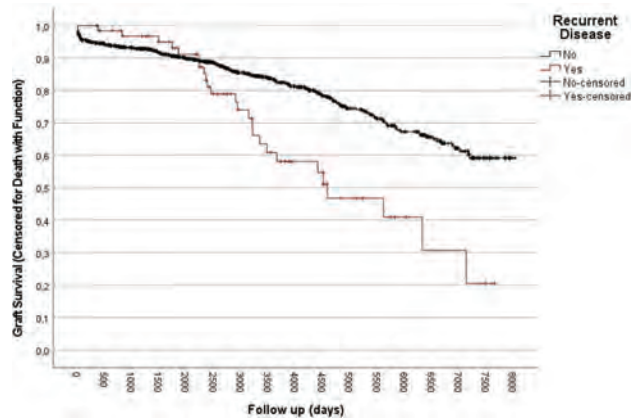

Recurrence of Glomerular Disease

PUB329

**Concurrent Transplant Renal Artery Stenosis and Antibody- and Cell-Mediated Rejection**

Asim Rizvi, Syed A. Hussain, Ann Kathleen N. Gamilla-Crudo, Michael Kueht, Muhammad A. Mujtaba. *The University of Texas Medical Branch at Galveston, Galveston, TX.*

**Introduction:** Transplant renal artery stenosis (TRAS) is an increasingly recognized complication affecting 1-23% of kidney transplant recipients. Allograft rejection continues to be a concern in kidney transplantation as 10% of patients experience rejection in their first year. Even though an individual presence of each disease is common, seeing both together is rare. We present a case of concurrent TRAS and antibody- (ABMR) and cell-mediated (TCMR) rejection in a living-related kidney transplant (LRKTx) recipient.

**Case Description:** A 22-year-old female underwent preemptive LRKTx from her sister. Patient's primary cause of ESRD is unclear. Due to immediate post-operative low arterial blood flow and suspected partial renal artery thrombosis, patient had re-exploration and thrombectomy. Patient received induction with Alemtuzumab and maintained on Mycophenolate, Belatacept, and Steroids. Given AKI, proteinuria, HTN, and edema at 3 months post-transplant, doppler ultrasound and kidney biopsy with MMDx were performed, which revealed concurrent TRAS with TCMR and ABMR. Patient underwent PTA and received Thymoglobulin, steroids, and IVIG. Patient was readmitted at 4 months post-transplant with AKI and doppler imaging revealed restenosis that led to PTA and stenting. Patient is currently being followed up for 7 months.

**Discussion:** Concurrent TRAS and acute rejection can occur in kidney transplant recipients. Clinicians should suspect both among patients presenting with refractory HTN, new-onset edema, and allograft dysfunction. Doppler ultrasound followed by arteriography are reasonable next steps for TRAS diagnosis and subsequent intervention. The utilization of allograft rejection monitoring tools including dd-cfDNA and addition of MMDx to kidney biopsy to add precision can help with early recognition and timely intervention.

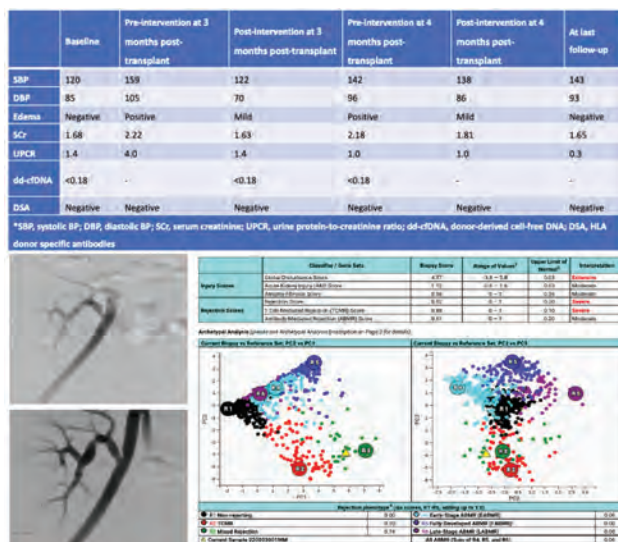

Figure. A) Patient's clinical parameters at baseline, pre- and post-intervention at 3- and 4 months, and at last follow-up; B) Percutaneous transluminal angioplasty (PTA) and stenting; and C) MMDx findings of acute antibody- and cell-mediated rejection.

## PUB330

**Cardiovascular Risk Assessment After Kidney Transplantation**

Elizabete Junk,<sup>1,2</sup> Inese Folkmane,<sup>1,3</sup> Evelina Merdane,<sup>1</sup> Kristofs Folkmanis,<sup>1,4</sup>  
<sup>1</sup>Faculty of Medicine, University of Latvia, Riga, Latvia; <sup>2</sup>Sankt Bonifatius Hospital Lingen gGmbH, Lingen, Germany; <sup>3</sup>Pauls Stradins Clinical University Hospital, Centre of Nephrology, Riga, Latvia; <sup>4</sup>Kreisklinikum Siegen GmbH International Center for Robotic Urology Siegen, Siegen, Germany.

**Background:** Cardiovascular (CV) events are one of the leading causes of death in patients with functioning kidney transplants (KT) and long-term graft loss. Detection and modification of potential risk factors (RF) of CV events are essential for improving both graft and patient outcomes. The aim of this study was to evaluate the incidence of CV events, risk factors, and long-term patient survival in a Latvian cohort of KT recipients.

**Methods:** A retrospective cohort study was performed using KT data prospectively collected at a single institution. A total of 184 patients undergoing KT from 2008 to 2011 at the Latvian Transplantation Centre were included. For data analysis, patients were divided into two groups: patients with CV events (n=70) and patients without CV events (n=114). Traditional and non-traditional CV risk factors that predict CV events were analyzed. Recipients were classified as having graft dysfunction if their Glomerular filtration rate (GFR) was < 60 ml/min per 1.73 m<sup>2</sup> body surface area, calculated with the CKD-EPI Creatinine, 2021 equation. Logistic regression analysis was used to determine the risk factors. Kaplan-Meier analysis assessing survival of patients with and without CV events was also conducted.

**Results:** Overall, 70 (38%) of all recipients had CV events. Analysis of clinical-demographic data showed that patients with CV events had a higher mean age (60.37 years vs 48.61 years, p<0.001), a higher incidence of smoking (52.9% vs 21.9%, p<0.001), and graft dysfunction were more common (85.7% vs 72.8%, p=0.03) than patients without CV events. In a multifactor analysis using logistic regression, significant CV risk factors were confirmed: age (OR:1.09; P<0.01); smoking (OR:5.80; P<0.001); proteinuria (OR:2.31; P=0.038), time on dialysis (OR:1.02; P=0.040), and graft dysfunction (OR=2.24; P=0.03). Kaplan-Meier 120-month survival curves for patients were significantly lower in patients with CV events (70% vs. 90%; P<0.0001).

**Conclusions:** It can be concluded that KT recipients have a high incidence of CV events, which occur in 38% of cases in our study. Important predictors of CV events were smoking, proteinuria, duration of hemodialysis, age, and KT dysfunction. CV events affect the survival of KTR compared to patients without CV events.

## PUB331

**Fatal Case of Epstein-Barr Virus-Negative Post-Transplant Lymphoproliferative Disorder With Hemophagocytic Lymphohistiocytosis in an Adult Kidney Transplant Recipient**

Sergio Mazzola Poli de Figueiredo, Syed A. Hussain, John C. Johnson, Muhammad A. Mujtaba, Rupak Kulkarni, Kirill A. Lyapichev, Alfred S. Lea, Michael Kueht. UTMB The University of Texas Medical Branch at Galveston, Galveston, TX.

**Introduction:** Renal transplantation requires lifelong immunosuppressive (IS) Medications to minimize rejection, which increase the risk of infection and malignancy. Post-transplant lymphoproliferative disorder (PTLD), a troublesome combination of both. Risk factors for PTLD include Epstein-Barr virus (EBV) infection and (IS). Although most cases are associated with EBV, EBV(-) PTLD is associated with worse outcomes. Hemophagocytic Lymphohistiocytosis (HLH) is a sepsis-like inflammatory syndrome, hyperferritinemic immune response that can rapidly progress to multi-system organ failure (MOF). Malignancies have been described as the main risk factors associated with HLH, but very few cases have been described associated with PTLD. Here, we describe a challenging case of an adult kidney transplant recipient who developed EBV(-)PTLD with HLH.

**Case Description:** A 68-year-old female with ESRD due to HTN and DMII underwent deceased donor kidney transplant. Donor and recipient were anti-EBV IgG (+) and anti-CMV (+). Thymoglobulin+solumedrol induction and maintain on belatacept, prednisone, and mycophenolate (MMF). Her Serum creatinine (Scr) was 1.38 mg/dL. She admitted 4 months later with altered mental status, fever, pancytopenia, lactic acidosis, refractory anemia, Scr 1.8 mg/dL coagulopathy, conjugated hyperbilirubinemia. She intubated received blood transfusion and antibiotics. Labs showed hypertriglyceridemia, hypofibrinogenemia and hyperferritinemia. Biopsy of inguinal lymph node consistent with EBV(-) monomorphic diffuse Large B-Cell Lymphoma. Given the clinical and laboratory findings without infectious source, HLH in the context of PTLD was diagnosed. The decision was made to withdraw care. Autopsy confirmed type A1 MN large B cell lymphoma with diffuse lymph node involvement.

**Discussion:** PTLD is a rare but serious complication of organ transplantation. Very few case reports on transplant recipients who developed PTLD with HLH. However, reported cases are EBV (+) PTLD with HLH in pediatric patients undergoing liver or stem cell transplantation. Our patient developed EBV (-) PTLD with HLH, in <4 months post-kidney transplant which has not been described previously in the literature.

## PUB332

**Living Kidney Donation From a Donor With a Remote History of Infection-Related Glomerulonephritis**

Sami Droubi, Heedeok Han, Michael B. Stokes, Lloyd E. Ratner, Andrew S. Bomback, Syed A. Husain. Columbia University Irving Medical Center, New York, NY.

**Introduction:** Although a history of active kidney disease is a contraindication to living kidney donation, the suitability of donors with a history of resolved glomerulonephritis has not been established.

**Case Description:** A 58-year-old woman was evaluated as a potential living kidney donor. Twenty-three years prior to evaluation, she had experienced an episode of gross hematuria associated with an upper respiratory tract infection and pharyngitis. Workup at that time showed serum creatinine 1.1mg/dL (baseline 0.4-0.5mg/dL), hematuria, proteinuria, and red blood cell casts, and a clinical diagnosis of post-streptococcal glomerulonephritis was made. Laboratory values normalized within 1 month of initial presentation. At the time of her donor evaluation, workup showed normal creatinine clearance and no hematuria or proteinuria. She underwent successful kidney donation, with immediate allograft function and reperfusion biopsy showing normal renal parenchyma and no evidence of active glomerular disease.

**Discussion:** Well-selected individuals with a history of mild, self-resolving glomerulonephritis and a low risk of recurrent disease should be considered suitable candidates for living kidney donation.

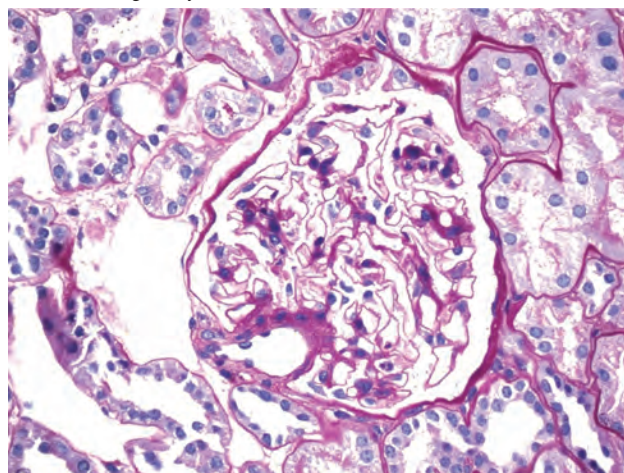

Light Microscopy of reperfusion biopsy. Hematoxylin & eosin stain showing a normal size glomerulus with normal cellularity.

## PUB333

**Clinical Outcomes of Simultaneous Heart-Liver-Kidney Transplant Recipients: Single Center Experience**

Juhi Bhargava, Sambhavi Krishnamoorthy, Michelle A. Josephson, Yousuf Kyeso. University of Chicago Division of the Biological Sciences, Chicago, IL.

**Background:** Multiorgan dysfunction is not uncommon in patients with end stage heart and liver disease. Simultaneous heart-liver-kidney transplants (HLK) are less commonly performed than simultaneous heart-kidney or liver-kidney transplants due to the complex nature of the surgery and challenges with patient selection. 25 HLK were performed in the US from 2011 to 2021, out of which 9 were performed at our center. Given the limited availability of organs for transplant and the lack of standardized qualifying criteria for these patients, it is imperative to understand the factors involved in better outcomes, to optimize utilization of scarce resources.

**Methods:** We performed a retrospective review of all HLK recipients at the University of Chicago medical center between 2011-2021 using Epic EMR. We evaluated their kidney outcomes, infection rates, number of hospitalizations, and mortality over a 12-month period post transplantation.

**Results:** Baseline characteristics are summarized in the figure. 5 (55.5%) were between the age of 50-64, 2 (22%) were between the age of 35-49, and 2 (22%) were between the age of 18-34. 6 (67%) had pre-transplant GFRs between 30-40 ml/min, 1 (11%) had a GFR between 15-30, and 2 (22%) had GFRs <15. 3 (33%) required renal replacement therapy pre transplant. All received grafts with a KDPI below 20% except 1 who had a KDPI of 59%. At 3 months, 8 (89%) had GFRs above 50 ml/min, out of which 5 (55.5%) had GFRs above 60, 1 (11%) had a GFR less than 15. At 6 months and 1 year, 3 (33%) had GFRs above 60, 3 (33%) were between 45-60, 2 (22%) had GFRs between 30-45. 2 (22%) developed delayed graft function. 1 died at 3 months post-transplant while 8 were alive at 12 months. 2 (22%) required a hospitalization within the 1st year post-transplant for infection related reason.

**Conclusions:** Our experience suggests that with careful selection of patients, simultaneous HLK can lead to successful patient outcomes at one year post transplantation. Longer follow up of these patients is needed to define long term allograft and patient survival which will help to standardize selection and allocation criteria of this subset of patients.

Parameter	Pretransplant	Posttransplant 1	Posttransplant 2	Posttransplant 3	Posttransplant 4	Posttransplant 5	Posttransplant 6	Posttransplant 7	Posttransplant 8	Posttransplant 9	Posttransplant 10
Age, mean (SD)	42.5 (16)										
Sex, male, n(%)	5(100)										
BMI, mean (SD)	23.7(4.3)										
Cause of ESRD	FSGS 3, unknown 2										
Dialysis modality, n(%)	HD, 5(100)										
Duration of dialysis, months, mean (SD)	14(11)										
Nephrectomy before transplantation, n(%)	0(0)										
Donor type - Live 5(100%)											
Donor age, mean(SD)	43.7(12)										
HLA (A,B,DR) mismatch, mean (SD)	3(1)										
Induction therapy, n(%)	Thymoglobulin, 5(100)										
Immunosuppression - Tacrolimus/MMF/Steroid, n(%)	5(100)										
Time to recurrence, days, median(IQR)	20(12-29)										
Systolic BP (mmHG), mean(SD)	136(9)										
Diastolic BP (mmHG), mean (SD)	85(15)										
FSGS confirmation, n	Light microscopy 3, EM 2										

PUB334

**Acton Prolongatum™ Induces Remission of Proteinuria In Recurrent FSGS Following Renal Transplantation**  
 Karpagavalli Subramaniam, Srimathi Ponnusamy, Mangalakumar Veerasamy. *KMCH, Coimbatore, India.*

**Background:** Idiopathic focal segmental sclerosis (FSGS) carries 30-40% recurrence rate following renal transplantation. Repository corticotropin injection - Acthar gel® has been found to be effective in reducing proteinuria in recurrent FSGS. Acthar gel® is expensive and not available in India. We describe the effect of Acton Prolongatum™ (AP), synthetic porcine sequence corticotropin in carboxy-methyl cellulose in recurrent FSGS.

**Methods:** Injection Acton Prolongatum™ was given at a dose of IU/kg twice a week subcutaneously for 12 months in applicable cases. Routine post-renal transplantation monitoring was done as per standard of care.

**Results:** Patient characteristics are given in table 1. Change in uPCR is given in figure 1. Mean uPCR(SD) at 0,6,12,24,52 weeks were 3.6(1.9), 0.7(0.7), 0.3(0.7), 0.3(0.65) and 0.2(0.3) respectively. Two developed new onset diabetes mellitus and there was no graft loss.

**Conclusions:** Acton Prolongatum™ is a viable alternative to induce remission of proteinuria in recurrent FSGS. The major advantage would be the cost saving with this preparation (cost is USD 27.6 per vial). Head-to-head comparison using different repository ACTH preparations will help to establish whether they are equipotent in inducing disease remission or not.

Baseline characteristics (Total no = 5)

Age in years, mean (SD)	42.5(16)
Sex, male, n(%)	5(100)
BMI, mean (SD)	23.7(4.3)
Cause of ESRD	FSGS 3, unknown 2
Dialysis modality, n(%)	HD, 5(100)
Duration of dialysis, months, mean (SD)	14(11)
Nephrectomy before transplantation, n(%)	0(0)
Donor type - Live 5(100%)	
Donor age, mean(SD)	43.7(12)
HLA (A,B,DR) mismatch, mean (SD)	3(1)
Induction therapy, n(%)	Thymoglobulin, 5(100)
Immunosuppression - Tacrolimus/MMF/Steroid, n(%)	5(100)
Time to recurrence, days, median(IQR)	20(12-29)
Systolic BP (mmHG), mean(SD)	136(9)
Diastolic BP (mmHG), mean (SD)	85(15)
FSGS confirmation, n	Light microscopy 3, EM 2

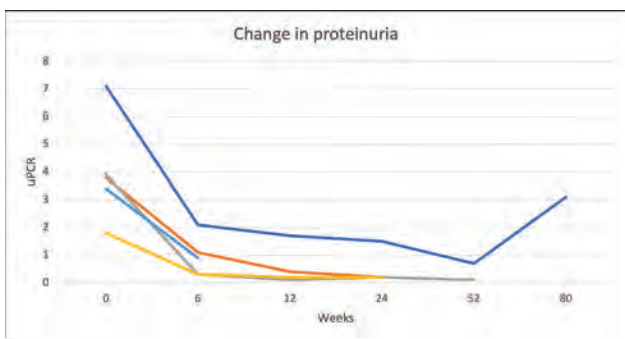

PUB335

**Potential Utility of TruGraf in the First 3 Months Post Kidney Transplantation**

Tariq Shah,<sup>1,2</sup> Paige E. Beckman,<sup>2</sup> Payam Javaherizadeh.<sup>1</sup> <sup>1</sup>Riverside Community Hospital, Comprehensive Transplant Center, Riverside, CA; <sup>2</sup>House of Transplant & Cancer, Riverside, CA.

**Background:** Subclinical acute rejection (subAR) has been associated with inferior renal transplant outcomes. TruGraf, a PCR-based gene expression blood test, is a non-invasive screening tool for subAR in kidney transplant recipients. Its utility as a preliminary screening tool is not yet well defined. In this study, we evaluate the clinical utility of TruGraf in the first 3 months after kidney transplantation. We examined the predictive value of TruGraf for subclinical acute rejection, and its concordance with dd-cfDNA and DSA results.

**Methods:** In this retrospective cohort study, we compare TruGraf results to DSA, biopsy, and dd-cfDNA (TRAC) results available at the time of TruGraf testing. Patients within the first 3 months of transplantation with stable and delayed graft function were included in this study.

**Results:** There were 10 patients included in this study that underwent TruGraf testing within the first 3 months post-transplantation. Of these 10 patients, one underwent repeat testing within the first 3 months post-transplantation. As such, we evaluated 11 TruGraf results—7 were negative (TX), indicating immune quiescence, and 4 were positive (not-TX), indicating potential subAR or acute rejection. Of the 7 TX results, 3/7 had positive DSA results. Four TX patients underwent TRAC testing, and 3/4 were positive for levels greater than 0.70%. Only one TX patient underwent biopsy, which was negative for t-cell-mediated rejection (TCMR) and antibody-mediated rejection (AMR). Of the 4 not-TX results, 2/4 had positive DSA results. One of the not-TX patients underwent TRAC testing, and this patient tested positive with a level of 0.95%. This same not-TX patient was the only one to undergo biopsy, which demonstrated CN1 toxicity and FSGS.

**Conclusions:** Our small sample size made it difficult to assess the utility of TruGraf testing among kidney transplant recipients during the first 3 months post-transplantation. However, we will continue to prospectively expand our sample size to strengthen our investigation of TruGraf, as well as TRAC testing among this population of patients. SubAR, which is associated with inferior transplant outcomes, can occur early after transplantation. Omnigraf testing, among this population of patients, could lead to earlier identification and better management of SubAR and potentially improve renal transplant outcomes.

PUB336

**BK Virus Associated With Collapsing Focal Segmental Glomerulosclerosis in a Renal Transplant Recipient**

Sujay D. Paudel, Surakshya Regmi, Rungwasee Rattanavich. *Loma Linda University, Loma Linda, CA.*

**Introduction:** BK Virus Nephropathy (BKVN) can occur up to 10% of renal transplant recipients. It is characterized by tubulointerstitial inflammation and less frequently with glomerular involvement. Here we present a rare case of BK virus associated with Collapsing Focal Segmental Glomerulosclerosis (FSGS) which could lead to persistent proteinuria and progressive graft dysfunction.

**Case Description:** 24 years old Caucasian male with ESRD secondary to lupus nephritis s/p living related donor kidney transplant in 12/2019, received thymoglobulin induction. He was on tacrolimus, mycophenolate mofetil and prednisone for maintenance immunosuppression. Cr baseline 1.2. In 11/2020, he developed BK viremia with viral load 260,000 copies/ml, Cr 1.4 mg/dL, spot urine protein to creatinine ratio (UPCR) 0.5 g/g. He was treated with reduction of immunosuppression and IVIG. Despite BK viremia improvement to 24,000 copies/ml, his renal function and proteinuria worsened, Cr 1.6 mg/dL, UPCR 2.3 g/g. Renal transplant biopsy showed interstitial nephritis, focal tubulitis with tubular epithelial nuclei positive for SV-40 staining, segmental sclerotic glomeruli with collapsed glomerular tufts, profound podocyte hypertrophy, moderate interstitial fibrosis and tubular atrophy 25%. No glomerulitis, peritubular capillaritis, vasculitis or endothelitis. EM revealed podocyte foot process effacement 30%, no immune complex deposits, no chronic thrombotic microangiopathy or tubuloreticular inclusions. These findings consist with BK virus nephropathy with collapsing FSGS. No evidence of active antibody mediated rejection or acute cellular rejection. Therefore, reduction of immunosuppression and IVIG were continued. His BK virus resolved but graft function slowly declined Cr 1.8 mg/dL with persistent proteinuria UPCR 2.7g/g.

**Discussion:** Collapsing variant of FSGS presents with moderate to severe proteinuria and have the worst outcomes among other variants. It could lead to graft dysfunction and subsequent graft loss. The pathogenesis of BK virus associated with collapsing FSGS remains unclear. We hypothesized that direct impact of BK Virus spread from adjacent tubules can cause direct podocyte injury. BK virus infection should be considered in the differential diagnosis of collapsing FSGS in kidney transplant recipient for therapeutic intervention to control the progression of disease.

PUB337

**Posttransplant Lymphoproliferative Disorder Diagnosed After Gastrointestinal Bleeding a Decade After Kidney Transplantation**

Katerina Hysi, Saira Sajid, Dina R. Al-Tuhafy, Jean H. Ancion, James Drakakis. *NYU Langone Hospital - Long Island, Mineola, NY.*

**Introduction:** Post transplant lymphoproliferative disorders (PTLDs) are lymphoid proliferations or lymphomas that are the second most common tumors in adult transplant recipients. Most cases are associated with Epstein-Barr Virus (EBV), which in the setting of solid organ transplant, can induce B-cell proliferation. While clinical presentation is quite variable, it is only recently that iron deficiency anemia has gained traction as a presenting symptom. In fact, PTLD with GI involvement is felt to be less common. To our knowledge, it has seldom been associated with gastrointestinal (GI) hemorrhage, with histopathological diagnosis confirmed on endoscopic biopsy of a gastric mass.

**Case Description:** 67 year old male with history of end stage renal disease (from IgA nephropathy) who underwent living donor kidney transplant in 2011. Immunosuppression consisted of Tacrolimus and Myfortic. Post transplant course remained stable and uneventful, until routine blood work done to investigate new onset fatigue revealed hemoglobin of 4.5 g/dL (from established baseline of 14-15 g/dL). He was admitted to the hospital where he was stabilized with transfusion of packed red blood cells and upper endoscopy was performed. This showed a large, infiltrative, non-circumferential mass in the gastric fundus with a clean based ulcer in the center of the mass. Pathology

was consistent with monomorphic post-transplant lymphoproliferative disorder, diffuse large B-cell lymphoma (DLBCL). EBV was negative. He completed 6 cycles of R-EP(O) CH and PET/CT done 3 months after initial diagnosis revealed complete response with interval resolution of gastric wall thickening.

**Discussion:** The incidence of PTLD in kidney transplant recipients is noted to be 1-3%. While risk factors such as EBV serostatus and type/duration of immunosuppression have been associated, an accurate diagnosis hinges on histopathologic confirmation. While GI symptoms such as iron deficiency anemia may be present, PTLD presenting with an isolated gastric mass and GI hemorrhage appears to be less common. Our case illustrates an EBV negative PTLD/DLBCL diagnosed on biopsy of an isolated gastric mass after presenting with an acute bleeding episode/associated ulcer. One need consider PTLD in a transplant patient presenting with GI symptoms and render prompt endoscopic assessment.

### PUB338

#### Hypomagnesemia in Solid Organ Transplant and Its Early Relevance

Miniolla Durosier Louis,<sup>1</sup> Jessie C. Fullmer,<sup>1,2</sup> Henry J. Fan,<sup>1</sup> Joshua Okorosokoh,<sup>1</sup> George N. Coritsidis,<sup>1</sup> Westchester Hospital, Department of Nephrology <sup>1</sup>Westchester Medical Center Health Network, Valhalla, NY; <sup>2</sup>The Brooklyn Hospital Center, New York, NY.

**Background:** Electrolyte abnormalities often follow solid organ transplants (TX), with hypomagnesemia (hypoMG) the most common. Information on post-TX electrolyte levels following solid organ TX abnormalities is scarce, and especially comparing Liver (LTx), Heart (HTx), and Kidney (KTx). In this study, considerable emphasis is placed on hypoMG, and what outcomes occur up to 1 year post solid organ TX.

**Methods:** A single Center retrospective EMR analysis from Jan 2015 – Dec 2020. Clinical data and Magnesium levels were collected on the TX day, at 3 months, and 1 year after LTx, HTx, and KTxs. Medications: PPI, diuretics, tacrolimus levels (TACRO) were recorded. EKG Abnormalities: new QRS and QTC prolongations, ectopy, arrhythmias, LBBB and fascicular blocks. Cardiovascular related hospitalizations: Non-infectious causes, CHF, dyspnea on exertion.

**Results:** 532 patient charts were reviewed: 46% KTx, 26% HTx and 28% LTxs. At 3 months 43% of patients had hypoMG and at 1 year 32% severely hypoMG. Elevated TACRO was seen more often in severe hypoMG than normals (54.7 vs 38.9%) while loop diuretics and PPIs were not significantly more prescribed in hypoMG patients. Surprisingly, less EKG abnormalities (p=.002) and hospitalizations (p=.01) were seen in hypoMG. However when correcting for hyperkalemia significance disappeared, except in LTx, where both EKG abnormalities (p<.04) and hospitalizations were increased (p<.004) now in severe hypoMG.

**Conclusions:** HypoMG was seen in solid organ TXs at 3 months and persisted to 1 year post transplant. Tacro levels appear to be of most influence compared to loop diuretics and proton pump inhibitors. Increased abnormal EKG findings, and hospitalizations were associated only in LTx once corrected for abnormal potassium levels. Effects of hypoMg can vary according to solid organ transplanted and concomitant electrolyte abnormalities.

### PUB339

#### Allograft Loss Secondary to Atypical Hemorrhagic Necrosis

Aditi A. Sen, Medha Airy. Baylor College of Medicine, Houston, TX.

**Introduction:** Atypical hemolytic uremic syndrome is characterized by hemolytic anemia, thrombocytopenia and renal failure caused by platelet thrombi in the microcirculation of kidneys and other organs. Genetic aHUS accounts for estimated 60% of all aHUS. It is associated reported mortality rate of 25% and about 50% progress to ESRD. In these patients, aHUS reoccurs in up to 50% kidney transplant patients while graft failure occurs in 9 out of 10 patients. It is important to investigate these cases to establish etiology and improve outcomes.

**Case Description:** 52-year-old lady with history of Lupus nephritis, ESKD received LRKT on 10/12/2021, initially admitted with gross hematuria and reduced urinary output and diarrhea for a day. Vitals were stable. Physical examination was benign. Labs: BUN 129mg/dl and creatinine 7.12 mg/dl Platelet count was 47, elevated LDH1600 and normal haptoglobin. Peripheral smear showed No schistocytes. INR was elevated to 5.9. Anti Xa: 325 (N= <190); Fibrinogen >700. She was on Tacrolimus that was held. ADAMTS -13 test and aHUS panel was sent. Renal biopsy resulted complete infarction of renal tissue due to coagulation necrosis and no viable cortical tissue. Genetic panel for aHUS showed homozygosity for complement factor mutations. She was positive for the large CFHR1-CFHR3 homozygous deletion. Factor H autoAb, ADAMTS-13 were negative.

**Discussion:** Genetic aHUS accounts for estimated 60% of all aHUS. Individuals with genetic aHUS frequently experience relapse after completing therapy and 60% progress to ESRD. Mutations in CFH, CFHR3, MCP, CFI, CFB and C3 genes predispose to the occurrence of aHUS. Our patient had CFH mutation positive in the aHUS panel. A comprehensive evaluation of the complement pathway is recommended. In addition to the supportive care and plasma exchange, complement dysfunction needs to be addressed with specific monoclonal antibodies such as eculizumab. A study by Levi et al administered eculizumab to 12 renal transplant patients with history of aHUS confirming that eculizumab is highly effective in preventing post-transplantation aHUS recurrence. Additional therapies are in pipeline for future and hence, these cases need to be diagnosed and treated to avoid graft failure.

### PUB340

#### Mineral Metabolism Parameters and Bone Density During the First Year of Kidney Transplantation

Carlo Alfieri,<sup>1,2</sup> Paolo Molinari,<sup>1</sup> Edoardo Campioli,<sup>1</sup> Maria Teresa Gandolfo,<sup>1</sup> Anna Regalia,<sup>1</sup> Mariarosaria Campise,<sup>1</sup> Donata C. Cresseri,<sup>1</sup> Evaldo Favi,<sup>1,2</sup> Giuseppe. Castellano.<sup>1,2</sup> <sup>1</sup>Fondazione IRCCS Ca' Granda Ospedale Maggiore Policlinico, Milan, Italy; <sup>2</sup>Universita degli Studi di Milano, Milano, Italy.

**Background:** The variations of mineral metabolism (MM) parameters, femoral and vertebral bone density in a cohort of kidney-transplanted patients (KTxp), during the 1<sup>st</sup> year of transplantation (KTx) were analyzed.

**Methods:** 383 KTxp (KTx 2004-2017 were studied). At 1st(T1) and 12th(T2) mth of KTx biochemical, femoral and vertebral DEXA data were recorded. T-score (Ts)-1>Ts>-2.5: Osteopenia (F-OPN/V-OPN); Ts<-2.5: osteoporosis (F-OPS/V-OPS).

**Results:** During the 1<sup>st</sup> year of KTx the steroids cumulative dose (SCD) was 2683±926 mg. An increase in BMI, Ca, P, 25OH-D, Hb, albumin was observed with a reduction in sCr, PTH and ALP. Femoral BMD (F-BMD) at T1 and F-Ts-T1 were 0.749±0.17 g/cm<sup>2</sup> and -1.55±1.06. F-OPS-T1 was present in 17.5% and F-OPN-T1 in 53%. F-BMD-T1 correlated with BMI-T1 and with 25OH-D-T1. F-Ts-T1 was correlated with DV, BMI-T1 and PTH-T1. KTxp with F-OPS-T1 had longer DV and lower BMI. At T12, F-BMD-T12 and F-Ts-T12 were 0.77±0.67 g/cm<sup>2</sup> and -1.4±0.9. F-OPS-T12 was present in 13.2% and F-OPN-T12 in 55.2%. F-BMD-T12 correlated with BMI-T12. F-Ts-T12 correlated with DV, Ca at T1, and T12 and with SCD at T12. F-DEXA category worsened in 3.5% of KTxp. At T1, V-BMD-T1 and V-Ts-T1 were 0.92±0.19 g/cm<sup>2</sup> and -1.5±1.58. V-OPS-T1 was present in 30% and V-OPN-T1 in 34.5%. V-BMD-T1 correlated with BMI-T1 and Ca-T1. V-Ts-T1 was correlated with DV, PTH-T1, Ca-T, ALP-T1. A direct correlation between V-Ts-T1 and BMI-T1 and 25OHD-T1 was present. V-OPS-T1 was more prevalent in males with lower BMI, albumin, higher Ca-T1 and ALP-T1. At T12, V-BMD-T12 and V-Ts-T12 were 0.90±0.22 g/cm<sup>2</sup> and -1.5±1.33 (NS vs T1). V-OPS-T12 was present in 27.7% of KTxp and V-OPN-T12 in 37.2%. V-BMD-T12 correlated with BMI-T12 and T12 and with Ca-T12 and SCD-T12. V-Ts-T12 was correlated with DV, SCD-T12 and with Ca at T1, and T12. A direct relation was found with BMI-T1 and T12. V-OPS-T12 was more prevalent in DD. They were older, had longer DV. V-DEXA category worsened in 32% of KTxp.

**Conclusions:** We found several modifications of MM in KTxp at 1<sup>st</sup> year of KTx. Femoral and vertebral DEXA were related to the pre-KTx status. Nutritional status and DV are related to bone status at T1. An important role on T12 bone and mineral status is taken by the SCD.

### PUB341

#### Factors Associated With Acute Renal Graft Rejection in a Series of Transplanted Patients

Juan Gómez Fregoso, Manuel Arizaga Napoles, Emmanuel Palomera Tejeda, José David G. Barajas, Guillermo Navarro Blackaller, Jonathan Chavez, Lidia Guadalupe Navarro Espinola, Benjamin Gomez-Navarro. Hospital Civil de Guadalajara, Guadalajara, Mexico.

**Background:** The survival of renal graft is affected by the presence of acute rejection, so knowing the factors associated with acute renal rejection could eventually help develop a model of prediction of renal graft loss.

**Methods:** An observational, case-control study, retrospective, was carried out in patients over 18 years of age, both sexes who were Kidney transplanted. During the period from June 2015 to December 2016. Acute rejection was diagnosed by renal biopsy. A statistical analysis was carried out in SPSS v. 25 consisting of descriptive and inferential statistics using the X2 and t of independent samples as inferential tests and a multivariate binary logistic regression type analysis to determine the factors independently associated with acute renal graft rejection. A p<0.05 will be considered significant.

**Results:** 134 kidney transplant patients of an average age of 30.7±10.4 years were included; 38.8% were female and 61.2% were male. The causes of kidney failure were indeterminate (82.1%), glomerulonephritis (3.7%), diabetes mellitus (3%), renal polycystosis (2.2%) and other (9%). 23.9% (n=32) had acute rejection in the first year after transplantation, the highest percentage of rejections occurred in the first 6 months. Patients with acute rejection had significantly higher levels of creatinine at baseline (1.8±1.5 mg/dL versus 1.2±1.1 mg/dL, p=0.016) and higher average of previous transplants (1.25 + 1.4 vs 1 + 0.2, p=0.002). The factors significantly associated with acute renal rejection in the bivariate analysis were: delayed graft function (OR=3.7, 95% CI 1.1-12.4) and a scheme other than Tacrolimus/Micophenolate/Prednisone (OR=7.4, 95% CI 1.3-42.6, p=0.026). In the multivariate analysis, the factors significantly associated with acute renal rejection were having had a previous transplant (ORa=6,354, 95% CI 1,867-21,627, p=0.003); and the use of an immunosuppression scheme other than Tacrolimus/Micophenolate/Prednisone (ORa=6,814, 95% CI 1,061—43,774).

**Conclusions:** The factors significantly associated with acute renal graft rejection were delayed graft function, having had a previous transplant and the use of an immunosuppression scheme other than Tacrolimus/Mycophenolate/Prednisone.

**Funding:** Government Support - Non-U.S.

**PUB342**

**An Oldie but a Goodie: A Rare Case of Candida in a Kidney Transplant Recipient**

Asim Rizvi, Syed A. Hussain, Muhammad A. Mujtaba, Alfred S. Lea, Michael Kueht, Ann Kathleen N. Gamilla-Crudo. *The University of Texas Medical Branch at Galveston, Galveston, TX.*

**Introduction:** Infections in the transplant population are common especially if accompanied by other systemic diseases such as diabetes, malignancies and other immunocompromised states. Fungal infections, even more rare, can cause significant morbidity and mortality in transplant recipients.

**Case Description:** We present a 66 year old Hispanic male with well-controlled DM and HTN, who received a kidney transplant in June 2021. Induction was done with Thymoglobulin. Patient's postoperative course was complicated by delayed graft function. He was maintained on Prednisone, Mycophenolic acid, and IV Belatacept. Serum creatinine was <1.2 mg/dL two months post-transplant. He was doing well until seven months after transplant when he complained of left ear pain, facial swelling, and headache, and was diagnosed with malignant otitis externa. Ear drainage cultures were obtained and showed *Candida duobushaemulonii*. Right myringotomy and tube insertion was performed. He was treated with IV Micafungin then oral Itraconazole, IV Piperacillin-Tazobactam then oral Ciprofloxacin, and hyperbaric oxygen therapy. His maintenance immunosuppression was reduced by 75%. His serum creatinine has been <1 mg/dL. Follow-up MRI revealed improvement in infection along with improvement in patient's presenting symptoms.

**Discussion:** *Candida Duobushaemulonii* is an old but frequently unreported pathogen of the *Candida haemulonii* family. It has reduced susceptibility to amphotericin B, azoles, and echinocandins, thus making it difficult to eradicate. A high clinical index of suspicion accompanied by accurate tissue specimen analysis using unconventional methods such as PCR, with significant reduction in overall immunosuppression, is necessary to achieve treatment success and preservation of kidney allograft function.

**PUB343**

**Pregnancy in Patients With C3 Glomerulopathy**

Mariam Charkviani, Fernando C. Ferenza, Vesna D. Garovic, Andrea G. Kattah. *Mayo Clinic Minnesota, Rochester, MN.*

**Background:** C3 Glomerulopathy (C3G) is a rare disease, characterized by proliferative glomerulonephritis with prominent complement factor 3 (C3) deposits and is caused by dysregulation of the alternative complement pathway. C3G in women of childbearing age is rare; thus, little is known about the natural history of C3G in pregnancy.

**Methods:** In this case series, we describe clinicopathologic features, clinical course, and maternal-fetal outcomes of 3 pregnancies in 2 women with C3G.

**Results:** We identified 4 patients with C3 glomerulonephritis (C3GN) by kidney biopsy with pregnancy episodes. 2 have ongoing pregnancies and not yet delivered. Of the 2 women with known pregnancy outcomes both developed the disease in adulthood, had stable kidney function that did not require immunosuppression, and treated with blood pressure control and RAAS blockade. Neither patient had known genetic mutations for atypical hemolytic uremic syndrome (aHUS) or C3G. The first patient had proteinuria prior to pregnancy that increased during pregnancy. Creatinine remained stable at 1mg/dL. She developed preeclampsia and required induction at 37 weeks. Her complement cascade showed low C3 and Factor H initially, but during pregnancy, the levels normalized. The second patient had two pregnancies; her creatinine was 1.5 mg/dl prior to pregnancy with proteinuria 167mg/24h. Similar to the first patient, she had low Factor H prior to pregnancy that increased to normal during pregnancy. During her first pregnancy, creatinine was stable, and urine protein remained below 1g/24h. Pregnancy was notable for rise in blood pressure at 33 weeks' gestation and she was induced for hypertension at 37 weeks. Postpartum her creatinine rose to 1.7 mg/dL, but then decreased to prior baseline. During her second pregnancy, her proteinuria and creatinine rose, and was again induced at 37 weeks due to hypertension. After delivery, creatinine returned to baseline. In all pregnancies, babies were born healthy, with normal birth weight and patients did not develop any significant postpartum complications.

**Conclusions:** We described characteristics, course, and maternal-fetal outcomes of pregnancies in 2 women with C3G. In contrast to aHUS, another disease related to dysfunction of complement system which can worsen during pregnancy, we found that in patients with preserved kidney function, pregnancy was well-tolerated, and no immunosuppression was needed.

**PUB344**

**Pregnancy-Associated Hemolytic Uremic Syndrome: Two Case Series From the University of Vermont Medical Center**

Colton Jensen,<sup>1</sup> Carolyn Geraci,<sup>2,1</sup> Macaulay A. Onuigbo.<sup>1,2</sup> <sup>1</sup>University of Vermont College of Medicine, Burlington, VT; <sup>2</sup>University of Vermont Medical Center, Burlington, VT.

**Introduction:** Atypical hemolytic syndrome (aHUS) is rare, incidence 0.23/year/million; 10–20% occur around pregnancy - pregnancy-associated aHUS (PAAHUS). In a recent review, 47 of 50 (94%) occurred post-partum, with a median of post-partum day 2. We present 2 patients, seen in 2012 and in 2021, with some unusual features.

**Case Description:** **Case I** A 37-yo female was diagnosed in late 2021 with PAAHUS following a preterm delivery by Cesarean section (Figure). She started hemodialysis for oliguric AKI, hyperkalemia and metabolic acidosis. First plasmapheresis was aborted due to anaphylactic reaction to plasma. She had Eculizumab for 4.5 months; switched to Revalizumab in February 2022. She came off hemodialysis after 23 days. Peak creatinine was 11.53 mg/dL, and the latest creatinine was 1.41 mg/dL in April 2022. **Case II** A 33-yo woman with 3 previous Cesarean sections, and who delivered her fourth child by Cesarean section 8 weeks previously, was diagnosed with PAAHUS, following transfer from an outside unit in late 2012, with weakness, anemia, schistocytes and oliguric acute kidney injury (Figure). She had 14 plasmaphereses alternating with hemodialysis. She came off hemodialysis after about 84 days. She had Eculizumab for nearly 7 years; switched to Revalizumab in December 2019. Peak creatinine was 7.7 mg/dL, and the latest creatinine was 1.64 mg/dL in May 2022.

**Discussion:** Although the renal and splenic arteries enhanced with contrast on CT in Case I, the kidneys did not. Whether this is typical of aHUS or if exposure to IV Ketorolac contributed to this picture is unknown. The nearly 60 days' post-partum presentation for Case II is most unusual. Our patients have done well on continued Ravulizumab, with sustained AKI recovery, more so with Case II now spanning over 9 years.

Clinical Data	Case I	Case II
Age (years)	37	33
Gestational age (weeks)	24	8 weeks post Cesarean section
Previous pregnancies	1	3
Previous abortion	1	None
Gestational diabetes mellitus	Yes	None
Preterm labor	Yes - At 24 weeks 5 days	None
Delivery method	C section for arrested preterm labor	C section for previous C sections
Viable infant delivered	Yes	Yes
Oliguria	Yes	Yes
Nephrotoxic exposures	IV Contrast + IV Ketorolac	None
Onset of Acute Kidney Injury	Hospital Day 1	Uncertain
New onset Hypertension	Yes	Yes
Previous Ob/Gyn history	Previous myomectomies	3 previous Cesarean sections
Post-partum Bleeding	Yes (At Day 2 post-partum)	Yes (At 8 weeks post-partum)
Nadir platelet (K/cm <sup>3</sup> )	72	30
Nadir hemoglobin (g/dL)	6	5.3
LDH peak (U/L)	1166	3527
PT Ratio	1.1	0.8
PTT (secs)	49	27
D-Dimer peak (ng/mL)	1087	893
Lupus anticoagulant	Negative	N/A
Fibrinogen (mg/dL)	621	202
Haptoglobin (mg/dL)	<7	<6
AST peak (<95 U/L)	189	93
ALT peak (15-46 U/L)	52	39
Schistocytes	Yes	Yes
C3 complement (mg/dL)	N/A	105
C4 complement (mg/dL)	N/A	25
Total serum complement U/mL	>75	N/A
CRP (mg/L)	86	N/A
Sed rate (mm/first hour)	N/A	N/A
Stool PCR for E. Coli /Shigella	Negative	Negative
Onset of AKI - post-partum	Post-op Day 0	Uncertain
Factor V Leiden Mutation B	Heterozygous FSDNA mut B	N/A
ADAMTS 13 (%)	82	85 (>67%)
Clinically evident DVT	Pulmonary embolism	None
GI Bleed	Yes - On hospital day 15	None
Non-enhancing kidneys on CT	Yes	Not applicable
Kidney BX - TMA + focal infarct	Yes	Yes
Other complications	Pulmonary embolism	Post kidney biopsy bleeding
First Hemodialysis treatment	On post-partum Day 6	Post-partum Day 61
Plasmapheresis treatments	X1 and aborted - anaphylaxis	Daily - Hospital Day 0 to Day 14
Eculizumab Rx Duration	4.5 months of Eculizumab	7 years of Eculizumab
Length of hospital stay (Days)	12	12
Switch to Ravulizumab at 8 weeks	Since February 2022	Since December 2019
Baseline creatinine (mg/dL)	0.44 mg/dL (Antepartum)	2.77 mg/dL (Uncertain)
Peak creatinine (mg/dL)	11.53 on post-partum day 6	7.7 on post-partum day 75
Hemodialysis duration (Days)	23	About 84 days
Latest creatinine	1.41 mg/dL (April 2022)	1.64 mg/dL in May 2022

Cases I and II

**PUB345**

**Trends in Pharmacotherapy Management In Pregnant Hemodialysis Patients**

Beatrice Drambarean,<sup>1</sup> Justyna I. Mastalerz,<sup>1</sup> Thomas M. Szwajnos,<sup>1</sup> Lisa M. Wendt,<sup>2</sup> Stephanie M. Toth-Manikowski.<sup>1</sup> <sup>1</sup>University of Illinois Chicago, Chicago, IL; <sup>2</sup>Rush University Medical Center, Chicago, IL.

**Introduction:** When patients on hemodialysis become pregnant, anti-hypertensive, anemia, and mineral-bone disease medications require adjustments to account for teratogenicity and intensified hemodialysis regimens. This can be a challenging experience for patients as they are at higher risk of pre-eclampsia, pre-term delivery, and fetal growth restriction. Over the years, studies have reported successful pregnancies with certain treatments, although data regarding medication dosing is lacking in this population. The purpose of this clinical case series is to trend medication dose adjustments based on changing laboratory values throughout pregnancy for patients on hemodialysis and provide examples of how pharmacotherapy management should be adjusted in this unique patient population.

**Case Description:** Data was retrospectively collected from 4 patients with a total of 5 pregnancies (A1, A2, B, C, D) from April 2019 through May 2021, e.g., hospitalizations, select laboratory values, vital signs, and medications for hypertension, anemia, and mineral-bone disease. Table 1 summarizes anemia medications used during pregnancy. All patients were on calcium and vitamin D supplementation and were switched to

nifedipine and/or labetalol for hypertension management. All patients delivered viable preterm infants ranging 30-36 weeks of gestation. Of 12 hospitalizations, 7 were related to hypertensive urgencies. Patient C required 2 blood transfusions due to a hemoglobin less than 7. Average hemoglobin values were 8 (A1), 8.9 (A2), 8.8 (B), 7.8 (C), and 7.9 (D). Average TSAT values were 17 (A1), 25 (A2), 24 (B), 47 (C), and 21 (D). Average phosphorus values were 3.5 (A1), 4.3 (A2), 3.1 (B), 3.0 (C), and 3.4 (D). Average calcium values were 8.6 (A1), 8.4 (A2), 8.4 (B), 8.4 (C), and 8.5 (D).

**Discussion:** All patients had successful pregnancy outcomes that have been described with the documented managements. Pregnant dialysis patients will require increased intravenous iron and erythropoietin doses to maintain adequate hemoglobin levels. Phosphorus supplementation is required at large doses up to 4 times daily; calcium and vitamin D is also required to maintain levels within normal limits.

Doses of Anemia Medications

	A1	A2	B	C	D
EPO Doses units TTW	10,000-15,000	22,000-28,000	12,000	5,000-30,000	5,000-6,000
IV Iron, Sirocose mg/month	200	200-1050	1000	1000	1000

**PUB346**

**Toward a Model-Based Patient Pre-Selection Tool to Identify Suspected Undiagnosed Albuminuria Using Electronic Health Records**

Nils Svängård,<sup>1</sup> Anders G. Hildeman,<sup>1</sup> Peter J. Greasley,<sup>1</sup> Shameer Khader,<sup>2</sup> Philip D. Ambery.<sup>1</sup> <sup>1</sup>AstraZeneca FoU Goteborg, Goteborg, Sweden; <sup>2</sup>AstraZeneca R&D Gaithersburg, Gaithersburg, MD.

**Background:** Urine albumin (uACR), a key marker for chronic kidney disease (CKD), is not regularly screened for in the primary care, leading to many undiagnosed patients. Developing a tool to identify patients suspected of having undiagnosed Albuminuria could help prevent CKD progression and significantly reduce screen-failure rates in CKD trials. In this study we develop models using machine learning to classify the patients into two categories, uACR  $\geq 30$  and  $\geq 200$  mg/g.

**Methods:** We developed and calibrated the models on the US Limited IBM MarketScan Exploratory Claims-EMR Data Set (LCED) and validated the models on Optum® Clinformatics™ Data Mart (US) and two global clinical trial datasets (DECLARE & SAVOR). We perform retrospective test and validation, requiring subjects to have an uACR test ( $0 < \text{uACR} \leq 5000$  mg/g) and be of at least 18 years of age. Patient demographics (age, sex), vital signs (BMI, Blood Pressure) and the 30 most common blood tests where used as covariates, with the last value carried forward 6 month as imputation method. A tree based gradient boosting framework (LightGBM) was used to train the classifiers for uACR  $\geq 30$ , and  $\geq 200$  mg/g. The model was trained on 80% of the LCED patients, with the remaining used to calibrate the model for a 0.75 precision threshold. The model was then evaluated on all qualified patients in OPTUM, SAVOR and DECLARE using Area Under the Curve (AUC) and Precision (PPV).

**Results:** Preliminary results show that the models have discriminative power (Figure 1) and met the acceptance criteria of a PPV greater than 0.7 for both the US datasets and one of clinical trial datasets (Table 1).

**Conclusions:** The patient pre-selection models generalized from the US based cohort to a global population and shows promise as a tool to identify patients with suspected albuminuria after further development and validation.

**Funding:** Commercial Support - AstraZeneca

Table 1: Model Validation Results

Dataset	uACR $\geq 30$		uACR $\geq 200$	
	AUC	PPV	AUC	PPV
LCED (test)	0.73	0.74	0.80	0.74
OPTUM	0.71	0.75	0.78	0.72

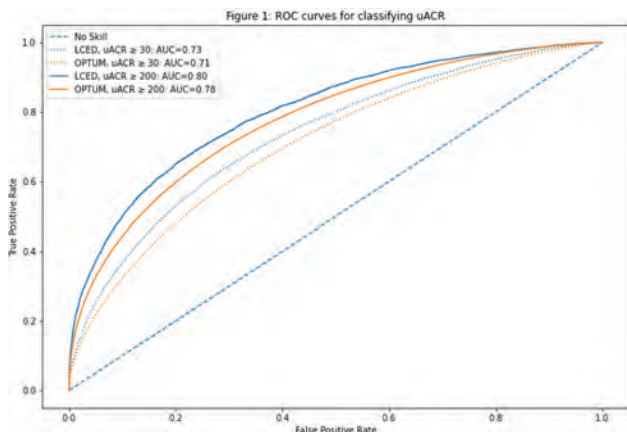

**PUB347**

**Risk Analysis of Healthy Life Expectancy Based on Renal Function Using the Medical Information Database**

Hisayuki Ogura, Tadashi Toyama, Megumi Oshima, Shiori Nakagawa, Taro Miyagawa, Shinji Kitajima, Akinori Hara, Yasunori Iwata, Norihiko Sakai, Miho Shimizu, Takashi Wada. Kanazawa Daigaku, Kanazawa, Japan.

**Background:** Extending healthy life expectancy is challenging in a super-aging society including Japan. Renal dysfunction is a risk for cardiovascular events, frailty, and sarcopenia. On the other hand, the relationship between renal dysfunction and healthy life expectancy, a more important outcome, has not been sufficiently investigated. We investigated the relationship between renal function and healthy life expectancy based on the available clinical records.

**Methods:** We analyzed the medical information database of residents of Hakui city, Ishikawa Prefecture, who were eligible for nursing care insurance, medical insurance and underwent health examinations between 2012 and 2020. The database contains care services, treatments, and medical examination results. The primary outcome was time to health-span composite defined as care levels  $\geq 2$  or death. Subjects were categorized into five groups by baseline eGFR. Associations between baseline eGFR categories and the outcome were analyzed using Cox proportional hazards model adjusted for baseline age, sex, care levels, body mass index, and smoking status.

**Results:** The number of subjects was 4,581, the median age was 65 years (1<sup>st</sup> and 3<sup>rd</sup> quartile: 62.0–70.0), the median eGFR was 72.6 mL/min/1.73m<sup>2</sup>(62.8–81.0), and the median observation period was 7.17 years(3.92–8.25). The outcome was achieved in 5.3% of patients during the observation period with eGFR 60-74 as the reference (hazard ratio [HR] 1.0). The analysis showed that the HRs for eGFR 45-59 and eGFR <45 were 1.07 (95% CI 0.77, 1.50) and 1.55 (95% CI 1.00, 2.40), respectively. HRs of the groups with eGFR 75-90 and eGFR  $\geq 90$  were 1.22 (95% CI 0.87, 1.71) and 1.72 (95% CI 1.16, 2.57), respectively.

**Conclusions:** For those who are eligible for nursing care insurance both lower and higher eGFR were risk factors for shorter healthy life expectancy.

**PUB348**

**CKD Risk Factors by Cluster in Mild- and Moderate-Risk Individuals**

Tadashi Toyama, Megumi Oshima, Shinji Kitajima, Akinori Hara, Norihiko Sakai, Miho Shimizu, Yasunori Iwata, Takashi Wada. Kanazawa Daigaku, Kanazawa, Japan.

**Background:** Risk management of mild and moderate risk cases is a challenge in the risk management of CKD. We performed machine learning clustering based on clinical information to examine the association between renal events and risk factors in each stratum.

**Methods:** We randomly selected 10,000 adults with normal proteinuria/± and eGFR  $>45$  mL/min/1.73 m<sup>2</sup> from adults with physical examination in Kanazawa. Individuals with diabetes were excluded. k-means clustering was used to classify subjects into 4 groups by risk factors including age, BMI, and blood pressure. A 30% decrease in eGFR was defined as renal event. The association between risk factors and renal event was analyzed by clusters.

**Results:** The subjects were on average 67 years old, and 7.2% developed renal events during a mean observation period of 5.8 years. Compared to group  $\alpha$ , groups  $\gamma$  and  $\delta$  had a significantly higher risk of renal events ( $P < 0.05$ ). Positive urinary occult blood (hazard ratio 1.66 [95% CI 1.13, 2.44]) was a significant risk factor associated with renal events in the  $\gamma$  group and low hemoglobin (hazard ratio 1.32 [95% CI 1.20, 1.45]) in the  $\delta$  group.

**Conclusions:** The general population at mild to moderate risk was classified into four clusters. The risk of renal events differed by cluster and the risk factors associated with renal events were different.

**PUB349**

**Reduction in Morbid Obesity With Bariatric Surgery and Improvement in Kidney Disease Burden**

Syeda S. Bukhari,<sup>1,2</sup> Sonalika Agarwal,<sup>1,2</sup> Isha Puri,<sup>1,2</sup> Omar N. Elhawary,<sup>1,2</sup> Mary C. Mallappallil,<sup>1,2</sup> <sup>1</sup>Kings County Hospital Center, Brooklyn, NY; <sup>2</sup>SUNY Downstate Health Sciences University, New York City, NY.

**Introduction:** Obesity is a risk factor for chronic kidney disease and the suggested pathophysiology includes hyperfiltration and glomerulosclerosis in the kidneys itself and the worsening of comorbidities like diabetes and hypertension. In dialysis dependent kidney failure bariatric surgery is reported to be safe and patients may be referred for weight reduction therapy before kidney transplantation despite the obesity paradox. We present two cases of advanced chronic kidney disease where there was improvement in glomerular filtration rate, proteinuria and hemodialysis prescription.

**Case Description:** Case 1: A 48-year-old female with history of hypertension, diabetes, chronic kidney disease and morbid obesity undergone gastric bypass on 14<sup>th</sup> September 2021 with a total of 176 pounds weight loss. There was profound regression in her chronic kidney disease as her creatinine decreased from 3.44 to 1.76 with decrease in her urine protein creatinine ratio from 3.5 to 1.4. Her estimated glomerular filtration rate improved from 14 mL/min to 39 mL/min with postponement of dialysis access placement and transplantation listing. Case 2: A 38 year old morbidly obese man with congestive heart failure, hypertension, obstructive sleep apnea, asthma, end stage renal disease on hemodialysis 4 times a week for 4 hours with a body mass index of 67.5 and a weight

of 201Kgs undergone robotic sleeve gastrectomy on 3/30/22. Her weight reduced to 20 pounds and a new body mass index was 65.5 two weeks after surgery which lead to subsequent decrease in hemodialysis to three times a week for 4 hours maintaining his dialysis parameter of adequacy including Kt/V 1.1 URR 66% and fluid and electrolytes status.

**Discussion:** Morbid obesity is usually treated by with lifestyle modification and bariatric surgery. Patients with advanced renal disease are usually referred for bariatric surgery when they are considered for kidney transplantation. The above discussed two cases illuminate other ways like weight reduction that may decrease the burden of kidney disease in those with advanced Chronic kidney disease. The nephrologist needs to distinguish between the risk and benefits of obesity in patients with advanced kidney disease including those on dialysis.

## PUB350

### Discrepancies in Policies Applied to CKD Patients Before IV Contrast Studies: A Three Countries Survey-Based Study

Mahmoud H. Imam,<sup>1</sup> Rizk Sarhan,<sup>1</sup> Mona A. Metwally,<sup>2</sup> <sup>1</sup>Benha University, Benha, Egypt; <sup>2</sup>Ain Shams University Faculty of Medicine, Cairo, Egypt.

**Background:** Chronic kidney disease patients frequently need to perform intravenous contrast enhanced radiological studies. However, there is vast variation among hospitals in applying clinical guidelines. This study aims to detect the variation in the application of current policies among different hospitals.

**Methods:** This cohort study is conducted through an online survey distributed to radiological departments in many hospitals in 3 countries (USA, Egypt, and Saudi Arabia). The survey included the pre-contrast requested labs, is it fixed for all kidney stages or not?, when to request nephrology consultation before the scan, and whether the dialysis session schedule is altered for the sake of radiological study. The results were compared among the 3 countries.

**Results:** We received 182 completed surveys (103 from Egypt, 48 from Saudi Arabia, and 31 from the USA). In total, 58% of the radiology departments requested nephrology assessment for patients with eGFR > 50 ml/min/1.73m<sup>2</sup>. Also, 52% reported they had patient sessions rescheduled before the iv contrast scan. There was a significant increase in reschedule burden in Saudi Arabia in comparison with the other 2 countries (*p* 0.04). There were no different radiological policies for CKD stages 1-5 and stage 5d.

**Conclusions:** There is a significant variation in policies for CKD patients before IV contrast studies. The discrepancy in applying the policies among hospitals creates an unjustified burden on CKD patients. There is an urgent need for international combined guidelines involving both radiology and nephrology societies.

## PUB351

### Improving the Quality of CKD Care with Risk Prediction and Personalized Recommendations: The GEMINI Project

Navdeep Tangri,<sup>1</sup> Geoffrey A. Block,<sup>2</sup> Mary O. Dittrich,<sup>2</sup> Navid Saigal,<sup>3</sup> Amit Sharma,<sup>4</sup> Samuel T. Fatoba,<sup>4</sup> Pablo E. Pergola,<sup>3</sup> <sup>1</sup>University of Manitoba Max Rady College of Medicine, Winnipeg, MB, Canada; <sup>2</sup>US Renal Care Inc, Plano, TX; <sup>3</sup>Renal Associates PA, San Antonio, TX; <sup>4</sup>Bayer Pharma AG, Berlin, Germany.

**Background:** CKD affects 1 in 7 Americans and can lead to progression to dialysis, cardiovascular disease, and early mortality. Effective interventions exist to slow the progression of CKD and prevent heart failure, but implementation remains a challenge, and use of guideline recommended testing and therapies remain low. Routine, complete collection of guideline recommended blood and urine tests allowing accurate risk prediction with personalized treatment recommendations can improve CKD care, when integrated into clinical workflow. Our objective is to implement risk prediction algorithms clinical decision support for identifying patients at risk of CKD progression in 5 large nephrology practices representing more than 100 nephrologists and 100,000 patients with CKD.

**Methods:** Data for estimated glomerular filtration rate, albuminuria, demographics, other laboratory tests and comorbid conditions will be extracted from the electronic health record (EHR). Patients already on dialysis will be excluded. The remaining individuals will be risk stratified using Klinrisk's proprietary risk prediction equations. A dashboard with disease specific educational information, personalized treatment recommendations and links to the EHR's of the identified patients will be created.

**Results:** We will aim to enroll 5 leading large US nephrology practices in the next 12 months. Eligible patients will be identified and quality of care as defined by appropriate testing (proportion of patients with albuminuria testing within 12 months), and appropriate therapy as recommended by the relevant guidelines (RAASi, SGLT2i, and non-steroidal MRA use) will be measured in the pre and post implementation period.

**Conclusions:** A highly accurate machine model for CKD progression when paired with EHR linked clinical decision support will improve testing and management of intermediate and GEMINI high-risk patients with CKD. Larger randomized trials of clinical decision support and practice audit applications will be needed to impact CKD management in primary care.

**Funding:** Commercial Support - Bayer U.S.

## PUB352

### Results From a Vermont CKD Navigator Program

Jeffrey M. Rimmer,<sup>1,2</sup> Kelly Julian,<sup>1</sup> Cydney J. Wolf,<sup>1</sup> Stacy Ladabouche,<sup>1</sup> <sup>1</sup>University of Vermont Medical Center, Burlington, VT; <sup>2</sup>University of Vermont College of Medicine, Burlington, VT.

**Background:** CKD is associated with suffering and expense. Programs involving education, healthy lifestyle, care management and patient motivation have been developed to improve outcomes. In advanced kidney disease, the focus is to select appropriate end-stage kidney disease (ESKD) therapy and ease transitions. In 2020, an 18 month project to improve care of patients with advanced CKD was started in Vermont.

**Methods:** In July a nephrologist recruited a nurse, half-time dietitian and social worker as navigators. Clinic patients with an eGFR  $\leq$  20 ml/min/1.73m<sup>2</sup> were identified by computer search. Navigators were trained in serious illness discussion skills. Education materials were reviewed and a curriculum was developed. Navigators developed education/assessments specific for their expertise. Patients were contacted by navigators. Participants had education/assessment sessions in CKD, health review, nutrition and social needs. Participant, family, navigator and MD met for a planning session after education. A plan for ESKD therapy was documented. Monitoring followed education/assessment and planning. Navigators followed patients monthly and laboratory every six weeks. Meetings were telephonic or videoconference.

**Results:** Clinic screening yielded 150 potential participants. During the year, 150 patients were contacted. 104 (69.3%) agreed to participate. 59 patients completed education, assessment, planning and entered monitoring. Planned ESKD choices were; peritoneal dialysis (PD) 30.5%, in-center hemodialysis (ICHD) 29%, transplantation 19%, supportive care (SC) 10%, home hemodialysis (HHD) 8.5% and no choice 3%. 3/59 died unexpectedly. Results for 13 who reached an endpoint with a plan include; 5 choosing ICHD started ICHD. All had a fistula. 4 required a bridging catheter, of 3 choosing HHD. 2 started HHD and one ICHD all with fistula. of 2 choosing PD both started PD. of 3 choosing SC. 2 died in hospice care while 1 dialyzed briefly then transferred to hospice. 54.5% of patients started dialysis with appropriate access. An additional 27.3% had a maturing access.

**Conclusions:** 71% of those participating in a Vermont CKD navigator program chose an ESKD therapy other than ICHD. 85% reaching ESKD maintained their initial choice. 40% of participants reaching ESKD started on home therapy. 81.8% started dialysis after access surgery. Increasing HHD and early kidney transplantation was difficult.

**Funding:** Clinical Revenue Support

## PUB353

### Design and Pilot Implementation of an Electronic Patient-Reported Outcomes Measure (ePROM) for Nephrology Clinic

Dipal Patel,<sup>1</sup> Sumeska Thavarajah,<sup>1</sup> Morgan Grams,<sup>2,1</sup> Deidra C. Crews,<sup>1</sup> <sup>1</sup>Johns Hopkins University, Baltimore, MD; <sup>2</sup>NYU Langone Health, New York, NY.

**Background:** Patients with kidney disease face a variety of symptoms and psychosocial stressors which have a large impact on quality of life. Patient-reported outcome measures (PROMs) capture aspects of physical and mental health, reported directly by the patient, in a manner tailored to conditions being treated. With wide utilization of electronic health records (EHRs), the implementation of electronic PROMs (ePROMs) presents an opportunity to reach large numbers of patients and evaluate outcomes longitudinally.

**Methods:** In our academic nephrology practice, we designed a "Kidney Disease Symptom Survey" derived from portions of the Kidney Disease Quality of Life-36 survey, with additional questions assessing overall quality of life and urinary frequency. We proceeded with pilot implementation of this survey as an ePROM.

**Results:** The "Kidney Disease Symptom Survey" (Figure 1A) was translated into an electronic questionnaire on MyChart, the patient portal for Epic Health Systems. The questionnaire is automatically pushed to any patient with an ICD10 diagnosis of CKD seen for follow-up in nephrology clinic, and is estimated to take 3-8 minutes to complete. Patients receive an alert to complete the ePROM 7 days prior to their visit and can also complete the ePROM on a tablet in person upon clinic check-in. Patient responses are scored and uploaded into patients' EHRs (Figure 1B). With data linked to our academic institute's Kidney Precision Medicine Center of Excellence, we can study associations between ePROM scores and clinical outcomes including hospitalizations, progression of kidney disease, and mortality.

**Conclusions:** We demonstrate successful design of a kidney-specific ePROM for use in nephrology clinic. Scores can be discussed during clinic visits to better align patient and provider preferences. Studies are needed to assess whether ePROM use influences providers' therapeutic decisions, and improves patient satisfaction with care and clinical outcomes.

**Funding:** Private Foundation Support



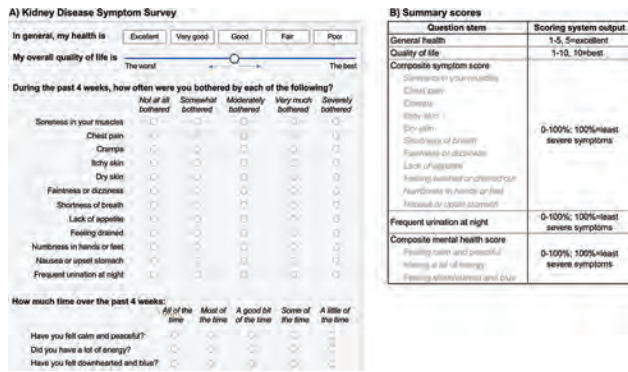

PUB354

**Is the “Slippery Slope” of Declining Renal Function in CKD Inevitable?**  
 Olivia M. Orteza,<sup>1</sup> James I. McMillan,<sup>1,2</sup> Enrica Fung,<sup>1,2</sup> <sup>1</sup>Loma Linda University, Loma Linda, CA; <sup>2</sup>Veterans Health Administration Operations, Loma Linda, CA.

**Background:** Patients with chronic kidney disease are expected to have a progressive decline in kidney function over time. Our study was inspired by a 65-year-old man with diabetes mellitus type 2 had kidney disease that had progressed from an eGFR of 55 down to 16 ml/min over 4 years. Fear of facing dialysis prompted him to significantly change his lifestyle including weight loss, exercise, smoking cessation, and dietary changes with a shift away from meat to vegetables and fruit, and eliminating sodas. Over the next 4 years his eGFR steadily rose to about 40 ml/min and now, 10 years after the change in lifestyle, he remains off dialysis. We assembled a retrospective cohort to examine the frequency of patients with declining renal function that experience a leveling or a sustained rise in renal function.

**Methods:** We selected patients in Loma Linda VA nephrology clinic with GFR < 60 between 2010 to 2020. Patients who had steady decline in GFR for at least 3 years were included in the study. We visually analyzed the GFR trend of each patient for a sustained rise, leveling, or continued decline in kidney function over at least 2 subsequent years.

**Results:** A total of 301 patients were screened. Of those, 208 patients had at least a 3-year decline in the GFR, and 21 were otherwise eliminated due to other exclusion criteria such as obstructive uropathy or receipt of transplant. This leaves 187 patients meeting final inclusion criteria. Of these patients, 58 (31.0%) had a rise in GFR, 14 (7.5%) had leveling of GFR and 115 (61.5%) had continued decline in kidney function.

**Conclusions:** GFR decline is generally accepted as inevitable in CKD. Our study challenges this dogma. Further larger studies will need to be performed to confirm and examine the reasons for the reversal or stabilization of GFR trends. We also found that observation of GFR trends can be quite subjective. This highlights the importance of using available tools such as kidney failure risk equation or development of more objective tools when examining GFR trends in patients.

	Total (N=187)	Rise in GFR (N=58)	Leveling in GFR (N=14)	Decline in GFR (N=115)	P-value
Age, mean ±SD	61.4 ± 9.6	62.5 ± 9.6	62.2 ± 6.7	60.7 ± 9.9	0.46
GFR at beginning of study, ml/min, mean ± SD	59.3 ± 19.3	53.4 ± 15.5	56.5 ± 14.4	60.6 ± 21.3	0.02
GFR at end of study, ml/min, mean ± SD	35.2 ± 11.2	38.1 ± 8.8	30.6 ± 8.5	34.3 ± 12.3	0.03
Diabetes, N (%)	118 (63.1%)	42 (72.4%)	7 (50.0%)	69 (60.0%)	0.16
Heart failure, N (%)	44 (23.5%)	12 (20.7%)	4 (28.6%)	28 (24.3%)	0.78
Peripheral vascular disease, N (%)	17 (9.0%)	4 (6.9%)	2 (14.3%)	8 (6.1%)	0.42

PUB355

**Hyperuricemia in Patients With Advanced CKD: Potential Impacts of This Often Overlooked Issue**

Leonard Stern,<sup>1</sup> Richard J. Johnson,<sup>2</sup> Payam Shakouri,<sup>3</sup> Amod Athavale,<sup>4</sup> Lissa Padnick-Silver,<sup>5</sup> Brian LaMoreaux,<sup>5</sup> Brad A. Marder,<sup>5</sup> Sreedhar A. Mandayam,<sup>6</sup> <sup>1</sup>Columbia University Irving Medical Center, New York, NY; <sup>2</sup>University of Colorado Health, Aurora, CO; <sup>3</sup>Advanced Kidney Care, Poughkeepsie, NY; <sup>4</sup>Trinity Life Sciences, Waltham, MA; <sup>5</sup>Horizon Therapeutics plc, Deerfield, IL; <sup>6</sup>The University of Texas MD Anderson Cancer Center, Houston, TX.

**Background:** Advanced CKD patients (pts) are susceptible to developing hyperuricemia and gout. Hyperuricemia has also been associated with hypertension, obesity, heart failure, diabetes, heart attack, and stroke. However, hyperuricemia’s influence on comorbidity occurrence and overall health has not been well described for advanced CKD pts. This study examines advanced CKD pts with and without hyperuricemia to better understand potential health sequelae in this high-risk population.

**Methods:** Medical record data of nephrologists’ most-recently seen pts with Stage 3-5 CKD were reported. Pts who had serum uric acid values (sUA) from their most recent visit were stratified into hyperuricemic (HU, sUA≥6 mg/dL) and normo-uricemic (NU, sUA<6 mg/dL) groups. Pt and CKD characteristics were examined and compared

between groups. Statistical significance was defined as p<0.05 and was examined using t-tests for continuous parameters and chi-square tests for categorical ones.

**Results:** 111 nephrologists reported on 746 advanced CKD pts. 247 (33.1%) had sUA recorded at their most recent visit, of which 143 (57.9%) had HU. Pts with HU (age: 55.5±19.7 years, 54% male, BMI: 32.4±12.8 kg/m<sup>2</sup>, sUA: 7.3±4.1 mg/dL, eGFR: 32.6±13.6 ml/min/1.73m<sup>2</sup>) and NU (age: 58.4±19.8 years, 57% male, BMI: 33.2±12.9 kg/m<sup>2</sup>, sUA: 4.9±0.7 mg/dL, 33.8±14.2 ml/min/1.73m<sup>2</sup>) had similar characteristics, renal function, and comorbidity profiles (including diabetes). HU pts did however have higher HbA1c levels (7.4±1.4 vs 6.7 ±1.4; N=83, 57), parathyroid hormone levels (163.8±133.5 vs 118.0±101.7; N=119, 87), and loop diuretic use (48% vs. 31%; all p≤0.009). In addition, HU pts reported more gout symptoms, including gout flares (36% vs. 19%) and chronic back pain (21% vs. 11%; both p≤0.030), and more often required urgent (18% vs 5%) and emergency (17% vs 8%) care (both p≤0.026).

**Conclusions:** This analysis demonstrates that despite having similar comorbidity prevalences and eGFR, pts with HU had worse control of their diabetes and metabolic bone disorder which could lead to poorer health outcomes. Additionally, CKD pts with HU had higher occurrences of gout flares, chronic back pain, and acute-care utilization.

**Funding:** Commercial Support - Horizon Therapeutics plc

PUB356

**Metformin-Associated Lactic Acidosis in a Patient With CKD**

Amira S. Kamboj,<sup>1,2</sup> Si Yuan Khor,<sup>1,2</sup> Sara Alattal,<sup>1,2</sup> Issa R. Haddad,<sup>1,2</sup> <sup>1</sup>Michigan State University, East Lansing, MI; <sup>2</sup>Sparrow Health System, Lansing, MI.

**Introduction:** Metformin use in the setting of chronic kidney disease (CKD) has become controversial. For many years it had been regarded as being contraindicated due to the known complication of lactic acidosis (LA). However, recent studies suggest that the benefits of metformin may outweigh the risks in this sub-population. Herein, we present a case of Metformin-associated lactic acidosis (MALA) requiring hemodialysis (HD).

**Case Description:** A 60 year old male with a history of CKD Stage III, Diabetes Mellitus Type II, Hypertension, and Prostate Cancer presented to the Emergency Department (ED) with altered mentation. Initial vital signs included a temperature of 92.5F, blood pressure of 107/30, heart rate 92, respiratory rate of 36, and oxygen saturation of 95%. Physical exam showed an ill appearing male, with coarse breath sounds, and generalized abdominal tenderness. He was intubated for airway protection due to decline in glasgow coma scale and admitted to the intensive care unit. Initial work up revealed: ABG pH 6.95, pCO<sub>2</sub> 41, pO<sub>2</sub> 104, potassium 6.3, bicarbonate of 2, lactate 20, BUN 95, creatinine 13.26, glucose 116, negative toxic alcohol studies, negative urine drug screen, and an unrevealing Computed Tomography of the brain, chest, abdomen and pelvis. The patient was started on a bicarbonate infusion and continuous renal replacement therapy. After one day, clinical status improved, he was extubated and reported that he had been prescribed Sitagliptin/Metformin eight weeks prior to presentation. The patient’s creatinine remained elevated with oliguria and the patient was transitioned to intermittent HD which was continued in the outpatient setting.

**Discussion:** MALA is a rare complication of metformin use with an incidence of 4.3 per 100,000 patient-years and it is associated with up to 50% mortality rate. The majority of previous clinical trials revealed that metformin was not associated with increased risk for LA. Although current guidelines permit metformin use in CKD if eGFR is >30 mL/min, frequent monitoring of renal function is mandatory and patients should be educated to discontinue metformin in the setting of acute illness. Although metformin use has recently been considered safe for use in patients with CKD, the risk of causing lactic acidosis should not be disregarded. Further studies are needed to facilitate explicit guidelines on the use of Metformin in CKD.

PUB357

**Age-Specific Estimated Glomerular Filtration Rate and Outcomes: Insights From the KNOW-CKD Cohort**

Ji Hye Kim, Hajeong Lee. Seoul National University Hospital, Jongno-gu, Seoul, Republic of Korea.

**Background:** Korea is one of the representative aging societies. We aimed to investigate the role of recently proposed age-adapted chronic kidney disease (CKD) definition and outcomes in Korea.

**Methods:** This study included 2238 patients from the KoreaN Cohort Study for Outcome in Patients With Chronic Kidney Disease. Patients were categorized into three age groups: <40, 40-64, and ≥65 years old. We defined CKD stages according to the estimated glomerular filtration rate (eGFR) calculated on centrally measured serum creatinine and cystatin C. Primary outcome was composite of renal events including end-stage renal disease (ESRD), fatal cardiovascular events (FCVE), and mortality.

**Results:** The aged (n = 471, 69.3 ± 2.9 years) patients had more metabolic and cardiovascular comorbidities, poorer socioeconomic status, and worse mental status compared to younger age groups. They had lower eGFR, but a similar proportion of albuminuria. During 5.5 ± 2.2 years of follow-up, 588 (26.6%) ESRD, 182 (8.2%) FCVE, and 138 (6.3%) deaths developed. Unsurprisingly, the aged showed worse ESRD, FCVE, and mortality outcomes. Moreover, higher CKD stage was associated with worse kidney and patient outcomes in Kaplan-Meier estimate. Interestingly, however, the cutoff-off eGFR associated with worse outcomes was different according to the age groups. The aged showed an increased risk for primary outcome from CKD stage 4 (HR 4.03, 95% CI [2.13, 7.62]) and 5 (HR 14.19, 95% CI [6.96, 28.91]) whereas middle-aged patients from stage 2 after adjustment with age, sex, diabetes, previous coronary artery disease,

smoking, body mass index, blood pressure, albuminuria, and total cholesterol. In all age subgroups, FCVE was not associated with CKD stages. ESRD risk increased from CKD stage 3b in aged group while middle-aged had increased risk even from stage 2.

**Conclusions:** This study suggested that the age-specific eGFR threshold associated with kidney and patient outcomes should be considered in Korean CKD patients.

**PUB358**

**Tele nephrology: Managing CKD During the COVID-19 Pandemic**

Sanjib K. Sharma, B P Koirala Institute of Health Sciences, Dharan, Nepal.

**Background:** The management of kidney diseases is challenging in areas where discrepancy exist between number of nephrologist and patient with kidney disease. COVID-19 pandemic added to this challenges. We initiated a tele nephrology service in 2020 with primary aim of education, targeted screening and treatment of kidney diseases focusing where there was no nephrologist.

**Methods:** In this study locally available paramedics were mobilized for information dissemination and follow up of index patient population. The consultation was performed by internists and nephrologist. After initial registration in telemedicine service, social media apps were used for communication. The mode of communication used was audio, text, photography, and video call when needed. Follow-up consultation was done as required and in 3 months which involved review of reports and medical advised as needed including medication. We analyzed the data from the records of tele nephrology service provided from april 2020 to april 2021 and who has completed at least 6 months follow up.

**Results:** A total of 266 participants who were known to have chronic kidney disease, hypertension, diabetes, and heart failure were enrolled. The mean age of the participant was 54.21 ± 17 years. Female constitute 53% (n=141). The most common mode of communication was WhatsApp (86.5%), followed by Viber (5.6%). Patients were advised to undergo investigations in primary health care set up or elsewhere as needed. Most of the participants (88.0%, n=232) were managed without need for physical hospital visit. Physical visit to hospital was needed in 84 patients (17%) and 4.1% (n=11) needed hospital admission. During follow up, half of the participants (n=134) had performed tests as advised and 44.4% (n=118) followed the treatment advised, in initial consultation and needed further advise to do so. Five persons dies during follow-up (1.9%). Few participants 1.1%(n=3) said that they don't want to use the telemedicine service again.

**Conclusions:** Tele nephrology services can bridge the gap in care in nephrology where access to nephrologists is limited.

**PUB359**

**Methotrexate Use in CKD Patients With Sarcoidosis**

Heidy Hendra, David Randall, Ravindra Rajakariar. *Barts Health NHS Trust, London, United Kingdom.*

**Background:** Sarcoidosis is a multisystem disease of unknown aetiology, characterised by presence of non-caseating granuloma in the organs involved; with lung, lymph nodes, skin, eyes, and liver being the most frequent affected sites. Treatments are initiated for those who does not have spontaneous resolution of the disease and those with extrapulmonary involvement including renal. Methotrexate has been used as an alternative agent for those with intolerance or insufficient response to steroids. It is contraindicated in advance CKD with eGFR < 10 ml/min and has not been recommended to be used in moderate CKD.

**Methods:** We identified patients with sarcoid who has been receiving methotrexate in our renal patient's database. Data including demographic, weekly dose of Methotrexate and renal function at initiation and current ones were collected.

**Results:** Out of 146 individuals who are on Methotrexates, 10 patients were diagnosed with sarcoidosis or granulomatous tubulointerstitial nephritis (TIN); half of them were men. Three patients have biopsy confirmed renal sarcoidosis. All patients have CKD at initiation of Methotrexate with 80 % being moderate with Class IIIA or IIIB (see Table 1 for details). None of the patients had significant adverse effect of Methotrexate or required treatment discontinuation. The medication dose was adjusted to the current eGFR (see Figure 1).

**Conclusions:** Methotrexate can be safely used in patients with sarcoidosis with moderate CKD at baseline. We also shown that it is an effective agent for treatment of granulomatous tubulointerstitial nephritis.

Age	Sex	Location	Organ involved	Classification of CKD	eGFR (ml/min/1.73m <sup>2</sup> )	Current eGFR (ml/min/1.73m <sup>2</sup> )	Current CKD Stage	Start date MTH	Duration of MTH (years)	Start MTH dose (mg/week)	Current dose of MTH (mg/week)
54	F	Sarcoid	Pulmonary	III	51	38A	III	06/09/2009	13	12.5	5
53	MA	Sarcoid	Cardiac	III	42	38B	III	01/05/2013	13	7.5	20
49	MA	Sarcoidosis	Lymph nodes	III	42	31	III	26/01/2011	11	25	27.5
45	F	Granulomatous TIN	Renal	III	34	38B	III	18/07/2014	7	12.5	12.5
79	F	SAR & sarcoid & vasculitis	Inter-epithelial	III	47	38A	III	04/09/2020	21	20	20
57	F	Sarcoid & sarcoid & vasculitis	Skin	III	83	36	II	18/03/2015	7	30	30
78	MA	Granulomatous TIN	Renal	III	38	38B	III	04/04/2014	10	15	15
58	MA	Sarcoid & sarcoid	Renal, pulmonary	III	42	38B	III	04/10/2017	5	17.5	30
65	F	Sarcoid & sarcoid	Heart, neck	III	32	38B	III	12/02/2010	12	10	12.5
67	MA	Sarcoid	Pulmonary	III	57	38A	III	12/06/2012	10	15	15

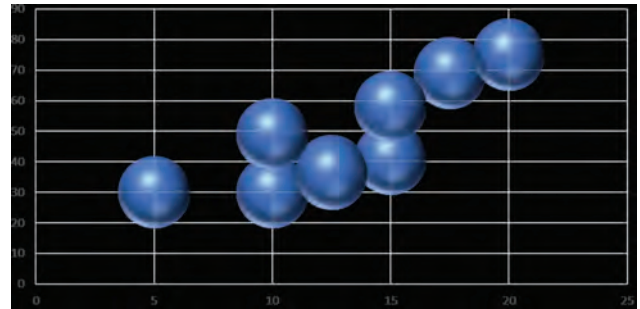

**PUB360**

**A Case of Bradycardia, Renal Failure, AV-Nodal Blockers, Shock, and Hyperkalemia (BRASH) Syndrome in a 65-Year-Old Patient**

Mohammad AL Wahadneh, Nidal Alhosainat, Mahmood Mubasher, Abdallah Hamayel. *Rochester Regional Health, Rochester, NY.*

**Introduction:** BRASH syndrome is a serious vicious cycle of complications in which renal failure causes hyperkalemia and accumulation of the patient's nodal blocking agent, both of which worsen bradycardia which leads to shock, further worsening renal perfusion, and so on. We are presenting a case of BRASH syndrome in a 65-year-old patient.

**Case Description:** A 65 year old Male with PMHx of hypertension, HIV, diabetes mellitus and end stage renal disease on hemodialysis, admitted with light headedness, fatigue and diarrhea for 3 days, was recently started on metoprolol. Physical exam revealed BP 113/54, HR 36-44 bpm, bilateral rales on lung auscultation. Labs were significant for hyperkalemia 6.9 mmol/L, bicarbonate 18 meq/L. ECG showing sinus bradycardia with 1st degree AV block and RBBB. The patient was medically managed, received hemodialysis and beta blockers discontinued with complete resolution of the Bradycardia.

**Discussion:** BRASH syndrome is a cycle of renal failure, shock and a synergistic effect of AV nodal blocker and hyperkalemia which causes profound bradycardia leading to shock and further worsening in renal function. Poor renal function leads to decrease clearance of AV nodal blocking agents with worsening bradycardia which is usually out of proportion to degree of hyperkalemia. The treatment should be aimed at correcting the inciting event of renal failure, correction of hyperkalemia either medically or by renal replacement therapy and stopping the AV nodal blocking agents, administration of beta agonist agents might be required in certain cases. Conclusion: Early detection of BRASH syndrome can be vital in the management of patients. Particular attention should be given to patients taking AV nodal blockers in the setting of worsening renal function.



## PUB361

**SGLT2 Inhibition Mitigates Intravascular Fluid Retention Driven by an Endothelin A Receptor Antagonist**

Robert I. Menzies,<sup>1</sup> Vandana Veenit,<sup>1</sup> Christine Ahlström,<sup>1</sup> Peter J. Greasley,<sup>1</sup> Stanko Skrtic,<sup>1</sup> Donald E. Kohan,<sup>2</sup> Pernille B. Laerkegaard Hansen.<sup>1</sup>  
<sup>1</sup>Astrazeneca, Gothenburg, Sweden; <sup>2</sup>University of Utah Health, Salt Lake City, UT.

**Background:** The development of endothelin receptor A antagonists (ETA<sub>R</sub>) in chronic kidney disease is hampered by mechanism-dependent fluid retention. Sodium-glucose cotransporter 2 inhibitors (SGLT2i) drive glucosuria and, in turn, osmotic diuresis with established benefits in T2D, CKD & HF.

**Methods:** We therefore hypothesized that co-administration of an SGLT2i with an ETA<sub>R</sub> would mitigate the fluid retaining effects of ETA<sub>R</sub> in a rat model using hematocrit (Hct) as an established surrogate of ETA<sub>R</sub> mediated hemodilution and fluid retention.

**Results:** In Wistar rats fed a high salt diet, 7-day treatment of the selective ETA receptor antagonist zibotentan (30, 100 and 300 mg/kg/day) resulted in a significant decrease in Hct compared to vehicle ( $p < 0.05$ ), an effect which persisted for 14 days with the 100 and 300 mg/kg doses. In a subsequent study over 7 days, co-administration of dapagliflozin (3.0 mg/kg/day) with zibotentan 30mg/kg/day attenuated the decrease in Hct. Zibotentan did not affect dapagliflozin-driven glucosuria at any dose tested.

**Conclusions:** These data support further evaluation of zibotentan and dapagliflozin in combination for a range of endothelin-driven pathophysiological processes.

**Funding:** Commercial Support - AstraZeneca

## PUB362

**Protective Effects of Anti-Fibrotic Gene on Ischemia-Reperfusion Kidney Injury via Inflammasome Suppression in Mice**

Ha nee Jang,<sup>1,2</sup> Jin H. Kim,<sup>3,2</sup> Seunghye Lee,<sup>1</sup> Sehyun Jung,<sup>1</sup> Hyun-Jung Kim,<sup>1,2</sup> Se-Ho Chang.<sup>1,2</sup>  
<sup>1</sup>Gyeongsang National University Hospital, Jinju, Republic of Korea; <sup>2</sup>Gyeongsang National University Institute of Health Sciences, Jinju, Republic of Korea; <sup>3</sup>Biomedical Research Institute, Gyeongsang National University Hospital, Jinju, Republic of Korea.

**Background:** Acute kidney injury (AKI) is common comorbidity in hospitalized patients and the most important risk factor of chronic kidney disease (CKD). Renal fibrosis is a final common pathology of CKD. However, the molecular mechanisms of renal fibrosis remain unclear. As ischemia-reperfusion injury (IRI) is as a major contributor to AKI, an effective therapeutic intervention for IRI is imperative. Anti-fibrotic gene is known as negative regulator of TGF- $\beta$ 1, but its role in renal fibrogenesis remains unknown. This study aims to elucidate the role of anti-fibrotic gene in IR-induced renal fibrosis.

**Methods:** Mice were assigned to sham, only IRI group, and anti-fibrotic gene-treated IRI group. The gene was administered at 5 min after reperfusion and once weekly. All mice sacrificed 21 days after IRI. The serum and urine were harvested for renal functional measurements. The kidneys were subjected to histological evaluation, and the biochemical changes associated with renal injury were assessed.

**Results:** This gene was abundantly expressed in the kidney and mostly in the nuclei of tubular epithelial cells in the steady state. Anti-fibrotic gene significantly attenuated the renal dysfunction associated with IRI, as well as tissue injury. Inflammatory cells infiltration like macrophage and Th17 cells were also significantly reduced in anti-fibrotic gene-treated mice as reflected by CX3CR1, CX3CL1, ROR- $\gamma$ t, and IL-17RA mRNA levels. Furthermore, the expression of inflammasome-related factors (NLRP3, cleaved caspase-1, IL-1 $\beta$  and IL-18) were significantly reduced following anti-fibrotic gene treatment. Finally, anti-fibrotic gene-treated IRI mice showed only moderate injury and minimal fibrosis and also larger reductions in the expression of extracellular matrix proteins and epithelial mesenchymal transition markers.

**Conclusions:** This is the first study to demonstrate that inflammasome-mediated inflammation might be a target of anti-fibrotic gene as a treatment for CKD from IRI.

## PUB363

**Kidney “Pathway Orphan” Genes as an Untapped Source of Novel Biology and Disease Understanding**

Dianne Acoba,<sup>1,2</sup> Sophie Gunnarsson,<sup>1</sup> Anna Reznichenko.<sup>1</sup>  
<sup>1</sup>Translational Science & Experimental Medicine, Research and Early Development, Cardiovascular, Renal and Metabolism, BioPharmaceuticals R&D, AstraZeneca, Gothenburg, Sweden; <sup>2</sup>Université Paris Cité, INSERM, INEM, Paris, France.

**Background:** A sizable proportion of the genome is still lacking functional annotation (“pathway orphans”), and, as a result, is often overlooked in downstream analyses of omics data, that are thus inherently biased towards the genes with established pathway link. We hypothesized that uncovering the pathway orphan genes implicated in human chronic kidney disease might shed new light on disease pathogenesis.

**Methods:** A list of human protein-coding genes (N=19,222) was downloaded from HGNC and annotated with pathway membership using a comprehensive collection of the most commonly used pathway databases (GO, KEGG, Hallmark and Curated gene sets from MSigDB, Reactome). ‘Pathway orphans’ genes were interrogated for differential case-control expression in previously published CKD kidney tissue transcriptomics studies (GSE30122, GSE104954, GSE32591, GSE37455, Levin *et al.* 2020).

**Results:** 373 (2% of protein-coding genome) genes that did not belong to any of the currently known pathways or gene sets were identified as ‘pathway orphans’. Of the 5 studies that we investigated, a total of 26 (7%) ‘pathway orphans’ were statistically significant (at  $p < 0.05$ ) on differential expression analysis comparing the diseased vs control kidney tissue (glomerular and/or tubulointerstitial microdissected fractions).

**Conclusions:** Significant modulation of expression in the human CKD kidney potentially implicates some ‘pathway orphan’ genes into the disease pathogenesis. Further characterization of this previously overlooked fraction of the genome might expand our biological understanding and highlight novel disease drivers.

**Funding:** Government Support - Non-U.S.

## PUB364

**The Uremic Toxin Indoxyl Sulfate Accelerates Senescence in Kidney Proximal Tubule Cells In Vitro**

Yi Yang,<sup>1</sup> Milos Mihajlovic,<sup>2</sup> Sabbir Ahmed,<sup>1</sup> Rosalinde Masereeuw.<sup>1</sup>  
 Prof. Roos’ group <sup>1</sup>Universiteit Utrecht Utrecht Instituut voor Farmaceutische Wetenschappen, Utrecht, Netherlands; <sup>2</sup>Vrije Universiteit Brussel Faculteit Geneeskunde en Farmacie, Brussel, Belgium.

**Background:** Kidney fibrosis is the common final pathway of nearly all chronic and progressive nephropathies, it reduces the capacity for tissue repair and ultimately causes kidney failure. One cause may be the accumulation of senescent cells that arise from diverse tissue damage signals and secrete factors (senescence associated secretory phenotype, SASP), which promote fibrosis and inflammation. It has been suggested that uremic toxins, like indoxyl sulfate (IS), may play a role in the development of progressive kidney fibrosis. We demonstrated recently that conditionally immortalized proximal tubule epithelial cells overexpressing the organic anion transporter 1 (ciPTEC-OAT1) represent a valid model for studying kidney senescence by simply adjusting culture conditions [1]. Here, we investigated whether IS accelerates senescence in ciPTEC-OAT1, thereby initiating kidney fibrosis.

**Methods:** CiPTEC-OAT1 were seeded into 6-well format plates and grown at 33°C, then transferred to 37°C for maturation and culturing in absence and presence of IS for up to 9 days. The culture medium and cell lysates were collected on day 0, 3, 6, and 9, and used for senescence phenotype assessment, including DNA damage markers and common SASP factors.

**Results:** Maturation at 37°C affects the senescence phenotype, which was accelerated by IS. Cell viability results suggested that the tolerance of ciPTEC-OAT1 against IS increased time-dependently at the same dose of IS, which was accompanied by SA- $\beta$ -gal staining confirming the accumulation of senescent cells. Compared to the non-senescence group (Day 0), the senescence marker p21 showed an upregulation, while laminB1 showed a downregulation at different time points. SASP factors IL-6 ( $p < 0.01$ ) and IL-8 ( $p < 0.01$ ) showed significant upregulations on day 3 dose-dependently; IL-1 $\beta$  ( $p < 0.05$  or  $p < 0.01$ ) was remarkably upregulated at all time points in a dose-dependent manner.

**Conclusions:** Our results suggest that IS accelerates cellular senescence in ciPTEC-OAT1. Future studies will be directed to further evaluate the underlying mechanisms *in vitro* and *in vivo*.

**Funding:** Government Support - Non-U.S.

## PUB365

**Establishment of an Adenine-Induced Nephropathy Mouse Model of CKD With Reduced GFR**

Jacob Nøhr-Meldgaard, Henrik H. Hansen, Lisbeth N. Fink, Mette V. Østergaard, Niels Vrang, Michael Christensen. Gubra, Hørsholm, Denmark.

**Background:** More than one out of seven of US adults are estimated to suffer from chronic kidney disease (CKD). While multiple factors (e.g. genetic, metabolic & acute kidney injuries) can lead to CKD, all CKDs clinically are characterized by a progressive decline in glomerular filtration rate (GFR). Various mouse models of CKD are available but often rely on surgical interventions, such as unilateral urethral obstruction or kidney ischemia reperfusion models, and do not consistently display measurable GFR decline. The rat adenine-induced nephropathy model is well-established (adenine is metabolized to 2,8-dihydroxyadenine forming crystals in the proximal tubular epithelium initiating inflammation as well as fibrosis) but has proven difficult to establish in the mouse model due to low palatability of the adenine-diet resulting in reduced diet intake and excessive weight loss. Here, we report an in-depth characterization of a mouse model of adenine-induced CKD.

**Methods:** Male C57BL/6JRj mice fed chow containing 0.2% adenine and flavours (banana and chocolate) were added to increase palatability. Following 6 weeks of dietary adenine administration, GFR was assessed (transdermal measurement of FITC-sinistrin clearance), urine/plasma markers of kidney function were measured, and kidney sections were stained for collagen 1a1 immunoreactivity.

**Results:** Compared to chow-fed controls, mice supplemented with dietary adenine displayed moderate and steady body weight loss, marked albuminuria, and elevated plasma levels of both creatinine and urea. Notably, GFR was robustly decreased indicating kidney failure, concurrent with development kidney fibrosis (increased collagen 1a1 expression).

**Conclusions:** Mice supplemented with adenine in the diet displayed functional and histological hallmarks of CKD, highlighting the suitability of the adenine-induced mouse model of CKD in preclinical drug development.

**Funding:** Commercial Support - Gubra

**PUB366**

**RNA Sequencing of Renal Tubular Epithelial Cells Uncovers Novel Players in Renal Fibrosis**

Vidhi Dalal,<sup>1,2</sup> Tomoko Hayashida,<sup>1,2</sup> <sup>1</sup>Ann and Robert H Lurie Children's Hospital of Chicago, Chicago, IL; <sup>2</sup>Northwestern University Feinberg School of Medicine, Chicago, IL.

**Background:** Tubular epithelial cells (TECs) play an important role in the development of renal fibrosis. When injured, they undergo dedifferentiation. Dedifferentiated TECs secrete cytokines that promote transdifferentiation of neighboring pericytes and fibroblasts into extracellular matrix (ECM)-producing myofibroblasts. TGF-β1 is a key fibrogenic cytokine that promotes TEC dedifferentiation after renal injury. Therapies targeting TGF-β1, however, have not been successful for treatment of renal fibrosis. This is likely because TGF-β1 also has protective functions, including anti-inflammatory effects and regulation of autophagy. Here, we used a transcriptomic approach to identify molecules downstream of TGF-β1 that specifically execute its profibrotic functions.

**Methods:** Cultured human proximal tubular epithelial cells (HKC) were treated with either 2.5 ng/mL of TGF-β1 or vehicle for 72 hours. Their RNA was extracted and subjected to RNA sequencing. Transcriptomic data from the renal tubulointerstitium of patients with various forms of chronic kidney disease (CKD) was also obtained via the GEO database. Genes significantly upregulated at the mRNA level in HKC after TGF-β1 treatment were compared to transcriptomic data from diseased tubulointerstitium. The genes that were upregulated in diseased tubulointerstitium across 3 or more GEO datasets and in TGF-β1 treated HKC were chosen for further evaluation.

**Results:** MARCKS and DOCK2 were the 2 genes from our *in vitro* RNA sequencing data that were most consistently and most highly upregulated across multiple GEO datasets. Their upregulation in HKC was confirmed by qPCR and western blot. Next, HKC were transfected separately with siRNA against each gene and then treated with TGF-β1. Knocking down MARCKS prevented upregulation of COL1A1 and αSMA by TGF-β1 in HKC. However, knocking down DOCK2 further increased the upregulation of αSMA by TGF-β1 in HKC.

**Conclusions:** MARCKS is likely a mediator of the fibrogenic activity of TGF-β1, given that knocking it down ameliorates the TGF-β1 induced fibrogenic changes in HKC. DOCK2 may be a negative regulator of TGF-β1 activity, upregulated as part of a negative feedback response. The functions of these molecules in tubular epithelial cells in the context of renal fibrosis need to be further characterized in an animal model of chronic kidney injury.

**Funding:** Private Foundation Support

**PUB367**

**Adenine Stimulates mTORC1 to Increase Matrix Protein Synthesis, Which Is Inhibited by Hydrogen Sulfide in Kidney Proximal Tubular Epithelial Cells**

Hak Joo Lee,<sup>1,2</sup> Jingli Gao,<sup>1</sup> Li Liu,<sup>1</sup> Goutam Ghosh-Choudhury,<sup>1,2</sup> Balakuntalam S. Kasinath,<sup>1,2</sup> Kumar Sharma,<sup>1,2</sup> Center for Precision Medicine <sup>1</sup>The University of Texas Health Science Center at San Antonio, San Antonio, TX; <sup>2</sup>South Texas Veterans Health Care System, San Antonio, TX.

**Background:** Adenine promotes chronic kidney disease (CKD) and cardiovascular damage in rodent models. However, the underlying mechanism is poorly understood. Hydrogen sulfide (H<sub>2</sub>S) deficiency is associated with kidney injury seen in aging and CKD which is ameliorated by exogenous H<sub>2</sub>S supplementation. We hypothesize that adenine induces kidney injury by activating mTORC1 to increase matrix protein synthesis which is ameliorated by H<sub>2</sub>S.

**Methods:** We employed mouse kidney proximal tubule epithelial (MCT) cells. LY294002, MK2206 and rapamycin were used as inhibitors of PI3K, Akt and mTORC1, respectively. Sodium hydrosulfide (NaHS) was used as a source of H<sub>2</sub>S.

**Results:** Adenine increased S6K phosphorylation, an index of mTORC1 activity, and fibronectin expression in a dose- and time dependent manner. Inhibitors of PI3K, Akt and mTORC1 abolished adenine-induced S6K phosphorylation. mTORC1 inhibitor also ameliorated adenine-induced fibronectin expression. Administration of NaHS inhibited adenine-induced S6K phosphorylation to ameliorate fibronectin accumulation.

**Conclusions:** Our results indicate that adenine-stimulated mTORC1 is regulated by PI-3K-Akt signaling. PI-3K-Akt-mTORC1 axis mediates adenine-induced matrix protein synthesis which is ameliorated by exogenous H<sub>2</sub>S administration. Inhibition of mTORC1 by H<sub>2</sub>S could be used as a therapeutic intervention for adenine-induced CKD.

**PUB368**

**Effects of Sacubitril/Valsartan on Hypertension in Patients With CKD Stage 5D**

Nan Chen, Xiao Li, Li Lin. *Ruijin Hospital, School of Medicine, Shanghai Jiao Tong University, Shanghai, China.*

**Background:** The purpose of this study was to evaluate the efficacy and safety of Sacubitril/Valsartan (SV) compared with angiotensin receptor blocker (ARB) in dialysis-dependent patients with CKD stage 5 (CKD stage 5D) complicated with hypertension, and to provide a reliable basis for the treating hypertension in patients with CKD stage 5D.

**Methods:** This is multicenter RCT study. CKD stage 5D patients with hypertension were prescribed SV vs ARB. Blood pressure, and adverse events were compared between the two groups at baseline, every 3 months of follow-up.

**Results:** 452 patients with CKD stage 5D (268 of HD and 254 of PD) were enrolled, with a median age of 58 (23-75) years old, and the male to female ratio is 1.9 to 1. 263 patients in SV group and 259 patients in ARB group. The 1 year treatment with SV 100–200 mg per day resulted in significantly reductions in mean BP from baseline (Figure 1). The mean sitting systolic BP (msSBP) was reduced from 149 ± 20 mm Hg at baseline to 144 ± 18 mm Hg, 141 ± 32 mm Hg, 137 ± 17 mm Hg, 140 ± 19 mm Hg at 3, 6, 9 and 12 months (P = 0.03, 0.02, <0.001, 0.004). The msSBP was lower in the SV group than in the ARB group at 3 and 9 months (P = 0.041, 0.005) (Table 1). During the follow-up period, SV was safe and well-tolerant in dialysis patients during.

**Conclusions:** The preliminary results of this study suggested that SV safely and effectively reduce blood pressure in patients with CKD stage 5D, and might be superior to ARB. The study also looked at the effects of SV on survival benefit, residual kidney function and blood pressure, and results will be released in due course.

Table1. SBP was lower in the SV group than in the ARB group

	ARB Group SBP(mmHg)	SV Group SBP(mmHg)	P value
Baseline	150±21	149±20	0.495
3-month	150±36	144±18	0.041
6-month	143±33	141±32	0.504
9-month	145±18	137±17	0.005
12-month	142±10	140±19	0.494

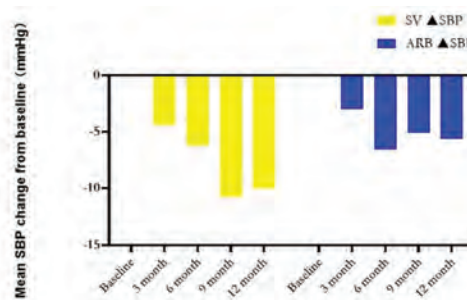

Figure1. Reductions of msSBP from baseline to 3, 6, 9, and 12 months of follow-up: -4mmHg(P=0.007), -6mmHg (P=0.002), -11mmHg (P=0.003), and -10mmHg (P=0.001). Reductions of msSBP from baseline to 3, 6, 9, and 12 months of treatment in the ARB group was -3mmHg(P=0.040), -6mmHg (P=0.001), -5mmHg (P=0.001), and -6mmHg (P=0.001).

**PUB369**

**Development and Validation of Multivariable Prediction Models of Serological Response to SARS-CoV-2 Vaccination in Kidney Transplant Recipients**

Bilgin Osmanodja,<sup>1</sup> Klemens Budde,<sup>1</sup> Eva V. Schrezenmeier,<sup>1,2</sup> Simon Ronicke,<sup>1</sup> <sup>1</sup>Charite Universitätsmedizin Berlin, Berlin, Germany; <sup>2</sup>Berlin Institute of Health at Charite, Berlin, Germany.

**Background:** Repeated vaccination against SARS-CoV-2 increases serological response in kidney transplant recipients (KTR) with high interindividual variability. Still, no decision support tool exists to predict SARS-CoV-2 vaccination response in KTR.

**Methods:** We developed, internally and externally validated five different multivariable prediction models of serological response after the third and fourth vaccine dose against SARS-CoV-2 in KTR. Using 27 candidate predictor variables, we applied statistical and machine learning approaches including logistic regression (LR), LASSO LR, random forest, and gradient boosted regression trees. For development and internal validation, data from 585 vaccinations were used. External validation was performed in four independent, international validation datasets comprising 191, 184, 254, and 321 vaccinations, respectively.

**Results:** Internal validation using a rigorous resampling approach showed AUC-ROC of 0.825 for LASSO LR, which was then used for model fitting and external validation. LASSO LR performed on the whole development dataset yielded a 23- and 11-variable model, respectively. External validation showed ROC-AUC of 0.855, 0.749, 0.828, and 0.763 for the sparser 11-variable model, yielding an overall AUC-ROC of 0.809, and a negative predictive value of 0.752. The 23-variable model showed AUC-ROC of 0.853, 0.714, 0.844, and 0.778 in four independent validation sets, yielding an overall AUC-ROC of 0.818, and a negative predictive value of 0.795.

**Conclusions:** Both, an 11- and 23-variable LASSO LR model predict vaccination response in KTR with good AUC-ROC. Implemented as an online tool at <https://www.tx-vaccine.com>, it can guide decisions when choosing between different immunization strategies to improve protection against COVID-19 in KTR.

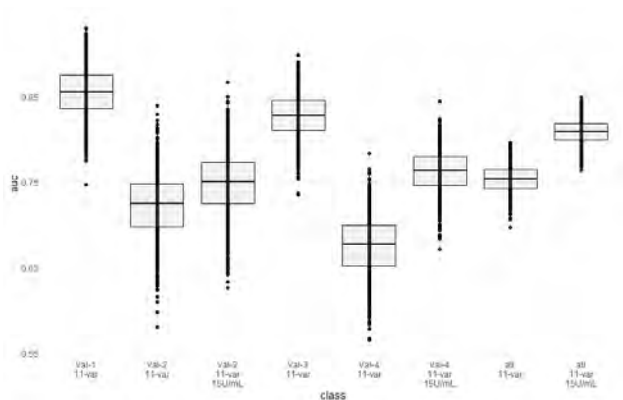

Predictive performance of the 11-variable model in four independent external validation cohorts.

### SA-OR30

#### Inhibition of Toll-Like Receptor 7 (TLR7) With a Selective Inhibitor of Human TLR7 ST-301 Reverse Lupus Progression in Murine Lupus Models

Michael Z. Yu,<sup>1,2</sup> Helen Lee.<sup>1</sup> <sup>1</sup>Hillhouse Medical Group, Houston, TX; <sup>2</sup>Singularity Therapeutics, Houston, TX.

**Background:** Toll-like receptor 7 (TLR7) is an endosomal innate viral RNA sensor, primarily expressed in plasmacytoid dendritic cells and B cells. A large body of evidence supports enhanced TLR7 signaling as a mechanism of human systemic autoimmune disease. Blocking the TLR7 pathway has been investigated in SLE disease models. ST-301 is a potent selective TLR7 inhibitor and has similar human and mouse potency. ST-301 was used to investigate the role of TLR7 signaling in murine lupus models.

**Methods:** MRL/lpr and NZB/W mice were treated with a vehicle or a selected dose of ST-301, prednisolone, and ST-301 plus prednisone. MRL/lpr mice were treated for 6 weeks on the early-stage disease with positive anti-dsDNA antibodies but negative proteinuria. NZB/W mice were treated for 20 weeks on the early-stage disease with positive anti-dsDNA antibodies but negative proteinuria, twelve weeks on established disease (proteinuria <100 mg/dL), and eight weeks on advanced disease (proteinuria >100 mg/dL).

**Results:** Six weeks of treatment with ST-301 on the MRL/lpr early-disease mice provided a significant delay of proteinuria onset, reduction of autoantibody production, and inhibition of IgG deposition in the kidney. Twenty weeks of treatment with ST-301 on the NZB/W early-disease mice resulted in a significant delay in the onset of lupus nephritis, onset of proteinuria, reduction of serum IgG level, and IgG deposition in the kidney. Treatment of NZB/W mice with ST-301 on established disease mice for twelve weeks and advanced disease mice for eight weeks resulted in a reduction of proteinuria, kidney IgG deposition, interstitial fibrosis, and a significant increase in survival in both established and advanced disease mice models. Serum autoantibody levels were significantly reduced in early-stage, established, and advanced disease mice models.

**Conclusions:** The novel highly selective TLR7 inhibitor ST-301 displayed robust efficacy in delaying the onset of Lupus nephritis, progression of Lupus nephritis, and survival benefit on MRL/lpr and NZB/W Murine Lupus Models. ST-301 significantly reduces proteinuria, autoantibodies production, and immune complex deposition. Resulting in a significant decrease of kidney interstitial fibrosis in established and advanced disease mice models. These results support that inhibiting the TLR7 pathway is a potential treatment for SLE.

**Funding:** Commercial Support - Singularity Therapeutics INC, Hillhouse Medical Group PLLC, Private Foundation Support

## AUTHOR INDEX

The number refers to the location of the body of the abstract in the publication section

A. AlGhamdi, Abdullah A. PUB291, PUB296  
 Aaron, Ashley E. SA-PO537  
 Aarup, Michael TH-PO685, TH-PO688  
 Abagero, Rahma A. FR-PO433  
 Abate, Mersema FR-PO875  
 Abaza, Masa TH-PO266  
 Abbott, Milly SA-PO979  
 Abbrescia, Daniela I. TH-PO491  
 Abd algayoum, Randa FR-PO051, SA-PO438  
 Abdalbary, Mohamed M. SA-PO193  
 Abdalla, Mubarak I. SA-PO834, PUB292, PUB293  
 Abdallah, Hussein S. SA-PO420  
 Abdallah, Shaimaa Z. SA-PO420  
 Abdel-Kader, Khaled TH-PO722, SA-PO942, SA-PO943  
 Abdel-Rahman, Emaad M. TH-PO777, FR-PO114  
 Abdel-Wahab, Noha SA-PO113, SA-PO125  
 Abdelghani, Eman TH-PO473  
 Abdelhadi, Jenna FR-PO904  
 Abdellatif, Abdul A. TH-PO372, FR-PO232, SA-PO553, SA-PO898  
 Abdellatif, Mohamed T. SA-PO331  
 Abdelmagid, Asma TH-PO175  
 Abdelmohsen, Waleed A. SA-PO420  
 Abdelnabi, Mahmoud FR-PO096  
 Abdelrahim, Maen FR-PO181, SA-PO125  
 Abdelwahab, Khaled G. SA-PO420  
 Abdi Pour, Amir TH-PO462, SA-PO934, PUB145  
 Abdrabou, Mahmoud M. FR-PO807  
 Abdul-Massih, Cesar E. SA-PO726  
 Abdulbasit, Muhammad FR-PO080, FR-PO111  
 Abdulgadir, Mohamad Y. FR-PO844, FR-PO845, FR-PO846, SA-PO834, PUB293, PUB297, PUB298  
 Abdullah, Ahmed PUB042  
 Abdullah, Rafidah TH-PO894  
 Abdullatif, Umayma TH-PO372, SA-PO553  
 Abdullin, Marat FR-PO557  
 Abdulrahman, Rula A. PUB215  
 Abdus Samad, Mohamed Anwar TH-PO435  
 Abe, Eriko TH-PO199, SA-PO456, SA-PO997  
 Abe, Kento T. TH-PO915, SA-OR10  
 Abe, Masanori FR-PO465, SA-PO399  
 Abe, Yasutomo SA-OR03  
 Abed, Ahmed FR-PO699  
 Abedini, Amin TH-PO252, FR-OR32, FR-OR38, FR-PO1006, SA-PO958, SA-PO1007  
 Abera, Mubarek FR-PO433  
 Abergel, Eden FR-PO291  
 Abid, Sidrah TH-PO434, SA-PO520, PUB140  
 Abidi, Hichem TH-PO273, TH-PO274  
 Abitbol, Carolyn L. FR-PO425, FR-PO437, SA-PO599  
 Abner, Clint TH-PO478  
 Abood, Delaney C. FR-OR42  
 Aboudehen, Karam S. FR-PO406  
 Abouras, Ahmed I. TH-PO298  
 Abra, Graham E. FR-PO508, FR-PO510, FR-PO518, FR-PO522  
 Abraham, Georgi TH-PO079  
 Abraham, Josephine TH-PO118, TH-PO119, TH-PO671, FR-PO200, SA-PO042, SA-PO424, SA-PO467, SA-PO666, SA-PO675  
 Abraham, Mona TH-PO727  
 Abraham, Nikita FR-PO559, FR-PO748  
 Abraham, Rahul R. TH-PO294, FR-PO888  
 Abrahams, Carl J. FR-PO727  
 Abramowitz, Matthew K. PUB276  
 Abreo, Kenneth D. FR-PO612  
 Abreu, Fernando TH-PO947, SA-PO865  
 Abshire Saylor, Martha FR-PO869  
 Abu Al Rub, Fadee SA-PO847, SA-PO850, SA-PO851  
 Abu Amer, Nabil TH-PO056  
 Abu Farsak, Hisham N. SA-PO500  
 Abu-Khaled, Jamal SA-PO469  
 Abu-Rmaileh, Muhammad FR-PO104  
 Abuazzam, Farah S. TH-PO462  
 Abubakar Ibrahim, Ismail TH-PO169  
 Abudaff, Naief N. TH-PO439  
 Abudayyeh, Ala FR-PO181, FR-PO198, SA-PO113, SA-PO123, SA-PO125, SA-PO134, SA-PO141  
 Abudula, Reziwanguli FR-PO470  
 Abuhelaiqa, Essa TH-PO941  
 Abukoush Szczerba, Jessica M. FR-PO192  
 Aceves, Brina A. FR-PO242  
 Achanti, Anand TH-PO479  
 Acharya, Anjali TH-PO688  
 Acharya, Prakrati C. SA-PO824, SA-PO835  
 Achi, Sai S. FR-PO181, FR-PO215  
 Achieng, Mary Anne A. FR-PO355, FR-PO382  
 Acoba, Dianne PUB363  
 Acosta Peña, Ana C. TH-PO648  
 Acosta-Ochoa, Maria Isabel TH-PO070, TH-PO766, FR-PO002  
 Adachi, Eriko SA-PO743  
 Adachi, Taiji TH-PO867  
 Adam, Mike FR-PO971  
 Adams, Marvin SA-PO738  
 Adang, Eddy M. TH-PO503  
 Adapa, Sharmila FR-PO688, FR-PO999  
 Adebile, Temitayo M. TH-PO805, TH-PO806, PUB076  
 Adelborg, Kasper TH-OR04  
 Aden, Luul SA-PO755  
 Adewuyi, Joel O. SA-PO442, SA-PO504  
 Adayemi, Emmanuel O. SA-PO936  
 Adhikari, Kailash FR-PO344  
 Adhikari, Rishav FR-PO902  
 Adi, Chudi SA-PO951  
 Adisa, Oluwadamilola TH-PO294, FR-PO888  
 Adiyeye, Esra FR-PO061  
 Adler, Joel T. TH-PO791  
 Adler, Scott H. FR-OR08  
 Adler, Sharon G. SA-PO446, SA-PO679  
 Adu, Dwomoa TH-PO805, TH-PO806, PUB118  
 Adwaney, Anamika SA-PO357  
 Afaq, Saima SA-PO890  
 Affatato, Stefania TH-PO508  
 Affeldt, Patrick SA-OR42  
 Afrouzian, Marjan TH-PO560, FR-PO673, SA-OR02, SA-PO733  
 Afshinnia, Farsad SA-PO688  
 Afzal, Maryam SA-PO584  
 Agarwal, Adhish TH-OR26, TH-PO634  
 Agarwal, Annanya TH-PO135  
 Agarwal, Anupam FR-OR16, FR-PO969, SA-PO110  
 Agarwal, Rajiv SA-PO275  
 Agarwal, Sanjay K. TH-PO504, FR-PO658, PUB287  
 Agarwal, Sonalika FR-PO622, FR-PO670, SA-PO476, PUB349  
 Agarwal, Tejita TH-OR26  
 Agate, Welly PUB326  
 Agborbesong, Ewud FR-PO255, FR-PO262, FR-PO267  
 Agelis, Georgios FR-PO589  
 Aggarwal, Arjun FR-PO735  
 Aggarwal, Nidhi FR-PO669, SA-PO047  
 Aggarwal, Sandeep TH-PO170, PUB231  
 Aggarwal, Vikram FR-PO668, SA-PO707  
 Agha, Irfan FR-PO659  
 Agharazii, Mohsen TH-PO578, FR-PO739  
 Agiro, Abiy FR-PO544, FR-PO546, FR-PO547, FR-PO548  
 Agoro, Rafiou TH-PO157  
 Agraharkar, Mahendra L. TH-PO286  
 Agrawal, Nikhil FR-PO765, FR-PO779, FR-PO781, FR-PO794, FR-PO803, FR-PO804, SA-OR45, PUB319  
 Agrawal, Shipra FR-PO723, SA-PO977  
 Agraz, Irene SA-PO130  
 Agren, Rasmus FR-OR52  
 Aguiari, Paola FR-PO378, FR-PO403, FR-PO690, FR-PO691  
 Aguilar, M. PUB098  
 Aguilar, R. B. PUB098  
 Aguilar, Rita B. FR-PO611, FR-PO734  
 Agwu, Chidera FR-PO366  
 Ahearn, Patrick SA-PO849  
 Ahlström, Christine PUB361  
 Ahmad, Ayah TH-OR57  
 Ahmad, Nurul Jannah Binti TH-PO539  
 Ahmad, Syeda B. FR-PO666  
 Ahmadi, Armin TH-PO821, TH-PO822, TH-PO823, TH-PO824, TH-PO829, SA-PO918  
 Ahmadzadeh, Ghazaleh FR-PO882  
 Ahmed, Ebad FR-PO780, FR-PO797  
 Ahmed, Hasban FR-PO057  
 Ahmed, Maha PUB097  
 Ahmed, Nusayba PUB183  
 Ahmed, Omer SA-PO701  
 Ahmed, Ranie FR-PO882  
 Ahmed, Sabbir TH-PO190, PUB364  
 Ahmed, Sadiq TH-PO290  
 Ahmed, Saeed FR-PO519  
 Ahmed, Sofia B. TH-PO610, TH-PO745, TH-PO746, TH-PO747, TH-PO767, TH-PO868, FR-PO885  
 Ahn, Curie TH-PO358, TH-PO365, TH-PO366, TH-PO381  
 Ahn, Jae Sung TH-PO042  
 Ahn, Jeongmyung PUB119  
 Ahn, Kyu Young TH-PO136  
 Ahn, Sun-Young SA-PO623  
 Ahn, Woojin SA-PO485, SA-PO502  
 Ahn, Yo Han TH-PO358, FR-PO413, FR-PO555, SA-PO550, SA-PO597, SA-PO611  
 Ahoubim, Joseph PUB167  
 Ahsan, Eram FR-PO398, SA-PO149  
 Ahuja, Roma N. SA-PO883, PUB250, PUB268  
 Aierken, Ailima TH-PO374  
 Aigner, Felix TH-OR55  
 Aihara, Seishi FR-PO117, FR-PO961  
 Airik, Merlin FR-PO336, SA-PO522  
 Airik, Rannar FR-PO336, SA-PO522  
 Airy, Medha PUB339  
 Ait Zaid, Kahina FR-PO531  
 Ajaimy, Maria TH-PO944, TH-PO945, FR-PO160, FR-PO827  
 Ajay, Amrendra K. TH-PO206, FR-PO981, FR-PO997, SA-PO972  
 Ajene, George O. SA-PO047  
 Ajiboye, Oyintayo TH-PO596, SA-PO501  
 Akabas, Myles TH-PO159  
 Akalin, Enver TH-PO641, TH-PO944, TH-PO945, FR-PO765, FR-PO827, SA-PO803  
 Akbar, Nouman SA-PO853  
 Akbari, Alireza SA-PO309  
 Akbari, Ayub SA-PO137  
 Akcan Arikan, Ayse FR-PO427, SA-PO602, SA-PO603  
 Akchurin, Oleh M. TH-PO705  
 Akeroyd, Julia TH-PO607, PUB099  
 Akers, James L. FR-PO590  
 Akers, Johnny C. FR-PO403  
 Åkesson, Anna FR-OR897  
 Akhgar, Ahmad SA-PO685  
 Aki, Fazil T. FR-PO802  
 Akilesh, Shreeram TH-PO557, TH-PO560, FR-PO373  
 Akinfolarin, Akinwande A. TH-PO127, TH-PO128, SA-PO972, PUB055  
 Akioka, Yuko FR-PO115  
 Akizawa, Tadao TH-PO155, TH-PO160, TH-PO161  
 Akkari, Abdel-Rauof M. FR-PO080, FR-PO111  
 Akkina, Sanjeev FR-PO794  
 Akliu, Abinet M. TH-OR09, FR-PO063  
 Akram, Sami M. TH-PO462, SA-PO843, PUB009  
 Aksornrat, Atchara FR-PO079  
 Akwo, Elvis A. TH-PO629, FR-PO761, SA-PO758, SA-PO759  
 Al Ammary, Fawaz SA-PO820, SA-PO839  
 Al Azzi, Yorg TH-PO944, TH-PO945, FR-OR827  
 Al Barbandi, Malek FR-PO425, FR-PO437  
 Al Jurdi, Ayman TH-PO916  
 Al sahlawi, Muthana FR-PO476, FR-PO477  
 AL Wahadneh, Mohammad PUB360  
 Al-Abcha, Abdullah TH-PO689, FR-PO573  
 Al-Ali, Fadwa S. SA-PO278, SA-PO290  
 Al-Ali, Hassan SA-PO244  
 Al-Alwan, Ahmad S. TH-PO133, SA-PO033, PUB043  
 Al-Chalabi, Saif PUB101, PUB256  
 Al-Dakkak, Imad TH-PO500, TH-PO502  
 Al-Dujaili, Murad PUB110  
 Al-Juboori, Amenah SA-PO488  
 Al-Malki, Hassan A. TH-PO175, TH-PO923, TH-PO941  
 Al-Obaide, Mohammed A. TH-PO537  
 AL-Obaidi, Mustafa TH-PO252  
 Al-Qusairi, Lama FR-OR42  
 Al-Rabadi, Laith TH-PO417  
 Al-Rashed, Ali M. FR-PO917  
 Al-Rousan, Tala FR-PO755  
 Al-Samkari, Hanny FR-PO067  
 Al-shurbaji, Ayman FR-PO550  
 Al-Shweiat, Wajdi SA-PO057  
 Al-Tuhafy, Dina R. FR-PO667, PUB188, PUB242, PUB337  
 Al-Uzri, Amira TH-PO473  
 Al-Wahsh, Huda SA-PO794, SA-PO822  
 Al-Yousif, Yahya SA-PO488  
 Al-Zadjali, Fahad FR-PO256  
 Alabdo, Ammar TH-PO908  
 Alabdulsalam, Abdulrahman K. SA-PO693  
 Alachkar, Nada TH-PO760

Alakwaa, Fadhl	TH-PO211, TH-PO534, SA-PO257, SA-PO258	Ali, Mohamed Y.	TH-PO923, TH-PO941	Alsuwaida, Abdulkareem	SA-PO297	Andersen, Reagan S.	FR-PO244, FR-PO245
Alam, Ahsan	PUB187	Ali, Omer	FR-PO852	Alsuwaida, Anas A.	SA-PO297	Andersen, Ulrik B.	TH-PO229
Alam, Ishmam Y.	FR-PO445	Ali, Rafia W.	FR-PO067, FR-PO075, SA-PO151	Altaher, Badawi A.	TH-PO298	Anderson, Amanda H.	TH-PO238, TH-PO719, TH-PO874, SA-PO931
Alam, Junaid M.	SA-PO503	Ali, Rimsha	SA-PO767	Althani, Abdullah S.	FR-PO844, FR-PO845, FR-PO847, PUB298	Anderson, Bjorn	PUB013
Alam, Sreyoshi F.	SA-PO722	Ali, Sehrish	FR-PO624	Altintas, Mehmet M.	TH-PO215, FR-PO594, SA-PO074	Anderson, Blake	PUB085
Alamilla Sanchez, Mario	TH-PO648, FR-PO618, SA-PO483, PUB061, PUB115, PUB244	Ali, Syed Saqib	SA-PO977	Altiparmak, Gülay	FR-PO393	Anderson, Brenda K.	TH-PO051
Alappan, Uma D.	TH-PO824	Ali, T'shura	PUB005	Altlea, Dania	TH-PO643	Anderson, Cheryl A.	TH-PO805, TH-PO806
Alattal, Saif Al-Deen	FR-PO573	Ali, Umair	TH-PO460, PUB171	Altun, Bulent	FR-PO802	Anderson, Christian	TH-PO124
Alattal, Sara	TH-PO689, FR-PO573, PUB071, PUB356	Aliano, Danielle N.	TH-PO073	Alvarado, Flor	TH-PO719, FR-PO894	Anderson, Christopher	SA-PO859
Alawadh, Nayef	SA-PO834, PUB292, PUB293, PUB294	Alicic, Radica Z.	TH-PO255, FR-PO662	Alvarenga, Livia D.	TH-PO832, TH-PO833, TH-PO834	Anderson, Christopher D.	TH-OR25
Alba, Marco A.	FR-PO579	Alithawi, Marwa	PUB218	Alvarez Betancourt, Alejandro	PUB052	Anderson, Nekayla	SA-PO601
Albadri, Sam	TH-PO461	Aljabri, Jawaher N.	FR-PO843, FR-PO847	Alvarez Retamales, Violeta	SA-PO497, PUB132	Anderson, Todd J.	TH-PO610
Albalas, Alian	TH-PO266	Aljassani, Khaldoon	SA-PO767	Alvarez Zapata, Naomi A.	FR-PO532	Ando, Fumiaki	TH-PO339, TH-PO425, SA-PO549, SA-PO1008
Albanese, Chris	TH-PO191, SA-PO242	Alkadi, Mohamad M.	TH-PO923, TH-PO941	Alvarez, Cristian M.	SA-OR47	Ando, Taro	SA-OR25
Albano, Giuseppe	FR-OR50	Alkaff, Firas F.	FR-PO773, FR-PO784	Alvarez, Jean-claude	SA-PO932	Andonegui, Graciela	FR-PO602
Albarazanji, Kamal	TH-PO088, SA-PO100	Alkamachi, Bassam	PUB218	Alvarez, Jesus A.	SA-OR15	Andrabi, Suhaib A.	TH-PO467, FR-PO222
Alberici, Federico	TH-PO508	Alkhansa, Sahar	TH-PO185	Alves Soares Vaz de Castro, Pedro	PUB034	Andrade-Sierra, Jorge	FR-PO837
Albert, Annemarie	FR-PO503	Alkhudairy, Lyan	FR-PO392	Alvi, Arsalan A.	FR-PO449	Andrade, Jessica L.	TH-PO904, PUB320
Albert, Christian	FR-PO503	Alkhudairy, Aya K.	FR-PO845, PUB294, PUB298	Alvin, Tng R.	TH-PO268	Andrade, Jorge C.	FR-PO837
Albert, John A.	SA-PO897	Allam, Sridhar Reddy	FR-PO779, SA-OR45	Aly, Mostafa G.	SA-OR47	Andrade, Lucia	TH-PO072, FR-PO028, SA-PO045, SA-PO072, SA-PO433, SA-PO505
Alberton, Valeria G.	TH-PO489, SA-PO684	Allan, Michelle E.	FR-PO785, PUB311, PUB315, PUB327	Aly, Sahar	TH-PO175, TH-PO941	Andrae, Michal S.	TH-PO433
Albrecht, Lauren V.	FR-PO423	Allen, Andrew S.	TH-PO054, FR-OR23, SA-PO528	Alzahrani, Mohammed T.	SA-PO297	Andrea, Tyler	SA-PO438
Albright, Robert C.	TH-PO733, TH-PO794, SA-PO461	Allen, Katherine C.	FR-PO688, FR-PO999	Alzayer, Husam	FR-PO864, SA-PO892, PUB227	Andrews, Darrell C.	TH-PO187
Albuquerque, Claudia C.	FR-PO880	Allen, Madeline T.	TH-PO617, SA-PO391	Amadid, Hanan	PUB096	Andrews, Robert	FR-PO163, FR-PO365
Alcaide, Maria L.	TH-PO762	Allen, Matthew R.	FR-OR01	Amann, Kerstin U.	TH-PO565, FR-PO013, FR-PO076, SA-PO784, PUB255	Androga, Lagu A.	SA-PO461
Alcantar Vallin, Maria de la luz	TH-PO045, PUB209, PUB220	Allen, Rebecca J.	TH-PO776, FR-PO898	Amano, Hiroaki	FR-PO940	Andronesi, Andreea	SA-PO150
Alcantara, Lorraine	TH-PO122	Alleyn, Saieda	TH-PO435	Amar, Ali	SA-PO566	Andronesi, Danut	SA-PO150
Alcegueire, Kara	SA-PO513	Allinovi, Marco	TH-OR11	Amaral, Sandra	TH-PO814, SA-PO393	Andrusenko, Maria	SA-PO895
Alder, Matthew N.	TH-PO081	Allon, Michael	TH-PO259	Amarapurkar, Pooja D.	TH-PO596, SA-PO339, SA-PO501	Andugan-Rocamora, Leonor	TH-PO249
Alderson, Helen	PUB256	Allred, Erika	FR-PO228, SA-PO540	Amari, Diana T.	FR-PO662, SA-PO702	Andujar-Rivera, Krystahl Z.	TH-PO526, SA-PO059, SA-PO480, PUB177, PUB219
Aldridge, Daniel	FR-PO1006	Allum, Alaster	FR-PO552	Amari, Kana R.	SA-PO707	Anelli, Vito walter	TH-PO491
Aldworth, Carolina A.	SA-PO657, SA-PO658	Almaani, Salem	TH-PO184, TH-PO479, TH-PO760, FR-PO640, FR-PO759, SA-PO631	Amato, Justin A.	PUB211	Ang, Fernando G.	SA-PO262
Aleksunes, Lauren	FR-PO223, SA-PO158	AlMalki, Najlaa	TH-PO273, TH-PO274	Amaty, Bibhas	SA-PO791	Angamuthan, Akilandanayaki	FR-PO478, SA-PO676
Alencar de Pinho, Natalia	TH-PO667, TH-PO854, FR-PO221, SA-PO925	Almehmi, Ammar	TH-PO266	Ambekar, Akhil	SA-PO711	Angeles, Carmichael	TH-PO003
Ales Rigler, Andreja	PUB328	Almehmi, Sloan	TH-PO266	Ambery, Philip D.	PUB346	Angeletti, Andrea	TH-PO417, FR-PO321, SA-PO524
Alexakou, Zoi	SA-PO408	Almeida, Paulo J.	FR-PO428	Amin, Md. Shahriar	FR-PO590	Angelousi, Anna	FR-PO729
Alexander, Evan	SA-PO610	Almon, Einat	FR-PO231, FR-PO339	Amin, Rasheda	FR-PO742	Anger, Michael S.	TH-PO164, TH-PO167, TH-PO168, SA-PO308, SA-PO419
Alexander, Kelsi	FR-PO432	Almutar, Sara S.	FR-PO499	Amin, Sahar	TH-PO878, SA-PO472, SA-PO864, SA-PO876	Amira, Christiana O.	TH-PO805, TH-PO806
Alexander, Mariam P.	TH-PO418, TH-PO529, FR-PO788, SA-PO132, SA-PO149	Alnasrullah, Ahmed S.	PUB291, PUB296	Amleh, Athar	TH-OR36	Amman, Helene	FR-PO563
Alexander, Sandra E.	TH-PO932, PUB011	Alnazari, Nasser M.	FR-PO846, PUB292	Ammerlaan, Carola	TH-PO331	Amodeo, Jaime	SA-PO120
Alfarra, Rashed	TH-PO264	Alolod, Maria Kristina	TH-PO064, PUB047	Amodu, Afolarin A.	FR-PO944	Amouyel, Philippe	TH-PO771
Alfieri, Carlo	TH-PO444, FR-PO798, FR-PO840, FR-PO842, SA-PO871, PUB340	Alom, Md S.	FR-PO626, FR-PO878	Amrutiya, Viralkumar	SA-PO826	Amundson, Rachel H.	SA-PO461
Alflaiw, Ahmad I.	FR-PO845, FR-PO846, FR-PO847, SA-PO834	Alomari, Anees J.	TH-PO175	An, Hongyu	SA-PO788	An, Hyun-Ju	FR-PO987
Alghamdi, Areej saud a	SA-OR46	Alon, Sari	FR-PO231, FR-PO339	An, Jaemin	TH-OR21, FR-PO547, FR-PO548	An, Jung Nam	TH-PO912, FR-PO543, SA-PO397, SA-PO935
Alghamdi, Hazim S.	FR-PO845, PUB293, PUB297	Alonso, Shawn	SA-PO473, SA-PO513	An, Sung wan	FR-OR46	An, Won Suk	SA-PO933
Alghamdi, Khaleda A.	TH-PO172	Aloor, Rohit	SA-PO874	Anam, Raman	SA-PO473	Anand, Manish	PUB271
Alghussein, Mohammad S.	SA-PO458	Aloria, E.j.	FR-PO245	Anand, Prince M.	TH-PO740, TH-PO791, SA-PO534, PUB319	Anand, Shuchi	TH-PO863
Alhamad, Tarek	TH-PO651, TH-PO791, PUB319	Alotaibi, Manal	TH-PO869, FR-PO041, PUB048	Anandakrishnan, Nanditha	FR-PO006	Anandakrishnan, Nanditha	FR-PO006
Alhamzah, Hamzah A.	FR-PO844, FR-PO845, FR-PO846, PUB298	Alper, Arnold B.	TH-PO169	Anandakumar, Harithaa	SA-PO626	Anandasisvam, Nidharshan S.	FR-PO735
Alharbi, Ali	TH-PO298	Alper, Seth L.	SA-PO566	Anandh, Urmila	FR-PO887	Anandh, Urmila	FR-PO887
Alhejaili, Fayeze F.	FR-PO844, FR-PO846, PUB292, PUB293, PUB297	Alpers, Charles E.	TH-PO570	Ananthakrishnan, Shubha	PUB216	Ananthakrishnan, Shubha	PUB216
Alhosainat, Nidal	FR-PO105, FR-PO673, SA-PO671, PUB360	Alphonse, Sebastian Anand A.	SA-PO014	Anazodo, Udunna C.	TH-OR12	Anazodo, Udunna C.	TH-OR12
Alhuneafat, Laith	TH-PO951, TH-PO963, PUB012	Alqadhi, Abdulaziz O.	TH-PO298	Ancion, Jean H.	FR-PO667, PUB188, PUB242, PUB337	Ancion, Jean H.	FR-PO667, PUB188, PUB242, PUB337
Ali, Abdul Mehdi S.	TH-PO848	Alqarni, Khaled A.	TH-PO839	Andag, Uwe	FR-OR60, FR-PO639, SA-PO1011	Andereg, Manuel	TH-PO409
Ali, Hamad	TH-PO376	Alqudsi, Muhannad	SA-PO710	Anders, Hans J.	FR-PO126	Anders, Hans J.	FR-PO126
Ali, Hassam	TH-PO935	Alrejjal, Kenan M.	TH-PO372, SA-PO553	Andersen, Gregers S.	FR-PO433	Andersen, Gregers S.	FR-PO433
Ali, Mahmoud	TH-PO106, TH-PO527, FR-PO184, FR-PO615	Alrwashdeh, Audai A.	FR-PO195				

Appel, Lawrence J. TH-PO059, TH-PO892, FR-PO907  
Apple, Benjamin J. TH-PO847  
Aqeel, Faten F. TH-PO507, FR-PO617, FR-PO648, SA-PO697  
Aquey, Mercedes FR-PO489  
Arabi, Nida FR-PO050  
Arabi, Ziad FR-PO843, FR-PO844, FR-PO845, FR-PO846, FR-PO847, SA-PO834, PUB290, PUB291, PUB292, PUB293, PUB294, PUB295, PUB296, PUB297, PUB298  
Aragon Mejia, Monica A. TH-PO442  
Aragon, Michael A. FR-PO509, FR-PO510, FR-PO521, FR-PO523, SA-PO428, SA-PO454  
Araki, Makoto FR-PO910  
Arandjelovic, Sanja FR-PO950  
Arantes de Oliveira, Marcia Fernanda FR-PO028  
Aranyi, Tamás FR-PO388  
Araoka, Toshikazu FR-PO346  
Arbes, Spiros M. SA-PO577  
Arce Renteria, Miguel TH-PO774  
Archer German, Dimitri P. PUB052  
Archer, Domonic D. PUB205  
Arcilla, Cristine K. PUB039  
Arcon, Luis C. TH-PO785  
Ardavin Ituarte, Juan M. TH-PO792, SA-PO316  
Ardissino, Gianluigi TH-PO500, TH-PO502, SA-PO576  
Ardura, Paula FR-PO002  
Aref, Hayam M. SA-PO420  
Arefin, Samsul TH-PO649, PUB254, PUB259  
Arend, Lois J. FR-OR19, FR-PO148, FR-PO172, FR-PO173, SA-OR05  
Arends, Eline J. FR-PO011  
Arévalo, Paola K. PUB089  
Argyropoulos, Christos TH-PO902, TH-PO903, FR-PO500, FR-PO893, SA-PO782, PUB326  
Ariceta, Gema TH-OR34, TH-PO500, TH-PO502  
Arici, Mustafa FR-PO802  
Arif, Ali SA-PO038  
Arif, Ehtesham TH-PO220  
Arifaj, Denada TH-OR27  
Arima, Hisatomi SA-PO896  
Arima, Shuji TH-PO241, TH-PO410, FR-PO911  
Arita, Michiko SA-PO370  
Arizaga Napoles, Manuel TH-PO047, PUB220, PUB341  
Arjune, Sita FR-PO242  
Arkell, Paul TH-OR03, TH-PO865, SA-PO991  
Arkling, Dan SA-PO991, SA-OR07  
Arkossy, Otto SA-PO783, SA-PO791  
Armando, Ines SA-PO412  
Armani, Rachel G. TH-PO444  
Armelloni, Silvia TH-PO433  
Armer, Richard PUB248  
Armijo, Kevin G. SA-PO563  
Arnaldi, Monica TH-OR54  
Arnaout, M. Amin FR-PO372, FR-PO387  
Arndt, Patrick SA-PO575  
Arnett, Justin J. TH-PO607  
Arney, Jennifer TH-PO699  
Arnlov, Johan TH-PO650, PUB328  
Arnol, Miha PUB005  
Arnold, Forest W. TH-PO536  
Arnold, Iris I. TH-PO855, TH-PO889  
Arnold, Matthew TH-PO601  
Arnott, Clare G. SA-PO261  
Arnous, Muhammad G. SA-PO574  
Arnoux, Gregoire TH-PO556, SA-PO099  
Arnst, Jamie TH-PO802  
Aroca Martinez, Gustavo TH-PO577  
Aronoff, George R. TH-PO663, TH-PO664  
Aronson, Judith SA-OR02  
Arora, Ria SA-PO383  
Arora, Swati TH-PO523, FR-PO664  
Arregui, Samuel TH-PO314  
Arriens, Cristina TH-PO486  
Arrigain, Susana TH-PO009, TH-PO010, TH-PO579, SA-PO808  
Arroyo Omelas, Juan Pablo TH-PO340  
Arroyo, Eliott TH-PO819, SA-PO302  
Arroyo, Jennifer SA-PO574  
Arrufat Goterris, Gemma TH-PO672, SA-PO695, PUB197  
Ars, Elisabet PUB197  
Arsiwala, Ali Haider TH-PO884  
Arteaga Muller, Giovanna Y. FR-PO611  
Arthur, John M. TH-PO033, TH-PO452, TH-PO460  
Artinger, Katharina FR-PO599  
Artola, Mercedes FR-PO002  
Arulratnam, Bhranavi TH-PO637  
Arvizu Hernández, Mauricio SA-PO411  
Asada, Nariaki SA-OR29  
Asahi, Koichi FR-PO925, SA-PO700  
Asahina, Yuta TH-PO899  
Asai, Yusuke FR-PO018  
Asef, Mark FR-PO566  
Asgari, Elham TH-PO674, TH-PO680, SA-PO285  
Asgar, Mariya SA-PO496  
Asgar, Muhammad Sohaib TH-PO418  
Ashari, Mahla TH-PO183, FR-PO169  
Ashby, Damien SA-PO812  
Ashka, Lauren L. SA-PO287  
Ashoor, Isa TH-PO472  
Ashour, Tarek PUB062  
Ashraf, Muhammad Imtiaz TH-OR55  
Ashrafi, Sadia Anjum TH-PO728  
Asic, Laureano D. SA-PO783, SA-PO791  
Asif, Shafaque PUB114  
Askenazi, David J. TH-PO039, SA-PO601  
Aslam, Nabeel TH-PO461, FR-PO446, FR-PO495, SA-PO694  
Aspinall, Sherrie L. SA-PO207  
Asplin, John R. FR-PO242, FR-PO295  
Asplund, David A. FR-PO295, TH-PO583  
Assimakopoulos, Stelios F. TH-PO316, FR-PO318  
Assimon, Victoria FR-PO318  
Assiri, Ibrahim A. TH-PO298  
Assis, Camila F. SA-PO433  
Astudillo Potes, Maria TH-PO733  
Astudillo, Yarityz M. FR-PO436  
Ataga, Kenneth I. FR-PO414  
Ataka, Eri TH-PO576  
Atari, Mohammad FR-PO633, SA-PO200, PUB073  
Atencio, Jeanette M. TH-PO123  
Ateya, Heba M. SA-PO278, SA-PO290  
Athavale, Amod PUB355  
Atiquzzaman, Mohammad TH-PO901, TH-PO905, FR-PO638  
Atizol Rodriguez, Denazir PUB036, PUB272, PUB273, PUB325  
Atkins, Michael B. SA-PO115  
Atta, Mohamed G. PUB223  
Attalla, Fady G. SA-PO766  
Atwood, Daniel FR-PO249, FR-PO280  
FR-PO250, FR-PO279, FR-PO280  
Aucella, Filippo SA-PO325  
Audard, Vincent TH-PO481  
Aufrecht, Christoph FR-PO454, FR-PO467  
Auguste, Bourne L. PUB069  
Augustine, Joshua J. SA-OR49  
Augusto, Jean francois FR-PO580, FR-PO588, FR-PO591  
Austin, Cary D. TH-PO567  
Avesani, Carla M. TH-PO781, TH-PO782, FR-OR05  
Avihingsanon, Yingyos TH-PO652, TH-PO790, SA-PO163, SA-PO406, SA-PO449  
Avila Bernabeu, Ana I. TH-PO501  
Avila-Casado, Carmen TH-PO760, SA-PO955  
Ávila, Gonçalo FR-PO469, PUB141  
Avila, Marcela FR-PO504, FR-PO505  
Aviles, Diego H. TH-PO479  
Avin, Keith G. TH-PO146, TH-PO811  
Avraham, Shimrit FR-PO912  
Avula, Uma Mahesh R. SA-PO495, SA-PO668  
Awad, Alaa S. PUB068  
Awad, Mina SA-PO198, SA-PO468  
Awdishu, Linda FR-PO101  
Aweh, Gideon N. TH-PO938, SA-OR08  
Awoyemi, Toluwalase TH-PO753  
Axelrod, David FR-PO814  
Ay, Birol FR-OR03  
Ayach, Taha FR-PO156  
Ayav, Carole TH-PO854, TH-PO880, FR-PO221, SA-PO925  
Ayele, Girma M. SA-PO431  
Ayis, Salma TH-PO674, TH-PO680  
Aylward, Ryan E. TH-PO788  
Aymes, Estelle TH-PO771  
Ayoub, Isabelle TH-PO479, TH-PO760, FR-PO606, SA-PO631, SA-PO679, SA-PO735  
Ayoub, Wadah J. FR-PO668  
Ayub, Fatima TH-PO741, FR-PO187, FR-PO229, SA-PO010, SA-PO201  
Azad, Shanaz SA-PO723  
Azati, Jiayinaxi FR-PO470  
Azeem, Zeeshan SA-PO867  
Azeloglu, Evren U. FR-PO006  
Azhar, Ambreen SA-PO817, SA-PO826  
Azim, Shafquat FR-PO787  
Aziz, Fahad PUB303, PUB306  
Azuelo, Andres J. TH-PO464, TH-PO519, TH-PO520  
Azushima, Kengo TH-PO199, SA-PO456, SA-PO997  
Azzi, Jamil R. TH-OR49, TH-OR51, TH-OR53, TH-PO653, TH-PO916, SA-OR46  
Ba aqeel, Sheeba H. PUB094  
Baatarjav, Chintogtokh TH-PO090  
Babayeva, Sima FR-PO292  
Babickova, Janka SA-PO715  
Babic, Richard S. TH-PO335  
Babu, Mathura FR-PO053  
Baca, Madison S. TH-PO253  
Bacci, Marcelo R. TH-PO940  
Bachmann, Sebastian TH-PO642, TH-PO645  
Bacich, Dean PUB268  
Backes, James M. TH-PO815  
Badal, Shawn S. FR-PO993, SA-PO240  
Badarinarayana, Vasudeo FR-PO322  
Badaruddin, Mohammed Q. TH-PO304, TH-PO305  
Bader, Michael FR-PO994, SA-PO793  
Badhesha, Harshanna TH-PO818, TH-PO820, TH-PO821, TH-PO823, TH-PO824  
Badour, Sanaa SA-PO504  
Badra, Sherif FR-PO103  
Baduwaylan, Reem A. PUB294, PUB297, PUB298  
Badve, Sunil TH-PO872  
Bae, Edward TH-PO942  
Bae, Eun Hui TH-PO358, TH-PO381, TH-PO813  
Bae, Eunjin TH-PO625, TH-PO793, FR-PO1001, SA-PO348  
Bae, Jinsuk TH-PO625, TH-PO713, SA-PO973  
Bae, Kyongtae T. SA-PO005  
Bae, Sunjae FR-PO814  
Baeg, Song in SA-PO367, PUB200  
Baek, Chung Hee FR-PO084, FR-PO091, FR-PO092, FR-PO817, SA-PO716, SA-PO836  
Baek, Seon Ha PUB180  
Baelde, Hans J. FR-PO1009  
Baez, Layla N. PUB089, PUB248  
Bagchi, Soumita TH-PO504, FR-PO658  
Bagga, Arvind FR-PO303, SA-PO538  
Baglieri, Nicholas TH-PO720, TH-PO721  
Bagnasco, S.M. TH-PO089, TH-PO114  
Bagshaw, Sean M. TH-PO040, FR-PO060  
Bagwell, Benjamin M. TH-PO736  
Baharani, Jyoti B. TH-PO954, FR-PO522, FR-PO530  
Bahmad, Hisham TH-PO464  
Bahrainwala, Jehan Z. SA-PO202  
Bähring, Sylvia FR-PO994, SA-PO793  
Bai, Isaac SA-PO717  
Baibutihan, Ahebaota PUB308  
Baid-Agrawal, Seema TH-PO228, TH-PO230  
Baig, Athar TH-PO304, TH-PO305  
Baig, Mirza S. SA-PO720  
Baigent, Colin TH-PO621  
Bailey, Charles SA-PO207  
Bailey, Christine K. TH-PO690, SA-OR37  
Bajaj, Arrrsh SA-PO043, SA-PO138, PUB031  
Bajaj, Harpreet S. SA-PO262  
Bajaj, Tushar FR-PO486, PUB178  
Bajema, Ingeborg M. FR-OR55  
Bajpai, Divya P. FR-PO887  
Bajwa, Amandeep TH-OR45  
Bak, Stine T. SA-PO222  
Baker, Atlee TH-PO294, FR-PO612  
Baker, Brian H. TH-PO567  
Baker, Cadence SA-PO542  
Baker, Luke A. TH-PO674, TH-PO680, TH-PO830, SA-PO979  
Baker, Lyle W. SA-PO490  
Baker, Megan L. SA-PO046  
Baker, Richard FR-PO186  
Bakhai, Ameet PUB172  
Bakhos Al Douaihy, Dalal FR-OR48  
Bakhoum, Christine Y. FR-PO412, FR-PO752  
Bakkaloglu, Sevcana A. FR-PO335, SA-PO578  
Bakker, Stephan J. TH-PO675, TH-PO676, TH-PO698, TH-PO803, TH-PO846, FR-PO773, FR-PO784, FR-PO810  
Bakris, George L. TH-PO244, FR-PO550, SA-PO275  
Balakrishnan, Suryanarayanan FR-PO208, SA-PO098  
Balaraman, Vasanthi SA-PO533, SA-PO864, SA-PO876  
Balasubramanian, Manjula SA-PO676  
Balasubramanian, Nithin SA-PO703  
Balcells, Merche TH-PO288  
Baldeomar, Edwin SA-PO788  
Bale, Charan B. TH-PO430, SA-PO813  
Baliga, Radhakrishna FR-PO042  
Balina, Hema FR-PO628  
Balis, Ulysses G. TH-PO570, SA-PO001  
Balkin, Sandy D. TH-PO887  
Ball, David A. FR-PO330, SA-PO738  
Ball, Mark SA-PO152  
Ballash, Gregory TH-PO113, SA-PO612, SA-PO613  
Ballew, Shoshana TH-PO786, TH-PO890  
Balliet, Wendy SA-PO797  
Balmir, Sacha PUB041  
Baltazar, Shelly R. SA-PO012  
Balza Pineda, Santiago FR-PO727  
Balzer, Michael S. FR-PO1006  
Baman, Sarang TH-PO718  
Bamberg, Krister TH-PO304, TH-PO305, FR-PO996  
Bamforth, Ryan J. TH-PO289, FR-PO519, FR-PO542  
Bammolker, Adi SA-PO710



Banaag, Amanda FR-PO411  
 Bándi, Péter TH-PO533  
 Banerjee, Debasish TH-PO674, TH-PO680  
 Banerjee, Tanushree FR-PO565  
 Banham, Gemma D. TH-PO928, FR-PO530  
 Banjongjit, Athiphat TH-PO790  
 Bankole, Adegbenga PUB211  
 Banks, Phillip SA-PO263  
 Banlengchit, Run TH-PO603, FR-PO083  
 Bansal, Aditya SA-PO488  
 Bansal, Amar D. TH-PO016  
 Bansal, Bhavik FR-PO658  
 Bansal, Nisha TH-PO605, TH-PO629, TH-PO678, FR-OR36, SA-PO912, SA-PO922, SA-PO929  
 Bansal, Rohan TH-PO515  
 Bansal, Shweta FR-PO476, FR-PO517, FR-PO743, FR-PO747, PUB250  
 Bansal, Vinod K. TH-PO550, TH-PO617, FR-PO206, SA-PO391  
 Bansode, Oshin M. PUB052  
 Bantewad, Devidas S. TH-PO076  
 Banu, Khadija FR-PO315  
 Bao, Aaron FR-PO326  
 Bao, Qianyi SA-PO1009  
 Bapat, Manasi TH-PO137  
 Baptista, Beatriz G. TH-PO832, TH-PO834  
 Barajas, José David G. TH-PO045, PUB220, PUB341  
 Baral, Nischit SA-PO281  
 Barany, Peter F. TH-PO649, TH-PO699  
 Barasch, Jonathan M. TH-PO544, SA-PO606, SA-PO994  
 Barati, Michelle T. TH-PO421, FR-PO578  
 Barba, Pere SA-PO160  
 Barbieri, Giulia TH-PO624, TH-PO845  
 Barbosa Silva, Oscar R. FR-PO029  
 Barbosa, Antonio FR-PO727  
 Barbosa, Nicholas Y. FR-PO032  
 Barbour, Sean FR-PO638, SA-PO714  
 Bardhi, Elissa TH-OR50, TH-PO459, TH-PO641  
 Baretta, Alessia SA-PO007  
 Barg, Frances K. TH-PO814  
 Bargagli, Matteo TH-PO409, SA-PO570  
 Barghouth, Muhammad TH-PO769, TH-PO882, TH-PO624  
 Barin, Laura TH-PO480  
 Barisoni, Laura TH-PO530, TH-PO534, TH-PO568, TH-PO569, TH-PO570, FR-OR20, SA-PO003, SA-PO711  
 Barit, David SA-PO565  
 Barker, Michael G. FR-PO471  
 Barker, Tara SA-PO115  
 Barnes, David C. FR-PO797  
 Barnes, Sylvester TH-PO287  
 Barnett, Katherine TH-PO951, TH-PO963, PUB012  
 Barnett, Sean SA-PO481, PUB002  
 Barone, Salvatore TH-PO888, TH-PO889, SA-PO887, SA-PO888  
 Barone, Sharon L. FR-PO290, SA-PO782  
 Barrantes Ramirez, Thelmo Fidel Ernesto SA-PO852, SA-PO951  
 Barratt, Jonathan TH-PO494, TH-PO498, TH-PO521, FR-OR59, FR-PO659, FR-PO891, SA-PO653, SA-PO654, SA-PO655, SA-PO712, PUB274  
 Barreto, Erin F. TH-PO051, FR-PO114  
 Barreto, Fellype PUB196  
 Barrett, Terry SA-PO714  
 Barretto, Carolina PUB196  
 Barrington, Fern FR-PO715, SA-PO233  
 Barrios, Richard TH-PO283, TH-PO631  
 Barros, Tamires O. TH-PO262, TH-PO263  
 Barrows, Douglas TH-PO840  
 Barry, Alexandra TH-OR29, FR-PO303  
 Barry, Marc FR-PO200  
 Barry, William T. TH-PO484  
 Bartel, Ronnda L. PUB108  
 Bartenschlager, Marie TH-PO920  
 Bartenschlager, Ralf TH-PO920  
 Bartolomaeus, Hendrik SA-PO626  
 Bartolomaeus, Theda U. FR-PO994  
 Bartolomeo, Korey SA-PO567  
 Bartosh, Sharon M. TH-PO473, FR-PO432  
 Bartosova, Maria FR-PO451, SA-PO627  
 Bartram, Malte P. FR-PO704  
 Barua, Moumita SA-OR11  
 Barwad, Adarsh TH-PO504  
 Barwinska, Daria TH-OR41, TH-PO183, TH-PO574, FR-OR09, FR-OR34, FR-PO149, FR-PO169, SA-PO956, PUB102  
 Bashir, Khawaja A. FR-PO680  
 Bashir, Nihal SA-PO199  
 Bashtawi, Yazan A. FR-PO187, FR-PO229, PUB171  
 Basta, Jeannine M. SA-PO956  
 Bastani, Bahar SA-PO847, SA-PO851, SA-PO850  
 Bastepe, Isinsu FR-OR03  
 Bastepe, Murat FR-OR03  
 Bastl, Christine P. FR-PO628  
 Bastos, José M. SA-PO377  
 Basu, Joydeep FR-PO394  
 Basuli, Debargha TH-PO935  
 Batal, Ibrahim FR-PO190  
 Batchinsky, Andriy TH-PO107  
 Bate, Sebastian G. SA-PO681  
 Bateman, Samantha TH-PO723  
 Bath, Kulwant S. SA-PO670, PUB175, PUB304  
 Bathini, Srikanth FR-PO853  
 Batista, Jordy PUB036, PUB272, PUB273  
 Batlle, Daniel TH-PO304, TH-PO305, FR-PO015, FR-PO020, PUB094  
 Batlle, Nicole M. PUB036, PUB325  
 Batool, Aisha SA-PO056, PUB067  
 Batool, Khadija SA-PO056  
 Batra, Radhika TH-PO818, TH-PO820, TH-PO821, TH-PO823, TH-PO824  
 Battistone, Maria A. SA-PO756  
 Batuman, Vecihi TH-PO189  
 Baudier, Robin L. TH-PO874  
 Baudoin, Ophélie PUB238  
 Baudy, Adrian J. TH-PO082, FR-PO487, SA-PO465, SA-PO471  
 Bauer, Abbie R. SA-PO590  
 Bauer, Michael FR-PO219  
 Bauer, Pascall SA-PO780  
 Bauer, Scott R. TH-PO797  
 Baum, Michel G. FR-OR46  
 Baum, Michelle A. TH-OR34, SA-PO566  
 Bauman, Allison A. TH-PO768  
 Bauman, John TH-PO481  
 Bavakunji, Riaz V. PUB110  
 Bawany, Fatima PUB225  
 Bawazir, Abdullah S. PUB292, PUB293, PUB297  
 Baxi, Pravir V. FR-PO683, PUB040  
 Bayaca, Jeanne B. TH-PO027  
 Bayat, Sahar SA-PO321  
 Bayer, Ruthee FR-PO185  
 Bayerlová, Michaela FR-OR60  
 Baylor, Noah TH-PO335  
 Baz, Bronwyn SA-PO590  
 Bazerbashi, Noor FR-PO444, FR-PO627  
 Bazzoni, Amy FR-PO738  
 Beale, Rupert TH-PO962  
 Beamish, Jeffrey A. SA-PO090  
 Bean, Katie SA-PO460  
 Beane, Timothy J. SA-PO760, SA-PO1002  
 Beaulac, Alexandre SA-PO673  
 Beaunoyer, Veronique SA-PO673  
 Beauvillain, Celine FR-PO588  
 Beavin, Sam TH-PO290  
 Bebb, Charlotte FR-PO519  
 Bebok, Zsuzsanna M. FR-PO278  
 Becherucci, Francesca SA-PO529, SA-PO621  
 Beck, Bodo B. FR-PO351, FR-PO704, SA-PO329, SA-PO625  
 Beck, George R. TH-PO802  
 Beck, Stephan FR-PO917  
 Beckerman, Pazit TH-PO056  
 Beckley-Hoelscher, Nick TH-PO680  
 Beckman, Paige E. PUB335  
 Becknell, Brian TH-PO113, FR-PO419, SA-PO604, SA-PO605, SA-PO607, SA-PO609, SA-PO610, SA-PO612, SA-PO613, SA-PO617, SA-PO619  
 Bedard, Patricia W. FR-OR56, FR-PO724  
 Beddhu, Srinivasan TH-OR23, TH-OR26, TH-PO634, TH-PO709, TH-PO710, FR-PO559, FR-PO737, FR-PO747, FR-PO748  
 Beddingfield, Frederick C. SA-PO636  
 Bedenbender, Simon SA-PO029  
 Bedenkov, Aleksandr SA-PO283  
 Beenken, Andrew TH-PO544  
 Beers, Kelly H. TH-PO434, SA-PO520, PUB140  
 Beetham, Kassia S. TH-PO606  
 Begue, Gwenaelle TH-PO818, TH-PO821, TH-PO823, TH-PO824, TH-OR829, SA-PO918  
 Behl, Nitin SA-PO488  
 Behm, Christine V. FR-PO714  
 Behning, Charlotte FR-PO666  
 Behrens, Felix FR-PO420, FR-PO626  
 Beige, Joachim H. FR-PO913  
 Bejoy, Julie SA-PO069  
 Bekker, Pirow FR-PO651, SA-PO696  
 Belal, Amer A. SA-PO205, SA-PO504  
 Belghasem, Mostafa FR-PO529  
 Bell, Christina FR-PO655  
 Bell, Elaine TH-PO012, TH-PO013  
 Bellin, Eran Y. FR-PO511  
 Bello, Vilber TH-PO959  
 Belmonte, Kathleen SA-PO310, SA-PO425  
 Belmouaz, Mohamed SA-PO409  
 Belostotsky, Vladimir TH-OR34  
 Belowich, Emily FR-PO877  
 Beltran, Karen SA-PO280  
 Bemelman, Frederike J. TH-PO416, TH-PO918, TH-PO919  
 Ben m'rad, Mona SA-PO673, PUB023  
 Ben-Dov, Iddo Z. TH-OR36, TH-PO145  
 Ben-Nun, David J. FR-PO735  
 Benardeau, Agnes M. TH-PO193, SA-PO247  
 Benavente, Melissa FR-PO639  
 Benchetrit, Sydney SA-OR09  
 Bencosme, Eliana PUB020, PUB233, PUB272, PUB273  
 Bendapudi, Pavan K. TH-PO501  
 Bendel, Emily TH-PO395  
 Bender, Alexis A. FR-PO540, FR-PO541  
 Bender, Filitsa H. FR-PO481  
 Bender, Kristin TH-PO182, SA-PO250, SA-PO614, SA-PO615  
 Bendtsen, Claus FR-PO1008  
 Benech, Nicolas SA-PO649  
 Benediktsson, Hallgrimur FR-PO602  
 Benes, Brian FR-PO201, SA-PO674  
 Benigno, Giuseppe D. TH-PO530  
 Benito, Begoña TH-PO178  
 Benjanuwattra, Juthipong TH-PO695, FR-PO096  
 Benjumea, Darrin W. TH-PO666  
 Benloukil, Souad TH-PO777  
 Benn, Vincent FR-PO241  
 Bennett, Kevin M. SA-PO788, SA-PO818  
 Bennett, Paul N. FR-PO522, SA-PO296, PUB138  
 Benning, Louise TH-PO920, FR-PO774, SA-PO812  
 Benny, Merline SA-PO599  
 Benoit, Stefanie W. FR-PO571  
 Bensink, Mark E. TH-PO496, SA-PO702  
 Benson, Douglas FR-PO735  
 Benson, Katherine A. TH-PO364, TH-PO646, TH-PO647, FR-PO935  
 Bentall, Andrew J. FR-PO788  
 Benusa, Elizabeth TH-PO708  
 Benway, Christopher FR-PO308  
 Benzing, Thomas FR-PO329, FR-PO600, FR-PO686, FR-PO687, FR-PO698, FR-PO704, FR-PO705, FR-PO707, FR-PO708, FR-PO716, SA-PO709  
 Beppu, Hiroko SA-OR03  
 Berasi, Stephen FR-PO695  
 Berbessi, Juan Carlos SA-PO314, SA-PO315  
 Berceci, Scott A. SA-PO015, SA-PO016, PUB082, PUB085  
 Beresis, Richard T. FR-PO946  
 Beretich, Lauren TH-PO372, SA-PO553  
 Berg, Gerrit V. FR-PO194  
 Berg, Peder TH-PO309  
 Bergamo, Samanta L. FR-PO430  
 Berger, Geraint C. SA-PO717  
 Berger, Stefan P. TH-PO643, TH-PO644, TH-PO676, TH-PO698, FR-PO784, SA-PO827  
 Bergeron, Jennifer TH-PO795, PUB241  
 Bergeron, Nicolas TH-PO578  
 Bergling, Karin FR-PO498  
 Bergmann, Carsten SA-PO551  
 Bergmann, Kelly R. TH-PO253  
 Bergmann, Matthias TH-PO513  
 Bergwall, Lovisa FR-PO718  
 Berlingerio, Sante Princiero FR-PO331  
 Berman, Cindy L. TH-PO408  
 Berman, Nathan FR-PO004  
 Berman, Nathaniel PUB075  
 Bermejo, Sheila TH-PO178, SA-PO130, SA-PO160  
 Bermudez, Maria TH-PO049  
 Berná, Gerson PUB197  
 Bernal, Efrén PUB230  
 Bernard, Chantal FR-PO438  
 Bernard, Geneviève FR-PO438  
 Bernard, Lauren FR-PO918, PUB223  
 Bernardo, Filipa TH-PO627, TH-PO628  
 Bernardo, João F. TH-PO947, SA-PO865  
 Bernardor, Julie SA-PO627  
 Bernat, John A. FR-PO339  
 Berne, Lynda SA-PO453  
 Bernemann, Carolyn FR-PO872  
 Berner, Todd TH-PO666  
 Berns, Jeffrey S. FR-PO517, SA-PO392  
 Berretta, Andrea TH-PO832  
 Berthelot, Laureline SA-PO564  
 Bertram, John F. FR-PO385  
 Bertram, Tim A. FR-PO394, SA-PO957  
 Bertrand, Carol A. FR-PO019  
 Besseling, Paul J. FR-PO383  
 Besser, Victoria H. TH-PO716  
 Best Rocha, Alejandro FR-PO190  
 Bestard, Oriol SA-OR49, SA-PO130, SA-PO160  
 Bestvater, Felix FR-PO451  
 Betsholtz, Christer FR-PO952  
 Bettiga, Arianna SA-PO118, SA-PO119, SA-PO135  
 Betts, Keith A. TH-PO411  
 Beumer, Jan H. SA-PO156  
 Beutel, Gernot SA-PO145  
 Bevan, Andrew M. TH-PO003

Bevc, Sebastjan	FR-PO010, SA-PO127, SA-PO291	Bijkerk, Roel	TH-OR43, FR-PO386	Bodana, Shirisha	SA-PO032	Bouché, Ann	FR-OR14
Beverly, Levi J.	FR-PO189	Bijol, Vanesa	SA-PO863, PUB072	Bodenstein, Katie	PUB023	Boucher, Robert E.	TH-OR23, TH-OR26, TH-PO634, TH-PO709, TH-PO710, FR-PO559, FR-PO737, FR-PO747, FR-PO748
Bevilacqua, Micheli U.	TH-PO905	Bijoy, Sini	PUB183	Bodnar, Andrew J.	FR-PO402	Boud'hors, Charlotte	FR-PO580, FR-PO591
Bezerra, Joao Braz	PUB131	Bilen, Yara	SA-PO808	Boerwinkle, Eric	FR-PO918	Bouillez, Audrey	TH-PO442
Bezerra, Regis F.	SA-PO147	Billah, Marzuq M.	FR-PO495	Boffa, Jean-Jacques	TH-PO481	Boulevard, L. Ebony	TH-PO153
Bhachu, Jasraj S.	SA-PO653	Bin Homam, Wadhah M.	PUB171	Bogale, Daniel Yilma	FR-PO433	Bourgeois, Sarah	SA-PO660
Bhagat, Amar M.	TH-PO078	Bin, Sofia	SA-OR28	Bogdanovic, Radovan	SA-PO738	Bourqui, Laurent	TH-PO318
Bhagat, Forum	SA-PO048	Binning, Elizabeth	TH-PO703	Bogen, Steve	TH-PO574	Boustany, Carine	FR-OR32
Bhalla, Anil	TH-PO044, SA-PO815, PUB150, PUB324	Binz, Julia	FR-PO698	Boger, Marta V.	PUB196	Bouteldja, Nassim	TH-PO565
Bhalla, Anshul	SA-PO533, SA-PO864, SA-PO876	Biondani, Andrea	TH-PO505	Bogunovic, Dusan	PUB277	Bouten, Carlijn V.	FR-PO383
Bhalla, Neelam M.	TH-PO011	Birardi, Vanessa	TH-PO488	Boh, Geraldine	PUB237	Boutin, Sylvie	SA-PO307
Bhamra, Inder	TH-PO433	Birk, Horst-Walter	SA-PO780	Bohlooly, Mohammad	FR-PO1008	Bouwman, Pim	TH-PO919
Bhandari, Gaurav M.	TH-PO044, PUB324	Birks, Peter C.	TH-PO901, FR-PO601	Bohm, Clara	TH-PO630, SA-PO944, PUB138	Bouwmeester, Romy N.	TH-PO503, FR-PO034, PUB236
Bhandari, Sunil	TH-PO674, TH-PO680	Birmingham, Daniel J.	FR-PO601	Bohmig, Georg	SA-OR47	Boven, Wim Jan V.	TH-PO597
Bharati, Joyita	TH-PO191, FR-PO661, SA-PO217	Birn, Henrik	TH-OR04	Bohnepoll, Tobias	FR-OR60, SA-PO1011	Bover, Jordi	PUB172
Bhardwaj, Mansi	PUB114	Biruete, Annabel	TH-PO146, TH-PO810, FR-OR01	Bohrquez, Arlette	FR-PO362, FR-PO390, SA-PO661	Bowen, Emily E.	TH-PO455, FR-PO715, FR-PO163, FR-PO365
Bhardwaj, Rishi	FR-PO345	Bishop, Meredith S.	PUB172	Boi, Roberto	TH-PO426, FR-PO718	Bowen, Timothy	FR-PO163, FR-PO365
Bhargava, Juhi	FR-PO836, SA-PO194, PUB333	Bissler, John J.	FR-PO256, SA-PO128	Boily, Marc-Olivier	FR-PO334	Bowen, William S.	FR-OR09
Bhargava, Pallavi	TH-PO116	Bistrup, Claus	TH-PO931	Boima, Vincent W.	PUB118	Bowers, Corrie	SA-PO703
Bhargava, Ramya	SA-PO466	Bisunke, Bijay	TH-OR45	Boinnelly, Varun Chandra	TH-PO949	Bowling, C. Barrett	FR-PO064
Bhargava, Rhea	TH-PO189, SA-PO024	Biswal, Sara	TH-PO121	Boivin, Felix	FR-PO270	Bowman, Brendan T.	TH-PO933, TH-PO934
Bhargava, Shruti	TH-PO171	Biswas, Shupti	TH-PO592, TH-PO593	Bokhari, Syed Rizwan A.	FR-PO270, PUB014, PUB042	Bowman, Nick	PUB084
Bhargava, Vinant	TH-PO044, SA-PO815, PUB150, PUB324	Bittinger, Kyle	TH-PO874	Boldrini, Luca	TH-PO398	Boyapati, Anita	SA-OR04
Bhasin, Artri A.	TH-PO767	Bitzler, Markus	TH-PO213, FR-OR36	Boletis, Ioannis	FR-PO729	Boyle, Suzanne	FR-PO060
Bhat, Lavleen	SA-PO350, SA-PO351	Bixler, Emily	PUB228	Boletta, Alessandra	FR-PO298, FR-PO299	Bzoczi, Ali C.	FR-PO802
Bhat, Samrat V.	TH-PO412	Bjergfelt, Sasha S.	SA-PO188	Bolisetty, Subhashini	FR-PO243	Braam, Branko	SA-PO346, SA-PO986
Bhati, Sonia	SA-PO236	Bjoerneklett, Rune	SA-PO715	Bolufer, Mónica	SA-PO130, SA-PO160	Braccagni, Beatrice	PUB124
Bhatia, Divya	TH-PO705, SA-PO1005	Björk, Jonas	FR-PO897	Bomback, Andrew S.	TH-PO474, PUB332	Bradauskaitė, Gitana	SA-PO867
Bhatnagar, Anshul	SA-PO326	Bjornstad, Petter	TH-PO211, TH-PO231, TH-PO247, TH-PO250, TH-PO253, TH-PO857, SA-PO257, SA-PO258, PUB100	Bonaca, Marc P.	TH-PO602, PUB172	Braddon, Fiona E.	TH-PO494
Bhatraju, Pavan K.	TH-OR02, TH-OR07, TH-OR10, TH-PO028, FR-OR20, FR-PO031, PUB028	Black, Mary Helen	TH-PO245	Bonanno, Charles	PUB288	Braden, Gregory L.	FR-PO046, FR-PO557, FR-PO561, FR-PO874, SA-PO722
Bhatt, Deepak L.	SA-PO264	Blackburn, Sophie M.	FR-PO361, SA-PO030	Bond, Mary	FR-PO751	Bradford, Shayna T.	SA-PO085
Bhatt, Purav R.	TH-PO661, TH-PO686, TH-PO688, TH-PO691, TH-PO692	Blackcorby, Allison	SA-PO115	Bond, Tanner	PUB051	Bradford, Tanner	TH-PO323
Bhatt, Udayan Y.	FR-PO759	Blaha, Charles	SA-PO018	Bondue, Tjessa	FR-PO331	Brady, Clayton	TH-PO312
Bhatta, Anuja	FR-OR46	Blaha, Michael J.	FR-PO902	Bongetti, Elisa K.	TH-PO271	Brady, Makayla	FR-PO577, FR-PO578
Bhattacharyya, Aniruddha	SA-PO431	Blair, Alex	FR-PO488	Bonilla, Marco A.	FR-PO184, FR-PO185	Braehler, Sebastian	FR-PO600, FR-PO686, TH-PO540
Bhatti, Saad A.	SA-PO725	Blake, Zoe	SA-PO152	Bonin, Léna L.	FR-PO351, FR-PO712	Braesens, Jan H.	TH-PO540
Bhave, Gautam B.	TH-PO284, TH-PO423	Blakey, Hannah	TH-PO751	Bontekoe, Emily	TH-PO617	Braga Barbosa, Gessica Sabrine	SA-PO433
Bhayana, Sagar	TH-PO193, TH-PO448	Blanc, Valerie	FR-PO122	Bonventre, Joseph V.	TH-PO026, TH-PO206, TH-PO332, FR-OR15, FR-PO357, FR-PO755, SA-OR17, SA-PO972	Braga, Juarez R.	FR-PO239
Bhde, Poorva P.	TH-PO133, SA-PO577	Blanc, Victoria	SA-PO947	Bonzi, Camilla Maria Ester	TH-PO075	Bragg-Gresham, Jennifer L.	TH-PO706, FR-PO936
Bhowmik, Dipankar M.	TH-PO504, FR-PO658	Blanchard, Anne	TH-PO322	Boo, Hyo jin	FR-PO039, FR-PO560	Brahmbhatt, Yasmin G.	FR-PO547, FR-PO548
Bhullar, Jasjot K.	PUB201	Blanchard, Simon	FR-PO580	Boonsayomphu, Theerapun	SA-PO464	Bramham, Kate	TH-PO481, TH-PO674, TH-PO680, TH-PO751, TH-PO756, TH-PO759, TH-PO830, SA-PO560, PUB078
Bhunyakarnjanarat, Thansita	TH-PO652	Blanchet, Odile	FR-PO588	Boonyakrai, Chanchana	FR-PO474	Branco, Carolina	FR-PO094, SA-PO041
Bhutani, Gauri	TH-PO384	Blanco, Gustavo	FR-PO264	Boor, Peter	TH-PO565, SA-PO111, SA-PO786	Branco, Patricia Q.	FR-PO469, PUB141
Bhutta, Salman	FR-PO012, SA-PO035	Bland, Alison	FR-OR13	Booth, John	TH-PO501	Brandt, Sabine	SA-PO1010
Biagioli, Marina	PUB124	Blank, Antje	TH-PO920	Boothroyd, Philippa G.	TH-PO906, PUB033, PUB035	Brant, Elizabeth J.	TH-PO465
Bian, Shuyang	SA-PO781	Blank, Kristina N.	SA-PO947	Borden, Chloe	SA-PO530, SA-PO531, SA-PO535	Brás, Ana C.	FR-PO428
Bian, Xiaohui	TH-PO180, TH-PO242	Blankenship, Derek M.	FR-PO502, FR-PO512, SA-PO341, SA-PO445	Borg, Rikke	PUB096, PUB106	Brashear, Sarah E.	TH-PO822
Bian, Xueqin	TH-PO293, SA-PO332	Blaser, William J.	TH-PO144	Borges Canha, Marta	FR-PO758, SA-PO792	Bratescu, Lavinia O.	SA-PO337
Bian, Xueyan	TH-OR16	Blasio, Angelo	TH-PO442	Borghoff, Kathleen	FR-PO052, SA-PO674, PUB317	Brathwaite, Latoya L.	FR-PO619
Bianca, Pierpaolo	TH-PO367	Blazius, Brooke A.	FR-PO663	Bork, Tillmann	FR-PO699	Brauer Ornelas, Claudia M.	FR-PO212, SA-PO139
Bianchi, Giada	PUB063	Bleich, Markus	TH-PO329	Borkan, Steven C.	PUB076	Braumann, Marie	FR-PO600
Bianchi, Maria Eugenia V.	PUB159	Bleyer, Anthony J.	TH-PO379, TH-PO380, FR-PO343, PUB192	Bornstein, Jeffrey D.	TH-PO498, FR-PO795, PUB299	Braun, Fabian	FR-PO342, FR-PO699
Bianco, Antonio C.	TH-PO215	Blijdorp, Charles J.	TH-PO406	Borodina, Tatiana A.	SA-PO793	Brauns, Nicolas	TH-PO540
Bible, Jon	FR-PO785	Blinder-Haddad, Liora	FR-PO231	Borooh, Shyamanga R.	SA-PO575	Bravo, Sabdi	FR-PO391
Bick, Alexander	TH-OR01, TH-PO246, FR-PO307, FR-PO312, FR-PO316	Blochousse, Marjorie	TH-PO294	Borovitz, Yaël	FR-PO421	Bravo, Susana	FR-PO270
Bicki, Alexandra	FR-PO435	Block, Clay A.	TH-PO130, TH-PO465, PUB097, PUB260	Borri, Mila	FR-OR14	Brearily, Adrian	TH-PO091
Bieber, Brian	TH-PO154, TH-PO694, TH-PO897, FR-PO221, FR-PO476, FR-PO477, SA-PO179	Block, Geoffrey A.	TH-PO869, FR-PO476, SA-PO401, PUB351	Bosch-Traberg, Heidrun	SA-PO265	Breeggemann, Matthew C.	SA-PO856
Biederman, Laura	TH-PO471, TH-PO541, TH-PO542, FR-PO601, PUB264	Blom, Hans	FR-PO707	Bose, Madhura	TH-PO205	Breiderhoff, Tilman	TH-PO329
Bielopolski, Dana	TH-PO840, FR-PO790	Blomberg, Linda	FR-PO342, FR-PO686	Bosgana, Pinelopi	TH-PO583	Breitwieser,	
Bierer, S. Beth	TH-PO009, TH-PO010	Bloom, Michelle	SA-PO553	Boshart, Alexander	TH-PO640, TH-PO765	Hannah-Madeleine	SA-PO422
Biering-Sørensen, Tor E.	SA-PO188	Blum, Christina L.	SA-PO519	Bosques, Jaymilite	SA-PO677	Breloh, Anne M.	TH-PO540, SA-PO112
Bieringer, Markus	FR-OR54	Blum, Matthew F.	FR-PO754	Bostom, Andrew	FR-PO834	Brennan, Daniel C.	FR-PO779, FR-PO804, FR-PO814, SA-OR43
Bierzynska, Agnieszka	TH-PO450, FR-PO302	Blydt-Hansen, Tom D.	TH-PO765	Bothe, Tim	TH-PO769, TH-PO882	Brennan, Eoin	TH-PO187, TH-PO205
Bignall, Orville Newton-Ray	FR-PO863	Boado, Carlo Antonio	TH-PO027	Botson, John K.	SA-PO898		
Bihorac, Azra	FR-PO061	Boakye, Priscilla	FR-PO882	Bou Matar, Raed	TH-PO474, FR-PO426		
		Bobadilla, Norma	TH-PO490, FR-PO087	Boubaker, Karima	TH-PO923		
		Bobart, Shane A.	TH-PO514, TH-PO558	Bouchard, Josee	FR-PO095		
		Bobba, Aniesh	TH-PO581				
		Bobrowski, Amy	FR-PO426				
		Bobu, Alexis	TH-PO020, SA-PO797				
		Bochter, M. Skye N.	SA-PO250, SA-PO615				
		Bock, Fabian	FR-PO368, FR-PO369				
		Bockhorst, Samuel P.	SA-PO094				

Brennand, Erin A.	TH-PO745, TH-PO746, TH-PO747	Brunner, Evelyn	FR-PO202	Busch, R. S.	PUB098	Campeiro, Joana D.	TH-OR46
Brenner, Thorsten	TH-PO105	Brunner, Hermine	PUB280	Busch, Veit	TH-PO267	Campillo de Blas, Sofia	FR-PO135, FR-PO968, FR-PO983
Bressendorf, Iain O.	PUB096, PUB106	Bruno, Gustavo	TH-PO875	Büscher, Rainer	FR-PO434	Campillo, Sarah	FR-PO438
Brewster, Ursula C.	SA-PO484	Bruno, Jonathan M.	FR-PO314	Busque, Stephan	SA-PO849	Campioli, Edoardo	PUB340
Brezzi, Brigida	SA-PO576	Bruno, Valentina	TH-PO455, FR-PO715	Busselman, Brook W.	FR-PO391	Campise, Mariarosaria	FR-PO798, FR-PO840, FR-PO842, PUB340
Brideau, Gaëlle	TH-PO333	Brunt, Vienna E.	FR-PO738	Bussolati, Benedetta	FR-PO691, SA-PO078	Campos, Begoña	SA-PO094, PUB117
Bridgewater, Darren	SA-PO959	Bryant, Claire	FR-PO723	Bustamante, Elena	FR-PO002	Campos, Diego	FR-PO109
Bridoux, Frank	TH-PO509, FR-PO588, SA-PO159, SA-PO409	Bu, Lihong	TH-PO509, TH-PO534, SA-PO527, PUB230	Bustamante, Maria	FR-PO002	Campos, Edwing	PUB006
Brier, Michael E.	TH-PO299, TH-PO421, TH-PO663, TH-PO664, SA-PO175, PUB005	Bu, Sarah	TH-PO209	Bustos, Brian	SA-PO478, SA-PO730, PUB217	Campos, Erwin I.	FR-PO489
Briganti, Alberto	TH-PO075	Bu, Seon-ah	SA-PO005	Buta, Sofija	PUB277	Campos, Isaac D.	TH-PO152, FR-OR04
Bright, Franklin	TH-PO442	Bucala, Richard	TH-OR49	Buti, Elisa	SA-PO621	Campos, Nuri P.	PUB006
Bright, Rupert B.	SA-PO382	Bucaloiu, Ion D.	SA-PO552, SA-PO582	Butler, Emily L.	TH-PO887, FR-PO904, FR-PO905	Canales Bueno, Natalia	FR-PO135, FR-PO968, FR-PO983
Brightbill, Hans D.	FR-PO912	Bucci, Romina	TH-PO367	Butler, Javed	TH-PO601, PUB172	Canas, Jorge J.	SA-PO608
Briley, Kimberly	TH-PO935	Buchalter, Robert B.	SA-PO800, SA-PO808	Butler, Matthew J.	TH-PO193	Cancarevic, Ivan	SA-PO313
Brill, April	SA-PO507	Buchan, Mairissa S.	TH-PO610	Butrovich, Morgan A.	SA-PO156	Canducci, Filippo	SA-PO714
Brilland, Benoit	FR-PO580, FR-PO588, FR-PO591	Buchsbaum, Steven F.	SA-PO418	Butt, Linus	FR-PO329, FR-PO707	Canela, Victor A.	TH-PO913, FR-PO106, PUB001, PUB027, PUB074
Brimble, K. S.	FR-PO499	Buck, Kristen K.	PUB108	Butterfield, Richard J.	FR-PO808	Canela, Victor Hugo	FR-OR09
Brinker, Meike Daniela	SA-PO275	Buckenmayer, Anna	TH-PO277	Buttram, Daniel J.	FR-PO406	Canetta, Pietro A.	TH-PO479, SA-PO713, SA-PO735
Brinkkoetter, Paul T.	TH-PO506, FR-PO600, FR-PO687, FR-PO704, FR-PO705, SA-PO233, SA-PO709	Buckley, Brian	FR-PO223	Buvall, Lisa	FR-PO718, FR-PO1008	Canfield, Christopher	PUB231
Brintz, Carrie E.	SA-PO303	Budd, Jayne	SA-PO283	Bykov, Katsiaryna	TH-PO856	Canney, Mark	TH-PO667, FR-PO638
Bro, Susanne	SA-PO188	Budde, Klemens	PUB369	Byrne, Daniel	TH-PO303	Cannon, Christopher P.	TH-PO602
Broadwell, Aaron	SA-PO897	Buddeewong, Darunee	SA-OR35	Byun, Jaeman	SA-PO770	Cano Escobar, Karla B.	PUB148
Broder, Benjamin	TH-PO724, FR-PO753, PUB225	Budden, Jeffrey J.	SA-PO401	Caballero-Islas, Adrián Esteban	FR-PO004, SA-PO411	Canonicio, Mario Enrico	TH-PO602
Brodka, Ian D.	TH-PO541, TH-PO542, PUB264	Budhiraja, Pooja	FR-PO820, SA-PO860	Cabanillas, Maria E.	FR-PO198	Cant, Rachel	FR-PO471
Brodsky, Sergey V.	TH-PO190, FR-PO194	Budoff, Matthew J.	SA-PO185	Caberto, Sheryl C.	FR-PO049	Cantley, Lloyd G.	FR-PO116, SA-PO967
Broekhuizen, Roel	FR-PO194, FR-PO914	Buenger, Florian	FR-PO326, FR-PO327, FR-PO328, FR-PO330, SA-PO525, SA-PO573, SA-PO578	Caceres, Paulo S.	SA-PO243	Cantor, Harvey	TH-OR53, TH-PO653
Brohammer, Elias	FR-PO803	Bugarski, Milica	FR-PO1007	Cacioppo, Paula A.	TH-PO055, TH-PO063	Canty, Ethan A.	SA-PO590
Bromberg, Jonathan	FR-PO803	Bugazia, Seif	TH-PO394, TH-PO395, SA-PO952	Cadet, Bair	FR-PO445, SA-PO035, PUB052	Canuelas, Pedro A.	PUB245
Bronner, Sarah	FR-PO318	Buglioni, Alessia	SA-PO527	Cahan, Patrick	FR-OR19, FR-PO116, FR-PO145, FR-PO147	Canziani, Maria Eugenia F.	SA-PO189, SA-PO412
Bronstein, Robert	SA-OR22, SA-OR26	Bui, Albert	SA-PO050	Cai, Mei, Zheng	SA-PO211	Cao, Karen H.	SA-PO571
Brooker, Anne	PUB168	Bui, Alex	FR-PO937, FR-PO939	Cai, Danlin	FR-PO217	Cao, Kevin X.	SA-PO618
Brookhart, M. Alan	FR-PO064	Bui, Danquynh C.	PUB026	Cai, Guangyan	SA-PO659, SA-PO907	Cao, Shuang	TH-PO341, FR-PO270
Brooks, Craig R.	FR-OR28, FR-PO164, FR-PO1005	Bui, Thuy-Anh	SA-PO383	Cai, Hong	SA-PO235	Cao, Tao	TH-PO693
Brooks, Daniel R.	SA-PO950	Bukabau, Justine B.	FR-PO897	Cai, Hui	SA-PO781	Cao, Yanxia	FR-PO726, SA-PO1004
Brooks, Marybeth	FR-PO290	Bukhari, Samar Qaisera	SA-PO681	Cai, Manqi	TH-PO722, SA-PO942	Cao, Yaochen	FR-PO235, SA-PO990
Brooks, William M.	FR-PO826, SA-PO404	Bukhari, Sarah	SA-PO892	Cai, Qingqing	TH-PO846	Cao, Yiling	TH-PO192
Brophy, William T.	SA-PO895	Bukhari, Syeda S.	FR-PO670, SA-PO476, PUB349	Cai, Xuan	TH-PO869, SA-PO192, PUB048	Capasso, Giovambattists	SA-PO119
Broseta Monzo, Jose Jesus	FR-PO901	Bullard, Kai M.	TH-PO706	Cai, Yiqiang	FR-PO345	Capellari, Emily C.	FR-PO101
Brosius, Frank C.	TH-PO211, SA-PO257, SA-PO258	Bullen, Alexander L.	TH-PO861, FR-PO916	Caires, Renato A.	FR-PO179, SA-PO121, SA-PO148	Capendale, Pamela E.	SA-PO025
Brosnahan, Godela M.	TH-PO402, TH-PO403	Bulls, Hailey W.	FR-PO862	Cairns, Tom	FR-PO660	Capitanio, Umberto	SA-PO118, SA-PO119, SA-PO135
Brosnan-Cashman, Jacqueline A.	TH-PO567	Bülow, Roman D.	TH-PO565	Calça, Rita	FR-PO469, PUB141	Caplan, Michael J.	FR-PO268, FR-PO300
Brossart, Katya	TH-PO356	Bulus, Nada M.	FR-PO368	Calcat-i-Cervera, Sandra	SA-PO078	Caplan, Richard	FR-PO058
Brown, Andrew	FR-PO811	Bundy, Joshua D.	TH-PO169	Calderon Garcia, Clementina Elizabeth	TH-PO046, FR-PO632, PUB122, PUB209, PUB252	Caplan, Ben	FR-PO917, FR-PO927
Brown, Catherine M.	TH-PO129, SA-PO701, PUB262	Bunke, Martin C.	TH-PO478, FR-PO662, SA-PO702	Calderon Gutierrez, Frida S.	PUB054	Capone, Valentina	SA-PO576
Brown, Dennis	TH-PO332, TH-PO335, SA-PO756	Bunse, Mario	FR-PO583	Caldovic, Ljubica	FR-PO278	Cappoli, Andrea	TH-OR34
Brown, Edwina A.	TH-PO799	Bunyard, Peter R.	TH-PO433	Caldwell, Jillian	TH-PO519	Caprara, Carlotta	TH-PO359
Brown, Jennifer A.	FR-PO602	Burant, Christopher J.	FR-PO553	Caldwell, John	SA-PO855	Cara-Fuentes, Gabriel M.	TH-PO253
Brown, Julia	TH-PO238, TH-PO605, TH-PO892, FR-PO928	Burcea, Andreea	SA-PO150	Caliskan, Yasar	FR-PO814, FR-PO824, SA-PO795, SA-PO847, SA-PO850, SA-PO851	Carbajal-Contreras, Hector	TH-PO318, TH-PO319, FR-PO007
Brown, Leanne	TH-PO126, PUB221	Burdmann, Emmanuel A.	SA-PO121	Callahan, Matthew	SA-PO453	Carbone, Vincenzo	SA-PO007
Brown, Maritza	SA-PO514, SA-PO725	Buren, Marleen V.	FR-PO857	Callas, Peter W.	TH-PO774	Cardarelli, Francesca	SA-PO849
Brown, Matthew A.	SA-PO298	Burger, Dylan	SA-PO082	Calle, Juan C.	FR-PO630	Cardenas, Andres	FR-PO917
Browne, Teri	TH-PO740	Buring, Julie E.	SA-PO910	Callejo, Ana	SA-PO130	Cardenas, Armando T.	PUB007
Bruchfeld, Annette	FR-PO651	Burka, Steven A.	TH-PO466	Calleros, Laura	FR-PO135, FR-PO968, FR-PO983	Cárdenas, Pilar	SA-PO227
Brucker, Anne M.	TH-PO188, SA-PO081	Burke, George W.	FR-PO431, FR-PO694, SA-PO750	Calvaruso, Luca	TH-PO398	Cardilla, Angelysia	TH-PO218
Bruckner, Shane	FR-PO598	Burkert, Katharina	SA-OR42	Calvelli, Hannah	FR-PO884, SA-PO816	Cardona, Magnolia	FR-PO860
Bruder do Nascimento, Ariane	FR-PO402	Burman, Jenny A.	FR-PO527	Calvert, John W.	SA-PO781	Cardoso, Daniela F.	SA-PO402, SA-PO979
Bruder do Nascimento, Thiago	FR-PO402	Burmester, Hanna	FR-PO284	Calvet, James P.	FR-PO257	Cardozo, Ludmila F.	TH-PO832, TH-PO833, TH-PO834
Brueder, Nicole	SA-PO145	Burney, Heather	FR-PO776	Calvino, Jesus	SA-PO928	Carey, Kyle	TH-OR06
Bruen, Diana	PUB191	Burns, Jeffrey M.	FR-PO826	Camacho-Ortiz, Adrian	PUB045	Carey, Laura	FR-PO919
Bruggeman, Leslie A.	FR-PO689	Burns, Kevin D.	SA-PO082	Camacho, Diana	SA-PO411	Carias Martinez, Karla G.	FR-PO483
Bruijn, Jan A.	FR-PO1009	Burrell, Anita D.	SA-PO811	Camacho, Raul	TH-PO088, SA-PO100	Cardi, Gianluca	SA-PO524
Brunelli, Steven M.	TH-OR15, TH-PO154, FR-PO873, SA-PO320, SA-PO340, SA-PO809, SA-PO810, PUB123	Burrill, Natalie	FR-PO278	Camargo, Marianne	TH-PO497	Carilli, Allison	SA-PO751
		Burrows, Brett	TH-PO817	Cameron, Flor	SA-PO943	Carioni, Paola	SA-OR07
		Burrows, Nilka Rios	TH-PO659, FR-PO411	Cameron, Lynda K.	TH-PO835	Carlozzi, Noelle E.	FR-PO663, SA-PO705
		Bursi, Roberta	SA-PO007	Cameron, Rory S.	SA-PO283	Carlson, Joann M.	FR-PO417, SA-PO949
		Bursic, Alexandra E.	TH-PO016	Campagna, Shawn R.	SA-PO762	Carmeliet, Peter	TH-OR43, FR-OR14
		Burstad, Kendal M.	TH-PO801	Campbell, Ian C.	FR-PO302	Carmines, Pamela K.	TH-PO826
		Burt, Rachel	FR-PO165	Campbell, Kirk N.	FR-OR57	Carmo, Gabriel A.	PUB034
		Burton, James	TH-PO012, TH-PO013, TH-PO674, TH-PO680	Campbell, Ruth C.	FR-PO609	Carmo, Lilian	PUB034
		Burugula, Bala Bharathi B.	FR-PO697			Carmona Martes, Ada L.	TH-PO577
						Carmona, Edgar J.	TH-PO047

Caron, Alex FR-PO334  
 Carpio, Cecilia SA-PO160  
 Carr, Audrey V. TH-PO744  
 Carr, Edward TH-PO962  
 Carracedo, Angel SA-PO742  
 Carracedo, Miguel FR-OR52  
 Carrasquillo, Rachel A. TH-PO590  
 Carrera, Fernando SA-PO457  
 Carrero, Juan J. TH-OR04, TH-PO300,  
 TH-PO699, TH-PO786, TH-PO898  
 Carriazo, Sol M. FR-PO014  
 Carrión Rodríguez, Astrid I. TH-PO558  
 Carrocci, Tucker J. SA-PO573  
 Carroll, Kevin SA-PO115, SA-PO712  
 Carroll, Thomas J. SA-OR15  
 Carroll, Tom S. TH-PO840  
 Carruthers, Jack E. FR-PO584  
 Carson, Kathryn A. TH-PO727  
 Carstens, Michael H. TH-PO007,  
 TH-PO559  
 Carstensen, Bendix SA-PO282  
 Carter, Caitlin E. FR-PO107,  
 FR-PO228, SA-PO575  
 Carter, Jessamyn S. SA-PO591  
 Carter, Stuart M. FR-PO030  
 Carvalho, Aluizio B. SA-PO189,  
 SA-PO412  
 Carvalho, Andrei Felipe S. SA-PO513  
 Carvalho, Luiz Roberto PUB196  
 Carvalho,  
 Maria Fernanda C. FR-PO430,  
 SA-PO600  
 Carvalho, Renata SA-PO377  
 Carver, Michelle FR-PO494  
 Casabar-Licayan, Mahalia FR-PO852  
 Casado-Barragán, Felipe S. SA-PO227  
 Casal Moura, Marta I. TH-PO454,  
 FR-PO649, SA-PO692  
 Casas Loyola, Cristina M. PUB177  
 Casas-Aparicio, Gustavo A. TH-PO096,  
 FR-PO023  
 Cascinu, Stefano SA-PO120  
 Cases, Aleix FR-PO901, SA-OR37  
 Casey, Anna L. TH-PO928  
 Casey, Ashley SA-PO710  
 Casey, Michael FR-PO819  
 Casey, Robert W. TH-PO129  
 Casiraghi, Federica SA-PO706  
 Caskey, Fergus TH-PO788,  
 FR-PO536, SA-PO932  
 Cason, Rachel K. SA-PO628  
 Caspary, Tamara TH-OR35  
 Cass, Alan TH-PO275  
 Cass, Jennifer FR-PO419  
 Casserly, Liam F. FR-PO864,  
 SA-PO701  
 Cassidy, Renin TH-OR18  
 Cassiere, Hugh FR-PO070  
 Cassina, Laura FR-PO299  
 Cassol, Clarissa A. TH-PO566,  
 SA-OR01, SA-PO711  
 Castañeda-Bueno, Maria TH-PO318,  
 TH-PO319, FR-PO007  
 Castellano, Giuseppe SA-PO871  
 Castellano, Giuseppe TH-PO444,  
 FR-PO798, FR-PO840, FR-PO842,  
 SA-PO576, PUB340  
 Caster, Dawn J. FR-PO577, FR-PO578,  
 FR-PO640, PUB005  
 Castillo, Carlo G. TH-PO705  
 Castillo, Jessica SA-PO482  
 Castillo, Kathleen SA-PO138  
 Castillo, Marcus PUB288  
 Castro-Pereira, Daniel J. PUB222  
 Castro, Angel R. PUB245  
 Castro, Gilberto SA-PO121  
 Castro, Maria cristina R. FR-PO880  
 Catanese, Lorenzo FR-PO913  
 Catania, Martina TH-PO367  
 Cathro, Helen P. FR-PO629,  
 SA-PO818, SA-PO880  
 Catiwa, Jayson TH-PO275  
 Catlett, Jerrel L. FR-PO889  
 Cattran, Daniel C. TH-PO455,  
 TH-PO479  
 Cavalcante, Livia B. TH-PO516,  
 FR-PO179, FR-PO678  
 Cavalier, Etienne FR-OR06,  
 FR-PO897, SA-PO179  
 Cavalleri, Gianpiero TH-PO364,  
 TH-PO646, TH-PO647, FR-PO935  
 Cavanaugh, Cassandre FR-PO237  
 Cavanaugh, Corey J. TH-PO522,  
 FR-PO629  
 Cavanaugh, Kerri L. FR-PO320,  
 FR-PO862  
 Caza, Tiffany TH-PO451, TH-PO452,  
 FR-PO195, FR-PO633, SA-OR01  
 Cazzoletti, Lucia TH-PO845  
 Cebotaru, Liudmila TH-PO414,  
 FR-PO272  
 Cechova, Sylvia SA-PO086, SA-PO978  
 Cejka, Daniel SA-PO174  
 Cerda, Jorge FR-PO101, FR-PO114  
 Cerezo Samperio, Beatriz R. PUB061  
 Cerkauskaitė, Agne TH-PO761  
 Cerkauskiene, Rimante TH-PO761  
 Cerman, Zdenek TH-PO860  
 Cerqueira, Tiago L. TH-PO262,  
 TH-PO263, PUB034  
 Cerrillos, Jose Ignacio FR-PO837  
 Cervantes, Carmen E. FR-PO048,  
 FR-PO448  
 Cervantes, Lilia FR-PO870,  
 FR-PO894, PUB156  
 Cha, Dae R. SA-PO1013  
 Cha, Jin Joo SA-PO1013  
 Cha, Seung-Kuy TH-PO177, SA-PO737  
 Cha, Yoseop FR-PO539  
 Chabi, Béatrice TH-PO821, TH-PO823  
 Chacko, Eric J. SA-PO040  
 Chadban, Steven J. PUB312  
 Chade, Alejandro R. SA-PO962,  
 SA-PO963  
 Chadha, Anushka SA-PO506,  
 SA-PO512  
 Chadha, Shiv PUB170  
 Chai, Biaoxin SA-PO770  
 Chaichana, Thiamjit SA-PO557  
 Chailimpamontree,  
 Worawon SA-PO941  
 Chaiprasert, Amnart TH-PO831,  
 FR-PO021, FR-PO908, SA-PO162,  
 SA-PO901  
 Chaisrimaneepan,  
 Nattanicha TH-PO598  
 Chaker, Layal FR-PO920  
 Chakraborty, Anubhav FR-PO294  
 Chakraborty, Ramyangshu FR-PO785,  
 PUB327  
 Chalkia, Aglaia FR-PO589, SA-PO408  
 Challa, Akshara Sree TH-PO256  
 Chalmers, Dustin TH-PO055,  
 TH-PO063, TH-PO134, FR-PO567,  
 FR-PO634, FR-PO635  
 Chalouhy, Charbel FR-PO160  
 Chamarthi, Gajapathiraju FR-PO103,  
 SA-PO521  
 Chamberlain, Jason FR-PO232  
 Chan, Brenda K. TH-PO261  
 Chan, Caleb C. FR-PO972  
 Chan, Chan Ip FR-PO473  
 Chan, Chang-Yien TH-PO449,  
 TH-PO539  
 Chan, Christopher T. TH-OR18,  
 TH-PO839, SA-OR10  
 Chan, Goldia SA-PO022  
 Chan, Gordon C. FR-PO468  
 Chan, Jenna SA-PO766  
 Chan, Lili TH-PO166,  
 TH-PO707, FR-PO006, FR-PO488,  
 SA-PO914, SA-PO953, PUB163  
 Chan, Loretta Y.Y. FR-PO964,  
 SA-PO220, SA-PO969  
 Chan, Melanie M. TH-PO357,  
 SA-PO554  
 Chan, Tak Mao D. TH-PO157,  
 FR-PO459, FR-PO545, FR-PO605,  
 FR-PO972, FR-PO982,  
 FR-PO1003, SA-PO414  
 Chanakul, Ankanee SA-PO557  
 Chanchlani, Rahul TH-PO589  
 Chandar, Jayanthi FR-PO425,  
 FR-PO431  
 Chandel, Navdeep S. FR-OR33  
 Chandler, Bridgett A. SA-OR32  
 Chandler, Jennifer C. FR-PO310,  
 FR-PO332, FR-PO731  
 Chandra, Saurabh SA-PO362  
 Chandrasekar, Indra FR-PO391  
 Chang, Alex R. TH-PO049,  
 TH-PO373, TH-PO750, TH-PO847,  
 TH-PO896, FR-PO216, FR-PO754,  
 SA-PO534, SA-PO552, SA-PO582  
 Chang, Anthony TH-PO567  
 Chang, Audrey N. FR-PO689  
 Chang, Danica H. TH-PO745,  
 TH-PO746, TH-PO747  
 Chang, Dongyuan FR-OR36  
 Chang, Erin B. FR-PO064  
 Chang, Se-Ho FR-PO1001,  
 SA-PO439, PUB362  
 Chang, Shirley S. FR-OR821  
 Chang, Tae ik TH-PO876  
 Chang, Tara I. TH-OR32  
 Chang, Ting-Ting TH-PO208  
 Chang, Tylis FR-PO070  
 Chang, Yoon-Kyung TH-PO201,  
 FR-PO396, FR-PO977, SA-PO232  
 Chang, Zhiren TH-OR16  
 Changsirikulchai, Siribha TH-PO957,  
 FR-PO881  
 Chanlerdfa, Nuntanutch FR-PO908  
 Chao, Allen TH-PO369, TH-PO370  
 Chapelaine, Isabelle FR-PO095  
 Chapman, Arlene B. TH-PO402,  
 TH-PO403, FR-PO879  
 Chapman, Donna J. SA-PO916  
 Chariyavilskul, Pajaree SA-PO406  
 Charkviani, Mariam FR-PO178,  
 SA-PO461, PUB343  
 Charlemagne, Thibaut FR-OR48  
 Charleston, Jeanne TH-PO892  
 Charlton, Jennifer R. TH-PO754,  
 SA-PO788, SA-PO818  
 Charrin, Emmanuelle FR-PO696  
 Charu, Vivek SA-PO718  
 Charytan, Amalya M. TH-PO739  
 Charytan, David M. TH-PO612,  
 TH-PO739  
 Chassot, Alexandra SA-PO099  
 Chatham, Ashlee SA-PO460  
 Chati, Priyanka FR-PO443, FR-PO742  
 Chatkralert, Aphichat TH-PO669  
 Chatoth, Dinesh K. FR-PO494,  
 FR-PO502, FR-PO512, SA-PO341  
 Chatterjee, Satabdi TH-PO726,  
 TH-PO893  
 Chatterton, Emma SA-PO657,  
 SA-PO658  
 Chau, Lillian TH-PO874  
 Chau, Sally SA-PO670, PUB175,  
 PUB304  
 Chaudhari, Harshad TH-PO104,  
 PUB041  
 Chaudhari, Juhi SA-PO913  
 Chaudhary, Anjana FR-PO249,  
 FR-PO250, FR-PO279, FR-PO280  
 Chaudhry, Muhammad A. FR-PO168,  
 SA-PO1001  
 Chaudhry, O'Neil P. TH-PO115  
 Chaudhry, Shahzad SA-PO056,  
 PUB067  
 Chaudhuri, Sheetal TH-PO837,  
 FR-PO494, FR-PO502, FR-PO942,  
 SA-PO328, SA-PO390  
 Chauhan, Kinsuk SA-PO953,  
 PUB111, PUB112  
 Chauhan, Suman SA-PO841  
 Chavan, Abhijit S. TH-PO430,  
 SA-PO813  
 Chavarria-Martinez, Uriel PUB045  
 Chaves, Paulo H. TH-PO678  
 Chavez, Efred TH-PO283,  
 SA-PO512, PUB249  
 Chavez, Hugo E. FR-PO533  
 Chavez, Jonathan TH-PO045,  
 TH-PO046, TH-PO047,  
 TH-PO524, FR-PO632, SA-PO445,  
 PUB122, PUB209, PUB220,  
 PUB232, PUB341  
 Chavez, Jose A. SA-PO095  
 Chavez, Rafael E. FR-PO163  
 Chawla, Jonathan S. FR-PO427  
 Chawla, Lakhmir S. TH-PO098,  
 FR-PO071  
 Che, Michael TH-PO763, TH-PO764  
 Cheate, Martin SA-PO303  
 Chebib, Fouad T. TH-PO368,  
 TH-PO396, TH-PO400, TH-PO412,  
 TH-PO413, FR-PO205, FR-PO851,  
 PUB189  
 Chedid, Alice SA-PO472  
 Chedid, Maroun TH-PO368,  
 TH-PO396, TH-PO400,  
 TH-PO412, FR-PO851, PUB189  
 Chege, Prafull B. PUB065  
 Chelikani, Vijaya SA-PO281  
 Chemmalakuzhy, Asha J. PUB139  
 Chemouny, Jonathan M. SA-PO649  
 Chen, Ashton SA-PO789, SA-PO790  
 Chen, Bo FR-PO666  
 Chen, Bohan FR-PO592  
 Chen, Britney SA-PO013  
 Chen, Caressa SA-PO018  
 Chen, Chang Huei TH-PO015  
 Chen, Chaosheng TH-OR16  
 Chen, Charles FR-PO217  
 Chen, Cheng-Hsu TH-PO925,  
 FR-PO828, PUB137, PUB195  
 Chen, Chia-Yu FR-PO420  
 Chen, Chien-Chou SA-PO569  
 Chen, Ching TH-PO208  
 Chen, Chuan FR-PO293  
 Chen, Dhruvi P. TH-PO479,  
 TH-PO482, FR-PO586  
 Chen, Fang FR-OR39  
 Chen, Fei FR-PO161  
 Chen, Gengshi FR-PO546  
 Chen, Guang TH-PO621  
 Chen, Hua-Chang TH-PO246,  
 FR-PO312, FR-PO316, FR-PO761  
 Chen, Huan-Sheng SA-PO386  
 Chen, Hui FR-PO695  
 Chen, Hungta (tony) TH-PO889,  
 PUB172  
 Chen, I-Ya SA-PO255  
 Chen, Jaw-Wen TH-PO208  
 Chen, Jia TH-PO024, FR-PO125,  
 SA-PO234  
 Chen, Jiasi TH-PO545, SA-PO104,  
 PUB092  
 Chen, Jin FR-PO030, FR-PO090  
 Chen, Jing TH-PO057, TH-PO059,  
 TH-PO169, TH-PO238, TH-PO618,  
 TH-PO719, TH-PO892, FR-PO319,  
 SA-PO191, SA-PO465  
 Chen, Jingsha TH-PO847, FR-PO918  
 Chen, Jinsong FR-PO928  
 Chen, Junliang TH-PO350  
 Chen, Junxiang TH-PO864  
 Chen, Kehong FR-PO119, FR-PO458  
 Chen, Liang PUB099, PUB153  
 Chen, Lihe TH-PO336, TH-PO337,  
 SA-PO961  
 Chen, Limeng TH-PO117, TH-PO306,  
 TH-PO510, TH-PO562, TH-PO881,  
 FR-PO140, FR-PO572, SA-PO006  
 Chen, Luoqing SA-PO760, SA-PO1002  
 Chen, Man FR-PO959  
 Chen, Mandy TH-PO535  
 Chen, Min FR-OR36, FR-PO962  
 Chen, Monica F. SA-PO117  
 Chen, Nan PUB368  
 Chen, Neal X. TH-PO146,  
 TH-PO810, FR-OR01, SA-PO775  
 Chen, Pei S. FR-PO730, SA-PO988  
 Chen, Peiling TH-PO621  
 Chen, Pingping SA-PO599  
 Chen, Qinkai TH-PO702, SA-PO311  
 Chen, Qiuju FR-PO159, SA-PO066  
 Chen, Ren-Shiang PUB137

Chen, Rongmin	FR-PO121	Cheung, Kennix-Kalen	FR-PO305	Choi, Miyoung	PUB180	Chung, Suk Min	FR-OR18,
Chen, Sarah	SA-PO798	Cheung, Matthew D.	FR-OR16,	Choi, Naye	FR-PO555, SA-PO550,	FR-PO112, PUB090	
Chen, Shasha	TH-PO492	FR-PO969, SA-PO110		SA-PO597, SA-PO611		TH-PO673,	
Chen, Shyh-Huei	TH-PO797	Cheung, Michael	PUB228	Choi, Rira	SA-PO774	TH-PO793, FR-PO340,	
Chen, Tao	TH-PO088, SA-PO100	Cheung, Pui Susan W.	TH-PO335	Choi, Seung-Ok	SA-PO737	SA-PO093, SA-PO365	
Chen, Teresa K.	TH-PO618,	Cheungpasitporn, Wisit	TH-PO695,	Choi, Soo Jeong	SA-PO652	TH-PO499	
TH-PO862, FR-PO907		SA-PO824, SA-PO835		Choi, Wonjung	TH-PO201,	FR-PO648	
Chen, Tian-Min	FR-PO121, FR-PO122	Cheval, Lydie	TH-PO322, TH-PO333	FR-PO977, SA-PO232		TH-OR06	
Chen, Wei	TH-PO150, TH-PO203	Chevarria, Julio L.	TH-PO303	Choi, Young Eun	FR-OR18,	SA-PO146	
Chen, Wen-Hung	TH-PO660,	Chewcharat, Api	SA-PO166,	FR-PO112, PUB090		FR-PO296	
TH-PO661		SA-PO167, SA-PO910		Cholin, Liza	SA-PO825	FR-PO806	
Chen, Wenfang	SA-PO845	Chewcharat, Pol	SA-PO910	Chonchol, Michel	TH-PO390,	FR-PO723	
Chen, Xiangmei	SA-PO659, SA-PO907	Chiaravalli, Marco	FR-PO299	TH-PO391, TH-PO392, TH-PO402,		FR-PO020	
Chen, Xiaolan	SA-PO172	Chiarini, Marco	TH-PO508	TH-PO403, TH-PO404, TH-PO405,		FR-PO586	
Chen, Xiaonong	TH-PO694	Chiba, Takuto	FR-PO138, FR-PO402,	TH-PO869, FR-PO738, SA-PO210		PUB289	
Chen, Xizhao	SA-PO659	SA-PO092, SA-PO103		Chong, Christy	SA-PO833	FR-PO840	
Chen, Xueguang (Gary)	TH-PO436,	Chieochanthanakij,		Chong, Crystal	TH-PO620	SA-PO928	
FR-PO614		Rutchanee	FR-PO474	Chong, Oliver	FR-PO334	FR-PO348	
Chen, Y. Eugene	TH-PO614	Chiga, Motoko	SA-PO549	Chong, Tze tec	TH-PO268	TH-PO588	
Chen, Yabing	TH-PO150	Chilcot, Joseph	TH-PO674, TH-PO759	Choo Chon Jun, Jason	SA-PO114	SA-PO647	
Chen, Yan	SA-PO930	Chimbo Lituma, Karina	PUB061,	Chopde, Purva R.	SA-PO014	PUB023	
Chen, Yi-Siao	SA-PO255	PUB115, PUB244		Chopra, Bhavna	FR-PO672, SA-PO799	TH-PO204	
Chen, Yi-Ting	FR-PO490	Chimote, Ameet A.	SA-PO236	Chou-Wu, Elaine	FR-PO789	TH-PO075,	
Chen, Yibang	FR-PO946	Chin, Andrew I.	TH-PO258, SA-PO434	Chou, Chia An	FR-PO709	SA-PO118, SA-PO119, SA-PO120	
Chen, Yijiang	TH-PO569, TH-PO570,	Chin, Ho Jun	FR-PO068, SA-PO372,	Chou, Ming-Hsien	SA-PO386	SA-OR26,	
SA-PO003		SA-PO662, SA-PO704, SA-PO716		Choudhry, Wajid M.	FR-PO105,	SA-PO017	
Chen, Ying M.	TH-PO443, FR-PO343,	Chinchilli, Vernon M.	TH-OR02,	SA-PO671		TH-OR11, SA-PO576	
FR-PO439		TH-OR07, TH-PO028		Choudhury, Devasmita	TH-PO659	SA-PO621	
Chen, Yinyin	SA-PO721	Ching, Christina B.	SA-PO604,	Choudhury, Sonali	FR-PO714	TH-PO367,	
Chen, Yiping	TH-PO621, SA-PO642,	SA-PO605, SA-PO607, SA-PO610		Choung, Hae Yoon Grace	FR-PO626,	FR-PO073, SA-PO754	
SA-PO643		Chinnadurai, Rajkumar	FR-PO866,	PUB225		TH-PO716	
Chen, Yuang	SA-PO672	SA-PO719		Chowdhury, Raad B.	SA-PO499	TH-PO761	
Chen, Yun	FR-PO466, SA-PO104	Chirieac, Madalina	TH-PO480	Chowdhury,		TH-PO685,	
Chen, Yung-Ming	FR-PO490	Chirra, Martina	SA-PO236	Sabiha Sultana	TH-PO224,	TH-PO687, FR-PO834, SA-PO115	
Chen, Yuqing	TH-PO694	Chishtii, Aftab S.	TH-PO472	SA-PO019, SA-PO020		TH-PO417	
Chen, Zhenglan	SA-PO256	Chitalia, Vipul C.	TH-PO288,	Chowdhury, Tahseen A.	FR-PO852,	FR-PO103,	
Chen, Zhengming	TH-PO621	TH-PO566, FR-PO529		PUB311		SA-PO492	
Cheng, Chen-Ting	SA-PO386	Chitnis, Debashish	TH-OR44	Christensen-Dalgaard,		TH-PO074,	
Cheng, Ching-Yu	TH-PO620	Chittinandana, Anutra	SA-PO941	Mikkel	TH-PO223	FR-PO978, SA-PO076	
Cheng, Daryl R.	TH-OR31	Chittinandana, Palita	SA-PO941	Christensen, Johanna L.	FR-PO805,	SA-PO387	
Cheng, Jizhong	FR-OR27	Chittoor, Shriman	FR-PO100	FR-PO811		TH-PO372	
Cheng, Joann	SA-PO422	Chiu, Brian	FR-PO024	Christensen, Michael	SA-PO222,	TH-PO759	
Cheng, Jonathan	SA-PO185, SA-PO186	Chiu, Hsien-Fu	FR-PO828	PUB365		FR-PO060, FR-PO831,	
Cheng, Kityan	TH-PO326, TH-PO327,	Chiu, Hui-Wen	SA-PO211	Christensson, Anders	SA-PO184	SA-PO794	
TH-PO328, SA-PO779, PUB257		Chiu, Ijen	FR-PO997	Christians, Uwe	TH-PO405	SA-PO892	
Cheng, Peifu	SA-PO418	Chiu, Jie-Wei	PUB137	Christiansen, Christian F.	TH-OR04	TH-OR48	
Cheng, Shuiqin	TH-PO621	Chiu, Yen-Ling	FR-PO656	Christianson, Annette L.	FR-PO514	TH-OR48	
Cheng, Siao Muk	TH-PO371,	Chiu, Yi-Wen	TH-PO371, TH-PO665,	Christodoulou, Michalis	TH-PO948	SA-OR34	
FR-PO462		FR-PO462		Christoffersen, Christina	FR-OR53,	TH-PO910, FR-PO032	
Cheng, Tao	FR-PO366, FR-PO367	Chivukula, Venkat Keshav	SA-PO027	SA-PO188		TH-PO566	
Cheng, Ying-Hua	TH-PO183,	Cho, A young	FR-PO098	FR-OR52		TH-PO566	
FR-OR09, FR-PO154,		Cho, Byoung-Soo	TH-PO427	Christoffersson, Jonas	FR-OR52	SA-PO571	
FR-PO169, SA-PO956		Cho, Heejin	FR-PO560	Christopher, Courtney J.	SA-PO762	PUB312	
Cheng, Yuan	TH-PO693	Cho, Heeyeon	SA-PO624	Chromek, Milan	PUB289	FR-PO252	
Cheofor, Vetalise K.	TH-PO614,	Cho, Hyunjeong	TH-OR56	Chrysochou, Constantina	SA-PO719	FR-PO923	
SA-PO770		Cho, Jang-Hee	TH-PO067,	Chryst-Stangl, Megan	SA-OR27,	SA-PO955	
SA-PO661		TH-PO793, SA-PO828		SA-PO628, SA-PO739		TH-PO904,	
Cherakara, Sreelakshmi	FR-PO130,	Cho, Jeongmin	TH-PO358, FR-PO091,	Chu, Chang	FR-PO777, PUB015	PUB320	
FR-PO244, FR-PO245		SA-PO840		Chu, Chi D.	TH-PO897, FR-PO896,	FR-PO298	
Cherezova, Alena	SA-PO762	Cho, Junghyun	TH-PO254,	TH-PO906, PUB033,		TH-PO730	
Cherif, Alhaji	TH-PO860, FR-PO564	FR-PO986, SA-PO1000		PUB035		TH-PO331	
Cherney, David	TH-PO253,	Cho, Kerry C.	SA-PO938	Chu, Qi Tiffany	FR-PO348	FR-PO180	
SA-PO264, SA-PO265, SA-PO268,		Cho, Min Hyun	FR-PO413, SA-PO595	Chuang, Chiao-Lin	TH-PO102	TH-PO811, SA-PO931	
SA-PO269		Cho, Monique E.	TH-PO118,	Chuapeco, Roberto L.	SA-PO663	TH-PO637,	
Chernin, Gil	SA-PO887	TH-PO659, SA-PO042		FR-PO079,		TH-PO640, TH-PO765	
Chernobriavaia, Ekaterina	FR-PO359	Cho, Sam	TH-PO140	Chuasawan, Anan	SA-PO941	FR-PO402	
Chernova, Irene	FR-PO315, FR-PO597	Cho, Yeoung Jee	FR-PO522	Chuengsamarn, Piyatida	FR-PO474	FR-PO192	
Cherny, Katya	FR-PO232	Chodick, Gabriel	SA-PO266	Chugh, Savneek S.	TH-PO173, PUB174	PUB299	
Chertkoff, Raul	FR-PO231, FR-PO339	Choi, Chulhee	SA-PO109	Chui, Hayton	FR-PO415, FR-PO416	SA-PO221	
Chertow, Glenn	TH-OR23,	Choi, Dae Eun	TH-PO071, FR-PO396,	Chukwu, Chukwuma A.	FR-PO769,	SA-PO288,	
TH-PO480, TH-PO481, FR-OR26,		FR-PO977, SA-PO384		FR-PO770		SA-PO695,	
FR-OR39, FR-PO550, FR-PO737,		Choi, Gwangho	TH-PO265	Chumley, Phillip H.	FR-PO245,	PUB084	
FR-PO747, SA-OR36, SA-PO181,		Choi, Hak soo	FR-PO234	FR-PO252		TH-PO685,	
SA-PO885, SA-PO886, SA-PO889		Choi, Hong sang	TH-PO813	Chun, Justin	FR-PO353, FR-PO602	SA-OR37, SA-PO115	
Chervova, Olga	FR-PO917	Choi, Hong Seok	TH-PO343	Chung, Byung ha	FR-PO782,	PUB253	
Chesnaye, Nicholas C.	TH-PO788,	Choi, Hoon Young	TH-PO827,	SA-PO365, SA-PO366, SA-PO881		TH-PO070, TH-PO766,	
SA-PO932		FR-PO085, FR-PO791		TH-PO254,		FR-PO002	
Chetcuti, Karen	FR-PO919	Choi, Hye Min	SA-PO367, PUB200	FR-PO986, SA-PO1000		TH-OR02,	
Cheung, Alfred K.	TH-OR23,	Choi, Hyunso	FR-PO396, FR-PO977	Chung, Eun ji	FR-PO690	TH-OR07, TH-PO026, TH-PO028,	
TH-PO297, TH-PO659, FR-OR22,		Choi, Ji-Young	TH-PO067, SA-PO828	Chung, Hyunjae	FR-PO602	TH-PO734, TH-PO797, FR-PO006,	
FR-PO737, FR-PO747, FR-PO748,		Choi, John Y.	TH-OR49, TH-OR51,	Chung, Joon-Yong	SA-PO958	SA-PO280, SA-PO914, SA-PO953,	
FR-PO756, SA-PO015, SA-PO016,		TH-OR53, TH-PO653, TH-OR46		Chung, Kevin K.	TH-PO107	PUB111, PUB112	
SA-PO924, PUB082		Choi, Jungmin	TH-PO365, TH-PO366	Chung, Madeline S.	SA-PO509,	TH-PO530, SA-PO543	
Cheung, Chee Kay	FR-PO891	Choi, Jusong	SA-PO442, SA-PO521	PUB179		FR-PO073	
Cheung, Katharine L.	TH-PO774,	Choi, Mary E.	TH-PO705, SA-PO1005	Chung, Ryan K.	FR-PO305	TH-OR34	
TH-PO795		Choi, Michael J.	SA-PO939, PUB135	Chung, Sharon	TH-PO484	TH-PO699	

Cockovski, Vedran	TH-OR30	Constantinescu,	FR-PO375,	Curtis, J. Randall	SA-OR32
Cockwell, Paul	FR-OR40	Alexandru R.	FR-PO950	Curtis, Katherine	SA-PO369
Cody, Ellen	PUB280	Constantinescu, Serban	PUB021	Cushman, Mary	TH-PO243,
Coe, Fredric L.	FR-OR09, SA-PO170		FR-PO233		TH-PO916
Coelho, Ana C.	SA-PO177	Conte, Brianna	TH-PO113,	Custer, James	FR-PO948
Coelho, Venceslau A.	TH-PO781,	Conte, Carolina	SA-PO612, SA-PO613	Custodio, Melani	SA-PO215
	TH-PO782	Conti, Simon	TH-PO627, TH-PO628	Cusumano, Ana M.	PUB159
Coffee, Sarah	SA-PO641	Contreras, Cynthia	TH-PO771	Cutino Moguel, Teresa M.	FR-PO785,
Cogal, Andrea G.	SA-PO568,	Contreras, Gabriel	PUB283		PUB327
	SA-PO574		SA-PO121	Cwiek, Aleksandra	SA-PO818
Coggan, Andrew R.	TH-PO819,	Contreras, Kateir	FR-PO029	Cybulsky, Andrey V.	SA-PO239
	SA-PO302	Cook, David L.	TH-PO021	Czarnecki, Peter G.	PUB063
Coggan, Sarah E.	TH-PO272,	Cook, Nancy R.	SA-PO187	Czock, David	SA-OR47
	TH-PO275	Coolidge, Bradley S.	TH-PO346	Czogalla, Jan	TH-OR42
Cohen - Hagai, Keren	SA-OR09	Coombes, Jeff S.	TH-PO606	D'Agati, Vivette D.	FR-PO190,
Cohen, Debbie L.	FR-PO736,	Coombs, Nickolas	FR-PO631, PUB221		SA-PO159, SA-PO974
	SA-PO192	Cooney, Danielle N.	FR-PO553	D'Agostino, Mariagrazia	TH-PO344
Cohen, Jordana B.	TH-PO849,	Cooney, Sarah	SA-PO333, SA-PO892	D'Alessandri-Silva,	
	FR-PO736	Coons, Eric M.	SA-PO710	Cynthia J.	FR-PO521, FR-PO523,
		Cooper-DeHoff, Rhonda M.	FR-PO320		SA-PO428, SA-PO454, PUB275
Cohen, Scott D.	TH-PO021, SA-PO841	Cooper, Jacie T.	SA-PO280	D'Ambrosio, Viola	FR-OR45
Colby, Liz	FR-PO639	Cooper, Mark E.	TH-PO205, SA-PO254	D'Andrea, Elvira	SA-PO260
Cole, Alicia S.	SA-PO460	Cooper, Matthew	FR-PO803, SA-OR45	D'Aquino, Katharine	SA-PO100
Coleman, Erin R.	TH-PO392	Copeland, Timothy P.	SA-PO806	D'Costa, Matthew	TH-PO950,
Coleman, Kyle P.	FR-OR32	Copin, Marie-Christine	FR-PO580,		SA-OR23
Collart, Frederic	SA-PO352		FR-PO588, FR-PO591	D'Cruz, Robert	FR-PO377
Collazo-Maldonado,		Coppo, Rosanna	PUB228	D'Haese, Patrick	FR-OR06
Roberto L.	FR-PO106,	Coppock, Gaia M.	TH-PO474,	da Costa Pereira, Alexandre	SA-PO556
	FR-PO240, PUB074,		FR-PO677, FR-PO1006	Da Costa, Jonathan	TH-PO520
Collette, Suzon	SA-OR43	Corapi, Kristin M.	TH-PO215	Da Sacco, Stefano	TH-PO417,
Collie, Mary M.	TH-PO482	Cordasic, Nada	PUB255		FR-PO378, FR-PO690, SA-OR28
Collier, Willem H.	SA-OR38,	Cordido, Adrian	FR-PO263, FR-PO273,	da Silva Fernandes, Sylvina	FR-PO1002
	SA-PO920		FR-PO345	Da Silva, Igor O.	SA-PO072
Collins, A. Bernard	FR-PO156	Coresh, Josef	TH-PO743,	Dabaghie, Dina	FR-PO696
Collins, Agnieszka	TH-PO215		TH-PO786, TH-PO847, TH-PO862,	Dacey, Madeleine T.	TH-OR12
Collins, Ashte K.	SA-PO051		TH-PO890, TH-PO898, FR-PO216,	Dadhania, Darshana M.	TH-PO791,
Collins, Christopher E.	TH-PO488		FR-PO409		TH-PO909, TH-PO956, FR-PO767,
Collins, Clifford	SA-PO298	Coritsidis, George N.	TH-PO292,		FR-PO783, FR-PO841, SA-PO116
Collins, Eric B.	TH-PO601		SA-PO548, PUB162, PUB338	Dado, David N.	PUB207
Collins, Jemetra	SA-PO541	Cork, David	SA-PO702	Daehn, Ilse S.	FR-PO123
Collins, Kane E.	TH-PO364,	Corkrean, Julie	TH-PO020	Daga, Ankana	SA-PO566
	TH-PO646, TH-PO647, FR-PO935	Cornacchia, Giandomenico	TH-PO491	Dagher, Michael M.	SA-PO452
Collins, Lauren F.	TH-PO762	Cornelissen, Elisabeth A.	FR-PO440	Dagher, Pierre C.	TH-PO183,
Collins, Michael	FR-OR08	Cornelius, Allen	SA-PO916		TH-PO184, FR-OR34, FR-PO124,
Collins, Michael G.	PUB312	Cornelius, Denise C.	SA-PO976		FR-PO169, SA-PO956, PUB093
Collins, Michaela	TH-PO039	Cornelius, Ryan J.	TH-PO320	Crispilha, Shirley F.	FR-OR05
Collister, David T.	TH-PO289,	Cornell, Lynn D.	TH-PO242	Crompton, Michael	TH-PO193
	TH-PO767, FR-PO519, FR-OR885,	Cornier, Marc-Andre	TH-PO220	Cronin, Jamie E.	TH-PO015
	SA-PO327, SA-PO944	Corona Villalobos, Celia P.	SA-PO947,	Crook, Jacob L.	PUB116
Colombo, Daniele	FR-PO024		PUB223	Cross, Jennifer	SA-PO688
Colon, Selene	TH-PO423	Corona, Antonio	FR-PO184, PUB128	Crossman, Ashley	TH-PO708,
Colson, Carey	FR-PO873, SA-PO320	Corradi, Andrea	FR-PO884		SA-PO838
Colucci, Manuela	SA-PO706	Corradi, Valentina	TH-PO359	Croteau, Jeff S.	PUB211
Colville, Deb J.	SA-PO565	Correa-Rotter, Ricardo	TH-PO244,	Crowley, Steven D.	FR-PO953
Colvin, Robert B.	TH-PO080,		TH-PO244,	Crowley, Susan T.	TH-PO870,
	FR-PO193, SA-OR44, SA-PO736		TH-PO397, TH-PO517, TH-PO687,		TH-PO871, FR-PO930, FR-PO941,
Comai, Giorgia	FR-PO399		TH-PO688, FR-OR26, FR-PO004,		SA-OR33, SA-PO304
Comas Soberats, Maria	FR-PO706		FR-PO562, SA-OR36, SA-OR37,	Croyle, Mandy J.	FR-PO130,
Comas, Angels	TH-PO501		SA-PO411, SA-PO885, SA-PO886,		FR-PO245, FR-PO252, FR-PO296
Combe, Christian	TH-PO854,		SA-PO887, SA-PO889	Cruz, Bethany	TH-PO020
	TH-PO880, FR-PO221, SA-PO184,	Corrigan, Dillon	SA-PO825	Cruz, Cristinoc	SA-PO686, SA-PO691
	SA-PO925	Corsi, Cristiana	SA-PO007	Cruz, Pedro A.	PUB057
Combes, Alexander N.	FR-PO356,	Cortado, Hanna H.	TH-PO113,	Cruz, Trixie	PUB076
	FR-PO385		SA-PO604, SA-PO605, SA-PO607,	Cruz, Zulma C.	SA-PO1012
	TH-PO123		SA-PO610, SA-PO613	Cuckow, Peter M.	SA-PO618
Comer, Amber	TH-PO784	Cortazar, Frank B.	TH-PO456,	Cueto-Manzano, Alfonso M.	SA-OR39
Comfort, Branden W.	SA-PO404		FR-PO646, FR-PO651	Cuevas Budhart, Miguel A.	FR-PO489
Compean, Abel Humberto V.	PUB061	Cortes-Sanabria, Laura	SA-OR39	Cuevas, Santiago	TH-PO249
Compton, Noah F.	FR-OR13	Cortes, Carlos	SA-PO677, PUB184	Cugno, Massimo	SA-PO576
Comrie, Cameron E.	TH-PO773	Cortes, Jorge A.	FR-PO029	Cui, Jie	SA-PO679
Comunidad Bonilla,		Cosgrove, Dominic E.	FR-PO692	Cui, Xinyuan	PUB235
Roque A.	FR-PO642	Cosimi, Anthony B.	TH-OR54	Cukor, Daniel	SA-PO303
Concepcion, Beatrice P.	TH-PO791,	Costa e Silva, Veronica T.	FR-PO179,	Culek, Christopher	SA-PO634
	SA-PO672, SA-PO854, SA-PO868,		SA-PO121, SA-PO147, SA-PO148	Cullen-McEwen, Luise A.	FR-PO385
	SA-PO875	Costa, Claudia	FR-PO094, SA-PO041	Cummins, Timothy	TH-PO446,
Concepcion, Danilo	TH-OR18	Costa, Gillian	FR-PO603		TH-PO447, TH-PO448
Conforti, Laura	SA-PO236	Costa, Joana	SA-PO457	Cunard, Robyn A.	SA-PO437
Conger, M.	PUB098	Costa, Rui M.	SA-PO377	Cunha, Milena V.	TH-PO516
Conlon, Peter J.	TH-PO364, TH-PO380,	Costa, Teresa V.	FR-PO428	Cunliffe-Koehler, Kennedy	SA-PO756
	TH-PO646, TH-PO647,	Costa, Tiago E.	TH-PO781, TH-PO782	Cunningham, Adam F.	TH-PO928
	FR-PO864, FR-PO935,	Costalonga, Elerson	FR-PO179,	Cunningham, Jason J.	SA-PO1002
	SA-OR27, SA-PO333,		SA-PO121, SA-PO148	Cunningham, Patrick	SA-PO869
	SA-PO578, SA-PO701, SA-PO892	Costello, Hannah M.	TH-PO326,	Cunnington, Marianne	TH-PO658
Connaughton, Dervla M.	SA-PO542,		TH-PO327, TH-PO328, SA-PO777,	Curci, Claudia	SA-PO647
	SA-PO563, SA-PO578		SA-PO779, PUB257	Curhan, Gary C.	SA-PO146, SA-PO259
Connor, Michael J.	SA-PO501	Costes-Albrespic, Margaux	TH-PO854	Currier, Helen	SA-PO443
Conserva, Francesca	TH-PO204			Curry, Kathryn M.	TH-PO356

Dansie, Kathryn	PUB312	de Holanda, Maria Isabel N.	SA-PO630,	Delles, Christian	SA-PO272, PUB095	Dia, Batoul	TH-PO219
Dao, Tram	SA-PO034, PUB216		PUB022	Delneste, Yves	FR-PO580	Dial, Katelyn	TH-PO191, FR-PO688,
Daoud, Ahmed	FR-PO819	De Jesus Ramos, Charlyenne	SA-PO677	Delos Santos, Noel	SA-PO128		FR-PO999
Daratha, Kenn B.	TH-PO255,	de Jong, Margriet	TH-PO761	Delos Santos, Rowena B.	FR-PO823,	Diamantidis, Clarissa J.	TH-PO052,
	FR-PO662	de la Serna, Mariano	FR-PO135,		FR-PO825		TH-PO057, FR-PO064, SA-PO598
Dart, Allison	TH-PO589, TH-PO765	De la torre quiroga,	FR-PO968, FR-PO983	Delozier, Sarah	TH-PO622	Diao, Hui	TH-PO203
Darwish, Tarek	TH-PO356	Andres E.	TH-PO166	Delpire, Eric J.	TH-PO319, FR-OR44	Dias, Christian	PUB051,
Das, Arjun	SA-PO159	de la Vega Méndez,		Delsante, Marco	TH-PO530	Dias, Cristiane B.	TH-PO516,
Das, Falguni	TH-PO197	Frida Margarita	TH-PO046,	Deluca, David S.	SA-PO112		FR-PO678, FR-PO732, SA-PO683
Das, Ujjalkumar S.	PUB287		PUB122, PUB209, PUB252	Deluca, Hector F.	TH-PO144	Dias, Daniel	TH-PO627, TH-PO628
Das, Vivek	TH-PO213	de Lastic, Anne-Lise	TH-PO583	Deluca, Thomas P.	SA-PO310,	Diatlov, Daniel	FR-PO362, FR-PO390,
Dasari, Surendra	TH-PO731,	De León, Werner	TH-PO524, PUB232		SA-PO445		SA-PO661
	TH-PO732, FR-PO190	De loor, Henriette	TH-PO810	Demaretz, Sylvie	FR-OR48	Diaz Bessone, Maria Ines	TH-PO166,
Dasgupta, Alana	TH-PO089,	De Luca, Francesco	PUB269	Dember, Laura M.	TH-PO814,		SA-PO314, SA-PO315
	TH-PO114, SA-PO693	De Luca, Thomas	FR-PO131,		SA-PO303	Diaz Cruz, Luis A.	PUB184
Dasgupta, Indranil	TH-PO154,		FR-PO137	Demir, Fatih	FR-PO351, FR-PO712	Diaz Garcia, Juan D.	FR-PO618,
	TH-PO688, FR-PO536, SA-PO184	De Meester, Johan M.	FR-PO923	Demirci, Hasan	TH-PO642, TH-PO645		SA-PO483, PUB061, PUB115
Date, Ryosuke	TH-PO210, SA-PO067	De Menezes, Nicole K.	SA-PO072	Demirjian, Sevag	FR-PO071,	Diaz Villavicencio, Bladimir	TH-PO046
Datta, Manoj K.	SA-PO968	De Miguel, Carmen	TH-PO121		SA-PO426, PUB062	Diaz-Jarquin, Alejandra	FR-PO027
Datta, Somenath	SA-OR27	De Nicola, Luca	TH-PO889, SA-PO887,	Demko, John E.	TH-PO311, TH-PO347	Dick, Andre	TH-PO738
Dattani, Rakesh	FR-PO660	de Paiva, Bruna R.	TH-PO832,	Denburg, Michelle	TH-PO605,	Dickinson, Stephanie	TH-PO811
Dauchet, Luc	TH-PO771		TH-PO834	Denic, Aleksandar	FR-PO408, FR-PO409,	Didsbury, Madeleine	TH-OR31
Daugas, Eric	SA-PO649		TH-PO834		SA-PO181, SA-PO207, SA-PO931	Diefenhardt, Paul	FR-PO600,
Daugirdas, John T.	SA-PO355	De Rosa, Liliana Italia	TH-PO367	Dendooven, Amélie	FR-PO923		FR-PO686
Davenport, Andrew	FR-PO536	De Rosa, Silvia	TH-PO041	Deng, Fei	TH-PO282, PUB239	Dieguez, Gabriela	TH-PO666
David-Neto, Elias	FR-PO880	de Ruitter, Anna	SA-PO346	Deng, Ruining	TH-PO572	Dieplinger, Georg	SA-OR42
David, Valentin	TH-PO149,	de Sá, Belise K.	FR-PO430	Denholm, Barry	FR-PO710	Dighe, Ashveena	SA-PO947
	TH-PO656, TH-PO657, FR-OR02,	de Seigneux, Sophie M.	TH-PO556	Denic, Aleksandar	TH-PO418,	Dighe, Tushar A.	TH-PO430,
	FR-OR07, FR-PO389, SA-PO177,	de Sequera, Patricia	TH-PO917		TH-PO568, FR-PO815, SA-PO937		SA-PO813
	SA-PO214	De Sousa, Ciria L.	SA-PO692	Dennis, Brittany	TH-PO850	Dijkstra, Kyra L.	FR-PO1009
Davidson, Kelly	PUB318	De Souza, Vitor S.	PUB034	Dennis, Michael D.	SA-PO229	Dillinger, Elizabeth K.	FR-PO259
Davidson, Nicholas	FR-PO122	De Vries, Aiko P.	FR-PO011	Denton, Jerod S.	TH-PO325	Dillon, John J.	PUB029
Davidson, Shania R.	FR-PO688,	de Zeeuw, Dick	TH-PO244	Deprele, Carole	PUB288	Dillon, Stacey R.	TH-PO499
	FR-PO999	Deaguero, Joshua	TH-PO091,	Derebail, Vimal K.	FR-PO133,	Dilmen, Emre	TH-PO331
	FR-PO639		TH-PO092, TH-PO848, SA-PO077		FR-PO809, SA-PO694	Dimino, Tara L.	SA-PO115
Davies, Elaine M.	FR-PO639	Deb, Dilip K.	FR-PO347, FR-PO389	Dergai, Mykola	SA-PO1011	Dimke, Henrik	TH-PO333
Davies, Michael J.	SA-PO263,	Deban, Christa A.	TH-OR49, TH-OR51,	DeRiso, Jennifer	FR-PO391	Dina-Battle, Eliana	PUB020,
	SA-PO264		TH-OR53, TH-PO653, SA-OR46	Dermady, Miranda	SA-PO710		PUB036, PUB233, PUB272,
Davies, Rupert H.	TH-PO499	Debbas, Victor	SA-PO102	Deronde, Kimberly	SA-PO818		PUB273, PUB325
Davies, Sean S.	FR-PO975	Debiec, Hanna	FR-PO303	Dervishi, Egrina	TH-OR11	Ding, Hao	TH-PO293
Davies, Simon J.	FR-PO536	Debnath, Neha	PUB112	Desai, Amishi S.	FR-PO794, PUB319	Ding, Jim	FR-PO334
Davila Terreros, Pedro J.	TH-PO489	Debreczeny, Martin	TH-OR38	Desai, Dhruv N.	TH-PO135	Ding, Linna	TH-PO484
Davis-Karim, Anne	SA-PO895	Debure, Ludovic	SA-PO319	Desai, Niraj	FR-PO553	Ding, Lu H.	TH-PO431, PUB109
Davis, Alyssa L.	SA-PO868	Decarli, Charles S.	TH-OR25	Desai, Tejas	TH-PO017	Ding, U Zhe	FR-PO641
Davis, Angela L.	FR-PO494	Decker, Eva L.	SA-PO592	Desbiens, Louis-Charles	FR-PO739	Dinh Phan, Johnny	FR-PO243,
Davis, Jason	SA-PO888	Dedhia, Charmi	FR-PO691	Deshmukh, Abhishek	SA-PO952		SA-PO745
Davis, Jessica L.	TH-PO187	Deep, Akash	FR-PO436	Deshmukh, Hemalata	TH-PO194,	Dimis-Oliveira, Ricardo J.	TH-PO627,
Davis, LaShara A.	SA-OR31	Deepak, Sachin K.	FR-OR56		SA-PO225		TH-PO628
Davis, Merin	SA-PO1003	Defilipp, Zachariah	SA-PO151	Deshpande, Sumukh	FR-PO365	Diniz, Renan G.	FR-PO880, SA-PO505
Davis, Michael	TH-PO839	Defreitas, Marissa J.	FR-PO425,	Desir, Gary V.	FR-PO121, FR-PO122	Dion, Sébastien	TH-PO578
Davis, Otis	FR-PO917		FR-PO431, FR-PO437, SA-PO599	Deslauriers, Louis	FR-PO563	Dionne, Janis M.	TH-PO667
Davis, Tyler A.	FR-PO937	Defronzo, Stefanie	FR-PO006	Desmeules, Simon	TH-PO578	Dionne, Jodie	TH-PO762
Davison, Sara N.	SA-PO327	Degnan, James H.	TH-PO091	Desmond, Hailey	PUB234	Diop, Momar A.	SA-PO781
Daw, Jonathan	FR-PO884	Dehde, Silke	SA-PO746, SA-PO747	Dessouche, Alice	FR-PO588, FR-PO591	Dipollina, Chris	SA-PO478, SA-PO730
Dawson, Anne E.	FR-PO417, FR-PO863, SA-PO949	Dehnadi, Abbas	TH-OR54	Dessen, Marcelo	PUB029	Dirim, Ahmet B.	FR-PO824, SA-PO795
Day, Meghan	SA-PO717	Dejhansathit, Siroj	TH-PO695	Detwiler, Randal K.	FR-PO809	Dissanayake, Imara	FR-PO478,
Dayalan, Lusyan	SA-PO233	Dejman, Adriana	TH-PO279,	Devalaraja-Narashimha,			SA-PO676
Daza Aguilar, Andrea C.	FR-PO800		TH-PO403	Kishor B.	TH-PO252, FR-OR32,	Dissanayake, Lashodya V.	FR-PO277,
De Blanco, Gladis S.	FR-PO264	Dekel, Benjamin	FR-PO376		SA-OR04		SA-PO753
de Boer, Ian H.	TH-PO247,	Dekker, Friedo W.	TH-PO300,	Devane, John	SA-PO551	Dissard, Romain	TH-PO556
	TH-PO605, FR-OR36, SA-PO185,		TH-PO788, SA-PO932	Devaraj, Susan M.	TH-PO722,	Disthabanchong, Sinee	TH-PO836
	SA-PO187, SA-PO912, SA-PO929,	Del Castillo Rix, Daniel S.	SA-PO358,		FR-PO867, SA-PO943	Ditt, Vanessa A.	SA-OR42
	SA-PO947, PUB100		SA-PO361	Devarajan, Prasad	TH-PO030,	Ditting, Tilmann	SA-PO784, PUB255
De Borst, Martin H.	TH-PO382,	Del Nonno, Franca	FR-PO024		TH-PO081, FR-PO971, PUB280	Dittrich, Mary O.	PUB351
	TH-PO675, TH-PO676, TH-PO698,	Del Rio-Pertuz, Gaspar	TH-PO695,	DeVita, Maria V.	PUB072, PUB266	Ditzler, Matthew	SA-PO603
	TH-PO803, TH-PO846, FR-PO810,		FR-PO096	Devresse, Arnaud	FR-PO335	Divakar, Prajan	SA-OR44
	SA-PO161, SA-PO536	Del Toro-Cisneros, Noemi	FR-PO003,	DeVries, Todd	TH-PO497	Divino-Filho, Jose C.	FR-PO489
de Cal, Massimo	TH-PO041,		FR-PO004, SA-PO411	Devuyt, Olivier	FR-PO891	Dixon, Bradley P.	SA-PO596
	SA-PO009, SA-PO011	Del Vecchio, Lucia	TH-PO687,	Dew, Mary amanda	SA-PO820	Dixon, Eryn E.	TH-OR44, FR-PO133
de Carvalho Ribeiro,			SA-OR37	Dhalla, Anisha	SA-PO821, SA-PO822	Djema, Assia Ilham	FR-PO580,
Patricia	SA-PO242	Delalla, Jacob	PUB051	Dhani Mohamed, Angelina	SA-PO724		FR-PO588, FR-PO591
De Castro, Leticia U.	SA-PO072	Delanaye, Pierre	TH-PO780, FR-PO897	Dhatt, Keerat	SA-PO434	Djordjev, Ognjenka	TH-PO667,
De Chiara, Letizia	TH-PO141,	Delap, Sara M.	SA-PO129	Dhaulta, Praveen	PUB152		TH-PO901, TH-PO905
	FR-PO146, FR-PO958, SA-PO065,	Delay, Agnes	PUB238	Dhawan, Rahul	TH-PO708, SA-PO838	Do, Ron	SA-PO914, PUB163
	SA-PO088	Delbuono, Joy A.	FR-PO874	Dhayalan, Dhayanithi	SA-PO446	Doan, Joseph	PUB203
de Courcy, Jonathan J.	SA-PO657,	Deleersnijder, Dries	FR-PO923	Dhillon, Poonam	FR-OR38, FR-PO963	Dobler, Claudia C.	FR-PO860
	SA-PO658	Delgado Figueroa,		Dhindsa, Sandeep		Dobre, Mirela A.	TH-PO622
	FR-PO073	Netzahualpilli	SA-PO445	Singh Dhindsa	FR-PO814	Dobronravov, Vladimir A.	TH-PO685
De Filippo, Marta	TH-PO417,	Delgado, Cynthia	FR-PO894	di Bari, Ighli	TH-PO361, TH-PO362	Dobson, Curtis B.	FR-PO471
De Filippo, Roger E.	FR-PO378, FR-PO403,	Delijani, David	FR-PO070	Di Cranziano, Veronica	SA-OR42	Doddi, Akshith	FR-PO176
	FR-PO690, SA-OR28	Delker, Don	TH-PO307, TH-PO308	Di leo, Vincenzo	SA-PO647	Doheny, Jane M.	FR-PO180
De frutos garcia, Sergio	FR-PO135,	Dell, Katherine M.	TH-PO594,	Di marco, Federico	SA-PO135	Doherty, Cathleen	FR-PO223
	FR-PO968, FR-PO983		SA-PO587	Di Mise, Annarita	FR-PO357	Doherty, Taylor	SA-PO437
De Gouville,		Dellanna, Frank	SA-PO416	Di noia, Tommaso	TH-PO491	Doi, Toshiki	SA-PO370, SA-PO396,
Anne-Charlotte M.	TH-PO658	Dellepiane, Sergio	TH-PO083,	Di Palo, Katherine E.	FR-PO551		SA-PO417
de Haan, Amber	SA-PO536		SA-PO914	Di, Mengyu	SA-PO830	Doke, Tomohito	FR-OR30, FR-PO1006

Dokladny, Karol TH-PO091, TH-PO092, TH-PO848, SA-PO077  
Dolan, Emma L. TH-PO724  
Doll, Mark A. FR-PO189  
Döllner, Johannes PUB255  
Dolma, Sonam PUB303, PUB306  
Dolzhan, Vita TH-PO650  
Dominello, Amanda G. FR-PO871  
Domingues, Bárbara F. TH-PO904, PUB320  
Domínguez Báez, Pamela TH-PO178  
Dominguez, Adrian T. SA-PO158  
Dominguez, Jesus H. TH-PO099, FR-PO118  
Dominguez, Wagner SA-PO213, SA-PO215  
Dommert-Breckler, Barbara TH-OR18  
Dommu, Aaron M. FR-PO620  
Domondon, Mark SA-PO762, SA-PO763  
Donadei, Chiara FR-PO399  
Donald, Joseph SA-PO404  
Donald, Maoliosa SA-PO322, SA-PO833  
Donato, Bonnie M. TH-PO601, TH-PO726, TH-PO893  
Donato, Tony J. TH-PO297  
Donders, Ella B. TH-PO303  
Donelle, Jessy FR-PO835  
Dong, Jiaming SA-PO423  
Dong, Jianhua SA-PO421, SA-PO689  
Dong, Ke FR-PO268, FR-PO345  
Dong, Weichuan SA-PO131, SA-PO143  
Dong, Xinyu FR-PO368, FR-PO369  
Dong, Zheng FR-PO127, FR-PO128, FR-PO175, FR-PO954, FR-PO973, SA-PO970, SA-PO971  
Dong, Zijun TH-PO953, FR-PO009, SA-PO430  
Donnan, Michael D. FR-PO389  
Donovan, Joshua FR-PO019  
Donow, Haley M. SA-PO244  
Doreille, Alice SA-PO545  
Dores, Mariana TH-PO257  
Doria, Alessandro TH-PO232, FR-OR37  
Dorie, Justin R. SA-PO373, SA-PO374  
Dorileo Leite Bernardi, Murillo SA-PO021  
Dorizas, Christopher A. SA-PO506  
Dorobisz, Sylvester TH-PO470, FR-PO038  
Dorr, Casey R. FR-PO799  
Dorshow, Richard B. TH-OR38  
dos Reis, Luciene TH-PO165, FR-OR07, SA-PO177, SA-PO213, SA-PO215  
Dos Santos, Ana Carolina A. SA-PO600  
Dos Santos, Fernanda G. SA-PO692  
Dosaanjh, Davinder P. FR-PO005  
Doshi, Mona D. TH-PO815  
Dossabhoy, Neville R. FR-PO633, SA-PO362  
Dossier, Claire FR-PO303  
Doucet, Alain TH-PO322  
Dougherty, Julie TH-PO446, TH-PO448  
Douglas- Ajayi, Clarica FR-PO540, FR-PO541  
Douma, Lauren G. TH-PO326, TH-PO327, TH-PO328, FR-PO288, SA-PO769, SA-PO779, SA-PO985, PUB257  
Doulos, Antonios TH-PO882  
Douvris, Adrianna SA-PO082  
Dovc, Ana PUB328  
Dow, Julian A. SA-PO580  
Dowdy, David W. TH-PO892  
Dowling, Francis FR-PO005  
Downie, Mallory L. SA-PO554  
Doyle, Alden M. PUB318  
Doyle, Brendan TH-PO129, PUB262  
Drakakis, James FR-PO667, PUB188, PUB242, PUB337  
Drakas, Robert FR-PO946  
Drakopoulos, Angelos TH-PO363, TH-PO388  
Drall, Kelsea FR-PO868  
Drambarean, Beatrice PUB345  
Draughon, Samantha FR-PO494  
Drawz, Paul E. TH-PO057, TH-PO059  
Drayson, Mark T. TH-PO751  
Drechsler, Christiane TH-PO788, SA-PO932  
Dreger, Kimberley TH-PO309  
Dreismeier, Julian TH-PO860  
Drel, Viktor TH-PO107  
Drenic, Vedran SA-PO222  
Dressler, Greg R. SA-PO090  
Drexel, Carole PUB228  
Drexler, Yelena TH-PO479, TH-PO631, FR-OR53, PUB249  
Drilon, Alexander SA-PO117  
Droste, Patrick SA-PO786  
Droubi, Sami PUB332  
Drucker, Charles B. TH-PO328, SA-PO777  
Drummond, Iain A. FR-PO405  
Drury, Zachary SA-PO424  
Drygin, Denis TH-PO408  
Du, Changhong SA-PO1006  
Du, Doantrang PUB043  
Du, Fuyong TH-PO088  
Du, Hao FR-PO970  
Du, Qin Y. PUB239  
Du, Te PUB031  
Du, Yan TH-PO850  
Du, Yongjing TH-PO492  
Du, Yuxian TH-PO718, FR-PO924  
Du, Zhaopeng TH-PO342  
Dua, Richa SA-PO577  
Duangkham, Samapon TH-PO695, FR-PO096  
Duann, Pu FR-PO404  
Duarte, Maria E. FR-PO692  
Duarte, Rui A. TH-PO937  
Dubay, Derek FR-PO819  
Duberstein, Paul TH-PO783  
Dubey, Manisha FR-PO870  
Dubief, Yves PUB084  
Dubourg, Laurence TH-PO731  
Duch, John M. FR-PO460  
Dudzinski, Chris SA-PO713, PUB164  
Dueck, Anne SA-PO626  
Duff, Stephen TH-PO031  
Duffield, Jeremy S. FR-PO343  
Duffin, Kevin L. TH-PO232, SA-PO269  
Duffy, Margaret TH-PO131  
Duineveld, Caroline TH-PO503  
Dukka, Hari FR-PO472  
Dullaart, Robin P. SA-PO270  
Dumanski, Sandi M. TH-PO610, TH-PO745, TH-PO746, TH-PO747, FR-PO868  
Dumas, Sébastien J. TH-OR43, FR-OR14  
Dumoulin, Bernhard FR-PO351  
Duncan, Heather SA-PO236  
Duncan, Neill D. SA-PO382  
Dunlap, Carolyn SA-PO633  
Dunn, Ian A. FR-PO697  
Dunn, Ken FR-PO169  
Dunning, Stephan C. FR-PO509  
Duong, Alex TH-PO270  
Duque, Eduardo J. FR-OR05  
Duque, Juan C. TH-PO256, TH-PO279, SA-PO403  
Duran Crane, Alejandro TH-PO010  
Durek, Pawel FR-PO420  
Duriseti, Parikshit TH-PO412, FR-OR851, SA-PO050, PUB189  
Durosier Louis, Miniolla PUB338  
Durrani, Muhammad PUB183  
Duru, Obidugwu FR-PO937  
Dutton, Debra M. SA-PO432  
Duvnjak, Blanka SA-PO761  
Dwinell, Melinda R. FR-PO275  
Dwivedi, Shaunak A. FR-PO033  
Dworkin, Lance D. FR-PO592  
Dworschak, Gabriel C. SA-PO572  
Dwyer, Jamie P. TH-PO456, SA-PO453  
Dzedzik, Siarhei TH-PO585  
Eadon, Michael T. TH-OR41, TH-PO183, TH-PO184, FR-OR09, FR-OR20, FR-OR34, FR-PO131, FR-PO154, FR-PO169, FR-PO320, SA-PO001, SA-PO956  
Easom, Andrea K. TH-PO741  
Eason, James D. TH-OR50, TH-PO459, FR-PO787  
Eaton, Amity F. TH-PO332, SA-PO756  
Eaton, Karen-Marie SA-PO809, SA-PO810  
Ebefors, Kerstin TH-PO426, FR-PO718  
Eberle-Singh, Jaime FR-PO675  
Ebert, Maximilian FR-PO582  
Ebert, Nadja FR-PO076  
Ebert, Natalie TH-PO769, TH-PO775, TH-PO780, TH-PO796, TH-PO882, FR-PO897  
Ebrahimi, Farhang TH-PO176, PUB014, PUB183  
Echeverri, Diego TH-PO481  
Eckardt, Kai-Uwe FR-PO066, FR-PO157, FR-PO550, FR-PO576  
Eckberg, Kara FR-PO406  
Ecker, Simone FR-PO917  
Eckermann, Leya TH-PO309  
Eckersley, Kay TH-PO433  
Eddy, Sean TH-PO211, TH-PO419, TH-PO422, TH-PO441, TH-PO530, FR-PO351, FR-PO724, SA-OR04, SA-PO258  
Edelstein, Charles L. FR-PO249, FR-PO250, FR-PO279, FR-PO280, SA-PO596  
Edelstein, Susan A. SA-PO400  
Eder, Matthias SA-PO145  
Edge, Mark P. SA-PO283  
Edgley, Amanda J. TH-PO422  
Ediale, Temi-Ete I. SA-PO514, SA-PO725  
Edmondson, Ricky TH-PO452  
Edson, Elise FR-PO521, SA-PO428  
Edwardsson, Vidar O. TH-PO591, FR-PO338, SA-PO579  
Edwards, Angelina FR-PO627, SA-PO872  
Edwards, Aurelie TH-PO316  
Edwards, Beth FR-PO882  
Edwards, Colin SA-PO350  
Edwards, John C. FR-PO314, SA-PO850, SA-PO851  
Edwards, Todd L. FR-PO761  
Eelen, Guy FR-OR14  
Egbuna, Ogo I. TH-PO480, TH-PO481  
Egstrand, Sören TH-PO142  
Eguchi, Makoto SA-OR25  
Ehlert, Lexy SA-PO694  
Ehmke, Heimo TH-PO309  
Ehret, Elodie SA-PO757  
Eiam-Ong, Somchai TH-PO582, TH-PO652, TH-PO790, FR-PO079, FR-PO474, SA-PO163, SA-PO406, SA-PO449, SA-PO894  
Eibensteiner, Fabian FR-PO454  
Eichenberger, Emily SA-PO452  
Eichinger, Felix H. TH-PO211, TH-PO422, FR-PO724, FR-PO992  
Eid, Assaad Antoine TH-PO185, TH-PO219, SA-PO246  
Eierhoff, Thorsten FR-PO699  
Eijgelsheim, Mark SA-PO536  
Eikrem, Oystein FR-PO699, SA-PO715  
Einbinder, Yael SA-OR09  
Einloft, Jonas SA-PO029  
Eirin, Alfonso FR-PO260, FR-PO398, SA-PO962, SA-PO963  
Eisenberger, Ute TH-PO505  
Eisenga, Michele F. TH-PO675, TH-PO676, TH-PO698, FR-PO810  
Eisert, Robyn J. TH-PO332  
Eitner, Frank SA-PO247  
Eiwaz, Mahaba B. FR-PO234  
Ekart, Robert FR-PO010, SA-PO291  
Ekiz, Esra FR-PO222  
Eklund, Jamey E. PUB240  
Ekpa, Ndifreke SA-PO503  
Ekperikpe, Ubong S. SA-PO976  
Ekwenna, Obi D. FR-PO771  
El Agroudy, Amgad E. SA-PO300, SA-PO807, PUB301  
El desoky, Sherif M. SA-PO538, SA-PO578  
El Fekih, Rania SA-OR46  
El ghormlı, Laure K. TH-PO247  
El Hachem, Karim TH-PO515  
El Kurdi, Abdullah B. TH-OR51  
El Saghır, Jamal TH-PO441, FR-PO351, FR-PO992  
El Shamy, Osama FR-PO477  
El Ters, Mireille TH-PO529  
El zinad, Nagla TH-PO288  
El-Achkar, Tarek M. TH-OR41, TH-PO183, TH-PO184, TH-PO574, FR-OR09, FR-OR34, FR-PO149, FR-PO150, FR-PO154, FR-PO169, SA-OR05, SA-PO001, SA-PO170, SA-PO956  
El-Hennawy, Adel S. PUB066  
El-Khoury, Bashir FR-PO883  
El-Mallah, Carla SA-PO772  
El-Youssef, Mounif TH-PO368  
Elavia, Nasha PUB147  
Elbita, Omar S. TH-PO299  
Elbraky, Abdelrahman A. SA-PO420  
Eldeniz, Cihat SA-PO788  
Eldrup, Nikolaj PUB103  
Elencwajg, Mauro SA-PO684  
Eley, Samuel T. FR-PO672  
Elfassy, Tali TH-PO631, FR-OR53, PUB249  
Elfering, Sarah L. FR-PO449, FR-PO450  
Elftouh, Naoual FR-PO227, FR-PO513  
Elgaali, Musab TH-PO923  
Elhassan, Elhussein A. TH-PO364, TH-PO646, TH-PO647, FR-PO864, FR-PO935, SA-OR27, SA-PO698  
Elhassan, Elwaleed A. FR-PO844, FR-PO845, FR-PO846, PUB295  
Elhawary, Omar N. FR-PO622, FR-PO670, SA-PO476, PUB349  
Elhusseiny, Khaled Mosaad TH-PO180, TH-PO242  
Eliades, Joel A. FR-PO385  
Elias Lopez, Marcos A. PUB053  
Elias, Bertha C. FR-OR28, FR-PO164, FR-PO1005  
Elias, Rosilene M. TH-PO165, TH-PO781, TH-PO782, TH-PO785, FR-OR05, SA-PO177  
Elijovich, Fernando SA-PO755  
Elimam, Hanan SA-PO239  
Elinder, Carl G. SA-PO1012  
Eliotok, Saban PUB015  
Eller, Kathrin FR-PO599  
Eller, Philipp FR-PO599  
Ellieman, Stephen J. FR-OR40  
Ellinger-Ziegelbauer, Heidrun C. SA-PO247  
Elliott, Mark SA-PO543  
Elliott, Meghan J. FR-PO868, SA-PO322, SA-PO833  
Ellis, Carla L. FR-PO041  
Ellison, David H. TH-PO319, TH-PO320, TH-PO323, TH-PO645  
Elmaleh, Hassan TH-PO296  
Elmayan, Ardem TH-PO073  
Elmer, Sarah FR-PO799  
Elsadawi, Murad TH-PO288  
Elsanjak, Abdelaziz A. FR-PO625, FR-PO947  
Elsayed, Hesham M. SA-PO420  
Elsayed, Ingi A. FR-PO088, SA-PO075  
Elsayed, Norhan SA-PO507, SA-PO723  
ElSharkawy, Magdy SA-PO420  
ElSheikhMohammed, Waleed A. FR-PO609  
Elsherif, Laila FR-PO414  
Elshirbeny, Mostafa TH-PO941  
Elwakiel, Ahmed SA-PO1010  
Emanuels, Davidson F. SA-PO806



Emara, Ahmed	SA-PO420	Evenepoel, Pieter	TH-PO810,	Fattah, Layla	TH-PO019	Fichadiya, Harshil	TH-PO133,
Emem-Chioma, Pedro C.	TH-PO050	FR-OR01, FR-OR06, SA-PO179,		Faubel, Sarah	TH-PO085	SA-PO033, SA-PO577,	
Emma, Francesco	SA-PO706	SA-PO325, SA-PO401, SA-PO932		Faucou, Anne-Laure	SA-PO925	PUB043, PUB070	
Enderle, Louise	PUB019	Ewhrudjakpor, Ruth	TH-PO289	Faugere, Marie-Claude M.	SA-PO193	Ficociello, Linda	TH-PO164,
Endlich, Nicole	FR-PO702,	Ewing, Elise	FR-PO627, SA-PO487	Faul, Christian	TH-PO152, FR-OR04	TH-PO167, TH-PO168, TH-PO932,	
	FR-PO726, SA-PO222	Eymael, Jennifer	TH-PO533	Faulhaber, Nicola	SA-PO679	SA-PO343, SA-PO378, SA-PO419,	
Endo, Mariko	SA-OR03	Eythorsson, Elias	FR-PO933	Fausto, Connor	FR-PO382	SA-PO425, PUB011	
Endres, Paul	TH-PO054	Ezzaiyani, Amal G.	SA-PO593,	Favarato, Daniela C.	SA-PO433	Fidalgo diaz, Manuel	SA-PO742
Eneanya, Nwamaka D.	TH-PO730,		PUB281	Favaron, Emanuele	TH-PO597	Fidler, Mary E.	FR-PO204, SA-PO050
	FR-PO862	Faddoul, Geovani	SA-PO468	Favi, Evaldo	FR-PO798, FR-PO840,	Fieuh, Ann	SA-PO930
Engelhardt, Stefan	SA-PO626	Fadel, Remy	TH-PO579		SA-PO871, PUB340	Fielding, Roger A.	TH-PO797
Engen, Rachel M.	FR-PO432	Fadem, Stephen Z.	SA-PO400	Fawad, Fnu	FR-PO156	Fields, Timothy A.	SA-PO745, PUB229
Enghard, Philipp	FR-OR54, FR-PO157	Fagan, Jack R.	FR-PO877	Fawaz, Souhiela	FR-PO544	Fieuw, Ann	TH-PO385
England, Bryant	SA-PO895	Fage, Nicolas	FR-PO591	Fayos de Arizón, Leonor	PUB197	Figueiredo, Constanca	TH-PO643
Englert, Jacob R.	TH-PO777	Fahim, Magid	PUB312	Fazio-Eynullayeva, Elnara	FR-PO849	Filipovic, Natalija	SA-PO622
Ennes, Gelzie S.	PUB1196	Fahim, Peter	FR-PO025	Fedarko, Neal S.	FR-PO757	Filiopoulos, Gerasimos	TH-PO604,
Enriquez, Raul V.	FR-PO017	Faienza, Sipontina	SA-PO754	Fedoruk, Mykhailo	TH-PO214		SA-PO275
Eom, Minseob	TH-PO177, SA-PO737	Fain, Margaret E.	FR-OR33	Fedson, Savitri	SA-PO047	Filler, Guido	FR-PO905, SA-PO436
Ephraim, Patti	TH-PO153, FR-PO537	Fairbourn, Brayden	TH-PO297,	Fegler, Alexandra L.	SA-PO296	Filus, Ania	TH-OR15, SA-PO340,
		SA-PO012, SA-PO013, SA-PO015,		Fei, Mingwei	FR-PO794, FR-PO804		PUB123
Eppenberger, Thomas G.	TH-PO011		PUB082	Fei, Yueyang F.	SA-PO619	Finer, Gal	FR-PO363
Epperson, Katrina	FR-PO107	Fairuz, Fabliha	FR-PO087	Feinstein, Matthew	SA-PO192	Fink, Annette	FR-PO774
Epstein, Ronald M.	TH-PO103	Faisatjatham, Surasak	FR-PO474	Felder, Robin A.	SA-PO791	Fink, Edward L.	FR-PO884,
Epting, Daniel	SA-PO551	Faivre, Anna	TH-PO556	Felderhoff, Thomas	TH-PO267		SA-PO814, SA-PO816
Epureanu, Bogdan I.	TH-PO867	Faizan, Mohammed		Feldman, Harold I.	TH-PO238,	Fink, Lisbeth N.	TH-PO223,
Er, Lee	TH-PO667, TH-PO905,	Khurram	SA-PO558		TH-PO605, TH-PO667, TH-PO814,		SA-PO222, PUB365
	FR-PO638	Fajol, Abul	FR-OR04		TH-OR874, SA-PO931	Finkelstein, Fredric O.	TH-PO691
Erdbruegger, Uta	TH-PO554,	Fakhredine, Sara	SA-PO197	Feldman, Katherine E.	FR-PO870	Finnerty, Andrew A.	FR-OR40
	TH-PO840	Fakrogha, Prelador E.	TH-PO050	Feldt-Rasmussen, Bo	TH-PO223,	Fiorentino, Desiree	TH-PO752
Erdogan, Cem	TH-OR55	Falci, Diego R.	TH-PO072		SA-PO188, SA-PO829	Fiorentino, Marco	FR-PO170
Erdreich-Epstein, Anat	FR-PO378	Falk, Ronald	TH-PO480,	Felger, Tim	SA-PO572	Fiorio, Francesco	SA-PO135
Erdut, Arda	FR-PO802		TH-PO482, FR-PO579, FR-PO586,	Felix Bauer, Karina C.	FR-PO562	Fischbach, Bernard V.	SA-OR43
Erekosima, Ibi	TH-PO050		FR-PO636, FR-PO809	Fels, Benedikt	TH-PO148	Fischer, Matthew	TH-PO441,
Eren, Dilara	TH-PO756	Fallahzadeh Abarghouei,		Feltkamp, Mariet	FR-PO011		FR-PO351, FR-PO992
Erickson, Chris	FR-PO349	Mohammad Kazem	SA-PO854	Fenaroli, Paride	TH-PO530	Fischer, Michael J.	FR-PO507
Erickson, Kevin F.	FR-PO859,	Fallen, Paul B.	FR-OR01	Feng, Guijuan	FR-PO136	Fishbane, Steven	FR-PO070,
	SA-PO326	Fan, Fan	TH-PO569	Feng, Ye	TH-PO546, FR-PO685,		FR-PO185, SA-PO400, SA-PO401,
Erickson, Sarah J.	FR-OR867	Fan, Henry J.	SA-PO548, PUB338		FR-PO946		SA-PO463
Erickson, Stephen B.	TH-PO412,	Fan, Stanley	FR-PO785, FR-PO852,	Fenici, Peter	TH-PO233	Fishbein, Jennifer	SA-PO544
	SA-PO952		PUB311, PUB315, PUB327	Fenton, Robert A.	TH-PO407,	Fisher, Mark	TH-PO808
Ericson, Elke	FR-OR52	Fan, Wenjing	TH-PO621, SA-PO421,		FR-PO920	Fisher, Marlena	TH-PO869
Eriguchi, Masahiro	TH-PO251,		SA-PO689	Feola, Kyle C.	SA-PO106	Fisher, Molly	TH-PO106, TH-PO120,
	FR-PO925, SA-PO312, SA-PO700	Fan, Xiaohong	SA-PO168	Feraille, Eric	SA-PO099, SA-PO983		TH-PO762, SA-PO803
Eriksen, Bjorn O.	TH-PO770,	Fan, Xueping	FR-PO695	Ferdaus, Mohammed Z.	FR-OR44	Fishman, Jay A.	TH-PO916
	FR-PO897	Fan, Yuting	TH-PO203	Ferguson, Ryan	SA-PO895	Fissell, William H.	FR-PO989,
Erman, Elise	FR-OR16, FR-PO969,	Fang, Brian	TH-PO373	Ferguson, Thomas W.	FR-PO542,		SA-PO018, SA-PO027, SA-PO418,
	SA-PO110	Fang, Hsin-Yu	TH-PO804, SA-PO360		FR-PO885, SA-PO157		PUB059
Erman, Orit	TH-PO056	Fang, Yi	PUB214	Ferkowicz, Michael J.	TH-PO183,	Flamant, Martin	FR-PO897
Ernst, Frank R.	TH-PO501	Fang, Yina	FR-OR18, FR-PO112,		TH-PO574, FR-PO169, PUB102	Flannery, Alexander H.	TH-PO030
Erol, Halil K.	TH-PO169		PUB090	Fermin, Damian	TH-PO211	Fledderus, Joost O.	FR-PO383
Errichiello, Carmela	SA-PO621	Fanton, Susane	TH-PO832	Fernandes, Ana	PUB057	Fleetwood, Vidya	SA-PO851
Ersoy, Alparslan	FR-PO824, SA-PO795	Fantus, Ivan G.	SA-PO239	Fernandes, Ancilla	TH-PO411	Fleig, Susanne V.	SA-PO112
Erspamer, Kayla J.	SA-PO590	Farag, Youssef M.	TH-PO711	Fernandez-Correa, Tomas	SA-PO032	Fleming, Fergus	TH-PO734, FR-PO006
Ertl, Linda	SA-PO633	Farahmand, Firoozeh	TH-PO087	Fernandez, Loreto	PUB008	Fletcher, Hansel M.	FR-PO475
Ertracht, Offir	SA-PO237	Fardeen, Kazi M.	TH-PO906,	Fernandez, Nicole	FR-PO625,	Fletcher, Robert A.	SA-PO261
Ertuglu, Lale A.	SA-PO758, SA-PO759		PUB033, PUB035		FR-PO947, SA-PO489	Fliser, Danilo	TH-OR33, TH-PO908
Escamilla-Illescas, David	FR-PO023	Fareed, Jawed	TH-PO550, TH-PO617,	Ferraresso, Mariano	FR-PO798,	Floegel, Jürgen	TH-PO837, SA-PO390
Escasinas, Edgar R.	SA-PO489		SA-PO391		SA-PO871	Floen, Miranda J.	PUB285
Escobar, G. P.	TH-PO091, TH-PO092,	Fareedy, Shoab B.	SA-PO141,	Ferraro, Pietro Manuel	TH-PO398,	Florens, Nans	TH-PO097
	TH-PO848, SA-PO077		SA-PO870		TH-PO409, PUB172	Flores Chang, Bessy Suyin	TH-PO527,
Esculto, Maricar	FR-PO570	Fares, Nassim	FR-PO160, SA-PO124	Freira Costa, Joao Luiz	PUB022		FR-PO615, SA-PO724, PUB185
Esper, Priscila L.	SA-PO161	Fargue, Sonia	SA-PO169	Ferreira Dias, Gabriela	TH-PO704,	Flores Chang, Marjorie	
Ester, Lioba	FR-PO708	Faria-Urbina, Mariana	TH-PO480,		SA-PO422	Mailing	TH-PO527, FR-PO615
Estiverne, Christopher	PUB063		TH-PO481	Ferreira Provenzano, Laura	TH-PO470	Flores Garnica, Julio Manuel	PUB115,
Estrada, Chelsea C.	SA-PO632	Faria, João	SA-PO078	Ferreira-Divino, Luis Felipe	PUB103,		PUB244
Estrella, Michelle M.	TH-PO762,	Faria, Maria	FR-PO428		PUB105	Flores Santiago, Josean O.	TH-PO575
	FR-PO907, FR-PO924	Faridi, Hafeez	FR-PO594	Ferreira, Anna	TH-PO480	Flores, Karen	FR-PO823
Etchegoimberry, Veronica	TH-PO875	Farinola, Nicholas	SA-PO636	Ferreira, Janaina F.	PUB022	Floris, Matteo	TH-PO075, SA-PO119,
Ethier, Isabelle	FR-PO531	Farma, Simrandeep	FR-PO415,	Ferreira, Juliana C.	SA-PO213		SA-PO120
Etwaru, Diana	TH-PO369, TH-PO370		FR-PO416	Ferreira, Manuel A.	TH-OR13,	Florquin, Sandrine	TH-PO533
Eudy, James	TH-PO655	Farmer-Bailey, Heather	TH-PO391		SA-PO402	Flowers, Adrienne E.	PUB147
Eugen-Olsen, Jesper	TH-PO105	Farmer, Jocelyn	FR-PO193	Ferrell, Nicholas J.	TH-PO424,	Floyd, Stephanie M.	FR-PO949
Eulenberg-Gustavus,		Farmer, Louise K.	FR-PO715		SA-PO418	Fogel, Joshua	FR-PO012
Claudia	FR-PO576	Farooqui, Naba	FR-PO398, SA-PO149	Ferrer, Francisco	SA-PO457	Fogelgren, Ben	FR-PO980
Eum, Sang Hun	FR-PO782,	Farouk, Samira S.	TH-PO019	Ferris, Maria E.	FR-PO905, SA-PO436	Fogo, Agnes B.	TH-PO439,
	SA-PO180, SA-PO381	Farrell, Douglas R.	TH-PO166	Ferro, Christine	TH-PO666		TH-PO572, SA-PO672,
Evangelista-Carrillo,		Farrington, Ken	FR-PO536	Ferverza, Fernando C.	TH-PO453,		SA-PO854, PUB241
Luis Alberto	FR-PO837	Farrington, Krista P.	FR-PO171		TH-PO454, TH-PO509, FR-PO585,	Fok, Patrick T.	SA-PO387
Evans, Elizabeth E.	SA-PO916	Farris, Alton B.	SA-PO685		FR-PO649, FR-PO671, SA-PO133,	Folkmane, Inese	PUB330
Evans, Marie	TH-PO300,	Farique, Md Omar	SA-PO404		SA-PO153, SA-PO629, SA-PO630,	Folkmantis, Kristofs	PUB330
	TH-PO699, TH-PO786,	Fascianella, John A.	FR-PO692		SA-PO692, PUB343	Fomin, Mikhail	SA-PO762
	TH-PO788, TH-PO898,	Fatehi, Pedram	PUB120	Festa, Maria Carolina	TH-PO619	Fomin, Vitalay	TH-PO387
	FR-PO760, SA-PO932	Fathy, Hanan	SA-PO566	Fiandaca, Cindi	FR-PO507	Fonarow, Gregg C.	TH-PO601
Evans, Michele K.	FR-PO948	Fatica, Richard A.	FR-PO442	Fibbe, Willem E.	FR-OR40	Fongheiser, Elizabeth A.	FR-OR13
Evans, Rachel C.	FR-PO989	Fatoba, Samuel T.	TH-PO255, PUB351	Fichadiya, Hardik	TH-PO133	Fons, Alexandria	TH-PO801
Evans, Rhys D.	FR-PO554	Fattah, Hasan	TH-PO960			Fonseca, Fernando L.	TH-PO940



Geetha, Duvuru	TH-PO507, FR-PO617, FR-PO648, SA-PO693, SA-PO697	Gholami, Samaneh	FR-PO087, SA-PO1003	Glenn Lecea, Eva M.	FR-PO040	Goncalves, Susana	TH-PO233, SA-PO283
Gehlen, Frank	FR-PO914	Ghonimi, Tarek A.	TH-PO175, TH-PO941, SA-PO331	Glenn, Dorey A.	TH-PO474, FR-PO636	Gong, Rong	TH-PO282
Gehr, Todd W.	TH-PO209	Ghosh-Choudhury, Goutam	TH-PO181, TH-PO197, PUB367	Glezerman, Ilya	TH-PO585, FR-PO207, FR-PO212, SA-PO116, SA-PO139	Gong, Rujun	FR-PO592
Gehrig, Jochen	FR-PO702	Ghosh-choudhury, Nandini	TH-PO197	Glicksberg, Benjamin S.	SA-PO914	Gong, Weiyuan	TH-PO139
Geiges, Linda	FR-PO265, FR-PO266	Ghosh, Arpita	TH-PO029	Glowacki, Francois	TH-PO771	Gonzalez Jauregui, Rebeca	PUB156
Geiss, Volker	SA-PO247	Ghosh, Sanat K.	FR-PO093	Gluck, Stephen L.	TH-PO369, TH-PO370, SA-PO856	Gonzalez Rivera, Grecia J.	FR-PO562
Geleijnse, Johanna M.	TH-PO846	Ghosh, Saptarshi	FR-PO093	Glynn, Robert J.	SA-PO910	Gonzalez Rivera, Jesus M.	SA-PO087
Gelfand, Samantha L.	TH-PO791	Ghosh, Siddhartha S.	TH-PO209	Go, Alan S.	TH-OR02, TH-OR07, TH-PO028, TH-PO057, TH-PO059, TH-PO618, SA-PO191	Gonzalez Sanchez, Hector R.	FR-PO027
Gelfond, Jonathan A.	TH-PO850	Ghossein, Cybele	FR-PO418, FR-PO848, PUB048	Gobbel, Glenn T.	TH-PO607	González Soria, Isaac	FR-PO003
Geller, David	SA-PO036, SA-PO037	Ghuman, Sapna K.	PUB108	Godfrey, Brad A.	TH-PO422, FR-PO724	Gonzalez Suarez, Maria Lourdes	FR-PO757
Gembardt, Florian	TH-PO188, TH-PO226	Giacopuzzi, Edoardo	FR-PO556	Godinho, Iolanda	TH-PO947, SA-PO865, TH-PO072	González Valero, Cristina	FR-PO135, FR-PO968, FR-PO983
Gemene, Emanuela M.	SA-PO337	Giamalis, Panagiotis	TH-PO948	Godoy, Cássia S.	TH-PO187, TH-PO205	Gonzalez- Mateo, Guadalupe T.	FR-PO461
Gemmel, David J.	PUB031	Giammattei, Victoria	TH-PO590, TH-PO592, TH-PO593	Godson, Catherine	TH-PO187, TH-PO205	Gonzalez-Fuentes, Carolina	PUB244
Gemoets, Darren E.	SA-PO190	Gianassi, Iacopo	TH-OR11	Goea, Laura	TH-PO213	González-King Garibotti, Hernán	FR-OR52
Geng, Siyi	TH-PO169, TH-PO719, SA-PO191	Giannini, Gabriel A.	SA-OR01	Goebel, Georg	FR-OR55	Gonzalez-Nicolas Gonzalez, Maria Angeles	TH-PO112
Geng, Tingting	TH-PO864	Giannou, Panagiota E.	FR-PO589	Goedken, Michael J.	SA-PO158	Gonzalez, Alexis A.	SA-PO227
Genin, Guy M.	FR-PO700, FR-PO713	Giardina, Federica	FR-PO337	Goenka, Anu	FR-PO165	Gonzalez, Camilo A.	FR-PO029
Gennarini, Alessia	TH-PO483	Giblon, Rachel	TH-PO733	Goerlich, Nina	FR-PO157	Gonzalez, Marvin A.	FR-PO917, FR-PO927, SA-PO950, SA-PO1012
Genovese, Federica	TH-PO234, TH-PO239, TH-PO429, FR-PO773, FR-PO784	Gibson, Cheryl	TH-PO815	Goes, Miguel Angelo	FR-PO157, TH-PO904, PUB320	Gonzalez, Pablo	FR-PO002
Gentile, Micaela	SA-OR28	Gibson, Keisha L.	TH-PO594	Goettsch, Claudia	SA-PO786	Gonzalez, Stevan A.	TH-PO034
Genzani, Camila P.	FR-PO430	Gidon, Ariel	TH-PO942	Goetzman, Eric S.	FR-PO138, FR-PO336, SA-PO092, SA-PO103	Gooch, Anna	TH-PO224, SA-PO019, SA-PO020
George, Aliza	PUB084	Giehl, Nolan M.	SA-PO204	Gogarty, Eoin	SA-PO698	Gooding, Mark J.	FR-PO877
George, Aneesh T.	SA-PO657, SA-PO658	Giera, Martin	TH-OR43	Gögele, Martin	TH-PO624	Gopal, Nikhil	SA-PO152
George, Diana	TH-PO392	Gietzen, Rachelle A.	SA-OR02	Goggins, Eibhlin S.	TH-PO138, TH-PO548, TH-PO933, TH-PO934, FR-OR12	Gopal, Sam	FR-PO942
George, James F.	FR-OR16, FR-PO245, FR-PO969, SA-PO110	Gifford, Cody C.	TH-PO538	Gogna, Arjun	PUB170	Gorantla, Vijay S.	FR-PO800
George, Michael W.	TH-PO470, FR-PO038, SA-PO426	Gigante, Eduardo	TH-OR35	Gohar, Eman Y.	SA-PO776	Goraya, Nimrit	SA-PO980, SA-PO982
Georgiadis, Despina	SA-PO358, SA-PO361	Gil, Luiz A.	SA-PO121	Gohh, Reginald Y.	FR-PO765	Gordon, Elisa J.	FR-PO507
Georgopoulou, Georgia	TH-PO583	Gilani, Sarwat	SA-PO527	Gojaseni, Pongsathorn	TH-PO032, SA-PO941	Gordon, Jonathan	SA-PO926
Geraci, Andriana	TH-PO583	Gilbert, Edmund H.	TH-PO364, TH-PO646, TH-PO647, FR-PO935	Gokden, Tamara	TH-PO755	Gordon, Sarah M.	FR-PO603
Geraci, Carolyn	PUB344	Gilbert, Rodney D.	TH-PO500	Gokden, Neriman	TH-PO460	Gorey, David	FR-PO180, FR-PO864
Geraghty, Robert M.	SA-PO570	Gilbertson, David T.	TH-OR17, TH-PO700, TH-PO955, FR-PO895	Goker-Alpan, Ozlem	FR-PO339	Goriacko, Pavel	FR-PO551
Gerardes, Pedro M.	FR-PO967	Gill, Alan	FR-PO795	Golbus, Alexa	SA-PO517	Goricar, Katja	TH-PO650
Gerardine, Supriya	TH-PO939, FR-PO192, FR-PO682, FR-PO766, PUB261	Gill, Carolyn	TH-PO756	Golbus, Ashley	TH-PO043, TH-PO069	Görlitz, Frederik	FR-PO716
Gerhardt, Louisa M.	TH-PO140	Gill, John S.	PUB299	Goldberg, Marcy E.	SA-PO425	Gorman, Gregory H.	FR-PO411
Gerlach, Gary F.	FR-PO350	Gillberg, Jake	TH-PO603, FR-PO083	Golden, Keisha J.	SA-PO657, SA-PO658	Gorzelanny, Christian	SA-PO592
Gerlach, Michael	FR-PO387	Gillen, Christopher M.	SA-PO580	Goldenstein, Patricia T.	TH-PO165	Gorzoni, João Lucas M.	SA-PO433
Germain, Michael J.	SA-PO286, SA-PO916	Gillespie, Avrum	TH-PO512, TH-PO714, FR-PO884, SA-PO814, SA-PO816, PUB019	Goldfarb, David S.	SA-PO568	Gosalia, Kinjal	FR-PO186
Germino, Gregory G.	FR-PO282, FR-PO346	Gillespie, Brenda W.	TH-PO479, TH-PO614, TH-PO706, FR-PO936	Goldner, Breanna S.	TH-PO131	Gosmanova, Elvira O.	SA-PO190, SA-PO198
Gernone, Giuseppe	SA-PO196	Gilligan, Sarah	FR-PO200, SA-PO467, SA-PO666	Goldsberry, Angie	SA-PO919	Gosselink, Margriet	TH-PO761, FR-PO857
Gerritsen, Karin G.	TH-PO190	Gillion, Valentine	TH-PO761	Goldschmeding, Roel	TH-PO190, TH-PO538, TH-PO555, FR-PO194	Goswami, Jitendra	TH-PO851, TH-PO946, PUB146
Gersting, Soeren W.	FR-PO699	Gimferrer, Idolia	FR-PO789	Goldstein, Benjamin A.	FR-PO537	Goswami, Shrea	SA-PO594
Gerstner, Lea	FR-PO706	Gindl-Bracho, Alfonso	FR-PO562	Goldstein, Judah	SA-PO387	Göth, Daniel	SA-PO812
Gertz, Chelsea	SA-PO140	Gingras, Anne-Claude	TH-PO915, SA-OR10	Goldstein, Stuart	TH-OR05, TH-PO039, TH-PO081, TH-PO098, FR-PO571, SA-PO596	Gothi, Anil K.	SA-PO423
Gessaroli, Elisa	FR-PO399	Ginriani, Larab L.	PUB266	Golestaneh, Ladan	FR-PO551	Goto, Shin	SA-PO640
Gesualdo, Loreto	TH-PO204, FR-OR57, FR-PO170, SA-PO647	GINRY, Brandon	TH-PO010	Goll, Yan L.	PUB034	Goto, Shunsuke	FR-PO465, SA-PO209
Getachew, Ruth	PUB138	Ginsbach, Laura F.	FR-PO420	Golovey, Rimon	PUB003	Gottlich, Harrison C.	TH-PO733
Geurts, Frank	TH-PO407, FR-PO920	Ginsberg, Charles	TH-PO605, SA-PO185, SA-PO186	Gomes, Janice	TH-OR12	Gou, Shen-Ju	FR-PO579
Gewin, Leslie S.	FR-PO114, FR-PO1007	Ginsberg, Pauline	SA-OR29	Gomes, Joshua	SA-PO779	Goulamhousen, Nadir	FR-PO095
Ghadieh, Hilda E.	TH-PO219	Giordano McAuliffe, Christin M.	PUB193	Gómez Fregoso, Juan	PUB220, PUB341	Gould, Edward	FR-PO517
Ghafar, Nargies	TH-PO818	Gipe, Jesse	TH-PO823, TH-PO824	Gómez García, Fernando	FR-PO273	Gould, Haley E.	TH-PO294
Ghag, Reetika R.	SA-OR05	Gipson, Debbie	TH-PO445, TH-PO473, TH-PO474, TH-PO479, TH-PO480, TH-PO594, FR-PO663, SA-PO705, SA-PO735, PUB234	Gómez Jackson, Julia A.	PUB273	Goumenos, Dimitrios S.	TH-PO583
Ghahramani, Nasrollah	FR-PO080, FR-PO111	Gipson, Graham T.	TH-PO209	Gómez Paz, Sandra	FR-PO012	Goupil, Remi	FR-PO513, FR-PO739, SA-PO327
Ghajar-Rahimi, Gelare	SA-PO110	Girard, Manon	SA-PO263	Gómez Ruiz, Ismael A.	TH-PO792	Goussard, Guillaume	SA-PO409
Gharaie, Sepideh	FR-OR19, FR-PO145, FR-PO147, FR-PO148, FR-PO172, FR-PO173, SA-PO965	Gisch, Debora L.	FR-PO169, SA-PO956	Gomez Villarreal, Juan P.	FR-PO611, FR-PO734	Govindarajan, Rajgopal	FR-PO723, SA-PO977
Gharavi, Ali G.	SA-PO543, SA-PO564, SA-PO606, SA-PO637	Gislason, Gisli	FR-PO099	Gomez-Navarro, Benjamin	PUB341	Govindji-Bhatt, Nishal	FR-PO471
Ghasemi-Semeskandeh, Dariush	TH-PO624	Gist, Katja M.	SA-PO601	Gomez, Damayanty	PUB006	Gowrishankar, Swarnalata	TH-PO557
Ghavami, Iman	SA-PO606	Gitomer, Berenice Y.	TH-PO390, TH-PO391, TH-PO392, TH-PO402, TH-PO403, TH-PO404, TH-PO405	Gomez, Daniel	SA-PO484	Gowthaman, Yogesh	SA-OR22
Ghazi, Lama	TH-PO599, FR-PO752	Giulianotti, Marc	SA-PO244	Gomez, Daniel G.	FR-PO561	Goyal, Rohan	TH-PO720, TH-PO721
Gheblawi, Mahmoud	FR-PO024	Givi, Jerome P.	FR-PO590	Gomez, Ivan G.	FR-PO993	Graber, Martha L.	TH-PO386, FR-PO822, SA-PO323, SA-PO324
Ghee, Jungyeon	SA-PO1013	Gkika, Vasiliki	TH-PO363, TH-PO388, PUB186	Gómez, Jorge A.	PUB143	Graham-Brown, Matthew	SA-PO979
Gheith, Osama	FR-PO807, SA-PO844	Glaberson, Wendy R.	FR-PO437	Gómez, Rafael A.	FR-PO493	Graham, Caleb	TH-PO301
Gherghiceanu, Mihaela	TH-PO561, PUB107	Glasgow, Eric	FR-PO283	Gomez, Robert	FR-PO334	Graham, Robert R.	FR-PO316
Ghofrani, Ardeschir	SA-PO780	Gleeson, James	SA-PO648, SA-PO649	Gomez, Roberto Ariel	FR-PO363	Grahammer, Florian	FR-PO699
				Gonçalves, Ilka P.	FR-PO430	Grainer, Hillary	PUB072
				Goncalves, Joao A.	TH-PO947, SA-PO865	Grampp, Steffen	TH-PO895
				Gonçalves, Sara	TH-PO947, SA-PO865		





Hernandez Mora, Victor M. SA-PO316  
Hernandez Morales, Karla TH-PO047  
Hernández-Estrada, Sergio SA-PO316  
Hernandez-Ordonez, Sergio O. FR-PO489  
Hernandez, Antonette Veronica B. SA-PO875, PUB059  
Hernandez, Edgar J. TH-PO245  
Hernández, Elisa N. TH-PO397  
Hernández, Jorge A. PUB232  
Hernandez, Laura SA-PO053  
Hernandez, Leah N. TH-PO649, PUB254, PUB259, PUB289  
Hernandez, Regina C. PUB244  
Herrera-Doerres, Brandon FR-PO735  
Herrero, Juan Carlos PUB018  
Herrington, William G. TH-PO621, TH-PO767  
Herrlich, Andreas SA-PO105  
Herrmann, Sandra FR-PO178, FR-PO193, FR-PO398, SA-PO144, SA-PO149  
Herzog, Christian TH-PO033, TH-PO452  
Herzog, Rebecca FR-PO451, FR-PO454, FR-PO467, SA-PO627  
Hess, Gregory FR-PO814  
Hessels, Niek TH-PO803  
Hetteema, Willem TH-PO385  
Heung, Michael FR-PO101, FR-PO936, SA-PO267  
Heuser, Michael SA-PO145  
Hewapathirana, Santhushya TH-PO863  
Hewavitharane, Pasan M. TH-PO863  
Hewitson, Timothy D. SA-PO174  
Hickson, LaTonya J. TH-PO180, TH-PO242, TH-PO733, TH-PO794  
Hidaka, Sumi FR-PO037  
Hidalgo- Hernandez, Yolanda I. SA-PO516  
Hidawa, Erika FR-PO115  
Hidmark, Asa TH-PO536  
Hiemstra, Thomas TH-PO667, FR-PO776  
Hiifumi, Toru SA-PO440  
Higdon, Lauren TH-OR57  
Higgins, Paul J. TH-PO538  
Hijazi, Fadi A. FR-PO306  
Hikida, Hiroshi D. FR-PO205  
Hildebrandt, Friedhelm TH-PO371, FR-PO326, FR-PO327, FR-PO328, FR-PO330, SA-PO525, SA-PO538, SA-PO566, SA-PO572, SA-PO573, SA-PO578, SA-PO738  
Hildeman, Anders G. PUB346  
Hilden, Patrick PUB323  
Hilgers, Karl F. SA-PO784, PUB255  
Hilhorst, Marc TH-PO416  
Hill Gallant, Kathleen M. TH-PO801, SA-PO210  
Hill, Claire TH-PO222  
Hill, Jonathan SA-PO1007  
Hillier, David TH-PO399  
Hilmanto, Dany SA-PO539  
Himmelfarb, Jonathan TH-OR02, TH-OR07, TH-PO028, FR-OR20, FR-PO497, SA-PO462, SA-PO947  
Himmerkus, Nina TH-PO188, TH-PO329, TH-PO642  
Hingorani, Sangeeta R. FR-PO766  
Hinke, Simon A. FR-PO237, SA-PO223, SA-PO224  
Hinze, Christian TH-PO341, FR-PO157, FR-PO270  
Hippen, Benjamin E. SA-PO314, SA-PO315, SA-PO343, SA-PO378  
Hirabayashi, Masumi FR-PO275  
Hirachan, Padam SA-PO581  
Hirano, Daishi TH-PO248, FR-PO380  
Hirano, Keita TH-PO552  
Hirata, Deborah FR-PO430  
Hirawa, Nobuhito SA-PO456  
Hiremath, Swapnil TH-OR47  
Hirose, Takayuki TH-OR54  
Hirose, Takuo SA-PO785  
Hirota, Keigo SA-PO997  
Hirsch, Jamie S. TH-PO601, FR-PO070, FR-PO875  
Hiser, Wesley TH-PO128, PUB055  
Hishikawa, Akihito SA-OR23  
Hitaka, Mai TH-PO701  
Hiyamuta, Hiroto TH-PO608  
Hjorten, Rebecca C. TH-PO752  
Hladek, Melissa D. FR-PO948, SA-PO305  
Hladunewich, Michelle A. TH-PO472, TH-PO760, TH-PO915, SA-OR10, SA-PO714  
Ho, Andrew T. PUB167  
Ho, Chih-Hu SA-PO422  
Ho, George TH-PO088, FR-PO171  
Ho, Jacqueline FR-PO402  
Ho, Kaku SA-PO386  
Ho, L. Tammy PUB178  
Ho, Melody SA-PO989  
Hoang, Victor D. PUB207  
Hobson, Sam PUB254, PUB259  
Hoche, Berthold FR-PO777, FR-PO956, PUB015  
Hockings, Paul TH-PO228, TH-PO230  
Hodge, Lucy S. TH-PO486  
Hodgin, Jeffrey B. TH-PO211, TH-PO534, TH-PO569, TH-PO570, FR-OR20, SA-PO003, SA-PO258  
Hodgins, Spencer FR-PO046, FR-PO557, FR-PO561, SA-PO722  
Hoeft, Konrad SA-PO111  
Hoek, Maarten FR-PO316, FR-PO318  
Hoenderop, Joost TH-PO331, FR-OR46  
Hoffman, Bob S. TH-PO515  
Hoffman, Marc L. SA-PO443  
Hofherr, Alexis FR-PO256  
Hofmeister, Andreas SA-PO029  
Hogan, Marie C. TH-PO394, TH-PO395, TH-PO412, FR-PO260, SA-PO527, SA-PO952  
Hogan, Richard E. TH-PO380  
Hogan, Susan L. TH-PO482, FR-PO586, FR-PO636, FR-PO809, SA-PO694  
Hogan, Timothy P. FR-PO507  
Hoge, Courtney E. FR-PO540, FR-PO541  
Hohenfellner, Katharina SA-PO625  
Hohenstein, Bernd FR-PO914  
Hohl, Mathias SA-PO786  
Höhne, Martin FR-PO329, FR-PO687, FR-PO707, FR-PO716  
Hojs, Radovan FR-PO010, SA-PO291  
Holahan, Brian J. TH-PO131  
Hole, Barnaby D. TH-PO788  
Holland, John SA-PO892  
Holle, Johannes FR-PO420, SA-PO626  
Holliday, Michael FR-OR17  
Holmberg, Christopher FR-PO769, FR-PO770  
Holmes, Heather L. FR-PO246  
Hölscher, David Laurin TH-PO565  
Holt, Stephen G. SA-PO174  
Holthoff, Joseph H. TH-PO033, FR-PO229, PUB171  
Holtzhausen, Stefan FR-PO387  
Holzenberger, Martin SA-PO233  
Holzman, Lawrence B. TH-PO569, SA-PO003  
Holzmann-Littig, Christopher SA-OR42  
Holznecht, Nickolas J. FR-PO242, FR-PO295  
Homan, Mal P. TH-PO131, PUB136  
Hommos, Musab S. TH-PO412  
Honda, Hirokazu TH-PO143, SA-PO182  
Honda, Kazuho SA-OR25  
Honda, Masakazu FR-PO115  
Honda, Shinya SA-PO1008  
Hong, Annie V. FR-PO475  
Hong, Daqing FR-PO750, PUB081  
Hong, Emily TH-PO092  
Hong, Jiajun SA-PO173  
Hong, Ling SA-PO845  
Hong, Yu Ah TH-PO201, TH-PO793, SA-PO232  
Hongalgi, Krishnakumar D. TH-PO434, SA-PO520, PUB140  
Honkanen, Iiro TH-PO124  
Hoofnagle, Andrew N. TH-PO605, TH-PO678, SA-PO185, SA-PO186, SA-PO187, SA-PO912, SA-PO929, SA-PO930  
Hoogenboom, Robin FR-PO451  
Hooper, David K. TH-PO098, SA-PO855  
Hooper, Stephen R. FR-PO408, FR-PO949  
Hoorn, Ewout J. TH-PO354, TH-PO382, TH-PO383, TH-PO406, TH-PO407, FR-PO920, SA-PO536  
Hoover, Donald TH-PO762  
Hoover, Madison TH-PO936, FR-PO008  
Hopf, Karen PUB006  
Hopkins, Rebecca PUB280  
Hopley, Charles W. PUB260  
Hopman, Wilma M. FR-PO835  
Hopp, Katharina TH-PO402, TH-PO403, TH-PO404  
Hoppe, Bernd TH-OR34, SA-PO329, SA-PO625  
Hoppensteinadt, Debra TH-PO550, TH-PO617, SA-PO391  
Horinouchi, Tomoko FR-PO043, FR-PO303, FR-PO447, SA-PO539, SA-PO562  
Horiuchi, Yu TH-PO031  
Horne, Robert SA-PO325  
Hornik-Lurie, Tzipi SA-OR09  
Hornik, Christoph SA-PO598  
Hornum, Mads TH-PO223, SA-PO829  
Horowitz, Benjamin S. PUB226  
Horowitz, Carol FR-PO320  
Horowitz, Laura SA-PO347  
Horwitz, Edward J. TH-PO057, TH-PO059, SA-PO399  
Hoshino, Junichi SA-PO573  
Hoskins, Aaron SA-PO573  
Hossain, Mohammad D. SA-PO568  
Hoste, Eric FR-PO071  
Hostetter, Thomas H. TH-PO238, SA-PO462  
Hotta, Naomi FR-PO115  
Hou, Fan Fan TH-PO244, TH-PO694  
Hou, Jean FR-PO190, SA-PO670, PUB304  
Hou, Xiaogang FR-PO690, FR-PO691  
Hou, Xiaoshuai FR-PO813  
Hou, Yi-Chou TH-PO789, SA-PO211  
Hou, Zuoxian SA-PO006  
Houillier, Pascal TH-PO333  
Houlihan, Jennifer TH-PO736  
Hovhannisyan, Karen TH-PO289  
How, Ira Doressa Anne L. SA-OR44  
Howard, Jennifer L. TH-PO828  
Howard, Matthew FR-PO808, SA-PO823  
Howard, Tamara A. TH-PO091  
Howden, Erin TH-PO606  
Howell, David N. TH-PO584  
Howell, Martin TH-PO723, FR-PO871  
Hoxha, Elion FR-PO351  
Hoyer, Joachim TH-PO277, TH-PO914, TH-PO922  
Hrafnkeldsdottir, Thordis J. TH-PO591  
Hrizat, Alaa S. FR-PO675  
Hruskova, Zdenka TH-PO429  
Hryzak, Sarah TH-PO170, SA-PO052  
Hsia, Judith TH-PO602, PUB172  
Hsiao, Li-Li FR-PO997  
Hsieh, Ray TH-PO660, TH-PO661  
Hsiung, Jui-Ting FR-PO544  
Hsu, Caroline M. TH-PO921, TH-PO938, FR-PO500, SA-OR08  
Hsu, Chan TH-PO665  
Hsu, Chi-yuan TH-OR07, TH-PO057, TH-PO059, TH-PO238, SA-PO931, PUB050  
Hsu, Fang-Chi TH-PO797  
Hsu, Jesse Y. TH-PO057, TH-PO059  
Hsu, Jung-Shan FR-PO261, FR-PO287  
Hsu, Raymond K. TH-PO897  
Hsu, Simon TH-PO605, SA-PO185  
Hsu, Stephanie SA-PO451  
Hsu, Yu-Juei TH-PO324  
Hti Lar Seng, Nang San SA-PO732, PUB003  
Hu, Chunyan SA-PO975  
Hu, David G. TH-PO026, TH-PO028, TH-PO564  
Hu, Dean SA-PO018  
Hu, Erding TH-PO252, FR-OR32  
Hu, Hailong TH-PO415, FR-OR38, FR-PO388  
Hu, Jian FR-OR32, FR-PO408, FR-PO409  
Hu, Jinghua FR-PO141, FR-PO271, FR-PO293  
Hu, Jinxiu TH-PO221  
Hu, Kebin FR-PO974  
Hu, Ningning SA-PO559  
Hu, Peiqi FR-PO579  
Hu, Qiongyao PUB085  
Hu, Queenie TH-PO915  
Hu, Xiaoru FR-PO973  
Hu, Xuzhen TH-PO103  
Hu, Yanglin FR-PO579  
Hu, Yichun TH-PO482, FR-PO586, FR-PO636, FR-PO809  
Hu, Zhaoyong SA-PO230  
Hua, Chen M. TH-OR16  
Hua, Shuangcheng FR-PO821  
Hua, Steven Y. TH-PO487  
Huang, Bin PUB280  
Huang, Cheng-Wei FR-PO753  
Huang, Chou-Long TH-PO348, SA-OR13  
Huang, Chun-Te TH-OR08  
Huang, Gaoyuan PUB066  
Huang, Hui TH-PO060  
Huang, Hui-Chun TH-PO102  
Huang, Huihui SA-PO991  
Huang, Jee-Fu SA-PO255  
Huang, Jiapeng PUB005  
Huang, Jifeng FR-PO287  
Huang, Jin SA-PO043, PUB031  
Huang, Jing SA-PO080, SA-PO207  
Huang, Li SA-PO421, SA-PO689  
Huang, Lili FR-PO136  
Huang, Ming SA-PO746  
Huang, Qian FR-PO876  
Huang, Xiangyang TH-PO702  
Huang, Xiaoyan TH-PO807  
Huang, Yijin SA-PO781  
Huang, Yufeng FR-PO174, SA-PO248  
Huang, Zhi qiang SA-PO638, SA-PO641, SA-PO642, SA-PO643  
Hub, Elin FR-PO599  
Hubeishy, Moudi SA-PO723  
Huber, Tobias B. TH-OR42, TH-PO213, TH-PO908, FR-PO342, FR-PO699, FR-PO710, SA-PO746  
Hübner, Christian A. TH-PO309  
Hückelhoven-Krauss, Angela SA-OR47  
Hudson, Amy SA-PO701  
Hudson, Thomas E. SA-PO240  
Huen, Sarah C. SA-PO106  
Hueso, Miguel TH-PO385  
Huffman, Jennifer E. FR-PO312  
Hufft-Martinez, Brittany M. SA-OR14  
Huggins, Kinsie SA-OR27, SA-PO628, SA-PO739  
Hughes, Parker K. FR-PO230  
Hughes, Samuel M. FR-PO405  
Hugo, Christian TH-PO188, TH-PO226, FR-PO372, FR-PO387  
Hugo, Hannah SA-PO566  
Huh, Hyuk TH-PO625, TH-PO679, TH-PO713  
Huh, Kyu ha FR-PO791

Huh, Wooseong	TH-PO048, TH-PO095, FR-PO132, SA-PO335	Iacoboni, Gloria	SA-PO160	Inman, Denise M.	SA-PO256	Ix, Joachim H.	TH-OR03, TH-PO026, TH-PO238, TH-PO243, TH-PO678, TH-PO797, TH-PO798, TH-PO861, TH-PO865, TH-PO869, FR-PO412, FR-PO755, FR-PO756, FR-PO916, SA-PO185, SA-PO186, SA-PO922, SA-PO991
Huijink, Tobias M.	TH-PO644	Iampenkhay, Koonpong	SA-PO557	Innocchi, Mariana L.	TH-PO781, TH-PO782	Iyengar, Yajur	TH-OR30
Huizenga, Noah	FR-PO646	Ibarra Santoyo, Luis A.	FR-PO027	Ino, Frederique	SA-PO757	Iyer, Sai Prasad N.	FR-PO659
Huizinga, Robert B.	SA-PO688	Ibrahim, Atif	TH-PO878	Inoue, Tsutomu	FR-PO595, FR-PO940	Iyer, Viswanathan S.	SA-PO338
Hullekes, Frank E.	TH-PO485	Ibrahim, Dalia Y.	TH-PO541, FR-PO176, PUB264	Inoue, Tsuyoshi	FR-PO120	Izuhara, Audrey	FR-OR56
Hulthe, Johannes	TH-PO228, TH-PO230	Ibrahim, Elhussein K.	TH-PO298	Intarak, Sompote	FR-PO079	Izumii, Yuichiro	TH-PO210, SA-PO067
Humanes Sanchez, Blanca	TH-PO112	Ibrahim, Eman H.	SA-OR47	Introna, Martino	FR-OR40	Izzedine, Hassan	FR-PO191
Humes, H. David	TH-PO039, SA-PO022	Ibrahim, Hanaa	FR-PO771	Ioannidis, Nilah	FR-PO305	Jaar, Bernard G.	TH-PO618, TH-PO719, TH-PO892, FR-PO537, FR-PO540, FR-PO541, SA-PO191, PUB135
Huml, Anne M.	SA-PO426, SA-PO800, SA-PO808, SA-PO825	Ibrahim, Hassan N.	FR-PO444, SA-PO487, SA-PO831	Iozzo, Renato V.	FR-PO459	Jaber, Bertrand L.	TH-PO513
Hummler, Edith	SA-PO757	Ibrahim, Jamil	FR-PO615, SA-PO724, PUB185	Iqbal, Dr Junaid	FR-PO846, SA-PO834, PUB290, PUB292, PUB297, PUB298	Jabrailov, Jabrayil	FR-OR802
Humphrey, Toby J.	FR-PO005	Ibrahim, Rania A.	TH-PO175, TH-PO923, TH-PO941, SA-PO278, SA-PO290	Iqbal, Fatima	FR-PO888	Jackrel, Meredith	FR-PO343
Humphreys, Benjamin D.	TH-OR44, FR-PO133, FR-PO308, FR-PO364, SA-PO085, SA-PO960	Ichikawa, Daisuke	PUB267	Iqbal, Omer M.	TH-PO617	Jackson, Ashley R.	SA-PO108, SA-PO604, SA-PO605, SA-PO607, SA-PO609, SA-PO612, SA-PO613, SA-PO617
Hundemer, Gregory L.	FR-PO736, SA-PO137	Ichikawa, Takafumi	TH-PO826	Irazabal, Maria V.	FR-PO260	Jackson, Ida M.	FR-PO471
Hung, Adriana	TH-PO246, TH-PO607, TH-PO629, FR-PO307, FR-PO312, FR-PO316, FR-PO761	Ichikawa, Yuta	FR-PO043	Irish, William	SA-PO537	Jackson, James	SA-PO660
Hunley, Tracy E.	SA-PO735	Ichimura, Koichiro	TH-PO339	Irvine, John	SA-PO714	Jackson, Jennifer L.	TH-PO471
Hunt-Tobey, Bridget	TH-PO149, FR-OR02, FR-OR07, SA-PO214	Ichimura, Takaharu	FR-OR15, FR-PO357	Irving, Lorraine M.	FR-PO167	Jackson, Melanie E.	SA-PO661 PUB278
Hunt, Kelly J.	TH-PO220, FR-PO065	Ide, Shintaro	TH-PO227	Irwin, Debra E.	TH-PO887, FR-PO904, FR-PO905	Jackson, Scott	PUB278
Hunter, Christopher A.	FR-PO1006	Idorn, Thomas	SA-PO893	Irwin, Ruairi	TH-PO031	Jacob, Molly	FR-PO517
Hunter, Kuniko	FR-PO989	Iesari, Samuele	FR-PO871	Isaac, Farid	TH-PO631	Jacob, Shancy	SA-PO477, PUB208
Hunter, Nicole	SA-PO671	Ifitkhar, Hassaan	SA-PO342	Isaacsohn, Jonathan	FR-PO751	Jacobina, Heloisa d.	SA-PO072
Huo, Bright	SA-PO717	Igarashi, Peter	FR-PO406	Isabella, Vincent	FR-PO233	Jacobs Cachá, Conxita	TH-PO178
Huo, Yuankai	TH-PO572	Iijima, Kazumoto	FR-PO303, FR-PO447, SA-PO539, SA-PO589	Isaeva, Elena	TH-PO325, SA-PO245	Jacobs, Elizabeth A.	TH-PO717
Huque, Sumaya	FR-PO655	Ikawa, Masamichi	TH-OR39	Isaka, Yoshitaka	TH-PO899, FR-PO955	Jacobson, Pamala A.	FR-PO799
Hur, Lisa	SA-PO373, SA-PO374, SA-PO447	Ikehata, Masami	TH-PO444	Isakova, Tamara	TH-PO605, TH-PO869, SA-PO191, SA-PO192	Jacobson, Stefan H.	FR-PO596, FR-PO760, SA-PO457
Hurcombe, Jenny	FR-PO715, SA-PO233	Ikejiri, Kazuaki	TH-PO160	Isaranuwatchai, Suramath	SA-PO557	Jacquelinet, Christian	TH-PO854, TH-PO880, FR-PO221, SA-PO925
Hurley, James	SA-OR46	Ikemori, Atsuko	SA-PO998	Isayeva Waldrop, Tatyana	TH-PO301, TH-PO302	Jadhav, Siddharth P.	SA-PO603
Hurt, Courtney N.	SA-PO705	Ikizler, Talat Alp	TH-OR02, TH-PO028, TH-PO246, TH-PO629, TH-PO829, FR-PO307, SA-PO758, SA-PO759, SA-PO916	Isbel, Nicole	TH-PO500, TH-PO606	Jadlowiec, Caroline	SA-PO823, SA-PO824, SA-PO835
Hurtado, Kevin A.	FR-PO142	Ilagan, Justin	PUB193	Iseki, Kunitoshi	FR-PO925, SA-PO700, SA-PO896	Jafari, Golriz	SA-PO858, SA-PO670, PUB175, PUB304
Husain-Syed, Faeg	SA-PO780	Ilatovskaya, Daria	SA-PO762, SA-PO763	Isermann, Berend H.	TH-PO212, TH-PO440, SA-PO1010	Jaffa, Miran A.	SA-PO772
Husain, Syed A.	PUB332	Ildstad, Suzanne	SA-OR48, SA-OR50	Ishibe, Shuta	FR-PO315, FR-PO684	Jaffer Sathick, Insara	FR-PO192
Husak, Nicholas	FR-PO236, SA-PO054	Iliuta, Ioan-Andrei	TH-PO361, TH-PO362, TH-PO377, FR-PO247	Ishida, Akio	SA-PO896	Jafree, Danial J.	TH-OR48, FR-PO310, SA-OR20
Husami, Samir	TH-PO651	Ilkun, Olesya	TH-PO118, TH-PO119	Ishida, Julie H.	FR-OR39	Jafry, Shehrezade A.	TH-PO607
Huscher, Doerte	TH-PO796	Illei, Gabor G.	SA-PO685	Ishigami, Junichi	TH-PO892	Jagadish, Apoorva	FR-PO042
Hüser, Jörg	SA-PO247	Ilori, Titilayo O.	TH-PO805, TH-PO806, PUB076	Ishii, Naohito	TH-PO826	Jagannath, Priyanka	PUB058
Hussain, Azm U.	FR-PO654	Ilyaskin, Alexandr V.	FR-PO265, FR-PO266	Ishii, Takeo	TH-PO844	Jager, Kitty J.	TH-PO788, SA-PO932
Hussain, Syed A.	PUB208, PUB314, PUB321, PUB329, PUB331, PUB342	Imam, Mahmoud H.	PUB350	Ishiko, Shinya	FR-PO447, FR-PO539	Jäger, Yannick	SA-PO757
Hussein, Hussein A.	PUB212	Imamura, Keigo	TH-PO779, SA-PO178, SA-PO294, PUB032	Ishimoto, Yu	FR-PO282, FR-PO346	Jahan, Farjana	FR-PO574
Hussein, Naser	FR-PO013	Iman, Yasmin A.	TH-PO289, SA-PO944	Ishimwe, Jeanne A.	SA-PO755	Jahnen-Dechent, Willi	SA-PO786
Hussein, Rasha H.	SA-PO436	Imani, Peace D.	SA-PO603	Ishioaka, Kunihiro	FR-PO037	Jaimes, Edgar A.	FR-PO155, FR-PO192, FR-PO223, FR-PO766, SA-PO787, PUB046
Hussein, Wael F.	FR-PO518, SA-PO296	Imasawa, Toshiyuki	TH-PO248	Ishiuuchi, Naoki	TH-PO109	Jain, Anshika	FR-PO415, FR-PO416
Hutchens, Michael	TH-PO086, FR-PO234	Imasuen, Uyi J.	TH-PO384	Ishiwatari, Ayumi	SA-OR03	Jain, Arsh	FR-PO497
Hutchinson, Stephanie	TH-OR18	Imbeault, Benoit	FR-PO513	Ishizuka, Kiyonobu	SA-OR25	Jain, Deepak	FR-PO394, SA-PO957
Hutchison, Colin A.	TH-PO685	Imoto, Akemi	TH-PO826	Isik gonul, Ipek	PUB246	Jain, Deepika	SA-PO667
Hutzfeldt, Arvid D.	FR-PO351, FR-PO712	Imsirovic, Haris	SA-PO137	Islam, Ali	SA-PO374	Jain, Koyal	FR-PO210
Huynh-do, Uyen	FR-OR48	Inaba, Naoto	SA-PO549	Islam, Md S.	TH-PO537	Jain, Nishank	SA-PO917
Huynh, Amy B.	FR-PO336, SA-PO522	Inage, Yuka	FR-PO380	Ismail, Gener	TH-PO561, FR-PO789, SA-PO150, PUB107	Jain, Sanjay	TH-PO651, FR-OR09, FR-OR20, FR-PO169, FR-PO366, SA-OR05, SA-PO001, SA-PO956
Huynh, Dao	PUB278	Inagi, Reiko	FR-PO120	Ismail, Hany E.	TH-PO923	Jaju, Neelam	TH-PO286
Hvas, Anne-Mette	PUB105	Ince, Can	TH-PO597	Ismail, Mohammed H.	TH-PO298	Jakopin, Eva	FR-PO010
Hwang, Daw-yang	TH-PO371, FR-PO462	Indridason, Olafur S.	TH-PO591, TH-PO770, FR-PO099, FR-PO637, FR-PO933	Ismail, Nader	FR-PO486	Jakubowski, Ann A.	SA-PO116
Hwang, Hyeon Seok	TH-PO611, FR-PO464, FR-PO818, SA-PO279, SA-PO379	Induruwage, Dilshani	TH-PO667, FR-PO638	Ito, Hiroki	SA-PO785	Jalal, Diana I.	TH-PO062, TH-PO600, FR-PO740, FR-PO741
Hwang, Jimin	TH-PO743	Infante, Sergio	FR-PO475, SA-PO934, PUB026, PUB145	Ito, Kiyooki	SA-PO858	Jalal, Kabir	FR-PO821
Hwang, Jin Ho	FR-PO039, FR-PO084, FR-PO091, FR-PO092, FR-PO560	Ingle, Kevin A.	TH-PO301, TH-PO302	Ito, Marie	TH-PO207	Jamadar, Abeda	FR-PO288
Hwang, Kyu-Hee	TH-PO177	Ingle, Marybeth	TH-PO718	Ito, Sakuya	TH-PO195, TH-PO389, FR-PO166, FR-PO613	Jamee, Muhammad	SA-PO660
Hwang, Seungyoung	FR-PO757	Ingram, Kelly	TH-PO580	Ito, Yugo	TH-PO911, FR-PO526, FR-PO558, SA-PO388, SA-PO440, SA-PO861	Jameel, Ihab	TH-PO467
Hwang, Shih-Jen	TH-OR25	Ingvia, Thammasin	TH-PO957, FR-PO881	Ito, Yumi	TH-PO885	James, Luke T.	TH-PO033
Hwang, Won Min	TH-PO793, FR-PO341, FR-PO782, SA-PO646	Inker, Lesley A.	TH-PO497, TH-PO743, TH-PO786, TH-PO847, TH-PO896, TH-PO898, FR-PO216, FR-PO754, SA-OR38, SA-PO121, SA-PO913, SA-PO920, SA-PO950	Ivanovic, Sasa	PUB323	James, Matthew T.	FR-PO060
Hwang, Yunji	TH-PO700	Inkong, Pitchamon	TH-PO831, FR-PO021, FR-PO908, SA-PO162, SA-PO901	Ivy, S. P.	SA-PO156	Jamil, Khurram	TH-PO034, TH-PO035, TH-PO037
Hymes, Jeffrey L.	TH-OR837, TH-PO932, SA-PO310, SA-PO390, SA-PO425, PUB011			Iwano, Masayuki	TH-OR39	Jampong, Malinporn	FR-PO943
Hysi, Katerina	FR-PO667, PUB188, PUB242, PUB337			Iwashita, Takatsugu	TH-PO025, TH-PO758	Jan, Stephen	TH-PO275
Hyun, Young Youl	TH-PO793, FR-PO921			Iwata, Yasunori	TH-PO094, FR-PO938, SA-PO911, PUB210, PUB347, PUB348	Janakiraman, Arun	TH-PO170
						Janda, Jaroslav	FR-PO142
						Jandal, Ali D.	TH-PO384
						Jandeleit-Dahm, Karin	SA-PO254

Janech, Michael G. TH-PO134, FR-OR13, PUB253  
Janeiro, Darío TH-PO095, FR-PO132, SA-PO335  
Jang, Charley Q. FR-PO025  
Jang, Ha nee SA-PO439, PUB362  
Jang, Hye Ryoum TH-PO048, TH-PO095, FR-PO132, SA-PO335  
Jang, Hyo-Ju TH-PO338, TH-PO343  
Jang, Hyun Bae PUB187  
Jang, Joon Young TH-OR52  
Jang, Soo min FR-PO224, FR-PO225, FR-PO226, FR-PO475, PUB026  
Jang, Sun-Joo PUB170  
Jang, Yunyoung FR-PO812  
Janga, Madhusudhana R. FR-PO391  
Jankowski, Jakub SA-PO084  
Jankowski, Joachim TH-PO171, SA-PO786, TH-PO171  
Jankowski, Vera TH-PO171  
Janmey, Paul A. FR-PO689  
Janosevic, Danielle FR-PO131, FR-PO137  
Janowczyk, Andrew TH-PO569, SA-PO003, SA-PO711  
Jansa, Petr FR-PO993  
Jansen, Jitske TH-PO533, FR-PO441, SA-PO025, SA-PO447  
Janssen, Barry SA-OR12  
Janssen, Manoe J. SA-OR12  
Janssens, Geert O. FR-PO194  
Januzzi, James TH-PO237  
Jaouni, Shahn TH-PO705  
Japes, Hina TH-PO413  
Jaquet, Vincent SA-PO254  
Jara, Maximilian K. SA-PO893  
Jarad, George TH-PO443  
Jaradeh, Mark TH-PO550, TH-PO617  
Jaramillo Morales, Javier TH-PO829  
Järbrink, Krister TH-PO889, FR-PO546, PUB172  
Jardine, Meg TH-PO767  
Jarjour, Wael FR-PO598  
Jarrah, Hala H. SA-PO772  
Jarvik, Gail P. FR-PO497  
Jaryal, Ajay PUB152  
Jaser, Ahmad FR-PO297  
Jauch-Lembach, Julia SA-PO679  
Java, Anuja FR-PO823, FR-PO825  
Javaherizadeh, Payam PUB335  
Javaugue, Vincent TH-PO509, FR-PO190, SA-PO159  
Jawaid, Tabinda TH-PO368, TH-PO375, TH-PO376  
Jawed, Areeba TH-PO773, TH-PO784  
Jayanama, Kulapong FR-PO016  
Jayaraman, Pushkala TH-PO083  
Jayasumana, Channa SA-PO1012  
Jayne, David R. FR-PO651, SA-PO696  
Jayson, Christina TH-PO567  
Jeannin, Pascale FR-PO580  
Jeansson, Marie FR-PO952  
Jefferies, John L. FR-PO339  
Jegatheesan, Dev K. TH-PO606  
Jenkinson, Celia P. FR-PO724  
Jenkinson, Patrick J. SA-PO057  
Jennette, J. Charles FR-PO579  
Jensen, Colton PUB344  
Jensen, Gert TH-PO228, TH-PO230  
Jensen, Per B. TH-PO931  
Jensen, Simon K. TH-OR04  
Jeon, Hojin FR-PO132  
Jeon, Hoonbae SA-PO802  
Jeon, Jae wan TH-PO071  
Jeon, Jin seek TH-PO254, SA-PO1000  
Jeon, Junseek TH-PO048, TH-PO095, FR-PO132, SA-PO335  
Jeon, Soojee TH-PO067, SA-PO828  
Jeong, Hyeyun FR-PO987  
Jeong, Kyung hwan TH-PO611, FR-PO464, FR-PO818, SA-PO279, SA-PO379  
Jeong, Rachel TH-PO040, FR-PO060, FR-PO831, SA-PO794  
Jeong, Saeyoung TH-PO635  
Jerke, Uwe FR-PO576  
Jernberg, Tomas FR-PO760  
Jesse, Kristin SA-PO282  
Jesse, Michelle TH-PO737  
Jesusdason, Shilpa TH-PO723  
Jewell, Nicholas P. FR-PO927  
Jeyabalan, Anushya FR-PO646, PUB060  
Jeyarajasingam, Arsitha PUB182  
Jha, Jay C. SA-PO254  
Jha, Kunal FR-PO902  
Jha, Vivekanand TH-PO029, TH-PO475, TH-PO686, TH-PO692, FR-PO005, FR-PO853, FR-PO886, FR-PO891, FR-PO934, SA-OR37, SA-PO887, SA-PO905, PUB243  
Jhamb, Manisha TH-PO722, TH-PO777, FR-PO862, FR-PO867, SA-PO303, SA-PO942, SA-PO943  
Jhaveri, Kenar D. TH-PO757, FR-PO070, FR-PO185, FR-PO186, FR-PO191, FR-PO213, FR-PO875, SA-PO122, SA-PO863  
Jhee, Jong Hyun TH-PO827, FR-PO085, FR-PO745, FR-PO746, SA-PO410, PUB180  
Ji, Peili TH-PO881  
Jia, Xiaoyuan FR-PO303  
Jiang, Anni FR-PO965  
Jiang, Fei F. PUB239  
Jiang, Gengru SA-OR18, SA-PO559  
Jiang, Guanglong FR-PO137  
Jiang, Hong TH-OR16, TH-PO374, FR-PO470, PUB308  
Jiang, Huan TH-PO387, TH-PO413  
Jiang, Jordan TH-PO369, TH-PO370  
Jiang, Lei SA-PO748  
Jiang, Li FR-PO254  
Jiang, Nan FR-PO377  
Jiang, Shuhan TH-PO753  
Jiang, Shumeng FR-PO700, FR-PO713  
Jianqin, Wang TH-OR16  
Jiao, Baihai FR-PO970  
Jiao, Yongyi SA-PO164  
Jiao, Yue TH-PO677, TH-PO837, FR-PO942, SA-PO308, SA-PO390  
Jim, Belinda SA-PO732  
Jimenez, Carlos PUB020  
Jimenez, José A. FR-PO461  
Jiménez, Lorgis I. PUB325  
Jimenez, Sonia TH-PO672, SA-PO695  
Jimenez, Viviana FR-PO594  
Jin, Haijiao TH-OR16, SA-PO311  
Jin, Harry FR-PO849  
Jin, Kyubok TH-PO157, TH-PO393, TH-PO495, TH-PO912, FR-PO026, FR-PO976, SA-PO407, SA-PO904  
Jin, Xin TH-PO348  
Jinadasa, Tushare FR-PO344  
Jinrong, Liu FR-PO218  
Jintanapramote, Kavita TH-PO652  
Jo, Hyung Ah FR-PO401, FR-PO976, SA-PO973  
Jo, Sang-Kyung FR-OR18, FR-PO112, PUB090  
Jo, Seongho SA-PO915  
Jo, Wonji TH-PO673, FR-PO340, SA-PO093  
Jo, Young-II FR-PO528, SA-PO407  
Joachim, Kole SA-PO123  
Joannou, Maria K. TH-OR48, FR-PO310, SA-OR20, SA-PO618  
Jobst-Schwan, Tilman TH-PO428, SA-PO566, PUB194  
Joekes, Elizabeth FR-PO919  
Joerg, David J. PUB080  
Joergensen, Hanne S. FR-OR06, SA-PO179  
Johal, Navroop S. SA-PO618  
Johal, Prabhjot K. TH-PO029, FR-PO934, SA-PO217, SA-PO731  
Johansen, Kirsten L. TH-OR17, TH-PO660, TH-PO661, TH-PO666, TH-PO686, TH-PO691, TH-PO692, TH-PO717, TH-PO936, TH-PO955, FR-PO008, FR-PO491, FR-PO520, FR-PO895, SA-OR37, SA-PO287, SA-PO806  
Johansson, Alva TH-PO426  
Johansson, Martin E. FR-PO393, PUB269  
John, Rohan TH-PO640, FR-PO681  
Johns, Tanya S. SA-PO803  
Johnson, Bryce G. FR-PO343  
Johnson, Curtis D. TH-PO932, PUB011  
Johnson, David W. FR-PO497, PUB312  
Johnson, Doug TH-PO921, TH-PO938, FR-PO500, SA-OR08  
Johnson, John C. PUB331  
Johnson, Matthew R. FR-PO683  
Johnson, Nathan TH-PO580  
Johnson, Rachel R. SA-PO938  
Johnson, Rebecca J. FR-PO417, SA-PO949  
Johnson, Richard D. TH-OR20  
Johnson, Richard J. TH-PO253, PUB355  
Johnson, Selma FR-PO494  
Johnson, Seth TH-PO261  
Johnson, Tim S. FR-PO639  
Johnston, Alexandra M. TH-PO018  
Johnston, James B. FR-PO438  
Johnston, Kimberly SA-PO022  
Joki, Nobuhiko TH-PO701  
Joli, Giancarlo TH-PO367  
Joly, Florent SA-PO409  
Jonas, Elizabeth A. FR-PO121  
Jonasdottir, Asta D. FR-PO637  
Jones-Burton, Charlotte TH-PO497  
Jones, Bryce A. TH-PO191, FR-PO688, FR-PO999  
Jones, Cami R. TH-PO255, FR-PO662, PUB274  
Jones, Caroline A. PUB274  
Jones, Clifford D. TH-PO433  
Jones, Heather SA-PO537  
Jones, Lindsey A. FR-PO507  
Jongejan, Aldo TH-PO416  
Jongkaewwattana, Anan TH-PO924  
Jongs, Niels FR-OR26, SA-OR36, SA-PO885, SA-PO886, SA-PO889  
Jonsson, Amar J. TH-PO770  
Joo, Kwon Wook TH-PO065, TH-PO066, FR-PO084, FR-PO091, FR-PO092, FR-PO162, FR-PO812, FR-PO922, SA-PO371, SA-PO716, SA-PO801  
Joo, Yoosun FR-PO528  
Joo, Young Su FR-PO909  
Jordan, Stanley C. SA-OR43  
Jorge, Leticia TH-PO516, FR-PO678, FR-PO732, SA-PO683  
Jorgensen, Justine FR-PO192, FR-PO223  
Jørgensen, Morten B. SA-PO829  
Jorgenson, Margaret R. PUB303  
Jorgetti, Vanda TH-PO165, FR-OR05, SA-PO165, SA-PO176, SA-PO177, SA-PO213, SA-PO215  
Jortani, Saeed A. TH-PO446, TH-PO447  
Jose, Arunima Mariya FR-PO196  
Jose, Pedro A. SA-PO783, SA-PO791, SA-PO958  
Joseph, Amer SA-PO274  
Joseph, Catherine SA-PO602  
Joseph, Corey FR-PO814  
Joseph, Jessica TH-OR18  
Josephson, Michelle A. FR-PO836, SA-PO799, SA-PO869, PUB333  
Joshi, Aditi A. FR-PO033, FR-PO050  
Joshi, Megha R. SA-PO519  
Joshi, Shashank R. TH-PO233  
Joshi, Trupti TH-PO445, SA-PO968  
Joslin, Jennifer R. TH-PO756  
Jotwani, Vasantha TH-OR03, TH-PO797, TH-PO865, FR-PO756, SA-PO991  
Joung, Jinwoon SA-PO624  
Jourdain, Pierre FR-PO588  
Jovanovich, Anna TH-OR24, TH-PO402, TH-PO404, TH-PO609, SA-PO210  
Jover, Bernard TH-PO171  
Joy, Melanie S. FR-PO223, SA-PO158  
Ju, Wenjun TH-PO211, TH-PO213, TH-PO422, FR-OR36, FR-PO724  
Juan, Yunting FR-PO656  
Juarez, Joana B. FR-PO027  
Judge, Conor S. FR-PO499  
Jue, Melinda L. SA-PO418  
Jue, Thomas TH-PO818, TH-PO821, TH-PO823, TH-PO824  
Juffre, Alexandria TH-PO326, TH-PO327, SA-PO769  
Juillard, Laurent TH-PO685  
Julian, Bruce A. FR-PO657, SA-PO641, SA-PO642, SA-PO643, SA-PO644, SA-PO645  
Julian, Kelly PUB352  
Jun, Jaehyun SA-PO049, SA-PO277  
Jun, Min TH-PO872  
Jung, Chan-Young FR-PO791, FR-PO906  
Jung, Gun Tae SA-PO407  
Jung, Hee-Yeon TH-PO067, SA-PO828  
Jung, Hyun Jun TH-PO337, TH-PO338, FR-PO145, FR-PO147, SA-PO961  
Jung, Ji Yong SA-PO927  
Jung, Jiyun FR-PO086, FR-PO817  
Jung, Kwan-Jin SA-PO360  
Jung, Sehyun SA-PO439, PUB362  
Jung, Su Woong SA-PO349, SA-PO407  
Jung, Yeonsoon FR-PO778  
Junge, Guido TH-PO505, FR-OR59  
Jungels, Nino FR-PO344  
Junk, Elizabete PUB330  
Jüppner, Harald SA-PO528  
Jurkovicz, Claudine T. FR-PO058  
Jurubita, Roxana A. TH-PO561, PUB107  
Juul-Sandberg, Rikke TH-PO931  
Jweehan, Duha A. TH-PO100, FR-PO621, FR-PO679  
Kabasawa, Keiko TH-PO885  
Kabir, Purnima SA-PO500  
Kaburagi, Yasushi TH-PO248  
Kadatz, Matthew J. PUB299  
Kado, Deborah M. SA-PO185  
Kadono, Mitsuki TH-PO109  
Kadota, Nozomi TH-PO911, FR-PO526, SA-PO388, SA-PO440, SA-PO861  
Kae, Soo H. SA-PO478, SA-PO730, PUB217  
Kaewput, Wisit TH-PO831, FR-PO021, FR-PO908, SA-PO162, SA-PO824, SA-PO835, SA-PO901  
Kaffke, Anna SA-OR29  
Kahan, Thomas FR-PO760  
Kahn, Ronald SA-PO253  
Kahnert, Antje SA-PO247  
Kaida, Yusuke TH-PO195, TH-PO389  
Kaidbay, Hasan-Daniel N. TH-PO400, FR-PO851, FR-PO919  
Kaimba, Sylvester FR-PO919  
Kaimori, Jun-Ya TH-PO899  
Kaiser, Toralf SA-PO589  
Kaito, Hiroshi SA-PO589  
Kajimoto, Sachio TH-PO899  
Kakei, Hiroko FR-PO115  
Kakinoki Teng, Andre FR-OR05  
Kalantar-Zadeh, Kamyar TH-PO167, TH-PO168, TH-PO681, TH-PO682, TH-PO683, TH-PO809, TH-PO838, TH-PO852, TH-PO853, TH-PO870, TH-PO871, TH-PO879, FR-OR24, FR-PO544, FR-PO574, FR-PO800, FR-PO899, FR-PO900, FR-PO926, FR-PO930, FR-PO941, SA-OR33, SA-PO304, SA-PO375, SA-PO376, SA-PO383, SA-PO463, SA-PO902, SA-PO903, SA-PO908, SA-PO909, PUB079  
Kalantar, Diana S. SA-PO908  
Kalantar, Sara S. SA-PO383  
Kalantri, Pooja TH-PO596, FR-PO209, SA-PO727  
Kalaria, Arjun L. FR-PO481, FR-PO666



Kalber, Tammy L. FR-PO332  
 Kälble, Florian TH-PO105, TH-PO920, FR-PO774, SA-PO812  
 Kaldas, Hoda SA-PO496  
 Kalim, Sahir TH-PO054, TH-PO240, TH-PO811, FR-OR23, SA-PO462, SA-PO931  
 Kalipatnapu, Sri Mahathi P. SA-PO194  
 Kalk, Philipp FR-PO503  
 Kallash, Mahmoud FR-PO663, SA-PO585, SA-PO735  
 Kalocsay, Marian TH-PO332  
 Kalot, Rita K. FR-PO292  
 Kalra, Gurmannaat TH-PO252, FR-OR32  
 Kalra, Kartik SA-PO368, SA-PO534  
 Kalra, Philip A. TH-PO674, TH-PO680, FR-PO769, FR-PO770, SA-PO719, PUB101, PUB256  
 Kälsch, Anna-Isabelle TH-PO543  
 Kalucka, Joanna FR-OR14  
 Kamal, Fahmeedah PUB120  
 Kamal, Layla FR-PO805, FR-PO855, SA-PO853  
 Kamalanabhaiah, Sahana R. TH-PO914, TH-PO922  
 Kamar, Fareed SA-PO794  
 Kamarzarian, Anita SA-PO458, SA-PO670, PUB175, PUB304  
 Kamboj, Amira S. TH-PO689, PUB071, PUB356  
 Kamboj, Kajal TH-PO029, TH-PO639  
 Kamei, Caramai N. FR-PO405  
 Kamei, Yuiko SA-OR03  
 Kamerling, Sylvia FR-PO011  
 Kamgar, Mohammad FR-PO025  
 Kamigaki, Yu TH-PO446, TH-PO447, TH-PO448, SA-PO585  
 Kamijo, Yuji TH-PO532, FR-PO587, SA-PO091  
 Kaminski, Dorian FR-OR33, FR-PO347  
 Kammerer, Jennifer A. SA-PO287  
 Kampf, Patrick FR-PO071  
 Kamuche, Princes TH-PO307  
 Kanai, Daisuke SA-PO456  
 Kaname, Shinya FR-PO652  
 Kanamori, Naoki SA-PO182  
 Kanamori, Toru SA-PO743  
 Kananuraks, Sarassawan FR-PO474  
 Kanda, Eiichiro TH-PO867, FR-PO546, FR-PO549  
 Kanda, Shoichiro SA-OR25  
 Kandary, Mark SA-PO047  
 Kanduri, Swetha Rani TH-PO073, FR-PO610, FR-PO635, SA-PO680  
 Kaneko, Hiyori TH-PO227  
 Kaneko, Thomas M. TH-PO465, PUB260  
 Kaneko, Yoshikatsu SA-PO640  
 Kang, Donghyuk SA-PO923  
 Kang, Duk-Hee FR-PO452, FR-PO453, FR-PO457  
 Kang, Eunjeong SA-PO801  
 Kang, Haemin SA-PO550, SA-PO597  
 Kang, Hee Gyung TH-PO358, TH-PO365, TH-PO366, FR-PO413, FR-PO555, SA-PO550, SA-PO597, SA-PO611  
 Kang, Hyun-Jung FR-PO452, FR-PO457  
 Kang, Jay H. FR-PO418  
 Kang, Kyung Pyo FR-PO593, FR-PO644  
 Kang, Min woo TH-PO065, TH-PO066  
 Kang, Renhong PUB149  
 Kang, Seok hui SA-PO379  
 Kang, Seong Ryeong FR-PO555  
 Kang, Shin-Wook TH-PO873, SA-PO650  
 Kang, Yihuang TH-PO665  
 Kanigicherla, Durga Anil K SA-PO681  
 Kanjanabuch, Talerngsak FR-PO474, FR-PO506, FR-PO522, SA-PO557  
 Kann, Martin TH-PO506, SA-OR42  
 Kannabhiran, Dinesh FR-PO590  
 Kannan, Lakshmi TH-PO768, SA-PO470, PUB247  
 Kano, Toshiaki TH-PO419  
 Kansal, Sheru TH-PO892  
 Kant, Kotagal S. SA-PO236  
 Kantagowit, Piyawat TH-PO924  
 Kantarcioglu, Bulent SA-PO391  
 Kantauskaite, Marta SA-PO761  
 Kanter, Genevieve SA-PO392  
 Kantharidis, Phillip TH-PO205  
 Kanwar, Yashpal S. TH-PO196, FR-PO020, FR-PO668, SA-PO707  
 Kao, Patricia F. TH-PO005, FR-PO101  
 Kapadia, Chintan H. PUB046  
 Kapales, Makenzie SA-PO010  
 Kapanadze, Tamar G. SA-PO987  
 Kaplan, Joshua PUB041  
 Kaplan, Kevin FR-PO427  
 Kaplanis, Lauren A. SA-PO117  
 Kapoor, Aromma FR-PO197  
 Kapoor, Sanjana TH-PO944, TH-PO945, FR-PO827, FR-PO803  
 Kapota, Athanasia SA-PO408  
 Kapp, Meghan TH-PO108, SA-PO142, SA-PO868  
 Kaptein, Matthew PUB173  
 Karaali, Ali TH-PO632  
 Karaboyas, Angelo SA-PO179, SA-PO184, SA-PO285  
 Karadjian, Oliver A. SA-PO347  
 Karafliidis, John TH-OR34  
 Karakala, Nithin FR-PO187, SA-PO201  
 Karasik, Avraham SA-PO266  
 Kareem, Samer FR-OR821  
 Kargin, Sinem FR-PO690  
 Kari, Jameela A. SA-PO538, SA-PO578  
 Karihaloo, Anil K. TH-PO213, TH-PO252, FR-OR32, SA-PO249  
 Karim, Aftab TH-PO035, TH-PO037  
 Karimi, Ava FR-PO735  
 Karimi, Hussain A. SA-PO496  
 Kariyil, Reshma J. TH-PO114  
 Karl, Bethany E. SA-PO062  
 Karp, Sharon L. SA-PO302  
 Karp, Sophie SA-PO028  
 Karpinski, Steph FR-PO873, SA-PO320  
 Karras, Alexandre TH-PO505  
 Karsdal, Morten A. TH-PO234, TH-PO239, TH-PO429, FR-PO773, FR-PO784  
 Kartchner, Laurel SA-PO537  
 Karttunen, Heidi TH-PO202  
 Karumanchi, Pranathi TH-PO550  
 Kasahara, Masato FR-PO925, SA-PO700  
 Kaseda, Ryohei TH-PO334, FR-PO945  
 Kasem, Sadat TH-PO135  
 Kashani, Kianoush TH-PO051, TH-PO061, TH-PO794, SA-PO780  
 Kashem, Tasnuva S. FR-PO785, PUB327  
 Kashfi, Simon A. PUB185  
 Kashgarian, Michael TH-PO080  
 Kashihara, Naoki TH-PO867, FR-OR39, FR-OR59  
 Kasinath, Balakuntalam S. TH-PO181, TH-PO197, PUB367  
 Kasiske, Bertram L. SA-PO820  
 Kaskel, Rick TH-PO476, TH-PO479  
 Kasner, Scott E. TH-PO618  
 Kassa, Katie SA-PO240  
 Kassem, Hania FR-PO673, PUB314  
 Kastner, Paul D. SA-PO755  
 Kasugai, Takahisa FR-PO108  
 Kasun, Zachary A. FR-PO993  
 Kasuno, Kenji TH-OR39  
 Kasztan, Malgorzata TH-PO703  
 Katagiri, Daisuke FR-PO018  
 Katagiri, Masato TH-PO826  
 Katavetin, Pisut TH-PO582, SA-PO894  
 Kathail, Pooja FR-PO305  
 Katia yuritzi, Rfos C. TH-PO907  
 Katmeh, Tulayla SA-PO717  
 Kato, Aya SA-OR25  
 Kato, Tadashi TH-PO143, SA-PO182  
 Katsara, Maria-Alexandra FR-PO915  
 Katsoufis, Chryso P. FR-PO425, FR-PO437  
 Kattah, Andrea G. TH-PO051, PUB343  
 Kattamanchi, Siddhartha SA-PO048  
 Katz, Nurit S. TH-PO958, SA-PO039, PUB060  
 Katz, Ronit TH-OR03, TH-PO243, TH-PO678, TH-PO865, FR-PO755, FR-PO756, FR-PO916, SA-PO185, SA-PO186, SA-PO922, SA-PO991  
 Kaufeld, Jessica K. TH-PO506  
 Kaufman, Allen FR-PO511  
 Kaufman, Harvey W. TH-PO725, SA-PO398  
 Kaufman, James S. TH-OR02, TH-OR07, TH-PO028  
 Kaul, Hitesh SA-PO867  
 Kaur, Gurpreet TH-PO137  
 Kaur, Jaskiran TH-PO029, TH-PO639  
 Kaur, Navchetan FR-PO797  
 Kaur, Navneet FR-PO527  
 Kaur, Ramandeep TH-PO130  
 Kaur, Tejinder SA-PO977  
 Kausler, Katalin PUB085  
 Kaushal, Amit FR-PO450  
 Kaushal, Madhurima SA-OR05  
 Kaushik, Swati SA-PO240  
 Kausman, Joshua Y. TH-OR31  
 Kavanagh, Kylie SA-PO789  
 Kavanagh, Matthew A. SA-OR14  
 Kawachi, Hiroshi SA-PO740  
 Kawaguchi, Takehiko FR-PO558  
 Kawai, Tatsuo TH-OR54  
 Kawamura, Masataka TH-PO637, TH-PO640  
 Kawanishi, Tomoko SA-OR03  
 Kawano, Mitsuhiro SA-PO858  
 Kawashima, Shun FR-OR15  
 Kawashima, Soko FR-PO652  
 Kawata, Takehisa TH-PO143  
 Kayhan, Merve FR-PO1007  
 Kayser, Séverine FR-PO706  
 Kaysi, Saleh SA-PO352  
 Kazama, Itsuro SA-PO984  
 Kazama, Junichiro J. TH-PO161  
 Kazancioglu, Rumezyza SA-PO221  
 Kazi, Basil S. TH-PO773  
 Kazi, Usman PUB014  
 Kazory, Amir SA-PO442, SA-PO504  
 Keane, Colin J. TH-PO739  
 Keane, David F. FR-PO536  
 Kearney, Matthew D. FR-PO516  
 Keddem, Shimrit FR-PO515  
 Keddis, Mira T. TH-PO412, FR-PO808, SA-PO823, SA-PO884  
 Keefe, Francis J. SA-PO303  
 Keeley, Tom J. TH-PO660, TH-PO661, TH-PO691  
 Keenan, Gregory F. TH-PO456  
 Keers, Grace TH-PO708  
 Kefalogianni, Eirini FR-PO367, SA-PO105  
 Keijzer-Veen, Mandy G. FR-PO194  
 Keilholz, Shella SA-PO788  
 Kelam, Nela SA-PO622  
 Kell, Darren FR-PO471  
 Keller, Brad FR-PO495  
 Keller, Christian TH-PO914, TH-PO922  
 Keller, Max SA-PO770  
 Kellner, Elias TH-PO866  
 Kellum, John A. FR-PO071, FR-PO081, FR-PO082  
 Kelly, Ciara M. FR-PO212  
 Kelly, Darren J. TH-PO422  
 Kelly, Dearbhla M. TH-OR25, TH-PO872, SA-PO701  
 Kelly, Katherine J. TH-PO099, TH-PO183, FR-PO118, FR-PO169, PUB204  
 Kelly, Tanika TH-PO874, FR-PO319, SA-PO931  
 Kempton, Kristalynn M. TH-PO081  
 Kenan, Daniel J. TH-PO452  
 Kendrick, Elizabeth A. SA-PO846  
 Kendrick, Jessica B. TH-PO800, TH-PO857, SA-PO596, SA-PO948, PUB100  
 Kenkre, Balchandre N. SA-PO943  
 Kennamer, Karen E. SA-PO537  
 Kennedy, Stephanie M. FR-PO471  
 Kennelly, Corey TH-PO600  
 Kenney, Re PUB098  
 Kenny, Rachel TH-PO828  
 Kenny, Rose Anne M. TH-PO632  
 Kent, Candice PUB054  
 Kentrup, Dominik FR-OR02, SA-PO214  
 Kercksmar, Macie M. SA-PO604, SA-PO605, SA-PO609  
 Kerdok, Amy SA-PO018  
 Kerlin, Bryce A. TH-PO473  
 Kern, Nicholas L. FR-PO344  
 Kerser, Jesper TH-PO416  
 Kersten, Maj V. SA-PO025  
 Kessel, Friederike TH-PO226  
 Kestenbaum, Bryan R. TH-OR01, TH-OR10, TH-PO605, FR-PO031, FR-PO944, SA-PO185, SA-PO912, SA-PO918, SA-PO929, SA-PO930, PUB028  
 Ketchersid, Terry L. SA-PO343, SA-PO378  
 Kethineni, Rama TH-PO118, FR-PO200, SA-PO666  
 Ketkar, Apurva SA-PO033  
 Kettritz, Ralph FR-PO575, FR-PO576, FR-PO582, FR-PO583  
 Keyes, Jonathan TH-PO596, SA-PO339  
 Kha, Michelle FR-PO393, PUB269  
 Khader, Ayesha PUB028  
 Khader, Shameer PUB346  
 Khairallah, Pascale FR-PO624, FR-PO856  
 Khaja, Taqui SA-OR872  
 Khalaily, Nareman TH-PO147  
 Khalid, Myda TH-PO472, TH-PO473, TH-PO474, SA-PO594  
 Khalid, Usman FR-PO163  
 Khalil, Patricia TH-PO518  
 Khalil, Steve I. TH-PO078  
 Khalili, Korosh TH-PO399  
 Khamash, Hasan SA-PO823  
 Khambati, Nadia PUB286  
 Khan, Akbar A. FR-PO056  
 Khan, Anum S. TH-PO122  
 Khan, Atlas SA-PO606  
 Khan, Ayesha A. TH-PO461, FR-PO446  
 Khan, Barbara C. FR-PO892  
 Khan, Hafiz Sarfraz A. PUB132  
 Khan, Hameeda T. FR-PO783  
 Khan, Maheen FR-PO612  
 Khan, Mohammad H. FR-PO799  
 Khan, Mohammed T. SA-PO660  
 Khan, Muhammad S. SA-PO036, SA-PO037  
 Khan, Naseer PUB307  
 Khan, Nazish SA-PO498  
 Khan, Nazleen TH-PO856  
 Khan, Rana Raheel H. SA-PO141, SA-PO870  
 Khan, Sabiha M. FR-PO046  
 Khan, Samia Q. FR-PO594  
 Khan, Samina SA-PO919  
 Khan, Sana F. FR-PO477  
 Khan, Shabtab FR-PO049  
 Khan, Shehnaz FR-PO149, FR-PO150, FR-PO154  
 Khan, Sobia N. TH-PO132, FR-PO087, PUB056  
 Khan, Umair TH-PO886, SA-PO866  
 Khandpur, Sukhanshi PUB114  
 Khangura, Rammik S. SA-PO454  
 Khanmoradi, Kamran SA-OR867  
 Khare, Atul TH-PO859, FR-PO220, SA-PO171  
 Khatib, Rasha TH-PO718  
 Khattak, Aisha TH-PO612  
 Khattak, Muhammad W. TH-PO035, TH-PO037  
 Khayat, Maurice I. SA-PO206

Khazoum, Elias S. SA-PO723  
 Khedr, Abdelrahman N. SA-PO420  
 Kher, Vijay K. TH-PO687, TH-PO688  
 Khezrian, Mina FR-PO546  
 Khoeiklang, Martin FR-PO219  
 Khor, Si Yuan TH-PO296, TH-PO689, FR-PO573, PUB071, PUB356  
 Khorana, Jiraporn TH-PO787  
 Khorsandi, Shiba SA-PO817  
 Khositrangsikun, Kamol FR-PO079, FR-PO474  
 Khosla, Pavan SA-PO606  
 Khosrovaneh, Katherine L. SA-PO267  
 Khoueiry, Pierre TH-OR51  
 Khoury, Nadeen J. TH-PO737  
 Khowaja, Saima TH-PO360, TH-PO361, TH-PO362, TH-PO377, TH-PO399  
 Khruewang, Kittiphon SA-OR35  
 Khunti, Kamlesh TH-PO233  
 Khwaja, Arif SA-PO681, SA-PO703  
 Kiberd, James A. FR-PO831, SA-PO794  
 Kidambi, Piran SA-PO418  
 Kidd, Jason M. FR-PO663, SA-PO448, SA-PO720, SA-PO735  
 Kidd, Kendrah O. TH-PO379  
 TH-PO380, FR-PO343, PUB192  
 Kielstein, Jan T. TH-PO291, FR-PO001, SA-PO145  
 Kiernan, Elizabeth TH-PO026  
 Kiernan, Michael S. TH-PO603, FR-PO083  
 Kikkawa, Yamato TH-PO158  
 Kikuchi, Hiroaki TH-PO337, SA-PO961, SA-PO1008  
 Kikuchi, Takashi FR-PO549  
 Kilbaugh, Todd J. FR-PO109  
 Kilduff, Stella R. PUB276  
 Killackey, Mary SA-PO802  
 Kilner, Jill TH-PO222  
 Kilpatrick, Mark D. SA-PO448  
 Kim, Alice TH-PO380, PUB192  
 Kim, Andrew Y. PUB167  
 Kim, Beom Seok TH-OR52, FR-PO772, FR-PO791, FR-PO906, SA-PO367  
 Kim, Beong Woo TH-PO679  
 Kim, Bong-Jo SA-PO650  
 Kim, Byung chang PUB300  
 Kim, Byung Sik TH-PO635  
 Kim, Chan-Duck TH-PO067, SA-PO828  
 Kim, Chang Seong TH-PO813  
 Kim, Connor SA-PO002  
 Kim, Dabin SA-PO611  
 Kim, Dae Kyu SA-PO379, SA-PO407  
 Kim, Dal-Ah FR-PO452, FR-PO453, FR-PO457  
 Kim, Do Hyoung FR-PO539  
 Kim, Dong Ki TH-OR56, TH-PO065, TH-PO066, TH-PO495, TH-PO812, TH-PO912, FR-PO026, FR-PO084, FR-PO092, FR-PO162, FR-PO922, FR-PO976, FR-PO979, SA-PO371, SA-PO716, SA-PO973  
 Kim, Eun Nim SA-PO228  
 Kim, Geon Woo FR-PO464, SA-PO279  
 Kim, Hannah SA-PO586  
 Kim, Heeyoung TH-PO920  
 Kim, Helena FR-PO067, FR-PO075, SA-PO151  
 Kim, Hyang FR-PO921  
 Kim, Hye-jung TH-OR53, TH-PO653  
 Kim, Hyo Jeong TH-OR52, TH-PO873, FR-PO763, FR-PO772, FR-PO791, FR-PO792, FR-PO830, PUB313  
 Kim, Hyo Jin FR-PO988, PUB180  
 Kim, Hyojin SA-PO111  
 Kim, Hyosang FR-PO086, FR-PO817, SA-PO836  
 Kim, Hyoungnae TH-PO254, SA-PO1000  
 Kim, Hyun-Jung SA-PO439, PUB362  
 Kim, Hyung Woo FR-PO791, FR-PO906, SA-PO367, SA-PO650  
 Kim, Hyunju FR-PO918  
 Kim, Hyunsuk TH-PO265, TH-PO793  
 Kim, Jae seok SA-PO737  
 Kim, Jae Young TH-PO876  
 Kim, Jee Hoon TH-PO587  
 Kim, Jennifer FR-PO522  
 Kim, Jeongwoo SA-PO049, SA-PO277  
 Kim, Ji Eun TH-OR56, FR-PO084, FR-PO091, FR-PO092, FR-PO812  
 Kim, Ji Hye TH-PO623, SA-PO547, PUB357  
 Kim, Ji hyun FR-PO413, SA-PO550, SA-PO597  
 Kim, Ji Young TH-OR45, SA-PO108  
 Kim, Ji-Hee TH-PO177, SA-PO737  
 Kim, Jin FR-PO354, FR-PO360  
 Kim, Jin Chul SA-PO881  
 Kim, Jin H. PUB362  
 Kim, Jin Ju FR-PO323, FR-PO694, FR-PO722  
 Kim, Jin kuk SA-PO652  
 Kim, Jin sug TH-PO611, FR-PO464, FR-PO818, SA-PO279, SA-PO379  
 Kim, Jinbaek SA-PO295  
 Kim, Jineop TH-PO265  
 Kim, Jinwon FR-PO354, FR-PO360  
 Kim, Jonghan FR-PO234  
 Kim, Jongho FR-PO464, SA-PO279, PUB119  
 Kim, Joong Kyung TH-PO640  
 Kim, Joseph FR-PO152  
 Kim, Junhyong TH-OR19, FR-PO543, FR-PO744, FR-PO988, SA-PO397, SA-PO935  
 Kim, Kevin FR-PO344  
 Kim, Kibum PUB116  
 Kim, Kipyoo SA-PO915  
 Kim, Kwang Poo SA-PO407  
 Kim, Kwon Soo PUB076  
 Kim, Kyu hong SA-PO973  
 Kim, Kyung Won FR-PO763, FR-PO830  
 Kim, Minseok SA-PO367  
 Kim, Moo Jun TH-PO071, FR-PO396  
 Kim, Myung-Gyu FR-OR18, FR-PO112, PUB090  
 Kim, Sang-Eun FR-PO921  
 Kim, Sejoong FR-PO068, SA-PO801, PUB180  
 Kim, Seo Rin TH-PO180  
 Kim, Seok-hyung TH-PO265  
 Kim, Seong Geun TH-PO065, TH-PO066, SA-PO371  
 Kim, Seoyoung C. TH-PO856  
 Kim, Serena J. FR-OR11  
 Kim, Seung J. FR-PO157  
 Kim, Sichan FR-PO817  
 Kim, Soo Wan TH-PO813  
 Kim, Suk young TH-PO201, SA-PO232  
 Kim, Sung Gyun TH-OR19, TH-PO497, FR-PO543, FR-PO744, SA-PO397, SA-PO935  
 Kim, Sungmi SA-PO335  
 Kim, Sungmin TH-OR19, FR-PO543, FR-PO744, SA-PO397, SA-PO935  
 Kim, Sungyeon FR-OR18, FR-PO112, PUB090  
 Kim, Tae Youn TH-PO818, TH-PO820, TH-PO821, TH-PO822, TH-PO823, TH-PO824, TH-PO829  
 Kim, Taehee TH-PO679  
 Kim, Victor D. TH-OR21  
 Kim, Yaeni SA-PO228, SA-PO923  
 Kim, Yaeirim TH-PO358, TH-PO365, TH-PO366, TH-PO381, TH-PO393, TH-PO495, TH-PO912, FR-PO026, FR-PO976, SA-PO407, SA-PO904  
 Kim, Yang gyun SA-PO349, SA-PO379, SA-PO407, PUB180  
 Kim, Yanghyeon FR-PO778  
 Kim, Ye na FR-PO778  
 Kim, Yeawon TH-PO443, FR-PO343  
 Kim, Yeong Hoon TH-PO381, TH-PO679  
 Kim, Yon Su TH-OR56, TH-PO065, TH-PO066, TH-PO812, FR-PO084, FR-PO092, FR-PO162, FR-PO922, FR-PO976, FR-PO979, SA-PO371, SA-PO716, SA-PO801, SA-PO840, SA-PO973  
 Kim, Yong Chul TH-OR56, TH-PO358, TH-PO365, TH-PO366, TH-PO381, TH-PO812, TH-PO912, FR-PO084, FR-PO812, FR-PO922, FR-PO979, SA-PO371, SA-PO716, SA-PO840, SA-PO973  
 Kim, Yong Kyun FR-PO354, FR-PO360  
 Kim, Yong-Lim TH-PO067, TH-PO157, SA-PO828  
 Kim, Yoon-Goo TH-PO048, TH-PO095, FR-PO132, SA-PO335  
 Kim, Youngwoo SA-PO005  
 Kim, Yuna SA-OR40  
 Kim, Yunmi TH-PO679  
 Kimmel, Paul L. TH-OR02, TH-OR07, TH-PO028, TH-PO238, TH-PO243, FR-PO408, FR-PO409, FR-PO755, SA-PO303, SA-PO931  
 Kimura, Hideki TH-OR39  
 Kimura, Hitomi SA-OR03  
 Kimura, Toshihiro SA-PO549  
 King, Alexis TH-PO804, TH-PO817  
 King, Andrew J. TH-PO419, TH-PO497, FR-OR60, FR-PO334, FR-PO659, SA-PO1011  
 King, Joshua D. FR-PO236, SA-PO054  
 Kinjo, Kazushi SA-PO896  
 Kino, Tomoshige SA-PO958  
 Kinoshita, Jun TH-PO157, TH-PO161  
 Kinsella, Bradley M. FR-PO786, FR-PO801  
 Kirabo, Annet SA-PO755  
 Kirby, Cassie L. TH-PO098  
 Kirby, Grant FR-PO056, SA-PO693  
 Kirik, Ufuk FR-PO1008  
 Kirita, Yuhei FR-PO133, SA-PO085  
 Kiriwandiya, Charani PUB312  
 Kirk, Michelle PUB162  
 Kirkham, Brian TH-PO040  
 Kirkland, James L. TH-PO180  
 Kirkpatrick, Mary P. PUB102  
 Kirsch, Alexander H. FR-PO599  
 Kirschner, Karin M. TH-PO642  
 Kirton, Kristyn SA-PO916  
 Kirwan, Jennifer A. FR-PO420, SA-PO626  
 Kiryluk, Krzysztof SA-OR06, SA-PO543, SA-PO561, SA-PO564, SA-PO606  
 Kiseljak-Vassiliades, Katja SA-PO158  
 Kisielewski, Michael TH-PO005  
 Kitajima, Shinji FR-PO938, SA-PO911, PUB210, PUB347, PUB348  
 Kitakado, Hideaki FR-PO043, FR-PO447  
 Kitamura, Hiromasa TH-PO608  
 Kitamura, Kenichiro SA-PO549  
 Kitamura, Mineaki TH-PO696, SA-PO330, SA-PO394, SA-PO450  
 Kitamura, Shunsuke SA-PO891  
 Kitayama, Tetsuya TH-PO143  
 Kitazono, Takanari TH-PO576, TH-PO608, FR-PO961  
 Kittidanairuk, Parinada TH-OR14  
 Kittrell, Hannah FR-PO062  
 Kitzman, Dalane TH-PO244  
 Kitzman, Jacob O. FR-PO697  
 Kiyan, Yulia FR-PO359  
 Kizer, Jorge R. TH-PO678  
 Kizilbash, Sarah J. PUB278  
 Klarenbach, Scott SA-PO821  
 Klawitter, Jelena TH-PO405  
 Klawitter, Jost TH-PO405  
 Kleiboeker, Steven FR-PO801  
 Klein, Jeffrey A. FR-PO765, FR-PO794, FR-PO804  
 Klein, Jon B. TH-PO421, TH-PO446, TH-PO447, TH-PO448, SA-PO631  
 Klein, Katrin TH-PO920  
 Kleindienst, Jessika SA-PO592  
 Kleist, Christian TH-PO536, SA-OR47  
 Klemman, Mark A. SA-PO879  
 Klemens, Christine A. TH-PO325, FR-PO277  
 Klemensen, Terry SA-PO298  
 Kleophas, Werner TH-PO952, SA-PO416  
 Klewinghaus, Juergen FR-PO564  
 Kleyman, Thomas R. SA-PO755  
 Kline, Timothy L. TH-PO390, TH-PO400, FR-PO815, SA-PO004, SA-PO937  
 Kling, Lovis FR-PO575, FR-PO576  
 Klinkhammer, Barbara M. TH-PO565, SA-PO111, SA-PO786  
 Klocke, Jan FR-OR54, FR-PO157  
 Klomjit, Nattawat FR-PO044, SA-PO132, SA-PO133  
 Klussmann, Enno FR-PO994, SA-PO793  
 Kmoch, Stanislav TH-PO380, FR-PO343, PUB192  
 Knapp, Christopher D. TH-OR17, FR-PO491, FR-PO520  
 Knaup, Karl X. TH-PO895  
 Knebelmann, Bertrand TH-PO481  
 Knehtl, Masa FR-PO010  
 Knepper, M. A. TH-PO336  
 Knepper, Mark A. TH-PO337, SA-PO958, SA-PO961  
 Knight, Chris FR-PO471  
 Knight, John FR-PO334, FR-PO527, SA-PO169  
 Knight, Richard A. SA-PO079  
 Knight, Silvin P. TH-PO632  
 Knob, Andrea FR-PO370  
 Knobbe, Tim J. TH-PO675, TH-PO676, TH-PO698, FR-PO810  
 Knoers, Nine V. SA-PO536  
 Knoll, Greg A. SA-PO794  
 Knoll, Jasmine FR-PO339  
 Knoop, Thomas SA-PO715  
 Knoppert, Sebastiaan FR-PO194  
 Knorr, John P. SA-PO867  
 Knox, Ellen TH-PO751  
 Knudsen, Annie R. TH-PO931  
 Knudsen, Majbritt TH-PO931  
 Knysheva, Marina TH-PO297  
 Ko, Gang Jee SA-PO279, SA-PO906  
 Ko, Gang-Jee TH-PO793  
 Ko, Hojoon TH-PO071, FR-PO396  
 Ko, Je Yeong FR-PO276  
 Ko, Ye Eun TH-PO873, FR-PO745, FR-PO746  
 Kobayashi, Eiji FR-PO374, FR-PO380, FR-PO400  
 Kobayashi, Hiroki TH-PO235, SA-PO253  
 Kobayashi, Mamiko TH-OR39  
 Kobayashi, Shuzo FR-PO037  
 Kobrin, Dale M. TH-PO523  
 Kobrin, Sidney M. TH-PO170  
 Koch Nogueira, Paulo C. FR-PO430, SA-PO600  
 Koch, Josephine TH-PO148  
 Koch, Mirijam TH-PO309  
 Kochar, Tina SA-PO733, PUB208, PUB213  
 Kochi, Masako SA-PO896  
 Kodali, Lavanya FR-PO820, SA-PO860  
 Kodama, Goh TH-PO195, TH-PO389, FR-PO166  
 Kodyianplakkal, Rosy Priya L. TH-PO909  
 Koduri, Sreekanth SA-PO219  
 Koehler, Sophia SA-PO145  
 Koehler, Sybille FR-PO710  
 Koehlmoo, Tracey L. FR-PO411  
 Koemann, Lisette SA-PO259  
 Koenigshausen, Eva FR-PO274, SA-PO251, SA-PO761  
 Koester, Lisa A. PUB144

Kofoed, Klaus F. SA-PO188  
 Kofotolios, Ioannis FR-PO729  
 Kogovšek, Polona TH-PO650  
 Koh, Eun Sil TH-PO673, FR-PO340, SA-PO093, SA-PO365, SA-PO716  
 Koh, Hee Byung TH-OR52, TH-PO873, FR-PO745, FR-PO746, FR-PO763, FR-PO791, FR-PO830  
 Koh, Kwi Hye TH-PO588, FR-PO726  
 Koh, Pao Kuen SA-PO336  
 Kohagura, Kentaro TH-PO553, SA-PO896  
 Kohan, Donald E. TH-PO244, PUB361  
 Kohli, Jatinder SA-PO515  
 Kohli, Kripa FR-PO100  
 Kohli, Shrey TH-PO212, TH-PO440, SA-PO1010  
 Koirala, Bhabuk TH-PO116  
 Koira, Fumihiko TH-PO143  
 Koizumi, Masahiro SA-PO510  
 Koizumi, Naoru FR-PO771  
 Kojc, Nika TH-PO650  
 Kojima, Masahiro TH-PO157  
 Kokubu, Maiko SA-PO891  
 Kolachalama, Vijaya B. TH-PO288, TH-PO566, SA-PO002  
 Kolb, Thilo SA-PO761  
 Kolkhof, Peter SA-PO274, SA-PO275  
 Kollins, Dmitrij FR-OR59  
 Köllner, Sarah SA-PO746  
 Kolpurka Abdul Samad, Mohamed Tahir PUB110  
 Kolvenbach, Caroline M. FR-PO326, FR-PO327, FR-PO328, SA-PO572  
 Komaba, Hiroataka SA-PO179, SA-PO184, SA-PO212, SA-PO510  
 Komada, Takanori TH-PO090  
 Komaru, Yohei SA-PO105  
 Komenda, Paul TH-PO289, TH-PO630, FR-PO519, FR-PO542, SA-PO944  
 Komers, Radko FR-OR56, FR-OR57, FR-PO724  
 Kömhoff, Martin FR-OR48  
 Kompa, Andrew TH-PO422  
 Kon, Valentina FR-PO975  
 Kondo, Atsushi FR-PO043, FR-PO447, SA-PO539  
 Kondo, Masahide FR-PO925  
 Kondo, Naoyuki FR-PO324  
 Kondo, Tatsuo FR-PO940  
 Kondragunta, Kaushika SA-PO508  
 Kong, Jinhwa SA-PO650  
 Kong, Sheldon X. TH-PO255, TH-PO718, FR-PO924  
 König, Eva FR-PO915  
 Konings, Constantijn TH-PO166  
 Konishi, Kasumi TH-PO911, FR-PO526, SA-PO388, SA-PO440, SA-PO861  
 Kono, Keiji SA-PO209  
 Konta, Tsuneo FR-PO925, SA-PO700  
 Konvalinka, Ana TH-PO637, TH-PO640, TH-PO765  
 Konwar, Swagata SA-PO592  
 Koo, Ho seek TH-PO713  
 Koo, Tai yeon TH-OR52, FR-PO112, FR-PO772, FR-PO792, PUB313  
 Kooienga, Laura FR-PO659, SA-PO919  
 Kooiman, Judith FR-PO857  
 Kooman, Jeroen SA-PO344  
 Koomen, Jeroen TH-PO244  
 Kopan, Raphael FR-PO392  
 Kopp, Jeffrey B. TH-PO479, TH-PO752, TH-PO754, SA-PO735, SA-PO958, SA-PO974  
 Koppitch, Kari A. TH-PO140  
 Kopyt, Nelson P. SA-PO271  
 Kopytina, Valeria FR-PO461  
 Korbet, Stephen M. FR-PO683  
 Korbmacher, Christoph FR-PO265, FR-PO266  
 Kore, Shruti TH-PO173  
 Korin, Ben FR-PO912  
 Kornowske, Lindsey M. TH-PO255, FR-PO662  
 Korolowicz, Kyle E. SA-PO242  
 Koroukian, Siran M. SA-PO131, SA-PO143  
 Korstanje, Ron TH-PO535, FR-PO985  
 Kos, Filip TH-PO567  
 Koshino, Akihiko SA-OR36, SA-PO261  
 Koshizaka, Masaya TH-PO227  
 Kosiborod, Mikhail TH-PO233, TH-PO601  
 Kosowan, Leanne TH-PO589  
 Kossmann, Robert J. TH-PO725, TH-PO860, SA-PO398  
 Kostidis, Sarantos TH-OR43  
 Kostka, Dennis FR-PO402  
 Kostopoulou, Myrto TH-PO363, TH-PO388, PUB186  
 Kosugi, Takaaki TH-PO251, FR-PO925, SA-PO700  
 Kotake, Hitoshi SA-PO238  
 Kotanko, Peter TH-PO166, TH-PO261, TH-PO677, TH-PO704, TH-PO725, TH-PO860, TH-PO953, FR-PO009, FR-PO496, FR-PO564, SA-PO292, SA-PO319, SA-PO344, SA-PO355, SA-PO382, SA-PO398, SA-PO422, SA-PO423, SA-PO427, SA-PO429, SA-PO430, SA-PO436, PUB080, PUB134  
 Kotlyar, Max TH-PO640, TH-PO765  
 Kotsis, Fruzsina K. FR-PO066, FR-PO931  
 Kottgen, Anna TH-OR01, TH-PO866, FR-PO066, FR-PO371, FR-PO373, FR-PO907, SA-PO564  
 Kottgen, Michael FR-PO256  
 Kotwal, Sradha S. TH-PO271, TH-PO272, TH-PO275  
 Kotzen, Elizabeth SA-PO879  
 Kou, Chuanyu TH-OR17  
 Koudijs, Angela TH-OR43, FR-PO386, FR-PO1009  
 Koul, Sheetal TH-PO512, SA-PO060  
 Koulinska, Irene FR-PO339  
 Koumangoye, Rainelli FR-OR44  
 Koumatsu, Nobuchika SA-PO395  
 Kourniotis, Dimitris SA-PO408  
 Koutsianas, Christos FR-PO589  
 Kovcsdy, Csaba P. TH-PO615, TH-PO616, TH-PO681, TH-PO682, TH-PO683, TH-PO691, TH-PO852, TH-PO853, TH-PO870, TH-PO871, TH-PO878, FR-PO574, FR-PO761, FR-PO899, FR-PO900, FR-PO930, FR-PO941, SA-OR33, SA-PO304, SA-PO307, SA-PO902, SA-PO903, SA-PO908, SA-PO909, PUB079  
 Koya, Daisuke SA-PO274  
 Koyama, Alain TH-PO659, FR-PO411, FR-PO936  
 Koyner, Jay L. TH-OR06, TH-PO022, TH-PO023, TH-PO036, FR-PO071  
 Koziell, Ania B. FR-PO639  
 Kozuka, Kazumi SA-PO510  
 Kraehling, Jan R. SA-PO247  
 Krajewska, Magdalena SA-PO932  
 Krallman, Kelli A. TH-OR05, TH-PO039, TH-PO081  
 Kramann, Rafael TH-OR42, TH-PO533, SA-PO111  
 Krämer, Bernhard K. FR-PO777, PUB015  
 Kramer, Holly J. TH-OR01  
 Kratochwill, Klaus FR-PO451, FR-PO454, FR-PO467, SA-PO627  
 Kraus, Abigail TH-PO121  
 Kraus, Michael A. TH-PO725, FR-PO502, FR-PO512, SA-PO341, SA-PO398  
 Krause, Benjamin C. FR-PO420  
 Krause, Silva TH-PO481  
 Krautkrämer, Ellen TH-PO105  
 Kravtsova, Olha SA-PO245  
 Krebber, Merle M. FR-PO383  
 Krebs, Christian F. SA-OR29  
 Kremer, Daan TH-PO675, TH-PO676, TH-PO698, FR-PO773, FR-PO784, FR-PO810  
 Kremer, Joseph SA-PO848, SA-PO873  
 Krenn, Simon SA-PO354  
 Krepinsky, Joan C. TH-PO186, TH-PO198, TH-PO742, SA-PO771  
 Kretschmer, Axel SA-PO247  
 Kretz, Martin FR-PO219  
 Kretz, Oliver TH-OR42, FR-PO699, FR-PO720  
 Kretzler, Matthias TH-OR02, TH-PO211, TH-PO213, TH-PO419, TH-PO422, TH-PO441, TH-PO530, TH-PO534, FR-OR20, FR-OR36, FR-PO351, FR-PO724, FR-PO992, SA-OR04, SA-PO257, SA-PO258, SA-PO543, PUB234  
 Kreuels, Benno FR-PO919  
 Kriegel, Alison J. FR-PO424, SA-PO776  
 Kriegel, Fabian L. FR-PO420  
 Kring, Lauren FR-PO177  
 Krinsky, Scott TH-PO054  
 Krishnamoorthy, Sambhavi FR-OR836, SA-PO869, PUB333  
 Krishnan, Sankaran FR-PO436  
 Krishnan, Suraj SA-PO779  
 Krishnaraju, Ellil O. TH-PO581  
 Krishnasamy, Rathika TH-PO606  
 Krishnasamy, Senthilkumar PUB110  
 Kristinsson, Sigurdur Y. FR-PO933  
 Kritchevsky, Stephen B. SA-PO186  
 Kroeger, Hannah TH-PO226, FR-PO372, FR-PO387  
 Kroes, Bradley C. FR-PO242, FR-PO295  
 Kroes, Michel SA-PO657, SA-PO658  
 Krolewski, Andrzej S. TH-PO232, TH-PO235, SA-PO253  
 Krolewski, Bozena TH-PO232, SA-PO253  
 Kronbichler, Andreas FR-OR55  
 Krueger, Thilo TH-PO952, SA-PO416  
 Kruger Gomes, Larissa PUB161  
 Krüger, René TH-PO895  
 Kronic, Damir FR-PO451  
 Krupa, Emily G. SA-PO391  
 Krupka, Emily FR-PO885  
 Krustup, Dorrit PUB106  
 Kshirsagar, Abhijit V. TH-PO777  
 Ku, Chan-Tung TH-PO665  
 Ku, Elaine FR-PO435, SA-PO393, SA-PO798, SA-PO806, PUB283  
 Kuai, Yuxian TH-PO060  
 Kubik, Gregory S. TH-PO655  
 Kublickiene, Karolina TH-PO649, PUB254, PUB259, PUB289  
 Kucharczyk, Patrycja FR-OR50  
 Kuck, Kai SA-PO023  
 Kuczumski, Marie FR-PO948  
 Kudo, Akiko SA-PO395, PUB010  
 Kudose, Satoru FR-PO671, SA-PO159  
 Kudva, Yogish C. SA-PO527  
 Kudyakov, Renat PUB307  
 Kuebler, Wolfgang M. FR-PO420  
 Kuehl, Malte B. TH-OR42  
 Kuehne, Lucas TH-PO506, FR-PO705, SA-PO709  
 Kueht, Michael TH-PO037, PUB321, PUB329, PUB331, PUB342  
 Kugita, Masanori FR-PO275  
 Kuhlman, Anja B. SA-PO265, SA-PO268  
 Kuhlmann, Martin K. TH-PO769, TH-PO775, TH-PO780, TH-PO796, TH-PO882  
 Kühn, Tessa TH-PO920  
 Kui, Mackenzie TH-PO317  
 Kukida, Masayoshi FR-PO463  
 Kukla, Aleksandra SA-PO527  
 Kukuy, Lesya TH-PO056  
 Kula, Alexander J. SA-PO744  
 Kulaheci, Yalcin FR-PO800  
 Kulandavelu, Shathiyah SA-PO599  
 Kulkarni, Akshay R. TH-PO430, SA-PO813  
 Kulkarni, Prathib A. SA-PO047  
 Kulkarni, Rupak PUB331  
 Kumamoto, Kanako FR-PO275  
 Kumar, Abhishek FR-PO839, SA-PO837  
 Kumar, Akash SA-PO890  
 Kumar, Anand SA-PO477, PUB314  
 Kumar, Anubhav FR-PO230, SA-PO317  
 Kumar, Arjun FR-PO619  
 Kumar, Dhiren FR-PO780, FR-PO805, FR-OR85, SA-OR45  
 Kumar, Gurinder TH-PO502  
 Kumar, Jayant SA-PO951  
 Kumar, Parveen FR-OR10  
 Kumar, Prashant FR-PO256  
 Kumar, Retesh K. TH-PO411  
 Kumar, Ramesh TH-PO442  
 Kumar, Sudhir FR-PO695  
 Kumar, Sumit FR-PO665  
 Kumar, Teerath SA-PO197  
 Kumar, Vineeta TH-PO729  
 Kumar, Vinod TH-PO420, SA-PO217, SA-PO731, PUB243  
 Kumar, Vivek TH-PO029, TH-PO639, FR-PO074, FR-PO886, FR-OR934, SA-PO905  
 Kumaresan, Maithrayie TH-PO079  
 Kunadi, Arvind R. SA-PO281  
 Kundu, Monica TH-PO029, FR-PO886, SA-PO905  
 Kunikata, Tetsuya FR-PO115  
 Kunin, Margarita TH-PO056  
 Kunz, Lisa-Marie FR-PO564  
 Kunze, Tamara TH-PO148  
 Kuo, Ting-Chun SA-PO026  
 Kuo, Willy TH-PO556  
 Kupchuk, Maksym TH-PO249  
 Kuperman, Michael B. TH-PO080, SA-PO668, SA-PO852  
 Kuppachi, Sarat C. TH-PO124, FR-PO839  
 Kuppe, Christoph TH-OR42, SA-PO111  
 Kurano, Makoto FR-OR53  
 Kurland, Irwin J. SA-PO787  
 Kurniawan, Helena PUB076  
 Kurosaki, Yoshifumi TH-PO826  
 Kurschat, Christine E. FR-PO342, FR-PO686, SA-OR42  
 Kurtcuoglu, Vartan TH-PO556  
 Kurtz, Ira TH-PO034  
 Kurtz, Vivian SA-PO705  
 Kurzhagen, Johanna T. FR-OR19, FR-PO147, FR-PO172, FR-PO173  
 Kusakabe, Miho TH-PO161  
 Kusch, Angelika TH-OR55  
 Kusche-Vihrog, Kristina TH-PO148  
 Kuscus, Canan TH-OR50, TH-PO459, TH-PO616, FR-PO787  
 Kuscu, Cem TH-OR50, TH-PO459, TH-PO616, FR-PO787  
 Kushner, Alexis J. FR-PO786  
 Kushner, Pam R. TH-PO888, TH-PO889  
 Kushmir, Daniel FR-PO534  
 Kustra, Robert FR-OR39  
 Kuwabara, Shuhei TH-PO138, TH-PO548, SA-PO096  
 Kuwabara, Takashige TH-PO210, SA-PO067  
 Kwakyi, Edward P. PUB118  
 Kwan, Shu H. TH-PO804, SA-PO360  
 Kwon, Donghyang TH-PO466, SA-PO939  
 Kwon, Eun-Jeong FR-PO068, SA-PO662  
 Kwon, Katherine W. SA-PO057  
 Kwon, Sang-Ho TH-PO531  
 Kwon, Soie FR-PO026, FR-PO084, FR-PO091, FR-PO092  
 Kwon, Soon hyo TH-PO254, TH-PO793, FR-PO986, SA-PO682, SA-PO1000  
 Kwon, Tae-Hwan TH-PO338, TH-PO343  
 Kwon, Young Eun SA-PO367, PUB200  
 Kwong, Yuenting D. FR-PO896, PUB050

Kyeso, Yousuf FR-PO836, SA-PO869, PUB333  
 KYlies, Dominik TH-OR42  
 Kyriakos, Raja N. PUB176  
 L Heerspink, Hiddo J. TH-PO233, TH-PO237, TH-PO244, TH-PO247, FR-OR26, FR-OR39, SA-OR36, SA-OR38, SA-PO261, SA-PO265, SA-PO268, SA-PO269, SA-PO270, SA-PO885, SA-PO886, SA-PO888, SA-PO889, SA-PO920  
 La Manna, Gaetano FR-PO399, SA-OR49  
 La Porta, Edoardo SA-PO524  
 La, Ashley TH-PO022, TH-PO023  
 Labriola, Laura SA-PO325  
 Labson, Daniel FR-PO877  
 Lacang, Joy Blossom Anne Y. PUB030  
 Lacey, Margaret FR-PO835  
 Lachmann, Nico FR-PO359  
 Lacson, Eduardo K. TH-PO921, TH-PO938, FR-PO500, SA-OR08  
 Ladabouche, Stacy PUB352  
 Ladd, Patricia E. TH-PO211, SA-PO257, SA-PO258  
 Laerkegaard Hansen, Pernille B. TH-PO891, FR-PO167, FR-PO1008, PUB361  
 Lafata, Kyle TH-PO569, SA-PO003  
 LaFavers, Kaice A. FR-OR09, FR-PO149, FR-PO150, FR-PO154, SA-PO170  
 Lafayette, Richard A. TH-PO498, SA-PO657, SA-PO658, SA-PO705, SA-PO712  
 Laffer, Cheryl L. SA-PO755  
 Laffitte Farina, Andre SA-PO027  
 LaFleur, Joanne PUB116  
 Laget, Jonas TH-PO171  
 Laghmani, Kamel FR-OR48  
 Lai Yee, Jennifer FR-PO697  
 Lai, George TH-PO011  
 Lai, Hsiao L. PUB127  
 Lai, Jennifer M. TH-PO857  
 Lai, Jin-Shei SA-PO705  
 Lai, Mason TH-PO797  
 Lai, Ping chin FR-PO473  
 Lai, Weiyan SA-PO230  
 Lajer, Maria TH-PO222  
 Lake, Blue FR-OR09, FR-OR20, FR-PO169, SA-PO956  
 Lakhani, Sunita PUB176  
 Lakhia, Ronak TH-PO355, TH-PO408  
 Lakin, Joshua R. TH-PO791  
 Lal, Mark FR-OR52, FR-PO696  
 Lalani, Areej TH-PO122  
 Lalitnithi, Pakin TH-PO598  
 Lam, Angela H. FR-PO236, SA-PO054  
 Lam, Carolyn TH-PO233  
 Lam, Eric H. FR-PO012  
 Lam, Kong Peng TH-PO449  
 Lam, Ngan FR-PO060, FR-PO831, SA-PO794, SA-PO821, SA-PO822, SA-PO833  
 Lam, Walter FR-PO567  
 Lama, Suman K. TH-PO837, SA-PO390, SA-PO445  
 Lamarche, Caroline SA-PO996  
 Lamarche, Florence FR-PO563  
 Lamba, Perola TH-PO909, TH-PO956  
 Lambelet, Marc SA-PO275  
 Lambert, Laura FR-PO252  
 Lambert, Oriane TH-PO658, TH-PO880, SA-PO925  
 Lambie, Mark FR-PO497  
 Lammerts, Rosa G. TH-PO643  
 LaMoreaux, Brian SA-PO897, SA-PO898, PUB355  
 Lampis, Matteo FR-PO299  
 Lamprea, Julio FR-PO924  
 Lanau, Maria PUB008  
 Landau, Daniel FR-PO421  
 Landau, Michael SA-PO842  
 Lande, Marc FR-PO417, SA-PO949  
 Landini, Samuela SA-PO529  
 Landler, Nino E. SA-PO188  
 Landry, Daniel L. FR-PO557, FR-PO561, FR-PO874, SA-PO722  
 Lane-Fall, Meghan B. FR-PO515, FR-PO516  
 Lane-Harris, Allison C. FR-PO996  
 Lane, Brandon M. SA-OR27, SA-PO628, SA-PO739  
 Lane, James E. TH-PO278  
 Lang, Eddy SA-PO322  
 Lang, Hannah SA-PO444  
 Lang, Julie SA-PO158  
 Lang, Konrad FR-PO370, FR-PO703  
 Langanki, Reika FR-PO994  
 Langham, Robyn G. TH-PO422  
 Langkilde, Anna Maria FR-OR26, SA-OR36, SA-PO885, SA-PO886, SA-PO889  
 Langlo, Knut Asbjørn R. TH-PO798  
 Langner, Ewa FR-PO367  
 Langsford, David SA-PO565  
 Lanktree, Matthew B. TH-OR01, TH-PO360, TH-PO361, TH-PO362, TH-PO377, TH-PO742, SA-PO959  
 Lanzani, Chiara FR-PO073, SA-PO754  
 Lara Monterrubio, Rubén PUB310  
 Larabi, Islam A. SA-PO932  
 Larive, Brett TH-PO869  
 Larkin, Amy TH-PO004  
 Larkin, John W. TH-PO677, TH-PO837, FR-PO494, FR-PO942, SA-PO308, SA-PO310, SA-PO390  
 Larkina, Maria FR-PO657  
 Larned, Catherine FR-PO603  
 Larosa, Luigi TH-PO398  
 Larsen, Christopher P. TH-PO451, TH-PO452, FR-PO190, FR-PO195, SA-OR01  
 Larson, Nicholas B. TH-PO418  
 Larsson, Anders FR-PO897  
 Lasaad, Samia TH-PO322  
 Lash, James P. TH-PO057, TH-PO059, TH-PO240, TH-PO874, TH-PO892, FR-OR23, FR-PO928  
 Laskin, Benjamin L. FR-PO109, PUB284  
 Lasky, Rachel A. FR-PO502, SA-PO341, SA-PO343, SA-PO378  
 Lassé, Moritz TH-PO441, FR-PO351, FR-PO712  
 Lassen, Emelie FR-PO123  
 Lassiter, Grace TH-OR54  
 Laster, Marciana FR-PO423  
 Laszik, Zoltan G. SA-PO857  
 Laszlo, Mary C. TH-PO777  
 Latimer, Helen TH-PO887  
 Latorre, Juan SA-PO928  
 Latour, Robert A. PUB083  
 Latt, Khun Zaw TH-PO754, SA-PO958  
 Latta, Femke FR-OR46  
 Lau, Wei Ling TH-PO808, TH-PO809  
 Lauer, Julia TH-PO781, TH-PO782  
 Lauer, Juliane TH-PO959  
 Laudon, Aksel D. SA-PO002  
 Laufer, Sandra D. FR-PO342  
 Laukhuf, Frank M. SA-OR07  
 Laurence, Emma FR-OR10  
 Laurens, Wim FR-PO923  
 Laurin, Louis-Philippe TH-PO479, FR-PO513  
 Laursen, Clara F. TH-PO429  
 Lavasani, Tooran TH-PO671  
 Lavenburg, Linda-Marie U. TH-PO722, TH-PO849  
 Laville, Maurice TH-PO854, TH-PO880, FR-PO221, SA-PO925  
 Laville, Solene M. TH-PO854, FR-PO221  
 Lavin, Andrew M. FR-PO258  
 Lawatscheck, Robert SA-PO274, SA-PO275  
 Lawrenz, Bettina SA-PO247  
 Lawsuwanakul, Rhonachai FR-PO474  
 Lay, Abigail C. FR-PO165  
 Layka, Ayman TH-PO464  
 Layne, Matthew SA-PO426  
 Layton, Anita T. TH-PO247, TH-PO250  
 Lazar, Andrew SA-PO581  
 Lazaro Fernandez, Alberto TH-PO112  
 Lazaro guervara, Jose M. TH-PO245  
 Lazarus, Ben TH-PO270, TH-PO271, TH-PO272  
 Lazcano-Páez, Geraldine M. SA-PO227  
 Lazear, Danielle SA-PO855  
 Lazovic, Bojana FR-OR52  
 Lazzeri, Elena TH-PO141, FR-PO146, FR-PO958, SA-PO065, SA-PO088  
 le Roux, Carel SA-PO333  
 Le, Dustin W. TH-PO868  
 Le, Ha D. SA-PO016  
 Le, Lisa TH-PO838  
 Le, Thu H. TH-PO280, TH-PO476, FR-PO317, SA-PO760  
 Lea, Alfred S. PUB331, PUB342  
 Lea, Janice P. TH-PO777, TH-PO778, TH-PO930, SA-PO298  
 Leaf, David E. TH-PO675, FR-PO067, FR-PO075, FR-PO182, FR-PO196, SA-PO151  
 Leal, Diogo V. TH-OR13, SA-PO402  
 Leal, Gabriela PUB148  
 Leask, Megan P. TH-PO351  
 Leavey, Sean F. TH-PO129, FR-PO864, PUB262  
 Lebel, Asaf TH-OR30  
 Lebensburger, Jeffrey FR-PO414  
 Lebowitz, Jonathan TH-PO078, PUB226  
 Leca, Nicolae FR-PO789  
 Leckie-Harre, Aidan TH-PO654  
 Lederer, Eleanor D. TH-PO315, FR-PO104, SA-PO175  
 Lederer, Swati FR-PO104  
 Ledoux, Sarah FR-PO494  
 Ledru, Nicolas FR-PO133, FR-PO364, SA-PO960  
 Lee, An Fu TH-PO371  
 Lee, Andrew PUB127, PUB225  
 Lee, Arthur FR-PO408, FR-PO409  
 Lee, Briana E. FR-PO884, SA-PO814  
 Lee, Byung Rho TH-PO531  
 Lee, Byung-Wan SA-PO274  
 Lee, Chang Min TH-PO531  
 Lee, Chi Ho Paul FR-PO545  
 Lee, Chien-Te SA-PO274  
 Lee, Dong Hee TH-OR19, FR-PO543, FR-PO744, SA-PO397, SA-PO935  
 Lee, Dong Ryeol PUB300  
 Lee, Dong-Young SA-PO218, SA-PO379  
 Lee, Dongwon FR-PO308, FR-PO309, SA-PO546  
 Lee, Dongyeon FR-PO817  
 Lee, Edison TH-PO863  
 Lee, Edmund TH-PO408  
 Lee, Eu Jin TH-PO071, FR-PO396, SA-PO384  
 Lee, Geunyoung FR-PO909  
 Lee, Gongmyung SA-PO367  
 Lee, Haekyung TH-PO254, FR-PO986, SA-PO1000  
 Lee, Hajeong TH-OR56, TH-PO812, FR-PO084, FR-PO091, FR-PO092, FR-PO812, FR-PO922, SA-PO547, SA-PO716, SA-PO801, SA-PO840, PUB357  
 Lee, Hak Joo TH-PO181, PUB367  
 Lee, Hanbi FR-PO782, SA-PO365, SA-PO366, SA-PO881  
 Lee, Helen SA-OR30  
 Lee, Heun-Sik SA-PO650  
 Lee, Hewang SA-PO791, SA-PO958  
 Lee, Hye kyung SA-PO084  
 Lee, Hyeonju SA-PO550  
 Lee, Hyun-Wook TH-PO310, SA-PO492  
 Lee, I-Min SA-PO187  
 Lee, Iris J. TH-PO512, TH-PO628  
 Lee, Jaehoon TH-PO815  
 Lee, Jakyung SA-PO367  
 Lee, James C. SA-PO811  
 Lee, Jangwook TH-OR56, FR-PO086, FR-PO817  
 Lee, Jean TH-PO714, SA-PO060, PUB019  
 Lee, Jeonghwan TH-PO625, TH-PO912, FR-OR21, FR-PO026, FR-PO084, FR-PO091, FR-PO092, FR-PO304, FR-PO932, PUB180  
 Lee, Jinwoo TH-PO065, TH-PO066, TH-PO365, TH-PO366, TH-PO381, SA-PO371  
 Lee, Jiwon M. TH-PO735  
 Lee, John R. TH-PO909, TH-PO956, FR-PO841, SA-OR48  
 Lee, Jong Soo TH-PO625, TH-PO713, SA-PO973  
 Lee, Jong Young FR-PO354, FR-PO360  
 Lee, Joo Eun SA-PO180, SA-PO381  
 Lee, Judy TH-PO942  
 Lee, Jun Young SA-PO737  
 Lee, Jung eun TH-PO048, TH-PO095, TH-PO827, FR-PO132, SA-PO335, SA-PO410  
 Lee, Jung Pyo TH-OR56, TH-PO495, TH-PO625, TH-PO912, FR-OR21, FR-PO026, FR-PO304, FR-PO932, SA-PO716  
 Lee, Kang Wook TH-PO071, FR-PO396, SA-PO384  
 Lee, Kyu-Beck TH-PO358, TH-PO381, FR-PO921  
 Lee, Kyung TH-PO546, FR-OR31, FR-PO685, FR-PO946, FR-PO959, SA-PO235, SA-PO974  
 Lee, Kyung Ho SA-PO652  
 Lee, Kyungho TH-PO095, FR-OR19, FR-PO132, FR-PO145, FR-PO147, FR-PO148, FR-PO172, FR-PO173  
 Lee, Lauren Elizabeth SA-PO106  
 Lee, Marsha May SA-PO856  
 Lee, Min-Jeong SA-PO656  
 Lee, Myeounggon SA-PO278, SA-PO290  
 Lee, Nagyeom FR-PO778  
 Lee, Richard SA-PO636  
 Lee, Samuel TH-OR07  
 Lee, Sangho SA-PO349, SA-PO379, SA-PO407  
 Lee, Sehun TH-PO048  
 Lee, Seung Heyck TH-PO399  
 Lee, Seunghun P. SA-PO100  
 Lee, Seunghye SA-PO439, PUB362  
 Lee, So-young FR-PO818, FR-PO987  
 Lee, Su Been TH-PO856  
 Lee, Su mi SA-PO933  
 Lee, Sua SA-PO049, SA-PO277, PUB113  
 Lee, Sunhwa FR-PO976, FR-PO979, SA-PO973  
 Lee, Tae Hoon FR-OR27  
 Lee, Tae won FR-PO1001, SA-PO348  
 Lee, Timmy C. TH-PO259, TH-PO301, TH-PO302, SA-PO012, SA-PO013, PUB082  
 Lee, Winston PUB066  
 Lee, Won June SA-PO306  
 Lee, Yeon Joo SA-PO116  
 Lee, Yeonhee SA-PO180, SA-PO381, PUB180  
 Lee, Yu ho FR-PO818, FR-PO987, SA-PO379  
 Lee, Yunsoo TH-PO095  
 Leeaphorn, Napat SA-PO824, SA-PO835  
 Leeds, Joseph T. SA-PO880  
 Leelahavanichkul, Asada TH-PO652  
 Leelaviwat, Natnicha TH-PO695, FR-PO096  
 Leeser, David B. SA-PO537  
 Leff, Richard TH-PO487, FR-PO606, FR-PO607, FR-PO608  
 Lefkowitz, Heather R. TH-PO886  
 Legouis, David TH-PO556  
 Legrand, Eric PUB238  
 Leh, Sabine SA-PO715  
 Leher, Henry TH-PO486, FR-OR58, FR-PO640  
 Lehmann, Christoph U. FR-PO069

Lehmann, Katrin	FR-PO420	Levin, Adeera	TH-PO667, TH-PO901, TH-PO905, TH-PO915, SA-OR10, SA-PO262	Li, Yi	TH-OR16, TH-PO431, TH-PO432, FR-PO153, SA-PO773	Lin, Eugene	FR-PO865, SA-PO392
Lehmann, Parker	FR-PO759			Li, Yifu	PUB235	Lin, Fang	SA-OR13
Lehne, Ramier J.	SA-PO507	Levine, Amanda	SA-PO599	Li, Yilong	TH-PO084	Lin, Fujun	SA-OR18, SA-PO559
Lehrke, Michael	SA-PO786	Levine, Zoey	SA-PO882	Li, Yin	FR-PO455	Lin, Hongchun	SA-PO230
Lei, Chen-Chou	SA-PO386	Levtchenko, Elena N.	FR-PO331	Li, Ying	TH-PO549, FR-PO144, FR-PO188, FR-PO998	Lin, Hsing-Fen A.	FR-PO473
Lei, Jinghong	PUB121	Levy, Marlon F.	FR-PO855, SA-PO817, SA-PO826	Li, Yiting	TH-PO706, FR-PO936	Lin, Hugo Y.	SA-PO255
Lei, Qunjuan	FR-PO813	Levy, Rebecca	TH-PO476	Li, Yong	FR-PO371, FR-PO373	Lin, Jamie S.	SA-PO113
Lei, Yan	TH-PO551, PUB092	Lewin, Ewa	TH-PO142	Li, Yuanqing	SA-PO230	Lin, Jonathan T.	FR-PO783
Leibowitz, Saskia	FR-PO522	Lewis, David M.	TH-PO050, TH-PO471	Li, Yupei	SA-PO008	Lin, Li	PUB368
Leidner, Alexander S.	SA-PO954	Lewis, Julia	PUB241	Li, Zeyu N.	SA-PO207	Lin, Li H.	SA-PO172
Leifheit-Nestler, Maren	TH-PO156, SA-PO987	Lewis, Katherine	TH-PO499	Li, Zhang	FR-PO130, FR-PO244, FR-PO245, FR-PO296	Lin, Ling	FR-PO974
Leigh, Fiona	TH-PO303	Lewis, Susan J.	FR-PO224, FR-PO225, FR-PO226	Li, Zhenhua	TH-PO539	Lin, Mercury Y.	FR-PO195
Leinenbach, Hans Peter	FR-PO564	Lewis, Taylor G.	TH-PO302	Li, Zhongwang	TH-PO571, TH-PO573	Lin, Ming-Yen	TH-PO371, TH-PO665
Leipzig, Jens G.	TH-PO309	Lhotta, Karl	FR-PO556	Liabeuf, Sophie	TH-PO854, FR-PO221, SA-PO925	Lin, Pei-Hui	FR-PO404
Leisman, Staci A.	FR-PO889	Li, Bin	TH-PO203	Liang, Dandan	FR-PO813	Lin, Shih-Hua P.	TH-PO324, FR-PO569, SA-PO569, SA-PO583
Leite-Dellova, Deise C.	TH-PO347	Li, Birong	TH-PO113, SA-PO604, SA-PO605, SA-PO607, SA-PO609, SA-PO613, SA-PO617	Liang, Dongmei	FR-PO813	Lin, Shuei-Liong	FR-PO490
Leite, Maurilo	TH-PO834	Li, Bo	TH-PO431	Liang, Judy	SA-PO637	Lin, Ting	TH-PO702
Leiter, Richard E.	TH-PO791	Li, Carol Y.	FR-PO192, FR-PO767, SA-OR48	Liang, Kelly V.	PUB037, PUB229	Lin, Ting-yun	TH-PO927
Leiva, Ricardo A.	SA-PO1012	Li, Changwei	FR-PO319	Liang, Kimberly P.	PUB229	Lin, Tsai-Ying	FR-PO258
Leiz, Janna	TH-PO341, FR-PO270	Li, Chengdong	TH-PO850	Liang, Lorrin	FR-PO330, SA-PO738	Lin, Xueying	FR-PO258
Lekhyananda, Sookruetai	SA-PO163	Li, Chenyu	FR-PO126	Liang, Lydia J.	FR-PO297	Lin, Yan Heather	SA-PO113, SA-PO123
Lely, Titia	TH-PO761, FR-PO857	Li, Chuang	TH-PO443, FR-PO343	Liang, Ming	FR-OR27	Lin, Yi	TH-PO203
Lemaitre, Rozenn	SA-PO912, SA-PO929	Li, Davey	FR-PO174	Liang, Shaoshan	FR-PO813	Linares, Andrea R.	SA-PO752
Lemberg, Katharina	FR-PO327, FR-PO328, SA-PO578	Li, Guisen	TH-PO282, TH-PO431, TH-PO432, FR-PO730, FR-PO750, SA-PO773, SA-PO988	Liang, Sitai	PUB268	Linares, Estefania R.	TH-PO397
Lemley, Kevin V.	TH-PO250, TH-PO417, FR-PO378, FR-PO690, SA-OR28	Li, Huan	PUB109	Liang, Xiaoyan	SA-OR24	Lincoln, Webster U.	TH-PO567
Lemoine, Sandrine	TH-PO731, SA-PO309	Li, Jiaying	FR-PO140	Liang, Xiaoyu	TH-PO615	Lindahl, Bertil	FR-PO760
Lemos, Dario R.	SA-PO026, SA-PO063	Li, Jing	TH-PO105	Liang, Xinling	TH-PO157, TH-PO694	Lindahl, Maria	FR-PO343
Lemos, Pedro Augusto B.	PUB034	Li, Jinhong	FR-PO960	Liang, Xiujie	FR-PO388	Lindberg, Ulrich	TH-PO229
Lempicki, Camille	FR-PO370	Li, Jun	TH-PO120, TH-PO285	Liang, Yumei	SA-PO721	Lindenmeyer, Maja	TH-PO556, TH-PO908, FR-PO710, FR-PO725
Lenassi, Metka	TH-PO650	Li, Kang	FR-OR11	Liang, Chia-Te	FR-PO365	Lindhardt, Morten	SA-PO272
Lentine, Krista L.	TH-PO791, FR-PO814, FR-PO824, SA-PO795, SA-PO820, SA-PO821, SA-PO850, SA-PO851	Li, Kanghui	SA-PO172	Liao, Joshua	FR-PO876	Lindholm, Bengt	FR-PO492, FR-PO495, FR-PO504, FR-PO505
Leon Mantilla, Silvia J.	TH-PO630	Li, Li	FR-PO199, FR-PO675	Liapis, Georgios	FR-PO729	Lindo, Steve J.	FR-PO501
León Román, Juan C.	SA-PO160, SA-PO692	Li, Lingyun	FR-PO219	Liarte Marin, Elena	FR-PO1008	Lindquist, Jonathan A.	SA-PO1010
Leonard, Anthony C.	FR-PO514	Li, Luping	SA-PO954	Licht, Christoph	TH-PO455, TH-PO500, TH-PO502, FR-PO022, FR-PO362, FR-PO390, FR-PO715	Lindstrom, Nils	FR-PO355, FR-PO382
Leonard, James B.	FR-PO236, SA-PO054	Li, Margaret	SA-PO386	Lickliter, Jason	TH-PO499	Lines, Kate E.	FR-PO556
Leonard, Kathryn	FR-PO445	Li, Mengshi	SA-PO154	Lidgard, Benjamin	TH-PO605, SA-PO912, SA-PO929	Ling, Jonathan E.	TH-PO271
Leonberg-Yoo, Amanda K.	SA-PO202	Li, Michael M.	FR-OR25, FR-PO069	Lieblich, Richard M.	SA-PO702	Ling, Kun	FR-PO293
Leone, Mario A.	FR-PO051, SA-PO842	Li, Min	TH-PO444	Liebman, Scott E.	FR-PO878	Ling, Wung-Man Evelyne	TH-PO333
Leonhardt, Henrik	TH-PO230	Li, Mingyao	FR-OR32	Liebschutz, Jane	FR-PO862	Linkermann, Andreas	TH-PO188, SA-PO081
Leotta, Chiara	PUB259, PUB289	Li, Mingzhu	PUB081	Lienaszewski, Chrysta C.	SA-OR04, SA-PO544	Linkhorst, John	SA-PO405
Lepage, Marc-Antoine	FR-PO903	Li, Nicholas	FR-PO601	Lienkamp, Soeren S.	FR-PO269	Linn, Sarah C.	SA-PO154, SA-PO616
Lepe, Carlos A.	PUB310	Li, Nien Chen	TH-PO921, FR-PO500, SA-OR08	Lieske, John C.	TH-OR34, TH-PO731, TH-PO732, FR-PO335, FR-PO450, SA-PO568, SA-PO574	Lins, Luiza	TH-PO959
Lepori, Nicola	SA-PO119	Li, Ping	FR-PO054, SA-PO841, SA-PO907	Liew, Adrian	TH-PO498, SA-PO712	Linz, Peter	SA-PO784, PUB255
Leppert, John	SA-PO208	Li, Qingtian	FR-OR17, FR-PO129	Lightfoot, Courtney J.	TH-PO674, TH-PO680, SA-PO946, PUB078	Lionakis, Michail	TH-PO135
Lepping, Rebecca J.	FR-PO826, SA-PO404	Li, Qiu	TH-PO088	Lightstone, Liz	TH-PO505	Liou, Hung-Hsiang	SA-PO386
Lerma, Edgar V.	TH-OR47, SA-PO401, SA-PO702, PUB228	Li, Renzhong	TH-PO198, SA-PO771	Liguori, Francesca	SA-PO135	Lioudis, Michael	PUB199
Lerman, Lilach O.	TH-PO180, FR-PO398	Li, Shiyu	TH-PO850	Liles, John T.	TH-PO252, FR-OR32, FR-PO993, SA-PO240	Lioulios, Georgios	TH-PO948
Lerner-Ellis, Jordan	TH-PO361	Li, Shuling	TH-OR17	Lilien, Marc	FR-PO194	Lipkin, Graham	TH-PO751
Lertussavavivat, Tanat	SA-PO449	Li, Shuping	FR-PO777	Lilley, Cullen M.	SA-PO878	Lipkowitz, Michael	TH-PO480
Lesén, Eva	FR-PO546	Li, Shuwei	TH-PO245	Lim, Brittany	FR-PO521, SA-PO428	Lipovsek, Jan	TH-PO866, FR-PO931
Leslie, Bruce R.	SA-PO712	Li, Siyao	FR-PO954	Lim, Chun Soo	FR-OR21, FR-PO304, FR-PO932	Lipschutz, Joshua H.	TH-PO214, TH-PO220
Lesniewski, Lisa	TH-PO297	Li, Suchun	TH-PO203	Lim, Cynthia C.	TH-PO620, SA-PO284	Liptay, Michael J.	SA-PO074
Lessig, Mary C.	TH-PO499	Li, Tina	TH-PO893	Lim, Jeong-Hoon	TH-PO067, SA-PO828	Liriano Cepin, Cristina M.	PUB163
Lester, Jeff	FR-PO334	Li, Tingting	TH-PO507, TH-PO858, PUB013	Lim, Ji Hee	SA-PO228	Liriano-Ward, Luz E.	TH-PO944, TH-PO945, FR-PO827, SA-PO803
Lester, Rhane	TH-PO723	Li, Wenjia	FR-PO593	Lim, Kenneth	TH-PO819, FR-PO776, SA-PO302, SA-PO775	Liscia, Nicole	SA-PO120
Leung, Nelson	TH-PO509, FR-PO190, FR-PO204, SA-PO132, SA-PO133, SA-PO149, SA-PO159, PUB263	Li, Wu L.	FR-PO188, PUB153	Lim, Ru Sin	PUB237	Lisovskaja, Vera	FR-PO550
Leuther, Kerstin	SA-PO296	Li, Xiang	SA-PO003	Lim, S. Sam	SA-PO685	Little, Dustin J.	TH-PO021
Leuvenink, Henri	TH-PO644	Li, Xiao	PUB368	Lim, Seon Hee	FR-PO555, SA-PO550	Little, Mark A.	SA-PO698, SA-PO701
Levai, Eszter	FR-PO451	Li, Xiaocun	FR-PO776	Lim, Sojin	FR-PO464, SA-PO279	Littmann, Karin	FR-PO897
Levassort, Hélène	TH-PO880	Li, Xiaogang	FR-PO254, FR-PO255, FR-PO262, FR-PO267	Lim, Soo Kun	PUB237, PUB302	Liu, Andrew C.	SA-PO058
Levchenko, Vladislav	SA-PO753	Li, Xiaobo	FR-PO594, FR-PO727	Lim, Tze Yin	SA-PO538	Liu, Bin	SA-PO172
Leventhal, Joseph	SA-OR48, SA-OR50	Li, Xiaochun	FR-PO776	Lima, Carolina M.	TH-PO165, SA-PO433	Liu, Caroline	PUB112
Levey, Andrew S.	TH-PO786, TH-PO847, TH-PO890, TH-PO898, FR-PO834, FR-PO918, SA-PO121	Li, Xiaolang	FR-PO254, FR-PO255, FR-PO262, FR-PO267	Lim, Florence	SA-PO193	Liu, Christine	TH-PO797
		Li, Xiaoyan	FR-PO254, FR-PO255, FR-PO262, FR-PO267	Limaye, Ajit	SA-OR43	Liu, Dijie	SA-PO154
		Li, Xin	TH-PO825, SA-PO334	Limonte, Christine P.	FR-OR36, SA-PO187	Liu, Esther	FR-PO313
		Li, Xingsheng	FR-PO334	Lin, Celia J.	SA-OR43, SA-PO655	Liu, Feng	SA-PO231
		Li, Xitong	FR-PO235, SA-PO990	Lin, Chien-Ming	TH-PO324	Liu, Gang	TH-PO864
		Li, Xuemei	TH-PO510, FR-PO572, SA-PO168, SA-PO273	Lin, Chu-Cheng	SA-PO386	Liu, Han	TH-PO808
		Li, Yan	PUB308			Liu, Hao	FR-PO104
		Li, Yang	FR-PO776			Liu, Hongbo	FR-OR38, FR-PO388
		Li, Yanhong	TH-PO060			Liu, Hua C.	SA-PO172
						Liu, Jiahao	FR-OR36
						Liu, Jiannong	TH-PO955, FR-PO491, FR-PO895
						Liu, Jianying	TH-PO088
						Liu, Jing	FR-PO944
						Liu, Junhao	TH-PO505

Liu, Kaixiang TH-PO432  
Liu, Kathleen D. TH-OR07, TH-PO028, TH-PO057, TH-PO059, FR-PO896, PUB050  
Liu, Li PUB367  
Liu, Lili SA-PO564  
Liu, Lucas J. FR-PO030, FR-PO090  
Liu, Ruisheng SA-PO766  
Liu, Sai TH-PO863, FR-PO518, SA-PO181  
Liu, Sheng TH-PO151  
Liu, Shiguang PUB068  
Liu, Shuya TH-PO213  
Liu, Song FR-PO206  
Liu, Tongqiang SA-PO172  
Liu, Wenjin SA-PO248  
Liu, Xi TH-PO458  
Liu, Xia TH-PO621  
Liu, Xiaoping TH-PO551  
Liu, Xumeng FR-PO813  
Liu, Yang FR-PO960  
Liu, Yingxue C. SA-PO172  
Liu, Yu TH-PO551, FR-PO960  
Liu, Zhenan FR-PO689  
Liu, Zhi Hong SA-PO274  
Liu, Zhihong TH-PO621, SA-PO273  
Livingston, Man J. FR-PO127, FR-PO954, FR-PO306  
Llanos, Maria TH-PO178  
Llorens Cebrià, Carmen SA-PO821  
Lloyd, Anita SA-PO821  
Lloyd, Mackenzie FR-PO553  
Lo, Emily K. FR-PO145, FR-PO147  
Lo, I-Ju FR-OR60  
Lo, Lowell J. FR-PO896  
Löber, Ulrike FR-PO420, SA-PO626  
Lobo, Peter I. SA-PO978  
Locatelli, Massimo SA-PO118  
Locke, Adam PUB084  
Locke, Jayme E. TH-PO729  
Lococo, Bruno J. SA-PO684  
Lodhi, Sameed K. FR-PO183  
Lodise, Thomas P. SA-PO453  
Lodka, Dörte FR-PO575, FR-PO582, FR-PO583  
Loeb, Gabriel TH-PO369, FR-PO305  
Loffing, Johannes TH-PO318  
Lofgren, Lars SA-PO023  
Loftus, Tyler J. FR-PO061  
Logenthiran, Prassana V. TH-PO753  
Login, Frédéric H. TH-PO344  
Loh, Alwin Hwai Liang SA-PO114  
Lohano, Kuldeep SA-PO511  
Lok, Sarah W.Y. FR-PO964, SA-PO220, SA-PO969  
Lomashvili, Koba A. FR-PO209, SA-PO727, SA-PO928  
Lombardi, Ed FR-OR08  
Long, Anne PUB093  
Long, David A. TH-OR48, FR-PO310, FR-PO332, FR-PO379, FR-PO725, FR-PO731, SA-OR20, SA-PO618  
Long, Gang SA-PO172  
Long, James P. TH-PO215  
Long, Li TH-PO487, FR-PO606, FR-PO607, FR-PO608  
Long, Thorir E. FR-PO933  
Longo, Nicola FR-PO339  
Longoi, Mattia TH-PO075  
Looker, Helen C. TH-PO231, TH-PO232, TH-PO235, TH-PO250, SA-PO257  
Lopes, Jose A. TH-PO257, TH-PO947, FR-PO094, FR-PO793, SA-PO041, SA-PO865  
Lopes, Karina TH-PO937  
Lopes, Renato D. TH-PO690  
Lopez Cantu, Diana O. SA-PO063  
Lopez Santiago, Isabel FR-PO688  
López Villa, Nayeli N. FR-PO611  
Lopez-Cabrera, Manuel FR-PO461  
López-Marfil, Marta SA-PO026  
López-Martínez, Marina SA-PO130  
Lopez-Rodriguez, Darlah M. FR-PO727  
López-Romo, Alicia Estela PUB045  
Lopez-Silva, Carolina TH-PO862  
López, Claudia B. FR-PO618, SA-PO483, PUB061, PUB244  
López, Cristina M. TH-PO249  
Lopez, David SA-PO240  
Lopez, Isabelle PUB283  
Lopimpisuth, Chawin TH-PO598  
Lora, Claudia M. TH-PO618, SA-PO191  
Lord, Graham M. TH-PO646, TH-PO647, FR-PO935  
Lord, Richard W. TH-PO736  
Lord, Stephanie TH-PO578  
Lorenz, Elizabeth C. FR-PO856  
Lorenzin, Anna TH-PO041, SA-PO009, SA-PO011, SA-PO415  
Lorenzo, Arturo TH-PO070, TH-PO766, FR-PO002  
Loreth, Desiree FR-PO720  
Loseke, Joshua D. SA-PO916  
Lotfollahzadeh, Saran TH-PO288, FR-PO529  
Lotz, Johannes TH-PO565  
Louie, Karly S. SA-PO325  
Louka, Michaela TH-PO363, TH-PO388, PUB186  
Lourenco, Maria C. SA-PO684  
Love, Harold D. FR-PO989  
Love, Tanzy PUB225  
Love, Thorvardur J. FR-PO933  
Lovett, Audrey FR-PO438  
Lovett, Kate FR-PO905  
Low, Benjamin FR-PO655  
Low, Gary K. FR-PO214  
Lowe, Mollie SA-PO660  
Lowther, W. T. FR-PO334  
Lozic, Mirela SA-PO620  
Lu, Chao-Chin PUB116  
Lu, Chien-Lin SA-PO211  
Lu, Ember TH-PO662  
Lu, Emily TH-PO791  
Lu, Hsueh-Wen SA-PO386  
Lu, Huiyan TH-PO754  
Lu, Jun Ling SA-PO908, SA-PO909  
Lu, Kuo-Cheng TH-PO157, TH-PO789, SA-PO211  
Lu, Liangjian TH-PO449, TH-PO539  
Lu, Meihua SA-PO104  
Lu, Pei-Chen FR-PO325  
Lu, Renhua TH-OR16, SA-PO311  
Lu, Sizhao TH-PO085  
Lu, Tzongshi FR-PO776, SA-PO255, SA-PO275, TH-PO702  
Lu, Wanhong TH-PO172  
Lu, Wei SA-PO172  
Lu, Weiming FR-PO695, SA-PO002  
Lu, Weiping SA-PO273  
Lu, Xiaohan FR-PO953  
Lu, Yi FR-PO077, FR-PO078  
Lu, Yibing SA-PO273  
Lu, Yuehan FR-PO365  
Lubas, Arkadiusz FR-PO647  
Lubetzky, Michelle L. FR-PO735  
Lucarelli, Nicholas TH-PO570  
Lucas, Carlos SA-PO299  
Lucas, Caroline TH-PO590, TH-PO592, TH-PO593  
Lucas, Renke SA-PO746, SA-PO747  
Lucato, Leandro T. TH-PO516  
Lucca, Leandro J. PUB196  
Luciano, Randy L. TH-PO437, TH-PO564, PUB054  
Lucke, Sylvia FR-PO582  
Ludlow, John W. FR-PO394  
Luehrs, Anthony C. TH-PO568  
Luersen, Kai TH-PO675, FR-PO810  
Lugani, Francesca SA-PO524, SA-PO564  
Lugli, Gianmarco TH-OR11, SA-PO529  
Lui, Sing-Leung SA-PO414  
Lukitsch, Ivo FR-PO610  
Lum, Ching TH-PO501  
Lum, Erik L. SA-PO846  
Lumlertgul, Nuttha TH-PO835, FR-PO079  
Luna García, Adrián TH-PO249  
Luna, Ingrid Y. SA-PO207  
Lund, Brian C. FR-PO740, FR-PO741, TH-PO770  
Lund, Sigrún H. TH-PO770  
Lundahl, Joachim FR-PO596  
Lundman, Pia FR-PO760  
Lundquist, Andrew L. SA-PO528  
Lundwall, Kristina FR-PO760  
Lung, Khristina I. FR-PO865, SA-PO392  
Luo, Jack FR-PO211, FR-PO728  
Luo, Jun H. TH-PO431  
Luo, Ping SA-PO172  
Luo, Qun TH-OR16, FR-PO077, FR-PO078, SA-PO311  
Luo, Xun SA-PO721  
Luo, Yang FR-PO303  
Luo, Yuan TH-PO293, SA-PO173, SA-PO363, SA-PO380  
Luong, Me Linh SA-PO673  
Lupusoru, Gabriela SA-PO150  
Lupusoru, Mircea SA-PO150  
Lusco, Mark SA-PO032, PUB059  
Lutf, Luciana G. FR-PO179, FR-PO880, SA-PO505  
Luttmann-Gibson, Heike SA-PO187  
Luvizotto, Mateus J. FR-PO678  
Luz, Ivan A. TH-PO937  
Lv, Zhimei TH-PO221, FR-PO951  
Ly, Jimmy SA-PO018  
Lyapichev, Kirill A. PUB331  
Lyman, Alessandra FR-PO553  
Lynch, I. Jeanette TH-PO328, SA-PO777, PUB257  
Lynch, Sue R. FR-PO527  
Lynn, Nyein Chann Wai FR-PO823  
Lysikova, Daria SA-PO763  
Lyu, Beini FR-PO216  
Ma, Alison L. FR-PO362  
Ma, Frank Y. FR-PO993  
Ma, Gang SA-PO1009  
Ma, Janice FR-PO606, FR-PO607, FR-PO608  
Ma, Jay SA-PO636  
Ma, Jennie Z. TH-PO933, TH-PO934  
Ma, Jie SA-PO168  
Ma, Jingyuan FR-PO964, SA-PO220, SA-PO969  
Ma, Junjie FR-PO535, SA-PO325  
Ma, Li-Jun TH-PO088, FR-PO237, SA-PO100  
Ma, Rong SA-PO256  
Ma, Ruixuan FR-OR53  
Ma, Seong Kwon TH-PO813  
Ma, Tiantian TH-PO306  
Ma, Xiaoxiao FR-PO470  
Ma, Xiaoyu FR-PO141  
Ma, Yaohua TH-PO242  
Ma, Yingchun PUB121  
Ma, Yixin TH-PO117, TH-PO881  
Ma, Zhengwei FR-PO973  
Ma, Ziyuan FR-OR32  
Ma'ayah, Audai FR-PO052, SA-PO674, PUB317  
Maaliki, Dina SA-PO772  
Maas, Rutger J. FR-PO440, FR-PO441  
Maass, Philipp G. SA-PO793  
Macario, Fernando SA-PO299, SA-PO337  
Macdonald, Alexis TH-PO253  
Macdonald, Jamie H. FR-PO536  
Macdonald, Melissa TH-PO186, SA-PO771  
Macdougall, Iain C. TH-PO674, TH-PO680, TH-PO830  
Mace, Camille E. SA-PO955  
Mace, Maria L. TH-PO142  
Macedo, Camila SA-OR46  
Macedo, Etienne TH-PO910  
Macedo, Karina M. SA-PO600  
Macedo, Sofia E. M. FR-PO642, SA-PO686, SA-PO691  
Maciejewski, Matthew L. FR-PO064  
Mack, Heather G. SA-PO565  
MacLennan, Paul A. TH-PO729  
MacPhee, Iain FR-PO1008  
MacRae, Jennifer M. FR-PO868, SA-PO322  
Madabhushi, Anant TH-PO569, TH-PO570, SA-PO003, SA-PO711  
Madan, Niti PUB216  
Madapoosi, Siddharth S. TH-PO472  
Madariaga, Hector M. TH-PO017  
Madden, Benjamin J. TH-PO453, TH-PO454, FR-PO671  
Madden, Michelle TH-PO129, FR-PO864, SA-PO669, PUB262  
Maddux, Franklin W. TH-PO677, TH-PO837, TH-PO860, FR-PO512, FR-PO942, SA-PO308, SA-PO310, SA-PO341, SA-PO390  
Mader, Michael J. TH-PO717  
Madera, Irvanny PUB036, PUB272, PUB273  
Madesh, Muniswamy FR-OR11  
Madeyski-Bengtson, Katja FR-OR52  
Madhavan, Sethu M. TH-PO184, SA-PO631  
Madhur, Meena S. SA-PO758, SA-PO759  
Madias, Nicolaos E. SA-PO980, SA-PO981, SA-PO982  
Madison, Jacob D. FR-PO692  
Madonia, Phillip TH-PO001, SA-PO508  
Madore, Francois FR-OR39  
Madsen, Charles D. TH-PO368, TH-PO375, TH-PO376  
Madsen, Karen SA-PO916  
Madsen, Martin R. TH-PO223, SA-PO222, TH-PO078  
Madu, Chioma TH-PO078  
Mae, Shin-ichi FR-PO346  
Maeda, Shihomi FR-PO955  
Maekawa, Hiroshi FR-OR33  
Maeoka, Yujiro TH-PO349  
Maes, Bart D. TH-PO685, FR-OR59  
Maeshima, Akito TH-PO025, TH-PO758  
Maeshima, Ruhina FR-PO332  
Maetzawa, Yoshiro TH-PO227  
Mafra, Denise TH-OR832, TH-PO833, TH-PO834  
Magaña, German R. TH-PO318, FR-PO007  
Magdi, Aya M. SA-PO420  
Magen, Daniella FR-PO335  
Maggiani, Pablo TH-PO045, TH-PO046  
Maggiore, Umberto TH-PO530  
Maghak, Lauren A. FR-PO149  
Maghen, Ariella SA-PO797  
Magirr, Annabel R. FR-OR59  
Magnaye, Arthur SA-PO289  
Magnone, Maria chiara FR-PO237  
Mahaffey, Kenneth W. FR-OR39  
Mahajan, Kunal PUB152  
Mahajan, Sandeep FR-PO768  
Mahar, Kelly M. TH-PO690  
Mahdi, Amar M. FR-PO485, FR-PO530  
Mahdi, Min FR-PO378  
Mahendrakar, Smita TH-PO104, PUB041  
Maheshwari, Vaibhav SA-PO423, SA-PO436  
Mahfouz, Ahmed TH-OR43  
Mahjoub, Moe FR-PO366, FR-PO367  
Mahler, Christoph F. SA-PO812  
Mahmood, Khalid SA-PO565  
Mahmood, Salman B. FR-PO044  
Mahmoodzadeh, Zahra FR-PO939  
Mahmoud, Osama A. FR-PO845  
Mahmoud, Tarek S. FR-OR807, SA-PO844  
Mahmoud, Yasmin N. FR-PO622  
Mahmoudzadeh, Samaan SA-PO035  
Mahoney, John M. TH-PO535  
Mahtani, Arun U. TH-PO176, PUB014  
Maillard, Marc P. SA-PO757  
Maillard, Nicolas SA-PO641  
Majchrzak, Karen M. TH-PO921, FR-PO500, SA-OR08

Majmundar, Amar J.	FR-PO330, SA-PO566, SA-PO738	Mane, Shrikant M.	SA-PO566, SA-PO738	Marques, Marco A.	SA-PO457	Massie, Allan	SA-PO839
Mak, Gina C.	FR-PO535	Manfredini, Silvia	SA-PO416	Marques, Mariana F.	FR-PO758, SA-PO792	Massoud, Mark N.	SA-PO675
Makanjuola, David	TH-PO906, FR-PO655, PUB033, PUB035	Mangahis, Emmanuel	TH-PO680	Marquez-Exposito, Laura	TH-PO555, FR-PO263, FR-PO461	Massy, Ziad	TH-PO658, TH-PO854, TH-PO880, FR-PO221, SA-PO925, SA-PO932
Makar, Robert	TH-PO501	Mangelis, Anastasios	TH-PO674	Marquez, Manuel A.	SA-PO441, PUB143	Mastalerz, Justyna I.	PUB345
Makary, Raafat F.	PUB068	Mangetti Gonçalves, Tássia	TH-PO443	Marr, Alissa S.	FR-PO201	Master sankar raj, Vimal	FR-PO422, PUB279
Makayes, Yaniv	FR-PO384	Mangos, Steve	SA-PO1004	Mars, Ronald L.	PUB132	Mastrangelo, Antonio	TH-PO761
Makino, Hirofumi	TH-PO244	Manis, Anna D.	TH-PO311	Marschner, Julian A.	FR-PO126	Mastrobattista, Enrico	SA-OR12
Makino, Yasushi	TH-PO697, TH-PO804	Manjarrez, Kristi L.	TH-PO499	Marsenic, Olivera	TH-OR32	Masud, Tahsin	TH-PO930, FR-PO476
Makita, Ayu	FR-PO463	Manley, Harold J.	TH-PO921,	Marston, Melissa	TH-PO008	Masuda, Chika	FR-PO043, FR-PO447
Makris, Angela	SA-PO714	Manllo-Karim, Roberto	TH-PO938, FR-PO500, SA-OR08	Marti, Hans-Peter	FR-PO699, SA-PO715	Masutani, Kosuke	TH-PO576, FR-PO850
Makuuchi, Mikio	SA-PO182	Manllo, John	SA-PO498	Martin del Campo, Fabiola	SA-OR39	Matas, Arthur J.	FR-PO799
Makvandi, Kianoush	TH-PO228, TH-PO230	Mann, James J.	SA-PO498	Martin Higuera, Cristina	SA-PO329, SA-PO625	Mateo, Marilou	TH-PO222
Makyoo, Jutamad	TH-PO2030	Mann, Jaskiran	TH-PO442	Martin-Alamany, Geovana	TH-PO792	Mathar, Ilka	SA-PO247
Mala, Princess Jasmine A.	SA-PO557	Mann, Johannes F.	SA-PO663	Martin, Aline	TH-PO149, TH-PO656, TH-PO657, FR-OR02, FR-OR07, SA-PO177, SA-PO214	Matheny, Michael E.	TH-PO607
Malavade, Tushar S.	TH-PO493	Mannella, Valeria	SA-PO268	Martin, Brian J.	SA-PO916	Matheson, Matthew	FR-PO412, FR-PO417, SA-PO949
Maldonado, Dawn	FR-PO681	Mannion, Peter J.	FR-PO299	Martin, Cecile	FR-PO588	Mathew, Anna V.	TH-PO614, TH-PO770
Malhotra, Ashwani	SA-PO514, SA-PO725	Mannon, Roslyn B.	FR-PO775	Martin, Kevin J.	FR-PO535	Mathew, Marcella	TH-PO884
Malhotra, Rakesh	TH-PO420, TH-PO731	Manoharan, Anjella	TH-PO943, FR-PO775, SA-OR49	Martin, Lauren	TH-PO379	Mathew, Mincy	SA-PO278, SA-PO290
Maliborski, Artur	FR-PO755, FR-PO756, SA-PO058	Manoharan, Jayakumar	TH-PO104	Martin, Suzanne G.	FR-PO208, FR-PO480, SA-PO098	Mathew, Roy O.	TH-PO620, FR-PO475, SA-PO934
Malik, Ayesha M.	FR-PO757	Manos, George	TH-PO440, SA-PO1010	Martínez Díaz, Irene	TH-PO178	Mathews, Robert J.	SA-PO940
Malik, Manish	TH-PO044, SA-PO815, PUB150, PUB324	Mansencal, Nicolas	TH-PO480, TH-PO481	Martínez Gallardo	González, Alejandro	Mathieu, Mickael	SA-PO787
Malik, Saif N.	FR-PO310, FR-PO332	Mansfield, Aaron	SA-PO925	Martínez Jimenez, Víctor	TH-PO046, TH-PO047	Mathos, Lauren	TH-PO018
Malik, Sheza	TH-PO776, FR-PO898	Mansfield, Sarah	SA-PO144	Martínez Osorio, Jorge I.	PUB197	Mathur, Mohit	SA-PO712
Malik, Uzma	TH-PO173, FR-PO197, PUB174	Manson, Joann E.	TH-PO472, TH-PO473	Martínez Pitre, Pedro J.	SA-PO751	Matias, Patrícia	FR-PO469, PUB141
Malinis, Maricar	SA-PO837	Mansour, Bshara	SA-PO187	Martinez-Rueda, Armando	TH-PO003, SA-PO087	Matos, Ana	TH-PO383
Mallappallil, Mary C.	FR-PO622, FR-PO670, SA-PO476, PUB349	Mansour, Ladan	FR-PO326, FR-PO327, FR-PO328, SA-PO578	Martínez Pulleiro, Raquel	SA-PO742	Matsuda, Jun	FR-PO955
Malle, Louise	PUB277	Manunta, Paolo	FR-PO327, FR-PO328, SA-PO578	Martínez Calle, Marta	TH-PO149, FR-OR07, SA-PO177	Matsuda, Satoshi	FR-PO289
Mallela, Shamroop Kumar	FR-PO693, FR-PO694, SA-PO750	Manvar, Sohilkumar	SA-PO754	Martínez Rojas, Miguel A.	TH-PO490, FR-PO003, SA-PO087	Matsui, Kenji	FR-PO374, FR-PO380, FR-PO400
Mallett, Andrew J.	TH-OR34	Manzur-Pineda, Karen	SA-PO131	Martínez Rueda, Armando	SA-PO411	Matsui, Masaru	TH-PO251, FR-PO925, SA-PO700, SA-PO891
Mallett, Stephen	TH-PO685, TH-PO688, TH-PO691, TH-PO692, SA-OR37, SA-PO115	Mao, Michael A.	TH-PO279, SA-PO403	Martínez Sanchez, Froylan D.	FR-PO027	Matsui, Sho	FR-PO955
Mallik, Ritwika	FR-PO852	Mara, Kristin C.	TH-PO0412, TH-PO461, FR-PO446, SA-PO824, SA-PO835	Martínez, Gracia	SA-PO148	Matsukuma, Yuta	TH-PO576
Mallipattu, Sandeep K.	TH-PO217, FR-PO087, SA-OR22, SA-OR26, SA-PO017, SA-PO632, SA-PO1003, PUB056	Maranto, Anthony R.	SA-PO835	Martínez, Joaquín	TH-PO256, TH-PO279, SA-PO403	Matsumoto, Kei	FR-PO374, FR-PO380, FR-PO400
Mallisetty, Yamini	TH-PO615, TH-PO616, FR-PO574, SA-PO902, SA-PO903	Marc, Jean Michel	FR-PO281	Martínez, Laisel	TH-PO256, TH-PO279, SA-PO403	Matsumoto, Naoto	FR-PO374, FR-PO380, FR-PO400
Malluche, Hartmut H.	SA-PO193	Marcello, Matteo	FR-PO073, SA-PO011, SA-PO415	Martínez, Manuel	FR-PO837	Matsunaga, Atsuhiko	TH-PO779,
Malmberg, Annika	FR-PO344	Marchant, Vanessa	TH-PO011, SA-PO415	Martínez, Maria	FR-PO002	Matsuda, Jun	SA-PO684
Malone, Andrew F.	TH-PO654, FR-PO825, PUB319	Marchionna, Nicola	TH-PO555, FR-PO263, FR-PO461	Martinho, Hugo M.	TH-PO627, TH-PO628	Matsushita, Kunihiro	TH-PO890, TH-PO892
Malone, Skylar	PUB091	Marcinek, David J.	TH-PO041, TH-PO042, TH-PO447, TH-PO448, TH-PO472, TH-PO474, TH-PO477, TH-PO534, TH-PO569, TH-PO760, FR-OR53, FR-PO657, FR-PO724, SA-PO003	Martins, Carlos M.	FR-PO094, SA-PO041	Matsuyama, Eriko	FR-PO275
Malta C.S Santos, Debora	FR-PO402	Marden, Tyson J.	SA-PO210	Martins, Carolina S.	FR-OR07, SA-PO177	Mattedi, Francisco Z.	FR-PO179, SA-PO148
Maltzman, Jonathan S.	TH-OR57	Marder, Brad A.	FR-PO232, SA-PO897, SA-PO898, PUB355	Martins, Pedro M.	TH-OR13, SA-PO402	Matten, Larissa	SA-PO251
Maluf, Daniel G.	TH-OR50, TH-PO459, TH-PO641, FR-PO787	Marelli-Berg, Federica M.	PUB315	Martins, Vitor Augusto Q.	TH-PO940	Mattinzoli, Deborah	TH-PO444
Malvar, Ana	TH-PO489, SA-PO684	Maremanda, Krishna P.	FR-PO981	Matos, Nerea	TH-PO178	Mattoo, Tej K.	SA-PO585
Malvik, Natalie	SA-PO851	Maremonti, Francesca	TH-PO188, SA-PO081	Martus, Giedre	FR-PO498	Maturossakul, Boonyanuth N.	TH-PO757, SA-PO474
Mamlouk, Omar	FR-PO215, SA-PO113, SA-PO125, SA-PO134, SA-PO870	Margetts, Peter	FR-PO499	Martuyama, Shoichi	TH-PO883	Mauer, Michael	FR-OR37, FR-PO699
Mamun, Abdullah A.	SA-PO980, SA-PO981, SA-PO982	Marian, Valentin	SA-PO667	Marwaha, Arjun	TH-PO838	Maugans, Cheoting C.	PUB257
Mamven, Manmak	TH-PO805, TH-PO806	Mariani, Laura H.	TH-PO422, TH-PO445, TH-PO446, TH-PO447, TH-PO448, TH-PO472, TH-PO474, TH-PO477, TH-PO534, TH-PO569, TH-PO760, FR-OR53, FR-PO657, FR-PO724, SA-PO003	Marwaha, Suraj	SA-PO507	Maursetter, Laura J.	TH-PO017
Man, Cheuk Yan	SA-PO618	Mariko, Anayama	TH-PO697, PUB004	Mas, Valeria R.	TH-OR50, TH-PO459, TH-PO641, FR-PO787, SA-OR50	Mavrakanas, Thomas	TH-PO612, TH-PO619, FR-PO749, FR-PO903, SA-PO262, SA-PO347
Manadan, Augustine	TH-PO633	Marinaki, Smaragdi	FR-PO709	Masakane, Ikuto	SA-PO399	Maw, Thin Thin	FR-PO779, SA-OR45
Manarang, Grace Haziël C.	PUB808	Marinacci, Silvana	PUB329	Masaki, Takao	TH-PO109, FR-PO456, SA-PO370, SA-PO396, SA-PO417	Mawe, Seamus	TH-PO535
Manatunga, Amita	TH-PO777	Maringer, Katherine	TH-PO413	Masbang, Armin N.	TH-PO027	Maxwell, Alexander P.	TH-PO222, FR-OR40
Mancini, Barbara	TH-PO359	Marinovic, Iva	FR-PO451, SA-PO627	Maschek, John A.	FR-PO144	May, Heather P.	TH-PO051
Mandai, Shintaro	TH-PO339, TH-PO425, SA-PO549, SA-PO1008	Mariyam joy, Christina	TH-PO587	Masereeuw, Rosalinde	TH-PO190, SA-OR12, SA-PO025, SA-PO078, PUB364	May, Rebecca	SA-OR01
Mandal, Asim	TH-PO351, TH-PO352	Markell, Mariana S.	TH-PO720, TH-PO721, TH-PO942	Masferrer, Sandra	FR-PO943	Mayeux, Erin L.	TH-PO294
Mandal, Rupasri	FR-PO024	Marko, Joy	TH-PO012, TH-PO013	Masoodi, Sumana	FR-PO943	Mayoral Andrade, Gabriel	SA-PO108, SA-PO154
Mandal, Sunny	SA-PO470	Marko, Lajos	FR-PO994, SA-PO793	Masry, Ahmad A.	TH-PO600, SA-PO862	Maza Rodas, Gabino M.	TH-PO699
Mandava, Swetha	PUB108	Markowitz, Glen S.	FR-PO190	Massey, Kenneth	TH-PO276	Mazo, Alexandra	SA-PO588
Mandayam, Sreedhar A.	TH-PO007, TH-PO559, FR-PO215, PUB355	Marmol Mosquera, Fernando A.	TH-PO304, TH-PO305	Massicotte-Azamiouch, David	FR-PO809	Mazza, Elena A.	TH-PO120
Mandel, Amrei M.	FR-PO686	Marneweck, Hava	FR-PO411			Mazzacani, Paolo	FR-PO929
Mandelbrot, Didier A.	TH-PO858, FR-PO803, PUB303, PUB306, PUB319	Marques da Silva, Bernardo	TH-PO257			Mazzaferrri, Ernest L.	FR-PO759
		Marques Vidas, Maria	PUB253			Mazzaferrri, Sandro	FR-PO179
		Marques, Filipe	FR-PO094, SA-PO041			Mazzierli, Tommaso	SA-PO621
						Mazzinghi, Benedetta	SA-PO529
						Mazzola Poli de Figueiredo, Sergio	PUB331
						Mbue, John E.	FR-PO669
						Mc Monagle, Edward P.	FR-PO864

McAdams-DeMarco, Mara	TH-PO896, FR-PO814, SA-PO462, PUB135	McMahon, Gearoid M.	TH-PO687, SA-PO039, PUB063	Melena, Isabella L.	TH-PO253, PUB144	Mettupalli, Neeharika	SA-PO472, PUB350
McAdams, Meredith C.	FR-OR25, FR-PO069, FR-PO926	McMahon, Kelly	TH-OR30	Meliambro, Kristin	FR-PO006	Metwally, Mona A.	TH-PO666
McAdoo, Stephen P.	FR-PO660	McMahon, Lawrence P.	TH-PO828	Melik, Anette	SA-PO444, SA-PO627	Metzger, Corinne E.	FR-OR01
McAndrews, Kyle	TH-PO655	McMillan, James I.	PUB354	Melo ferreira, Ricardo	TH-PO183, FR-OR09, FR-OR20, FR-PO131, FR-PO154, FR-PO169, SA-PO001, PUB102	Metzger, Maureen J.	TH-PO777
McCabe, James C.	FR-PO218, FR-PO241	McMurray, Brandon J.	SA-PO793	Melo, Maria Joao	SA-PO865	Meuleman, Yvette	TH-PO788
McCafferty, Kieran	TH-PO481, TH-PO674, TH-PO680, FR-PO785, FR-PO852, SA-PO288, PUB311, PUB315, PUB327	McMurray, John	TH-PO244, TH-PO685, FR-OR26, SA-OR36, SA-PO115, SA-PO886, SA-PO889	Melotti, Roberto	TH-PO624, TH-PO845	Meulendyke, Kelly	SA-PO193
Mccaleb, Michael	SA-PO714	Mcnabb, Katherine C.	SA-PO305	Melson, Toralf	FR-PO897	Meyer-Schwesinger, Catherine	TH-PO720, SA-PO746
McCallum, Wendy I.	TH-PO603, TH-PO899, FR-PO083	Mcnamara, Margaret	TH-PO921, SA-OR08	Melzer Cohen, Cheli	SA-PO266	Meyer, Colin J.	SA-PO919
Mccann, Timothy P.	FR-PO733	McNamara, Timothy	FR-PO942	Melzer, Franz Leonard	FR-PO362	Meyer, Timothy W.	SA-PO462
Mccarthy, Angela L.	TH-PO739	Mcneil, Daniel W.	SA-PO303	Memon, Aliza Anwar	FR-PO057, SA-PO850, SA-PO851	Meyers, Kevin E.	TH-PO594
Mccarthy, Donald P.	TH-PO724	McNulty, Michelle	TH-OR29, FR-PO303, FR-PO308, FR-PO309, SA-PO546	Memon, Rahat A.	SA-PO038	Meyerson, Brian	TH-PO538
McCartney, Audrey	FR-PO619	McPhail, Ellen D.	FR-PO190	Mendelovich, Ilona	FR-PO534	Meziyerh, Soufian	FR-PO011
McCausland, Finian R.	TH-PO612, TH-PO686, TH-PO687, FR-PO758, FR-PO834, SA-PO115, SA-PO358, SA-PO361, SA-PO364, SA-PO369, SA-PO792	McPherson, Paul	FR-PO071	Mendelsohn, Cathy L.	SA-PO606	Mhaske, Aditi	SA-PO554
McClenahan, Samantha J.	TH-PO325	Mcrae, Andrew	SA-PO322	Mendez, Nicole D.	SA-OR31	Miao, Jing	PUB029
McClure, Candace	SA-PO416	Mcritchie, Susan	TH-PO446, TH-PO447, TH-PO448	Mendez, Victor M.	TH-PO326, PUB257	Miao, Shiyuan	SA-PO913
McClure, Charles P.	TH-PO115	Md Dom, Zaipul I	TH-PO232, FR-OR37, SA-PO253	Mendiluce, Alicia	TH-PO070	Miao, Zhen	FR-PO152
McConnell, Mark	TH-PO419, SA-PO1011	Me, Hay Me	FR-OR37, SA-PO253	Mendley, Susan R.	FR-PO411	Miao, Zhenhua	SA-PO633
McConnochie, Rachael C.	PUB312	Meade, Laurie A.	TH-PO051	Mendonça, Luís C.	TH-PO627, TH-PO628	Micanovic, Radmila	FR-PO149, FR-PO150, FR-PO154, SA-PO170
McCormack, Vincent	PUB274	Meadowcroft, Amy M.	TH-PO086, TH-PO115	Mendonca, Ninoshka	SA-PO802	Michael, Mini	FR-PO335
McCormick, James A.	TH-PO320, TH-PO349	Meagher, Sean	TH-PO795	Mendoza Flores, Brenda	TH-PO074, FR-PO978, SA-PO076	Michaleff, Zoe A.	FR-PO860
Mccormick, Linda	TH-PO413	Mealy, Shane	TH-PO951, TH-PO963, PUB012	Mendoza, Susana M.	SA-PO458, SA-PO670, PUB175, PUB304	Michalick, Laura	FR-PO420
McCown, Phillip J.	TH-PO211, TH-PO419, SA-PO257, SA-PO258	Medeiros, Joana	SA-PO377	Menez, Steven	TH-PO028, TH-PO564, FR-PO116, SA-PO079, PUB112, PUB223	Michaud, Jennine	TH-PO104, TH-PO469, PUB041
McCoy, Ian	TH-PO057, TH-PO059, PUB050	Medhus, Annika L.	FR-PO735	Menezes, Luis F.	FR-PO282, FR-PO346	Michel, Niklas	FR-OR60, SA-PO1011
Mccoy, Matthew S.	SA-PO392	Medikayala, Sushma	PUB044	Meng, Rong	TH-PO088, FR-PO171	Michos, Erin D.	SA-PO185
Mccoy, Rozalina G.	TH-PO051	Medina Rangel, Paulina	FR-PO684	Meng, Xiangwen	TH-OR16	Miciak, Gerald	SA-PO289
McCracken, Kyle	TH-PO332, FR-PO357, SA-OR17	Medina, Christopher B.	FR-OR12	Mengjio, Austine Y.	FR-PO045	Middleman, Christopher F.	FR-PO674
Mcculloch, Charles E.	TH-PO897, SA-PO393, SA-PO798, SA-PO806	Medina, Paula A.	FR-PO610	Menn-Josephy, Hanni	TH-PO730, FR-OR58	Middleton, John P.	TH-PO869
Mccutchan, Braeden	TH-PO294	Medina, Ramon	TH-PO045, PUB209, PUB220	Menon, Madhav C.	FR-PO315	Middleton, Rachel	TH-PO521, FR-PO769, FR-PO770, FR-PO866
McDaniels, Jennifer M.	TH-OR50, TH-PO459, TH-PO641, FR-PO787, SA-OR50	Medipally, Ajay kumar	TH-PO542	Menon, Rajasree	TH-OR02, TH-PO211, FR-OR20, SA-OR04	Middleton, Rachel	TH-PO521, FR-PO769, FR-PO770, FR-PO866
Mcdermott, Jeff P.	FR-PO264	Medjeral-Thomas, Nicholas R.	FR-PO660	Menon, Shina	TH-PO081, SA-PO601	Miehls, Alexa	SA-PO609, SA-PO617
McDonald, Stephen P.	TH-PO275, TH-PO723	Medunjanin, Danira	TH-PO220, FR-PO065	Menzaghi, Frederique	SA-PO286, SA-PO288, SA-PO401, SA-PO463	Miele, Emily	SA-PO916
McDonough, Alicia A.	TH-PO316	Meehan, Daniel T.	FR-PO692	Menzies, Robert I.	PUB361	Mielke, Nina	TH-PO769, TH-PO775, TH-PO796, TH-PO882
Mcdougan, Felecia	FR-PO780	Meena, Priti	FR-PO887	Mercer, Alex	TH-PO494	Mieses, Laura	TH-PO533
McElliott, Madison C.	SA-PO090	Meeusen, Jeff W.	TH-PO731, TH-PO732	Merchant, Michael	TH-PO421, TH-PO446, TH-PO447, TH-PO448, SA-PO631	Miglinas, Marius	TH-PO761
McEvoy, Caitriona M.	TH-PO640, TH-PO765, TH-PO915	Meganathan, Karthikeyan	FR-PO113, FR-PO514, PUB117	Merchant, Paul T.	SA-PO877	Mihaila, Silvia M.	TH-PO190, SA-PO025, SA-PO078
McEwan, Philip	SA-PO887	Megersa, Bikila Soboka	FR-PO433	Merchant, Sanjay	FR-PO829, FR-PO849	Mihajlovic, Milos	PUB364
Mcfadden, Jennifer E.	TH-PO412	Mehdi, Ali	TH-PO010, TH-PO470, TH-PO579, TH-PO618	Mercer, Michael	TH-PO421, TH-PO446, TH-PO447, TH-PO448, SA-PO631	Mii, Akiko	FR-PO035, SA-PO068
Mcfarlane, Samy I.	TH-PO762	Mehmood, Zaneb	TH-PO820	Mercant, Michael	TH-PO421, TH-PO446, TH-PO447, TH-PO448, SA-PO631	Mikhailov, Alexei V.	TH-PO007, TH-PO559
McFarlin, Brandon E.	TH-PO316	Mehrabani, Arianeb	SA-OR47, SA-PO812	Meredith, Garrett D.	SA-PO766	Mikhailina, Galina	TH-PO542
Mcgahan, Stacey	FR-PO878	Mehrad, Borna	TH-PO135	Merle, Uta	SA-OR47	Mikkelsen, Håvard	SA-PO715
McGavock, Jonathan	TH-PO765	Mehrotra, Rajnish	TH-OR18, TH-PO497	Mermelstein, Ariella E.	TH-PO166, SA-PO355	Mikuls, Ted R.	SA-PO895
McGill, Rita L.	FR-PO836, FR-PO879, SA-PO799	Mehta, Ankit	FR-PO339	Merrill, Kyle	TH-PO098, FR-PO571	Milano, Victoria	SA-PO044
Mcgonigle, Mercedes B.	FR-PO243, SA-PO745	Mehta, Darshan	FR-PO256	Merriman, Tony	TH-PO351	Miles, Clifford D.	FR-PO052
McGrath, Martina M.	FR-PO834	Mehta, Jaya	SA-PO802	Merscher, Sandra M.	TH-PO207, FR-OR53, FR-PO323, FR-PO693, FR-PO694, FR-PO722, SA-PO244, SA-PO749, SA-PO750	Millar, Adam C.	FR-PO885
Mchale, Teresa	FR-PO180	Mehta, Kshama R.	SA-PO296	Mertens, Nils D.	FR-PO327, FR-PO328, SA-PO525, SA-PO538, SA-PO573	Millar, Catherine	FR-PO438
McIntyre, Christopher W.	TH-OR12, SA-PO309, SA-PO373, SA-PO374, SA-PO447	Mehta, Ravindra L.	TH-PO910	Mertens, Peter R.	SA-PO1010	Miller, Edgar R.	TH-PO727
Mckay, Heather S.	TH-PO762	Mehta, Rupal	TH-PO238, SA-PO192, SA-PO931	Merwat, Shehzad N.	TH-PO035, TH-PO037	Miller, Forrest	FR-OR43
Mckee, Annalisse R.	TH-PO326, TH-PO327	Mehta, Shikha	FR-PO803	Merz, Lea M.	FR-PO327, FR-PO328, SA-PO573	Miller, Lorraine	FR-PO167
Mckee, Trevor D.	FR-PO788	Mehta, Swati	TH-PO434, PUB140	Merzkani, Massini	FR-PO823, FR-PO825	Miller, Mikaela A.	FR-PO801
Mckinney, Warren T.	SA-OR41, SA-PO804	Mei, Li X.	TH-PO200	Mesa, Robert	PUB249	Miller, R. Tyler	FR-PO689
Mcknight, A.J.	TH-PO222	Meier, Matthias	TH-PO505, FR-OR59	Mescia, Federica	TH-PO508	Miller, Robin	SA-PO575
Mclaughlin, Tara	TH-PO077	Meijer, Esther	TH-PO406, TH-PO407	Mesnard, Laurent	SA-PO545	Miller, Ryan	SA-PO887
McLawnhorn, Kristel J.	SA-PO537	Meinders, Andrea M.	SA-PO796	Messaggio, Elisabetta	FR-PO073, SA-PO754	Milliron, Brandy-Joe	SA-OR40
McLeish, Kenneth R.	TH-PO421	Meireles, Christiane L.	TH-PO850	Messchendorp, A. L.	TH-PO407, TH-PO919	Mills, Katherine T.	TH-PO892
McLeod, Daryl J.	FR-PO419, SA-PO619	Meisels, Ira S.	TH-PO515, PUB168	Meta, Elda	FR-OR14	Milne, Ginger	FR-PO410
McLeod, Marshall C.	TH-PO729	Mejia-Vilet, Juan M.	TH-PO490, TH-PO517, FR-PO642, SA-PO686, SA-PO691	Metallinou, Eleftheria Theodora	SA-PO648, SA-PO649	Milner, Adam S.	FR-PO471
McMahon, Andrew P.	TH-PO140	Mekraksakit, Poemlarp	TH-PO695, FR-PO096	Metaoay, Sara	SA-PO719	Milosevic, Hila	SA-PO543
McMahon, Blaitain A.	TH-PO043, TH-PO069, FR-PO202	Mela, Christopher	TH-PO486	Meter, Anita	TH-PO644	Milosavljevic, Julian	FR-PO370, FR-PO703



Minto, Wesley	SA-PO240	Mohamed, Amr E.	SA-PO193	Moore, Kyle H.	FR-OR16, FR-PO969, SA-PO110	Morton, Lori	TH-PO252, FR-OR32, SA-OR04
Mir, Hamza	TH-PO902, TH-PO903	Mohamed, Maha A.	PUB303, PUB306	Moore, Linda W.	SA-PO796	Morton, Sarah N.	TH-PO153
Miranda, Renata L.	SA-PO600	Mohamed, Muner	TH-PO038, TH-PO563, FR-PO634, SA-OR01	Moore, Shaun C.	SA-PO783	Moschini, Marco	TH-PO075
Mirioglu, Safak	FR-PO824, SA-PO795	Mohammad, Saleh	FR-PO375, FR-PO950	Moore, Theodore C.	FR-PO233	Mosenzon, Ofri	FR-OR26, SA-PO266
Miró C6, Adrián A.	TH-PO345	Mohammadi, Ario	FR-PO297	Mooren, Fieke	TH-PO533	Moses, Andrew A.	PUB266
Mirshahi, Tooraj	TH-PO847	Mohan, Arjunmohan	FR-PO398	Moorthi, Ranjani N.	TH-PO811, SA-PO462	Mosoyan, Gohar	FR-PO006, PUB112
Mirshahi, Uyenlinh L.	TH-PO373	Mohan, Kritika	FR-PO887	Moorthy, Monica	FR-PO891	Moss, Emily	SA-PO811
Mirza, Kamran	FR-PO206	Mohan, Muthukumar	TH-PO205	Mora, Samia	SA-PO187	Mostafa, Mohamed M.	FR-PO807, SA-PO844
Mirza, Taaha M.	SA-PO767	Mohandas, Rajesh	SA-PO779	Moraes, Thyago P.	TH-PO166, TH-PO677	Mota, Conceição	FR-PO428
Mischak, Harald	FR-PO913, SA-PO272, PUB095	Mohandes, Samer	TH-PO252	Moragny, Julien	FR-PO221	Motallebzadeh, Reza	TH-OR48
Mishkin, Aaron D.	PUB019	Mohtat, Davoud	FR-PO443	Morales Guillén, Mónica L.	PUB053	Mottl, Amy K.	TH-PO472, FR-PO636, SA-PO735
Mishra, Arunima	FR-PO475	Moinuddin, Irfan A.	FR-PO805, SA-PO817, SA-PO826, SA-PO853	Morales Lopez, Enrique F.	FR-PO618, SA-PO483	Motwani, Shveta S.	SA-PO123, SA-PO146
Mishra, Rahul	PUB247	Moise, Pamela	FR-PO829	Morales Molina, Pedro	PUB061, PUB115	Mouawad, Sarah	PUB318
Mishra, Ram kinker	SA-PO290	Mok, Jinwon	SA-PO349	Morales-Alvarez, Martha Catalina	FR-PO672	Moubarak, Simon	TH-PO529, SA-PO153
Miskulin, Dana	TH-PO921, FR-PO500, SA-OR08	Mok, Maggie ming yee	SA-PO414	Morales-Buenrostro, Luis E.	FR-PO642, SA-PO686, SA-PO691	Mount, David B.	TH-PO351, TH-PO352, PUB063
Missiakas, Dominique	FR-PO020	Mok, Wing Long Cody	FR-PO459	Morales, Michael Joshua G.	TH-PO008	Mount, Rebecca	TH-PO815
Mistry, Nirav	PUB323	Mokhlesi, Babak	SA-PO074	Morales, Natacha U.	FR-PO880	Moura, Luiz A.	TH-PO557
Mistry, Nupur S.	PUB286	Mokrzycki, Michele H.	SA-PO803	Morales, Samantha M.	SA-OR44	Mourani, Chebl	FR-PO335
Mitash, Nilay	FR-PO019	Moldenhauer, Julie	FR-PO278	Moran, Karen	TH-PO708	Moursy, Safa	PUB058
Mitch, William E.	FR-OR27, SA-PO964	Moldoveanu, Zina	SA-PO641, SA-PO644	Moran, Sarah M.	TH-PO455, TH-PO701	Mousa, Dujanah H.	TH-PO298
Mitchell, Elizabeth C.	TH-PO594	Moledina, Dennis G.	TH-OR07, TH-PO026, TH-PO080, TH-PO564, FR-PO116, SA-PO967, PUB054	Morath, Christian	TH-PO105, TH-PO536, TH-PO920, FR-PO774, SA-OR47, SA-PO812	Moustafa, Amr	TH-PO568, FR-PO815
Mitchell, Reece B.	TH-PO033	Molina David, Judith T.	FR-OR53, FR-PO323, FR-PO694, FR-PO722, SA-PO244, SA-PO750	Moratto, Daniele	TH-PO508	Moustafa, Khaled M.	TH-PO296
Mitchell, Sarah E.	SA-PO811	Molina J-ijon, Eduardo	SA-PO955	Morcos sandino, Michelle	FR-PO734	Mowery, Yvonne M.	SA-PO003
Mitchell, Tanecia	FR-OR10	Molinari, Paolo	FR-PO840, FR-PO842, SA-OR071, PUB340	Mores, Keigan	SA-PO387	Mowrey, John	TH-PO258, TH-PO820
Mitrofanova, Alla	FR-PO694, SA-PO750	Molitch, Mark E.	PUB094	Moreau, Julie L.	FR-PO385	Mowrey, Wenzhu	TH-PO150
Mitsnefes, Mark	FR-PO409	Molkentin, Jeffery D.	TH-PO097	Morelle, Johann	FR-PO497	Moy, Vincent T.	FR-PO693
Mittal, Amol	TH-PO173, PUB174	Moll, Solange	TH-PO556, TH-PO567	Morena, Anthony	TH-PO724	Moyer, Jarrett	SA-PO018
Mittrücker, Hans-willi	SA-OR29	Mollah, Shamim	SA-PO956	Morena, Leela	TH-PO916	Moyses, Rosa M.	TH-PO165, TH-PO781, TH-PO782, TH-PO785, FR-OR05, FR-OR07, SA-PO177, SA-PO213, SA-PO215
Miura, Kenichiro	SA-OR25	Møller, Alexandra L.	TH-PO234, TH-PO239, TH-PO429	Moreno, Gordon, Gina	PUB196	Mozhui, Khyobeni	TH-PO615
Miyagawa, Bradley	SA-PO855	Möller, Bianca	TH-PO277	Moreno Quinn, Carol P.	FR-PO219	Mprua, Margarita	SA-PO408
Miyagawa, Taro	FR-PO938, SA-PO911, PUB210, PUB347	Møller, Marie	PUB096, PUB106	Moreno Amaral, Andrea N.	TH-PO704	Mrug, Michal	FR-PO245, FR-PO252
Miyake, Itsuki	FR-PO463	Molnar, Miklos Z.	SA-PO817	Moreno, Daiiana R.	TH-PO958	Mu, Yi	SA-PO146
Miyake, Sayoko	TH-PO241	Molyneux, Karen	SA-PO654, SA-PO655	Moreno, Erika	FR-PO007	Muaddi, Luba	TH-PO523, FR-PO664
Miyashita, Ryumon	TH-PO552	Momin, Anmol S.	SA-PO278	Moreno, Rodolfo A.	TH-PO524, PUB232	Mubasher, Mahmood	FR-PO105, PUB360
Miyashita, Yoshihiro	FR-PO018	Monaghan, Caitlin	SA-PO310	Morenz, Anna M.	TH-PO738	Mucha, Krzysztof	SA-PO564
Miyata, Kana N.	FR-PO814	Monaghan, Sarah	TH-PO346	Morevati, Marya	TH-PO142	Mucsi, Istvan	TH-PO399, FR-PO882
Miyauchi, Takamasa	FR-PO832, FR-PO850	Monette, Sebastien	SA-PO787	Morgan, Ashley	TH-PO817, SA-PO360	Mudge, David W.	FR-PO708
Miyazaki-anzai, Shinobu	SA-PO596	Monk, Brian	PUB073	Morgan, Jennifer C.	FR-PO540, FR-PO541	Mueangpaisarn, Pattranid	SA-PO162
Miyazaki, Takashi	FR-PO595	Monk, Muhammad A.	SA-PO503	Morgan, Kathy Y.	FR-PO344	Mueller, Bruce A.	FR-PO224, FR-PO226
Miyazaki, Toshiaki	FR-PO595	Monroy-Trujillo, Jose M.	FR-PO617, PUB265	Morgans, David J.	FR-PO318	Mueller, Niklas	FR-PO225, FR-PO226, TH-PO267
Mizerska-wasiak, Malgorzata	SA-PO564	Monroy, Mauricio	SA-PO053	Mori, Andres	FR-PO1008	Mueller, Roman-Ulrich	FR-PO242, SA-OR42
Mizobuchi, Masahide	TH-PO143, SA-PO182	Montalto, Michael	TH-PO567	Mori, Andrea	FR-PO1008	Muellers, Nina L.	TH-PO860
Mizuri, Sonoo	SA-PO370, SA-PO396, SA-PO417	Montane, Bryce	TH-PO009	Mori, Takayasu	TH-PO339, TH-PO425, SA-PO549, SA-PO1008	Muff-Luett, Melissa A.	SA-PO585
Mizukami, Takuya	TH-PO155	Monteiro-Martins, Sara	SA-PO564	Mori, Yutaro	TH-PO206, FR-OR15, SA-PO549	Muhamad, Qasim	FR-PO054
Mizuki, Britta	SA-PO710	Monteiro, Renato C.	SA-PO648, SA-PO649	Mori, Takefumi	SA-PO785	Muhammad, Shahid N.	PUB155, PUB160
Mizumoto, Teruhiko	TH-PO210, SA-PO067	Montellano, Richard	TH-PO850	Morgans, David J.	FR-PO318	Muir, Kate-Lynn	FR-PO201
Mizuno, Hiroki	TH-PO401	Montemayor, Daniel	TH-PO107	Mori, Andres	FR-PO1008	Muiru, Anthony N.	TH-PO059
Mizuno, Masashi	FR-PO108	Montepio, Rafael	SA-PO318, PUB088, PUB133	Mori, Takayasu	TH-PO339, TH-PO425, SA-PO549, SA-PO1008	Mujtaba, Muhammad A.	TH-PO035, TH-PO037, PUB314, PUB321, PUB329, PUB331, PUB342
Mizuno, Tomoyuki	SA-PO855	Montez-Rath, Maria E.	TH-PO863, FR-PO518, SA-PO181, SA-PO718	Mori, Yutaro	TH-PO206, FR-OR15, SA-PO549	Mukaiyama, Hironobu	SA-PO589
Mizushima, Ichiro	SA-PO858	Montford, John R.	TH-PO085	Mori, Catherine	FR-PO513	Mukamel, Dana B.	TH-PO870, TH-PO871, FR-PO930, FR-PO941, SA-OR33, SA-PO304
Mo, Zhaohui	SA-PO273	Montgomery, Ann Elizabeth E.	TH-PO717	Morin, Isabelle	SA-PO286, SA-PO288, SA-PO401, SA-PO463	Mukherjee, Kamalika	TH-PO215
Moallem, Niala	TH-PO077	Montgomery, Elizabeth E.	TH-OR18	Morita, Naru	TH-PO883, FR-PO546, FR-PO549	Mukherjee, Malini	FR-PO391
Mobeen, Haris	PUB258	Montgomery, Neel	SA-PO404	Morita, Sae	TH-PO527	Mukku, Venkata Kishore R.	SA-PO733, PUB208
Modelli de Andrade, Luis Gustavo	PUB196	Montorsi, Francesco	TH-PO075, SA-PO118, SA-PO135	Morita, Sayu	TH-OR39	Mukoyama, Masashi	TH-PO210, SA-PO067
Modi, Jwalant R.	FR-PO113	Montoya, Christopher	TH-PO279	Moriyama, Tomofumi	TH-PO195, TH-PO389	Mukuba, Dorcas	FR-PO852
Modur, Vijay	FR-PO322	Moochhala, Shabbir H.	TH-OR34	Morizetti, Phani P.	FR-PO612	Mulay, Shrikant R.	FR-PO966
Moe, Sharon M.	TH-PO146, TH-PO810, TH-PO811, TH-PO819, FR-OR01, SA-PO302, SA-PO462, SA-PO775	Moody, Taylor R.	FR-PO236	Morita, Naru	TH-PO883, FR-PO546, FR-PO549	Mulhern, Jeffrey	FR-PO557, FR-PO874
Moeckel, Gilbert W.	TH-PO080, FR-PO121, FR-PO122	Moon, Ju young	SA-PO279, SA-PO407	Morla, Luciana	TH-PO322	Mullholland, Kelly A.	FR-OR38
Moellmann, Julia	SA-PO786	Moon, Salina	FR-OR37	Morohoshi, Hokuto	TH-PO155	Mullan, Aidan F.	TH-PO418
Moerland, Perry	TH-PO416	Moon, Sung Jin	TH-OR19, FR-PO988	Morrell, Eric D.	TH-OR10, PUB028	Muller, Karine	TH-PO385
Moes, Dirk jan	FR-PO011	Moonen, Lies	SA-PO088	Morris, Austin M.	SA-PO469	Muller, Matthew R.	FR-PO495
Mogga, Phanidhar	TH-PO079	Moore, Barry	TH-PO245	Morris, Jon D.	FR-PO552	Müller, Dominik	TH-PO329, FR-PO420, SA-PO626
Moghadam, Bahman J.	TH-PO468	Moore, Brittni	SA-PO966	Morris, Van	FR-PO181	Muller, Sandra	TH-PO267
Moghaddam, Farahnaz A.	TH-OR26, FR-PO559	Moore, Bryn S.	SA-PO552, SA-PO582	Morrison-Nozik, Jordan	FR-PO837	Mullican, Shannon	FR-PO171
Moguel, Bernardo	PUB148	Moore, Carol	FR-PO535	Morrison, Benjamin G.	TH-PO960		
Mohamed Ahmed, Mohamed A.	FR-PO105	Moore, Catherine A.	FR-PO626, SA-PO494, PUB225	Morrison, Hannah	SA-PO818		
Mohamed Razif, Noor Adeebah	TH-PO303			Mortberg, Josef L.	FR-PO760		



Ni, Zhaohui	TH-OR16, TH-PO157, TH-PO694, SA-PO311	Noguera Barrera, Nicole D.	PUB248	O'Neill, Liam	FR-PO180	Oh, Yun Kyu	TH-PO358, TH-PO365, TH-PO366, TH-PO381
Niazi, Nicholas S.	TH-PO850	Noh, Hee Won	TH-PO067, SA-PO828	O'riordan, Edmond	FR-PO866	Ohashi, Yasushi	TH-PO701
Nic an Riogh, Eithne M.	SA-PO698	Nøhr-Meldgaard, Jacob	PUB365	O'Seaghda, Connall M.	SA-PO350, SA-PO351	Ohkido, Ichiro	TH-PO552
Nicholas, Susanne B.	TH-PO255, FR-PO662, FR-PO894, FR-PO937, FR-PO939, SA-OR31	Noiri, Eisei	FR-PO018	O'Shaughnessy, Michelle M.	TH-PO472, TH-PO760, SA-PO181, SA-PO701, SA-PO718, PUB227	Ohri, Ritika	FR-PO200, SA-PO042
Nicholson, Joey	TH-PO739	Nolan, Marie T.	FR-PO869	O'Shea, Michael H.	FR-PO873, SA-PO809, SA-PO810	Ohya, Yusuke	TH-PO553, SA-PO896
Nicholson, Rebekah	FR-PO144	Nolan, Stephen	SA-PO887	O'Toole, John F.	TH-PO009, TH-PO010, SA-PO734	Oikawa, Daisuke	TH-PO339
Nickeleit, Volker	TH-PO560	Nolin, Thomas D.	FR-PO216, SA-PO156, SA-PO942	Oballa, Renata	FR-PO334	Oishi, Kimihiko	FR-PO380
Nickerson, Megan N.	TH-PO086, FR-PO234	Noller, Kathleen	FR-PO147	Obana, Masanori	FR-PO984, FR-PO990	Ojeda Damas, Dayan	SA-PO521
Nicolaescu, Vlad I.	FR-PO015	Nopp, Anna	FR-PO596	Obata, Shota	FR-PO037	Ojemolon, Pius E.	PUB104
Nicolas Frank, Camille H.	FR-PO327, SA-PO525, SA-PO578	Noppakun, Kajohnsak	TH-PO787, TH-PO926	Obayomi, Mobolaji A.	SA-PO548	Ojo, Akinlolu	TH-PO480, TH-PO805, TH-PO806
Nicolucci, Antonio	TH-PO233	Nopsopon, Tanawin	TH-PO924	Obeid, Omar	SA-PO772	Okabe, Yasuhiro	TH-PO576
Nicorici, Alina	TH-PO818	Norby, Suzanne M.	TH-PO733	Obeid, Wassim	TH-PO028, TH-PO080, FR-PO907	Okada, Eri	SA-PO562
Nie, Xiaoyu	TH-PO411	Nordholm, Anders	SA-PO188	Obeid, Wassim	FR-PO195	Okada, Hirokazu	FR-PO940
Nielsen, Anne K.	FR-PO299	Norman, Jennifer E.	TH-PO821, TH-PO823, TH-PO824, SA-PO918	Obeidat, Mohammad	FR-PO195	Okada, Manabu	TH-PO158
Nielsen, Hatsumi	FR-PO518	Noronha, Irene L.	TH-PO516	Öberg, Carl M.	FR-PO498, SA-PO418	Okamoto, Keisuke	SA-PO312
Nielsen, Jens Christian	TH-PO223	Norouzi, Sayna	TH-PO462, SA-PO934	Obermeyer, Katie L.	SA-PO898	Okamura, Kayo	TH-PO085
Niemczyk, Stanislaw	FR-PO647	Norregaard, Rikke	TH-PO344	Obi, Yoshitsugu	TH-PO879, FR-OR24, FR-PO537, FR-PO926, SA-PO362, SA-PO375	Okazaki, Masaki	SA-PO375, SA-PO376
Niesnerova, Anezka	TH-OR44	Norris, Colleen M.	FR-PO868	Obrador, Aina	TH-PO672, SA-PO695	Okazawa, Hidehiko	TH-OR39
Nieto, Julio C.	FR-PO618, SA-PO483, PUB061, PUB115, PUB244	Norris, Keith C.	TH-PO255, TH-PO659, FR-OR22, FR-PO662, FR-PO937, FR-PO939, SA-PO924	Obrador, Gregorio T.	TH-PO686, SA-OR37	Okita, Jun	SA-PO395, PUB010
Nieuwkerk, Pythia T.	TH-PO919	Northrup, Hannah M.	SA-PO012, SA-PO013, SA-PO015, SA-PO016, PUB082	Obradovic, Zoran	FR-PO884, SA-PO814, SA-PO816	Oklepčic, Anja	SA-PO703
Niewczas, Monika A.	FR-OR37	Novak, Jan	SA-PO564, SA-PO637, SA-PO638, SA-PO641, SA-PO642, SA-PO643, SA-PO644, SA-PO645	Obradovic, Zoran	FR-PO884, SA-PO814, SA-PO816	Okoh, Alexis K.	SA-PO805
Niewold, Timothy B.	FR-PO594	Novak, Lea	SA-PO642, SA-PO644	Obriscica, Bogdan	TH-PO561, FR-PO789, PUB107	Okoh, Princess N.	FR-PO882
Nigatu, Tsinuel Girma	FR-PO433	Novick, Tessa K.	TH-PO717, FR-PO948	Ocasio Melendez, Ileana E.	TH-PO526, SA-PO059, SA-PO480, PUB177, PUB219	Okonko, Darlington	TH-PO674, TH-PO680, TH-PO830
Nigro, Elisa Agnese	FR-PO299	Novoa-Vargas, Alejandra	TH-PO870	Ochoa De Leon, Guadalupe Montserrat	PUB220	Okoro-sokoh, Joshua	PUB338
Nigwekar, Sagar U.	TH-PO054, FR-OR23, SA-PO166, SA-PO167, SA-PO532	Novosad, Shannon	SA-PO451	Ochoa, Alejandro	SA-PO628	Okoro, Tony	TH-PO660, TH-PO661, TH-PO662
Nihe, Yoshihito	SA-PO639	Nowak, Kristen L.	TH-OR24, TH-PO390, TH-PO391, TH-PO392, TH-PO402, TH-PO403, TH-PO404, TH-PO609	Ochoa, Alejandro	SA-PO628	Öktem, Mert	SA-OR12
Nijenhuis, Tom	FR-PO337	Nowak, Natalia Z.	SA-PO253	Ochoa, Alejandro	SA-PO628	Okumpa, David	TH-PO294
Nikiforova, Anna	SA-PO762	Nozu, Kandai	FR-PO043, FR-PO303, FR-PO447, SA-PO539, SA-PO562, SA-PO589	Ochoa, Alejandro	SA-PO628	Okubo, Aiko	SA-PO396, SA-PO417
Nikolic-Paterson, David J.	FR-PO356, FR-PO993	Nugent, James	TH-PO599, FR-PO752	Ochoa, Alejandro	SA-PO628	Okubo, Akihiro	FR-PO143, SA-PO064
Nikolic, Dejan	SA-PO423	Nunes, Lucas A.	SA-PO215	Ochoa, Alejandro	SA-PO628	Okusa, Mark D.	TH-PO101, TH-PO138, TH-PO548, FR-OR12, SA-PO086, SA-PO096, SA-PO978
Niles, John	FR-PO646, PUB060	Nunes, Sophia	FR-PO415, FR-PO416	Ochoa, Alejandro	SA-PO628	Okutsu, Mika	SA-PO743
Nilsson, Christine	TH-PO931	Nunez Nescolarde, Ana B.	FR-PO356	Ochoa, Alejandro	SA-PO628	Olabisi, Opeyemi A.	SA-OR27
Nilsson, Karolina A.	FR-PO1008	Nunez Sanchez, Alierca	PUB288	Ochoa, Alejandro	SA-PO628	Olano, Claudia G.	PUB009
Nimkar, Abhishek	TH-PO757, FR-PO185, SA-PO474, SA-PO664, SA-PO665	Nuñez-Gonzalez, Laura	FR-PO263, FR-PO273	Ochoa, Alejandro	SA-PO628	Olde Engberink, Rik H.	FR-OR47
Nimkietkajorn, Veerapatr	TH-OR14, FR-PO079	Núñez, María Guadalupe C.	PUB148	Ochoa, Alejandro	SA-PO628	Olde Hanhof, Charlotte	TH-PO331
Nimura, Takayuki	TH-PO532, FR-PO587, SA-PO091	Nunna, Sasikiran	TH-PO411	Ochoa, Alejandro	SA-PO628	Oleas, Diana	TH-PO260, FR-PO203, PUB151
Ninan, Anna	SA-PO350	Nurko, Saul	SA-PO877	Ochoa, Alejandro	SA-PO628	Olejniczak, Donna	FR-PO862
Ning, Liang	SA-PO105	Nussahg, Christian	TH-PO105, TH-PO920, FR-PO774, SA-PO812	Ochoa, Alejandro	SA-PO628	Olex, Amy L.	TH-PO943
Ning, Wang Y.	TH-PO200	Nwachukwu, Chinedu O.	SA-PO582	Ochoa, Alejandro	SA-PO628	Olgaard, Klaus	TH-PO142
Nisar, Zara	SA-PO890	Nyamsuren, Gunsmaa	SA-PO107	Ochoa, Alejandro	SA-PO628	Olinger, Eric G.	TH-PO378, SA-PO551, SA-PO570
Nishi, Laura	FR-PO418	Nyman, Heather A.	PUB116	Ochoa, Alejandro	SA-PO628	Oliva-Cadima, Leydi M.	FR-PO910
Nishi, Shinichi	SA-PO209	Nyman, Ulf	FR-PO897	Ochoa, Alejandro	SA-PO628	Oliva, Ana E.	TH-PO046, PUB122, PUB209, PUB252
Nishikawa, Sho	TH-OR39	Nystrom, Jenny C.	TH-PO426, FR-PO718	Ochoa, Alejandro	SA-PO628	Oliva, Jonathan	FR-PO314
Nishikawa, Yudai	TH-OR39	O'Brien, Frank J.	FR-PO890, SA-PO342, PUB144	Ochoa, Alejandro	SA-PO628	Oliveira, Benjamin A.	TH-PO674, TH-PO680, TH-PO830
Nishimori, Kazuhisa	TH-OR39	O'Brien, Lori L.	FR-PO350, SA-OR19	Ochoa, Alejandro	SA-PO628	Oliveira, Brenner K.	TH-PO110
Nishimoto, Masatoshi	TH-PO251, FR-PO925, SA-PO700	O'Brien, Sorcha	SA-PO701	Ochoa, Alejandro	SA-PO628	Oliveira, Ivone B.	FR-OR05, SA-PO177, SA-PO213, SA-PO215
Nishino, Tomoya	TH-PO696, SA-PO330, SA-PO394, SA-PO450	O'Brien, Timothy	FR-OR40, SA-PO078	Ochoa, Alejandro	SA-PO628	Oliveira, João M.	FR-PO793
Nishio Lucar, Angie G.	SA-PO880	O'Connell, Blathnaid	TH-PO129, SA-PO701	Ochoa, Alejandro	SA-PO628	Oliveira, Juliana H.	SA-PO287
Nishioka, Ryo	SA-PO858	O'Connell, Tom	TH-PO601	Ochoa, Alejandro	SA-PO628	Oliveira, Mariana d.	PUB034
Nishizawa, Yoshiko	SA-PO370, SA-PO396, SA-PO417	O'Connor, Christopher L.	TH-PO213	Ochoa, Alejandro	SA-PO628	Oliveira, Meloney	TH-PO633, PUB040
Nistala, Ravi	SA-PO968	O'Connor, Kyle D.	FR-PO063	Ochoa, Alejandro	SA-PO628	Oliveira, Roberto L.	TH-PO262, TH-PO263
Nithagon, Pravarut	FR-PO646	O'Connor, Ryan	PUB225	Ochoa, Alejandro	SA-PO628	Oliver, Elizabeth	FR-PO165
Nitsch, Dorothea	FR-PO433, FR-PO927	O'Dell, James R.	SA-PO895	Ochoa, Alejandro	SA-PO628	Oliver, James D.	FR-PO411
Nitta, Kosaku	TH-PO154, SA-PO399	O'Driscoll, Steve	PUB084	Ochoa, Alejandro	SA-PO628	Oliver, Matthew J.	TH-PO905, TH-PO915, SA-OR10
Niu, Jingbo	FR-PO856, FR-PO859	O'Hanlon, James	SA-PO701	Ochoa, Alejandro	SA-PO628	Oliver, Ryan A.	FR-PO344
Njaravelil, Kristi A.	PUB044	O'Hara, Paul	FR-PO864	Ochoa, Alejandro	SA-PO628	Oliveri, David	SA-PO702
Njeim, Rachel	TH-PO185	O'Hare, Ann M.	TH-PO794, FR-PO515	Ochoa, Alejandro	SA-PO628	Oliverio, Andrea L.	TH-PO760
Nketiah Sarpong, Kwabena S.	PUB170	O'Keefe, Hannah M.	TH-PO303	Ochoa, Alejandro	SA-PO628	Oliveros, Cerman C.	PUB133
Nkomo, Vuyisile T.	FR-PO851	O'Meara, Yvonne M.	TH-PO295	Ochoa, Alejandro	SA-PO628	Olivier, Valerie	SA-PO099, SA-PO983
Nlandu khodo, Stellor	FR-PO1007	O'Neil, Kian S.	TH-PO198, SA-PO771	Ochoa, Alejandro	SA-PO628	Ollarvide, Oscar	PUB143
Nmecha, Ifeanyi K.	TH-PO186	O'Neill, Kalisha	TH-PO146, TH-PO810, FR-OR01	Ochoa, Alejandro	SA-PO628	Oloo, Alice A.	TH-PO728
Nobakht, Niloofar	FR-PO025			Ochoa, Alejandro	SA-PO628	Olshefski, Randal S.	SA-PO129
Noboa, Oscar A.	TH-PO875			Ochoa, Alejandro	SA-PO628	Olson, Elsa	PUB029
Noel, Edva	TH-PO512, FR-PO628			Ochoa, Alejandro	SA-PO628	Olson, N. E.	TH-PO419, FR-OR60, SA-PO1011
Noel, Sanjeev	FR-OR19, FR-PO145, FR-PO147, FR-PO148, FR-PO172, FR-PO173			Ochoa, Alejandro	SA-PO628	Olson, Stephen W.	FR-PO603
Noguchi, Emiko	SA-PO395			Ochoa, Alejandro	SA-PO628	Olszowska, Anna	FR-PO492
Noguchi, Yuki	TH-PO637			Ochoa, Alejandro	SA-PO628	Oluwatosin, Yemisi	FR-PO544, FR-PO547, FR-PO548
Nogueira, Emmanuel	TH-PO637			Ochoa, Alejandro	SA-PO628	Omachi, Kohei	FR-PO322, FR-PO364



Pastan, Stephen O. SA-PO830  
 Patel, Ami M. PUB147  
 Patel, Amrith U. SA-PO292, SA-PO319, SA-PO423, SA-PO429, SA-PO430, SA-PO436, PUB080  
 Patel, Ankit B. TH-PO332, FR-PO357, SA-OR17  
 Patel, Chirag H. FR-PO172  
 Patel, Darpan I. TH-PO850  
 Patel, Dheer SA-PO770  
 Patel, Dipal TH-PO259, FR-PO483, PUB353  
 Patel, Hiral SA-PO048  
 Patel, Kashyap A. TH-PO373  
 Patel, Kirtan PUB1169  
 Patel, Kshama SA-PO766  
 Patel, Mital SA-PO598  
 Patel, Mohan P. TH-PO851, TH-PO946  
 Patel, Neha FR-PO733  
 Patel, Nimish SA-PO453  
 Patel, Niralee FR-PO619  
 Patel, Priti R. SA-PO451  
 Patel, Rahul FR-PO743, PUB250  
 Patel, Ridham SA-PO766  
 Patel, Sagar TH-PO284, TH-PO439  
 Patel, Samir S. TH-PO021  
 Patel, Sunil SA-PO507  
 Patel, Uptal D. FR-OR39  
 Patel, Vishal TH-PO408, SA-OR15  
 Patell, Rushad PUB1161  
 Paterson, Andrew TH-PO360, TH-PO361, TH-PO362, TH-PO377, SA-OR11  
 Pathan, Faraz K. FR-PO214  
 Pathmasiri, Wimal TH-PO446, TH-PO447, TH-PO448  
 Patick, Amy SA-OR43  
 Patil, Chetan N. FR-PO424  
 Patino, Edwin TH-PO705  
 Patnaik, Aswini P. SA-PO061  
 Patorno, Elisabetta SA-PO259, SA-PO260, SA-PO266  
 Patrakka, Jaakko FR-PO696  
 Patricio-Liebana, Marc SA-PO692  
 Patriquin, Christopher J. FR-PO681  
 Pattaro, Cristian TH-PO624, TH-PO845  
 Pattharanitima, Pattharawin SA-PO824, SA-PO835, SA-PO953  
 Pattrapornpisut, Prapa SA-OR35  
 Patwardhan, Geetika Y. FR-PO980  
 Patzak, Andreas TH-OR55, SA-PO793  
 Patzer, Rachel E. SA-PO830  
 Paudel, Sujay D. SA-PO843, SA-PO934, PUB376  
 Pauksantun, Paisit SA-PO672  
 Paul, Dirk S. FR-PO1008  
 Paul, Shejuti TH-PO681, TH-PO682, TH-PO683, FR-PO574, PUB079  
 Paul, Sudeshna TH-PO778, SA-PO455, SA-PO830  
 Paunas, Flavia T. SA-PO715  
 Paust, Hans-Joachim SA-OR29  
 Pavkov, Meda E. TH-PO706, FR-PO411, FR-PO936  
 Pavkovic, Mira SA-PO247  
 Pavlova-Wolf, Anna TH-PO488  
 Pavo, Imre SA-PO269  
 Pavuluri, Lakshmi Aishwarya SA-PO690, PUB016, PUB017  
 Pawar, Nikita SA-PO815  
 Pawlinski, Rafal TH-PO703  
 Pawluczyk, Izabella Z. SA-PO653  
 Pazarin-Villaseñor, Leonardo PUB310  
 Peach, Emily J. TH-PO888, TH-PO889  
 Peacock, Katherine A. SA-PO471  
 Pearce, David TH-PO311, TH-PO347, TH-PO350  
 Pearce, John L. FR-PO065  
 Pearce, Neil FR-PO917, FR-PO927  
 Pearce, Suzanne H. SA-PO299  
 Pearson, Odette R. TH-PO723  
 Pecoits-Filho, Roberto TH-PO677, TH-PO694, TH-PO854, TH-PO897, SA-PO925  
 Pedersen, Erik B. TH-PO931  
 Pedersen, Rune P. TH-PO229  
 Pedreira, Wilfredo M. SA-PO677  
 Peearopornratana, Sadudee FR-PO079  
 Pei, Steven Lim Cho FR-PO345  
 Pei, York TH-PO399  
 Pei, York P. TH-PO360, TH-PO361, TH-PO362, TH-PO377, FR-PO247  
 Peipert, John D. SA-PO705, SA-PO796, SA-PO797  
 Peired, Anna J. SA-PO088  
 Pelayo, Blessa Marie H. TH-PO064  
 Peleg, Yonatan A. FR-PO041, FR-PO668  
 Pelkmans, Jordan L. SA-PO455  
 Pell, John F. FR-PO315  
 Pellegrini, James R. FR-PO012  
 Pelletier, Karyne FR-PO095  
 Pelouto, Anissa FR-OR49  
 Peña Rodríguez, Marcela SA-OR39  
 Pena, Michelle SA-PO270  
 Peñaloza, Arturo SA-PO441  
 Pendergast, Jane F. TH-PO153  
 Pendergraft, Rick FR-PO501  
 Pendyala, Prashant PUB038  
 Pendyala, Reshub R. PUB038  
 Penfield, Jeffrey G. FR-PO104  
 Peng, Ai SA-PO172  
 Peng, Chen FR-PO876  
 Peng, Huajing TH-PO203  
 Peng, Hui FR-PO455, SA-PO230, SA-PO311, SA-PO389  
 Peng, Ji-Bin TH-PO353  
 Peng, Stanford TH-PO499  
 Peng, Xiaomei TH-PO702  
 Pennathur, Subramaniam TH-PO614, FR-PO992, SA-PO688  
 Pennekamp, Alexander TH-PO111, SA-PO486, SA-PO848, SA-PO873  
 Penny, Jarrin D. TH-OR12, SA-PO309, SA-PO373, SA-PO374  
 Pensak, Meredith J. TH-PO748  
 Pépin, Marion TH-PO880  
 Pepper, Ruth FR-PO731  
 Peracha, Nawal TH-PO737  
 Perazella, Mark A. TH-PO564  
 Perego, Marta FR-PO798  
 Pereira Leite Nakamura, Vinicius TH-PO904, PUB320  
 Pereira-Simon, Simone TH-PO256  
 Pereira, Duane G. FR-PO168, SA-PO1001  
 Pereira, Tanya E. FR-PO436, SA-PO588  
 Perens, Elliot FR-PO107, SA-PO540  
 Pérez Arias, Abril A. FR-PO642, SA-PO686, SA-PO691  
 Pérez Casares, Luis E. SA-PO928  
 Pérez Gómez, María vanessa PUB197  
 Pérez-Villalva, Rosalba TH-PO490, FR-PO991, SA-PO087  
 Perez, Aaron H. TH-PO397  
 Pérez, Adela U. FR-PO004  
 Perez, J. PUB006  
 Perez, Luis M. TH-PO800, SA-PO948  
 Pergola, Pablo E. TH-PO692, FR-OR39, SA-PO919, PUB108, PUB351  
 Perico, Norberto FR-OR40  
 Perin, Laura TH-PO417, FR-PO321, FR-PO378, FR-PO403, FR-PO690, FR-PO691, SA-OR28  
 Perkins, James D. TH-PO738  
 Perkovic, Vlado TH-PO244, TH-PO872, FR-OR39, FR-OR59, SA-PO115, SA-PO261, SA-PO712  
 Perl, Jeffrey FR-PO475, FR-PO476, FR-PO477, FR-PO497, FR-PO517  
 Perlman, Sharon FR-PO421  
 Perreault, Mylene FR-PO233, FR-PO333  
 Perrin, Nancy A. TH-PO715, FR-PO869  
 Perrin, Steven FR-PO795  
 Perrone, Ronald D. TH-PO402, TH-PO403, TH-PO413  
 Perrot, Nicolas TH-PO742  
 Perry, Priscilla E. FR-PO688  
 Persson, Frederik SA-PO263, SA-PO272, SA-PO282, PUB095, PUB096, PUB106  
 Persson, Pontus SA-PO793  
 Pesce, Francesco TH-PO204, SA-PO647  
 Peters-Sengers, Hessel SA-PO827  
 Peters, Anett SA-OR29  
 Peters, Lisa FR-PO420  
 Peters, Verena SA-PO627  
 Peters, Vincent TH-PO166  
 Petersen, Elina L. TH-PO908  
 Petersen, Jeffrey TH-PO700  
 Peterson, Samantha TH-PO346  
 Petgrave, Yonique P. SA-PO128  
 Peti-Peterdi, Janos FR-OR56  
 Petousis, Panayiotis FR-PO937  
 Petras, Dimitrios I. FR-PO589, SA-PO408  
 Petreski, Tadej SA-PO127, SA-PO291  
 Petrosyan, Astgik FR-PO378, FR-PO690, FR-PO691, SA-OR28  
 Petrosyan, Romela TH-PO054  
 Pettiford, Sharee FR-PO233  
 Pettus, Jason R. TH-PO130, TH-PO465  
 Petyo, Christina PUB019  
 Peyronel, Francesco TH-PO530  
 Pezzolesi, Marcus G. TH-PO245, SA-PO252, SA-PO253  
 Pezzolesi, Melissa H. TH-PO245  
 Pfeffer, Marc A. FR-PO834  
 Pfeffer, Zoe FR-PO884, PUB019  
 Pfefferkorn, Anna M. TH-OR55  
 Pfister, Katherine FR-PO138, SA-PO092  
 Pham, Nghia T. TH-PO177, SA-PO737  
 Pham, Ngoc-Yen PUB326  
 Pham, Phuung-Chi T. SA-PO458, SA-PO670, PUB175, PUB304  
 Pham, Phuung-Thu T. SA-PO458, SA-PO670, PUB175, PUB304  
 Pham, Tin T. SA-PO751  
 Phan, Tramanh TH-PO783, FR-PO878  
 Phang, Chee Chin TH-PO268  
 Phannajit, Jeerath TH-PO652, FR-PO474, SA-PO163, SA-PO449, SA-PO894  
 Phelps, Kenneth R. SA-PO190  
 Pherson, Michelle SA-PO956  
 Philibert, David TH-PO578  
 Phillips, Carrie L. TH-PO183, FR-PO169, PUB102, PUB204  
 Philp, Jamie TH-PO058  
 Phisalwut, Suphanan FR-PO021  
 Phutrakool, Phanupong TH-PO924  
 Piani, Federica TH-PO253  
 Pianta, Timothy J. SA-PO565  
 Piburn, Kim H. TH-OR28  
 Picard, Nicolas TH-PO322  
 Piccoli, Giorgina B. FR-PO580, FR-PO591  
 Picerno, Angela SA-PO647  
 Pichaiwong, Warangkana FR-PO604  
 Pichette, Maude FR-PO227, FR-PO513  
 Pichilingue Reto, Patricia FR-PO042  
 Picken, Maria M. FR-PO206, SA-PO140, SA-PO878  
 Pickett, Sara D. FR-OR37  
 Pieper, Michael P. TH-PO178, FR-PO386, SA-PO248  
 Pierce, Nancy TH-OR18  
 Piero, Nicole PUB117  
 Pierorazio, Phillip M. FR-PO172  
 Pietilä, Riikka S. FR-PO952  
 Pietka, Terri A. FR-PO343  
 Pietrafesa, Angela FR-PO519  
 Pigeyre, Marie TH-PO742  
 Piggott, Raymond S. TH-PO295, SA-PO701  
 Pike, Mindy SA-PO758, SA-PO759  
 Piko, Nejc FR-PO010, SA-PO127, SA-PO291  
 Pilco Teran, Melissa PUB197  
 Pillai, Anil K. TH-PO355  
 Pillai, Sneha S. FR-PO168, SA-PO1001  
 Pillinger, Michael SA-PO895  
 Pimenta, Isabela L. TH-PO262, TH-PO263  
 Pina, Paula M. TH-PO785  
 Pinheiro, Adlin TH-OR25  
 Pinnell, Derek SA-PO307  
 Pinney, Kevin FR-PO781, PUB319  
 Pino-Chavez, Gilda FR-PO163  
 Pinner, Christopher SA-PO022  
 Pinter, Jule SA-PO359  
 Pinto, Lionel FR-PO662  
 Pintor Chocano, Aranzazu FR-PO014  
 Pippin, Jeffrey W. SA-PO031  
 Piraino, Beth M. FR-PO476, FR-PO477  
 Piran, Mehran TH-PO356  
 Piret, Sian FR-PO087, SA-PO1003  
 Pirkle, James L. TH-PO778, FR-PO497  
 Pisani, Antonio TH-PO385, FR-PO231  
 Pisarczyk, Konrad FR-PO606, FR-PO607, FR-PO608  
 Pisarenka, Sofiya SA-PO635  
 Pisoni, Roberto FR-PO065, FR-PO609  
 Pisoni, Ronald L. TH-PO154, FR-PO476, FR-PO477, SA-PO285, SA-PO325  
 Pisutpaisan, Chaiwat FR-PO474  
 Pitcher, David TH-PO494, SA-PO560  
 Pitt, Bertram SA-PO264, SA-PO274, SA-PO275  
 Pitts, Todd SA-PO158  
 Pitzer, Ashley L. SA-PO755  
 Pizzagalli, Giorgio SA-PO118  
 Pizzuti, Valeria FR-PO399  
 Placona, Andrew TH-PO900  
 Plagmann, Ingo FR-PO707, PUB041  
 Plamm, Alex TH-PO777, FR-PO540, FR-PO541, SA-PO298, SA-PO830, PUB135  
 Plascencia Cruz, Marcela TH-PO447  
 Plata, Consuelo FR-PO007  
 Platakis, Maria SA-PO1005  
 Platt, Alyssa C. TH-PO153  
 Plautz, Emilee SA-PO585  
 Pleniceanu, Oren FR-PO376  
 Plosser, Kevin TH-PO708, SA-PO838  
 Plotskaya, Natalia PUB039  
 Plum, Lori A. TH-PO144  
 Pluznick, Jennifer L. TH-PO317, FR-PO148, SA-PO774, SA-PO965, SA-PO966  
 Poca, Alessandro FR-PO171, SA-PO100  
 Poda Shakked, Naomi FR-PO376  
 Podesta, Manuel A. TH-PO483  
 Podrini, Christine FR-PO299  
 Poggio, Emilio D. FR-PO803, SA-PO800, SA-PO592  
 Pohl, Martin SA-PO570  
 Pohlmeier, Lea TH-OR12  
 Poirier, Stefan E. SA-PO827  
 Pol, Robert FR-PO489  
 Polanco, Elianny S. SA-PO014  
 Polichnowski, Aaron J. SA-PO014  
 Polisetty, Lakshmi D. PUB170  
 Polkinghorne, Kevan TH-PO270, TH-PO271, TH-PO272, TH-PO275  
 Pollack-Zollman, Martine PUB168  
 Pollack, Charles V. FR-PO546  
 Pollak, Martin TH-PO480, FR-PO370, SA-PO028, SA-PO736, SA-PO741  
 Pollock, Carol A. FR-PO550  
 Polzin, Jacob Q. SA-PO791  
 Pomeranz, Gideon TH-OR48, FR-PO310  
 Ponath, Gerald TH-PO536  
 Ponce Nava, Maria S. SA-PO087  
 Pongpirul, Krit TH-PO924  
 Pongsitsak, Wanjak FR-PO079  
 Ponnusamy, Arvind FR-PO641  
 Ponnusamy, Srimathi SA-PO678, PUB334  
 Ponsirenas, Renata FR-PO431  
 Pontrelli, Paola TH-PO204  
 Popovic, Suncica TH-PO645



Ravani, Pietro FR-PO060, FR-PO831, SA-PO794, SA-PO821  
 Ravera, Federica SA-PO576  
 Ravi, Katherine S. TH-PO612, FR-PO758, SA-PO792  
 Ravipati, Prasanth SA-PO674  
 Rawala, Muhammad FR-PO673, SA-PO477  
 Rawson, Ashley E. SA-PO593  
 Ray, Justina SA-PO203  
 Ray, Samrat TH-PO637  
 Ray, Saurabh TH-PO726, TH-PO893  
 Raymond, Laure SA-PO545  
 Raymond, Maxime SA-PO996  
 Rayner, Brian TH-PO688  
 Rebellato, Lorita TH-PO935  
 Rebello, Christabel FR-PO786, FR-PO801, FR-PO918  
 Rebholz, Casey TH-PO489  
 Recalde, Cecilia SA-PO494  
 Rechlin, Daniel TH-PO295  
 Redahan, Lynn FR-PO864  
 Reddan, Donal N. FR-PO851  
 Reddy, Prajwal TH-PO061  
 Reddy, Uttam G. FR-PO800  
 Reddy, Yuvaram N. FR-PO515, FR-PO516, FR-PO517, FR-PO876  
 Reed, Christine E. FR-PO183  
 Reed, Rhiannon D. TH-PO729  
 Reese, Peter P. TH-PO849, FR-PO515, FR-PO516, FR-PO884, SA-PO814, SA-PO816  
 Reeves, William B. FR-OR11  
 Refoios Camejo, Rodrigo TH-PO660, TH-PO661, TH-PO662, TH-PO691  
 Regalia, Anna FR-PO840, FR-PO842, PUB340  
 Reghuvaran, Anand FR-PO315  
 Regmi, Surakshya SA-PO843, PUB336  
 Regunathan-Shenk, Renu SA-PO051  
 Rehaume, Linda M. SA-PO688  
 Rehman, Michael FR-PO345  
 Rehman, Mohammed Z. PUB094  
 Reich, Amanda J. TH-PO791  
 Reich, Heather N. TH-PO498  
 Reichenbach, Dawn SA-PO811  
 Reid, Chante TH-PO680  
 Reid, Fiona TH-PO674, TH-PO680  
 Reidlinger, Donna PUB312  
 Reidy, Kimberly J. TH-PO476, TH-PO752, TH-PO754, SA-PO587  
 Reif, Gail FR-PO253, FR-PO294  
 Reilly, Dermot F. TH-PO245  
 Reilly, Timothy M. TH-PO316  
 Reily, Colin SA-PO638, SA-PO645  
 Rein, Joshua L. SA-PO914  
 Reineke, Marvin TH-PO920  
 Reinelt, Anna FR-PO342  
 Reinhard, Linda FR-PO351  
 Reinhart, Glenn A. SA-PO248  
 Reinoso, Paulo PUB089  
 Reis, Drielly Cristhiny M. TH-PO834  
 Reiser, Jochen TH-PO105, TH-PO215, FR-PO594, FR-PO726, SA-OR47, SA-PO074, SA-PO1004  
 Reisewitz, Timo SA-PO251  
 Reisinger, Heather TH-PO062, TH-PO600, FR-PO740, FR-PO741  
 Reiss, Jacob E. SA-PO267  
 Reiter, Jeremy FR-PO305  
 Reitmeier, Katrin FR-PO705  
 Rej, Soham PUB023  
 Remmel, Rory P. FR-PO799  
 Remmerswaal, Ester B. TH-PO416, TH-PO918  
 Remuzzi, Giuseppe TH-PO483, TH-PO505, FR-OR40, SA-PO706  
 Ren, Fei TH-PO562  
 Ren, Jiafa FR-PO953  
 Ren, Jianwei PUB121  
 Ren, Jing SA-PO968  
 Ren, Sarah FR-PO009, SA-PO430  
 Ren, Yuanfang FR-PO061  
 Ren, Yuqing SA-PO311  
 Renders, Lutz SA-OR42  
 Renfrow, Matthew B. SA-PO641  
 Renné, Thomas TH-PO908  
 Rennke, Helmut G. SA-OR46, PUB063  
 Renoirte, Karina TH-PO045  
 Requena, Gema TH-PO658  
 Requiao-moura, Lucio R. SA-PO161  
 Resnick, Murray TH-PO567  
 Restrepo, Ricardo J. SA-PO968  
 Reuhl, Kenneth R. SA-PO158  
 Reule, Scott FR-PO520  
 Reutter, Heiko M. SA-PO572, SA-PO573  
 Revelo Penafiel, Monica P. TH-PO132, SA-PO675  
 Rex, Ryan FR-PO643, FR-PO892  
 Rexrode, Kathryn SA-PO910  
 Reyna Juárez, Yatzil FR-PO027  
 Reynolds, Carmen J. SA-PO580  
 Reynolds, Monica L. TH-PO760, FR-PO183  
 Rezaei, Fariborz PUB323  
 Reznichenko, Anna PUB363  
 Reznik, Sandra E. TH-PO752, TH-PO754  
 Rheault, Michelle N. TH-PO473, TH-PO497, FR-OR57, FR-OR872, SA-PO585, SA-PO668  
 Rhee, Christopher J. SA-PO602  
 Rhee, Connie TH-PO681, TH-PO682, TH-PO683, TH-PO809, TH-PO838, TH-PO870, TH-PO871, FR-PO574, FR-PO800, FR-PO930, FR-PO941, SA-OR33, SA-PO304, SA-PO375, SA-PO376, SA-PO383, SA-PO902, SA-PO903, PUB079  
 Rhee, Eugene P. TH-PO811, FR-OR03, FR-OR23, FR-PO408, FR-PO409, FR-PO918, SA-PO462, SA-PO736, SA-PO931  
 Riad, Samy M. FR-PO799  
 Riascos-Bernal, Dario F. TH-PO150  
 Riaz, Ramsha SA-PO667  
 Ribagorda, Marta FR-PO014  
 Ribeiro-Alves, Marcelo TH-PO832, TH-PO833, TH-PO834  
 Ribeiro, Bárbara SA-PO377  
 Ribeiro, Márcia G. PUB196  
 Ribeiro, Marcia M. TH-PO832  
 Ribeiro, Rayra G. SA-PO433  
 Ricardo, Ana C. TH-PO059, TH-PO719, FR-PO928, SA-PO192, SA-PO931  
 Ricca, Joseph TH-PO232, SA-PO253  
 Riceman, Michael D. TH-PO723  
 Richards, Anna TH-PO662, TH-PO667  
 Richardson, Ashley PUB277  
 Richardson, Peter TH-PO607  
 Richardson, Trey PUB059  
 Richels, Lindsay PUB206  
 Richter, Alex TH-PO928  
 Richter, Beatrice TH-PO152, TH-PO156, SA-PO987  
 Richter, Manuel FR-PO780  
 Rickenbach, Fran W. FR-PO540, FR-PO541  
 Rida, Suzann FR-PO807  
 Riddle, Heather A. FR-PO257, FR-PO714  
 Riddle, Rebecca B. FR-OR52  
 Ridinger, David FR-PO451  
 Riehl-Tonn, Victoria J. TH-PO746, FR-PO868  
 Riekert, Kristin TH-PO892  
 Riella, Leonardo V. TH-PO485, TH-PO916, PUB234  
 Rietjens, Rosalie TH-OR43, FR-OR35  
 Rifkin, Dena E. TH-PO861, FR-PO916, SA-PO922  
 Rigas, Christina PUB023  
 Rigato, Matteo TH-PO359  
 Rigatto, Claudio TH-PO630  
 Rigodon, Vladimir TH-PO677, SA-PO308  
 Rigotti, Paolo SA-PO119  
 Rim, Hark FR-PO778  
 Rimbach, Gerald TH-PO675, FR-PO810  
 Rimmer, Jeffrey M. PUB352  
 Rimmer, Andreas SA-PO787  
 Rincon-Choles, Hernan SA-PO523, SA-PO931  
 Ringling, Jessica TH-PO404  
 Rinschen, Markus M. TH-PO441, FR-PO329, FR-PO351, FR-PO712, FR-PO720  
 Rios Rios, Fabiola V. PUB053  
 Rios Torres, Hillarie A. PUB177  
 Rios, Andrea SA-OR44  
 Riou, Jérémie FR-PO588, FR-PO591  
 Riphagen, Ineke J. TH-PO803  
 Rishel Brakey, Heidi FR-PO893  
 Ritchie, James SA-PO719, PUB101, PUB256  
 Rius Peris, Asunción PUB197  
 Rivara, Matthew B. TH-OR18  
 Rivedal, Mariell SA-PO715  
 Rivera Fuentes, Lemuel TH-PO953, FR-PO009, SA-PO292, SA-PO427, SA-PO429, SA-PO430, PUB080  
 Rivera Gonzalez, Alexis TH-PO526, SA-PO059, SA-PO480, PUB177, PUB219  
 Rivera Sepulveda, Jose SA-PO482  
 Rivera-Bermudez, Carlos G. SA-PO059, SA-PO480, PUB177  
 Rivera, Eleanor TH-PO719, TH-PO814  
 Rivera, Elias A. FR-PO394  
 Rivera, Maria E. TH-PO526, SA-PO059, SA-PO480, PUB177, PUB219  
 Rizk, Dana TH-PO479, TH-PO498, TH-PO760, FR-OR59, FR-PO657, SA-PO641, SA-PO643, SA-PO644, SA-PO712  
 Rizo Topete, Lilia M. FR-PO017, FR-PO611, FR-PO734, PUB045  
 Rizvi, Ali W. TH-PO523, TH-PO951, TH-PO963, PUB012  
 Rizvi, Asim PUB321, PUB329, PUB342  
 Rizwan, Arshi FR-PO768  
 Rizzolo, Katherine M. FR-PO870, PUB156  
 Robben, Catherine E. PUB280  
 Robbie, Gabriel SA-PO571  
 Robbins, Lynn SA-PO956  
 Roberts, Glenda V. SA-PO947  
 Roberts, J. Scott SA-PO544  
 Roberts, Mary S. FR-OR08  
 Roberts, Mary-Beth FR-PO306  
 Roberts, Teryn R. TH-PO107  
 Robertson, Michele SA-OR37  
 Robideaux, Bridget R. FR-PO494  
 Robins, Victoria C. TH-PO379, PUB192  
 Robinson-Cohen, Cassianne TH-OR01, TH-PO246, TH-PO605, TH-PO629, FR-PO307, FR-PO312, FR-PO316, SA-PO758, SA-PO759, SA-PO912, SA-PO929  
 Robinson, Anthony G. SA-PO453  
 Robinson, Bruce M. TH-PO154, TH-PO472, TH-PO473, TH-PO474, TH-PO479, TH-PO694, TH-PO897, FR-PO497, SA-PO179, SA-PO184, SA-PO285  
 Robinson, Cal FR-PO429  
 Robinson, Jennifer PUB091, PUB164  
 Robinson, Lisa TH-PO637, TH-PO640  
 Robinson, Lucy SA-OR40  
 Robison, Laura PUB312  
 Robles-Franceschini, Mario J. SA-PO677  
 Robson, Richard A. SA-PO714  
 Roccato, Dario SA-PO657, SA-PO658  
 Rocco, Rossana FR-PO231, FR-PO339  
 Rocha e Silva, Monique V. SA-PO412  
 Rocha, Daniel R. TH-PO383  
 Rockenbach, Mariana G. FR-PO430  
 Rodby, Roger A. SA-PO491, PUB040  
 Rodionova, Kristina SA-PO784, PUB255  
 Rodovalho Guimaraes, Marilia TH-PO072  
 Rodrigues, Adelson TH-PO904, PUB320  
 Rodrigues, Camila E. FR-PO028, SA-PO433  
 Rodrigues, Fernanda G. SA-PO161  
 Rodrigues, Natacha TH-PO947, FR-PO094, SA-PO041  
 Rodrigues, Prerana R. FR-PO222  
 Rodriguez Negron, Cyndia PUB184  
 Rodriguez puyol, Diego FR-PO135, FR-PO968, FR-PO983  
 Rodriguez-Espinosa, Diana FR-PO901  
 Rodriguez, Cándido D. FR-PO273, SA-PO742  
 Rodriguez, Esteban FR-PO055  
 Rodriguez, Juan C. SA-PO316  
 Rodriguez, Juanly N. TH-PO631  
 Rodriguez, Martha D. PUB021  
 Rodriguez, Olga C. TH-PO191, SA-PO242  
 Rodriguez, Patricia FR-PO029, PUB045  
 Rodriguez, Ronald SA-PO883, PUB268  
 Rodziewicz, Natalie SA-PO142  
 Rodzlan Akib, Mohd Radzi PUB305  
 Roehm, Bethany A. SA-PO345, SA-PO926  
 Roelofs, Joris TH-PO557, SA-PO072  
 Roer, David A. PUB123  
 Roeser, Nancy F. SA-PO770  
 Roetker, Nicholas S. TH-PO936, FR-PO008  
 Roger, Simon D. SA-PO708  
 Rogers, Benjamin A. TH-PO270  
 Rogers, Brooks E. SA-PO425  
 Rogers, Emma S. FR-PO882  
 Røgnvaldsson, Sæmundur FR-PO933  
 Rojas-Campos, Enrique FR-PO837, SA-OR39  
 Rojas, Claudia P. SA-PO599  
 Rojas, Miguel G. TH-PO256  
 Rolando, Delphine M. FR-PO1008  
 Rollman, Bruce L. FR-OR867  
 Romagnani, Paola TH-PO141, FR-PO146, FR-PO958, SA-PO065, SA-PO088, SA-PO529, SA-PO621  
 Römer, Winfried FR-PO699  
 Romero Tafoya, Juan O. PUB053, PUB310  
 Romero-Ortuno, Roman TH-PO632  
 Romero-Reyes, Carlos A. FR-PO027  
 Romero, Alexia TH-PO046, PUB122  
 Romero, Jose R. TH-OR25  
 Romero, Michael F. FR-PO246, SA-PO580  
 Romine, Margaret M. SA-PO537  
 Romoli, Simone FR-OR60, SA-PO1011  
 Ronco, Claudio TH-PO041, TH-PO359, SA-PO009, SA-PO011, SA-PO415, SA-PO780  
 Ronco, Pierre M. FR-PO303, SA-PO679  
 Rondeau, Eric TH-PO500  
 Rong, Chen SA-PO773  
 Rong, Song SA-PO112  
 Rongkiettechakorn, Nuttawut FR-PO943  
 Ronskley, Paul E. TH-PO746, SA-PO322, SA-PO833  
 Rønn, Pernille F. TH-PO234, TH-PO239  
 Rookmaaker, Maarten B. TH-PO331, SA-PO021  
 Ros Madrid, Inmaculada TH-PO249  
 Rosales, Amber FR-PO640  
 Rosales, Ivy A. TH-PO080, FR-PO193, SA-OR44, SA-PO736  
 Rosales, Laura TH-PO261, FR-PO496, SA-PO344, PUB134  
 Rosaly Martinez, Jan Paul SA-PO482  
 Rosario Aulet, Alexandra TH-PO345, SA-PO516

Rosario, Aldo A.	TH-PO442	Roy, Shuvo	FR-PO989, SA-PO018, SA-PO027, SA-PO418	Sadlier, Denise M.	TH-PO295, SA-PO701	Salinas, Thalia	TH-PO909, TH-PO956, FR-PO767, FR-PO783, FR-PO841
Rosas, Sylvia E.	SA-PO191	Royal, Virginie	SA-PO735	Saeed, Fahad	TH-PO772, TH-PO773, TH-PO776, TH-PO783, TH-PO784, FR-PO898	Saljoughian, Noushin	FR-PO598
Rose, James	FR-PO571, PUB280	Roychoudhury, Smita	TH-PO589	Saeed, Jahanzeb	PUB211	Sallmon, Hannes	SA-PO626
Rose, Michael P.	SA-PO947	Rozen-zvi, Benaya	FR-PO790	Saenz-Ancira, Santiago	FR-PO027	Sallustio, Fabio	FR-PO170, SA-PO647
Rosen, Raphael J.	SA-PO502	Rozenberg, Aliza	SA-PO266	Safak, Seda	FR-PO824, SA-PO795	Salman, Sheherzad	TH-PO172
Rosen, Raquel M.	PUB042	Rüh, Marcus	FR-PO914	Safdar, Shahzad	PUB169	Salmanullah, Daanya	FR-PO330
Rosenbaum, David P.	TH-PO162, TH-PO163	Rubens, Lexie	FR-PO904	Saffer, Tonya	FR-PO509	Salmon, Eloise	SA-PO587, SA-PO705, PUB234
Rosenberg, Avi Z.	TH-PO530, TH-PO534, TH-PO570, TH-PO754, SA-OR05, SA-PO079, SA-PO693, SA-PO958, PUB223	Ruberwa, Joseph	SA-PO805, SA-PO879	Safirstein, Robert L.	FR-PO121, FR-PO122	Salonia, Andrea	TH-PO075, SA-PO118, SA-PO135
Rosenblum, Norman D.	FR-PO377, FR-PO379, SA-OR20	Rubin, Jeremy	TH-PO477, TH-PO569	Saha, Aditi	PUB323	Salupo, Nicholas W.	TH-PO471
Rosengart, Matthew R.	FR-OR20	Rubinstein, Sofia	FR-PO012	Saha, Aninda D.	TH-PO640, TH-PO765	Salvatore, Steven	TH-PO585, FR-PO207, FR-PO212, FR-PO682, FR-PO766, FR-PO767, FR-PO783, SA-PO139, SA-PO728
Rosengren, Birgitta E.	FR-PO696	Rubio, Irene	FR-PO461	Saha, Aparna	FR-PO006, PUB167	Salviani, Chiara	TH-PO508
Rosenkranz, Alexander R.	FR-PO599	Rubis, Nadia	TH-PO483	Saha, Bidisha	TH-PO311, TH-PO347, TH-PO350	Saly, Danielle L.	TH-PO744
Rosenstock, Jordan L.	PUB072, PUB266	Ruchi, Rupam	FR-PO103, SA-PO205	Saha, Manish K.	FR-PO809	Salzinger, Barbara	FR-PO760
Roshanravan, Baback	TH-PO818, TH-PO820, TH-PO821, TH-PO822, TH-PO823, TH-PO824, TH-PO829, SA-PO918	Ruckle, Jon L.	SA-PO714	Sahi, Sukhdeep S.	SA-PO527	Sam, Ramin	SA-PO938
Rosiello, Giuseppe	SA-PO119	Ruddy, Alyssa E.	PUB275	Sahinoz, Melis	SA-PO758, SA-PO759	Samaha, Antoine L.	SA-PO726
Rosillo-Salgado, Ydris Z.	PUB115	Rudloff, Stefan	FR-OR48	Sahota, Amrik	FR-PO333	Samaniego-Picota, Milagros D.	TH-PO737, SA-OR49
Rosin, Diane L.	FR-OR12	Rudman-Melnick, Valeria	FR-PO971	Sai, Wenli	FR-PO136, FR-PO161	Samarakoon, Rohan	TH-PO538
Rosique, Florentina	TH-PO249	Ruengorn, Chidchanok	TH-PO787	Said, Samar M.	TH-PO509, FR-PO190, SA-PO159	Sambandam, Kamalanathan K.	SA-PO345
Rosner, Bernard A.	SA-PO146	Ruffin, Felicia	SA-PO452	Saida, Ken	FR-PO327, FR-PO328	Sambe, Takehiko	TH-PO155
Rosolowska, Alicja	TH-OR47	Ruggenenti, Piero L.	FR-OR40, SA-PO706	Saigal, Navid	PUB351	Sambharia, Meenakshi	TH-PO062, TH-PO600, FR-PO740, FR-PO741
Ross, Bonnie	TH-PO935	Ruilope, Luis M.	SA-PO274, SA-PO275	Saigusa, Hanako	SA-PO993	Samejima, Ken-ichi	TH-PO251, TH-PO925, SA-PO312, SA-PO700
Ross, Michael J.	TH-PO150, TH-PO202, TH-PO762, PUB003	Ruiz-Ortega, Marta	TH-PO555, FR-PO263, FR-PO461	Saigusa, Takamitsu	FR-PO261, FR-PO287, SA-PO460	Samiratedu, Michael M.	PUB288
Rossanti, Rini	SA-PO539	Ruiz-Rosado, Juan de Dios	TH-PO113, SA-PO604, SA-PO605, SA-PO612, SA-PO613	Sairavi, Anusha	FR-PO407	Sammons, Stephen R.	TH-OR26, TH-PO710, SA-PO675
Rossi, Giovanni Maria	TH-PO530	Ruiz, Christina	FR-PO107	Saito, Tomohiro	TH-PO143, SA-PO182	Sammut-Powell, Camilla	SA-PO283
Rossing, Kasper	SA-PO829	Rule, Andrew D.	TH-PO051, TH-PO418, TH-PO568, TH-PO794, FR-PO808, FR-PO815, FR-PO897, SA-PO823, SA-PO937	Saito, Yatsumu	FR-PO374, FR-PO380, FR-PO400	Samoreau, Clément	FR-PO588, FR-PO591
Rossing, Peter	TH-PO222, TH-PO229, TH-PO234, TH-PO239, TH-PO244, FR-OR26, FR-OR39, SA-OR36, SA-PO263, SA-PO268, SA-PO272, SA-PO274, SA-PO275, SA-PO282, SA-PO885, SA-PO886, SA-PO889, PUB095, PUB096, PUB103, PUB105, PUB106	Rump, Lars C.	TH-OR27, FR-PO274, SA-PO251, SA-PO2761	Sajgure, Atul	TH-PO430, SA-PO813	Sampath, Ramya	TH-PO783
Rossini, M.	TH-PO204	Rune, Ida	SA-PO222	Sajid, Saira	FR-PO667, PUB188, PUB242, PUB337	Sampson, Matt G.	TH-OR29, FR-PO303, FR-PO308, FR-PO309, SA-PO532, SA-PO544, SA-PO546
Rost, Hannes L.	TH-PO765	Runolfssdottir, Hrafnhildur L.	SA-PO579	Sajjad, Hassan	SA-PO890	Samsonov, Dmitry V.	FR-PO436, SA-PO588
Rostam Shirazi, Niyousha	FR-PO022, FR-PO715	Rupprecht, Harald D.	FR-PO913	Sakaguchi, Mika	FR-PO911	Samuelson, Gina C.	FR-PO692
Roszko, Kelly	FR-OR08	Rusineck, Henry	SA-PO954	Sakaguchi, Yusuke	TH-PO899	San Román, Sofia	TH-PO875
Rot, Antal	FR-PO599	Russell, Lauren G.	TH-OR48, FR-PO379, SA-OR20	Sakai, Kentaro	SA-PO183	Sanabria, Mauricio	SA-PO301
Rota, Maria Rita	TH-PO075	Russo, Eduarda C.	SA-PO165, SA-PO176	Sakai, Mariko	TH-PO143	Sanada, Hajime	SA-PO858
Rotbain Curovic, Viktor	SA-PO272, PUB095, PUB103, PUB105	Rustum, David S.	SA-PO864, SA-PO876	Sakai, Norihiko	FR-PO938, SA-PO911, PUB210, PUB347, PUB348	Sanches, Talita R.	TH-PO072, SA-PO072
Roth, Hannah	SA-PO405	Rutherford, Peter	FR-PO495	Sakamoto, Kazuo	SA-PO209	Sanchez Gracias, Jose A.	SA-PO010
Roth, Isabelle	SA-PO099	Rutkowski, Nelli	FR-PO716	Sakashita, Midori	SA-PO992	Sanchez Navarro, Andrea	TH-PO490, FR-PO991
Roth, Joshua	SA-PO594	Rutzen, Christopher R.	FR-PO494	Sakata, Miwa	FR-PO275	Sanchez Russo, Luis F.	SA-OR28
Roth, Sharin	TH-PO387	Ruzycki, Shannon M.	TH-PO745, TH-PO747	Sakima, Atsushi	SA-PO896	Sanchez Vazquez, Omar H.	TH-PO907
Rothschadl, Morgan J.	FR-PO391	Ryaboshapkina, Maria	FR-PO1008	Sakurada, Tsutomu	PUB267	Sanchez-Navarro, Andrea	FR-PO963
Rothweiler, Stephanie	PUB068	Ryan, James	TH-PO433	Sakurai, Goro	FR-PO938	Sanchez-Nino, Maria Dolores	FR-PO014
Rotmans, Joris I.	TH-PO354, FR-PO386, SA-PO536	Ryland, Jamie	FR-PO919	Sakurai, Hayato	FR-PO115	Sanchez-Ramirez, Carmen	SA-OR39
Rouault, Morgane	TH-OR44	Ryu, Ji Young	PUB180	Sakya, Judy	SA-PO486, PUB169	Sanchez-Salazar, Sergio Saul	PUB045
Roumelioti, Maria-Eleni	TH-PO902, TH-PO903, FR-PO500, FR-PO867, PUB326	Ryu, Jiwon	FR-PO091, FR-PO092	Salako, Babatunde L.	TH-PO805	Sanchez-Zamora, Yuriko I.	TH-PO113
Rousseau, Marina	FR-PO967	Ryu, Jung-hwa	FR-PO792, PUB313	Salam, Syazrah	SA-PO703	Sánchez, Alejandra R.	TH-PO577
Rousselle, Anthony	FR-PO575, FR-PO576, FR-PO582, FR-PO583	Rzepa, Ewelina	PUB172	Salama, Alan D.	FR-OR54	Sanchez, Alejandro	PUB094
Rousselle, Thomas	TH-OR50, TH-PO459, TH-PO641, FR-PO787, SA-OR50	Saad, Anis J.	TH-OR49, TH-OR51, TH-OR53, TH-PO653, SA-OR46	Salameh, Omar K.	FR-PO080, FR-PO111	Sanchez, Jason	SA-PO965
Rovin, Brad H.	TH-PO183, TH-PO184, FR-OR59, FR-PO169, FR-PO404, FR-PO598, FR-PO601, FR-PO608, SA-PO079, SA-PO631, SA-PO679, SA-PO684, SA-PO956	Saade, Marie Christelle	TH-PO074, FR-PO978, SA-PO076	Saland, Jeffrey	PUB277	Sanchez, Maria C.	PUB185
Rovira-Gonzalez, Manuel J.	TH-PO525	Saag, Kenneth G.	FR-PO232	Salant, David J.	FR-PO695, SA-OR22	Sanchez, Ricardo	SA-PO301
Rowan, Christopher	FR-PO379, SA-OR20	Sabanayagam, Charumathi	TH-PO620, SA-PO284	Salari, Ellika	PUB167	Sanchez, Virginia C.	TH-PO249
Rowe, Sandy	SA-PO432	Sabapathy, Vikram	FR-PO375, FR-PO950	Salcedo Betancourt, Juan D.	TH-PO355	Sanders, Jan-Stephan	TH-PO643, FR-PO869
Rowland, Emma	FR-PO688	Sabbiseti, Venkata	TH-PO206, FR-PO981, SA-PO972	Salcedo, Ernesto	TH-PO015	Sanders, Justin J.	FR-PO869
Roy Chowdhury, Chitran	FR-PO981	Sabo, Angela R.	TH-OR41, TH-PO183, FR-OR09, FR-PO149, FR-PO150, FR-PO169	Saleem, Maryam	PUB013	Sanders, M. Lee	SA-PO862
Roy-Chaudhury, Prabir	TH-OR20	Sachdev, Moldovan	SA-PO937	Saleem, Mohammad	SA-PO755	Sanders, Stephanie M.	PUB173
Roy, Debajyoti M.	SA-PO219	Sachdeva, Bharat	TH-PO294	Saleem, Moin	TH-PO450, TH-PO494, TH-PO753, FR-PO302, FR-PO325, FR-PO639, FR-PO709, FR-PO715	Sanderson, Russell J.	TH-PO499
Roy, Kasturi	FR-PO345	Sachdeva, Gunveen	TH-PO418	Saleem, Najma	FR-PO535, SA-PO325	Sandholm, Niina	TH-PO222
Roy, Nervik	SA-PO475	Sachdeva, Mala	TH-PO757	Saleh, Tara A.	FR-PO134	Sandhu, Eleanor C.	PUB305
		Sachs, Wiebke	FR-PO720	Salehin, Salman	PUB314	Sandhu, Kulwant	SA-PO454
		Sacnun, Juan M.	FR-PO451	Salem, Saba	SA-PO500	Sandner, Peter	SA-PO247
		Sadeghi-Alavijeh, Omid	TH-PO357, SA-PO554	Salenger, Page	FR-PO500	Sandoval, Leticia A.	FR-PO398, SA-PO144
		Sadeghi, Maryam	FR-OR55	Salgado, Joao Victor	SA-PO189	Sandoval, Pilar	FR-PO461
		Sadeghiani, Golnaz	SA-PO593	Saliba, Afaf	FR-PO1000	Sandys, Vicki K.	SA-PO350, SA-PO351
		Sadiq, Sanobar	FR-PO435	Saliba, Youakim	FR-PO160, SA-PO124	Sang, Yingying	TH-PO786, TH-PO890, TH-PO898
		Sadler, Holli	FR-PO735	Salih, Mahdi	TH-PO382, TH-PO383, TH-PO406, TH-PO407	Sanghani, Neil S.	TH-PO439
				Salinas-Ramirez, Mauricio A.	FR-PO027	Sanghavi, Sarah F.	TH-PO006
						Sanghi, Pooja	SA-PO534



Sangthawan, Pornpen TH-PO957, FR-PO881  
 Sanjurjo amado, Ana maria SA-PO928  
 Sankar, Lakshna SA-PO368, SA-PO534  
 Sanna-Cherchi, Simone FR-PO303, SA-PO606  
 Sannapaneni, Shilpa TH-PO127, TH-PO128, PUB055  
 Sannier, Aurelie SA-PO649  
 Sansom, Steven C. TH-PO321  
 Sansone, Marissa M. SA-PO667  
 Santacruz, Angel C. PUB089, PUB248  
 Santacruz, Juan C. PUB089, PUB248  
 Santana, Alice TH-PO947, FR-PO793, SA-PO865, SA-PO018  
 Santandreu, Ana SA-PO0818  
 Santhanam, Lakshmi SA-PO774  
 Santhirasekaran, Schanhave PUB101  
 Santhitisate, Sriladda SA-PO276  
 Santoriello, Dominick FR-PO190  
 Santos Araujo, Carla Alexandra R. TH-PO627, TH-PO628, SA-PO299, SA-PO337  
 Santos, Angelie TH-PO749, PUB303, PUB306  
 Santos, Nieves TH-PO256  
 Santos, Noélia L. TH-PO947  
 Santos, Paulo A. TH-PO937  
 Santos, Sydney TH-PO715, SA-PO305  
 Sanz, Ana B. FR-PO263  
 Sapa, Hima PUB111  
 Sapek, Katja SA-PO127  
 Saqan, Rola FR-PO335  
 Saraber, Pepijn FR-OR14  
 Sarabu, Nagaraju FR-PO814, SA-PO131, SA-PO143  
 Sarac, Erdal SA-PO138, PUB031  
 Saran, Ishan TH-OR09  
 Saran, Rajiv TH-PO614, TH-PO706, FR-PO936, SA-PO267  
 Sarangarm, Preeyaporn SA-PO044  
 Sarav, Menaka FR-PO486  
 Sardarli, Kamil SA-PO469  
 Sardell, Rebecca J. TH-PO621  
 Sarder, Pinaki TH-PO570, SA-PO001  
 Sarguroh, Tauseef A. TH-PO346, SA-PO507, SA-PO723  
 Sarhan, Rizk PUB350  
 Sariikhani, Hamed TH-PO527  
 Sarkar, Mrinalini SA-PO846  
 Sarkar, Sudipa TH-PO762  
 Sarkaria, Paul FR-PO735  
 Sarker, Mohammad H. TH-PO002  
 Sarkisova, Natalya SA-PO947  
 Sarnak, Mark J. TH-OR03, TH-PO243, TH-PO603, TH-PO865, TH-PO899, FR-PO083, FR-PO755, FR-PO826, SA-PO186, SA-PO991  
 Saro-Nunez, Lilian TH-PO078, PUB226  
 Sarosh, Muneeba PUB067  
 Sarov-Blat, Lea TH-PO252, FR-OR32  
 Sarrafzadeh, Majid FR-PO937  
 Sarvode Mothi, Suraj FR-PO944, SA-PO364  
 Sarwal, Amara TH-OR23, TH-OR26, TH-PO634, TH-PO709, FR-PO559, FR-PO737, SA-PO042, SA-PO467  
 Sarween, Nadia TH-PO751, FR-PO654  
 Sasaki, Kensuke TH-PO109, FR-PO456  
 Sasaki, Susumu TH-PO334  
 Sassi, Ali SA-PO099  
 Satake, Eiichiro TH-PO232, TH-PO235, SA-PO253  
 Satchell, Simon C. TH-PO193  
 Sathaliya, Taher FR-OR60, FR-PO659  
 Sathe, Adwait FR-PO689  
 Satirapoj, Bancha TH-PO831, FR-PO021, FR-PO908, SA-PO162, SA-PO901  
 Sato, Mariko TH-PO758  
 Sato, Shigemitsu SA-PO785  
 Sato, Tetsuhiko TH-PO158  
 Sato, Yoshinori SA-PO526  
 Satoh, Atsushi SA-PO896  
 Satoh, Hiroyuki TH-OR34  
 Satokata, Kazunori SA-PO640  
 Satoskar, Anjali A. TH-PO184, TH-PO541, TH-PO542, SA-PO631, PUB264  
 Sattar, Naveed TH-PO237, SA-PO269  
 Satyam, Abhigyan SA-PO024  
 Sauer, Brian C. SA-PO307  
 Sauer, Igor M. TH-OR55  
 Saulnier, Pierre Jean TH-PO231, TH-PO250  
 Saunders, Milda R. TH-PO719, TH-PO928, FR-PO928  
 Sautenet, Benedicte TH-PO854  
 Sav, Adem FR-PO860  
 Savige, Judith A. SA-PO565  
 Saville, Jessianna PUB191  
 Savin, Virginia J. TH-PO949  
 Sawada, Erika TH-PO758  
 Sawada, Kaichiro SA-PO212  
 Sawaf, Hanny TH-PO558  
 Sawinski, Deirdre L. TH-PO909, TH-PO956, FR-PO841  
 Saxena, Amit TH-PO487, FR-PO640  
 Saxena, Ramesh TH-PO488, FR-PO484, PUB007  
 Saxena, Vijay TH-PO314  
 Sayer, John A. TH-PO378, SA-PO551, SA-PO566, SA-PO570  
 Sbaih, Ahmed S. FR-PO487, SA-PO435  
 Scambler, Peter TH-OR48, SA-OR20  
 Scandling, John D. FR-PO232  
 Scanlon, Nicholas SA-PO437  
 Scaranti, Vanessa FR-PO430  
 Scartozzi, Mario SA-PO120  
 Schaefer, Christopher SA-PO010  
 Schaefer, Franz S. TH-OR33, TH-PO500  
 Schaefer, Gideon SA-PO111  
 Schaeffner, Elke TH-PO769, TH-PO775, TH-PO780, TH-PO796, TH-PO882, FR-PO897  
 Schaier, Matthias TH-PO536, TH-PO920, SA-OR47, SA-PO812  
 Schall, Thomas J. SA-PO633  
 Schaller, André SA-PO570  
 Schaub, Jennifer A. TH-OR02, TH-PO211, FR-OR20, FR-PO992, SA-OR04, SA-PO257, SA-PO258  
 Schaubel, Douglas E. TH-PO849  
 Schaufler, Thilo SA-PO285, SA-PO286, SA-PO288, SA-PO463  
 Schechter, Meir FR-OR26, SA-OR36, SA-PO266  
 Schechter, Shula FR-PO481  
 Schell, Christoph FR-PO699  
 Schell, Jane O. TH-PO016  
 Schelling, Jeffrey R. TH-PO238, FR-PO755, PUB111  
 Schena, Francesco P. TH-PO491  
 Schena, Giorgia FR-PO268  
 Schenk, Heiko J. FR-PO405  
 Schensul, Stephen L. TH-PO863  
 Scheppach, Johannes B. TH-PO884  
 Scherer, Andreas SA-PO715  
 Scherer, Nora FR-PO371  
 Scherer, Sabine SA-OR47  
 Schermer, Bernhard FR-PO329, FR-PO600, FR-PO686, FR-PO687, FR-PO704, FR-PO705, FR-PO707, FR-PO708, FR-PO716  
 Scherr, Rebecca FR-PO663, SA-PO705  
 Schibalski, Ryan SA-PO762, SA-PO763  
 Schick-Makaroff, Kara FR-PO868  
 Schierbaum, Luca M. SA-PO572  
 Schiffer, Eric TH-PO731, TH-PO732  
 Schiffer, Mario TH-PO428, TH-PO895, SA-PO784, PUB194, PUB255  
 Schiller, Brigitte FR-PO508, FR-PO518, SA-PO296  
 Schilling, Craig G. FR-PO547, FR-PO548  
 Schimmel, Margaret FR-PO242, FR-PO295  
 Schimmenti, Lisa A. TH-PO394  
 Schindler, Maximilian FR-PO702  
 Schindler, Thomas TH-PO567  
 Schissel, Makayla TH-PO943  
 Schladt, David P. SA-OR41, SA-PO804  
 Schlender, Julia SA-PO626  
 Schlosser, Pascal FR-PO371  
 Schlotman, Kelly E. SA-PO491  
 Schmedt, Niklas SA-PO259  
 Schmidt-Lauber, Christian TH-PO908  
 Schmidt-Ott, Kai M. TH-PO341, FR-PO157, FR-PO270  
 Schmidt, Augusto F. SA-PO599  
 Schmidt, Bernhard M. SA-PO444  
 Schmidt, Claudia SA-PO761  
 Schmidt, Darren W. FR-PO893  
 Schmidt, Insa M. TH-PO730, TH-PO877, SA-OR34  
 Schmidt, Julius TH-PO291, FR-PO001  
 Schmieler, Roland E. SA-PO784, PUB255  
 Schmitt, Anita TH-PO536, SA-OR47  
 Schmitt, Claus Peter FR-PO451, SA-PO627  
 Schmitt, Jörg S. FR-PO219  
 Schmitt, Michael TH-PO536, SA-OR47  
 Schmitt, Roland SA-PO112  
 Schmitz, Jessica TH-PO540  
 Schneider, Alice TH-PO769, TH-PO775, TH-PO796, TH-PO882  
 Schneider, Eugene SA-PO714  
 Schneider, John E. SA-PO280  
 Schneider, Markus P. TH-OR889, FR-PO066, PUB172  
 Schneider, Ronen FR-PO326, FR-PO327, FR-PO328, SA-PO538, SA-PO578  
 Schneider, Udo FR-OR54, FR-PO582  
 Schnell, Jack FR-PO355, FR-PO382  
 Schnellmann, Rick G. FR-PO142, SA-PO071  
 Schnitzler, Mark FR-PO814  
 Schnitzler, Paul SA-OR47  
 Schödel, Johannes TH-PO895  
 Schoer, Morgan FR-PO890  
 Schold, Jesse D. TH-PO009, TH-PO010, TH-PO579, TH-PO618, SA-PO800, SA-PO808  
 Scholes-Robertson, Nicole J. FR-PO871  
 Scholey, James W. TH-PO765, FR-PO024, FR-PO247  
 Scholz, Carsten C. TH-PO556  
 Schomber, Tibor SA-PO247  
 Schömig, Thomas FR-PO600  
 Schönbrunn, Anne PUB015  
 Schopp, Mary M. FR-PO867  
 Schrauben, Sarah J. TH-PO238, TH-PO243, TH-PO814, PUB284  
 Schreiber, Adrian FR-OR54, FR-PO575, FR-PO576, FR-PO582, FR-PO583  
 Schreiber, Martin J. FR-PO476, FR-PO477  
 Schreiber, Diana J. TH-PO051  
 Schretlen, Claire F. FR-PO048, FR-PO448  
 Schreurs, Gerd FR-PO1002  
 Schrezenmeier, Eva Vanessa PUB369  
 Schub, Micah TH-PO584  
 Schuh, Meredith P. FR-PO392  
 Schulte, Philip SA-PO780  
 Schultheiss, Ulla T. FR-PO066, FR-PO931, SA-PO154  
 Schultz, Michael K. SA-PO154  
 Schumacher, Ann M. PUB108  
 Schumacher, Björn FR-PO686  
 Schumacher, David SA-PO111  
 Schumacher, Josh FR-PO510, FR-PO521, FR-PO523, SA-PO428  
 Schunk, Stefan J. TH-OR33  
 Schwab, Constantin SA-OR47  
 Schwaderer, Andrew L. TH-PO314, SA-PO594, SA-PO608  
 Schwartz, Brian S. FR-PO659  
 Schwartz, Carter V. FR-PO633, SA-PO495  
 Schwartz, Daniel SA-PO289, PUB003  
 Schwartz, Gregory G. SA-PO210  
 Schwartz, Laura TH-PO182, SA-PO250, SA-PO614, SA-PO615, SA-PO616  
 Schwarz, Angelina SA-PO1012  
 Schwasinger, Emma T. FR-PO424  
 Schwelberger, Hubert G. TH-OR55  
 Schwingel, Andiana TH-PO728  
 Scialla, Julia J. TH-PO153, FR-OR22, FR-PO537, SA-PO924  
 Sciarrone Alibrandi, Maria Teresa TH-PO367  
 Scindia, Yogesh M. TH-PO135  
 Scolari, Francesco TH-PO508  
 Scordo, Michael FR-PO192  
 Scott, Charlie SA-PO274  
 Scott, Jennifer FR-PO698  
 Seaayfan, Elie FR-OR48  
 Seabra, Daniel TH-PO627, TH-PO628  
 Seah, Carina FR-PO889  
 Seales Kasangana, Maxine C. PUB202  
 Sealey, Mary Lynn TH-PO018  
 Sealfon, Rachel S. FR-OR20  
 Seals, Douglas R. FR-PO738  
 Sears, Sophia M. FR-PO189  
 Seay, Norman W. SA-PO460  
 Sebastian, Kuruvilla K. PUB227  
 Secher, Thomas SA-PO222  
 Sedaka, Randee S. FR-PO261, FR-PO287  
 Sedej, Ivana TH-PO650  
 Sedlacek, Martin PUB064, PUB130  
 Sedlacek, Valentina PUB064  
 Sedor, John R. TH-PO009, TH-PO010, FR-PO038, SA-PO734  
 Sedrakyan, Sargis TH-PO417, FR-PO321, FR-PO378, FR-PO403, FR-PO691  
 See, Emily TH-OR31  
 Seeger, Werner SA-PO780  
 Seegmiller, Jesse C. TH-PO238, FR-PO756, SA-PO950  
 Seeherunvong, Wacharee FR-PO425, FR-PO437  
 Seethapathy, Harish FR-PO193  
 Seethapathy, Ritu TH-PO958  
 Seffer, Malin-Theres TH-PO291  
 Segal, Alan PUB049, PUB224  
 Segal, Christine TH-PO513  
 Segal, Mark S. FR-PO061  
 Segar, Jeff L. SA-PO601  
 Segev, Dorry L. SA-PO462  
 Segoviano, Miriam SA-PO063  
 Segura, Gabriela C. FR-PO678, SA-PO148  
 Seib, Carolyn D. SA-PO208  
 Seibert, Eric FR-PO914  
 Seibert, Felix S. TH-PO267  
 Seif, Nay TH-PO869  
 Seifert, Larissa SA-PO746, SA-PO747  
 Seitter Pérez, Robert H. SA-PO146  
 Sejling, Anne-Sophie SA-PO893  
 Sekercioglu, Nigar PUB322  
 Sekhon, Harmehr TH-PO233  
 Sekhon, Inderpreet S. TH-PO008  
 Sekula, Peggy TH-PO866  
 Selamet, Umud SA-PO123, SA-PO125  
 Selek, Sahabettin SA-PO221  
 Selesky, Margaret TH-PO554  
 Selewski, David T. TH-PO472, SA-PO598, SA-PO601, SA-PO705, SA-PO735  
 Sellier-Leclerc, Anne-Laure A. FR-PO335  
 Sellin, Lorenz FR-PO274, SA-PO251  
 Sellinger, Isaac E. FR-PO529  
 Seltzer, Jay R. FR-PO635  
 Selukar, Subodh R. SA-PO128  
 Selvakumar, Prakash Parthiban TH-OR20  
 Selzner, Markus TH-PO637  
 Seman, Leo SA-PO259  
 Sembach, Frederikke E. TH-PO223  
 Semenikhina, Marharyta TH-PO214, FR-PO277

Sen, Aditi A.	FR-PO669, SA-PO125, PUB339	Shah, Vaqar H.	FR-PO821	Shashar, Moshe	SA-OR09	Shin, Jeong-Hun	TH-PO635
Sen, Sidharth	SA-PO968	Shaha, Atin K.	FR-PO222	Shastri, Jay G.	TH-PO122	Shin, Jung-Im	TH-PO743, TH-PO896, FR-PO216, FR-PO754
Sendic, Senka	FR-PO596	Shahid, Abdullah	PUB270	Shastri, Shani	TH-PO355	Shin, Kentaro	PUB125
Sendino Garvı, Elena	SA-OR12, SA-PO025	Shahid, Nauman	TH-PO481	Shaw, Andrew S.	FR-PO912	Shin, Seok Joon	SA-PO180, SA-PO381
Seneschall, Charlotte	FR-PO660	Shahinian, Vahakn	TH-PO706	Shaw, Melissa M.	TH-PO564, PUB054	Shin, Sung Joon	TH-PO793, FR-PO086, FR-PO817
Seneviratne, Mechelle K.	TH-PO270	Shahmoradi, Arezou	FR-PO835	Shaw, Sally F.	FR-PO753	Shinbashi, Meagan	FR-PO805
Senter, Timothy J.	TH-PO442	Shahoori, Neda	TH-PO631	Shawki, Howida	FR-PO769, FR-PO770	Shinde, Nilesh	TH-PO430, SA-PO813
Senum, Sarah R.	TH-PO368, TH-PO375, TH-PO376, TH-PO400, FR-PO851	Shahzad, Khurram	TH-PO212, TH-PO440, SA-PO1010	Shawwa, Khaled	FR-PO176, FR-PO590, PUB058	Shinde, Sejal Sanjay	FR-PO261, FR-PO287
Seo-Mayer, Patricia	FR-PO443	Shahzad, Muhammad A.	SA-PO491	Shayan, Katayoon	FR-PO107, SA-PO575	Shinjo, Samuel K.	FR-OR05
Seo, Jaecin	TH-PO662	Shaik, Zakir	PUB019	Shcherbak, Konstantin	FR-PO637	Shinoda, Kazunobu	FR-PO832
Seo, Minsuk	TH-PO048, TH-PO095, SA-PO335	Shaikh, Aisha	FR-PO682, SA-PO203, PUB261	Shcolnik Szor, Roberta	FR-PO179	Shirai, Yoko	SA-OR25
Sepulveda, Alberto	TH-PO887	Shaikh, Sana J.	SA-PO857	Shean, Brittany R.	TH-PO900	Shirali, Anushree C.	TH-PO438, SA-PO040
Sequeira Lopez, Maria Luisa S.	FR-PO363	Shaikh, Taha M.	SA-PO852	Sheehan, Susan M.	TH-PO535, FR-PO985	Shirozu, Takahiro	FR-PO275
Sequeira, Maria Jose	FR-PO929	Shaikh, Zahir Ali	FR-PO478, SA-PO676, SA-PO867	Sheerin, Neil S.	TH-PO751	Shiu, Yan-Ting E.	TH-PO297, SA-PO012, SA-PO013, SA-PO015, SA-PO016, PUB082
Serrano Salazar, Maria Luisa	PUB253	Shaily, Shikha	FR-PO052	Shehadah, Ali E.	SA-PO297	Shivappa, Nitin	PUB172
Serrano-Santiago, Victor E.	FR-PO240	Shaker, Mohamed	FR-PO807	Shehzad, Pir	FR-PO046	Shlipak, Michael	TH-OR03, TH-PO026, TH-PO238, TH-PO243, TH-PO678, TH-PO797, TH-PO798, TH-PO865, FR-PO755, FR-PO756, FR-PO924, SA-PO186, SA-PO991
Serrano, Mariana	TH-PO730	Shakouri, Payam	PUB355	Sheikh-Hamad, David (Daud)	FR-OR17, FR-PO129	Shoheit, Sally	FR-PO032
Serre, Justine	SA-PO545	Shallcross, Amanda J.	SA-PO303	Sheikh, Rayees Y.	SA-PO197	Shrestha, Prabin	TH-PO682, TH-PO683, FR-PO574, SA-PO902, SA-PO903, SA-PO909, PUB079
Servais, Aude	TH-PO761	Shamatova, Margarita	SA-PO763	Shekar, Niveda	PUB104	Shrestha, Praygi	SA-PO270
Serveaux Dancer, Marine	SA-PO545	Shamieh, Elias	TH-PO219	Shekar, Pooja	PUB217	Shrestha, Rojesh	FR-PO1006
Seshadri, Sandhya	TH-PO783	Shamim, Daniyal	SA-PO705	Shekhtman, Grigoriy	FR-PO765, FR-PO779, FR-PO781	Shrii, Shirlee	FR-PO326, FR-PO327, FR-PO328, SA-PO525, SA-PO538, SA-PO566, SA-PO573, SA-PO578
Seshan, Surya V.	TH-PO557, TH-PO585, FR-PO207, FR-PO766, FR-PO767, FR-PO783, SA-PO139	Shamseddin, M. Khaled	FR-PO835	Shelton, Brittany A.	TH-PO729	Shrivastava, Shashi	TH-PO754, SA-PO958
Sesso, Howard D.	SA-PO187, SA-PO910	Shang, Ning	SA-OR06	Shen, Carol L.	PUB277	Shroff, Urvi Nikhil	FR-OR56
Seth, Asha	TH-PO891, FR-PO167	Shankaranarayanan, Divya	TH-PO511	Shen, Hongying	FR-PO268	Shu, Shuangshuang	SA-PO230
Seth, Divya	FR-PO435	Shankland, Stuart J.	SA-PO031	Shen, Jincheng	TH-OR23, FR-PO737, FR-PO747	Shu, Winston	SA-PO038
Sethi, Amit	FR-PO585	Shanks, Josiah	SA-PO555	Shen, Tian	SA-PO994	Shuai, Richard W.	FR-PO305
Sethi, Jasmine	TH-PO029, FR-PO074	Shannon, Jennifer	TH-PO690	Sheng, Tao	FR-PO334	Shueib, Ali	TH-PO563
Sethi, Samdish	PUB170	Shao, Guojian	SA-PO311	Sheng, Xin	FR-OR38, SA-PO1007	Shukla, Kushal	PUB323
Sethi, Sanjeev	TH-PO453, TH-PO454, FR-PO649, FR-PO671, SA-PO133, SA-PO629, SA-PO630, SA-PO692	Shao, Selena	TH-PO901	Sheny, Prashamsa	FR-PO199	Shukla, Neetu	FR-PO237
Sethna, Christine B.	TH-PO590, TH-PO592, TH-PO593, TH-PO594	Shapiro, John P.	TH-PO184, SA-PO631	Shenoy, Robert	SA-PO708	Si, Jiayi	PUB087
Sethu, Palaniappan	TH-PO301	Shapiro, Joseph I.	FR-PO168, SA-PO1001	Sheshadri, Anoop	TH-PO797	Sibbel, Scott	FR-PO873, SA-PO320
Setty, Suman	TH-PO560	Shapiro, Lawrence	TH-PO544	Sheta, Mohamed A.	PUB142	Sibinga, Nicholas	TH-PO150
Sever, Sanja	TH-PO215	Shapiro, Roman	SA-PO151	Sheth, Himesh	TH-PO842, FR-PO568	Siddiqui, Fakiha	TH-PO550, TH-PO617, SA-PO391
Sevignani, Gabriela	PUB196	Shappell, Taryn	PUB283	Sheth, Khushboo	TH-PO497	Siddiqui, Neha	TH-PO122, SA-PO515, SA-PO940
Sexton, Donal J.	TH-PO632, SA-PO350, SA-PO351, SA-PO701	Sharfuddin, Asif A.	SA-PO820	Shettigar, Shruti	TH-PO514, TH-PO558	Sidell, Margo A.	TH-PO724
Seyedin, Roxanna	TH-PO276	Sharifi, Bobak	TH-PO522, SA-PO880	Shetty, Amol C.	TH-OR50, TH-PO459, TH-PO641, FR-PO787, SA-OR50	Sidhu, Manavjot	TH-PO913, PUB027
Sfeir, Jad G.	TH-PO396	Sharma Divyadarshini, Divya	FR-PO210	Shi, Caifeng	TH-PO236	Sidotı, Antonino	FR-PO929, PUB124
Sha, Daohang	TH-PO618	Sharma Priamvada, Gargi	FR-PO210	Shi, Hongmei	FR-PO315	Siedlecki, Andrew M.	TH-PO500, TH-PO502, FR-PO057
Sha, Eric	FR-PO369	Sharma, Abhinav	TH-PO619, FR-PO749	Shi, Jiaoxiao	TH-OR21, FR-PO753	Siegenthaler, Julie A	SA-OR20
Shabbir, Waheed	TH-PO347	Sharma, Akash	FR-PO743, PUB250	Shi, Ming	SA-PO172	Siegerist, Florian	FR-PO702
Shackleford, Gregory M.	FR-PO378	Sharma, Alisha	TH-PO951, TH-PO963, PUB012	Shi, Qihui	TH-PO762	Sievert, James J.	SA-PO507
Shad, Fariha	FR-PO306	Sharma, Amit	PUB351	Shi, Wen	TH-PO626	Sierra Gonzalez, Claudio	FR-PO600
Shaddinger, Bonnie	TH-PO685	Sharma, Amy	SA-PO122	Shi, Xiaojian	FR-PO268	Sierra, Mario	TH-PO524
Shaffer, Kelly	TH-PO815	Sharma, Anjali	TH-PO762	Shi, Xiaoxiao	TH-PO306, TH-PO510, FR-PO140, FR-PO572	Sietsema, William K.	PUB108
Shaffer, Samantha E.	TH-PO600	Sharma, Avika	TH-PO319, TH-PO349	Shi, Yifan	SA-PO311	Siew, Edward D.	TH-OR02, TH-OR07, TH-PO028, TH-PO246, FR-PO307, FR-PO312, FR-PO316
Shafi, Tariq	TH-PO153, TH-PO238, TH-PO811, TH-PO879, FR-OR24, FR-PO537, FR-PO757, FR-PO926, SA-PO362, SA-PO375, SA-PO462, SA-PO859, SA-PO931	Sharma, Binu	TH-PO933, TH-PO934	Shibagaki, Yugo	FR-PO832, FR-PO925, SA-PO238, SA-PO700, SA-PO998, PUB267	Siew, Keith	TH-OR40, TH-PO571, TH-PO573, FR-OR41, FR-OR45, FR-PO151, FR-PO397, FR-PO554
Shah, Aaisha	TH-PO951, TH-PO963, PUB012	Sharma, Deep	TH-PO120	Shibata, Hirotaaka	SA-PO395, PUB010	Siff, Melody L.	SA-PO720
Shah, Amy S.	TH-PO247	Sharma, Dheeraj	PUB152	Shichijo, Satoru	FR-PO463	Sifontis, Nicole M.	TH-PO714
Shah, Ankur	FR-PO949, PUB070	Sharma, Isha	TH-PO196	Shieh, Jeng-Jong	TH-OR38	Sifiri, Costi D.	PUB318
Shah, Chintan V.	SA-PO492	Sharma, Kumar	TH-PO107, TH-PO181, TH-PO247, TH-PO850, FR-PO694, FR-PO1000, PUB367	Shieh, Michelle	SA-PO044	Sigurdardottir, Asdis H.	TH-PO591
Shah, Chintav	PUB198	Sharma, Madhulika	FR-PO243, SA-PO745	Shiels, Paul G.	TH-PO832	Sigurdarson, Magnus T.	FR-PO637
Shah, Hitesh H.	FR-PO680, SA-PO474	Sharma, Monika	SA-PO240	Shigemoto, Kenichiro	SA-PO370, SA-PO396, SA-PO417	Sigurdsson, Engilbert	FR-PO099
Shah, Kavya M.	FR-PO997	Sharma, Mukut	TH-PO445, TH-PO949, FR-PO410	Shigenaga, Judy	FR-PO756		
Shah, Mamta	TH-PO100, FR-PO621	Sharma, Nisha	FR-PO174, SA-PO248	Shih, Chia-Yu	TH-PO925, PUB195		
Shah, Maulin	FR-PO669, SA-PO047	Sharma, Pranav	TH-PO078	Shihab, Fuad S.	FR-PO779		
Shah, Nikhil A.	TH-OR47, FR-PO522	Sharma, Purva D.	FR-PO070, SA-PO665	Shim, Kyuwan	FR-PO366		
Shah, Parag P.	FR-PO189	Sharma, Rahul	FR-PO375, FR-PO950	Shima, Yuko	FR-PO658, SA-PO589		
Shah, Pratik B.	TH-PO008	Sharma, Ram	TH-PO949	Shimabukuro, Wataru	SA-PO589		
Shah, Rohan J.	TH-PO887, FR-PO905	Sharma, Ravindra K.	SA-PO779	Shimamoto, Sho	TH-PO608		
Shah, Rutu	SA-PO873	Sharma, Rishi	TH-PO949	Shimamoto, Yuki	TH-OR39		
Shah, Sangam	FR-PO047	Sharma, Sanjit B.	PUB358	Shimamura, Yoshinosuke	TH-PO269		
Shah, Shilpi	SA-PO202	Sharma, Sapna	SA-PO724	Shimbo, Masaki	SA-PO861		
Shah, Shweta S.	FR-PO427	Sharma, Shilpa	TH-PO678	Shimizu, Akira	FR-PO035, PUB267		
Shah, Silvi	TH-PO748, FR-PO514	Sharma, Shree G.	SA-OR01	Shimizu, Mao	SA-PO209		
Shah, Sujal I.	SA-PO039	Sharma, Shuchita	FR-PO488, FR-PO495	Shimizu, Miho	FR-PO938, SA-PO911, PUB210, PUB347, PUB348		
Shah, Tariq	PUB335	Sharma, Surabhi	PUB108	Shimizu, Shigeomi	SA-PO1008		
Shah, Vallabh O.	TH-PO719, SA-PO931	Sharma, Tina	PUB218	Shimizu, Tatsuya	FR-PO346		
		Sharma, Vijay	TH-PO443, FR-PO343	Shimomura, Tsuyoshi	SA-PO395		
		Sharma, Vineeta	FR-PO330, SA-PO738	Shimoyama, Kotaro	TH-PO911, FR-PO526, SA-PO388, SA-PO440, SA-PO861		
		Sharp, Joseph D.	TH-PO020	Shin, Ho Sik	FR-PO778		
		Sharpe, Claire C.	TH-PO496				
		Sharshir, Moh'd	TH-PO169, SA-PO435				
		Shasha-Lavsky, Hadas	FR-PO335				

Sigurjonsdottir, Vaka K. TH-OR28, FR-PO425  
 Sikora, Axel FR-PO914  
 Silas, Daniel P. SA-OR27  
 Sillesen, Henrik H. PUB103  
 Silva Barbosa, Anne C. FR-PO138, SA-PO092  
 Silva Centeno, Faustino J. PUB244  
 Silva, Alejandra TH-PO233  
 Silva, Arnold L. SA-PO919  
 Silva, Artur Q. PUB131, PUB196  
 Silva, Beatriz M. TH-PO904, PUB320  
 Silva, Cassiano Augusto PUB196  
 Silva, Claudia D. PUB022  
 Silva, Cleonice SA-PO215  
 Silva, Eliana M. SA-PO299, SA-PO337  
 Silva, Eloiza O. TH-PO110, SA-PO102  
 Silva, Guilherme D. TH-PO516  
 Silva, Israel P. SA-PO299  
 Silva, Jose M. FR-PO237  
 Silva, Onassis TH-PO257  
 Silveroli, Josie A. TH-OR45  
 Silveira, Vinicius S. TH-PO516  
 Silver, Justin TH-PO145, TH-PO147  
 Silver, Samuel A. FR-PO114, FR-PO835  
 Silverberg, Rachael A. SA-PO206  
 Silvertown, Natalie SA-PO023  
 Sim, John J. TH-OR21, TH-PO724, FR-PO547, FR-PO548, FR-PO753  
 Simanyi, Kristin L. FR-PO245, FR-PO296  
 Simeone, Christopher A. SA-PO252  
 Simeone, Stephen N. TH-PO100, FR-PO621  
 Simic, Petra FR-OR03  
 Simkova, Eva FR-PO335  
 Simmons, Alicia L. FR-PO391  
 Simmons, Szandor FR-PO420  
 Simões e Silva, Ana cristina PUB034  
 Simon, Adolfo TH-PO959  
 Simon, James F. TH-PO579, FR-PO517  
 Simon, Sarah E. PUB067  
 Simoni, Aaron A. SA-PO250, SA-PO614  
 Simoni, Jan SA-PO980, SA-PO981, SA-PO982  
 Simonini, Marco FR-PO073, SA-PO754  
 Simpson, Stephen J. FR-PO385  
 Sims-Lucas, Sunder FR-PO138, FR-PO402, SA-PO092, SA-PO103  
 Sinclair, Matthew R. SA-PO452  
 Sinclair, Nari TH-PO723  
 Singam, Sharma SA-PO780  
 Singer, Alexander TH-PO589  
 Singer, Richard F. FR-PO335  
 Singh, Aditi TH-PO100, TH-PO126, FR-PO621, PUB221  
 Singh, Ajay K. TH-PO685, TH-PO686, TH-PO687, TH-PO688, TH-PO690, TH-PO691, TH-PO692, TH-PO711, SA-OR37, SA-PO115  
 Singh, Anika T. SA-PO358, SA-PO364  
 Singh, Geetika TH-PO504  
 Singh, Gurmukteshwar SA-PO534, SA-PO582  
 Singh, Harpreet K. TH-PO584  
 Singh, Jaswinder P. FR-PO445  
 Singh, Karandeep TH-PO612  
 Singh, Kunal TH-PO212  
 Singh, Manisha TH-PO460, TH-PO741, FR-PO239, SA-PO010  
 Singh, Neeraj TH-PO791, FR-PO794  
 Singh, Nikhil SA-OR04  
 Singh, Nisha M. SA-PO458, SA-PO670  
 Singh, Pallav SA-PO968  
 Singh, Poonam R. TH-PO941  
 Singh, Pragya TH-PO107  
 Singh, Rakesh TH-PO255, TH-PO718, FR-PO924  
 Singh, Ram PUB152  
 Singh, Ravinder FR-PO559, FR-PO748  
 Singh, Rohanit PUB135  
 Singh, Shivali D. FR-PO553  
 Singh, Shivam FR-OR55  
 Singh, Tripti TH-PO749, TH-PO858  
 Singh, Vartika SA-PO952  
 Singh, Vikas TH-PO949  
 Singhal, Pravin C. TH-PO420, SA-PO731, SA-PO745  
 Singla, Nirmish FR-PO147  
 Sinha, Avilasha SA-PO055  
 Sinha, Debanjan D. FR-PO093  
 Sinha, Ram TH-PO122, SA-PO515, SA-PO940  
 Sinha, Rohita FR-PO786, FR-PO801  
 Sinha, Sharad C. TH-PO906, PUB033, PUB035  
 Sinha, Smeeta SA-PO719, PUB101, PUB256  
 Sinibaldi, Dominic P. SA-PO685  
 Sিনnett, Mark FR-PO551  
 Sinz, Christopher FR-PO318  
 Sirich, Tammy L. PUB120  
 Sirisuksakun, Chumphon SA-PO901  
 Siritiwattanasit, Narongrit TH-PO831, FR-PO021, SA-PO162, SA-PO901  
 Siscovick, David SA-PO185  
 Sise, Meghan E. TH-PO080, TH-PO958, FR-PO182, FR-PO193, SA-PO155  
 Sisk, Rose SA-PO283  
 Siskind, Leah J. FR-PO189  
 Siudak, Krystyna SA-PO247  
 Sivapackiam, Jothilingam TH-PO443, FR-PO343  
 Siwy, Justyna FR-PO913  
 Sjostrom, David FR-OR26, SA-PO885, SA-PO886  
 Skaff, Caroline J. TH-PO180  
 Skliar, Mikhail SA-PO019, SA-PO020  
 Skog, Johan SA-OR46  
 Skopnik, Christopher FR-OR54, FR-PO157  
 Skovronova, Renata SA-PO078  
 Skroblin, Philipp FR-PO639  
 Skrtic, Stanko PUB361  
 Skrypynyk, Nataliya FR-OR12, SA-PO100  
 Slagle, Cara L. TH-OR05  
 Slattery, Laura M. SA-PO701  
 Slaven, James TH-PO784  
 Slawson, Chad SA-OR14  
 Slee, April E. SA-PO262  
 Sloan, Alexis J. TH-PO207  
 Sloand, James A. FR-PO501  
 Slusher, Barbara S. FR-PO172  
 Smeets, Bart TH-PO533, TH-PO441  
 Smeijer, Johannes D. TH-PO244  
 Smiliansky, Natasha TH-PO875  
 Smith, Abigail R. TH-PO472, TH-PO473, TH-PO474, TH-PO477, TH-PO479, SA-PO735  
 Smith, Alice C. TH-PO674, TH-PO680, TH-PO830, SA-PO946, SA-PO979, PUB078  
 Smith, Alina TH-PO499  
 Smith, Alisha J. SA-PO708  
 Smith, Anastasia L. TH-PO180  
 Smith, Bridget M. FR-PO507  
 Smith, Cathy FR-PO697  
 Smith, Edward R. SA-PO174  
 Smith, Frederick PUB205  
 Smith, Lucas R. TH-PO822, TH-PO829  
 Smith, Maxwell L. TH-PO587  
 Smith, Paul SA-PO425  
 Smith, Paul E. FR-PO494  
 Smith, Peter H. TH-PO405  
 Smith, Priscilla TH-PO756, TH-PO759  
 Smith, Rex N. TH-PO080, FR-PO193, SA-OR44  
 Smith, Richard J. TH-PO763, TH-PO764, SA-PO634, SA-PO635  
 Smith, Rona M. FR-PO005  
 Smith, Russell SA-PO308  
 Smith, Steven TH-PO004  
 Smith, Tanya A. FR-PO365  
 Smolentzov, Igor FR-PO028, SA-PO433  
 Smoyer, William E. TH-PO446, TH-PO447, TH-PO448, TH-PO479, SA-PO564, SA-PO585  
 Smyth, Andrew TH-PO742  
 Smyth, Brendan TH-PO767  
 Smythe, Jon FR-OR40  
 Snapinn, Steven M. SA-PO115  
 Snijder, Eric J. FR-PO011  
 Snoek, Rozemarijn TH-PO761  
 Snopkowski, Catherine FR-PO767, SA-PO116  
 Snow, Zachary K. TH-PO180  
 Snyder, Ryan J. TH-PO308  
 So, Carmen SA-PO386  
 So, Yu Fai Benjamin FR-PO545  
 Soares, Renata B. TH-PO072  
 Sobral, Vinicius V. SA-PO433  
 Sobremisana, James A. SA-PO318  
 Sodhi, Komal FR-PO168, SA-PO1001  
 Soe, Thin Thin FR-PO222  
 Sofue, Tadashi FR-PO850  
 Sogbein, Olusola PUB213, PUB321  
 Sohail, Mohammad A. TH-PO278, FR-PO630  
 Sohail, Saad FR-PO344  
 Sohara, Eisei TH-PO339, TH-PO425, SA-PO549, SA-PO743, SA-PO1008  
 Soiffer, Robert SA-PO151  
 Sokol, Harry SA-PO648, SA-PO649  
 Sola, Darlene Y. TH-PO610  
 Solanki, Ashish K. TH-PO220  
 Solanki, Kaushal V. TH-PO049, SA-PO552  
 Solorin, Adaobi TH-PO805, TH-PO806  
 Soldano, Karen SA-OR27  
 Soleimani, Manoocher FR-PO290, SA-PO782  
 Soler, Maria Jose TH-PO178, TH-PO505, TH-PO917, FR-PO024, FR-PO182, SA-PO130, SA-PO160, SA-PO692  
 Solhjoui, Zhabiz TH-OR49, TH-OR51, TH-OR53, TH-PO653, SA-OR46  
 Soliman, Karim M. FR-PO819  
 Solis-Trapala, Ivonne FR-PO536  
 Solis, Damayanty PUB006  
 Solis, Edgar SA-PO316  
 Solis, Emmanuel TH-PO151  
 Solis, Kevin A. PUB232  
 Soljic, Violeta SA-PO622  
 Solomon, Scott D. SA-PO115  
 Solomon, Sonia FR-PO436, SA-PO588  
 Soloyan, Hasmik TH-PO417, FR-PO321, FR-PO403  
 Soman, Sandeep S. PUB135  
 Somarathana, Maheshika S. TH-PO302  
 Somaia, Nikunj FR-PO406  
 Somlo, Stefan FR-PO268, FR-PO345  
 Sommer, Nicole FR-PO243, SA-PO745  
 Sompuram, Seshi R. TH-PO574  
 Son, Hyung Eun SA-PO372, SA-PO704  
 Sondheimer, James H. TH-PO059  
 Soneji, Nisha FR-PO735  
 Song, Bo FR-PO970  
 Song, Chelsey FR-PO811  
 Song, Jehun TH-PO625, TH-PO713, SA-PO973  
 Song, Juhee SA-PO125  
 Song, Mi-Kyung TH-PO777, TH-PO778, SA-PO455  
 Song, Rui SA-PO038, PUB176  
 Song, Sang Heon TH-PO793  
 Song, Seung Hwan FR-PO791  
 Song, Wenru SA-PO636  
 Song, Xuewen TH-PO361, TH-PO362, FR-PO247  
 Song, Yang TH-PO480  
 Song, Young Woo SA-PO180, SA-PO381  
 Soni, Aakriti FR-PO480  
 Sonnemann, Janis FR-OR54  
 Sood, Bhriгу Raj TH-PO906, FR-PO655, PUB033, PUB035  
 Sood, Manish M. SA-PO137, SA-PO157, FR-PO804, SA-OR43  
 Soofi, Abdul A. SA-PO090  
 Soomro, Asfia SA-PO771  
 Soomro, Qandeel H. TH-PO739  
 Sor, Murat FR-PO502  
 Soranno, Danielle FR-PO349  
 Sorensen, Bess FR-PO659  
 Sørensen, Ida M. SA-PO188  
 Sorohan, Bogdan SA-PO150  
 Sosa, Marie A. TH-PO283, PUB288  
 Soto-Vargas, Javier PUB053, PUB310  
 Sotolongo, Gina SA-PO003  
 Soudant, Celine PUB112  
 Soundarya, Kudithi PUB154  
 Sousa, Henrique S. PUB057  
 Sousa, Hiago M. TH-PO383  
 Sousa, Patricia FR-PO428  
 South, Andrew M. TH-PO590, TH-PO592, TH-PO593, SA-PO789, SA-PO790  
 Souza, Camila A. PUB034  
 Souza, Eduarda M. PUB196  
 Souza, Felipe L. SA-PO072  
 Souza, Lucas A. TH-PO516  
 Spaak, Jonas FR-PO760  
 Spainhour, Mitzie H. TH-PO736  
 Spanuchart, Ittikorn TH-PO586, FR-PO016  
 Sparber, Lauren FR-PO861, PUB157  
 Sparding, Nadja TH-PO429  
 Sparidans, Rolf TH-PO190  
 Sparkenbaugh, Erica TH-PO703  
 Sparks, Matthew A. TH-OR47, TH-PO019  
 Spear, Ryan FR-PO726, SA-PO1004  
 Specks, Ulrich FR-PO585, FR-PO649, SA-PO692  
 Speer, Claudius TH-PO105, TH-PO536, TH-PO920, FR-PO774, SA-PO812  
 Speer, Thimoteus TH-OR33  
 Spence, Amanda B. TH-PO762  
 Spencer, John D. TH-PO182, SA-PO250, SA-PO591, SA-PO604, SA-PO605, SA-PO610, SA-PO614, SA-PO615, SA-PO616  
 Spennati, Giulia SA-PO030, SA-PO249  
 Sperati, John TH-PO473, SA-PO735, PUB223  
 Spicer, Morgan J. SA-PO762  
 Spiegel, David M. TH-PO162, TH-PO163, SA-PO400  
 Spies, Daniel FR-PO298  
 Spigler, Michael SA-PO541  
 Spindler, Jadeah J. TH-PO149, TH-PO656, FR-OR07, SA-PO214  
 Spinella, Kaitlyn E. PUB169  
 Spino, Cathie SA-PO705  
 Spires, Denisha R. SA-PO763  
 Spitz, Dominik FR-PO706  
 Splocharski, Grzegorz FR-PO647  
 Spolnik, Margaret FR-PO629  
 Sprague, Stuart M. TH-PO162, TH-PO869, FR-PO535, SA-PO194, SA-PO954, PUB091, PUB286  
 Sprangers, Ben FR-OR59, FR-PO923, SA-PO679  
 Squire, Evan J. TH-PO198  
 Sradnick, Jan TH-PO226, FR-PO372, FR-PO387  
 Sran, Hersharon K. TH-PO950  
 Sravanthi, Metlapalli Venkata SA-PO466  
 Sreemantula, Harsha Sai TH-PO115  
 Sri Pathmarajah, Danisha TH-PO918  
 Srialhuri, Nityasree TH-PO750  
 Srichaichana, Inthira SA-OR35  
 Sridhar, Abhinaya TH-PO173, FR-PO197, PUB174  
 Srikanth, Theesitha PUB182  
 Srikantharajah, Mukunthan PUB305  
 Srila, Kanyapa SA-OR35

Srinivasan, Harini	SA-PO756	Stelfox, Henry T.	FR-PO060	Subramaniam,	Suresh Kumar, Varsha	SA-PO074
Srinivasan, Shruthi	TH-PO146,	Stengel, Benedicte	TH-PO658,	Karppagavalli	Sureshkumar, Kalathii K.	TH-PO951,
	TH-PO810, FR-OR01		TH-PO667, TH-PO771, TH-PO854,	SA-PO678, PUB334		TH-PO963, FR-PO051, SA-PO438,
Sriperumbuduri, Sriram	FR-PO926,		TH-PO880, FR-PO221, SA-PO925	Subramaniam Sahasranamam,		SA-PO799, SA-PO842, PUB012
	SA-PO495, SA-PO729, SA-PO859	Stennett, Amanda	SA-PO425	Adithya		FR-PO727
Srisawat, Nattachai	FR-PO079	Stenson, Erin K.	SA-PO596	Subramanian,		
Srivastava, Anand	TH-PO057,	Stensvold, Dorthie	TH-PO798	Balaji karthick	SA-PO028,	
	TH-PO869, TH-PO877, FR-PO944,	Stenvinkel, Peter	TH-PO649,		SA-PO741	
	SA-PO192, SA-PO931, SA-PO954		TH-PO837, FR-PO497, SA-PO390,	Suchin, Elliot J.	SA-PO159	
Srivastava, Anjali	FR-PO966		SA-PO932, PUB254, PUB259,	Suderman, Matthew	TH-PO450	
Srivastava, Tarak	TH-PO445,		PUB289	Sugahara, Mai	SA-PO992	
	TH-PO473, TH-PO594, FR-OR57,	Stephany, Brian R.	FR-PO442	Sugahara, Sho	FR-OR28, FR-PO164,	
	FR-PO410, SA-PO735	Stephens, Mary Ann C.	TH-PO727		FR-PO1005	
Srivatana, Vesh	TH-PO939, FR-PO476	Stephens, Tayte A.	SA-PO010	Sugase, Taro	TH-PO826	
Srivaths, Poyyapakkam	FR-PO427,	Stephensens, Sigurdur S.	TH-PO591	Sugaya, Takeshi	FR-PO018, SA-PO238,	
	SA-PO602, SA-PO603	Sterling, Sara	FR-PO811		SA-PO998	
Sroda, Natalie	FR-PO993	Stern, Aaron S.	SA-PO514, SA-PO725	Suh, Jin-Soon	PUB180	
Srouf, Habib	SA-PO193	Stern, Lauren D.	FR-PO529	Suh, Junwoo	TH-PO443	
Sruges, Fabian	SA-PO761	Stern, Leonard	PUB355	Suh, Sang Heon	TH-PO813, PUB180	
St. Hillien, Shelsea A.	TH-PO054	Stevanovic, Mirjana	TH-PO386,	Sukmark, Theerapon	FR-PO079	
St. Ledger, Katie	TH-PO692		FR-PO822, SA-PO323, SA-PO324	Sukul, Nidhi	FR-PO482, SA-PO285	
St. Peter, Wendy L.	TH-PO936,	Stevens, Kelsey O.	SA-PO637	Sukumaran Nair, Sumi	FR-PO820,	
	FR-PO008	Stewart, Benjamin J.	TH-OR48		SA-PO860	
Stachowska-Pietka, Joanna	FR-PO492	Stewart, Erik	FR-PO896	Sulaiman, Karina	FR-PO888	
Stadler, Krisztian	SA-PO762,	Stewart, Thomas G.	SA-PO758,	Suleiman, Hani	TH-PO651, FR-PO700,	
	SA-PO763		SA-PO759		FR-PO713	
Staggs, Vincent S.	FR-PO410	Stillman, Isaac E.	FR-PO672,	Sullivan, Dawn	FR-PO339	
Stalbow, Daniel	FR-PO207		FR-PO944	Sullivan, Debra K.	TH-PO815	
Stalekar, Maja	TH-PO650	Stippel, Dirk L.	SA-OR42	Sullivan, Kathleen M.	SA-PO633	
Staley, Christopher	FR-PO799	Stites, Erik	FR-PO779	Sullivan, Katie	PUB282	
Stam, Wendy	FR-PO386	Stockholm, Scott C.	PUB013	Sullivan, Kelly E.	TH-PO442	
Stambolliu, Emelina	SA-PO408	Stockmann, Helena	FR-PO931	Sullivan, Shawn P.	FR-PO663	
Stämmler, Frank	TH-PO731,	Stoddard, Gregory J.	SA-PO023	Sulowicz, Wladyslaw	TH-PO385	
	TH-PO732	Stojceva, Olivera	SA-PO337	Sultan, Mohammad T.	TH-PO055,	
Stanaway, Ian B.	TH-OR02, TH-OR10,	Stokes, Michael B.	PUB332		TH-PO063	
	FR-PO497	Stokman, Marijn F.	FR-PO194	Sultan, Reem A.	SA-PO420	
Ständer, Sonja	SA-PO463	Stoller, Marshall L.	SA-PO856	Sultanova, Regina F.	SA-PO762,	
Stanek, Joseph	SA-PO129	Stone, Fehlin	PUB025	Suma Kumaran, Sharmil	SA-PO466,	
Stanescu, Cristina	SA-PO150	Stone, Hillarey	SA-PO855		PUB199	
Stangou, Maria J.	TH-PO948	Stoop, Reinout	SA-PO224	Sumaili, Ernest K.	FR-PO897	
Stanilova, Katerina	SA-PO710	Storey, Aaron J.	TH-PO452	Sumida, Keiichi	TH-PO615,	
Stanton, Tony	TH-PO606	Storarr, Joshua	TH-PO521, SA-PO719		TH-PO616, TH-PO681,	
Stapleton, Sharon	TH-PO734,	Stougaard, Elisabeth B.	SA-PO263		TH-PO682, TH-PO683, TH-PO852,	
	FR-PO006	Stowell-Connolly, Holly	FR-PO165		TH-PO853, FR-PO574, FR-OR899,	
Staplin, Natalie	TH-PO621	Strande, Natasha T.	SA-PO552,		FR-PO900, SA-PO902, SA-PO903,	
Star, Robert A.	TH-PO103, SA-PO070		SA-PO582	Summers, Scott	FR-PO144, SA-PO252	
Stark, Ana I.	FR-PO610, SA-PO032	Strauss, Philipp	SA-PO715	Sumner, Susan J.	TH-PO446,	
Starr, Michelle C.	SA-PO601	Streis, Joachim	TH-PO267		TH-PO447, TH-PO448	
Staruschenko, Alexander	TH-PO214,	Streja, Elani	TH-PO681,	Sun, Franklin W.	SA-PO264	
	TH-PO325, FR-PO277, SA-PO245,		TH-PO682, TH-PO683, TH-PO852,	Sun, Hao	SA-PO006	
	SA-PO753		TH-PO853, TH-PO879, FR-OR24,	Sun, Hua	TH-PO216	
Stasch, Johannes-Peter	SA-PO247		FR-PO544, FR-PO899, FR-PO900,	Sun, In O	TH-PO793, FR-PO098,	
Stasi, Alessandra	FR-PO170,		FR-PO926, SA-PO902, SA-PO903,		SA-PO682	
	SA-PO647		SA-PO908, SA-PO909, PUB079	Sun, Ke	SA-OR21	
Staudner, Tobias	FR-PO265, FR-PO266	Stringer, Sonja M.	TH-PO660,	Sun, Sumi J.	FR-PO518	
Staudt, Meghan	SA-PO945		TH-PO661	Sun, Xiaobo	FR-PO271	
Stauss-Grabo, Manuela	TH-PO837,	Strohbehn, Ian A.	TH-PO744,	Sun, Xiuli	TH-OR16	
	SA-OR07, SA-PO390		SA-PO155	Sun, Xuefeng	SA-PO907	
Stavas, Joseph	TH-PO877, FR-PO904,	Strong, Amy	FR-PO109	Sun, Yan	FR-PO761	
	FR-PO905, SA-PO957	Stroth, Nikolas	FR-OR60	Sun, Yuxiang	SA-PO230	
Stavrou, Christoforos	TH-PO380	Stroupe, Kevin	FR-PO507	Sun, Zeguo	FR-OR31, SA-PO974	
Steck, Anna-Lena	FR-PO219	Strubl, Sebastian	FR-PO295	Sunaga-Franze, Daniele Y.	SA-PO793	
Steel, Jennifer L.	FR-PO867,	Strubler, Diana	FR-PO942	Sundaram, Madhivanan	FR-PO658	
	SA-PO303	Struempf, Taylor	TH-PO391,	Sundaram, Sruthi	PUB203	
Steele, Courtney	TH-PO390, TH-PO391,		TH-PO392	Sunderraj, Ashwin	SA-PO192	
	TH-PO392, TH-PO609	Strufaldi, Fernando L.	FR-PO179,	Sundin, Per-Ola	FR-PO897	
Steenkamp, Devin	PUB102		FR-PO678, FR-PO880,	Sung, Chih-Chien	TH-PO324,	
Steenkamp, Retha D.	TH-PO494		SA-PO147, SA-PO148, SA-PO505		FR-PO569, SA-PO569	
Steers, Nicholas J.	SA-PO637	Strutz, Frank M.	TH-PO685	Sung, Jonathan	TH-PO843	
Stefanenko, Mariia	TH-PO214	Stryjniak, Gabriel J.	TH-PO909,	Sung, Min ji	FR-PO987	
Stefanidis, Constantinos J.	SA-PO329		TH-PO939, TH-PO956, FR-PO841	Sunilkumar, Siddharth	SA-PO229	
Steffen, Janos	SA-PO100	Stuard, Stefano	SA-OR07	Suo, Liye	SA-PO113	
Steffen, Lynn M.	FR-PO918	Stuart, Deborah	FR-PO144, SA-PO975	Supasynndh, Ouppatham	TH-OR831,	
Steffick, Diane	TH-PO706	Su, Baihai	SA-PO008		FR-PO021, FR-PO908, SA-PO162,	
Steg, Philippe Gabriel	SA-PO264	Su, Emily	FR-PO116		SA-PO901	
Stegall, Mark D.	FR-PO788	Su, Hong	FR-PO951	Supokawej, Aungkura	FR-PO943	
Stegbauer, Johannes	TH-OR27,	Su, Hua	SA-PO080, SA-PO101	Sura, Oleg	FR-PO534	
	SA-PO761	Su, Xiao-Tong	TH-PO319, TH-PO320	Surapaneni, Aditya L.	TH-PO750,	
Steidl, Maria Elena	FR-PO299	Su, Yanhui	TH-PO220		TH-PO862, FR-PO754, FR-PO907	
Steiger, Stefanie	FR-PO126	Su, Zemin	FR-PO819	Surasit, Karjundid	FR-PO079	
Stein, Quinn P.	SA-PO558	Suarez, Gina G.	PUB245	Surbhi, Satya	TH-PO681, TH-PO682,	
Steinberg, Julie	FR-PO861, PUB157,	Suarez, Juan S.	FR-PO029		TH-PO683, SA-PO902, SA-PO903,	
	PUB316	Suárez, Nicole M.	PUB020, PUB036,		PUB079	
Steinbrenner, Inga	FR-PO931		PUB233, PUB325	Surendradoss, Jayakumar	FR-PO334	
Steinke, Julia M.	TH-PO479,	Subbiah, Arunkumar	TH-PO504,	Surendran, Kameswaran	FR-PO391	
	TH-PO760		FR-PO658, PUB287	Surendran, Tejus	TH-PO566	

Taggart, Jerald L.	SA-PO471	Tan, Yifan	FR-PO712	Taylor, Kathryn	TH-PO715, SA-PO305	Thavarajah, Sumeska	PUB353
Taguchi, Kensei	TH-PO195,	Tan, Yixiang	FR-PO470	Taylor, Philip	FR-PO365	Theberge, Ashleigh B.	SA-PO031
	TH-PO389, FR-OR28,	Tanaka, Junta	TH-PO885	Taylor, Scott	SA-PO654	Theberge, Jean	TH-OR12
	FR-PO166, FR-PO613,	Tanaka, Ryojiro	SA-PO589	Taylor, Steven	FR-PO735	Theilhaber, Joachim	FR-PO795
Taguchi, Shinya	TH-PO199, SA-PO997	Tanaka, Shigeru	TH-PO608	Tayyeb, Muhammad	SA-PO033	Theis, Jason D.	FR-PO190, SA-PO629,
Taguri, Masataka	TH-PO844	Tanaka, Shinji	TH-PO101, TH-PO548	Tchakarov, Amanda	FR-PO181,		SA-PO630
Taha, Mohed Y.	TH-PO175	Tanaka, Shohei	TH-PO199, SA-PO997		FR-PO113, SA-PO134,		SA-PO985
Tahaai, Seyedmohammadebrahim		Tanaka, Tetsuhiro	TH-PO883,		SA-PO141, SA-PO870	Thelwell, Rianne S.	SA-PO174
	TH-PO305, FR-OR42		SA-PO992	Tchervonkov, Jean	PUB299	Thiem, Ursula	TH-OR03,
Tahir, Muhammad Khalid	TH-PO176,	Tanaka, Yu	FR-PO043, SA-PO589	Tchkonkia, Tamara	TH-PO180	Thiessen Philbrook, Heather	TH-PO564,
	PUB014, PUB183	Tanaka, Yuri	TH-PO701	Tchokhoniidze, Irma	FR-PO036		TH-PO865, SA-PO991
Taiwo, Adetokunbo A.	TH-PO519,	Tanasiychuk, Tatiana	FR-PO534	Teakell, Jade M.	TH-OR47	Thiffault, Isabelle	SA-PO572
	SA-PO849	Tandon, Shweta	FR-PO577, FR-PO578	Tecson, Lor	FR-PO429	Thijssen, Stephan	SA-PO319,
Takabatake, Eliane	FR-PO430	Taner, Timucin	FR-PO788, SA-PO149	Tedesco, Martina	TH-PO508		SA-PO427, PUB080
Takabatake, Yoshitsugu	FR-PO955	Tang, Anna	FR-PO174, SA-PO248	Teerapornlertratt, Tanyarat	SA-OR35	Thilakarathne, Dihan	SA-PO057
Takagi, Enzo	TH-PO347,	Tang, Ben	FR-OR29	Tefera, Beakal Z.	FR-PO433	Thimachai, Paramat	TH-OR0831,
	TH-PO350	Tang, Chun	TH-PO545, TH-PO551	Tefera, Eshetu	TH-PO237		FR-PO021, FR-PO908, SA-PO162,
Takahashi, Atsushi	FR-PO955	Tang, Fei	TH-PO693	Tegel, Andrew	SA-PO010		SA-PO901
Takahashi, Hiroyuki	TH-PO826	Tang, Hong	FR-OR51	Tezgess, Erzi	SA-PO827	Thimmareddygar, Divya Mounisha R.	TH-PO886,
Takahashi, Kazuhiro	SA-PO785	Tang, Jessica	FR-PO780	Teigen, Levi	FR-PO799		TH-PO866
Takahashi, Kazuo	FR-PO275	Tang, Jie	TH-PO842, FR-PO568	Teitelbaum, Isaac	FR-PO476,	Thimphithaya, Chanattha	TH-PO598
Takahashi, Masafumi	TH-PO090	Tang, Mengyao	TH-PO240, FR-OR23		FR-PO477	Thind, Amarpreet K.	TH-PO799
Takahashi, Masahiro	FR-PO143,	Tang, Mila	TH-PO667	Teixeira, Ana	FR-PO428	Thiruvardulsothy, Srikanth	PUB182
	SA-PO064	Tang, Qiao	FR-PO153	Teixeira, Gabriela	FR-PO428	Thiruvillakkat, Kris	SA-PO811
Takahashi, Naohiro	SA-PO1008	Tang, Shuifu	TH-PO702	Teixeira, J. Pedro	TH-PO123,	Thomas, Betous	SA-PO409
Takahashi, Naoki	TH-OR39	Tang, Sydney C.	TH-PO498,		SA-PO044	Thomas, Charlotte	FR-PO067,
Takahiro, Yamaji	SA-PO997		FR-PO964, SA-PO220, SA-PO969	Tejedor, Lucia	TH-PO555, FR-PO263,		FR-PO075, SA-PO151
Takale, Dipti	TH-PO734	Tang, Yun	TH-PO431, SA-PO773		FR-PO461	Thomas, David C.	TH-PO019
Takano, Hideki	FR-PO018	Tangchitthavorngul, Suri	FR-PO079	Tello, Khodr	SA-PO780	Thomas, Dorothy	PUB206
Takayama, Suguru	SA-PO998	Tangredi, Marianna	SA-PO576	Ten Eyck, Patrick	TH-PO600,	Thomas, Dylan	FR-PO821
Takayanagi, Kaori	TH-PO758	Tangren, Jessica S.	TH-PO744		FR-PO839	Thomas, Fridtjof	TH-PO681,
Takeda, Masayoshi	TH-PO883	Tangri, Navdeep	TH-PO630,	Tendulkar, Ketki K.	FR-PO201		TH-PO682, TH-PO683, TH-PO852,
Takemoto, Yoshiaki	PUB125		TH-PO888, TH-PO889, FR-PO885,	Teng, Yoe Kie Onno	FR-PO011,		TH-PO853, FR-PO899, FR-PO900,
Takenaka, Tsuneo	TH-PO826,		SA-PO157, SA-PO262, SA-PO307,		FR-PO607, FR-PO645		SA-PO902, SA-PO903, SA-PO908,
	FR-PO595		SA-PO327, SA-PO944, PUB172,	Tennankore, Karthik K.	SA-PO327,		PUB079
	SA-PO1008		PUB351		SA-PO387, SA-PO717	Thomas, George	TH-PO470
Takeuchi, Koh	FR-PO945	Tangvoraphonkchai, Kamonwan	FR-PO079	Tenorio-Aguirre, Erika K.	FR-PO027	Thomas, Hanna	FR-PO659
Takeuchi, Mizuki	TH-PO911, FR-PO526,		TH-PO831,	Tentori, Francesca	TH-OR15,	Thomas, I-Chun	SA-PO208
Taki, Fumika	FR-PO558, SA-PO388, SA-PO440,	Tangwonglert, Theerasak	SA-PO901		FR-PO873, SA-PO320, SA-PO340,	Thomas, Isis	FR-PO245, FR-PO296
	SA-PO861		SA-PO068	Teo, Boon Wee	SA-PO809, SA-PO810, PUB123	Thomas, Jane J.	TH-PO657
Takizawa, Akiko	FR-PO275	Tani, Hitomi	SA-PO068	Teo, Sharon	TH-PO449	Thomas, Katie	PUB084
Takkar, Chandan	FR-PO460	Tani, Takashi	SA-PO068	Tepel, Martin	FR-PO773, FR-PO784	Thomas, Konstantinos	FR-PO589
Takkavatakan, Kullaya	TH-PO582,	Tanigawa, Masato	SA-PO395	Terada, Yasuhiko	TH-PO334	Thomas, Leslie F.	TH-PO587
	SA-PO449	Tanriover, Bekir	SA-PO817	Terashita, Maho	FR-PO832, FR-PO850	Thomas, Litty	FR-PO484
Talabani, Bnar	FR-PO365	Tansho, Kosuke	SA-PO891	Terinte-Balcan, George	TH-PO561,	Thomas, Madison	TH-PO152,
Talaulikar, Girish S.	TH-PO272,	Tantisattamo, Ekamol	TH-PO598,		PUB107		FR-OR04
	TH-PO275		FR-PO800, SA-PO874	Terker, Andrew S.	TH-PO340,	Thomas, Rae	FR-PO860
Talawalla, Tasneem	SA-PO711	Tantiyavarong, Pichaya	TH-PO668,		FR-OR44	Thomas, Raj Jessica	TH-PO580
Talbot, Ben	FR-PO527		TH-PO669, FR-PO079	Terness, Peter	TH-PO536, SA-OR47	Thomas, Sandhya S.	SA-PO964
Talbot, Steven	SA-PO145	Tantraworasin, Apichat	TH-PO787	Teruel, Benjamin R.	FR-PO202	Thomas, Sarah T.	FR-PO860
Taliercio, Jonathan J.	TH-PO009,	Tao, Jiang	TH-PO708, SA-PO838	Terzian Ganadjan, Thiago	TH-PO904,	Thomas, Stephen B.	TH-PO456
	TH-PO010, TH-PO057,	Tao, Lei	PUB086		PUB320	Thompson, Austin D.	SA-PO071
	TH-PO059, TH-PO579, TH-PO618,	Tao, Li	SA-PO083	Terzibachi, Michel	TH-PO120	Thompson, David	FR-PO564
	TH-PO892, SA-PO426	Tao, Ran	TH-PO246, FR-PO307,	Tesar, Vladimir	TH-PO429, TH-PO498,	Thompson, Elizabeth A.	FR-PO172
Tallapaka, Shailendra	TH-PO116		FR-PO312, FR-PO316, FR-PO761		FR-OR55, FR-OR57, SA-PO712	Thompson, Jeffrey	SA-PO287
Talleur, Aimee	SA-PO128	Tao, Xia	SA-PO292, SA-PO319,	Tesfaye, Helen	SA-PO259	Thompson, Jordyn R.	TH-PO901
Talley, Melinda M.	PUB073	Tao, Yu	SA-PO427, SA-PO429	Tessier, Jean-François	FR-PO227	Thompson, Lauren E.	FR-PO223,
Talluri, Rajesh	FR-OR24, FR-PO926	Tapia Silva, Leticia M.	SA-PO532	Testani, Jeffrey M.	TH-PO603,		SA-PO158
Talukder, Niloy	FR-OR34	Tapia, Irati	TH-PO260, FR-PO203,		FR-PO083	Thompson, Trevor	FR-PO312
Talwar, Manish	TH-OR50, FR-PO787,		PUB151	Tevdoradze, Tamar	FR-PO036	Thompson, Zachary M.	SA-PO047
	SA-PO533, SA-PO864, SA-PO876,	Tariq, Anam	TH-PO511	Tew, Wei	TH-PO567	Thomson, Holly	SA-PO884
Tam, Tsz Wai	FR-PO1003	Tarng, Der-Cherng	FR-PO395	Tezuka, Yuta	FR-PO736	Thongprayoon, Charat	SA-PO824,
Tamaki, Hiroyuki	TH-PO251	Tasaki, Ayako	SA-PO395	Thaden, Joshua T.	SA-PO452		SA-PO835
Tamargo, Christina L.	PUB265	Tasaki, Hikari	TH-PO251, FR-PO925,	Thadhani, Ravi I.	SA-PO187,	Thongsricome, Thana	SA-PO449
Tammara, Alessandra	SA-PO072		SA-PO700		SA-PO462	Thoonkuzhy, Christina E.	FR-PO482
Tampe, Bjoern	FR-PO581, FR-PO653	Tasanavipas, Pamila	TH-PO831,	Thajudeen, Bijin	PUB126	Thornton, Mackenzie	FR-PO243,
Tampe, Desiree	FR-PO581, FR-PO653		FR-PO021, FR-PO908, SA-PO162,	Thakar, Charuhas V.	FR-PO113,		SA-PO745
Tamura, Kouichi	TH-PO199,		SA-PO901		FR-PO514, SA-PO094, PUB117	Thornton, Matthew E.	FR-PO321,
	TH-PO844, SA-PO456, SA-PO997	Tasian, Gregory E.	SA-PO207	Thaker, Jugal	PUB166		FR-PO378
Tamura, Manjula	TH-PO774	Tassinari, Sarah	FR-PO331	Thakkar, Asish	FR-PO759	Thorpe, Carolyn T.	SA-PO694
Tamura, Teiichi	SA-PO549	Taveira Gomes, Tiago	TH-PO627,	Thakkar, Jyotsana	TH-PO120,	Thorsteinsdottir, Bjoerg	TH-PO733,
Tan Lim, Pamela O.	SA-PO687		TH-PO628		TH-PO285		TH-PO794
Tan, Akira F.	SA-PO114	Tawadrous, Hanan K.	PUB275	Thakker, Kamlesh M.	FR-PO662,	Thorsteinsdottir, Margret	SA-PO579
Tan, Chee Wooi	TH-PO288	Tawfik, Ronda	TH-PO505		SA-PO702	Thorsteinsdottir, Sigrún	FR-PO933
Tan, Chieh-suai	TH-PO268	Tawhari, Ibrahim	FR-PO848	Thakker, Rajesh V.	FR-PO556	Thorsteinsdottir, Unnur A.	SA-PO579
Tan, Gavin	TH-PO620, SA-PO284	Tawhari, Mohammed H.	FR-PO843,	Thalakola, Anish R.	SA-PO766	Thu, Mya S.	FR-PO403
Tan, Hui Zhuan	SA-PO114		FR-PO846, FR-PO847, PUB291,	Tham, Mingshen	FR-PO345	Thuesen, Anne D.	TH-PO931
Tan, Jia Wei	PUB170		PUB293	Thamer, Mae	TH-PO259	Thurman, Joshua M.	SA-PO596
Tan, Judy	FR-PO218	Tay, Hsien Ts'ung	TH-PO268	Thammavaranucupt, Kanin	TH-PO586,	Thwin, Ohnmar	TH-PO953, FR-PO009,
Tan, Li Ping	SA-PO336		TH-PO268		FR-PO016		SA-PO292, SA-PO319, SA-PO427,
Tan, Ru Yu	TH-PO268	Tay, Kiang Hiong	TH-PO268	Thanamayooran, Aran	SA-PO387,		SA-PO429, SA-PO430
Tan, Sven-Jean	SA-PO714	Tayeb, Maliha	FR-PO402		SA-PO717	Tian, Frances	FR-PO031
Tan, Wei	TH-OR20	Taylor, Abigail	TH-PO379, TH-PO380	Thattai, Ashwin	FR-PO198	Tian, Jin	SA-PO173
Tan, Weihao	SA-PO386	Taylor, Jenny C.	FR-PO556	Thau, Matthew R.	TH-OR10	Tian, Runxia	SA-PO599
Tan, Xin Yee	SA-PO530, SA-PO531,	Taylor, Jeremy G.	FR-PO878	Thaunat, Olivier	FR-PO773, FR-PO784	Tian, Wenlan	FR-PO803
	SA-PO535	Taylor, Jo	SA-PO325				

Tian, Xin	FR-PO345	Torres, Jordan	SA-PO503	Tsai, Min Kuang	TH-PO613,	Ueda, Michiko	TH-PO697, PUB004
Tian, Zhejia	SA-PO444	Torres, Vicente E.	TH-PO368,		TH-PO816, PUB251	Uehara, Atsuko	PUB267
Tighiouart, Hocine	TH-PO603,		TH-PO375, TH-PO395,	Tsai, Ming-Tsun	TH-PO547	Uehara, Genta	FR-PO819
	TH-PO899, FR-PO083,		TH-PO400, TH-PO402, TH-PO403,	Tsai, Peihuan R.	TH-PO280	Ueki, Kenji	TH-PO576
	SA-PO913		TH-PO412, FR-PO254, FR-PO260,	Tsai, Shangfeng	PUB137, PUB195	Uemura, Takayuki	TH-PO251,
Tigka, Eirini	TH-PO363, TH-PO388,		FR-PO851	Tsai, Yu-Chen	PUB137		SA-PO700
	PUB186	Tory, Kalman	TH-PO761	Tsao, Philip S.	FR-PO761	Ufere, Nneka	TH-PO054
Tijani, Aminat A.	SA-PO710	Toth-Manikowski,		Tschongov, Todor A.	SA-PO592	Uhlmann, Anne-Catrin	SA-PO606
Tillquist, Kristen N.	FR-PO949	Stephanie M.	PUB345	Tseng, Min-hua	SA-PO569, SA-PO583	Uhlmann, Wendy R.	SA-PO544
Timmons, Winnfred L.	SA-PO298	Toth, Balazs	TH-PO567	Tseng, Tzu-Ling	TH-PO547	Ukrainetz, Judy A.	SA-PO346
Tin, Adrienne	FR-PO757	Tothova, Lubomira	PUB289	Tseng, Wei-Cheng	TH-PO547,	Ulasi, Ifeoma I.	TH-PO475, TH-PO805,
Tinaglia, Angeliki G.	TH-PO051	Toto, Robert D.	FR-OR26, FR-PO550,		FR-PO395		TH-PO806, FR-PO891
Ting, Tze L.	SA-PO336		SA-OR36, SA-PO886, SA-PO889			Ulloa Galvan, Victor M.	PUB244
Tingskov, Stine Julie	TH-PO344	Tougaard, Ninna H.	TH-PO234,			Umeda, Masataka	SA-PO024
Tio, Maria Clarissa	TH-PO463,		TH-PO239			Umemoto, Shuro	TH-PO210
	TH-PO879, FR-OR24, FR-PO926,	Toussaint, Nigel D.	SA-PO174			Unemekeje, Ebele M.	SA-PO305
	SA-PO362, SA-PO495	Tovar Padua, Leidy	FR-PO107			Uni, Rie	TH-PO705
Tipneni, Raghu	TH-PO133, PUB043	Townamchai, Natavudh	TH-PO652			Unnersjö-Jess, David	FR-PO329,
Tiranathanagul, Khajohn	SA-PO406	Townsend, Raymond R.	TH-PO238				FR-PO698, FR-PO707
Tischfield, Jay A.	FR-PO333	Townsley, Erin	SA-PO508			Unnerstall, Tim	TH-PO230
Tisdale, Lela	TH-PO953, FR-PO009,	Toyama, Tadashi	FR-PO938,			Unoki-Kubota, Hiroyuki	TH-PO248
	FR-PO496, SA-PO430, PUB134		SA-PO911, PUB210,			Unruh, Mark L.	TH-PO867
			PUB347, PUB348			Unwin, Robert J.	FR-PO639
Titan, Silvia M.	SA-PO556	Trachtman, Howard	TH-PO594,			Upadhyay, Rohit	TH-PO189
Titus, Thomas T.	FR-PO860		FR-OR57, FR-PO663,			Uppal, Nikhil	SA-PO959
Tiwari, Swasti	PUB114		SA-PO735, PUB234			Uppal, Nupur N.	SA-PO664,
Tiwari, Vaibhav	TH-PO044, SA-PO815,						SA-PO863, PUB024
	PUB150, PUB324	Tracy, LaRee A.	TH-PO413			Upson, Samantha G.	TH-PO554
Tobe, Sheldon W.	SA-PO262	Trakarnvanich, Thananda	TH-PO929			Ural, Zeynep	FR-PO854
Tobias, Jonathan	SA-PO848	Tran Thuy, Huong Quynh	FR-PO289,			Urano, Fumihiko	TH-PO443,
Tobin, Jonathan N.	TH-PO840		FR-PO324, SA-PO526				FR-PO343
Toda, Minami	SA-OR03	Tran, Cheryl L.	TH-PO594,			Urate, Shingo	TH-PO199, SA-PO997
Todorov, Vladimir T.	TH-PO226,		PUB230			Urbak, Lærke	PUB103
	FR-PO372, FR-PO387	Tran, Diana	TH-PO853, FR-PO899,			Urbanski, Megan A.	FR-PO540,
Toenshoff, Burkhard	TH-OR34		FR-PO900				FR-PO541
Tofte, Nete	SA-PO272, PUB095,	Tran, Huong Elena	TH-PO398			Urena Torres, Pablo A.	SA-PO325
	PUB103, PUB105	Tran, Linh N.	FR-PO289, FR-PO324,			Urey, Cristian J.	TH-PO559
			SA-PO526			Uribarri, Jaime	TH-PO166, FR-PO488,
Tokuhara, Daisuke	SA-PO589	Tran, Melanie	FR-PO970				FR-PO495
Tokunaga, Fuminori	TH-PO339	Tran, Michelle	SA-PO317			Uribe, Ricardo	FR-PO460
Tolani, Renuka	TH-PO125, SA-PO493	Tran, Nghia D.	PUB250			Uriol Rivera, Miguel	TH-PO501,
Tolerico, Matthew	FR-PO694,	Tran, Pamela V.	FR-PO252, FR-PO257,				TH-PO672, SA-PO695
	SA-PO750		SA-OR14			Urisman, Anatoly	SA-PO938
Töllner, Maximilian	TH-PO920	Tran, Thuong H.	TH-PO920,			Uriyanghai, Unimunkh	TH-OR20
Tolwani, Ashita J.	FR-PO101		FR-PO774, SA-OR47			Urrutia, Andrea L.	PUB009
Tom, Mark anthony A.	PUB030	Tran, Tiffany	TH-PO808			Usui, Koji	SA-PO370
Tomar, Bhawna	FR-PO966	Tran, Yuen	SA-PO734			Usvyat, Len A.	TH-PO677, TH-PO725,
Tomar, Ojaswi S.	TH-PO507	Tranah, Gregory J.	TH-OR03,				TH-PO837, FR-PO512, FR-PO942,
Tomas, Nicola M.	TH-OR42,		TH-PO797, TH-PO865				SA-OR07, SA-PO308, SA-PO310,
	SA-PO746, SA-PO747	Trant, Jordan	FR-PO264				SA-PO328, SA-PO341, SA-PO343,
Tomaszewski, John E.	SA-PO001	Trapani, Angelo J.	TH-PO505				SA-PO378, SA-PO390, SA-PO398
Tomaszewski, Kristen	TH-PO470,	Trask, Cassandra	FR-PO260				FR-PO802
	FR-PO038, FR-PO630, SA-OR44,	Traum, Avi	SA-PO528				FR-PO278,
	SA-PO877	Trautman, Christopher L.	TH-PO412				TH-PO296
Tomaz, David C.	FR-PO167	Trebach, Joshua	TH-PO515				SA-PO946
Tomazdas, Ioannis	TH-PO501	Treger, Richard M.	TH-PO703				TH-PO297,
Tommerdahl, Kalie L.	TH-PO247,	Tremblay, Julien	FR-PO566				TH-PO601
	TH-PO253, TH-PO857, PUB100	Trepiccione, Francesco	PUB249				SA-PO135
Tomonari, Tatsuya	FR-PO108	Turner, A. Neil	TH-PO494, SA-PO560				SA-PO148
Tomori, Koji	FR-PO940	Turner, Jeffrey M.	SA-PO046				FR-PO736
Tøndel, Camilla	FR-PO231, FR-PO699	Turzhitsky, Vladimir	FR-PO829,				SA-PO859
Toneli, Pernilla	FR-PO696		FR-PO849				SA-PO934
Tonelli, Marcello	SA-PO462	Trevisani, Francesco	TH-PO075,				FR-PO029,
Tong, Allison	FR-PO871, FR-PO894		SA-PO118, SA-PO119, SA-PO120,				SA-PO301
Tong, Lili	TH-PO843		SA-PO135				SA-PO473
Tong, Nanwei	SA-PO273	Trigo, Filipa	TH-PO937				PUB053
Tong, Vincent	FR-PO334	Trimarchi, Hernan	FR-OR59,				SA-PO732
Tonnus, Wulf	TH-PO188, SA-PO081		FR-PO658, SA-PO712				SA-PO918
Tonoli, Mattia	TH-PO508	Trink, Jackie	TH-PO186, TH-PO198				TH-PO408
Topete reyes, Jorge fernando	TH-PO907, PUB053,	Trinka, Teresa	SA-PO558				FR-PO237
	PUB310	Trinsch, Bastian	FR-PO600				SA-PO918
		Triozzi, Jefferson L.	TH-PO246,				SA-PO815
			FR-PO307, SA-PO854				FR-PO357
Topf, Joel M.	TH-OR47, SA-PO288	Trisal, Shehjar	FR-PO214				FR-PO194
Toquica Gahona,		Trivedi, Anuja	FR-PO486				TH-PO815
Christian C.	FR-PO033	Trivedi, Mona	FR-OR39				SA-PO996
Torban, Elena	FR-PO292	Trongtorsak, Angkawipa	FR-PO096				PUB233
Torii, Satoru	SA-PO1008	Troost, Jonathan P.	TH-PO530				SA-PO433
Torino, Claudia	TH-PO788, SA-PO932	Trotter, Benjamin	TH-PO567				PUB175,
Torisu, Kumiko	FR-PO117, FR-PO961	Troutman, Ashley D.	TH-PO146				PUB304
Torra, Roser	TH-PO761, PUB197	Troyanov, Stephan	FR-PO095,				TH-PO718
Torres Cintron, Jose	TH-PO345		FR-PO563				TH-PO644
Torres Cuevas, Jose L.	FR-PO027	Troyanskaya, Olga	FR-OR20				FR-PO1009
Torres Nunez, Marleni R.	FR-PO040	Trujillo, Jacquelyn	TH-PO869				TH-PO761
Torres Rivera, Silvina	TH-PO838,	Truman, Matt	FR-OR58				FR-PO104,
	TH-PO870	Truong, Luan D.	FR-OR27				SA-PO345
Torres, Armando	TH-OR34, SA-PO329	Truong, Tai	PUB097				TH-PO761
Torres, Jacob A.	FR-PO242, FR-PO295,	Truys, Tânia P.	SA-PO213				TH-PO503,
	PUB191	Tsai, Hao-Hsuan	SA-PO214				FR-PO034, PUB236

Van De Wetering, Jacqueline FR-PO857  
 van den Berg, Bernard TH-OR43, FR-OR35  
 Van den Berg, Cathelijne W. TH-OR43  
 van den Berge, Bartholomeus T. TH-PO533, FR-PO441  
 Van den Bergh, Davinia TH-PO385  
 Van den born, Bert-jan FR-OR47  
 van den Born, Jacob TH-OR46, TH-PO148, TH-PO643, TH-PO644, FR-PO773, FR-PO784, SA-PO270  
 Van den brink, Marcel M. FR-PO155  
 van den Broek, Martijn TH-PO533  
 van den Heuvel-Eibrink, M.M. FR-PO194  
 Van den heuvel, Lambertus P. TH-PO503, FR-PO331  
 van den Heuvel, Marius C. FR-PO784  
 van der Burch, Anna C. FR-PO920  
 Van Der Eems, Tara J. FR-PO863  
 van der Giet, Markus TH-PO769, TH-PO775, TH-PO780, TH-PO796, TH-PO882  
 van der Heijden, Olivier W. FR-PO857  
 Van der kooij, Sandra W. FR-PO011  
 van der Pluijm, Lois TH-OR43, FR-PO386, SA-PO344  
 van der Sande, Frank SA-PO918  
 Van Doren, Matthew P. TH-PO761, SA-PO536  
 van Eerde, Albertien M. FR-PO440, FR-PO441  
 van Genderen, Anne Metje SA-PO025  
 Van Ginkel, Michael J. TH-OR12  
 Van Hamersvelt, Henk W. FR-PO857  
 Van Hemert, Martijn J. FR-PO011  
 van Heugten, Martijn H. TH-PO406  
 Van Hummelen, Paul FR-PO780  
 van Kooten, Cees FR-PO011, FR-PO1009  
 Van Koppen, Arianne SA-PO223, SA-PO224  
 van Leeuwen, Jolijn R. FR-PO645  
 Van Manen, Lori N. FR-PO835  
 Van Nuys, Karen FR-PO865  
 Van Nynatten, Logan R. SA-PO542  
 van Raalte, Daniël H. TH-PO253, PUB100  
 van Schijndel, Emma H. TH-PO597, FR-OR47  
 Van Sciver, Robert E. TH-OR35  
 Van Spitzenbergen, Beatriz Akemi K. TH-PO704  
 van Willigenburg, Hester TH-PO354  
 Van Zonneveld, Anton J. FR-PO386  
 Van Zuilen, Arjan D. FR-PO034  
 Vanbeek, Christine A. FR-PO947, SA-PO751, TH-PO655  
 Vance, Krysten TH-PO502  
 Vande walle, Johan TH-PO081  
 Vandenheuvel, Katherine A. TH-PO528  
 Vangapalli, Ananthaxmi TH-PO369, TH-PO370  
 Varanasi, Laalasa SA-PO291  
 Varda, Luka FR-PO471  
 Vardhan, Anand TH-PO739  
 Varela, Dalila SA-PO928  
 Varela, Eva P. FR-PO029  
 Vargas angel, Diana C. TH-PO818, TH-PO821, TH-PO823, TH-PO824  
 Vargas, Chenoa R. TH-PO818, TH-PO821, TH-PO823, TH-PO824  
 Varghese, Julie A. PUB312  
 Varghese, Vipin TH-PO055, TH-PO063, FR-OR13, FR-PO634, FR-PO635, SA-PO680  
 Varma, Disha TH-PO588  
 Varma, Elly FR-PO767  
 Varnell, Charles D. FR-PO571, SA-PO855  
 Varona Santos, Javier T. TH-PO207, FR-PO323, SA-PO244  
 Varothai, Narittaya TH-OR14, TH-PO831, FR-PO021, FR-PO908, SA-PO162, SA-PO276, SA-PO901  
 Varrone, Francesca TH-PO408  
 Vart, Priya SA-OR36, SA-PO889  
 Vartanian, Nicholas TH-PO629  
 Vartanian, Shant M. SA-PO018  
 Varughese, Jeryl P. FR-PO624  
 Vasconcelos, Pedro D. FR-PO094, SA-PO041  
 Vasilyev, Arseniy FR-PO025  
 Vasnawala, Hardik TH-PO233, SA-PO283  
 Vasquez Espinosa, Carla F. FR-PO033  
 Vasquez Espinosa, William A. FR-PO033, FR-PO050  
 Vasquez Martinez, Gabriela SA-PO108, SA-PO154  
 Vázquez Perez, Ana K. PUB089  
 Vasquez-Rios, George TH-OR07, TH-PO083, TH-PO243, SA-PO953, PUB112  
 Vasquez, Arinson FR-PO002  
 Vassalotti, Allison FR-OR38, SA-PO764  
 Vassilopoulos, Dimitrios FR-PO589  
 Vasudevan, Jaya FR-PO735  
 Vasylyeva, Tetyana L. TH-PO537, TH-PO760, SA-PO585  
 Vatanapradith, Athip FR-PO612  
 Vathsala, Anantharaman TH-PO950  
 Vatish, Manu TH-PO753  
 Vattimo, Maria de Fatima F. TH-PO110, SA-PO102  
 Vaughan, Lisa E. SA-PO149, SA-PO153  
 Vayalakkada, Suresh PUB286  
 Vaz, Julia B. SA-PO165, SA-PO176, SA-PO195  
 Vazquez Mendez, Estefania TH-PO233, SA-PO283  
 Vazquez Salas, Sandra I. PUB265  
 Vazquez-Padron, Roberto I. TH-PO256, TH-PO279, SA-PO403  
 Vázquez, Jorge PUB253  
 Vázquez, Norma H. TH-PO318, FR-PO007  
 Veelken, Roland SA-PO784, PUB255  
 Veenit, Vandana PUB361  
 Veerasamy, Mangalakumar SA-PO678, PUB334  
 Vega Lopez de Nava, Jesus A. TH-PO907, PUB053, PUB310  
 Vega-Colon, Jesus D. TH-PO526, SA-PO059, SA-PO480, PUB177, PUB219  
 Vega-Warner, V. TH-PO441, FR-PO992  
 Vega, Almudena TH-PO154  
 Vega, Molly R. FR-PO427, SA-PO602  
 Vega, Natali SA-OR39  
 Vega, Olynka FR-PO003, FR-PO004, SA-PO411  
 Vegting, Yosta TH-PO416  
 Veiga, Nuphar FR-OR14  
 Veinot, Tiffany C. TH-PO706, FR-PO936  
 Velagapudi, Ramya Krishna SA-PO032, SA-PO672, SA-PO854  
 Velar, Alex A. TH-PO519, TH-PO520  
 Velasco Garcia Lascurain, Francisco FR-PO618, SA-PO483, PUB115  
 Velasquez, Maile FR-PO993  
 Velazquez, Heino FR-PO122  
 Velez, Juan Carlos Q. TH-PO034, TH-PO038, TH-PO055, TH-PO063, TH-PO073, TH-PO134, TH-PO563, TH-PO575, FR-OR13, FR-PO567, FR-PO610, FR-PO634, FR-PO635, SA-OR01, SA-PO032, SA-PO680, SA-PO702, SA-PO710  
 Velioglu, Arzu FR-PO824, SA-PO795  
 Vellanki, Kavitha FR-PO206, SA-PO140  
 Veloso, Valeria PUB196  
 Velpandian, Thirumurthy PUB287  
 Vemulapalli, Uday SA-PO508  
 Vena, Natalie SA-PO543  
 Venable, Andrea H. SA-PO106  
 Vendeville, Nicolas FR-PO903  
 Venegas, Miguel Ángel P. TH-PO045, PUB209  
 Venkataraman, Kavita SA-PO284  
 Venkatesan, Manigandan FR-OR11  
 Venkatesh, Ishwarya TH-PO588  
 Ventura, Sara TH-PO110, SA-PO102  
 Ventzke, Michel T. FR-PO708  
 Verbitsky, Miguel SA-PO606  
 Vergani, Maria Vittoria TH-PO367  
 Vergara Pérez, Hugo PUB197  
 Vergara-Rejante, Lorraine S. PUB047  
 Vergara, Ander TH-PO178, FR-PO024, SA-PO130  
 Verghese, Priya S. SA-PO744  
 Verhaar, Marianne C. TH-PO331, FR-PO383, SA-PO021  
 Verissimo, Thomas TH-PO556  
 Verlander, Jill W. TH-PO310  
 Verma, Ashish TH-PO877, FR-PO944, SA-OR34, PUB102  
 Verma, Neeraj FR-PO217  
 Vermonden, Tina FR-PO025  
 Vernon, Katherine A. TH-OR51  
 Vernon, Margaret TH-PO660, TH-PO661  
 Verploegen, Maartje F. FR-PO337  
 Verrelli, Alyssa M. SA-PO698  
 Vervaet, Benjamin A. SA-PO088  
 Vervloet, Marc G. TH-PO685, SA-PO179, SA-PO286  
 Vespa, Marta TH-PO367  
 Vest, Michael T. FR-PO058  
 Vestergaard, Ane Emilie F. TH-OR04  
 Vezzoli, Giuseppe TH-PO367, FR-PO073  
 Viana, Joao L. TH-OR13, SA-PO402, SA-PO979  
 Victoria Castro, Angela M. TH-PO599, FR-OR20, SA-PO947  
 Victoria, Carla d. TH-PO110  
 Vidal-Petiot, Emmanuelle FR-PO897  
 Viehman, Jason K. SA-PO153, SA-PO780  
 Vieira Jr., Jose M. SA-PO045, SA-PO433  
 Vieira Neto, Osvaldo M. TH-PO687, TH-PO688, PUB196  
 Vieira, Ana Teresa P. SA-PO433  
 Vieira, Fernando A. PUB196  
 Vieira, Mariana O. PUB034  
 Vieira, Simone FR-PO430, SA-PO600  
 Vienenkoetter, Julia SA-PO247  
 Vienken, Theresia FR-PO274, SA-PO251  
 Vierling, John M. TH-PO034  
 Vigers, Tim TH-PO231, TH-PO247  
 Viggewarapu, Manjula TH-PO802  
 Viggiano, Davide SA-PO130  
 Vigneau, Cecile M. SA-PO321  
 Vijay, Adarsh SA-PO802  
 Vijayan, Anitha FR-PO114  
 Vikrant, Sanjay PUB152  
 Vila-Beamonte, Pablo PUB084  
 Vilardeñ, Jordi TH-PO638  
 Villa, Alessandro TH-PO483  
 Villacorta Monge, Valerie J. TH-PO533  
 Villafior, Lierisa D. TH-PO011  
 Villani, Valentina FR-PO378, FR-PO691, SA-OR28  
 Villano, Svetlana O. SA-PO458, SA-PO670, PUB304  
 Villanueva Macedo, Roxana PUB053  
 Villanueva, Veronica FR-PO594  
 Villarama, Maricar FR-PO496, PUB134  
 Villasana Ballesteros, Mariana SA-OR39  
 Villavicencio López, Carlos A. TH-PO907  
 Villegas Gutierrez, Luz Yareli PUB310  
 Villicana, Rafael SA-PO843  
 Villiger, Ross FR-PO980  
 Vinas, Jose L. SA-PO082  
 Vinatier, Emeline FR-PO588, FR-PO591  
 Vincent, Carol TH-PO590, TH-PO592, TH-PO593, SA-PO789, SA-PO790  
 Vincent, Thomas FR-PO361  
 Vincenti, Flavio SA-PO798, SA-PO1004  
 Vincenzi, Paolo FR-PO806  
 Vinchi, Francesca TH-PO705  
 Vinke, Joanna Sophia J. TH-PO675, TH-PO676, TH-PO698  
 Vinovskis, Carissa PUB100  
 Vinson, Amanda J. TH-PO943, SA-PO387, SA-PO717  
 Viquez, Olga FR-PO368, FR-PO369  
 Virani, Salim S. TH-PO607, PUB099  
 Virgincar, Rohan S. FR-PO912  
 Virgitti, Jean Blaise J. TH-PO889  
 Viroliya, Krina SA-PO503  
 Vishnepolsky, Mark TH-PO497  
 Vishnu, Neelanjani FR-OR11  
 Vishy, Courtney E. FR-PO251  
 Visser, Leo G. FR-PO011  
 Vissing, Andrew FR-PO668  
 Vistsen, Dorte SA-PO263, SA-PO282  
 Viswanathan, A. TH-OR25  
 Vitzthum, Helga TH-PO309  
 Vivarelli, Marina FR-PO303, SA-PO706  
 Viviano, Irina TH-PO590, TH-PO592, TH-PO593  
 Vizoso, Marta FR-PO273  
 Vlahos, Penny TH-PO863  
 Vlasschaert, Caitlyn TH-OR01  
 Vo, Nam D. TH-PO497  
 Vo, Nicole FR-PO352  
 Vo, Thanh-Mai N. SA-PO850, SA-PO851  
 Vodošek Hojs, Nina FR-PO010  
 Vogt, Beth A. FR-PO863  
 Vogt, Isabel TH-PO156, SA-PO987  
 Vogt, Liffert TH-PO416, TH-PO597, TH-PO761, FR-OR47, SA-PO536  
 Volker, Linus A. TH-PO506, FR-PO687, SA-PO709  
 Vollmer Barbosa, Clara SA-PO444  
 Volovelsky, Oded TH-OR36, TH-PO147, FR-PO291, FR-PO384  
 von Baehr, Volker PUB015  
 von der Leyen, Heiko SA-PO272, PUB095  
 Von Drasek, John C. TH-PO149, TH-PO656, SA-PO214  
 Von Vietinghoff, Sibylle TH-PO540, SA-PO112  
 Von Visger, Jon R. FR-OR821  
 Vonbrunn, Eva FR-PO013, FR-PO076  
 Vornicu, Alexandra TH-PO561, PUB107  
 Votta, Claudio TH-PO398  
 Vouillamoz, Judith FR-PO1007  
 Vrana, Julie A. FR-PO190  
 Vranes, Samantha SA-PO015  
 Vrang, Niels PUB365  
 Vrhnjak, Blaz SA-PO268  
 Vrtovsniak, Francois SA-PO649  
 Vukojevic, Katarina SA-PO620, SA-PO622  
 Vuong, Kimmy T. SA-PO602  
 Vuong, Lynda SA-PO1007  
 Vy, Thi ha my FR-PO311  
 Vyas, Charnee H. PUB043  
 Vyas, Prema D. TH-PO748  
 Vychytil, Andreas FR-PO454, FR-PO467  
 Vyletal, Petr TH-PO380  
 Wabnitz, Paul SA-PO636  
 Wachtel, Heather FR-PO736  
 Wacrenier, Samuel FR-PO580, FR-PO588, FR-PO591  
 Wada, Atsushi SA-PO399

Wada, Takashi	TH-PO094, FR-PO938, SA-PO911, PUB210, PUB347, PUB348	Wang, Chia-Shi	TH-PO472, TH-PO474	Wang, Zhaoze	SA-PO002	Weiner, Lia	TH-PO484
Wada, Takehiko	SA-PO212, SA-PO510	Wang, Dan	TH-PO424, SA-PO418	Waniewski, Jacek	FR-PO492	Weingärtner, Nina	SA-PO987
Wadei, Hani	SA-PO823, PUB319	Wang, Daniel Y.	FR-PO181	Wanigatunga, Melanie	SA-PO471	Weinhandl, Eric D.	TH-OR17,
Wadhwa, Anuradha	FR-PO479	Wang, Feng	TH-PO350	Wankowicz, Zofia	FR-PO492	TH-PO700, TH-PO955, FR-PO491, FR-PO508, FR-PO509, FR-PO510,	
Wadhvani, Shikha	TH-PO472, TH-PO473, TH-PO760, FR-PO041	Wang, Gangan	TH-PO200	Wannaphut, Chalothorn	TH-PO598	FR-PO511	
Wadud, Mohammad H.	SA-PO507	Wang, Gangqi	TH-OR43, FR-OR35	Wanner, Christoph	TH-PO685, TH-PO690, TH-PO788, SA-PO115, SA-PO932	Weinreich, Thomas	FR-PO914
Wagner, Benjamin R.	PUB190	Wang, Guanchao	TH-PO246, FR-PO307	Wanner, Nicola	FR-PO342, FR-PO699	Weins, Astrid	SA-OR46
Wagner, Brent	TH-PO091, TH-PO092, TH-PO848, SA-PO077	Wang, Guanyu	TH-PO442	Wapinski, Ilan	TH-PO567	Weinstein, Alan M.	TH-PO342, SA-PO728
Wagner, Carsten A.	TH-PO309	Wang, Hanwen	TH-PO852	Warady, Bradley A.	FR-PO408, FR-PO409, FR-PO410, FR-PO417, SA-PO949	Weinstein, Jason N.	TH-PO564, PUB054
Wagner, Leonie F.	FR-PO157	Wang, Henry	SA-OR14	Ward, Donald T.	TH-PO172	Weir, Matthew R.	TH-PO057, TH-PO618, FR-PO550, FR-PO765, FR-PO803, FR-PO834
Wagner, Matilda	FR-PO799	Wang, Hong	TH-PO891	Ward, Francis	SA-PO669	Weisbord, Steven D.	FR-OR67
Wahba, Joseph	SA-PO764	Wang, Hubert	TH-PO132	Ward, Heather H.	SA-PO249	Weiser-Evans, Mary C.	TH-PO085
Waheed, Ahmed A.	SA-PO473, SA-PO513	Wang, I-kuan	FR-PO473	Ward, Liam J.	TH-PO649	Weiss, Nick	TH-PO565
Wai, Christine	TH-OR20	Wang, Jing	TH-PO850	Ward, Michaela	FR-PO516	Weiss, Steven	TH-PO292
Waikar, Sushrut S.	TH-OR03, TH-PO215, TH-PO243, TH-PO247, TH-PO686, TH-PO687, TH-PO730, TH-PO805, TH-PO806, TH-PO865, TH-PO877, FR-PO944, SA-OR34, SA-OR37, SA-PO364, SA-PO369, SA-PO736, SA-PO960, SA-PO991, PUB102	Wang, Jingjing	TH-PO621	Ward, Richard	FR-PO681	Weissenbacher, Davy	PUB282
Wainstein, Marina	FR-PO032	Wang, Kaijun	TH-PO478, TH-PO494, FR-PO662, SA-PO702	Ward, Sandra E.	TH-PO777	Weisser, Ivan D.	FR-PO406
Waizman, Joshua S.	FR-PO347	Wang, Kaiming	FR-PO024	Ward, Stephen C.	TH-PO515, SA-PO725	Welch, Richard C.	SA-PO069
Wakai, Sachiko	FR-OR03	Wang, Lei	TH-PO536, FR-PO158, SA-OR47	Wardrop, Richard M.	TH-PO009, TH-PO010	Welling, Paul A.	TH-PO305, FR-OR42, FR-PO145, FR-PO147
Wakasugi, Minako	FR-PO945	Wang, Li	TH-PO432, SA-PO273, SA-PO773	Warehime, Jacqueline R.	FR-PO872	Wells, Catherine C.	SA-PO362
Wakhare, Pavan	TH-PO430, SA-PO813	Wang, Lihua	SA-PO172	Warner, David M.	PUB271	Wells, James	FR-PO584
Wakui, Hiromichi	TH-PO199, TH-PO844, SA-PO456, SA-PO997	Wang, Lili	SA-PO274	Warnock, David G.	FR-PO231	Wells, Jonathan C.	FR-PO433
Walawender, Laura E.	SA-PO619	Wang, Lin	SA-PO642, SA-PO643, SA-PO845	Warraich, Fatima Z.	TH-PO886	Welsh, Gavin I.	TH-PO193, TH-PO450, FR-PO302, FR-PO325, FR-PO639, FR-PO709, FR-PO715, SA-PO233
Wald, Ron	TH-PO040, SA-PO327	Wang, Lin-Chun	SA-PO319, SA-PO427, SA-PO430, PUB080	Warren, Helen R.	SA-PO774	Weltman, Melanie R.	SA-PO942
Waldek, Stephen	FR-PO231	Wang, Linda	SA-PO623	Wasehuus, Victor	SA-PO272	Wen, Chi pang	TH-PO613, TH-PO816, PUB251
Waldherr, Ruediger	SA-OR47	Wang, Lingyun	TH-PO353	Watanabe, Hirofumi	SA-PO640	Wen, Donghai	SA-PO736
Waldman, Meryl A.	TH-PO760, FR-OR51	Wang, Lucas	TH-PO913, PUB001, PUB027	Watanabe, Kentaro	SA-PO209	Wen, Huei Hsun	TH-PO707, FR-PO488
Walker, Adam G.	FR-OR873, SA-PO320	Wang, Lulu	SA-PO748	Watanabe, Takashi	FR-PO275	Wen, Jin	FR-PO676
Walker, David D.	SA-OR02	Wang, Minxian	FR-PO370	Watanabe, Yusuke	FR-PO940	Wen, Lu	FR-PO128
Walker, Patrick D.	TH-PO478, TH-PO566	Wang, Ping	FR-PO218	Waterman, Amy D.	TH-PO020, SA-OR31, SA-PO796, SA-PO797	Wen, Pei	FR-PO308
Walker, Rebecca V.	FR-PO281	Wang, Qian	SA-PO389	Waters, Aoife M.	FR-PO310, FR-PO332	Wen, Ping	PUB214
Wall, Barry M.	TH-PO878, SA-PO864, SA-PO876	Wang, Qiuxia	SA-PO651	Wathanavasin, Wannasit	TH-PO790	Wen, Warren	SA-PO286, SA-PO288, SA-PO401, SA-PO463
Wall, Nadezhda	TH-PO928	Wang, Qiyu	TH-PO958, FR-PO193, SA-PO155	Watnick, Suzanne	FR-PO476	Wen, Xia	FR-PO223
Wall, Susan M.	TH-PO310, FR-OR42	Wang, Rong	TH-PO221, FR-PO951	Watnick, Terry J.	FR-PO248, FR-PO252, FR-PO257, FR-PO281, FR-PO282	Wen, Xiaoquan	FR-PO308
Wallace, Darren P.	FR-PO243, FR-PO253, FR-PO257, FR-PO294, SA-OR14	Wang, Runping	SA-OR13	Watson, Emma L.	TH-PO674, TH-PO680, TH-PO830, SA-PO979	Wen, Yi	FR-PO953
Wallace, David C.	SA-PO663	Wang, Shixuan	FR-PO175	Watson, Maura A.	TH-PO014, FR-PO674, SA-PO519, PUB025	Wen, Yu	TH-PO282
Wallace, Eric L.	FR-PO231, FR-PO339, SA-PO460	Wang, Song	TH-PO282, SA-PO172, SA-PO173	Watt, John D.	TH-PO091	Wen, Yubing	TH-PO510, TH-PO562, FR-PO572
Wallace, William	TH-PO468	Wang, Stella Q.	TH-OR30	Wattanachayakul, Phuuwadith	TH-PO598	Wen, Yumeng	FR-PO116, SA-PO697
Wallen, Hakan	FR-PO760	Wang, Tao	TH-PO752, SA-PO745	Watts, Jason A.	TH-PO307, TH-PO308	Wenderfer, Scott E.	SA-PO585
Waller, Maximilian	SA-PO354	Wang, Tian	FR-PO593	Ways, Javaghn M.	TH-PO739	Wendt, Linder	TH-PO600
Walpen, Sebastian	SA-PO285, SA-PO286	Wang, Tong	TH-PO342	Weaver, Donald J.	TH-PO472, TH-PO590, TH-PO592, TH-PO593, TH-PO594	Wendt, Lisa M.	PUB345
Walsh, Michael	TH-PO767, FR-PO885, SA-PO327	Wang, Virginia	FR-PO064	Webb, Hanna T.	PUB204	Wendt, Ralph	FR-PO913
Walsh, Stephen B.	TH-OR40, TH-PO571, TH-PO573, FR-OR41, FR-OR45, FR-PO151, FR-PO337, FR-PO397, FR-PO554	Wang, Wei	TH-PO402, TH-PO403, TH-PO404, TH-PO492, FR-PO257, SA-OR14, SA-PO651	Webb, Nicholas	TH-PO505	Weng, Christina	SA-PO636
Walter Lamouroux, Christine	TH-PO322	Wang, Weiwei	FR-OR11	Webber, Allison B.	SA-PO857	Weng, Chunhua	SA-PO561
Walters, Laura	SA-PO038	Wang, Xiangling	FR-PO306, FR-PO442, SA-PO530, SA-PO531, SA-PO535, SA-PO567	Weber, Catherine L.	SA-PO347	Weng, Francis L.	SA-PO796, SA-PO797
Walther, Carl P.	TH-PO058, FR-PO110	Wang, Xiaodong	SA-PO845	Webster, Joshua	FR-PO912	Wenger, Roland H.	FR-PO1007
Walz, Gerd	FR-PO706	Wang, Xiaofang	FR-PO254	Weedon, Michael	TH-PO373	Weon, Boram	FR-OR21, FR-PO304, FR-PO932
Wan, Jun	TH-PO151	Wang, Xiaohua	TH-PO545, TH-PO551, PUB092	Weeravittayasate, Jakkrathip	TH-PO668	Wernerson, Annika	SA-PO1012
Wan, Qijun	TH-PO693	Wang, Xiaoling	TH-PO953, FR-PO009, SA-PO422, SA-PO427, SA-PO430	Wei, Chengguo	FR-PO959	Wertheim, Jason	FR-PO701
Wanchoo, Rimda	FR-PO213	Wang, Xiaonan H.	SA-PO781	Wei, David C.	TH-PO105, TH-PO215, SA-PO074	Wesselman, Hannah M.	FR-PO381, SA-OR16
Wander, Seth	SA-PO155	Wang, Xiaojin	TH-PO374	Wei, Guilong	SA-PO363, SA-PO380	Wessely, Oliver	SA-PO734
Wang-France, Jun	TH-PO321	Wang, Xiaoxin	TH-PO191, FR-PO688, FR-PO721, FR-PO999, SA-PO242	Wei, Guo	TH-OR23, TH-OR26, TH-PO634, TH-PO709, TH-PO710, FR-PO559, FR-PO737, FR-PO747, FR-PO748	Wessling, Matthias	SA-PO405
Wang, Anyu	SA-PO1009	Wang, Xichu	SA-PO026	Wei, Lulu	TH-PO942	Wessman, Peter	FR-PO550
Wang, Bangchen	TH-PO321, TH-PO569, TH-PO584, SA-PO711	Wang, Xin	SA-PO319, SA-PO422, SA-PO423, SA-PO427, SA-PO436	Wei, Rong	FR-PO547, FR-PO548	Wesson, Donald E.	SA-PO980, SA-PO981, SA-PO982
Wang, Baolin	FR-PO366, FR-PO367	Wang, Xueyan	TH-PO149, FR-OR02, FR-OR07, SA-PO214	Wei, Rong	FR-PO547, FR-PO548	Wesson, Jeffrey	SA-PO216
Wang, Baoxing	SA-PO172	Wang, Yan	TH-PO501, SA-PO097	Wei, Zemeng	FR-PO345	Westbrook, Adrianna	FR-PO319
Wang, Catherine Y.	TH-PO725, SA-PO398	Wang, Yanlin	FR-PO970	Wei, Qingqing	SA-PO970, SA-PO971	Westbrook, David G.	TH-PO152, FR-OR04
Wang, Chen	SA-PO735	Wang, Yanzhe	FR-PO285, FR-PO286, FR-PO1004	Wei, Rong	FR-PO547, FR-PO548	Westenfelder, Christof	TH-PO224, SA-PO019, SA-PO020
		Wang, Yeli	SA-PO921	Wei, Yuhong	FR-PO345	Wester Trejo, Maria	FR-OR55
		Wang, Yi	FR-PO962	Weidner, Jillian	TH-PO216	Westfall, Laura	FR-PO544
		Wang, Yihan	PUB193	Weimbs, Thomas	FR-PO242, FR-PO295, PUB191	Westhoff, Timm H.	TH-PO267
		Wang, Ying	SA-PO845	Weiner, Daniel E.	TH-PO153, TH-PO163, TH-PO921, TH-PO938, FR-PO500, FR-PO537, FR-PO834, SA-OR08, SA-PO286	Westing, Anniek V.	TH-PO846
		Wang, Yuedong	TH-PO725, SA-PO355, SA-PO398	Weiner, I. D.	TH-PO310, SA-PO492	Westphal, Scott G.	FR-PO052, PUB317
		Wang, Yujie	TH-PO445, SA-PO587, SA-PO705, SA-PO735			Wetmore, James B.	TH-OR17, TH-PO008
		Wang, Yves T.	FR-PO317, SA-PO760, SA-PO1002			Wetten, Sally	TH-PO658
						Wettersten, Nicholas	TH-PO031



Wetzels, Jack F. TH-PO503, TH-PO533, FR-PO034, FR-PO440, FR-PO441, SA-PO679	Wilson, Camille FR-PO417, FR-PO419, SA-PO949	Wong, Sandy W. SA-PO857, SA-PO938	Xiao, Qiong TH-PO431, SA-PO773
Wetzels, Roy TH-PO533	Wilson, Dan SA-PO275	Wong, Susan P. SA-OR32	Xiao, Rui FR-PO408, FR-PO409
Wexler, Deborah J. SA-PO259, SA-PO260, SA-PO010	Wilson, Daniel J. SA-PO271	Wongboonsin, Janewit SA-PO532	Xiao, Sheng PUB239
Whale, Larissa N. SA-PO010	Wilson, Francis P. TH-OR09, TH-PO080, TH-PO564, TH-PO599, FR-OR20, FR-PO063, FR-PO752, PUB054	Woo, Hyun Ah SA-PO550	Xiao, Youwen TH-PO282
Whaley, Kristin FR-PO863	Wilson, Gabrielle L. SA-PO738	Woo, Minna TH-PO765	Xiaokun, Ma FR-PO455
Wheeler, David C. TH-PO674, TH-PO680, FR-OR26, FR-PO552, SA-OR36, SA-PO885, SA-PO886, SA-PO888, SA-PO889	Wilson, Ian J. TH-PO378	Woodard, Lauren E. SA-PO069	Xie, Chuy SA-PO104
Whelton, Paul K. TH-OR23, FR-PO737, FR-PO747	Wilson, Jonathan A. TH-PO153, FR-PO537	Wooden, Benjamin SA-PO502	Xie, Guotong FR-PO813
White, Arthur SA-PO698	Wilson, Jonathan M. TH-PO232, SA-PO269	Woodhead, Jeffrey L. TH-PO116	Xie, Jian TH-PO348, SA-OR13
White, Eoghan SA-PO701	Wilson, Mark W. SA-PO018	Woodroffe, Carolyn C. SA-PO070	Xie, Jingyuan FR-PO962, SA-PO273
White, Kenneth E. TH-PO151	Wilson, Nancy A. TH-PO636	Woods, Steven D. SA-PO307	Xie, Lin FR-PO962
White, Neil H. TH-PO247	Wilson, Otis D. TH-PO246, FR-PO307, FR-PO312	Woodward, Owen M. FR-PO996	Xie, Luke FR-PO912
White, Wendy I. SA-PO685	Wilson, Parker C. FR-PO133, FR-PO308, SA-PO960	Woollf, Adrian S. SA-OR20	Xie, Xisheng TH-PO282
Whitecavage, Shaun M. TH-PO853, FR-PO900	Wilson, Peter W. FR-PO312, FR-PO761	Woollard, Kevin FR-PO167, FR-PO1008, SA-PO382	Xin, Yan FR-PO232
Whitlock, Reid TH-PO289, TH-PO630, FR-PO519, FR-PO885, SA-PO327	Wilt, Emily SA-PO954	Woolley, Ryan SA-PO541	Xing, Chao FR-PO689
Whitson, Jeremy A. FR-PO134	Wilund, Kenneth R. TH-OR13, TH-PO804, TH-PO817, SA-PO360, SA-PO402	Wopperer, Florian J. PUB194	Xiong, Fenfen FR-PO136
Whittier, Millan L. TH-PO633	Winfree, Seth TH-OR41, TH-PO655, FR-OR09, FR-OR34, FR-PO149, FR-PO150, FR-PO154, FR-PO169	Worcester, Elaine M. FR-OR09, SA-PO170	Xiong, Lin SA-PO773
Whittier, William L. FR-PO683	Wing, Richard E. TH-PO280	Workeneh, Biruh TH-PO007, TH-PO559, FR-PO659, SA-PO126	Xiong, Weijian TH-PO549, FR-PO188, PUB149
Wibaek, Rasmus FR-PO433	Wingert, Rebecca A. FR-PO381, SA-OR16	Worsley, Melandrea L. FR-PO859	Xochelli, Aliko TH-PO948
Wicklow, Brandy A. TH-PO765	Wingo, Charles S. TH-PO328, SA-PO769, SA-PO777	Wortley, Phillip PUB307	Xu, Alan Y. SA-PO947, PUB223
Wickman, Terrance J. TH-PO038	Winkelmayer, Wolfgang C. TH-OR32, FR-PO856, FR-PO859, SA-PO181, SA-PO326, SA-PO718, PUB172	Wright Nunes, Julie A. SA-PO267	Xu, Anna FR-PO537
Widmeier, Eugen SA-PO566	Winkler, Brennan TH-PO220	Wright, Jason M. TH-PO855	Xu, Anping FR-PO159, SA-PO066
Wiecek, Andrzej TH-PO685, SA-PO115	Winkler, Cheryl A. TH-PO752, TH-PO754, SA-PO958	Wright, Natasha C. FR-PO872	Xu, Chunyi TH-PO496
Wiech, Thorsten TH-OR42, TH-PO557, SA-PO251	Winkler, Rebecca L. FR-PO314	Wright, Nathan SA-PO018	Xu, Chuxue FR-PO281
Wieërs, Michiel L. FR-PO337	Winnett, Claire E. FR-PO217	Wu, Andrew TH-PO737	Xu, Hao TH-OR44
Wiegmann, Thomas TH-PO949	Winslow, Claire Winslow H. TH-PO392	Wu, Baolin FR-PO799	Xu, Jiatong TH-PO117
Wiemer, Hana SA-PO387	Winstead, Ryan FR-PO811	Wu, Chaoqing TH-PO273	Xu, Julia FR-PO233, FR-PO333
Wiese, Russell J. SA-PO269	Winter, Anke TH-PO837, SA-OR07, SA-PO390	Wu, Chia-Chao TH-PO157	Xu, Katherine SA-PO994
Wiesener, Antje PUB194	Winyard, Paul FR-PO379, SA-PO618	Wu, Emily TH-PO777	Xu, Leyuan FR-PO116, FR-PO122, SA-PO967
Wiesener, Michael S. TH-PO895, PUB194	Wipattanakitcharoen, Aschariya TH-PO582	Wu, Eric FR-PO488	Xu, Lillian TH-PO507, SA-PO697
Wiesner, Eva FR-PO698	Wirth, Anika FR-PO372	Wu, Gary TH-PO874	Xu, Lubin TH-PO117
Wigerinck, Stijn TH-PO400, TH-PO412, FR-PO851	Wiseman, Alexander C. FR-PO781, SA-OR45	Wu, Guanghong SA-OR27, SA-PO739	Xu, Minze TH-OR55, SA-PO793
Wijkstrom, Julia SA-PO1012	Wishart, David S. FR-PO024	Wu, Haojia TH-OR44, FR-PO133, SA-PO085, SA-PO960	Xu, Phoenix TH-PO104, PUB041, PUB323
Wijnsma, Kioa L. TH-PO503	Wisniewski, Addie SA-PO820	Wu, Hongsheng SA-PO895	Xu, Pin FR-OR25, FR-PO069, SA-PO926
Wilck, Nicola FR-PO420, SA-PO626	Wisniewski, Thomas SA-PO319	Wu, Hongwei FR-PO956	Xu, Pin FR-PO926
Wilcock, Daniel J. TH-PO433	Wisnivesky, Juan FR-PO006	Wu, Jiao SA-PO964	Xu, Xiaolei FR-PO258
Wilcox, William FR-PO339	Witt, Mallory D. TH-PO762	Wu, Jing-Tao SA-PO571	Xu, Xiaodong TH-OR16, SA-PO273
Wilde, Benjamin SA-OR42	Wittbrodt, Eric T. TH-PO855, FR-PO552	Wu, Jingtao SA-PO636	Xu, Xudong TH-OR16, SA-PO273
Wilflingseder, Julia SA-PO084	Wittes, Janet SA-PO115	Wu, Jining PUB214	Xu, Yan FR-PO072, FR-PO726, SA-PO1004, PUB121
Wilhelm, David J. PUB005	Witton, Natalie FR-PO835	Wu, Joyce FR-PO334	Xu, Yang TH-PO699
Wilhelm, Kevin O. FR-PO692	Woiatas, Rainer P. FR-PO503	Wu, Junnan FR-OR38, SA-PO764	Xu, Youjun FR-PO077, FR-PO078
Wilhelm, Maria FR-PO219	Wojciechowski, David FR-PO804	Wu, Keping TH-PO545, PUB092	Xu, Yunwen TH-PO896, FR-PO408, FR-PO409
Wilk, Adam S. SA-PO830	Wolf, Amber M. FR-PO405	Wu, Michael TH-PO589	Xu, Zhenjian FR-PO159, SA-PO066
Wilkins, Katy G. TH-OR18	Wolf, Bethany TH-PO220, FR-PO065	Wu, Ming FR-PO285, FR-PO286, FR-PO1004	Xuan, Gao FR-PO188
Wilkerson, Joseph L. SA-PO252	Wolf, Cydney J. FR-PO352	Wu, Raftar Y. FR-PO459	Xuantong, Dai SA-PO559
Wilkey, Daniel W. TH-PO446	Wolf, Matthias T. FR-OR46	Wu, Ruoxue FR-PO899	Xue, Laixi TH-PO382, TH-PO383
Wilkie, Caroline M. FR-PO862	Wolf, Michael FR-PO913	Wu, Shu SA-PO599	Xue, Xiaonan SA-PO156
Wilkie, Martin E. FR-PO471, FR-PO536	Wolf, Myles TH-PO869, SA-PO191	Wu, Sylvia PUB075	Yabes, Jonathan TH-PO722, FR-PO867, FR-PO942
Wilkinson, Thomas J. TH-PO674, TH-PO680, SA-PO946, SA-PO979	Wong-Jaen, Manuel PUB045	Wu, Wen-Chieh SA-PO386	Yadati, Pranav TH-PO730
Willcocks, Lisa TH-PO498	Wong, Cheuk Yin FR-PO972	Wu, Xiaomei TH-PO236	Yadav, Ashok K. TH-PO029, TH-PO639, FR-PO074, FR-PO886, FR-PO934, SA-PO905
Willemsen, Brigith TH-PO533	Wong, Craig S. TH-PO473	Wu, Yaqin FR-PO470	Yadav, Brijesh FR-PO139
Willett, Duwayne L. FR-OR25, FR-PO069	Wong, Dickson W. SA-PO786	Wu, Yongdong FR-OR27	Yadav, Kunal FR-PO797
Willett, Thomas C. FR-PO471	Wong, Dickson Y. TH-OR12	Wu, Yuanyan FR-PO136, FR-PO161	Yadav, Nikita S. SA-PO766
Willets, Joanna TH-PO837, TH-PO932, FR-PO494, FR-PO942, SA-PO390, SA-PO445, PUB011	Wong, Edwin K. TH-PO505, TH-PO751	Wulczyn, Kendra E. SA-PO462, SA-PO931	Yadla, Manjusha TH-PO076, PUB065, PUB154
Willey, Richard G. FR-PO335	Wong, Emmett Tsz Yeung TH-PO950	Wulfmeyer, Vera C. SA-PO112	Yagan, Jude A. FR-PO807, SA-PO844
William, Jeffrey H. PUB161	Wong, Germaine FR-PO871	Wurfel, Mark M. TH-OR02, TH-OR07, TH-OR10, FR-PO031, PUB028	Yahr, Jordana SA-PO523
Williams, Adrienne H. TH-PO379	Wong, Kari E. FR-PO918	Wuttiathanun, Thunyatorn SA-PO894	Yahya, Rosnawati SA-PO336
Williams, Anna E. TH-PO052	Wong, Katie SA-PO560	Wuttke, Matthias FR-PO915	Yajima, Toshitaka TH-PO883, FR-PO549
Williams, Dimeji O. PUB104	Wong, Limy TH-PO828	Wyatt, Christina M. SA-PO452	Yakoub, Mina TH-OR27
Williams, Hanah L. PUB167	Wong, Milagros N. TH-OR42, TH-OR47	Wyatt, Nicole TH-PO001	Yakubu, Idris FR-PO811, FR-PO855, SA-PO826
Williams, James C. TH-OR41, FR-OR09, FR-PO149, SA-OR05, SA-PO170	Wong, Muh Geot TH-PO497, TH-PO498, TH-PO688, SA-PO708, SA-PO712, SA-PO714	Wyatt, Robert J. SA-PO564	Yalamanchili, Venkata A. SA-PO690, PUB016, PUB017
Williams, Jan M. SA-PO976	Wong, Ryan TH-PO006	Wynne, Brandi M. SA-PO756	Yalikun, Dilina TH-PO374
Williamson, Geoffrey A. SA-PO014		Wysocki, Jan TH-PO304, TH-PO305, FR-PO015, FR-PO020, PUB094	Yama Estrella, Martin B. FR-PO618, SA-PO483
Williamson, Todd E. TH-PO718, FR-PO924		Wysocky, Gregory TH-PO708, SA-PO838	Yamada, Koshi SA-PO638
Willicombe, Michelle TH-PO799		Xavier, Kelia TH-PO959	Yamada, Masaaki TH-PO062,
Wilmington, Alyssa FR-PO495		Xi, Gang FR-PO719	Yamada, Takayuki FR-PO481
		Xia, Fang FR-PO924	Yamada, Yosuke TH-PO532,
		Xia, Peng TH-PO510, TH-PO562, TH-PO881, SA-PO006	FR-PO587, SA-PO091
		Xia, Yun TH-PO218	Yamagata, Kunihiro FR-PO925, SA-PO700
		Xiang, Qiong TH-PO693	
		Xiao, Hong FR-PO579	
		Xiao, Huiling FR-PO814	
		Xiao, Jian TH-PO282	
		Xiao, Jie SA-PO311	
		Xiao, Min TH-PO542	

Yamaguchi, Hiroki SA-PO640  
 Yamaguchi, Kosei TH-PO696, SA-PO330, SA-PO394, SA-PO450  
 Yamaguchi, Osamu FR-PO463  
 Yamaguchi, Shinobu FR-PO261, FR-PO287  
 Yamaguchi, Tamio FR-PO275  
 Yamaguchi, Yutaka SA-OR25  
 Yamamoto, Ayaha FR-PO984, FR-PO990  
 Yamamoto, Keiko SA-PO999  
 Yamamoto, Masamichi FR-PO143, SA-PO064  
 Yamamoto, Shigenori FR-PO143, SA-PO064  
 Yamamoto, Shinya FR-PO143, SA-PO064  
 Yamamoto, Shohei TH-PO779, SA-PO178, PUB032  
 Yamamoto, Suguru SA-PO179, SA-PO184, SA-PO640  
 Yamamoto, Tadashi FR-PO999  
 Yamamoto, Takeshi FR-PO955  
 Yamamura, Ayaka TH-PO701  
 Yamamura, Tomohiko FR-PO447, SA-PO539, SA-PO562  
 Yamamura, Yuta FR-PO938  
 Yamanaka, Shuichiro FR-PO374, FR-PO380, FR-PO400  
 Yamane, Masamoto SA-PO891  
 Yamani, Fatmah N. SA-PO707  
 Yamashita, Kazuomi SA-PO370, SA-PO396, SA-PO417  
 Yamashita, Michifumi TH-PO534  
 Yamazaki, Tomotaka FR-PO995  
 Yamazato, Masanobu SA-PO896  
 Yan, Guofen TH-PO659, FR-OR22, SA-PO924  
 Yan, Hanying FR-OR32  
 Yan, Jingyin SA-PO055  
 Yan, Qingshang TH-PO342  
 Yan, Songkai SA-PO811  
 Yanagi, Tomoki SA-PO1008  
 Yanagita, Motoko TH-PO532, FR-PO143, FR-PO955, SA-PO064, SA-PO091, SA-PO992  
 Yanai, Mitsuru FR-PO037  
 Yanda, Murali K. TH-PO414, FR-PO272  
 Yandell, Mark TH-PO245  
 Yanez Salguero, Valeria FR-PO618, SA-PO483  
 Yang, Aicheng TH-PO702  
 Yang, Bin FR-PO136, FR-PO161  
 Yang, Chao-Ling TH-PO319, TH-PO320  
 Yang, Chaozhe FR-PO278  
 Yang, Chin-Rang TH-PO336, SA-PO961  
 Yang, Chul Woo FR-PO782, SA-PO365, SA-PO366  
 Yang, Dong Ho FR-PO987  
 Yang, Eun mi FR-PO413, PUB180  
 Yang, Eunji FR-PO085  
 Yang, Fan FR-PO813  
 Yang, Haichun TH-PO572, FR-PO975  
 Yang, Hongying FR-PO695  
 Yang, Jae Won TH-PO793, SA-PO737  
 Yang, Jaeseok TH-OR52, FR-PO763, FR-PO772, FR-PO791, FR-PO792, FR-PO830, PUB313  
 Yang, Jihyun FR-PO112, FR-PO921  
 Yang, Jing TH-PO092  
 Yang, Junlan TH-PO684  
 Yang, Junwei TH-OR16, TH-PO236, SA-PO172, SA-PO173, SA-PO332, SA-PO363, SA-PO380, SA-PO748, PUB214  
 Yang, Ke SA-PO1006  
 Yang, Keum-Jin TH-PO201, SA-PO232  
 Yang, Min FR-PO333  
 Yang, Ming FR-PO299  
 Yang, Pa Chia FR-PO799  
 Yang, Qingqing SA-PO714  
 Yang, Qionqiong SA-PO311  
 Yang, Seung Hee FR-PO401, FR-PO976, FR-PO979, SA-PO973  
 Yang, Sunah FR-PO092  
 Yang, Taeyoung FR-PO987  
 Yang, Ting FR-PO953  
 Yang, Tse-Chuan FR-PO883  
 Yang, Y. Fred FR-PO218, FR-PO241  
 Yang, Yang TH-PO162, TH-PO163, SA-PO400  
 Yang, Yi PUB364  
 Yang, Yide FR-PO777  
 Yang, Yihe SA-PO039  
 Yang, Yiya SA-PO721  
 Yang, Zhengyu SA-PO269  
 Yang, Zhiyong FR-PO237  
 Yanik, Andrew TH-PO671  
 Yanucil, Christopher TH-PO152, FR-OR04  
 Yanuv, Ilan SA-PO266  
 Yao, Junlan TH-PO138, SA-PO086, SA-PO096  
 Yao, Li SA-PO311, SA-PO657, SA-PO658  
 Yao, Ying FR-PO256  
 Yap, Desmond FR-PO545  
 Yap, Hui Kim TH-PO449, TH-PO539  
 Yaqoob, Muhammad FR-PO785, FR-PO852, PUB311, PUB315, PUB327  
 Yaqub, Daniel A. SA-PO783  
 Yarandi, Niloufarsadat FR-PO204, PUB263  
 Yard, Benito TH-PO543  
 Yarlagaadda, Sunitha FR-PO392  
 Yaru, Xie TH-PO192, SA-PO241  
 Yasar, Emre PUB246  
 Yaseen, Najjar SA-PO053, SA-PO468  
 Yaseen, Wid PUB069  
 Yashroy, Kannagi FR-PO780  
 Yasin, Fadumo Y. TH-PO941  
 Yasuda, Hidenori SA-PO740  
 Yasui, Atsuko TH-PO758  
 Yatim, Karim PUB060  
 Yatomi, Yutaka FR-OR53  
 Yau, Amy SA-PO509, PUB179  
 Yau, Kevin TH-PO915, SA-OR10  
 Yavin, Yshai TH-PO237  
 Yavuz, Hayretin TH-PO554  
 Yazawa, Masahiko FR-PO832, FR-PO850  
 Yazdizadeh Shotorbani, Parisa SA-PO256  
 Yazici, Halil FR-PO824, SA-PO795  
 Ye, Bingwei SA-PO089  
 Ye, Chaoyang FR-PO285, FR-PO286, FR-PO1004  
 Ye, Hong TH-PO293, SA-PO173, SA-PO332, SA-PO363, SA-PO380  
 Ye, Hongping TH-PO107, TH-PO181, TH-PO850, FR-PO1000  
 Ye, Minghao TH-PO304, TH-PO305, FR-PO020, PUB094  
 Ye, Qin SA-PO002  
 Ye, Siyang TH-PO203  
 Ye, Wen Qing Wendy SA-PO295  
 Ye, Xiangyang TH-OR23, TH-PO634, TH-PO709, TH-PO710, FR-PO559, FR-PO737  
 Ye, Xiaoling TH-PO261, SA-PO382, SA-PO430, PUB080  
 Ye, Zengchun SA-PO389  
 Yee, Su M. FR-PO222  
 Yeggy, Jared PUB169  
 Yekinni, Ibrahim O. FR-PO872  
 Yekula, Anuroop FR-PO480  
 Yelken, Berna FR-PO824, SA-PO795  
 Yellapragada, Sarvari FR-PO669  
 Yen, Chia-Hung SA-PO255  
 Yen, Hong-Ren TH-PO665  
 Yen, Timothy E. SA-PO361, SA-PO364  
 Yeo, See Cheng PUB237  
 Yeom, Jihyun FR-PO593, FR-PO644  
 Yeon, Wenxiang SA-PO219  
 Yepes Calderon, Manuela FR-PO810  
 Yerlikaya, Esma I. SA-PO229  
 Yesilyurt, Burcu SA-PO786  
 Yessayan, Lenar T. TH-PO039  
 Yew, Soo Ying PUB237  
 Yi, Xiangling TH-PO024  
 Yildirim, Saliha PUB246  
 Yildirim, Tolga FR-PO802  
 Yildiz, Abdulmecit FR-PO824, SA-PO795  
 Yilmaz, Duygu E. TH-PO642, TH-PO645  
 Yilmaz, Zehra FR-PO005  
 Yin, Lixuan SA-PO714  
 Yincharoen, Picha SA-OR35  
 Yiu, Wai Han FR-PO964, SA-PO220, SA-PO969  
 Yoder, Bradley K. FR-PO130, FR-PO244, FR-PO245, FR-PO252, FR-PO257, FR-PO296  
 Yodice, Paul C. PUB323  
 Yokoba, Masanori TH-PO826  
 Yokoo, Takashi TH-PO552, FR-PO374, FR-PO380, FR-PO400  
 Yokota, Yunosuke TH-PO195, TH-PO389, FR-PO166  
 Yokote, Koutaro TH-PO227  
 Yong, Zhong FR-PO650  
 Yoo, Kyung Don TH-PO625, TH-PO713, TH-PO793, TH-PO912, FR-PO976, SA-PO973, PUB180  
 Yoo, Tae-Hyun FR-PO745, FR-PO746, SA-PO650  
 Yoon Sook, Ko FR-OR18, FR-PO112  
 Yoon, Hye Eun FR-PO089, SA-PO180, SA-PO381  
 Yoon, Ji Hoon TH-PO838, TH-PO870, TH-PO871, FR-PO930, FR-PO941, SA-OR33, SA-PO304, SA-PO383  
 Yoon, Jihoon FR-PO309, SA-PO546  
 Yoon, Jong-woo TH-PO265  
 Yoon, Joonho FR-PO689  
 Yoon, Kuk Ro FR-PO341  
 Yoon, Se-Hee FR-PO341, FR-PO782, SA-PO646  
 Yoon, Soo-Young FR-PO464, SA-PO279  
 Yoon, Sung Bin TH-PO048, FR-PO132, SA-PO335  
 Yoowannakul, Suree SA-PO464  
 York, Allen J. TH-PO097  
 York, Brian K. SA-PO636  
 Yoshida, Hisako FR-PO925, SA-PO700  
 Yoshida, Kiryu TH-PO155  
 Yoshida, Teruhiko TH-PO754, FR-PO282, SA-PO958  
 Yoshigi, Masaaki SA-PO756  
 Yoshikawa, Norishige FR-PO043, SA-PO589  
 Yoshikoshi, Shun TH-PO779, SA-PO178, SA-PO294, PUB032  
 Yoshimura, Aya FR-PO275  
 Yoshimura, Yasuhiro FR-PO364  
 Yoshizawa, Katsuhiko FR-PO289  
 Yosipovitch, Gil SA-PO287  
 Yottasan, Pattareeya FR-PO348  
 You, Amy S. TH-PO838, TH-PO870, TH-PO871, FR-PO930, FR-PO941, SA-OR33, SA-PO304, SA-PO383  
 You, Ruilian TH-PO117  
 You, Zhiying TH-OR24, TH-PO390, TH-PO402, TH-PO403, TH-PO404, TH-PO609, TH-PO800, TH-PO857, SA-PO210, SA-PO596, SA-PO948  
 Young, Brian Y. TH-PO014, SA-PO034  
 Young, Clarence L. SA-PO453  
 Young, Karen SA-PO599  
 Young, Kate J. SA-PO404  
 Young, Sarah E. SA-PO475  
 Younis, Nour K. TH-OR49, TH-OR51, TH-PO653, SA-OR46  
 Yousef Yengej, Fjodor TH-PO331  
 Yousef, Kirolos FR-PO327, FR-PO328, SA-PO578  
 Yousef, Natalie SA-PO246  
 Youssouf, Talha M. FR-PO844, FR-PO845, SA-PO834, PUB290, PUB293, PUB295, PUB297, PUB298  
 Yousuf, Adil TH-PO038  
 Yu, Alan S. TH-PO402, TH-PO403, FR-PO714, SA-PO404  
 Yu, Albert FR-PO753  
 Yu, Bing FR-PO918  
 Yu, Byung chul TH-PO793, SA-PO652  
 Yu, Cecile FR-PO318  
 Yu, Chen TH-PO458, TH-PO825, FR-PO957, SA-PO334  
 Yu, Chih-Chuan TH-PO371  
 Yu, Fang FR-PO458  
 Yu, Garrett PUB175  
 Yu, Hyokyeong PUB200  
 Yu, Jing FR-PO982  
 Yu, Kate Nicole T. TH-PO961  
 Yu, Kevin SA-PO663  
 Yu, Lei TH-OR16  
 Yu, Liping FR-PO123  
 Yu, Luis TH-PO516, FR-PO678, FR-PO732, SA-PO683  
 Yu, Margaret K. TH-PO519  
 Yu, Michael SA-OR30  
 Yu, Mi-yeon TH-PO635, SA-PO973  
 Yu, Pey-Jen FR-PO070  
 Yu, Samuel Mon-Wei FR-OR15  
 Yu, Tammy TH-PO842, FR-PO568  
 Yu, Tsuan-Shih SA-PO386  
 Yu, Tung-Min FR-PO833  
 Yu, Wei TH-PO659, FR-OR22, SA-PO924  
 Yu, Weimin SA-PO311  
 Yu, Xueqing TH-PO157, TH-PO702  
 Yu, Zhihong FR-PO312, FR-PO316  
 Yuan, Christina M. TH-PO014, TH-PO021, PUB025  
 Yuan, Qian FR-OR29  
 Yuan, Shuguang PUB235  
 Yuan, Wei jie TH-OR16, SA-PO172  
 Yuan, Xiao-Dong SA-PO1009  
 Yudd, Michael TH-PO104, TH-PO469, PUB041  
 Yuen, Darren A. TH-PO915  
 Yuen, Peter S. TH-PO103, SA-PO070  
 Yun, Donghwan TH-PO065, FR-PO162, SA-PO371  
 Yun, Sung-Ro FR-PO341, FR-PO782, SA-PO646  
 Yung, Susan FR-PO459, FR-PO605, FR-PO972, FR-PO982, FR-PO1003  
 Yurcso, Toni SA-PO432  
 Yusuf, Salim TH-PO742  
 Zafar, Waleed TH-PO049  
 Zafar, Zunaira TH-PO035, TH-PO037  
 Zagato, Laura FR-PO073, SA-PO754  
 Zagorska, Anna SA-PO240  
 Zahedi, Kamyar A. FR-PO290, SA-PO782  
 Zahner, Gunther SA-PO746, SA-PO747  
 Zahr, Rima S. FR-PO414, PUB281  
 Zaidan, Mohamad TH-PO481  
 Zaidan, Nadim SA-PO989  
 Zaidi, Mark FR-PO788  
 Zaidman, Nathan TH-PO317  
 Zaki, Abdullah TH-PO776  
 Zaki, Kirolos E. FR-PO566  
 Zaki, Radi SA-PO867  
 Zakoul, Heidi SA-PO259  
 Zacrocka, Izabela FR-PO238  
 Zaleski, Julie SA-PO443  
 Zaltz, Emily FR-PO695  
 Zaluska, Wojciech T. FR-PO238  
 Zamami, Ryo TH-PO553  
 Zaman, Azkaa SA-PO507, SA-PO723  
 Zaman, Warda FR-PO211, FR-PO728  
 Zamanzadeh, Davina J. FR-PO937  
 Zamaro, Aleksandra SA-PO762  
 Zamauskaite, Aurelia TH-PO481  
 Zambrano, Cesar TH-PO464, TH-PO520  
 Zamir, Zamir A. SA-PO869, PUB042  
 Zamlauski-Tucker, Marianna J. SA-PO089  
 Zand, Jaleh TH-PO529  
 Zand, Ladan TH-PO529, SA-PO132, SA-PO133, SA-PO153, SA-PO692  
 Zandbergen, Adrienne A. FR-OR49

Zanella, Monica	TH-PO041, TH-PO359, SA-PO009, SA-PO011, SA-PO415	Zhang, Jay	FR-PO218, FR-PO241	Zhao, Xuesong	TH-PO562	Zhu, Ping	FR-PO258
Zang, Yanyi	TH-PO107	Zhang, Jie	SA-PO766, PUB214	Zhao, Yanli	FR-PO550	Zhu, Quansheng	FR-OR51
Zanganeh, Mandana	FR-PO536	Zhang, Jing	FR-OR46	Zhao, Yi	FR-PO240	Zhu, Richard	FR-OR51
Zangla, Emily E.	PUB278	Zhang, Jingjing	FR-PO199	Zhao, Yinshan	TH-PO667, FR-PO638	Zhu, Saiya	FR-PO957
Zaniew, Marcin	SA-PO572	Zhang, Jiong	FR-PO623	Zhao, Yitong	TH-PO808, TH-PO809	Zhu, Tongying	FR-PO466
Zanolin, Maria E.	TH-PO845	Zhang, Jun	TH-PO374	Zhao, Yiyang	FR-OR36	Zhu, Xiaodong	TH-PO179
Zanoni, Francesca	SA-PO564	Zhang, Kun	TH-PO825, FR-OR09, FR-OR20, SA-PO956	Zhao, Yongmei	TH-PO754, SA-PO958	Zhu, Xuejing	PUB235
Zaoui, Philippe	SA-PO679	Zhang, Li	SA-PO786	Zhao, Yu	TH-PO179	Zhu, Yi	TH-PO180
Zapanta, Ivan Kenneth S.	FR-PO570	Zhang, Lihong	SA-PO311	Zhao, Yue	TH-PO448	Zhu, Yinjie	TH-PO803
Zapf, Ava M.	FR-OR42, FR-PO996	Zhang, Lucy	SA-PO393	Zhao, Yuming	SA-PO104	Zhu, Yuan O.	SA-OR04
Zappitelli, Michael	TH-OR30, FR-PO415, FR-PO416, SA-PO596	Zhang, Nan	FR-PO808, SA-PO823, SA-PO884	Zhao, Zhibo	FR-PO126	Zhu, Zhang-Yi	TH-PO825
Zarei, Mohammad	TH-PO332	Zhang, Pingchuan	FR-PO178, FR-PO210	Zhao, Zhizhuang J.	SA-PO104 SA-OR18	Zhuang, Bing	SA-PO172, SA-PO173, SA-PO363, SA-PO380
Zarogiannis, Sotirios G.	FR-PO451	Zhang, Qi	FR-PO690, SA-OR28	Zheng, Feng	SA-PO172	Zhuang, Jing	TH-PO374, PUB308
Zaslow, Shari J.	TH-PO150	Zhang, Qihuang	FR-OR32	Zheng, Hongguang	SA-PO273	Zhuang, Jun	FR-OR34
Zatz, Roberto	TH-PO785	Zhang, Qinghong	SA-PO311	Zheng, Hua	TH-PO881	Zhuang, Kun D.	TH-PO268
Zavala Miranda, María F.	FR-PO642, SA-PO686, SA-PO691	Zhang, Qingqing	PUB308	Zheng, Hui X.	SA-PO172	Zhuo, Jia L.	SA-PO768
Zavala, Mariana N.	PUB045	Zhang, Ruiyuan	FR-PO319	Zheng, Jamie	FR-PO260	Zidan, Elena	FR-PO620
Zayed, Hany	TH-PO499	Zhang, Shiyang	SA-PO172	Zheng, Ke	TH-PO200	Ziegler, Wolfgang H.	FR-PO284
Zec, Jarcy	TH-PO477, TH-PO530, TH-PO534, TH-PO569, TH-PO760, FR-PO109, SA-PO003	Zhang, Shuzhen	FR-PO077, FR-PO078	Zheng, Ke	TH-PO200	Zielinski, Stephanie	FR-PO720
Zehnder, Daniel	FR-PO776	Zhang, Tancy C.	FR-PO904	Zheng, Sijie	TH-PO138, FR-OR12, SA-PO096	Zietara, Adrian P.	SA-PO753
Zeid, Ahmed S.	SA-PO129	Zhang, Tian	TH-PO218	Zheng, Yi	TH-PO011, FR-PO525	Zietse, Robert	TH-PO382, TH-PO406, TH-PO407
Zeier, Martin G.	TH-PO105, TH-PO536, TH-PO920, FR-PO774, SA-OR47, SA-PO812	Zhang, Tian	TH-PO218	Zheng, Yuyan	TH-PO905, FR-PO638	Zijp, Tanja R.	SA-PO270
Zeisberg, Michael	SA-PO107	Zhang, Wei	TH-PO753	Zheng, Zhihua	TH-PO545, TH-PO551, FR-PO777, FR-PO960, SA-PO104, SA-PO845, PUB092	Zimmerman, Asha	FR-OR822
Zeitler, Evan	FR-PO183, FR-PO636	Zhang, Weifeng	SA-PO173	Zhiehong, Zhou	TH-OR16	Zimmerman, Brandon	TH-PO442
Zelnick, Leila R.	TH-OR10, TH-PO605, FR-PO031, SA-PO187, SA-PO912, SA-PO929, PUB028	Zhang, Weijia	FR-OR31, FR-PO959, SA-PO974	Zhong, Aimin	TH-OR16	Zimmerman, Cortney T.	FR-PO427
Zen, Renata D.	FR-PO732	Zhang, Xianwen	SA-PO642, SA-PO643	Zhong, Chutong	TH-OR40, FR-PO397	Zimmerman, Kurt	FR-PO245
Zeng, Cai-hong	FR-PO813	Zhang, Xiao	FR-PO159, SA-PO066	Zhong, Fang	SA-PO235	Zimmermann, Marina	TH-OR42
Zeng, Guang	TH-PO282	Zhang, Xiaoliang	TH-PO179, TH-PO626, SA-PO164, PUB087	Zhong, Jianyong	TH-PO572, FR-PO975	Zimmermann, Nives	FR-PO619
Zeng, Jieyu	TH-PO192, SA-PO101	Zhang, Xiaoming	TH-PO057, TH-PO059	Zhong, Ming	FR-PO960	Zimmermann, Silke	SA-PO1010
Zeng, Lixia	SA-PO770	Zhang, Xin	FR-PO206	Zhong, Ming	TH-PO431, TH-PO432	Ziolkowski, Susan	SA-PO181
Zeng, Shufei	FR-PO777	Zhang, Xinzhou	TH-OR16, SA-PO311	Zhong, Xiang	TH-PO431, TH-PO432	Zippursky, Jonathan S.	PUB069
Zeng, Yuting	SA-PO031	Zhang, Xueyuan	TH-PO562	Zhong, Yan	TH-PO468	Zitt, Emanuel	FR-PO556
Zent, Roy	FR-PO368, FR-PO369	Zhang, Y. Shrike S.	SA-PO025	Zhou, Dong	SA-PO073	Zivna, Martina	TH-PO380, PUB192
Zepeda-Orozco, Diana	SA-PO108, SA-PO129, SA-PO154	Zhang, Yan	FR-PO253, FR-PO294, SA-OR07	Zhou, Fang	FR-PO282	Ziyadeh, Fuad N.	TH-PO185, TH-PO219, SA-PO246
Zepel, Lindsay	FR-PO064	Zhang, Yan	FR-PO253, FR-PO294, SA-OR07	Zhou, Fangfang	FR-PO077, FR-PO078	Zmijewska, Anna A.	TH-PO655
Zha, Weibin	FR-PO318	Zhang, Yani	SA-PO431, SA-PO939	Zhou, Hui	TH-PO724, FR-PO547, FR-PO548, FR-PO753	Zoghby, Ziad	TH-PO412, FR-PO851, SA-PO461, PUB029
Zhang, Baichuan	TH-PO562	Zhang, Yanmin	SA-PO447	Zhou, Jianfu	FR-PO388	Zollman, Amy	FR-PO124, PUB093
Zhang, Bin	TH-PO081	Zhang, Yanmin	SA-PO447	Zhou, Jiannan	FR-PO538	Zolota, Vasiliki	TH-PO583
Zhang, Chun	TH-PO192, TH-PO225, FR-OR29, FR-PO711, SA-PO080, SA-PO101, SA-PO231	Zhang, Yaochun	TH-PO539	Zhou, Jing	FR-PO297	Zona, Emily E.	PUB303, PUB306
Zhang, Conghui	FR-PO451, SA-PO627	Zhang, Yi	TH-PO259	Zhou, Juling	FR-PO252	Zonderman, Alan B.	FR-PO948
Zhang, Dan	TH-PO186, SA-PO771	Zhang, Yichi	TH-PO288, TH-PO566	Zhou, Matt M.	TH-PO724	Zonoozi, Shahrzad	TH-PO511, SA-PO051, SA-PO841
Zhang, Dengyang	SA-PO104	Zhang, Yimeng	SA-PO356	Zhou, Meijiao	TH-PO164, TH-PO167, TH-PO168, SA-PO419	Zonozi, Reza	FR-PO646, PUB060
Zhang, Fan	SA-PO721	Zhang, Ying	TH-PO179, SA-PO740	Zhou, Mo	TH-PO496	Zor, Fatih	FR-PO800
Zhang, Gu-Mu-Yang	SA-PO006	Zhang, Yingyi	FR-PO141	Zhou, Peng	FR-PO237	Zotta, Federica	SA-PO706
Zhang, Haitao	SA-PO273	Zhang, Yue	FR-PO750	Zhou, Rong	TH-OR16	Zou, Yixin	FR-PO964, SA-PO220, SA-PO969
Zhang, Haiyan	SA-PO058	Zhang, Yunxi	SA-PO362	Zhou, Wei	TH-PO282	Zschummel, Maria	FR-PO583
Zhang, Hanjie	TH-PO261, SA-PO319, SA-PO344, SA-PO386, SA-PO427, SA-PO430	Zhang, Yuzhou	SA-PO635	Zhou, Wen	FR-OR03, SA-PO736	Zsengeller, Zsuzsanna K.	SA-PO991
Zhang, Hengcheng	TH-OR49, TH-OR53, TH-PO653	Zhang, Zhizheng	SA-PO173	Zhou, Xia	FR-PO255, FR-PO262, FR-PO267	Zubair, Haseeb	FR-PO787
Zhang, Heping	TH-PO282	Zhao, Amy Y.	TH-PO307	Zhou, Yalu	FR-OR33, FR-PO347, FR-PO389	Zubaidat, Dalia	TH-PO396, FR-PO671, FR-PO851, SA-PO692, PUB230
Zhang, Hong	FR-OR59, SA-PO564, SA-PO712	Zhao, Guoyan	TH-PO443	Zhou, Yan-Feng	TH-PO864	Zuchowski, Yvonne	TH-PO340
		Zhao, Haidan	PUB121	Zhou, Yang	TH-PO236, SA-PO332	Zuehlke, Kerstin	FR-PO994, SA-PO793
		Zhao, Hongjuan	PUB308	Zhou, Zheng-Yi	TH-PO496	Zuo, Li	TH-OR16, TH-PO694, SA-PO172, SA-PO173, SA-PO184, SA-PO311, PUB121
		Zhao, Hongsheng	FR-PO136	Zhu, Dalong	SA-PO273	Zuo, Xiaofeng	TH-PO220
		Zhao, June	TH-OR16	Zhu, Enyi	TH-PO551, FR-PO960	Zuo, Yiqin	FR-PO437
		Zhao, Junhui	SA-PO179, SA-PO184	Zhu, Fansan	FR-PO496, PUB134	Zuquello, Radames A.	SA-PO841
		Zhao, Liang	TH-OR55	Zhu, Fengge	SA-PO659		
		Zhao, Liang	TH-OR55	Zhu, Guangjin	TH-PO881		
		Zhao, Lihui	FR-PO786	Zhu, Huadong	TH-PO117		
		Zhao, Lihong	FR-PO232	Zhu, Ke	TH-PO215		
		Zhao, Lin	FR-PO232	Zhu, Li	SA-PO564		
		Zhao, Long	FR-PO072				
		Zhao, Runqi	TH-PO805, TH-PO806				
		Zhao, Sophia	FR-OR23				
		Zhao, Xinju	TH-PO694, PUB121				
		Zhao, Xixi	TH-OR32				

# KEYWORD INDEX

The number refers to the location of the body of the abstract in the publication section

- AASK (African American Study of Kidney Disease and Hypertension)** ..... TH-OR23, TH-PO862, FR-PO315, FR-PO907, SA-PO535, PUB013
- ABC transporter** ..... TH-PO351, TH-PO844
- access blood flow** ..... TH-PO268, TH-PO287, SA-PO015, SA-PO767
- access flow rate** ..... TH-PO267, TH-PO272, TH-PO287, TH-PO291, PUB147
- ACE inhibitors** ..... TH-PO226, TH-PO255, TH-PO419, TH-PO603, TH-PO607, TH-PO670, TH-PO727, TH-PO744, TH-PO854, FR-PO275, FR-PO353, FR-PO547, FR-PO548, FR-PO613, FR-PO631, FR-PO750, FR-PO759, FR-PO896, SA-PO836, SA-PO904, SA-PO905, PUB172, PUB368
- acidosis** ..... TH-PO125, TH-PO312, TH-PO314, TH-PO321, TH-PO332, FR-PO026, FR-PO564, FR-PO565, FR-PO566, SA-PO033, SA-PO059, SA-PO440, SA-PO442, SA-PO489, SA-PO492, SA-PO493, SA-PO494, SA-PO495, SA-PO496, SA-PO498, SA-PO499, SA-PO500, SA-PO501, SA-PO502, SA-PO503, SA-PO528, SA-PO872, SA-PO980, SA-PO981, SA-PO982, PUB136, PUB169, PUB181, PUB261, PUB356, PUB360
- activated vitamin D** ..... TH-PO153, FR-PO792, SA-PO184, SA-PO185, SA-PO202, SA-PO508, PUB313
- acute allograft rejection**... TH-OR51, TH-OR56, TH-PO643, FR-PO773, FR-PO805, SA-PO815, SA-PO852, PUB002, PUB322, PUB329, PUB335, PUB341
- acute kidney failure**..... TH-OR01, TH-OR03, TH-OR04, TH-OR06, TH-OR09, TH-OR44, TH-OR45, TH-PO024, TH-PO025, TH-PO027, TH-PO028, TH-PO029, TH-PO030, TH-PO031, TH-PO032, TH-PO034, TH-PO035, TH-PO038, TH-PO040, TH-PO041, TH-PO043, TH-PO045, TH-PO046, TH-PO047, TH-PO048, TH-PO049, TH-PO050, TH-PO051, TH-PO053, TH-PO055, TH-PO056, TH-PO057, TH-PO061, TH-PO062, TH-PO064, TH-PO065, TH-PO066, TH-PO069, TH-PO071, TH-PO072, TH-PO074, TH-PO076, TH-PO077, TH-PO079, TH-PO081, TH-PO083, TH-PO084, TH-PO087, TH-PO088, TH-PO090, TH-PO093, TH-PO095, TH-PO103, TH-PO104, TH-PO105, TH-PO107, TH-PO108, TH-PO109, TH-PO114, TH-PO118, TH-PO119, TH-PO120, TH-PO125, TH-PO130, TH-PO131, TH-PO133, TH-PO134, TH-PO135, TH-PO138, TH-PO139, TH-PO188, TH-PO278, TH-PO434, TH-PO463, TH-PO467, TH-PO470, TH-PO471, TH-PO519, TH-PO526, TH-PO575, TH-PO766, TH-PO835, TH-PO842, TH-PO848, TH-PO865, TH-PO904, TH-PO910,
- acute kidney failure (continued)**..... TH-PO946, FR-OR11, FR-OR18, FR-OR19, FR-OR28, FR-PO003, FR-PO004, FR-PO010, FR-PO017, FR-PO021, FR-PO023, FR-PO024, FR-PO025, FR-PO027, FR-PO028, FR-PO029, FR-PO031, FR-PO032, FR-PO033, FR-PO039, FR-PO042, FR-PO044, FR-PO045, FR-PO046, FR-PO051, FR-PO053, FR-PO054, FR-PO058, FR-PO061, FR-PO064, FR-PO068, FR-PO069, FR-PO071, FR-PO072, FR-PO074, FR-PO076, FR-PO077, FR-PO078, FR-PO081, FR-PO082, FR-PO084, FR-PO085, FR-PO086, FR-PO088, FR-PO089, FR-PO091, FR-PO094, FR-PO098, FR-PO099, FR-PO100, FR-PO103, FR-PO106, FR-PO108, FR-PO113, FR-PO114, FR-PO115, FR-PO116, FR-PO117, FR-PO119, FR-PO124, FR-PO125, FR-PO128, FR-PO129, FR-PO132, FR-PO133, FR-PO140, FR-PO142, FR-PO145, FR-PO146, FR-PO151, FR-PO153, FR-PO156, FR-PO157, FR-PO160, FR-PO164, FR-PO167, FR-PO170, FR-PO174, FR-PO182, FR-PO183, FR-PO185, FR-PO186, FR-PO192, FR-PO193, FR-PO196, FR-PO197, FR-PO210, FR-PO212, FR-PO214, FR-PO215, FR-PO238, FR-PO567, FR-PO616, FR-PO620, FR-PO622, FR-PO624, FR-PO637, FR-PO675, FR-PO752, FR-PO958, SA-OR05, SA-PO033, SA-PO034, SA-PO035, SA-PO036, SA-PO039, SA-PO041, SA-PO042, SA-PO044, SA-PO045, SA-PO049, SA-PO050, SA-PO051, SA-PO054, SA-PO055, SA-PO057, SA-PO060, SA-PO061, SA-PO062, SA-PO064, SA-PO067, SA-PO068, SA-PO070, SA-PO073, SA-PO075, SA-PO076, SA-PO079, SA-PO080, SA-PO081, SA-PO085, SA-PO087, SA-PO103, SA-PO110, SA-PO113, SA-PO116, SA-PO117, SA-PO126, SA-PO128, SA-PO129, SA-PO134, SA-PO142, SA-PO144, SA-PO148, SA-PO149, SA-PO150, SA-PO155, SA-PO160, SA-PO212, SA-PO277, SA-PO335, SA-PO432, SA-PO442, SA-PO452, SA-PO458, SA-PO476, SA-PO498, SA-PO501, SA-PO503, SA-PO511, SA-PO512, SA-PO514, SA-PO594, SA-PO597, SA-PO600, SA-PO601, SA-PO603, SA-PO667, SA-PO670, SA-PO672, SA-PO730, SA-PO801, SA-PO868, SA-PO882, SA-PO940, SA-PO995, PUB002, PUB003, PUB005, PUB006, PUB008, PUB013, PUB031, PUB037, PUB038, PUB039, PUB041, PUB045, PUB046, PUB047, PUB049, PUB050, PUB051, PUB052, PUB053, PUB055, PUB060, PUB061, PUB066, PUB067, PUB069, PUB070, PUB075,
- acute kidney failure (continued)**..... PUB076, PUB183, PUB189, PUB198, PUB212, PUB241, PUB262, PUB284, PUB304, PUB318, PUB344
- acute rejection** ..... TH-OR54, FR-PO774, FR-PO780, FR-PO786, FR-PO821, SA-PO841, SA-PO874, PUB300, PUB306, PUB317, PUB341
- acute renal failure** ..... TH-OR02, TH-OR07, TH-OR08, TH-OR10, TH-PO022, TH-PO023, TH-PO037, TH-PO039, TH-PO040, TH-PO045, TH-PO046, TH-PO047, TH-PO067, TH-PO068, TH-PO070, TH-PO078, TH-PO084, TH-PO086, TH-PO106, TH-PO112, TH-PO115, TH-PO117, TH-PO123, TH-PO124, TH-PO127, TH-PO129, TH-PO132, TH-PO134, TH-PO140, TH-PO528, TH-PO542, TH-PO579, TH-PO585, TH-PO835, TH-PO907, TH-PO956, FR-OR12, FR-OR13, FR-PO003, FR-PO004, FR-PO017, FR-PO036, FR-PO041, FR-PO048, FR-PO057, FR-PO059, FR-PO060, FR-PO063, FR-PO066, FR-PO067, FR-PO070, FR-PO072, FR-PO075, FR-PO079, FR-PO087, FR-PO096, FR-PO101, FR-PO102, FR-PO104, FR-PO105, FR-PO111, FR-PO112, FR-PO131, FR-PO137, FR-PO172, FR-PO173, FR-PO187, FR-PO234, FR-PO437, FR-PO564, FR-PO573, FR-PO621, FR-PO626, FR-PO673, FR-PO682, SA-OR06, SA-PO019, SA-PO023, SA-PO032, SA-PO037, SA-PO038, SA-PO044, SA-PO048, SA-PO056, SA-PO093, SA-PO097, SA-PO101, SA-PO105, SA-PO109, SA-PO125, SA-PO151, SA-PO201, SA-PO460, SA-PO481, SA-PO488, SA-PO500, SA-PO505, SA-PO514, SA-PO548, SA-PO596, SA-PO598, SA-PO602, SA-PO728, SA-PO860, PUB009, PUB025, PUB040, PUB042, PUB043, PUB048, PUB056, PUB057, PUB058, PUB065, PUB073, PUB077, PUB090, PUB126, PUB208, PUB232
- adhesion molecule** ..... TH-PO703, FR-PO001, FR-PO350, FR-PO713, SA-PO094
- adiponectin**.....FR-PO307, SA-PO383
- ADPKD** ..... TH-PO355, TH-PO356, TH-PO357, TH-PO358, TH-PO359, TH-PO360, TH-PO361, TH-PO362, TH-PO363, TH-PO364, TH-PO367, TH-PO374, TH-PO376, TH-PO377, TH-PO378, TH-PO381, TH-PO382, TH-PO383, TH-PO384, TH-PO385, TH-PO387, TH-PO388, TH-PO389, TH-PO390, TH-PO391, TH-PO392, TH-PO393, TH-PO397, TH-PO398, TH-PO400, TH-PO401, TH-PO402, TH-PO403, TH-PO404, TH-PO405, TH-PO406, TH-PO407, TH-PO408, TH-PO409, TH-PO410, TH-PO411, TH-PO412,

- ADPKD (continued)**.....TH-PO413, FR-PO242, FR-PO243, FR-PO244, FR-PO245, FR-PO246, FR-PO248, FR-PO250, FR-PO252, FR-PO253, FR-PO255, FR-PO256, FR-PO257, FR-PO258, FR-PO259, FR-PO260, FR-PO261, FR-PO262, FR-PO263, FR-PO264, FR-PO265, FR-PO266, FR-PO267, FR-PO268, FR-PO269, FR-PO271, FR-PO273, FR-PO274, FR-PO281, FR-PO285, FR-PO286, FR-PO287, FR-PO288, FR-PO289, FR-PO293, FR-PO294, FR-PO295, FR-PO297, FR-PO298, FR-PO299, FR-PO300, FR-PO345, FR-PO346, FR-PO357, FR-PO406, FR-PO851, FR-PO879, FR-PO892, SA-OR13, SA-OR14, SA-PO005, SA-PO007, SA-PO028, SA-PO880, PUB007, PUB186, PUB187, PUB188, PUB189, PUB191, PUB267
- AIDS**..... TH-PO072, TH-PO762
- albuminuria**..... TH-OR02, TH-OR25, TH-PO177, TH-PO181, TH-PO186, TH-PO193, TH-PO199, TH-PO220, TH-PO229, TH-PO233, TH-PO247, TH-PO437, TH-PO523, TH-PO596, TH-PO681, TH-PO682, TH-PO769, TH-PO796, TH-PO857, TH-PO875, TH-PO877, TH-PO884, TH-PO890, FR-PO329, FR-PO330, FR-PO686, FR-PO720, FR-PO721, FR-PO723, FR-PO725, FR-PO754, FR-PO755, FR-PO896, FR-PO916, FR-PO924, FR-PO944, SA-OR06, SA-OR11, SA-OR38, SA-PO123, SA-PO137, SA-PO223, SA-PO239, SA-PO241, SA-PO242, SA-PO251, SA-PO254, SA-PO262, SA-PO264, SA-PO268, SA-PO270, SA-PO272, SA-PO276, SA-PO556, SA-PO745, SA-PO813, SA-PO822, SA-PO912, SA-PO983, SA-PO999, PUB094, PUB095, PUB103, PUB105, PUB114, PUB249, PUB314, PUB346, PUB365
- aldosterone**.....TH-OR21, TH-PO309, TH-PO326, TH-PO349, FR-OR42, FR-PO735, FR-PO736, FR-PO751, SA-PO272, SA-PO471, SA-PO486, SA-PO757, SA-PO761, SA-PO765, SA-PO958, SA-PO985, PUB170, PUB260
- Alport syndrome**..... TH-PO377, TH-PO761, FR-PO321, FR-PO322, FR-PO323, FR-PO403, FR-PO440, FR-PO441, FR-PO688, FR-PO689, FR-PO690, FR-PO691, FR-PO692, FR-PO693, FR-PO694, FR-PO722, SA-PO543, SA-PO552, SA-PO553, SA-PO554, SA-PO555, SA-PO556, SA-PO557, SA-PO558, SA-PO559, SA-PO560, SA-PO561, SA-PO562, SA-PO668, SA-PO795, PUB195, PUB197, PUB199, PUB247
- ANCA**..... TH-PO122, TH-PO416, TH-PO436, TH-PO439, TH-PO507, TH-PO508, TH-PO518, TH-PO561, FR-OR54, FR-OR55, FR-PO035, FR-PO047, FR-PO180, FR-PO575, FR-PO579, FR-PO580, FR-PO581, FR-PO582, FR-PO583, FR-PO585, FR-PO586, FR-PO587, FR-PO588, FR-PO589, FR-PO590, FR-PO591, FR-PO610, FR-PO616, FR-PO617, FR-PO618, FR-PO620,
- ANCA (continued)**.....FR-PO621, FR-PO622, FR-PO624, FR-PO645, FR-PO646, FR-PO647, FR-PO648, FR-PO649, FR-PO650, FR-PO651, FR-PO652, FR-PO653, SA-PO046, SA-PO692, SA-PO693, SA-PO694, SA-PO696, SA-PO697, SA-PO698, SA-PO720, SA-PO862, PUB008, PUB062, PUB070, PUB206, PUB211, PUB220, PUB221, PUB229, PUB246
- anemia**..... TH-PO149, TH-PO656, TH-PO657, TH-PO658, TH-PO659, TH-PO660, TH-PO661, TH-PO662, TH-PO664, TH-PO665, TH-PO666, TH-PO667, TH-PO668, TH-PO669, TH-PO670, TH-PO671, TH-PO672, TH-PO673, TH-PO674, TH-PO677, TH-PO679, TH-PO680, TH-PO684, TH-PO685, TH-PO686, TH-PO687, TH-PO688, TH-PO689, TH-PO690, TH-PO691, TH-PO693, TH-PO694, TH-PO695, TH-PO696, TH-PO698, TH-PO699, TH-PO701, TH-PO702, TH-PO703, TH-PO704, TH-PO711, TH-PO830, FR-PO078, FR-PO830, FR-PO832, FR-PO947, SA-OR36, SA-OR37, SA-PO115, SA-PO152, SA-PO326, SA-PO330, SA-PO487, SA-PO851, PUB074, PUB080, PUB081, PUB145, PUB290, PUB320
- angiotensin**..... TH-PO321, FR-PO015, FR-PO717, SA-PO768, SA-PO904, SA-PO1002, PUB094
- anti-GBM disease**.....TH-PO119, FR-PO056, FR-PO611, FR-PO612, FR-PO672, FR-PO673, FR-PO674, SA-PO667, SA-PO669, SA-PO720, SA-PO725, PUB211
- apolipoprotein E**.....SA-PO787
- Apolipoprotein L1 (ApoL1)**.....TH-PO420, TH-PO442, TH-PO480, TH-PO481, TH-PO482, TH-PO734, TH-PO754, FR-OR52, FR-PO312, FR-PO313, FR-PO314, FR-PO315, FR-PO316, FR-PO317, FR-PO318, FR-PO319, FR-PO320, FR-PO414, SA-OR01, SA-PO534, SA-PO731, SA-PO732, SA-PO733, SA-PO734, SA-PO735, SA-PO764, SA-PO953, PUB003
- apoptosis**..... TH-PO109, FR-PO118, FR-PO164, FR-PO289, SA-PO080, SA-PO083, SA-PO256, SA-PO770, SA-PO842
- arteries**.....FR-PO738, SA-PO773
- arteriosclerosis**..... TH-PO576, SA-PO112, PUB048, PUB139
- arteriovenous access**..... TH-PO269, TH-PO278, TH-PO280, TH-PO295, TH-PO301, FR-PO859, PUB149
- arteriovenous fistula**.....TH-OR19, TH-PO256, TH-PO259, TH-PO261, TH-PO262, TH-PO263, TH-PO264, TH-PO267, TH-PO284, TH-PO287, TH-PO288, TH-PO294, TH-PO297, TH-PO301, TH-PO303, FR-PO205, SA-PO012, SA-PO013, SA-PO015, SA-PO016, SA-PO310, PUB082, PUB085, PUB149, PUB150
- arteriovenous graft**..... TH-PO266, FR-PO383, SA-PO015
- arteriovenous shunt**..... TH-PO269, TH-PO280
- Bartter syndrome**..... FR-OR48, FR-PO450, SA-PO569, PUB167
- blood pressure**..... TH-OR23, TH-OR25, TH-PO002, TH-PO589, TH-PO597, TH-PO598, TH-PO621, TH-PO752, TH-PO804, TH-PO806, TH-PO881, FR-OR47, FR-PO098, FR-PO230, FR-PO426, FR-PO433, FR-PO435, FR-PO657, FR-PO739, FR-PO744, FR-PO756, FR-PO844, FR-PO994, SA-PO358, SA-PO362, SA-PO403, SA-PO774, SA-PO777, SA-PO788, SA-PO789, SA-PO985, PUB118, PUB258
- cadaver organ transplantation**.....SA-PO675, SA-PO828, SA-PO843
- calcium**..... TH-PO144, TH-PO171, TH-PO173, TH-PO176, TH-PO177, TH-PO333, TH-PO336, TH-PO353, TH-PO842, FR-OR41, FR-PO390, FR-PO567, FR-PO568, FR-PO569, FR-PO571, FR-PO698, FR-PO846, SA-OR13, SA-PO164, SA-PO194, SA-PO196, SA-PO201, SA-PO202, SA-PO210, SA-PO246, SA-PO338, SA-PO464, SA-PO487, SA-PO504, SA-PO505, SA-PO506, SA-PO507, SA-PO508, SA-PO511, SA-PO512, SA-PO513, SA-PO514, SA-PO515, SA-PO516, SA-PO566, SA-PO847, PUB166, PUB168, PUB174, PUB259, PUB340
- calcium receptor**..... TH-PO158, TH-PO172
- calcium-sensing receptor**..... TH-PO142, TH-PO143, TH-PO157, FR-OR08, FR-PO348, SA-PO211
- cancer**.....TH-OR30, TH-PO075, TH-PO103, TH-PO106, TH-PO434, TH-PO673, FR-PO181, FR-PO185, FR-PO186, FR-PO188, FR-PO189, FR-PO191, FR-PO197, FR-PO198, FR-PO204, FR-PO205, FR-PO207, FR-PO213, FR-PO214, FR-PO223, FR-PO378, FR-PO415, FR-PO416, FR-PO809, SA-PO041, SA-PO052, SA-PO113, SA-PO114, SA-PO115, SA-PO118, SA-PO120, SA-PO121, SA-PO122, SA-PO129, SA-PO130, SA-PO131, SA-PO132, SA-PO135, SA-PO143, SA-PO154, SA-PO155, SA-PO156, SA-PO158, SA-PO467, SA-PO492, SA-PO840, PUB051, PUB223, PUB261, PUB263, PUB331
- cardiovascular**..... TH-OR19, TH-OR24, TH-PO097, TH-PO612, TH-PO615, TH-PO616, TH-PO676, FR-PO070, FR-PO425, FR-PO638, FR-PO738, FR-PO760, SA-PO263, SA-PO349, SA-PO374, SA-PO403, SA-PO759, SA-PO834, PUB044, PUB255, PUB257, PUB326
- cardiovascular disease**.....TH-OR24, TH-PO156, TH-PO233, TH-PO238, TH-PO251, TH-PO301, TH-PO601, TH-PO602, TH-PO605, TH-PO606, TH-PO609, TH-PO610, TH-PO613, TH-PO617, TH-PO620, TH-PO622, TH-PO624, TH-PO629, TH-PO631, TH-PO633, TH-PO685, TH-PO825, TH-PO872, TH-PO913, FR-OR02, FR-PO081, FR-PO096, FR-PO342, FR-PO409, FR-PO420, FR-PO466, FR-PO537,

**cardiovascular**

**disease (continued)**...FR-PO736, FR-PO749, FR-PO775, FR-PO817, FR-PO834, FR-PO851, FR-PO901, FR-PO951, FR-PO968, SA-PO191, SA-PO346, SA-PO380, SA-PO388, SA-PO626, SA-PO688, SA-PO770, SA-PO775, SA-PO781, SA-PO787, PUB014, PUB110, PUB125, PUB252, PUB253, PUB256, PUB259

**cardiovascular events**.....TH-OR23, TH-PO057, TH-PO086, TH-PO155, TH-PO237, TH-PO238, TH-PO265, TH-PO472, TH-PO611, TH-PO614, TH-PO617, TH-PO618, TH-PO619, TH-PO623, TH-PO628, TH-PO775, TH-PO788, TH-PO844, FR-PO499, FR-PO548, FR-PO661, FR-PO739, FR-PO747, FR-PO808, FR-PO854, SA-PO186, SA-PO187, SA-PO262, SA-PO366, SA-PO373, SA-PO379, SA-PO702, SA-PO780, SA-PO792, SA-PO888, SA-PO906, SA-PO907, SA-PO925, SA-PO927, SA-PO1001, PUB021, PUB027, PUB101, PUB278, PUB330, PUB357

**cell activation**.....TH-PO588, SA-OR21, SA-PO731

**cell adhesion**.....FR-PO261, FR-PO374, FR-PO576, FR-PO700, FR-PO713, SA-PO094, SA-PO737, SA-PO740

**cell and transport physiology**..... TH-OR40, TH-PO309, TH-PO335, TH-PO351, TH-PO352, TH-PO554, FR-OR44, FR-PO324, FR-PO355, FR-PO451, FR-PO492, SA-PO021

**cell biology and structure**.....TH-PO091, TH-PO092, TH-PO147, TH-PO335, TH-PO531, TH-PO544, FR-PO022, FR-PO238, FR-PO251, FR-PO252, FR-PO272, FR-PO299, FR-PO365, FR-PO372, FR-PO381, FR-PO397, FR-PO399, FR-PO684, FR-PO689, FR-PO706, FR-PO710, FR-PO718, FR-PO727, SA-OR14, SA-PO251, SA-PO614, PUB269

**cell death**..... TH-PO188, FR-PO123, FR-PO128, FR-PO150, FR-PO314, FR-PO575, FR-PO1000, SA-PO081, PUB364

**cell signaling**.....TH-OR51, TH-PO091, TH-PO092, TH-PO150, TH-PO182, TH-PO185, TH-PO197, TH-PO198, TH-PO201, TH-PO336, TH-PO338, TH-PO343, TH-PO448, TH-PO539, TH-PO546, TH-PO638, TH-PO848, FR-OR04, FR-OR27, FR-PO019, FR-PO253, FR-PO256, FR-PO267, FR-PO271, FR-PO274, FR-PO284, FR-PO293, FR-PO300, FR-PO310, FR-PO341, FR-PO347, FR-PO379, FR-PO382, FR-PO391, FR-PO395, FR-PO687, FR-PO709, FR-PO710, FR-PO716, FR-PO953, FR-PO959, FR-PO960, FR-PO961, FR-PO970, FR-PO986, FR-PO1001, SA-OR05, SA-OR22, SA-OR24, SA-OR26, SA-PO019, SA-PO020, SA-PO031, SA-PO074, SA-PO080, SA-PO095, SA-PO096, SA-PO097, SA-PO638, SA-PO771, SA-PO778, SA-PO793, SA-PO957, SA-PO1008, PUB002

**cell survival**.....SA-PO064

**cell volume**..... TH-PO348, SA-PO961

**cell volume regulation**.....TH-PO335

**cell-matrix-interactions**..... FR-PO368, FR-PO378, FR-PO981, SA-OR26, SA-PO025, SA-PO736, SA-PO1009

**chemokine**..... TH-PO080, TH-PO208, TH-PO540, FR-OR15, FR-PO001, FR-PO154, FR-PO404, FR-PO577, FR-PO593, FR-PO979, SA-PO112, PUB255

**chemokine receptor**.....FR-PO579, FR-PO599, SA-PO973

**chemotherapy**..... TH-PO074, FR-PO094, FR-PO107, FR-PO180, FR-PO182, FR-PO198, FR-PO209, FR-PO211, SA-PO052, SA-PO120, SA-PO126, SA-PO144, SA-PO145, SA-PO160, SA-PO466, SA-PO483, SA-PO491, SA-PO518, PUB262

**children**..... TH-OR30, TH-PO039, TH-PO074, TH-PO447, TH-PO590, TH-PO592, TH-PO593, TH-PO594, FR-PO194, FR-PO408, FR-PO409, FR-PO412, FR-PO416, FR-PO417, FR-PO419, FR-PO431, FR-PO697, SA-PO540, SA-PO624, SA-PO949, SA-PO976

**chronic allograft failure**.....FR-PO769, FR-PO774, FR-PO806, FR-PO810, SA-PO828, PUB310

**chronic allograft nephropathy**..... FR-PO813

**chronic allograft rejection**..... TH-OR48, TH-OR50, TH-PO636, TH-PO653, FR-PO773, PUB304

**chronic diabetic complications**.....PUB326

**chronic dialysis**..... TH-PO011, TH-PO290, TH-PO666, TH-PO844, TH-PO913, TH-PO929, TH-PO932, TH-PO938, TH-PO957, FR-PO009, FR-PO426, FR-PO489, FR-PO523, SA-PO195, SA-PO289, SA-PO297, SA-PO305, SA-PO308, SA-PO318, SA-PO322, SA-PO427, SA-PO428, SA-PO457, SA-PO828, PUB011, PUB088, PUB089, PUB122, PUB136, PUB153, PUB360

**chronic glomerulonephritis**.....SA-PO639, SA-PO727, PUB215

**chronic graft deterioration**.....SA-PO883

**chronic heart failure**..... TH-PO602, TH-PO630, SA-PO904, PUB148

**chronic hemodialysis**..... TH-PO161, TH-PO273, TH-PO274, TH-PO663, TH-PO804, TH-PO829, FR-PO227, FR-PO429, FR-PO861, SA-PO178, SA-PO291, SA-PO319, SA-PO329, SA-PO352, SA-PO354, SA-PO360, SA-PO395, SA-PO405, SA-PO411, SA-PO415, SA-PO695, PUB026, PUB248

**chronic hypoxia**.....TH-PO078

**chronic inflammation**..... TH-PO205, TH-PO212, TH-PO249, TH-PO833, TH-PO873, FR-OR38, FR-PO134, FR-PO174, FR-PO400, FR-PO454, FR-PO598, FR-PO605, FR-PO760, FR-PO969, SA-PO220, SA-PO229, SA-PO382, SA-PO623, SA-PO761, SA-PO916, SA-PO938, SA-PO969, SA-PO976, SA-PO979, SA-PO987, SA-PO1010

**chronic kidney disease**..... TH-OR04, TH-OR16, TH-OR24, TH-OR30, TH-OR33, TH-OR34, TH-OR39, TH-PO001, TH-PO002, TH-PO003, TH-PO012, TH-PO013, TH-PO015, TH-PO016, TH-PO018, TH-PO028, TH-PO029, TH-PO053, TH-PO086, TH-PO110, TH-PO141, TH-PO145, TH-PO146, TH-PO149, TH-PO156, TH-PO162, TH-PO163, TH-PO169, TH-PO190, TH-PO196, TH-PO205, TH-PO211, TH-PO213, TH-PO230, TH-PO238, TH-PO240, TH-PO241, TH-PO246, TH-PO252, TH-PO255, TH-PO258, TH-PO261, TH-PO283, TH-PO304, TH-PO305, TH-PO364, TH-PO367, TH-PO381, TH-PO387, TH-PO394, TH-PO410, TH-PO433, TH-PO475, TH-PO481, TH-PO505, TH-PO547, TH-PO559, TH-PO568, TH-PO583, TH-PO606, TH-PO607, TH-PO608, TH-PO609, TH-PO610, TH-PO612, TH-PO619, TH-PO620, TH-PO621, TH-PO622, TH-PO623, TH-PO624, TH-PO625, TH-PO627, TH-PO628, TH-PO629, TH-PO630, TH-PO649, TH-PO657, TH-PO658, TH-PO662, TH-PO667, TH-PO678, TH-PO680, TH-PO681, TH-PO682, TH-PO685, TH-PO686, TH-PO688, TH-PO689, TH-PO690, TH-PO691, TH-PO692, TH-PO693, TH-PO699, TH-PO702, TH-PO704, TH-PO705, TH-PO706, TH-PO710, TH-PO711, TH-PO712, TH-PO713, TH-PO714, TH-PO718, TH-PO719, TH-PO720, TH-PO721, TH-PO722, TH-PO724, TH-PO726, TH-PO728, TH-PO729, TH-PO732, TH-PO733, TH-PO734, TH-PO735, TH-PO736, TH-PO739, TH-PO741, TH-PO742, TH-PO743, TH-PO744, TH-PO745, TH-PO756, TH-PO759, TH-PO761, TH-PO768, TH-PO774, TH-PO776, TH-PO780, TH-PO784, TH-PO788, TH-PO798, TH-PO801, TH-PO806, TH-PO808, TH-PO810, TH-PO814, TH-PO818, TH-PO820, TH-PO821, TH-PO822, TH-PO823, TH-PO824, TH-PO830, TH-PO845, TH-PO846, TH-PO850, TH-PO851, TH-PO852, TH-PO853, TH-PO854, TH-PO856, TH-PO859, TH-PO861, TH-PO864, TH-PO865, TH-PO866, TH-PO868, TH-PO869, TH-PO872, TH-PO874, TH-PO876, TH-PO877, TH-PO879, TH-PO881, TH-PO882, TH-PO883, TH-PO885, TH-PO887, TH-PO888, TH-PO889, TH-PO893, TH-PO895, TH-PO897, TH-PO899, TH-PO902, TH-PO903, TH-PO904, TH-PO905, TH-PO908, TH-PO910, TH-PO911, TH-PO912, TH-PO913, TH-PO929, TH-PO940, FR-OR02, FR-OR05, FR-OR07, FR-OR17, FR-OR18, FR-OR21, FR-OR22, FR-OR23, FR-OR24, FR-OR26, FR-OR40, FR-OR47, FR-PO006, FR-PO008, FR-PO014, FR-PO061, FR-PO065, FR-PO066, FR-PO076, FR-PO110, FR-PO115, FR-PO119, FR-PO135, FR-PO189, FR-PO221, FR-PO232, FR-PO235, FR-PO237, FR-PO239, FR-PO285,

**chronic kidney**

**disease (continued)**.....FR-PO288, FR-PO302, FR-PO304, FR-PO307, FR-PO316, FR-PO319, FR-PO320, FR-PO331, FR-PO335, FR-PO338, FR-PO342, FR-PO356, FR-PO386, FR-PO394, FR-PO396, FR-PO402, FR-PO407, FR-PO408, FR-PO409, FR-PO410, FR-PO411, FR-PO412, FR-PO413, FR-PO414, FR-PO415, FR-PO417, FR-PO420, FR-PO421, FR-PO423, FR-PO435, FR-PO513, FR-PO529, FR-PO546, FR-PO550, FR-PO552, FR-PO558, FR-PO708, FR-PO738, FR-PO741, FR-PO743, FR-PO745, FR-PO746, FR-PO753, FR-PO758, FR-PO760, FR-PO776, FR-PO857, FR-PO871, FR-PO874, FR-PO886, FR-PO891, FR-PO893, FR-PO895, FR-PO899, FR-PO900, FR-PO901, FR-PO902, FR-PO903, FR-PO906, FR-PO907, FR-PO908, FR-PO909, FR-PO912, FR-PO916, FR-PO917, FR-PO920, FR-PO921, FR-PO923, FR-PO926, FR-PO928, FR-PO930, FR-PO931, FR-PO932, FR-PO933, FR-PO934, FR-PO936, FR-PO937, FR-PO938, FR-PO939, FR-PO941, FR-PO943, FR-PO945, FR-PO946, FR-PO948, FR-PO951, FR-PO952, FR-PO954, FR-PO957, FR-PO958, FR-PO964, FR-PO965, FR-PO966, FR-PO969, FR-PO971, FR-PO972, FR-PO973, FR-PO976, FR-PO977, FR-PO978, FR-PO982, FR-PO983, FR-PO984, FR-PO985, FR-PO986, FR-PO987, FR-PO988, FR-PO995, FR-PO998, FR-PO999, FR-PO1005, SA-OR06, SA-OR10, SA-OR31, SA-OR32, SA-OR34, SA-OR36, SA-OR37, SA-OR40, SA-PO005, SA-PO014, SA-PO087, SA-PO127, SA-PO129, SA-PO135, SA-PO153, SA-PO162, SA-PO164, SA-PO171, SA-PO188, SA-PO189, SA-PO191, SA-PO192, SA-PO193, SA-PO194, SA-PO210, SA-PO213, SA-PO214, SA-PO218, SA-PO222, SA-PO230, SA-PO241, SA-PO247, SA-PO253, SA-PO260, SA-PO261, SA-PO274, SA-PO275, SA-PO284, SA-PO286, SA-PO287, SA-PO288, SA-PO294, SA-PO327, SA-PO354, SA-PO400, SA-PO401, SA-PO412, SA-PO463, SA-PO504, SA-PO506, SA-PO508, SA-PO523, SA-PO529, SA-PO533, SA-PO534, SA-PO536, SA-PO542, SA-PO550, SA-PO552, SA-PO571, SA-PO579, SA-PO597, SA-PO631, SA-PO749, SA-PO751, SA-PO771, SA-PO773, SA-PO775, SA-PO786, SA-PO789, SA-PO794, SA-PO888, SA-PO889, SA-PO891, SA-PO892, SA-PO894, SA-PO895, SA-PO896, SA-PO897, SA-PO901, SA-PO905, SA-PO908, SA-PO910, SA-PO911, SA-PO914, SA-PO915, SA-PO917, SA-PO918, SA-PO919, SA-PO924, SA-PO931, SA-PO932, SA-PO933, SA-PO934, SA-PO937, SA-PO939, SA-PO941, SA-PO942, SA-PO943, SA-PO944, SA-PO945, SA-PO946,

**chronic kidney**

**disease (continued)**..... SA-PO949, SA-PO953, SA-PO955, SA-PO959, SA-PO963, SA-PO978, SA-PO979, SA-PO981, SA-PO982, SA-PO984, SA-PO989, SA-PO990, SA-PO991, SA-PO993, SA-PO996, SA-PO998, SA-PO999, SA-PO1000, SA-PO1001, SA-PO1003, SA-PO1006, SA-PO1007, SA-PO1008, SA-PO1012, SA-PO1013, PUB014, PUB018, PUB078, PUB082, PUB083, PUB087, PUB098, PUB099, PUB101, PUB108, PUB111, PUB112, PUB114, PUB115, PUB159, PUB160, PUB163, PUB172, PUB201, PUB250, PUB252, PUB253, PUB286, PUB288, PUB289, PUB348, PUB349, PUB350, PUB351, PUB352, PUB356, PUB357, PUB358, PUB359, PUB361, PUB362, PUB363, PUB365

**chronic kidney failure**..... TH-PO209, TH-PO697, TH-PO886, FR-PO424, FR-PO975, SA-PO130, SA-PO219, SA-PO331, SA-PO337, SA-PO618, SA-PO838, SA-PO980, PUB042, PUB112, PUB134, PUB360

**chronic metabolic acidosis**..... SA-PO497

**chronic nephropathy**..... FR-PO997, FR-PO1002, SA-PO709

**chronic renal disease**..... TH-OR26, TH-PO228, TH-PO269, TH-PO354, TH-PO417, TH-PO550, TH-PO703, TH-PO750, TH-PO770, TH-PO880, TH-PO896, TH-PO907, FR-PO634, FR-PO914, FR-PO942, FR-PO957, FR-PO961, FR-PO979, FR-PO997, FR-PO1004, SA-OR21, SA-PO167, SA-PO395, SA-PO845, SA-PO887, SA-PO890, SA-PO928, SA-PO950, PUB155, PUB196, PUB355

**chronic renal failure**..... TH-OR07, TH-PO070, TH-PO549, TH-PO663, TH-PO793, TH-PO939, FR-PO074, FR-PO079, FR-PO430, SA-PO384, SA-PO621, SA-PO995, PUB088

**chronic renal insufficiency**..... TH-PO059, TH-PO394, TH-PO892, PUB215

**cisplatin**..... TH-OR45, FR-PO130, FR-PO189, FR-PO223, FR-PO244, SA-PO124, SA-PO466, SA-PO472

**cisplatin nephrotoxicity**..... TH-PO209, FR-PO117, FR-PO121, FR-PO122, FR-PO138, FR-PO196, FR-PO954, FR-PO973, FR-PO980, SA-PO472, SA-PO483, SA-PO518

**clinical epidemiology**..... TH-OR09, TH-PO069, TH-PO153, TH-PO474, TH-PO601, TH-PO608, TH-PO667, TH-PO733, TH-PO807, TH-PO846, TH-PO901, TH-PO905, TH-PO908, TH-PO922, FR-PO027, FR-PO058, FR-PO109, FR-PO112, FR-PO491, FR-PO638, FR-PO814, FR-PO864, FR-PO865, FR-PO866, FR-PO902, FR-PO916, FR-PO917, FR-PO926, FR-PO927, SA-OR34, SA-PO166, SA-PO259, SA-PO535, SA-PO717, SA-PO925

**clinical hypertension**..... TH-PO854, FR-PO735, FR-PO742

**clinical immunology**..... TH-PO751, FR-OR51, FR-PO841, SA-PO714, PUB335

**clinical nephrology**..... TH-OR08, TH-PO033,

TH-PO044, TH-PO058, TH-PO081, TH-PO427, TH-PO500, TH-PO525, TH-PO534, TH-PO632, TH-PO708, TH-PO763, TH-PO768, TH-PO908, TH-PO919, FR-PO002, FR-PO012, FR-PO021, FR-PO074, FR-PO209, FR-PO240, FR-PO570, FR-PO624, FR-PO639, FR-PO643, FR-PO663, FR-PO732, FR-PO892, FR-PO933, SA-PO123, SA-PO156, SA-PO307, SA-PO329, SA-PO529, SA-PO542, SA-PO550, SA-PO588, SA-PO625, SA-PO727, SA-PO812, SA-PO823, SA-PO911, PUB033, PUB040, PUB063, PUB158, PUB173, PUB175, PUB179, PUB186, PUB218, PUB354, PUB358

**clinical trial**..... TH-OR09, TH-OR38, TH-PO003, TH-PO157, TH-PO162, TH-PO163, TH-PO385, TH-PO480, TH-PO488, TH-PO497, TH-PO498, TH-PO499, TH-PO506, TH-PO934, FR-OR58, FR-PO005, FR-PO241, FR-PO506, FR-PO536, FR-PO570, FR-PO646, FR-PO651, FR-PO659, FR-PO774, SA-OR10, SA-OR43, SA-OR49, SA-PO164, SA-PO400, SA-PO410, SA-PO416, SA-PO584, SA-PO655, SA-PO679, SA-PO696, SA-PO893, SA-PO894, SA-PO898, SA-PO917, SA-PO920, PUB050, PUB056, PUB078, PUB192, PUB299

**cognition**..... TH-OR12, TH-PO774, TH-PO800, TH-PO880, FR-PO417, SA-PO319, SA-PO404, SA-PO948

**collapsing FSGS**..... TH-PO420, TH-PO470, TH-PO512, FR-PO041, FR-PO043, FR-PO678, SA-OR01, SA-OR22, SA-PO869, PUB003, PUB038, PUB336

**collecting ducts**..... TH-PO310, TH-PO314, TH-PO331, TH-PO332, FR-OR09, FR-PO290, FR-PO369, FR-PO391, SA-OR17, SA-PO099

**community engagement and health**..... TH-PO007, TH-PO015, TH-PO020, FR-PO891, FR-PO893, FR-PO894, SA-PO541, SA-PO947, PUB155, PUB165, PUB352

**complement**..... TH-OR46, TH-PO100, TH-PO455, TH-PO501, TH-PO502, TH-PO503, TH-PO504, TH-PO519, TH-PO652, TH-PO751, TH-PO763, TH-PO764, FR-OR37, FR-OR59, FR-PO022, FR-PO034, FR-PO037, FR-PO057, FR-PO201, FR-PO390, FR-PO581, FR-PO601, FR-PO618, FR-PO629, FR-PO645, FR-PO656, FR-PO715, FR-PO823, SA-OR28, SA-PO024, SA-PO577, SA-PO592, SA-PO595, SA-PO596, SA-PO629, SA-PO630, SA-PO631, SA-PO632, SA-PO633, SA-PO634, SA-PO635, SA-PO636, SA-PO661, SA-PO671, SA-PO672, SA-PO676, SA-PO695, SA-PO696, SA-PO719, SA-PO871, PUB004, PUB193, PUB207, PUB208, PUB240

**complications**..... TH-PO012, TH-PO013, TH-PO075, TH-PO239, TH-PO270,

- complications (continued)** ..... TH-PO277, TH-PO294, TH-PO299, TH-PO564, TH-PO619, TH-PO658, TH-PO819, TH-PO883, TH-PO910, TH-PO956, FR-PO195, FR-PO449, FR-PO460, FR-PO469, FR-PO479, FR-PO483, FR-PO503, FR-PO506, FR-PO534, FR-PO612, SA-PO310, SA-PO441, SA-PO448, SA-PO452, SA-PO488, SA-PO494, SA-PO846, SA-PO854, SA-PO864, SA-PO990, PUB039, PUB132, PUB136, PUB201, PUB266, PUB273
- congestive heart failure**..... TH-PO082, TH-PO104, TH-PO603, FR-PO083, FR-PO085, FR-PO740, SA-PO353, SA-PO926, PUB141
- coronary artery disease** ..... TH-PO550
- coronary calcification**..... FR-PO745, FR-PO746, SA-PO162, SA-PO185
- creatinine**.... TH-PO029, TH-PO059, TH-PO073, TH-PO111, TH-PO786, TH-PO881, TH-PO898, FR-PO004, FR-PO088, FR-PO229, FR-PO249, FR-PO493, FR-PO494, FR-PO574, FR-PO837, FR-PO885, FR-PO914, FR-PO921, FR-PO934, SA-PO034, PUB028
- creatinine clearance** ..... TH-PO116, TH-PO166, TH-PO648, FR-PO216, FR-PO492, PUB241
- cyclic AMP** ..... TH-PO318, FR-PO278, FR-PO348
- cyclic GMP**..... SA-PO247, SA-PO248
- cyclosporine nephrotoxicity** ..... TH-PO642, TH-PO645, TH-PO655
- cystic kidney** ..... TH-OR36, TH-PO357, TH-PO360, TH-PO365, TH-PO366, TH-PO374, TH-PO378, TH-PO393, TH-PO395, TH-PO401, FR-PO248, FR-PO264, FR-PO272, FR-PO278, FR-PO281, FR-PO282, FR-PO283, FR-PO290, FR-PO291, FR-PO296, FR-PO347, FR-PO366, SA-PO937, PUB187, PUB188, PUB197, PUB260
- cytokines**..... TH-OR01, TH-OR27, TH-PO042, TH-PO085, TH-PO096, TH-PO097, TH-PO101, TH-PO102, TH-PO105, TH-PO148, TH-PO194, TH-PO279, TH-PO548, FR-PO001, FR-PO036, FR-PO050, FR-PO139, FR-PO165, FR-PO166, FR-PO213, FR-PO375, FR-PO592, FR-PO593, FR-PO626, FR-PO950, FR-PO976, FR-PO980, FR-PO982, FR-PO991, SA-PO008, SA-PO074, SA-PO444, SA-PO638, SA-PO770, SA-PO792, SA-PO963, SA-PO1004, PUB030, PUB047
- cytomegalovirus**..... TH-OR57, FR-PO768, FR-PO801, FR-PO829, FR-PO849, SA-PO826, PUB303
- cytoskeleton** ..... TH-PO221, FR-PO271, FR-PO366, FR-PO367, FR-PO368, FR-PO700, FR-PO711, FR-PO731, SA-PO642
- daily hemodialysis** ..... TH-PO959, FR-PO514, SA-PO422, SA-PO454, PUB185
- delayed graft function**..... TH-OR54, TH-PO098, TH-PO396, TH-PO640, TH-PO641, FR-PO793, FR-PO806, FR-PO819, SA-PO819, SA-PO866, PUB312
- dementia**..... TH-OR25, TH-PO659, TH-PO880, FR-PO559, FR-PO826, PUB131
- Dent disease** ..... SA-PO574, SA-PO575, SA-PO580, SA-PO581
- depression** ..... TH-PO191, TH-PO384, TH-PO817, FR-PO230, FR-PO748, FR-PO948, SA-PO218, SA-PO295, SA-PO298, SA-PO852, PUB023, PUB026
- diabetes**..... TH-PO001, TH-PO002, TH-PO088, TH-PO178, TH-PO191, TH-PO216, TH-PO237, TH-PO247, TH-PO255, TH-PO601, TH-PO604, TH-PO820, FR-OR35, FR-PO758, FR-PO840, FR-PO936, SA-PO241, SA-PO262, SA-PO265, SA-PO268, SA-PO273, SA-PO274, SA-PO275, SA-PO399, SA-PO887, SA-PO954, SA-PO964, PUB095, PUB098, PUB103, PUB105, PUB111, PUB113, PUB222
- diabetes insipidus** ..... TH-PO339, TH-PO345, FR-PO357, SA-PO476, SA-PO477, SA-PO478, PUB097, PUB171, PUB177, PUB185
- diabetes mellitus** ..... TH-PO219, TH-PO224, TH-PO228, TH-PO229, TH-PO231, TH-PO234, TH-PO240, TH-PO253, TH-PO254, TH-PO736, TH-PO785, TH-PO849, FR-OR50, FR-PO104, FR-PO402, FR-PO464, FR-PO814, FR-PO817, FR-PO825, FR-PO827, FR-PO852, SA-PO221, SA-PO227, SA-PO258, SA-PO261, SA-PO264, SA-PO269, SA-PO276, SA-PO279, SA-PO283, SA-PO330, SA-PO999, SA-PO1000, PUB100, PUB107, PUB109, PUB125, PUB163, PUB256, PUB304, PUB311, PUB315, PUB326
- diabetic glomerulopathy** ..... TH-PO184, TH-PO207, TH-PO210
- diabetic glomerulosclerosis**..... TH-PO195, TH-PO225, TH-PO248, SA-PO224, SA-PO231, SA-PO527
- diabetic nephropathy** .... TH-PO026, TH-PO110, TH-PO178, TH-PO179, TH-PO186, TH-PO187, TH-PO188, TH-PO189, TH-PO190, TH-PO192, TH-PO193, TH-PO194, TH-PO196, TH-PO197, TH-PO199, TH-PO200, TH-PO201, TH-PO202, TH-PO203, TH-PO205, TH-PO206, TH-PO208, TH-PO211, TH-PO213, TH-PO214, TH-PO215, TH-PO217, TH-PO218, TH-PO219, TH-PO220, TH-PO221, TH-PO222, TH-PO227, TH-PO228, TH-PO230, TH-PO232, TH-PO234, TH-PO235, TH-PO236, TH-PO241, TH-PO244, TH-PO245, TH-PO250, TH-PO252, TH-PO253, TH-PO334, TH-PO560, TH-PO566, FR-OR31, FR-OR32, FR-OR40, FR-PO680, FR-PO696, FR-PO825, FR-PO904, FR-PO911, SA-PO220, SA-PO224, SA-PO225, SA-PO228, SA-PO229, SA-PO230, SA-PO232, SA-PO234, SA-PO235, SA-PO236, SA-PO237, SA-PO238, SA-PO244, SA-PO245, SA-PO248, SA-PO249, SA-PO252, SA-PO253, SA-PO255, SA-PO256, SA-PO260, SA-PO263, SA-PO266, SA-PO267, SA-PO270, SA-PO272, SA-PO274, SA-PO275,
- diabetic nephropathy (continued)**..... SA-PO277, SA-PO280, SA-PO281, SA-PO282, SA-PO283, SA-PO537, PUB092, PUB093, PUB095, PUB096, PUB099, PUB102, PUB104, PUB106, PUB108, PUB109, PUB110, PUB116, PUB117
- dialysis**..... TH-OR16, TH-OR18, TH-OR32, TH-PO011, TH-PO025, TH-PO040, TH-PO042, TH-PO049, TH-PO066, TH-PO073, TH-PO078, TH-PO155, TH-PO160, TH-PO266, TH-PO272, TH-PO282, TH-PO290, TH-PO295, TH-PO296, TH-PO298, TH-PO664, TH-PO687, TH-PO688, TH-PO695, TH-PO717, TH-PO725, TH-PO741, TH-PO745, TH-PO747, TH-PO771, TH-PO773, TH-PO776, TH-PO790, TH-PO794, TH-PO795, TH-PO811, TH-PO831, TH-PO835, TH-PO851, TH-PO860, TH-PO867, TH-PO870, TH-PO871, TH-PO914, TH-PO921, TH-PO922, TH-PO925, TH-PO928, TH-PO930, TH-PO932, TH-PO937, TH-PO938, TH-PO951, TH-PO954, TH-PO955, TH-PO957, TH-PO958,
- dialysis endothelial cells**..... TH-PO962, FR-PO009, FR-PO025, FR-PO030, FR-PO090, FR-PO222, FR-PO224, FR-PO225, FR-PO226, FR-PO227, FR-PO236, FR-PO464, FR-PO485, FR-PO488, FR-PO489, FR-PO512, FR-PO525, FR-PO531, FR-PO535, FR-PO537, FR-PO538, FR-PO564, FR-PO571, FR-PO573, FR-PO651, FR-PO674, FR-PO856, FR-PO862, FR-PO865, FR-PO870, FR-PO872, FR-PO881, FR-PO898, FR-PO930, FR-PO941, SA-OR08, SA-OR09, SA-OR33, SA-PO013, SA-PO022, SA-PO051, SA-PO053, SA-PO055, SA-PO057, SA-PO059, SA-PO171, SA-PO196, SA-PO199, SA-PO285, SA-PO289, SA-PO292, SA-PO296, SA-PO304, SA-PO306, SA-PO307, SA-PO313, SA-PO314, SA-PO315, SA-PO320, SA-PO326, SA-PO331, SA-PO334, SA-PO335, SA-PO336, SA-PO339, SA-PO341, SA-PO346, SA-PO358, SA-PO359, SA-PO364, SA-PO369, SA-PO371, SA-PO374, SA-PO381, SA-PO392, SA-PO393, SA-PO397, SA-PO398, SA-PO399, SA-PO415, SA-PO418, SA-PO420, SA-PO426, SA-PO432, SA-PO436, SA-PO437, SA-PO440, SA-PO443, SA-PO447, SA-PO448, SA-PO493, SA-PO499, SA-PO500, SA-PO501, SA-PO600, SA-PO603, SA-PO689, SA-PO827, PUB009, PUB010, PUB011, PUB012, PUB014, PUB019, PUB029, PUB032, PUB045, PUB049, PUB050, PUB061, PUB067, PUB091, PUB120, PUB122, PUB126, PUB127, PUB128, PUB132, PUB135, PUB149, PUB156, PUB175, PUB183, PUB284, PUB293, PUB298, PUB305, PUB309, PUB345, PUB350, PUB368
- dialysis access** ..... TH-PO006, TH-PO258, TH-PO259, TH-PO264, TH-PO268, TH-PO282, TH-PO285, TH-PO286, TH-PO291, TH-PO294, TH-PO295,



- dialysis access (continued)**.....TH-PO296, TH-PO299, TH-PO303, FR-PO428, FR-PO479, FR-PO495, FR-PO531, FR-PO534, FR-PO859, FR-PO872, FR-PO876, SA-PO437, PUB151, PUB154
- dialysis volume** ..... TH-PO036, FR-PO499, FR-PO536, SA-PO345, SA-PO347, SA-PO350, SA-PO351, SA-PO353, SA-PO433, PUB124, PUB147
- dialysis withholding** ..... TH-PO870, TH-PO871, FR-PO480, FR-PO941, SA-PO304, SA-PO371, SA-PO394
- distal tubule** ..... TH-PO325, TH-PO328, TH-PO568, SA-PO119, SA-PO777
- diuretics**..... TH-PO009, TH-PO010, TH-PO081, TH-PO082, TH-PO330, FR-OR50, FR-PO071, FR-PO560, FR-PO562, FR-PO747, SA-PO481, SA-PO517, SA-PO902, SA-PO903, SA-PO986, PUB097, PUB284
- drug excretion**.....FR-PO236, SA-PO036, SA-PO117, PUB039, PUB064, PUB275
- drug interactions** ..... TH-PO123, TH-PO170, TH-PO297, TH-PO587, TH-PO851, FR-PO051, FR-PO052, FR-PO217, FR-PO218, FR-PO219, FR-PO223, FR-PO280, FR-PO301, SA-PO009, SA-PO034, SA-PO474, SA-PO477
- drug metabolism**..... TH-PO525, TH-PO527, FR-PO239, FR-PO753, FR-PO771, FR-PO782, FR-PO799, SA-PO496, SA-PO498, SA-PO499, SA-PO886
- drug nephrotoxicity**.....TH-OR04, TH-PO068, TH-PO116, TH-PO129, TH-PO131, TH-PO587, TH-PO681, TH-PO682, FR-PO099, FR-PO134, FR-PO197, FR-PO199, FR-PO207, FR-PO212, FR-PO238, FR-PO400, FR-PO487, SA-PO033, SA-PO035, SA-PO037, SA-PO039, SA-PO049, SA-PO083, SA-PO120, SA-PO144, SA-PO149, SA-PO158, SA-PO722, SA-PO863, PUB040, PUB058, PUB073, PUB075, PUB171, PUB356
- drug transporter**..... SA-PO930, SA-PO977
- dyslipidemia**.....FR-PO304, SA-PO955, PUB278, PUB291, PUB296
- echocardiography**..... TH-PO038, TH-PO233, TH-PO606, FR-PO758, SA-PO353, SA-PO373
- economic analysis**.....FR-PO509, FR-PO542, FR-PO608, SA-PO280, SA-PO326, SA-PO392, SA-PO694
- economic impact**..... TH-PO503, FR-PO829, SA-PO280, SA-PO432, SA-PO453, SA-PO811, PUB309
- electrolytes** .....TH-OR31, TH-PO058, TH-PO065, TH-PO305, TH-PO311, TH-PO318, TH-PO331, TH-PO350, TH-PO873, FR-OR43, FR-OR44, FR-PO007, FR-PO028, FR-PO184, FR-PO209, FR-PO446, FR-PO559, FR-PO560, FR-PO561, FR-PO569, FR-PO570, SA-PO467, SA-PO480, SA-PO486, SA-PO489, SA-PO491, SA-PO515, SA-PO519, SA-PO521, SA-PO784, PUB177, PUB180, PUB338
- electron microscopy** ..... TH-PO350, PUB004, PUB193
- electrophysiology**..... TH-PO325, FR-OR46, FR-PO265, FR-PO266, SA-PO784
- ENaC** .....TH-PO332, TH-PO347, FR-PO007, FR-PO275, SA-PO755, SA-PO757
- endocytosis**...FR-PO370, FR-PO685, FR-PO703, FR-PO719, SA-OR25, SA-PO739
- endoplasmic reticulum**.....TH-PO083, TH-PO443, TH-PO642, FR-PO343, FR-PO685, SA-PO067, SA-PO791
- endothelial cells** .....TH-OR48, TH-PO206, TH-PO302, TH-PO425, TH-PO643, TH-PO764, FR-OR14, FR-OR52, FR-PO359, FR-PO360, FR-PO362, FR-PO363, FR-PO389, FR-PO951, SA-OR20, SA-PO039, SA-PO082, SA-PO243, SA-PO632, SA-PO764, SA-PO778
- endothelium** ..... TH-PO148, TH-PO506, TH-PO644, FR-OR56, FR-PO057, FR-PO306, FR-PO372, FR-PO766, FR-PO952, FR-PO1009, SA-PO238, SA-PO412, SA-PO592, SA-PO659, SA-PO661, PUB102, PUB254
- eosinophilia** ..... TH-PO131, PUB119
- epidemiology and outcomes** ..... TH-PO231, TH-PO243, TH-PO282, TH-PO474, TH-PO485, TH-PO558, TH-PO591, TH-PO599, TH-PO613, TH-PO624, TH-PO694, TH-PO699, TH-PO713, TH-PO718, TH-PO722, TH-PO769, TH-PO771, TH-PO774, TH-PO775, TH-PO780, TH-PO812, TH-PO816, TH-PO852, TH-PO853, TH-PO855, TH-PO856, TH-PO860, TH-PO862, TH-PO868, TH-PO872, TH-PO874, TH-PO879, TH-PO882, TH-PO884, TH-PO887, TH-PO889, TH-PO896, TH-PO902, TH-PO903, TH-PO914, TH-PO949, TH-PO952, FR-OR22, FR-OR24, FR-PO066, FR-PO067, FR-PO075, FR-PO091, FR-PO221, FR-PO411, FR-PO476, FR-PO477, FR-PO574, FR-PO637, FR-PO754, FR-PO756, FR-PO810, FR-PO864, FR-PO880, FR-PO899, FR-PO900, FR-PO904, FR-PO905, FR-PO917, FR-PO919, FR-PO921, FR-PO922, FR-PO929, FR-PO931, FR-PO938, SA-PO167, SA-PO207, SA-PO382, SA-PO449, SA-PO601, SA-PO800, SA-PO845, SA-PO908, SA-PO913, SA-PO914, SA-PO924, SA-PO941, PUB096, PUB121, PUB159, PUB225, PUB251, PUB352
- epidermal growth factor** ..... FR-PO920
- epithelial**..... TH-PO312, FR-OR29, FR-OR34, FR-PO019, FR-PO981, SA-PO607, SA-PO613, SA-PO972
- epithelial sodium channel** ..... TH-PO349
- epithelial sodium transport** ..... TH-PO347, FR-PO989, SA-PO977
- epoetin** ..... TH-PO664, TH-PO669
- erythropoietin** ..... TH-PO665, TH-PO666, TH-PO670, TH-PO671, TH-PO673, TH-PO687, TH-PO689, TH-PO700, FR-PO161, SA-PO115, PUB080
- ESRD (end-stage renal disease)** ..... TH-OR14, TH-PO015, TH-PO028, TH-PO222, TH-PO232, TH-PO251, TH-PO290, TH-PO386, TH-PO400, TH-PO429,
- ESRD (end-stage renal disease) (continued)**.....TH-PO479, TH-PO492, TH-PO494, TH-PO500, TH-PO502, TH-PO580, TH-PO615, TH-PO616, TH-PO627, TH-PO633, TH-PO634, TH-PO671, TH-PO716, TH-PO777, TH-PO778, TH-PO783, TH-PO789, TH-PO792, TH-PO795, TH-PO799, TH-PO807, TH-PO813, TH-PO816, TH-PO878, TH-PO918, TH-PO927, TH-PO933, TH-PO934, TH-PO936, TH-PO938, TH-PO949, TH-PO961, FR-OR37, FR-PO050, FR-PO065, FR-PO080, FR-PO092, FR-PO316, FR-PO473, FR-PO478, FR-PO480, FR-PO483, FR-PO507, FR-PO510, FR-PO515, FR-PO516, FR-PO521, FR-PO523, FR-PO530, FR-PO533, FR-PO534, FR-PO540, FR-PO541, FR-PO544, FR-PO642, FR-PO662, FR-PO674, FR-PO757, FR-PO826, FR-PO860, FR-PO864, FR-PO875, FR-PO881, FR-PO903, FR-PO935, SA-OR09, SA-OR10, SA-PO010, SA-PO016, SA-PO157, SA-PO180, SA-PO181, SA-PO197, SA-PO198, SA-PO253, SA-PO287, SA-PO302, SA-PO307, SA-PO311, SA-PO321, SA-PO323, SA-PO324, SA-PO333, SA-PO342, SA-PO352, SA-PO391, SA-PO395, SA-PO404, SA-PO419, SA-PO452, SA-PO460, SA-PO462, SA-PO528, SA-PO533, SA-PO537, SA-PO549, SA-PO552, SA-PO584, SA-PO586, SA-PO702, SA-PO806, SA-PO861, SA-PO892, SA-PO902, SA-PO903, SA-PO909, SA-PO932, SA-PO936, SA-PO938, SA-PO968, PUB024, PUB029, PUB034, PUB052, PUB079, PUB084, PUB113, PUB118, PUB133, PUB145, PUB146, PUB156, PUB174, PUB201, PUB210, PUB246, PUB251, PUB345, PUB349, PUB357
- ethnicity**..... TH-PO725, TH-PO739, TH-PO878, FR-PO859, FR-PO882, FR-PO892, SA-OR33, SA-OR34, SA-PO056, SA-PO131, SA-PO685, SA-PO889, SA-PO913, PUB156
- expression**.....FR-PO712, SA-PO237
- extracellular matrix** ..... TH-PO121, TH-PO186, TH-PO225, TH-PO239, TH-PO288, TH-PO423, TH-PO424, TH-PO429, TH-PO822, FR-PO246, FR-PO322, FR-PO351, FR-PO970, FR-PO974, SA-OR26, SA-PO017, SA-PO635
- Fabry disease** ..... TH-PO537, FR-PO339, FR-PO340, FR-PO341, FR-PO442, PUB193, PUB195, PUB196
- factor** ..... TH-PO917, SA-PO331
- failure** ..... FR-PO877
- familial nephropathy**..... TH-PO359, SA-PO530, SA-PO559, SA-PO563
- family history**..... TH-PO363, TH-PO876, SA-PO497, PUB198
- fibroblast** ..... TH-PO227, FR-PO458, FR-PO990, SA-PO107, SA-PO204, SA-PO205
- fibronectin** .....FR-PO459, SA-PO971, PUB109, PUB367
- fibrosis** ..... TH-OR19, TH-OR50, TH-PO204, TH-PO206, TH-PO208, TH-PO234, TH-PO239, TH-PO256, TH-PO415,

- fibrosis (continued)**..... TH-PO422, TH-PO431, TH-PO546, TH-PO547, TH-PO556, TH-PO822, TH-PO869, FR-OR28, FR-PO135, FR-PO161, FR-PO237, FR-PO246, FR-PO262, FR-PO285, FR-PO286, FR-PO356, FR-PO369, FR-PO396, FR-PO452, FR-PO453, FR-PO456, FR-PO457, FR-PO459, FR-PO461, FR-PO462, FR-PO463, FR-PO529, FR-PO688, FR-PO910, FR-PO946, FR-PO956, FR-PO958, FR-PO963, FR-PO964, FR-PO966, FR-PO967, FR-PO968, FR-PO971, FR-PO973, FR-PO976, FR-PO977, FR-PO978, FR-PO979, FR-PO980, FR-PO981, FR-PO982, FR-PO984, FR-PO990, FR-PO995, FR-PO997, FR-PO999, FR-PO1001, FR-PO1004, FR-PO1005, FR-PO1009, SA-OR05, SA-PO037, SA-PO063, SA-PO093, SA-PO106, SA-PO111, SA-PO240, SA-PO633, SA-PO781, SA-PO972, SA-PO983, SA-PO987, SA-PO997, SA-PO1005, SA-PO1007, SA-PO1009, SA-PO1013, PUB364, PUB365, PUB366
- gastrointestinal complications**..... TH-PO104, TH-PO837, SA-PO390, SA-OR82, PUB337
- gastrointestinal medications**..... FR-PO233
- gender difference**..... TH-PO139, TH-PO181, TH-PO598, TH-PO943, FR-OR02, FR-PO514, FR-PO868, FR-PO885, FR-PO886, FR-PO887, FR-PO905, FR-PO931, SA-PO227, SA-PO776, SA-PO925, PUB249, PUB325
- gene expression**..... TH-OR34, TH-PO145, TH-PO204, TH-PO246, TH-PO248, TH-PO317, TH-PO537, TH-PO641, TH-PO654, TH-PO829, FR-OR36, FR-OR53, FR-OR60, FR-PO116, FR-PO139, FR-PO147, FR-PO152, FR-PO251, FR-PO294, FR-PO306, FR-PO308, FR-PO309, FR-PO373, FR-PO451, FR-PO586, FR-PO696, FR-PO730, FR-PO767, FR-PO799, FR-PO1006, SA-OR44, SA-OR50, SA-PO079, SA-PO084, SA-PO177, SA-PO622, SA-PO647, SA-PO763, SA-PO959, SA-PO966, SA-PO974, SA-PO1011, SA-PO1012, PUB188, PUB268, PUB363
- gene therapy** ..... FR-PO268, FR-PO332, FR-PO352, FR-PO407, SA-OR12
- gene transcription** ..... TH-PO415, TH-PO657, FR-OR34, FR-PO441, SA-PO091, SA-PO653, SA-PO769
- genetic renal disease**..... TH-PO151, TH-PO333, TH-PO357, TH-PO358, TH-PO359, TH-PO361, TH-PO362, TH-PO364, TH-PO365, TH-PO367, TH-PO369, TH-PO372, TH-PO373, TH-PO374, TH-PO377, TH-PO378, TH-PO379, TH-PO380, TH-PO388, TH-PO389, TH-PO394, TH-PO408, TH-PO450, TH-PO742, TH-PO752, TH-PO761, TH-PO895, FR-OR45, FR-PO252, FR-PO253, FR-PO270, FR-PO282, FR-PO283, FR-PO309, FR-PO312, FR-PO317, FR-PO318, FR-PO324, FR-PO325, FR-PO326, FR-PO328, FR-PO335,
- genetic renal disease (continued)** ..... FR-PO337, FR-PO362, FR-PO407, FR-PO439, FR-PO440, FR-PO441, FR-PO443, FR-PO446, FR-PO447, FR-PO448, FR-PO449, FR-PO450, FR-PO554, FR-PO692, FR-PO697, FR-PO699, FR-PO704, FR-PO709, FR-PO761, FR-PO823, FR-PO824, SA-OR11, SA-OR12, SA-PO026, SA-PO205, SA-PO206, SA-PO519, SA-PO522, SA-PO524, SA-PO525, SA-PO527, SA-PO529, SA-PO530, SA-PO531, SA-PO532, SA-PO533, SA-PO534, SA-PO535, SA-PO536, SA-PO538, SA-PO540, SA-PO541, SA-PO542, SA-PO543, SA-PO544, SA-PO545, SA-PO546, SA-PO547, SA-PO548, SA-PO549, SA-PO550, SA-PO551, SA-PO553, SA-PO554, SA-PO555, SA-PO558, SA-PO559, SA-PO561, SA-PO562, SA-PO565, SA-PO566, SA-PO567, SA-PO568, SA-PO569, SA-PO570, SA-PO571, SA-PO572, SA-PO573, SA-PO574, SA-PO576, SA-PO578, SA-PO581, SA-PO582, SA-PO586, SA-PO591, SA-PO624, SA-PO625, SA-PO628, SA-PO738, SA-PO741, SA-PO742, PUB186, PUB190, PUB194, PUB197, PUB240
- genetics and development**..... TH-OR02, TH-PO324, TH-PO476, TH-PO495, TH-PO646, TH-PO647, FR-PO248, FR-PO381, FR-PO384, FR-PO935, SA-OR15, SA-OR16, SA-OR18, SA-OR20, SA-PO497, SA-PO523, SA-PO546, SA-PO573, SA-PO583, SA-PO606
- geriatric nephrology**..... TH-PO101, TH-PO535, TH-PO768, TH-PO779, TH-PO781, TH-PO782, TH-PO783, TH-PO785, TH-PO787, TH-PO792, TH-PO794, TH-PO795, TH-PO796, TH-PO799, FR-PO095, FR-PO490, FR-PO511, FR-PO925, FR-PO955, FR-PO978, SA-OR35, SA-PO372, SA-PO923, PUB200
- Gitelman syndrome**..... TH-PO324, FR-PO337, SA-PO483, SA-PO484
- glomerular disease**..... TH-PO415, TH-PO422, TH-PO428, TH-PO430, TH-PO431, TH-PO432, TH-PO435, TH-PO436, TH-PO438, TH-PO444, TH-PO451, TH-PO452, TH-PO466, TH-PO467, TH-PO468, TH-PO469, TH-PO472, TH-PO473, TH-PO477, TH-PO478, TH-PO482, TH-PO486, TH-PO489, TH-PO500, TH-PO501, TH-PO513, TH-PO517, TH-PO518, TH-PO529, TH-PO530, TH-PO534, TH-PO558, TH-PO563, TH-PO569, TH-PO579, TH-PO902, TH-PO906, FR-OR53, FR-OR58, FR-PO038, FR-PO044, FR-PO047, FR-PO055, FR-PO178, FR-PO191, FR-PO200, FR-PO318, FR-PO330, FR-PO332, FR-PO403, FR-PO439, FR-PO619, FR-PO622, FR-PO631, FR-PO634, FR-PO635, FR-PO636, FR-PO644, FR-PO652, FR-PO665, FR-PO670, FR-PO675, FR-PO679, FR-PO688, FR-PO693, FR-PO695, FR-PO715, FR-PO721, FR-PO723, FR-PO725, FR-PO726, FR-PO727, FR-PO729, FR-PO732, FR-PO770,
- glomerular disease (continued)**..... SA-OR27, SA-PO001, SA-PO002, SA-PO031, SA-PO132, SA-PO133, SA-PO138, SA-PO239, SA-PO251, SA-PO524, SA-PO525, SA-PO532, SA-PO547, SA-PO553, SA-PO563, SA-PO636, SA-PO651, SA-PO653, SA-PO663, SA-PO666, SA-PO673, SA-PO674, SA-PO703, SA-PO705, SA-PO707, SA-PO709, SA-PO711, SA-PO718, SA-PO720, SA-PO721, SA-PO730, SA-PO739, SA-PO741, SA-PO865, SA-PO880, PUB008, PUB022, PUB033, PUB035, PUB194, PUB217, PUB220, PUB227, PUB228, PUB230, PUB231, PUB234, PUB238, PUB239, PUB242, PUB246, PUB247, PUB334
- glomerular endothelial cells** ..... TH-PO212, FR-OR36, FR-PO321, FR-PO401, FR-PO716, SA-PO228, PUB060
- glomerular epithelial cells** ..... FR-PO353, SA-OR21, SA-OR22
- glomerular filtration barrier**..... TH-PO193, TH-PO250, TH-PO417, TH-PO424, TH-PO542, TH-PO753, FR-PO329, FR-PO350, FR-PO690, FR-PO691, FR-PO703, FR-PO707, SA-PO249, SA-PO556, SA-PO737
- glomerular filtration rate**..... TH-OR38, TH-OR39, TH-PO059, TH-PO085, TH-PO226, TH-PO413, TH-PO521, TH-PO596, TH-PO631, TH-PO648, TH-PO725, TH-PO729, TH-PO731, TH-PO732, TH-PO742, TH-PO743, TH-PO780, TH-PO786, TH-PO805, TH-PO845, TH-PO847, TH-PO878, TH-PO882, TH-PO890, TH-PO898, TH-PO901, FR-OR39, FR-PO216, FR-PO413, FR-PO765, FR-PO808, FR-PO875, FR-PO885, FR-PO897, FR-PO908, FR-PO911, FR-PO922, FR-PO927, FR-PO934, FR-PO939, SA-OR38, SA-PO022, SA-PO118, SA-PO121, SA-PO147, SA-PO148, SA-PO155, SA-PO223, SA-PO224, SA-PO240, SA-PO269, SA-PO282, SA-PO587, SA-PO768, SA-PO780, SA-PO788, SA-PO813, SA-PO821, SA-PO822, SA-PO829, SA-PO839, SA-PO886, SA-PO887, SA-PO888, SA-PO890, SA-PO891, SA-PO893, SA-PO909, SA-PO912, SA-PO913, SA-PO920, SA-PO921, SA-PO922, SA-PO926, SA-PO950, SA-PO959, SA-PO965, PUB028, PUB111
- glomerular hyperfiltration** ..... TH-PO553, TH-PO611, TH-PO875, SA-PO968
- glomerulonephritis**..... TH-PO122, TH-PO137, TH-PO434, TH-PO439, TH-PO471, TH-PO487, TH-PO488, TH-PO493, TH-PO499, TH-PO509, TH-PO518, TH-PO519, TH-PO522, TH-PO523, TH-PO524, TH-PO541, TH-PO560, TH-PO575, TH-PO584, TH-PO886, FR-OR51, FR-OR55, FR-PO039, FR-PO045, FR-PO046, FR-PO049, FR-PO056, FR-PO200, FR-PO201, FR-PO437, FR-PO575, FR-PO578, FR-PO579, FR-PO582, FR-PO583, FR-PO585, FR-PO599, FR-PO600, FR-PO614, FR-PO615, FR-PO621, FR-PO625,

- glomerulonephritis (continued)** ..... FR-PO630, FR-PO635, FR-PO637, FR-PO645, FR-PO673, FR-PO682, FR-PO683, FR-PO730, FR-PO769, FR-PO809, SA-OR29, SA-PO114, SA-PO134, SA-PO141, SA-PO181, SA-PO565, SA-PO629, SA-PO630, SA-PO650, SA-PO662, SA-PO666, SA-PO667, SA-PO668, SA-PO671, SA-PO674, SA-PO675, SA-PO677, SA-PO680, SA-PO682, SA-PO684, SA-PO685, SA-PO701, SA-PO703, SA-PO719, SA-PO728, SA-PO729, SA-PO853, SA-PO857, PUB004, PUB017, PUB022, PUB205, PUB208, PUB209, PUB212, PUB213, PUB218, PUB219, PUB225, PUB242, PUB244, PUB274, PUB328, PUB332, PUB343
- glomerulopathy** ..... TH-PO505, TH-PO520, TH-PO524, TH-PO906, FR-PO040, FR-PO041, FR-PO310, FR-PO611, FR-PO632, FR-PO723, SA-PO029, SA-PO136, SA-PO543, SA-PO547, SA-PO634, SA-PO714, SA-PO725, SA-PO732, PUB033, PUB237
- glomerulosclerosis** ..... TH-PO184, TH-PO421, TH-PO444, TH-PO569, TH-PO576, FR-OR56, FR-OR57, FR-PO439, FR-PO662, FR-PO686, FR-PO702, FR-PO709, FR-PO711, FR-PO714, FR-PO728, FR-PO731, FR-PO734, FR-PO913, SA-PO159, SA-PO222, SA-PO223, SA-PO702, SA-PO708, SA-PO709, SA-PO711, SA-PO752, SA-PO879, PUB115, PUB203, PUB233, PUB234, PUB235
- glomerulus** ..... TH-PO187, TH-PO417, TH-PO418, TH-PO424, TH-PO572, FR-PO361, FR-PO387, FR-PO690, FR-PO691, FR-PO720, FR-PO823, SA-OR11, SA-PO256, SA-PO763, PUB269
- glycation** ..... TH-PO240, SA-PO645
- Goodpasture syndrome**..... FR-PO587, FR-PO611, PUB241
- health equity, diversity, and inclusion** ..... TH-PO007, TH-PO559, TH-PO714, TH-PO715, TH-PO716, TH-PO720, TH-PO721, TH-PO722, TH-PO723, TH-PO724, TH-PO728, TH-PO730, TH-PO735, TH-PO743, TH-PO772, TH-PO773, TH-PO894, TH-PO936, TH-PO942, FR-PO008, FR-PO862, FR-PO867, FR-PO871, FR-PO873, FR-PO876, FR-PO877, FR-PO887, FR-PO889, FR-PO894, FR-PO929, FR-PO945, SA-OR31, SA-PO156, SA-PO313, SA-PO459, SA-PO804, SA-PO951, PUB155, PUB160, PUB258
- health policy**.....TH-OR17, TH-PO723, TH-PO735, TH-PO737, TH-PO798, TH-PO894, TH-PO900, TH-PO903, FR-PO509, FR-PO535, FR-PO865, FR-PO898, FR-PO943, SA-PO297, SA-PO321, SA-PO434, SA-PO830, PUB164
- health status** ..... TH-PO815, TH-PO819, TH-PO820, TH-PO828, FR-PO503, SA-PO278, SA-PO295, SA-PO297, SA-PO402, SA-PO820, PUB161, PUB346
- heart disease** ..... TH-PO099, TH-PO152, TH-PO612, FR-PO070, FR-PO279, SA-PO677, SA-PO829, SA-PO928, PUB251
- heart failure** .....TH-OR26, TH-PO031, TH-PO043, TH-PO069, TH-PO087, TH-PO244, TH-PO280, TH-PO604, TH-PO627, TH-PO628, TH-PO634, TH-PO678, TH-PO709, TH-PO710, TH-PO899, FR-PO110, FR-PO526, FR-PO546, FR-PO743, FR-PO748, FR-PO750, FR-PO753, FR-PO834, SA-PO780, SA-PO792, SA-PO863, SA-PO962, SA-PO963, PUB148, PUB167, PUB250, PUB253
- heme oxygenase** ..... SA-PO778, SA-PO994
- hemodialysis**..... TH-OR11, TH-OR12, TH-OR13, TH-OR15, TH-PO012, TH-PO013, TH-PO032, TH-PO034, TH-PO037, TH-PO064, TH-PO148, TH-PO154, TH-PO165, TH-PO167, TH-PO168, TH-PO260, TH-PO263, TH-PO275, TH-PO276, TH-PO277, TH-PO279, TH-PO286, TH-PO288, TH-PO626, TH-PO668, TH-PO669, TH-PO679, TH-PO694, TH-PO696, TH-PO700, TH-PO715, TH-PO779, TH-PO787, TH-PO792, TH-PO793, TH-PO809, TH-PO817, TH-PO825, TH-PO827, TH-PO831, TH-PO833, TH-PO838, TH-PO839, TH-PO917, TH-PO923, TH-PO924, TH-PO926, TH-PO927, TH-PO931, TH-PO933, TH-PO934, TH-PO937, TH-PO941, TH-PO942, TH-PO948, TH-PO953, FR-PO010, FR-PO036, FR-PO059, FR-PO228, FR-PO229, FR-PO425, FR-PO427, FR-PO508, FR-PO510, FR-PO512, FR-PO518, FR-PO519, FR-PO521, FR-PO523, FR-PO525, FR-PO539, FR-PO542, FR-PO544, FR-PO867, FR-PO868, SA-OR07, SA-OR35, SA-PO018, SA-PO054, SA-PO056, SA-PO057, SA-PO163, SA-PO165, SA-PO172, SA-PO173, SA-PO174, SA-PO176, SA-PO179, SA-PO180, SA-PO182, SA-PO183, SA-PO184, SA-PO195, SA-PO209, SA-PO215, SA-PO279, SA-PO286, SA-PO287, SA-PO288, SA-PO290, SA-PO294, SA-PO298, SA-PO299, SA-PO300, SA-PO301, SA-PO302, SA-PO311, SA-PO316, SA-PO317, SA-PO325, SA-PO328, SA-PO330, SA-PO332, SA-PO338, SA-PO341, SA-PO343, SA-PO344, SA-PO348, SA-PO349, SA-PO356, SA-PO357, SA-PO361, SA-PO362, SA-PO363, SA-PO365, SA-PO366, SA-PO367, SA-PO368, SA-PO370, SA-PO372, SA-PO377, SA-PO378, SA-PO379, SA-PO380, SA-PO384, SA-PO386, SA-PO387, SA-PO388, SA-PO389, SA-PO396, SA-PO400, SA-PO401, SA-PO402, SA-PO405, SA-PO406, SA-PO407, SA-PO408, SA-PO409, SA-PO410, SA-PO411, SA-PO412, SA-PO414, SA-PO416, SA-PO417, SA-PO418, SA-PO419, SA-PO423, SA-PO425, SA-PO431, SA-PO434, SA-PO435, SA-PO436, SA-PO439, SA-PO441, SA-PO445, SA-PO446, SA-PO449,
- hemodialysis (continued)**.....SA-PO451, SA-PO453, SA-PO457, SA-PO460, SA-PO461, SA-PO463, SA-PO464, SA-PO549, SA-PO816, PUB010, PUB016, PUB020, PUB023, PUB024, PUB032, PUB036, PUB052, PUB080, PUB081, PUB084, PUB087, PUB118, PUB119, PUB121, PUB124, PUB129, PUB133, PUB144, PUB154, PUB166, PUB173, PUB181, PUB252, PUB275, PUB344
- hemodialysis access** ..... TH-PO257, TH-PO262, TH-PO271, TH-PO272, TH-PO278, TH-PO284, TH-PO298, TH-PO300, FR-PO429, FR-PO430, SA-PO012, SA-PO310, SA-PO357, PUB082, PUB085, PUB150, PUB152, PUB153
- hemodialysis adequacy** ..... TH-OR11, TH-PO289, SA-PO309, SA-PO408, SA-PO409, SA-PO415, SA-PO419, SA-PO425, SA-PO426, PUB120, PUB124
- hemodialysis biocompatibility**..... SA-PO416
- hemodialysis hazards**.... TH-PO270, TH-PO271, SA-PO448, SA-PO459, PUB130
- hemolytic uremic syndrome** ..... TH-PO124, TH-PO503, FR-PO034, FR-PO042, FR-PO044, FR-PO212, FR-PO443, FR-PO715, SA-PO043, SA-PO576, SA-PO871, PUB060, PUB236, PUB240
- hemoperfusion** ..... TH-PO041, FR-PO002, FR-PO016, SA-PO008, SA-PO009, SA-PO011, SA-PO408, SA-PO421, SA-PO444, PUB030, PUB047
- Henoch-Schonlein purpura** ..... SA-PO564
- hepatitis** ..... FR-PO855, FR-PO906, SA-PO011, SA-PO449, SA-PO826, SA-PO893, PUB066
- histopathology** ..... TH-PO515, TH-PO566, TH-PO571, TH-PO573, FR-OR60, FR-PO590, FR-PO779, FR-PO803, FR-PO944, SA-PO093, SA-PO627, SA-PO633, PUB204
- HIV nephropathy** ..... TH-PO202, TH-PO421, TH-PO470, SA-PO745, SA-PO958, SA-PO974, PUB202
- homocysteine** ..... TH-PO625
- hospitalization** ..... TH-PO054, TH-PO058, TH-PO474, TH-PO599, TH-PO633, TH-PO708, TH-PO719, TH-PO771, TH-PO772, TH-PO789, TH-PO837, TH-PO921, FR-OR26, FR-PO002, FR-PO063, FR-PO064, FR-PO113, FR-PO240, FR-PO533, FR-PO551, FR-PO752, FR-PO928, FR-PO930, SA-OR04, SA-OR08, SA-OR33, SA-PO328, SA-PO336, SA-PO337, SA-PO343, SA-PO378, SA-PO387, SA-PO390, SA-PO398, SA-PO471, SA-PO951, PUB036, PUB043
- human genetics**..... TH-PO245, FR-PO305, FR-PO444, FR-PO497, SA-PO252, SA-PO520, SA-PO536, SA-PO541, SA-PO548, SA-PO554
- hypercalciuria**..... FR-OR08, FR-OR45, FR-PO235, FR-PO421, SA-PO200, SA-PO208, SA-PO582, SA-PO990
- hyperglycemia** ..... TH-PO204, TH-PO209, SA-PO245, SA-PO424, PUB113, PUB294
- hyperkalemia** ..... TH-OR16, TH-PO046, TH-PO311, TH-PO604, TH-PO781,

- hyperkalemia (continued)** .....FR-OR42, FR-OR43, FR-PO051, FR-PO098, FR-PO219, FR-PO542, FR-PO543, FR-PO544, FR-PO545, FR-PO546, FR-PO547, FR-PO548, FR-PO549, FR-PO550, FR-PO551, FR-PO552, SA-PO271, SA-PO311, SA-PO459, SA-PO488, PUB001, PUB121, PUB168, PUB172, PUB175, PUB216
- hypertension** .....TH-OR31, SA-PO464, SA-PO469, SA-PO476, SA-PO477, SA-PO480, PUB097, PUB171, PUB177, PUB183, PUB185
- hyperparathyroidism** .....TH-PO142, TH-PO143, TH-PO157, TH-PO158, TH-PO175, TH-PO836, FR-OR05, FR-PO847, SA-PO177, SA-PO197, SA-PO198, SA-PO199, SA-PO200, SA-PO208, SA-PO513, SA-PO516, SA-PO517, PUB086, PUB088, PUB091, PUB129, PUB174
- hyperphosphatemia**..... TH-PO154, TH-PO160, TH-PO161, TH-PO162, TH-PO163, TH-PO164, TH-PO165, TH-PO166, TH-PO167, TH-PO172, TH-PO802, FR-OR04, FR-PO184, FR-PO422, FR-PO481, FR-PO846, SA-PO172, SA-PO173, SA-PO190, SA-PO907
- hypertension** ..... TH-OR21, TH-OR27, TH-PO001, TH-PO062, TH-PO132, TH-PO169, TH-PO323, TH-PO589, TH-PO590, TH-PO591, TH-PO592, TH-PO593, TH-PO594, TH-PO596, TH-PO598, TH-PO599, TH-PO600, TH-PO607, TH-PO621, TH-PO622, TH-PO635, TH-PO709, TH-PO727, TH-PO755, TH-PO757, TH-PO758, TH-PO840, TH-PO857, TH-PO904, FR-OR45, FR-OR50, FR-PO279, FR-PO320, FR-PO340, FR-PO398, FR-PO402, FR-PO434, FR-PO436, FR-PO554, FR-PO556, FR-PO609, FR-PO613, FR-PO735, FR-PO736, FR-PO737, FR-PO739, FR-PO740, FR-PO741, FR-PO742, FR-PO743, FR-PO747, FR-PO748, FR-PO751, FR-PO752, FR-PO754, FR-PO755, FR-PO759, FR-PO761, FR-PO845, FR-PO940, SA-PO265, SA-PO345, SA-PO358, SA-PO363, SA-PO364, SA-PO482, SA-PO537, SA-PO545, SA-PO753, SA-PO755, SA-PO756, SA-PO757, SA-PO758, SA-PO759, SA-PO760, SA-PO763, SA-PO764, SA-PO765, SA-PO766, SA-PO768, SA-PO769, SA-PO772, SA-PO776, SA-PO782, SA-PO783, SA-PO789, SA-PO790, SA-PO791, SA-PO793, SA-PO874, SA-PO896, SA-PO905, PUB015, PUB048, PUB163, PUB170, PUB182, PUB250, PUB260, PUB263, PUB285, PUB292, PUB295, PUB297, PUB368
- hypertrophy** .....TH-PO320, FR-PO146, SA-PO961
- hypoalbuminemia**..... TH-PO836, FR-PO239, FR-PO474, SA-PO752
- hypokalemia**..... TH-PO319, TH-PO320, TH-PO322, TH-PO345, TH-PO349, TH-PO757, FR-OR43, FR-PO337, FR-PO448, FR-PO450,
- hypokalemia (continued)** ..... FR-PO555, SA-PO206, SA-PO469, SA-PO485, SA-PO487, SA-PO490, SA-PO517, PUB076, PUB170, PUB176, PUB182
- hyponatremia**..... TH-PO035, TH-PO133, TH-PO346, FR-OR49, FR-PO033, FR-PO211, FR-PO556, FR-PO557, FR-PO558, FR-PO560, FR-PO561, FR-PO562, FR-PO563, SA-PO440, SA-PO465, SA-PO466, SA-PO467, SA-PO468, SA-PO469, SA-PO470, SA-PO471, SA-PO473, SA-PO474, SA-PO475, SA-PO479, PUB173, PUB178, PUB179, PUB180, PUB184
- hypotension**....TH-OR11, TH-OR32, SA-PO349, SA-PO364, SA-PO365, SA-PO367, SA-PO368, SA-PO369, SA-PO370, SA-PO372, PUB043, PUB128
- hypoxia**..... TH-PO556, TH-PO638, TH-PO696, TH-PO697, TH-PO869, TH-PO895, FR-OR48, FR-PO017, FR-PO018, FR-PO356, FR-PO398, FR-PO576, FR-PO992, SA-PO023, SA-PO092, SA-PO097, SA-PO107, SA-PO257, SA-PO992, SA-PO993, PUB041, PUB323
- ICD-9-CM codes**.....FR-PO833, SA-PO561, SA-PO934
- idiopathic nephrotic syndrome** ..... FR-PO639, SA-PO1004
- IgA** ..... TH-PO176, TH-PO499, FR-PO610, SA-PO590, SA-PO637, SA-PO654, SA-PO668
- IgA deposition**..... TH-PO426, SA-PO564, SA-PO643, PUB218, PUB231
- IgA nephropathy** ..... TH-PO419, TH-PO426, TH-PO427, TH-PO491, TH-PO492, TH-PO493, TH-PO494, TH-PO495, TH-PO496, TH-PO497, TH-PO498, TH-PO521, TH-PO526, FR-OR59, FR-OR60, FR-PO013, FR-PO038, FR-PO204, FR-PO620, FR-PO633, FR-PO656, FR-PO657, FR-PO658, FR-PO659, FR-PO769, FR-PO813, SA-OR03, SA-PO565, SA-PO581, SA-PO589, SA-PO637, SA-PO638, SA-PO639, SA-PO640, SA-PO641, SA-PO642, SA-PO643, SA-PO644, SA-PO645, SA-PO646, SA-PO647, SA-PO648, SA-PO649, SA-PO650, SA-PO651, SA-PO652, SA-PO653, SA-PO654, SA-PO655, SA-PO656, SA-PO657, SA-PO658, SA-PO659, SA-PO660, SA-PO670, SA-PO699, SA-PO712, SA-PO713, SA-PO714, SA-PO715, SA-PO716, SA-PO722, PUB195, PUB221, PUB228, PUB229, PUB232, PUB239, PUB274, PUB328
- immune complexes**..... TH-PO548, TH-PO584, FR-PO437, FR-PO596, FR-PO675, SA-PO641, SA-PO644, SA-PO646, SA-PO649, SA-PO654, SA-PO655, SA-PO662, PUB202, PUB226, PUB231
- immune deficiency**.....FR-PO179, FR-PO554, FR-PO835
- immunohistochemistry** .....TH-PO158, TH-PO310, TH-PO574, TH-PO583, FR-PO020, SA-PO003, SA-PO096, SA-PO177, SA-PO557, SA-PO652, SA-PO656
- immunology** ..... TH-OR27, TH-OR28, TH-OR49, TH-OR51, TH-OR52, TH-OR57, TH-PO080, TH-PO099, TH-PO101, TH-PO113, TH-PO138, TH-PO144, TH-PO314, TH-PO416, TH-PO445, TH-PO449, TH-PO543, TH-PO545, TH-PO588, TH-PO643, TH-PO652, TH-PO653, TH-PO914, TH-PO918, TH-PO925, TH-PO926, TH-PO927, TH-PO931, TH-PO932, TH-PO933, TH-PO937, TH-PO940, TH-PO962, FR-OR15, FR-OR16, FR-OR30, FR-PO118, FR-PO120, FR-PO147, FR-PO148, FR-PO149, FR-PO155, FR-PO162, FR-PO165, FR-PO167, FR-PO193, FR-PO375, FR-PO383, FR-PO404, FR-PO405, FR-PO462, FR-PO471, FR-PO577, FR-PO578, FR-PO628, FR-PO950, FR-PO959, FR-PO963, FR-PO969, FR-PO991, FR-PO1006, SA-OR23, SA-OR29, SA-OR42, SA-PO008, SA-PO063, SA-PO109, SA-PO110, SA-PO113, SA-PO125, SA-PO211, SA-PO456, SA-PO626, SA-PO631, SA-PO637, SA-PO639, SA-PO640, SA-PO645, SA-PO648, SA-PO662, SA-PO750, SA-PO756, SA-PO761, SA-PO772, SA-PO869, PUB011, PUB071, PUB277, PUB299
- immunology and pathology**.....TH-PO105, TH-PO135, TH-PO180, TH-PO242, TH-PO306, TH-PO440, TH-PO453, TH-PO454, TH-PO460, TH-PO548, TH-PO551, TH-PO567, TH-PO574, TH-PO585, TH-PO636, FR-OR09, FR-OR12, FR-OR38, FR-PO126, FR-PO132, FR-PO203, FR-PO582, FR-PO583, FR-PO584, FR-PO592, FR-PO598, FR-PO599, FR-PO613, FR-PO671, FR-PO788, FR-PO1008, SA-PO058, SA-PO104, SA-PO112, SA-PO149, SA-PO158, SA-PO250, SA-PO604, SA-PO605, SA-PO607, SA-PO612, SA-PO613, SA-PO644, SA-PO684, SA-PO727, SA-PO755, SA-PO939, SA-PO1004, PUB214, PUB277
- immunosuppression** ..... TH-PO126, TH-PO436, TH-PO462, TH-PO483, TH-PO490, TH-PO507, TH-PO508, TH-PO509, TH-PO536, TH-PO920, TH-PO960, FR-OR19, FR-PO005, FR-PO011, FR-PO052, FR-PO107, FR-PO399, FR-PO600, FR-PO617, FR-PO623, FR-PO638, FR-PO647, FR-PO648, FR-PO652, FR-PO655, FR-PO663, FR-PO666, FR-PO768, FR-PO780, FR-PO785, FR-PO787, FR-PO790, FR-PO800, FR-PO809, FR-PO821, FR-PO835, FR-PO837, SA-OR47, SA-PO032, SA-PO047, SA-PO217, SA-PO678, SA-PO680, SA-PO687, SA-PO697, SA-PO701, SA-PO721, SA-PO729, SA-PO840, SA-PO849, SA-PO854, SA-PO875, SA-PO877, SA-PO882, PUB209, PUB219, PUB221, PUB321, PUB334
- insulin resistance** ..... TH-PO246, TH-PO311, FR-PO307, SA-PO250, SA-PO758
- interstitial fibrosis** ..... TH-PO121, TH-PO241, TH-PO428, TH-PO432, TH-PO433,

- interstitial fibrosis (continued)**..... TH-PO520, TH-PO758, TH-PO861, FR-OR27, FR-PO142, FR-PO162, FR-PO367, FR-PO395, FR-PO589, FR-PO960, FR-PO972, FR-PO987, SA-PO220, SA-PO659, SA-PO940, PUB226
- interventional nephrology** ..... TH-PO552, TH-PO586, FR-PO532, SA-PO018, PUB146, PUB151, PUB273
- intestine** ..... TH-PO583, TH-PO810, TH-PO874, FR-PO333, SA-PO648, SA-PO649, SA-PO782
- intoxication** ..... FR-PO106, FR-PO230, FR-PO557, SA-PO486, PUB058, PUB169, PUB181, PUB275
- intracellular pH** ..... SA-PO970
- intracellular signal** ..... TH-PO351
- intrauterine growth** ..... FR-PO380
- ion channel** ..... TH-PO414, FR-OR46, FR-PO237, FR-PO265, FR-PO266, FR-PO272, FR-PO597
- ion transport** ..... TH-PO312, TH-PO333, TH-PO342, TH-PO347, FR-OR277, SA-PO580
- ischemia** ..... TH-OR12
- ischemia-reperfusion** ..... TH-OR43, TH-OR44, TH-OR52, TH-OR55, TH-PO088, TH-PO095, TH-PO098, TH-PO099, TH-PO136, TH-PO637, TH-PO644, FR-OR14, FR-OR17, FR-OR18, FR-OR19, FR-PO116, FR-PO119, FR-PO122, FR-PO125, FR-PO126, FR-PO127, FR-PO129, FR-PO132, FR-PO133, FR-PO138, FR-PO143, FR-PO144, FR-PO147, FR-PO148, FR-PO158, FR-PO159, FR-PO163, FR-PO166, FR-PO173, FR-PO175, FR-PO995, SA-PO066, SA-PO072, SA-PO078, SA-PO082, SA-PO086, SA-PO088, SA-PO089, SA-PO090, SA-PO091, SA-PO100, SA-PO102, SA-PO104, SA-PO106, SA-PO373, SA-PO815, SA-PO819, SA-PO973, SA-PO978, SA-PO992, PUB362
- ischemic renal failure** ..... TH-PO093, SA-PO067
- kidney** ..... TH-PO021, TH-PO118, TH-PO152, TH-PO327, TH-PO350, TH-PO489, TH-PO557, TH-PO650, TH-PO748, FR-PO171, FR-PO243, FR-PO264, FR-PO354, FR-PO418, FR-PO573, FR-PO598, FR-PO767, FR-PO815, FR-PO822, SA-OR02, SA-PO001, SA-PO766, SA-PO774, SA-PO783, SA-PO808, SA-PO836, SA-PO837, SA-PO952, SA-PO962, SA-PO966, PUB266, PUB320, PUB347
- kidney anatomy** ..... TH-PO437, TH-PO570, SA-PO203, SA-PO309, SA-PO859, PUB074, PUB176
- kidney biopsy** ..... TH-OR41, TH-PO007, TH-PO108, TH-PO128, TH-PO130, TH-PO183, TH-PO223, TH-PO438, TH-PO453, TH-PO454, TH-PO461, TH-PO509, TH-PO510, TH-PO522, TH-PO524, TH-PO541, TH-PO552, TH-PO558, TH-PO559, TH-PO563, TH-PO564, TH-PO566, TH-PO567, TH-PO578, TH-PO582, TH-PO584, TH-PO587, TH-PO640, TH-PO861,
- kidney biopsy (continued)** ..... FR-OR55, FR-PO103, FR-PO107, FR-PO169, FR-PO180, FR-PO186, FR-PO190, FR-PO609, FR-PO610, FR-PO634, FR-PO649, FR-PO783, FR-PO923, SA-OR45, SA-PO002, SA-PO053, SA-PO133, SA-PO140, SA-PO277, SA-PO281, SA-PO683, SA-PO692, SA-PO711, SA-PO717, SA-PO863, SA-PO868, SA-PO947, SA-PO956, SA-PO991, SA-PO1012, PUB055, PUB074, PUB104, PUB106, PUB229, PUB245, PUB264, PUB266, PUB270
- kidney cancer** ..... SA-PO119, SA-PO157
- kidney development** ..... FR-PO347, FR-PO351, FR-PO361, FR-PO364, FR-PO365, FR-PO368, FR-PO374, FR-PO377, FR-PO379, FR-PO380, FR-PO381, FR-PO382, FR-PO385, FR-PO388, FR-PO392, FR-PO394, FR-PO405, SA-OR16, SA-OR18, SA-PO599, SA-PO619, SA-PO622, SA-PO957
- kidney disease** ..... TH-PO089, TH-PO213, TH-PO218, TH-PO224, TH-PO237, TH-PO360, TH-PO402, TH-PO442, TH-PO570, TH-PO579, TH-PO588, TH-PO659, TH-PO728, FR-OR24, FR-PO006, FR-PO035, FR-PO062, FR-PO220, FR-PO233, FR-PO263, FR-PO341, FR-PO352, FR-PO635, FR-PO891, FR-PO915, SA-PO027, SA-PO130, SA-PO242, SA-PO418, SA-PO558, SA-PO762, SA-PO776, SA-PO793, SA-PO796, SA-PO886, SA-PO947, SA-PO975, SA-PO997, PUB227, PUB353
- kidney donation** ..... TH-PO639, TH-PO644, TH-PO648, TH-PO729, FR-PO111, FR-PO797, FR-PO802, FR-PO824, SA-OR31, SA-PO795, SA-PO797, SA-PO805, SA-PO809, SA-PO810, SA-PO813, SA-PO814, SA-PO820, SA-PO821, SA-PO822, SA-PO823, SA-PO831, SA-PO839, SA-PO859, PUB332
- kidney dysfunction** ..... TH-PO389, TH-PO641, TH-PO912, FR-PO085, FR-PO091, FR-PO110, FR-PO136, FR-PO152, FR-PO155, FR-PO168, FR-PO241, FR-PO750, FR-PO925, FR-PO938, SA-PO240, SA-PO265, SA-PO268, SA-PO391, SA-PO692, SA-PO700, SA-PO788, SA-PO877, SA-PO910, PUB071
- kidney failure** ..... TH-PO041, TH-PO117, TH-PO231, TH-PO250, TH-PO276, TH-PO382, TH-PO383, TH-PO493, TH-PO677, TH-PO683, TH-PO723, TH-PO747, TH-PO879, TH-PO905, FR-OR22, FR-PO060, FR-PO206, FR-PO653, FR-PO680, FR-PO777, FR-PO830, FR-PO856, FR-PO882, FR-PO926, FR-PO942, FR-PO949, SA-PO094, SA-PO109, SA-PO153, SA-PO186, SA-PO308, SA-PO327, SA-PO589, SA-PO805, SA-PO915, SA-PO920, SA-PO922, SA-PO944, PUB062, PUB068
- kidney stones** ..... TH-OR34, TH-PO353, TH-PO402, TH-PO403, TH-PO842, TH-PO843, FR-OR09, FR-OR10, FR-PO103,
- kidney stones (continued)** ..... FR-PO242, FR-PO333, FR-PO334, FR-PO444, FR-PO568, SA-PO004, SA-PO036, SA-PO161, SA-PO166, SA-PO168, SA-PO169, SA-PO170, SA-PO202, SA-PO203, SA-PO207, SA-PO208, SA-PO216, SA-PO259, SA-PO329, SA-PO509, SA-PO566, SA-PO567, SA-PO568, SA-PO570, SA-PO574, SA-PO580, SA-PO582, SA-PO623, SA-PO624, SA-PO625, SA-PO823, SA-PO856, SA-PO884, SA-PO989, PUB090, PUB268
- kidney transplantation** ..... TH-OR50, TH-OR52, TH-OR55, TH-PO008, TH-PO164, TH-PO649, TH-PO650, TH-PO652, TH-PO654, TH-PO675, TH-PO732, TH-PO737, TH-PO915, TH-PO918, TH-PO919, TH-PO920, TH-PO946, TH-PO947, TH-PO955, TH-PO956, TH-PO957, FR-PO011, FR-PO232, FR-PO431, FR-PO442, FR-PO449, FR-PO701, FR-PO768, FR-PO771, FR-PO772, FR-PO776, FR-PO780, FR-PO781, FR-PO782, FR-PO784, FR-PO787, FR-PO792, FR-PO794, FR-PO797, FR-PO798, FR-PO801, FR-PO803, FR-PO804, FR-PO806, FR-PO807, FR-PO808, FR-PO810, FR-PO812, FR-PO817, FR-PO818, FR-PO820, FR-PO824, FR-PO827, FR-PO828, FR-PO829, FR-PO830, FR-PO832, FR-PO833, FR-PO837, FR-PO839, FR-PO841, FR-PO843, FR-PO844, FR-PO845, FR-PO846, FR-PO847, FR-PO848, FR-PO850, FR-PO857, FR-PO881, FR-PO884, SA-OR42, SA-OR43, SA-OR47, SA-PO795, SA-PO798, SA-PO799, SA-PO800, SA-PO802, SA-PO807, SA-PO811, SA-PO816, SA-PO817, SA-PO818, SA-PO825, SA-PO827, SA-PO832, SA-PO834, SA-PO840, SA-PO844, SA-PO849, SA-PO852, SA-PO856, SA-PO861, SA-PO865, SA-PO871, SA-PO872, SA-PO883, PUB276, PUB281, PUB289, PUB291, PUB292, PUB293, PUB294, PUB295, PUB296, PUB297, PUB298, PUB301, PUB302, PUB303, PUB306, PUB308, PUB309, PUB310, PUB312, PUB313, PUB314, PUB318, PUB330, PUB331, PUB335
- kidney tubule** ..... TH-OR41, TH-PO026, TH-PO056, TH-PO116, TH-PO179, TH-PO306, TH-PO342, TH-PO510, TH-PO645, FR-OR15, FR-PO755, FR-PO756, FR-PO993, SA-PO058, SA-PO575, SA-PO583, SA-PO615, SA-PO616
- kidney volume** ..... TH-PO390, TH-PO393, TH-PO398, TH-PO399, TH-PO404, TH-PO413, FR-PO108, FR-PO280, FR-PO413, FR-PO802, FR-PO919, SA-PO006, SA-PO007, SA-PO147, SA-PO832, SA-PO915, PUB187
- kinase** ..... FR-PO977
- LDL cholesterol** ..... SA-PO270, SA-PO955, PUB291
- lean body mass** ..... TH-PO789, TH-PO827

- left ventricular hypertrophy** ..... FR-PO466, FR-PO854, SA-PO790
- lipids** ..... TH-PO195, TH-PO229, TH-PO251, TH-PO409, TH-PO532, TH-PO614, TH-PO695, TH-PO864, FR-OR53, FR-PO170, FR-PO321, FR-PO323, FR-PO694, FR-PO722, FR-PO975, SA-PO238, SA-PO244, SA-PO366, SA-PO382, SA-PO424, SA-PO688, SA-PO749, SA-PO750, SA-PO787, SA-PO912, SA-PO929
- liver cysts**.... TH-PO356, TH-PO366, TH-PO368, TH-PO372, TH-PO375, TH-PO395, FR-PO284, FR-PO345
- liver failure**..... TH-PO038, TH-PO054, TH-PO055, TH-PO102, TH-PO126, TH-PO731, FR-PO240, FR-PO910, SA-PO011, SA-PO421, SA-PO551, SA-PO928, PUB069, PUB148, PUB190, PUB261
- lupus nephritis**..... TH-PO126, TH-PO429, TH-PO486, TH-PO487, TH-PO488, TH-PO489, TH-PO490, TH-PO527, TH-PO528, TH-PO536, TH-PO551, TH-PO560, TH-PO567, TH-PO577, TH-PO749, FR-OR58, FR-PO011, FR-PO040, FR-PO050, FR-PO053, FR-PO593, FR-PO594, FR-PO595, FR-PO596, FR-PO597, FR-PO601, FR-PO602, FR-PO603, FR-PO604, FR-PO605, FR-PO606, FR-PO607, FR-PO608, FR-PO623, FR-PO625, FR-PO627, FR-PO628, FR-PO629, FR-PO630, FR-PO632, FR-PO633, FR-PO640, FR-PO641, FR-PO642, FR-PO643, FR-PO644, FR-PO676, SA-PO024, SA-PO032, SA-PO593, SA-PO595, SA-PO684, SA-PO685, SA-PO686, SA-PO687, SA-PO689, SA-PO691, SA-PO724, SA-PO733, PUB021, PUB206, PUB209, PUB210, PUB216, PUB219, PUB226, PUB272, PUB280, PUB287
- lymphocytes** ..... TH-PO067, TH-PO948, FR-OR54, FR-PO162, FR-PO172, FR-PO173, FR-PO195, FR-PO250, FR-PO597, FR-PO600, FR-PO623, FR-PO798, FR-PO993, SA-PO003, SA-PO851, SA-PO881, SA-PO967, SA-PO984, SA-PO996
- macrophages**.....TH-OR01, TH-PO090, TH-PO210, TH-PO242, TH-PO416, TH-PO458, TH-PO543, TH-PO705, FR-OR10, FR-OR16, FR-PO013, FR-PO117, FR-PO126, FR-PO136, FR-PO149, FR-PO153, FR-PO235, FR-PO243, FR-PO245, FR-PO313, FR-PO359, FR-PO383, FR-PO594, FR-PO950, FR-PO956, FR-PO963, FR-PO967, FR-PO974, SA-OR08, SA-PO098, SA-PO110, SA-PO111, SA-PO246, SA-PO604, SA-PO612, SA-PO835, SA-PO967, SA-PO1005
- mal folding proteins** ..... FR-OR48, FR-PO208, FR-PO322, SA-PO837
- malnutrition**.....TH-OR26, TH-PO713, TH-PO782, TH-PO790, TH-PO836, TH-PO838, FR-PO474, SA-OR39, SA-PO334, SA-PO496, PUB200, PUB248
- MCP-1 (monocyte chemoattractant protein 1)**.....TH-PO180, TH-PO302, TH-PO758, TH-PO891, SA-PO691, PUB280
- membranous nephropathy** .....TH-PO355, TH-PO435, TH-PO451, TH-PO452, TH-PO453, TH-PO454, TH-PO455, TH-PO456, TH-PO457, TH-PO458, TH-PO460, TH-PO461, TH-PO462, TH-PO463, TH-PO464, TH-PO465, TH-PO466, TH-PO482, TH-PO483, TH-PO484, TH-PO485, TH-PO514, TH-PO515, TH-PO516, TH-PO906, FR-OR51, FR-PO055, FR-PO203, FR-PO602, FR-PO603, FR-PO654, FR-PO655, FR-PO665, FR-PO666, FR-PO667, FR-PO668, FR-PO669, FR-PO671, FR-PO672, FR-PO733, SA-OR28, SA-PO132, SA-PO139, SA-PO678, SA-PO679, SA-PO680, SA-PO681, SA-PO682, SA-PO710, SA-PO721, SA-PO724, SA-PO725, SA-PO726, SA-PO746, SA-PO876, SA-PO880, PUB035, PUB223, PUB243, PUB245
- mesangial cells** ..... TH-PO183, TH-PO198, TH-PO210, TH-PO225, TH-PO426, TH-PO891, FR-PO166, FR-PO387, SA-PO231
- metabolism**.... TH-OR36, TH-OR43, TH-PO181, TH-PO236, TH-PO304, TH-PO305, TH-PO392, TH-PO405, TH-PO448, TH-PO532, TH-PO577, TH-PO640, TH-PO765, TH-PO811, TH-PO829, TH-PO847, FR-OR03, FR-OR12, FR-OR14, FR-OR30, FR-OR33, FR-OR35, FR-PO121, FR-PO138, FR-PO172, FR-PO260, FR-PO268, FR-PO299, FR-PO336, FR-PO371, FR-PO384, FR-PO408, FR-PO424, FR-PO468, FR-PO705, FR-PO775, FR-PO811, FR-PO992, FR-PO1007, SA-OR15, SA-OR23, SA-PO064, SA-PO071, SA-PO073, SA-PO076, SA-PO091, SA-PO092, SA-PO103, SA-PO108, SA-PO169, SA-PO189, SA-PO255, SA-PO257, SA-PO317, SA-PO360, SA-PO753, SA-PO760, SA-PO762, SA-PO918, SA-PO961, SA-PO965, SA-PO970, SA-PO977, SA-PO1008, PUB092, PUB367
- microalbuminuria** ..... SA-PO276, SA-PO885, PUB265
- mineral metabolism** ..... TH-PO146, TH-PO149, TH-PO151, TH-PO155, TH-PO169, TH-PO171, TH-PO605, TH-PO656, TH-PO785, TH-PO802, TH-PO812, FR-OR01, FR-OR04, FR-OR06, FR-OR07, FR-PO028, FR-PO338, FR-PO465, FR-PO812, FR-PO840, SA-PO161, SA-PO165, SA-PO167, SA-PO169, SA-PO175, SA-PO176, SA-PO179, SA-PO182, SA-PO183, SA-PO185, SA-PO188, SA-PO191, SA-PO193, SA-PO194, SA-PO195, SA-PO198, SA-PO205, SA-PO206, SA-PO209, SA-PO211, SA-PO212, SA-PO214, SA-PO215, SA-PO1006, PUB340
- minority health and disparities**.....TH-PO709, TH-PO727, TH-PO737, FR-PO869, FR-PO894, PUB089
- mitochondria** ..... TH-OR03, TH-OR45, TH-PO083, TH-PO094, TH-PO195, TH-PO203, TH-PO308, TH-PO443, TH-PO637, TH-PO680, TH-PO821, TH-PO823, TH-PO824, TH-PO826, TH-PO830, TH-PO865, FR-OR10, FR-OR11, FR-OR29, FR-OR30, FR-PO121, FR-PO134, FR-PO135, FR-PO140, FR-PO142, FR-PO143, FR-PO144, FR-PO158, FR-PO260, FR-PO281, FR-PO324, FR-PO336, FR-PO343, FR-PO705, FR-PO722, FR-PO966, FR-PO986, FR-PO996, SA-PO071, SA-PO076, SA-PO077, SA-PO095, SA-PO106, SA-PO527, SA-PO652, SA-PO762, SA-PO918, SA-PO991, SA-PO1005
- molecular biology** ..... TH-PO097, TH-PO202, TH-PO223, TH-PO315, TH-PO341, TH-PO418, TH-PO446, TH-PO447, TH-PO459, TH-PO828, FR-OR03, FR-PO140, FR-PO247, FR-PO273, FR-PO292, FR-PO300, FR-PO342, FR-PO378, FR-PO687, FR-PO699, FR-PO788, SA-OR15, SA-OR16, SA-PO522, SA-PO627, SA-PO738, SA-PO997, SA-PO998, PUB363
- molecular genetics** .....TH-OR35, TH-PO222, TH-PO323, FR-OR03, FR-PO159, FR-PO258, FR-PO330, FR-PO371, FR-PO578, FR-PO971, FR-PO985, SA-PO563, SA-PO754
- mortality**..... TH-OR06, TH-OR07, TH-OR32, TH-PO036, TH-PO062, TH-PO063, TH-PO070, TH-PO277, TH-PO609, TH-PO618, TH-PO623, TH-PO625, TH-PO635, TH-PO675, TH-PO683, TH-PO787, TH-PO790, TH-PO803, TH-PO922, TH-PO923, TH-PO946, TH-PO951, TH-PO954, TH-PO963, FR-PO010, FR-PO025, FR-PO030, FR-PO059, FR-PO064, FR-PO086, FR-PO092, FR-PO112, FR-PO465, FR-PO504, FR-PO505, FR-PO514, FR-PO537, FR-PO539, FR-PO545, FR-PO737, FR-PO772, FR-PO777, FR-PO812, FR-PO850, FR-PO932, SA-PO131, SA-PO153, SA-PO178, SA-PO284, SA-PO312, SA-PO316, SA-PO335, SA-PO336, SA-PO337, SA-PO339, SA-PO359, SA-PO384, SA-PO386, SA-PO397, SA-PO399, SA-PO417, SA-PO444, SA-PO450, SA-PO453, SA-PO458, SA-PO686, SA-PO704, SA-PO745, SA-PO903, SA-PO922, SA-PO926, SA-PO929, PUB001, PUB009, PUB012, PUB027, PUB028, PUB029, PUB053, PUB061, PUB079, PUB090, PUB200
- mortality risk** ..... TH-PO063, TH-PO064, TH-PO243, TH-PO626, TH-PO631, TH-PO766, TH-PO770, TH-PO793, TH-PO867, TH-PO930, TH-PO947, FR-PO012, FR-PO026, FR-PO027, FR-PO032, FR-PO080, FR-PO090, FR-PO102, FR-PO473, FR-PO493, FR-PO501, FR-PO569, FR-PO744, FR-PO757, FR-PO775, SA-OR07, SA-OR40, SA-PO045, SA-PO151, SA-PO279, SA-PO294, SA-PO348, SA-PO355, SA-PO375, SA-PO379, SA-PO383, SA-PO388, SA-PO396,

- mortality risk (continued)** ..... SA-PO398, SA-PO600, SA-PO824, SA-PO902, SA-PO906, SA-PO932, PUB249
- MPGN (membranoproliferative glomerulonephritis)**..... FR-PO037, FR-PO199, FR-PO628, FR-PO683, SA-PO114, SA-PO577, SA-PO593, SA-PO635, SA-PO665, SA-PO719, SA-PO857, PUB244
- mRNA**.....TH-PO117, TH-PO464, TH-PO537, TH-PO828, TH-PO948, FR-PO137, FR-PO192, FR-PO354, FR-PO729, SA-OR44, SA-OR46, SA-OR49, SA-PO020, SA-PO116, SA-PO715, SA-PO769, SA-PO962
- multiple myeloma**..... TH-PO176, FR-PO176, FR-PO177, FR-PO184, FR-PO190, FR-PO206, SA-PO050, SA-PO051, SA-PO123, SA-PO127, SA-PO136, SA-PO137, SA-PO138, SA-PO148, SA-PO159, SA-PO513, PUB263
- mycophenolate mofetil**..... FR-PO853, FR-PO1003, SA-PO588
- myeloma** .....FR-PO933, SA-PO122
- NADPH oxidase**..... TH-PO113, TH-PO185, SA-PO246, SA-PO254
- nephrectomy** .....SA-PO118, SA-PO119, SA-PO152, SA-PO157, SA-PO585, SA-PO839, SA-PO937
- nephrin**.....FR-PO291, FR-PO326, FR-PO327, FR-PO328, FR-PO698, SA-OR25
- nephritis** .... TH-PO108, TH-PO132, TH-PO487, TH-PO545, FR-PO035, FR-PO156, FR-PO179, FR-PO193, FR-PO207, FR-PO214, FR-PO577, FR-PO619, FR-PO953, SA-PO048, SA-PO491, SA-PO688, PUB059
- nephrology** .....TH-OR47, TH-PO003, TH-PO005, TH-PO014, TH-PO019, TH-PO741, FR-PO220, FR-PO476, FR-PO477, FR-PO658, FR-PO713, FR-PO800, FR-PO888, SA-PO470, SA-PO875, PUB162, PUB164, PUB282
- nephron** ..... TH-PO316, FR-PO352, FR-PO355, FR-PO377, FR-PO380, SA-PO957, SA-PO986
- nephropathy**..... TH-PO249, TH-PO457, FR-PO203, FR-PO440, FR-PO681, FR-PO949, FR-PO1008, SA-PO146, SA-PO254, SA-PO545, SA-PO849, SA-PO860, PUB232
- nephrotic syndrome** .....TH-OR29, TH-PO355, TH-PO441, TH-PO443, TH-PO445, TH-PO446, TH-PO447, TH-PO449, TH-PO450, TH-PO457, TH-PO462, TH-PO464, TH-PO465, TH-PO466, TH-PO468, TH-PO477, TH-PO478, TH-PO483, TH-PO511, TH-PO513, TH-PO515, TH-PO516, TH-PO517, TH-PO520, TH-PO522, TH-PO525, TH-PO530, TH-PO594, FR-PO038, FR-PO043, FR-PO048, FR-PO177, FR-PO202, FR-PO303, FR-PO308, FR-PO309, FR-PO325, FR-PO326, FR-PO327, FR-PO328, FR-PO370, FR-PO445, FR-PO447, FR-PO614, FR-PO615, FR-PO627, FR-PO639, FR-PO660, FR-PO661, FR-PO663, FR-PO664, FR-PO670, FR-PO680,
- nephrotic syndrome (continued)**..... FR-PO684, FR-PO697, FR-PO724, FR-PO733, FR-PO734, FR-PO770, SA-PO217, SA-PO525, SA-PO526, SA-PO532, SA-PO538, SA-PO539, SA-PO544, SA-PO577, SA-PO585, SA-PO586, SA-PO587, SA-PO588, SA-PO591, SA-PO594, SA-PO628, SA-PO663, SA-PO664, SA-PO673, SA-PO677, SA-PO683, SA-PO704, SA-PO705, SA-PO706, SA-PO707, SA-PO710, SA-PO723, SA-PO724, SA-PO730, SA-PO733, SA-PO742, SA-PO743, SA-PO744, SA-PO746, SA-PO751, SA-PO752, PUB007, PUB204, PUB205, PUB222, PUB224, PUB235, PUB237, PUB277
- nephrotoxicity**.....TH-OR05, TH-PO043, TH-PO053, TH-PO071, TH-PO072, TH-PO127, TH-PO307, TH-PO555, FR-PO068, FR-PO096, FR-PO106, FR-PO128, FR-PO194, FR-PO201, FR-PO204, FR-PO228, FR-PO1002, SA-PO052, SA-PO069, SA-PO077, SA-PO079, SA-PO100, SA-PO141, SA-PO154, PUB069
- nitric oxide** .....TH-PO214, TH-PO302, FR-OR21, SA-PO012, SA-PO225, SA-PO248, PUB254
- nutrition** .... TH-PO095, TH-PO381, TH-PO715, TH-PO781, TH-PO782, TH-PO800, TH-PO801, TH-PO803, TH-PO804, TH-PO805, TH-PO806, TH-PO809, TH-PO810, TH-PO812, TH-PO815, TH-PO831, TH-PO832, TH-PO833, TH-PO834, TH-PO838, TH-PO839, TH-PO840, TH-PO845, TH-PO846, TH-PO850, TH-PO873, FR-OR01, FR-PO247, FR-PO287, FR-PO295, FR-PO385, FR-PO433, FR-PO468, FR-PO565, FR-PO918, SA-OR39, SA-PO135, SA-PO166, SA-PO348, SA-PO376, SA-PO389, SA-PO414, SA-PO509, SA-PO602, SA-PO989, PUB191, PUB248
- obesity**..... TH-PO191, TH-PO254, TH-PO390, TH-PO392, TH-PO553, TH-PO564, TH-PO581, TH-PO813, TH-PO847, TH-PO848, TH-PO849, TH-PO850, TH-PO875, FR-PO216, FR-PO434, FR-PO568, FR-PO636, FR-PO843, SA-OR40, SA-PO072, SA-PO242, SA-PO255, SA-PO333, SA-PO493, SA-PO732, SA-PO758, SA-PO782, SA-PO892, SA-PO968, PUB100, PUB203, PUB349
- obstructive nephropathy**..... TH-PO118, TH-PO344, TH-PO431, TH-PO539, TH-PO843, FR-PO144, FR-PO183, FR-PO444, FR-PO961, FR-PO964, SA-PO609, SA-PO617
- obstructive uropathy**.....FR-PO104, FR-PO208, SA-PO509, SA-PO609, SA-PO617, SA-PO864, PUB075
- organ transplant**.....FR-PO836, FR-PO876, SA-OR49, SA-PO431, SA-PO819, SA-PO825, SA-PO826, SA-PO833, SA-PO837, PUB318, PUB342
- organic anion transporter** ..... FR-PO996, SA-PO100, PUB064
- osmolality** ..... TH-PO340, TH-PO540, FR-PO562, SA-PO361, SA-PO465, SA-PO480, PUB130
- osteopontin**.....TH-PO538
- outcomes**..... TH-OR06, TH-PO017, TH-PO034, TH-PO035, TH-PO037, TH-PO051, TH-PO061, TH-PO063, TH-PO071, TH-PO077, TH-PO275, TH-PO397, TH-PO445, TH-PO472, TH-PO473, TH-PO502, TH-PO504, TH-PO634, TH-PO683, TH-PO746, TH-PO779, TH-PO824, TH-PO852, TH-PO853, TH-PO926, TH-PO943, TH-PO944, TH-PO945, TH-PO950, FR-OR06, FR-OR49, FR-PO083, FR-PO176, FR-PO502, FR-PO512, FR-PO549, FR-PO566, FR-PO572, FR-PO606, FR-PO649, FR-PO807, FR-PO899, FR-PO900, SA-PO291, SA-PO341, SA-PO343, SA-PO378, SA-PO387, SA-PO430, SA-PO445, SA-PO451, SA-PO678, SA-PO687, SA-PO690, SA-PO799, SA-PO820, SA-PO821, SA-PO844, SA-PO865, SA-PO908, SA-PO909, SA-PO946, SA-PO952, SA-PO980, SA-PO982, PUB012, PUB056, PUB079, PUB098, PUB158, PUB162, PUB271, PUB283, PUB313, PUB354
- oxidative stress**..... TH-PO087, TH-PO092, TH-PO196, TH-PO201, TH-PO219, TH-PO249, TH-PO531, TH-PO555, TH-PO826, TH-PO834, FR-PO118, FR-PO150, FR-PO160, FR-PO168, FR-PO331, FR-PO717, FR-PO719, FR-PO975, SA-PO069, SA-PO072, SA-PO087, SA-PO089, SA-PO102, SA-PO103, SA-PO225, SA-PO232, SA-PO599, SA-PO753, SA-PO760, SA-PO791, SA-PO901, SA-PO916, SA-PO1001, PUB086, PUB259
- pancreas transplantation**..... FR-PO467, FR-PO819, FR-PO827, PUB307
- parathyroid hormone**.... TH-PO145, TH-PO147, TH-PO153, TH-PO165, FR-OR05, FR-OR08, FR-PO535, SA-PO176, SA-PO179, SA-PO187, SA-PO190, SA-PO199, SA-PO200, SA-PO213, SA-PO515, SA-PO516, PUB087, PUB089, PUB166
- pathology**..... TH-OR42, TH-PO170, TH-PO248, TH-PO252, TH-PO421, TH-PO451, TH-PO452, TH-PO510, TH-PO517, TH-PO529, TH-PO535, TH-PO541, TH-PO542, TH-PO557, TH-PO562, TH-PO572, TH-PO586, FR-PO053, FR-PO446, FR-PO601, FR-PO656, FR-PO766, FR-PO912, SA-PO003, SA-PO055, SA-PO133, SA-PO557, SA-PO673, SA-PO818, SA-PO848, SA-PO854, SA-PO858, PUB013, PUB059, PUB072, PUB235, PUB238, PUB265, PUB272
- patient satisfaction** ..... TH-PO016, FR-PO501, FR-PO607, SA-PO296, SA-PO325, SA-PO833, SA-PO943, SA-PO946, PUB054, PUB131, PUB236
- patient self-assessment**.....TH-PO477, FR-PO101, FR-PO221, FR-PO471, FR-PO536, FR-PO552, FR-PO841, SA-PO285, SA-PO301, SA-PO325,

**patient self-assessment**

(continued) ..... SA-PO356,  
SA-PO362, SA-PO428, SA-PO429,  
SA-PO797, PUB144, PUB283

**patient-centered care** ..... TH-OR15, TH-PO016,  
TH-PO020, TH-PO052, TH-PO054,  
TH-PO271, TH-PO448, TH-PO772,  
TH-PO773, TH-PO777, TH-PO778,  
TH-PO783, TH-PO791, TH-PO797,  
TH-PO817, TH-PO858, TH-PO911,  
FR-PO068, FR-PO101, FR-PO419,  
FR-PO507, FR-PO508, FR-PO509,  
FR-PO511, FR-PO520, FR-PO521,  
FR-PO526, FR-PO527, FR-PO561,  
FR-PO860, FR-PO867, FR-PO898,  
FR-PO943, SA-PO295, SA-PO296,  
SA-PO299, SA-PO303, SA-PO321,  
SA-PO328, SA-PO340, SA-PO350,  
SA-PO402, SA-PO451, SA-PO454,  
SA-PO455, SA-PO941, SA-PO943,  
SA-PO952, PUB023, PUB084, PUB123,  
PUB128, PUB130, PUB138, PUB160,  
PUB161, PUB236, PUB271, PUB350,  
PUB353

**pediatric intensive care medicine**..... TH-OR31,  
SA-PO596, SA-PO601

**pediatric kidney transplantation** ..... TH-PO098,  
FR-PO704, SA-PO618, PUB276, PUB278,  
PUB283, PUB316

**pediatric nephrology** ..... TH-OR33, TH-PO052,  
TH-PO060, TH-PO589, FR-PO043,  
FR-PO109, FR-PO115, FR-PO228,  
FR-PO303, FR-PO310, FR-PO414,  
FR-PO415, FR-PO418, FR-PO419,  
FR-PO424, FR-PO426, FR-PO427,  
FR-PO429, FR-PO435, FR-PO436,  
FR-PO438, FR-PO443, FR-PO661,  
FR-PO742, SA-PO540, SA-PO555,  
SA-PO572, SA-PO584, SA-PO585,  
SA-PO587, SA-PO593, SA-PO597,  
SA-PO598, SA-PO599, SA-PO602,  
SA-PO603, SA-PO605, SA-PO606,  
SA-PO609, SA-PO617, SA-PO619,  
SA-PO620, SA-PO623, SA-PO626,  
SA-PO628, SA-PO744, SA-PO949, PUB274,  
PUB279

**pediatrics**.... TH-PO060, TH-PO247, TH-PO253,  
TH-PO449, TH-PO590, TH-PO591,  
FR-PO042, FR-PO392, FR-PO410,  
FR-PO411, FR-PO423, SA-PO595,  
SA-PO790

**peritoneal dialysis**..... TH-OR17, TH-PO011,  
TH-PO166, TH-PO662, TH-PO677,  
TH-PO832, TH-PO834, TH-PO925,  
TH-PO939, TH-PO954, FR-PO236,  
FR-PO451, FR-PO452, FR-PO453,  
FR-PO454, FR-PO455, FR-PO456,  
FR-PO457, FR-PO458, FR-PO460,  
FR-PO461, FR-PO463, FR-PO464,  
FR-PO465, FR-PO466, FR-PO468,  
FR-PO469, FR-PO470, FR-PO471,  
FR-PO472, FR-PO473, FR-PO474,  
FR-PO475, FR-PO476, FR-PO477,  
FR-PO478, FR-PO480, FR-PO481,  
FR-PO482, FR-PO483, FR-PO484,  
FR-PO485, FR-PO486, FR-PO489,  
FR-PO490, FR-PO491, FR-PO492,  
FR-PO493, FR-PO494, FR-PO495,  
FR-PO496, FR-PO497, FR-PO499,  
FR-PO500, FR-PO501, FR-PO502,

**peritoneal dialysis (continued)** ..... FR-PO503,  
FR-PO504, FR-PO505, FR-PO506,  
FR-PO508, FR-PO513, FR-PO515,  
FR-PO516, FR-PO517, FR-PO518,  
FR-PO520, FR-PO522, FR-PO526,  
FR-PO527, FR-PO528, FR-PO529,  
FR-PO530, FR-PO531, FR-PO532,  
FR-PO533, FR-PO744, FR-PO863,  
FR-PO872, SA-OR39, SA-PO010,  
SA-PO298, SA-PO301, SA-PO338, PUB026,  
PUB122, PUB132, PUB133, PUB134,  
PUB137, PUB138, PUB140, PUB141,  
PUB142, PUB143, PUB144, PUB145,  
PUB146, PUB147

**peritoneal membrane**.....FR-PO454, FR-PO458,  
FR-PO459, FR-PO460, FR-PO461,  
FR-PO462, FR-PO463, FR-PO467,  
FR-PO475, FR-PO478, FR-PO479,  
FR-PO486, FR-PO494, FR-PO496,  
FR-PO498

**pharmacokinetics** .....TH-OR38, TH-PO244,  
TH-PO484, TH-PO663, TH-PO958,  
FR-PO217, FR-PO218, FR-PO220,  
FR-PO224, FR-PO225, FR-PO226,  
FR-PO227, FR-PO231, FR-PO232,  
FR-PO241, SA-PO636, SA-PO855, PUB287,  
PUB288

**phosphate binders** ..... TH-PO154, TH-PO164,  
TH-PO168, TH-PO170, TH-PO859,  
FR-PO549, FR-PO988,  
SA-PO171, SA-PO172, SA-PO173,  
SA-PO174, SA-PO210,  
PUB164, PUB286

**phosphate uptake** ..... TH-PO151, TH-PO152,  
TH-PO156, TH-PO159, TH-PO160,  
TH-PO161, TH-PO315, FR-PO988,  
SA-PO190, SA-PO204, SA-PO213,  
SA-PO987, SA-PO1006

**platelets** ..... TH-PO067, TH-PO120, TH-PO212,  
FR-PO067, FR-PO075, SA-PO111,  
SA-PO917, PUB105

**podocyte** ..... TH-PO177, TH-PO189, TH-PO207,  
TH-PO216, TH-PO220, TH-PO221,  
TH-PO444, TH-PO455, TH-PO467,  
TH-PO469, TH-PO530, TH-PO753,  
TH-PO755, TH-PO756, FR-OR56,  
FR-PO143, FR-PO325, FR-PO329,  
FR-PO331, FR-PO332, FR-PO350,  
FR-PO353, FR-PO370, FR-PO401,  
FR-PO447, FR-PO604, FR-PO625,  
FR-PO679, FR-PO684, FR-PO686,  
FR-PO687, FR-PO689, FR-PO692,  
FR-PO693, FR-PO695, FR-PO696,  
FR-PO698, FR-PO699, FR-PO700,  
FR-PO702, FR-PO703, FR-PO704,  
FR-PO705, FR-PO706, FR-PO707,  
FR-PO708, FR-PO710, FR-PO711,  
FR-PO712, FR-PO714, FR-PO716,  
FR-PO717, FR-PO718, FR-PO720,  
FR-PO721, FR-PO726, FR-PO727,  
FR-PO728, FR-PO730, FR-PO731,  
SA-OR23, SA-OR24, SA-OR25, SA-OR27,  
SA-OR28, SA-PO002, SA-PO024,  
SA-PO029, SA-PO030, SA-PO031,  
SA-PO229, SA-PO230, SA-PO233,  
SA-PO235, SA-PO239, SA-PO244,  
SA-PO249, SA-PO524, SA-PO703,  
SA-PO708, SA-PO731, SA-PO734,  
SA-PO736, SA-PO737, SA-PO738,  
SA-PO739, SA-PO740, SA-PO741,  
SA-PO743, SA-PO744, SA-PO746,

**podocyte (continued)**..... SA-PO747, SA-PO748,  
SA-PO749, SA-PO750, SA-PO1010,  
SA-PO1013, PUB007, PUB237, PUB269

**polycystic kidney disease** ..... TH-OR35,  
TH-PO004, TH-PO356, TH-PO358,  
TH-PO361, TH-PO362, TH-PO365,  
TH-PO366, TH-PO368, TH-PO369,  
TH-PO370, TH-PO371, TH-PO372,  
TH-PO375, TH-PO385, TH-PO386,  
TH-PO387, TH-PO396, TH-PO399,  
TH-PO403, TH-PO404, TH-PO405,  
TH-PO408, TH-PO414, FR-PO130,  
FR-PO242, FR-PO247, FR-PO249,  
FR-PO251, FR-PO254, FR-PO257,  
FR-PO274, FR-PO275, FR-PO276,  
FR-PO277, FR-PO278, FR-PO279,  
FR-PO280, FR-PO283, FR-PO287,  
FR-PO288, FR-PO295, FR-PO296,  
FR-PO301, FR-PO348, FR-PO406,  
FR-PO935, SA-OR14, PUB189, PUB190

**potassium (K) channels**.....TH-PO321,  
TH-PO325, TH-PO354, FR-OR42,  
FR-PO314, SA-OR13, SA-PO482,  
SA-PO781, SA-PO984, PUB167

**primary glomerulonephritis**.....TH-PO516,  
TH-PO760, FR-PO191, FR-PO658,  
FR-PO701, SA-PO658

**progression**..... TH-PO363, TH-PO382,  
TH-PO383, TH-PO388, TH-PO406,  
TH-PO535, TH-PO630, TH-PO849,  
FR-OR23, FR-OR54, FR-PO003, FR-PO914,  
FR-PO937, FR-PO939, FR-PO991,  
SA-PO088, SA-PO282, SA-PO284,  
SA-PO657, SA-PO658, SA-PO686,  
SA-PO919, SA-PO981, SA-PO995, PUB160

**progression of renal failure** ..... TH-OR10,  
TH-OR33, TH-PO027, TH-PO031,  
TH-PO194, TH-PO257, TH-PO300,  
TH-PO407, TH-PO476, TH-PO877,  
TH-PO887, TH-PO888, TH-PO897,  
TH-PO907, FR-OR36, FR-PO079, FR-  
PO092, FR-PO410, FR-PO589, FR-PO749,  
FR-PO905, FR-PO910, FR-PO929,  
FR-PO942, FR-PO1000, SA-PO007,  
SA-PO023, SA-PO271, SA-PO656,  
SA-PO691, SA-PO794, SA-PO901,  
SA-PO923, SA-PO983, PUB037, PUB083,  
PUB191, PUB267, PUB354

**proliferation**..... TH-PO140, TH-PO142,  
TH-PO192, TH-PO322, TH-PO414,  
TH-PO420, FR-PO262, FR-PO289

**proteinuria**..... TH-PO057, TH-PO100,  
TH-PO428, TH-PO430, TH-PO442,  
TH-PO446, TH-PO461, TH-PO463,  
TH-PO476, TH-PO479, TH-PO480,  
TH-PO481, TH-PO484, TH-PO494,  
TH-PO497, TH-PO498, TH-PO504,  
TH-PO505, TH-PO514, TH-PO521,  
TH-PO526, TH-PO544, TH-PO547,  
TH-PO556, TH-PO752, TH-PO770,  
TH-PO805, TH-PO883, TH-PO886,  
FR-OR25, FR-OR57, FR-OR59, FR-PO039,  
FR-PO048, FR-PO181, FR-PO208,  
FR-PO210, FR-PO215, FR-PO438,  
FR-PO558, FR-PO574, FR-PO626,  
FR-PO641, FR-PO657, FR-PO659,  
FR-PO666, FR-PO667, FR-PO681,  
FR-PO682, FR-PO694, FR-PO695,  
FR-PO702, FR-PO714, FR-PO718,  
FR-PO728, FR-PO732, FR-PO733,



- proteinuria (continued)**..... FR-PO734, FR-PO944, SA-PO137, SA-PO247, SA-PO271, SA-PO489, SA-PO546, SA-PO575, SA-PO589, SA-PO657, SA-PO671, SA-PO674, SA-PO700, SA-PO704, SA-PO707, SA-PO708, SA-PO723, SA-PO751, SA-PO862, SA-PO876, SA-PO879, SA-PO927, SA-PO938, SA-PO976, PUB093, PUB194, PUB198, PUB203, PUB212, PUB228, PUB242, PUB243, PUB244, PUB245, PUB265, PUB334, PUB351
- proximal tubule** ..... TH-OR36, TH-OR40, TH-OR46, TH-PO009, TH-PO027, TH-PO091, TH-PO189, TH-PO217, TH-PO310, TH-PO352, TH-PO418, TH-PO533, TH-PO544, TH-PO568, TH-PO572, TH-PO675, FR-OR20, FR-OR28, FR-PO127, FR-PO146, FR-PO355, FR-PO572, FR-PO947, FR-PO1005, FR-PO1007, SA-OR12, SA-PO025, SA-PO065, SA-PO078, SA-PO085, SA-PO098, SA-PO243, SA-PO245, SA-PO490, SA-PO930, SA-PO992, SA-PO1002, PUB064
- pulse wave velocity** ..... SA-PO163, SA-PO779
- pyelonephritis** ..... TH-PO113, TH-PO182, SA-PO053, SA-PO604, SA-PO605, SA-PO607, SA-PO608, TH-PO610, SA-PO612, SA-PO613, SA-PO614, SA-PO615, SA-PO616, SA-PO994
- quality of life**..... TH-OR14, TH-PO167, TH-PO168, TH-PO270, TH-PO399, TH-PO496, TH-PO674, TH-PO698, TH-PO776, TH-PO791, TH-PO799, TH-PO811, TH-PO818, TH-PO819, TH-PO919, FR-PO427, FR-PO513, FR-PO607, FR-PO860, FR-PO861, FR-PO863, FR-PO868, FR-PO871, SA-PO285, SA-PO288, SA-PO299, SA-PO300, SA-PO303, SA-PO361, SA-PO463, SA-PO698, SA-PO699, SA-PO931, PUB078, PUB120, PUB131, PUB157, PUB288, PUB353
- randomized controlled trials** ..... TH-PO486, TH-PO501, TH-PO582, TH-PO674, TH-PO739, TH-PO767, TH-PO797, TH-PO798, TH-PO818, FR-PO063, FR-PO504, FR-PO505, FR-PO640, SA-OR38, SA-PO308, SA-PO910, SA-PO919, PUB311, PUB312, PUB315
- reactive oxygen species** ..... TH-PO185, FR-PO250, SA-PO108
- regulation** .... TH-PO179, TH-PO352, FR-PO137, FR-PO390, FR-PO525, SA-PO434
- rejection**..... TH-OR49, TH-OR53, TH-PO650, TH-PO654, FR-PO431, FR-PO763, FR-PO765, FR-PO767, FR-PO779, FR-PO781, FR-PO783, FR-PO784, FR-PO789, FR-PO797, FR-PO798, FR-PO801, FR-PO803, FR-PO804, FR-PO820, FR-PO828, SA-OR42, SA-OR46, SA-PO811, SA-PO848, SA-PO850, SA-PO851, SA-PO873, SA-PO876, PUB319, PUB322
- renal ablation**...FR-PO786, SA-PO784, PUB255
- renal artery stenosis** ..... SA-PO767, SA-PO874, PUB285, PUB329
- renal autoregulation**.....SA-PO014
- renal biopsy**..... TH-PO080, TH-PO114, TH-PO130, TH-PO427, TH-PO439, TH-PO460, TH-PO478, TH-PO529, TH-PO557, TH-PO578, TH-PO586, TH-PO749, FR-OR20, FR-PO177, FR-PO206, FR-PO602, FR-PO604, FR-PO641, FR-PO665, FR-PO671, SA-PO001, SA-PO040, SA-PO043, SA-PO141, SA-PO159, SA-PO258, SA-PO630, SA-PO717, SA-PO728, SA-PO939, PUB054, PUB068, PUB096, PUB115, PUB238, PUB267
- renal carcinoma**..... FR-PO298
- renal cell biology**..... TH-PO531, TH-PO533, FR-OR35, FR-PO292, FR-PO346, FR-PO369, FR-PO406, FR-PO712, FR-PO729, SA-OR19, SA-OR24, SA-PO243, SA-PO740
- renal development** ..... FR-PO292, FR-PO367, FR-PO376, SA-OR19, SA-OR20, SA-PO583
- renal dialysis** ..... TH-PO125, FR-PO029, FR-PO472, FR-PO507, SA-PO042, SA-PO405, SA-PO907
- renal dysfunction**..... TH-PO617, FR-PO170, FR-PO179, FR-PO551, PUB158
- renal epithelial cell** ..... TH-OR41, FR-PO130, FR-PO141, FR-PO277, FR-PO953, SA-PO099, SA-PO101, SA-PO616, SA-PO960, PUB092
- renal failure** ..... TH-PO082, TH-PO096, TH-PO491, TH-PO618, FR-PO023, FR-PO073, FR-PO167, FR-PO349, SA-PO005, SA-PO018, SA-PO059, SA-PO663, SA-PO953, PUB031, PUB032
- renal fibrosis** ..... TH-PO192, TH-PO227, TH-PO433, TH-PO538, TH-PO549, TH-PO555, TH-PO638, TH-PO705, FR-OR27, FR-OR29, FR-OR31, FR-PO127, FR-PO294, FR-PO349, FR-PO912, FR-PO954, FR-PO959, FR-PO962, FR-PO965, FR-PO970, FR-PO974, FR-PO983, FR-PO994, FR-PO998, FR-PO1006, SA-PO124, SA-PO785, SA-PO894, SA-PO969, SA-PO971, PUB362
- renal function**..... TH-PO085, TH-PO329, TH-PO398, TH-PO731, TH-PO734, TH-PO746, TH-PO762, TH-PO775, TH-PO901, FR-PO171, FR-PO345, FR-PO433, FR-PO751, FR-PO811, FR-PO820, SA-PO071, SA-PO104, SA-PO117, SA-PO269, SA-PO439, SA-PO897, SA-PO898, SA-PO930, SA-PO935, PUB268
- renal function decline**.....TH-PO232, TH-PO395, TH-PO407, TH-PO760, TH-PO797, TH-PO863, TH-PO888, FR-PO083, FR-PO245, SA-PO152, SA-PO266, SA-PO896, SA-PO954, PUB057, PUB083, PUB243
- renal hemodynamics** .....TH-OR39, TH-PO061, TH-PO230, FR-PO896, SA-PO014, SA-PO027, SA-PO986, PUB100
- renal hypertension**..... SA-PO774, SA-PO785
- renal injury** ..... TH-PO026, TH-PO056, TH-PO073, TH-PO079, TH-PO096, TH-PO100, TH-PO102, TH-PO121, TH-PO459, TH-PO545, FR-OR38, FR-PO012, FR-PO021, FR-PO071, FR-PO093, FR-PO094, FR-PO109,
- renal injury (continued)**..... FR-PO139, FR-PO141, FR-PO155, FR-PO213, FR-PO244, FR-PO372, FR-PO393, FR-PO679, FR-PO726, SA-OR45, SA-PO022, SA-PO040, SA-PO058, SA-PO074, SA-PO150, SA-PO227, SA-PO423, SA-PO772, SA-PO785, SA-PO972, PUB006, PUB114
- renal ischemia** ..... TH-PO139, FR-PO158, SA-PO089, SA-PO594, SA-PO767, SA-PO967, SA-PO973, PUB037
- renal morphology** ..... TH-PO136, TH-PO565, TH-PO570, FR-PO815, FR-PO919, SA-PO004, SA-PO621, SA-PO622
- renal osteodystrophy** ..... TH-PO802, FR-OR01, FR-OR06, FR-PO423, SA-PO175, SA-PO189, SA-PO197, SA-PO214, SA-PO215, SA-PO218
- renal pathology** ..... TH-PO490, TH-PO533, TH-PO534, TH-PO563, TH-PO576, FR-PO013, FR-PO020, FR-PO357, FR-PO631, FR-PO644, FR-PO683, SA-OR01, SA-PO038, SA-PO098, SA-PO629, SA-PO729, SA-PO868
- renal progression**..... TH-PO024, TH-PO479, TH-PO736, TH-PO862, FR-PO886, FR-PO908, SA-PO715, SA-PO927, SA-PO934, PUB104, PUB112, PUB351
- renal protection** ..... TH-PO112, TH-PO138, TH-PO826, FR-OR40, FR-PO148, FR-PO234, FR-PO404, FR-PO550, FR-PO994, SA-PO066, SA-PO085, SA-PO086, SA-PO092, SA-PO096, SA-PO221, PUB025
- renal proximal tubule cell**..... TH-OR43, TH-PO203, TH-PO307, TH-PO308, TH-PO315, TH-PO532, TH-PO765, FR-PO133, FR-PO194, FR-PO234, FR-PO336, FR-PO365, FR-PO393, FR-PO996, FR-PO1003, SA-PO025, SA-PO086, SA-PO088, PUB066
- renal stem cell**.....FR-PO169, FR-PO374, FR-PO376, FR-PO386, FR-PO400
- renal transplantation** .... TH-PO459, TH-PO485, TH-PO909, TH-PO916, TH-PO960, FR-PO399, FR-PO778, FR-PO795, FR-PO821, FR-PO834, FR-PO853, SA-OR45, SA-PO806, SA-PO814, SA-PO824, SA-PO838, SA-PO853, SA-PO855, SA-PO867, SA-PO866, SA-PO867, SA-PO875, PUB319, PUB323, PUB324, PUB327, PUB329
- renal tubular acidosis**... TH-PO309, TH-PO345, SA-PO485, SA-PO490, SA-PO492, SA-PO494, SA-PO528, PUB076, PUB176, PUB216
- renal tubular epithelial cells**.....TH-PO136, TH-PO180, TH-PO197, TH-PO198, TH-PO322, TH-PO324, TH-PO331, TH-PO546, FR-OR34, FR-PO157, FR-PO270, FR-PO394, FR-PO685, FR-PO960, FR-PO972, FR-PO1002, SA-PO077, SA-PO154, SA-PO170, SA-PO971, SA-PO988, SA-PO1009, PUB041
- renin angiotensin system** ..... TH-PO030, TH-PO199, TH-PO214, FR-PO024, FR-PO545, FR-PO724, FR-PO903, SA-PO222, SA-PO481, SA-PO765,

**renin angiotensin**

**system (continued)** ..... SA-PO766,  
SA-PO853, SA-PO975, SA-PO998,  
PUB094, PUB117, PUB182, PUB285

**rhabdomyolysis** ..... TH-PO090, TH-PO112,  
TH-PO133, FR-PO105, SA-PO035,  
PUB067, PUB073

**rheumatology** ..... TH-PO306, TH-PO514,  
TH-PO523, FR-PO596, FR-PO646,  
FR-PO667, SA-PO038, SA-PO040,  
SA-PO895, SA-PO897, SA-PO898,  
SA-PO940, PUB211, PUB355

**risk factors** ..... TH-OR28, TH-PO022,  
TH-PO023, TH-PO032, TH-PO243,  
TH-PO245, TH-PO300, TH-PO400,  
TH-PO581, TH-PO595, TH-PO608,  
TH-PO613, TH-PO615, TH-PO616,  
TH-PO620, TH-PO635,  
TH-PO759, TH-PO786,  
TH-PO807, TH-PO813, TH-PO816,  
TH-PO827, TH-PO864, TH-PO867,  
TH-PO884, TH-PO890, TH-PO898,  
FR-OR21, FR-PO014, FR-PO018, FR-  
PO023, FR-PO029, FR-PO032, FR-PO033,  
FR-PO060, FR-PO077, FR-PO081,  
FR-PO082, FR-PO084, FR-PO089,  
FR-PO099, FR-PO111, FR-PO311,  
FR-PO434, FR-PO436, FR-PO662,  
FR-PO819, FR-PO845, FR-PO847,  
FR-PO923, FR-PO925, FR-PO932,  
SA-PO041, SA-PO150, SA-PO168,  
SA-PO178, SA-PO219, SA-PO504,  
SA-PO831, SA-PO834, SA-PO884,  
SA-PO914, SA-PO954, PUB045, PUB057,  
PUB159, PUB293, PUB294, PUB295,  
PUB297, PUB298, PUB306, PUB323,  
PUB346, PUB347, PUB348

**SGLT2** ..... TH-PO178, TH-PO211, TH-PO226,  
TH-PO602, TH-PO855, TH-PO858,  
TH-PO860, FR-OR26, FR-OR33, FR-PO217,  
FR-PO323, FR-PO386, FR-PO401,  
FR-PO498, FR-PO553, FR-PO749,  
FR-PO807, FR-PO902, FR-PO904,  
FR-PO911, FR-PO937, FR-PO956,  
SA-OR36, SA-PO102, SA-PO221,  
SA-PO237, SA-PO257, SA-PO258,  
SA-PO259, SA-PO260, SA-PO261,  
SA-PO263, SA-PO264, SA-PO266,  
SA-PO267, SA-PO518, SA-PO521,  
SA-PO885, SA-PO889, SA-PO890,  
SA-PO891, SA-PO942, SA-PO945,  
SA-PO1000, PUB027, PUB101, PUB110,  
PUB117, PUB192, PUB256, PUB361

**signaling** ..... TH-PO147, TH-PO172, TH-PO215,  
TH-PO410, FR-PO129, FR-PO168,  
FR-PO576, FR-PO594, SA-OR19,  
SA-PO063, SA-PO105, SA-PO233,  
SA-PO642, SA-PO643, SA-PO650,  
SA-PO975, SA-PO979,  
SA-PO1002, PUB367

**social determinants of health** ..... TH-PO592,  
TH-PO593, TH-PO706, TH-PO707,  
TH-PO708, TH-PO710, TH-PO711,  
TH-PO714, TH-PO716, TH-PO717,  
TH-PO718, TH-PO719, TH-PO730,  
TH-PO733, TH-PO738, TH-PO740,  
TH-PO911, FR-PO491, FR-PO539,  
FR-PO540, FR-PO541, FR-PO814,  
FR-PO861, FR-PO862, FR-PO863,  
FR-PO883, FR-PO884, FR-PO889,

**social determinants**

**of health (continued)** ..... FR-PO890,  
SA-PO322, SA-PO800, SA-PO808,  
SA-PO814, SA-PO816, SA-PO838

**social health justice** ..... TH-PO730, TH-PO740,  
FR-PO061, FR-PO870, FR-PO884,  
FR-PO889, FR-PO890

**sodium (Na) transport** ..... TH-PO047,  
TH-PO316, TH-PO318, TH-PO319,  
TH-PO323, TH-PO326, TH-PO328,  
TH-PO329, TH-PO330, TH-PO334,  
TH-PO354, FR-PO007, FR-PO340,  
SA-PO099, SA-PO359, SA-PO360,  
SA-PO447, SA-PO472, SA-PO482,  
SA-PO958, PUB184

**statins** ..... FR-PO100, SA-PO906, PUB296

**stem cell** ..... TH-PO109, TH-PO224, TH-PO441,  
FR-PO185, FR-PO192, FR-PO301,  
FR-PO313, FR-PO349, FR-PO351,  
FR-PO354, FR-PO359, FR-PO360,  
FR-PO361, FR-PO362, FR-PO364,  
FR-PO375, FR-PO376, FR-PO384,  
FR-PO395, FR-PO396, FR-PO398,  
FR-PO403, FR-PO405, FR-PO992,  
SA-OR17, SA-OR27, SA-PO019, SA-PO020,  
SA-PO028, SA-PO030, SA-PO069,  
SA-PO078, SA-PO734, SA-PO870

**survival** ..... TH-OR13, TH-OR49, TH-PO263,  
TH-PO581, TH-PO794, FR-PO089,  
FR-PO113, FR-PO122, FR-PO528,  
FR-PO606, FR-PO636, FR-PO757,  
FR-PO822, FR-PO851, SA-OR35, SA-  
PO127, SA-PO143, SA-PO312, SA-PO316,  
SA-PO370, SA-PO397, SA-PO417,  
SA-PO431, PUB031, PUB053, PUB325

**systemic lupus erythematosus** ..... TH-PO577,  
FR-PO040, FR-PO603, FR-PO605,  
FR-PO629, FR-PO630, FR-PO632,  
FR-PO633, FR-PO642, FR-PO643,  
FR-PO676, FR-PO678, SA-PO683, PUB021,  
PUB204, PUB207, PUB210, PUB220

**systolic blood pressure** ..... TH-OR21,  
FR-PO737, SA-PO754

**tacrolimus** ..... TH-PO642, TH-PO645,  
FR-PO052, FR-PO202, FR-PO518,  
FR-PO660, FR-PO771, FR-PO782,  
FR-PO785, FR-PO790, FR-PO791,  
FR-PO800, FR-PO853, SA-PO061,  
SA-PO842, SA-PO843, SA-PO855,  
SA-PO873, PUB222, PUB300

**target organ damage** ..... TH-OR46, SA-OR04,  
SA-PO160, SA-PO843, PUB307

**TGF-beta** ..... TH-PO430, FR-PO019, FR-PO123,  
FR-PO946, FR-PO962, FR-PO987,  
FR-PO989, FR-PO1003, FR-PO1007,  
SA-PO231, SA-PO551, SA-PO771

**thrombosis** ..... TH-PO266, TH-PO281,  
TH-PO283, TH-PO473, TH-PO506,  
TH-PO513, TH-PO550, FR-PO627,  
SA-PO134, SA-PO318, SA-PO391,  
SA-PO590, SA-PO592, SA-PO710, PUB042,  
PUB207, PUB316

**tolerance** ..... TH-OR53, TH-PO536, FR-PO787,  
SA-OR47, SA-OR48,  
SA-OR50, SA-PO850

**transcription factors** ..... TH-PO140,  
TH-PO217, TH-PO317, TH-PO326,  
TH-PO327, TH-PO328, TH-PO341,  
TH-PO551, TH-PO832, FR-PO152,

**transcription factors (continued)** ..... FR-PO258,  
FR-PO363, FR-PO373, FR-PO393,  
FR-PO990, SA-PO084, SA-PO090,  
SA-PO610, SA-PO743, SA-PO777,  
SA-PO779, SA-PO960,  
SA-PO1003, PUB257

**transcription regulation** ..... TH-PO207,  
TH-PO216, TH-PO256, TH-PO307,  
TH-PO308, TH-PO317, TH-PO337,  
TH-PO341, FR-OR07, FR-PO124,  
FR-PO131, FR-PO174, FR-PO270,  
FR-PO305, FR-PO308, FR-PO319,  
FR-PO373, SA-PO084, SA-PO956,  
SA-PO960, SA-PO985

**transcriptional profiling** ..... TH-OR44,  
TH-PO183, TH-PO223, TH-PO419,  
TH-PO422, TH-PO441, TH-PO655,  
FR-OR20, FR-OR31, FR-OR32, FR-PO124,  
FR-PO131, FR-PO145, FR-PO154,  
FR-PO169, FR-PO298, FR-PO317,  
FR-PO724, SA-OR04, SA-PO236,  
SA-PO1011, PUB106

**transgenic mouse** ..... TH-OR35, TH-PO754,  
FR-OR17, FR-PO020, FR-PO327,  
FR-PO377, FR-PO387,  
FR-PO389, SA-PO029, SA-PO124,  
SA-PO608, SA-PO610, SA-PO783

**transplant nephrectomy** ..... SA-PO119,  
SA-PO801

**transplant outcomes** ..... TH-OR54, TH-PO008,  
TH-PO397, TH-PO738, TH-PO900,  
TH-PO935, TH-PO943, FR-PO160,  
FR-PO432, FR-PO772, FR-PO773,  
FR-PO785, FR-PO790, FR-PO792,  
FR-PO804, FR-PO818, FR-PO822,  
FR-PO836, FR-PO842, FR-PO849,  
FR-PO850, FR-PO855, FR-PO879,  
FR-PO883, SA-OR41, SA-OR50, SA-PO122,  
SA-PO313, SA-PO314, SA-PO794,  
SA-PO796, SA-PO798, SA-PO803,  
SA-PO804, SA-PO805, SA-PO812,  
SA-PO824, SA-PO827, SA-PO831,  
SA-PO850, SA-PO864, SA-PO866,  
SA-PO878, SA-PO883, SA-PO884, PUB234,  
PUB300, PUB303, PUB308, PUB310,  
PUB311, PUB315, PUB325, PUB327,  
PUB328, PUB330, PUB333, PUB341

**transplant pathology** ..... TH-PO093, TH-PO636,  
TH-PO651, FR-PO432, FR-PO770,  
FR-PO788, FR-PO805, FR-PO813,  
SA-OR44, SA-PO047, SA-PO672,  
SA-PO818, SA-PO845, SA-PO858,  
SA-PO870, SA-PO878, SA-PO879, PUB327,  
PUB337, PUB339

**transplantation** ..... TH-OR28, TH-OR48,  
TH-OR53, TH-OR57, TH-PO008,  
TH-PO020, TH-PO637, TH-PO646,  
TH-PO647, TH-PO651, TH-PO653,  
TH-PO676, TH-PO698, TH-PO738,  
TH-PO740, TH-PO791, TH-PO815,  
TH-PO900, TH-PO929, TH-PO944,  
TH-PO945, TH-PO951, TH-PO963,  
FR-PO571, FR-PO619, FR-PO765,  
FR-PO779, FR-PO786, FR-PO791,  
FR-PO811, FR-PO826, FR-PO831,  
FR-PO840, FR-PO842, FR-PO852,  
FR-PO854, FR-PO855, FR-PO856,  
FR-PO870, FR-PO873, FR-PO874,  
FR-PO875, FR-PO877, FR-PO878,  
FR-PO880, FR-PO882, FR-PO883,

<b>transplantation (continued)</b> .....SA-OR41, SA-OR48, SA-PO101, SA-PO143, SA-PO180, SA-PO315, SA-PO796, SA-PO803, SA-PO804, SA-PO808, SA-PO809, SA-PO810, SA-PO812, SA-PO829, SA-PO830, SA-PO835, SA-PO836, SA-PO841, SA-PO847, SA-PO848, SA-PO860, SA-PO862, SA-PO869, SA-PO870, SA-PO872, SA-PO873, SA-PO877, SA-PO878, SA-PO881, SA-PO882, PUB290, PUB299, PUB305, PUB314, PUB320, PUB322, PUB332, PUB337, PUB340, PUB369	<b>uromodulin (continued)</b> ..... FR-PO343, FR-PO344, FR-PO412, FR-PO802, FR-PO907, SA-PO170, PUB192	<b>vasculitis (continued)</b> .....PUB068, PUB070, PUB071, PUB225, PUB287
<b>tubular epithelium</b> ..... TH-PO329, TH-PO471, TH-PO538, TH-PO540, FR-OR44, FR-OR46, FR-PO123, FR-PO136, FR-PO145, FR-PO284, FR-PO290, FR-PO291, FR-PO296, FR-PO305, FR-PO366, FR-PO1000, FR-PO1001, SA-PO021, SA-PO090, SA-PO126, SA-PO522, SA-PO615, SA-PO970, SA-PO974, SA-PO1010, PUB364	<b>USRDS (United States Renal Data System)</b> ..... TH-OR17, TH-PO386, TH-PO936, TH-PO955, FR-PO008, FR-PO065, FR-PO895, SA-PO181, SA-PO323, SA-PO324, SA-PO392, SA-PO798, SA-PO806	<b>vasopressin</b> ..... TH-PO336, TH-PO337, TH-PO338, TH-PO340, TH-PO343, FR-PO273, FR-PO556, SA-PO479
<b>tubule cells</b> ..... TH-PO182, TH-PO242, TH-PO330, FR-OR33, FR-PO156, FR-PO161, FR-PO190, FR-PO256, FR-PO920, FR-PO983, FR-PO989, SA-PO028, SA-PO095, SA-PO108, SA-PO956, SA-PO1007, PUB059	<b>vascular</b> ..... TH-OR55, TH-PO391, TH-PO597, FR-PO195, FR-PO205, FR-PO360, FR-PO363, FR-PO389, SA-PO021, SA-PO030, SA-PO969, PUB085, PUB102, PUB103, PUB307, PUB361	<b>VEGF</b> .....FR-PO199, FR-PO202, FR-PO215, FR-PO1009, SA-PO228, SA-PO232
<b>ultrafiltration</b> .....FR-PO496, FR-PO498, FR-PO707, SA-PO355, SA-PO357, SA-PO368, SA-PO375, SA-PO621, PUB134, PUB141	<b>vascular access</b> .....TH-OR20, TH-PO257, TH-PO258, TH-PO259, TH-PO260, TH-PO261, TH-PO262, TH-PO265, TH-PO268, TH-PO273, TH-PO274, TH-PO275, TH-PO276, TH-PO279, TH-PO281, TH-PO283, TH-PO284, TH-PO286, TH-PO291, TH-PO292, TH-PO293, TH-PO296, TH-PO297, TH-PO298, TH-PO299, TH-PO303, SA-PO016, SA-PO312, SA-PO403, SA-PO438, PUB150	<b>vesico-ureteral reflux</b> .....FR-PO432, SA-PO606, SA-PO611
<b>uninephrectomy</b> .....TH-PO423	<b>vascular calcification</b> ..... TH-PO106, TH-PO150, TH-PO159, TH-PO171, TH-PO265, TH-PO266, FR-PO949, SA-PO060, SA-PO161, SA-PO162, SA-PO163, SA-PO165, SA-PO174, SA-PO175, SA-PO209, SA-PO376, SA-PO773, SA-PO786	<b>virology</b> ..... TH-PO465, TH-PO512, TH-PO917, TH-PO920, TH-PO931, FR-PO014, FR-PO024, FR-PO105, FR-PO165, FR-PO670, FR-PO833, FR-PO842, SA-OR09, SA-OR43, SA-PO042, SA-PO047, SA-PO116, SA-PO456, SA-PO457, SA-PO458, SA-PO670, PUB038, PUB317
<b>urea</b> ..... TH-PO045, TH-PO289, FR-OR23, FR-PO249, SA-PO426, PUB006, PUB077	<b>vascular disease</b> ..... TH-PO150, TH-PO808, FR-PO022, SA-PO627, SA-PO661, SA-PO779, PUB108, PUB125, PUB254, PUB279	<b>vitamin B1</b> ..... FR-PO222
<b>urea modeling</b> ..... SA-PO420, SA-PO436	<b>vascularitis</b> .....TH-PO114, TH-PO119, TH-PO137, TH-PO423, TH-PO507, TH-PO508, TH-PO543, FR-PO047, FR-PO580, FR-PO581, FR-PO584, FR-PO585, FR-PO586, FR-PO587, FR-PO588, FR-PO591, FR-PO609, FR-PO615, FR-PO616, FR-PO617, FR-PO618, FR-PO647, FR-PO648, FR-PO650, FR-PO653, FR-PO677, SA-PO062, SA-PO564, SA-PO590, SA-PO693, SA-PO694, SA-PO695, SA-PO697, SA-PO698, SA-PO701, PUB022, PUB062,	<b>vitamin C</b> .....TH-PO129
<b>uremia</b> ..... TH-PO190, TH-PO582, TH-PO704, FR-PO222, FR-PO420, FR-PO968, SA-PO352, SA-PO404, SA-PO409, SA-PO411, SA-PO414, SA-PO462, SA-PO916, SA-PO931, SA-PO996		<b>vitamin D</b> .... TH-PO144, TH-PO605, TH-PO672, TH-PO837, FR-PO421, FR-PO777, SA-PO186, SA-PO187, SA-PO201, SA-PO204, SA-PO217, SA-PO219, SA-PO390, SA-PO505, SA-PO510, SA-PO511, SA-PO512, SA-PO847
<b>ureteric bud</b> .....SA-OR17, SA-OR18		<b>water channels</b> ..... TH-PO337, TH-PO338, TH-PO339, TH-PO342, TH-PO343, TH-PO344
<b>urokinase</b> .....TH-PO215		<b>water transport</b> ..... TH-PO009, TH-PO348
<b>uromodulin</b> ..... TH-PO025, TH-PO379, TH-PO574, FR-OR13, FR-PO076, FR-PO149, FR-PO150, FR-PO154,		<b>water-electrolyte balance</b> .....TH-PO010, TH-PO316, TH-PO334, TH-PO340, TH-PO597, FR-OR47, FR-PO391, SA-PO302, SA-PO354, SA-PO356, SA-PO465, PUB179
		<b>women's health</b> ..... TH-PO610, TH-PO744, TH-PO745, TH-PO746, TH-PO747, TH-PO748, TH-PO749, TH-PO751, TH-PO753, TH-PO757, TH-PO759, TH-PO760, TH-PO762, TH-PO763, TH-PO764, TH-PO765, TH-PO766, TH-PO767, FR-PO857, FR-PO880, FR-PO887, SA-PO250, SA-PO317, SA-PO614, SA-PO619, SA-PO994, PUB168, PUB258, PUB344, PUB345

FR-OR61

**The BEST-Fluids Trial: A Randomized Controlled Trial of Balanced Crystalloid Solution vs. Saline to Prevent Delayed Graft Function in Deceased Donor Kidney Transplantation**

Michael G. Collins,<sup>1,2</sup> Magid Fahim,<sup>3,4</sup> Elaine Pascoe,<sup>3</sup> Carmel Hawley,<sup>3,4</sup> David W. Johnson,<sup>3,4</sup> Philip A. Clayton,<sup>5,1</sup> Steven J. Chadban.<sup>6,7</sup> The BEST-Fluids Investigators <sup>1</sup>Central Northern Adelaide Renal and Transplantation Service, Royal Adelaide Hospital, Adelaide, SA, Australia; <sup>2</sup>Department of Renal Medicine, Auckland City Hospital, Auckland, New Zealand; <sup>3</sup>Australasian Kidney Trials Network, The University of Queensland, Brisbane, QLD, Australia; <sup>4</sup>Department of Nephrology, Princess Alexandra Hospital, Woolloongabba, QLD, Australia; <sup>5</sup>Australia and New Zealand Dialysis and Transplant Registry, Adelaide, SA, Australia; <sup>6</sup>Department of Renal Medicine, Royal Prince Alfred Hospital, Camperdown, NSW, Australia; <sup>7</sup>Charles Perkins Centre, The University of Sydney, Sydney, NSW, Australia.

**Background:** Delayed graft function (DGF) is a frequent complication of deceased donor kidney transplantation and is associated with inferior outcomes. Saline (0.9% sodium chloride) is the most widely used intravenous (IV) fluid in transplantation but may increase the risk of DGF due to its high chloride content. We hypothesized that using a balanced low-chloride crystalloid solution (Plasma-Lyte 148) instead of saline would reduce the incidence of DGF.

**Methods:** BEST-Fluids was an investigator-initiated, pragmatic, registry-based, multicenter, double-blind, randomized controlled trial (NCT03829488). Deceased donor kidney transplant recipients were randomized 1:1 to IV fluid therapy with balanced crystalloid solution or saline during surgery and for up to 48 hours post-transplant until fluids were ceased. The primary outcome was DGF, defined as dialysis within seven days of transplant. Secondary outcomes included post-transplant hyperkalemia (potassium  $\geq 5.5$  mmol/L), and graft function (eGFR), acute rejection, graft failure (censored for death) and mortality to 52 weeks.

**Results:** In total, 808 participants (median age 55 years, 37% female, 41% non-white) were randomized and received a transplant; 807 (99.9%) were included in the primary analysis (404 balanced crystalloid, 403 saline). Participants in the balanced crystalloid group had a lower incidence of DGF compared with the saline group (30.0% vs 39.7%; adjusted relative risk [RR] 0.75, 95% CI 0.66–0.84,  $P < 0.0001$ ). The effect was consistent across pre-specified subgroups of donor type, kidney donor risk index, machine perfusion and ischemic time (RR 0.65 to 0.88). The incidence of hyperkalemia (56.4% vs 56.6%, RR 1.00, 95% CI 0.90–1.12) was the same in both groups. There were no significant differences in graft function at 52 weeks ( $54.0 \pm 20.4$  vs  $54.8 \pm 21.6$  mL/min/1.73m<sup>2</sup>; adjusted mean difference -0.87, 95% CI -2.93–1.19), acute rejection (RR 1.28, 95% CI 0.94–1.76), graft failure (hazard ratio [HR] 0.72, 95% CI 0.48–1.10) or mortality (HR 1.06, 95% CI 0.39 to 2.85). Numbers of serious adverse events were similar in both groups.

**Conclusions:** In deceased donor kidney transplant recipients, IV fluid therapy with balanced crystalloid solution reduced the incidence of DGF compared with saline.

**Funding:** Commercial Support - Baxter Healthcare Corporation, Government Support - Non-U.S.

FR-OR62

**Effect of Isuzinaxib, Pan NOX Inhibitor in Patients With Type 2 Diabetes and CKD in a Randomized, Double Blind, Placebo Controlled Phase 2 Trial**

Dae R. Cha,<sup>1,3</sup> Istvan Wittmann,<sup>4</sup> Sung Hwan Moon,<sup>2</sup> Soo Jin Lee.<sup>2</sup> <sup>1</sup>Internal Medicine, Korea University College of Medicine and School of Medicine, Seoul, Republic of Korea; <sup>2</sup>Aptabio Therapeutics Inc., Yongin-si, Gyeonggi-do, Republic of Korea; <sup>3</sup>Nephrology, Korea University Ansan Hospital, Ansan, Gyeonggi-do, Republic of Korea; <sup>4</sup>Medicine and Nephrology-Diabetes Center, Faculty of Medicine, University of Pécs, Pécs, Hungary.

**Background:** Isuzinaxib (APX-115), a novel inhibitor of pan NOX; oxidative stress modulator was investigated a kidney outcome in patients with type 2 diabetes (T2DM) and chronic kidney disease (CKD) compared with Placebo.

**Methods:** In this phase 2 trial, patients with T2DM and CKD were randomized (1:1) from 4 countries in Europe and treated with Isuzinaxib 400mg QD or Placebo for 12 weeks orally. Eligible patients had a urinary albumin to creatinine ratio (UACR) of 200 to 3000 mg/g cr, an estimated glomerular filtration rate (eGFR) of 30 to 90 mL/min/1.73 m<sup>2</sup> and stable treatments with renin angiotensin system inhibitors (ACEi or ARB). The primary endpoint was mean change in UACR at Week 12. The secondary outcomes assessed safety, tolerability, pharmacokinetics of Isuzinaxib and change in biomarkers compared with Placebo. (NCT04534439)

**Results:** Mean age of patients was 63 years and 62.9% were male. At baseline, mean eGFR was 65.1 and 65.6 mL/min/1.73 m<sup>2</sup> and mean UACR was 978 and 853 mg/g cr in Isuzinaxib (N=68) and Placebo (N=72), respectively. Mean change of UACR was -21% in Isuzinaxib and -2.5% in Placebo, at Week 12. In group with baseline eGFR <45, Isuzinaxib reduced UACR -36%, whereas increased 11% in Placebo ( $P=0.0197$ ). Interestingly, KIM-1 was reduced significantly in Isuzinaxib ( $P=0.0128$ ). In an ad-hoc analysis, patients with Isuzinaxib stable state in pharmacokinetics data depending on its drug compliance, showed significant UACR (-31.2%,  $P=0.0165$ ) and UPCR (Urine protein to creatinine ratio, -23.8%,  $P=0.045$ ) reductions compared with Placebo. Overall treatment-emergent adverse events were balanced between groups. There was no clinically relevant safety finding in use of Isuzinaxib.

**Conclusions:** Isuzinaxib resulted in anti-albuminuric effect and was safe and well tolerable in patients with T2DM and CKD. The results demonstrate first clinical evidence by NADPH oxidase (NOX) inhibitors contributing to oxidative stress in patients with T2DM and CKD.

**Funding:** Commercial Support - Aptabio Therapeutics Inc.

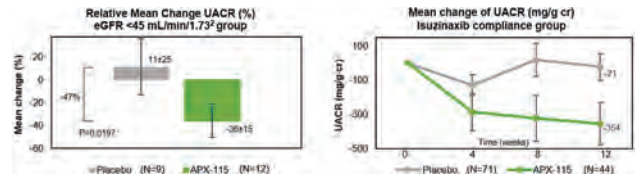

FR-OR63

**Automated, Medication-Targeted Alerts on AKI Outcomes: A Multi-Center Randomized, Controlled Trial**

Francis P. Wilson,<sup>1</sup> Yu Yamamoto,<sup>1</sup> Melissa Martin,<sup>1</sup> Lama Ghazi,<sup>1</sup> Dennis G. Moledina,<sup>1</sup> Chirag R. Parikh,<sup>2</sup> Sherry Mansour,<sup>1</sup> Jason H. Greenberg,<sup>1</sup> Ugochukwu C. Ugwuowo.<sup>1</sup> <sup>1</sup>Medicine, Yale School of Medicine, New Haven, CT; <sup>2</sup>Medicine, Johns Hopkins University, Baltimore, MD.

**Background:** Acute kidney injury (AKI) is common among hospitalized individuals, particularly those exposed to certain medications. Whether prompt detection of AKI with discontinuation of relevant medications improves clinical outcomes is unknown.

**Methods:** Pragmatic, open-label, parallel group, randomized controlled trial conducted from August 2020 to November 2021 at four hospitals in a large, regional US health system. Participants included hospitalized adults with AKI and an active order for any of three classes of MOIs: non-steroidal anti-inflammatory drugs (NSAID), renin-angiotensin-aldosterone system inhibitors (RAASI), or proton pump inhibitors (PPI). The intervention was an automated, electronic “pop-up” alert which appeared during medication order entry and flagged the MOIs for potential discontinuation. The primary outcome was a composite of progression of AKI, dialysis, or death within 14 days or hospital discharge.

**Results:** We enrolled 5,060 individuals over 15 months. The median (IQR) age was 70 (59 – 80) years, 48% were female and 19% self-described as Black. Within 24 hours of randomization, an MOI was discontinued in 61.1% of the alert group versus 55.9% of the usual care group ( $p=0.0003$ ). The primary outcome occurred in 585 (23.1%) of individuals in the alert group and 639 (25.3%) of patients in the usual care group (RR 0.92, 0.83 – 1.01,  $p=0.09$ ). The pre-specified subgroup analysis found a significant benefit of alerting among those exposed to PPI.

**Conclusions:** A medication-targeted AKI alert led to increased discontinuation of medications that may affect kidney function. While the overall impact on clinical outcomes was not statistically significant, the alert system led to significantly improved outcomes among those exposed to PPI.

**Funding:** NIDDK Support

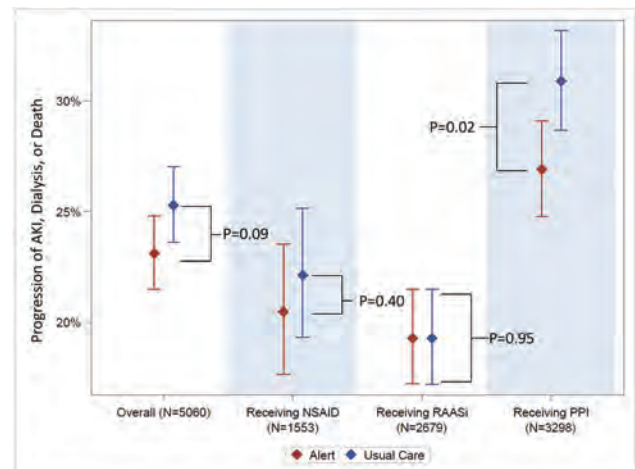

Primary outcome rates

FR-OR66

**Dietary Intervention Trial for Hypertensive Black Adults With CKD**

Deidra C. Crews,<sup>1</sup> Arlene T. Dalcin,<sup>1</sup> Kathryn A. Carson,<sup>1</sup> Jeanne Charleston,<sup>1</sup> Mary Ann C. Stephens,<sup>1</sup> Lisa A. Cooper,<sup>1</sup> Anika L. Hines,<sup>2,1</sup> Michael C. Albert,<sup>1</sup> Hsin-Chieh Yeh,<sup>1</sup> Lawrence J. Appel,<sup>1</sup> Edgar R. Miller,<sup>1</sup> Five Plus Nuts and Beans for Kidneys Investigators <sup>1</sup>*Johns Hopkins University, Baltimore, MD;* <sup>2</sup>*Virginia Commonwealth University, Richmond, VA.*

**Background:** Black Americans are disproportionately affected by hypertension and advanced CKD. Inequitable access to healthy foods and knowledge gaps about healthy eating may be key drivers of these disparities.

**Methods:** Black adults with hypertension, urine albumin-to-creatinine ratio (ACR)  $\geq 30$  and  $< 1000$  mg/g, and eGFR  $\geq 30$  ml/min/1.73m<sup>2</sup> were randomized in a 1:1 ratio to: 1) Self-Shopping Dietary Approaches to Stop Hypertension (S-DASH) diet with a \$30/week grocery allowance for 4 months (m) but no guidance on purchases, followed by no grocery allowance for 8m; or 2) Coaching (C-DASH) diet advice group with a \$30/week food allowance and assistance in purchasing high potassium (K) foods for 4m, followed by coaching without food allowance for 8m. Primary outcome was percent change in urine ACR at 4m; secondary outcomes were change in systolic BP at 4m and ACR at 12m. We present 4m outcomes using mixed effects regression models.

**Results:** A total of 150 participants were randomized (Feb 2018-Aug 2021); 142 remained after COVID restrictions. Mean age was 61yrs; 37% were male; 44% had diabetes; mean systolic BP was 129 mmHg, eGFR was 75 ml/min/1.73m<sup>2</sup>. Majority (64%) were taking a RAAS blocker and 26% were food insecure. Characteristics were balanced across study arms, except male sex (29% C-DASH, 44% S-DASH). C-DASH group had greater increases in dietary K and fruit/veg consumption than S-DASH (p<0.01); and C-DASH group had declines in ACR that did not differ statistically from S-DASH (p=0.17) (Figure), except among the subgroup with urine ACR  $\geq 300$  (n=26), where C-DASH group had a 73.3% decrease in ACR, and S-DASH had a 20.5% increase, p=0.01. There was also a suggestion of benefit for those with diabetes (p=0.09). Hyperkalemia ( $>5.5$  mEq/L) occurred in 1 C-DASH participant, and no S-DASH participants.

**Conclusions:** Among Black adults with hypertension and CKD, a dietary intervention led to improvements in diet quality and a suggestion of benefits for albuminuria lowering, particularly among persons with severely increased albuminuria and those with diabetes.

**Funding:** Other NIH Support - NIMHD, Commercial Support - Baxter Investigator Initiated Research

Least Squares Means (SE of mean), Change from Baseline to 4-month Follow-up, and Difference in Differences Between Intervention Arms for Primary and Secondary Outcomes

Outcome	C-DASH		S-DASH		Mean (95% CI)	P value
	Baseline	Change at 4 mo	Baseline	Change at 4 mo		
ACR, mg/dL	108.0 (85.7-136.1)	-28.6% (12.0%)	105.2 (83.8-132.2)	-5.6% (11.6%)	-23.0% (-56.1-10.1)	0.17
Systolic BP, mmHg	126.1 (11.6)	-1.4 (1.8)	130.8 (11.6)	-0.9 (1.7)	-2.3 (-7.1-2.6)	0.36
Diastolic BP, mmHg	72.3 (1.3)	-2.1 (1.0)	74.1 (1.3)	-0.1 (1.0)	-1.9 (-4.4-0.5)	0.29
Urine sodium (Na), mmol/L	88.0 (4.9)	-3.7 (4.1)	80.6 (4.8)	2.2 (4.0)	-5.9 (-17.2-5.4)	0.30
Urine potassium (K), mmol/L	52.2 (2.5)	7.0 (2.5)	47.0 (2.5)	0.4 (2.4)	6.6 (-0.3-13.5)	0.06
Urine Na/K ratio	2.12 (0.14)	-0.19 (0.15)	2.23 (0.13)	0.10 (0.15)	-0.28 (-0.69-0.17)	0.23
Sodium consumed, mg/day	3075 (189)	-146 (182)	3179 (186)	-552 (177)	-405 (-97-809)	0.11
Potassium consumed, mg/day	2635 (192)	978 (92)	2607 (191)	258 (89)	420 (-196-674)	0.001
Daily servings of fruits & vegetables	3.48 (0.22)	1.52 (0.24)	3.13 (0.21)	0.73 (0.23)	1.19 (0.53-1.85)	<0.001

Results are from repeated measures mixed effects regression including baseline, 1 and 4 month follow-up data (except dietary variables that were collected at baseline and 4 months), and adjusting an unstructured covariance matrix.  
Differences in differences are calculated as the difference from baseline at 4 months for C-DASH minus the difference from baseline at 4 months for S-DASH.  
\*ACR was not normally distributed and was natural log transformed for analysis. The baseline values reported are the geometric mean and 95% CIs. The change and difference values are the percent change and percent difference.  
†Dietary measures are estimated from the Block Sodium and Fruit, Vegetable, Fiber Scales.

FR-OR65

**VALOR-CKD: A Multicenter, Randomized, Double-Blind Placebo-Controlled Trial Evaluating Veverimer in Slowing Progression of CKD in Patients With Metabolic Acidosis**

Navdeep Tangri,<sup>1</sup> Vandana S. Mathur,<sup>2</sup> David A. Bushinsky,<sup>3</sup> Lesley A. Inker,<sup>4</sup> Gerrit Klaerner,<sup>5</sup> Elizabeth Li,<sup>6</sup> Dawn Parsell,<sup>5</sup> Yuri Stasiv,<sup>5</sup> Michael Walker,<sup>7</sup> Donald E. Wesson,<sup>8</sup> David C. Wheeler,<sup>9</sup> Vlado Perkovic,<sup>10</sup> <sup>1</sup>*University of Manitoba, Winnipeg, MB, Canada;* <sup>2</sup>*MathurConsulting LLC, Woodside, CA;* <sup>3</sup>*University of Rochester Medical Center, Rochester, NY;* <sup>4</sup>*Tufts Medical Center, Boston, MA;* <sup>5</sup>*Tricida Inc., South San Francisco, CA;* <sup>6</sup>*Pharmastat LLC, Fremont, CA;* <sup>7</sup>*University of California San Diego, La Jolla, CA;* <sup>8</sup>*The University of Texas at Austin, Austin, TX;* <sup>9</sup>*University College London, London, United Kingdom;* <sup>10</sup>*University of New South Wales, Sydney, NSW, Australia.*

**Background:** Veverimer is a novel hydrochloric acid binder that removes acid from the gastrointestinal tract leading to an increase in serum bicarbonate. It is being developed to treat chronic metabolic acidosis and this trial was designed to assess whether it would slow progression of chronic kidney disease (CKD).

**Methods:** VALOR-CKD trial is an international, Phase 3, randomized, multicenter, double-blind, placebo-controlled study evaluating the effect of once-daily veverimer on kidney disease progression in patients with CKD and chronic metabolic acidosis. Eligible participants had CKD (estimated glomerular filtration rate [eGFR] of 20-40 mL/min/1.73 m<sup>2</sup>) and a serum bicarbonate of 12-20 mEq/L. The primary outcome was the composite endpoint of kidney disease progression, defined as the development of end-stage kidney disease (kidney transplantation or maintenance dialysis), a sustained decline in eGFR of  $\geq 40\%$  from baseline, or death due to kidney failure. Key secondary endpoints included effects on physical function, cardiovascular death, and all-cause death. Components of the primary endpoint and deaths were adjudicated by an independent, blinded, clinical endpoint adjudication committee.

**Results:** We screened 5,254 patients and randomized (1:1) 1,480 from 34 countries and 191 sites. The mean (standard deviation) age at baseline was 65.1 $\pm$ 12.5 years with 42% female. The mean baseline eGFR was 29.1 $\pm$ 6.3 mL/min/1.73 m<sup>2</sup> and mean serum bicarbonate was 17.5 $\pm$ 1.4 mEq/L. The median (interquartile range) urine albumin-to-creatinine ratio was 168 (707) mg/g and the median 5-year predicted risk of kidney failure was 24%. More than 98% of patients were on an angiotensin-converting enzyme

inhibitor or angiotensin II receptor blocker and ~12% were on background alkali supplements. At baseline, 56%, 98%, and 32% of patients had a history of diabetes, hypertension, and heart failure, respectively. Topline data and results for the VALOR-CKD trial will be available in October 2022.

**Conclusions:** VALOR-CKD will test the efficacy of veverimer to slow CKD progression and preserve physical function, along with safety, in patients with CKD and chronic metabolic acidosis.

**Funding:** Commercial Support - Tricida, Inc.

FR-OR66

**Personalized Cooler Dialysate for Patients Receiving Maintenance Hemodialysis**

Amit X. Garg,<sup>1,2</sup> Major Outcomes with Personalized Dialysate Temperature (MyTEMP) Trial Investigators <sup>1</sup>*Medicine, Western University, London, ON, Canada;* <sup>2</sup>*Institute for Clinical Evaluative Sciences, Toronto, ON, Canada.*

**Background:** Conventionally, centers have provided maintenance hemodialysis using a standard dialysate temperature (e.g., 36.5°C or 37°C) for all patients. Many centers now use cooler dialysate (e.g., 36°C or lower) in patient care (nearly half of 273 centers in a recent international survey). This practice change is based on limited evidence (26 RCTs; total 484 patients; low quality methods).

**Methods:** We conducted a pragmatic, 2-arm, parallel-group, registry-based, open-label, cluster-randomized trial in Ontario, Canada. We assigned 84 centers (1:1) to use either (1) personalized cooler dialysate (nurses set the dialysate temperature 0.5–0.9°C below each patient’s measured pre-dialysis body temperature, with a lowest recommended dialysate temperature of 35.5°C), or (2) standard-temperature dialysate (36.5°C for all patients and treatments). The trial period was from April 2017 to March 2021. The primary outcome was a composite of cardiovascular-related death or hospital admission with myocardial infarction, ischemic stroke, or congestive heart failure. The key secondary outcome was the mean drop in intradialytic systolic blood pressure. Patient reported symptoms were collected in 10 centers.

**Results:** Over four years, the 84 centers provided outpatient maintenance hemodialysis to 15,413 patients (~ 4.3 million hemodialysis treatments). The mean dialysate temperature was 35.8°C in the cooler dialysate group versus 36.4°C in the standard-temperature group. The primary outcome occurred in 1711 of 8000 patients (21.4%) in the cooler dialysate group versus 1658 of 7413 patients (22.4%) in the standard-temperature group; adjusted hazard ratio, 1.00 (96% confidence interval [CI], 0.89 to 1.11; P=0.93). The mean drop in intradialytic systolic blood pressure was 26.6 mmHg versus 27.1 mmHg, respectively (P=0.14). Patients in the cooler dialysate group were more likely to report feeling uncomfortably cold on dialysis.

**Conclusions:** Center-wide delivery of personalized cooler dialysate versus standard-temperature dialysate did not significantly reduce the risk of major cardiovascular events. A lack of benefit compounded by the likelihood of patient discomfort indicates that cooler dialysate should not be adopted as a center-wide policy. The role of cooler dialysate in select patient care warrants scrutiny and clarification. Protocol: PMID 32076569  
Statistical analytic plan: PMID 34471542 ClinicalTrials.gov record: NCT02628366

**Funding:** Commercial Support - The Quality Management Division of Dialysis Clinics Inc., a non-profit dialysis provider in the United States, Government Support - Non-U.S.

FR-OR67

**Exploratory Results From the Phase 2 Study of Cemdisiran in Patients With IgA Nephropathy**

Jonathan Barratt,<sup>1</sup> See Cheng Yeo,<sup>2</sup> Anders Fernstrom,<sup>3</sup> Sean Barbour,<sup>4</sup> John Sperati,<sup>5</sup> Anthony Russell Villanueva,<sup>6</sup> Ming-Ju Wu,<sup>7</sup> Dazhe Wang,<sup>8</sup> Anna Borodovsky,<sup>8</sup> Prajakta Badri,<sup>8</sup> Elena Yureneva,<sup>8</sup> Ishir Bhan,<sup>8</sup> Daniel C. Catran,<sup>9</sup> <sup>1</sup>*Leicester General Hospital, Leicester, United Kingdom;* <sup>2</sup>*Tan Tock Seng Hospital, Singapore, Singapore;* <sup>3</sup>*Linköpings universitet, Linköping, Sweden;* <sup>4</sup>*The University of British Columbia, Vancouver, BC, Canada;* <sup>5</sup>*Johns Hopkins University, Baltimore, MD;* <sup>6</sup>*National Kidney and Transplant Institute, Quezon City, Philippines;* <sup>7</sup>*Taichung Veterans General Hospital, Taichung, Taiwan;* <sup>8</sup>*Alnylam Pharmaceuticals Inc, Cambridge, MA;* <sup>9</sup>*Toronto General Hospital, Toronto, ON, Canada.*

**Background:** Immunoglobulin A nephropathy (IgAN) is the most common primary glomerulonephritis. Proteinuria  $>1$  g/day is a risk factor for progression to kidney failure; treatment options are limited. In IgA nephropathy, data suggest that activation of the lectin and alternative complement pathways lead to complement component 5 (C5) cleavage, and to production of C5a and the membrane attack complex (MAC), with subsequent inflammation and tissue injury. Cemdisiran is an investigational RNA interference therapeutic that suppresses liver production of C5.

**Methods:** This Phase 2 study is a randomized, double-blind, placebo-controlled trial (NCT03841448) of cemdisiran in adults with IgAN and proteinuria  $>1$  g/day. Patients were randomized (2:1) to subcutaneous cemdisiran 600 mg or placebo once every 4 weeks (Q4W) alongside standard of care. Primary endpoint is change from baseline to Week 32 in 24-hour urine protein/creatinine ratio (UPCR). Exploratory endpoints include change from baseline to Week 32 in eGFR and change from baseline in complement activity and C5 levels over the study.

**Results:** 31 patients (22 cemdisiran, 9 placebo) were randomized: mean (SD) age, 39.7 (10.1) yrs. Mean (SD) baseline 24-hour UPCR g/g: cemdisiran 1.6 (1.0), placebo 2.0 (0.8). Cemdisiran led to a 37.4% (90% CI: -0.5, 61.0) adjusted geometric mean reduction in 24-hour UPCR compared with placebo at Week 32 (primary endpoint).

Key: TH - Thursday; FR - Friday; SA - Saturday; OR - Oral; PO - Poster; PUB - Publication Only

Underline represents presenting author.

eGFR data suggested stability at Week 32 following cemdisiran, in contrast to a decline shown in placebo-treated patients (median change from baseline [IQR] ml/min/1.73m<sup>2</sup>: cemdisiran 0 [-6.5, 3.5], placebo -6 [-9.5, -2.5]). Cemdisiran also led to a 98.7% (SD: 1.2) mean reduction from baseline in serum C5 at Week 32. Cemdisiran was generally well tolerated with no treatment-related serious or severe adverse events (AEs). AEs in ≥10% of cemdisiran-treated patients: injection site reactions (41%) and peripheral edema (14%).

**Conclusions:** Suppression of hepatic C5 production with cemdisiran led to clinically meaningful improvements in proteinuria in patients with IgAN; with cemdisiran generally well tolerated. These results support further investigation in this population.

**Funding:** Commercial Support - Sponsored by Alnylam Pharmaceuticals

## FR-OR68

### Empagliflozin in Patients With CKD

William G. Herrington, Richard Haynes. On behalf of the EMPA-KIDNEY Collaborative Group *Medical Research Council Population Health Research Unit at the University of Oxford, Oxford, United Kingdom.*

**Background:** More evidence is needed on the effects of sodium-glucose co-transporter-2 inhibition on renal and cardiovascular (CV) disease in patients with chronic kidney disease (CKD), in particular those without diabetes (DM), low estimated glomerular filtration rate (eGFR) or low albuminuria.

**Methods:** Between May 2019 and Apr 2021, 6609 participants were randomly allocated empagliflozin 10mg once daily or matching placebo. Eligible patients had an eGFR of 20 to <45 ml/min/1.73m<sup>2</sup>; or an eGFR of 45 to <90 ml/min/1.73m<sup>2</sup> with a urinary albumin-to-creatinine ratio (uACR) of ≥200 mg/g and were receiving standard of care (including a renin angiotensin system inhibitor, where indicated and tolerated). The primary outcome is a composite of end-stage kidney disease (ESKD), a sustained eGFR <10 ml/min/1.73m<sup>2</sup>, a sustained decline in eGFR of ≥40%, or death from renal or CV causes. The main pre-specified subgroups are by DM status, eGFR and uACR. Key secondary outcomes are hospitalization for heart failure (HHF) or CV death; all-cause hospitalizations; and all-cause death.

**Results:** Mean eGFR was 37.5 mL/min/1.73m<sup>2</sup> (SD 14.8), including 78% with an eGFR <45 mL/min/1.73m<sup>2</sup>. 48% had a uACR <300 mg/g and 54% had no history of DM. Final follow-up visits are complete and data are under analysis, but the Steering Committee remain blind to results. About 900 participants have had a primary outcome, including ~250 developing ESKD (with similar numbers of primary outcomes among patients with and without DM respectively). About 280 participants have experienced HHF or CV death, and ~310 have died.

**Conclusions:** EMPA-KIDNEY is the largest kidney disease progression trial to assess SGLT-2 inhibition in CKD. The trial was stopped early for benefit on the recommendation of the independent data monitoring committee and the unblinded results will be presented for the first time at ASN Kidney Week 2022.

**Funding:** Commercial Support - Boehringer Ingelheim & Eli Lilly (Clinicaltrials.gov: NCT03594110).

## FR-OR69

### Sodium Glucose Cotransporter-2 (SGLT2) Inhibitors Among Patients with and without Diabetes: Collaborative Meta-Analysis of Large Placebo-Controlled Trials

Natalie Staplin, Kaitlin J. Mayne, Richard Haynes, William G. Herrington. On Behalf of the Renal Studies Group & SGLT2 Meta-Analysis cardio-Renal Trialists' Consortium (SMART-C) *Medical Research Council Population Health Research Unit at the University of Oxford, Oxford, United Kingdom.*

**Background:** The effects of SGLT2 inhibitors on kidney disease progression, cardiovascular (CV) disease and safety outcomes from all the reported large placebo-controlled trials have not been quantified in a combined fashion.

**Methods:** We performed a collaborative 2-stage trial-level meta-analysis of 13 large (>500 participants/arm) placebo-control SGLT2 inhibitor trials. The key outcome is kidney disease progression, standardized to a definition of a sustained ≥50% decline in eGFR from randomization, development of end-stage kidney disease, or renal death. Other outcomes include acute kidney injury, hospitalization for heart failure (HF) or CV death, non-CV death, ketoacidosis and amputations. Meta-analyses include unpublished data from 8 trials, including EMPA-KIDNEY which is presenting its main results at ASN Kidney Week 2022. Effects of SGLT2 inhibitors will be presented overall and by diabetes mellitus (DM) status. Kidney disease progression outcomes will also be presented by primary kidney diagnosis (CKD trials only).

**Results:** A total of 90,413 participants are included from the 13 trials: four type 2 DM high-atherosclerotic CV disease risk trials (n=42,568); five HF trials (n=21,947, including 10,962 with & 10,985 without DM), and four CKD trials (n=25,898, including 20,930 with & 4968 without DM). The SMART-C Steering Committee currently remain blind to results. Over 2000 participants had a kidney disease progression outcome. This includes about 1600 with DM and 450 without DM. From the CKD trials, kidney disease progression outcomes occurred in about 940 participants with diabetic kidney disease, 130 with hypertensive/ischemic disease, 230 with glomerular disease and 110 with other/unknown causes.

**Conclusions:** This collaborative meta-analysis of 13 large SGLT2 inhibitor trials is aggregating data across key outcomes studies with previously unpublished analyses on kidney disease progression, including data from EMPA-KIDNEY. Quantification of the relative and absolute benefits and harms of SGLT2 inhibitors in the broad range of patients with and without DM treated by nephrologists will be presented at Kidney Week 2022.

**Funding:** Commercial Support - All the 13 included trials are funded by the pharmaceutical industry. The meta-analysis has been developed without industry support., Government Support - Non-U.S.

## TH-PO964

### Hydrochlorothiazide for the Prevention of Kidney Stone Recurrence

Daniel G. Fuster,<sup>1</sup> Nasser Dhayat,<sup>1</sup> Olivier Bonny,<sup>2</sup> Alexander Ritter,<sup>7</sup> Nilufar Mohebbi,<sup>7</sup> Nicolas Faller,<sup>1</sup> Lisa Pellegrini,<sup>12</sup> Reto M. Venzin,<sup>11</sup> Philipp B. Grosse MD,<sup>11</sup> Carina Hüslér,<sup>3</sup> Irene Koneth,<sup>3</sup> Christian Bucher,<sup>3</sup> Luca Gabutti,<sup>8</sup> Michael Mayr,<sup>6</sup> Urs Odermatt,<sup>5</sup> Florian Buchkremer,<sup>9</sup> Luca Tamò,<sup>1</sup> Grazia M. Cereghetti,<sup>1</sup> Marie C. Roumet,<sup>10</sup> Beat Roth,<sup>4</sup> Sven Trelle.<sup>10</sup> <sup>1</sup>Nephrology and Hypertension, Inselspital Universitätsspital Bern, Bern, Switzerland; <sup>2</sup>Nephrology, Université de Lausanne, Lausanne, Switzerland; <sup>3</sup>Nephrology, Kantonsspital Sankt Gallen, Sankt Gallen, Switzerland; <sup>4</sup>Urology, Université de Lausanne, Lausanne, Switzerland; <sup>5</sup>Nephrology, Kantonsspital Luzern, Luzern, Switzerland; <sup>6</sup>Internal Medicine, Universitätsspital Basel Bereich Medizin, Basel, Switzerland; <sup>7</sup>Nephrology, Universitätsspital Zurich, Zurich, Switzerland; <sup>8</sup>Internal Medicine, Regional Hospital Bellinzona, Bellinzona, Switzerland; <sup>9</sup>Nephrology, Kantonsspital Aarau AG, Aarau, Switzerland; <sup>10</sup>Clinical Trial Unit, Universität Bern Medizinische Fakultät, Bern, Switzerland; <sup>11</sup>Nephrology, Kantonsspital Graubünden, Chur, Switzerland; <sup>12</sup>Nephrology, Ospedale Regionale di Lugano, Lugano, Switzerland.

**Background:** Nephrolithiasis is one of the most frequent conditions affecting the kidney and characterized by a high risk of recurrence. Thiazide diuretics are widely used for kidney stone recurrence prevention, but data are limited regarding their efficacy as compared with placebo and any dose-response relationship.

**Methods:** In this double-blind trial, we randomly assigned patients with recurrent calcium-containing kidney stones to 12.5 mg, 25 mg or 50 mg hydrochlorothiazide or placebo once daily. The main objective was to investigate the dose-response relationship for prevention of the primary end point, a composite of symptomatic or radiologic recurrence.

**Results:** A total of 416 patients underwent randomization, median duration of follow-up was 2.92 years. A primary end point occurred in 60 of 102 patients (59%) receiving placebo, in 62 of 105 patients (59%) receiving 12.5 mg hydrochlorothiazide (rate ratio, 1.33; 95% confidence interval [CI], 0.92 to 1.93), in 61 of 108 patients (56%) receiving 25 mg hydrochlorothiazide (rate ratio, 1.24; 95% CI, 0.86 to 1.79), and in 49 of 101 patients (49%) receiving 50 mg hydrochlorothiazide (rate ratio, 0.92; 95% CI, 0.63 to 1.36). There was no linear relationship between hydrochlorothiazide dose and the primary end point (P=0.66). Hypokalemia, gouty arthritis and new onset diabetes mellitus occurred more frequently in patients assigned to hydrochlorothiazide compared to placebo.

**Conclusions:** Among patients with recurrent kidney stones, recurrence rates were not different between patients receiving once daily 12.5 mg, 25 mg or 50 mg hydrochlorothiazide or placebo. (Funded by the Swiss National Science Foundation; NOSTONE ClinicalTrials.gov number, NCT03057431).

**Funding:** Government Support - Non-U.S.

## TH-PO966

### Multi-Center Randomized Controlled Trial of Angiotensin Converting Enzyme Inhibitor (ACEi)/Angiotensin Receptor Blocker (ARB) Withdrawal in Advanced Kidney Disease: The STOP-ACEi Trial

Sunil Bhandari,<sup>1</sup> Arif Khwaja,<sup>3</sup> Natalie Ives,<sup>4</sup> John G. Cleland,<sup>5</sup> Paul Cockwell,<sup>2</sup> Samir Mehta,<sup>4</sup> Elizabeth A. Brettell,<sup>4</sup> Marie Chadburn,<sup>4</sup> STOP ACEi Investigators and Committees <sup>1</sup>Nephrology, Hull University Teaching Hospitals NHS Trust, Hull, United Kingdom; <sup>2</sup>Nephrology, Queen Elizabeth Hospital Birmingham, Birmingham, United Kingdom; <sup>3</sup>Nephrology, Northern General Hospital Sheffield Kidney Institute, Sheffield, United Kingdom; <sup>4</sup>Clinical Trials Unit, University of Birmingham, Birmingham, United Kingdom; <sup>5</sup>Clinical Trials Unit, University of Glasgow, Glasgow, United Kingdom.

**Background:** Angiotensin Converting Enzyme inhibitors (ACEi) or Angiotensin Receptor Blockers (ARB) slow progression of mild to moderate chronic kidney disease (CKD). However small studies have reported delayed progression in patients with advanced CKD after discontinuation of ACEi/ARBs. We assessed whether discontinuation of ACEi/ARBs could slow progression of CKD in patients with advanced CKD in the STOP-ACEi Trial (methods paper-NDT 2016; 31(2):255-61)

**Methods:** In this open label, phase 2, multicenter, randomized controlled trial, we recruited adult patients with stage 4-5 CKD receiving ACEi and/or ARB from 37 UK renal centers. Patients were randomized (1:1 ratio) to discontinue (experimental arm) or continue (control arm) ACEi/ARB. Patients were stratified based on age, baseline eGFR, diabetes, BP and proteinuria. Outcomes were assessed in an intention to treat population. The primary endpoint is kidney function (MDRD 4-variable eGFR) at 3y between the two groups and will be analyzed using a linear regression model. Sensitivity analysis will be undertaken including use of pattern mixture and joint models. Secondary outcome measures include the number starting renal replacement therapy (RRT) and/or sustaining a >50% decline in eGFR, quality of life/wellbeing, hospitalization rates, and safety measures including cardiovascular event rates and mortality.

Key: TH - Thursday; FR - Friday; SA - Saturday; OR - Oral; PO - Poster; PUB - Publication Only

Underline represents presenting author.

**Results:** Between 11 July 2014-19 June 2018 we recruited 411 patients (target 410), 206 to the discontinuation and 205 to the continuation arm. Median age was 63.4y (interquartile range: 51.5-72.1) and 31.6% were women; 85.4% white, 7.2% Asian and 5.6% black. In total 37.3% were diabetic (32.4% type II diabetes). Median baseline creatinine was 299 (243-367) $\mu$ mol/L, eGFR was 18 (14-22)mL/min/1.73m<sup>2</sup>; urinary protein:creatinine ratio was 115mg/mmol (28-248). Comorbidities: 71% with hypertension; 14% ischemic heart disease; 45% atrial fibrillation; 5% peripheral vascular disease, 4% with heart failure and 6% with a previous history of stroke. We will present the primary and key secondary outcomes, including progression to RRT, cardiovascular events and death.

**Conclusions:** The results of this trial will inform future clinical practice worldwide and guideline recommendations.

**Funding:** Government Support - Non-U.S.

**TH-PO967**

**Fixed-Dose Combination (FDC) Therapy for Prevention of Cardiovascular Diseases (CVD) in Patients With or Without CKD**

Sadaf G. Sepanlou,<sup>1</sup> Johannes F. Mann,<sup>2,3</sup> Philip G. Joseph,<sup>2</sup> Reza Malekzadeh,<sup>1</sup> Salim Yusuf,<sup>2</sup> <sup>1</sup>Tehran University of Medical Sciences, Tehran, Islamic Republic of Iran; <sup>2</sup>Population Health Research Institute, Hamilton, ON, Canada; <sup>3</sup>KfH Kidney Center, Munich, Germany.

**Background:** CKD patients carry a high CVD risk. To reduce that risk, a FDC containing at least two antihypertensive agents, statin, with or without aspirin may be effective in primary prevention.

**Methods:** Three randomized trials comparing FDC to control were included in an individual participant data meta-analysis (TIPS-3, HOPE-3, PolyIran), with 18,162 participants free from CVD. Main composite outcome was time to first event of CV death, myocardial infarction, stroke, or revascularization. Here, we explored differential effects of FDC on the outcome among participants with CKD (eGFR <60 ml/min/1.73m<sup>2</sup>). Median follow-up was 5 years.

**Results:** Baseline mean eGFR was 75.8 ml/min/1.73m<sup>2</sup> (SD 16.8) overall and 51.6 ml/min/1.73m<sup>2</sup> (SD 7.1) in those with CKD (N= 3315). In participants without CKD, the outcome occurred in 232 (3.1%) participants in the FDC group and in 339 (4.6%) in control group (HR 0.68; 0.57-0.81). In participants with CKD, the outcome occurred in 64 (3.9%) of participants in the FDC group and in 130 (7.9%) in control group (Fig. 1) (HR 0.48; 0.35-0.65; p-value for interaction 0.047). The number needed to treat to prevent one outcome was 67 and 25 in participants without and with CKD respectively. Results were consistent with FDC therapies that did or did not include aspirin. Across sub-groups, there was no significant decline in eGFR or substantial differences in adverse events other than dizziness.

**Conclusions:** Relative and absolute reductions in CVD risk with a FDC treatment strategy are larger in individuals with CKD than without CKD. The large benefits in those with CKD should prompt consideration of wider use of FDC in this population for primary prevention of CVD.

**Funding:** Government Support - Non-U.S.

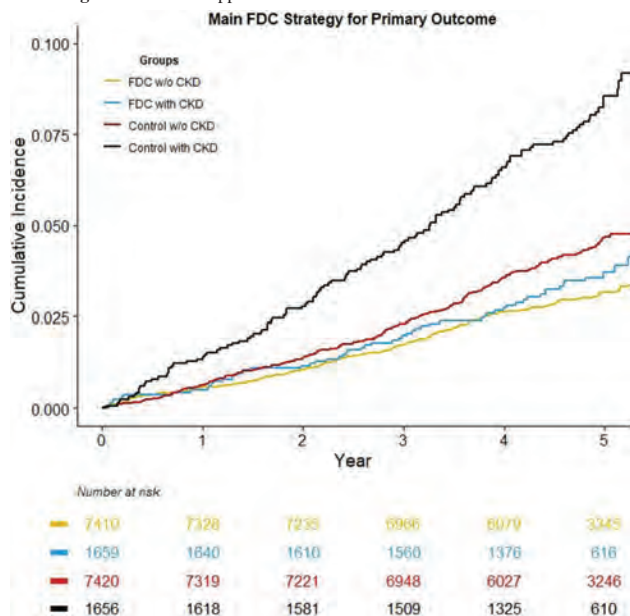

Effect of FDC on primary CV outcome in those with/without CKD

**TH-PO968**

**Effects of Pantoprazole on Kidney Outcomes: Post Hoc Analyses From the COMPASS Randomized Controlled Trial**

Lonnie Pyne,<sup>1,2</sup> Andrew Smyth,<sup>1,3</sup> Amber O. Molnar,<sup>1,2</sup> Paul Moayyedi,<sup>1,5</sup> Salim Yusuf,<sup>1</sup> John Eikelboom,<sup>1</sup> Jackie Bosch,<sup>1,4</sup> Michael Walsh,<sup>1,2</sup> <sup>1</sup>Population Health Research Institute, Hamilton, ON, Canada; <sup>2</sup>Division of Nephrology, Department of Medicine, McMaster University, Hamilton, ON, Canada; <sup>3</sup>Nephrology, Galway University Hospitals, Galway, Ireland; <sup>4</sup>School of Rehabilitation Science, McMaster University, Hamilton, ON, Canada; <sup>5</sup>Division of Gastroenterology, Department of Medicine, McMaster University, Hamilton, ON, Canada.

**Background:** The effect of proton pump inhibitors (PPIs) on kidney function is uncertain. We assessed the effect of pantoprazole on long term kidney function using data from the Cardiovascular Outcomes for People Using Anticoagulation Strategies (COMPASS) trial.

**Methods:** COMPASS was a placebo-controlled, partial factorial randomized controlled trial that randomized 17,598 participants with chronic atherosclerotic vascular disease, not taking a proton pump inhibitor, to pantoprazole 40 mg daily or placebo (in addition to aspirin, aspirin and rivaroxaban, or rivaroxaban alone). Our primary outcome was the mean rate of change of estimated glomerular filtration rate (eGFR) in participants with eGFR recorded at baseline and at entry to the long-term, open label extension (LTOLE). Secondary outcomes included the risk of chronic kidney disease (eGFR <60 ml/min/1.73 m<sup>2</sup>), acute kidney injury (AKI), acute nephritis, and nephrotic syndrome.

**Results:** 8,991 participants had an eGFR recorded at baseline and the beginning of LTOLE and were included in the rate of eGFR change population. Over a mean follow-up of 3.4 years, the mean rate of eGFR change in the placebo group was -1.37 (standard deviation [SD] 4.29) ml/min/1.73 m<sup>2</sup> per year. The mean rate of eGFR change in the pantoprazole group was -1.59 (SD 4.27) ml/min/1.73 m<sup>2</sup> per year. The pantoprazole group had a 0.26 ml/min/1.73 m<sup>2</sup> per year greater decline in mean eGFR as compared to the placebo group (95% CI 0.10 to 0.41, p=0.002). The adjusted odds ratio for the effect of pantoprazole on incident CKD was 1.11 (95% CI 0.98 to 1.25, p=0.09) and on AKI was 0.89 (95% CI 0.65 to 1.21, p=0.441).

**Conclusions:** Pantoprazole resulted in a greater rate of eGFR decline as compared to placebo. The clinical importance of this effect is uncertain.

**Funding:** Commercial Support - Bayer

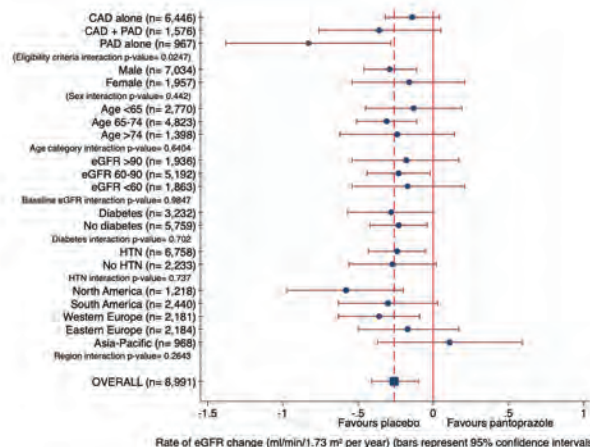

Mean rate of eGFR change (ml/min/1.73 m<sup>2</sup> per year) pantoprazole as compared to placebo by subgroup and overall population.

**TH-PO969**

**Efficacy of Extended-Release Calcifediol to Treat Secondary Hyperparathyroidism in Stages 3-4 CKD Is Unaffected by Declining eGFR**

Charles W. Bishop, Stephen A. Strugnelli, Akhtar Ashfaq. *OPKO Health Inc, Miami, FL.*

**Background:** Serum 25-hydroxyvitamin D (25D) repletion for secondary (SHPT) is often abandoned in favor of vitamin D hormone treatment when intact parathyroid hormone (iPTH) levels progressively increase with advancing chronic kidney disease (CKD) with justification that renal CYP27B1 expression has become inadequate for sufficient 1,25-dihydroxyvitamin D (1,25D) production. This study examined the effect of declining estimated glomerular filtration rate (eGFR) on the ability of extended-release calcifediol (ERC) to increase 1,25D production and, thereby, suppress elevated iPTH secretion.

**Methods:** Two identical, randomized, double-blind, placebo-controlled trials were conducted in patients with SHPT (iPTH>85 pg/mL), stage 3 or 4 CKD and vitamin D insufficiency (VDI; serum 25D of 10-29 ng/mL). The trials enrolled 429 subjects from 77 US sites, stratified by CKD stage and randomized 2:1 to receive ERC or placebo for 26 weeks. ERC dosing started at 30  $\mu$ g/day and increased, as needed, to 60  $\mu$ g/day after 3 months. Changes in serum 25D and 1,25D, and plasma iPTH were monitored at baseline and at weekly, biweekly or monthly intervals during treatment.

**Results:** Pooled per-protocol data from 234 subjects treated with ERC and 120 with placebo were grouped by baseline eGFR of  $\leq 20$ , 21-30, 31-40 and  $>40$  mL/min/1.73 m<sup>2</sup>. Mean serum 25D levels increased with ERC treatment from a baseline of 19.7 ng/mL to at least 62 ng/mL by the end of treatment, and produced nearly identical increases in mean serum 1,25D (43-54%) and decreases in mean plasma iPTH (19-25%) irrespective of eGFR group. Serum 25D and 1,25D remained unchanged with placebo. Changes in mean 1,25D and iPTH with ERC were consistently proportional to increases in mean 25D. Mean iPTH (pg/mL) decreased linearly across all eGFR categories in proportion ( $R^2 = 0.9273$ ) to increases in mean 1,25D (pg/mL) indicating that iPTH suppression depended on the degree to which serum 25D was elevated.

**Conclusions:** ERC effectively raised serum 25D and 1,25D and reduced elevated plasma iPTH in patients with stage 3 or 4 CKD irrespective of declining eGFR. These findings demonstrate that vitamin D repletion with ERC is an attractive alternative to vitamin D hormone therapy for SHPT in pre-dialysis patients with VDI.

**Funding:** Commercial Support - OPKO Health

**TH-PO970**

**ICD Pieces: A Pragmatic Clinical Trial in Patients With CKD, Diabetes, and Hypertension**

Miguel A. Vazquez,<sup>1</sup> George R. Oliver,<sup>2</sup> Venkatraghavan Sundaram,<sup>2</sup> Kevin L. Chan,<sup>8</sup> Chul Ahn,<sup>1</sup> Song Zhang,<sup>1</sup> Tuan-Minh Nguyen,<sup>2</sup> Perry Bickel,<sup>1</sup> R. Tyler Miller,<sup>1,4</sup> Barbara Wells,<sup>3</sup> Adeola O. Jaiyeola,<sup>2</sup> Susan Hedayati,<sup>1</sup> Brett Moran,<sup>2</sup> Noel O. Santini,<sup>2</sup> Blake R. Barker,<sup>1</sup> Ferdinand T. Velasco,<sup>5</sup> Lynn M. Myers,<sup>5</sup> Thomas P. Meehan,<sup>6</sup> Jonathan H. Rosen,<sup>7</sup> Robert D. Toto.<sup>1</sup>  
<sup>1</sup>The University of Texas Southwestern Medical Center, Dallas, TX; <sup>2</sup>Parkland Health and Hospital System, Dallas, TX; <sup>3</sup>National Heart Lung and Blood Institute, Bethesda, MD; <sup>4</sup>VA North Texas Health Care System, Dallas, TX; <sup>5</sup>Texas Health Resources, Arlington, TX; <sup>6</sup>Quinnipiac University Frank H Netter MD School of Medicine, North Haven, CT; <sup>7</sup>ProHealth Physicians Inc, Farmington, CT; <sup>8</sup>National Institute of Diabetes and Digestive and Kidney Diseases, Bethesda, MD.

**Background:** Patients with the triad of CKD, type 2 diabetes (DM) and hypertension (HTN) are at high risk for kidney failure and cardiovascular morbidity and mortality. Implementation of guidelines to prevent complications from CKD, DM and HTN is suboptimal.

**Methods:** ICD-Pieces is a pragmatic trial in 4 health systems that randomized 11,000 patients (141 clusters) to intervention or usual care. The intervention leveraged information technology to identify patients with the triad of CKD, DM and HTN in the electronic health records for practice facilitators who assisted primary care providers to increase delivery of CKD, DM and HTN guideline care. The primary outcome was the one-year all-cause hospitalization rate and secondary outcomes included emergency department visits, readmissions and cardiovascular events.

**Results:** Characteristics of the study population were well balanced in the two groups with 20% of participants African American and close to 20% Hispanic. (Table 1). There was no difference in the primary outcome of one-year hospitalization rate nor in the secondary outcomes (Figure 1).

**Conclusions:** Practice facilitators can help primary care practices focus on guideline-based care in CKD, DM and HTN. In this study such interventions, did not translate into significant reductions in hospitalizations.

**Funding:** NIDDK Support

CHARACTERISTICS		Intervention (n=5,508)	Usual Care (n=5,492)
Age	Mean +/- SD (years)	68.1 +/- 10.4	68.9 +/- 10.3
Gender	Male (%)	2,958 (53.7%)	2,951 (53.7%)
Ethnicity	Hispanic or Latino (%)	1,129 (20.5%)	944 (17.2%)
Race	Black or African American (%)	1,159 (21%)	1,088 (19.8%)
Blood Pressure	Mean Systolic BP +/- SD (mmHg)	133.1 +/- 18.7	132.5 +/- 17.9
HbA1C	Mean +/- SD (%)	7.6 +/- 2.1	7.5 +/- 2.1
Estimated GFR	Mean +/- SD (mL/min/1.73 m <sup>2</sup> )	48.1 +/- 16.8	49.3 +/- 15.6

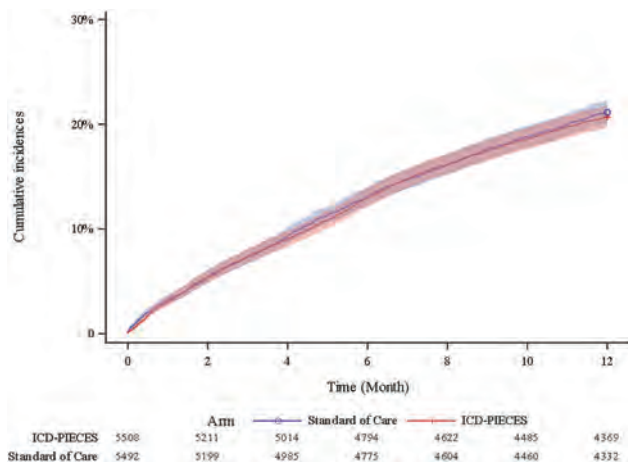

One-Year Hospitalization Rate

**TH-PO971**

**Recombinant SARS-CoV-2 Antibodies in Kidney Transplant Recipients Without Neutralizing Antibodies Following Vaccination: The RESCUE-TX Trial**

Roman Reindl-Schwaighofer, Andreas Heinzl, Rainer Oberbauer. *Division of Nephrology and Dialysis, Medical University of Vienna, Vienna, Austria.*

**Background:** Pre-exposition prophylaxis (PrEP) with monoclonal antibodies is used to prevent COVID-19 in high-risk individuals. Cilgavimab/tixagevimab remains the only drug approved for PrEP. A reduced efficacy against Omicron BA.1 has been reported.

**Methods:** We started the RESCUE-TX trial in kidney transplant recipients not responding to SARS-CoV-2 vaccination in April 2022. n=194 patients were enrolled and received 300 mg of cilgavimab/tixagevimab (i.m.). Patients are followed at the outpatient department of the Medical University of Vienna after 2, 4, 8, 12, 24, 36 and 48 weeks after dosing including blood draw for drug level quantification (PPD diagnostics; primary endpoint) and SARS-CoV-2 neutralization testing (secondary endpoint). Additional secondary outcomes include the rate and severity of breakthrough infections compared to the overall transplant population not receiving PrEP.

**Results:** A total of 34 individuals tested positive for SARS-CoV-2 infection following PrEP with cilgavimab/tixagevimab over a 12 week follow-up period (17.5%): Importantly, none of the participants suffered from severe COVID-19. The majority of breakthrough cases were due to the Omicron BA.2 variant. SARS-CoV-2 Omicron BA.2 neutralization tests in a subgroup of 30 patients confirmed strong activity for 12 weeks after PrEP (Figure 1). BA.2 neutralization titers were 160 [Q1, Q3: 120, 220], 160 [Q1, Q3: 120, 220], 120 [Q1, Q3: 80, 150] and 80 [Q1, Q3: 60, 120] at two, four eight and twelve weeks, respectively [Figure 1].

**Conclusions:** One in six patients tested positive for SARS-CoV-2 after PrEP with cilgavimab/tixagevimab over a 12-week follow-up period in a population with Omicron BA.2 pre-dominance. However, most cases were asymptomatic/oligosymptomatic individuals performing routine PCR testing. In-vivo neutralization capacity was present in all tested individuals for at least 12 weeks.

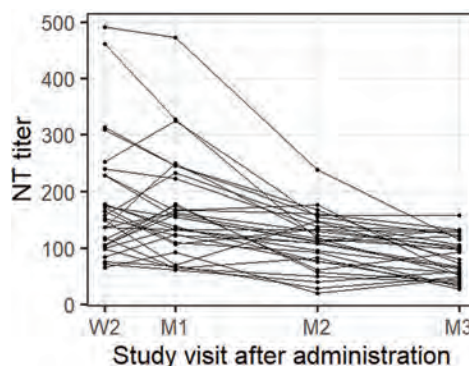



## TH-PO972

**Angiotensin Receptor Blockers for Treatment of COVID-19: A Phase 3, Adaptive Multi-Centre, Randomised Controlled Trial**

**Meg Jardine**,<sup>1,3</sup> Sradha S. Kotwal,<sup>2,4</sup> Abhinav Bassi,<sup>5</sup> Carinna Hockham,<sup>6</sup> Mark A. Jones,<sup>7</sup> Arlen Wilcox,<sup>1</sup> Carol A. Pollock,<sup>8,9</sup> Louise Burrell,<sup>10,11</sup> James M. McGree,<sup>12</sup> Vinay Rathore,<sup>13</sup> Christine Jenkins,<sup>3,2</sup> Lalit Gupta,<sup>14,15</sup> Angus G. Ritchie,<sup>3</sup> Ashpak Bangi,<sup>16</sup> Sanjay D'Cruz,<sup>17</sup> Andrew J. McLachlan,<sup>18</sup> Simon Finfer,<sup>2</sup> Michelle M. Cummins,<sup>1</sup> Thomas L. Snelling,<sup>19</sup> Vivekanand Jha.<sup>5,20</sup> CLARITY Investigators\* <sup>1</sup>NHMRC Clinical Trials Centre, The University of Sydney, Camperdown, NSW, Australia; <sup>2</sup>The George Institute for Global Health, University of New South Wales, Newtown, NSW, Australia; <sup>3</sup>Concord Repatriation General Hospital, Concord, NSW, Australia; <sup>4</sup>Prince of Wales Hospital and Community Health Services, Randwick, NSW, Australia; <sup>5</sup>The George Institute for Global Health, University of New South Wales, New Delhi, India; <sup>6</sup>The George Institute for Global Health, Imperial College London, London, United Kingdom; <sup>7</sup>Sydney School of Public Health, The University of Sydney, Camperdown, NSW, Australia; <sup>8</sup>Royal North Shore Hospital, St Leonards, NSW, Australia; <sup>9</sup>Kolling Institute of Medical Research, The University of Sydney, St Leonards, NSW, Australia; <sup>10</sup>Department of Medicine, Austin Health, The University of Melbourne, Heidelberg, VIC, Australia; <sup>11</sup>Institute of Breathing and Sleep, Heidelberg, VIC, Australia; <sup>12</sup>Queensland University of Technology, Brisbane, QLD, Australia; <sup>13</sup>All India Institute of Medical Sciences, Raipur, India; <sup>14</sup>Maulana Azad Medical College, New Delhi, India; <sup>15</sup>Lok Nayak Hospital, New Delhi, India; <sup>16</sup>Jivanrekha Multispeciality Hospital, Pune, India; <sup>17</sup>Government Medical College and Hospital, Chandigarh, India; <sup>18</sup>Sydney Pharmacy School, The University of Sydney, Camperdown, NSW, Australia; <sup>19</sup>The Sydney Children's Hospitals Network, Westmead, NSW, Australia; <sup>20</sup>Prasanna School of Public Health, Manipal Academy of Higher Education, Manipal, India.

**Background: Importance:** People with chronic kidney disease may experience worse COVID-19 outcomes than the general population. SARS-CoV-2 virus enters cells via angiotensin-converting enzyme 2 (ACE2) receptors. ACE2 disruption promotes angiotensin type 1 receptor-mediated inflammation, which is potentially countered by angiotensin receptor blockers (ARBs). **Objective:** The Controlled Evaluation of Angiotensin Receptor blockers for COVID-19 respIraTorY disease (CLARITY) trial aimed to determine the effect of ARB treatment in SARS-CoV-2 infection.

**Methods: Design:** CLARITY was a pragmatic, adaptive, multi-centre, phase III, randomised, double-masked, controlled trial. Between May 2020 and November 2021, 787 participants were randomised to ARB (predominantly telmisartan) or control. The trial stopped due to meeting the pre-specified futility rule. **Setting:** Seventeen hospital sites in India and Australia. **Participants:** Eligible participants were people at least 18 years old, ARB-naïve, and with a laboratory-confirmed diagnosis of SARS-CoV-2 infection who had been hospitalised for management of COVID-19. **Intervention:** Oral ARB (telmisartan in India) or placebo (1:1) for 28 days. **Main outcome measures:** The primary endpoint was disease severity using a modified World Health Organization Clinical Progression Scale (WHO scale) at Day 14. Secondary outcomes included WHO scale scores at Day 28. Analyses were evaluated on an ordinal scale performed according to intention-to-treat principle. **Trial registration:** ClinicalTrials.gov, NCT04394117.

**Results:** The median WHO scale score at Day 14 was 1 (IQR 1, 2) in participants assigned ARBs and 1 (IQR 1, 3) in participants assigned placebo (adjusted odds ratio [OR] 1.51 [95% credible interval (CrI), 1.02–2.23], Pr(OR)1 = 0.98). WHO scale scores at Day 28 showed little evidence of difference between groups (adjusted OR 1.02 [95% CrI, 0.55–1.87], Pr(OR)1 = 0.53).

**Conclusions:** In patients hospitalised for COVID-19, mostly with mild disease, not requiring oxygen, we found no evidence of benefit for ARBs using predominantly 40 mg/day of telmisartan, based on disease severity score.

**Funding:** Private Foundation Support, Government Support - Non-U.S.

## TH-PO973

**Comparative Effectiveness of Glucose-Lowering Medications on Kidney Outcomes in the Glycemia Reduction Approaches in Type 2 Diabetes: A Comparative Effectiveness (GRADE) Randomized Clinical Trial**

**Deborah J. Wexler**,<sup>1,2</sup> Ian H. de Boer,<sup>3</sup> Alokannanda Ghosh,<sup>3</sup> Sunder Mudaliar,<sup>7,8</sup> Naji Younes,<sup>3</sup> Ionut Bebu,<sup>3</sup> Janet B. McGill,<sup>6</sup> William V. Tamborlane,<sup>9</sup> Menghee Tan.<sup>4</sup> The GRADE Research Group <sup>1</sup>Diabetes Center, Massachusetts General Hospital, Boston, MA; <sup>2</sup>Harvard Medical School, Boston, MA; <sup>3</sup>The Biostatistics Center, Department of Biostatistics and Bioinformatics, The George Washington University Milken Institute of Public Health, Rockville, MD; <sup>4</sup>Division of Metabolism, Endocrinology & Diabetes, University of Michigan, Ann Arbor, MI; <sup>5</sup>Division of Nephrology and Kidney Research, University of Washington, Seattle, WA; <sup>6</sup>Division of Endocrinology, Metabolism, and Lipid Research, Washington University in St Louis School of Medicine, St Louis, MO; <sup>7</sup>VA San Diego Healthcare System, San Diego, CA; <sup>8</sup>Division of Endocrinology and Metabolism, University of California San Diego, La Jolla, CA; <sup>9</sup>Pediatric Endocrinology, Yale School of Medicine, New Haven, CT.

**Background:** Here we report kidney outcomes in the GRADE Study, which evaluated the comparative effectiveness of sitagliptin, glimepiride, liraglutide, or insulin glargine added to metformin for glucose control in individuals with type 2 diabetes (T2D); basal or prandial insulin was added to maintain glycemic control if the HbA1c exceeded 7.5% on the assigned combination.

**Methods:** Co-primary outcomes: slope of eGFR, measured annually, between year 1 and end of follow up; and a composite of kidney disease progression (progression to moderately or severely elevated albuminuria, kidney transplant, dialysis, or death). Secondary outcomes were incident eGFR <60 mL/min/1.73m<sup>2</sup>, 40% decline in eGFR to <60 mL/min/1.73m<sup>2</sup>, doubling of urine albumin-creatinine ratio to ≥30 mg/g, and KDIGO stage progression.

**Results:** GRADE enrolled 5,047 participants with baseline mean (SD) age 57.2 years (10.0), HbA1c 7.5% (0.5), diabetes duration 4.2 (2.8) years, BMI 34.3 (6.8) kg/m<sup>2</sup>, blood pressure 128/77 mmHg (15/10), eGFR 94.9 (16.8) mL/min/1.73m<sup>2</sup>, and median urinary albumin-to-creatinine ratio (UACR) 6.4 (IQR 3.1, 16.9) mg/g; 58% were treated with ACE inhibitor or angiotensin receptor blocker. Mean follow-up was 5.0 (range 0-7.6) years. Mean (95% CI) eGFR slope was -2.03 (-2.20, -1.86), -1.92 (-2.08, -1.75), -2.08 (-2.26, -1.90), and -2.02 (-2.19, -1.84), mL/min/1.73m<sup>2</sup>/year among participants assigned to sitagliptin, glimepiride, liraglutide, and insulin glargine, respectively (p=0.61). The composite kidney disease progression outcome occurred among 135 (10.6%), 155 (12.4%), 152 (12.0%), and 150 (11.9%), participants, respectively (p=0.56). Moderately (83%) and severely (15.8%) elevated albuminuria accounted for the majority of kidney disease progression. There were no differences by treatment arm in secondary outcomes.

**Conclusions:** Among people with T2D and little or no evidence of prevalent kidney disease, we observed no difference in kidney outcomes over 5 years when a DPP-4 inhibitor, sulfonylurea, GLP-1 receptor agonist, or basal insulin was added to metformin.

**Funding:** NIDDK Support, Other NIH Support - National Heart, Lung, and Blood Institute, Other U.S. Government Support

## TH-PO974

**Efficacy and Safety of Finerenone in Patients With an Acute Change in Estimated Glomerular Filtration Rate: FIDELITY Analysis**

Sankar D. Navaneethan,<sup>1</sup> Rajiv Agarwal,<sup>2</sup> Stefan D. Anker,<sup>3</sup> George L. Bakris,<sup>4</sup> Gerasimos Filippatos,<sup>5</sup> Bertram Pitt,<sup>6</sup> Peter Rossing,<sup>7,8</sup> Luis M. Ruilope,<sup>9,10</sup> Phyllis August,<sup>11</sup> Alan G. Jardine,<sup>12</sup> Pantelis Sarafidis,<sup>13</sup> Meike Daniela Brinker,<sup>14</sup> Andrea Z. Lage,<sup>15</sup> Luke Roberts,<sup>16</sup> Charlie Scott.<sup>17</sup> On behalf of the FIDELIO-DKD and FIGARO-DKD Investigators <sup>1</sup>Department of Nephrology, Baylor College of Medicine, Houston, TX; <sup>2</sup>Richard L Roudebush VA Medical Center, Indianapolis, IN; <sup>3</sup>Department of Cardiology (CVK), and Berlin Institute of Health Center for Regenerative Therapies, German Centre for Cardiovascular Research Partner Site Berlin, Charité Universitätsmedizin, Berlin, Germany; <sup>4</sup>Department of Medicine, The University of Chicago Medicine, Chicago, IL; <sup>5</sup>Department of Cardiology, Attikon University Hospital, National and Kapodistrian University of Athens, School of Medicine, Athens, Greece; <sup>6</sup>Department of Medicine, University of Michigan School of Medicine, Ann Arbor, MI; <sup>7</sup>Steno Diabetes Center Copenhagen, Herlev, Denmark; <sup>8</sup>Department of Clinical Medicine, University of Copenhagen, Copenhagen, Denmark; <sup>9</sup>Cardiorenal Translational Laboratory and Hypertension Unit, Institute of Research imas12, Madrid, Spain; <sup>10</sup>CIBER-CV, Hospital Universitario 12 de Octubre, Madrid, Spain; <sup>11</sup>Division of Nephrology and Hypertension, Weill Cornell Medicine, New York, NY; <sup>12</sup>Institute of Cardiovascular and Medical Sciences, University of Glasgow, Glasgow, United Kingdom; <sup>13</sup>Department of Nephrology, University of Thessaloniki, Thessaloniki, Greece; <sup>14</sup>Cardiology and Nephrology Clinical Development, Bayer AG, Wuppertal, Germany; <sup>15</sup>Cardiology and Nephrology Clinical Development, Bayer SA, São Paulo, Brazil; <sup>16</sup>Clinical Development, Bayer plc, Reading, United Kingdom; <sup>17</sup>Data Science and Analytics, Bayer plc, Reading, United Kingdom.

**Background:** Renin-angiotensin-aldosterone blocker use is associated with an acute decline in estimated glomerular filtration rate (eGFR). This pooled, post hoc analysis of FIDELIO-DKD and FIGARO-DKD trial data assesses the efficacy and safety of finerenone, a distinct, nonsteroidal mineralocorticoid receptor antagonist in patients who sustained an acute change in eGFR upon drug initiation.

**Methods:** Patients (N=13,171) with type 2 diabetes (T2D), eGFR  $\geq 25$  ml/min/1.73 m<sup>2</sup>, and albuminuria, on optimized renin-angiotensin system blockade were randomized to finerenone or placebo. Risks of composite cardiovascular (CV) (CV death, nonfatal myocardial infarction, nonfatal stroke, or heart failure hospitalization) and composite kidney (kidney failure, sustained eGFR decrease  $\geq 57\%$ , or renal death) outcomes were analyzed by eGFR change (>10% decline, 0–10% decline, 0–10% increase, >10% increase) from baseline to month 1. Safety was assessed by investigator-reported adverse events (AEs).

**Results:** Of 12,834 patients, 24.7%, 33.8%, 23.5%, and 16.6% had a >10% eGFR decline, 0–10% decline, 0–10% increase, and >10% increase in eGFR, respectively. Finerenone consistently reduced the risk of CV and kidney outcomes irrespective of percentage eGFR change to month 1 ( $p_{\text{interaction}}=0.60$  and 0.35, respectively; Figure 1). Treatment-emergent AEs were similar across subgroups.

**Conclusions:** The efficacy and safety of finerenone in reducing CV and kidney outcomes were not modified by eGFR change at month 1.

**Funding:** Commercial Support - Bayer AG

**Figure 1: Event probability at 3.5 years for time to a) the composite CV outcome and b) the composite kidney outcome, by percentage eGFR change to month 1**

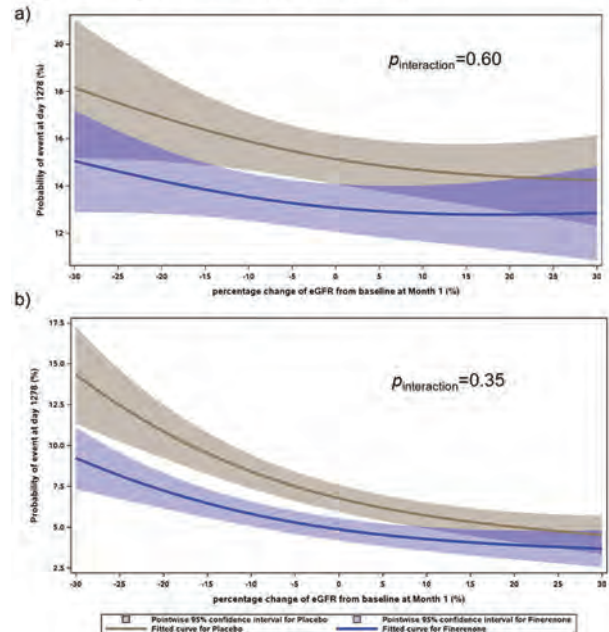

## TH-PO975

**Efficacy and Safety of Roxadustat in Peritoneal Dialysis CKD: Pooled Analysis of Four Phase 3 Studies**

Danilo Fliser,<sup>1</sup> Sunil Bhandari,<sup>2</sup> Alberto Ortiz,<sup>3</sup> Vicki R. Santos,<sup>4</sup> Alina Jiletovcici,<sup>4</sup> Tadao Akizawa,<sup>5</sup> <sup>1</sup>Saarland University Medical Center and Saarland University, Homburg, Germany; <sup>2</sup>Hull University Teaching Hospitals NHS Trust and Hull York Medical School, York, United Kingdom; <sup>3</sup>Fundacion Jimenez Diaz, Madrid, Spain; <sup>4</sup>Astellas Pharma US Inc, Northbrook, IL; <sup>5</sup>Showa University School of Medicine, Tokyo, Japan.

**Background:** Roxadustat is an oral HIF-PH inhibitor for anemia of CKD treatment. This pooled subgroup analysis examined the efficacy, need for transfusions, and safety of roxadustat compared with ESA in patients with anemia of CKD on peritoneal dialysis (PD) from the ALPINE studies, a large global phase 3 program.

**Methods:** Data from four multicenter, randomized, open-label studies comparing roxadustat to ESAs (epoetin alfa or darbepoetin alfa) in patients on PD were included in this pooled analysis (PYRENEES, SIERRAS, HIMALAYAS, ROCKIES). Hb target (g/dL) for roxadustat in all studies was 10.0-12.0, and ESA use followed local guidelines and labeling. Endpoints evaluated were Hb change from baseline to Weeks 28-36 (without rescue therapy, ie, RBC transfusion and/or ESA use), Hb change from baseline to Weeks 28-52 (regardless of rescue therapy), and time to rescue therapy. Safety and tolerability were assessed by treatment-emergent adverse events (TEAEs) from first study drug administration up to 28 days after the last dose. Nominal *P*-values are reported.

**Results:** In total, 422 patients were included (215 roxadustat, 207 ESA). Mean (SD) baseline Hb (g/dL) was 9.8 (1.2) for patients treated with roxadustat and 9.7 (1.2) for patients treated with ESA. Patients treated with roxadustat achieved a larger least-squares mean (LSM) change from baseline to Weeks 28-36 in Hb without rescue therapy versus ESA (roxadustat LSM: 1.38; 95% CI: 1.21-1.56; ESA LSM: 0.97; 95% CI: 0.78-1.16; LSM difference: 0.41; 95% CI: 0.16-0.67; *P*=0.0017) and Hb change from baseline to Weeks 28-52 regardless of rescue therapy (roxadustat LSM: 1.31; 95% CI: 1.15-1.47; ESA LSM: 1.00; 95% CI: 0.82-1.17; LSM difference: 0.32; 95% CI: 0.08-0.55; *P*=0.0077). Risk for RBC transfusion was reduced for patients treated with roxadustat versus ESA (HR: 0.49; 95% CI: 0.25-0.93; *P*=0.0304). The incidence rates per 100 patient-exposure years for overall TEAEs (56.5 vs 54.4), grade  $\geq 3$  TEAEs (27.7 vs 27.5), and serious TEAEs (37.2 vs 35.8) were similar in the roxadustat and the ESA treatment groups, respectively.

**Conclusions:** This pooled analysis demonstrates that roxadustat, an oral medication, corrected and maintained Hb levels in patients with anemia of CKD on PD similarly to ESAs with a comparable safety profile.

**Funding:** Commercial Support - Astellas Pharma, Inc., FibroGen, Inc., AstraZeneca

TH-PO976

Antithrombotic Treatment With Fesomersen vs. Placebo in Patients With ESKD on Hemodialysis (ESKD-HD)

Wolfgang C. Winkelmayr. For the RE-THINC Investigators Baylor College of Medicine, Houston, TX.

Background: Patients with ESKD-HD are at high risk for both atherothrombotic events and bleeding. Fesomersen, a ligand-conjugated antisense oligonucleotide drug, targets a region of the FXI mRNA to selectively and specifically inhibit expression of FXI. We performed a randomized placebo-controlled dose-ranging phase 2 study in patients with ESKD-HD to evaluate bleeding and atherothrombotic complications relative to fesomersen dose and individual predicted FXI levels.

Methods: Patients received fesomersen 40, 80, or 120 mg once-monthly, or matching placebo, for up to 12 months. The main safety outcome was the composite of major bleeding (MB) and clinically relevant non-major bleeding (CRNMB). Other outcomes included major atherothrombotic events (fatal/nonfatal myocardial infarction or stroke; systemic embolism; acute limb ischemia/amputation; venous thromboembolism), arteriovenous (AV)-access thrombosis, clotting of the HD circuit, and post-dialysis AV-access bleeding.

Results: Following randomization, 307 patients received study treatment. Fesomersen led to a dose-dependent and sustained median reduction of steady-state FXI levels by 53.1%, 72.2% and 86.6% in the 40, 80, and 120 mg groups, respectively. MB or CRNMB events occurred in 6.5% (1 MB, 4 CRNMB), 5.1% (1 MB, 3 CRNMB), 3.9% (2 MB, 1 CRNMB) of the fesomersen 40, 80, and 120 mg groups, respectively, compared with 4.0% (3 CRNMB) of those receiving placebo (not significant). MB or CRNMB and post-dialysis AV-access bleeding were not related to predicted FXI levels. Occurrence of AV-access thrombosis (P<0.05) and HD circuit clotting (P<0.01) diminished with decreasing FXI levels. Major atherothrombotic events occurred in only 4 patients, 1 (1.3%) in each treatment arm. A total of 19 fesomersen recipients underwent major surgery during the study (non-prespecified subgroup). At the time of surgery, predicted FXI levels were <0.2, 0.2-0.5, and ≥0.5 U/ml in 0, 8 (42.1%), and 11 (57.9%), respectively; no associated MB or CRNM bleeding events were observed.

Conclusions: Fesomersen did not significantly increase the risk of bleeding in patients with ESKD-HD. Incidences of HD circuit clotting and AV-access thrombosis diminished significantly with decreasing FXI levels.

Funding: Commercial Support - Bayer

TH-PO977

Effect of Technology Assisted Stepped Collaborative Care Intervention on Fatigue, Pain, and Depression in Patients on Hemodialysis: The TACCare Trial

Manisha Jhamb,<sup>1</sup> Jennifer L. Steel,<sup>1</sup> Jonathan Yabes,<sup>1</sup> Maria-Eleni Roumelioti,<sup>2</sup> Sarah J. Erickson,<sup>2</sup> Susan M. Devaraj,<sup>1</sup> Kevin Vowles,<sup>3</sup> Yoram Vodovotz,<sup>2</sup> Scott Beach,<sup>1</sup> Steven D. Weisbord,<sup>1</sup> Bruce L. Rollman,<sup>1</sup> Mark L. Unruh.<sup>2</sup> <sup>1</sup>University of Pittsburgh, Pittsburgh, PA; <sup>2</sup>University of New Mexico School of Medicine, Albuquerque, NM; <sup>3</sup>Queens University of Belfast, Belfast, United Kingdom.

Background: Patients receiving hemodialysis experience a high symptom burden including pain, fatigue, and depression, and effective treatment options are limited. Our goal was to compare the efficacy of a stepped collaborative care intervention with an attention control group on these patient-centered outcomes.

Methods: In this multi-site, parallel-group, randomized controlled trial, patients undergoing hemodialysis at sites in New Mexico or Pennsylvania, with at least one of the 3 symptoms (fatigue, pain, or depression) and at least in contemplation phase of behavior change were enrolled. The intervention arm comprised of a stepped approach of cognitive behavioral therapy (CBT) and/or pharmacotherapy, in collaboration with the dialysis and primary care teams. Twelve sessions of CBT were delivered weekly using telemedicine in dialysis units or at home. The control arm received 6 sessions of health education using telemedicine. The co-primary outcomes were change in fatigue [Functional Assessment of Chronic Illness Therapy Fatigue], pain [Brief Pain Inventory] or depression [Beck Depression Inventory-II] scores measured post-intervention. Mixed models with linear contrast at post-intervention were employed adjusting for pre-specified covariates (age, sex, site, and comorbidity score) and used Benjamini-Hochberg-adjusted p-values.

Results: Among the 160 (Intervention n=83; Control n=77) randomized patients (mean age 58±14 yrs, 45% female, 28% Blacks, 13% American Indian, 18% Hispanics), the baseline symptom prevalence was 95% for fatigue, 46% for pain and 43% for depression. All intervention patients chose to receive CBT and <5% chose additional pharmacotherapy. Compared to controls, patients in the intervention arm experienced greater reduction in fatigue (mean difference [md] 2.81 [95% CI, 0.86 to 4.75]; p=0.014), pain (md -0.96 [CI, -1.70 to -0.23]; p=0.032), and depression (md -1.73 [CI, -3.18 to -0.28]; p=0.06) post-intervention, with similar adverse events in both arms.

Conclusions: Among patients on hemodialysis, a 12-week psychotherapy-based stepped collaborative care intervention resulted in clinically significant improvement in fatigue and pain.

Funding: NIDDK Support

TH-PO978

Arterial and Venous Thromboembolic Events in Patients With Anemia of Dialysis-Dependent CKD Treated With Roxadustat: Exploratory Post Hoc Analysis

Takayuki Hamano,<sup>1</sup> Yusuke Yamaguchi,<sup>2</sup> Kashia Goto,<sup>3</sup> Alina Jiletcovici,<sup>4</sup> Shaka Martin,<sup>4</sup> Frank Dellanna,<sup>5</sup> Tadao Akizawa,<sup>6</sup> Jonathan Barratt,<sup>7</sup> <sup>1</sup>Yagoyu Shiritsu Daigaku Daigakuin Igaku Kenkyuka Igakubu, Nagoya, Japan; <sup>2</sup>Astellas Pharma Global Development Inc, Northbrook, IL; <sup>3</sup>Astellas Seiyaku Kabushiki Kaisha, Chuo-ku, Japan; <sup>4</sup>Astellas Pharma US Inc, Northbrook, IL; <sup>5</sup>MVZ DaVita Rhein-Ruhr GmbH, Düsseldorf, Germany; <sup>6</sup>Showa Daigaku, Shinagawa-ku, Japan; <sup>7</sup>University of Leicester, Leicester, United Kingdom.

Background: Venous and arterial thromboembolic events (TEs) are of interest in patients with anemia of DD-CKD. We evaluated clinical characteristics of patients with TEs treated with roxadustat, an oral medication.

Methods: We performed post hoc analyses separately using 2 pooled data sets of patients with DD-CKD anemia who received roxadustat in global phase 3 studies (PYRENEES, SIERRAS, HIMALAYAS, ROCKIES) and Japanese phase 3 studies with Hb correction and/or ESA conversion. Endpoints were the incidence of TEs with onset before and after Week 12. Risk factors for baseline characteristics potentially associated with TEs were identified by Cox regression analyses. Nested case-control analyses explored relationships between TE incidence and last-known laboratory parameters using conditional logistic models with matched pairs of case-control data. Matching variables were selected from Cox regression analysis results.

Results: Cox regression analysis of global studies identified age, hemodialysis, race, history of thromboembolism, CV event and/or diabetes, high BMI, low TSAT, and high baseline CRP as associated with increased risk of TE before and/or after Week 12. Nested case-control analysis of global studies suggested the risk of TE increased with Hb rate of increase before Week 12 and with low Hb and low TSAT after Week 12 (Table). Similar trends were observed in the analysis of studies in Japan.

Conclusions: TEs in patients with anemia of CKD are complex; these results should be interpreted cautiously as hypothesis-generating. Hb levels ≤10 g/dL, Hb rate of change and iron deficiency may augment the risk of TEs in patients with anemia of DD-CKD treated with roxadustat.

Funding: Commercial Support - Astellas Pharma, Inc., FibroGen, Inc., AstraZeneca

Table: Cox Regression and Nested Case-Control Analysis of Global Data Exploring Risk Factors for Thromboembolic Events in Patients Treated With Roxadustat

Table with multiple columns: Cox Regression Analysis (Events With Onset Before Week 12, Events With Onset After Week 12) and Nested Case-Control Analysis (Events With Onset Before Week 12, Events With Onset After Week 12). Rows include Patient Characteristics, Risk Factor, History of thromboembolism, History of CV event, History of diabetes, Baseline TSAT (mg/dL), Baseline TSAT (%), Body mass index (kg/m²), and various patient characteristics like Age, Sex, Race, etc.

TH-PO979

**Impacts of Conventional In-Center Hemodialysis and Peritoneal Dialysis on All-Cause Mortality in Patients With ESKD: A Randomized Controlled Trial With 10-Year Follow-Up**

Xueqing Yu,<sup>1</sup> Li Fan,<sup>1</sup> Jie Li,<sup>2</sup> Xia Zou.<sup>2</sup> The SURIND and China Q study investigators <sup>1</sup>Nephrology, Guangdong Provincial People's Hospital, Guangdong Academy of Medical Science, Guangzhou, China; <sup>2</sup>Global Health Research Center, Guangdong Provincial People's Hospital, Guangdong Academy of Medical Science, Guangzhou, China.

**Background:** Conventional in-center hemodialysis (HD) and peritoneal dialysis (PD) are treatment options for patients with end-stage kidney disease (ESKD). However, their long-term impacts on all-cause mortality of patients with ESKD have not been determined.

**Methods:** This was an open-label, randomized trial from 36 sites in China, with 1082 incident ESKD patients randomly assigned to either HD or PD. The primary outcome was all-cause mortality, and was assessed in the intention-to-treat (ITT) population, with sensitivity analyses in the per-protocol and actual treatment datasets. We calculated the difference in restricted mean survival time (RMST) to compare the impacts of HD and PD on all-cause death (NCT01413074 and 02378350).

**Results:** 537 ESKD patients allocated to HD and 545 to PD between June 2011 to July 2016. The mean (SD) age was 49.8 (14.9) years; 232 (21.4%) had diabetes and 158 (14.6%) had pre-existing cardiovascular disease. During a median follow-up of 3.1 (IQR 1.0–5.8) years, 122 (22.7%) patients in HD and 157 (28.8%) in PD group died. Survival was not different between HD and PD during the overall follow-up period after adjustment for age, sex, diabetes, and baseline eGFR (adjusted RMST difference 0.45[95% CI -0.39–1.30] years, *P*=0.29). However, the survival curves of HD and PD separated after 4-year follow-up. During the first 4 years after randomization, patients received HD and PD had comparable survival (adjusted RMST difference -0.03 [95% CI -0.16–0.10] years, *P*=0.65). In contrast, patients with HD had better survival than those with PD in the last 6 years of follow-up (adjusted RMST difference 0.70 [0.05–1.34] years, *P*=0.03). HD was superior to PD in the patients without diabetes (adjusted RMST difference 0.49 [0.16–0.82] years, *P*=0.004) or cardiovascular diseases (adjusted RMST difference 0.51 [0.23–0.80] years, *P*<0.001). PD patients with cardiovascular disease had better survival than HD, although the RMST difference was not significant. The result of the sensitivity analyses were consistent.

**Conclusions:** HD and PD had comparable survival in ESKD patients during the overall follow-up period and the first 4 years of treatment, but HD was superior to PD afterward. Our findings are essential for decision making in choosing the optimal dialysis modality in ESKD patients.

**Funding:** Commercial Support - Baxter Healthcare Corporation.

TH-PO980

**Understanding Use of a Dedicated Infant Continuous Kidney Replacement Therapy Device in the United States through ICONIC: Improving Carpediem™ Outcomes in Neonates and Infants Through Collaboration**

Cara L. Slagle,<sup>1,2</sup> Kimmy T. Vuong,<sup>3</sup> Kelli A. Krallman,<sup>4</sup> Lauren W. Casey,<sup>3</sup> Catherine Joseph,<sup>3</sup> Stuart Goldstein,<sup>4,2</sup> Jolyn Morgan.<sup>4</sup> <sup>1</sup>Neonatology, Cincinnati Children's Hospital Medical Center, Cincinnati, OH; <sup>2</sup>Pediatrics, University of Cincinnati, Cincinnati, OH; <sup>3</sup>Nephrology, Texas Children's Hospital, Houston, TX; <sup>4</sup>Center for Acute Care Nephrology, Cincinnati Children's Hospital Medical Center, Cincinnati, OH.

**Background:** Carpediem™ (Medtronic, US) is a dedicated platform designed to provide continuous kidney replacement therapy (CKRT) in infants using heparin for anticoagulation. Infants receiving CKRT historically experienced worse outcomes attributed to the lack of CKRT devices designed for children <10 kg. We created a multicenter research collaborative aimed at improving infant outcomes.

**Methods:** The ICONIC study (NCT05161078) assesses infants receiving Carpediem™ (CD) prospectively, unless discharged prior to IRB approval. Aims include: describing CD prescription, delivery and establishing a registry for benchmarking efforts. A treatment course (TC) was deemed complete if >72 hrs elapsed between CD procedures. Survival to TC end was considered survival to 72 hrs post CD. Variables are described by median [IQR] or fractions (%).

**Results:** 22 subjects were enrolled 8/2020 – 8/2022, comprising 31 TC and 499 procedures. Admit weight (wt) was 3.2 kg [2.6, 4.5]; wt at TC start 4.8 kg [3.4, 5.6]. Birth gestational age (GA) was 36 wk [33, 37] with corrected GA 43 wk [36, 47] at TC start. Most common vascular access attributes were: non-tunneled (49%), internal jugular (80%), 7.5 Fr (36%). Common TC indications were: congenital anomaly of the kidney and urinary tract with end stage kidney disease (CAKUT/ESKD) (48%) and acute kidney injury (AKI) (35%). Regional citrate anticoagulation was used most often (76%). 65% of circuits were blood primed. Continuous veno-venous hemodialysis was almost exclusively used (99%); effluent dose 94 mL/kg/hr [82, 110] with a procedure time limit of 24 hrs. Hypotension requiring intervention occurred during 5% of initiations. 74% of filters met prescribed time; median filter life was 19 hr [13, 23]. Common reasons for unplanned filter change were clotting (70%) and vascular access issues (24%). Survival to TC end was 84% (AKI:100%, CAKUT/ESKD: 66%). Survival to hospital discharge was 55%; 4 remain hospitalized.

**Conclusions:** We describe an early experience with CD in the US including ESKD. AKI outcomes remain consistent with historical CD cohorts. As more centers enroll, further experience will provide baseline information for benchmarking efforts.

TH-PO981

**Dialysis Symptom Control-Restless Legs Syndrome (DISCO-RLS): A Multicenter, Randomized, Double Blinded, Placebo Controlled 4x Crossover Trial**

David T. Collister,<sup>1,2</sup> Colin S. Hardy,<sup>2</sup> Christian G. Rabbat,<sup>9</sup> Karthik K. Tennankore,<sup>3</sup> Deborah Lynn Zimmerman,<sup>4</sup> Navdeep Tangri,<sup>5</sup> Ron Wald,<sup>6</sup> Braden J. Manns,<sup>10</sup> Annie-Claire Nadeau-Fredette,<sup>7</sup> Remi Goupil,<sup>7</sup> Samuel A. Silver,<sup>8</sup> Michael Walsh.<sup>9,2</sup> DISCO-RLS investigators <sup>1</sup>University of Alberta Faculty of Medicine & Dentistry, Edmonton, AB, Canada; <sup>2</sup>Population Health Research Institute, Hamilton, ON, Canada; <sup>3</sup>Dalhousie University Faculty of Medicine, Halifax, NS, Canada; <sup>4</sup>University of Ottawa Faculty of Medicine, Ottawa, ON, Canada; <sup>5</sup>University of Manitoba Max Rady College of Medicine, Winnipeg, MB, Canada; <sup>6</sup>University of Toronto, Toronto, ON, Canada; <sup>7</sup>Université de Montreal, Montreal, QC, Canada; <sup>8</sup>Queen's University, Kingston, ON, Canada; <sup>9</sup>McMaster University, Hamilton, ON, Canada; <sup>10</sup>University of Calgary Cumming School of Medicine, Calgary, AB, Canada.

**Background:** Restless legs syndrome (RLS) affects 30% of patients with kidney failure and reduces quality of life. Commonly used pharmacologic treatments may reduce RLS severity but residual symptoms are common as are side effects at higher doses.

**Methods:** Potential participants were adults receiving in-center hemodialysis at least 3x weekly with at least moderate RLS symptoms after a 2-week placebo run-in period off their baseline RLS medications. Eligible participants were randomly allocated to the four weeks each of the four following treatments in random order: 1) gabapentin 100mg + ropinirole 0.5mg, 2) gabapentin 100mg + ropinirole placebo, 3) gabapentin placebo + ropinirole 0.5mg, 4) gabapentin placebo + ropinirole placebo, each taken once daily. In each treatment period, participants were seen weekly. The primary outcome was the International Restless Legs Study Group Rating Scale (IRLS) score at 3 and 4 weeks of each treatment period.

**Results:** Of the 52 participants randomized, the mean (SD) age was 58.5 (13.6) years, 21 (40.4%) were female, 30 (57.7%) had diabetes, and the mean (SD) baseline IRLS was 23.8 (8.6). No treatment group reduced estimated IRLS to a greater extent than placebo (Figure 1). There were no significant effects of either treatment on other measures of RLS severity, quality of life or serious adverse effects.

**Conclusions:** Neither gabapentin 100 mg daily, ropinirole 0.5 mg daily or the combination reduced RLS symptoms in this trial of adults receiving hemodialysis. New approaches to treating RLS in patients receiving dialysis are needed. (ClinicalTrials.gov NCT03806530)

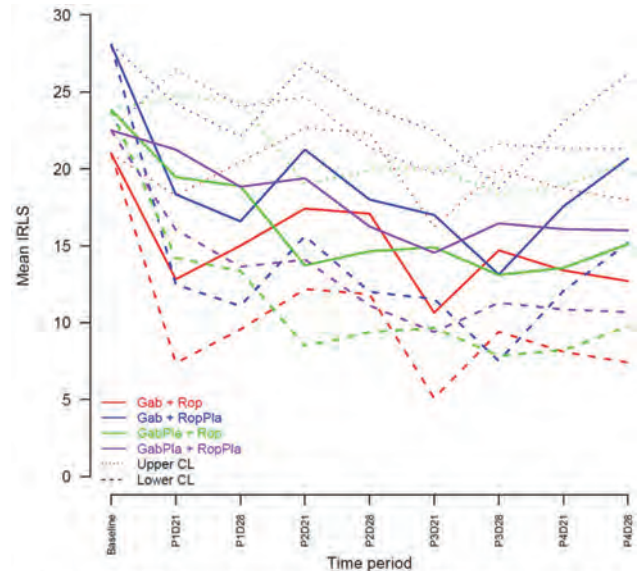

**Figure 1:** Multilevel mixed models adjusted for baseline IRLS with treatment/period and treatment/study visit interactions  
 Note: IRLS= International Restless Legs Study Group Rating Scale, Gab = gabapentin, Rop = ropinirole, Gab Pla = gabapentin placebo, Rop Pla = ropinirole placebo, CL = 95% confidence interval, P = period, D = day

## TH-PO982

**Pre-Dialysis Point-of-Care (POC) Chemistry-Guided Dialysate Adjustment: The Reducing Arrhythmia in hemoDialysis by Adjusting the Rx Electrolytes (RADAR) Pilot Trial**

Patrick H. Pun,<sup>1</sup> Michele Santacatterina,<sup>4</sup> Sana Al-Khatib,<sup>3</sup> Larry A. Chinitz,<sup>4</sup> David M. Charytan.<sup>2</sup> <sup>1</sup>Medicine/Nephrology, Duke University School of Medicine, Durham, NC; <sup>2</sup>Medicine/Nephrology, NYU Langone Health, New York, NY; <sup>3</sup>Medicine/Cardiology, Duke University School of Medicine, Durham, NC; <sup>4</sup>Medicine/Cardiology, NYU Langone Health, New York, NY.

**Background:** Excessive dialytic potassium (K) and acid removal are risk factors for arrhythmia, suggesting a need to personalize HD prescriptions. We conducted a multicenter prospective blinded randomized cross-over study to test safety, feasibility, and efficacy of 4 POC chemistry-guided protocols to adjust dialysate K and bicarbonate (HCO<sub>3</sub>).

**Methods:** HD patients from 2 centers received implantable cardiac monitors. Subjects crossed over to four 4-week periods with dialysate K or HCO<sub>3</sub> adjustment at each treatment according to preHD POC values: 1) K removal maximization (lower dialysate K); 2) K removal minimization (higher dialysate K); 3) Acidosis avoidance (higher dialysate HCO<sub>3</sub>); 4) Alkalosis avoidance (lower dialysate HCO<sub>3</sub>). Efficacy on clinically significant arrhythmia (CSA) rate was assessed.

**Results:** Of 19 subjects enrolled, 42% were Black and 16% female. Mean age was 59 and median HD time was 2.6 years. HD staff completed POC testing and correctly adjusted the dialysate in 604/708 (85%) of available HD treatments; missed POC testing accounted for most nonadherence. There was 1 K<3 mEq/L, 29 HCO<sub>3</sub><20 and 2 HCO<sub>3</sub>>32 mEq/L during respective intervention periods and no serious adverse events related to study interventions. There were no significant differences between POC results and standard monthly labs drawn on the same day. However, inter-treatment K and HCO<sub>3</sub> variability was high (Figure). There were 45 total CSA events, the majority transient atrial fibrillation, with numerically fewer events during the alkalosis avoidance (8) and K-removal minimization (3) periods compared to other intervention periods (17).

**Conclusions:** Algorithm-guided K and HCO<sub>3</sub> adjustment based on pre-treatment POC testing is feasible. The variability of inter-treatment K and HCO<sub>3</sub> we observed suggests that a POC-lab guided algorithm could markedly alter dialysate-serum chemistry gradients. Definitive, endpoint-powered trials should be considered.

**Funding:** Other NIH Support - NHLBI R34HL140477, Clinical Revenue Support

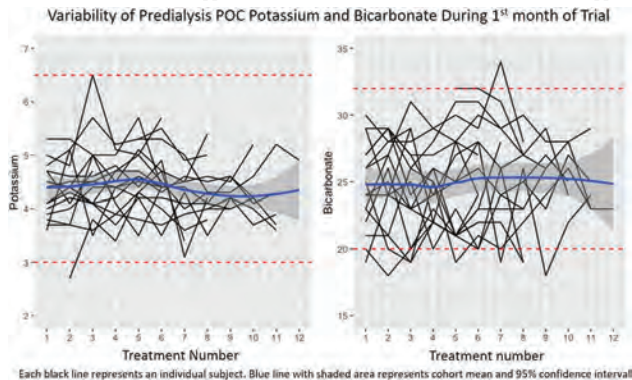

## TH-PO983

**Prevention of Pre-Training Peritonitis in Patients Non-Integrated to a Peritoneal Dialysis Program**

María de la Luz Alcantar Vallín, Alexia Romero, Cynthia G. Cervantes, Ramon Medina, Jonathan Chavez, Francisco Gonzalo Rodríguez García, Clementina Elizabeth Calderon Garcia, Guillermo Navarro Blackaller. *Nephrology, Hospital Civil de Guadalajara Unidad Hospitalaria Fray Antonio Alcalde, Guadalajara, Mexico.*

**Background:** Around 70% of patients without Social Security who develop end stage chronic kidney disease (ESKD) whom choose peritoneal dialysis require urgent-start, after stabilization, integration to our CAPD program can take more than two months due to the lack of infrastructure and patient resources. During this time they receive intermittent PD every two weeks until training and integration but the uremic milieu and the poor nutritional status increase the risk of peritonitis events, associated with prolonged hospitalizations, technique failure and death in up to 87.5%. Intraluminal peritoneal catheter antibiotic lock has been used in patients with recurrent peritonitis, but the usefulness in pre-training peritonitis prevention in this group of patients is unknown.

**Methods:** Randomized clinical trial, 1:1, blinded placebo controlled in patients with urgent start peritoneal dialysis (Fig 1); after receiving Intermittent peritoneal dialysis, prior to hospital discharge, a PD catheter lock was used with 3 ml of heparin/gentamicin solution (concentration 909U/3.6mg/ml) or 3ml of 1.5% dialyzing fluid Fortnightly during 6 months or until CAPD program integration. We evaluated the number of peritonitis and mechanical dysfunction.

**Results:** 42 patients were analyzed (70% men), 22 received antibiotic lock, no difference in Mean age between groups (47.5y in the intervention vs 33y in placebo), diabetes (45% vs 20%), urea (209.5 vs 298 mg/dl) respectively, similar Hemoglobin

levels (8 g/dl) in both groups. The integration time to CAPD was 76 days in control group and 104 days in the antibiotic group. The peritonitis rate was 0.2 in the intervention group vs 1.9 in the placebo group ( $p=0.49$  CI 0.48-1). No microbial resistance was reported and no difference in adverse events between groups.

**Conclusions:** The application of PD catheter antibiotic lock with gentamicin its safe and can be considered for pre-training peritonitis prevention until CAPD program integration, however, larger studies are required.

## TH-PO984

**A Prospective Clinical Study to Evaluate the Ability of the CloudCath System to Detect Peritonitis Compared to Standard of Care During In-Home Peritoneal Dialysis (CATCH)**

Rajnish Mehrotra,<sup>1</sup> Eric H. Yu,<sup>3</sup> Aly ElBady,<sup>3</sup> Brian Fisher,<sup>3</sup> Don E. Williamson,<sup>3</sup> Glenn Chertow.<sup>2</sup> <sup>1</sup>Nephrology, University of Washington, Seattle, WA; <sup>2</sup>Nephrology, Stanford University School of Medicine, Stanford, CA; <sup>3</sup>CloudCath Inc., San Francisco, CA.

**Background:** Peritonitis has long been recognized as the leading complication of peritoneal dialysis. Current standard practice is to advise patients to monitor for signs of infection (abdominal pain and cloudy effluent). CloudCath developed a continuous monitoring device that pairs with CloudCath software to monitor turbidity changes in the effluent when peritonitis may be visually undetectable and asymptomatic.

**Methods:** We conducted a single arm, open label, multicenter outpatient study where study participants used the CloudCath system that had the notification capability deactivated so that neither participants nor investigators were aware of the device results. We measured the time between device detection of turbid fluid and the study participant presentation to the clinic/hospital with signs/symptoms of peritonitis.

**Results:** As of June 30, 2021, the Cloudcath system has been used by 185 participants for a total of 26,185 days and has analyzed 126,300 individual PD exchange cycles. A total of 28 participants presented to the clinic/hospital with 34 potential peritonitis events including 22 participants who experienced 26 peritonitis events that met ISPD criteria (>100 WBC/ul and > 50% PMN), 7 participants who experienced 8 events that did not meet ISPD criteria and 1 participant who experienced both. The median time from when the CloudCath system detected changes in turbidity scores to the time in which the participant presented to clinic/hospital was **4.5 days**, (range < 0.2 to 15.4).

**Conclusions:** The present study demonstrates that the CloudCath system can detect changes in effluent turbidity scores that may prompt evaluation for peritonitis significantly earlier than current standard of care. The time gained by the early detection may allow for earlier diagnosis and treatment of peritonitis that may, in turn, reduce risk of peritonitis-related complications such as hospitalizations, PD catheter removals or permanent transfer to HD.

**Funding:** Commercial Support - CloudCath Inc.

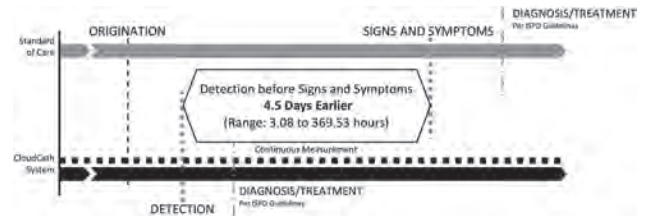

## TH-PO985

**Pruritus and Labor Force Participation in Dialysis Patients**

Tejas Desai,<sup>1</sup> Jennifer A. Kammerer,<sup>1</sup> Jeffrey Thompson,<sup>2</sup> Juliana H. Oliveira,<sup>1</sup> Kirsten L. Johansen.<sup>3</sup> <sup>1</sup>CSL Vifor, Redwood City, CA; <sup>2</sup>Cerner Enviza, North Kansas City, MO; <sup>3</sup>Hennepin Healthcare, Minneapolis, MN.

**Background:** Nearly one-quarter of in-center hemodialysis (HD) patients are in the labor force at HD initiation. Fewer remain employed as HD vintage increases. Involuntary exit from labor participation can be a devastating sequela of end-stage kidney failure for patients and society. The PRImE ITCH study assessed the association between pruritus (itch) and unintentional/undesired productivity losses.

**Methods:** The PRImE ITCH study surveyed members of the American Association of Kidney Patients or Cerner Enviza patient panel to assess itch burden. Adult HD patients reporting itch in the past 28 days were stratified by Worst Itch Numerical Rating Scale (WINRS) severity. The Work Productivity and Activity Impairment questionnaire (WPAI; 0-100% scale) was completed by currently employed HD patients to assess labor productivity changes attributed to itch. Higher WPAI scores indicate greater work impairment and lower productivity. Absenteeism is defined as work time missed. Presenteeism is defined as working with reduced effectiveness.

**Results:** Of 369 patients, 354 (96%) completed the WINRS. Of 354 patients, 145 (41%) completed the WPAI and were employed with 75% reporting an annual salary of <\$100K. Their mean ± SD age was 36.7 ± 11.8 years, and 87% reported moderate or severe itch. Patients with severe itch had more work impairment (mean difference [95% CI] 23.9% [13.3-34.5%]) than those with mild symptoms, and more absenteeism and presenteeism than those with mild (19.2% and 40.4%, respectively) or moderate itch (15.9% and 18.0%, respectively). Patients with moderate itch had more work impairment (19.1% [8.7-29.4%]) and employment presenteeism (22.4% [10.6-34.1%]) than those with mild itch (Figure).

Key: TH - Thursday; FR - Friday; SA - Saturday; OR - Oral; PO - Poster; PUB - Publication Only

Underline represents presenting author.

**Conclusions:** Results of the PRImE ITCH study show that increasing severity of itch is associated with reduced labor force participation among prevalent HD patients. Further study is needed to confirm these findings and determine if itch treatment can mitigate loss of labor productivity in employed US HD patients.

**Funding:** Commercial Support - CSL Vifor

**WPAI scores by WINRS severity**

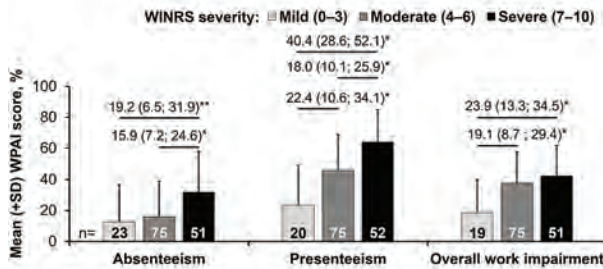

Percentage differences shown above the chart are mean (95% CI). \*P<0.001; \*\*P<0.005. WINRS, Worst Imaginable Itch Numerical Rating Scale; WPAI, Work Productivity and Activity Impairment.

**TH-PO986**

**Bicarbonate Administration and Vascular Function in CKD: A Randomized Placebo-Controlled Trial**

Jessica B. Kendrick, Heather Farmer-Bailey, Kristen L. Nowak, Cortney Steele, Zhiying You, Michel Chonchol, Kerrie Moreau, Wei Wang. *University of Colorado, Denver, CO.*

**Background:** Lower serum bicarbonate levels, even within the normal laboratory range, are strongly linked to risks of cardiovascular disease in chronic kidney disease (CKD), possibly by modifying vascular function. However, the effects of sodium bicarbonate (NaHCO<sub>3</sub>) on patient outcomes in moderate to advanced CKD are lacking. We examined the effect of NaHCO<sub>3</sub> on vascular endothelial function and arterial stiffness in patients with CKD stage 3B-4.

**Methods:** We performed a prospective, double-blind, placebo-controlled randomized trial of 109 patients with CKD stage 3B-4 (eGFR 15-44 ml/min/1.73m<sup>2</sup>) with serum bicarbonate levels 22-27 mEq/L. Participants were randomly assigned to receive either NaHCO<sub>3</sub> or placebo at a dose of 0.5 mEq/LBW-kg/day for 12 months. The co-primary endpoints were change in brachial artery flow mediated dilation (FMD) and in aortic pulse wave velocity (aPWV) over 12 months.

**Results:** 90 patients completed the study. The mean (SD) age and eGFR were 61.7 ± 11.6 years and 35.9 ± 9.8 ml/min/1.73m<sup>2</sup>, respectively. The mean (SD) serum bicarbonate level at baseline was 23.4 ± 2.2 mEq/L. After 12 months, serum bicarbonate levels increased significantly in the NaHCO<sub>3</sub> group compared to placebo (difference between groups 1.35 95% CI (0.34-2.36), p=0.003). NaHCO<sub>3</sub> did not result in a significant improvement in aPWV from baseline (Figure). NaHCO<sub>3</sub> did result in a significant increase in FMD after 1 month, however this effect disappeared at follow-up. NaHCO<sub>3</sub> resulted in a significant increase in 24-hour urine citrate and decrease in 24-hour urine ammonia. There was no significant change in eGFR over 12 months with NaHCO<sub>3</sub>, however, there was a trend of a decrease in urine protein excretion. NaHCO<sub>3</sub> was safe and well-tolerated with no significant changes in blood pressure, antihypertensive medication, weight, calcium or potassium levels.

**Conclusions:** Twelve months of NaHCO<sub>3</sub> in patients with moderate to advanced CKD and normal serum bicarbonate levels did not improve vascular endothelial function or reduce arterial stiffness.

**Funding:** Other NIH Support - NHLBI

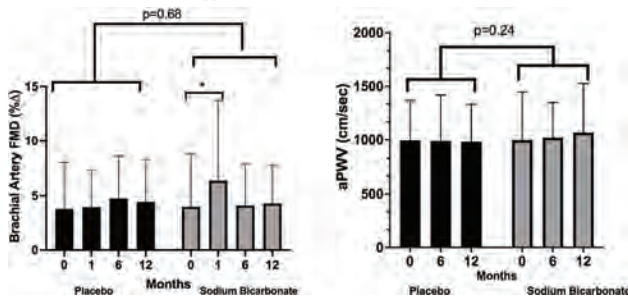

\*p<0.01

**TH-PO987**

**KETO-ADPKD: A Randomized, Controlled Trial on Ketogenic Dietary Interventions in Autosomal Dominant Polycystic Kidney Disease**

Sadrija Cukoski,<sup>1</sup> Christoph H. Lindemann,<sup>1</sup> Theresa Brecht,<sup>1</sup> Adrian Kühn,<sup>1</sup> Sita Arjune,<sup>1</sup> Polina Todorova,<sup>1</sup> Franziska I. Meyer,<sup>2</sup> Florian Siedek,<sup>2</sup> Philipp Antczak,<sup>3</sup> Ingo Gottschalk,<sup>2</sup> Thomas Weimbs,<sup>4</sup> Franziska Grundmann,<sup>1</sup> Roman-Ulrich Mueller.<sup>1</sup> <sup>1</sup>Department II of Internal Medicine, Nephrology, Uniklinik Köln, Cologne, Germany; <sup>2</sup>Uniklinik Köln, Cologne, Germany; <sup>3</sup>Center for Molecular Medicine, Universität zu Köln, Cologne, Germany; <sup>4</sup>Molecular, Cellular, and Developmental Biology, and Neuroscience Research Institute, University of California Santa Barbara, Santa Barbara, CA.

**Background:** ADPKD animal models revealed a potent beneficial effect of ketogenic dietary interventions (KDIs).

**Methods:** 63 ADPKD patients were randomized to 3 months of ketogenic diet (KD), monthly 3-day water fasting (WF) or ad libitum diet (Control). The primary endpoint was a feasibility analysis combining a questionnaire and metabolic efficacy (blood β-Hydroxybutyric acid (BHB), breath acetone), to be reached by ≥75% in each group. Total kidney volume (TKV) and total liver volume (TLV) were quantified among secondary endpoints using MRI at baseline (BL) and end-of-treatment (EOT). Safety analyses focused on uric acid levels and hepatic/renal complications.

**Results:** The primary feasibility endpoint was reached for the WF (80%) but not the KD (43%) group. The lower percentage (KD) was driven by the pre-defined BHB threshold (≥0.8 mmol/l at all visits). 18/23 KD patients showed higher BHB levels at all on-diet visits compared to BL. Mean ΔhtTKV from BL to EOT was: Control +13.9ml/m±28.8, WF +7.1±47.2, KD -12.8±61.2; ANOVA vs. Control: p KD=0.08, WF=0.67. Mean ΔhtTLV from BL to EOT was: Control +42.2ml/m±166.0, WF -10.0±98.2, KD -55.1±72.5, with a statistically significant difference between KD and Control (p KD=0.01, WF=0.17). 2 patients experienced symptomatic kidney stones in KD. At EOT, uric acid levels > ULN were detected in 3 Control, 6 KD and 4 WF patients. Only 1 patient (Control) showed a mild ALT elevation (<1.5xULN). No cases of AST > ULN (EOT) or creatinine increase ≥50% from BL to EOT were recorded. eGFR increased in KD and WF (BL to EOT; KD 5.04ml/min±9.45, WF 0.21±5.12) while decreasing in the Control (-1.26±9.48). This difference was statistically significant comparing KD to Control (p KD=0.01, WF=0.5).

**Conclusions:** Both KDIs induced ketogenesis and were rated as feasible by patients, also when asked about long-term feasibility. KD did not reach the combined primary feasibility endpoint based on a predefined BHB threshold, but nearly all KD patients showed increased BHB at all visits. The impact of KD on TLV/TKV and eGFR is of special interest. Regarding safety, the formation of kidney stones will need specific attention.

**Funding:** Other NIH Support - PKD Foundation

**TH-PO988**

**Estimated Glomerular Filtration Rate Predicts Frailty After 3 Months in Patients Admitted to Emergency Department**

Anna Maria Meyer, Thomas Benzing, Volker R. Burst, M. Cristina Polidori, Roman-Ulrich Mueller. *Department II of Internal Medicine and Center for Molecular Medicine Cologne, Universität zu Köln, Köln, Germany.*

**Background:** Renal failure and frailty are interwoven and common conditions in patients seeking help in emergency departments (ED). Despite the impact on patients' trajectories, their association and severity degree are not systematically evaluated.

**Methods:** Data from 937 multimorbid patients (76.3 ±7.0 years, 43% women) randomized to either geriatric co-management (GM) or usual care, to investigate the effects of GM on rehospitalization, were analyzed. Patients underwent routine care and comprehensive geriatric assessment (CGA) with calculation of the Multidimensional Prognostic Index (MPI). Kaplan-Meier was used to calculate mortality outcomes, survival curves evaluated with Log-Rank test.

**Results:** 5% of patients were frail, 43% pre-frail, 52% robust, 30-day mortality was 7.5%, 12.9% after 90 days. MPI-frailty was significantly associated with eGFR on admission (p<0.001), 73.2% of patients with an eGFR <15 ml/min/1.73m<sup>2</sup> were classified as pre-frail or frail. Of patients with an eGFR of <30 ml/min/1.73m<sup>2</sup> frail patients had a significantly higher mortality rate after 90-days compared to patients being classified as pre-frail/robust (40.0% vs 16.8%/ 16.7%, p=0.045). Adjusted for age and sex, the eGFR was significantly associated with in-hospital mortality (p=0.041), but not significance after adjusting for MPI. Frailty was significantly associated with in-hospital mortality (p<0.001) independent of age, sex and eGFR. The eGFR on admission showed a significant association with the MPI-frailty after three months (adjusted for age, gender and MPI-group on admission, p<0.001, Fig.1).

**Conclusions:** In older multimorbid patients admitted to the ED, reduced eGFR is tightly associated to multidimensional frailty beyond the physical phenotype and is a strong, independent predictor for frailty at 3 months. The use of a frailty assessment combined with kidney function measures might enable ED physicians and nephrologists to recognize and treat factors beyond organ disease strongly associated with adverse outcomes.

**Figure 2. Association of the eGFR at ED-admission with the MPI-frailty status after 3 months**

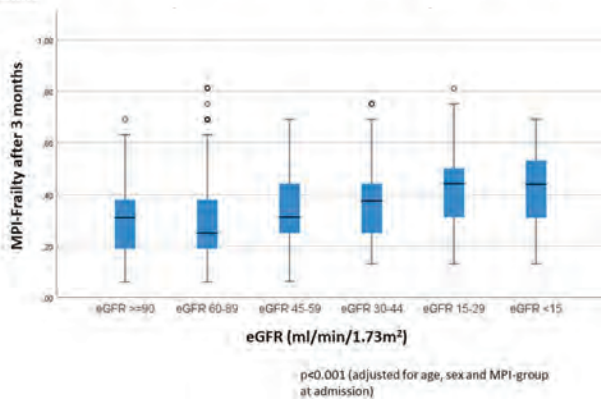

**TH-PO989**

**A Prospective Study on Long-Term Clinical Outcomes of Patients With Lupus Nephritis Treated With an Intensified B-Cell Depletion Protocol Without Maintenance Therapy**

Dario Roccatello, *CMID-Nephrology and Dialysis Unit (ERK-net Member), Center of Research of Immunopathology and Rare Diseases, Coordinating Center of the Network for Rare Diseases of Piedmont and Aosta Valley, Department of Clinical and Biological Sciences, University of Turin and S. Giovanni Bosco Hub Hospital, Turin, Italy.*

**Background:** We aimed to investigate the safety and efficacy of an intensified B-cell depletion induction therapy (IBCDT) without immunosuppressive maintenance regimen compared with standard of care in biopsy-proven lupus nephritis (LN).

**Methods:** Thirty patients were administered an IBCDT (4 weekly rituximab [RTX] 375 mg/m<sup>2</sup> and 2 more doses after 1 and 2 months; 2 infusions of 10 mg/kg cyclophosphamide [CYC], 3 methylprednisolone pulses), followed by oral prednisone (tapered to 5 mg/d by the third month). No immunosuppressive maintenance therapy was given. Thirty patients matched for LN class and age were selected as controls: 20 received 3 methylprednisolone pulses days followed by oral prednisone and mycophenolate mofetil (MMF) 2 to 3 g/d, whereas 10 were given the Euro Lupus CYC. MMF (1-2 g/daily) or azathioprine (AZA, 1-2 mg/kg/day) were given for > 3 years as a maintenance therapy.

**Results:** At 12 months, complete renal remission was observed in 93% of patients on IBCDT, in 62.7% on MMF, and in 75% on CYC (P = 0.03); the dose of oral prednisone was lower in the IBCDT group (mean ± SD 2.9 ± 5.0 mg/dl) than MMF (10.5 ± 8.0 mg/d, P < 0.01) or CYC group (7.5 ± 9.0 mg/d, P < 0.01). Mean follow-up after treatment was 44.5 months (interquartile range [IQR] 36-120 months), 48.6 months (IQR 36-120 months), and 45.3 (IQR 36-120 months) for IBCDT, MMF, and CYC, respectively. At their last follow-up visit, we observed no significant differences in proteinuria and serum creatinine, nor in the frequency of new flares among the 3 groups.

**Conclusions:** In biopsy-proven LN, the IBCDT without further immunosuppressive maintenance therapy was shown to be as effective as conventional regimen of MMF or CYC followed by >3-year maintenance either MMF or AZA regimen. Moreover, the use of IBCDT was associated with a marked reduction of glucocorticoid cumulative dose.

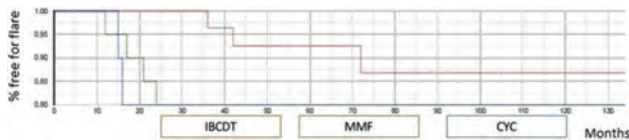

Time free from flares curves in patients treated with IBCDT, MMF, or CYC. CYC, cyclophosphamide; IBCDT, intensified B-cell depletion induction therapy; MMF, mycophenolate mofetil.

**TH-PO990**

**Abstract Withdrawn**

**TH-PO991**

**Interim Analysis (IA) of a Global Phase 2 Randomized Controlled Trial of Sibeprenlimab (VIS649), an APRIL-Neutralizing Monoclonal Antibody, in IgA Nephropathy**

Laura Kooienga,<sup>1</sup> Yusuke Suzuki,<sup>2</sup> Bobby Chacko,<sup>10</sup> Muh Geot Wong,<sup>3</sup> Jonathan Barratt,<sup>4</sup> Kook-Hwan Oh,<sup>5</sup> Manisha Sahay,<sup>6</sup> Mohit Mathur,<sup>7</sup> Xiaofeng Wang,<sup>8</sup> Jill Yarbrough,<sup>7</sup> Brian J. Pereira.<sup>9</sup> <sup>1</sup>Colorado Kidney Care, Denver, CO; <sup>2</sup>Juntendo Daigaku, Bunkyo-ku, Japan; <sup>3</sup>Royal North Shore Hospital, St Leonards, NSW, Australia; <sup>4</sup>University of Leicester, Leicester, United Kingdom; <sup>5</sup>Seoul National University Hospital, Jongno-gu, Seoul, Republic of Korea; <sup>6</sup>Osmania Medical College, Hyderabad, India; <sup>7</sup>Visterra Inc., Boston, MA; <sup>8</sup>Otsuka Pharmaceutical Development and Commercialization, Inc., Rockville, MD; <sup>9</sup>Visterra Inc., Boston, MD; <sup>10</sup>John Hunter Hospital, New Lambton Heights, NSW, Australia.

**Background:** Pathogenesis of primary Immunoglobulin A Nephropathy (IgAN) is driven by A Proliferation-Inducing Ligand (APRIL). Sibeprenlimab is a humanized IgG2 monoclonal antibody that prevents APRIL signaling.

**Methods:** VIS649-201 (NCT04287985) is a global multicenter, randomized controlled study evaluating monthly intravenous (IV) Sibeprenlimab (2, 4, or 8 mg/kg) versus placebo in adults with IgAN on optimized supportive treatment, who have eGFR ≥ 30 ml/min/1.73m<sup>2</sup> and proteinuria ≥ 1.0 g/d or urine protein creatinine ratio (uPCR) ≥ 0.75 g/g. A protocol specified group unblinded IA was conducted when 72 participants completed month-9 of a 12-month study course.

**Results:** Among pooled Sibeprenlimab recipients there was a 43% placebo-adjusted reduction from baseline in 24-hour uPCR values at month 9 (Figure 1a) with reduction in serum APRIL, total IgA & galactose-deficient IgA1. Among subjects with ≥ 9 months on study, the estimated annualized eGFR slope was stable (+1.2 mL/min/1.73m<sup>2</sup>/year) in pooled Sibeprenlimab recipients versus declining (-6.5 mL/min/1.73m<sup>2</sup>/year) in the placebo group, with a slope difference of +7.7 mL/min/1.73m<sup>2</sup>/year (95% CI 1.32 to 14.01). The mean of eGFR change from baseline over time is shown in Figure 1b. No serious adverse events were considered study-drug related & most adverse events were mild or moderate in severity.

**Conclusions:** This Phase 2 IA of a precision therapeutic for IgAN, Sibeprenlimab, demonstrated acceptable safety & tolerability with robust uPCR reduction associated with eGFR stability, when compared to the placebo arm at 9 months of study follow up.

**Funding:** Commercial Support - Visterra Inc.

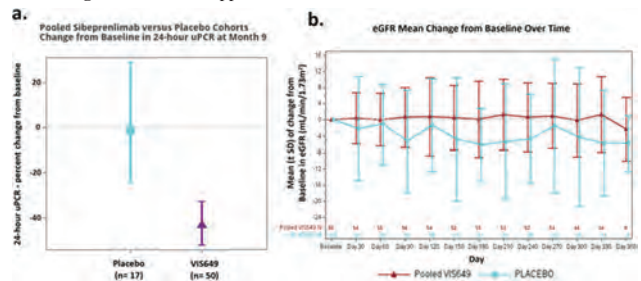

**TH-PO992**

**Dapagliflozin and Kidney Outcomes in Heart Failure With Mildly Reduced or Preserved Ejection Fraction: Results From DELIVER**

Finnian R. McCausland,<sup>1</sup> Brian Claggett,<sup>1</sup> Rudolf A. de Boer,<sup>8</sup> Kieran F. Docherty,<sup>7</sup> James C. Fang,<sup>2</sup> Adrian F. Hernandez,<sup>9</sup> Silvio E. Inzucchi,<sup>10</sup> Mikhail Kosiborod,<sup>3</sup> Carolyn Lam,<sup>4</sup> Felipe Martinez,<sup>5</sup> Jose F. Kerr Saraiva,<sup>13</sup> Martina M. McGrath,<sup>1</sup> Sanjiv Shah,<sup>11</sup> Muthiah Vaduganathan,<sup>1</sup> Subodh Verma,<sup>6</sup> Magnus Petersson,<sup>12</sup> Anna Maria Langkilde,<sup>12</sup> John McMurray,<sup>7</sup> Scott D. Solomon.<sup>1</sup> <sup>1</sup>Brigham and Women's Hospital, Boston, MA; <sup>2</sup>University of Utah Department of Cardiology, Salt Lake City, UT; <sup>3</sup>Saint Luke's Health System, Kansas City, MO; <sup>4</sup>National University of Singapore, Singapore, Singapore; <sup>5</sup>Universidad Nacional de Cordoba, Cordoba, Argentina; <sup>6</sup>Saint Michael's Hospital, Toronto, ON, Canada; <sup>7</sup>University of Glasgow, Glasgow, United Kingdom; <sup>8</sup>Universitair Medisch Centrum Groningen Afdeling Cardiologie, Groningen, Netherlands; <sup>9</sup>Duke University School of Medicine, Durham, NC; <sup>10</sup>Yale University, New Haven, CT; <sup>11</sup>Northwestern University Feinberg School of Medicine, Chicago, IL; <sup>12</sup>AstraZeneca PLC, Cambridge, United Kingdom; <sup>13</sup>Instituto de Pesquisa Clínica de Campinas, Campinas, Brazil.

**Background:** SGLT2i reduce heart failure (HF) events and slow progression of kidney disease among patients with HF and reduced ejection fraction (EF). In patients with HF and mildly reduced or preserved EF in DELIVER, dapagliflozin significantly reduced the primary composite outcome of cardiovascular (CV) death or worsening HF. We assessed the influence of baseline kidney function on CV outcomes and the effect of dapagliflozin on renal outcomes and eGFR trajectory.

**Methods:** DELIVER randomized 6,263 patients with EF>40% and eGFR ≥25 ml/min/1.73m<sup>2</sup> to dapagliflozin 10mg per day or placebo. We assessed if baseline kidney function modified the treatment effect on the primary CV outcome and its components. In prespecified exploratory analyses, we examined the treatment effect on eGFR slope and a composite kidney outcome (≥50% decline in eGFR; eGFR <15 ml/min/1.73m<sup>2</sup>; renal death).

**Results:** Mean eGFR was 61±19 ml/min/1.73m<sup>2</sup>; 3,070 (49%) had eGFR <60 ml/min/1.73m<sup>2</sup>. The effect of dapagliflozin on the primary CV outcome was not influenced by baseline eGFR (hazard [HR] 0.84; 95%CI 0.70,1.00 for eGFR≥60 and HR 0.81; 95%CI 0.69,0.94 for eGFR<60; P-interaction=0.76). Dapagliflozin did not reduce the kidney composite outcome, which occurred in 77 of 3,131 patients assigned to dapagliflozin (2.5%) and 71 of 3,131 assigned to placebo (HR 1.09; 95%CI 0.79,1.50). However, dapagliflozin attenuated the decline in eGFR from month 1 to 36, vs. placebo (difference 1.4 (95%CI 1.0,1.8) ml/min/1.73m<sup>2</sup>/year) **Figure 1**.

**Conclusions:** Baseline kidney function did not modify the benefit of dapagliflozin in patients with HF with mildly reduced or preserved EF. Dapagliflozin slowed the rate of decline in eGFR to a greater extent than placebo.

**Funding:** Commercial Support - Astra Zeneca

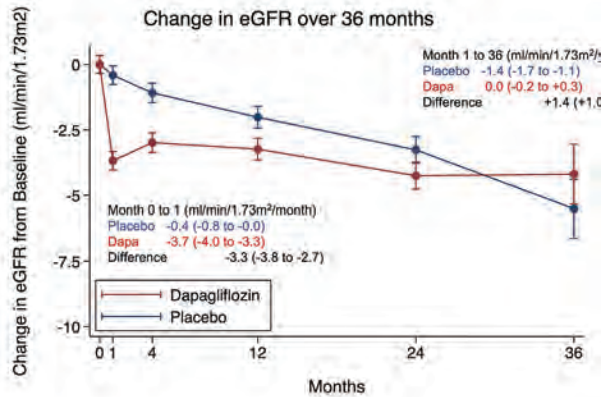

**TH-PO993**

**Dietary Counselling to Reduce Moderate Sodium Intake and Cardiovascular and Renal Biomarkers: Primary Findings of the COSIP and STICK Trials**

Andrew Smyth,<sup>1,2</sup> Conor S. Judge,<sup>1,2</sup> Matthew D. Griffin,<sup>1</sup> Salim Yusuf,<sup>2</sup> Martin O'donnell,<sup>1,2</sup> <sup>1</sup>HRB Clinical Research Facility Galway, National University of Ireland Galway, Galway, Ireland; <sup>2</sup>Population Health Research Institute, Hamilton, ON, Canada.

**Background:** While low sodium intake (<2.3g/day) is recommended, there is uncertainty about long-term feasibility and effects on biomarkers in those with moderate intake.

**Methods:** In two phase IIb randomised parallel, open-label, controlled, single-centre trials, individuals aged >40 years with stable blood pressure (BP), without heart failure or postural hypotension were randomised to an intensive dietary counselling intervention (target sodium <2.3g/day) or usual care. The STICK trial focused on chronic kidney disease (CKD); the COSIP trial excluded those with CKD or cardiovascular disease. All participants received healthy eating advice. Primary outcomes were NT-pro B-type natriuretic peptide (NT-proBNP), high sensitivity troponin T (hsTnT), C-reactive protein (CRP), renin, aldosterone and creatinine clearance (CrCl) at 2years.

**Results:** 373 participants, with mean sodium excretion 3.1±1.5g/day, were randomised to intervention (n=187) or usual care (n=186). At 2 years, the intervention significantly reduced self-reported salt use (73% vs. 41%; p<0.001), but not 24-hour urine sodium (intervention -0.23g/day vs. usual care +0.05g/day, p=0.47). At 3 months, the intervention reduced BP (systolic -2.52mmHg, p=0.05; diastolic -1.92, p=0.02) and increased renin (+33.35 [95%CI 3.78-62.91]). At 2 years, there were no between-group differences in systolic BP (p=0.66), diastolic BP (p=0.09), NT-proBNP (p=0.68), hsTnT (p=0.20), CRP (p=0.56), renin (p=0.52), aldosterone (p=0.61) or CrCl (p=0.68)(Figure).

**Conclusions:** Among individuals with moderate intake, intensive dietary counselling resulted in short-term reductions in sodium and BP, but no significant effects on cardiorenal biomarkers at two years. Our trial suggests it may not be feasible to sustainably reduce sodium to guideline levels through intensive dietary counselling.

**Funding:** Government Support - Non-U.S.

Table. Change in Outcome Measures from Baseline in CODEX

Outcome Measure	Low Sodium Target (n=187)	Usual Care (n=186)	Between-Group Difference		
			Unadjusted	Adjusted	
<b>Office Blood Pressure at Three Months</b>					
Systolic BP (mmHg)	-1.88 (2.38 to -0.27)	+0.87 (2.25 to -0.52)	-2.75 (-4.38 to -1.06)	0.22	-2.52 (-4.05 to -0.99)
Diastolic BP (mmHg)	-0.78 (1.23 to -0.32)	0.04 (1.39 to -1.31)	-0.75 (-2.08 to +1.52)	0.43	-1.91 (-3.49 to -0.35)
<b>Biomarkers at Three Months</b>					
NT-proBNP (pg/L)	-7.12 (-8.77 to -5.47)	-11.26 (-8.07 to -14.56)	+4.14 (1.85 to +6.43)	0.33	+12.54 (10.75 to +14.32)
hsTnT (ng/L)	+0.32 (0.14 to +0.50)	-0.66 (-1.47 to +0.51)	+1.00 (0.56 to +2.54)	0.09	+0.60 (-0.49 to +1.7)
CRP (mg/L)	-0.34 (-1.10 to +0.05)	-0.84 (-1.39 to -0.27)	-0.69 (-1.39 to -0.06)	0.07	+0.05 (-0.44 to +0.54)
Renin (mIU/L)	+13.84 (13.27 to +14.41)	-15.24 (-8.47 to +5.99)	+29.07 (16.37 to +41.69)	0.12	+18.15 (13.78 to +22.51)
Aldosterone (pmol/L)	+52.46 (1.91 to +93.01)	+40.85 (0.02 to +81.72)	+11.61 (44.87 to +109.09)	0.66	+12.87 (44.28 to +107.22)
Creatinine Clearance (mL/min)	-0.11 (0.33 to +0.10)	+2.39 (0.28 to +4.49)	+2.50 (1.84 to +3.16)	0.48	+4.51 (3.52 to +5.50)
eGFR (mL/min/1.73m <sup>2</sup> )	-0.80 (1.2 to +1.26)	+1.37 (0.38 to +2.3)	-2.22 (2.58 to +0.89)	0.22	-3.22 (2.87 to +0.43)
MDRD eGFR (mL/min/1.73m <sup>2</sup> )	+0.09 (1.27 to +1.44)	+1.32 (0.29 to +2.35)	-1.03 (2.18 to -0.82)	0.30	-1.35 (2.89 to -0.88)
<b>Office Blood Pressure at Two Years</b>					
Systolic BP (mmHg)	-0.81 (2.35 to +1.61)	-0.75 (1.06 to +1.36)	+0.33 (1.43 to +1.39)	0.84	-0.63 (1.48 to +1.22)
Diastolic BP (mmHg)	-0.79 (1.31 to +0.62)	-0.84 (1.38 to +1.31)	-0.75 (2.42 to +1.32)	0.43	-1.51 (1.46 to +0.23)
<b>Biomarkers at Two Years</b>					
NT-proBNP (pg/L)	-03.98 (-14.3 to +6.29)	-24.58 (-13.12 to -35.97)	+20.60 (10.93 to +30.27)	0.74	+11.71 (4.20 to +19.22)
hsTnT (ng/L)	+2.42 (1.07 to +3.77)	+1.01 (0.06 to +2.06)	+1.41 (0.44 to +2.38)	0.14	+1.07 (0.58 to +1.57)
CRP (mg/L)	+0.59 (0.39 to +0.79)	+0.40 (0.27 to +0.56)	+0.19 (0.10 to +0.28)	0.83	+0.45 (1.07 to +0.97)
Renin (mIU/L)	-3.17 (-24.74 to +18.4)	-4.73 (-21.29 to +11.82)	+1.55 (15.28 to +13.19)	0.82	+8.79 (18.24 to +19.73)
Aldosterone (pmol/L)	+48.43 (46.38 to +50.48)	+54.84 (50.27 to +59.42)	-6.41 (1.78 to +10.04)	0.46	+15.36 (13.59 to +17.13)
Creatinine Clearance (mL/min)	-3.17 (0.39 to +3.51)	+3.39 (1.29 to +5.49)	-3.72 (3.19 to -4.41)	0.41	-1.37 (1.49 to -0.87)
Urine Protein Excretion (mg/24hrs)	+24.77 (29.27 to +20.27)	+14.45 (0.49 to +28.78)	+10.32 (6.30 to +14.34)	0.40	+10.36 (8.93 to +11.81)
CODEX eGFR (mL/min/1.73m <sup>2</sup> )	-0.64 (2.11 to +1.82)	+0.47 (1.31 to +1.34)	-1.11 (1.18 to +1.34)	0.29	-2.77 (2.37 to -0.77)
MDRD eGFR (mL/min/1.73m <sup>2</sup> )	1.13 (1.02 to +1.25)	+1.51 (0.29 to +2.73)	-0.21 (1.22 to +1.33)	0.47	-0.73 (1.78 to +0.72)

**TH-PO994**

**Long-Term Outcomes of Tacrolimus or Sirolimus in Kidney Transplant Recipients**

Ibrahim Tawhari,<sup>1,2</sup> Sookhyeon Park,<sup>2</sup> Mohammed Javeed Ansari,<sup>2</sup> Joseph Leventhal,<sup>2</sup> Lorenzo G. Gallon,<sup>2</sup> <sup>1</sup>Internal Medicine, King Khalid University College of Medicine, Abha, Saudi Arabia; <sup>2</sup>Nephrology, Northwestern University Feinberg School of Medicine, Chicago, IL.

**Background:** Although calcineurin inhibitors (CNIs) such as tacrolimus have improved the outcomes of kidney transplantation, those drugs are associated with long nephrotoxicity and renal allograft dysfunction. CNI exposure minimization have gained significant interest. The long-term outcomes of late conversion of tacrolimus to sirolimus in a steroid-free immunosuppressive regimen in kidney transplant recipients have not been widely investigated by clinical trials.

**Methods:** Two hundred and seven kidney transplant recipients who received an induction with alemtuzumab and rapid steroid withdrawal, and a maintenance therapy with tacrolimus and mycophenolate, were randomized in 2:1 ratio to undergo conversion of tacrolimus to sirolimus or continue tacrolimus respectively at 6-12 months post-transplantation. The endpoints included the change in estimated glomerular filtration rate (eGFR), renal allograft loss, patient loss, biopsy proven graft rejection and development of de novo donor specific antibody (DSA) over 10 years follow up

**Results:** Of the 207 subjects, 132 subjects underwent conversion of tacrolimus to sirolimus at 6-12 months, and 75 subjects continued tacrolimus. The baseline characteristics were well-balanced between the two groups. At 10 years, the sirolimus group showed 8.18 ml/min/1.73 m<sup>2</sup> increase in the eGFR [95% CI, 6.55 to 9.81], whereas the tacrolimus group showed a decline in the eGFR by 5.12 [95% CI, -6.71 to -3.53], the difference was statistically significant, P<0.001. There was no significant difference in terms of graft survival (hazard ratio, 1.16; 95% CI, 0.50 to 2.71), patient survival (hazard ratio, 1.26; 95% CI, 0.48 to 3.31), biopsy-proven acute rejection (hazard ratio, 1.68; 95% CI, 0.60 to 4.66), and development of de novo DSA (incidence rate; 8.33% in sirolimus group versus 10.67% in tacrolimus group, p= 0.758). The adverse effect profile was similar between the two groups.

**Conclusions:** This study demonstrated that late conversion of tacrolimus to sirolimus (≥ 6 months post-transplantation), is associated with a long-term improvement in the eGFR without increased risk of renal allograft rejection or graft loss.



TH-PO995

**Viral Resistance and Neutropenia/Leukopenia with Letermovir (LET) vs. Valganciclovir (VGCV) as Cytomegalovirus (CMV) Prophylaxis in Adult Kidney Transplant Recipients (KTRs): A Phase 3 Randomized Study**

Flavio Vincenti,<sup>1</sup> Ajit Limaye,<sup>2</sup> Klemens Budde,<sup>3</sup> Atul Humar,<sup>4</sup> Julia Garcia-Diaz,<sup>5</sup> Robert P. Carroll,<sup>6</sup> Diana F. Florescu,<sup>7</sup> Yoshihiko Murata,<sup>8</sup> Julie Strizki,<sup>9</sup> Valerie Teal,<sup>9</sup> Christopher L. Gilbert,<sup>9</sup> Barbara A. Haber.<sup>9</sup> <sup>1</sup>University of California at San Francisco, San Francisco, CA; <sup>2</sup>University of Washington Medical Center, Seattle, WA; <sup>3</sup>Charité-Universitätsmedizin Berlin, Berlin, Germany; <sup>4</sup>University Health Network, Toronto, ON, Canada; <sup>5</sup>Ochsner Medical Center, New Orleans, LA; <sup>6</sup>Central Northern Adelaide Renal and Transplantation Service, Adelaide, SA, Australia; <sup>7</sup>University of Nebraska Medical Center, Omaha, NE; <sup>8</sup>Formerly Merck & Co., Inc., Rahway, NJ; <sup>9</sup>Merck & Co., Inc., Rahway, NJ.

**Background:** VGCV is indicated for CMV prophylaxis in adult donor CMV-seropositive/recipient CMV-seronegative (D+/R-) KTRs; use is limited by myelosuppression and need to adjust dose for renal function, placing KTRs at risk for CMV breakthrough/resistance. LET is non-myelotoxic and needs no renal adjustment; it is approved for CMV prophylaxis in adult R+ allogeneic hematopoietic cell transplant recipients. This Phase 3, double-blind, non-inferiority study (NCT03443869) evaluated CMV prophylaxis with LET vs VGCV in adult D+/R- KTRs.

**Methods:** KTRs were randomized (1:1)  $\leq$ 7 days post-KT to receive LET 480 mg PO QD with acyclovir (400 mg PO BID) or VGCV (900 mg PO QD) through Week 28 and followed through Week 52 post-KT. The primary endpoint was proportion of participants (pts) with adjudicated CMV disease through Week 52 post-KT. Genotyping for resistance-associated variants (RAVs) was performed when pts were evaluated for CMV disease or when study medication was discontinued due to CMV viremia.

**Results:** The proportion of pts with CMV disease through Week 52 post-KT was 10.4% with LET (N=289) vs 11.8% with VGCV (N=297). The rate of CMV viremia through Week 28 post-KT was 2.1% with LET vs 8.8% with VGCV. No LET RAVs (pUL51/pUL56/pUL89) were found among 52 evaluated LET pts; VGCV RAVs were found in 8/66 (12.1%) evaluated VGCV pts (pUL54, n=2; pUL97, n=7). The incidence of neutropenia/leukopenia was lower with LET vs VGCV (overall, 26.0% vs 64.0% [p<0.0001]; Grade 3/4 neutropenia, 2.1% vs 7.9%; Grade 3/4 leukopenia, 2.7% vs 6.6%). Rates of treatment discontinuation due to adverse events (AEs) were 4.1% for LET vs 13.5% for VGCV (most commonly due to neutropenia/leukopenia).

**Conclusions:** In preventing CMV disease in D+/R- KTRs through Week 52 post-KT, LET was non-inferior to VGCV. Neutropenia/leukopenia were the most common AEs leading to discontinuation of CMV prophylaxis. The prevalence of viral RAVs was lower in LET (0%) vs VGCV (12.1%) pts.

**Funding:** Commercial Support - Merck & Co., Inc

TH-PO996

**POWERED Study: Prophylaxis With Metformin to Prevent Post-Transplant Diabetes Mellitus**

Michelle E. Allan,<sup>1,2</sup> Tahseen A. Chowdhury,<sup>1,2</sup> Stanley Fan,<sup>1,2</sup> Muhammad Magdi Yaqoob,<sup>1,2</sup> Kieran Mccafferty.<sup>1,2</sup> <sup>1</sup>Barts Health NHS Trust, London, United Kingdom; <sup>2</sup>Queen Mary University of London, London, United Kingdom.

**Background:** Advances in immunosuppression have improved kidney transplant outcomes. However, calcineurin inhibitors and steroids, and other transplant-specific and general diabetogenic risk factors, contribute to the development of post-transplant diabetes mellitus (PTDM). PTDM is associated with increased cardiovascular morbidity and mortality, graft loss and infection. Despite its clinical relevance, there has been a historic lack of diagnostic criteria or clear management strategies. Rather than treating patients who have already developed PTDM, new trials are focusing on prevention.

**Methods:** We present the results of a single-centre prospective randomised placebo-controlled trial comparing metformin 500mg OD vs placebo in kidney transplant recipients in the first 3 months post-transplant. 60 patients who passed screening within 10 days of transplant, including eGFR  $\geq$ 30ml/min and 2hr oral glucose tolerance test (OGTT)  $<$ 11.1 mmol/L, were randomised to either metformin (n=30) or placebo (n=30). They returned at 3, 6 and 12 months post-transplant for fasting bloods, including OGTT. The primary endpoint was a diagnosis of PTDM, defined by a positive OGTT. Secondary endpoints included the effect on HbA1c, HOMA-IR, impaired glucose tolerance or elevated fasting plasma glucose, renal function, graft/patient survival and safety.

**Results:** The groups were well-matched for baseline demographics including age, ethnicity, BMI, cause of ESRF, co-morbidities, immunological risk and induction. There was no significant difference in PTDM development survival curves by either OGTT or composite outcome (OGTT, IGT, FPG, HbA1c, Rx) log-rank p0.53 and p0.41, respectively. There was no difference in renal function, HOMA-IR or in safety signal.

**Conclusions:** Metformin was not associated with a reduction in the diagnosis of PTDM at this dose and in this study which was significantly impacted by the COVID-19 pandemic, especially with regards to missing data during follow-up. However, there is no contraindication to further studies including larger doses of metformin or patients with positive OGTT at baseline.

**Funding:** Clinical Revenue Support

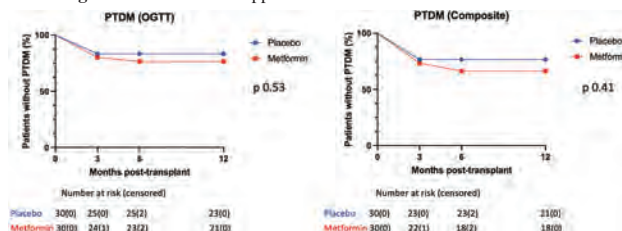

Figure 1: time to PTDM diagnosis